

UNIVERSITY OF TORONTO

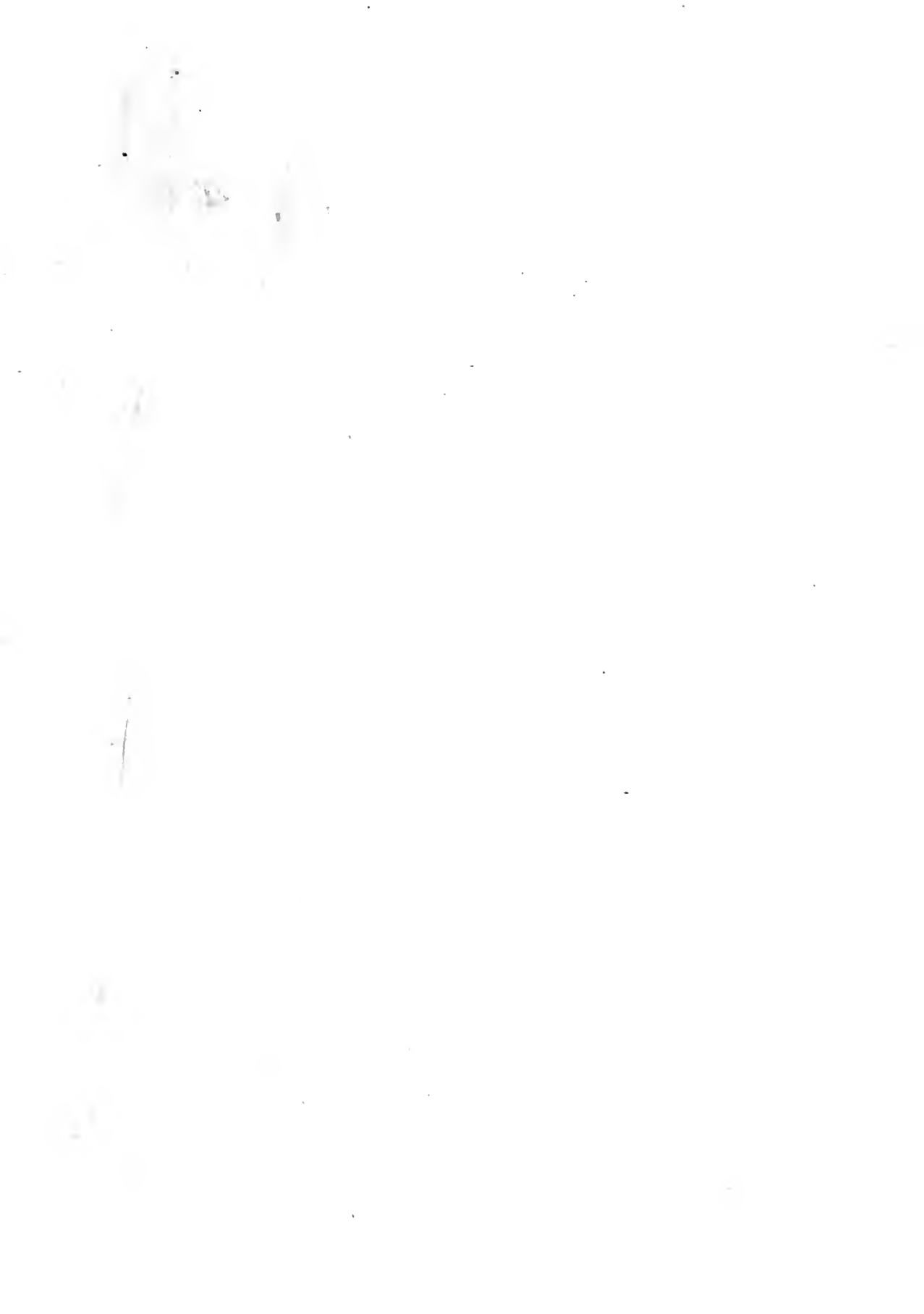

3 1761 00475142 6





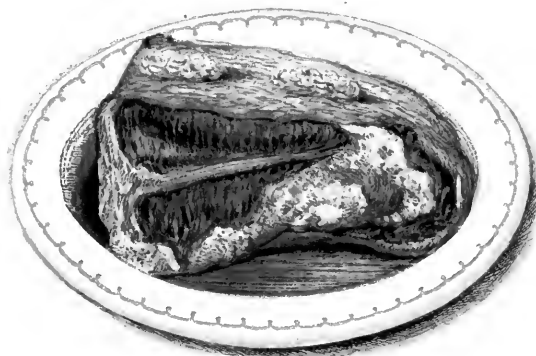

1

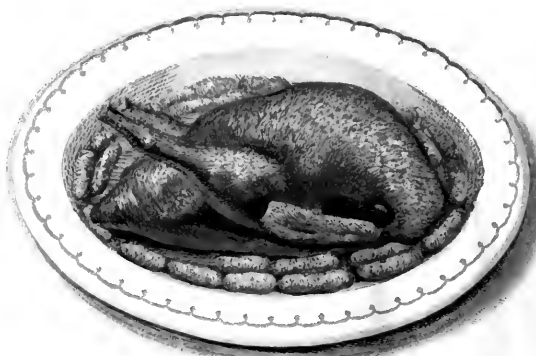

2

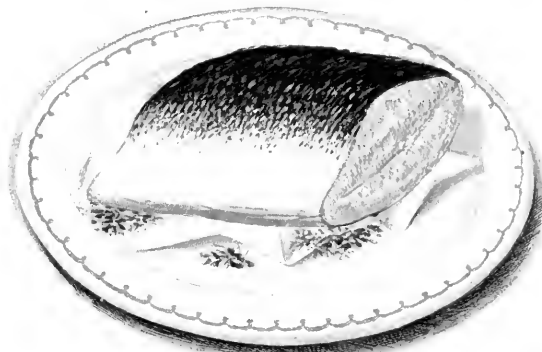

3

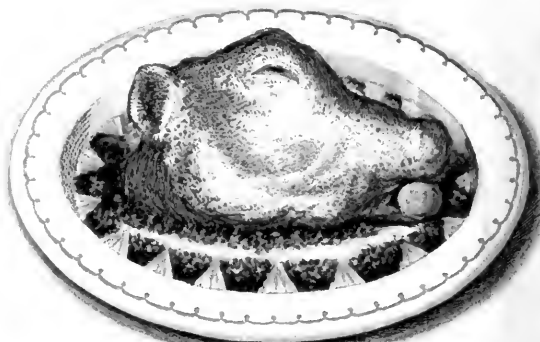

4

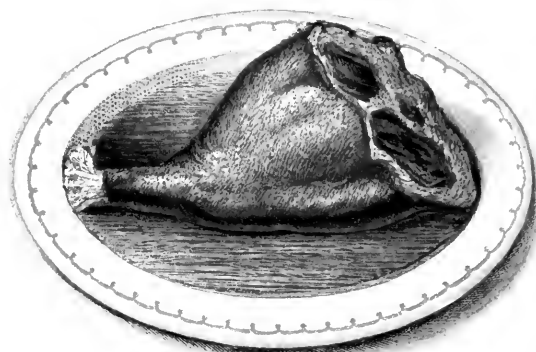

5

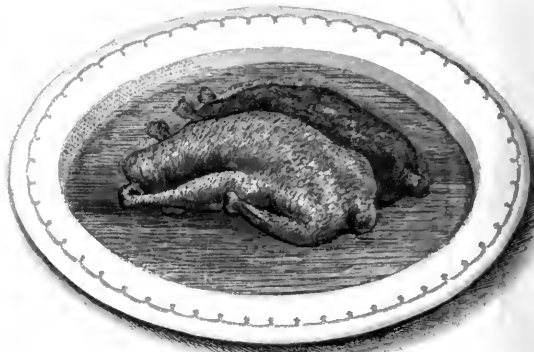

6

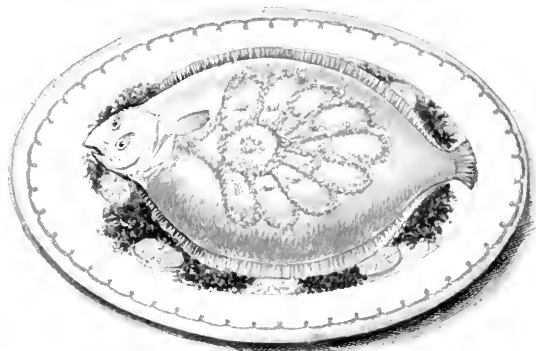

7



8

1. Sirloin of Beef 2. Roast Turkey 3. Boiled Salmon 4. Calf's Head
5. Leg of Mutton 6. Roast Ducks 7. Boiled Turbot 8. Roast Hare

CASSELL'S
HOUSEHOLD GUIDE:

BEING

A Complete Encyclopædia

OF

DOMESTIC AND SOCIAL ECONOMY,

AND FORMING

A Guide to Every Department of Practical Life.

VOLUME I.



LONDON:

CASSELL, PETTER, AND GALPIN,

LUDGATE HILL, E.C.;

AND 596, BROADWAY, NEW YORK.

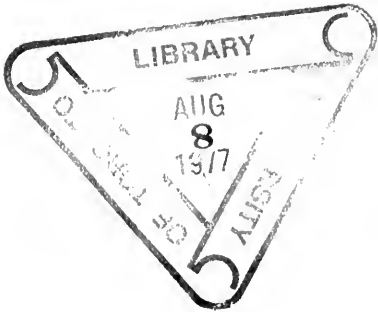

TX
145
C39
V1

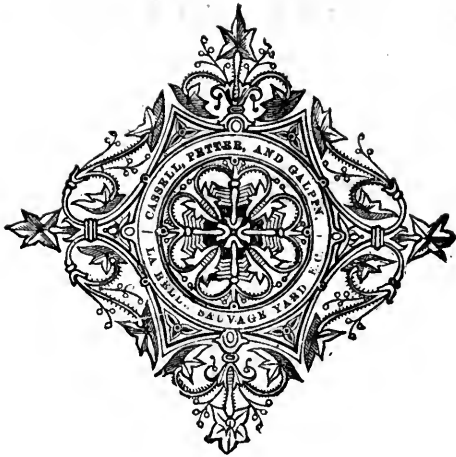

INDEX TO VOL. I.

- Abscess, Treatment of, 303.
 Acted Charades, 320, 347.
 Ague, Treatment of, 302.
 Alum Baskets, How to Make, 263.
 Animals Kept for Pleasure, 11, 60, 76, 106, 204, 266, 395, 308, 325, 358, 375.
 Animals Kept for Profit, 30, 46, 95, 121, 145, 168, 188, 217, 228, 295, 309, 325, 375.
 Apoplexy, Treatment of, 318.
 Aquarium, The, 17, 63, 69, 105, 132, 161.
 Arable Husbandry, 301, 327, 344.
 Asthma, Treatment of, 319.

 Back Windows, How to Ornament, 299.
 Baking Powders, 263.
 Bedroom Furniture, 155.
 Bell Hanging, 180.
 Biliousness, How to Treat, 334, 350.
 Blankets, How to Wash, 299.
 Blinds, Construction of, 175.
 Boot-Cleaning, 305.
 Bread, 5.
 Bronchitis, How to Treat, 358.
 Broths, How to Make, 253, 258.
 Bunions, How to Treat, 201.
 Burns and Scalds, Treatment of, 71.
 Busts and Statuettes in Marble, How to Imitate, 164.

 Cage Birds, 175.
 Cameos, a Word or Two About, 123.
 Card Games, 261.
 Carpenter's Bench, 101.
 Carpets, to Remove Grease from, 312.
 Carving, Hints on, 6, 55, 79, 143, 197, 256.
 Cattle, 188, 228, 309.
 Chapped Hands, &c., 124.
 Cheap Home Comforts, Some, 312.
 Cheese Cement, 248.
 Chicken-Pox, Treatment of, 271.
 Chilblains, Treatment of, 123.
 Choosing a Trade, 307, 362.
 Christmas Decorations, 97.
 Christmas Fare, 150, 166.
 Cinder-Sifting, 305.
 Citizenship, Law of, 230.
 Clothes-Brushing, 306.
 Clothing for Children, 88, 116, 177, 236, 291, 331, 369.
 Clothing for Infants, 33, 88.
 Coffee Making, 294.
 Colds, Precautions against, 284.
 Coloured Transparencies, How to Make, 165.
 Comical Combinations, 320.
 Convulsions, Treatment for, 83.

 Cook, the Duties of, 170.
 Cooking, 4, 27, 36, 53, 66, 86, 103, 119, 139, 166, 181, 195, 219, 232, 253, 258, 282, 304, 310, 322, 340, 364, 376.
 Cottage Farming, 25, 93, 152, 209, 276, 300, 327, 344.
 Corns, Treatment of, 124.
 Correspondence, 106.
 Croup, Treatment of, 115.
 Curtains, Construction of, 208.

 Dairy Cows, Management of, 309.
 Diaphanie, 92.
 Diarrhœa, How to Treat, 83.
 Dietary in Early Childhood, 314.
 Dietary of Youth, 343, 354.
 Dinner Tables, Dressing of, 371.
 Dinner Table, Hints on Arranging the, 114.
 Diseases Incidental to Children, 83, 114.
 Diseases of Dogs, 266, 308.
 Dislocations, How to Treat, 71.
 Doctors and Patients, 359.
 Dog, The, 11, 60, 76, 106, 204, 266, 308, 358.
 Domestic Medicine, 7, 41, 83, 114, 186, 215, 226, 271, 302, 318, 334, 350, 359.
 Domestic Servants, Their Duties, 102.
 Domestic Surgery, 7, 29, 51, 71, 111, 154, 172, 201, 252, 286.
 Doors, Construction of, 128.
 Drainage, 25, 93, 247.
 Draughts, How to Stop, 312.
 Ducks and Geese, Keeping, 169.
 Dyeing, a Few Words about, 360.

 Eruptive Fevers, Treatment of, 186, 215.
 Exercise for Children, 242.

 Feather Screens, 289, 321.
 Fencing, 276, 300.
 Fevers, How to Treat, 186, 215, 226.
 Fish, How to Cook, 67, 86, 322, 340, 364.
 Fish Soups, How to Make, 260, 282.
 Food in Infancy, 270.
 Forfeits, Game of, 163, 202.
 Fractures, Treatment of, 71.
 Frost-Bite, 154.
 Frying, 171.
 Furniture, 18, 125, 155, 183, 243, 285, 346.
 Furniture-Hiring, 312.

 Gardening, 43, 81, 113.
 Garden Furniture and Decorations, 372.
 Gardening, Home, 20, 58, 65, 109, 136, 148, 174, 190, 223, 239, 246, 271, 287, 330, 355, 378.
 Gas, 250, 273, 299.
 General Servant, Duties of, 147.

- Godfrey's Cordial, 284.
 Gold and Silver Marks, 180.
 Gold and Silver, Qualities and Values of, 279
 Gold, How to Cleanse, 284.
 Gutta-Percha for Mending Shoes, 214.

 Hæmorrhage, How to Stop, 9, 29.
 Hair, Management of, 241, 274, 366, 379.
 Hooping Cough, Treatment of, 226.
 Horse, The, 295, 325, 374.
 Hot Dishes Easily Served at Short Notice, 167.
 House, The, 2, 38, 74, 99, 134, 162, 179, 198, 247, 257,
 317, 351.
 House Hunting, 99.
 Household Amusements, 127, 159, 163, 191, 202, 238, 251,
 261, 278, 319, 347.
 Household Chemistry, 338.
 Household Decorative Art, 39, 57, 92, 97, 129, 164, 193, 264,
 289, 315, 321, 345, 353.
 Household Mechanic, 14, 23, 42, 49, 77, 84, 101, 128, 140,
 175, 180, 208, 213, 250, 273, 299, 372.
 Housemaid, her Duties, 221.
 Housing Hay, 276, 300.

 Inmates of the House, 13, 35, 90, 102, 130, 147, 170, 206,
 221, 230, 140, 175, 180, 221, 268, 305, 363.
 Invalid Broths and Beverages, 283.

 Jaundice, How to Treat, 350.
 Joints, in Carpentry, 78, 84.

 Kitchen Requisites, 232.
 Knife-Cleaning, 306.

 Lady's Maid, her Duties, 363.
 Lamp-Trimming, 306.
 Leather Work, 39, 57.
 Letter-Writers, Hints to, 79, 101, 207, 235, 267, 335.
 Life Assurance, 74, 134, 179, 198.
 Liquids, How to Keep them Warm, 299.
 Local Ailments, Treatment of, 252, 268.
 Locks and Door-Fittings, 213.
 Lodgers, Advice to, 211.

 Mad Dogs, 308.
 Marketing, 261, 336.
 Master and Servant, Law of, 13.
 Mats, 312.
 Mattresses, Stuffing, 263.
 Meat Dishes at Moderate Cost, 103, 119, 139.
 Modelling in Clay, 315, 345, 353.
 Mumps, How to Treat, 227.
 Mushrooms, How to Cook, 195.

 Novelties in Toys and Tricks, 191.
 Nursery, The, 110.

 Odds and Ends, 190, 203, 223, 230, 255, 263, 284, 299, 312,
 349, 361, 377.

 Page, the Duties of, 305.
 Paint for Out-Door Work, 248.
 Paper Flower Making, 193, 264.

 Parlour Maid, Duties of, 268.
 Parent and Child, Law of, 35.
 Patchwork, 337.
 Pickles, How to Make, 195, 219.
 Plain Cookery, 4.
 Point Lace Work, 225, 280, 356.
 Pomades, Receipts for Making, 276.
 Poor-Rate, The, 131.
 Poultry, Management of, 30, 46, 95, 121, 145, 168, 217.
 Preserves, How to Make, 219.
 Property-Tax, 131.

 Qualities, The, and Values of Gold and Silver, 279.
 Qualities of Beef and Veal, 261.
 Quilts and Counterpanes, 284.

 Rates and Taxes, Law of, 130, 206.
 Rearing and Management of Children, 10, 33, 88, 110, 116,
 142, 177, 236, 242, 270, 291, 314, 331, 343, 354, 369.
 Recipes, Miscellaneous, 234.
 Recipes, Simple, 5, 27, 36, 53.
 Recreations for Long Evenings, 129.
 Relapsing Fevers, Treatment of, 226.
 Roasting, 170.

 Sauce for Calf's Head, 374.
 Sealing Wax, How to Make, 368.
 Seasonable Food, 111, 148, 235, 284.
 Shell Fish, How to Cook, 140, 181.
 Skin, The Management of, 22, 45, 62, 70, 123, 157.
 Sleep of Children, 142.
 Soups, How to Make, 87, 103, 258, 283, 304, 310.
 Stools for Children, How to Make, 299.
 Stoppers, How to Remove, 306.
 Substitute for Common Washing Soda, 299.
 Suspended Animation, To Restore, 111.
 Sweetmeats, How to Make, 291.

 Table Ornaments, How to Make, 313.
 Tea, How to Make, 380.
 Teething of Children, 172.
 Toast, How to Make and Butter, 313.
 Toilette, The, 21, 45, 62, 70, 123, 157, 241, 274, 366, 379.
 Tool Chest, The, 15, 23, 42, 49.
 Typhoid and Typhus and Infantile Intermittent Fevers, 215.

 Vegetables, How to Cook, 182.

 Wages and Income Table, 368.
 Waiting at Table, 268.
 Warts, Cure of, 124.
 Watchmaking, 307, 362.
 Water Supply, 162, 257, 317, 351.
 Ways and Means, 2, 38, 106.
 Weights and Measures, 160.
 Weights of Bread and Flour, 284.
 Whist, Game of, 262, 278, 319.
 Window Garden, 43, 81, 113.
 Windows, Construction of, 140.
 Will Making, Lay of, 50.
 Woods used in Household Carpentry, 77.
 Worms, Treatment for, 302.
 Wounds, Bruises, and Sprains, How to Treat, 51.

CASSELL'S HOUSEHOLD GUIDE.

INTRODUCTION.

IN an age when, owing to the spread of education and the consequent growth of intelligence and of competition, the affairs of human life are becoming in every department more intricate and complicated, no apology can be needed for an endeavour to set out accurately, and in something like scientific order, the laws which govern, and the rules which should regulate, that most necessary and most important of all human institutions, THE HOUSEHOLD. It is there that the fruits of man's labour are ultimately enjoyed; there that woman finds her chief sphere of duty, as the helpmate of man; there that the coming generation is being trained for the duties of life. It is there, then, if anywhere, that the secret of man's material well-being should be sought out and its principles carried out into constant practice.

The lesson, above all others, which is required to be learnt in the present day, is the good old homely one that wealth is to be found not in the possession of a large income, but in the possession of a *surplus* after the income has been made to meet the necessary demands upon it. He who earns a hundred a year and spends ninety, is really richer than he who earns two hundred and spends two hundred and ten. And it not unfrequently happens that where the resources of the household are judiciously husbanded, a relatively smaller income is found to yield more solid results than a larger one. Domestic comfort, in short, together with all the benign influences that flow therefrom, as health, good spirits, equability of temper, clearness of head, prudence in enterprise, happiness in the home circle, and the esteem of one's neighbours, centres in the practice of a wise ECONOMY—in the thoughtful and intelligent fitting of means to ends, so as to secure the most advantageous results at the lowest possible cost.

More especially is this so at a time when a deeper investigation of the laws of health has brought into prominence the necessity of increased recreation, and longer and more frequent migrations into purer atmospheres—desiderata which, when men have moderate incomes, can be supplied only by a prudent curtailment of expenditure in other directions. For we believe it will be found by many that when they have learnt how to obtain economically the necessaries of the household, and to do for themselves what hitherto they have had to get done by expensive assistance, they will have in every case something left with which they can augment the convenience, the comfort, and possibly even the luxury of their house and living—bettering at once their mode of life and their measure of enjoyment.

MANAGEMENT is the one thing needful in the household. No matter what the amount of income may be, everything depends upon the careful laying out of the money. In one house the owner always seems to get full value for his outlay; in another it is difficult to imagine where the money expended goes to, the apparent return is so inadequate. And this difference does not always and of necessity spring from recklessness, or even from carelessness in management; far more frequently it is owing to the want of an intelligent appreciation of the way in which the available resources can be best turned to account.

To supply, in a plain, practical, and exhaustive manner, this information, which otherwise must be ineffectively obtained by long and wearisome experience, is the object of THE HOUSEHOLD GUIDE. We shall take up in succession each department of domestic and social economy, and the various branches of household management, showing in every case how true economy can be practised—how by the *minimum* of expenditure the *maximum* of comfort and of luxury may be obtained. In each department we shall commence with the treatment of the subject in its simplest possible form, so as to meet the requirements of the most moderate incomes.

We shall first treat of the HOUSE itself, in the threefold aspect of a building, a possession, and a home. Those who are about to take a house for the first time, or to change their present residence for another, will find information as to the points which they ought to look to as essential in regulating their choice, what evils they ought specially to avoid, and how such evils may most readily be detected. For those who are about to build, there will be papers on the best way of planning a house, and the best materials to be employed in its construction; while those who are already occupying houses which they are unable or unwilling to leave, will find advice as to the best plan for remedying or removing existing defects which are making their houses unhealthy or uncomfortable. We shall also explain, in language as free as possible from technicality, those points of law with which it is desirable that the occupiers of houses or masters of households should be fully acquainted.

In the articles on FURNITURE, information will be given as to what sort of furniture in each part of the house will be found most economical, durable, and pleasing, both in colour, material, shape, and texture. Under this head we shall include some of the simplest branches of the decorative art, a knowledge of which

will enable our readers to find amusement and gratification in the exercise of their taste and ingenuity.

Our papers upon COOKING will be a practical, simple, and complete work upon the subject in every department, commencing with receipts for the most ordinary and homely operations, and proceeding gradually to the highest and most elaborate branches of the culinary art. Hints will be given which will enable the cooking to be performed with the most limited appliances, while the best and most improved form of cooking utensils will also be described. Various methods of preparing food almost unknown at present in this country, but which in other lands are a great boon to those of limited means, will be explained; while a place will also be found for instructions in the serving of the choicest dishes.

The INMATES OF THE HOUSE will be considered from two points of view. First of all with regard to their position in law and their legal obligations, as standing in a civil relation to each other; secondly, their social position and domestic duties as members of a household. Under the latter head will be found instructions to servants in their various capacities.

The articles on DOMESTIC SURGERY and MEDICINE (which will be contributed by professional men of eminence) will give merely simple remedies for simple ailments, and instructions how to act in sudden emergencies and accidents when medical aid cannot readily be procured; showing, also, how symptoms which are trivial and unimportant are to be distinguished from those which prognosticate a serious illness, and call imperatively for the doctor's interference.

While some of our papers on the TOILETTE will contain hints upon various matters of dress and personal adornment, we shall give in others instructions on the management of the skin and hair, especially with regard to health and cleanliness—a matter which has by no means received the attention which its great importance demands.

A subject of kindred importance, and one about which a large amount of ignorance prevails, is the FEEDING, CLOTHING, and TRAINING OF CHILDREN; and we shall therefore treat of these points in detail from an economic, social, and medical point of view.

Passing to the outside of the House, the GARDEN, the COTTAGE FARM, and ANIMALS kept for PLEASURE and for PROFIT, will form the three series which will be occupied with what we may term the out-of-door departments of the household.

In the papers on the GARDEN, one of the earliest features will be instructions in Window Gardening, as being that branch of the art within reach of every one who has but a room which he can call his own, and thence we shall proceed gradually to the most complex operations, which require the greatest care and most elaborate contrivances to be carried out successfully. Pursuing the same plan in our papers upon ANIMALS kept for PLEASURE and for PROFIT, we shall begin with papers upon Poultry, as being the most universally useful, and as suiting the means of the largest number, and afterwards give information on the breeding, rearing, management, and diseases of all other domestic animals.

Those who possess more land than need be devoted to

gardening, will find in the COTTAGE FARMING complete instructions for carrying on farming upon a small scale. Drainage, rotation of crops, the variety of soils, and the various agricultural operations which are possible in a limited portion of land, will be treated of in turn.

As a kind of essentially practical supplement to nearly all the above-mentioned departments, we shall give a series of papers entitled THE DOMESTIC TOOL-CHEST.

From this, which is after all but a brief outline of our plans, it will be seen that our work will be at once comprehensive in scope and exhaustive in detail, treating in each branch of our subject alike of the simplest necessities and the most refined luxuries—furnishing, in the truest sense, a Guide to every department of the Home, and affording instruction the most valuable and practical to every member of the Household.

THE HOUSE.

I.—WAYS AND MEANS.

IT is attributed to the Rev. Sydney Smith to have said, "All degrees of nations begin with living in a pig-stye. The king or the priests first get out of this style of living, then the noble, then the pauper, just in proportion as each class becomes more and more opulent; better tastes arise from better circumstances, and what is termed luxury in one period bears the name of wretchedness in another."

Far too often an appearance of luxury, but with real wretchedness, exists in the same habitation. Living in a fine house with very straitened means frequently entails great discomfort, and is in most cases excessively imprudent, although, under others, it may be quite the reverse. A respectable-looking house, in a desirable locality, is to a profession or trade absolutely necessary to future success, even though the tenants be poor. The style of a house in a degree determines the respectability, class, credit, or means of its occupier, even though he be without a fixed income, and living to the extent of or beyond his means.

Where there is a fixed income, derivable from whatever source, it is positive dishonesty to live in a finer house than the means honestly permit. Hundreds, perhaps thousands, of people make no calculations how far their incomes will go, or in what manner their money should be spent. The daily life of the household is a happy-go-lucky style; the wife has her allowance freely given, sometimes without any consideration of what proportion the amount so allotted really should bear to the entire income; but by those acting thus it is soon found that both ends will not meet, and "once in debt, rarely out of trouble," for the home and all that the word means are neglected, and contentment and wretchedness are rife. "In for a penny in for pound" is the reckless proverb of such people, ever recurring in thought and producing the most fearful results.

It would be impossible to give minute details for every item of expenditure in any household, be the income small or large, but the following rules for the expenditure of some fixed incomes have been found to work well when the different items of cost have been faithfully adhered to in their limitations. There is no doubt difficulty in this, for the "tis buts," the "unforeseens," and the "musts" are devouring moths, always intruding and ever spoiling the finest plans of housekeeping.

Speaking roughly, one-half may be appropriated to housekeeping, including the expenses of coals, candles, gas charges (beer, wines, and spirits, if such liquors be used), and laundry. One-eighth to rent, taxes, and water-rate. One-eighth to clothing of all descriptions, inclusive of dressmaking and milliner's bills, and needlework. One-eighth to wages, medical attendance, insurance from

fire, and life assurance. One-eighth to incidentals—as general travelling expenses, the cost of carriage, cabs, and horses, whether of stable expenses or hiring, the purchase or repairs of furniture, personal expenses of the family, as pocket-money, &c.—which *et cetera* has a very extended signification, but must be provided for.

We may, however, be able to approximate to something like definite information if we take a series of different incomes, and apportion out their expenditure. To begin with, let us take an income of £100 a year, which may be divided as follows:—

Expenditure for an Income of £100 per annum.

Rent and taxes, rates and water-rate	£17 0 0
Housekeeping	55 0 0
Clothing	12 10 0
Incidentals, which will include travelling expenses, medicine, education of children, repairs of furniture, &c., pew rents, and charitable gifts	15 10 0

£100 0 0

Weekly Expenditure.

Rent	£0 6 6½
Housekeeping	1 1 2
Clothing	0 4 9½
Incidentals	0 5 11

£1 18 5

Daily, 5s. 5¼d.; Monthly, £8 6s. 8d.

Expenditure for an Income of £200 a year.

Rent, taxes, rates, and water-rate	£35 0 0
Housekeeping, laundry, coal, gas, also wines, spirits, and beer (where used)	80 0 0
Wages—one servant, £10. Beer, 7d. weekly; laundry, 6d. weekly	12 16 4
Clothing of all descriptions	30 0 0
Incidentals	42 3 8

£200 0 0

Weekly Expenditure.

Rent and taxes	£0 13 5¾
Housekeeping	1 10 9
Wages	0 5 0
Clothing	0 11 6½
Incidentals	0 16 1¾

£3 16 11

Daily, 10s. 11¼d.; Monthly, £16 13s. 4d.

Expenditure for an Income of £300 a year.

Rent, rates, taxes, and water-rate	£46 0 0
Housekeeping—laundry, coals, candles, gas, also wines, spirits, and beer (where used)	150 0 0
Wages—one servant, £16, inclusive of tea and sugar. Beer, 1s. 2d. weekly; laundry, 1s. 2d. weekly	19 0 0
Clothing, including tailor's bills, millinery, and dress-making	45 0 0
Incidentals, as above	40 0 0

£300 0 0

Weekly Expenditure for £300 a year.

Rent	£0 17 8
Housekeeping	2 17 8
Wages	0 7 5
Clothing	0 17 3½
Incidentals	0 15 4½

£5 15 5

Daily, 16s. 5¼d.; Monthly, £25.

£400 per annum allows of the following Disbursement.

Rent, taxes, and all rates, including water-rate (one-eighth of income)	£50 0 0
Housekeeping—laundry, coal, gas charge, also wines, spirits, and beer, where used (one-half)	200 0 0
Wages—two servants—general servant, £16; housemaid, £14, inclusive of tea and sugar. Beer, 1s. 2d. each, weekly; laundry, 1s. 2d. each, weekly	36 1 4
Clothing of all descriptions, including tailor's, milliner's, and dress-making bills (one-eighth)	50 13 8
Incidentals	63 0 0
	£400 0 0

Weekly Expenditure for £400 per annum.

Rent	£0 19 3
Housekeeping	3 16 11
Wages	0 13 10
Clothing	0 19 7½
Incidentals	1 4 2½

£7 13 10

Daily, £1 1s. 11d.; Monthly, £33 6s. 8d.

The balance in favour of surplus cash, over that of £500 a year—for incidentals—arises from keeping two servants instead of three.

Expenditure for an Income of £500 a year.

Rent, rates, taxes, and water-rate (one-eighth of income)	£62 10 0
Housekeeping—including laundry expenses, coal, candles, gas charge, also wines, spirits, and beer, where used (one-half)	250 0 0
Clothes, including tailor's, dress-making, and millinery bills (one-eighth)	62 10 0
Wages—one-eighth, expended thus: three servants—cook, £18; nurse, or housemaid, £16; general servant, £10; or cook, housemaid, and nurse—tea and sugar being included in their wages—£44. Beer money—1s. 2d. each weekly—£9 2s.; laundry, £9 8s. (being a fraction less than 1s. 2½d. weekly)	62 10 0
Incidental expenses—one-eighth	62 10 0

£500 0 0

Weekly Expenditure for £500 a year.

Rent	£1 4 0½
Housekeeping	4 16 2½
Clothing	1 4 0½
Wages	1 4 0½
Incidentals	1 4 0½

£9 12 3½

Daily, £1 7s. 4¾d.; Monthly, £41 3s. 4d.

It is a matter for prudential consideration whether three servants can be maintained on an income of £500 a year—we think not.

The above calculations show how very little money can be honestly spent in extravagance of any kind, whether of clothes, of amusements, of visiting, or entertainments, and what perpetual watchfulness is required to guard against waste of the most trivial nature in all incomes below six hundred a year.

It will be observed that we have omitted from our list the items of expenditure of an income of £150 a year, an income which is a very common one. In our next paper on this subject we propose to enter at still greater length and in fuller detail into the question of household expenses, and to take the £150 income as the basis of a more exhaustive article.

COOKING.

PLAIN COOKERY.—INTRODUCTION.

EVERYBODY knows that a good cook is an economical cook, so that a knowledge of the elementary rules regarding the preparation of food must prove an economy to all, and not only an economy of money, but of life and strength, by enabling people to get better food, and thus obtain more actual nourishment out of the materials they can afford to provide.

The great secret in cooking is to make food palatable, and not to waste the nutriment contained in the meat, neither to let it boil out or steam out. If you boil your dinner, always keep the liquor in which it is boiled; there must be the very essence of the meat in it, and it is therefore always good for vegetable soup. Always cover your pot, and let the steam, which contains the strength, fall back into the stew. Never waste anything. Remember the old adage, "Waste not, want not." Save every bone, every leaf, every crust, and make them into soup, if not

abandon altogether the attempt to cook their dinners for themselves, and after preparing it in the rudest possible form, send it to the baker's oven to be cooked, a proceeding utterly wasteful and bad, the reason showing upon the very face of it; for how is it possible that dishes of all sizes and sorts can be equally well cooked in the same heat? Besides, think of the different gases all condensing, and flowing mingled back upon the meat. Fish, flesh, fowl, pastry, and vegetables, all share alike. Then, again, there is the mixture of gravy, for basting must go on quite "promiscuously." You cannot expect the baker's man to dip his ladle into the very dish he wants to baste. Will he not, as a matter of course, dip where the dish is deepest and handiest?

In many families of moderate means, after the Sunday dinner is eaten, the meat that is left comes in cold day after day through the week until it is consumed. Such a disagreeable sameness might easily be avoided, and a wholesome and pleasant variety be obtained, by a slight

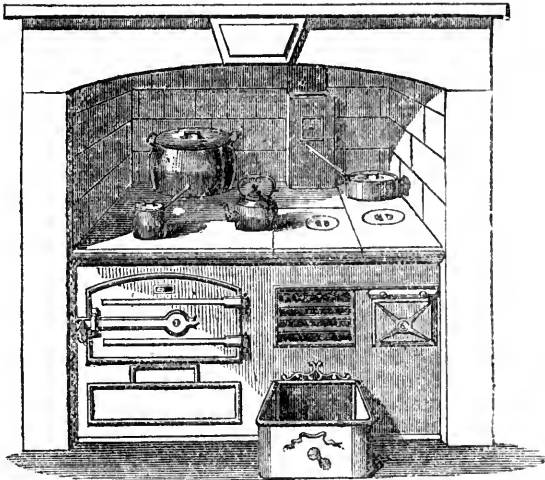

Fig. 1.

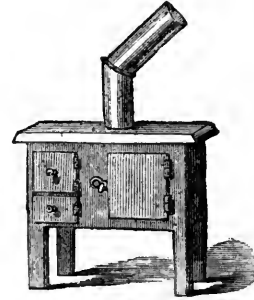

Fig. 2.

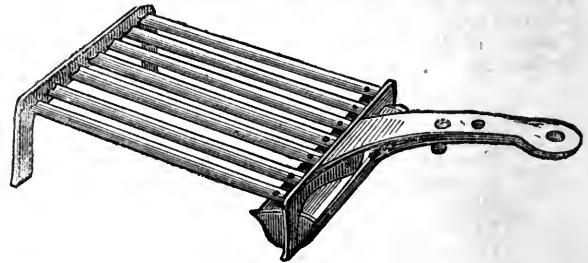

Fig. 3.

for your own children, for the children of those poorer than yourself.

It should always be remembered that "wholesome fare" is well-prepared fare, and fare necessary to keep up the system, especially where there is an extra amount of wear and tear by any exhausting labour. In rural districts, where work is done in the open air, and without any excitement to the nervous system, nature does not seem to make such large demands for replenishment, and turns out fine muscular men upon no stronger feeding than potatoes and oatmeal. This, however, does not hold good in all cases. With many animal food is a necessity, and reasoning from this necessity, it is not too much to argue that every young woman ought to study the rudiments of cookery—so as to learn that a clear quick fire is required to cook a chop or a steak, which may be rendered tender by beating, either with the point of a knife or a rolling-pin; that a stew ought never to boil; that meat boiled is meat spoiled, unless simmered; that vegetables must be put in boiling water, and without a cover; that bread goes twice as far, and is three times as wholesome stale as fresh; and that brown flour is much more nutritious and cheaper than white.

Many people, especially such as live in large towns,

but sound knowledge of cooking. Of course, some people have greater facilities than others. Where there is a small garden a good dinner may be eaten every day; but even without this, it is possible, by a little judicious economy, to obtain a regular supply of vegetables.

As almost all who possess a garden may keep a pig and a few hens, they may vary their bill of fare, either by using or selling the home produce. For growing children a full supply of food is a necessary to health and development. Where oatmeal is cheap, nothing can be better than well-boiled porridge; but where any prejudice exists against this, let the breakfast and supper consist of coarse brown bread, and, if you can get it, skim or butter milk; if not, treacle and toast-and-water.

Children will generally thrive well upon bread alone, but nature requires something else, and the more you can vary the diet, even by the use of common vegetables boiled down, the better. Onions are easily grown, are cheap to buy, and contain a large amount of nutriment; so, too, do carrots; both are wholesome and palatable, and make a loaf of bread go much further. Always teach children to masticate their food, and eat slowly; half the quantity so eaten will suffice. Bolting food is not only

wasteful but unhealthy, and ought to be carefully guarded against.

In France the culinary art is much more generally known or understood than in Great Britain, and without doubt Scotland and the Border land come next in attention to it in its simpler branches.

As a rule, people in this country do not pay sufficient attention to the matter of culinary vessels; quite forgetting that it is really the best economy to have such vessels as will enable them to cook their food easily and well without at the same time necessitating any great outlay. In many houses in this country a great deal of fuel is wasted in the large open grates generally in use, and they are being consequently superseded in most places by some sort of cooking range. Fig. 1 shows a range suitable for a household of moderate means, which will be found convenient and economical; to the details of such a range we shall have occasion to refer in treating of the preparation of various dishes.

It will be found an economical plan to use a stove like that shown on page 4, Fig. 2, ranging from about two feet and a half by two, and only containing an oven (the larger sizes have a boiler as well). They heat equally all over; will boil, bake, and roast, all at once; use very little fuel, and can be allowed to go out directly their work is done. In addition to this they are easy to manage; the saucepans require little or no scrubbing, as they never come in contact with the smoke; and the consumption of fuel is very small. We use coke to advantage, French people use charcoal, but coal is the best. The first outlay in a stove without a boiler is about £2 10s., with a boiler, £3; and this is soon saved in fuel and time occupied in cleaning the saucepans.

A frying-pan, a gridiron, a saucepan, and a three-legged pot or "getlin," are all the culinary utensils absolutely necessary for ordinary plain cookery. These vary in price, according to size; for example—a moderate-sized gridiron costing from 1s. 2d. to 2s. 6d.; frying-pan, 1s. to 1s. 6d.; saucepan, 1s. 6d. to 3s.; iron pot, 4s. 6d. to 7s. With these, a decent cook can do all that is necessary. As for a roasting-jack, nothing is better than a skewer and a hank of yarn.

The gridiron is a serviceable utensil, which deserves to be kept with special care. It is not unfrequently the friend in need to whom we resort when other means of cooking fail. It has also been made the subject of modern improvements. In olden time a silver gridiron was the pride of aristocratic cooks; but an enamelled or a well tinned one is scarcely its inferior. A good gridiron now has grooved bars (as shown in Fig. 3), which render the double service of keeping the fire clear of dropping fat, and consequently of smoke, and of conducting the gravy to a trough in front, whence it may be poured over steaks or chops in their dish.

A rusty gridiron will not improve a steak, while one still greasy with last week's broil will spoil it. Although not made of silver, it should be as bright, and scrupulously clean between the bars. For broiling, a charcoal fire is best; a coke fire, second best. With a cinder fire, you must wait till it is quite clear, and then sprinkle it with salt. Then heat your gridiron before laying on the steak, otherwise the parts touching the bars will remain raw when the rest is cooked. If made too hot, the bars will burn and char the steak, marking it with black lines, besides spoiling the flavour. Turning the steak several times keeps the gravy inside. This turning, which should be done not with a fork, but with a pair of meat tongs, will slightly prolong the time of cooking. A good rump steak will take ten minutes; pork chops and mutton cutlets less, according to their thickness; the former, however, should always be well done. For turning chops and steaks without pricking them with a fork, a double gridiron has been invented, the only objec-

tions to which are that it is more trouble to keep clean and less easy to heat its bars equally to the proper temperature. When placed on the fire, the gridiron should stand forwards, to cause the fat to run in that direction, instead of dropping into the fire, and so smoking the steak. This position is now insured by making the hind legs of the gridiron higher than the front ones, as shown in our illustration, Fig. 3.

The above utensils we have indicated here as especially useful in a household of moderate means. As our work proceeds, we shall give illustrations of others necessary for the more advanced and elaborate branches of cookery, and proceed now with

SIMPLE RECIPES.

Bread is the Briton's staff of life; we therefore begin our Homely Cookery with that important article of food. It is sometimes a good deal helped out with potatoes, but the use of more than a certain proportion of that vegetable is not desirable for maintaining strength. People who live almost entirely on potatoes become too stout, and are comparatively weak. The Hindoos and other Eastern nations, who eat little besides rice, are inferior in bodily strength not only to the northern peoples of Europe, who consume fish in large quantities, and to the South American races of men, whose diet is meat exclusively, but to bread-and-meat eating people like ourselves. It is the large quantity of bread they consume that maintains the strength of the French labourers, many of whom do not taste fresh meat more than once or twice a year. All the soups so liked by the working classes in France, contain soaked bread in some shape or another.

Bread, if we think of it, is an ingenious contrivance for rendering corn eatable by human mouths, and digestible by human stomachs, which could only have been discovered step by step. The eating of dry barley, wheat, or rye, must have been working hard for one's living. Even frumity (new wheat boiled soft and flavoured with sugar, nutmeg, and eggs) is tolerably trying to the jaws. Pounded corn might furnish an ingredient for stews and gruel; after the further invention of grinding it into flour between two flat stones, it would make porridge, and could even be baked on the hearth into cakes, which, however, would not yet be bread. It is the FERMENTATION, the "working," the causing of the dough to "rise" and become light, without which there is no real BREAD. Unleavened bread is an incomplete article, the produce of an unfinished process; and is therefore the symbol of pressure, danger, and consequent haste, in the eyes of the persons who partake of it at stated seasons. We may believe that the discovery of the fermentation of dough, converting it from heavy cake into light bread, was the result of some lucky accident.

Good Household Bread.—To ten pounds of flour in your kneading-trough, put a small handful of salt. Stir into this about two quarts of water, more or less; but some flours will soak up more water than others. For very white bread, made with superfine flour, the dough should be softer than for seconds or brown bread. In summer the water may be milk-warm; in winter, considerably warmer, *but never hot enough to kill the yeast*. After the water is mixed with the flour, add the yeast. Much depends on the quality of the yeast. Then knead your bread. After kneading, leave it to rise in a warm place, covered with a cloth. If all goes well, it will have risen in something between an hour and an hour and a half. Then divide it into rolls, loaves, or tin-breads, as wanted, and bake.

For a three-pound loaf, you must take three pounds and a half of dough; for a four-pound loaf, four pounds eleven ounces; for a six-pound loaf, six pounds and three-quarters; and for an eight-pound loaf, nine pounds of dough.

You cannot make good bread without good water. The

water should be good drinking water, pure both to the taste and smell—water which dissolves soap without curdling, and which boils fresh vegetables green, and dry vegetables (as peas and haricots) tender. None is better than rain-water, when it can be had clean and without the taste of soot. Stagnant water, hard water, and water from melted ice or snow, are all to be avoided. The quality of the water has a considerable effect on the quantity of it which the flour will take up. The quantity varies according to the kind of bread you want to make, and even according to the season. You can put in more water in winter than in summer, because the dough remains firmer in winter than in summer.

It takes more water to make soft bread, like the French, than to make firm bread, like the generality of bakers' bread in England. When it is kneaded with salt and yeast, as for making unusually light rolls, there enters into the composition of the dough almost as much water as flour. The smaller the rolls are, the less stiff the dough should be. But, as we have already stated, exact precision in these matters is not possible. In kneading dough, too much water is less inconvenient than too little. Nevertheless, when the dough is too moist, the "eyes" in the bread become too big, irregular, and unequal; and the crust is apt to separate from the bread and get burnt.

Oaten bread requires to be made with warm water, good yeast and plenty of it, and to be well kneaded; to be thoroughly baked in a hot oven, and left there some time, according to the size of the loaf, because the inside is apt to be pasty. Barley-bread takes less yeast, but should also be thoroughly baked in a brisk oven. The German peasantry make bread with a mixture of barley-flour and potatoes, which they highly relish, custom being second nature. For rye-bread, make a stiff dough with cold water and plenty of good yeast; knead well; when risen, put it into a smart oven, and be in no hurry to take it out. In Sweden, bread is made with a mixture of flour and barley; in some districts, buckwheat-flour is mixed with rye-flour.

When yeast cannot be got, we recommend the following way of making

Bread without Yeast.—To every half-quarter of flour, add one teaspoonful of carbonate of soda, and half a teaspoonful of salt. Mix all together; then, to the water sufficient to make a dough, add half a teaspoonful of *muritic* acid. Set into the oven at once. This makes beautiful sweet bread, and is wholesome. Some use tartaric acid; in which case the bread will contain tartrate of soda, which, although not poisonous, is medicinal—slightly purgative even. On the other hand, *muritic* acid neutralises soda just as well as tartaric acid, and the resulting compound is only common salt.

Potato Pie.—There is one dish, a home invention, which will be found both useful and economical, and

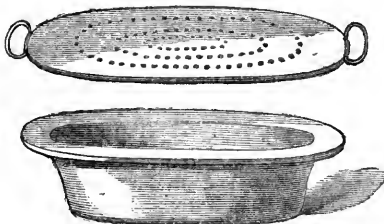

Fig. 4.

of which an illustration is annexed. Take a good-sized pie-dish. Cut out a tin lid which will fit down an inch at least below the level of the rim of the dish (Fig. 4). This must be perforated, and have a wire handle at

each end. Fill the pie-dish with slices of cold meat, two boiled onions, a little seasoning, and a cup of water; flour the meat, and set on the tin lid. Pile upon the lid cold mashed potatoes, done up with salt, pepper, and a little dripping (as shown in Fig. 5), and bake, either in a regular oven or before the fire, for an hour. When served, lift up the lid and place it with the potatoes upon a spare dish.



Fig. 5.

Potato Dumpling.—This cheap, simple, and wholesome preparation of food, not much known in England, but which forms the daily meal of poor artisans and others in North Germany (who never taste meat, and, as they say, never think of it), will be found to supply a useful variety in nurseries, and for invalids whose allowance of meat is limited. The potatoes, which must be mealy and of good quality, are cooked in the usual way, and then pounded. To three parts of potatoes put one part of wheat-flour, with a little salt, and mix them well together. Milk sufficient to make a paste is then stirred in, and it is to be boiled in a cloth or basin. The proper length of time for cooking can only be learned by experience, but it must be *well* boiled. It will then be firm and light, and may be eaten either with butter or meat gravy, or with cooked apple, stewed prunes, jam, treacle, or other sweet sauce. It is very palatable with salt fish, or meat, while the addition of suet, currants, raisins, and sugar converts it into a nice plum-pudding.

HINTS ON CARVING.

It has been said that "a poet is born, not made;" and so it is to a great extent with the carver. The skill to carve well depends on certain qualities that are gifts in the possessor—a true eye, a steady and skilful hand. Still, even those who do not possess a natural aptitude, acquire the art by care and perseverance sufficiently to enable them to acquit themselves without awkwardness, or the risk of wasting and spoiling what they attempt to carve, though they may not be able ever to attain to that almost magical dexterity with which some people appear to be gifted; and even those who possess this natural skill will find it useless, without they take care to discover the best and most advantageous modes of cutting the viands brought to table.

There are many persons who fancy that as long as a joint is cut up, it little matters how it is done; they would, by travestying the words of Shakespeare, "stand not upon the order of their cutting, but cut at once," and have a notion that all attempts at choice carving are contemptible—mere extravagances of fancy, or epicurean self-indulgence. But no greater mistake was ever made. Not only is it true that meat is twice as nice if nicely divided, but also a joint properly carved will go nearly twice as far as another of similar size and weight clumsily cut up; and every careful housewife and true economist will do her best to master the art of carving as soon as possible. Not only will she be taking the best means to avoid waste, but she will also get the credit of keeping a well-provided table; for even where there is but little to serve, if it is well cooked, well carved, well served, and neatly put on the table, a single dish is preferable

to a profusion ill prepared. Even in so small a matter as cutting a slice of bread, a loaf always cut straight and even goes much farther than one hacked and hewn irregularly, or in all directions, and it is palatable to the last piece, so that there is no excuse for leaving odds and ends. Every good housewife should make a rule in this matter, to which she should, expressing her wishes in a courteous and gentle manner, compel every member of the household and every visitor to adhere—that is, to begin at the top of the loaf, and take off the two sides equally, and in evenly-cut pieces. Nothing is more disagreeable than to come to table, and be served with a loaf of bread after some careless slattern has hacked it about in all directions.

Leg of Mutton.—This joint is the most frequent staple of the family dinner, and yet is very often badly cut. The leg of mutton comes to table as shown in the illustration, Fig. 1. Take the carving-fork as usual in your left hand, and plant it firmly in the joint, as shown by A

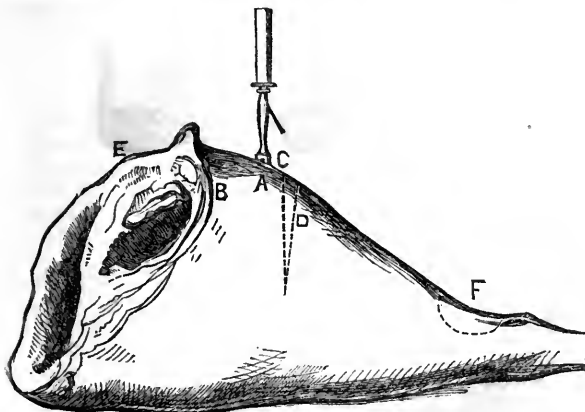

Fig. 1.—LEG OF MUTTON.

in Fig. 1, placing it rather over to the other side of the joint, and drawing the leg over towards you on the dish about one third, which brings the position of the fork from A to B. Cut straight down across the joint at the line marked C, not quite to the bone. Make the second cut a little on the slant, as shown in D, and take the piece out. Continue cutting from each side slantingly as the line marked D either from the thick

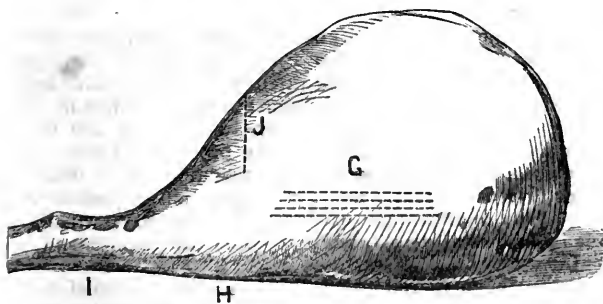

Fig. 2.—BACK OF LEG OF MUTTON.

or the knuckle end, according to the taste of the person to be helped. A very small piece of the udder fat should be given with each slice of meat to those who like it. The knuckle, if any one asks for it, is first cut off in a lump, as shown by the circular line at F, and afterwards in slices. Mutton should be cut thick, but it should not be cut to the bone; the slices in the centre should not penetrate as far as the circular kernel of fat found there, and called the

“poppe’s eye,” which it is generally considered best to leave for hashing. But some persons consider the poppe’s eye a delicacy; in that case it is sliced out in a lump with a circular cut, similar to that used to remove the knuckle, but twice as large. The poppe’s eye should be cut out entire, with a handsome piece of meat round it. The back of a leg of mutton is not generally cut until cold, when it is best sliced lengthways, as shown in Fig. 2; the meat is still cut thick, but not quite so thick as in the cuts previously described. Cold mutton should be served with mashed potatoes and pickles, and the remains hashed, as there is much left on the bone that does not cut up well hot or cold. There is a part called the “cramp bone” in a leg of mutton, which may be removed by a circular cut from H to I in Fig. 2; it is usually relished cold. Fig. 2 shows the joint when turned three parts over, held by the fork, as previously described, and the dotted line at J indicates the direction of the first cut.

Sirloin of Beef.—This is served as shown in Fig. 2 of the coloured plate, with tufts of horse-radish on the top. A sirloin should be cut with one good firm stroke from end to end of the joint, at the upper portion, making the cut very clean and even from A, B to C, Fig. 3. Then disengage it from the bone by a horizontal cut exactly to the bone, B to D, using the tip of the knife. Bad carving bears the hand away to the rind of the beef, eventually, after many cuts, peeling it back to the other side, leaving a portion of the best of the meat adhering rigidly to the bone. Every slice should be clean and even, and the sirloin should cut fairly to the very end. Most persons cut the under side whilst hot, not reckoning it so good cold; but this is a matter of taste, and so is the mode of carving it. The best way is first of all to remove the fat, E, which chops up well to make puddings, if not eaten at table. Then the under part can be cut, as already described, from end to end, F to G, or downwards, as shown by the marks at H.

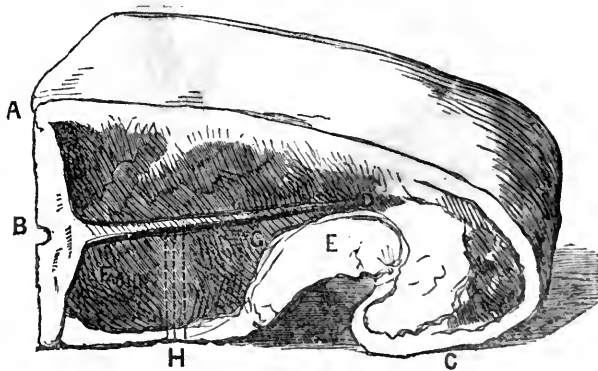

Fig. 3.—SIRLOIN OF BEEF.

Roast ribs of beef are cut in the same manner as the upper portion of a sirloin. Each person should be asked if he prefers his meat well done or with the gravy in it (*i.e.*, underdone), and if fat is desired. The outer cuts of roast beef are of course the most cooked, the inner ones the reverse.

DOMESTIC MEDICINE AND SURGERY.

I.—INTRODUCTION.

MEDICAL men have a natural prejudice against systems of domestic medicine. They know, better than anybody else can know, the difficulty of understanding the very simplest medical facts. They know how often, with all their special knowledge, acquired by years of study and close observation of disease, they are themselves puzzled in trying to explain fully the cases which they meet with.

It is not to be wondered at, then, that they should have a distrust of domestic medicine, and have a strong tendency to advise people that are not well, not to take this medicine or the other, but "to send for the doctor." And yet a little reflection will show that there must be more or less of domestic medicine. People will try their hands at curing themselves or their children; and for two or three reasons such experiments are not to be altogether discouraged. In the first place, there are some ailments that are really very trifling and require for their treatment only a little care and common sense. They are not grave enough to need medical science or to be materially helped by it. It seems scarcely respectful to the profession to call it in to cure a common cold, or the stomach-ache which clearly comes of having eaten forbidden fruit. Then there is another good reason for trying to help people to understand the rudiments of medicine for domestic purposes. They are often so situated as to be out of the reach of immediate assistance. A sudden faint

At the same time, opportunity will be taken to point out those circumstances that indicate the necessity for immediate recourse to a medical man, and the rules laid down must be regarded as only preliminary to his arrival, and on no account to be insisted on should he, from the special nature of the case, see fit to carry out some different mode of treatment. Great harm may be done to a patient by injudicious meddling on the part of a well-meaning, but only partially-informed friend, who, finding the treatment being pursued under medical advice different from that here laid down, should venture to express disapproval, and shake the confidence of the patient or his friends in their medical adviser. When a patient's case has once been undertaken by a medical man, it is only just, and for his own interest, that the surgeon should be treated honestly, his directions fairly carried out, and his prescriptions attended to. If a patient or his friends are dissatisfied with their medical attendant, it is always open to them to have further medical advice.

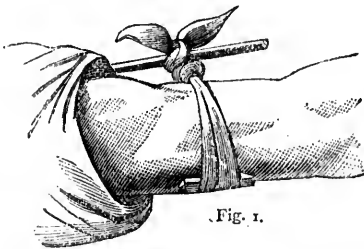

Fig. 1.

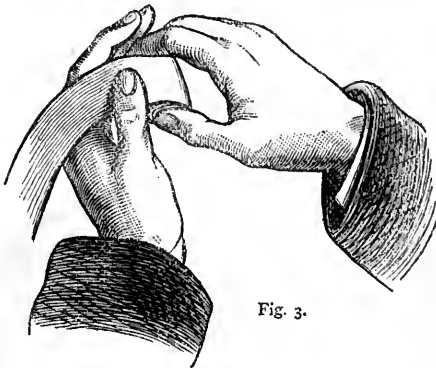

Fig. 3.

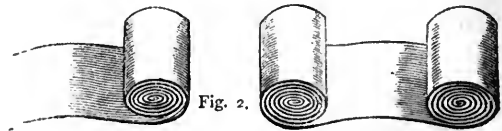

Fig. 2.

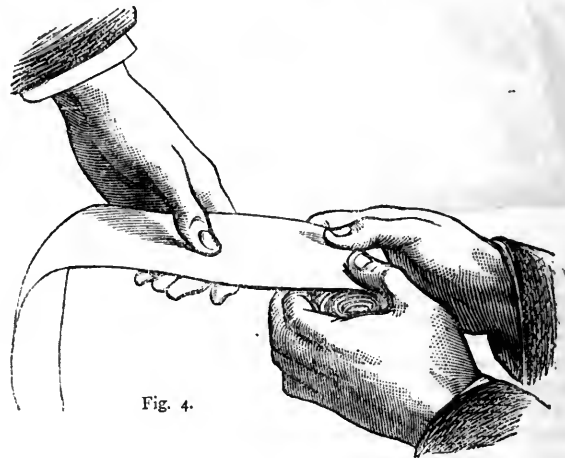

Fig. 4.

may happen, or a vein or artery may be bleeding fast, and even a near doctor may be too far off; or the doctor may live at a great distance; and a little wise instruction would save hours of pain to the patient and anxiety to his friends.

Many of the mistakes of domestic medicine would be avoided if it could be restricted to simple cases. But here the difficulty arises of distinguishing between cases that are simple, and cases that are serious. In an early number, we shall try to enumerate a few symptoms which show disease to be important, and therefore beyond the proper province of domestic treatment. The only information that we shall pretend to give concerning such serious diseases, will be such as will enable our readers to form some intelligent notions of their nature, their course, and their symptoms; and, what is perhaps of most importance, to understand the onset of them, and the kind of symptoms which indicate a severe attack.

The object of the articles on Domestic Surgery will be, not the perfectly futile and mischievous one of attempting to make every one his own surgeon, but only to furnish our readers with such simple rules for the treatment of the slight accidents and emergencies of every day life as are commonly treated without resorting to medical advice.

There are certain affections which are commonly denominated "surgical," because they require some manual attention on the part of the attendant. These will be briefly discussed, in order to point out how far they may with safety be treated domestically, and when it will be desirable, and even essential, to have professional advice. Opportunity will be taken, in connection with these subjects, to describe the mode of preparation of poultices and other applications of household surgery, which, though they are in fact matters of every day requirement, are frequently mismanaged.

It may be here remarked how essential for relief in these surgical affections it is that there should be no concealment of symptoms from one's medical adviser, on account of scruples, no doubt honourable, but misplaced, because of the so-called "delicacy" of some of the subjects involved. Valuable lives (as for instance, that of Caroline, queen of George II.) have been lost from the concealment of the existence of a rupture; and many persons live a life of discomfort for years, and even allow their health to be undermined by some concealed affection of the lower bowel which can be readily remedied by medical advice.

HEMORRHAGE.

Bleeding, which is a constant accompaniment of accidental cuts and wounds, is always very alarming to non-professional bystanders, and it occasionally happens that for want of knowing how to arrest it readily, serious results occur before the arrival of professional aid. In order to be able to stop bleeding the reader must understand that blood may be poured out in two ways—1st, pumped out in jets of a bright red colour, in which case one of the *arteries* which convey the blood from the heart to the surface is wounded; or, 2ndly, it may flow out in a dark-coloured continuous stream from the *veins* which return the blood from the limbs to the heart. In many cases, however, the injury is a mixed one, and the blood, though principally venous, is mingled with blood poured out by arteries too small to give their characteristic jet.

It is evident, then, that the wound of an artery of large

possible by a medical man, and the bandage should on no account be interfered with before his arrival.

Before explaining the mode of applying the dressings necessary to restrain hæmorrhage of an ordinary kind, it will be advisable to say a few words about bandages. A bandage or roller is simply a strip of calico, six yards in length, and from two to three inches in width. Soft unbleached calico or coarse cambric is the best for this purpose, but on an emergency any suitable material may be employed; and for binding up fingers broad tape or narrow ribbon is very convenient. In order to use a bandage properly it must be rolled neatly and tightly from one or both ends, as seen in Fig. 2; but it is only the "single-headed roller," or that rolled from one end, which can be required in domestic surgery. A bandage may either be rolled by keeping it tight with the thumb and fingers of the left hand, whilst being rolled

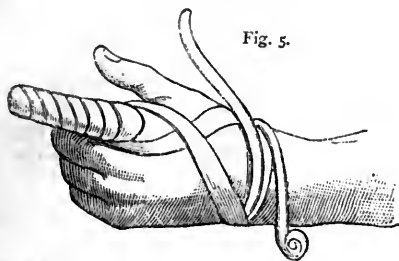

Fig. 5.

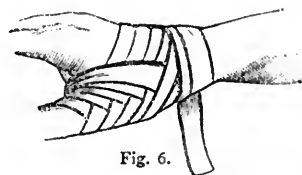

Fig. 6.



Fig. 7.

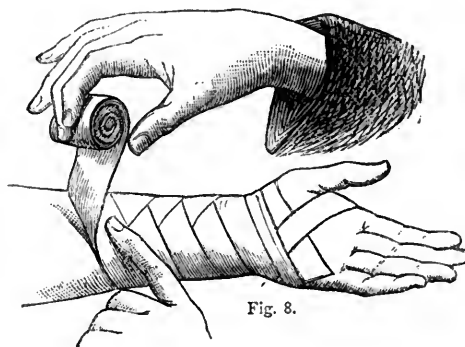

Fig. 8.

size will give rise to the most serious form of bleeding, and as the blood in this case is flowing from the heart to the circumference, we must arrest it between the trunk and the wound by compressing the main artery. On the other hand, if the bleeding is from the wound or rupture of a large vein, the point for the application of the pressure will be either upon or *below* the wound. In the case of the upper arm the principal artery runs along the inner side of the limb, where it may easily be felt beating, and in the case of arterial bleeding from the hand or arm, pressure can be efficiently obtained by tying a strong tape or handkerchief around the arm and tightening it by twisting a stick in it on the outer side of the limb, as shown in the cut, Fig. 1. In the thigh the main artery runs down the middle of the front of the limb, and can be controlled in the same way as in the arm. In both cases the introduction of a wine cork beneath the handkerchief in the situation of the vessel will lead to more efficient pressure upon it, and without so much tightening of the bandage as would be otherwise necessary.

This mode of extemporising what is surgically called a *tourniquet*, is of course only for temporary employment, and any case in which the bleeding has been severe enough to require its use should be seen as soon as

with the right, as shown in Fig. 3; or this may be more conveniently and rapidly done by using both hands for rolling, whilst the bandage is kept on the stretch by an assistant, as shown in Fig. 4.

In bleeding from slight cuts about the fingers and hand, plaster (either court or adhesive) may be conveniently employed if a bandage is used over it at first, and until the plaster has become firmly fixed; but when the wound is considerable it is better to use other means. A piece of lint or soft linen should be placed over the wound, and over this a bandage should be firmly applied, and should extend if possible a little above and below the seat of the injury. In the case of a finger a roll of tape may be taken, and ten or twelve inches being drawn out and left loose, the finger should be rolled in a series of spiral turns from the web to the nail, where the spiral arrangement being reversed, the tape can be carried back again and across the back of the hand, and tied round the wrist with the end left out as in Fig. 5. If the wound is in the ball of the thumb the bleeding is often sufficiently severe to require medical attendance, and this should be obtained, if possible; though the vulgar fear of "lock-jaw" from an injury of this kind is unfounded. When it is necessary to bind up the thumb the broad tape

may be conveniently used, and a turn having been taken round the wrist to fix the bandage, a series of figure of eight loops around the thumb and wrist should be made, beginning as low down on the thumb as may be necessary, and making each fold of the bandage overlap that which preceded it, as shown in the illustration, Fig. 6.

Wounds of the palm of the hand, if severe, should be immediately seen by a surgeon, but as a temporary measure a slice of cork wrapped up in a piece of linen may be firmly bound upon the bleeding point with a bandage. This should be applied in figure of eight loops around the wrist and hand, being made to cross at the point where the pressure is required, as shown in the illustration, Fig. 8, and this should be repeated a few times so as to control the bleeding. It may be advisable where assistance is not readily obtainable, to bandage the forearm in addition, and this may be done by carrying the bandage once or twice round the wrist alone, and then proceeding up the arm, turning down the bandage in the manner shown in the illustration, Fig. 8, when the shape of the arm does not allow it to lie flat and close upon the injured limb.

THE REARING AND MANAGEMENT OF CHILDREN.

I.—THE MOTHER AND BABY.

WHEN a woman is about to become a mother, she ought to remember that another life of health or delicacy is dependent upon the care she can take of herself; that all she does will inevitably affect her child, and that mentally as well as physically.

We know that it is utterly impossible for the wife of the labouring man to give up work, and what is called, "take care of herself," as others can. Nor is it necessary. The "back is made for its burthen." It would be just as injurious for the labourer's wife to give up her daily work and exercise, as for the lady to take to sweeping her own carpets or cooking the dinner. Habit becomes second nature. We know

"Use almost can change the stamp of nature."

So that, although naturally the delicacy of the womanly frame might seem to demand rest at such a time, the nature acquired by habit or use demands, for health's sake, the same routine of exercise and exertion. He who placed one woman in a position where labour and exertion are parts of her existence, gives her a stronger state of body than her more luxurious sisters. To one inured to toil from childhood, ordinary work is merely exercise, and, as such, necessary to keep up her physical powers, though extra work should be, of course, avoided as much as possible. Lifting heavy weights, taking long walks, stooping for many hours over a washing-tub—all these things might be avoided or done in moderation even by the cottager's wife.

At such a time, too, the woman ought to be as careful as she can of her diet, and eat regularly, and in moderate quantity. Over-loading the stomach increases the sickness so often attendant upon her state. The vulgar notion of what is called "longing" for unusual food should be discouraged as inconsistent and ridiculous.

Country women very seldom send for the doctor until it is too late, and are therefore subjected to the treatment of an amateur, and often utterly ignorant, nurse, who acts with the best intentions in the world, and saves her neighbour a few shillings, but will often lay the foundation of many years of debility and suffering.

Good and correct nursing is indispensable to future health and strength, and the importance of this people are beginning to recognise; and ere long, we may hope that every village will be supplied with a trained and

certificated nurse—an invaluable boon to the cottager, and the saving of many a valuable life.

It is a fatal error, very prevalent, however, in some classes of society, that to get up soon is the sign of a "clever woman;" and a sort of rivalry exists upon the point—the mother who can soonest "feel her feet," and get to her usual work or business, being looked up to and envied by her neighbours.

There can scarcely ever be any necessity why a woman should get up and work under nine days, at least. Neighbours are always ready to come in and set the house to rights, or see to the children and husband. Therefore, by all means, rest the prescribed nine days. Let Nature perform her work her own way, and you will find your reward in an after-time of strength and comfort. We do not hesitate to affirm that, in nine cases out of ten, the rash and indecently early rising from childbed is not from a sense of duty or necessity, but simply out of bravado. This period of after-repose is particularly required at a first confinement, the strength and health of the mother's whole life depending upon judicious treatment at such a critical time.

The great thing for the nurse to observe, after the baby is born, is to keep the mother's mind free from excitement or anxiety, and to preserve as much quiet in the house as possible. In a healthy woman, Nature will do her own doctoring, and do it thoroughly; but when there is ill-health or debility, the nurse or doctor must help Dame Nature, and be in their turn attended to and assisted by those immediately connected with the patient.

For a few days, weak tea and bread, or gruel, is the proper food. After that, gradually increase the strength as well as the quantity of the diet. During nursing a considerable amount of support is required. So much, then, for the mother. Let us see to the cause and consequence of all this trouble and anxiety—the Baby.

The first thing, after washing and dressing, is to feed the child. Most babies make a sucking motion with their lips almost directly they come into the world, and ought to have their hunger gratified within a few hours. If the mother is not in a state to do this (as is very seldom the case under thirty-six hours), give the baby a little oatmeal gruel, very thin and smooth. Most nurses administer a couple of drops of castor-oil with this first meal.

A baby for the first week requires to be very often fed—in fact, its existence consists of eating and sleeping. A healthy baby will generally, therefore, be a quiet one. If it fidgets and whimpers, there is something the matter. Screaming as often proceeds from temper as from pain; babies learning wonderfully soon to assert their rights; and, finding out that by crying they can get their desires gratified, crying is resorted to whenever they are thwarted. Never dose a baby with narcotics. Laudanum has a poisonous effect upon some infants—one drop having been known to produce death. The safest remedy for a pain in the stomach is a few drops of peppermint in water and sugar, and a hot flannel laid upon the stomach or across the back. If this does not stop the pain and quiet the fretting, give a few drops, or half a teaspoonful, of castor-oil, apportioning your dose to the age of the child. In our articles on Domestic Medicine ample directions will be found for the treatment of all more important symptoms.

Generally the baby sleeps with its mother; and this is a good plan, as warmth is of great importance to its well-being; and having very little power to generate heat itself, the warmth derived from the mother is a great source of comfort and health. During the day the cradle should be near the fire; and if the weather is very cold, put a hot brick wrapped in flannel, or a bottle of hot water, into the cradle, at the child's feet.

Be very careful that the bed and bedding are perfectly dry.

And the mother should remember that she cannot too soon begin to teach order and punctuality. This must be especially observed if the child gets any feeding except its mother's milk. The hours for this extra diet must be regular. For the purpose of feeding, rusks, tops and bottoms, and biscuits are used, soaked in hot water, and then beaten to a pulp, and sweetened. A teaspoonful of cream should be added when the food is given, but it should not be left standing about, or the whole will sour, and disorder the child's stomach. For our part, we have found patent barley the best infantile food. It can be procured from any grocer; and is prepared, like gruel, with half skim-milk, half water, boiled for twenty minutes, a little sugar added, then put into a jug, and poured into the feeding-bottle when required. The quantity of meal used will of course vary according to the number of times you feed the child; but a very short-experience will show the right proportions.

For a delicate child, or one inclined to be what is known as "rickety," no recipe can be better than the following:—

Buy two pounds of shin of beef bone, without meat or gristle upon it—purely and simply bone. Chop it up into very small pieces, not larger than a farthing-piece. Wash, and put these into a saucepan, with a quart of water and a pinch of salt. Boil very gently for six or eight hours—the object being to extract the lime from the bones; then strain and set aside in a basin. When cool, take the fat off, and you will find a clear, hard, white, tasteless jelly—a table-spoonful of which, melted in half a teacupful of hot water, will pulp a small piece of toast or biscuit, and make a meal for the child. Twice, or even once a day is sufficient for an infant. As the age increases, increase the quantity gradually.

Many new inventions in feeding-bottles have lately been introduced, few of which, in our opinion, can vie with the old-fashioned bottle, provided with an india-rubber nipple, or one formed of the calf's teat. This last requires more attention on the mother's part. She ought, in fact, to have two, and use them on alternate days, keeping that not in use in a little gin or whisky, and washing in warm water before putting it upon the bottle, where it must be very firmly tied with a piece of fine tape. The bottle so frequently used now, with the long gutta-percha tube, no doubt saves the nurse a certain amount of trouble, but requires too strong a pull and strain from the tongue; besides, the food is apt to get cold, and cold food always gives an infant wind, and causes it to torment the mother by a fit of crying.

Careful washing night and morning is all important. The whole body must be well rubbed and soaped. Then put the child into the water, supporting its back with your left hand, having your fingers well spread out; rub off the soap with the right, and lave the water over the back and head; taking care never to frighten or force the child into the water; but, if on any occasion it shows an aversion to the "ducking," coax it in, or even give it a wash only upon your knee, rather than risk exciting its fears.

Every part must be carefully dried, especially the folds of the skin, as these, if left wet, are sure to chafe and become sores, often very difficult to heal. Violet-powder is used to dust into these folds, but is worse than nothing unless the skin is perfectly free from damp. When washed, let the child stretch well, and, lying flat upon your knees, enjoy its freedom from the trammels of clothing. A healthy child will always stretch and use its small limbs in a most energetic manner when naked; nor does it at all relish having itself dressed again.

Always use rain or soft water, if you can get it, curd

soap, and a bit of flannel made into a fingerless glove. Rub till the skin is in a glow, taking care not to ruffle or chafe it. In winter weather, a few drops of glycerine in the water will prevent frost-roughness or chapping, both entailing much suffering upon the little one, and at the same time capable of being avoided by proper care and attention.

The garments heaped upon infants seem incongruous, but are much the same, as regards quantity, in all ranks; quality, of course, depending upon the parents' purse, and accordingly the outlay in baby-linen will vary very considerably.

In our next paper we shall begin the consideration of the question of clothing for children, commencing with full instructions for making all the most necessary articles of baby linen.

ANIMALS KEPT FOR PLEASURE.

I.—THE DOG: ORIGIN AND PRINCIPAL VARIETIES.

It is impossible now to determine with certainty the origin of the dog. It seems generally agreed (there are a few exceptions) that all the varieties now known have had some common ancestor; but about the character of that ancestry very different opinions prevail. Perhaps the most popular view amongst naturalists is that which considers the *wolf* as the original type; and there certainly are strong reasons to be urged for the belief, absurd as at first sight it may seem. That the wolf and the dog will breed together, and that the progeny is fertile, has often been proved; and Arctic travellers have again and again remarked that the Esquimaux dog and the wolf can hardly be distinguished. In his account of the well-known expedition led by him in search of Sir John Franklin, Dr. Kane relates that on one occasion a wolf was reported at the meat-house, that he went out to shoot it, and shot—"one of our *dogs*." I could have sworn he was a wolf." Many of them have all a wolf's ferocity; and Hayes, in his "Arctic Boat Journey," gives a thrilling narrative of his narrow escape from being devoured alive by them. Having on one occasion, when they were hungry, incautiously come near them with nothing in his hand, they lost their instinctive feeling of dread, and he only saved his life by providentially perceiving one of the dreaded Esquimaux whips a few feet distant, before which the gaunt animals retreated. He also relates how, at Proven, where many of these dogs were kept, the grandson of the governor was actually devoured by them before his mother's eyes, while walking from one house to another only twenty yards distant.

Most of these Arctic dogs have lost the wag of the tail when pleased, which is so distinct a peculiarity of the dog family; but some of the finest individuals retain it, and, in fact, in some part of the world or other it is indisputable that almost every conceivable gradation between the dog and the wolf may be found, both in zoological character and mental disposition. We cannot therefore deny, as some have done, that the wolf *may* have been developed into the dog; and yet we think there are still stronger reasons for holding the contrary opinion—reasons which cold science little considers, but which really ought to have as much weight as those which she herself relies upon.

The wolf has been bred in captivity for *four generations*, with scarcely any abatement in its ferocity and wildness of character. Now men do not take a great amount of trouble for no return; and is it likely that the earlier races of men would or could have had such *faith* in the ultimate reward as to persevere age after age in the attempt to reclaim the untamable beast? Such questions may be unscientific, but they are reasonable; and there is another case which bears so strong an analogy, that we cannot forbear quoting it in point. There is not, and,

back to the farthest period which we can trace, there has not been, a *wild camel* on the face of the earth: it is only known in its subjection to man's use. Further, it is wonderfully adapted to his use, and it has on its knees callosities which fit it for the constant *kneeling down* which is required to receive the burden or the rider, but which, in a state of nature, it would never require. Well, the reader may think, there seems nothing strange in this; we all know how constant use will harden our own bodies, as is proved by the horny hand of the mechanic. Yes, this is true; but while the hand of the mechanic's *infant* is soft and delicate as that of the imperial prince's, it is not so with the callosities on the knees of the camel: the *young camel is born with them*; and to those who are not too proud to receive it, the conclusion seems irresistible, that the animal was created by a gracious Providence expressly for the use of man. And when we consider the matchless sagacity of the dog, his bodily strength and power of attack, which make him so formidable, but combined with that marvellous affection and disposition to obedience, which put all at the service of the human race, we find it far easier to believe that he also was received at the hand of a

white, or black and tan. The muzzle is fine and sharp, with a "foxy" look about it, the eye bright and sparkling with intelligence, the ears nicely rounded, and well falling over—we hate to see them cropped or the tail cut. The tail is fine, the limbs graceful but muscular, and the whole animal "tight" and well made.

The black and tan smooth terrier is often bred very small under the name of the "toy" terrier, and some animals have fetched extraordinary prices. We cannot say we admire these little beasts. They are excessively delicate, and difficult to rear, often having not even strength to "grow their own hair" till nearly at maturity, and consequently growing up in a state of miserable nudity it is painful to witness.

The *Scotch* or rough terrier is a hardier animal, and the hair makes the body and muzzle appear of very different shape, but if this be put back, the muzzle, as in all the varieties, will be found fine, though the dog is rather more robustly made altogether. This breed is not quite so lively as the preceding, but of dauntless courage. Our illustration shows a specimen of this very favourite variety of dog.

The broken-haired terrier is mid-way between the

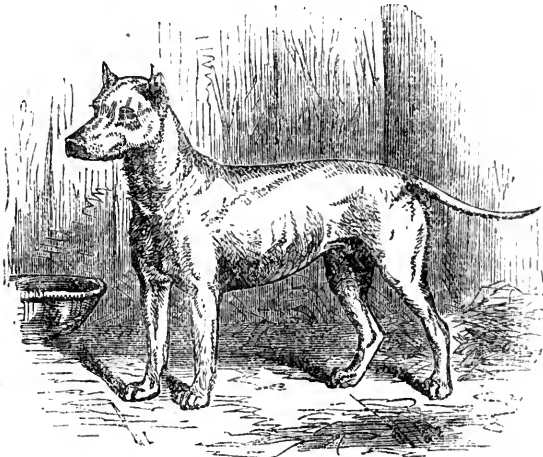

THE BULL-TERRIER.



THE SCOTCH TERRIER.

Creator, than that man, in the course of a century or two, *made* him out of a wolf! and that if the two be identical, it is more likely that the wolf is a feral dog, than that our faithful guardians are wolves reclaimed. The plan which we propose to pursue in these papers is, first to describe the different varieties of dogs, noticing their special peculiarities and the use for which each is best fitted, and pointing out clearly what are the "points" to be specially attended to in the choice of an animal of each individual species. We shall then proceed to give instructions as to their rearing and feeding, both as regards the sort of food to be given, and the system of giving it, as there can be no doubt that information on these subjects is very much needed; and we shall also describe fully what have been found to be the best methods of "breaking" dogs and training them for the special purposes for which they may be intended.

And first must be named the *terriers* as being a class of universally popular dogs, while the hereditary enmity of the whole race to vermin makes them very useful. They all share this feeling, but while the smooth English terrier will always pursue a flying rat, he often declines a real fight. This is not, however, the case with well-bred dogs, which, as an old rat-catcher said, "never die in debt."

The smooth English terrier is most prized when pure

two, the coat being moderately long, and of hard, wiry texture, yet close to the body. This is a splendid vermin dog.

The *Skye* is well known as the longest in proportion and hairiest of all dogs. He is always kept as a pet, though possessing a good share, when well bred, of the courage of his race. The delicate, white, woolly-coated dogs, often called *Skyles*, are nothing but mongrels, the coat of the true *Skye* being always of a hairy character. This species is more or less good at vermin, though his long hair hindering his sight, gives him less chance than other dogs.

There is a Scotch breed known as the "Dandie Dinmont," celebrated by Sir Walter Scott, which somewhat resembles the *Skye* in length of body, but has a shorter coat, and the legs are without "feather," while the *Skye* is covered to the toes. It has the squarest muzzle of all the terriers, and is also characterised by a downward curve in the middle of the back. This terrier, as described by Sir Walter, is perhaps the "gamest" of the lot, and certain death to anything "that ever cam' wi' a hairy skin on't."

All the terriers are good-tempered, faithful, companionable dogs, and from their "wide-awake" qualities, very serviceable to awake a larger, but more sleepy animal.

The *bull-terrier* is a larger and more powerful dog, obtained by crossing the bull-dog with the old English

terrier. When there is too much bull blood, or the animal is carelessly bred, the temper is apt to be ferocious and quarrelsome. Such a dog is absolutely worthless, and highly dangerous from his great power. But well-bred animals are generally good-tempered, civil, and obedient, and as vermin dogs, have no equal. The jaws should show great power from the bull-dog blood, but the loins and back are also strong, and the general shape very nearly approaching that of the smooth terrier, but rather more massive.

Where a large dog cannot be kept or is not desirable, the bull-terrier is a splendid watch dog, or protector for a lady, provided his disposition be trustworthy, a point which is easily ascertained. His fidelity and courage cannot be surpassed. The illustration given of the bull-terrier is taken from a very finely-formed and well-bred specimen of this variety.

The *poodle* is *par excellence* the "clever dog." Nearly all the learned dogs which know the alphabet, or play dominoes, &c., are French poodles. Everywhere this breed shows an extraordinary aptitude for learning tricks, and hence is a great favourite with children. Their affection and fidelity are also exemplary; but they belong rather to the class of pets than useful dogs.

INMATES OF THE HOUSE.

I.—LAW OF MASTER (OR MISTRESS) AND SERVANT.

THE relation of master and servant arises out of the necessity under which a man labours to call in the assistance of others, where his own skill and capacity are insufficient to answer the cares incumbent on him.

In the following remarks, what may be said of master and man will be equally applicable to mistress and maid.

Domestic Servants.—These are also called *menial* servants, because their service lies *intra mania*, within the walls of a house. They may be of several kinds, as butler, footman, nurse, cook, housemaid, &c.; and the nature of their service, its limits and its obligations, may vary according to the terms agreed upon at the time of the hiring. But there are certain duties which are generally required of such servants, and in the absence of any express agreement it will be understood that it was for such general and customary service that the hiring took place. Whenever anything unusual or special is to be required of a servant, it should form the subject of an express stipulation previously to engagement. Otherwise, after the trouble taken to get character, and trouble caused to the servant by coming in, the master or mistress will be liable to be told, "I was not engaged to do this." So that if the coachman is intended to wait at table, in addition to his duties in the stable; the nurse to do part of the house-work; the cook to assist the housemaid in doing what is commonly understood to be "housemaid's work," the intention should be made clear at the time of hiring; and though it is not absolutely necessary, it will be found for every purpose most convenient if the conditions of the service, that is to say, the work to be done and the wages to be paid, be reduced into a memorandum and signed or "marked" by the servant. What is the regular duty commonly required of servants with whom no express contract has been made is matter of common fame to which any one can testify in the event of a dispute. It is, however, too universally known, often to form the subject of a quarrel.

Duration of the Service.—It is customary in this country to hire domestic servants at so much a year, but there is not generally any agreement as to the time the service is to last. Unless any express agreement be made on the subject, the law understands *that either party may de-*

termine the service at will, upon giving a month's warning, or upon payment or forfeiture of a month's wages. With clerks, governesses, or others holding posts not menial, it is otherwise—a quarter's notice or a quarter's salary is the condition of leaving.

Summary Dismissal.—This power is reserved to a master or mistress, in order to prevent them from being saddled with what might be an intolerable nuisance. It must, however, be exercised, if at all, under such circumstances only as the law would approve, else servants would be liable to be cast forth suddenly upon the world at the caprice of their employers, who might do injustice in a moment of passion, or under the influence of mistaken judgment. When a domestic servant is guilty of immoral conduct, wilfully refuses to obey orders, gets intoxicated, stays out all night without being able to give a satisfactory reason for so doing, or habitually neglects to carry out his or her master's (or mistress's) lawful commands, such domestic servant may be summarily dismissed, without any more wages being paid than are actually due. Of course in cases of detected theft, summary dismissal is allowed; and dismissal is generally accompanied by delivery into the hands of the police. A master or mistress has the right, in the case of loss through theft, to cause the servants' rooms and boxes to be examined. The act of giving into custody on mere suspicion, however, is attended with the responsibilities which attach to the act when done towards anyone whatever. In the event of any mistake, or failure to show reasonable ground for suspicion, the employer will be liable to an action for false imprisonment, and possibly also for defamation of character.

Warning.—A clear month's warning is all that is required. So that this be given, it does not matter whether it be a month from the last pay-day, or, indeed, from any other particular date. It generally is a month from the date of the act committed, or omitted, which induced the employer to give warning. This is true also of warning given by the servant.

Duties of Employers to Servants.—It is the duty of an employer to pay his servant the wages agreed upon, and to house and to feed him in a suitable manner. What is a "suitable" manner must depend upon the class of servant, the nature of his service, and the means of the employer; but it may be understood to be required by law, that the lodging must be such as would be approved for size, cleanliness, ventilation, and power of shelter from the weather, by the health officer of the district. As to diet, that is very much a matter of agreement; and it is well, in all cases, to settle it at the time of hiring, when the allowance of beer (if any), of tea, the number of meat meals per diem, and other matters, can be arranged. The law would simply require that sufficiency of good and wholesome food for a man or woman of the servant's age should be supplied. Custom has much control in the matter, however, the law seldom being invoked except in cases of brutality, malicious ill-feeding, or stinting on starvation allowance. A servant who is at all dissatisfied with his meat, has the remedy in his own hands by leaving it.

Though we do not profess to write for persons who would be guilty of malicious ill-treatment of their servants, it may be useful to mention, for the information of whomsoever it may concern, that an Act of Parliament, passed in the present reign, provides for the better protection of persons under the care and control of others as apprentices or servants, by declaring that where the master or mistress of any person shall be legally bound to provide for such apprentice or servant necessary food, clothing, or lodging, and shall wilfully refuse or neglect to provide the same; or where the master or mistress shall unlawfully and maliciously assault such apprentice or servant, whereby the life of such person shall be endangered, or

the health of such person permanently injured, or likely to be so, such master or mistress shall be guilty of a misdemeanour, and punishable with imprisonment for a term not exceeding three years, with or without hard labour.

An employer is not bound to provide a servant with medicine or medical attendance, but he must not discharge him (or her) without a month's warning or a month's wages, in the event of his (or her) becoming disabled by sickness or other accident from performing duty. He cannot refuse admittance to a medical attendant called in by the servant at his own expense, during the time the servant is in the house. If he be annoyed by the visits of such medical man, or suspect him of misconduct, he can give his servant warning, and so get rid of the invalid and doctor together.

Giving "Character."—The law does not oblige any one to give a "character" to a servant. It is perfectly competent to a master or mistress to refuse one without assigning any reason for the refusal. If, however, a character be given, the law prescribes the circumstances under which it shall be given. The conversation or letter in which the character is given is a privileged communication, and is exempt from the operation of the law of libel and slander, if the information be given in good faith, and without a malicious intent to injure the character of the servant. Proof of malice does away with the privilege, and lays the injurious character given open to an action for defamation. Short of covering malice, the law protects those who give characters honestly, that is to say, in accordance with what they know, and in accordance, also, with what they suspect; and even if what they say be untrue in fact, but yet honestly said, the law holds them excused. It may often happen that a mistress has good reason to suspect that her late servant was not in some particular what she should have been, though she may not have been able to bring an accusation home to her. Under such circumstances the character giver is warranted in disclosing to the character seeker what she really thinks.

A statute of George III. provides that if any person shall personate a master and give a false character to a servant, or assert in writing that a servant has been hired for a period of time or in a station, or was discharged at any time, or had not been hired in any previous service, contrary to truth; or if any one shall offer himself as a servant, pretending to have served where he has not served, or with a false certificate of character, or shall alter a certificate, or shall pretend not to have been in any previous service, contrary to truth, the offenders in such cases are liable, on conviction before two justices of the peace, to be fined twenty pounds, or in default, to be imprisoned, with hard labour, for from one to three months.

Liability of Master (or Mistress) for a Servant.—A master may justify an assault committed in defence of his servant, as a servant may justify an assault committed in defence of his master. If any one cause or procure a servant to quit his master's service, or hire him at the time he is in that service, so that he leave it before he be legally entitled to do so, the master can bring an action for damages against the new master and the servant.

For all acts of a servant done by command of the master, that master is responsible, as he is also for certain acts not done by his command, but done under circumstances that seem to warrant the idea that the master has consented to be responsible. If a servant, in pursuance of direct orders, shoots a neighbour's dog, the master of the servant will be clearly responsible to the owner of the dog; and if a man has a coachman who drives badly and runs into a carriage, that man, by trusting such a driver with the reins, is assumed to have undertaken the responsibility of his acts. Some one must suffer loss; who so worthy as the man who caused it, by

employing an unskilful servant? If a blacksmith's servant lame a horse in shoeing him, the blacksmith must make good the damage caused to the owner. It is at the same time no excuse to the servant who does an unlawful act, such as shooting the dog, that he did it by order of his master. He is not bound to obey any unlawful command.

If a servant commit an injury without the authority of his master, the master is not liable. So that if the laundry-maid at Mrs. A's, having a quarrel with the laundry-maid at Mrs. B's, destroys Mrs. B's clothes-lines, or throws lighted lucifer matches among the clothes hanging out to dry, so that the clothes are burned, Mrs. A is not liable. If the cook at Mrs. A's come into Mrs. B's house and says that her mistress is in need of change for a five-pound note, and that if Mrs. B will give the cook the change, she will herself presently bring the note, in such a case, if the cook, unauthorised to say what she did, goes off with the money, her mistress is not liable to make good the loss to the deceived person.

If a servant procure articles on credit from a tradesman with whom her mistress has been in the habit of dealing for cash payments, it is the tradesman's loss if the servant prove a cheat. If, however, the mistress has had articles sometimes for cash, sometimes on credit, it is her loss; for the tradesman cannot know whether she has really ordered the goods or not. But by far the most preferable system is that now adopted by most respectable tradesmen—namely, to have every order entered in a book, the tradesman undertaking not to supply anything without a written order from the customer.

THE HOUSEHOLD MECHANIC.

INTRODUCTION.

IN commencing a series of papers upon the subject we have before us, it is satisfactory to know, that while comparatively few people possess more than a very slight knowledge of the mode of construction of the commonest articles of domestic use, yet there are a vast number of persons who, either from motives of economy, or for the sake of having an unfailling means of recreation, desire and seek after assistance and instruction on this subject. In writing these articles our aim will be, first to incite a taste for the constructive and mechanical arts, and then, by a series of familiar examples, beginning with the most simple forms, and gradually getting up to the more complex and difficult, to put the would-be learner in the way of educating himself, sufficiently at least for him to be able to accomplish any ordinary task likely to be required in a moderate household. We shall also take it for granted that our readers are entirely ignorant of the smallest knowledge in handling a tool, and we must, therefore, ask those who have attained some slight proficiency to bear with us if, in the first chapter or two, we enter rather more minutely into details than they might consider necessary.

We shall first introduce to our readers the principal tools with which they will have to become acquainted, explaining briefly their separate uses and the principles which should govern their application, in order to produce the greatest effect with the least amount of labour, and also the means to be taken to preserve their effectiveness. Next we intend describing the nature and mode of treatment of the different woods and other materials likely to be required by the beginner, giving some idea of their different qualities; and having thus brought together the objects to be worked upon and the means of working them, we shall proceed to give practical directions for the construction of some common object found in every house, such as a door or window frame,

&c.; judging that having once learned to handle tools well, our readers will find no difficulty in adapting their knowledge to each particular piece of work. We intend to give, in detail, instructions whereby the householder who is fortunate enough to possess out-door space, may be enabled to erect sheds or fowl-houses and cucumber frames, and, if necessary, small greenhouses, not forgetting that if he gets these, he will most likely want some such thing as a wheelbarrow, and other conveniences, which he may be enabled, by our directions, to construct for himself.

In-doors, the details of window-blinds, curtain-poles, shutters, door locks, and springs, will be explained; and as now-a-days almost every house contains some specimen of patent machine, we shall devote a chapter to the explanation of the working of a few of these labour-saving contrivances. Then again, it is necessary, and in many cases indispensable, that every occupant of a house should be familiar with the arrangement of his gas and water apparatus; for every one knows how many serious gas explosions and expensive overflows of water might have been prevented by a very slight knowledge of these matters.

In all our instructions we shall aim at being rather practical than theoretical, though not forgetting that a thorough knowledge of the theory if not indispensable is certainly a great assistance to the attainment of perfection in practice.

We give the following list of tools for the benefit of those who do not intend getting a complete set, so that each may pick out what he most requires, either as his convenience may dictate or his pocket admit. The prices are of course only approximate, and will vary with the degree of excellence sought.

	s.	d.	s.	d.
Hammer	1	0 to	2	0
Mallet	0	8 ,,	1	0
Hand-saw	4	6 ,,	6	0
Tenon-saw, with iron back			5	0
Jack-plane with double iron			4	6
Smoothing-plane ,, ,,			3	6
6 Chisels, various widths, @ 8d.			4	0
2 Mortice-chisels (½ in. & ¾ in.) @ 1s.			2	0
1 Screw-driver			1	0
2 Gouges @ 10d.			1	8
4 Gimlets (patent twisted are best) @ 4d.			1	4
6 Brad-awls @ 2d.			1	0
Pair of Pincers			0	9
,, ,, Pliers			0	9
Pair of Compasses (with wing)			2	0
Square			2	0
Mitre Bevel			2	6
Rule			1	6
Marking-gauge			1	0
Brace & Bits (according to number) 10	0	0 to	30	0
6 Files and Rasps @ 8d.			4	0
Oilstone (Turkey)			1	6
Oil-can			0	6
Glue-pot and Brush			1	0
Nail-punch			0	2

The above are almost indispensable, and the following will be found useful.

	s.	d.	s.	d.
Keyhole-saw in pad			2	0
Table-vice	3	6 to	6	0
Axe			3	0
Spokeshave			1	3
Mortice-gauge			4	6
Blowpipe (common bent)			0	6
Grindstone	5	0 and upwards.		

As the above prices are taken from the catalogue of a noted London tool-maker, we do not fear that any of our readers will have to pay more. It will be seen that for an outlay of between two and three pounds a very complete and serviceable set of tools may be obtained; but do not let any with short purses get the idea that they cannot do with a much smaller quantity than named here, while at the same time we certainly advise those who can afford it to start with some such assortment. From time to time, as we enter into the different branches mentioned in our introduction, we shall need to make additions to our stock.

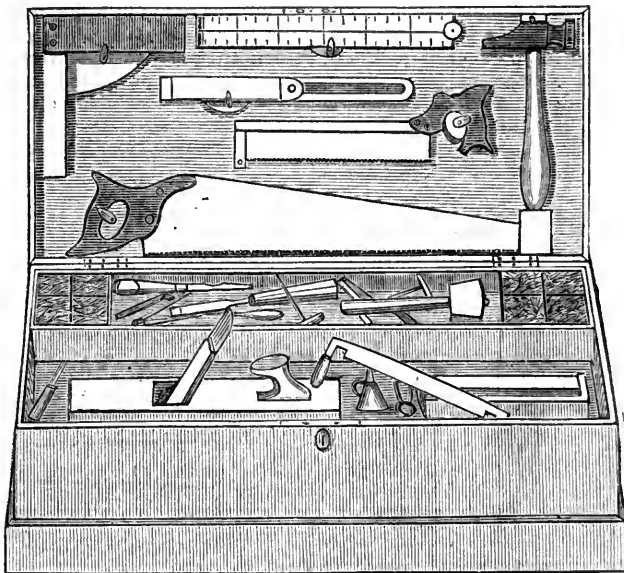

TOOL-CHEST.

THE TOOL-CHEST.

In cases where the expenditure of two or three pounds is possible we should advise the purchase, from some respectable tool-maker, of a complete set in a chest, which will form a nucleus, to which additions can be made as they are required. If, however, any of our readers are fortunate enough to be able to set aside a room as a workshop, the chest will hardly be needed, as it

will be found much more convenient to hang the tools in racks or perforated shelves fixed by brackets to the walls over the bench. This saves the trouble of having to replace the tools in their box each time after using, and also facilitates the finding of them when wanted.

The engraving (purposely drawn out of perspective so as to show the interior of the box and lid) exhibits a convenient arrangement for a chest, supposing our amateur cannot manage to devote a room exclusively to the purpose. It will be seen that the lid is fitted with narrow contrivances and fastenings, by which the tools are fixed, so that the lid may be closed without their falling from their places. The tray rests on slides in the sides of the box, so as to admit of its being pushed backwards and forwards for greater convenience in getting at the articles underneath. Sometimes two trays are used instead of one. These trays generally contain partitions or divisions at either end, to keep the nails, screws, &c., distinct, the centre space holding the lighter tools, such as brad-awls and gimlets. For the chisels and screw-drivers, a rack made of two slips of wood the whole length of the box, screwed at about three-eighths of an inch apart, fastened inside the front at just such a distance from the bottom as to prevent the hanging tools from touching it, will be found handy. The planes, oilstone, and heavier tools will go best underneath. Any strongly-made box may be easily fitted up for a tool-

chest in this manner, and the work will be found capital practice for a beginner.

We now proceed to explain fully the different varieties of the tools, and the uses for which the various forms are specially contrived.

In so doing we shall doubtless have to place before our readers many that they will not be likely to require, but in order that those who are intending to purchase tools should not be put to unnecessary expense, it is important they should rightly understand what they need and what they need not have. We shall, therefore, at once proceed to the description of the different contents of our tool-chest, explaining as simply as possible the way of using each tool, and the work for which it is adapted, and adding instructions as to the proper way for keeping it in order.

Brad-awls.—These are merely pieces of steel wire ground with two faces at the point, which faces meet and form a cutting edge. In use, however, this tool does not cut, but wedges the fibres of wood on either side. The upper end is sharpened and driven into a wooden handle, which has a brass ring or ferule to prevent it splitting. Some awls are square wires sharpened to a point. Coopers' awls have curved blades. Sets of brad-awls which all fit into one socket, and store away in the handle, which is hollow, and unscrews, may be met with; but being mostly got up cheaply they are seldom satisfactory.

Brace and Bits.—Fig. 1. is a diagram of an ordinary carpenter's brace made of wood with brass mountings.

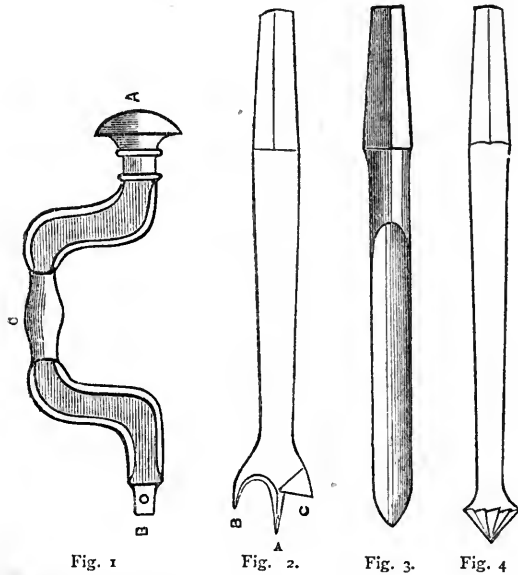

It is in principle a simple crank handle. The top, A, which swivels loose, is rested against the chest; and in the bottom, B, is a square hole, into which the bit is inserted, and held either by a spring catch, or a screw. There are various forms and varieties of this instrument, but the principle and action are the same. The brace is turned by the right hand, which grasps the part C; the handle, A, being kept in position on the chest by the left hand.

Fig. 2 is a centre-bit. It consists of a central triangular point, A, which enters the wood first and guides the tool; an arm or knife, B, which regulates the diameter of the hole, cutting the edge cleanly, and a cutter or chisel, C, set obliquely, which follows and pares up the wood into shavings. Centre-bits are of various fixed sizes, but may also be obtained with movable blades, so that by shifting this blade, holes of different diameters

may be made with the same cutter. For small holes a gimlet-bit, which is only an ordinary gimlet with a square end made to fit the hole in the brace, and pin and nose-bits, are used. The pin-bit, Fig. 3, is a fluted wire, sharpened at the end like a small gouge; the nose-bit is like a pin-bit with a small blade turned under, which cuts out the wood; Fig. 4 is a countersink-bit, used for enlarging holes, or to sink a depression to allow the heads of screws to be buried level with the surface. Augers and screw-drivers are also fitted as bits, and rymers or broaches, for enlarging or making holes taper, are used in the same way. Of drills and the more powerful forms of ratchet braces, we shall have to treat when we arrive at metal work.

Chisels.—A common chisel, Fig. 5, is a flat blade of steel sharpened from one side at an angle of about thirty degrees. It is driven into a wooden handle up to the shoulder. In principle all chisels are wedges, and it should be borne in mind that as such they tend to split and tear up the fibre of wood when the shaving cut is too thick to bend to the pressure of the edge of the tool. Paring chisels are much thinner and wider than ordinary ones, and are used for clearing out deep holes, such as mortices.



Fig. 5.

Mortice Chisels, Fig. 6, are much stronger and thicker, and are sharpened in the same way, but with an angle rather less acute. Gouges are only curved chisels, and are used in the same manner. Chisels are used either by the pressure of the hand, or by blows of a mallet, the flat side being always kept in the intended path of the blade, which path it regulates and guides.

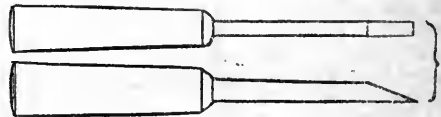

Fig. 6.

The above diagrams show the chisel-blades seen on the edge and from the back.

In sharpening chisels they should be ground on the stone slightly more acute than their finished edge is intended to be; this is in order to reduce the surface, which will have to be perfected or polished upon the oilstone. In all cases after sharpening it will be found that there is a slight burred or wire edge upon the extreme end of the flat side of the blade which must be removed by rubbing on the stone, taking care to keep the blade down perfectly flat on the stone, or a second bevel will be produced, thereby increasing the angle of the edge, and destroying the keenness of the tool. In sharpening on the oilstone the tool must be firmly held by both hands, and rubbed backwards and forwards, always being traversed in a parallel path, as any approach to a rocking motion would produce a thick rounded edge. Gouges are sharpened in the same way, of course receiving a rolling motion to bring all parts of its edge into contact with the stone. This motion requires some little practice to perform satisfactorily. The wire edge on the inside of the gouge is removed by rubbing a small round slip of oilstone against it, but in this case the chisel is fixed and the stone moved.

In large workshops stones are kept having hollow grooves in their surfaces, in which the round gouge blades are rubbed. Both chisels and gouges are made of various widths and strength; but three or four of each will be found sufficient.

THE AQUARIUM.

As the study of all animal and vegetable life presents to the mind a special and elevating influence in addition to the interest it excites, it is a subject for personal gratitude, that the principles upon which the structure of the aquarium is founded have been so carried out and simplified, that this little world in miniature may be adapted to any scale, and that in place of the bowl in which gold-fish were formerly imprisoned and doomed to a slow consumptive death, we can adorn the parlour window with a self-renovating, self-supporting lake, in which the denizens of the water imbibe their natural food, and breathe the gases necessary to their healthy existence.

To the hard-working town dweller, who seldom sees the country, or has an opportunity of witnessing the interesting operations of nature, an aqua-vivarium must be especially entertaining, and, as in the course of our papers we hope to prove, easily attainable, being neither expensive to form nor difficult to manage.

The first matter essential to be understood is the principle upon which the aquarium should be managed. To support animal life certain natural operations must be carried on, and upon the proper provision for these, success will depend. If a gold-fish be placed in a "globe" of water, it will at first glide comfortably round, about half-way between the surface and the bottom, but after a few hours it will become languid, get nearer to the surface, and ultimately raise its mouth out of the water, as if gasping for breath—a sure sign that the water does not furnish it with what is required for its comfort. No animal can exist without air, and fish, like creatures that live on land, need a supply of oxygen, which is the gaseous element in air that supports life. Besides this, animals give off by respiration a poisonous gas, called carbonic acid, which must by some means be disposed of, or it will impregnate the surrounding air or water, and ultimately destroy the creatures within reach of its influence. Now the reason that the gold-fish becomes uncomfortable is that it has by breathing exhausted the air in the water, and polluted it with its exhalations; the oxygen has been

consumed, and the carbonic acid has been imported into the water, although to all appearances it remains clean and pure. It will thus be seen that what is required to render the aquarium self-supporting, and obviate an otherwise necessary change of water, is that something should be introduced that will supply air and at the same time absorb carbonic acid. To ascertain what will perform this office, we have only to look into a pond or river, or peep into the pools among the rocks at the seaside, when we shall discover that Nature's own method of purifying and aerating the water is by vegetable

growth. In fact, it may be laid down as a principle, that in an aquarium the natural condition of its inmates should as nearly as possible be imitated in every particular. There should be the same animals, the same kind of vegetation, the same amount of light, and the same temperature as if the aquarium were a nook in the corner of a natural piece of water.

The dimensions of the aquarium must of course depend upon the space that can be afforded. The simplest and least expensive is the bell glass, Fig. 1, such as confectioners use to cover cakes. This being inverted and placed upon a stand, forms a pretty ornament, and has the advantage of being adaptable to any situation. By the arrangement of a few ferns in pots, and a basket of creeping plants suspended from above, a window may be made exceedingly ornamental. Where space is not so much an object, an oblong tank may be selected. This may be

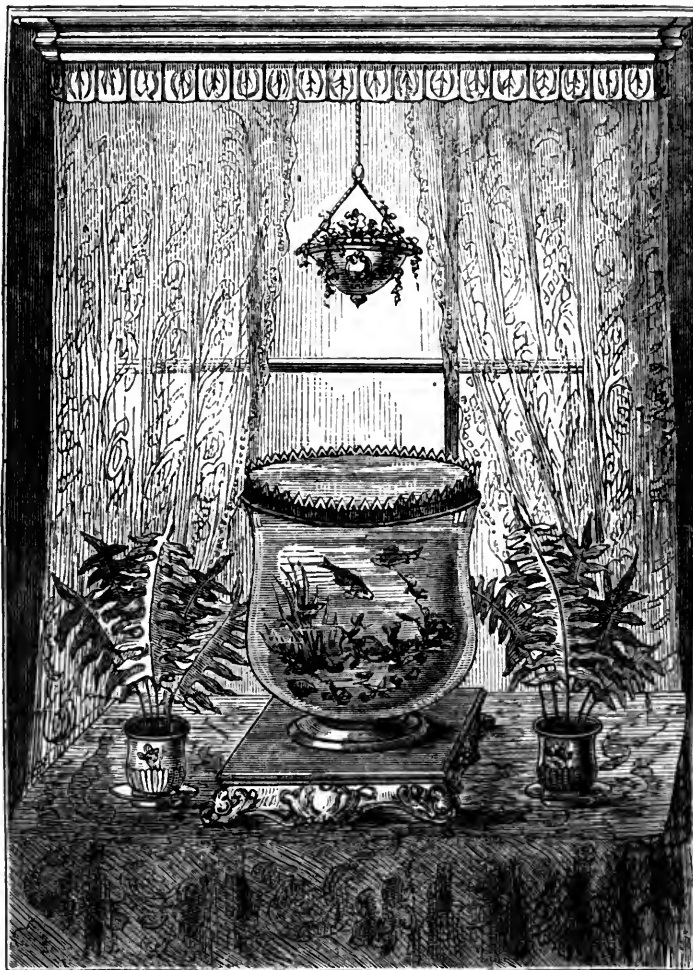

AQUARIUM FOR THE WINDOW.

made of any size. For fresh water the framework may be of wood, zinc, iron, or glass pillars, with glass sides, but the best are those made of slate with a glass front, or with slate ends and glass at the front and back. If not made of slate, the bottom should be lined either with glass or slate, which can be embedded in a thin layer of Portland cement. Wood frames are undoubtedly the least durable for the purpose, for they soon leak, and cannot be satisfactorily repaired.

Tanks for fitting on the outside of window-sills, where much weight would be an objection, may be made with a sloping back, as in Fig. 2. This shape has also the advantage of presenting a large surface of water to the action of the air, but it is most suited for marine aquaria,

in which the objects do not require so much space to move in. When it is intended to place the aquarium some distance from the window, the hexagonal shape, Fig. 3, is often chosen as the most ornamental; but this is also better adapted for marine than fresh-water specimens.

Having selected the shape of the aquarium, the next

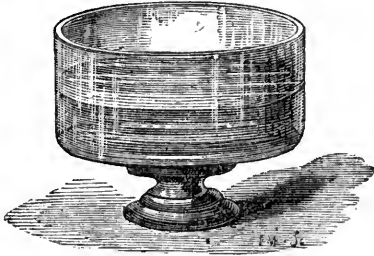

Fig. 1

consideration is the place it should occupy, which in most cases will be in front of a window. The best situation is a window looking towards the east, where it will get the morning sun for about two hours. The mid-day sun is too hot. If you have not a window looking to the east, give it a southern aspect, but be careful to shade off the noonday sun; a northern aspect is never good for an aquarium; a western is seriously bad. The great point

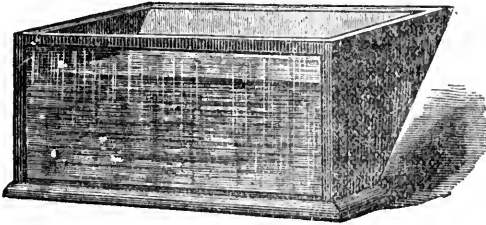

Fig. 2.

is to keep up an equal temperature as much as possible, the range being from 45° to 65° Fahr. This may be done by opening the window in summer, and by drawing back the tank from the window on winter evenings. On no account should the water be allowed to freeze. Not only do you risk the bursting of your tank, but the fish and plants will droop and die.

It is a matter of importance that the admission of light and heat should be properly regulated, and that they

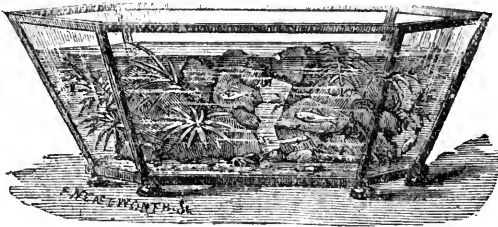

Fig. 3.

should be admitted only through the surface of the water. To accomplish this, in the case of bell-glasses or tanks with glass ends and back, thin green paper should be pasted over all the glass except the front, up to the water-line; by this means the light is subdued, besides which the objects in the aquarium will always present a better and more natural appearance if the light is admitted at the top. The aquaria in the gardens of the Paris Exhibition—the most successful experiment of the kind yet tried—were all constructed on this principle, and presented an exceedingly beautiful appearance. The

admission of light through the opposite side or end of a tank will produce an excessive growth of vegetation, and cause the accumulation of a green film on the front, that will, in a short time, obscure the contents of the aquarium from view.

Having made or planned your aquarium, you must prepare the bed of your pond. The first thing is to get some river sand, or fine gravel, cleanse it thoroughly till the water runs from it quite clear, and then lay it in the bottom of the tank to the thickness of an inch at least; over this, in places, lay small pebbles; if you want a rock-work or miniature caverns, pile up small blocks of granite, fastening them together with the best Portland cement; other cements are liable to taint the water and injure the fish, and even this should be allowed to remain in water for a week, in order that it may part with any soluble matter it may contain. Having laid your sand and gravel, and built your rockery, let the cement get firm, then add the water, and empty and refill it till the water is perfectly clear, when it will be in a proper condition to receive the plants intended to be introduced.

FURNITURE.

I.—GENERAL REMARKS.

ON the correctness of the taste displayed in furnishing a house, or only a few rooms, depends altogether the air of comfort which either will wear, and a corresponding degree of pleasure or discomfort in those who live in them. Often on entering a strange room one feels a sense of indescribable irritability, arising either from the incongruity of the furniture as regards size, style, and general ornamentation, or from the inharmonious colouring of the draperies, the confusion of pattern on the carpet, or the dazzling design of the wall-paper, not dazzling from its brilliancy, but from the regular and close recurrence of stripes, circles, and other geometrical forms, which bewilder the sight as if the pattern were in motion.

The proper furnishing of a house is as much a fine art as painting, and if the rules do not come by an intuitive faculty they may be acquired. The glaring defects in modern house-furnishing are, first, incongruity of form and size of furniture with the surroundings and means of the possessor, and next, an elaborate decoration of the rooms out of keeping with the position of the owner. And the third is the elaboration of ornament on the furniture, this not being superadded to utility, but subversive of it—ornament being understood to mean a superfluity above utility—permanently fixed or carved upon the article. Decoration means something portable, as vases, glasses, and pictures. The walls of a room covered with an appropriate wall-paper, a ceiling elaborately worked in moulded forms, as well as its cornices, and carved or beaded doors, are said to be ornamental. The meanings of the two words are very distinct. A person may be decorated with a feather, but is not thereby rendered more ornamental. A man's own fine head of hair is an ornament—it is irremovable by ordinary means—but his medals and jewellery are decorations.

Elaboration of ornament and decoration, in a house of great pretension but with small means to support it, is not a mark of good taste; neither is confusion of colour, for when blues and greens, reds and violets, are indiscriminately mingled in large masses, the eye of correct taste is thereby offended.

A few words on wall-papers may not be out of place—such as are suitable for cottage homes or houses of from £20 to £50 a year. In the suburbs of large towns the rooms of such houses are generally small. A large-patterned paper of a variety of colours will certainly cause them to appear much smaller than they really are,

and whether there be a cornice or not to such rooms, there must be no bordering-paper, this causing an apparent decrease in the height. Better by far than flowered paper or geometrical design is the "bloom" paper recently come into fashion. It is composed of different shades of grey, of pale pink and pale violet, all of them giving an impression of the beautiful colour "French white." There is a blue-grey, which borders on a pale steel tint, or a very pale smalt-blue. There is a pink-grey, which approaches either a very light blue-pink, or a very delicate mauve or lilac. There are two or three designs on the ground of this paper, but all in outline of distinct colours, and they are sold very cheaply, though the superior kinds of the same tints are expensive enough, and closely resemble silk upon a satin ground. Sometimes a pale lilac outline covers a creamy-white surface. Whatever be the patterns, the tints of these papers give an exquisite bloom and freshness to the room. All furniture, if it be selected with taste, looks well against them; and a great merit in them is that they can readily be cleaned with bread.

Striped papers on low walls are admissible, but these stripes interfere greatly with picture-frames. It is often impossible to hang the pictures at equal distances on the side of a wall so striped, so that the lines shall not interfere with the frames, and give an undue breadth on one side out of proportion to that of the other.

Ceilings, too, ought to have an individuality of their own—a requirement, not a fancy, which is but little attended to. A room on the north side of a house should have the ceiling of the palest tint of straw-colour, not yellow; or of the palest pink, either of which will diffuse a warm tone as of reflected sunlight. If the walls be of a mauve hue you can let the ceiling be a straw-colour; if of pink or smalt-blue, then the ceiling should be pink—but only of a very pale tint.

The blinds of a house it is a matter of elegance and comfort to arrange properly. They should be uniform in material in the front of a house, and indeed on every side. But then the front windows may have the Venetian kind, and if it be a southern aspect these are the best, while if facing the north they may be made of buff union cloth, which produces a mellow, warm tone when the light reflects through it.

There are some rules for furnishing rooms properly which may be always remembered. As regards form, the more cultivated and refined the intellect the greater is the craving for correct and refined forms. It is truthfully said that "the eye creates its own beauty," but on the other hand the eye may be educated not to select forms of ugliness and fancy them beautiful.

In small rooms, if any of the furniture be too large, no matter how good its quality, how handsome its shape, or how perfect its finish, if it has no fitness for its place it will exhibit the pretension and vulgar ambition of its owner, and look more as if taken in payment of a debt than as if selected by an educated mind. Costly carved furniture, or imitation of such, is totally out of place under the circumstances of small means and limited domestic service; for it is either covered to keep it from dust, or it is not kept clean and bright, as carved work should be; and thus it gives a look of "seediness" to the whole place, which irritates the temper of an observer, but is totally unfelt by those who see without observing. Plain but well-shaped furniture, without angles or stiffness, shining and clean, and having no dust-holes, gives a marvellous sense of repose to the looker-on, provided such furniture is for use and not for show.

Almost the first thing to be done towards furnishing is the making and putting-up of blinds, and where expense is a matter of consideration, and Venetian blinds not to be thought of, the affair is not one of trouble or much cost. Brass blind-furniture, requiring only fixing with nails or screws, can be obtained at most ironmongers'. It

consists of the wheel and pin for each end of a roller; also, the sockets for fixing them into the proper place. The wooden rollers and laths are usually kept by carpenters ready for sale. A woman may manage to fix all this properly, and afterwards make the blinds and put them up.

The blind must not be nailed close to the ends of the roller, but a space of half an inch left on each side. Thus, if the roller be 36 inches long from end to end, allow 35 inches for the space the calico of the blind is to fill, and the calico for this blind must measure 37 inches in width—always keeping the blind material one inch wider than the roller. The cloth will require the selvage to be cut off straight, and then the two sides folded down an inch in width. To do this accurately, with an inch measure and black-lead pencil nick the width of an inch down each side. Then fold the seam, single-turned, on these marks, and herring-bone them down.

For the seam to admit the lath, turn down a hem, and work in the centre of it an eyelet-hole in overcast stitch for the purpose of admitting the ring-screw. Then, instead of hemming this, sew it. Turn down once the remaining raw edge of the blind, and mark the centre with marking-ink; write on it, also, the name of the room in which it is to be placed. Mark with ink the centre of the blind-roller, and the lath the same, and also with the name of the room; so that, when a change of blinds is necessary, there is no waste of time or trouble in measuring them for the different windows. In nailing on the blind, nail it first in the centre, then at the two ends, with a few tin tacks, not driven close; then try with the two hands whether the blind will roll well. If not, it is certain that somewhere it is not straight, and will require to be put so.

After the blinds, the kitchen requisites should, in order of priority, be first mentioned. The matter of kitchen ranges is a vexed one. Makers recommend different kinds; but a truly economical and serviceable range—one that burns little fuel, not as matter of choice, but of necessity, and gives the greatest amount of heat without waste—is yet to be found. Many of them are wonderful contrivances, apparently, for the saving of labour, but with far too much ingenuity about them for any but an engineer to manage; being also, at the same time, the most coal-consuming. Under a person with thinking faculties, no doubt, many will prove all that their makers profess for them; but in the hands of ignorant girls—who are thankless pupils, even if they can be taught—these ranges are too often instruments of destruction, rather than labour-saving. To know how to cook with simple means and moderate appliances, is an art which may be acquired and never be forgotten, and to this object our papers on Cooking will be especially directed.

There is one thing which all kitchens may have at a moderate expense, and that is a warm-plate, made in the shape of a tin box, a quarter of a yard deep, half a yard wide, and forty inches long, similar in shape to those which pastry-cooks keep filled with boiling water to re-warm their pastry. This can be fixed to serve as a table, and forms, with the aid of gas, a hot-plate for keeping food in dishes warm till the moment of serving. The top should have two hinged lids, and the bottom be perforated to admit of two jets of gas underneath the lids, which can be opened for the purpose of lighting it. This same contrivance can be placed in the cupboard adjoining the boiler; a pipe fitted to the latter will conduct the steam, and so keep it always hot, without the expense of gas.

Kitchen cupboards should have shelves which, unless the landlord places them in, need not be fixtures. Movable shelves, fitted into a groove like the sides of a box, and furnished with rollers, can be drawn in and out at pleasure for the purpose of cleaning them.

It is not often that laths and hooks for hanging up dish-covers are found in houses of moderate rental. For

these, two uprights require to be driven into the wall, one at each end, and not deeper than the largest dish-cover, and upon these a wooden lattice-work is fixed, with also the necessary brass hooks screwed in, for holding the covers. The lattice-work prevents the covers from greasing the wall when, as is too often the case, a careless servant puts them up without wiping.

In dark kitchens, or others where the range is set in a dark place, one of the greatest comforts to a cook is to have a gas-light placed, with movable joint, on the left-hand side of the range when facing it, but high up, so that a light may be thrown on the saucepans or frying-pans when needed. In the shelves of the kitchen dresser, and in all shelves of cupboards, there should be a sloping groove in the centre, terminating in a raised rim, otherwise too often on the slamming of a door the crockery will clatter down and be broken. A beading put on is of little use.

Every mistress, no matter what her income, has her own ideas about the kind and quantity of kitchen furniture required. A young bride leaves her home, where a sufficient number of servants have been kept for all household work, where the kitchens are bright with tins and coppers, and everything looks as comfortable as sufficient time for labour can make it. This same young bride has no idea but that her kitchen must look nearly the same, and therefore provides the usual adornments, though having but one servant, perhaps, to perform all the duties of a regular staff.

In a small family with less than two servants, we hold that no more bright articles should be introduced than are needed for daily use, and no more time be expended upon the polishing of them than is absolutely necessary. A general servant cannot do more in the kitchen than to keep the dish-covers, kitchen fender and fire-irons, tin funnels, tea and coffee pots bright; but it does not follow that ample requisites in the way of saucepans, strainers, and things of the kind should not be provided. In our Cookery articles our readers will find instructions as to the various culinary utensils which are requisite. We here only suggest the kitchen furniture generally.

HOME GARDENING.

IT is one of the best of the signs of the times that the love of gardening and its practice, in and around our towns, have greatly increased within the last few years. Men of all classes, deeply engaged in business, from the humblest mechanic upwards, show a growing disposition to cultivate what Bacon has termed "the purest of human pleasures," and add to their homes that adornment which may be found in the culture of such a piece of ground as their means will allow them to secure. Much has been written to assist in the gratification of this wholesome taste, but there can be no doubt that people generally have still a great deal to learn as to the principles which should guide them in their gardening amusements, and the direction in which their time and outlay might be expended to the best advantage. In the present paper we shall offer a few hints as to the general principles which should be kept in view in suburban gardening, especially in small plots of ground, leaving gardening upon a larger scale for future consideration; and we shall follow these hints by details as to the profitable culture of flowers, vegetables, and fruit, by persons whose means and whose opportunity for gardening are alike limited.

CONDITIONS OF TOWN GARDENING.

It is often supposed that the conditions of soil, atmosphere, &c., under which gardening is pursued in the vicinity of towns, render it difficult to meet with a similar measure of success to that found in country gardens. If any proof were wanted of the general ignorance which

exists on gardening subjects, it would be afforded by the prevalence of this belief. The fact is that, rightly followed, town gardening may be made as successful and as profitable as gardening in the country; and the reason why the one so often presents an unfavourable contrast to the other is chiefly that suitable subjects are not employed, or, if used, are not tended with proportionate care. What will grow well in the country will often not thrive well in a town, and the attempt to rear the same plants and the same varieties under the two widely different conditions, frequently results in conspicuous failure. But, on the other hand, town growth is peculiarly suited to some classes of plants, which positively flourish better in the more heavily-charged air. The greater quantity of ammonia in a town atmosphere, which is constantly being brought down in large quantities by the rains and absorbed into the ground, is precisely what many vegetables and plants require for their full development; and the town gardener has therefore in this case a constant and natural supply of that which the country farmer is at considerable expense to procure by artificial means.

Again, the greater warmth which is found in towns as compared with the open country in winter, is eminently favourable to many of the forms of vegetable life. The superior growth and condition often observed in many of our best evergreens in town as compared with the same objects in the country, is an instance of the peculiar suitability of the neighbourhood of town to a certain class of plants; and in other classes it is equally favourable to some varieties, although it may be injurious to others. What these varieties are we shall have occasion to point out under their several headings, when we come to touch upon the different kinds of plants cultivated in our gardens.

But, while the gardener in town or suburb should bear these facts in mind for his encouragement, he must also remember not only that it is necessary to choose suitable plants for his garden, but to counteract the impurity of a town atmosphere by greater attention to the cleanliness of his plants. The leaves of a plant are its air-vessels, through which impurity will be conveyed to its system if it exists in the surrounding air. A good supply of water in dry and dusty weather is therefore doubly necessary to plants grown in town; but the water should be applied, not to the roots only, as is the general practice, but by gentle sprinkling or washing as in a rainfall, over the entire surface of the plant. At frequent intervals the soot and dust which are sure to settle more or less on the leaves should be entirely washed away, and the plants, if healthy, will immediately repay the attention by their fresh appearance and vigorous growth.

These two principles of suitable selection of plants and constant attention to cleanliness, are the chief points necessary to be observed to enable the town and suburban gardener to compete successfully with the resident in the country. But now as to other matters which demand his consideration.

THE SOIL, AND HOW TO IMPROVE IT.

The first is, to study at the outset the character of the soil with which he has to deal. This must be his guide as to the class of plants that he should attempt to grow. Some flourish in light while others thrive in heavy soils, and his choice must be made accordingly; but it is always possible in a small garden, by a little judicious outlay, to do much to alleviate the general character of the soil, whether of the one kind or the other. Stiff clayey soil, for instance, may be lightened by the addition of sand, road-scrappings, and vegetable manure; while too light a soil requires the addition of clay or marl and rich vegetable earth.

Many suburban gardens, attached to newly-built houses, are formed of meadow land recently broken up; and the soil in these is generally sufficiently rich and fertile to form a basis for operations without much trouble in preparation. But in others the ground which the gardener has to cultivate

is thickly strewn or intermixed with brick and rubble, which must be carefully cleared away before he can do any good with it. Even this rubbish, however, will be useful in small quantities, as a little of it interspersed in the subsoil will assist in the drainage of the ground. It is a common mistake to remove all stones from the earth or mould. They assist in keeping the ground open and making it porous, preventing it from caking in the heat of summer, or being washed out of the beds on to the paths in heavy showers of rain. Moreover, in hot weather stones are highly useful in preventing the loss of moisture from the plants by evaporation; for, if you remove a stone from the surface of the mould, you will generally find the earth damp underneath.

Then, again, the soil may be shallow in depth, and require either that fresh soil should be imported or that the subsoil should be brought up by trenching—an operation which we shall hereafter explain. Lastly, and more commonly still, the fruitfulness of the ground may have been quite exhausted by previous operations, in which case plenty of manure must be dug well into it. Rotted stable manure is the best possible material for this purpose, but many others are easily procured. Road scrapings, matter gathered from ditch bottoms, all kinds of vegetable refuse, with lime, soot, &c., are all useful in their way, according to the character of the soil and its condition. The right use of manures will form the subject of a future chapter.

ASPECT OF THE GROUND.

Other considerations to which proper regard must be paid are the aspect and the surroundings of the garden. If the general aspect be south or south-west, you may attempt to grow vines, fruit trees, and many delicate vegetables and flowers with which you would certainly fail if your garden were exposed chiefly to north and easterly winds. It may be that your plot of ground is so situated that you have two entirely different aspects, one side being fully exposed to the genial influences of the sun and the south-west breezes, and the other lying nearly always in the shade, and meeting only the keener winds. You will find both sides useful for different purposes. On the brighter side, for instance, besides planting your vines and fruit trees, you may sow your seeds in spring, and the rising plants will get warmth and shelter until they are ready for planting out. The other side will be equally valuable as summer advances; for many of your vegetables and tender plants which would be burnt up by the heat, will here flourish in the shade. You must carefully observe, then, the aspect of the ground, and be guided by this in your planting.

WALLS AND FENCES.

The next point for consideration is the manner in which the garden is enclosed—whether by fence or wall. Brick walls, as a rule, are much less suited to gardening purposes than open fences. They obstruct the light, and the free passage of air to the plants. The wind and the rain beat forcibly against them, and all things immediately within their shelter suffer in consequence. On the other hand, they have their occasional advantages. A good wall facing the sun is the most suitable spot in the garden for a vine or a plum tree, as it retains and reflects the heat to ripen the fruit. If fruit is not desired, many of the climbing plants, such as the Virginian creeper and the blue passion-flower, common in the southern counties of England, may be used as a covering and ornament. For a damp wall, ivy is the best thing, as it will keep it dry; but in a garden it should be kept cut close, and thinned from time to time, otherwise it will grow unsightly, and form a breeding place for a colony of vermin. A continuous wooden fence presents the disadvantages of a wall without its advantages; therefore choose, if you can, a garden enclosed by an open palisading, which will admit the light

freely to the plants, and at the same time break the force of strong currents of wind, while it allows a thorough circulation of air.

LAYING OUT THE GARDEN.

Now as to the planning out and arrangement of your garden. If you have an open fence, this will require less consideration, and the usual plan of a narrow bed round the sides, with others in the centre, will do very well, supposing you wish to grow flowers chiefly. But if you aim at the culture of vegetables, it is preferable, if the garden is a small one, to have the sides occupied by wider beds, with one pathway running down the centre. Thus you get more available space, and can cultivate your vegetables in larger and wider strips, which will be much more convenient for planting, &c., and, at the same time, more favourable to their growth.

If a small garden is enclosed by a wall, the best arrangement is to have the paths running round the outer sides, leaving the whole of the central space for your plants and flowers. Thus you bring them out of the shade into as much light and air as can find their way into the enclosure. It will be better still if you can raise the bed or beds into which you may divide this central space, above the general level of the ground, so as to give them still more exposure, and at the same time a better drainage. In many cases this may easily be done when you are making a garden, by importing a quantity of broken bricks and similar rubbish, and with this forming a foundation for the soil. The expense is trifling, and the trouble will be amply repaid in the saving of labour and the better condition of your plants at a future time.

In all cases remember to lay out your garden and place your beds so that the plants may be readily got at in all stages of their growth. And when you come to plant, do not fall into the common error of planting so thickly that the subjects choke up each other, and you have a difficulty in attending to one without injury to the rest. The air should be allowed to circulate freely around the stem, and the sun's rays and the rain should be able to reach all the leaves of every single plant, if you wish to have a collection of anything more than weak and sickly vegetation.

SUCCESSION OF PLANTS.

If you intend to devote your ground to the culture of vegetables, you will not need to be reminded that it is desirable to have a constant succession of plants in the ground, and that gardening will therefore require your attention and afford you amusement throughout the year. But if you think of growing flowers only, avoid, above all things, the modern practice of occupying the ground in the summer months alone by tender and showy plants, geraniums, calceolarias, and the like, and leaving it a barren and desolate space throughout the rest of the year. The smallest piece of ground is capable of affording you a new pleasure in every month from January to December inclusive, as we shall show in detail, in the course of these papers, if you will plant such flowers as follow each other in reaching perfection at the successive seasons of the year.

So much for the general principles which should be kept in view in setting out. We now come to the practical details of the subject; and shall treat in our next paper of the laying out of the small suburban flower garden.

THE TOILETTE.

WE propose, in a series of short articles, to give a concise account of the every day management of the Skin, the Hair, and the Teeth, when these are generally in a healthy state; and, moreover, to indicate very briefly the nature and causes of the more common disorders which

affect these parts of the body, and the means which should be employed to prevent and to remove such disorders. We hope to afford such information as the reader may use with daily advantage—such as will oftentimes prevent not only discomfort, but even the visit of the doctor, conducing also in some degree to the preservation of a good exterior, and the satisfying therefore of that amount of personal vanity, the existence of which in the individual is in reality essential to the exhibition of true politeness. The first subject for notice, then, is

THE MANAGEMENT OF THE SKIN.

Structure and Functions.—A few words may suffice to describe the skin, and they are necessary for the simple reason that it is manifestly imperative to know the construction and properties of an organ, in order that we may appreciate how best to use it, to preserve its proper functions from irregularities, and to prevent the action upon it of injurious influences. The skin is a soft membrane composed of cuticle or scarf-skin—the part which is raised on the application of a blister—made up of small cells flattened together, and of the true skin, or *derma* beneath, whose structure is that of a mass of fibres arranged in network fashion, projecting at the upper part into little finger-like processes, called papillæ, which we see through the cuticle on looking at any part of the skin. The true skin is furnished with blood-vessels, called capillaries, which form a horizontal layer, and send offshoots into the papillæ. The nerves are distributed like the blood-vessels. Besides these elements, the whole thickness of the skin is perforated by the ducts of the little sweat glands and by the hair follicles, into each of which two little fat glands open by their proper ducts. The scarf-skin does not block up the openings of these ducts, but opens down and lines their interior. The cells of which it is composed are constantly shed as scurf, and it is the tardiness of this shedding which blocks up the pores of the skin. The little glands secrete a fatty matter, which also tends to choke the pores of the skin; the action of soap is to soften up and remove this fatty matter. The true skin or *derma* is that part which is made into leather. The little projections or papillæ each contain a nerve twig, and are in fact the “feelers” or sensitive organs of the skin—the parts which constitute the organs of touch. Beneath the skin is a layer of fat, which forms an admirable “cushion,” breaks the force of blows, and allows the movements of the skin to take place freely. The little sweat glands are tubes which open on the exterior, and run down in a spiral direction, till they end in a little coil, surrounded by blood-vessels, from whence the fluid sweat is derived. Now it is very important to be aware of the number and length of sweat-tubes. There are nearly three millions of these tubes in the body, and it is calculated that they are in all twenty-eight miles in length. It will be at once evident how important it is to keep the pores of the skin open, in order that the body may be properly purified by allowing these sweat glands and tubes to perform their functions properly. This may suffice for the structure. Then what useful purpose does the skin serve? What are its functions? In the first place it is the organ of sensibility; secondly, it is a protection to the body; thirdly, it is a great breathing organ, really an extensive lung. The dark and impure blood circulating through its veins becomes changed by the action of the oxygen of the air, and fitted to nourish the tissues more perfectly. Hence the need of keeping the “pores of the skin open” by proper washing. The importance of the breathing function of the skin can be easily shown by experiment, for if we varnish over the skin the subject so varnished often dies of what is nothing more nor less than suffocation. Insects breathe entirely through their skin. The skin does about one-thirtieth of the work

similar to that performed by the lungs, and in disease of the latter it is very likely much more active in purifying the blood. Then, fourthly, the skin carries off by the sweat much solid matter, that would be, if retained in the body, very injurious. Under ordinary circumstances about a pound and a half of sweat is given off by a man in a day. The body is also kept at a proper temperature by the evaporation of the sweat; hence the importance of keeping the skin in order, especially in cleanliness, in order that nature may regulate the heat of the body. Inattention to these points gives rise to various disorders of the system, especially colds, coughs, and the like. The fluid which is sweated out of the body comes from the blood-vessels in the deeper part of the skin. A word more about the work of the little fatty glands, and this part of the subject may be left. These little structures give exit to fatty matter; that by inducing a slightly greasy state of skin, prevents too great evaporation; it acts as a protection to the skin against irritants, and it also carries off certain fatty acids from the body. In an inactive skin these glands get choked up by the retained fatty matter, and we then have pimples, as about the face.

To keep the Skin in Health.—It is necessary that it be properly nourished, that all things that will irritate it be avoided, that it be kept in a proper state of warmth, and above all things that the utmost and constant cleanliness be observed. Now, in the first place, with regard to the influence of food on the health of the skin, it may simply be said that in proportion as plain food is regularly taken will the skin be preserved in health in common with other parts of the body. The skin of infants is very liable to get out of order when the milk they take is poor; and it is very important that mothers should attend to this matter, and see that the milk they give infants is really good; or if the natural food which their babies get from them is poor, that means be taken to improve the supply. Fair mothers of fair children should be particular in this respect. If parent or child be weakly, then it may be advisable to give a special meal to a child—say between three or four months of age—of milk with a little water, perhaps thickened with bread, jelly, or a little fine baked flour. A child at seven or eight months should be taking two pints of milk a day; and after the teeth are shown, broths and the like may be taken. By such a plan as this there is the best chance of keeping the skin of infants firm and healthy, so far as diet is concerned. More will be said in speaking of bathing. The growing girl or boy of five, seven, or eleven years of age, requires a full supply of meat, otherwise the skin is liable to be deranged, and such abominations as scald head, ringworm, and the like are likely to show themselves. Such young persons as are here indicated require enough food not only to repair the ordinary wear and tear of their bodies, but to provide for the actual increase in growth from day to day. The dietary of schools should be much improved. The following is a capital meal chart, we believe suggested by Soyer, for those in charge of boys and girls:—“Bread and milk at eight; dinner at one: roast mutton and apple pudding; roast beef and currant pudding; boiled mutton with turnips, after rice or vermicelli pudding; occasionally a little salt beef with suet dumplings, plain or with currants in them, or pease pudding;” and to these we should add bread and butter and milk and water for tea, and a fair meal of bread and cheese or butter for supper. In the case of those youngsters who look under-fed, a piece of meat at night and a glass of beer or milk in the day time should be added. There is one other point in reference to young persons worth notice. It is the importance of eating a certain amount of fat with the food. Children who have unhealthy skins are often those who seem to avoid eating fat. This is a point which parents would do well to

notice. Fat is a very influential item in the food as regards the skin, and if it cannot be taken in the ordinary way, it is just a question whether it should not be given in an artificial form, by way of cod-liver oil, which has great effect for good on the skin. The dose for a child of a year old is ten to twenty drops; for those of five, half a teaspoonful. With regard to adults, the guide to what is best to be taken for the good of the skin, is the effect of food upon the stomach. If there be any article which in being taken does not sit lightly upon the stomach, or flushes the face, that should be avoided, for its use will very likely lead to the development of pimples and red blotches. It has been said that tea and coffee act injuriously upon the skin. There is no foundation for this opinion, but this is certain that a very close sympathy exists between the face and the stomach, and when there is a feeling of heat, or the appearance of a red flush after taking beer or wine, or any particular article of diet, in young persons, we may expect the face to become disordered, and blotches and pimples to appear.

THE HOUSEHOLD MECHANIC.

THE TOOL-CHEST (*continued*).

Files and Rasps.—Files are flat blades of steel fixed by a tang into a wooden handle, and cut all over with a series of teeth more or less minute, the various sizes of which are known as rough cut, bastard cut, second cut, smooth, and superfine, and they are of various shapes and sections, such as round, half-round, square, oblong, triangular, oval, &c., according to the purpose for which they are required. The square and oblong shapes often have one edge not cut. This is called a "safe edge," and is used as a guide in filing up shoulders, &c. Usually files are of fully hardened steel, and are therefore capable of attacking any metal which is not equal to themselves in hardness. A large proportion are made rather thicker in the middle than at either end, in order to in some degree counteract the rolling motion of the hands, which it is very difficult altogether to prevent in the filing of flat surfaces. They are, however, sometimes made with parallel surfaces and edges. For the purposes of cutting thin slits, such as the nicks on the heads of screws, thin blades, cut only on the edge, are used. These are called slitting files.

In all cases where from use on material of adhesive nature files have become clogged up, the teeth should be brushed out with a file-card, for which purpose a piece of worn out cotton combing-card, a kind of thick fustian woven with steel wires, answers admirably. As files are a somewhat large item of expenditure in a workshop, from the speedy wear to which they are subject, many methods have been tried for recutting the teeth, when worn away, by means of acid. The following method we have found very effective for fine files, but of little use with coarse ones. After being brushed clean, an old file is dipped into a mixture of three parts sulphuric acid, one part nitric acid, and seven parts water for a time varying from five to twenty minutes, according to the freshness of the mixture, and the depth of cut required; it is then washed in water, and dipped in lime-water to prevent any further action of the acid, again washed, and dried by heat, and brushed over with a mixture of oil and turpentine to prevent it from rusting. Whether this process acts only by clearing out dirt and dust, or really cuts into the surface, we cannot say, but we know from experience that it is certainly effective, although not quite so good as recutting, a process we do not advise our readers to attempt. The acid process should be performed out of doors, as the fumes given off are rather unpleasant.

Considerable practice is necessary to attain much proficiency in hand filing, especially of flat surfaces, as, from the motions of the elbow and shoulder joints, the hands

naturally tend to move the tool in curved lines, thereby making the work convex or rounded. The same fault is further induced by the fact that in sweeping a file of moderate length across a narrow surface, one hand being at each end, the blade becomes a lever, the fulcrum of which is continually shifting in position; and if the pressure at each hand is kept constant, the ends will alternately be raised or depressed, and will, of course, produce a convex surface, instead of a square and true one. As before explained, it is in some degree to counteract this tendency that files are made thicker in the middle than at the ends, or "bellied," as it is termed. In finishing and smoothing filed works the files are slid along sideways or laterally. This motion is called draw filing, the teeth only scratch, and do not cut. Rasps are the same in action as files, but, being used for wood, the teeth are larger, being produced one at a time by blows of a small chisel or punch. The teeth are always in lines, ranged diagonally, or in curved rows across the blade.

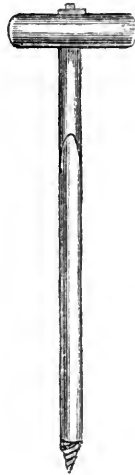

Fig. 7.



Fig. 8.



Fig. 9.

Gimlets and Augers.—Fig. 7 shows the ordinary form of gimlet, which is simply a piece of steel wire fastened into a handle at right angles to it, the lower or cutting part of which is grooved and fluted out so as to leave sharp edges. At the extreme end is a small taper screw, by which the tool is kept continually forcing its way into the wood, the edges of the flute cutting out the shavings which escape out up the groove. Twisted gimlets, Fig. 8, are by far the best, the effect being exactly the same, for as the flute is twisted round the barrel the wire is not so

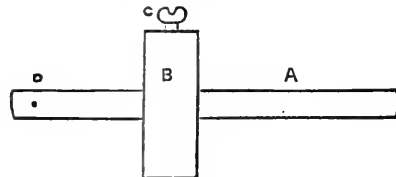

Fig. 10.

much weakened, and the groove being in the form of a screw, the shavings are lifted out, instead of having to force their way up the groove. Augers, Fig. 9, are like twisted gimlets, but in place of one groove they have two wound round the rod; the bottom edges of the metal left by the two grooves are sharpened into a cutting edge, and consequently their action is very easy, smooth, and rapid. The largest augers are not fixed into handles, but have their tops expanded into rings, into which a movable handle is thrust.

Gauges.—Fig. 10, page 23, shows a common marking-gauge, in which the rod A slides backwards and forwards in the block B, but capable of being fixed at any required place by the screw E; near one end is a hole through which the steel point D is driven. In using this tool the right end is grasped by the right hand, the thumb and forefinger of which take hold round the block. In gauging a piece of wood, one edge, previously planed, is used as a guide, the left of the block being kept close up to it, the point of course marking a line parallel to the edge of the wood at any required distance from it. In cutting thin parallel laths, a knife is used instead of the point D;

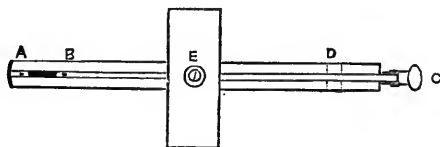

Fig. 11.

this is called a cutting-gauge. Fig. 11 shows a mortice-gauge, which is used for marking two parallel lines at once, as in marking mortices and tenons. The point A is driven through in the same manner as in the common gauge, but a second point, B, is fixed on the piece of brass sliding in a groove in the rod, which slide is moved by the screw C. The screw C works in a box or nut shown by the dotted lines at D. The method of using is the same as with common gauges. The rod is fixed by the screw E.

Hammers and Mallets.—It would seem almost absurd



Fig. 12.



Fig. 13.

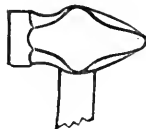

Fig. 14.

to trouble our readers with a description of tools so universally known, but as no tool-chest would be complete in their absence, we should not feel altogether justified in passing them over. Fig. 12 shows the head of an ordinary claw-hammer, the claw of which is useful in taking out nails wrongly driven, &c. Fig. 13 shows the head of a tang hammer, the tang being convenient for slight blows



Fig. 15.



Fig. 16.

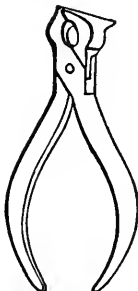

Fig. 17.

on nails, just for fixing them in a position to be driven in. Fig. 14 is a smith's chipping-hammer, the weight of which is nearly all in the lower end, the tang being usually rounded. Of mallets we need say nothing, except to recommend the square-headed ones for morticing and

carpenters' work, and the cylindrical ones for more domestic purposes, such as tapping beer-barrels, &c.

Pincers and Pliers.—Fig. 15 is a diagram of a pair of ordinary pincers, which are contrivances for obtaining a firm grasp on small objects, such as nails or pieces of wire, &c. Common pliers, Fig. 16, are used for the same purposes as pincers, but being smaller, do not grasp quite so firmly; and Fig. 17, a pair of cutting-pliers, used for severing small wires. The cutting edges are sometimes on the side, and sometimes on the top edges of the tool. In the former case the ends are prolonged into regular pinching surfaces, thereby serving the twofold purpose of cutting and holding.

Planes.—Fig. 18 is a section showing the construction and arrangement of an ordinary plane. The body, A, is of

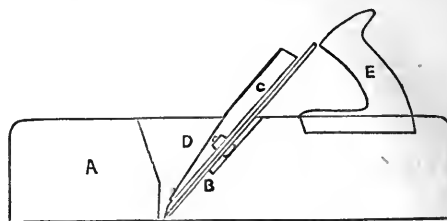

Fig. 18.

wood, usually beech, the bottom of which is called the *sole*. The line B, on which the iron rests, is the *bed*, and for carpenters' planes is mostly inclined at an angle of forty-five degrees. The iron is kept firmly fastened down to the bed by the wedge C, which fits into grooves on each side of the mouth D. The angle of the wedge is about ten degrees, and it is cut away in the middle so as to leave room for the screw which holds the two irons together. The plane is pushed forward by the handle E, which is let into the top. Fig. 19 shows the arrangement of the double iron found in most planes. A is the bottom iron, which is the cutting part, and B is the top iron or *break*, as it is termed, which is intended to throw off the shavings from the cutting edge. It is set with its edge about one-

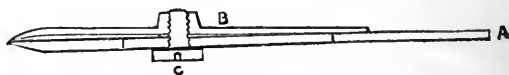

Fig. 19.

twentieth of an inch from the edge of the cutting-iron, to which it is held by the screw C. The adjustment is allowed by the long slot in the bottom iron in which the screw slides. The top iron is curved in the direction of its length, in order to keep its edge in more complete contact with the lower iron, and so to allow no shavings to pass between.

In setting a plane the two irons are screwed together, and placed on the bed with the wedge lightly pressed in its place; the edge will then be felt underneath by the hand, and can be adjusted. Should it be too far out, a tap with a hammer on the fore-part of the plane will bring it up, or should it not project enough a slight blow on the top of the iron will be necessary; when in its place a sharp blow on the top of the wedge will fix it there. The diagram, Fig. 18, shows about the proportion of a jack-plane, the length of which is from fourteen to sixteen inches. The smoothing-plane is smaller, about seven or eight inches. The trying-plane is much longer, about twenty inches, the greater length giving greater accuracy in the surface to be operated on. The order of using is generally jack, trying, and smoothing. Plane-irons are sharpened in the same way as directed for chisels, but from the greater width of the blade, three inches, the operation is more difficult.

COTTAGE FARMING.

I.—DRAINAGE.

COTTAGE farming, to be profitable, must be very carefully done; and where there are only a few acres, these few acres must be kept in the highest state of cultivation to render them profitable. This applies especially to the section we shall deal with in the first place—namely, grass-land.

To be farmed profitably, grass-land must be in the greatest state of fertility. No matter upon what tenure the

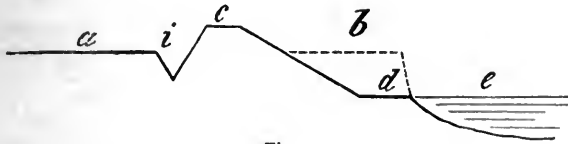

Fig. 1.

land is held—long or short leases, copyholds or freeholds—the rule applies equally and to all. The smaller the farm, the more strongly does it demand attention. Land, if neglected, deteriorates rapidly; and it stands to reason that, where a man has only a few acres to depend upon, he must get the very best he can out of the land by treating it liberally and carefully.

There are a large number of cottage farms in every county, and it is now the fashion to devote the spare land adjoining railway-stations to cottage farming. In Wales and Ireland the system of farming a few acres prevails largely. Now, although most of these small farms combine arable with grass-land, there always exists a strong desire to keep a portion in grass, which, in many instances, suits the farmer better. It may be that the land

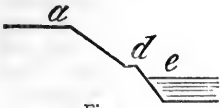

Fig. 2.

is at a distance from his house or his trade—of, say, butcher or dairyman—which makes grass-land the most profitable; and, moreover, the farming of grass-land does not require any team-work, which is one of the farmer's greatest expenses.

It is our intention to go minutely into the detail of grass farming on this small scale, and in the first case to give our attention to the roads, fences, drainage, and other permanent improvements, which form the basis of successful practice.

The ground taken up by a cart or carriage road is a serious loss upon a farm of a few acres; therefore, if

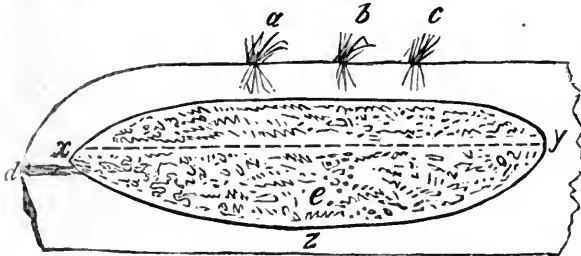

Fig. 3.

absolutely necessary for farming purposes, it should be as narrow and as short as possible. If, however, the ground is only grass, a permanent road is not absolutely necessary for mere farming traffic; carts can go over the grass as easily as along a made road. The only road necessary then, in this case, is the outlet or approach to the cottage. Still, even in this case it will be found the best economy to make a road. We have seen good grass-lands sadly spoiled by carts being driven in all directions over them.

Drainage is one of the most necessary points to be

attended to in the farming of grass-land. If the drainage is defective, the grass will be poor and sour, so that cattle will not feed upon it. It will also be full of rushes and rank weeds. And there are four ways of draining grass-lands:—1, by rivers and ditches; 2, by tapping; 3, by

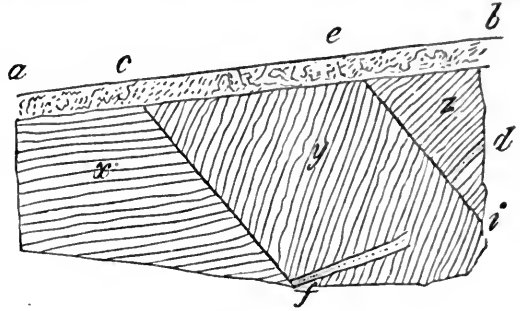

Fig. 4.

cutting off springs; 4, by parallel draining. Rivers and their tributaries are the main drains of the country, carrying off the waters from open ditches, while open ditches carry off the waters collected in covered drains.

Industrious, intelligent cottagers, whose farms are bounded on one side by a river, often turn the land outside the embankment to profitable account by planting osiers, &c. Thus, in the annexed diagram, Fig. 1, *a* is the surface of the meadow inside the embankment, *c*, and the dotted lines, *b*, represent the natural level of the outside, and *e* the surface level of the river at ordinary occasions, the soil within the dotted lines having been dug out down to *d*, a foot to eighteen inches above *e*, to form the embankment *a*. The slope, *c d*, is turfed over or sown with

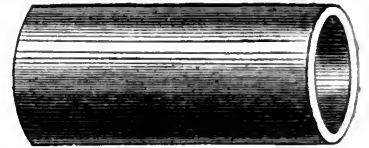

Fig. 5.

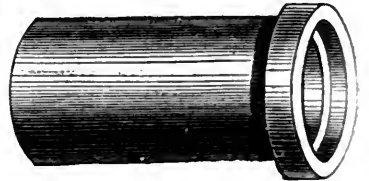

Fig. 6.

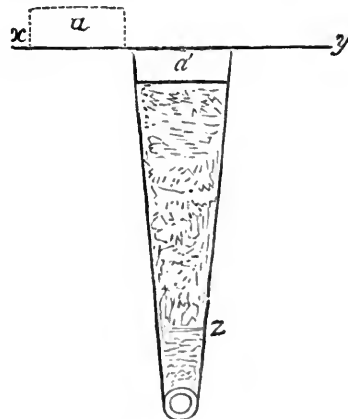

Fig. 7.

grass seeds adapted for occasional floodings, and the level space at the bottom, *d*, planted with osiers, &c. In some cases basket-makers rent this space at so much annually; in others, the cottager farms it himself, and sends the produce to market. The slope, *c d*, grows as

much grass and often more than is done by the land when left on the level of the dotted line, *b*; and the grass on the slope is not much more liable to be silted during the floods of summer than the grass on the level, *b*. But, about the time of floods, the grass should be frequently cut, so as to keep it short and avoid loss by silting. Sometimes an open ditch, *z*, inside the embankment, is necessary in the winter time, and the water from it is drawn off under the embankment by means of a pipe or trunk with a weighted sluice on its mouth at the water's edge.

In open ditches, where there is a continuous flow of water during the greater portion of the year, the sides may receive a greater slope than they generally have, so as to prevent falling in; and a row of osiers, &c., may be planted, to protect the bottom by means of their spreading roots. Thus, if *a*, Fig. 2, is the surface of the meadow, and *e* the surface of the water in the ditch, the side *a d* may be sloped down, so as to produce several mowings of grass. The space, *d*, may be a foot in breadth, and on this plant closely a row of osiers or willows, whichever is best adapted for the soil; the roots of these will keep the water-way below in a proper state. In the summer-time a sluice put across at short distances will form dams to retain thunder showers.

When an open ditch has no more water to remove than what falls upon the small farm, it may, in most cases, be converted into a covered drain.

Tapping.—A large area of land is often found to be wet, owing to the collection of stagnant water below. Subterranean pools of this kind are common in many of our clay formations, as the Oxford and London clays. Thus in the section, Fig. 3, a large basin, *x z y*, has been scooped out by the action of the water, gravel and sand are drifted into it, as represented by *e*, and over this porous material clay is again drifted, forming a tenacious soil. Through this the water in course of time filters, and fills the interior of *e* full to the top. Then, by capillary action, this water keeps the surface above wet, and adapted for the growth of rushes, *a, b, c*, which send down their roots to the water below. By boring at *d* the water may be drawn off to the level of the dotted line, *x y*, so as to drain effectually the land above. This operation is termed tapping. A covered drain not shown on the diagram removes the water from *d x*.

Draining Springs.—When soils lie on rock, springs frequently break out to the surface, and by spreading far and wide keep much land wet. When the spring bursts out in the bottom of a small basin, so as to form a lake, in a soil naturally adapted to produce bog moss, a "live bog" is formed; and in Ireland such are very common, and owe their existence to this, that as the moss grows the bog rises above the surface level many feet in height, and the strength of the moss to retain the water having a limit, when the weight of water and moss exceeds this, the bog breaks from its moorings and slides away, carrying everything before it. Had the small spring been cut off by a drain before the formation of the bog began, or while the spring was accessible to the tools of the drainer, such a catastrophe would have been prevented, and healthy meadow or pasture-land found in the place of the live bog.

Something similar to live bogs takes place wherever springs pipe out to the surface. Thus, let the section *a c c b*, Fig. 4, be the surface of the meadow, lying at a small inclination with the horizon, and let the rocky sub-soil form three beds or strata, *x y z*, two of which, *y z*, crop out to the staple, or top soil—that is to say, they have the fissures of the strata so tilted as to receive the water collected in the top soil—the lower one at *c e*, and the upper one at *e b*. The fissures *c f* and *e i* sometimes run right across the field; at other times obliquely; but when they contain water, as they invariably do, and

that water is not drained off naturally at the lower end of the dips *f* and *i*, it will rise and burst out in one or more springs along the surface, as at *c* and *e*. The spring *e* receives its supply of water from higher ground, by the cleft or fissure *d*, and *c* by that of *f*.

In this case the spring at *e* keeps the ground between it and *c* wet; and the spring *c* does the same with the ground below it; so that the work of drainage consists in cutting a single drain right up to each spring, or through both, so as to drain the ground. If, however, there are a series of springs along each fissure, viz., *c* and *e*, then a deep drain along each fissure will be necessary.

By far the largest area of land requires to be drained by parallel drains placed at short distances from each other. Even in examples of rocky grounds, as Fig. 4, and when the soil is of considerable depth over the rock, it cannot be effectually drained otherwise; for although a single drain will remove the flow of water from a spring, the water across the fissures, from their irregular direction, oozes out so imperceptibly that the eye of the spring cannot be detected, while in other cases the eye is too deep to be reached by a drain.

At one time the pipes used in parallel draining were of a horseshoe form, but now round ones are generally used. The most popular are those represented by Fig. 5, without sockets, or with sockets, as in Fig. 6. They are placed as in Fig. 7, which also gives the section of a common drain, showing the pipe as it lies in the ground. In this case *x y* is the surface of the ground.

In draining land lying in grass, the surface spit *a'* requires to be carefully dug out, turned over, and laid at the side, as shown by the dotted line *a*, the grassy side undermost. The object of this is that it may be replaced with the grassy side uppermost when the pipe has been laid and the earth filled in. Sometimes burnt earth, gravel, and the like, is put over the pipe as high as *z*.

The earth should be trampled in as closely as practicable, and if a water barrow or cart be drawn along the drain before the sod *a'* is replaced, the water will both consolidate the earth below, and assist the roots of the grass above to strike and recover life.

The depth of drains varies from three to four feet; the pipe being seldom placed at a less depth below the surface than three feet, and seldom at a greater depth than four feet; but to both these extremes there are exceptions, which experience and intelligence can direct.

The distance between parallel drainings is even more varied than their depth—15, 18, 24, 30, 40, and even 60 feet asunder being common. In practice the depth of the drain and the distance asunder are determined by the nature of the soil. The general error fallen into in clay soils is to place the drains too far asunder, under the fallacious notion that the greater depth will draw the greater distance; but the pipe in the bottom of the drain, Fig. 7, has no active function of this kind—*i.e.*, it does not draw. The water merely percolates through the soil by gravitation, and as the density of soils generally increases with their depth, the opposite is the practical conclusion. If, therefore, the density thus increases—for this is the true question—drains three feet in depth, and 12 and 15 feet asunder, must act upon tenacious clays more effectually than if laid four feet in depth and 18 to 24 feet asunder.

Draining pipes are about 13½ inches long, and from one to six inches and upwards in diameter. In practice, the size is regulated, first, by the distance asunder at which you put the drains; secondly, the climate; thirdly, by the inclination of the ground. The small bore is liable to be closed if the pipes are not laid—and continue to lie—closely in a line.

It generally answers better to divide the field into two or more lengths of, say, five chains each. If, therefore,

the drains are fifteen chains in length, lay the upper five chains with $1\frac{1}{2}$ -inch pipes, the middle five chains with 2-inch pipes, and the lower five chains with $2\frac{1}{2}$ -inch pipes; the distance between the drains being 15 feet, and the inclination uniform and sufficient to keep a smart flow through the pipes.

Sometimes it is found easier and more advisable to run a main drain across the field than to increase the diameter of the pipes towards the bottom headland. At the bottom headland there requires to be a main drain into which the common drains discharge themselves. This main drain, if of considerable length, and running parallel to the open ditch, may discharge itself in two or more places; but without special provision being made, the common drains should not flow directly into an open watercourse.

COOKING.

II.—SIMPLE RECIPES (*continued*).

Potato Bread.—Boil the required quantity of mealy potatoes in their skins; drain, dry, and then peel them. Crush them on a board with a rolling-pin, till they are a stiff paste without lumps. Then mix your yeast with them, and flour equal in quantity to the potatoes. Add water enough to make the whole into dough, and knead the mass well. When risen, set into a gentle oven. Do not close the door immediately, but bake a little longer than for ordinary bread. Without these precautions the crust will be hard and brittle, while the inside still remains moist and pasty. Other flours can be in like manner made into bread with a mixture of potatoes, but they are best cooked as cakes on the hearth, or in the way given below for potato cake. In Scotland oatmeal is frequently mixed with wheaten flour in making cakes, and in the west of Ireland with maize flour in making stirabout.

Potato Cake.—Very acceptable to children at supper, especially if they have had the fun of seeing it made. Cold potatoes, if dry and floury, will serve for this. If you have none, boil some, as for potato bread. Crush them with butter and salt; mix in a small proportion of flour (wheaten, oaten, rye, or maize) and a little yeast (the last may be omitted at pleasure), and with milk work the whole to the consistency of very firm dough. Roll it out to the thickness of an inch and a half or two inches. Cut it out the size of your frying-pan, the bottom of which you smear with grease, and in it lay your cake, after flouring it all over. Bake, covered with a plate, on the trivet of your stove, over a gentle fire, or better on the hearth, when turf or wood is burnt. Shake and shift it a little from time to time, to prevent burning. When half done, turn it, and cover with a plate again. Other cakes of unfermented pastes may be baked in the same way.

Light Dumplings, steamed.—These, as well as light dumplings boiled, are, in reality, nothing but bread boiled or steamed instead of being baked. In light dumpling countries, housewives buy, in the course of the morning, so many pennyworths of dough at the baker's, and keep it warm and covered till wanted, which saves their having to make bread themselves. Steaming dumplings is by far the neatest way, besides saving an extra saucepan. The dumpling is cooked in the steamer on the top of the saucepan, while the bit of meat and the vegetables are boiled below. The dough receives a little extra kneading, is rolled into the shape of a good-sized apple, is dusted all over with flour, and then put into the steamer. As the dumplings swell in cooking, they should neither touch each other nor the sides of the steamer. The water must be kept boiling all the while. When done, their outsides are smooth and dry. Set them on the table the minute they are taken out of the

steamer. Cold light dumpling, steamed, sliced across, toasted, and buttered, is not a bad substitute for muffins. Boiled light dumplings are prepared in the same manner, and are thrown into *boiling* water, which must be kept boiling all the while. They take less time to cook—from twenty minutes to half an hour—than steamed ones do. The outside of boiled dumplings is apt to be a little sloppy.

The best sauce to eat with these is good roast-meat dripping, with the fat and the brown gravy mixed together. Treacle is also used. A nice way of serving it is to put a bit of butter into the treacle, and then pour a *little* boiling water over them, stirring till they are mixed together. Equally approved is

Matrimony Sauce.—Put a bit of butter into cold water in a saucepan; dust in a little flour, stirring one way till they are completely mixed; then add some brown sugar and a table-spoonful or so of vinegar. Continue stirring till it boils; pour into a basin, and serve with your dumplings.

Hard, or Suffolk, Dumplings are unleavened dumplings, and as indigestible as unleavened bread. They are nothing but flour and water made into a stiff paste, with a little salt. This is rolled into balls as big as one's fist, floured outside, thrown into boiling water, and boiled three-quarters of an hour. Some housewives (when there is no gravy to eat with them) put a little bit of butter in the middle. They make a dish of eatable cannon-balls, each enclosing a spoonful of oil.

Drop Dumplings.—Make a *thick* batter with flour, milk, salt, eggs, and yeast. Set it for an hour in a warm place, to rise. Throw table-spoonfuls of this, one by one, into a saucepan of water boiling gallopping. When done, let them drain on your slice an instant as you take them up, and serve with gravy, matrimony sauce, or sugar and butter. They are nearly, if not quite, the same as the popular Bavarian *Dampf Knödeln*.

Gingerbread.—Mix well together two pounds of flour, half a pound of butter oiled, one ounce of ground ginger, and a table-spoonful of baking-powder; then stir in two pounds of treacle. Bake in a slow oven, putting it in as soon as made, and watching it carefully afterwards.

Mrs. Smith's Gingerbread.—Beat up well together one pound of treacle, one pound of flour, half a pound of oiled butter, two ounces of candied citron-peel, and one ounce of powdered ginger. Put it into shallow tins, and set it into the oven immediately. The addition of powdered cinnamon and a little honey to the above ingredients makes a very nice and striking variety of gingerbread.

Egg-Powder Cake.—Egg-powder, as it is called, is a vegetable compound, intended to serve as a substitute for eggs, to four of which one penny packet professes to be equivalent in cake-making, and sufficient to add to two pounds of flour. Some cooks, however, think it best to use it *in addition* to eggs. The powder is first mixed with the flour, and then water or milk is added, for plum, batter, and other puddings, cakes, pancakes, &c. For a cake: mix well together one quarter of flour, half a pound of butter, two ounces of sweet pork lard, three-quarters of a pound of well-washed currants, half a pound of sugar, two packets of egg-powder, and three eggs. You may add mixed spices, grated nutmeg, and candied citron-peel, to your taste. When these are thoroughly stirred up together, with enough milk to bring the whole to a proper consistency, butter the inside of your cake-tin, put the cake in, and bake immediately. The top of the cake may be glazed with beat-up egg.

Cheap Cake.—While making bread, take some of the dough after it has begun to rise. To every pound of dough knead in an ounce or more of butter or dripping, a quarter of a pound of coarse sugar, some grated nutmeg, and either a quarter of a pound of currants and chopped raisins or a few caraway seeds. When your

cake is thus made up, dust it with flour, cover it with a cloth, and set it in a warm place to rise again. When well risen, set it into the oven immediately. Bake thoroughly, but not too fast, and it will turn out firm and light.

Sally Lunn Cakes.—Make a soft dough with flour, a little salt and butter, two or three eggs, yeast, and milk and water. After kneading well, let it rise before the fire. Then make it into cakes of a size convenient to slice across and toast. Bake slightly, but in an oven sharp enough to make them rise. When wanted, slice, toast, and butter your Sally Lunn, and serve piping hot on a plate which you cannot hold with your naked fingers. There are two objections to these and the following—they are indigestible, and are also terrible “stroys” (destroyers, consumers) for butter.

Muffins.—With warm milk, a liberal allowance of yeast, flour, a little salt, and an egg or two, make dough still softer in its consistence than the above. After kneading or beating, get it to rise well. Then make your muffins as you would small dumplings; dust them with flour, flatten them, and bake them slightly on a hot iron plate, or in tin rings, turning them to bake the upper side when the under side is done. The great object is to keep them light, moist, and full of eyes. Muffin-making is a profession, but its secrets are not inscrutable. Once possessed of the iron plate (which you will be able to obtain without difficulty from any ironmonger), a few trials will put you in the way; and if you have one or two failures at first, they will be eaten with the greater relish because they are your failures. Before toasting a muffin, cut it nearly in two, leaving it slightly attached in the middle. When toasted brown and crisp on both sides, slip the butter into the gaping slit, and serve on a plate not quite red-hot.

Crumpets are made in the same way as muffins, only the paste is still softer, approaching batter in its consistency. Let them also rise well. Bake slightly in like manner on an iron plate made for the purpose. The usual size and thickness of crumpets you learn from the specimens sold in the shops. After toasting, muffins should be crisp; crumpets, soft and woolly. It is like eating a bit of blanket soaked in butter. If you are pining for crumpets, and have no iron plate, you may bake them in the frying-pan, which the Americans often use for cake-making.

Raised Buckwheat Cakes (American).—Warm a quart of water. Stir into it a good table-spoonful of treacle, and a teaspoonful of salt. Mix in enough buckwheat-flour (or oatmeal or Indian corn-flour) to make a stiff batter, together with a table-spoonful of good yeast. Let it stand to rise before the fire. Then bake on a hot plate, in iron rings, like muffins, or in a slack oven. Toast and eat it hot with butter.

Fried Bread Cakes (American).—To a quantity of light dough equal to five tea-cupfuls, add half a cupful of butter, three of brown sugar, a teaspoonful of salt, four eggs, and a little grated nutmeg. Knead these well together with flour; let them rise before the fire until very light. Knead the dough again after it rises; cut it into diamond-shaped cakes; let them rise; and fry in lard or dripping, as soon as light. These cakes are best eaten fresh.

Johnny or Fourney Cake (American).—Boil a pint of sweet milk; pour it over a tea-cupful and a half of Indian corn-meal, and beat it for fifteen minutes. Unless well beaten, it will not be light. Add a little salt, half a tea-cupful of sour milk, one beaten egg, a table-spoonful of oiled butter, a table-spoonful of flour, and a tea-spoonful of carbonate of soda. Beat well together again. This cake is best baked in a spider (a deep iron pan) on the stove. When browned on the bottom, turn it into another spider, or finish it off on the griddle.

Plum-Pudding (Economical and Excellent).—Mix together in a bowl one pound of flour; one pound of beef or veal suet, chopped fine; half a pound of currants, previously washed; half a pound of raisins, stoned; two eggs, a little salt, grated nutmeg, and finely minced lemon-peel, with enough new milk to bring the pudding to a proper consistence. You may boil it either in a cloth floured inside, tying it up not too tightly, but allowing a little room for it to swell; or in a pudding-basin buttered inside. In the latter way, it will look handsomer when turned out on the dish, and will be less liable to loss of sweetness from the water getting in; but it will take somewhat longer to boil. In either case, the boiling should be maintained continually. The pudding may be increased in size, by adding bread crumbs and a little sugar, with one more egg and a little more flour, to bind the whole together.

If pudding sauce is wanted to eat with this, put a little flour and water into a saucepan, stir in a lump of butter and a little brown sugar, and when they are blended smoothly, throw in a glass of orange, ginger, or other home-made wine. An elegant sauce for boiled puddings is made by mixing with the above a dessert-spoonful of red currant jelly.

Plum-pudding may be “lengthened” (some would call it “adulterated”) with carrots chopped very fine; it may be enriched with sultana (stoneless) raisins, candied citron-peel, blanched almonds, crushed macaroons, brandy, white wine, and a variety of other good things. But we have eaten plum-puddings with *too many* ingredients. Enough is as good as a feast.

Baked Apple-Pudding.—Peel the required quantity of apples; quarter them; take out the cores; set them on the fire in a stewpan with a little sugar and water, and the rind of a lemon chopped exceedingly fine. Boil them, closely covered with the lid, till they are soft enough to be mashed with a fork. While mashing them, add the juice of your lemon. Turn them out of the stewpan, and set them aside to cool. Butter or grease the inside of a rather shallow pie-dish; line it throughout with good ordinary pie-crust. Beat up (not to a froth) two or three eggs; mix them well with your apple-pulp, and put the mixture into your pie-dish; smooth the top with the back of a spoon, and grate a little nutmeg over it. Bake it in a moderate oven. The pudding is good either hot or cold. For stylish dinners, bake the pudding in a dish or tin with *upright*, instead of slanting sides. Use puff-paste, instead of ordinary pie-crust; mix orange-flower or rose-water, or some liqueur, as noyau, with the eggs when you beat them up; when the pudding is cold, take out of the tin, and dust the top with pounded lump sugar.

Sausage Dumpling.—Bend one sausage neck and heels together; enclose it in crust as you did with apple-dumpling, taking care to prevent all leakage. Tie it in a cloth, and boil. Making one large sausage-dumpling, or boiling several sausages in a crust in a pudding-basin, does not produce half the fun nor half the enjoyment as when each child has a dumpling to itself, full of savoury, steaming gravy. It is good, sound, substantial fare, and at the same time wholesome, but it should be prepared with some care, and it is not often that one can buy good hot sausage-dumplings with crusts that keep the gravy in.

Mince-meat or Bacon Pudding.—After pig-killing and the like, there are often sundry scraps too small to put in store, and too good to waste. Chop them up with a little salt bacon, season with pepper and all-spice, and make into dumplings like sausage-dumplings.

Mince-meat or Bacon Roll.—Prepare the meat as for dumplings of the same, and with it make rolls like sausage-rolls, only on a larger scale, so as to be able to stop a little gap in the stomach of a hungry man.

DOMESTIC SURGERY.

II.—HÆMORRHAGE (*continued*).

IN all cases of bleeding from the hand or arm it is important that the limb should be kept quiet, and in a raised position. For this purpose, and for many others, a sling is most conveniently made of a silk handkerchief, which should be folded like a cravat, and of a convenient width. The limb being placed in the loop of the sling, the front end is to be brought forward over the opposite shoulder, and the other end over the shoulder of the same side to meet it at the back of the neck, as seen in the illustration. In this way the arm will be drawn forward, and can be easily raised to any height, and the sling will not slip as it always does if tied in the opposite way (Fig. 9).

Bleeding from cuts about the face is seldom serious,



Fig. 9.

and a strip of plaister should be put across the wound on each side. Stitches should not be left in the skin of the face more than two days, and should then be cut close to the knot with a sharp pair of scissors, and drawn out gently. Narrow strips of plaister applied across a wound, and slightly overlapping one another, will, in many cases, obviate the necessity for stitches.

In wounds about the head, a little of the hair on each edge of the wound should be cut away, and a pad of lint be placed over it, and be bound on firmly with a bandage. This will of course vary somewhat according to the position of the cut, but will consist essentially of one or two turns round the front and back of the head, which should be secured with a pin, followed by a turn beneath the chin and over the top of the head, which will keep the other tight, as in the illustration.

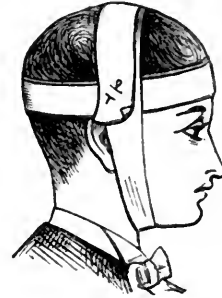

Fig. 10.

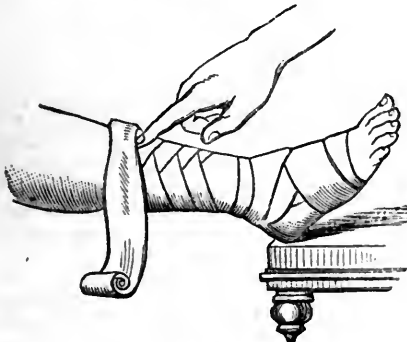

Fig. 11.

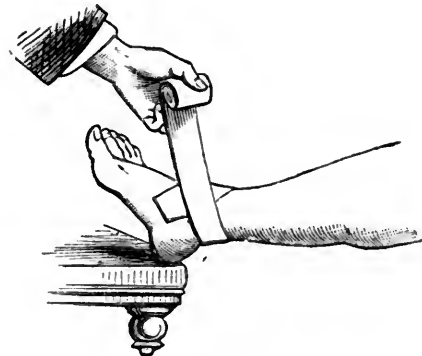

Fig. 12.

unless the lip should be divided by a blow upon the mouth, in which case a surgeon should be immediately consulted, or the resulting deformity may be great. Collodion is a very useful application to cuts about the face, and in applying it the part should be firmly pinched with the fingers for a few moments, so as to stop the bleeding, then having been wiped dry, the collodion may be painted on, and after a few minutes, when it has dried, the part may be released from the fingers. Court plaister may be applied with the same precautions, care being taken that both sides of the plaister are thoroughly wetted, without removing the adhesive material. In extensive cuts upon the face, it is advisable to have recourse to stitches of silk, in order to reduce the resulting scars to a minimum. In cases when the assistance of a medical man cannot be obtained, an ordinary stout sewing needle, with purse-silk or stout cotton, may be pushed through the whole thickness of the skin on each side of the cut, and an eighth of an inch from the margin, and the silk be tied in a double knot when the loop has been drawn tight, so as to bring the edges together. One stitch will be required for a cut an inch long, and so on in proportion ;

The trunk and lower limbs are seldom wounded, unless the injury is a severe one, which would necessitate immediate medical attendance. Before this arrives, the only assistance bystanders can give is to stop any bleeding, either by making pressure upon the bleeding spot, or by encircling the limb with a handkerchief tourniquet as already described.

A *burst varicose vein* in the leg gives rise to serious bleeding, which will be dangerous if not rapidly checked. As the accident ordinarily happens when the patient is standing, she (for it is usually women who suffer from varicose veins) should immediately lie down, and the leg should be raised, whilst a bystander presses the finger upon the bleeding point. A pad of lint and a firm bandage should then be applied, and the patient should rest the leg for a few days, and continue the use of the bandage as long as the veins are swollen.

To bandage a leg properly the foot must be raised and the bandage secured round the ankle by crossing the ends in front of it, as seen in the illustration. The bandage is then carried beneath the foot, and again around the ankle once or twice, and then round the leg, each turn over-

lapping the preceding one. When the calf is reached, it will be necessary, in order to make the bandage fit properly, to turn it down on the outer side of the limb each time it surrounds it; and in order to do this neatly, the bandage should not be drawn tight until after the "turn" has been made. It will assist in doing this neatly if the finger is laid upon the bandage to fix it at the point where the turn is to be made, as shown in the illustration.

Bleeding Piles may depend upon plethora, and be salutary, if slight; but if severe, and much blood is habitually lost, medical advice should be sought, in order that they may be permanently relieved. To check the bleeding temporarily, the injection of cold water, or cold decoction of oak-bark, is the best remedy.

Wounds.—The immediate treatment of ordinary wounds of a slight character has been sufficiently indicated in the sections relating to hæmorrhage. The after-treatment of a wound cannot be of too simple a character. Where there is no pain or discomfort about the wounded part, there can be no object in disturbing the first dressing applied, and this should be left undisturbed for from two to four days, according to the severity of the injury. It all has gone well, it is quite possible that a skin-wound may heal at once, and merely require the application of a piece of plaster over it, to protect it for a few additional days. If, however, it is found on carefully soaking off the original dressing that the wound is open and discharging, the best application will be the "water-dressing." This consists simply of a double fold of lint or soft linen suited to the size of the wound, and wetted with warm water, over which a piece of oiled silk, slightly larger than the lint itself, is secured with a strap of adhesive plaster or a bandage. The lint should be changed twice a day, but the oiled silk will serve for many days in succession. If a simple wound fails to heal in a few days under this treatment, medical advice should be had recourse to. If on removing the first dressing, a wound is found to have its edges red and tender, and the part is painful, a poultice of bread or linseed-meal may be applied for a day or two before the water-dressing is begun. The vulgar dread of what is termed "proud flesh" may be mentioned here, simply for the purpose of stating that the so-called proud flesh is only a slight exaggeration of the ordinary process of healing and is of no moment unless it rises high above the general surface, in which case the occasional application of a piece of blue-vitriol (sulphate of copper) will soon reduce it to proper dimensions.

ANIMALS KEPT FOR PROFIT.

I.—POULTRY.

Houses and Runs.—The first essential requisite to success in poultry-keeping is a thoroughly good house for the birds. This does not necessarily imply a large one or a costly: we once knew a young man who kept fowls most profitably, with only a house of his own construction not more than three feet square, and a run of the same width, under twelve feet long. It means simply that the fowl-house must combine two absolute essentials—be both perfectly weatherproof, and well ventilated. With regard to the first point, it is not only necessary to keep out the rain, but also the wind—a matter very seldom attended to, but which has great influence on the health and laying of the inmates. The cheapest material is wood, of which an inch thick will answer very well in any ordinary English climate; but if so built, the boards should either be tongued together, or all the cracks between them carefully caulked by driving in string with a blunt chisel. Care should also be taken that the door fits well, admitting no air except under the bottom; and, in short, every precaution taken to prevent draught. The hole by which

the fowls enter, even when its loose trap-door is closed, should admit enough air to supply the inmates, and the object is to have but this *one* source of supply, and to keep the fowls out of all direct draught from it. For the roof, tiles alone are not sufficient, and if employed, there should be either boarding or ceiling under them; otherwise all the heat will escape through the numerous interstices, and in winter it will be impossible to keep the house warm. Planks alone make a good roofing. They may either be laid horizontally, one plank overlapping the other, and the whole well tarred two or three times first of all, and every autumn afterwards; or perpendicularly, fitting close edge to edge, and tarred, then covered with large sheets of brown paper, which should receive two coats of tar more. This last makes a very smooth, waterproof, and durable roofing, which throws off the water well. But, on the whole, we prefer board covered with patent felt, which should be tarred once a year.

In the north of England, a house built of wood, unless artificially warmed, requires some sort of lining. Matting is often used, and answers perfectly for warmth, but unfortunately makes a capital harbour for vermin. When used, it should only be slightly affixed to the walls, and at frequent intervals be removed and well beaten. Felt is the best material, the strong smell of tar repelling most insects from taking up their residence therein.

If a tight brick shed offers, it will, of course, be secured for the poultry habitation. But let all dilapidations be well repaired.

Ventilation is scarcely ever provided for as it should be, and the want of it is a fruitful source of failure and disease. An ill-ventilated fowl-house *must* cause sickly inmates; and such will never repay the proprietor. This great desideratum must, however, as already observed, be secured without exposing the fowls to any direct draught; and for the ordinary detached fowl-houses, the best plan is to have an opening at the highest point of the roof, surmounted by a "lantern" of boards, put together in the well-known fashion of Venetian blinds. A south or south-east aspect is desirable, where it can be had; and to have the house at the back either of a fire-place or a stable is a great advantage in winter; but we have proved by long experience that both can be successfully dispensed with if only the two essentials are combined, of good ventilation with perfect shelter.

We do not approve of too large a house. For half a dozen fowls, a very good size is five feet square, and sloping from six to eight feet high. The nests may then be placed on the ground at the back, where any eggs can be readily seen; and one perch will roost all the birds. This perch, unless the breed kept is small, had better not be more than eighteen inches from the ground, and should be about four inches in diameter. A rough pole with the bark on answers best: the claws cling to it nicely, and bark is not so hard as planed wood. By far the greater number of perches are much too high and small; the one fault causing heavy fowls to lame themselves in flying down, and the other producing deformed breastbones in the chickens—an occurrence disgraceful to any poultry-yard. The air at the top of any room or house is, moreover, much more impure than that nearer the floor. Many prefer a movable perch fixed on trestles. In large houses they are useful, but in a smaller they are needless. If the perch be placed at the height indicated, and a little in advance of the front edge of the nests, placed at the back, no hen-ladder will be required; and the floor being left quite clear, will be cleaned with the greatest ease, while the fowls will feel no draught from the door.

Besides the house for roosting and laying, a shed is necessary, to which the birds may resort in rainy weather. Should the house, indeed, be very large, and have a good

window, this is not absolutely needed; otherwise it must be provided, and is better separate in any case. If this shed be fenced in with wire, so that the fowls may be strictly confined during wet weather, so much the better; for next to bad air, wet is by far the most fruitful source, not only of barrenness, but of illness and death in the poultry-yard. If the space available be very limited—say five or six feet by twelve or sixteen—the whole should be roofed over; when the house will occupy one end of the space, and the rest will form a covered “run.” But in this case the shed should be so arranged that *sun-light* may reach the birds during some part of the day. They not only enjoy it, but without it, although adult fowls may be kept for a time in tolerable health, they droop sooner or later, and it is almost impossible to rear healthy chickens.

Should the range be wider, a shed from six to twenty feet long and four to eight wide may be reared against the wall. Next the fowl-house will still, for obvious reasons, be the most convenient arrangement, and it is also best fenced in, as before recommended. The whole roof should be in one to look neat, and should project about a foot beyond the enclosed space, to throw the water well off. To save the roof drippings from splashing in, a gutter-shoot will of course be provided, and the wire should be boarded up a foot from the ground. All this being carried out properly, the covered “run” ought at all times to be perfectly dry.

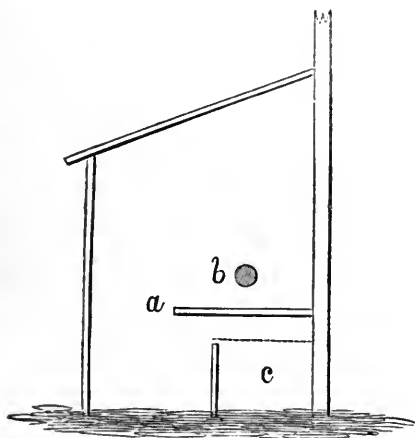

Fig. 1.

- a Broad shelf, eighteen inches high.
 b Perch, four inches above.
 c Nests, open at top and in front.

The best flooring for the fowl-house is concrete made with strong, fresh-slaked hydraulic lime and pounded “clinkers,” put down hot, well trodden once a day for a week, and finally smoothed. The process is troublesome, but the result is a floor which is not only very clean in itself, but easily kept so. Trodden earth will also answer very well. The floor of the shed may be the same, but, on the whole, it is preferable there to leave the natural loose earth, or cover it with sand, which the fowls delight to scratch in.

Cleanliness *must* be attended to. In the house it is easily secured by laying a board under the perch, which can be scraped clean every morning in a moment, and the air the fowl breathes thus kept perfectly pure. Or the droppings may be taken up daily with a small hoe and a housemaid's common dustpan, after which a handful of ashes or sand lightly sprinkled will make the house all it should be.

There is another most excellent plan for preserving

cleanliness in the roosting-house, for which we are indebted to “The Canada Farmer,” and which is shown in Fig. 1. A broad shelf, *a*, is fixed at the back of the house, and the perch, *b*, placed four or five inches above it, a foot from the wall. The nests, *c*, are conveniently placed on the ground underneath, and need no top, whilst they are perfectly protected from defilement and are also well shaded, to the great delight of the hen. The shelf is scraped clean every morning with the greatest ease and comfort, on account of its convenient height, and slightly sanded afterwards; whilst the floor of the house is never polluted at all by the roosting birds. The broad shelf has yet another recommendation in the perfect protection it affords from upward draughts of air.

The covered “run” should be raked clean two or three times a week, and dug over whenever it looks sodden or gives any offensive smell. Even this is not sufficient. Three or four times a year, two or three inches deep—in fact, the whole polluted soil—must be removed, and replaced by fresh earth, ashes, or sand, as the case may be. If the floor be hard, there must be kept under the shed a heap of dry dust or sifted ashes, for the fowls to roll in and cleanse themselves in their own peculiar manner, which should be renewed as often as it becomes damp or foul from use.

If chickens be a part of the intended plan, a separate compartment should be provided for the sitting hens; but this will be further treated of in a subsequent article.

Many will wish to know what space is necessary. The “run” for the fowls should certainly be as large as can be afforded; an extensive range is not only better for their health, but saves both trouble and food, as they will to a great extent forage for themselves. Very few, however, can command this; and poultry may be kept almost anywhere by bearing in mind the one important point, that the smaller the space in which they are confined, the greater and more constant attention must be bestowed upon the cleanliness of their domain. They decline rapidly in health and produce if kept on foul ground. If daily attention be given to this matter, a covered shed, ten or twelve feet long by six feet wide, may be made to suffice for half a dozen fowls without any open run at all. By employing a layer of dry earth as a deodoriser, which is turned over every day and renewed once a week, the National Poultry Company kept such a family in each pen of their late large establishment at Bromley. These pens did not exceed the size mentioned, yet the adult fowls were in the highest health and condition; and, with birds thus confined, the company took many prizes at first-class shows.

Poultry-keeping, therefore, is within the reach of all. The great thing is purity, which must be secured, either by space, or in default of that, by care: hardy fowls will sometimes thrive in spite of draughts, exposure, and scanty food; but the strongest birds speedily succumb to bad management in this particular, which is perhaps the most frequent cause of failure. It should also be remarked that poultry thus confined will require a different diet to those kept more at liberty; but this will be more fully explained by-and-by.

If the run be on the limited scale described, dry earth is decidedly the best deodoriser. It is, however, seldom at the command of those who have little space to spare, and sifted ashes an inch deep, spread over the floor of the whole shed, will answer very well. The ashes should be raked every other morning, and renewed at least every fortnight, or oftener if possible. Of course, the number of fowls must be limited; they should not exceed five or six; and unless a second shed of the same size can be allowed, the rearing of chickens should not be attempted.

To those who can give up a portion of their garden, the plan, Fig. 2, of a poultry-yard can be confidently recommended. It represents, with very slight modification, our own present accommodation; and having tested it by experience, we are prepared to say that it is not only more convenient, more simple, and more cheaply erected than any plan on a similar scale we have seen, but, with the addition of a lawn on which the chickens may be cooped, is also adapted to rearing in the highest perfection any single variety of either ordinary or "fancy" fowls. The space required in all is only twenty-five by thirty-five feet. If more can be afforded, give it, by all means; but we have found this, with very moderate care, amply sufficient, and we believe it will meet the requirements of a larger class of readers than any other we are acquainted with.

This plan, as will be seen, comprises two distinct houses, sheds, and runs, with a separate compartment for sitting hens. The nests are placed on the ground at the back of the houses, and the perches, as before recommended, a foot in advance of them, and eighteen inches high. The holes by which the fowls enter open into the sheds, which are netted in, so that in wet weather they can be altogether confined. In dry weather the shed is opened to give them liberty. The fencing should be boarded up a foot high, not only to prevent rain splashing in, but to keep in when necessary young chickens, which would otherwise run out between the meshes.

A walk in front of the sheds should be gravelled, and the remainder of the open runs covered with sand, or they may be laid down in grass, which, if well rooted first, will bear the fowls upon it for several hours each day, but should be renewed in the spring by sowing when needed. The runs should be enclosed with wire netting, two inches mesh, which may be conveniently stretched on poles, 1½ inch square, driven two feet into the ground, and placed five feet apart. The height of the fence depends on the breed chosen. Cochins or Brahmas are easily retained within bounds by netting a yard high; for moderate-sized fowls six feet will do; whilst to confine game, Hamburgs, or bantams, a fence of eight or nine feet will be found necessary. The netting should be

simply stretched from post to post, without a rail at the top, as the inmates are then far less likely to attempt flying over.

We do not like to see fowls with their wings cut. If their erratic propensities are troublesome, open one wing, and pluck out all the first or flight feathers, usually ten in number. This will effectually prevent the birds from flying, and as the primary quills are always tucked under the others when not in use, there is no external sign of the operation.

The holes by which the fowls enter the houses should be furnished with trap-doors, that they may be kept out at pleasure whilst either part is being cleaned. Each house must also have a small window. Having a shed at the side, ventilating lanterns will not be necessary, as the end will be attained by boring a few holes in the wall between the house and shed, towards the highest part of the roof. The compartment for the sitting hen may be walled in at the front or not; for ourselves, we prefer it open. Her run may also be covered over or not, at pleasure. To have it in the middle, as here shown, we consider most convenient.

Such a yard possesses many advantages. Two separate runs are almost necessary if the rearing of chickens forms part of the plan of proceeding. It is also in some respects convenient to keep two different breeds, as one may supply the deficiencies of the other; and many persons consider it advisable to separate the cocks and hens, except during the breeding season, believing that stronger chickens

are obtained thereby. The need of the separate compartment for the sitting hens is further insisted on hereafter, but it has also other uses; being, when not so employed, often very convenient for the temporary reception of a pen of strange birds, for which there may be no other accommodation.

Each run, as here described, will accommodate from six to ten fowls, according to their size and habits; and we close this paper with one very simple but important stipulation, which is a *sine qua non* in rearing poultry: fowls should not be kept unless proper and regular attention can be given to them; and we would strongly urge that this needful attention should be as far as possible *personal*.

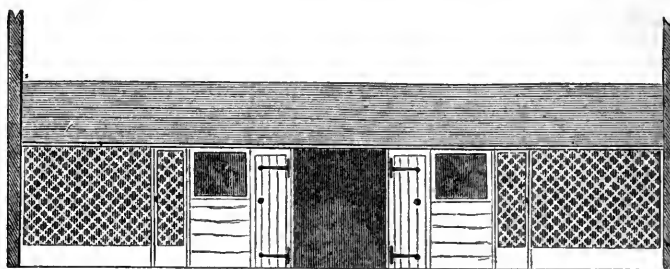

ELEVATION

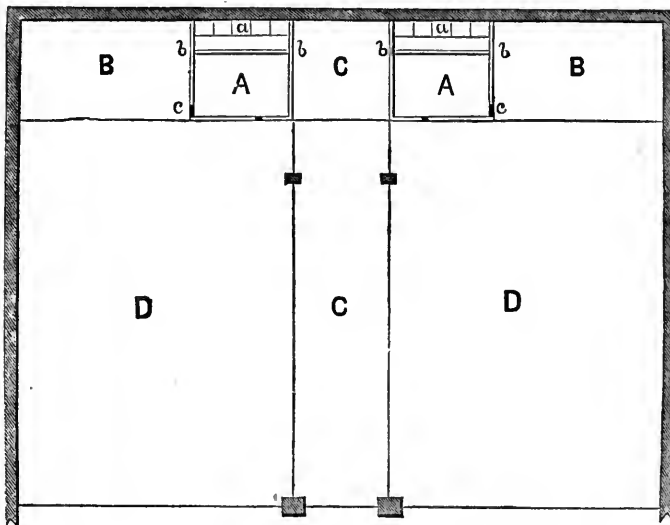

PLAN



SCALE

Fig. 2.

- A A Roosting and laying houses.
- B B Fenced-in covered runs.
- C C Shed and run for sitting hens.
- D D Grass runs.
- aa Nests.
- bb Perches.
- cc Holes for fowls to enter.

THE REARING AND MANAGEMENT OF CHILDREN.

II.—CLOTHING FOR INFANTS.

SUCH clothing as is *absolutely necessary* for a baby may be supplied at a small cost, if the mother is able to make up the materials at home. Almost any amount of money

do well to remember the admirable example of simplicity set them by our Royal family, whose little ones are clad without finery or ostentation.

Materials.—If a word about work materials is necessary, we would suggest the following: Purchase an easy-fitting thimble of *steel, lined with silver*; it is well worth what it will cost. Have two good pairs of scissors—one pair of large ones, worth about three shillings, and a fine em-

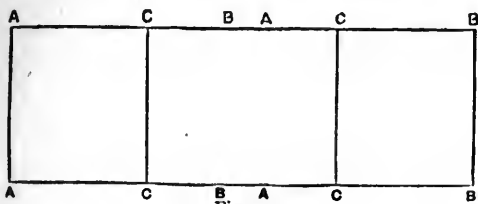

Fig. 1.

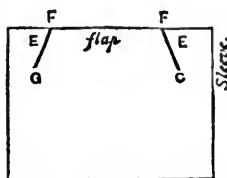

Fig. 2.



Fig. 3.

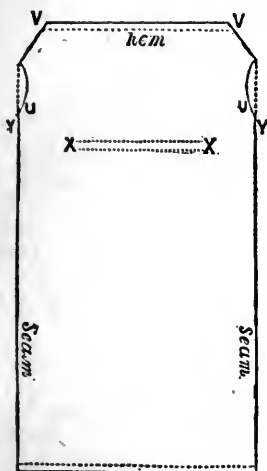

Fig. 8.

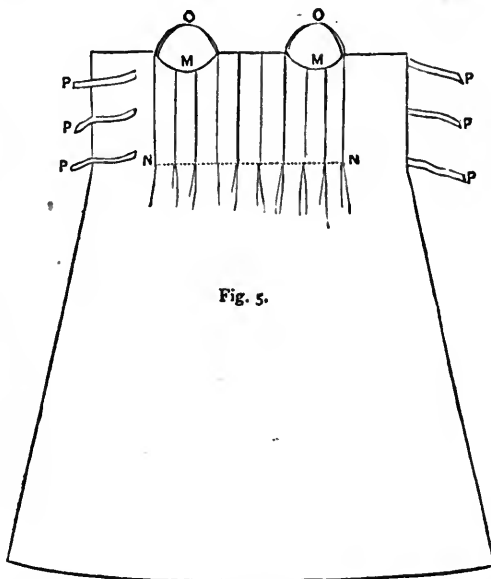

Fig. 5.

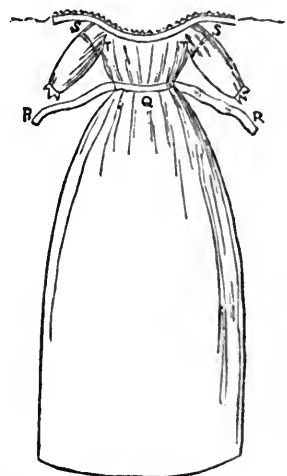

Fig. 9.



Fig. 11.

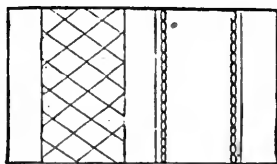

Fig. 6.



Fig. 7.

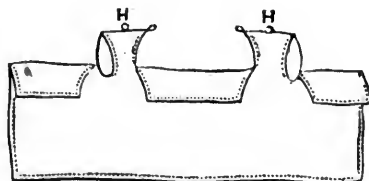

Fig. 4.

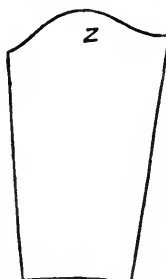

Fig. 10.

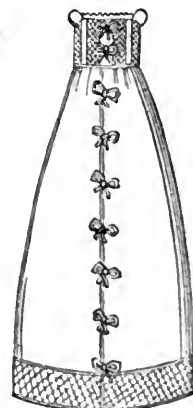

Fig. 12.

may be laid out upon extra fineness of texture or trimming. How much need be spent on the superfluities and luxuries of the unconscious child's toilette must depend on the social position of the parents, and the good sense and discretion of the mother, and in all cases the great aim should be to get what is substantial and good, in preference to what is gaudy and showy, and not so liable to stand wear. All lovers of unnecessary display would

broidery pair that will cost 1s. 6d. It is always a good plan to have an old or common pair kept handy where any one can have free access to them, because this saves good scissors. Always take care to have good needles and cotton; bad cotton knots, breaks, and makes bad work. Sewing machine cotton is the best made. Always have a lead pencil—an HB is the most useful—and a penknife in the work-basket. One of those

covered baskets that stand on legs are the tidiest and most useful to hold work, and do not cost more than four or five shillings. A large work-box to hold materials is also needed. Procure fine cotton and fine needles for babies' work; needles Nos. 8 and 9 should be used, and the best cotton, in about three sizes. Do not use the glazed cotton. Some persons like to wax their cotton; if the hands are over-warm, an emery cushion is useful to thrust the needles in; and do not commence work without a good leaden pincushion, a yard measure, and plenty of pins. If you employ a machine, the cotton used will be finer than that quoted, which is suitable for hand work.

We will commence our labour of love, by instructing the young mother how to provide for the charge she anticipates, and enumerate, first of all, the requisites for the babe during the month.

To Cut and Make a Baby's Chemise.—Half a dozen little chemises are the first requisites for an infant's toilette, to make which it will be necessary to purchase a yard and three-quarters of lawn at 1s. 6d. a yard; the lawn should measure twenty-eight inches wide. Cut this up in six lengths of ten inches each. To cut the material accurately, measure ten inches on each side with a yard measure, put a pin at each place, fold the stuff across, and crease it quite flat. Get a friend or servant to hold the opposite end as you cut it, or pin it to a leaden pincushion. Take one of the ten-inch strips to make the first chemise, and fold it across the narrow way to ascertain the centre; open it again; measure six and a half inches each side of the centre, and mark the place with a pencil dot or a pin (never attempt to work without a paper of pins, short whites); make a fold again at each of these marks—the narrow way. These folds are lettered with four C's in Fig. 1. Double first the right and then the left side of the stuff over, like the page of a book, at these folds, so that A A at the right corners meets A A in the centre, and B B at the left corners meets B B in the centre, the two ends folding over about a couple of inches on the right hand. Your work now looks of the shape shown in Fig. 2—that is, nearly square. With your pencil mark the two slanting lines E E in Fig. 2. Try with your yard measure if they are in the right place. From the corners to F, each side, it should measure three inches and a half; from the corner to G, the bottom of the slanting line, two and a quarter. The line itself is to measure two and a half inches long. If your pencil line is not correct, make it so, and then cut the stuff, cutting downwards from F through both pieces, just as they are folded together, and exactly over the correct pencil mark. If you have pinned the stuff together closely all round the edge and each side of the mark before cutting, you will be the more sure of accuracy. These two simple acts form the sleeves and the flaps of the little chemise; the sleeves must first be run and felled together on the shoulders (H, Fig. 4). The next thing to do is to turn down a very tiny hem and work it finely with a 9 needle and fine cotton. The corners between the sleeves and flaps of the garment should be shown either button-holed or gusseted. The button-holing is done by working long graduated stitches finely and close, as in K, Fig. 3, or letting in a gusset, as in L, Fig. 3. A gusset is a three-cornered piece of stuff laid on. In this instance, it measures not quite one inch across by half an inch deep. It is run on at the top, turned down, and stitched; the other two sides are hemmed to the chemise. Next turn a very fine hem down for the edge of the sleeves; afterwards hem the bottom of the little garment rather deeper. The selvage for the sides may be left. Fig. 4 shows its appearance when completed. The points of the sleeves are armed with straps, and fine linen buttons are placed midway on the shoulders. These are used, when the child is

older, to button down the flannel straps, and need not be added till required.

For a handsome Chemise.—Those who can afford it use French cambric for babies' chemises, edge the sleeves with very narrow Valenciennes lace, and instead of running and felling the shoulders together, hem them very narrow, and sew them to the two sides of an extremely narrow Valenciennes insertion.

The Flannel.—Next to the chemise a flannel is worn. This should be Saxony, and measure not less than forty or forty-four inches wide. It may be purchased for 1s. 6d. a yard, unless it is desirable to give more. Two yards must be purchased to make two of these. Mark the centre of the flannel, and form a box-plait there an inch and a half wide, or two inches in the wider flannel (the forty-four inch). Make two other similar plaits on each side of this—five plaits in all—with full an inch space between each, and about four inches over at each end. Tack these plaits down for seven inches to form a body, and let the rest hang free; cut out two half-circlets between the two outer plaits each side, to form the arm-holes, as shown in Fig. 5 at M and M. Run the plaits very neatly down each side, and stitch them across at the ends marked by the letter N. Stitch a washable binding all round the flannel, and add two tapes for shoulder-straps, marked O, and tapes each side at the places marked by six P's, to tie the flannel, which folds across the baby. This is the description for a night flannel.

For a Day Flannel.—Purchase two more yards of better quality flannel, say 2s. 6d. or 3s. per yard. Make as before directed. Some persons give as much as 4s. 6d. or 5s. a yard for perfectly white flannel, bind it with white sarcenet ribbon, and tie it down the front with sarcenet bows. The plaits are either quilted across with white or coloured silk, or sewn down with chain-stitch. If blue or scarlet silk is used for this purpose, the flannel must be bound with blue or scarlet ribbon or washable binding. Fig. 6 represents parts of two folds of a baby's flannel, the one quilted the other chain-stitched. Chain-stitches are formed by leaving the loop of the first thread above the work and entering the needle of the second stitch through it, as shown in Fig. 7.

The First Gowns.—These are made half high, and with long sleeves. Buy twelve yards of bird's-eye spotted cambric muslin, at a shilling a yard, and make six of them. The material is a yard wide. Cut off two lengths of a yard each, and run and fell them together till they look like a sack with two seams, Fig. 8. Leave these seams open (U U, Fig. 8) for the sleeves to be put in; slope off pieces at V V, as shown in the illustration, to form the shoulders, which should measure about two inches long. Run and fell these together. Either merely hem the top and run a string in it, or gather it into a band, which must, however, also have a string in it to draw it close to the baby's little neck. Gather in the skirt from X to X to form a waist. The piece gathered should be fifteen inches long, and brought into a band one inch deep and five long, as shown in Fig. 9, at Q. One end at each side of this band (R R) ties round the back of the waist, and draws the loose part of the robe close to the baby's figure. A placket hole is made five inches long down the back of the body. The robe is not really open at the back, it is only drawn like this in the diagram to show the looseness of the back, and how far the waist gathers extend. The seams come at the sides. The sleeve is of the coat shape, cut like Fig. 10; it is run and felled together, the seam being placed downwards at Y in Fig. 8. The Z marked in the diagram of the sleeve, Fig. 10, shows how the top is rounded to sew it into the armhole. It is run and felled in, and eased a little at the top; the armhole should not be quite so large as the sleeve. The baby's sleeve is eight inches long, six across the top before it is

joined, and five at the cuff. The measurements are all given allowing for turnings, hems, &c.

A rich First Frock (Fig. 11) is made of fine cambric muslin; three rows of insertion embroidery, edged each side by narrow pointed work, trim the body. The cuffs and epaulettes are enriched to correspond, and the neck and waistband are also of fancy work. The skirt is embellished with a number of narrow tucks, and edged with pointed embroidery.

A handsome Day Flannel.—Fig. 12 gives a design for a handsome day flannel. It is made of very fine white Saxony. The body plaits are machine quilted, with white crochet silk. The skirt has a deep hem also quilted. It is bound with broad white ribbon and tied with large bows.

In our next article we propose giving another pattern for a baby's flannel, a baby's house wrapper, a baby's cloak, cape, and hood, with ample directions for cutting them out and making them up as in the case of the garments described in the present paper.

INMATES OF THE HOUSE—LEGAL.

II.—PARENT AND CHILD.

IT might, perhaps, be thought that if any law were required to regulate the relations between parent and child, it would be found innate in the human breast. But human nature has so many weaknesses, to say nothing of positive evil impulses, that we cannot allow ourselves to trust to it alone, and experience has shown that a public law is necessary, in order to define the relation in which parents and children stand towards each other, and towards those who are without.

The law of Rome gave to a father the most absolute power over his children, at one period allowing him even the power of life and death; but always giving him ownership in all that his sons or daughters had, with power of disposing of it during his own lifetime. Only upon the father's death did the children become free, unless he had emancipated them previously, and in that case the children of the free were in their turn in legal bondage to their father. These principles never found favour in the West, and were not adopted even by those nations which engrafted the greater portion of the Roman law upon their own stocks. In this country the Roman law never had any footing, in spite of many strenuous efforts to import it; and the English law of parent and child is therefore not founded upon it, but upon those principles of general convenience and utility which suggested themselves as the demand for them came.

The Duties imposed upon Parents by the English law are the maintenance and protection of their children. It has been considered an unwarrantable thing that those through whose instrumentality children have been called into being, should be allowed to neglect those children, or to throw them as a burden upon others. This is a common-sense view of the matter, and one that would be approved even by persons devoid of that natural affection which is a law of itself to those who have it. It is required, then, of parents that they shall feed, clothe, and house their children; but it does not follow legally from this that they must do so in a manner according with the style in which they themselves are living. So long as they arrange in such a way that the children are not chargeable to the parish, they may bring them up in what station of life they please. It might, no doubt, be matter for comment, if an unnatural father should deny to his children a share in the comforts he is able to procure; but the law would only compel him to provide them with actual necessities. "The policy of our laws," says Black-

stone, "which are ever watchful to promote industry, did not mean to compel a father to maintain his idle and lazy children in ease and indolence; but thought it unjust to oblige the parent against his will to provide them with superfluities and other indulgences of fortune, imagining they might trust to the impulse of nature, if the children were deserving of such favours." Supposing, however, that the child be living away from home, and there is not any intimation given by the father of his own peculiarities, it will be understood that he intends his child to live in a manner consonant to that in which he himself lives; and tradesmen supplying goods to such child will be able to recover from the father not only the price of such goods as were actually necessary to sustain life, but also of such other goods as were not incompatible with the father's position in the world. What goods were necessary for the child's existence, it is not difficult to determine; what other goods were, under the circumstances, allowable, is a question which is left to a jury to answer. Some of the decisions have been sufficiently remarkable. In one case it was held that a gold latch-key was "necessary" to an officer in the Life Guards, evidence having been given to show that it was the custom for the officers of that regiment to use gold keys. But in the same case it was held by the jury, with the full approval of the court, that gold lockets, bracelets, and earrings, could not be "necessary" to an officer, and the items were struck out of the account. A diamond ring was allowed to stand in a jeweller's bill, for which an action was brought against a nobleman—the goods having been supplied to his son, an undergraduate at Oxford—on the ground that such an ornament was a common one among gentlemen in the young man's position, and might therefore be considered in the light of a "necessary," for which the father was chargeable. Instances might be multiplied indefinitely; but the rule is, that where a father allows his child to be in that position, from which it might reasonably be supposed he intended him to be treated as his son, he will be liable for supplies made to him, in accordance with the appearance he allowed him to keep up. It is at all times competent, however, to a father to limit his liability, by giving notice that he will not be liable for any debts his child may incur; and if he does this, by advertising for a reasonable time in such papers as are generally read, or by special notice to tradesmen and others in the places where his son may be, he will not be liable except for bare necessities, and even for these it is a question whether he will be made to pay, if he causes it to be known that he is paying his son a sufficient necessary allowance. So firmly, however, does the law hold to its rule that a parent shall maintain his children, that it requires the father to repay to a parish, on the rates of which the son has become chargeable, the value of the supplies made to him. By virtue of his office of guardian to his child a father may bring an action against any person injuring the child, and he may recover damages not only for the child, but for himself also, because the child is supposed to have been a help to his father, and damages are awarded to compensate for the loss of service. The Roman law carried the principle of parental maintenance so far that it would not allow a man to disinherit his children, that is to say, it would not allow him to leave more than three-fourths of his property away from his children. If he did so, his will was set aside as insane, and a fourth of the property was taken for the children's benefit. At one time our law recognised the children's right to "a reasonable part" of the father's estate; but at the present day, the utmost freedom is given to testators in disposing of their property, and a man possessed of a million of money may, for all the law will interfere, leave the whole of his wealth away from his family.

Education.—Up to the present moment parents are

not under any legal obligation to educate their children, but are free to follow their own instincts on the subject.

Power of Parents over Children.—A father has a right to the custody of his children until they attain twenty-one years, and he may recover them, if detained from him, by the writ of *habeas corpus*. Cases arise sometimes in which this right to custody is modified, so that the child is free at the age of fourteen; but he must himself express his desire to leave the protection of his parents, and must do so in open court, or he will be given up to his father. Under the age of fourteen the child is absolutely within the power of his father, and any person enticing, stealing, or detaining a child under ten years of age, with intent to deprive its father or proper guardian of the charge of it, incurs the penalties of felony. A father has legal right to correct or chastise his child, so the punishment be not immoderate; his consent must be obtained to a marriage, if the child be a minor; and his dissent, on publication of banns, will be sufficient to stop the marriage. A licence for a minor to be married will not as a rule be granted, and should not be granted, except on oath that the father's consent has been obtained. Where a minor has property, independently of his parents, his father is the guardian and administrator of it during the minority; but he will be liable to be called upon for an account of his guardianship on the infant attaining his majority. A father has power by his will to appoint guardians for his children under age, and such guardians are invested, by the law, with the same rights and powers and responsibilities as the father.

Mother and Child.—A mother has not any power over her children during her husband's lifetime, except in one case which is created by statute. If the children are under seven years of age, the Lord Chancellor may order, on the mother's petition, that they be given over to her—the mother being considered a better and more natural guardian for children of tender years. On the death of her husband, she steps into his place as guardian, having a right to the custody of her children till they are of age. She cannot, however, appoint a guardian by her will, as she is not mentioned in the statute which gave the father that privilege.

Duties of Children to Parents.—These are not defined by the municipal law, being supposed to be contained in the law of nature; but the poor law which compels parents, who are able to do so, to pay for the maintenance of their children, of whatever age, who may become chargeable to the parish, also makes it incumbent on children having ability to pay, to provide for their poor and impotent parents, at such a rate as the justices in quarter sessions may order.

COOKING.

SIMPLE RECIPES (*continued*).

Baked Tapioca Pudding.—To each pint of milk put four table-spoonfuls of tapioca, and boil gently until it is swollen. Sweeten and flavour to taste and your means. A little bit of cinnamon, or of orange or lemon-peel, boiled with the milk is agreeable. Let it stand to cool until it is tepid. Into the pie-dish in which your pudding is to be baked, break two or three eggs; more, if you can afford them. Break them up with a fork, and stir into them your lukewarm milk and tapioca. Grate a little nutmeg on the top, and set into a very gentle oven. Watch that it does not boil. Sago and semolina baked puddings are made in the same way. You may, if you like, line the bottom of the dish with a crust, as in making baked apple-pudding; it will make it more satisfying. When eggs are scarce, their loss may be in some measure supplied by the addition of a little flour, arrowroot, or

baking-powder; but always use eggs when you can get them.

Baked Rice Pudding.—Boil rice (after washing it) in a little more milk than it will absorb, with a little bit of cinnamon or lemon-peel, and a small quantity of finely-chopped suet; sweeten to taste. When nearly cool, mix with it as many beat-up eggs as are allowed you, pour it into a greased pie-dish, grate nutmeg on the top, and bake in a very gentle oven, especially if the allowance of eggs is liberal. The suet directed in this receipt (or a bit of butter instead) will be found a very great improvement. Some people are obliged to leave out the eggs altogether; some do so from choice, but of course when this is the case the pudding becomes a very plain one, and though good, wholesome fare, and very nice, if well made, it hardly deserves the name of a pudding.

Savoury Rice Milk.—Steep your rice an hour or two in soft water. Set it on the fire in half milk and half good broth, cold. Mutton broth is excellent, with the fat left floating on the top; if turnips have been boiled with the meat, so much the better. Season with a small quantity of finely-chopped onion, and a dust of pepper and salt. Keep stirring all the while, to keep the rice from burning and the milk from boiling over. When the rice is quite tender, the members of the household can be served with their share, warning them not to burn their mouths.

Sweet Rice Milk is more of a treat for delicate little girls, perhaps a little spoiled. By additions you may easily bring it up to custard or pudding point. Boil rice, previously steeped in new milk, with the same precautions as before; season with a little salt and sufficient sugar. You may flavour with lemon-peel, cinnamon, or grated nutmeg. You may stir in, after taking it off the fire, as many beat-up eggs as you please; and you may, if you choose, add to it a bit of butter, a glass of home-made wine, or, if needful, on a sharp winter's evening, a table-spoonful of brandy.

Broken-Bread Pudding, Baked.—You will often have sundry scraps and remnants of bread. Crusts are even better for this purpose than crumb. No matter how *dry* they are, so long as they are not *musty* or *mouldy*. Break up your fragments into small bits, and put them in a bowl. Put into a saucepan as much milk as you judge will soak the bread; throw into it two or three table-spoonfuls of suet chopped very fine, sugar to taste, and a pinch of salt. When it boils up, pour it over the bread. When nearly cold, add two or three beat-up eggs, and just a few currants and raisins. Break up and mix the whole equally together with a spoon. Put it into a buttered pie-dish; smooth the top, put a few little bits of butter and raisins on the surface, and set into the oven to bake. This pudding is as good cold as hot. The addition of a table-spoonful of rum to the beat-up eggs is by some thought to be an improvement. By putting in more eggs and a little flour, to make it hold together, broken-bread pudding may be boiled in a basin, and turned out on a dish. It may be served with some one of the sweet sauces for which we have already given recipes, poured over and round it, and then becomes a very delicate and presentable form of using up remnants.

Bread-and-Butter Pudding, without Butter.—This makes a capital pudding, and we strongly recommend our readers to try it. When well made, it is quite equal to the best varieties of marrow pudding. To make it first-rate, however, a liberal allowance of sugar and eggs is indispensable. Bake a nice fat piece of beef—the thin end of the ribs, for instance—on a three-legged wire stand, over a dish of potatoes. By setting it into a brisk oven, and turning the potatoes soon afterwards, they will be crusted outside, floury within, and will soak up very little of the dripping. After the beef and potatoes have been served (which may thus become the staple of the

first day's dinner), and before the dripping is quite cold, cut several slices of bread, not too thick, and butter their upper surface with the cooling fat, until you have enough to *half* fill the pie-dish which is to hold your pudding. The half left empty is to allow for the swelling of the bread. Stone some raisins; wash a few currants. Lay a few of these at the bottom of your dish; on them slices of bread and fat; then more fruit, and so on. Sweeten, according to taste or your pocket; a little more milk than will cover the whole; add a pinch of salt; beat up with that the number of eggs you can afford—one, two, three, or four. A little brandy can, if desired, be added. Pour this over the sliced bread. Let it stand to soak. If it is all absorbed, fill up the dish with more milk and egg. On the top drop a few currants and raisins, and some bits of the cold beef dripping as big as hazel-nuts. Set into a moderate oven, and bake very gently, just allowing the top slice of bread to brown. This pudding is *richest* hot, but excellent cold. We are inclined to think raisins only to be more economical for these and most other puddings than currants, which may, therefore, be left out. Raisins, especially when opened and stoned, make a greater show and communicate more flavour. But a sprinkling of currants looks prettier.

Batter is a mixture of flour, salt, eggs, and milk, beaten together, whose proportions depend—first, on the housewife's means; secondly, on the purpose for which she wants it. Some batter, as that for pancakes, fritters, and frying things in, is lightened by the addition of yeast or spirit. It may be also lightened by beating the *whites* of the eggs to a froth, and then mixing them with the batter. Batter, when cooked, should cut firmly, and not stick to the knife like paste. To ensure this, five eggs to every half a pound of flour is a good allowance. Put first the flour and salt (in very small quantity) together in the bowl; then the eggs. When those are incorporated, pour in the milk, a little at a time, beating it with the back of a large wooden spoon till all is smooth and of the required consistency.

Plain Batter Pudding, Boiled, is the above batter tied in a well-floured cloth, or in a buttered basin, and boiled, galloping, from an hour to an hour and a half, according to size. The basin takes longer than the cloth. Do not take the pudding out of the boiler till the minute before you want to serve it. It is eaten most frequently with meat gravy; occasionally, however, with sweet or wine sauce.

Black-Cap Pudding is nothing more than the above, with the addition of a handful of well-washed currants, and slightly sweetened, boiled in a basin. Let the basin stand on its bottom in the boiler; the currants in the batter will sink to the bottom, and remain fixed there when the pudding is cooked; and when turned out, they will all be at the top. Serve with any good sweet or wine sauce. Instead of grocers' currants, fresh fruit, as sliced apples, cherries, &c., may be used; but the batter must be stiffer, to enable it to hold together; and the pudding mostly turns out a "mess" in the unfavourable sense of the word. Fruit with batter is much better *baked*.

Baked Batter Pudding, with Apples.—Grease the inside of a shallow pie-dish. Peel, quarter, and core apples enough to cover the bottom of the dish one layer thick. Over this pour enough batter, slightly sweetened, to fill the dish. The layer of apple will float to the top. Bake in a tolerably brisk oven, and serve immediately after taking out. It will then be a great improvement to put a few bits of butter (which will melt immediately), and sprinkle a little sugar on the top. Similar batter puddings may be made with almost any fresh fruit. Even those of inferior quality are softened and mellowed by the baking. Strawberries, cherries, plums of various kinds, even bullaces, make exceedingly nice and wholesome baked batter puddings.

Baked Batter Pudding, with Sausages or Bacon.—Exactly as above, only, of course, not sweetening the batter, and using sausages or slices of bacon, or both, instead of fruit. In this case also it is best to lay the meat at the bottom of the dish, and pour the batter over it; because the coating of batter which adheres to it prevents its surface from being scorched, and retains the gravy.

Toad in a Hole is a good lump of fat meat, perhaps with plenty of bone—beef is best, veal second best—laid in the middle of a deep dish, and baked with batter poured round it. When done, the toad, or bit of meat, is taken out of its hole, laid on a hot dish, and served, accompanied by vegetables, after the hole itself has been eaten. This is also a capital way of getting all that is to be had out of an underdone joint of cold meat, especially if fat enough.

Batter Pudding, Baked under Meat, is also very good, when the meat is raised *above* the batter on a wire stand with three or four legs. The gravy, dropping from the meat, enriches the pudding, which in this case has a level surface, instead of presenting a hollow vacancy as with the toad-in-a-hole. When cooked, the meat is transferred to a hot dish, the wire stand removed, and the pudding left entire without flaw or defect.

Yorkshire Pudding is batter made a little stiffer than usual, put into a shallow tin, and set in the catchpan under *roasting* meat, and cooked by the fire which roasts it. Large joints would flood the pudding with too much gravy; while with a small fire the pudding is apt to remain underdone and pasty, for which the only remedy is to set it for awhile in the oven. Cold Yorkshire and other baked batter puddings may be heated in a Dutch oven before the fire. Cold boiled batter pudding may be either fried, or sliced, toasted, and buttered like crumpets.

Carrot Pudding.—Mix together half a pound of flour, half a pound of chopped suet, a pound of chopped carrot, a quarter of a pound each of washed currants, stoned raisins, and brown sugar, with grated nutmeg, a little salt, four eggs, and enough new milk to bring the mixture to the proper consistence. Boil for an hour in a pudding-basin.

Saratoga Pudding (American).—Beat together three table-spoonfuls of sugar, two of flour, three eggs, and a little salt. Stir into them a quart of hot milk. Beat together again, and bake a quarter of an hour.

Dr. Dobell's Flour Pudding.—That eminent physician informs us, in his "Manual of Diet and Regimen," that four ounces of flour, an ounce and a quarter of sugar, three-quarters of an ounce of suet, three-quarters of a pint of milk, and one egg, form a combination of alimentary principles in nearly exact normal proportions.

Gâteau, French country cake, for high days and holidays.—Five eggs to every pound of flour is the rule; when they are dear, you may content yourself with four; when cheap, you may bestow six or seven on each pound of flour; but the more eggs you put, the drier the cake will be. Put also to the same a quarter of a pound of butter (which rich folk increase to half a pound), and either a quarter of a pound of currants, washed, or the same quantity of raisins, stoned and chopped. The plums will thus be few and far between, as if they had been shot into the cake at a long range. Indeed, you have a fair chance of getting a slice of plum cake without plums. No sugar. Work these into dough with water and yeast, and proceed exactly as with bread, making your cake into a long roll-shaped loaf, to bake the more thoroughly. You may use milk instead of water, but it makes the cake drier. *Gâteau* is eaten in slices spread with butter, at the end of a repast, or at the usual five o'clock *collation*. It may also be made plain, *i.e.* without plums.

THE HOUSE.

WAYS AND MEANS (*continued*).

IN accordance with the plan laid down in our previous paper on this subject, we propose now to enter into the question of household economy somewhat more in detail, and as this can be made more intelligible if some actual sum is taken as an illustration, we propose to lay out in this chapter a scheme for the expenditure of £150 a year. Still, in what we are now about to say, we must be understood as speaking generally, for it is difficult, nay, almost impossible, to lay down any precise rules for expenditure upon different items of housekeeping. A man, his wife, and four children, will live in the country, when provisions and coals are cheap, and save upon a sum, which in the suburbs of a town will not much more than keep them from starvation. To live in London is more economical than in the outskirts, because, there, the markets are available; and at the close of the day most edibles may be purchased at a very low rate. Even in groceries there is a wide difference in the price. Sugar, which at one end of the town can be had for fourpence, is fivepence elsewhere; the same with cocoa, tea, coffee, cheese, and butter. Where a wife is at all clever, is a womanly woman, and thoroughly understands her position and responsibility, it is marvellous how much of wholesome food she will make a small outlay produce.

We have seen that in an income of £100 per annum, only 6s. 6d. per week for rent can be expended. In that of £150, the rent and taxes may be allowed for at the rate of £30 per annum, or 11s. 6d. per week—that is, rent £25, taxes £5. A servant cannot be kept with an income of £150 a year, unless her wages and maintenance be taken from the sum allotted to housekeeping, or that she saves, by undertaking the washing, four pounds of her wages.

It is a disputed point among housekeepers whether there is really any economy in having the washing done at home. Under some circumstances, undoubtedly it is; but under others it is not so. Given a good drying ground, 1s. a day to the washerwoman, cheap coals, and plenty of time at disposal, then it is better, undoubtedly, to wash at home; but when, as in London, 2s. 6d. a day is paid for labour, coals being dear, and time is apportioned by the washerwoman, who must be allowed, beyond her pay, beer or gin, or both, then it is cheaper to put the clothes out to wash. An excellent way is to put out to be washed shirts, sheets, and table-cloths, and have the remainder done at home by the servant. Children's clothes are readily washed and ironed, or ought to be so, where a narrow income is to be battled with, to make it yield as much as it possibly can; and in a case like this, the wife's value may be exhibited, in her ingenuity and contrivance to make one shilling do the work of two completely and satisfactorily, while at the same time the clothes will be far better and more carefully done than if they had been put out. Taking then an ordinary family, consisting of husband, wife, and two children, the following is the mode of expenditure of £150 per annum, which we think will be found the best:—

	Yearly.	£	s.	d.
Rent, taxes, and water rate	...	30	0	0
Housekeeping	...	70	0	0
Clothing	...	25	0	0
Washing	...	6	0	0
Incidentals...	...	19	0	0
		£150	0	0

The weekly expenditure of this income may be allotted as nearly as possible in the following manner:—

	Weekly.	£	s.	d.
Rent, &c.	0	11	7½
Housekeeping	...	1	6	11½
Washing	...	0	2	3½
Clothing	...	0	9	5
Incidentals...	...	0	7	4½
		£2	17	8½

The £1 6s. 11½d. which we have allowed per week for housekeeping, ought to be spent as nearly as possible in the following manner:—

	s.	d.
11 lbs. of meat at 9½d.	8	8½
5 quarter loaves at 7d.	2	11
1 quarter of flour at 7½d.	0	7½
¾ of a lb. of tea at 2s. 6d.	1	10½
¼ lb. of coffee at 1s. 4d.	0	4
2 lbs. of sugar at 4d.	0	8
7 pints of milk at 2d.	1	2
1 lb. of butter at 1s. 4d., and 4 eggs at d.	1	8
1 lb. of cheese	0	8
Greengrocery and fruit	2	0
Beer, 7 pints at 3½d.	2	0½
Pepper, salt, mustard, vinegar	0	3
½ lb. of soap, 1 lb. of soda...	0	3½
Candles and gas	1	3
Wood	0	3
2 cwt. of coals at 22s. 6d. per ton	2	3

£1 6 11½

This estimated allowance gives three ounces of meat a day to each person, exclusive of bone, bread half a pound, and potatoes one pound. It shows, also, how very particular every one should be that they receive the weights and measures they pay for. It is a terrible thing for the poor when provisions are short in weight. Every ounce tells one way or the other for subsistence or deprivation.

Of course it will be seen at once that to such a calculation as the above there must be many modifications: the size of the family may be larger or smaller, the neighbourhood may be cheaper, or, again, some of the articles we have set down in our list may be so far from being necessities of life to some that they may be quite content to do without them altogether.

In the country, where land is cheap, thirty pounds a year for rent and taxes is somewhat high, and a saving of ten pounds may probably be made in this expense only, because rents differ with the localities; but there is one item for saving, which depends more on inclination than aught else, and that is—the cost of beer. Threepence-halfpenny a day sounds no great deal, but it amounts to £5 6s. 5½d. in the year. A man or woman would heedlessly spend the pence, but would hail that friend as a benefactor who, at the end of a twelvemonth, proffered a gift of five guineas. The proverb says of an extravagant man, "He is no man's enemy but his own." Now a man's best friend is himself, not in a selfish sense, but in that of saving and spending judiciously—of learning how to do without superfluities.

These instances will serve the purpose of illustrating the general principle we are laying down. One man will find an opportunity for saving in one direction, another in another, but every one should endeavour to save somewhere, so as to get a surplus of income over expenditure. How that surplus should be applied to the best advantage is a matter which we will discuss further. Of course the obvious use of such a surplus is to provide against an occasion when from sickness or misfortunes of some kind the annual sum on which we were formerly able to count comes in to us no longer. Unfortunately, as a rule, there is great want of forethought shown in these matters by

too many among us, and especially in the present age there is often displayed great improvidence among those who marry early and only upon a small annual sum.

A man with thirty to five-and-thirty shillings a week, or even a lesser sum, marries a heedless servant girl. A clerk or mechanic marries a girl perhaps in a superior station to a servant, and on an annual salary of from £100 to £300. There is not much thought between them for the present, and none for the future, or for the period of sickness, sorrow, and bereavement. After a time the wife may reflect that if the bread-winner dies, her all is gone. The thought of a benefit society or an insurance office may occur to her, and of all the misery she could be saved from, if some money were deposited in either, but it cannot come from herself to suggest this. To mention money in which she can have no interest but by the death of her husband, naturally seems to her unfeeling. With the husband, then, rests all the responsibility of rescuing his wife and children from destitution when he exists no longer to provide for them. Let him ask himself what punishment could be greater to his spirit, if cognizant of human affairs, than to witness or know of the distress and perhaps crime, which his own prudence might have averted, and which five pounds a year would, in a measure, have alleviated. If a just and well-thinking man but steadily contemplated the possible future of his family, he would save every penny not absolutely needful for daily subsistence, and insure his life for the benefit of the helpless ones he leaves behind him. Five pounds yearly, commencing to insure at the age of thirty-three, would not secure more than £200, but it is all a man with a very limited income can do, and he cannot be said to have done his duty to his family or country who neglects to make this provision.

If every father who cannot secure a settlement for his daughter would not give his consent to her marriage unless her intended husband, perhaps of the age of twenty-five, insured his life for £200, by a yearly payment of £3 16s., much distress and trouble at the death of the husband might be avoided. Also if the father himself, having the means, secured a policy of insurance for £200, available on the death of either husband or wife, and payable to the survivor, it would be of greater benefit under distressing circumstances than making them a present of six pounds yearly. Then there would be £400 at disposal, and the father might so arrange that £200 of it should go to benefit the children.

The advantages of insurance, both of life and from fire, are so obvious, and the sums so trifling to obtain them, that it becomes a matter for censure where there is carelessness about either. Even a bachelor who may never intend to marry, or who may, at the age of thirty, have at his disposal a sum of £24 5s. a year, or who can save this sum from his salary, may secure £1,000 to his relatives or others, in the event of his dying before he reaches the age of sixty-five, or, passing that age himself, he may receive £1,000, or exchange this sum for an annuity of £112 10s. 8d. during the remainder of his life. Such a prospect should be an inducement to save nine and fourpence weekly from the age of thirty for a period of thirty-five years.

At first, to a man or woman not having a miser's spirit, this petty saving of pence is distasteful, but the results are astounding, and offer every encouragement to economy. It is troublesome to persist in saving pence unless it be begun and continued in a resolution to avoid any unnecessary expenses; but evils often repressed soon cease to become exacting. It will thus be seen that, at a definite early age—and a man may insure his life till he is sixty—by the saving of two shillings weekly, and invested as an insurance at the end of the year, will in twelve months represent a value of £200; that is, whether death comes early or late. But if the insurance is allowed to drop from

nonpayment of the premium, the whole is lost. Now the Post Office savings banks offer a very ready mode of taking care of the pence and shillings till the end of the year, when, without delay, the life should be insured. If two shillings out of a weekly wage is deposited in the bank, there should arise no inducement to take it out again. Some inevitable circumstance might happen, or a pressing need, and it may be withdrawn; but let it be imagined that the money is not there, and the need will not be so prominent.

In recommending to our readers thus strongly the system of life insurance, we cannot overlook the fact that, especially at the present time, there is a tendency to view all associations of this nature with suspicion, owing to a series of disclosures which have revealed the unsoundness and insecurity of the working of some of them. But it must be clearly understood that these are only a few individual cases; the principle of life insurance is sound enough, and very many insurance offices fully deserve the confidence they inspire. We propose in our next paper on this subject to explain fully to our readers the principles and working of an insurance office, and thus enable them to judge for themselves of the stability of the undertaking in which they purpose investing their savings.

HOUSEHOLD DECORATIVE ART.

I.—LEATHER WORK.

LEATHER work, or the art of modelling leather in imitation of carved wood, is an artistic occupation which has been revived of late, but has not yet reached either in beauty or utility the high standard it may be expected to attain. Wherever lightness, elegance, and durability in ornamentation are required, leather work, either plain or gilt, may be called into requisition. Cornices and borderings for panels, groups for the latter, picture-frames, brackets, card-baskets, and many of the thousand and one appliances of modern luxury can receive embellishments at the hand of a tasteful designer and worker in leather work, which may elevate them to the rank of art-furniture.

Leather work is of very ancient date. In the Egyptian Room of the British Museum there are specimens of embossed leather supposed to have been manufactured 900 B.C., and over the door of the same room there is a cross from the vestment of a Coptic priest, attributed to the year of our Lord 640. In the early part of the 17th century leather work was introduced into England in the form of tapestry or hangings.

In Flanders especially, this tapestry was carried to great perfection. Its superiority over carved and moulded work consists in its adaptability to ornamentation, where lightness and elegance, with economy of cost, are desirable. It improves by age, does not break, nor chip, and is not readily affected by heat or damp. It can be gilt, silvered, or stained to any colour to imitate old carvings in oak, ebony, &c., and admits of being easily cleaned.

The *materials* and *instruments* required consist of basil and skiver leathers, liquid glue, copper wire of various sizes, some very small headless tacks, a sharp pen-knife, a fine brad-awl, cutting pliers, and a veiner (Fig. 1); moulds for grapes, brushes, and one or two bottles of size and varnishes; all of which can be purchased at any fancy repositories. Basil leather is sheep-skin tanned brown, and is used for the leaves and petals of the flowers. Skiver leather consists of shavings from the currier's block, and is used for stalks, tendrils, &c. Those who wish to become proficient in the art of making leather ornaments should work from nature in all its varied forms, taking specimens from the fields, hedges, and gardens. When these are not procurable, the bought patterns may be used.

To make leaves, &c., soak the leather in water, dry well

with a towel, and then cut out the proper shapes thus: lay the pattern on the leather, holding it firmly down with the left hand, while with the right draw a line round the



Fig. 1.

pattern with a hard lead pencil; then, with a pair of sharp scissors cut out each leaf or petal thus traced, taking

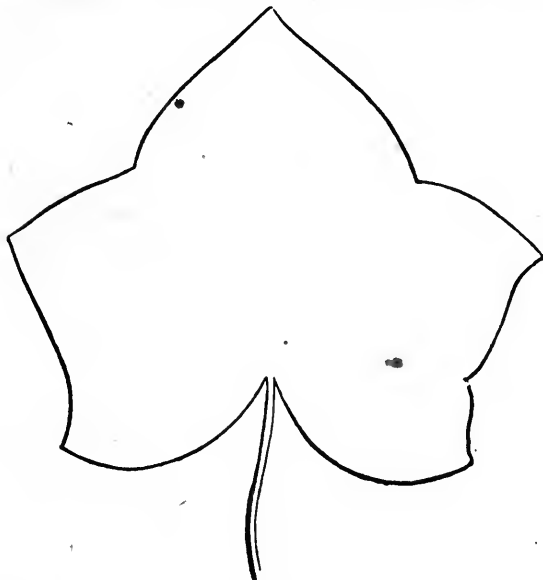

Fig. 2.

care to have the edges sharp and clear; proceed thus until a sufficient number of one size are cut out; and con-

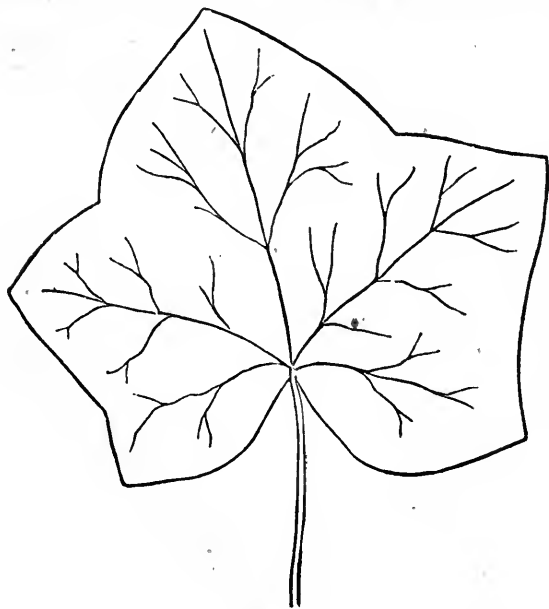

Fig. 3.

tinue in the same manner until several sizes have been cut, and the requisite number obtained. Now throw them into a basin of cold water for about five minutes, then take them out and squeeze them gently in a cloth,

lay them separately on a board, wipe and smooth them out; next mark or vein them deeply with the veiner on the smooth side of the leather, pressing heavily where a thick vein is required, and more lightly where only finer ones should be visible; next mould the leaf with the fingers, laying it upon the palm of the left hand to the form which taste or the model designs for it, endeavouring, as far as possible, to give the required effect at once, as working the leather is apt to injure it: if any of the veins seem pressed out by the moulding, vein them afresh. In veining a better effect is obtained by working the tool *from* rather than *towards* the operator.

The next process is to twist the stalk between your finger and thumb until it acquires a rounded form. A leaf sometimes requires a pinch between the finger and thumb to give it a graceful turn.

If the leaves are for a formed design, to be constructed before it is attached to the frame, the appearance of the work may be considerably improved by passing a *small* wire into the leather at the under part in a direction corresponding to the central vein; it strengthens and gives firmness of form to it.

After moulding, the leaves should be dried as quickly as possible, without artificial heat, as fire is apt to shrivel, and make them brittle. When the leaves are dry, brush them all over (particularly the edges) with the prepared stiffening, applied with a camel's hair brush, thinly and evenly. When dry they will be ready for use. The stiffening or size can be procured ready made, but it is preferable to make it, after the following recipe, which is not affected by damp, and dries quickly: mix cold, two ounces of Australian red gum, six ounces of orange shellac, half-pint of spirits of wine, put into a bottle, and shake up occasionally until the gums are dissolved; strain, and it is fit for use.

Stems are made of strips of basil leather, one-third of an inch wide, and as long as the leather will allow; soak them till soft, wipe them, and then roll them round as tightly as possible (the smooth side outwards) on the table, and dry them; if required very stiff, add inside a piece of wire. Tendrils are made in a similar manner, using skiver leather, and cutting it into very narrow strips, and winding them, when damp, round a brad-awl or knitting-pin; dry by the fire, remove from the awl, and a delicate tendril will be the result; cut it to the length desired, and apply a coat of stiffening to keep it in shape.

Berries are made by smearing with liquid glue a long

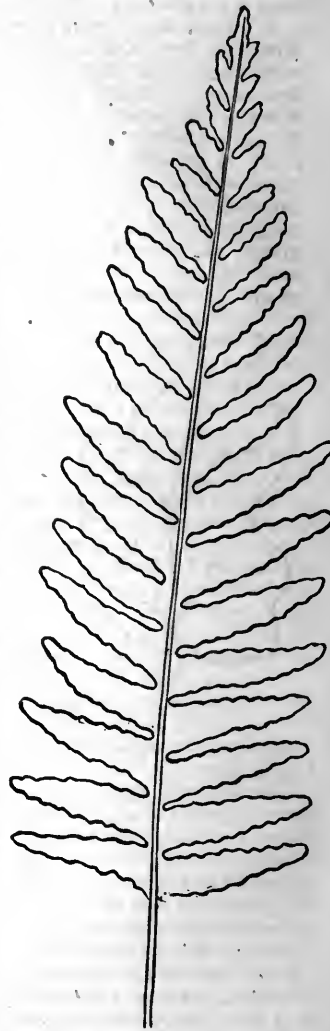

Fig. 4.

thin shaving of leather, and rolling it between the finger and thumb until it becomes round; several of these berries are glued together to a thin strip of rolled leather which forms the stalk. Grapes are formed by cutting rounds of skiver leather to the size required, which should be wetted and placed in the grape mould; then fill the leather in the mould firmly with wadding, and tie the grapes securely with fine twine; when the grape is finished put a piece of wire through the part where it has been tied up to form a stalk. For acorns and filberts the acorn and nut itself should be covered in leather. For larger fruits the leather must be moulded, while moist, over a plaster cast.

It is advisable for the beginner to keep to foliage entirely at first, and learn to cover frames and brackets with them before attempting flowers; therefore we will conclude this article with directions for that purpose, and a recipe for preserving leaves, and keeping them in form for imitation.

Procure a frame, draw an outline of the design upon it, then cut strips of leather about three-quarters of an inch wide, and as long as the skin will allow; turn the rough side outwards, and with the palm of the hand roll these strips on a table till they are somewhat rounded; then *smear* the inside with liquid glue; now roll them together till the two sides have adhered closely.



Fig. 5.

The branch is now to be affixed to the frame, by giving it occasional touches of the liquid glue, and here and there inserting headless tacks; then glue or nail the foliage on thickly, so as to hide all the woodwork. Great taste can be displayed in the arrangement. Among the most effective and easiest imitations for beginners to make and arrange, are the ivy, vine, oak, and fern patterns.

We give patterns for the ivy and a fern frond, copied from nature and of the natural size. Fig. 2 represents the ivy leaf, as cut out of the basil: it may be used as a pattern. Fig. 3 represents the same leaf veined: this also may be used as a pattern. Fig. 4 is an accurate tracing of a natural fern frond; and Fig. 5 of an oak leaf.

Stains and varnishes are to be procured of every shade when it is intended to imitate the appearance of old wood carvings. To imitate old oak or walnut-wood procure asphaltum varnish. For modern oak, brown or yellow varnish; for pine, white. To stain the leaves, brush each stem and leaf entirely over with the varnish, using a hog's hair brush for the purpose. Brush well over the veined parts, and should the leaves, when dry, not be so dark as desired, another coat may be given, but it should not be put on too thickly, and one coat must dry before another is applied. The frames and brackets must be coloured before the foliage is put on, but before the wood will take the stain, the frame-work must be sized all over twice with melted size.

Recipe for Preserving Leaves.—Take one pound white powdered starch, dry it before the fire, when cool put a layer of half an inch at the bottom of a small box, taking care that the box is dry; gather the leaves on a fine day, and lay as many leaves on the starch powder as can be done without touching each other; then sprinkle starch powder over them, covering all the leaves well; then put another layer of leaves, and proceed with the powder as before, until the box is filled. Fill up with the powder, and fasten the box lid firmly down until the leaves are required.

DOMESTIC MEDICINE.

IN commencing a system of domestic medicine it is necessary to determine the classification of subjects. The best arrangement of diseases will be that which is most practical, which can be most easily comprehended and recollected. We will endeavour to be practical in our division of diseases, and also to be simple in the language which we use, avoiding technical phrases as much as possible. Before describing particular diseases we shall devote a few lines to a consideration of the symptoms by which we may know that a person is out of health, and we shall be particular in pointing out symptoms which imply a serious case, or one for which the doctor should be sent. It is lamentable to see in some cases how the importance of symptoms is overlooked until disease has made serious advance. Let us, accordingly, first mention

A FEW SYMPTOMS THAT SHOULD ALWAYS BE CONSIDERED GRAVE ENOUGH TO JUSTIFY US IN SENDING FOR THE DOCTOR.

1. Foremost among these is a shivering, or what doctors call a *rigor*, a Latin word meaning a stiff coldness. Most inflammations and fevers begin with more or less of this shivering or rigor, and it is a symptom to which doctors always attach importance. It may be a severe shivering, severe enough to make the teeth of the patient chatter, and the bed shake; or it may be slight enough only to make the patient feel a little cold, as if cold water were running down the back. Sometimes there is only a paleness of the face and the surface generally to represent this peculiar symptom. This shivering is a very remarkable thing, and the exact nature and cause of it is yet a matter of discussion among doctors. But, nevertheless, the significance of it is admitted on all hands, and it is generally the beginning of an illness more or less severe; often of only a sore throat, but often, too, of an internal inflammation, or of rheumatic fever, or of one of the eruptive diseases, such as scarlet fever or small-pox. In lying-in-women it is generally a significant thing, but the exact significance of it can only be judged of by a doctor. It may mean the beginning of an abscess in the breast, or it may simply denote a weed, that is, a slight child-bed fever, characterised by alternate shiverings and sweatings, or it may imply a child-bed fever of a more serious kind, or an inflammation of the womb. It is probable that this symptom—a rigor—is a nervous symptom, and that it depends upon some effect produced upon the nerves or the nervous centres. In children it is sometimes represented or replaced by a thorough convulsion. It is always an important thing, though the exact significance of it is to be determined by other symptoms, which do not always immediately follow. These symptoms are generally pain in some part, as, for example, the throat, or in joints, or, in lying-in-women, in the breast. In other cases an eruption will succeed the rigor. When a shivering does occur, the proper thing to do is to administer some warm drink, put the patient to bed, apply warmth to the feet, and cover the body well, and, if he is not well in twelve hours, to send for the doctor.

2. Another symptom of interest and importance is an *unusual heat of the body*, or, as doctors say, an elevation of the temperature. The natural heat of the body is about 98°. The temperature may be judged of roughly by the hand, but much more accurately by a thermometer, the bulb being placed under the tongue or in the arm-pit, the body being carefully covered over with bed-clothes. The patient should be an hour in bed before the thermometer is used. A very convenient and sensitive thermometer for medical purposes, and costing half-a-guinea, lately invented, will be found very useful for this purpose. It is at the same time an index thermometer, that is to say, it has a short column of mercury detached from the mercury of the bulb by a little air, which remains at any point to

which it has been raised by the heat of the patient, after the withdrawal of the instrument. This increased heat of the body is not only a symptom of the severity of disease, but it is a very early symptom. Dr. Burdon Sanderson, during the cattle-plague, made the interesting observation that the very first symptom which occurred was this elevation of temperature. When to all ordinary appearance the animal was well, a thermometer thrust into an internal part, often showed an elevation of the temperature of the body by two or three degrees; and in these cases he was able to predict confidently that the animal was in for cattle-plague. The advantage here was that the animal might sooner be slaughtered and removed from contact with other animals before the more contagious stages of its disease occurred. And so in human diseases a rise of temperature is an early and significant symptom, and one not difficult to ascertain. A child, a few years old, will not unwillingly become a party to an interesting thermometric observation, and will hold the bulb of the thermometer under its tongue. The writer may illustrate these points by a case:—A little girl at church on a Sunday evening, and making no particular complaint, was noticed the next day to be rather hot in the skin, by the medical man who was calling at the house for another purpose. Sore throat was immediately suspected and soon after found. And the thermometer being at hand, it was kept in the mouth by the little patient, and found to rise to 102° Fahrenheit. The patient may feel shivery, and yet the thermometer will show an elevation of temperature: so early does this occur in disease. As our object at present is to specify early symptoms which imply complaints serious enough to have a medical opinion upon, we will not dwell further upon the significance of an elevated temperature. We will only say, with the view of showing our readers how careful and precise medical science is becoming, that the thermometer is often used for ascertaining the existence of serious disease when other symptoms are very vague, and also for determining the danger of particular cases. A very high temperature occurring in the course of diseases, such as fevers or rheumatic fever, is a dangerous symptom. If a high temperature succeeds a severe shivering, the case is certainly one for medical, not domestic treatment.

Shiverings and subsequent heat, or alternate shiverings and heat, accompanied with general aching and soreness, are the symptoms by which we may generally judge of the onset of some acute attack. Other preliminary symptoms occur, according to the particular nature of the disease setting in. For example, sickness generally accompanies the preliminary shiverings and heats of scarlet fever; sneezing and red eyes, those of measles; severe acute pain in the back, those of small-pox. But these will come in for more particular notice under the head of the special diseases which they characterise. The grand thing to remember here is that shiverings and subsequent heat of the body are generally the indications of a smart attack of some kind.

Let us now mention a few symptoms which may not be the forerunners of any acute attack, but which must nevertheless be seriously regarded; amongst these we may notice—sickness, loss of flesh, loss of colour, loss of strength.

Sickness may be of no consequence. It may be caused by an error of diet, eating unwholesome food or forbidden fruit, and it may cure itself. There is one kind of sickness, against neglecting which we warn people, that is, a very acute, incessant sickness in children or young people, accompanied with costiveness. Such a sickness as this leading the patient to vomit even water, should be regarded as of serious import. Vomiting is a common symptom at the outset of scarlet fever. Of this more hereafter. Pending the arrival of a doctor the proper treatment of it is the blandest food in small quantities, such as milk, or milk and water; and a little effervescing drink from time to time.

Loss of Flesh, Loss of Colour, or Loss of Strength, if they occur either singly or together, are things to take advice about rather than to take physic for.

With these preliminary hints about important symptoms, we will give in a future number a more detailed notice of particular diseases

THE HOUSEHOLD MECHANIC.

THE TOOL-CHEST (*continued*).

FOR mahogany a tool like a smoothing-plane is used, but the angle of the bed is much greater, eighty or ninety degrees, and the edge of the iron is cut into little teeth. The action of this tool is more scraping than cutting, and is of most use in roughing veneers. It is called a *toothing-plane*. Beading-planes, for cutting beads of various sizes and curves, are constructed with irons of the required shape. Hollows, rounds, and various mouldings are cut by the same means. Fillisters, or rebating-planes, are provided with knives which cut on the sides as well as at the sole, and are chiefly used for cutting out the channel in window-frames in which the glass lies. They are often provided with movable stops and guides, without which their action is very uncertain. Match-planes are provided with two sides, one of which has an iron constructed to hollow out a groove on the edge of a plank, the other side having a double iron, which cuts a tongue exactly to match the groove, the object being to fit two planks together, edge to edge. It is common to work a small bead on one edge, which is a great improvement to the appearance. These planks are termed "match-boarding."

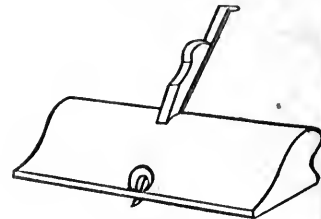

Fig. 20.

Fig. 20 is what is known as an "old woman's tooth," and is used for cutting out grooves across the grain, such as slides, into which shelves are fitted. The edges of these grooves should be sawn out with a tenon-saw.

Compass-planes have round soles according to the curve they are required to cut, and of course are of great variety.

The principle in a plane is the same as with a chisel, with the advantage of much greater steadiness on account of the increased power of guiding given by the sole, which prevents too great a degree of penetration.

The spokeshave is the lowest form of plane, and is only used for small widths. It is pulled towards the operator by both hands. The angle of the edge being only twenty-five degrees, the tool cuts quickly and easily.

Saws.—It is by means of saws that the more easily worked materials are converted from the tree form to the crude shape they are required to assume before the finishing processes are begun; and as the ends to be accomplished are so varied in magnitude and difficulty, so are the forms these tools are given numerous and diversified. All saws, however, consist of thin blades of steel, fixed in convenient handles, and having one edge serrated, or cut into teeth; and it is in the size and shape of these teeth, and the angles at which they are inclined, that the most important variations are to be noticed. In all saws intended for wood, the teeth are slightly bent alternately outwards, in order that the cutting edge should present a larger surface to the material than the blade

will require to follow in. If this were not done, the tool would become clogged and choked with the sawdust. In metal saws, the teeth being too fine and thick to admit of being bent, or "set," as it is termed, the back of the blade is made much thinner than the cutting edge.



Fig. 21.

Fig. 21 shows a "saw-set," the nicks of which are of different sizes, to suit the various thicknesses of the blades.

As none of our readers are likely to have occasion to use the pit-saw, it is of no use to bring it before them. The next largest variety is the cross-cut saw, Fig. 22,

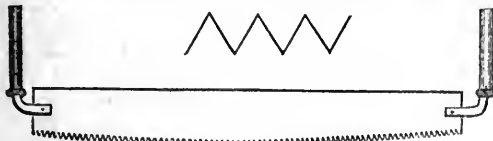

Fig. 22.

which is used for felling and cutting trees or timber in a direction across its grain. It is worked by two men, one at each end, and pushed backwards and forwards with equal force, cutting both ways; and for this reason the front and back angles of the teeth are equal, or about sixty degrees. The teeth are kept so upright to prevent too great a degree of penetration.

The rip-saw, Fig. 23, is the largest single-handed saw—about 2 ft. 6 in. or 3 ft. long—and is used for sawing or

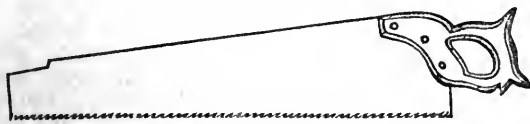

Fig. 23.

ripping along planks in the direction of the grain. The teeth are, therefore, inclined forward, and work very fast, and number about three and a half teeth to the inch. The half-rip saw is of the same shape and form of teeth as the rip, but altogether smaller. The panel-saw is much narrower at the bottom end than the half-rip. Its width there is about two inches, and it is much finer in the teeth, which generally number about six or seven to the inch.

The last three may be considered to represent the most usual form of plain hand-saws. In use they are grasped by the right hand on the handle—the work to be sawn being laid on the sawing-stool, and held by the left hand or either knee. After just notching the end of the line to be cut, the strokes are lengthened gradually, and swept downwards with considerable vigour and force, and brought up with the teeth kept well down in the cut, the blade being used from top to bottom. A little grease smeared on the blade occasionally makes the saw go easier.

The tenon-saw, Fig. 24, consists of a thin blade, fastened at the top edge in a metal rim or back, which keeps it firmly stretched out. It is, nevertheless, rather a delicate instrument, and requires careful usage, or the blade will be crumpled or buckled—a fault very difficult to remedy. If the buckle is only slight, a smart blow with a hammer on the middle of the top of the back will often set it right; but failing this, the blade must be

taken out and re-fitted by a smith, as it is entirely unfit for its work while in that condition. The teeth are fine—ten to the inch—and the pitch is not very forward, the back angle being about thirty degrees with the cut, and the forward angle ninety degrees. Dovetail-saws exactly resemble tenon-saws, but are smaller and much thinner in the blade and finer in the teeth. The hint

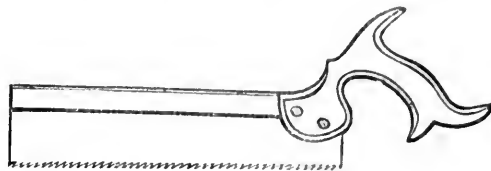

Fig. 24.

about careful usage should be doubly observed with them. After making the line intended to be sawn, these two saws are used horizontally, and across the grain of the wood, and are grasped by the right hand, being moved with short, quick, parallel strokes. The work should be fixed higher than in rip sawing; the bench is a convenient height.

We now come to saws intended to cut in curves or

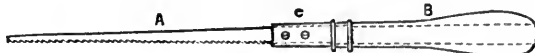

Fig. 25.

circles—the most ordinary form being the keyhole-saw, Fig. 25. This is a long, thin, tapering blade, A, much thicker on the teeth edge than at the back, to allow of the curve to be made. In order that the extreme end of the thin part may be used for small circles without danger of crippling or breaking, the blade is made to slide into a long hole right through the handle, and is fixed at any required place by the screws, C. In using, a hole is first bored with a gimlet, touching the required path of the saw, the thin end of which is then introduced and pushed backwards and forwards rapidly, but not too forcibly, the straight or curved path, being regulated by the twist of the hand.

GARDENING.

II.—THE WINDOW GARDEN.

ALTHOUGH it is not in every man's power to have a garden, in the ordinary sense of the word, it is not difficult to improvise a greenhouse, or to cultivate flowers in the very heart of a town. Window-gardening is within reach of all who have a roof to cover them, and the nearer the sky the operations are carried on the better chance have the flowers of thriving. A few boxes made of rough boards nailed together, or, indeed, anything that will hold earth and permit drainage, will serve as the ground-work of a window garden; and even in a house where there are only two or three rooms, flowers may be cultivated successfully.

It is erroneous to imagine that it is unhealthy to have plants in living-rooms. There are, of course, exceptional cases, where the perfume of some particular flower produces sickness or headache, but this only occurs with delicate persons; from sleeping-rooms, however, growing plants ought to be excluded. As a rule, it is a good plan to keep flowers in a living-room during the day, as they absorb the noxious gases in the atmosphere. These they exhale by night; and as they thus poison the air of the room, it is desirable, as far as possible, then to remove them.

We have said that anything capable of containing soil and affording an outlet to moisture will do for flowers to grow in. Ordinary flower-pots are most frequently used, but they are not desirable when economy of space is an object. The great advantage of pots is the facility which they afford for changing the plants from time to time. Zinc boxes are often preferable to clay pots, and they can be had at a very trifling cost, or made at home without much trouble. The bottom must be perforated, and the box either raised upon small feet of wood or iron, or set upon bricks. A wooden outside case is a very great advantage—it ought to be a trifle larger than the zinc one—the intervening space being filled with moss, or straw, or dried leaves. The object to be gained by this is one every window-gardener must attend to—namely, to prevent the rays of the sun over-heating the earth in which the roots of his plants are lying. Very pretty and ornamental cases are made by planting common ivy between the zinc and wood, and letting it trail over the sides, or upon a little trellis-work, which is easily made by bending and interlacing willow wands, such as basket-makers use, sticking the ends into the earth. I once saw a box of this sort with a very picturesque device. Four wands were fastened at the corners, from which four more met in the centre; round these a small-leaved clematis was trained, and kept so close that it did not interfere with the passage of air or light to the other flowers.

The pots or cases having thus been secured, the next thing to do before filling in the earth will be to attend to the drainage. Be very particular never to let your plants stand in water. Some few plants, it is true—hydrangeas, for example—like to have their roots kept constantly moist, but, as a rule, plants, like men, are better with their feet dry.

The best way to set about the drainage is to cover the hole at the bottom of the pots with a piece of a broken pot, so placed as to afford a free passage for the water; over this spread moss or straw, to prevent the earth running down and choking up the drainage. If a case is used, set to work in the same way, only lay the broken pieces a little thicker, and let the moss be also thicker, and well pressed down. A very good drainage may be easily obtained by filling the bottom of the box or pot with a layer of common coal cinders, about an inch in thickness.

The next thing is to get soil—not always an easy matter in a crowded town, and often entailing many a long walk. In London it is very difficult indeed to get soil, if there is no ground adjoining the dwelling which can be laid under contribution. It will often prove the best economy to procure some from a gardener, which will have the advantage of being specially prepared for the growth of flowers; and the expense of getting such a small quantity as would be required for a window-garden would be very trifling indeed. At any large market where flower roots are sold, the gardeners are glad to part with any of the refuse soil they have brought there round the roots of the plants for a very trifling cost. For a penny or two the amateur window gardener will get enough soil to fill at least

two good-sized flower boxes. When people can get out into the country, they will have little difficulty in obtaining leave to gather the earth that they want from the little hillocks of road-scrapings piled at the side of the road, which are full of valuable manure, choosing always those parts where the grass is stiff and sharp. For some plants—namely, those of the fine hair-rooted sorts, such as heaths, &c.—a more fibrous earth, mixed with flints and sands, will be required. This can always be obtained where heath grows. When you have time, and really mean to excel in your flowers, it is an excellent plan to carry home a few sods of the wire grass we mentioned, and having charred the grass at the fire, lay the sods away in any dark dry corner for a month or two, when it will be ready to powder down with the hand. In some cases it is a good thing to mix sand with it. All soils, however, do not require an extra quantity of sand, and you can determine as to this in a very simple way. Take a little soil in your hand, and work it into a pulp. If it feels gritty, you will require very little sand, perhaps none at all; if it gets simply soft and smooth,

add sand accordingly. The manure you mix with the soil must be perfectly rotten, and in a crumbling state. You must use your own judgment, when it is thoroughly mixed with the soil, as to adding sufficient moisture. It is a mistake to use too fine soil, as it is apt to run together and cake; therefore take rough soil in proportion to the size of your pots.

In transplanting or repotting you must be careful to damp the earth and roots thoroughly, then spread the fingers over the surface, reverse the plant, and tap the pot smartly, the contents will come out unbroken; separate the outer roots a little at the outside, place the plant in the pot, and crumble in the fresh earth round the ball of roots. If the earth is lumpy, and the roots scanty, wash the roots free from soil, keeping them in your hands and manipulating very quietly, for fear of breaking the fibres; then, replacing the plant in the pot, throw in the fresh earth, packing carefully, but lightly, when rapid growth is the object. This last should always be observed; but if you want to stimulate flower bulbs, pack the earth firmly. After transplanting, water equally with a rose, or if you have not such a convenience, take any flat thing—a lid or a piece of wood—and by holding it over the plant, a gentle stream of water falls upon the surface, which will thus be diffused over the foliage as well as the soil.

For raising seedlings, warmth, air, and comparative darkness are essential. Warmth must range at 45° or 50° to germinate the seed, after which 60° is quite as much as the young plants will bear. Moisture is essential, but should be equal, and never excessive.

Comparative darkness is desirable, as the seed will sooner germinate, and throw forth its shoot, than when kept in a hardened condition by the influence of a hot sun. Care must, however, be taken to accustom the plants gradually to the light, and that as soon as they begin to show above the surface. The great secret in raising seedlings is never to allow them to get a check.

It is more difficult to raise seeds in pots than in the

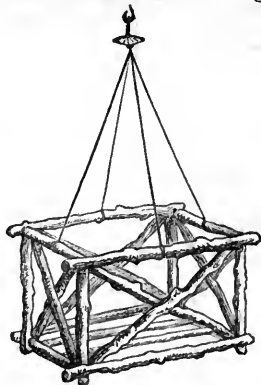

Fig. 1.

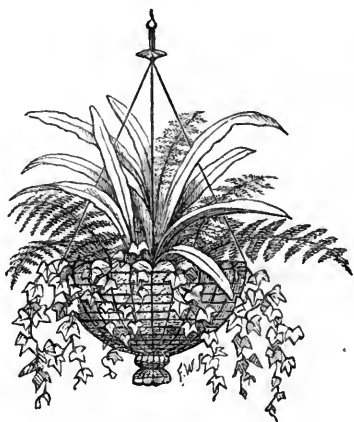

Fig. 2.

open air, and we shall therefore give a few practical directions for planting and raising them.

Our illustrations show designs for hanging-baskets, which may be suspended in the window by a hook driven into the ceiling of the apartment, and, when filled with ferns, creepers, &c., will be found to produce a very elegant effect. Of these Fig. 1 represents a basket made of rough pieces of rustic wood joined together, while Fig. 2 is of a little more elaborate kind, being composed of twisted wire.

THE TOILETTE.

I.—THE MANAGEMENT OF THE SKIN (*continued*).

Warmth.—If we would have the skin doing its duty properly, we must be sure that we do not subject it to too great changes of temperature, at least that we protect it sufficiently against surprises in this respect. This we are enabled to do by means of properly selected clothing, which prevents the heat from being conducted, as it is termed, too rapidly away from the body. Flannel garments are the best for this purpose, since flannel is what is called a bad conductor of heat. Merino is the next best protector. The young and the old require more clothing than the middle aged. Now in cold weather the young should, in this variable climate, be provided with flannel or woollen garments next the skin; the feet should be kept especially warm. The custom of allowing young children to be dressed in a half-naked style is fraught with considerable danger. It may be fashionable, Spartan, and so on, but it is not sensible. The chest should be well protected, and the sensitive stomach of the child as well. Flannel may be irritable to the skin; in that case merino should be substituted, or a thin layer of linen placed inside the flannel. When the skin (be it in the infant, the lad, or the man) is kept uniformly warm, the circulation through its texture is much facilitated, and diseases, both of skin and internal organs, are warded off. In summer time, however, flannel is to be dispensed with, and cotton under-garments used instead, as the keeping the body too hot is then followed by various summer rashes, the most uncomfortable of which is the "prickly heat." When we say that infants should be warmly clad, we do not mean that they should be boxed up indoors or in stuffy rooms all day; they should be clothed warmly, in order that they may get the benefit of open air and the like, without running any risk of being injured by it, or the alternations of temperature that characterise our variable climate in England. So, in the summer time, when the average temperature of the day is high, the child should not be muffled up as though he or she were in a vapour bath; nothing so readily induces little red rashes, which result from the excessive perspiration. These rashes are known by the name of the red gum, "red gown," &c., and are most frequently an indication that the sufferer from them requires to be kept much cooler. Clothe well and wisely in winter, but lightly and thinly in the summer. Flannel encasing the chest and stomach, especially in children, in cold weather, must give way to thin garments of cotton in the hotter days of the summer. This is a matter of common sense.

Exercise is absolutely necessary to a healthy state of skin. The only remark we would here make is this, that exercise should be regularly taken each day, and that it should not be taken for at least two or three hours after a meal, since it then stops digestion; and that exercise before meals is certainly the best kind to take, as it puts a man in the fittest condition for food taking. Any kind of exercise, when excessive, is of course accompanied in warm weather by perspiration. When the latter is too great, it should never be checked by plunging into cold water, sitting in draughts, or by throw-

ing off the clothes and going to sleep. If the surface be too rapidly cooled, it is not at all unusual for eruptions of various kinds to follow.

Cleanliness.—The virtues of the use of soap and water have been more appreciated of late. It is impossible to define the amount of good which results from habits of cleanliness, and this can very readily be understood by the reader, if he has comprehended the description of the structure of the skin already given. The skin is a great breathing organ: oxygen enters the blood through it and helps to purify the blood; then the glands of the skin carry off, in the sweat and fatty secretion, matters that if retained would act as poison in the blood. The tendency of an unwashed skin is to become sluggish, the pores get blocked up, the oxygen cannot reach the blood, the perspiration does not readily escape, so as to keep the temperature of the body equable; the injurious action of outside heat is therefore not counteracted by the free evaporation of the perspiration, the circulation gets deranged, and inflammation may be set up. Any one may guess for himself what an unwashed skin can do in choking up the ducts of the skin, if he examine the mass of cuticle and dirt which can be rubbed off the skin of a man who, not having had recourse to a bath or the application of soap to his skin for some time, takes a Turkish bath, or a hot bath, and remains under the influence of heat and moisture sufficiently long to soften the skin and the useless scales of cuticle which should long before have been cast off from the body. Nature can be helped by art in the preservation of health and vigorous action of organs. The application of water to the skin should be part and parcel of the daily toilette. From oldest time "purification by water" has been inculcated as part of man's daily duty, and not without sound reason. By its aid the accumulation of a layer of worn-out and useless cuticle is prevented, which otherwise forms a complete barrier to the entrance of the life-giving oxygen, and prevents, to a greater or less degree, the exit of poisonous products. So far, then, as to the necessity; now as to the mode in which the skin should be cleansed. The use of soap is the most sure way of purifying the surface of the body. Soap contains what chemists call an alkali—a chemical substance (potash or soda) which, brought in contact with animal membranes or substances, softens them. Moreover, it emulsifies fat. The effect of soap on the skin is therefore clear; it softens up the cuticle, and it enters into combination with the fatty layer, so enables the water to gain free access to the skin, and friction to remove the loose particles of cuticle and dirt. But there are good and bad soaps. Some have too much alkali in them, and then they dissolve or soften up the cuticle too much, and so expose or irritate the delicate deeper layers of the skin. We should use a soap that has a small amount of alkali in it. The best of all the soaps made, considered from a medical point of view, are, in the writer's opinion, the transparent soap of Messrs. Pears, or the well-known old brown Windsor, or a glycerine soap. The nicest to use is certainly Pears's, but it is somewhat expensive. It is the best for babies unquestionably, and may be used freely to them. Well, having obtained a nice mild soap, it should be used to the face once a day, the heads of children twice a week, and the whole body once a week at least. This is in addition to taking the daily cold water bath to be by-and-by noticed. If persons can afford the time and have the inclination, there can be no question that the best possible results follow the use of soap to the arm-pits, the groin and parts about, and the feet, each day, and to those who luxuriate in the thing, it cannot hurt to employ Pears's soap to the body generally each day. We have, however, stated that at least once a week the whole body should be soaped. Ordinary yellow soap does not meet with any favour at our hands, and we condemn it in the case of young children.

There is one more point on this head. The face, when very hot or dirty, or after a walk, should not be washed in soap. It is better to bathe, not rub, it in a little warm water, and then powder it with ordinary baby powder and let it dry.

THE BATH, AND BATHING IN GENERAL.

There are very few individuals who could not take daily ablution in the way of the sponge bath. It is true that the majority of people are quite unacquainted with such a thing, from childhood to old age, as the morning dip or the cold douche, but this is the reverse of what really should be the case. It is, perhaps, hopeless to expect that any reformation can be effected in the case of those who have up to the mid period of life avoided the bath, but we may be able, perhaps, to persuade mothers of families to train up their children in the way they should go, and the young portion of our readers to adopt a means of promoting health, which will alone do very much, if persistently followed, in even prolonging life. The babe should be subject every morning to a good sponge all over, with, in the winter time, warmish water; soap being used as well. Those parts in contact with the napkins should be washed carefully at night as well as in the morning. The temperature of the room should also be good in winter, and the babe dried rapidly by the use of towels warmed before the fire. In the summer a dip into tepid or nearly cold water itself, or in the case of ruddy children, quite cold, is to be given. When the child comes to be three or four months old it should have become accustomed to its "tub" regularly in the morning, and in the summer time the water may be even cold, provided the skin feels warm after the child comes out of the bath, and after gentle friction with a warm or dry towel. The head should be washed first of all with soap and flannel. When the child is in the bath the back may be freely douched with the sponge.

When children are given the bath from an early age, they take it each day with peculiar enjoyment. There need be no difficulty in the way of expense; a wooden bath suitable for infants can be bought in the turners' shops for a few shillings, and the ordinary sponge baths, fitted for youths, girls, and adults, of a common sort, cost something inconsiderable.

If the cold douche bath is taken at an early age, it should be persevered with throughout life, and only relinquished temporarily in febrile ailments. The best time for every one to take the cold bath is immediately on getting out of bed, before the body becomes chilled. The test whether the bath does good or harm is to be found in the occurrence of shiverings, cold feet, a sense of coldness over the body, and an absence of "glow" over the surface. In such circumstances, the water taken must be tepid, and friction with towels must be freely employed.

Hot baths should only be taken, as a rule, as a cleansing operation; in fact, for the "Saturday night's wash," so to speak. Those who are taking active exercise, on the one hand, in their occupation, and those, on the other, who lead a sedentary life, are benefited by a good soaping all over and a rinsing in warm water every fortnight, in addition to their cold douche each day.

So with the Turkish bath. It may be taken as a cleansing operation; it cannot supersede the cold bath in the morning. When the skin gets dry and inactive, and the cuticle feels rough, the forced perspiration and the thorough wash and soaping one gets in the Turkish bath, tend to remove the worn out and dead cuticle which collects on the skin. The Turkish bath should be taken before a meal, not at least until three hours after a meal, and the bather should be perfectly quiescent in the bath, lying down as much as possible. He may drink a little water from time to time, and place a little water on the head if it gets dry and hot. Turkish baths, however, for healthy persons, do not find much favour with us.

A good deal has been said with regard to the efficacy of flesh gloves and brushes. These are very good in their way, but there is no better way of promoting the proper circulation of the blood (for flesh brushes and the like act in this way) than by rubbing the skin freely, but moderately and firmly, with a fairly rough towel. If, from long-continued cold weather, or east winds, the perspiration has been retarded, the skin may become harsh to the feel from the plugging up of the little sweat glands by dead cuticle; then a vigorous application of the flesh brush, after a good soaping of the surface, may do very much good.

In addition to the home or douche bath, there is the plunge bath, river or other, to be considered. Bathing in general, such as we now refer to, is very injudiciously practised, and it is much to be regretted that parents, heads of schools, and others, are so extremely ignorant generally of the best rules for bathing. The proper time is when the body is moderately heated with exercise, and when the process of digestion is at an end, and the water into which the bather goes has been somewhat warmed by the sun.

The reason for bathing when the body is heated slightly by exercise is simply this, that the circulation is excited and active, and is on the *qui vive*, as it were, to prevent any bad effect of the shock of the plunge. If the body is cool, or the bather fatigued, the vital powers are depressed rather than stimulated by the cold plunge. The whole body should be immersed. As stated before, in reference to the cold douche, the test of a bath agreeing with any individual is to be found in the occurrence of what is termed "reaction." If after the plunge the blood circulates freely through the skin, and a feeling of warmth and freshness is experienced, we know that the bath has acted as a tonic. If the bather feels shivery and cold, the bath does harm, and when this latter condition is found to exist in weakly subjects, it is better that medical advice should be at once taken, before bathing is again permitted. The following rules, drawn up by the Royal Humane Society, are good:—

1. Avoid bathing within *two* hours after a meal.
2. Avoid bathing when exhausted.
3. Avoid bathing when the body is cooling after perspiration.
4. Bathe when the body is warm.
5. Avoid chilling the body after bathing by sitting naked on banks or in boats.
6. Avoid staying too long in the water. Leave it directly there is the slightest feeling of chilliness.
7. Avoid bathing altogether in the open air if, after having been a short time in the water, there is a sense of chilliness or numbness of hands and feet.
8. The vigorous and strong may bathe early in the morning on an empty stomach.
9. The young and the weak had better bathe three hours after a meal—best after breakfast.
10. Those who are subject to attacks of giddiness and faintness, or palpitation, &c., should not bathe without first consulting their medical adviser.

ANIMALS KEPT FOR PROFIT.

II.—THE FEEDING AND GENERAL MANAGEMENT OF ADULT FOWLS.

A judicious system of feeding is very essential to the well-being of poultry, and has, of course, more *direct* influence upon the profit or loss than any of the circumstances—though equally important—which we have before enumerated. We shall, therefore, endeavour to give the subject a full and practical consideration.

The object is to give the quantity and quality of food

which will produce the greatest amount of flesh and eggs; and if it be attained, the domestic fowl is unquestionably the most profitable of all live stock. But the problem is rather a nice one, for there is no "mistake on the right side" here. A fat hen is not only subject to many diseases, but ceases to lay, or nearly so, and becomes a mere drag on the concern; while a pampered male bird is lazy and useless at best, and very probably, when the proprietor most requires his services, may be attacked by apoplexy and drop down dead.

That fowls cannot be remunerative if starved need scarcely be proved. *Ex nihilo nihil fit*; and the almost daily production of an article so rich in nitrogen as an egg—the very essence of animal nourishment—must demand an ample and regular supply of adequate food. We say no more upon this point, knowing that the common mistake of nearly all amateur poultry-keepers is upon the other side—that of over-feeding.

The usual plan, where fowls are regularly fed at all, appears to be to give the birds at each meal as much barley or oats as they will eat; and this being done, the owner prides himself upon his liberality, and insists that his at least are properly fed. Yet both in quantity and quality is he mistaken. Grain will do for the regular meals of fowls which live on a farm, or have any other extensive range where they can provide other food for themselves, have abundant exercise, and their digestive organs are kept in vigorous action. But poultry kept in confinement on such a diet will not thrive. Their plumage, after awhile, begins to fall off, their bowels become affected, and they lose greatly in condition; and though in summer their eggs may possibly repay the food expended, it will be almost impossible to obtain any in winter, when they are most valuable.

All fixed dietary scales for fowls are delusive. The one simple rule is to give them as much as they will eat *eagerly*, and no more; directly they begin to feed with apparent indifference, or cease to run when the food is thrown at a little distance, the supply should be stopped. In a state of nature, they have to seek far and wide for the scanty morsels which form their subsistence; and the Creator never intended that they, any more than human beings, should eat till they can literally eat no more. It follows, from this rule, that food should never be left on the ground. If such a slovenly practice be permitted, much of what is eaten will be wasted, and a great deal will never be eaten at all; for fowls are dainty in their way, and unless at starvation point always refuse sour or sodden food.

The number of meals per day best consistent with real economy will vary from two to three, according to the size of the run. If it be of moderate extent, so that they can, in any degree, forage for themselves, two are quite sufficient, at least in summer, and should be given early in the morning, and the last thing before the birds go to roost. In any case, these will be the principal meals; but when the fowls are kept in confinement, they will require, in addition, a scanty—and only a very scanty—feed at mid-day.

The first feeding should consist of soft food of some kind. The birds have passed a whole night since they were last fed; and it is important, especially in cold weather, that a fresh supply should be as soon as possible be got into the system, and not merely into the crop. If grain be given, it has to be ground in the poor bird's gizzard before it can be digested; and on a cold winter's morning the delay is anything but beneficial. But for the very same reason, at the evening meal grain forms the best food which can be supplied; it is digested slowly, and during the long cold nights affords support and warmth to the fowls.

A great deal depends upon this system of feeding, and as we are aware it is opposed to the practice of many,

who give grain for the breakfast, and meal, if at all, at night, let the sceptical reader make one simple experiment. Give the fowls a feed of meal, say at five o'clock in the evening; at twelve visit the roosts, and feel the crops of the poor birds. All will be empty; the gizzard has nothing to act upon, and the food speedily disappears, leaving with an empty stomach, to cope with the long cold hours before dawn, the most hungry and incessant feeder of all God's creatures. But if the last feed has been grain, the crop will still be found partially full, and the birds will awake in the morning hearty, strengthened, and refreshed.

With respect to the morning meal of pultaceous food, when only a few fowls are kept, to supply eggs for a moderate family, this may be provided almost for nothing by boiling daily the potato peelings till soft, and mashing them up with enough bran, slightly scalded, to make a tolerably stiff and dry paste. There will be more than sufficient of this if the fowls kept do not exceed one for each member of the household; and as the peelings cost nothing, and the bran very little, one half the food is provided at a merely nominal expense, while no better could be given. A little salt should always be added, and in cold or wet days in winter a slight seasoning of pepper will tend to keep the hens in good health and laying. This food may be mixed boiling hot over night, and covered with a cloth, or be put in the oven; in either case it will remain warm till morning—the condition in which it should always be given in cold weather.

If a tolerable stock of poultry be kept, such a source of supply will be obviously inadequate; and in purchasing the food there is much variety to choose from. Small or "pig" potatoes may be bought at a low price and similarly treated; or barley-meal may be mixed with hot water; or an equal mixture of meal and "sharps," or of Indian meal and bran; either of these make a capital food. Or, if offered on reasonable terms, a cart-load of swede or other turnips, or mangel-wurzel, may be purchased; and when boiled and mashed with meal or "sharps," we believe forms the very best soft food a fowl can have, especially for Dorkings; but they cannot everywhere be obtained at a cheap rate, and the buyer must study the local market. A change of food, at times, will be beneficial, and in making it the poultry-keeper should be guided by the season. It is, however, necessary to avoid giving too great a proportion of maize, either as meal or corn, or the effect will be a useless and prejudicial fattening from the large quantity of oil it contains; it is best mixed with barley or bean-meal, and is then a most economical and useful food. Potatoes, also, from the large proportion of starch contained in them, are not good as a regular diet for poultry; but occasionally mixed with bran or meal will be found most conducive to condition and laying.

In mixing soft food, there is one general rule always to be observed: it must be mixed rather *dry*, so that it will break if thrown upon the ground. There should never be enough water to cause the food to glisten in the light, or to make a sticky porridgy mass, which clings round the beaks of the fowls and gives them infinite annoyance, besides often causing diarrhoea.

If the weather be dry, and the birds are fed in a hard gravelled yard, the food is just as well, or better, thrown on the ground. If they are fed in the shed, however, it is best to use an oblong dish of zinc, or, preferably, earthenware, such as represented in Fig. 3. The trough or dish must, however, be protected, or the fowls will walk upon it, scratch earth into it, and waste a large portion; and this is best prevented by having a loose curved cover made of tin and wire, as shown in Fig. 4, which, when



Fig. 3.

placed on the ground over the dish; will effectually prevent the fowls having anything to do with the food except to eat it, which they are quite at liberty to do through the perpendicular wires, two and a half inches apart. Many experienced poultry-keepers prefer to drive the wires into the ground, leaving them six inches high; the trough is then put behind them, and a board laid over, leaning on the top of the wires. The effect of such a plan is precisely similar as regards the protection of the food, and its only disadvantage is, that the wires being always in the ground rather hinder the sweeping of the shed.

If the fowls have a field to run in they will require no further feeding till their evening meal of grain. Taking it altogether, no grain is more useful or economical than barley, and in summer this may be occasionally changed with oats; in winter, for the reasons already given, Indian corn may be given

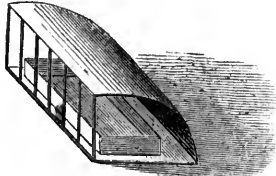

Fig. 4.

every second or third day with advantage. Buckwheat is, chemically, almost identical in composition with barley, but it certainly has a stimulating effect on the production of eggs, and it is a pity it cannot be more frequently obtained at a cheap rate. We never omit purchasing a sack of this grain when we can, and have a strong opinion that the enormous production of eggs and fowls in France is to some extent connected with the almost universal use of buckwheat by French poultry-keepers. Wheat is generally too dear to be employed, unless damaged, and if the damage be great it had better not be meddled with; but if only slightly injured, or if a good sample be offered of light "tail" wheat, as it is called, it is a most valuable food, both for chickens and fowls. "Sweepings" sometimes contain poisonous substances; are invariably dearer, weight for weight, than sound grain; and should never be seen in a poultry-yard.

The mid-day meal of penned-up fowls should be only a scanty one, and may consist either of soft food or grain, as most convenient—meal preferably in cold weather.

The regular and substantial diet is now provided for, but will not alone keep the fowls in good health and laying. They are omnivorous in their natural state, and require some portion of animal food. On a wide range they will provide this for themselves, and in a small establishment the scraps of the dinner-table will be quite sufficient; but if the number kept be large, with only limited accommodation, it will be necessary to buy every week a few pennyworths of bullocks' liver, which may be boiled, chopped fine, and mixed in their food, the broth being used instead of water in mixing; these little tit-bits will be eagerly picked out and enjoyed. A very little is all that is necessary, and need not be given more than three times a week. If fowls be much over-fed with this kind of food the quills of the feathers become more or less charged with blood, which the birds in time perceive, and almost invariably peck at each other's plumage till they leave the skin quite bare.

There is yet another most important article of diet, without which it is absolutely impossible to keep fowls in health. We refer to an ample and daily supply of green or fresh vegetable food. It is not perhaps too much to say that the omission of this is the proximate cause of nearly half the deaths where fowls are kept in confinement; whilst with it, our other directions having been observed, they may be kept in health for a long time in a pen only a few feet square. It was to provide this that we recommended the open yards, to be laid down in grass—the very best green food for poultry; and a run of

even an hour daily on such a grass plot, supposing the shed to be dry and clean, will keep them in vigorous health, and not be more than the grass will bear. But if a shed only be available, fresh vegetables must be thrown in daily. Anything will do. A good plan is to mince up cabbage-leaves or other refuse vegetables, and mix pretty freely with the soft food; or the whole leaves may be thrown down for the fowls to devour; or a few turnips may be minced up daily, and scattered like grain, or simply cut in two and thrown into the run; or if it can be got, a large sod of fresh-cut turf thrown to the fowls will be better than all. But something they must have every day, or nearly so, otherwise their bowels sooner or later become disordered, their feathers look dirty, and their combs lose that beautiful bright red colour which will always accompany really good health and condition, and testifies pleasantly to abundance of eggs.

The water vessel must be filled fresh every day at least, and so arranged that the birds cannot scratch dirt into it, or make it foul. The ordinary poultry-fountain is too well known to need description, but a rather better form than is usually made is shown in the annexed figure. The advantages of such a construction are two: the top being open, and fitted with a cork, the state of the interior can be examined, and the vessel well sluiced through to remove the green slime which always collects by degrees, and is very prejudicial to health; and the trough being slightly raised from the ground, instead of upon it, the water is less easily fouled. Some experienced breeders prefer shallow pans; but if these be adopted they must be either put behind rails, with a board over, or protected by a cover, in the same way as the feeding-troughs already described.

Fowls must never be left without water. During a frost, therefore, the fountain should be emptied every night, or there will be trouble next morning. Care must always be taken also that snow is not allowed to fall into the drinking vessel. The reason has puzzled wiser heads than ours; but it is a fact, that any real quantity of snow-water seems to reduce fowls and other birds to mere skeletons.

It is well in winter to add to the water a few drops of a solution of sulphate of iron (green vitriol), just enough to give a slight mineral taste. This will, in a great measure, guard against roup, and act as a bracing tonic generally. The rusty appearance the water will assume is quite immaterial.

Whilst the fowls are moulting, sulphate of iron should always be used; it will assist them greatly through this, the most critical period of the whole year. A little hempseed should also be given every day at this season, at least to all fowls of value; and with these aids, and a little pepper on their food, with perhaps a little extra meat, or even a little ale to delicate breeds during the few weeks the process lasts, there will rarely be any loss. With hardy kinds and good shelter such precautions are scarcely necessary, but they cost little, and have their effect also on the early recommencement of laying.

In addition to their regular food it will be needful that the fowls have a supply of lime, in some shape or other, to form the shells of their eggs. Old mortar pounded is excellent; so are oyster-shells well burnt in the fire and pulverised; of the latter they are very fond, and it is an excellent plan to keep a "tree-saucer" full of it in their yard. If this matter has been neglected, and soft shell-less eggs have resulted, the quickest way of getting matters right again is to add a little lime to the drinking-water.



Fig. 5.

THE HOUSEHOLD MECHANIC.

THE TOOL-CHEST (continued).

Saws.—For larger curves and coarser work, a strong, narrow, tapering blade, fixed into a handle, is used. This is called a compass-saw. For more elaborate curves, a narrow parallel blade, thinner on the back than in front, is stretched in a wooden frame. This is called a turning-saw, and a common arrangement is shown in Fig. 26.

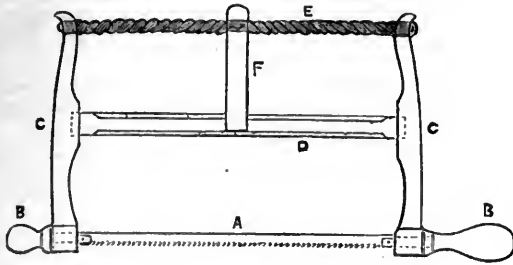

Fig. 26.

The blade, A, is fixed by a rivet at each end to the handles, B B, which are thrust through holes in the sides of the frame, C C. A centre bar, D, keeps this frame distended, and acts as a fulcrum, whereby the force generated by the twisting of the cord, E, is transmitted to the blade. The cord is twisted by the lever, F, and should consist of five or six turns of strong whipcord. The parts of the handles which go through the frame

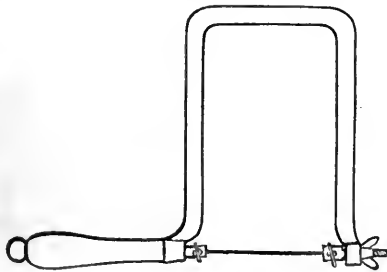

Fig. 27.

being cylindrical, they can be turned so as to put the blade in any required position to keep the frame out of the way of the work. The handle behind the pitch of the teeth—which is the one taken hold of—is usually larger than the one at the other end. A stronger and larger form of this kind of saw is much used on the Continent for all sorts of carpentry work, in place of our rip and half-rip saws. The turning-saw may be used to cut out spaces, by first boring a hole, into which the

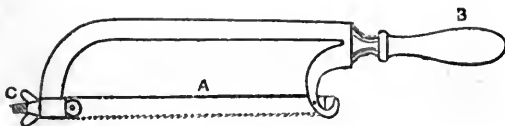

Fig. 28.

blade, released from one of the handles by taking out the rivet, is inserted. Of course, the limit of distance from the edge of the work at which these saws can act, is equal to the space between the blade and the centre bar, D. Fig. 27 is a diagram of the buhl-saw; these saws are used for cutting delicate and elaborate patterns through thin materials, such as veneer for inlaying, and they are fitted in frames with very long backs of light metal, so that they

may take in work of some size. The blade is of extremely thin metal, with very fine teeth, so that if a pattern is sawn through two layers of veneer at once, one of light colour and the other dark, temporarily stuck together, with a piece of paper glued between them for the convenience of separation, the pieces of each set would correspond and fit into the holes of the other, and *vice versa*; and so, with the one operation, two patterns are produced, one dark on light ground, and the other light on dark ground. The joints of the pattern are barely perceptible, owing to the extreme thinness of the saw. In use, this saw is held with the blade vertical, and the

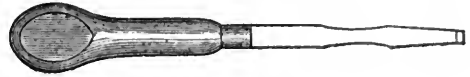

Fig. 29.

handle below the work, and both frame and work are twisted about as the curves of the pattern require. The professed buhl cutter often uses a kind of wooden vice, one jaw of which acts with a treadle, in which case the work is in a vertical position, and the saw is held horizontally. Fig. 28 shows a common metal saw, which is a stout blade, A, of hard, tempered steel, thicker at the teeth edge than the back in order to allow clearance way, the teeth not being "set," fixed in a metal frame, B, in which it is strained by the nut, C. This saw is held by the handle in the right hand, and pushed forward with considerable force, the left hand being lightly pressed in the curve of

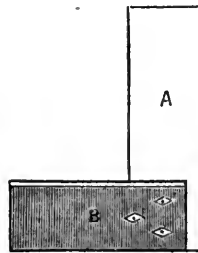

Fig. 30.

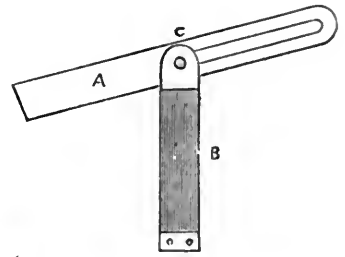

Fig. 31.

the frame in order to steady the blade. These saws should be used as little as possible for cutting steel, which wears them out very quickly, and they are too hard to be filed up again economically. The ordinary forms of wood saws are sharpened with three-cornered files, known as saw files, which are moved rapidly to and fro over the front and back edges of the tooth. The blade of the saw

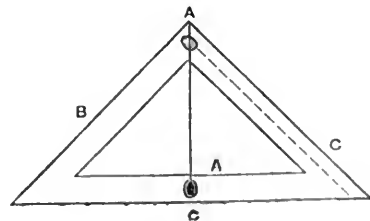

Fig. 32.

is held in a wooden vice, but an ordinary bench or tail-vise may be made to answer the purpose, if a couple of wooden clamps be placed in the jaws one on each side of the blade, otherwise the grating noise is almost unbearable. Of circular or vertical machine saws, it will not be necessary to say anything here, as they will not be likely

to be required for the small jobs we shall probably meet in our household.

Screw-driver.—Fig. 29 is the diagram of a screw-driver, a tool in which the only variation noticeable is in size. The longer the handle, of course the greater the power obtained. The point should not be ground up sharp, but bevelled nearly to an edge, so as exactly to fit the nick in the head of a screw. Screw-drivers are also fitted as bits, and used in the brace, a most convenient form where much screwing is to be done.

Squares, Levels, &c.—Fig. 30 shows the ordinary form of carpenter's square, which consists of a thin, flat, steel

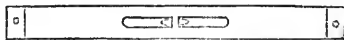

Fig. 30.

blade, A, which is riveted into a thicker piece of wood, B, at right angles to it, the inner edge of the wood being generally faced with brass. In using, the blade is laid flat on the wood to be squared, with the brass part of the handle held close up to the edge, and being brought to the required place, a line drawn along the metal edge will be exactly at right angles to the guide edge of the wood. Squares are also used in testing the accuracy of planed work, in which case the work should be held between the eye and the light, so that, on applying the tool, it will at once appear if it is at all untrue. Similar in principle and application is the mitre bevel, Fig. 31, which is a handle, B, with a shifting blade, A, which can be set at any required angle by the screw, C. The blade can be drawn out to the full extent of the slot in it, by which means a much longer line can be drawn. When not in use, the blade is turned round and brought in a line with the handle, in which position it occupies very little space. Fig. 32 shows the form of larger squares used by masons and others, which also serve as levels and tests of upright lines, by means of the plummet and line, c. For the horizontal test, it may be used on the same position as in the diagram, or turned over with the side, B, downwards, in which case the plumb-bob falls into the hole at A. The opposite side, C, held to vertical work, will test its uprightness. The plummet will fall in this case into the hole A, as with the last. Fig. 33 shows a common form of spirit-level, which consists of a hollow tube of glass, closed at each end, and full of spirits of wine, all but a small bubble of air. This tube is mounted in a block of wood, faced with brass, in the centre of which is an opening, through which the tube is seen; across the slit is a thin line, which marks the exact middle of the level, and when placed on the surface to be tested,



Fig. 34.

the bubble should stand exactly under this index if the work is correct. Levels are of many different shapes, and are sometimes found set in rules or squares; but in all forms their application is the same. Analogous in use to squares and levels are carpenters' straight-edges, often called winding-sticks, which are simply parallel slats of wood about two feet long, with their edges planed perfectly true. Suppose a long block of wood has been planed up to an apparently true surface, place one straight-edge on each end, and parallel to one another; bring the eye down so as to get the two sticks in a line, and if any twist should exist in the log of wood, the greater length of the straight-edge will magnify the fault. If, however, the two sticks appear, when foreshortened, exactly parallel, the work is correct. One edge of a straight-edge is usually bevelled to a point, which is used for testing long surfaces,

by bringing this sharp edge in contact with the work when between the eye and the light. If the light is seen plainly through at any part, it is obvious that that part is too low, and therefore the surrounding portions must be reduced to the same level. For gauging across narrow logs, the metal edge of the square is mostly used in the same manner. For marking across the grain, a tool is used called a striking knife, shown in our illustration, Fig. 34, which is a blade sharpened with a slanting edge, which is bevelled from both sides. The other end of the blade terminates in a point, which is used for such purposes as pricking holes as guides for the position of nails, &c.

Vices.—These useful contrivances are almost indispensable if any work in metal is attempted; but should our amateur only desire to work in softer materials, he will find the screw bench, to be described hereafter, answer his purpose, or at all events will only need a small table-vise. Fig. 35 shows the usual arrangement for the larger

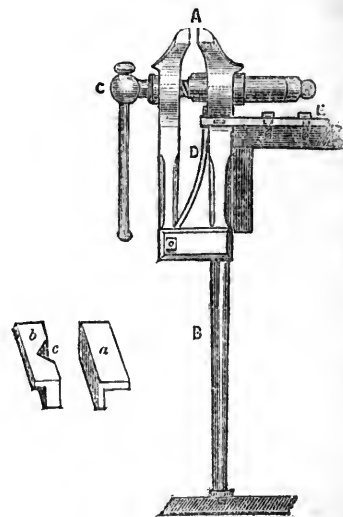

Fig. 35.

kinds of vices, called tail-vices, from the fact that one of its arms is prolonged downwards into a tail, B, which rests on the floor, and contributes much to the steadiness of the hold. The work is held between the jaws, A, which are closed by turning the handle working the screw, C, the jaws opening when released by the action of the spring, D. These vices should be screwed firmly to the bench or table. Table-vices are much the same as the above, but smaller, and have no tail, but are screwed to the edge of the bench. They are only fit for light work, however. In both the above, the insides of the jaws are faced with steel, and cut into teeth, in order to increase the holding power; these teeth, however, are liable to injure the surface of finished work, if such is required to be held. To prevent this, clamps are used, made of soft metal, and may be had ready to fit the jaws; although, for nearly all purposes, nothing answers better than two strips of thick sheet lead, the length of the jaws, and about three or four inches wide, nipped half-way in, and the remaining half bent over on each side with a hammer, so as to fit round the jaws and keep on them when opened. For holding round bars or pipes, a pair of clamps, like *a* and *b*, Fig. 35, will be found useful. *a* is a piece of angle iron, and *b* is similar, but thicker on one side, which side is filed out into a gap, *c*; the three faces formed by the sides of the neck and the clamp *a* giving a vastly increased grip on rods, &c., besides altogether preventing them from slipping out of the upright position.

Fig. 36 shows a hand or pin-vice, much used by watch-makers, &c., for holding small wire. The jaws are closed by a fly nut, and the handle is hollow, to admit of a long rod being slipped through. The round handle is very

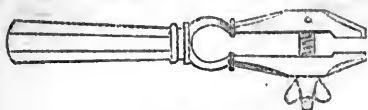

Fig. 36.

convenient for keeping work cylindrical if required, as the file may be moved in a straight path while the vice is rolled backwards and forwards by the left hand, the work being lodged in the partially-opened jaws of another vice. To obviate the difficulty in holding large works, owing to the disadvantage produced by the radial motion of the jaws in these arrangements, vices have been contrived in which the jaws move horizontally. Fig. 37 shows one

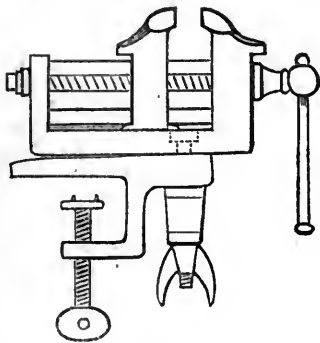

Fig. 37.

of these, which, though usually fine specimens of workmanship, are of course rather expensive (about 30s.). Tail-vices may be had from 10s. upwards, according to weight, about 6d. or 7d. per lb. being the average price. Table-vices are about 5s., and pin about 2s. 6d. upwards.

Wrenches.—These are used chiefly for turning nuts or bolts by means of their heads, which are shaped so as to admit of being gripped, mostly having four or six sides. The ordinary form is known as a spanner, but, being of certain fixed size, is, of course, limited in effectiveness to only just those nuts or bolts it happens to fit. In order to do away with the necessity of having a large

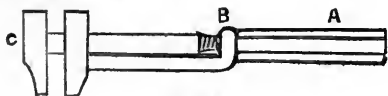

Fig. 38.

number to fit every size, wrenches are made with sliding jaws, which open or close by various means. Fig. 38 is a diagram of what is popularly known as a screw hammer. The handle, A, turns in the collar, B, and has a screw cut in a hole bored inside it, into which screw the movable jaw, C, is drawn by the turning of the handle. There are many other forms of screw wrenches, but in all the application is similar, and it is needless to describe each form.

Before concluding this chapter on tools, it will be as well to bring before the reader the common forms of nails, &c., he will be sure to want, and just to let him know the names by which to call them. In Fig. 39, A shows that most common form, the "cut" nail. It will be seen that, looked at from the side, this is wedge formed, but from the edge parallel. It follows, therefore, that the nail, when driven into wood, should be placed with its wedge side in a line with the grain of the wood. If this is not attended to, the wood, if at all thin, is sure to be split, besides which the hold is not so firm,

as the fibres, being bulged away, do not maintain so complete a contact with the nail as if driven in right. A practical trial or two will soon show the truth of this argument. These nails are very cheap, about 2½d. per lb., and are known as inch, two-inch, &c., cut nails. At one time the standard for their length was the height of piles of pennies; but since the alteration in the coinage this standard has given way to the more rational one of inch measure. Brads, B, are cut by machinery from sheet

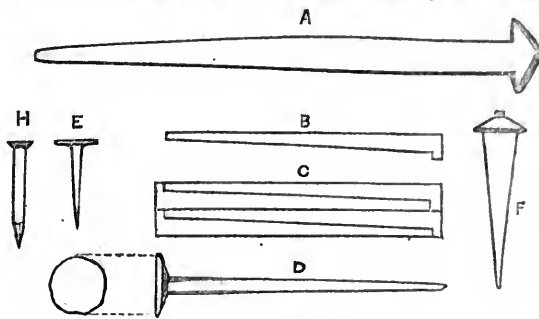

Fig. 39.

iron, which is used without waste in their manufacture, as the diagram C, showing the manner in which they fit one another, will show. These are also wedge-formed in one direction, and should be driven as directed for cut nails. The price of brads varies according to size, being from about 3d. to 1s. per 1,000. D is a round, flat-headed nail, called a "clout," much used for such purposes as nailing on sacking of beds, &c., or in any case where a broad holding surface is required. These nails, being almost exclusively wrought by hand, are expensive, about 6d. per 100 and upwards, according to size. The tack, E, is a reduced form of the above, and will perhaps be the most used of all nails in household requirements, for nailing down carpets, blinds, &c. They may be had as japanned or tinned tacks, at 4d. to 6d. per packet, containing 1,000. Wall-nails, F, are used only for nailing up trees to walls, and such purposes. They are made of cast iron, and consequently very brittle. Price, 2d. per lb. The sort of long iron tacks known as French pins, deserve to be much more generally used, as their grasp is very firm, although, owing to their cylindrical shape, there is but little danger of splitting the wood in using them. They are made of iron wire, flattened at one end into a head, sharpened at the other into a point. The price ranges from 6d. to 1s. and over per lb. Gimp-pins, H, will be found useful for tacking on bordering, fringe, &c., to curtains, ottomans, &c. They are only short, very stout forms of pins made of brass wire, and lacquered of different colours to suit the different furniture; price about 2d. per oz. Nails with iron or steel points and brass heads or hooks of various shapes, will most likely be in much request; they may be had with screws instead of points, if required.

DOMESTIC SURGERY.

WOUNDS, BRUISES, AND SPRAINS.

Poisoned Wounds.—The form of poisoned wound most familiar in domestic surgery is in the finger of a cook who has pricked herself whilst trussing game or cleaning fish. The slight prick, which is not noticed at the moment, becomes painful in the course of a few hours, when the finger becomes hot and swollen, and a red flush is seen to be extending up the finger to the hand. This state of things, if taken in time, may be effectually checked by the application of a wetted stick of lunar caustic over all the inflamed surface, and for some little distance beyond it. The caustic, of course, causes a

smarting pain, and turns the finger black, but this wears off in a few days. A solution of caustic answers as well, or even better, than the solid caustic in these cases, and the ordinary "nitrate-bath" of photography, to be found in so many houses, is very good for the purpose. Instead of the inflammation spreading in the above described way, it may be concentrated in the wounded spot, and give rise to a whitlow. In this case, fomentation of the whole hand, hot linseed-meal poultices, and support in a sling, will be the proper treatment; but if matter forms, it will probably require an incision, in order to save the finger, and therefore early recourse should be had to a surgeon. Bites of animals may give rise to poisoned wounds, without there being any risk of hydrophobia; and this is seen in the case of pet dogs, cats, squirrels, &c. The same treatment as for ordinary wounds, followed by that indicated for poisoned wounds, if occasion arises, would be proper in such cases. When there is the least reason to fear hydrophobia in the animal which has bitten, every precaution should be taken, which should include thorough cauterisation or extirpation of the wounded part; but this it is impossible for a non-medical person to carry out effectually. The bite of the adder is the only example of snake-poison met with in this country, and its effects, though serious, are not ordinarily fatal. In order to prevent, as far as possible, absorption of the poisonous material into the system, a string should be tied tightly above the wounded spot, which should be well sucked, the operator taking care to rinse his mouth out with a little brandy and water, and not to swallow any of the poison. After this, hot fomentations and a poultice will be the proper treatment. If the poison has spread up the limb, it gives rise to great swelling of the part, and this may even extend to the trunk. Friction with warm oil is the best remedy for this state of things, but it often does not subside for some days. The stings of wasps or bees are painful, but not dangerous, unless some vital part, such as the inside of the throat, is stung. The stings, which are often left in the part, should be extracted with fine forceps or tweezers, and the smarting pain may be allayed by a little moistened carbonate of soda being laid over, or some sal-volatile and oil rubbed on the part.

Penetrating Wounds of a slight character arise from the incautious use of some common articles of domestic use, such as an ordinary sewing-needle, a crochet-needle, or a fish-hook. The ordinary needle, if buried beneath the skin of the hand or other part, may be readily extracted if so placed that both ends can be felt. In that case, it is only necessary to press the end nearest the surface through the skin, and it can be easily withdrawn. If, however, as more frequently happens, only one end can be felt, and it is uncertain what length of steel is in the tissues, attempts to force the needle out lead generally to its being buried deeper; and it is better, therefore, to have recourse to medical advice at once, in order that the surgeon may, if he think it advisable, at once cut down upon the foreign body. Operations of this kind, though apparently trivial, should never be undertaken by amateurs, since the hand is too important an organ to be cut into lightly by one unacquainted with its anatomy; and, besides, there is usually no great urgency in the case, and the needle may very well be left alone until, in process of time, it makes its way to the surface, as it is pretty sure to do. Crochet-needles are more difficult to manage than ordinary needles, owing to the hook at one end. If merely driven accidentally into the skin, the wound may be cautiously enlarged with a lancet or sharp and clean pen-knife, so as to allow of the withdrawal of the barb; but if deeply embedded in a finger, or, as has happened, in the tongue of a child, it will be necessary to push the point through in order to cut the hook off with a pair of wire-pliers, and for this medical assistance should, if possible,

be obtained. Fish-hooks are to be treated on a similar plan, except that the disciple of Walton, being generally alone and at a distance when the accident happens, must be content to cut the line from the mischievous hook, and having forced the barb through the nearest point of skin, should draw the hook through the wound thus made.

Bleeders are persons who suffer from what is scientifically called a "hæmorrhagic diathesis"—i.e., they bleed profusely with the slightest scratch, and the blood is so peculiar that there is the greatest difficulty in stopping its flow. This disease is found to affect sometimes only one or two members of a family, is often hereditary, and may be traced through many generations. It is, fortunately, of not very common occurrence, and is only mentioned here in order to warn parents of children who suffer from a tendency to bleed, that they should always inform their medical man and their dentist of the fact, so that, as far as possible, all sources of bleeding may be avoided; and should hæmorrhage accidentally occur, immediate medical assistance should be obtained, since every hour's delay renders it more difficult to stop the bleeding.

Bleeding from the Nose is sometimes violent, and usually an evidence of some derangement of the general health, for which medical advice should be sought. In order to check the bleeding, cold water may be employed to bathe the face and head; or ice-water may be injected with a syringe or india-rubber bottle into one nostril, when, if the patient will keep the mouth open, the water will flow round the nose and out of the opposite nostril. In slight cases, merely sniffing up cold air forcibly will often check the bleeding, and, in addition, powdered alum or tannin may be used as snuff. When the bleeding continues for any time, the surgeon should be called in to plug the nostrils.

Bruises and Contusions are common accidents where there are children, and fortunately a child is able to sustain, without serious after-consequences, a bruise which might be of importance to an older person. A severe bruise is alarming to the bystanders on account of the rapid swelling which takes place, and is annoying, in addition, to the recipient on account of the *ecchymosis* or discoloration left for some days after. The application of cold in any form has a tendency to check the swelling and sub-cutaneous extravasation of blood constituting a bruise, and this may be applied in any form most convenient—cold vinegar and water, iced water, or the favourite cold metal spoon. Raw beef-steak is popularly supposed to have a great controlling effect upon bruises, but apparently without good foundation. There is a medical remedy of recognised utility in these cases, however, and this is the tincture of arnica; and this may be painted on the skin, if not broken, or applied diluted with water, if the skin is torn. There is, however, one caution to be observed in the use of arnica—that in some persons it excites an irritation of the skin closely resembling erysipelas, particularly if applied to a broken surface. Some caution should, therefore, be used in its first application, though the frequency of the occurrence of any untoward result is probably very greatly exaggerated. Contusions are more severe accidents than mere superficial bruises (with which, however, they may be combined), since they may endanger the life of the sufferer from injury to deep-seated and important organs. The immediate effect of a severe contusion of any part is ordinarily to produce faintness and nausea, and for this the patient should be laid in an horizontal position, should be allowed plenty of fresh air (and consequently should not be crowded upon by bystanders), and may, if able to swallow, drink a *small* quantity of weak brandy and water or wine. On recovering from the first faintness, no other symptoms may appear, and the patient may have received no further injury than the "shock" of the accident; but if, from the

nature and severity of the injury itself, it may be suspected that some internal injury has been received—as shown by long-continued faintness, by hiccup, or pain in the abdomen or chest—immediate recourse should be had to medical aid.

Concussion of the Brain is the common result of a concussion of the head, and cannot be too seriously regarded. In *any* case of injury to the head, where insensibility has occurred, a doctor should be sent for; but even in slighter cases, when the concussion has apparently only produced a temporary dizziness, careful treatment, both at the time and after the injury, will be necessary to restore the patient to a healthy state of both mind and body. In any case of insensibility from injury to the head, no harm can possibly be done by cutting the hair close, and applying cold to the head until the surgeon's arrival; or should this be delayed, and the patient's body be cold and the skin clammy, hot bottles may be put to the feet in addition. Beyond this, however, it is never safe for a non-professional person to go in a case of severe injury to the head; and most particularly ought the administration of stimulants in any form to be avoided.

Sprains.—A severely sprained ankle is a common, and at the same time a serious, accident. As it is very possible that the accidental twisting of the foot to one side may have broken the small bone of the leg near the ankle, such a case should always be seen as soon as possible by a medical man. But if the sprain is of a sufficiently slight character to be treated domestically, it should be borne in mind that complications may occur at a later period, for which medical advice should not be too long delayed. In the case of a sprained ankle, it is of the first importance to get the boot off before the swelling, which invariably follows, has come on. If the accident has happened at a distance from home, the foot should then be firmly bound up with a bandage applied round the ankle in a series of figure of 8 loops, and the foot kept in an elevated posture during the conveyance of the patient to his home. On reaching home, the bandage is to be removed, and the foot assiduously fomented with water as hot as can be borne, until the pain is relieved; some tincture of arnica or poppy-heads being useful adjuncts to the fomentation. The application of leeches to bad sprains is often of service, but it is not safe to have recourse to them without medical sanction. The use of cold applications to sprains, though popular, is not to be recommended. The cold lowers the vitality of the part, and tends to prevent the very repair which it is our object to bring about. Support and rest are the points to be insisted on, and these are most readily obtained by strapping the joint firmly with adhesive plaister, so that no movement of the ankle is possible. In order

to do this, it is necessary to have a yard or two of good "strapping" or "soap plaister," so that the pieces required may be cut "in the length" of the calico. Strips long enough to encircle the foot and cross by some inches, are to be cut, and must be thoroughly warmed, one by one, either by holding them with the plain side to the fire, or, better, by plunging them for a moment into a basin of hot water. The foot being then brought to a right angle with the leg, and supported on the heel at a convenient



Fig. 13.

height, the strips of plaister are to be applied as follows:—Beginning near the roots of the toes, the first strip is to be passed beneath the sole, and the ends crossed over the instep, and each strap is to be placed nearer the heel, and to overlap its predecessor for about half its width. When half a dozen straps have thus been applied, another series

is to be made to pass around the upper part of the joint horizontally, crossing the first set on the instep, and thus the whole joint will be supported and compressed, and the patient will be able to get about (Fig. 13). A bandage should be applied over the plaister, to keep it from slipping. In a couple of days the plaister will have become loose, owing to the subsidence of the swelling, and must be renewed, the old plaister being most easily removed by slipping the blunt end of a pair of scissors beneath it on one side of the foot, and dividing it so that it can be taken away in one piece. For a sprain of moderate severity the plaister will require renewing three or four times; but even when its use is abandoned, it will be advisable to employ a bandage or an elastic "foot-piece" for some time, as the foot will still require support. A sprain of one of the larger joints, and especially of the knee, is a serious injury; and if any severe symptoms show themselves, immediate recourse must be had to medical aid. When a knee merely gives way occasionally under a person when walking, and there is no swelling or heat about the part, it will often be of service to support the joint with a knee-cap, which may be of elastic material, and is better made to lace up than to draw over the leg. When the joint continues weak for some time, it may be advantageously treated like an ankle by strapping, the plaister being cut long enough to go once-and-a-half round the joint, and about an inch in width. The straps are then made to overlap in regular series, from below upwards, crossing in front until the joint is completely covered, as seen in the illustration, Fig. 14.

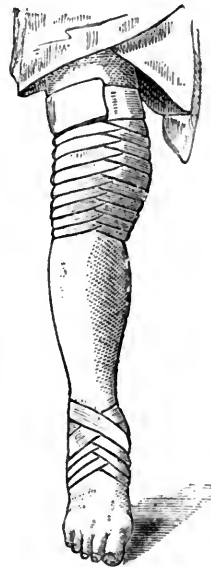

Fig. 14.

A *Strain* is much the same as a sprain, except that it does not necessarily occur in the neighbourhood of a joint. It consists in the tearing of some tendinous or muscular fibres, and is generally the result of some violent and unwonted exertion. The treatment consists in obtaining rest and support for the part by careful bandaging, the use of a sling, &c. The term "a strain" is sometimes applied by the lower classes to the occurrence of a rupture from some violent exertion. If any swelling should be noticed in the neighbourhood of the groin after some exertion or athletic exercise, a surgeon should be immediately consulted, as the case may be a serious one, and a little delay be a matter of life or death.

COOKING.

SIMPLE RECIPES (continued).

Suet Dumpling.—This is an excellent dish both for rich and poor, for several reasons. It is wholesome, pleasant, and cheap; it may be made more or less substantial; and its flavour may be varied according to taste; it can be eaten either as a savoury or as a sweet. Its value as nourishment consists in its containing a good proportion of fat. Writers on cookery cannot too strongly insist, and mothers of families cannot be too fully persuaded, that a certain quantity of *fat* in our daily food is absolutely necessary to health. Young people, especially, who have not enough of it to eat, are more liable than others to fall into a consumption at the period when they are making rapid growth. To such persons fat in the shape of cod-liver oil is administered as a medicine;

for it matters little in what shape the fat is taken, whether as dripping, butter, or oil, their effects on the system being exactly the same. Unfortunately, though one man can lead a horse to water, a hundred can't make him drink; and it is useless to set before delicate, perhaps fanciful, stomachs things from which, however good for them, they turn away with dislike and loathing. The only way is to cheat them, as it were, into taking, almost without knowing it, what is essential for their bodily welfare. The housewife at least ought to be thoroughly convinced of the great importance of all kinds of fat in family dishes, and never to waste any; but, on the contrary, to procure all she can at an economical rate. There are families in which every scrap of fat which is helped to its members seated at table is left on the plate, and thrown to the cat or the pig. This ought never to be. It will not often happen in families who live by outdoor employment, but it will when their occupations are different. We have no right to say an unkind word about "daintiness" and the rest, if persons who are confined nearly all day long to sedentary and monotonous employment, in a close, in-door atmosphere, have not the sharp-set appetite of the ploughman who hears the singing of the lark and feels the freshness of the winds of March, from misty daybreak to ruddy sunset; only, if they can eat no meat but lean, we urge them to use the fat under some disguise. They already take it in many shapes, unconsciously or without thinking of it, as in broths, milk, bread and butter, and even in meat which they call and consider lean. Let them buy, therefore, not one ounce the less of good wholesome fat with their meat, and let them employ it in some of the ways we are about to mention. For plain suet dumpling, the best is the kidney fat of beef or veal, which is sold separately in small quantities, and at a moderate price. Chop this fine, and to one pound of flour, put from a quarter to half a pound of chopped suet, according to the richness you wish to make it of. Add a pinch of salt, and water or milk enough to make it into a paste that will hold well together. It is a good plan to mix the salt (and, if you like, the least dust of pepper) with the suet before mixing with the flour. Make this paste into dumplings about the size of your fist. It is better to make several of a moderate size, than a few large ones: they boil more thoroughly, and in a shorter time; besides, each person can have his dumpling to himself. Flour them well; tie each one in a cloth, well floured inside, not too tight, but allowing a little room to swell. A very little practice will teach you the degree of tightness. Throw them into boiling water, and keep boiling (galloping) a couple of hours or so, according to the size of your dumplings, and see that none of them stick to the bottom. Serve them the minute they are taken out of the cloth. They need no sauce; but a little bit of butter, as an indulgence, or some roast meat gravy, does no harm. For sweet suet dumpling, allow a liberal quantity of suet. With the salt mix a little grated nutmeg, and a good table-spoonful of brown powdered sugar; or, instead of using sugar, you may mix a table-spoonful of treacle with the water with which you make the dumpling-paste. Boil as before. If sauce be wanted, give matrimony sauce.

Plum Dumpling.—As before; only mix with the salt, sugar, and suet six ounces of washed currants, or of raisins stoned and chopped. Same cooking, and same sauce. We once saw an ailing child crying for plum-dumpling when there was only plain, and refusing to dine. A good-natured friend, who happened to look in, said, "Give me one of those nasty plain dumplings," and disappeared with it into the kitchen. In two minutes he returned with it stuck over the outside with plums. The child set to with appetite, and ate it. If your quantity of plums is scanty, mix just a few with your flour and

suet, and stick the rest on the outside of your dumplings before tying them up in their cloth and boiling them. They will be received by the little ones with a heartier welcome than if the treasures they contained were unseen. It is said that "a pleasing appearance is the best letter of recommendation." You may call them dumplings in their Sunday clothes. Moreover, the plan has a highly-approved precedent. Cabinet pudding (which is nothing but sponge-cake soaked in beat-up egg, and boiled in a mould) ought to have its *outside* only garnished with dried cherries, or, in default of them, with jar-raisins stoned, by sticking them *inside* the mould before boiling.

Suet Pudding.—Mix up the above ingredients with milk, a quarter of a pound of bread-crumbs, two or three eggs, a little lemon-peel chopped fine, and a little larger allowance of sugar. Do not make this up into separate dumplings, but boil in one lump, in a well-floured cloth, for a longer time—three or four hours. You see that in this case, as in the soldier's famous flint-soup, we are gradually enriching a preparation which started from a very simple beginning. By adding sundry nice things to suet and flour, we have got from plain suet pudding almost up to plum pudding itself.

Short Cake.—We now come to things that are made with a crust (which we may call pie-crust, though in many cases it is boiled), enclosing something either sweet or savoury. And as we have said a few words about fat, so now we would call the attention of housewives to the importance of sugar as an article of food. Its effects on the constitution are similar to those of fat, and it may be used as a partial substitute for, or in addition to it. They should also know that there are three things which, although so different to the taste and the touch, are alike in their nature and their chemical composition. Those three things are gum, starch, and sugar. We often eat these, especially the two last, without being aware of it. Arrowroot is starch. There is starch in potatoes and in bread. Indeed, the more of it there is in potatoes, the more nourishing they are. There is sugar not only in most ripe fruits, but in many roots, as turnips, carrots, and parsnips; and in many vegetables, as in *young* green peas. When they grow older, it changes into starch. Almost all the sugar eaten in France is made from the beetroot or mangold-wurzel. Sugar helps to fatten, and is therefore one of the aliments which supply animal heat. It is a valuable addition to food, though not an economical one; and families who can afford its use are to blame if they pinch themselves in the article of sugar. Sweet things, however, require to be backed up with a supply of those kinds of food which *nourish* the body—that is, which supply the materials for growth. Short-cake is merely pie-crust sweetened with a little sugar, rolled out about three-quarters of an inch thick, and then baked in pieces of any convenient size. It is mostly eaten hot, as a little treat, at tea-time or supper, and is often made of what remains over and above of

Good Common Pie-Crust.—You may make this by putting six or seven ounces of finely-chopped suet, with a little salt, to every pound of flour, and working it into a paste with a little cold water. But it is better to "try down," or melt in a saucepan over a gentle fire, any suet or fat you happen to have, and put it to the flour just before it gets cold. Very eatable crust may be made with the dripping from roast beef, veal, pork, or mutton. Even goose-dripping makes a not bad crust (though a little strong in flavour) for meat dumplings or pies. Butter is really the grease for pie-crust. Sweet, fresh pork-lard, too, makes excellent pie-crust, but it is often as dear as butter, so that it is a question of price which you will use. The *quantity* of fat to each pound of flour is also a matter on which you will consult your pocket, and cut your garment according to your cloth. Ten

ounces of dripping or lard will make a rich crust. But many things do not *want* a rich crust. They are the better for its being at once substantial and *light*, which will somewhat depend on the cook's expertness in the use of her rolling-pin, and in her not being afraid to employ a little of what homely folk call "elbow-grease." A few quick turns and rollings out, with judicious sprinklings of flour between them, will often make, with the same materials, all the difference between a light crust and a heavy one.

Treacle Pudding.—Roll out your crust, to the thickness of from one-third to one-quarter of an inch, into an oblong shape, approaching to what learned men call "a parallelogram," and simpler people "a long square." Spread this with good treacle; then roll it into the shape of a bolster; work the ends together with your fingers, and give them a twist to keep the treacle in. Tie it up in a well-floured cloth, taking particular care of the ends. An oval boiler is the most convenient, because the pudding *must not be bent*. Throw it into boiling water, and let it boil *well* at least two hours. Indeed, it is not easy to boil this class of puddings (roly-polies) too much, unless you sit up all night to do it. N.B. They should be kept boiling till the minute before you want to serve them.

Sugar Roly-poly.—Make rather a rich crust; spread it with brown sugar, and proceed as above. Matrimony sauce (p. 27) is very nice to eat with this.

Apple Roly-poly.—Peel and quarter a quantity of apples, and cut out their cores. Set them on the fire in a saucepan with a little water and a clove or two. As they boil, stir them, and mash to a pulp. It will be a great improvement if you can put with them the *rind* of an orange peeled thin and shred fine. Of the pulp of the orange you will have no difficulty in disposing, especially if there are children in the house. When smooth and tender, reduce your apple-pulp to a thick marmalade by letting it stand by the side of the fire to evaporate. On the Continent, a similar marmalade is made with pears, especially with windfalls after a heavy gale. Sweeten your marmalade, if required, and with it make your roly-poly as in the case of treacle-pudding. It is clear that you can make a roly-poly pudding with any description of fruit, jam, or marmalade; or you may even substitute for them a few plums and currants.

Apple Dumplings.—Peel and core your apples; cut them into small pieces. Put a small handful of these into the middle of a bit of pie-crust, and with them one clove and a little lemon-peel chopped fine. It is these little additions which make things *nice*, and it is not the cost, but the thought and the trouble which prevent their being added. You may also put in a teaspoonful of brown sugar. Then work the crust round them, closing it at the top with a clever twist, and tie them, not too tight, nor yet too loose, in cloths floured inside, and boil galloping an hour and a half. There are recipes for baking apple-dumplings, respecting which we beg to observe that when baked they certainly are dumplings no longer, but become turnovers, rolls, or whatever else you please.

Apple Rolls.—Chop apples *very* fine, and sweeten them with sugar. Lay three or four tablespoonfuls of this in the middle of a circular or oval bit of paste, rolled out a quarter of an inch thick. Fold it in two lengthwise; unite the edges, and press or scollop them with the bowl of a teaspoon, or the tines of a fork. Lay your rolls on a flat sheet of iron or baking-tin, that has been previously greased, and set into a moderate oven. To make quite sure of the apple being cooked, it will be found a good plan, instead of chopped or sliced fruit, to use apple marmalade, as made for apple roly-poly pudding.

HINTS ON CARVING.

CARVING is quite a modern art, for forks have not been introduced in Europe many centuries. The first were brought to England from Italy by Coryat, an English traveller, in 1611. In the days of our Saxon ancestors, joints of meat, poultry, and game, were brought to table on the spits on which they were cooked, and handed round to the company by the serving men on their knees. Each person cut what he pleased from the joint, using a knife which he carried at his girdle for the purpose, and tearing and conveying the pieces to his mouth with his fingers. The invention of forks is ascribed to the Italians, who used them in the fifteenth century. Other European nations fed out of the same dish, the gentlemen cutting off pieces of meat for the ladies first, and all using their fingers. The first forks were two-pronged, much like our carvers.

In 1653 it had become an elegant habit to use a fork, but the roughness of the general manners at a period ignorant of forks and of the art of carving may be gleaned from the instructions given in etiquette in a little work published at the date above named, and entitled, "The Accomplished Lady's Rich Closet of Rarities," in which it seems necessary to warn her against a demeanour only likely to be found amongst the very lowest members of society in our days, as the following extract shows:—

"A gentlewoman being at table abroad or at home, must observe to keep her body straighte, and not lean by any means upon her elbowes; nor by ravenous gesture discover a voracious appetite; talke not when you have meat in your mouthe, and do not smacke like a pig, nor eat spoone-meat so hot that the tears stand in your eyes. It is very uncourtly to drink so large a draught that your breath is almost gone, and you are forced to blow strongly to recover yourself; throwing doune your liquor as into a funnel is an action fitter for a juggler than a gentlewoman. In carving at your own table, distribute the best pieces first, and it will appear very decent and comely to use a fork, so touch no piece of meat without it."

Twenty years later than this, the Highlanders in Scotland cut the joints of food brought to table with the daggers they wore at their sides. Even at the present day in France, which takes the lead in so many elegancies, carving is an unknown art amongst the mass of the middle classes. If a leg of mutton is brought to table, the master of the house grasps the joint in his left hand by the knuckle, and holds it up from the dish, cutting off junks of meat with a knife, commencing from the knuckle end, but without system. When about enough for the family or company has been severed from the joint, the rough-hewn lumps of mutton are transferred to a large meat dish, a fork placed at the edge, and the dish handed round by the servant. Veal and boiled beef is cut carelessly into lumps with a knife and fork, and handed round in the same way.

And yet refined manners at table have been admired by the *élite* of all ages. Even the poet Ovid, so long ago as the Roman era, advised those who sought to gain the affections of others to be careful in their ways at table. He instructs his readers—

"Your meat genteelly with your fingers raise,
And, as in eating there's a certain grace,
Beware with greasy hands lest you besmeare your face."

We, who have the assistance of forks, and can readily obtain instruction in the daintiest and most economical methods of cutting the food brought to table, ought to blush to be behindhand with the ancients, not only as there is in "eating" but also in carving, "a certain grace" most desirable to be achieved.

Forks

Roast Fowls are by no means an uncommon dish, and one is often requested to carve a fowl, who, from want of practice, is obliged to blush and refuse. As sideboard carving is not yet sufficiently general to render the challenge impossible, we recommend every one of our readers to master so really simple a thing; for nothing makes a person look more stupid than a bashful refusal to perform such a little service for host or hostess upon occasion. It looks as though one would eat his dinner at another's expense, but would not even put out a hand to assist. Poultry-carvers are placed to divide fowls; the poultry knife is short and thick, and pointed and sharp at the top. The great art in dividing all kinds of birds is to hit the joint at once, else there is an awkward fumbling about, cut after cut made, and a stupid delay. To take off the leg, which should be the first joint



Fig. 6.

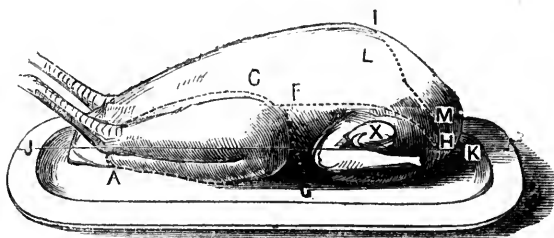

Fig. 5.

removed, thrust the fork into the breast at A, in Fig. 4. Take one careful glance at your bird before you touch it with the knife; in this glance ascertain where the joint is likely to be relative to the width of the leg and the width of the body. Strike the knife to the joint; feel for the centre of it, where the joint is united; send in the tip of the knife upright; press it down straight; and then, with the weight of the hand, turn the knife over, as shown in Fig. 4. Instantly the joint cracks, and is severed. Now cut it off from the side, taking a nice slice of meat with it, according to the line indicated from A to C, in Fig. 5. Having removed one of the legs, take off the wing on the same side in a similar manner. A good-sized piece of meat is taken off from the side of the breast with the wing, and is almost of triangular shape; it is shown by the dotted line from G to F, and from F to H. Remove the leg and wing from the other side, and then take the "merry-thought" off the breast. This is done by inserting the knife under the point of the breast-bone at I, in Fig. 5, and sweeping it round at each side by a circular cut from I, past L to M. Afterwards separate the remainder of the breast from the back by cutting it right through the small rib bones at the straight line, from end to end of the fowl, marked J K in Fig. 5. This last piece of the breast is generally helped entire. Now only the back remains. Turn it over on the dish with the outside upward; plant the knife upright in the

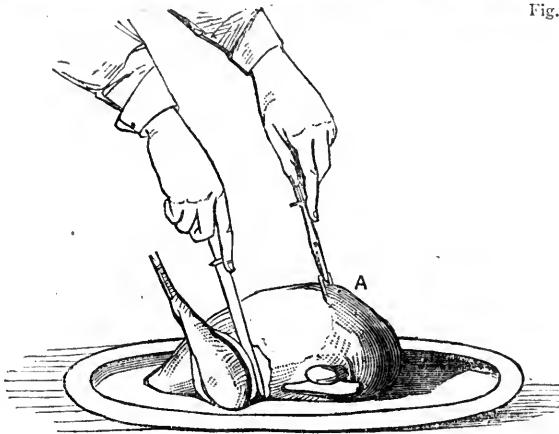

Fig. 4.

centre of it, hold it firmly, place the fork under the portion to the left of the knife, and raise it from the dish at right angles, till the bone snaps; then cut right through, and help the two halves separately. The wings are deemed the most choice portions of the fowl, and are usually served first. In Fig. 5 a little round is noticeable just in the bend of the wing, marked X. This is the gizzard in the one wing, and the liver in the other. The liver wing is generally most esteemed. When carving a fowl, it is usual to ask which is preferred, the liver or the gizzard wing.

Salmon.—Fig. 3 in the coloured plate represents a slice of salmon when brought to table. Salmon should be served on a napkin, and it is often garnished with sprigs of fennel or slices of lemon. A silver or plated slice or knife, Fig. 6, is used for this, as for

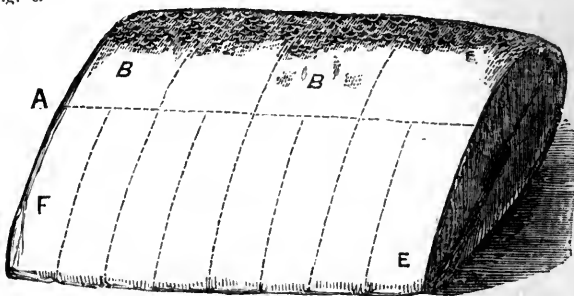

Fig. 7.

other kinds of fish, because steel spoils the flavour of fish. A knife needs to be broad to divide the flakes without breaking them. A fish-knife has a sharp curved point to disengage the fish from the bones, and is perforated with holes to allow any water retained about the fish to run off. A fork is not used in helping fish. With the blade of the fish-knife, A to B, in Fig. 6, cut through the salmon from end to end, close to the backbone, at the line marked A in Fig. 7. If the fish is large, it will be necessary to make one or more cuts parallel with A. These are again divided across into square pieces, as shown at B. This part of the salmon, which is the prime, is called the "thick."

With each slice of the thick, cut also one of the "thin," or belly, which is cut down in smaller slices, as shown from E to F in the illustration. When the upper portion is consumed, remove the centre bone with the fish-slice to the side of the dish. Cut the remainder as before, taking care not to damage the napkin on which it is laid. Each piece of fish is served from the dish to the plate on the flat of the silver slice. The centre of the salmon towards the shoulders, and the centre cuts are reckoned the best. In our next article on this subject we shall give instructions for carving the other dishes figured in our coloured illustration, as well as some more plain joints of butchers' meat.

HOUSEHOLD DECORATIVE ART.

II.—LEATHER-WORK.

To make flowers and fruit in leather, it is advisable that Nature should guide the learners entirely; never trusting to their own taste, nor to paper patterns, when natural leaves and productions are procurable. It is almost impossible to give a really practical written description; however, I will endeavour to explain the process of making two or three of the easiest, as simply as I can, but really recommend those desiring to be proficient in the art, to take a couple of lessons to learn the more complicated species, as roses, passion-flowers, &c.

Camellias.—Cut out the petals (Figs. 6, 7) according to the number and sizes required, damp and mould them into shape with the fingers, and give them as natural a form as possible; fasten all the petals together with thread and liquid glue, and put a piece of wire through the whole for a stalk, covered with skiver leather. The buds are made by

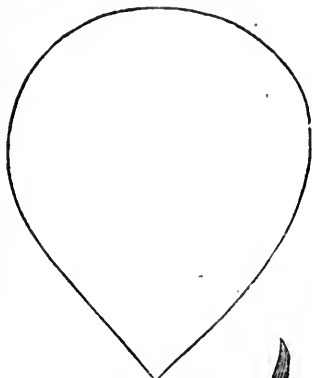

Fig. 6.

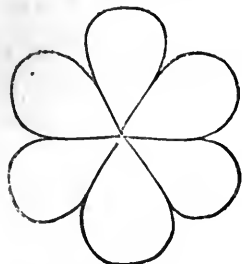

Fig. 7.



Fig. 11.

rolling some leather chips, smeared with liquid glue, into the proper shape, then covering with two or three petals, and gluing down the base to the calyx, taking care to leave the upper part of each petal free. The calyx should be formed by cutting a piece of leather to pattern, and moulded into shape with the fingers and the handle of the veiner.

Dahlias, Fig. 9, are formed by cutting out circles of leaves, each circle being smaller than the other, and each having a hole in the centre; a fine roll or pledget of leather is passed through these holes, and holds all the circles together.

White Lilies.—Take a piece of leather and cut it into six petals, formed of one piece, thus: the three largest petals which alternate with the others are brought uppermost, while the three smaller ones are placed behind; the leaves are then to be veined, and curled or moulded into shape, as in the natural flower, and the petals will require to be glued to keep them in their proper places. Moulds can be procured to work the lily on; but if there is not one at hand, something should be adapted to place the lily upon while modelling it as near the shape of the interior as possible. It has six stamens with oblong anthers, which are made by cutting strips of leather, and leaving a

piece of leather uncut at one end, rolling the strips round between the thumb and finger. The anthers are formed by a thin strip of leather being cut into small pieces, and each portion rolled between the finger and thumb, the end of each stamen being tipped with liquid glue; the anther can be easily affixed. The piece of leather left at the end of the stamens should be rolled up as a stalk, put into the interior of the lily, pulled through the hole at the base, and then glued to its proper place. The bud of the lily is formed by merely folding the whole corolla together, veined (see Fig. 8).

To make Hops.—Cut twenty petals out of skiver leather all the same size, the shape of the single petal, B, Fig. 10; then take a piece of wire, and wind leather round the end of it, as in A, Fig. 10, fastening it well with liquid glue; this inner body should be somewhat shorter than the hop is to be when completed, and pointed at both ends. Mould the petals into a convex form at the end of each petal, then glue them alternately, com-

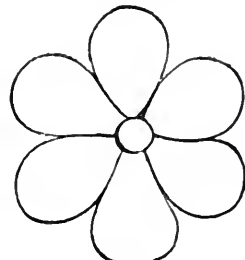

Fig. 9.



Fig. 10.



Fig. 8.

mencing at the bottom and finishing at the top of the flower (C, Fig. 10).

In constructing Fruit, much care is necessary in the formation of the moulds, the choice of specimens, and the manipulation throughout. The materials required consist of some gutta-percha sheets of various degrees of thickness, and some natural moulds; the rest of the materials are the same as those used for other work, with the addition of two fruit-moulding tools of different sizes.

To construct a Peach.—

Choose a hard, unripe specimen, and obtain a cast of the exact half by dipping a piece of gutta-percha sheet into hot water, and pressing it firmly over the peach, previously smeared with olive oil. If neatly done—and the art will be acquired by practice—the natural division of the fruit may be imitated. Remove the cast from the fruit, smear the inside with oil, and cut a piece of leather larger than the mould, dip it into cold water, and with the moulding-tool press it gradually and firmly, with a circular motion, into the mould, then set it aside to dry. Next pour some liquid glue into the inside, and press in any odd pieces of leather or shavings until the half is filled. Construct another half, and join the two parts with liquid glue; rub off the irregular edges that remain with the end of the

moulding-tool, and smear with liquid glue, to keep the parts firm, then size and varnish. Lemons, apples, melons, plums, or any similar fruits, are formed in the same manner. Pears, figs, or such shaped fruit, require casting with the apex at one end and the base at another.

Cherries are made in a similar way to grapes, which we described in our former article.

Walnuts should be made by forming a mould of gutta-percha from the half, and pressing in the moist leather as usual, then filling up and varnishing.

Filberts are very effective when made, and are thus produced:—Crack several nuts, and choose as many *half* pieces as you can; cut the edges smooth with a knife, and there is the mould ready. Lay one of the halves upon a piece of basil, run a pencil round the edge, and cut out the piece, which should then be dipped into water and pressed into the half-shell mould and set aside to dry; when dry, fill up with leather in the manner described for a peach; remove from the mould, then glue the two halves together, rub the edges down, and the nut is finished. The bract is made by taking the natural bract of the nut, as in Fig. 11, laying it on the leather, and cutting it out from it. The base of the nut is glued to the centre, and the rest of the leather is brought round the nut so as to give as natural an appearance as possible. When several have been formed, they should be glued together by their bases, to resemble a cluster, and the stem and leaves, which are formed in the usual manner, affixed and arranged according to Nature's own design.

Currants, &c., are formed in the same manner as ivy-berries.

Strawberries are constructed like grapes, but of course the shape is different; and, when the fruit is finished, the seeds are imitated by digging up the leather with the sharp point of a pen-knife; it is then fastened to its calyx with glue, &c.

Raspberries and Mulberries are formed by rolling up slips of smeared leather until they are the size of the seeds, and having previously formed a pyramidal piece, the seeds are to be fixed to it until they are clustered into the proper size and form. The mass is then to be fastened to the calyx, previously cut out by pattern, and attached to the stem as usual.

Wheat is made by rolling up leather strips, and covering the seed with small oval chips, rendered concave by means of pressure, and fastening them to a zig-zag strip of leather.

To make Leather Figures.—Choose a good plaster of Paris cast, or a statue, and proceed as follows:—Oil the figure well with sweet oil, and having warmed a sheet of gutta-percha by immersion in hot water, press it firmly with a cloth into every part of the cast required; allow it to cool, and remove it carefully. The mould is then to be oiled inside, and the leather (having been previously stretched) should be dipped into cold water and afterwards pressed into the mould, the inside to be filled with leather chips, as in the fruit process, and, when dry, removed; but I recommend that a couple of lessons be taken in this as well as in the modelling of flowers; as to excel in this, the highest order of leather modelling, practical demonstration is better than verbose descriptions.

Bee-hives can be made with leather stems as follows:—Cut a piece of wood to the shape and size required; wind and glue upon it the stems, beginning at the top and finishing off at the bottom. To join the stems, cut each end to an angle, so that they fit; join them with liquid glue, and tie a piece of thread round to hold them tightly together till the glue is dry, when the thread can be cut off. To imitate the "*ying*," mark with a pen, with the darkest stain, lines and dots from top to bottom, cut a little bit out of the lower tier to make the entrance, and make a handle at the top with a piece of stem. And with

this example of *industry* we will conclude our lesson on leather work. It will be observed that the instructions we have given have been merely rudimentary, teaching the reader how to form imitations in leather of single natural objects. We may, at some future time, give some designs for the grouping of these together, for the purposes of household decoration. Such groupings may, of course, be infinite in their variety, according to the shape or requirements of the object the leather-work is intended to ornament. Frames for pictures, and mirrors, brackets, bookstands, and similar articles, are good subjects for the artist in leather-work to try his hand upon, and may be rendered highly ornamental by a tasteful employment of this simple but effective branch of the household decorative art.

HOME GARDENING.

THE SMALL SUBURBAN GARDEN.

AMONG the many thousands of houses which have been built during the last few years in the neighbourhood of our large towns, few are without some small patch of ground which may be turned to account for flowers. There may not be room for an extensive and showy display, but there is usually enough, either at back or front, to make an ornament to the house, and to afford some degree of amusement and interest to the owner. What to do with these small plots, is the difficulty with many who are without gardening experience, and have little time to acquire it, and consequently we very often find such spaces either very injudiciously filled, or neglected altogether. We shall try to put our readers in the way of making a flower garden, even if the space at their disposal be only a few yards in extent, and this at a very small outlay of either money or labour.

We must ask our readers to keep in view the hints we gave in our last paper, as to the planning of the small garden, and the preparation and improvement of the soil. Taking these as a starting-point, we will suppose the beginner to have put his piece of ground in order by clearing away rubbish, well turning and breaking up the soil, and importing mould if necessary. For getting the ground ready, if it has ever been used as a garden before, he will find a three-pronged fork far more useful than a spade. It will be more effective in its work, while at the same time it is more easily handled. But, in selecting either spade or fork, do not choose a large, or heavy implement. Select a tool that you can wield with ease, for by so doing you will be able to go over far more ground in a given time, than if you chose one which apparently would turn up a great deal more at a stroke, but would entail in its use a degree of fatigue which might soon compel you to desist altogether. People very often fancy that it is necessary to get tools for their work of the same size and weight as those which a regular gardener is in the habit of using, but this is a mistake.

With such operations as trenching, manuring, and making pits, all of which are most important, and will require a full explanation, it is not our purpose to deal at present. Our readers who may desire information on those subjects will find it as we proceed; it being our intention to describe all the various gardening operations in their regular order, as they are successively required.

The ground prepared, it has next to be laid out. There must be the space in which the flowers are to be grown, and—what it is equally important to provide for—the means of getting at the flower-bed or beds from all points, for planting or cultivation. A small garden should have small beds; but it is a common mistake to make one large bed in such a place, usually in the form of a circle or an oblong square. If the garden is surrounded by an open, fencing, the best arrangement is a flower border running round three of its sides, with a walk up the centre.

If there is sufficient width, a middle space may be allotted to flower-beds in addition. But if, as we have before remarked, a wall or close fence encloses the plot, make your flower-beds in the centre, and your walks around the sides.

The arrangement of side beds may be made either in the usual fashion of a straight and uniform line, or with the outer border forming a waved line. The latter plan is decidedly preferable where the available space is not so limited as to cause a trivial effect. Besides being a departure from the tiresome uniformity which ordinarily meets the eye, it affords somewhat better means of tending the flowers, as the indentation of each curve gives a more convenient approach to the plants. But in these and other matters, it is hardly possible to lay down any very definite rules, and the reader must be guided by the suitability of the plan suggested to the space at his disposal.

As to centre beds, beware, in any case, of the mistake to which we have before alluded. It may be easy enough to plant a large bed, beginning from the middle and working outward; but when the plants come to grow, it is impossible to tend them properly without risk of injury. When they require trimming or watering, the plants are difficult of access, and you must step upon the bed to accomplish the work. For watering, in town gardens, should be given occasionally to every individual plant; not to its roots alone, but thoroughly over its leaves, to remove from them the dust

and other pollutions which choke their pores. And when plants are in flower, it is necessary to remove from them continually all decaying leaves and spent blossoms, so that they may be kept in health, and their period of blooming may be prolonged as far as possible.

Accordingly, for any central space, let the ground be divided, so that access to all the plants is freely open. If the space will allow the formation of one good-sized bed only, reject the form of either circle or square; there are others which will be both more pleasing to the sight and more convenient from the gardening point of view. We give two or three diagrams of suitable forms of single beds, Figs. 1, 2, and 3, which will suggest others to our ingenious readers.

When there is a larger space available, and more than one central bed can be made, the ground may be portioned out in geometrical forms, comprising a circle or an oval, with segments of a circle. Our illustrations, Figs. 4 and 5, suggest figures applicable in this case, always remembering to let the forms chosen satisfy the eye, as well as afford ready access to the plants.

We have seen, where plans similar to these are adopted, and especially where the garden is formed on

what was previously meadow land, the grass left on the spaces around or between the beds. But we must confess we would rather relay turfs at any time than attempt to renovate old and coarse grass, which can never be made to look so well as new; neither do we approve of turf for either edging or lawn in very small gardens. It requires, in summer particularly, incessant clipping and attention to keep it in tolerable order, and the time which should properly be devoted to the plants is thus occupied by their surroundings. What is best for the purpose is a walk of neat gravel.

FORMATION OF GARDEN PATHS.

In the case of paths, we have heard it stated that perfect drainage is only absolutely essential in a very damp locality, or where there is a rush of water from

higher ground near at hand; but we beg to differ in this respect, because we look upon it that "whatever is worth doing is worth doing well," and as it is merely the question of a little extra labour, there is no good reason why so important a matter should be slighted. Our plan is to shape out the paths exactly, and remove the earth in their entire course to the depth of eighteen inches, making, as it were, a clean, square trench; then, having spread stones or rubbish, such as broken crockery, burnt brick clay, or some similar hard material, so as to fill to the surface, we permit it to lie for a time, ramming it down every

now and again, until it has become perfectly solid. In a week or more, according to the weather and labour bestowed, it will be sunk to a distance of six inches from the top of the trench. Then place upon it a layer of coarse gravel, from three to four inches thick, and let it be well rammed down, and afterwards rolled as flat as possible; and as soon as you have made the surface to your liking, put another two-inch layer of finer gravel over the whole, roll it as before, and you will have a path that will discharge any amount of wet, and never give way or become rotten or untidy, let the weather be what it may. The gravel for the purpose may be obtained in many localities at a very slight expense, and it is not necessary, although it may be desirable, to have more than the usual bottom of well-beaten earth; but where it is not so easily procured, stones, shingle, rubble, or any similar material, may be beaten into the ground to form a solid path. All garden paths, great or small, should be somewhat higher in the centre than at the sides, to allow water to run off freely, and so prevent their getting into a sloppy and unpleasant condition in wet weather.

In the choice of material for the borders of beds, tastes differ widely, some preferring a permanent edging of tiles,

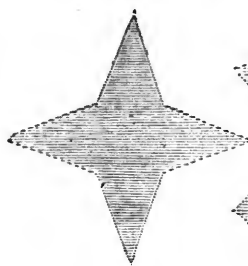

Fig. 1.

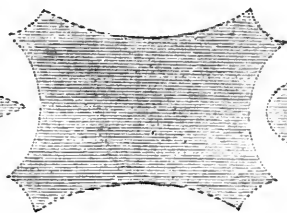

Fig. 2.

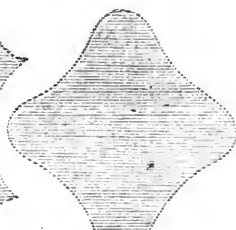

Fig. 3.

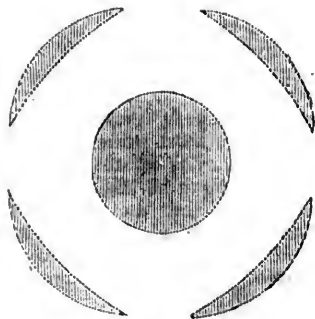

Fig. 4.

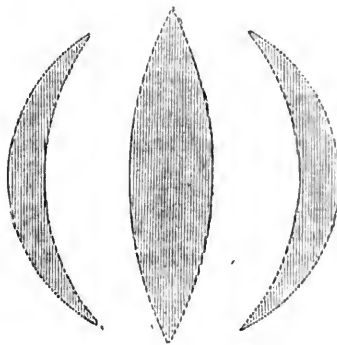

Fig. 5.

or similar material, while others will have nothing but flowers. But where flowers are used for the purpose, it is necessary to plant very closely, or one of the chief objects of the edging—namely, to keep the mould from being brought down on to the path by rain, &c.—will not be secured. Nothing answers this end better, or looks neater, than good terra-cotta tiles, which may be obtained at the rate of about 15s. the hundred, each tile nine inches in length. Where this edging cannot be procured, rounded stones are sometimes used; and in small gardens, in the vicinity of towns, we have frequently seen borders of oyster-shells, or broken bricks driven into the ground with the corners uppermost.

Box is the best and most lasting material for a permanent green edging, but it must be planted with great care, to protect it against frost. The soil round the edge of the bed to be formed must be patted down firm and even, or level, and having chopped out the trench in a slanting direction towards the walk, the roots of the box must then be laid against this, and the soil pressed down tight as the trench is being filled up around them. They should be planted in March or September, and clipped in July or August. An edging of grass is objectionable, as we have already remarked, as it requires constant attention to keep it tidy.

GARDENING OPERATIONS FOR NOVEMBER.

Having described as minutely as possible the principal work to be done so far as regards the laying out, or, more properly speaking, formation of a new garden, we may now proceed to give some instructions to those whose gardens are already laid out, it being our intention to furnish throughout the course of our work a general calendar of operations in the various departments of gardening. November will be found as good a month as any for carrying out any alterations in the laying out of the garden that may be thought desirable. It will, however, be necessary to see to such work at once, as it must be borne in mind that frost is very likely, nay, almost certain, to overtake us at this season of the year, and accordingly not a moment should be lost in fixing upon the changes you intend to adopt, and carrying them out with all possible expedition; for if the frost does come it will put a complete stop to any operation of importance for the time being, and the progress of your garden may be very seriously delayed in consequence. Any deciduous trees and shrubs (as those that drop their leaves in the autumn are called) that it may be thought desirable to move should be taken up and replanted in their new places without further delay; but evergreens (those that retain their foliage the whole year round) will not necessarily require to be so hastily dealt with, as they will take no hurt for a week or two. All such work as digging, trenching, making new paths or renovating old ones, laying turf, &c., should be seen to at once, for every fine day lost now is worse than a month at any other time, and especially in the case of bad weather setting in for any length of time, no matter whether it be wet or frost; indeed, in many respects the former does more mischief than the latter, so far as retarding progress is concerned. You should also be thinking now of providing a show of blossom for the following spring. Such bulbs as anemones may now be planted, in patches of six or more, three inches deep, or they may be put in five or six inches apart all over a bed or border; while crocuses, snow-drops, and similar small kinds, which always do best when planted in patches of a dozen or more, may be got into their respective situations as soon as you can manage to do so. Only a very few flowers will be left in the garden at this season, though there are some notable exceptions. The chrysanthemum, which will grow almost anywhere and under any circumstances, will nevertheless thrive all the better for a little extra

care; therefore, those in flower out of doors should have their dead and dying blooms removed at once, so as to throw additional strength and vigour into such as have not yet opened. Small gardens will require to the full as much attention as larger ones, where a constant display of bloom is wanted, and as we presume that to be a principal aim of all flower gardeners, we recommend everything to be grown in pots first of all, as you will then have merely to sink them in the beds; and as each one fades it can be removed and replaced with something else of greater importance. As an example, let pots of tulips be planted between hyacinths, and by the time the latter have done flowering and are taken up the former will be in bloom. The vacancies caused by the removal of the hyacinths may in turn be filled up with pots of nemophila, stocks, or verbenas, which will be in bloom by the time the tulips are off. Another very good plan, by which your small plot of ground may be made to look very cheerful, if not exactly gay, during the winter months, is to dress it out with dwarf potted evergreens, to be sunk in the same manner as already stated; taking care, of course, to select hardy sorts, and to protect them against excessive frost.

ANIMALS KEPT FOR PLEASURE.

II.—THE DOG: PRINCIPAL VARIETIES (*continued*).

NEXT in point of general interest to those varieties of dogs which we described in the previous paper, come those larger animals which, on account of their strength and courage, man allies to himself as the protectors of his property or his person. Of these the most important is undoubtedly the *English mastiff*, one of the finest and most powerful of all the many varieties of dogs. This breed is probably that which was so eagerly sought by the ancient Romans for combat in the circus, and was then known as the most powerful fighting dog in the world. William Edwardes relates that in 1615 an English mastiff killed a tiger in India in single combat; but it is not certain whether the modern mastiff is of quite such colossal strength as these ancient animals. Still, he is a grand dog. The height to the shoulder should be from twenty-six to thirty inches (some reach thirty-four inches); all the limbs sturdy and strong. The head is massive, with a noble forehead; eyes rather small and mild; ears small and pendant; muzzle broad and square; chest broad and capacious; and body very large, with powerful loins; tail fine, and reaching rather below the hocks. The handsome colour is fawn, or dark buff, with a rich black muzzle; but very handsome dogs all black are sometimes met with; brindled and red dogs also occur; but white does not as a rule look well, and is little valued.

The character of the mastiff generally is truly noble. Indeed, he is said to be the *only* dog from which even his master dare take away a bone. Calm and quiet to all, he takes pleasure in the rough gambols of children, and an infant of a few months old may be fearlessly cradled in his colossal limbs. But let him be set at any living thing, or let danger assail those he loves, or even let him see violence attempted to be done, and all his fearful strength is exerted with a courage that even the bull-dog cannot exceed. What the lion is among wild beasts, the mastiff is among dogs—the strongest, noblest, most dignified: and what the lion is not, the gentlest of them all.

The *Bull-dog* was probably bred from the mastiff originally, and the old and powerful breed is extinct. The modern bull-dog is a highly artificial animal, the very shape of the skull being obviously the result of art; the jaw is under-hung (the lower jaw projecting), the forehead

flat and high, and deeply sunk between the eyes, and the muzzle turning upwards, yet broad and deep, so as to cover the teeth. The chest is deep and full, and forelegs powerful, this part of the dog showing the mastiff character; but the loins are often weak, the dog's strength being chiefly in the neck, fore-legs, and jaws. The colour varies greatly, white being most fashionable, and so does the weight, which may be anything from fourteen to sixty pounds. The character of the bulldog is uncertain; some are very intelligent and peaceable, others are uniformly surly. Many are apt to be friendly with all unless something sudden occurs, when they will attack without the slightest warning. Hence, although they are generally inoffensive, unless the temper be known as trustworthy, they are dangerous dogs. But whatever the disposition be, the pure-bred bull-dog always shows the following characters: he always flies straight at the head of man or beast, and at no other part; he attacks without a sound or warning, and will remain mute if beaten to death; and he never lets go till killed or made insensible. It is singular that the slightest cross of alien blood makes the point of attack uncertain. Though the bull-terrier, for instance, may be of equal courage, he will fly at the legs as well as the head—the true bull-dog never.

The *Bloodhound* is now somewhat rare. A good dog stands about twenty-eight inches at the shoulder, and is a muscular animal, but not nearly so massive as the mastiff. The ears are large and pendulous. It is unnecessary to remark on the exquisite power of scent possessed by this breed. The aspect of the animal is generally quiet and very sagacious, and the disposition gentle if not roused.

The *St. Bernard* dog is apparently derived from the bloodhound. The breed has several times been on the point of extinction, being kept up in very few hands, and it is much to be regretted it is not more extensively propagated. The *St. Bernard* is a really magnificent animal. The colour is generally orange or tawny, getting lighter or even white on the belly, and what are considered by the monks the best specimens have a white collar round the neck, and a white streak down the poll; but many of the finest dogs have little or no white about them.

The head of the *St. Bernard* is not unlike in expression to the *Newfoundland*, but there is rather a deep furrow between the eyes. The limbs are of immense size, and the whole animal colossal

in his proportions, being especially powerful about the loins. This gives to the breed what is, perhaps, its strongest characteristic—a *slinging* gait, or walk, like that of the lion. Indeed, this peculiarity, combined with the size and colour, make the resemblance between a lioness and this dog very strong. Some uncertainty exists amongst naturalists as to the ideal type of this particular species. The original *St. Bernard* breed is stated to have died out some forty years ago. That which we have described is the kind now kept by the monks of *St. Bernard*.

The *Newfoundland* is, perhaps, the most popular breed of any. He is simply unequalled in the water, and has been picked up in the middle of the Bay of Biscay, out of sight of land, or of any other ship from which he had probably jumped overboard. His

character, as a rule, is of the noblest kind; generous, brave, gentle, and of great intelligence, he becomes almost part of the family to whom he belongs. Equally good-natured with the mastiff, he is far less dignified,

and enters into all their pastimes with a zest of which the larger breeds elsewhere mentioned would be ashamed; he is, in short, not only a good, but eminently a companionable dog. The large breed has been known to reach thirty-four inches at the shoulder, and though rather smaller now than formerly, thirty inches is often met with. The head is splendid, with an expression at once intellectual and benevolent; but the eyes are to our fancy rather too small in proportion. The chest is well developed, and all the fore part of the body muscular and powerful; but there is generally a weakness about the loins which gives rather a slovenly gait to the animal compared with other large breeds. We are convinced that this defect could be bred out with a little

care. The feet are large, and flatter than usual, which greatly aids the animal in swimming, an exercise it is really fond of. The best colour is pure black; next to this, we prefer a dun colour inclining to red;



THE ENGLISH MASTIFF



THE NEWFOUNDLAND.

but black and white are often met with. Besides the well-known long-haired breed, there is a variety of the large Newfoundland, with a short coat resembling that of a mastiff, but thicker and more dense; this, however, is not common. There is also a curly-haired variety; but this kind of coat is rather troublesome to keep in good order, unless the animal can have constant access to the water. We give an illustration of this very favourite variety of dog.

Besides the large Newfoundland, there is a smaller variety, known as the Labrador dog, which is only about twenty inches high at the shoulder. Peeler, the celebrated "dog of the police," one of the most remarkable examples on record of canine sagacity, was a Labrador Newfoundland. It should be observed, that although the Newfoundland dog is generally of an excellent temper, there are many individuals of a very surly character; and the variety, though bearing the antics of children with great complacency, cannot bear to be long deliberately *tensed* so well as some others. The animal's great intelligence seems to resent such unworthy treatment.

Next to the Newfoundland naturally come the spaniels and retrievers, which show a strong resemblance to it in conformation—indeed, the Labrador is often called a spaniel. Of these we propose to treat in our next article on this subject, as well as of the other principal varieties of dogs most commonly used in sport. This branch of our subject being exhausted, we shall pass on to the feeding and rearing of the animal, together with an account of the principal diseases to which he is liable, and the most approved methods of treating them.

THE TOILETTE.

I.—THE MANAGEMENT OF THE SKIN (*continued*).

Sea-Bathing.—Sea water is rather more stimulating than ordinary water, and this difference is perhaps the only one of any importance to be considered in reference to this subject—that is to say, so far as the action of the sea water itself upon the body is concerned. It can be readily understood that if ordinary bathing is sometimes followed by disagreeable results, because it is employed in an injudicious manner, or at an improper time, ill effects are much more likely to arise under similar circumstances when the skin is stimulated by sea water. We do, indeed, discover that sea-bathing occasionally does harm; it is said not to "agree" with this or that person or child, and such an opinion is now and then firmly held by parents and others. But it is often an unfair conclusion, for the simple reason that proper precautions have not been taken to use the sea douche, as before observed, fairly and at the right time. It is also true that in some exceptional instances sea-bathing cannot be taken with comfort under any circumstances—when the best precautions are taken to prevent its disagreement. But these examples are rare; and in the majority of cases in which it seems objectionable, sea-bathing can be had recourse to with benefit, if it be used with proper regulations. Now, as in the ordinary bath, we should be particular not to bathe when the surface is too much cooled, nor allow the body to be chilled. Half should not be out and half in the water for any length of time, but the whole immersed. The bather should not go into the sea too soon after a meal, nor when he is exhausted, but when moderately warm by exercise, or on first getting up in the morning, if he or she be in very vigorous health.

In the case of children, it is best that they wait till the sands have become thoroughly warmed by the sun, when the water is consequently warmest. They should not

be permitted to go into the sea late in the evening, especially if the weather be in the least degree inclined to be chilly. The *best* time of all, perhaps, is in the afternoon; but there is no reason why a dip, as before observed, should not be taken in the morning, if the weather be suitable. The bather should be careful not to alter his usual habits. Children, of course, dine in the middle of the day. They are ready for their plunge two hours afterwards. We think it best that the sea water should be allowed to come into direct contact with the body, without the intervention of any dress. It is best to follow this plan where it is convenient to do so. On entering the sea, bathers should go thoroughly into it, and not dabble about, to get chilled knee-deep in the water. There is more harm done in this than in any other way, and it is the fault of young ladies. Bathers should keep moving about, frequently dip, and, at the outset of sea-bathing, be a short time in the water. The latter is a most important consideration, and must be noticed a little more in detail. When an individual commences bathing, it is best that he or she take one or two plunges, and then leave the water. After the next two or three days, five minutes' immersion may be allowed; but it should be noticed if there is any feeling of chilliness. If so, the time should even be lessened, when a glow is felt after one or two plunges into the sea, but a coldness if the bather remains longer in the water. It may be well to take the bath twice a day; but for short intervals each time. The majority of persons, however, especially if they bathe in the afternoon, when the water is somewhat warmed, will be able to remain immersed for ten minutes, and this is quite long enough for the majority of persons. At all events, when the first sensation of chilliness or coldness is experienced, the bather should leave the water. Much harm is done by a protracted stay in the water, so as to check the reaction of the skin. Instead of the sea water acting as a stimulant, it then acts as a depressant. The bather on coming out of the water should dress at once and rapidly. The conveniences at our watering places are not what they should be; towels should be dry and warm, and it should be possible to have a pail or foot bath, with warm water to stand in, especially for ladies and children, so as not only to rinse the feet, but as a preventive against the body being chilled. Reaction should be encouraged by vigorous friction of the body, and the bather, when dressed, should take a short and brisk walk, which will call the circulation into activity, if it be at all inclined to flag. If there be any actual shivering or chilliness, a little warm tea or wine and water, or some warm simple, may be required.

We have finished with the treatment of the skin in health, and now proceed to speak of its management when it becomes disordered.

DISORDERS OF THE SKIN.

Dry Skin.—The skin may be dry generally or only in certain places. In the former case it may be a congenital disorder. Every now and again one sees children at six months or a year old exhibiting a peculiar harsh, dry, and somewhat wrinkled state of skin. They never perspire, feel the cold very much, and winds chafe their skin. There is more or less scaldiness, and often little dark plates collect about the ankles, knees, and other parts of the body. These can be picked off, leaving the skin harsh and rough, like a nutmeg-grater almost. In these severe cases much may be done, under medical advice, by the use of baths and frictions, with oil or glycerine, to make the sufferer comfortable. In other cases a dry skin is not an affair which is congenital, but it comes on in after life—in the child as well as the adult. The skin looks dirty and muddy besides feeling dry; it itches, and scratching produces pimply eruptions. This state usually arises from a neglect of the

proper use of the bath in those who do not take much exercise and who are not very strong. In other cases the skin generally perspires properly, but some one part is harsh and dry, such as the face or hands. Washing the face with strong soap will make it rough and uncomfortable, and so will exposure to cold winds. The remedies here are simple—the avoidance of all irritants, tepid bathing, and anointing the face with glycerine and water—or, what is often better, painting it over with a little whiting paste at night for several times. There is just one remark worth making here, and it is this: Glycerine should generally be used to the skin diluted. It has much affinity for water, and if the skin be very dry and harsh, pure glycerine may, by rapidly uniting with the water of the tissue, occasionally do harm. The remark just made will apply to the skin when rough. It is the localised forms of dryness and roughness that trouble persons, and, as before observed, these are often the result either of the too free use of soap or the action of irritants.

Moist Skin.—This is one of the most unpleasant disorders to which the skin is subject, and it is a source of very great annoyance to most persons. In some cases the whole skin is affected, being cold and clammy. In children it is a sign—especially if the perspiration occur particularly about the head, soaking the pillow through and through at night—of deficient nutrition, and of a tendency to or actual rickets. No mother should make light of it, but consult a doctor when it occurs. The use of all that is bracing, plenty of fresh air, of good milk, and steel wine, will do wonders in these cases. In young persons and in adults, moist skins imply a very weak constitution, or some special kind of debility, and need the physician's care. We shall refer here particularly to those cases only which are partial—such as uncomfortable moisture of the hands or feet or armpits. Every one knows what a cold clammy hand is. It may be a constitutional peculiarity, and it is not at all unfrequently seen in persons of a lymphatic, lethargic temperament. Here it is very troublesome in warm weather. It is possible in many cases to find out nervous debility, unfair treatment of the stomach, an inactive skin as a whole from neglect, or some cause of weakness. Locally much may be done. Bathing the hands or feet in very hot water twice a day, the use of a solution of alum and salt (two or three teaspoonfuls of these to a pint of water), putting on prepared chalk made into a paste, sponging with a lotion made of strong ammonia solution (one part to four or five of water), may be tried without fear and with success. But in other cases the perspiration is offensive, especially about the feet. In these cases it is often due to uncleanliness. The feet should be washed most sedulously twice a day with warm soap and water, and then bathed with a solution of carbolic acid in water (one part to twenty or thirty). Clean socks must be put on. Oftentimes the perspiration soaks into the boots, and there becomes rancid, and the unpleasantness will not be removed until the boots are once and for ever dispensed with.

THE AQUARIUM.

FRESH WATER VEGETATION.

ALTHOUGH the aquarium, as herein treated, may be viewed chiefly as an object for the decoration of a room, its utility as a means of amusement and instruction should not be lost sight of. The development of vegetation, the peculiarities of the class to which the plants belong, the habits of the creatures that may be introduced into the tank, and the microscopic wonders that are invariably generated, are not only a source of endless recreation, but may be turned to excellent account in the educa-

tion of a family. The receptacle having been provided, and the bed of the aquarium prepared according to the instructions previously given, the next operation is to choose the plants and place them in their proper position.

The best and most lasting of all aquarium plants is the spiral valisneria. This, however, being a native of southern Europe, is not easily procurable; but once established in your tank, it will grow luxuriantly. The

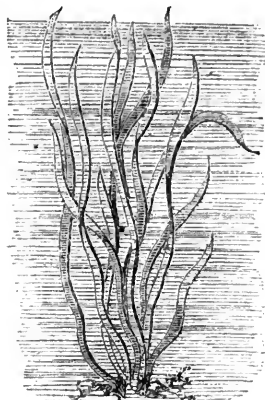

VALISNERIA.

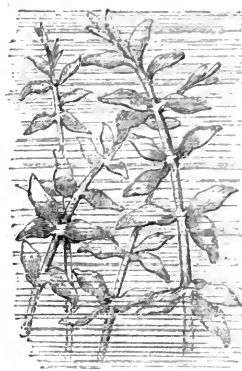

ANACHARIS ALSINASTRIUM.

most prolific of the river weeds is the American water-thyme (*Anacharis alsinastrium*), but this is a plant we do not recommend encouraging. Of its introduction into this country there are several accounts, the most probable being that given by a Cambridge gentleman, who, having received a plant from a friend in Canada, kept it for a time in a glass jar, but not seeing it develop itself into anything interesting or beautiful, ordered it to be thrown away; this was done, and the drain from the house emptying itself into the Cam, carried down the germs of the weed, which soon spread and became a great nuisance, as it nearly filled the river. Those of our readers, therefore, who introduce this plant into their aquarium should take special care to prevent any opportunities of its being similarly propagated.

Another suitable plant is the common frog-bit (*Hydrocharis morsus-ranae*). Its habit of growth differs con-

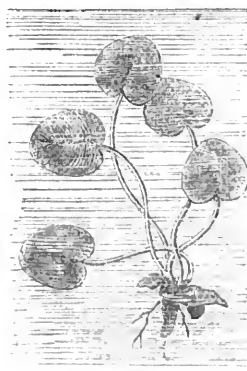

FROG-BIT.

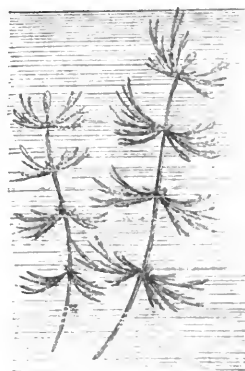

CHARA VULGARIS.

siderably from either of the above, which is an advantage where variety is desirable. Of the other plants suited for our purpose, may be named the arum (*Calla palustris*), the common stone-wort (*Chara vulgaris*), the water-soldier (*Stratiotes alvodes*), and the spiked water-milfoil (*Myriophyllum spicatum*).

In the largest-sized tanks small water-lilies may be

introduced. Of these there are two kinds, white (*Nymphaea alba*) and yellow (*Nuphar buteum*), both of which are to be found in ponds. A disadvantage attendant on the use of these is, that lilies die down in winter, and their leaves, if not removed, encumber the tank without enhancing its beauty. The common water-shield has pretty oval-shaped leaves, which float upon the surface, and from the peculiar way in which they unfold themselves are an object of interest. Reeds and rushes are sometimes used, but require a deeper foundation for their roots than can be usually given.

The best method of planting the weeds is to tie each of them to a pebble and sink them below the surface of the shingle. Care should be taken to arrange them with some regard to effect, the shortest being placed in front and the longest behind. A glass of aquatic plants neatly arranged is as ornamental an object as a fern case, and certainly less common.

After all the plants are arranged, a little duckweed (*Lemna minor*) may be thrown in. These float upon the surface and harbour minute insects, which serve as occasional dainty morsels for the fish.

Before the intended inhabitants of the aquarium are introduced, the plants should be given time to establish themselves—say about a fortnight. If it be found that a green film overspreads the surface of the glass, this must be taken as a sign, either that too much light has been given, or too many plants have been introduced in proportion to the quantity of water.

If the aquarium be sufficiently large, a pretty effect may be obtained by building up the rock-work till it reaches some distance above the water, and leaving a space into which a fern may be planted, as shown in our illustration.

If it be intended to introduce small frogs or newts, which are quite admissible, the aquarium should be covered with glass, to prevent their crawling over the sides. They may appear perfectly contented and happy all day, but newts have nocturnal migratory habits, and are most likely to find their way down-stairs before morning, unless prevented. The cover of a bell-glass should be a circular piece of glass, large enough to project a quarter of an inch over the rim, with a round hole cut in the centre to admit the air. This also answers the purpose of keeping out the dust when the room is swept.

Amphibious creatures should never be kept entirely in the water. To give them a resting-place, a little island should be prepared for them, in this manner:—Take a piece of cork of an irregular shape, smear it over with marine glue, and then sprinkle it with sand; let it stand to dry, and then place it in water for some time. When "seasoned," it may be floated on the surface of the aquarium. The newts will soon give evidence of their

appreciating this provision for their convenience, by climbing upon it and diving from it.

THE SELECTION OF FRESH-WATER ANIMALS.

The first specimens of animal life which should be placed in an aquarium are the molluscs. Of these, the horny coil shell (*Planorbis cornuus*) and the pond mud shell (*Limnaea stagnalis*) are the most plentiful and best suited. Both these aquatic snails may be found in stagnant pools or sluggish rivers. They feed upon the weeds, and may be captured by drawing a net along the submerged stems of rank grass or rushes that grow close to the shore. They have been termed the scavengers of the aquarium, because they assist in keeping down the superabundant vegetation, and consume the minute green growth that accumulates upon the sides of the glass.

They are very active, and the motion of the planorbis is particularly graceful.

There are also two kinds of mussel that may be introduced, the swan mussel (*Anodon cygneus*) and the duck mussel (*Unio pictorum*), but they possess no especial recommendation, and require careful watching lest they die and pollute the water.

Among the lively creatures that deserve a place in the aquarium, there are few more interesting than the common water-spiders (*Argyroneta aquatica*). These form especially attractive objects on account of their activity, and their habit of rising to the surface, drawing a globule of air underneath the water, and carrying it down, as if it were a jewel attached to the hind part of the body. If the aquarium be in good condition, the water-spider will sometimes weave a web and construct its nest, and live in confinement for a considerable period.

There are several varieties of the beetle to be found

in rivers and ponds, but only two that can be safely introduced into the aquarium—the large harmless beetle (*Hydrotus piceus*), and the little whirligig (*Gyrinus natator*). The former, though large in size, is distinguished for its amicable disposition; the latter, though small, makes up for its insignificant proportions by whirling about and persistently forcing itself into notice.

The caddis-worm, or cad-bait, is a favourite object for the aquarium. It is the larvæ of the May-fly, and may be found in the shallows of rivers and streams. With minute pieces of twigs, grains of sand, and other obtainable materials, these worms construct grotto-like nests, the particles of which they fasten together by means of silken threads, secreted in the same manner as in the silk-worm. The methodical, careful, and business-like way in which the caddis builds its dwelling affords an admirable illustration of the instinct possessed by the insect tribe; and the operation may be easily observed in the aquarium, by the use of an ordinary magnifying glass placed on the outside near the spot where the creature is at work.



AQUARIUM WITH ROCKWORK AND FERN.

HOME GARDENING.

THE CULTIVATION OF SMALL GARDENS.

IN the outskirts of London, and, indeed, of most towns, there are to be found numbers of small houses at a moderate rental, with a very small patch of ground at the back, from twenty to thirty yards in length, and six or seven yards wide, so small, in fact, that at first sight it might appear questionable whether it would be really worth the time, trouble, and necessary expense to keep it in a state of cultivation. We hope to be able to show that this would be a mistake. A plot of ground, however small, is far too valuable to be wasted, especially in the suburbs of towns, where all garden produce is very expensive; and our present object is to show those of our readers who have small gardens of this kind how to cultivate them to the best advantage. The laying-out of them should be as

endive, onions, spinach, and the various useful herbs necessary for a small family, and, if all the ground were kept continually under cultivation, or, in other words, as soon as one crop is done with it were cleared off, and another put in its place, it might be made remunerative.

Smaller plots of ground, such as belong or accompany dwellings of a minor description, which might be better understood by the name of yards, if they were only paved, would likewise pay the tenant to grow useful pot herbs, and such crops as onions, lettuces, radishes, and so forth, and as such, there is no reason why a foot of soil should lie idle. In a future paper, we shall again revert to the subject of gardens on a somewhat larger scale, and how to make them pay.

Cauliflowers, rhubarb, sea-kale, and even asparagus might be grown. A few of the most useful fruits, such as raspberries, currants, gooseberries—of course, small sized—might be

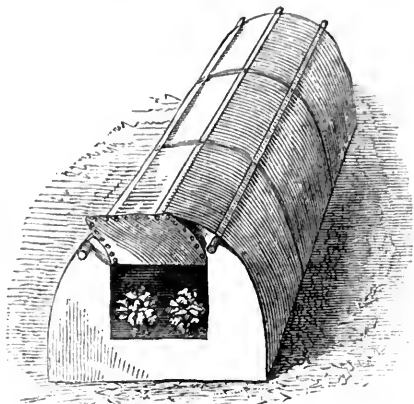

Fig. 1.

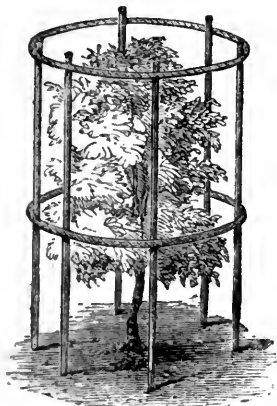

Fig. 2.

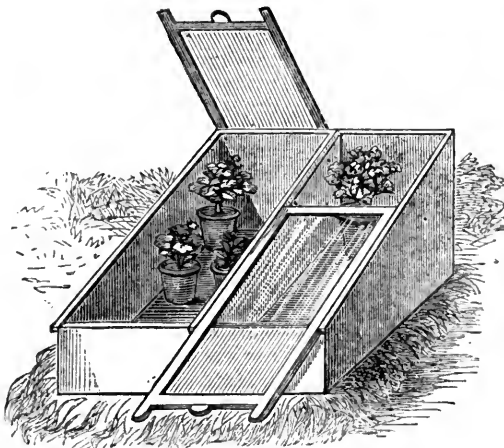

Fig. 3.

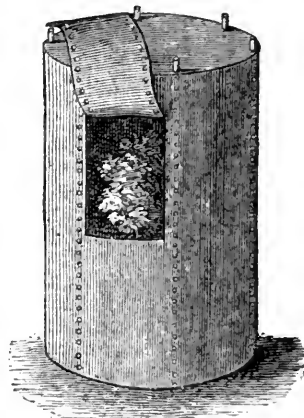

Fig. 4.

simple as possible—either with a path down the centre, and beds on each side to the boundary walls, or else with a path running round the garden at about two or three feet from the wall. Of these, the latter is preferable, for several reasons; it is certainly more sightly, and enables one to reach every part of the ground with facility. Of course, if it be merely intended to use the garden as an ornament, it will be easy enough to fill the surrounding beds with flowers, the centre being laid out in grass, with a few small beds of flowers in the centre, as described in our last paper, but this is an expensive matter, as all the plants will have to be procured fresh year after year, there not being sufficient space to propagate fresh ones, or to keep a stock through the winter for the next summer's planting. If it is desired to make the garden remunerative, flowers must be made a secondary consideration, and the principal part of the space should be filled with a judicious selection of vegetables. In favourable situations such a plot would grow the cabbages, lettuces, radishes,

planted here and there in the garden, currants might be nailed against the wall with advantage, and space might also be found for a few strawberries.

GARDENING OPERATIONS FOR DECEMBER.

Such of our readers as are desirous of obtaining an early spring display of bloom, may do so by preserving a few autumn-sown annuals in pots. Should they depend upon self-sown seedlings, which are always the best, when obtainable, they should take them up out of the ground, and plant two, three, or four, according to the size and habit of the plant, in good-sized pots, which should then be placed in a frame or pit. Of these the latter will be found to

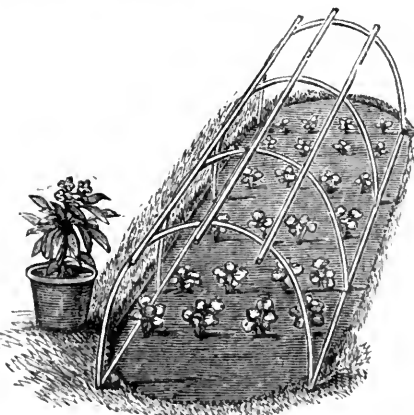

Fig. 5.

be the most effective for protecting these or any other small flowering plants or shrubs through the winter. To form a pit, the ground should be excavated to a depth of three feet, and lined all round with brickwork nine inches in thickness, rather higher at the back than the front, so as to allow of the covering sloping to the front. We have found stout boards answer the purpose fairly, but of

course they are not so good a protection as brick, and they will want renewing each season; and for a flooring or bottom there should be a layer of fine coal ashes six inches thick, which will not harbour vermin, or retain the moisture that runs from the pots after watering. In ordinary winters, a frame on a hot-bed such as has been used for forcing in the earlier part of the year, will be found a sufficient protection. Both pits and frames are covered with the ordinary glass sashes, and in severe weather a bass mat is the best additional covering. Those who are not prepared to go to the expense of glass sashes, will find the following substitute both cheap and effective. Procure some cheap calico and stretch it quite tight on an ordinary frame, and then proceed to make it waterproof by means of a composition for which we subjoin the recipe. Get some thin cheap calico, and after having stretched it on your frames (or, if required in a piece, on the ground) quite tight, then cover it by means of a brush with a composition made of two pints of pale linseed oil, one ounce of sugar of lead, and four ounces of white resin. The sugar of lead is to be ground with a little of the oil, after which add the remainder and the resin, and mix the ingredients well together while warm.

Water should be given with great caution in winter, but, when it is found necessary to apply it, moisten the soil entirely, without spilling any on the foliage if it can be avoided. In wet weather, the best way of admitting air to plants in pits and frames, is to tilt the glass sashes up behind, as by this means the rain is kept out of the bed, and that which falls on the glasses runs away more readily. In dry weather, these plants should be fully exposed, except in the case of frost, when it will be necessary to keep the sashes close. A frame with one light open and the other partially closed, is shown in Fig. 3. An admirable plan for protecting small shrubs, when you are unable to afford a green-house, is to drive six or more stakes into the ground in a circle, at equal distances from each other, round the shrub, and bind them together with two hoops, whose size and diametrical proportions must depend entirely upon the size of the plant or plants to be surrounded. One of these hoops is to be nailed or tied within an inch of the top, and the other about half-way down, as shown in Fig. 2. This framework is to be covered with waterproof calico, as in the previous case. Fig 4 represents its appearance when completed. The third and last, though by no means the least important, is not a new idea, but it is equally useful in its way for the protection of rectangular beds of plants. It consists of a sufficient number of arches, which may be formed of hoops from an old tub, which have been opened and pointed at each end. These should be thrust into the ground at the extreme edges of the bed, at about eighteen inches apart all the way down. Then place a straight stick or lath on the top, and one on each side, about a foot from the ground; tie each arch securely to these laths, and you will have a frame strong enough to hold the waterproof calico, as at Fig. 5. Care must be taken that in both cases the material used as a covering reaches the ground, where it must be secured, as, without this, the plants would be as well, and even better off without any covering at all. To give air to plants thus protected, you must contrive to have some portion of the covering movable, as shown at Figs. 1 and 4. This opening should be as near the top as possible. Open these doors or windows, as they may be termed, whenever the weather will permit, but close them at night, or, in fact, as often as you think there is any danger of their taking harm.

Keep everything as tidy as possible, and if you have any bulbs still out of the ground, get them in without delay. Cut down fuchsias that are to remain out all the winter, and see that their roots are protected by a covering of coal ashes, sawdust, or similar material. It is a

good plan to take up tea-roses, and lay them by in a shed or out-house, or, in fact, in any place where frost cannot reach them. Auriculars and other plants in frames should be kept moderately dry, and they should also be kept free from weeds and dead and dying leaves.

COOKING.

PUDDINGS—CAKES—FRITTERS—FISH.

Sausage Rolls.—Lay one sausage, whole, without removing the skin, in the middle of the rolled-out pie-crust, and then proceed as with apple-rolls. This is capital, cold or hot, for hungry boys.

Beef Pudding.—Cut beef into bits half the size of a walnut, fat and lean together; they need not be the prime parts. Make them into a pudding, as you would make apple-pudding, seasoning with pepper, salt, all-spice, and chopped onions. Put in a little water to make gravy. People that can get them, add mushrooms and oysters; but these are not absolutely necessary. This pudding takes a great deal of boiling.

Saffron Cakes or Buns are a nice little treat for children; pretty to look at, and easy to make. Their slight medicinal quality is stimulant—likely to do more good than harm. Their tendency is to help digestion, and they are said to kill or drive out intestinal worms. To make your saffron loaves, cakes, or buns, buy at the druggist's as small a quantity of saffron as he will sell. Infuse enough of this in the water with which you make your dough to give it a clear, light, yellow tinge, and the decided taste and smell peculiar to the flower, both which it will retain after baking. Then make your cake exactly as the *gâteau*—directions for making which were given in a previous number (page 37)—with the addition of a little sugar, and taking care that it rises well. If to be kept some time, make it into good-sized loaves; if to be consumed or distributed immediately, make into small buns or rolls. Bake in a moderate oven, neither fierce nor slack.

Good Common Cake.—Mix a teacupful of good yeast with half a pint of milk; warm it slightly; stir it into two and a half pounds of flour, and half a pound of brown sugar, and set it to rise. Then melt half a pound of butter with another half-pint of milk, and add it to the former ingredients, with half a pound of washed currants, or a few caraway seeds, a little bruised. Again leave it for awhile to rise. When well risen, put it into tins, and bake.

Pancakes.—As these are a holiday treat, you will try and make them as good as you can. Shrove Tuesday comes but once a year. Allow eight eggs to a pound of flour. Separate the yolks from the whites. With the flour mix the yolks, a pinch of salt, a little milk, and some good yeast. The quality of the yeast is more important than the quantity. Beat the whites of the eggs to a froth with a little milk; this is done to help the yeast in making the pancakes light. Mix this with the flour and the other ingredients. Stir in as much more tepid milk as will bring the whole to the thickness of batter. Some people add a glass of rum or brandy, and a little grated nutmeg. Cover with a cloth, and set it for two or three hours somewhere near the fire, to rise. Always wipe out your frying-pan immediately before using it. You may have hung it up clean, but dust falls, blacks fly, and rust goes to work. When the pan is warm, put in a liberal quantity of dripping, pork lard, or butter. When that is hot, pour into the middle of the pan enough batter to make a pancake. As it fries, keep raising the edges with a knife or with a fish-slice. When the under side is done, turn it quickly, taking care not to break it; to do this cleverly requires a little practice.

When the pancake is cooked, sprinkle its surface with a little moist sugar after it is laid on a very hot dish ; and so on, until your pile of pancakes is finished, sprinkling each with sugar in its turn. Over the top pancake squeeze the juice of one or two oranges. The oranges are quite an excusable extra. Peel them before squeezing, and dry the peel, if not wanted for immediate use. It will serve to flavour puddings and stews. Boiling water poured over it, with a lump of sugar, makes a pleasant drink to quench feverish thirst, the bitterness and essential oil in the peel being slightly tonic. Some people prefer the juice of lemons with the pancake, so it will be well to give them the opportunity of choosing.

Apple Pancakes.—Put a little less milk into your batter—that is, make it a little stiffer, and sweeten it slightly. Chop apple very small, mix it with the batter, and proceed as before. The pancakes will require more care in turning, to keep them whole, but they are very nice when you do succeed. Stir up the batter every time you use it, to mix the apple equally.

Apple Fritters.—Peel a few large apples ; cut out their cores with an apple-scoop, and cut them across in slices a quarter of an inch thick. Some cooks will tell you to soak them an hour in brandy, in a soup-plate, with a little sugar dusted over them ; but that expenditure of time, trouble, and materials is perfectly unnecessary. We do not say that it does no good, but you may make capital apple fritters without it. Let your batter be even stiffer than the preceding, with the allowance of one or two more eggs to the same quantity of flour. The frying-pan, which may be smaller and deeper, should also contain plenty of hot fat. With a fork, dip each slice of apple first into flour, then into the batter, to make as much stick to it as you can ; then with your slice push it off the fork into the frying-pan. Turn it, if necessary ; but there should be fat enough to cover it. When you judge the apple is tender, take up your fritters, let them drain on the slice an instant, then pile them in a pyramid on your dish. Fritters should be fried so dry as to be eaten, like cake, with the fingers, and served hot enough to burn the mouth. Other fruit may be fried in the same way as apples. We have eaten peach fritters, in the course of our travels, but hold them to be inferior to apple, the peach being one of the fruits which lose flavour by cooking, while both the apple and the apricot gain by the process. Small slices of meat, cold cooked vegetables, as carrots and celery, joints of fowl, &c., are all excellent fried in batter. It is worth knowing, not only that a great many little remnants may be dressed again in this way, in a pleasing shape, but (in case you have to help to cook a stylish dinner) are actually used to ornament and accompany other dishes. They are largely so employed both by French and American cooks.

Parsnip Fritters (American).—Boil the parsnips in salted water, so as to flavour them through ; make a light batter ; cut the parsnips into rounds, and dip them in the batter. Have ready hot lard ; take the parsnips out of the batter with a spoon, and drop them into the lard while boiling. When they rise to the surface, turn them ; when browned on both sides, take them out ; let them drain, and set them into the oven to keep hot. Serve them with broiled, fried, or roast meats or fowls. Proceed in the same way for turnip fritters, to be used as garnish for fried meats, hashes, stews, &c.

FISH.

Perch, Eels, and small Pike are excellent fried ; but frying is rather a costly way of cooking fish. The fat it takes would be better employed in making sauce to be eaten with them boiled. With roach, dace, and bream (the bigger these are the better), you may make a very nice, light, and extremely palatable dish in the following manner :—

After cleaning your fish, salt them for a night. Throw them into as much boiling water as will cover them. Let them boil about five minutes, and as soon as the flesh will come away from the bone, take them up, and pick it off clean with a knife and fork, taking care not to leave any of the little bones in it. You will then have a plateful of fish without any bone. Boil some mealy potatoes ; mash them ; season with pepper and salt ; add a bit of butter or some roast meat dripping, and mix up the fish with the mashed potatoes equally, so that there is not more of it in one place than in another. You may then turn it out on a dish, and serve it ; or you may put it in a basin, and set it before the fire, to keep it hot till wanted. When once made, it will warm up again easily.

Eels are occasionally to be had in tolerable plenty. There are two easy ways of cooking them which are convenient, because in both they are as good cold as hot. The first is—

Potted Eels.—For people with good stomachs and hearty appetites, there is no need to skin eels. There is no doubt, however, that their flavour and digestibility are increased by skinning, although the skin contains fat, which greatly helps to warm us, by supplying fuel for the slow combustion within us, by which our animal heat is maintained. The pickled eels that are sent in casks from the northern countries of Europe to the south are never skinned. After cleaning your eels, and cutting off their heads, cut them into pieces about two inches long. Put them into a brown earthen pot, to which, if there is not an earthen cover, you have fitted a wooden one. Season them with pepper, salt, and allspice ; if you have parsley and thyme in your garden put in a few sprigs. Pour over the eels a little more vinegar and water than will cover them ; put on the lid, and set the pot into a *slow* oven, or on the ashes on your hearth. They should not be too much done ; as soon as the flesh will come away from the bone, they are done enough. They will keep some time. When herrings are cheap, and before they are shotten, you may pot them in the same way. These you scale, cut off the heads and tails, and cut them across into two or three pieces.

Collared Eels, though a little more trouble than potted eels, make a very good and handsome dish. For this, the larger the eels the better ; quite small eels can hardly be collared. Empty your eel ; cut off its head ; open it at the belly the whole of its length ; wash it ; take out the backbone, tearing the flesh as little as may be. Dry it by pressing it with a coarse cloth. You will then have a flat strip of eel-flesh, broad at one end and narrow at the other. Season the inner surface of the eel by dusting it with salt, pepper, and allspice. Then roll it tightly upon itself, as you would a ribbon, beginning at the broad end, until you have rolled it into a lump something like a short, thick sausage, blunt at both ends. Tie it with broad *tape* (not with string, which would cut into the flesh when cooked), to keep it from unrolling, and then cook in an earthen pot with a lid, exactly as you do potted eels. One large eel will be enough to do at a time, and be as much as there is room for in your pot. If undersized, you can collar several (rolling each one separately) at once. When you want them, you take them out of the pot, and after cutting off as many slices as are required, you return them to their liquor for future use. They will keep thus several days or longer, and are very convenient to have in store, to save cooking in hot weather.

Conger Eel Pie.—In many parts of the country, congers, or sea eels, are often plentiful and cheap. In Cornwall, where they put everything into a pie, conger pie is one of the most approved. Take congers not thicker than your wrist (they may be less) ; empty, and cut them into two-inch lengths, rejecting the heads. Wash, drain, and dry them in a coarse cloth. Roll the pieces in flour, then

place them in your pie-dish, seasoning, as you do so, with pepper, salt, and allspice. You may sprinkle amongst them a little chopped parsley and lemon, or common thyme. Pour over them a tumbler of water, with a table-spoonful of vinegar in it, to help to make gravy. Two or three hard eggs quartered will be a nice addition. Cover all with a good solid crust, and bake in a moderate oven. This dish may be eaten either hot or cold; if cold, the pie may be a little more highly flavoured with spice and vinegar.

Large Conger, Roasted, is very good and easy to do. Take a cut, about a foot long, out of the middle of one of the largest. Clean it without opening the belly. If you can manage to stuff it with a stuffing made of bread crumbs, chopped parsley and lemon thyme, pepper, salt, and shred fat or suet, bound together with a raw egg, your roast will be all the better, as well as all the bigger, for it. Tie it round with string, and after a good dredging with flour, roast it. Put into your catch-pan a lump of butter or some roast-meat dripping, and, if you live in a cyder country, a tumbler of cyder; if not, the same quantity of one-third vinegar, two-thirds water. Baste well your roasting conger with this, dredging it with flour from time to time. When half-done, change the end by which it hangs before the fire, and continue basting till it is done enough. Serve the gravy with it. Large conger, so prepared, can be baked in a dish, if the shape and size of the oven allow of its being basted now and then with the liquor (the same as you put into the catch-pan) in the dish, into which you may also put a few potatoes. Baking the fish is less trouble than roasting it, but if cooked in this way it is more liable to over-doing and drying up.

Skate is a wholesome fish, often to be had at a reasonable price, as it bears travelling well, and is indeed, in cool weather, the better for being kept a couple of days after catching. It is best in autumn, but is never exactly out of season. Choose fish with the brown skin clear and healthy-looking, the flesh and under skin very white. Young skate, called "maids," are tender fleshed and delicate; larger fish are firmer, and altogether more profitable, having thicker flesh in proportion to the quantity of gristle, for they have no real bones. The upper skin should be removed. If you have to do it yourself, strip it from the middle outwards. Save the liver. Cut your fish into pieces about four inches square—some out of the thick parts, some out of the thin. After washing, throw the thick pieces and the liver into boiling salt and water; when they have boiled up a couple of minutes, put in the thin. They will take from ten minutes to a quarter of an hour in cooking. When they are done, arrange them on your dish, and make for them some liver sauce, for which we subjoin a recipe.

Liver Sauce.—Chop some of the liver into pieces smaller than peas. Put some of the water in which the fish has been boiled into a saucepan; thicken it with a little flour and butter or dripping; add some vinegar, with a very small quantity of mustard mixed in it. Then put in your chopped liver; let it come to a boil, and it is ready.

Plain Boiled Mackerel, with Fennel Sauce.—If the fish have roes and milts, by making an opening near the vent, you will be able to draw the entrails at the opening made by the removal of the gills, at the same time leaving the roe or milt in its place, and also to wash the inside of the fish through those two apertures. The mackerel will thus have a much plumper appearance than if the roes were taken out and laid beside them. When the fish-kettle boils, throw in a few sprigs of the freshest light green fennel you can get. Add a little salt, and when the water boils again, throw in your mackerel. Skim carefully. They will take from twenty minutes to half an hour, according to the size. When done, lay your

mackerel on the strainer in your dish, previously warmed. Have ready some melted butter, not too thick. Take the boiled fennel out of the fish-kettle, chop it fine, and add enough of it to the melted butter to give it a light green tint. Add a dessert-spoon of vinegar, either common or flavoured with tarragon. You may also stir in a very little made mustard, but so little as scarcely to be perceptible. When well mixed over the fire, serve separately in a sauce-boat.

Cods' Heads.—In some places, fishmongers take the heads off their codfish before they cut up the rest of the fish to retail it by the pound. In that case, the heads are sold cheap; and when they can be had for somewhere about twopence each, they are well worth buying. They are in season through the whole of autumn and winter; and we have enjoyed many a cheap fish-treat with a dish of cods' heads, which contain several of the tit-bits prized by epicures—namely, the tongue, the cheek-pieces, and the nape of the neck. The fishermen in the northern regions, who take cod in large numbers for salting (to do which they are obliged to cut off the heads), might be expected to throw them away, and waste them, in the midst of such abundance. But instead of that they turn them to the best possible account. The tongues and the neck-pieces, as well as the *sounds*, or swimming bladders of the fish, are cut out and salted. Even the fins are dried, to furnish glue. The only inconvenience attending cods' heads is, that if there are several, they require a large kettle to boil them in; but they can be cooked one or two at a time, reserving the flesh from the second batch for next day's use. After taking out the eyes, wash the heads, drain them, and if you can let them lie all night with a little salt sprinkled over them, they will be none the worse for it. Put them into a kettle of boiling water, and boil from a quarter of an hour to twenty minutes, according to size. Dish them on a strainer, if you can, and help with a spoon.

For sauce, oiled butter is good—*i.e.*, simply set a lump of butter in a cup before the fire until it melts, and with a spoon pour a little of it over the fish on your plate. In some English counties, nice mealy potatoes are considered a necessary "sauce" for codfish.

For sharp sauce, take a few table-spoonfuls of the cods' head boilings; put them in a saucepan with a lump of butter or dripping, and a table-spoonful of vinegar; dust in a little flour, and keep stirring in one direction till they are all mixed smooth and come to a boil.

Both these sauces go well with any boiled fish, and are very nice served with many sorts of vegetables. To these we will add a third, which will be found equally simple and good.

For brown sauce, put a good lump of butter or dripping into a saucepan. Set it on a brisk fire, shake it round now and then, and keep it there till it is browned, not burnt. Take it off the fire, and stir into it a good table-spoonful of vinegar. When they are well mixed, pour it into your sauce-boat, and serve. The mixing of the vinegar with the hot fat had better be done out of doors, on account of the quantity of vapour that rises when they are put together. Although the reverse of an unhealthy smell, it may not be agreeable to the persons in the house.

Any meat remaining on cods' heads after a meal should be separated from the skin and bone *before it gets cold*. This rule applies to all other fish. Arrange it neatly on a plate, and dust a little pepper, and drop a little vinegar over it. It will furnish a nice little delicacy when cold, or you may warm it up with potatoes, adding any sauce that may be left, in the way we have already directed for roach and bream; or, after putting on it the cold sauce left, or a bit of butter, you may sprinkle over it bread crumbs or mashed potatoes, and brown them before the fire or in the oven.

THE AQUARIUM.

FRESH WATER ANIMALS (concluded).

AS temporary residents tadpoles certainly claim a few words of notice. They are easily obtainable in the spring, and their gradual development into frogs affords a lesson in natural history especially interesting to the young. They should be introduced in the proper tadpole stage, when they consist but of an oval body terminating in a pointed tail, which is actively used as a propeller. Then may be observed the gradual budding of the hind-legs, the appearance of the head, and the ultimate change into the frog.

On arriving at the final stage of its development it becomes amphibious, and will climb on the cork island that should float on the surface of the aquarium; then, of course, it requires its liberty, and should be placed in the way of finding a more congenial place of retirement. When the plants have become fairly established, and the beetles and snails have settled down in their new home, it will be time to consider what fish shall be chosen to complete the furnishing of the aquarium. For the sake of appearance precedence

must be given to the golden carp; two of these, not exceeding four inches long, will be sufficient for a circular glass. The most interesting of the fish which may be kept in confinement is, however, the minnow; these little creatures will live for a considerable time—sometimes for years—in a

healthy condition, and become so tame that they will take food from the fingers at the surface of the water, and follow the hand that feeds them round the glass. From six to a dozen of these will not be too many for even a small aquarium. Sometimes a disease will attack the minnow, and therefore, before being placed in the aquarium, they should be carefully examined. If a whitish fluffy spot be noticed near the tail, the fish should be kept in quarantine, or it will contaminate the rest, and a general mortality will ensue. This disease usually spreads gradually from the tail towards the head, till nearly half the body becomes coated with a woolly fungus, the fish moves with an awkward jerk, and then occasionally floats helplessly on its back, till in a few days it dies.

The loach is also to be recommended as an inhabitant of the aquarium. It agrees well with the other fish, soon becomes tame, and invariably thrives; its movements are somewhat curious, for instead of gliding about like the rest, it lies at the bottom, turns over the pebbles in search of food, and jerks itself round the glass with a spasmodic motion, resting occasionally on the rockwork that lies in its way. It is also useful in a sanitary point of view, for it picks up the stray morsels that may have fallen to the bottom, and thus prevents the water becoming fouled by decaying fragments of food that have been unobserved by its more lively neighbours. To the above may be added the com-

mon carp, Prussian carp, the roach, the tench, and the gudgeon; the two first named being the most preferable.

As it is important to know what to avoid, it should be mentioned that the stickleback, though an amusing little creature when kept with companions of its own kind, is too pugnacious to be admitted into a general collection; and the same objection holds good with the perch.

There is another animal that may be safely placed in a small vessel in company with those we have named, and that is the newt, of which there are two kinds—the small newt and the triton. They are both perfectly harmless, and the latter is especially attractive on account of its bright yellow body, which is striped with black.

An aquarium furnished with the creatures we have named will contain sufficient variety in form, colour, and habit to render it very attractive and interesting, and will need but little attention to keep it in order. Care should of course be taken that the water does not get too warm or too cold, and that no more food be given than can be consumed. The best food is a little biscuit powder, kneaded up into pills about the size of pin-heads, and shreds of raw beef cut

with a pair of scissors; these should be dropped in alternately, when the fish will catch the bits before they sink to the bottom. This operation should not be performed more frequently than once a day.

As it is not desirable to disturb the contents of an aquarium oftener than can

be avoided, two or three inexpensive instruments are required. To remove the stones at the bottom a pair of forceps should be obtained—a wooden glove-stretcher, to be purchased at any hosier's for a shilling, answers the purpose better than anything else; to remove lighter matters, such as decayed leaves, morsels of food, &c., a glass tube open at both ends is the most effective. By putting one end of the open tube against the debris to be removed, and then placing the finger over the other end, any light substance can be lifted out of the water;

to take it out by any other method is no easy task, and often results in breaking it up and fouling the water. When the bottom of the aquarium becomes dirty from an accumulation of sediment, a syphon of india-rubber tubing may be used; by letting the tube draw the water from the lower part of the vessel the refuse will pass out without disturbing the weeds, and clean water can be introduced gently to make up for what has been taken out. It should always be borne in mind that an aquarium, properly managed, needs no change of water; in warm weather, however, it is necessary to add a little water to make up for evaporation. The writer has kept both large tanks and small vessels for more than a twelvemonth without changing the water.

An aquarium is more interesting and less troublesome than most other decorative objects that involve the support of either vegetable or animal life.

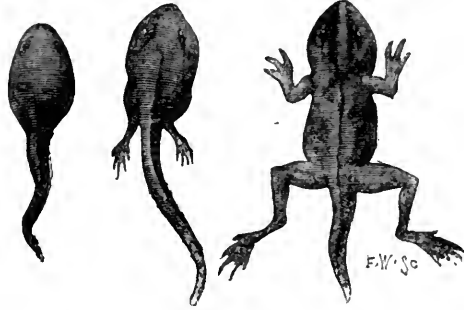

DEVELOPMENT OF THE FROG.



THE LOACH.

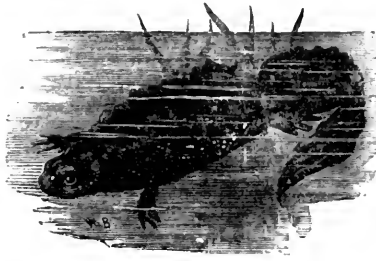

THE TRITON.



THE COMMON NEWT.

THE TOILETTE.

I.—THE MANAGEMENT OF THE SKIN (*continued*).

Pimples and Rashes of the Face.—Infants at the breast, when they are much wrapped up or heated, suffer from the development—on the cheeks, neck, arms, body—of little, vivid red, soft, raised pimples, the size of pins' heads, sometimes scattered about, often congregated together, and accompanied by a little red blush. This eruption is called the "red gum," or "red gown," "tooth rash," and the like. It is a simple affair, due to congestion and slight inflammation of the skin, and it is a sign, as a rule, that the babe is kept too warm. Formerly, when infants were half smothered in clothes and close rooms, red gum was very common indeed. As regards medicine, it may be well to give a few grains of carbonate of soda, to correct acidity, two or three times a day—in the food is as good a way as any—and to use locally several times a day a simple lotion composed of a quarter of an ounce of oxide of zinc, a half tea-spoonful of glycerine, and six ounces of rose-water. A little borax and glycerine, or lemon juice and water will also be of service. In young persons who are passing into adolescence, "pimples" on the face are common, in the shape of black specks, or red pimples, which are hard and raised, and often exhibit a central yellow spot; a little fatty matter may often be squeezed from these spots, and from its form it has been mistaken for a worm. The extruded mass is, however, only a plug of cuticle and fat which fills up the tubes of the little fat glands. The disease of which we are speaking is technically called *acne*. Some persons think that *acne* is due to a superabundance of nutritive fluids in the body; but this is not the case. About the age of puberty the whole glands of the body become active, and if anything interferes with the circulation through the skin, that is, makes it sluggish, the glands will not secrete their oily matter properly, and will become, therefore, choked up with secretion, and the collection of dirt from the external air upon the top of the choked-up gland appears as a black speck; this is the simplest kind of *acne*. It will be seen that a vigorous use of soap and water, and rubbing with a fairly rough towel is best adapted to get rid of *acne*, because by these means the skin is roused from its torpor; but in other cases the glands will not only be choked up, but inflamed, the *acne* spots will be red and tender, and the face hot and uncomfortable. Here we must use soothing remedies. The same remark applies to those cases of face pimples which form a rosy rash in middle-aged females, or in those who drink. As regards the general health, there is frequently indigestion present, and the face may flush after every meal. This must be prevented, as the rush of blood to the face only aggravates the *acne*. The best medicine is about half a teaspoonful of carbonate of soda, with a little ginger, in water, an hour before every meal, and aperients must also be regularly taken if in the least degree needed. After the indigestion is gone, the sufferer may take five drops of dilute nitric acid, five of dilute hydrochloric acid, and a tea-spoonful of tincture of gentian in water, twice a day. Arsenic may be required in severe cases; but it should only be taken under medical advice. The face should not be roughly used, but bathed with warm gruel and water night and morning; soap should be avoided, and the following lotion should be applied several times a day with a piece of sponge; it is a panacea for pimples of all kinds about the face:—Take of oxide of zinc powder sixty grains; fine calamine powder, as prepared at Apothecaries' Hall, half-an-ounce; bichloride of mercury, one grain; glycerine, one teaspoonful; and rose-water, six ounces. For use, shake the lotion up, pour out, and dab on to the face, allowing the powdery substance to dry on, then brush off the superabundant powder with a soft handkerchief, so as to make the appearance passable. Everything

that flushes or heats the face, especially beer, should, of course, be avoided. The same remarks apply to red blushes of the face. In the one case the disease is in the fat glands; in the other, the skin substance. The same remedies are useful in each case.

Skin Cosmetics.—This is the place to say a few words on the use of cosmetics. Some of them are harmless, some are dangerous, and most of them injurious to the skin. Cosmetics are used either to give a delicate complexion or to heighten the colour, and they include soaps, lotions, powders, and creams. The whites are formed of magnesium, starch, bismuth (which hardens the skin), lead, zinc, white precipitate, &c. The red paints are rouge and carmine. The only admissible substances are zinc, magnesia, and starch (violet powder). But those who use these should be very careful to well wash their faces night and morning, so that no cosmetic powder may remain behind to choke up the pores. We would recommend to all who "will use something," the use at night of perfectly freshly prepared or well preserved elder-flower ointment, and the use of the following lotion as a cosmetic; a little practice will soon enable the user to finish off the application with a brush in such a way that it cannot be seen:—Powdered borax, five grains; oxide of zinc powder, two drachms; finely powdered calamine powder, as made at Apothecaries' Hall, two drachms; glycerine, eighty drops; dilute nitric acid, four drops; spirits of wine, thirty drops; distilled water, four ounces. Some of the compounds sold under the name of milk of roses, bloom of beauty, and the like, contain lead or bismuth in large quantities, which may after awhile harden the face and injure the complexion. As we have already said, only the mildest soaps should be used to the face.

Dandriff or Scurfiness is a common and troublesome complaint affecting children and grown-up persons alike. The skin scales over very freely, bran-like pieces being constantly shed, and there is more or less itching; occasionally heat and redness are present. The scalp is the part most usually affected. In some cases the scurfiness is a symptom that there is debility in the system or a slightly gouty tendency, when internal medicine is needed; but usually local applications suffice. When the scalp is rather tender, very irritable, and inclined to inflame, we know of no better application of a simple nature than an embrocation made of equal parts of olive oil and lime-water well shaken together. The scalp should be well cleansed with warm water, but without rough handling, and then the embrocation should be applied with a piece of sponge directly to the scalp. This may be done every night. In some cases the washing is only needed every other day; no soap should be used. This is for the irritable cases. In the more indolent instances, where there is no heat of head, but mere scalliness, it may be best to apply at once some slight stimulant, either in the form of ointment or a wash, according to the taste of the user. The ointment should be made of five grains of the nitric oxide of mercury to the ounce of lard, or three drops of carbolic acid to the ounce of lard. The wash should be of the following ingredients:—Spirits of wine, two drachms; spirit of rosemary, one ounce; strong ammonia solution, a teaspoonful; glycerine, a drachm; and rose-water, six ounces. Where the disease is obstinate, medical advice must be sought. The lime-water and olive-oil embrocation above referred to may be scented according to taste, and is the best application for general use. It should be mixed in small quantities, because it does not keep long in warm weather.

Eruptions.—These are very numerous, and occur over different parts of the body, and it would be an unprofitable task to describe them in any fulness. We shall therefore make some general observations upon them, and give a few plain directions how to treat the simpler and more

common forms. Whenever a child is feverish and really ill, and any eruption shows itself, it should be kept very quiet and warm in bed. It is not difficult even for a non-medical person to see when a child is distinctly feverish, by the flushed face, the languid look, the headache, red tongue, quick pulse, and hot dry skin. If a rash shows itself about the face first, and there be much sneezing, running of the eyes, and a little cough, we suspect measles. If the child "comes out" with a scarlet rash of uniform character, if the skin be pungently hot, the fever very marked, and there be sore throat, with a strawberry tongue, we suspect scarlatina. If the rash show all over the back first, and then above the face and head and other parts, as little watery heads, it is probably chicken-pox. When modified small-pox occurs, there is a good deal of fever, and pains in the back, and the eruption appears first of all in the face, which is distinctly pitted in a day or two. All these cases require medical care.

Red Blushes of various sizes occur about the bodies of children in summer-time, and are known as rose-rash; they demand the employment of a slight aperient and the use of a little weak spirit lotion, or, better still, smearing over with benzoated zinc ointment.

Sometimes, on the legs of young people, raised red lumps of an oval shape appear; they are painful, and they look like circles of erysipelas, or as if an abscess were going to form, but this is never the case. After they have existed a few days the circumference assumes a bluish tinge, and then as the places disappear, hues similar to those seen in a bruise which is going away are noticed. These cases require rest, quinine, mild aperients, and the outward application of a little whitening and water. They soon get well with rest.

Whenever a child about a month old is attacked with eruption about the soles of the feet and the parts adjoining the bowels behind, and there be loss of flesh, with sore mouth and the "snuffles" (cold in the nose), it should be taken to a doctor.

Very frequently mothers are distressed by the occurrence of chafings and sore red patches in their infants about the buttocks, the bend of the thigh, the root of the neck, and the armpits, just, in fact, where two portions of skin come into contact; the irritation is accompanied by great soreness and more or less thin discharge, which stains the clothes put to the child and gives them an offensive odour. These chafings are frequently an accompaniment of thrush; in that case we should treat the thrush at once; the best remedy for ordinary cases is a mixture made of chlorate of potash and honey. For a child a couple of months old we should give as follows:—Chlorate of potash, ten grains; honey, half a teaspoonful; hot water, an ounce. When cold, give a teaspoonful three times a day, and wash the mouth out after each time of feeding with a little honey and borax. When there is no thrush, and the child is weak and thin, or very fat and flabby, cod-liver oil and steel wine—five to ten drops of the former and half a teaspoonful of the latter—should be given twice a day; but the local treatment is the most important. When the chafings are slight the parts may be dusted over with fuller's earth, or, what is very much the best, equal parts of starch powder and the finely-prepared calamine powder made at Apothecaries' Hall which we have referred to so many times before. The object is to keep the parts very dry indeed; night and morning they should be well washed with oatmeal gruel, but gently handled, the powder being used afterwards. The child should be kept scrupulously clean and dry, its napkins changed on every necessary occasion, and the nurse should be most careful that the napkins are not washed in soda. Whenever the child is changed, the powder should be dusted on to the sore places. In severe cases it may be advisable, when there is much discharge, to apply an ointment,

and there is none better than the lead ointment of the *old London Pharmacopœia*, spread *thinly* on burnt rag, and changed twice or thrice a day. Where, however, the case is severe, there is something radically wrong, and medical advice should be sought, as also in those cases in which the simple remedies named fail after perseverance.

DOMESTIC SURGERY.

FRACTURES, DISLOCATIONS, BURNS, AND SCALDS.

Fractures.—The treatment of broken bones is much too important to be entrusted to any but professional hands, but there are some points connected with the early care of such cases which may be advantageously insisted on. The great majority of fractures are what is technically called "simple," *i.e.*, there is no wound of the skin communicating with the broken bone; the more serious cases, where there is a wound, and possibly laceration of the soft tissues of the limb, are termed "compound;" and when the bone is broken into several pieces, the fracture is said to be "comminuted." In all cases of fracture it is most important to avoid all rough manipulation of the limb, lest the "simple" fracture should become "compound," by the end of the broken bone being thrust through the skin; and as the muscles of the limb itself, if excited to action, have a direct tendency to produce this undesirable result, the patient should not only abstain from all voluntary effort, but means should be taken to restrain all involuntary contraction of the muscles of the limb, as will be afterwards explained.

The immediate effect of a severe injury likely to produce a fracture is ordinarily a certain amount of faintness, and this need give no alarm if the patient is not losing blood at the same time. The only treatment required will be fresh air, with perhaps a little cold water sprinkled on the face, the head being kept low until the faintness has passed off, when a little brandy may be given if the patient continues exhausted.

Since severe accidents usually happen in the open air, the next requisite will be to place the patient under shelter; and the method of conveying an injured person safely for some distance is a matter of no small moment.

In the case of a broken arm the sufferer will naturally support the injured limb with the opposite hand in the position least painful to himself. When this has been ascertained, and if there is any distance to travel before a surgeon can be seen, the arm should be supported both by handkerchiefs arranged so as to sling it, and also by a handkerchief or bandage bound—not too tightly—round the arm itself, so as to support the parts. A piece of card-board (such as is used for tying up gloves), or a piece of a common hat-box, four inches wide, may be advantageously placed on each side of the broken bone and secured with the bandage which envelops it. The patient may then be safely driven some miles in a carriage; and a four-wheel conveyance with good springs is to be preferred.

If one of the bones of the leg is broken the patient is immediately rendered helpless, and the greatest care will be requisite, lest in moving him great pain should be inflicted.

By far the most satisfactory way to carry a wounded man is on some form of litter borne by four bearers. A hurdle, or a small door taken off its hinges, is a very good substitute for a regular "stretcher," and either, with a mattress and pillow, will form a very comfortable temporary means of transport. When neither of these is at hand, a blanket may be used to carry a patient in for a short distance, or if four poles can be procured and fastened together to form a frame-work, the blanket can be tied to the corners, as shown in the illustration, Fig. 15, and will

then be much more efficient and easy to carry. Whatever method is adopted there are certain rules with regard to carrying a stretcher which should be carefully attended to:—A stretcher should be carried by four men rather than by two, and should always be carried by the hands and not on the shoulders; the drawbacks to the latter proceeding are the difficulty of finding on an emergency four men of the same height, so that a level position may be secured; and also that any tilting of the stretcher may throw the patient off from such a height as seriously to aggravate his injury. Besides, the raising and

wheaten straw laid along each side of the broken limb, and bound to it by two or three handkerchiefs.

In the case of a badly-sprained ankle, or a crushed foot, it will be sometimes convenient to carry a patient between two bearers in a sitting position, or semi-recumbent. The first method is shown in the accompanying illustration, Fig. 16, the opposite hands of the bearers being interlaced under the thighs and behind the loins, and the patient putting his arms round the bearers' necks. This method is very trying to the bearers, and could only be endured for a short distance. A patient is much more



Fig. 15.



Fig. 16.

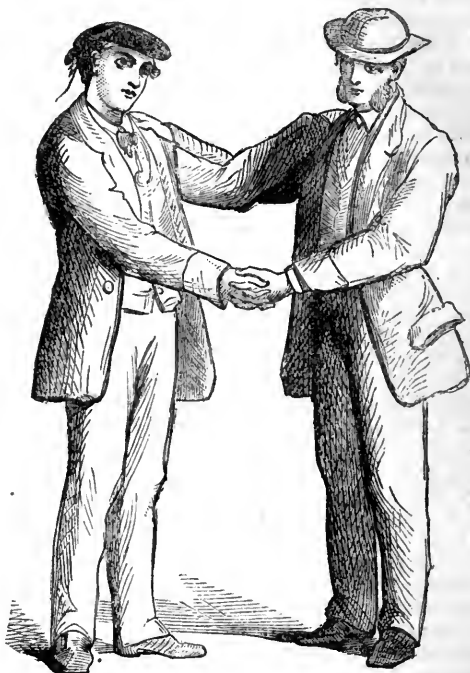

Fig. 17.

lowering of the burden is not an easy matter, and is apt to frighten the patient when unskilfully performed.

It is *not* advisable that the bearers of a stretcher should "keep step." If only two men are carrying a stretcher, and they march "in step," the load they are carrying will be swayed to the right and left side alternately, to the great discomfort of the patient; but if one advances his right foot and the other his left, the burden will be kept perfectly even. The same rule applies to the case of four bearers, only here the front and rear men of *opposite* sides should keep step and be out of step with their companions.

A temporary splint may be advantageously applied to a broken leg before the patient is moved on to the litter, as has already been advised in the case of a broken arm, and for this purpose nothing answers better than some clean



Fig. 18.

easily carried in the semi-recumbent position, if placed in the arms of two men, arranged as shown in the illustration, Fig. 17, their opposite hands firmly interlacing in front, and their other hands being placed on each other's shoulders, so as to support the patient behind; thus the weight of the patient falls chiefly on the two arms behind him, and he can be carried for some distance without fatigue.

Another way of carrying a patient is upon what is known among schoolboys as a "sedan-chair," each bearer grasping his own fore-arm and that of his fellow about its middle, as shown in the illustration, Fig. 19, and the patient grasping the bearers' necks, as shown before in Fig. 16. This is a convenient way to carry ladies over shallow streams, &c., in the course of country walks or at picnics; and as on those occasions sprained ankles are not altogether unknown, a disabled member of a party may

thus be transported for a long distance with relays of bearers, the two working together being as far as possible of a height.

Dislocations.—A dislocation, like a fracture, should always be submitted to the care of a surgeon as soon as possible. When a bone has slipped from its socket the limb is useless, and there is more or less pain, and the neighbourhood of the joint is deformed.

A dislocation of the shoulder is at once the most common, the most painful, and the most readily reduced of these accidents, and we venture, therefore, to give a few hints for its treatment. A fall into a ditch is a common cause of this accident, the elbow being caught on the bank and suddenly thrust upwards, when the head of the bone slips out of its socket and into the arm-pit, giving rise to excruciating pain from its pressure upon the large nerves.

This being an accident which may happen to a rider when hunting, or when unable to obtain assistance, he may safely make an attempt to reduce the arm himself, by using a gate for the purpose of a fulcrum, as shown in Fig. 18. Here, lifting his arm over the gate with the other hand, the patient grasps the lowest bar he can reach, and allows the weight of his body to hang on the other side of the gate until by the pressure of the top bar the bone is forced into its socket with a snap.

Another method, which may be safely employed by a bystander, is to seat the sufferer in a strong chair and to put the foot on the seat with the bent knee under the dislocated shoulder, as shown in Fig. 20. The arm is then to be grasped and forcibly bent over the knee, when the dislocation will probably be reduced; no more violent efforts are justifiable in the hands of non-professional persons, and in any case, even of reduced dislocation, the patient should be seen by a surgeon as soon as it is convenient, lest any other injury which he may have sustained at the same time should have been overlooked.

Burns and Scalds.—Burns are probably not quite so frequent as scalds, but are much more alarming at the time of their occurrence, and, if severe, are much more serious in their results than scalds. The slightest form of burn, viz., a superficial burn or scorch,

merely reddening without destroying the skin, may be produced by a slight explosion of gas, or the ignition of some article of clothing, which has been rapidly extinguished. Here the pain is severe for the moment, but rapidly subsides as soon as the surface burnt is protected. This can be readily effected by dredging flour over the part, and wrapping it up in cotton wadding; or, should the part burnt be one not readily covered in this way, e.g., the face, by painting it over with a mixture of equal parts of collodion and castor-oil, or with a solution of nitrate of silver, such as the nitrate-bath of photography. When the burn is more severe, little blisters rapidly form on the burnt part, and these vesicles, as they are surgically termed, require careful treatment. If, as is sometimes recommended, these vesicles are left to themselves, the contents solidify, and a jelly-like

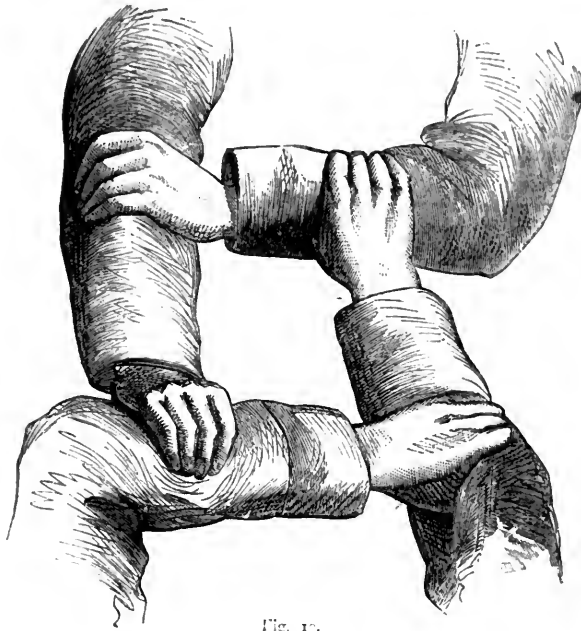

Fig. 18.

mass is left, which has afterwards to be got rid of by poulticing, to the great discomfort of the patient; or, even if this coagulation does not take place, the thin scarf-skin or cuticle raised by the blister is apt to be torn away and leave a tender surface beneath. The best plan, therefore, is at once to prick the blisters on one side with a needle, or to make a small opening with a sharp pair of scissors, and then carefully to squeeze out the watery contents, pressing down the skin gently but firmly with a piece of cotton wool. When this has been done, the case may be treated by any of the methods already given for slight burns, but it must be borne in mind that fresh vesicles may form after the first dressing, and hence great care must be taken, in the subsequent dressings, not to tear open the blisters unintentionally. Scalds closely resemble slight burns in both their symptoms and treatment, and need not, therefore, be treated of at greater length. Severe burns, such as arise from the clothes-taking fire—crinoline accidents, as they have been called—are



Fig. 20.

very serious, both as regards the life of the patient, and her future comfort, should she survive; and medical attendance should be immediately obtained. Lacking this, however, it may be noted that the immediate danger to the sufferer's life is due to the violent "shock" which the system sustains, as is shown by the faint, semi-conscious, and pallid condition in which the patient is left when the conflagration is extinguished. The proper treatment will

be to restore warmth and vitality to the sufferer, and this can be best done by wrapping her in a blanket, and placing her in bed (or before a fire, if it is winter), with hot bottles or bricks so arranged about the legs and trunk as to impart warmth without interfering with the burnt surface. In the case of a child (and of an adult too, if conveniences are at hand), a warm bath is at once the most soothing and appropriate treatment, since the warm water (the temperature of which must be carefully maintained at 90°) soaks off all the charred clothing, &c., and leaves the burns in the most healthy condition for dressing. At Vienna, baths are so contrived that patients suffering from burns or obstinate skin diseases, can spend days or even weeks in them, and anywhere, with care and attention, the temperature of a bath could be kept up for some hours, at least. In addition to external warmth, a severely-burnt patient will bear the administration of some hot cordial drink, and then, pending the arrival of a medical man, no harm can possibly be done by enveloping the burnt parts with cotton wadding.

Burns are dangerous, not merely from their immediate effects, but from the complications which are apt to follow in their train. Thus, in children especially, inflammation of the lungs is very apt to follow a burn about the trunk; and again, ulceration of the bowel is found to be a frequent cause of death in these cases. The friends of a patient who has been burnt should, therefore, be careful to call the attention of the medical man in attendance to any cough or difficulty of breathing on the one hand, or to the occurrence of any diarrhoea on the other.

With the best care, burns are, undoubtedly, very fatal accidents, and, as prevention is better than cure, it may not be out of place to urge the necessity for wire fire-guards over *all* fire-places to which children or females have access. Men, from the nature of their clothing, are much less liable to burns than women, unless, indeed, they indulge in the pernicious practice of "reading in bed" by candle-light. Even when the first dangers of a severe burn are surmounted, the patient will have much to undergo in the healing of the wound, and here a fresh danger comes in—that of the contraction of the tissues in healing, so as to leave great deformity behind. Patients and their friends are sometimes more to blame than their attendant for terrible contractions of the neck, arms, &c., frequently seen after burns; and they do not carry out fully the surgeon's instructions, from not understanding their importance, and, being intent only upon healing-up the wound, cannot understand the necessity for care and attention. It may be laid down as an axiom that the quicker a wound heals, the more it contracts, and it is evident, therefore, that the slower a wound can be made to heal, the less likely it is to leave unsightly contractions behind. In order to prevent contractions, it is often necessary to confine the patient to an irksome position, so as, *e.g.*, to stretch the neck, or to apply a splint to keep out the arm, and these should be cheerfully borne, when they are ordered by a competent medical man.

It may not be inappropriate here to give a few hints as to the best method of extinguishing the flames, when a woman's or child's dress has unfortunately caught fire. If the sufferer has presence of mind enough to throw herself on the ground and roll over and over until the by-standers can envelop her with some thick and non-inflammable covering, her chances of escape from serious injury will be much increased; but, unfortunately, the terror of the moment ordinarily overcomes every other feeling, and the sufferer rushes into the open air—the very worst thing she could do. The first thing for a by-stander to do is to provide himself with some non-inflammable article with which to envelop the patient, and a coat or cloak—or, better, a table-cloth or drugget—will answer the purpose. Throwing this around the sufferer, he should,

if possible, lay her on the ground and then rapidly cover over and beat out all the fire, keeping on the covering until every spark is extinguished. To attempt to extinguish fire by water is useless, unless the whole body of flame can be put out at one blow; and for one lightly-clad female to attempt to succour another, when other persons are at hand, is simply to imperil two lives instead of one. In the case of a house on fire, it is to be remembered that death is more frequently the result of suffocation from smoke than from contact with flame, and every effort should be made to reach the open air by crawling along the floor (where there is usually breathing space) so as to reach a window, or, if necessary, by enveloping the head in a thick shawl to exclude the smoke while making a rush along a passage or down a staircase.

THE HOUSE.

LIFE ASSURANCE.

IN furtherance of the promise contained in the article on "The House," in a previous number (page 39), we now proceed to explain the principles upon which life insurance, or more strictly life assurance, depends. It is usual to speak of the *insurance* of any doubtful event, such as fire or loss at sea, and of the *assurance* of an event certain to happen, as death.

The theory of life assurance depends upon calculations based upon the uniform mortality which has been observed to prevail among large numbers of individuals, and upon the increase of money at compound interest.

From the death registers, mortality tables are constructed which tell us how many persons, out of a certain number living at each age, die annually. From these tables the actuary computes what money payment—usually a sum or premium paid annually in advance throughout life—is sufficient to provide for the payment of a fixed sum, say £100, at death. Several tables are in use for this purpose, of which the principal are the Northampton, the Carlisle, and the English life tables.

The following is a simple illustration of the manner in which the premium for a life assurance is deduced.

Supposing, according to any table of mortality, that out of 500 persons, all aged forty years, five die in the year, and that it is required to provide £500 for the families of those who die, the contribution of each of the 500 will clearly be a five-hundredth part of £500, or £1. In practice, however, the premiums being invested at compound interest, a less sum than £1 would be required, viz., such a sum as invested at interest for the year would produce £1 at the end of the year. An addition to the net premium thus deduced is then made by the office for the expenses of management, and to provide for the bonuses, the nature of which will be hereafter explained.

Upon these two simple principles of mortality and interest, the whole theory of life assurance depends, and upon them contracts have been undertaken by the different companies in the United Kingdom alone amounting probably to £400,000,000 sterling.

Life assurance is an institution which has now been in operation for 160 years, the first company dating from 1706, and, notwithstanding the large amount of business transacted, it has not been, we may say, until 1869, that discredit has been cast upon life assurance companies.

It is almost essential for us to make a passing allusion to this matter, temporary panic appearing to have taken possession of the public in consequence of certain appeals to the Court of Chancery, which resulted in the compulsory winding up of one large company.

It cannot, accordingly, be too clearly understood that the collapse in that case arose mainly from numerous ill-considered amalgamations with unsuccessful companies,

whose business was acquired at an excessive cost, and from reckless disregard of the well-known fundamental principles of life assurance, which are based upon unchangeable and mathematical laws, that cannot be ignored with impunity.

The public were very much indebted, in this matter, to the intelligence of the writers in the daily papers, by whom this great question, one of the gravest importance to a large portion of the community, was very generally taken up. Of their widely-expressed opinions on this point, these remarks are an echo.

The writer of this article long before pointed out the mischief that must arise, if the unsatisfactory methods of business pursued by a particular class of life assurance companies were persevered in. The result proved that his view was correct.

The absolute necessity of life assurance in the case of persons whose incomes are dependent upon their lives—and this is so with the far greater portion of the population of this country—we assume to be admitted by everyone.

There can be no doubt of the fact that no other method exists by which a provision can be so well made for a dependent family, as by a policy of life assurance, for the moment the contract is executed, no matter whether death take place the next day or twenty years after, a capital sum is provided, which can be invested for the benefit of the family of the assured, or applied in any way for their advantage, according to the circumstances and requirements of the case.

No investment, in either a savings bank or a friendly society, will answer the same purpose—the essential peculiarity of a life policy being that the amount contracted for is paid at *death*, whenever that event shall happen, and, from the uncertainty of life, it does occur, over and over again, that claims become payable and are honourably met, very shortly after the policy is effected. So that a young man with a fixed income derived from a profession or other source, need not be deterred from marriage on account of it being impossible for him to make a due provision for his wife and family—indeed, we may safely say that by means of life assurance, many marriages take place which otherwise prudence must have prevented altogether.

The first thing to be done by a person who has made up his mind to effect an assurance on his life, is to fix upon an office. There are two descriptions of companies, viz., proprietary and mutual, the former being joint-stock or trading companies, and the latter private partnerships on a large scale—all the profits of the business belonging strictly to themselves, while, in the proprietary companies, only a certain proportion of the profits are divided in the shape of bonuses among the policy-holders, the remainder belonging to the shareholders.

There are numerous good companies of both classes to be found. We feel a difficulty in pointing out how a selection should be made, and can only suggest that the applicant should make choice of an office which, above all things, regularly publishes full and intelligible accounts, showing clearly the amount of the liability and the sum in hand to meet it, and particularly how that sum is invested. Probably, one of the best tests will be the fact that the statements of the office fixed upon can be readily understood by the intending applicant; for the accounts of many companies are so mystified as to be unintelligible to the general public.

The prospectus of the company should next be thoroughly studied. The date of establishment, though no guarantee in itself, still affords evidence of whether the company has stood the test of time. The names of the directors should be scrutinised, to see if they are men of business and of good standing in the commercial world. The rates of premium should then be consulted. These

vary according as the Northampton, Carlisle, or other tables are adopted as a basis. The Northampton table gives an unfavourable view of life at the younger ages—say, up to forty-five—and the premiums deduced from it are consequently higher than those that are based on the Carlisle mortality; while, on the other hand, the Northampton rates are decidedly favourable at ages above forty-five—the exact reverse being the case with the Carlisle table.

The applicant would accordingly do well to select his office according to his age, provided always that the office charging the higher rate of premium does not offer, which it very possibly may, some compensating advantage; for it must be borne in mind that the rate of premium is not the only point to be considered in the choice of an office—the amount of bonus addition likely to be allotted to the policy, and the character of the company for liberal conduct and honourable dealing being important elements to be taken into account.

The bonus system will be explained hereafter.

The annual premium per £100 for a life of thirty varies in the different companies from £2 1s. 8d. to £2 19s. 3d.; at sixty, from £6 1s. 9d. to £7 15s. The rates without participation in profits are of course less.

Life premiums are usually paid annually in advance. Some companies receive half-yearly or even quarterly payments.

Assurances may also be effected by the payment of a fixed number of premiums, which are of course much higher than those quoted. Some companies grant endowment assurances, by which the sum assured becomes payable at death, or on the life assured attaining a certain age, and indeed, generally, contracts can be entered into with the large companies for the issue of policies to meet almost every conceivable requirement.

The applicant, if at all likely to go abroad, should ascertain the regulations of the company with which he is in treaty as to foreign residence, for which an extra premium is charged, according to the healthiness or otherwise of the locality. The conditions in this respect of some companies are much more liberal than those of others. It is now very usual to allow free residence in any part of the world distant more than 33° north or south of the equator, as well as in certain other healthy places within the excluded limits.

Policies become void if the person assured die by his own hand, by duelling, or by the hands of justice, or if the premium be not paid annually within the thirty days of grace which are allowed from the date of the same becoming due.

Tables showing the amount of bonuses declared will be found in the prospectuses of most of the offices, and though the past bonuses afford no just criterion of what the future results may be, still they are the best guides the public can have as to the prospects of bonus additions to their policies. It often happens that the assured, from unforeseen circumstances, are unable to continue their annual payments. When this is the case, a return of some portion of the premium paid is made, such return being called the surrender value of the policy. And here it may be desirable to point out that in such cases a return of only a small proportion of the premium paid (usually about a third, without interest) can be looked for, for though in the individual case no claim for payment of the sum assured has been made upon the company, still other policies effected at the same period having become claims, the excess of premium paid on the policy to be surrendered must be retained by the company to meet the losses occasioned by premature deaths.

Loans, also, for amounts varying with the value of the policies, are advanced upon their security, usually at five per cent. interest. We propose to continue our remarks on life assurance in a future number.

ANIMALS KEPT FOR PLEASURE.

II.—THE DOG: PRINCIPAL VARIETIES (*continued*).

The *Water Spaniel* is a moderate sized animal, rather stoutly built, with a close curly coat, which is generally of a brown colour. As might be supposed, he is very fond of water, and appears to be specially adapted to that element, by an unusual secretion of oil in the coat. This, however, often causes rather a strong odour when indoors, and makes him less suitable for a domestic dog.

The *Setter* is too well known to need description, and is so named from the habit, either natural or acquired, of crouching when he comes on the scent of game. Both this habit, and that of the pointer, have been thought to be originally the natural start of surprise at coming on a fresh scent, cultivated and improved by successive training. The best setters are more or less liver-coloured, or mixed with white. The setter makes a capital pet dog, being very handsome in shape, docile, and intelligent. Like the little cocker, and in fact all the spaniels, it is also remarkably affectionate and mild in its disposition. For sportsmen who are noted pedestrians, or for shooting over wild moorland, setters are often better companions than pointers; their superior speed and dash, and harder feet, enabling them to keep on with vigour after the pointer would be exhausted. They should, however, be allowed to wet the body thoroughly every now and then, and to take a good drink at intervals, or they cannot stand the work.

The little *King Charles* and *Blenheim Spaniels* are known to every one. They certainly are little beauties, as far as looks go—and often are affectionate, good tempered, and amazingly clever at learning tricks; but too often also are such spiteful little wretches, as to be a nuisance to all save their fond owners. A great deal of this, however, we suspect to be owing to bad feeding and consequent indigestion.

The *Retriever* is scarcely a distinct variety, being bred from any dogs likely to produce a suitable animal. It is often bred from the water-spaniel and terrier crossed, or a spaniel and poodle; but the dog so well known under that name, is generally bred from the spaniel crossed with the Newfoundland. Hence it much resembles rather a small Newfoundland, but with a sharper muzzle, and a sharper look, having also longer legs and a more lively carriage. The handsomest colour is black. By care some few strains have been perpetuated without a recent cross, and reared to nearly the size of a Newfoundland; but there is always more *silkenness* in the hair than is usual in that breed. A good retriever is a wonderfully handsome and intelligent dog, very playful, and with a good temper nothing can exceed.

The *Pointer* is a very characteristic dog, trained to

such perfection through successive generations, that a well-broken dog will, on the scent of game, stand with every member rigid, in the exact position in which it happened to be at the moment. This habit has now become almost instinctive, so that a well-bred dog takes to it with little training; and it is recorded that a brace of pointers have stood at "point" for nearly an hour and a half, without moving a muscle, whilst a sketch was made from which their portraits were painted. The pointer should have a rather large head in proportion, with a broad muzzle, the lips or flews slightly projecting. The neck is very long, and set on at the shoulders in a very peculiar manner not found in any other breed, the shoulders being prominent, and higher than the head when the animal is in motion. The chest is well developed, something in the style of the hound; but the tail, like the shoulder, is altogether peculiar. At the base it is rather thick, but lessens somewhat suddenly, and then continues with a scarcely perceptible taper to within two or three inches of the end, when it lessens to a very fine point. Some of the best judges affirm that this formation of the tail is the proper



THE POINTER.

criterion of good blood, and that its absence shows a cross; but we are not sure this can be maintained. The pointer is intelligent, and of an extremely mild and affectionate disposition. When properly trained, and in good condition, it is always willing to work; and no words of scorn are too deep and bitter for the conduct of those who can deliberately *shoot* the poor beast with small shot, not to kill, but to *punish* him for disregard to their very likely contradictory commands. No variety is so foully abused as the poor pointer, and no dog merits or needs it less, and the owner himself is mostly in fault.

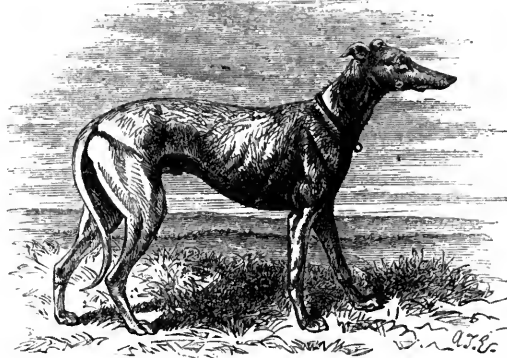

THE GREYHOUND.

The *Greyhound* is in shape the very ideal of light and winged speed, and when well bred, is of singularly graceful outline. All the bulk of the animal's body seems collected in the capacious chest, whilst the slender limbs are models of symmetry and grace. Our engraving will save the necessity for detailed description, but it is necessary to remark that inferior breeds of this dog are very apt to show an awkward and ugly droop at the loins, which not only spoils their

speed, but also their beauty of form.

The old English greyhound must have been a larger animal than the present breed, as it was used to hunt the stag, and even the wolf. Indeed, we are inclined to think that the original breed was the hairy or rough variety still known as the Scotch greyhound, but which is nearly extinct. This animal is both larger and more powerfully built than the English greyhound, and with very long hair. We saw recently a noble animal of this breed, which was considered the finest specimen in England, and had taken many first prizes. It was as tall at the shoulder as the largest mastiff, was "feathered" down to the toes,

and of an iron-grey colour. Like the modern greyhound, the dog was good-tempered enough, but had an unmistakably ferocious look about the head. The few who possess these dogs now are anxiously endeavouring to perpetuate them, and we trust their efforts may be successful.

The greyhound is moderately affectionate and intelligent, but sometimes snappish to strangers. As is well known, it is now only employed in coursing.

The other hounds, such as the foxhound, the harrier, and the beagle, do not belong in any sense to the household, being, as a rule, only adapted for the pack. They vary in size, but resemble each other remarkably in shape and qualities. We believe them all to have been originally derived from the bloodhound, crossed with the greyhound, but we question very much if there be not a dash of the bulldog in some celebrated strains, though this has been denied by good authorities.

Hounds are kept under the severest discipline, but when not under the control of the huntsman, whipper-in, or other attendants, are highly dangerous to strangers. There are, however, individual dogs which have shown remarkable attachment and docility.

Of *Sheep Dogs* there are two kinds, the English rough sheep dog, which very much resembles a very large rough terrier without a tail, and the Scotch collie. The English dog is a very useful animal, having a splendid constitution and great intelligence; but the Scotch collie is a far superior breed, and is every year becoming more highly prized in England. This beautiful breed has a very fox-like muzzle, expressive but shy-looking eyes, sharp and graceful ears turning well over forwards, and generally a white line down the forehead between the eyes. There are both smooth and rough varieties—the latter is most admired—but his coat is different from that of the Newfoundland, the hair straighter, and not so long. The tail is very large and bushy, and when running is always carried high, though in repose it droops. The loins are beautifully arched, and the whole outline remarkably sprightly and graceful. Down the legs the coat is short. The colour varies greatly.

The true-bred collie is one of the most intelligent dogs in the world, and perhaps surpasses all others in quick resource and readiness of invention in cases of emergency. It is in minding sheep, however, that its capacities are best tested; for having been trained to this work for generations, a well-bred collie takes to it "naturally," and needs comparatively little training. A Scotch shepherd said his dog "could do anything except carry the hurdles," and the praise was not exaggerated.

The *Dalmatian* or *Carriage Dog* is doubtless a hound, the well-known spotted skin having probably appeared accidentally from some cross. As a rule, they seem to care most for the stable, and hence are not adapted for domestic pets, though inoffensive and good-tempered; but we have known individuals which have displayed considerable intelligence and affection.

Many less marked varieties have been omitted from our list, and we will only add in conclusion that in choosing a dog, care should always be taken to ascertain his disposition. Individuals of every race may be troublesome or even actually ferocious, and every person owes it to society not to keep a dangerous dog. In our next paper we shall enter upon the subject of *training dogs*.

THE HOUSEHOLD MECHANIC.

WOODS USED IN HOUSEHOLD CARPENTRY.

HAVING completed our survey of the most necessary tools, it will only be necessary to make acquaintance with the few sorts of wood we shall at first require, to be able to at once proceed with a practical job. In starting, we feel that a few words on the all-important subject of seasoning may possibly save some of our readers much unnecessary trouble and vexation. When a living tree is cut down the pores or vessels between the fibres will be found to be full of sap, and it is in the complete, though gradual extraction of this sap, that the success of the process of "seasoning" consists. If we look at the section across the grain of a tree, which is mostly nearly circular, we shall notice a number of annular rows of fibres, or rather the ends of them, and it is from between these rings that the sap has to escape. It stands to reason that the cells contained between the rings nearest to the surface will be the first to lose their moisture, and that the heart of the wood will continue wet long after the outside is ready for use.



Fig. 40.

It is also well known that in the process of drying, wood contracts considerably; but the inner fibres, being protected from the influence of the atmosphere by the outer rows, do not shrink in the same proportion. The consequence will be readily seen by reference to the diagram, Fig. 40, which shows the result which is almost sure to ensue if a log of green wood is merely left to take care of itself. It cracks in directions mostly radial. To prevent this, it is common to grease or wax the ends and sides of the log to defend it from the results consequent upon a too sudden exposure to the atmosphere. The effect is much more completely avoided, however, by having the logs split into quarters where the tree is of sufficient size to warrant it, although this plan is not economical. The only safe means to guard against the disastrous effects of too sudden drying, is to expose the wood very gradually to the influence of the atmosphere. It is considered that, in the case of large timber, the process of seasoning is much facilitated by an immersion in water, which is said to dilute the sap anyhow; it is of the highest importance that wood should be quite dry before being used, as, if it is not, the finished work will warp and shrink in a manner very unsatisfactory and discouraging; none of our readers who are

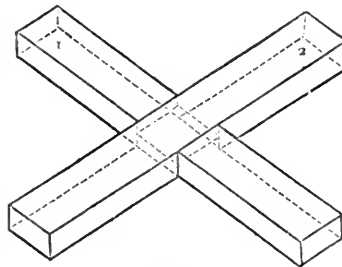

Fig. 41.

fortunate enough to possess access to plantations of growing timber, must imagine they will be able to cut down a tree and use it at once to any advantage. It will be found much more economical to purchase just the required article from some respectable timber or hard-wood merchant, who will only supply it in a condition fit for immediate use. Shrinking does not take place to any sensible degree in the direction of the length of the fibre.

The time allowed for seasoning should in no case be less than two years, and in the large hard woods must be even considerably longer.

We have selected the following *six* woods as being at once the most likely to be used in household carpentry, and at the same time enough for our present purposes, and shall describe the more valuable and exclusively ornamental varieties as occasion requires:—

Ash (Fraxinus).—The wood of this tree, which is a native of Britain and North Europe, is one of the toughest,

most flexible, and elastic of home-grown timbers, and for this reason is eminently suited to all purposes requiring these qualifications, such as the construction of agricultural tools, wooden springs, frames of railway carriages, wheels, &c.; but as it is of very slight durability, it is not suitable for construction of out-door work, or building purposes.

Some specimens may be found dark and beautifully marked in grain, and are then much prized for cabinet work.

Beech (*Fagus sylvatica*) is a tree which attains considerable size in this country, the wood of which is of a reddish brown colour, and of very even texture and fine grain. It is much used in small turned work, handles for tools, common furniture, &c.; but is unsuited for building purposes, owing to its liability to be attacked by a small worm and dry rot. It stands water well, however, and is comparatively cheap.

Mahogany (*Swietenia*) is the most universally known and prized of the furniture woods, as its immense size and great soundness, its almost perfect immunity from dry rot, its freedom from shrinkage, and its beautiful appearance, render it the most valuable of all woods for domestic purposes. The finest in grain, or Spanish, is imported from Cuba, and is mostly cut into veneers, which are overlaid on common and cheaper wood. The Honduras is lighter in colour and weight than Spanish, but is better for solid work.

Mahogany is also good for turning, and admits of a fine polish.

Oak (*Quercus*).—It is from the numerous varieties of oak that our strongest and most durable timber for heavy building purposes and ship-building is selected, the wood being of immense strength and large size, and peculiarly unsusceptible to the attacks of the weather. There are many different varieties, nearly all being found in the temperate zone. The growth of the oak is slow, and the wood is consequently hard and firm, and of great tenacity, the best being of a light brown colour.

The darker kinds are softer and less durable, but being in most cases beautifully marked with crossings of lighter colour, called the flower, are much prized for ornamental purposes, especially in church architecture and carving.

Oak is rather difficult to work, owing to its great hardness, but is susceptible of a splendid polish. Wheelwrights use oak almost exclusively for the spokes of wheels, the rims or felloes being generally ash, and the nave elm.

Pine (*Pinus*).—Under this head properly come all the varieties of the order *Conifera*, such as fir, white and yellow deal, larch, &c. The different species of pine supply the largest part of the timber employed for building purposes, on account of the immense size and straightness of the wood, the abundance of the supply, and the ease and facility with which it can be worked, combined with its durability and comparative strength.

A large proportion is imported from Russia and Norway, and other mountainous countries produce great quantities. The durability of the pine tribe is in proportion to the quantity of resin and turpentine contained.

Yellow deal, as it is called, is the best for carpenters, is even and straight in grain, and tolerably free from knots. Some varieties are entirely without these knots, such as St. John's pine, imported from Newfoundland, which may often be had two or three feet wide and forty feet long. This kind is very soft, however.

The white kinds are harder and freer from resin, but less durable if exposed to variations of moisture.

Larch is softest of all, but the grain is large and coarse, and, owing to the immense quantity of turpentine contained in it, is well suited for out-door work, such as fence-posts, buried work, &c.

It is perhaps worth while here just to touch upon the

various technical terms applied to the sizes into which pine and other woods are cut.

In its largest state (generally about one foot square and of indefinite length) it is known as timber, and when cut into three slices, these are known as deals—deal being only the name for a certain size of pine, and not, as is erroneously supposed by many, a species of wood by itself. A smaller size than deals, about seven inches by two or three, are termed battens; and deals ripped into three or four nearly square logs, of two inches by three, or three inches by four, are known as quartering. If sawn into slices of about one inch by nine to twelve wide, these slices go under the name of planks, which being again sliced form boards. If sliced diagonally, from corner to corner, feather-edged or weather-boards will be produced. These are used for roofs and outsides of sheds to throw off the wet. Thinner slices than boards are leaves and veneers, each different thickness being reckoned by its size in inches, or parts of an inch. In the midst of the immense variety of size and quality it would be useless to attempt to give any idea about cost; but pine may be obtained at any respectable timber-merchant's at a cost within the capacity of almost every purse, as it is the cheapest of all woods.

Walnut (*Juglans regia*) is highly esteemed as a furniture wood, and is procurable of large size. The colour of the wood is grey, with brown or black blotches and streaks, which deepen in colour towards the centre of the tree. The grain is rather large and coarse, as the growth of the tree is comparatively rapid. Walnut is easily worked, and susceptible of a fine polish. Its principal consumption is for gun-stocks, for which it is admirably suited, owing to its light weight and durability.

JOINTS.

Having now the materials and tools before us, let us go through a short preliminary course of what may fairly be called carpenters' joints, as the very essence of carpentry is a thorough knowledge of how to build up of many pieces a fabric of the greatest possible strength, with the smallest outlay of material, bearing in mind the influence which humidity or over-dryness exerts over all kinds of wood. If our reader is new to the work, let him commence by taking a log of quartering, say three feet long, and planing it up square, testing its accuracy as directed in our remarks on the square. When he has accomplished this feat satisfactorily, he may saw the log in half with the tenon-saw, and will then have two logs eighteen inches long, with which to make the first and simplest joint in carpentry—the cross joint. The object will be merely to let the two pieces one into the other at right angles, until their corresponding surfaces are flush or level, that is to say, the part where the joint is made shall be no thicker than the log itself. The quartering, we will say, is three inches by two, and we will make the joint flat-wise. Lay down log No. 1, and mark a line across it with the square and pencil or striking-knife; from this line measure the width of the log to be let in, and also draw this line across with the square, and produce each of these lines round the narrow sides of the log. Set the marking-gauge to half the thickness of the narrow side, and mark on both sides with it between the two lines. The part thus marked off must be removed by sawing the lines across the grain, and then chiselling the piece out, thus leaving a gap in log No. 1 three inches wide and one inch deep. Take exactly the same course with log No. 2, and, if properly done, the two will fit exactly together, in the form of a cross. This joint may be varied, for practice, by placing the logs obliquely to each other, instead of at right angles, in which case, the required angle must be got by the mitre bevel, instead of the square. Fig. 41 shows the finished joint. This joint is much used in wooden erections, especially in its oblique form, as will be seen hereafter.

HINTS TO LETTER-WRITERS.—I.

MOST persons have to write letters, and it is desirable that in doing so attention should be paid to a number of details. There is no doubt that a well-written letter is often a great advantage to the sender, while it is always a pleasure to the receiver. The result is promoted by the proper choice of paper and envelopes, pens and ink. All these are so cheap and easily obtainable that there is seldom any excuse for the use of inferior materials, which are at once impediments to good writing, and indications of neglect. The writer should endeavour to execute his penmanship in a free and legible hand, so as to be neither crabbed and inelegant, nor overloaded with flourishes. Some persons of distinction, we know, have been famous for their bad writing; and it is a fact that they have found it very difficult to read it themselves. We do not think there is a valid excuse for this sort of thing, and we are sure that it can be avoided by proper attention and practice. The opposite evil of fine writing, which covers a sheet of paper with fancy curves and luxuriant flourishes, is almost as much to be deprecated. A somewhat compact hand, with every letter defined, is the best for all purposes. It need not be formal and precise, without character, "like copper-plate," in order to be good; but it must be accurate and readable. Some persons think it beneath them to dot an *i*, to cross a *t*, and to distinguish between such letters as *n* and *u*; but all who aspire to pleasing those they write to, and getting a good name, will be mindful of such matters. It may happen that the character of a young writer will be partly estimated by his regard to correctness in his letters; and we all know how much may depend on the estimate formed.

Spelling is a decided accomplishment, and of even more importance than graceful penmanship. Therefore let diligent heed be given to this, and let every word be spelt as accurately as in a printed book.

When a letter is written in a scrawling and an irregular hand; when the lines are at uneven distances, or not straight across the page, when the characters are ill-formed, the paper blotted, and the spelling bad, it has an air of decided vulgarity and negligence.

Persons who really ought to know better, and who have had a good deal of instruction, sometimes fall into the error of using small letters where capitals are necessary. Thus they will write a small *i*, when speaking of themselves, instead of using a capital *I*, and they will even begin proper names of persons and places with small letters if they do not happen to begin a sentence.

There is another fault of which some are guilty, and it is to write a whole letter as if it were a single sentence. They run on from beginning to end, joining their words with *ifs*, *ands*, *buts*, and so forth, until their name at the conclusion winds up the whole. Of course such persons never think of their stops; and, indeed, the use of stops, or punctuation, is very commonly neglected in otherwise well-written letters. The number of persons who carefully mark the stops in their epistles is very small indeed. The reason, or at any rate one reason, is, that it is difficult to teach the rules for the use of stops in actual practice. Such as master the art in any respectable measure, commonly owe it to reflection and habit.

HINTS ON CARVING.

Hare.—A hare is considered a difficult dish to carve, for unless very young the bones are hard to divide. The coloured plate, Fig. 8, shows the proper appearance of a roasted hare when brought to table. The head should be set to the left of the carver. If the hare is not very

young, cut thin slices the length of the back from G to H, Fig. 8. Next remove the shoulders by inserting the knife between the shoulder and the side at the dotted line J, feel the joint, cut down through it with some strength, and treat it as the leg of a fowl is treated, only more vigorously. None of the adjoining meat is cut off with the shoulders or legs of a hare. Having removed the shoulders, insert the knife at the dotted line at K and take off the leg. Treat the other side in the same manner. The head is cut off by inserting the point of the knife at M, which must be fitted into a niche between the vertebrae of the neck, and taking a circular stroke from M to N, when the back-bone has been divided through. Cut the lower from the upper jaw through the line O to P, Fig. 8. Then place the point of the knife upright at Q, and split and cut open the head at the line visible in the centre of the skull from the nose to the ears. Many persons like the brain, ears, and cheeks. If the hare is young, cut off the shoulders, legs, and head, before touching the back, and then, instead of taking off slices, cut the back across the narrow way in several pieces at the lines marked R R R R, in Fig. 8. This is done by planting the knife upright, feeling for the niche between the bones, and splitting the back. The ribs are cut right through on either side lengthways, and separate pieces served. The back of a hare is considered the best, and the leg the next most choice part. The shoulders are not usually coveted, as they are apt to be dry. Nevertheless some like them, and they are wholesome, and prudent carvers will find a use for them. Serve a little seasoning and one of the forcemeat balls with each piece.

Rabbit.—A rabbit, roast or boiled, is carved precisely as the young hare is, the back being cut across in small pieces after the shoulders, legs, and head have been removed. The head is cut up last. Every part of the rabbit is good. The back is considered the choice help, especially the centre piece. The shoulder is preferred to the leg. For rabbit pie, cut up the animal in the same way. If roast, serve the forcemeat balls and seasoning with the meat; if boiled, a little onion sauce. The kidney is considered a delicacy. Each one may be cut in half and served separately; and though not much to look at it will suffice for a relish, which is all that can be looked for.

Turkey.—A turkey generally appears on the board at Christmas, if at no other time. It requires more skill to carve a turkey than any other bird, excepting a goose, and on the carver's operations will depend how far the bird will go in point of economy. The breast is reckoned the best, and the wing the next in preference. Gentlemen are often partial to the drumstick, the slender part of the leg. Commence by cutting slices from the breast on each side, as shown by the lines at A, in Fig. 9. If seasoned with herbs, the seasoning will be found in doing this; a little seasoning is served with every portion of the bird. If truffles or mushrooms have been used in stuffing, open "the apron," as it is called, by cutting a slit at C, and taking out the seasoning in slices; next remove the wings at the dotted line D, precisely in the same way as from a fowl. Draw out the silver skewer, E, and take off the leg at the joint by inserting the knife between the leg and the side of the body at E, and parting the joint, which it requires some strength to do, without cutting off any meat with it. When separated, the leg appears as shown in Fig. 10. There is a joint at the dotted line A, which must be severed, and the two pieces served separately. B is the drumstick, E the scaled leg of the bird which is part of the drumstick; C is called the cushion. The drumstick is often reserved till the bird is cold, and then grilled for breakfast. The rest must be carved as you would a fowl, dividing the breast, and cutting the back in half.

Calf's Head is a very delicate and by no means an

uncommon dish, but it is noteworthy that it is far more economical if carved in the manner we are about to describe, than any other way. Commence by making long slices from end to end of the cheek, cutting quite through, so as to feel the bone throughout the entire stroke, according to the dotted lines from A to B in Fig. 11. With each of these slices serve a cut of what is called the throat sweet-bread, which lies at the fleshy part of the neck end. Cut also slices at D, which are gelatinous and delicate, and serve small pieces with the meat; this greatly economises the joint. A little of the tongue is usually placed on each plate, and about a spoonful of the brains. The tongue is served on a separate dish, surrounded by the brains, and is cut across, the narrow way, in rather thin slices. Some persons like the eye. It is removed by a circular cut, marked by dots at E. First put the knife in slanting at F, inserting the point at that part of the dotted line, and

more than does that from a leg on the skill of the carver, and it is also a joint which may be made to go much further by skilful cutting. Commence by thrusting in the fork at G in Fig. 12, firmly. Raise and half turn the shoulder over and upwards, holding it in this position by means of the fork; slash lightly in with the knife at A, but do not cut quite down to the bone; the meat now flies open, leaving a gap, as if a thick slice had been removed. Cut a few slices thickly at the lines marked B, and then at the knuckle side at those marked H, making both slope so as to meet at D. Those to be helped to meat should

always be asked whether they prefer the knuckle end or the thick end. The cut on the blade-bone, marked C in Fig. 12, is usually reserved till the joint is cold, and so is that at E. The circular cut F removes the fat, a slice of which should be proffered with each piece of lean. Very many people think the most delicate cuts are to be found underneath

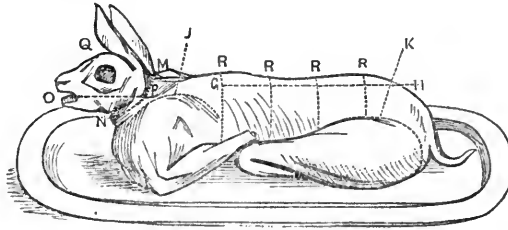

Fig. 3.

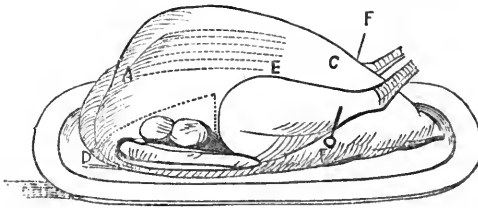

Fig. 9.

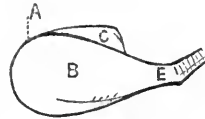

Fig. 10.

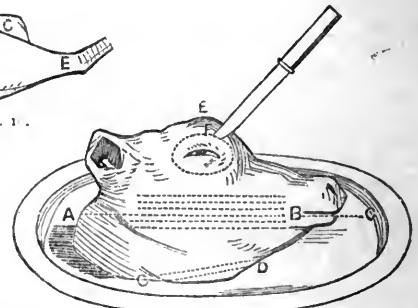

Fig. 11.

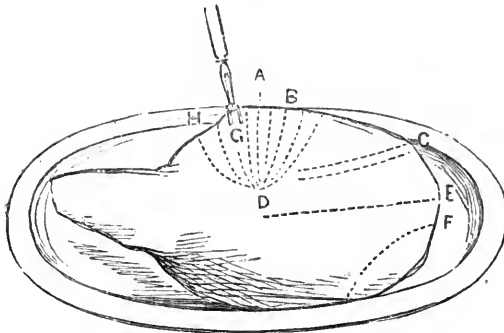

Fig. 12.

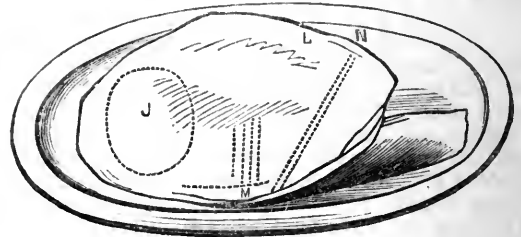

Fig. 13.

driving it in to the *centre* under the eye; then wheel the hand round, keeping the circle of the dotted line with the blade of the knife, the point still in the centre. The eye will come out entire, cone-shaped at the under part, when the circle is completed by the knife. There are some gelatinous pieces round the eye, which are generally considered very desirable. The lower jaw must next be removed by cutting through at the dotted line from G to H, to do which successfully the dish must be turned. Many persons consider the palate a dainty, and it should always be offered at table to the guests or members of the family. It is found under the head, of course, lining that part which forms the roof of the mouth. For the proper appearance of a calves' head when brought to table, reference must be made to Fig. 4 in the coloured plate.

Shoulder of Mutton, though costing less per pound, is not reckoned by some managers to be so economical a joint as a leg. Still, there are many persons who hold a contrary opinion, and a shoulder of mutton is a very frequent joint on a family dinner-table. The palatableness of the meat served from a shoulder depends much

the joint, which parts are represented in Fig. 13. The cut at J is a thin slice of brown meat, followed by other slices cut in succession. From K to L, long slices can be removed, by cutting through to the bone. The long lines at N, and the short ones at M, indicate the situation of similar cuts. Taste varies so much in regard to which are the nicest cuts on a shoulder of mutton, that individuals should always be consulted before helping. Every part of a shoulder of mutton, except the first cuts, should be carved in thin slices, and even those are not made so thick as they are in a leg. The blade-bone is, in our opinion, the choicest cut of all (that marked C in Fig. 12), and may be eaten hot, if the remainder of the shoulder is hashed, instead of bringing it to table cold; it is the better way to hash it, for the meat is insipid cold. A shoulder of lamb is treated similarly; so is a shoulder of veal, which is sent to table with the under part turned to the carver, who commences by serving the knuckle, and then cuts as the under part of a shoulder of mutton is cut, afterwards turning the joint and carving the upper part, according to Fig. 12.

GARDENING.

THE WINDOW GARDEN.

THE practical result of good gardening is to keep up a show of blossom or ornamental foliage all through the year, to effect which it is necessary to know the seasons when the various plants arrive at perfection. Supposing, therefore, we begin our year in winter, though few flowers are blooming out of doors, yet our window garden may be gay enough, as may be seen from the following list of flowers which bloom at that season, all of which are available for our purpose:—Pompon chrysanthemum, tree carnation, Chinese primrose, polyanthus, single garden anemone, mignonette, musk, Neapolitan and Russian violet, wallflower, scarlet geranium, myrtle, camellia, China rose, heaths, daphne.

Besides these there are many more, but as these require more attention and greater space for growth than most of our readers will be able to spare, we shall leave their names until a future number, and say a few words upon the culture of each of those given in our present list.

Pompon Chrysanthemums are especially suitable for winter window decoration, both on account of their size and variety of colour. Though naturally dwarf plants, they will admit of still further dwarfing, by having the points of the shoots "laid" at the end of August. In potting you will require rich light soil, give plenty of water afterwards, and when they have done flowering remove them into a yard or spare window, and protect them from sharp frosts. You can increase your stock by dividing the roots or suckers, in April or May.

Tree Carnation.—Make cuttings in spring, repot in May, again in September; pinch off the points of the early shoots when you first repot, so as to retard the flower-buds. Train upon a wooden frame or up the sides of the window.

Chinese Primrose.—Sow in April or May under a square of glass; pot and repot, twice, as the plants increase in size. Use sandy, fibrous, rich earth, and see that you have free drainage. When past flowering treat as chrysanthemums, and repot for the second season.

Polyanthus takes a moderately large pot, rich loamy soil, and should be watered with liquid manure.

Single Garden Anemone.—The roots of these and their bulbous brethren, are the better for being taken out of the earth when flowering is over, and stored for the summer. This, however, must not be done until the foliage withers, which shows that nature is resting. Good plants may be had by putting in the roots early in winter, and keeping the pots in a dark cool place until their leaves appear.

Mignonette.—To bloom through the winter, select from the box or bed, and repot a strong woody plant, train it up a frame of sticks, and water sparingly.

Musk—grown either from seed, cuttings, or division of the roots. Keep very moist while growing, and dry while the plant is sleeping.

Violets, Neapolitan and Russian.—Repot in May, expose to the air as much as possible, either in a border, yard, or window-box. Use well-manured, rich earth, watering freely. When the runners appear, nip them back, so as to concentrate the strength in the main root. In September repot into light loamy good soil, and place in

your window. Give all the air you can, and wash the leaves frequently.

Wallflowers may be made to bloom in winter by cutting back in spring or summer, and from their perfume are always a favourite adjunct of the window garden.

Scarlet Geraniums.—The sweet-scented and oak-leaved are the best for winter growing, and will go on flowering up to February. Of their treatment we shall have occasion to speak under the head of pelargoniums.



Fig. 1.

Myrtle.—No foliage is prettier and fresher. The plant will last for years, is easily propagated by cuttings, and although apt to grow too large for its share in a window case, can be kept within bounds by pruning. Sandy loam, mixed with heath and a little silver sand, is the best soil in which to grow myrtles. Repot once a year; wash the foliage now and then, as soot smuts blister the delicate green leaves.

Camellias.—Choose the double, which are the best flowering sort, and treat in the same way as the myrtle. A very simple way of striking camellia cuttings is by merely putting a spray (first nipping off the flower-bud) in a small medicine bottle half full of water; let the stalk just enter the water. Hang up the bottle in a light warm place, and in a short time you will have a well-rooted young plant to pot.

China Roses.—Plant in midsummer, or even later; use rich loamy soil, well drained. Strike at any time from cuttings.

Heaths—being rather capricious in their growth, must be planted in heathy soil well mixed with silver sand and leaf mould, thoroughly drained, and kept free from wet. The pot must be rather small in proportion to the size of the plant. Give plenty of air, and protect carefully against hard frosts.

Daphne—although not very ornamental, and apt to straggle in its growth, will nevertheless always find a place where sweet perfume is acceptable. Heath soil and loam is the most suitable earth.

Be careful to keep off frost, or even a sudden chill, and remove from the window at night. Indeed, we may here observe that this rule should apply to all winter flowers. The temperature falling so suddenly inside the room by the dying out of the fire, renders the plants extremely sensitive to the change in the outside atmosphere. If such a misfortune as a frost-bite occurs, remove the plant to a dark place, and let it recover itself; light will blister and decay the surface affected by the frost.

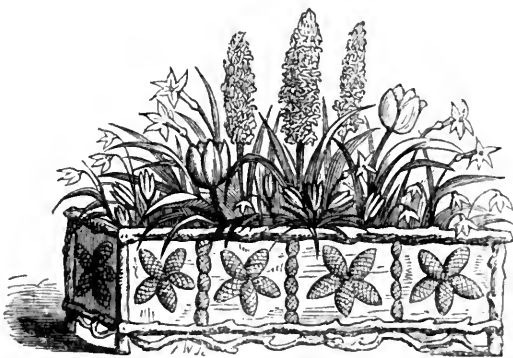

Fig. 2.

These flowers will have shed their beauty in January, when you should have your bulbs ready to fill their place. Of these the following will flower in January and February:—Hyacinths, narcissus, jonquils, tulips, crocuses, snowdrops, and scillas. The pretty effect a selection of these will produce when well arranged, is shown in our illustration, Fig. 2.

The treatment of these several sorts is much alike. Plant in soil mixed with leaf mould and well-rotted manure, early in autumn, say September. Keep in the dark until well rooted, which process is encouraged by having a saucer supplied with water below the pot. When the roots are thoroughly grown, which will generally take place in eight weeks, remove the pots to the light, and the flower and foliage stems will soon show. Great

care should be taken to have the drainage act quickly, as although the plant should be well supplied with constant moisture, it must not get clogged with *wet earth*. If the flowers of the hyacinth begin to show before the stem has sprung up far enough to let them develop fully, you can force its growth by twisting a paper funnel and placing it over the plant; flowers always seek the light, so the hyacinth will strain to reach the greatest light as shown by the aperture at the top of the funnel.

By the time your bulbs have finished flowering there are many pretty spring flowers ready to blossom, so we will suppose you have been preparing a stock of primroses, violets, ranunculus, anemone, Indian pink, forget-me-not, and lily of the valley.

Of these, *Primroses* are perhaps the most popular, reminding as they do of country lanes; they require no further care than good drainage, and to be planted in light soil mixed with leaf mould.

Violets we have already described.

Ranunculus, Anemone.—These are treated in the same manner as the single anemone mentioned before.

Indian Pink, Forget-me-not.—Sow in November, thin out if too thick, keep cool and dry.

Lily of the Valley.—Take close plump roots and pack tightly in the pot, shake in a light sandy soil, and place in a saucer constantly half-full of water.

To follow the early spring show you have a large and very beautiful family of flowers, known as annuals. We scarcely need say that an "annual" is a plant which is sown, blossoms, goes to seed, and dies in a year. Some annuals, it is true, may be made to live on for several years, but this is only by coaxing nature into an unusual course, by picking off the buds, or pruning back. The annuals suitable for our purpose are those not requiring artificial heat, and therefore designated hardy and half-hardy; of these the following list will suffice to keep up the summer supply:—Mignonette, lobelia, mesembryanthemum, portulaca, balsam, cockscomb, convolvulus, anagallis, calandrinia, nemophila, and mimulus.

The treatment of these small-seeded annuals is alike. Sow in March or April under a pane of glass, thin out, and transplant when large enough. They will then be ready to fill your window in June, or even the end of May, and continue flowering until the harder wooded perennials are ready. Of these, the favourite sorts suitable to the window are:—Pelargoniums of various sorts, fuchsia, salvia, and calceolaria.

For low-growing plants to fill up the case, you should keep up a supply of lobelia, musk, and moss. Mignonette never comes amiss for an odd corner, and the common wild mosses, grown in flower-pots, form a lovely relief to the bright colours of the geranium.

Pelargoniums, usually known as geraniums, are propagated by cuttings made from March up to the end of August.

The scarlet geraniums are not quite so suitable for window gardening as the large florists' geraniums, which grow luxuriantly in the house, and often, too, under the most adverse circumstances. In taking cuttings you should select well-ripened stems, removed as far as possible from the flowering shoot; let them be about three inches in length, and cut across a joint with two or three joints above; the cutting should not be sunk deeply in the soil, an inch is quite deep enough.

Pelargoniums require forcing every year; first you must prepare them for the operation by hardening the wood in the open air. When they have been out of doors three or four weeks, cut back the young shoots, giving the plant the form required; this is the fittest opportunity for cuttings, as you then make a better selection, and do not damage the plant.

After pruning, the plant should be kept pretty dry until

the young shoots break away, then they must be repotted into sandy loam, leaf mould, and fibrous earth. Take care to nip off any decaying roots, water freely, and shade from the glare of sunlight. Plants repotted in February will flower in June, and you can go on, keeping up a continuous show by merely taking care to repot at proper seasons, beginning when the plant is young, or by nipping off the first young shoots, thus obliging the parent stem to send out fresh flower stems.

Fancy or dwarf geraniums are much grown now, and if nicely pruned form lovely little shrubby plants. These require more water while sprouting, and should have smaller pots in proportion, while the addition of a little heath soil is a great advantage. The best time to make cuttings of any geranium is in March and April, and then you should take the little side shoots, and having struck repot them once or even twice during the summer. Before leaving the subject of propagation by cutting, we must impress upon the window gardener that to have a good strong plant to stand the winter he must strike his cuttings not sooner than March or later than June.

Some of the fancy geraniums bloom almost continually. This is a grand object to achieve in a window garden, so we advise our readers to buy a plant of Gaines' scarlet, Rollisson's purple, or the Prince of Orange, a strong young plant, any one of which may be had for three or four pence at a nursery gardener's; and here let us observe that the first outlay is the last, as a good stock can always be kept up by propagation, or exchange. Those geraniums which are kept in foliage all the winter require considerable care; the leaves will grow yellow and drop off if you do not keep them moist, which is best done by syringing, or washing delicately leaf by leaf with a small sponge or bit of flannel, an operation which can be easily done after the day's work, if you are careful to draw the plant-case into the room, and avoid any chance of frost catching the damp leaves. While plants are blooming, care should be taken to keep them moderately moist.

Fuchsia.—There is nothing more graceful or ornamental than this queen of window plants, and on the whole nothing more simple in its cultivation. Propagated like the pelargoniums from cuttings, the plants require much the same treatment, that is to say, repotting, pruning, and hardening. One thing, however, the fuchsia is more greedy of, and that is water; you can scarcely water a healthy plant too much, always understanding that the pot has a quick and thorough drainage. Give all the air possible, and when the lovely bells fall and the leaves turn yellow put the plant out of doors to drink in life and vigour from the pure breath of heaven. Take care however, that it does not get frost-bitten; prune and remove into smaller pots for the winter in October or November, and set it somewhere where neither frost nor excessive damp can reach it.

In March, when the plant is shooting, you must form it carefully. Slips pulled off close to the old wood in April will strike well, and make neat plants for flowering in autumn; the parent plant must be repotted in a slightly larger pot, and kept well watered by syringing the stem, rather than deluging the root.

The best form in which to train a fuchsia is that shown in Fig. 1. The plant throws out more graceful branches, and takes up less room in the winter; the stem will go on growing until it attains a considerable thickness. Liquid manure is good for fuchsias while they are preparing to bud, but should not be given after flowering, and the flowers should never be wetted, or they will drop off before their time.

Salvias.—The scarlet, by proper management, may be contemporary with the chrysanthemum as well as the pelargoniums, and all the precaution necessary is to top your cuttings taken in early summer, and force the plant to go over its preparation for flowering again.

DOMESTIC MEDICINE.

DISEASES INCIDENTAL TO CHILDREN.

IN treating of the diseases which are incidental to childhood, we shall content ourselves with noticing those of common occurrence. Now, as most of our ailments are the result of our own imprudence or misfortune, it might be expected that childhood would be free from disease; but it is really the most dangerous part of life, if we exclude age, which has been called second childhood. The organisation of an infant is a very sensitive one, capable of being injured by many things, especially by improper food, by bad air, by cold, and by heat. In some large towns it is very difficult to rear children; in Liverpool, for example, one child in every four dies before attaining the age of twelve months. It would be well if people would regard the constitution of a child as a thing requiring great consideration and care. Generally speaking, the life of a child is endangered by affections of its nervous system, such as convulsions; or of its bowels, such as diarrhœa; or of its breathing apparatus, such as bronchitis; but these are by no means the only dangers with which childhood has to contend. In these papers we propose to treat shortly of the following diseases of children:—1, convulsions; 2, diarrhœa; 3, dentition; 4, bronchitis and croup, and nervous croup; 5, eruptive fevers; 6, whooping cough; 7, certain skin diseases; and 8, worms.

I.—CONVULSIONS.

These are of common occurrence in young children, owing to the extreme sensitiveness of their nervous system; still a child is not always convulsed when it is said to be so. Nurses are very fond of talking about "inward convulsions," which often mean nothing more than a few slight twitches about the muscles of the face, especially of the lips. Such twitches often precede or forbode an attack of convulsions, but are not themselves entitled to this name. When a real fit comes on it is too easily perceived. The twitching of the face is no longer slight, but of the nature of a jerk; the muscles of the trunk and limbs are alternately stiffened and relaxed; and if the muscles of the chest and body are much affected, the child becomes blue from the way in which the fits interfere with respiration.

Causes.—What are the causes of such fits? They vary in different cases; but they may be resolved into three or four principal classes. First, *some fault in the food of the child.* The food may be unfitted to the tender wants of the infant. It may be artificial milk instead of maternal; or it may be bad milk instead of good. And even in the case of a child fed with its own mother's milk it may happen that a sudden derangement of the mother's milk—as, for example, by a fright—will occasion a convulsion in the child. Another error of diet, recognised as an occasional cause of fits in children, is giving too much food at one time—gorging the stomach. Another common cause of fits is the irritation caused in sensitive children by the process of *teething*. It is amazing how one or more teeth pressing on the gum may irritate and derange a child. Prolonged *diarrhœa*, exhausting a child, will be occasionally followed by a convulsion. *Worms* in the bowels are often a cause of convulsions in children; and may be suspected to be the cause in any particular case if they have been noticed before the occurrence of the fits. Our list of the causes of such attacks would be incomplete if we did not specify bad air, such as is met with in close, ill-ventilated, unhealthy rooms. Formerly, in the Rotunda Lying-in Hospital, Dublin, a large proportion of the children used to die of fits. No less than a sixth of the children died within a fortnight after their birth of the disease known as the lock-jaw of infants, in which not only the muscles of the jaw, but the

other muscles of the body are affected with a stiffness. The children attacked with it almost invariably died. Dr. Joseph Clarke entirely abolished this disease in the Rotunda by securing the better ventilation of the wards by a system of shafts. We mention this disease, not only because it is of the nature of fits, but also because its complete extinction in the Rotunda is one of the most striking instances that can be brought forward of the good effects of fresh air.

Treatment.—When a child is attacked with convulsions, pending the arrival of the doctor, two or three things may be done by those in attendance. First, let them be advised not to be too excited or too officious. It is very alarming to see a child convulsed, but generally children do not die in fits, and the best service will be that which is rendered in quietness. The things which it is generally right to do are to admit plenty of air to the child's face and mouth, and to put it into a warm bath in such a position as to give it plenty of air in breathing. The further treatment of the child will be best judged of by the medical man; but if from any cause his arrival be delayed, the steps to be taken must depend on the probable causes of the attack. If the child should have taken doubtful food, this source of irritation must be rectified. If it have taken a large quantity of food, there would be little harm in trying to excite vomiting, in the interval of the fits, by tickling the mouth with a feather or with the finger. If the child be in an exhausted state from previous diarrhœa or other causes, a little simple food should be introduced, either breast-milk or fresh milk and water, or barley water, or, if the child be very much reduced, a little very weak brandy and water sweetened with sugar. If the gum is red or swollen over a coming tooth, nothing gives such relief as lancing the gums; this, of course, can only be done by a medical man. But the medical man is sometimes foolishly opposed by parents in this matter. We need scarcely remark that in the actual fit the child will not be able to swallow, and during this time the attendants should be careful to let it have plenty of air.

Before leaving the treatment of children subject to convulsions, we should say the great duty of friends is to preserve such children from the causes of them, which we have specified, and in every way to strengthen the children. It should be remembered that fits imply a morbid sensitiveness, which is often constitutional. By good food, by pure air, by plenty of sleep, and regular living on the part of the parent, such sensitiveness is diminished, and with it the chance of fits.

II.—DIARRHŒA.

This, like the preceding, is a very common ailment of children. It is the cause of much of the mortality of young children; and where it is not fatal it often greatly weakens and injures the system. It is so common, and it injures a child so slowly and gradually, that it is on the whole too lightly regarded. We shall describe the general causes of it, and some domestic means by which it will often be remedied; but if these fail we advise parents not to neglect to get medical advice for diarrhœa. A child with diarrhœa should especially not be neglected when it looks pale, when it is cold and clammy in the skin, and when it lies with its eyelids half closed. The diarrhœa of children may be divided for practical purposes into two classes:—1, that which occurs in very young children in the first few weeks or months of life; and 2, that which occurs in children about and after the age of six months, during the period of teething. Both these forms of diarrhœa are most apt to occur and most difficult to cure during summer and autumn.

1. *The Diarrhœa of very Young Children.*—This generally depends on error of diet, on artificial food,

or on something faulty in the milk of the mother. The motions of the child are generally green in colour, and frequently passed. The child cries much, or gives other signs of uneasiness in the bowels. Very often some degree of vomiting exists along with this diarrhœa. Such a case as this is eminently one for good domestic management. It is impossible to lay down rules that will suit every case; but wise women will find out what food agrees with a child and what seems to poison it. This kind of diarrhœa is often seen in children that are fed with the bottle, or in other artificial ways. And it is wonderful how such children will often improve as soon as a wet-nurse is got for them. The green motions become yellow, the wrinkled skin looks plump and fresh again, and the expression of the face alters from an aged, haggard look to a happy, well-fed appearance. Where a wet-nurse cannot be procured, the best artificial food should be given, and of this, generally speaking, the best is that which is made of milk and water in equal proportions, or in the proportion of two-thirds milk to one-third water. It should be sweetened with a little sugar, and given at a temperature of 90° to 95° Fahr. It is of the greatest moment that the milk should be fresh and free from all acidity. In the way of domestic medicine, a teaspoonful or two of lime-water may be given mixed with the food, or a teaspoonful of the following mixture may be taken two, three, or four times a day:—

Chalk mixture	6 drachms.
Water	6 "
Bicarbonate of soda	6 grains.

Where this diarrhœa depends on any temporary fault of the mother's health, this must be rectified by appropriate means, especially by simple diet and quietness of mind. If the diarrhœa is not quickly removed by domestic care and treatment, medical advice should be taken on the subject.

2. *The Diarrhœa of Teething Children.*—Many children never cut a tooth without having some diarrhœa. If it continues long, or if it is associated with vomiting, or if the child is getting obviously thinner, then it should be regarded seriously, and the doctor should be sent for. The domestic treatment of it will consist in the most careful regulation of the mother's living, favouring good milk on her part; where the child is brought up by the hand, in giving suitable food, especially milk as above directed. If this produces vomiting, then give barley-water, or barley-water and milk, until the stomach settles a little. If the child is very exhausted, and lies with its eyes half closed, then a little very weak brandy and water may be administered. For example, a teaspoonful of pale brandy may be put into a wineglassful of water and sweetened; of this a teaspoonful may be given frequently. If the motions are green, and the skin hot and dry, two teaspoonfuls of the above chalk mixture may be given every three or four hours. If there is sickness or sweating, the following mixture will often answer better:—

Dilute sulphuric acid	12 minims.
Compound tincture of cardamoms	1 drachm.
Simple syrup	2 "
Water	1½ ounce.

A teaspoonful or two teaspoonfuls to be taken (according to the age of the child) every three, four, or six hours.

When diarrhœa occurs in older children than those of a year or two, it should not be checked immediately, especially if it have followed close upon some obvious error of diet. It may even be proper in this latter case to give a very small quantity of castor oil or Gregory powder. If the diarrhœa continues, then the above mixtures may be procured in twice the quantity, and a dessert-spoonful or a table-spoonful given every three or four hours. Generally speaking, it will be safe to begin

with the chalk mixture, and if this is not effective the other may be tried. If the case is urgent, however, or the child delicate, or the summer very hot, it will be proper to take medical advice at first.

Inflammatory Diarrhœa.—Sometimes, particularly in young children fed with the bottle in unhealthy large towns, diarrhœa resists all remedies, and changes its character; the motions losing altogether the appearance of ordinary motions, becoming green and sour, consisting largely of slime, perhaps mixed with a little blood; sometimes they resemble spinach or chopped vegetables. Vomiting is apt to set in. The little patient gets very pallid and thin, and soft and flabby. The case is not now one of simple diarrhœa. It requires the best medical skill, and should at once be removed from the sphere of domestic medicine.

THE HOUSEHOLD MECHANIC.

JOINTS (*continued*).

THE next kind of jointing we will try to describe is morticing. For simplicity, we will use logs of the same size as before, and will suppose that it is required to join the end of No. 2 log into the middle of the narrow side of No. 1 (Fig. 42), a T-shaped piece, of course, being the result. Plane up true, as before, and square a line, A B, on No. 2, at three and a quarter inches from the end, and continue the line all around the log. Now take the mortice-gauge (Fig. 11, page 24) and set the two points to the width of the mortice-chisel, which should, in this case, be about three-quarters of an inch, and then adjust the pair of points to mark on the narrow edges of the log two parallel lines, each at an equal distance from its respective side. The gauge is easily set by tapping with a hammer to about the right place, and then tested by pricking holes from one edge, and then reversing the action to the other edge, until the marks made from either side coincide, and when once set correctly, the screw should be tightened, to prevent the points shifting. Mark the narrow edges of the log with these points from the square marks A and B to the end, and then across the end to join them, and remove the wood on either side as far as these marks, as shown by the dotted lines, the cut in the direction of the grain to be taken with a rip-saw, and the transverse cut with the tenon-saw. It only remains to smooth off the roughness left by the saw, and this part of the joint, which is called the tenon, is finished. In the middle of log No. 1 mark round the log, with the square, two lines, A B, A B, at a distance from each other equal to the width of No. 2, viz., three inches, and mark the narrow edges, A A, between these lines with the gauge in the same position as before, and as the logs are of equal thickness, the marks will fall in the middle in this case, as on No. 2. If we now look at our marks, we shall find we have two parallel lines, *aa*, three-quarters of an inch apart, and three inches long. Turn the log completely over, and make the same gauge marks on the bottom, and a corresponding oblong slit mark, *bcd e*, placed exactly opposite A, will be the result. Next lay the log on the stool or bench, and fix it in the most convenient manner (it is usual with carpenters to sit on the work to keep it steady), and take the chisel, and holding it with the edge at right angles to the length of the hole to be cut somewhere between the two gauge lines, and the blade quite upright, hit it a smart blow with the mallet. Now, with the chisel, take a cut a little further either way, but always keeping the flat side of the blade towards the end you are approaching, and gradually advance about one-eighth of an inch at a cut, to the end of the required slit, or mortice, as it is termed. When the line A is reached, the tool is reversed from the place where the cut commenced till it comes to the B. Once below the surface, the blows of the mallet must be smart and swift, and the

chisel will be required to be used obliquely sometimes, in order to prize out the slips, which would otherwise clog the hole. About the depth of two cuts should reach the centre of the block, when the log must be turned over, and worked from the other side, until the two holes meet in one and so form the mortice. Even though the wood to be morticed were very thin, it would be necessary to commence from both sides, or the edges of the work, supposing the chisel to come right through from either side to the other, would be splintered and uneven from being forcibly bulged out. The oblique ends, E F, of the hole are afterwards cut from the top of the log, to make room for the wedges, H I, in No. 2. Clean out the ragged parts inside the mortice, with a wide, thin-bladed chisel, and drive in the tenon; from the under side, it should project about a quarter of an inch through the top. Now drive in the wedges, H I, lightly, saw off all that projects above the surface, and plane smooth. If the directions have been attended to, and the work accurately done, the joints should fit exactly, without play or looseness, and the shoulders should come well up to the under side of the block. Should it be required to remove the tenon from the mortice, before finally wedging up, the morticed block, No. 1, must be tapped on the side from which the tenon enters it. The weight of the block and the force of inertia will cause it to jerk out a little at each tap. Any attempt to force it out from the top would spread the fibres in the tenon, and rivet it more firmly in its place. This joint will tax the powers of the novice, but will be found capital practice, and in after work we shall have constant need of it, as it is about the most important joint in carpentry. The correct proportion for the thickness of the tenons is rather more than one-third the total thickness of the morticed log, but the drawing is purposely made with the tenon larger for distinctness. For the best work, two tenons are used, as Fig. 43, ranged side by side on the end of the log, and fitting into two corresponding mortices, in which case the lines ABCD are sawn down with the half-rip saw, the space E being removed with the mortice-chisel.

It is often necessary to join beams together end-wise, and in Fig. 44 we show one of many methods of doing this. The ends of the logs A and B are shaped as there shown, leaving a space at C where the diagram is shaded, and into this space the rectangular piece C is

driven tightly, thereby closing the joint well up at the angles F G, which are the holding part of the joint. At D and E, as shown by the dotted lines, holes are bored with an auger, and wooden pins driven in, making all secure and immovable. It must be remembered that no joint, however well constructed and executed, is so sound and strong as the same size of solid wood, and, therefore, piecing should be avoided, if consistent with efficiency.

We next come to dove-tailing, which, though not by any means difficult, will, nevertheless, require considerable care and dexterity to produce accurate work. We will suppose we require to make a box two feet long, one foot thick, and one foot deep, of inch material. For this, we shall want ten feet six inches of inch board, twelve

inches wide, but, as deal is only usually nine inches wide, we shall have to glue up three inches more, to make the right width. Cut up the planks into lengths of two feet one inch each, and strip down ten feet three inches wide, and cut also into the same lengths. Plane, or shoot, as it is called, one edge of each width, perfectly true, and square carefully, testing the accuracy with the square and straight-edge, and then with a brush smother the planed edges with hot glue rather thin. Now place the pieces edge to edge, and press evenly and smoothly, so as to force out all the superfluous glue, sliding the edges a little across each other. Be very careful to bring the pieces back flush and level. It will be necessary to leave these boards for some hours under pressure, and when perfectly dry, if properly done, the glue joint will be stronger

than the wood is itself. The essence of success is the complete exclusion of the excess of glue. These pieces must be carefully planed up smooth, and the edges shot and squared.

Next square up the ends, and reduce the length of two pieces to two feet and a quarter of an inch for the front and back, and of two for the ends for one foot and a quarter of an inch. The quarter inch is for a slight overplus it is usual to leave until the joint is finished, when it is planed

off true. Now rule off on the end of each of the four pieces, and on both sides, a space equal to the thickness the wood is reduced to and the above overplus. These marks, e e e e, will show the exact size of the interior of the box, when complete. The dove-tail joint, Fig. 45, consists of the pin A and the dove-tail B—the pins being usually made first—and should be on the end or short side of the

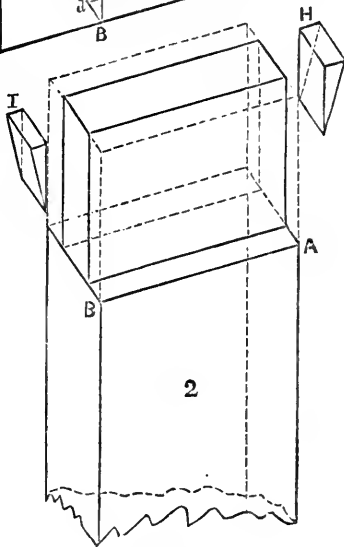
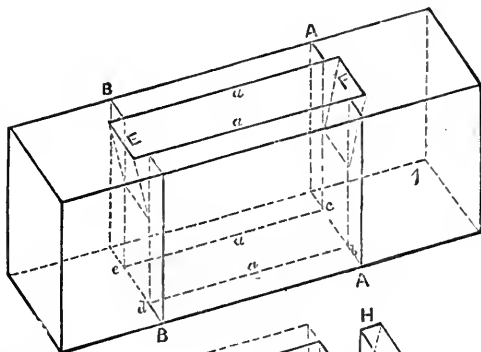

Fig. 42.

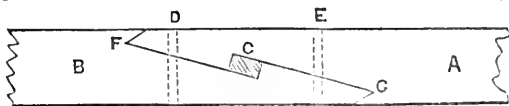

Fig. 44.

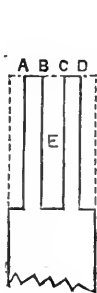

Fig. 43.

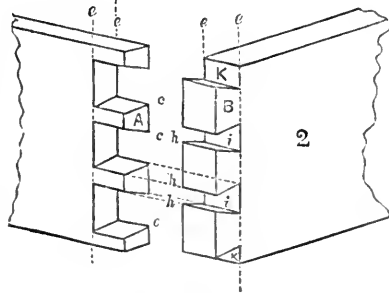

Fig. 45.

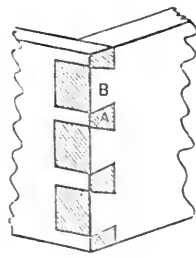

Fig. 45.

box. Take the mitre-bevel and set it to about 60° or 70° , the exact angle is not important, and set off on the edge of each end of A, the two outside pins, and any convenient number of pins between them, the bevel being reversed to mark the two sides of each pin. Produce the bevel round both faces of the board, with the square, as far as the gauge lines *ee*. Now fix the board firmly in the bench, end up, and with the dove-tail saw (Fig. 24, page 43) cut the gashes *ccc*. Lay the board flat on the bench, face downwards, and take a sharp chisel and a mallet, and give a cut exactly on the square line, *e*, between each pin. Turn the piece over and cut from the other side gauge-line until the pieces between the pins are removed, taking care that the pins should not be injured in the process. Carefully square the spaces with the chisel, without using the mallet, and trim off the roughness left by the saw on the pins.

Next take the front or back (2) of the box and lay on the bench inside uppermost, and place on it the end A on edge, with its inside edge touching the square mark *e*, and with its top and bottom edges flush with those of 2. Now, with the point of the striking-knife, mark off the bevels on the edges of each pin, and produce the lines with the square across the end of B and to the square mark on the other side, with the mitre-bevel. Saw the lines *hh* with the dove-tail saw, and remove the spaces *ii* by chiselling out across the square line, and *kk* by sawing. The pins on the ends of A will then exactly fit the dove-tails in B. The four corners of the box require to be treated in the same way, the pins being worked on each end of the shortest side or *end*, and the dove-tails on each end of the longest or *side* of the box. Glue in firmly, and, after the work is dry, carefully plane off the projecting ends. The appearance of the joint will then be as shown in Fig. 46, in which the end grain of the wood is shaded.

The bottom, which should be of thinner wood, may be nailed or screwed on, and the top should have a ledge round the front and end edges which will shut over the body. A narrow slip of wood (about three inches) nailed round the bottom and nicely bevelled or mitred at the corners, will much improve the appearance of the work and add to its strength.

For small common work, it is a very frequent practice to mitre up the edges to an angle of 45° and glue them together, and then, when dry, to make little saw cuts obliquely, alternately inclined upwards and downwards, and glue thin slips of veneer into these niches. This method is much easier than dove-tailing, and is tolerably strong. It is known as the mitre and key-joint. There are several modifications of the dove-tail joint, such as Fig. 47, which shows only from the side, and not in front.

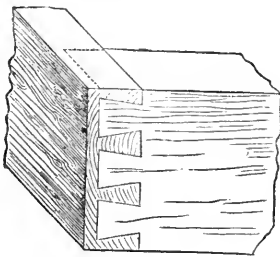

Fig. 47.—THE LAP DOVE-TAIL.

This arrangement is used for drawers in cabinet work. The mitre or secret dove-tail has the pins and dove-tails worked on a bevelled edge, and when joined up, neither can be seen at all. These, however, are required chiefly for the higher class of cabinet work.

In our next paper we shall give instructions for making and fixing a carpenter's bench.

COOKING.

FISH (*continued*). PLAIN SOUPS.

Plain Broiled Mackerel.—Moderate-sized fish are the most convenient for broiling. Open them at the belly the whole of their length. Remove the head; you may leave the tail—it will make the dish look more important. In districts where fish is a rarity, it is common to leave every fin, even on fried fish—that is, on fish truly fried by *plunging* them in boiling fat—for the sake of improving their appearance; it makes them look half as big again. When the fish is opened, and laid flat on its back, you may remove the bone; but leaving it will help you to handle it, and save all tearing of the flesh. Dry the inside of the fish with a napkin; sprinkle it with a little pepper and salt. Grill the inside of the mackerel first. After turning it, while the back of the fish is exposed to the fire, lay on the upper surface a few little bits of butter. These will melt and enrich the fish while the broiling is being completed. As soon as done, serve at once. No special sauce is usually served with broiled mackerel. Those who like it can add a few drops of catchup, or other flavouring. When broiling is not convenient, mackerel so split open can be fried. In that case, the tail-fin is best cut off. The fish must be well dried on both sides, between the folds of a napkin, and then rubbed with flour before frying. Putting butter to it afterwards is needless. No sauce is absolutely required, but anchovy sauce may be sent up with it.

Potted Mackerel.—Clean the fish in the way directed for plain broiled mackerel; cut off the heads and tails, and divide each fish across into three pieces, so as to have the shoulders, the middles, and the tails. After washing, let them drain. Have an earthen pot, a paté dish, with a cover of the same material. A common glazed deep stoneware pot, with a wooden cover, will do in case of need. At the bottom put a layer of mackerel; season with salt, ground pepper, whole pepper, bay-leaf, and cloves. Then put in more mackerel, and season again, and so on, until all is in its place. Over this pour a little more vinegar than will cover the mackerel. If, however, the vinegar be very acid, or if it be desired to keep the fish for any time, the vinegar must be diluted with cyder, water, or beer; because, in either case, too strong vinegar would dissolve the fish, instead of allowing the flesh to remain firm, which it will do if the strength of the liquid is nicely adjusted, even after the back-bone has become so soft as to be eatable. Cover the dish or pot with its lid, and set into a slow oven for an hour or two—if *very* slow, it may pass the night there. Mackerel so potted, and closely covered, will keep good for a week or a fortnight, or longer. It may be eaten with a little of its own liquor poured over it, to which a little salad oil is a great addition when people are not frightened by the words "eating oil." With the accompaniment of a well-dressed salad, it makes a nice cool supper dish after a fatiguing evening's work. It is economical, because the mackerel can be bought when they are plentiful and cheap, and kept in this way till their season is over. Potted mackerel, too (being classed with *hors d'œuvres*, works of supererogation, side dishes, kickshaws), may be presented even at wealthy tables, as a supplement to any meal.

Pickled Herrings, French Way (excellent cold).—Towards the end of the herring season, the fish is often very cheap; but it is better to pay a trifle more before they are shotten. Choose herrings which, retaining their shape, are plump, and not too bloodshot about the eyes—*i.e.*, which have not been crushed together in large heaps, either in the fishing-boats, or in casks, or baskets. If many of the scales come off, it is a sign they have so suffered. For this reason, when you live near the coast, the fishings of small boats are often to be preferred. The

herring is one of the fishes which die almost instantly they are out of the water. Comparatively few people have seen a *live* herring. Scale your herrings; draw the entrails, leaving the milts and roes in their place; cut off their heads, wash them, wipe them dry with a cloth; salt them four-and-twenty hours in an earthen vessel. Then put them into a well-tinned or enamelled saucepan with whole pepper, cloves, sliced onions, and bay leaf. Pour over the fish enough vinegar and water to cover them, set them on a brisk fire, and let them boil *two minutes*. Take them off the fire, and let them get nearly cold in the saucepan before you put them into the covered dish in which they are to be kept for use. Arrange them in that with care not to break them; pour the liquor over them, put on the lid, and set them in a dry cool place. Sprats and pilchards may be pickled in the same way; indeed, all that is directed for herrings, is applicable to the latter of those fishes especially.

Fresh Herrings, Broiled.—Frying herrings is a needless expenditure of fat; their flesh is quite oily enough in itself to broil them, and they will need no butter to be eaten with them, particularly if they are salted for a night, which renders them firmer, and improves their flavour. Scale the fish, draw the entrails without opening them; score them crosswise on each side in two or three places, cutting the flesh down to the backbone, but not dividing that. Heat your gridiron, and then lay your fish upon it over a clear fire, into which (if of coal cinders) you have first thrown a little salt. While the fish are broiling, raise them gently now and then to prevent them sticking to the bars. When well done on one side, turn them to the other without breaking the skin. Although they should not be dried up, they require thorough cooking, especially if they have roes and milts. Serve on a hot dish, immediately they are taken off the gridiron. They need no sauce, but a little salt and a hot mealy potato are proper accompaniments.

Siamese Herrings, Broiled as Twins.—Scale your herrings, cut off their heads, open them at the belly the whole of their length, from the tail upwards. Flatten them; with great care, draw out the backbone, and remove any little bones that have not come away with it. Sprinkle the inner surface of each fish with pepper, salt, and a dust of flour. Then place them together in pairs, pressing the two inner surfaces into as close a contact as you can. Lay them on the gridiron; when the undermost fish is broiled, turn them with a pair of tongs or between a couple of spoons without separating them. When thoroughly broiled and served on their dish, each person can have a pair of herrings still holding together, as his rightful portion.

Red Herring.—Lay a red herring in a deep dish, pour *boiling* water over it, and let it lie there five or ten minutes, according to the degree of dryness and saltiness. Take it out of the water, peel off the skin, open it at the belly, and by laying hold of the head, carefully draw out the backbone and every little bone that springs from it. Lay the herring-flesh on a board, and cut one-half of it into long narrow strips or fillets, the whole length of the fish, the other half into small squares. Make some buttered toast; cut each round of toast into quarters. In the middle of each quarter lay a square of herring-flesh, encircling it with one of the narrow strips. This will give you mock anchovy toast. Slice bread and butter; lay squares and fillets of herring upon it; place another slice of bread and butter over it, and you have mock anchovy sandwiches. Put a few bits of herring-flesh into a mortar; pound them well. Put them into a saucepan with a lump of butter, and some flour and water. Keep stirring in one direction till they are mixed thoroughly and smooth. When it boils, you obtain mock anchovy sauce, to be eaten with beef steaks or fish. N.B. If this and similar sauces *oil* in the making, the introduction of a small

quantity of *cold* water will set all to rights. The same pounded herring-flesh may be used in a similar way to essence of anchovies, for heightening the relish of several brown soups—*haré*, soup for instance.

PLAIN SOUPS.

Boil some water in a saucepan, with a clove of garlic chopped small, and a small quantity of salt. Cut very thin slices of bread into a soup-tureen, pour over them a table-spoonful of good eating oil, grate a little nutmeg over them, and, when the water boils galloping, pour it over the bread. This, which is the genuine Provençal water boiled, does not read like a very substantial mess; nevertheless, a hundred thousand families in the south of France have nothing else but this for breakfast, and enjoy good health, notwithstanding. You may make the same kind of thing, only better, thus: If you dislike, or have not, garlic, chop two or three onions into a saucepan of new milk, or skimmed milk, or even butter-milk. Put slices of bread and butter into your soup-tureen, grate nutmeg on them, and pour your boiling milk over them. Let the tureen stand to soak three or four minutes before the fire, before serving. Instead of buttering the bread, you may use unbuttered slices, and, to make up for the deficiency of oily matter, boil some finely-chopped suet with the milk, which will be found a very tolerable substitute.

Cabbage Soup (from "Wholesome Fare, or the Doctor and the Cook").—Please try this. Wash thoroughly, and shred very fine—as if for making pickled cabbage—the hearts of one or two summer cabbages, or of a very delicate savoy, according to size. Slice and mince some carrots, turnips, and two or three leeks, all very fine, and mix these chopped vegetables well together in a salad-bowl. Have ready a good broth; pork or beef-boilings will do, when not too salt—the great point is that the *meat* should not have been *too long* in salt; not more, say, than three or four days—French cooks prefer a *variety* of meats boiled together; for instance, a piece of lean beef, a knuckle of veal, a small piece of salt pork, and a bit of the neck or shoulder of mutton. These meats should not be cooked so much as to render them uneatable, either cold or warmed up in a stew, or even served hot at the same dinner at which the soup appears. (Thus, the beef, served in the middle of a stew made of sliced carrots, turnips, and onions fried brown, will be welcomed as a dish of beef *à la mode*; the veal, covered with a little parsley and butter, will be excellent boiled knuckle of veal: the neck of mutton, masked with caper or nasturtium sauce, accompanied by mashed turnips, will give you the Welshman's notion of heaven; and the pork, cold, will be delicious for breakfast, or to cap a thumb-piece in the field.) For these purposes, they are invariably used in France, instead of being thrown out to the dogs, as broth-meat too frequently is in England. When the meat is enough done, according to your judgment, take it out, make the broth boil galloping, and then throw in your bowlful of well-drained shred and chopped vegetables. Let them boil on, without the lid, till the cabbages, &c., are quite tender, but not cooked to a mash. While the vegetables are boiling, slice and chop one or two large onions; fry them, in butter or dripping, to a rich brown. If more convenient, they may be prepared beforehand, and set by, cold, till wanted. Add them to the soup, and mix them up with it.

Meagre Cabbage Soup, for abstinence days, is made in the same way as above, using water instead of broth, and often adding to the cabbage a large handful of chopped sorrel—an excellent anti-scorbutic and purifier of the blood. A larger quantity of fried onions is used, and, at the time of adding them to the soup, a small basinful of grated crumb of bread is also incorporated with it, to make it more nourishing.

THE REARING AND MANAGEMENT OF CHILDREN.

II.—CLOTHING FOR INFANTS (*continued*).

THE fashions change in regard to babies' clothing as well as in the toilettes of the more mature, but usually less often and less conspicuously. The greatest alteration that has been made for some time is a very sensible one, and affects the length of the little ones' toilettes. Robes that once reached absurd proportions are curtailed to the length of a yard; nothing is to exceed this; the yard may even include the bodice. Of course, the petticoats and flannels are all shorter in proportion. In our last number we promised another description for a chemise and a flannel. The chemise we now describe is cut precisely like the first, but sleeves are added. Instead of hemming round the open sleeve edge, as before described, the little sleeves are added in, and help the better to cover the baby's arms. For the sleeve, cut a piece of the cambric four inches wide and eight inches long. Hem it along the upper edge, then unite. Unite the edge A B to the edge C D, Fig. 24, in a kind of loop, as shown in Fig. 18. When laid down flat on the table the loop takes the form of Fig. 19. E is run and felled into the chemise. F is the outer edge of the sleeve already hemmed. Two other ways of making sleeves are shown by Fig. 16. The first, a finely-drawn piece with a gusset; the second, as a frill drawn at one end only; both are edged with lace. Another way of making the baby's flannel is shown in Fig. 23, which represents the back of the little garment, and Fig. 21, which displays the front. The back has either three or four box-plaits in one with the back breadth of the skirt. The front of the bodice is made of two plain pieces wide enough to wrap over one another, and joined by a band (which also goes over the plaits behind) to the skirt in front, which wraps over and ties on one side. The dotted line L shows how far the body of the flannel folds over on the under side. M shows where the under skirt ends, and is buttoned to the upper one. The third way of making a flannel, very suitable for summer, is given in Fig. 28. A strip of flannel six inches deep and fourteen inches long, from G to G, is cut away to points each side, H and H. This is bound all round. The skirt is plaited and set on

from I to I. There are semicircles for armholes cut and tape straps added at K and K. The dotted lines show the portions meant for the back, and to wrap over in front. The points are folded round the baby's body, and tied by strings sewn on at H and H. Another necessary item will be twelve yards of good linen diaper, a yard wide. It will cost about one shilling and sixpence a yard. Cut twelve squares from this, hem them round, and fold four times. For a pilch to wear over the squares, take a square of flannel, fold it shawl-shape, and cut it in half. Take off the two shawl ends, marked by the dotted lines N and N in Fig. 22, and gather it into a band, as in Fig. 17, about fifteen inches long. Button it at R and R, and add a loop at O also to fasten on to the buttons at R.

The House Cloak or Flannel Wrapper.—A yard of flannel twenty-seven or twenty-eight inches wide will be required. This must be shaped to an exact square of twenty-eight inches. To cut a square of anything always fold your material across, as shown in Fig. 13, bringing the material where it is cut across equally to the selvage at B. The fold comes at the dotted line C C, and when folded the material resembles Fig. 15. Cut it off at the dotted line D D D, you then have a square exact. To cut the baby's wrapper, keep your square folded, as shown in Fig. 15, and cut it out as shown in the plain line in Fig. 30, the dotted line indicating the folded square. To ornament the flannel, work it all round the edge in

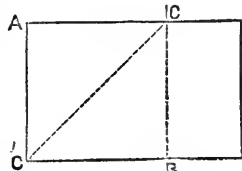

Fig. 13.



Fig. 14.

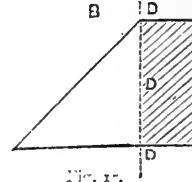

Fig. 15.

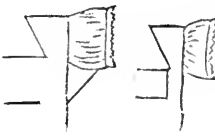

Fig. 16.

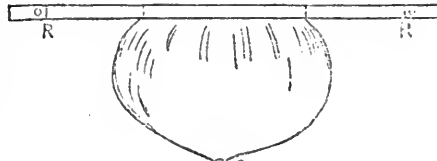

Fig. 17.



Fig. 18.



Fig. 19.

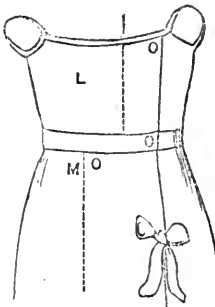

Fig. 21.

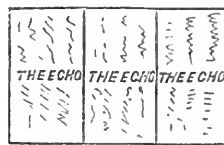

Fig. 23.

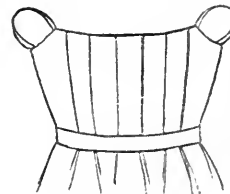

Fig. 24.

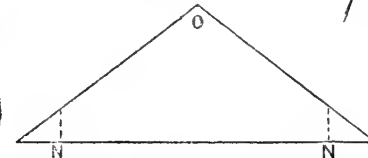

Fig. 22.

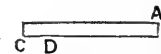

Fig. 28.

scallops with blue or scarlet crochet silk, and work a dot in every scallop. To scallop the edge cut a card out, like Fig. 31, cutting holes for the rounds. This can be done by tracing the outline on the card first. Then with a red chalk pencil mark the scallops and holes all along the edge of the flannel. Run them over with cotton, afterwards button-hole the edge in silk, and work the large dots in satin stitch. On the wrong side of the flannel square, at the dotted line marked S, in Fig. 30, put on a ribbon case, and run in a string to draw the hood round the baby's neck. This flannel square is worn over the dress in the house during the month; and afterwards when the child is carried from room to room. In another number we shall describe some babies' frocks and petticoats.

The Baby's Cloak.—It has been very usual lately, and more fashionable, to drape a baby in a simple deep circular cape out of doors, in preference to the old cloak

with its cape. There is no essential difference in the pattern needed. The cape is merely a cloak without its second cape, and with the trimming differently arranged. If a young mother has not a pattern for the purpose she can easily make one herself. In the first place, let her take one or two old newspapers—we will suppose she takes *The Echo*—and tack three of them together neatly with needle and thread, as shown in Fig. 20. The centre of these united papers must be ascertained by doubling them. Then spread them out upon a table that has a cloth upon it. Pin the end of a yard measure securely to the centre, through the cloth at the top of the paper. Then take

of colours. Cashmere washes well, and dyes equal to new. A very pretty circular cape can be made of white cashmere, trimmed with bright, light blue llama. A design for this is given in Fig. 26. The llama is put on broadly; it must be cut to the curved shape of the cloak, and joined in breadths; it encircles the lower edge, and is rounded off towards the front. Up the front several handsome blue ribbon bows are sewn on, and the cloak secured beneath them by hooks and eyes. The llama should be tacked on flat after the breadths are joined, and very fine cotton should be used for the purpose. Turn in the upper edge, and sew it down with a narrow white silk braid. A

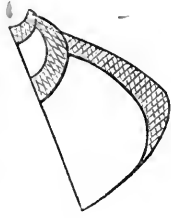

Fig. 25.

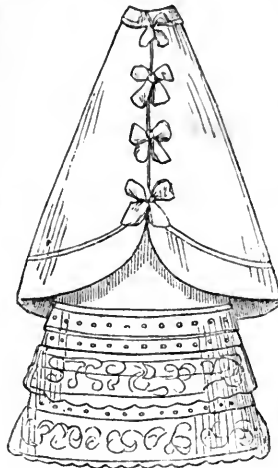

Fig. 26.

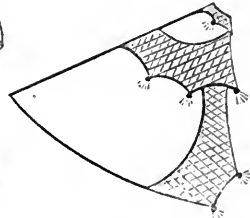

Fig. 27.

figure thirty-six inches denotes the yard, and move it from end to end of the paper, holding a pencil in the same hand to mark its movements. The yard measure is pinned at A in Fig. 29, and moves from B to G at the other end, the thirty-six inches, or yard, marked on the tape, and then again from B to G. The line in the centre, it will be observed, is exactly straight, being rendered so by folding the paper after the circular line is made. Having marked the half circle thus described with a pencil, allow it at the line C and G, each side of the centre B, five inches shorter, according to the dotted line D D. Pencil this nicely off as shown in the illustration. Now cut out the pattern with scissors; fold it together, and give the corners the little slope or curve marked at E and F.

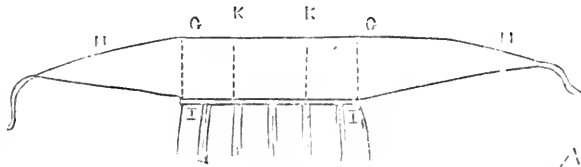

Fig. 28.

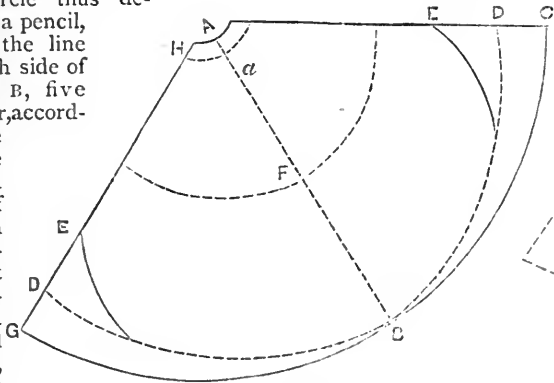

Fig. 29.

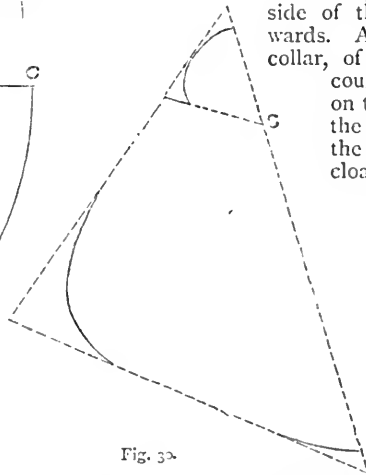

Fig. 30.



Fig. 31.

When a cloak is to be made it is cut just the same, but a cape is formed two-thirds of the size, at the dotted line marked F, and a collar at that marked A. For a baby's circular cape a collar is added, but the trimming is put on the neck like a collar, and of the same shape. Either cloak should measure in the longest part, that is, from the neck to the edge in the centre of the back, not more than one yard; a circular cape rather less. Having obtained an accurate pattern it is easy to cut the material. Two yards of cashmere at 3s. 6d. or 4s. a yard is required. White is the most esteemed, and scarlet the most durable

handsome cloak may be lined throughout with white sarcenet; but it is very general, and far less costly, to use fine white cambric for the purpose. Having tacked on the blue trimming, and neatly run it into the braid at the edge, put the lining upon

the cloak face to face, and tack it round, leaving the outside of both visible. Run it nicely together at the edge, and then turn it inside out, so that the right side of the cloak is outwards. A trimming, like a collar, of the blue has, of course, been placed on the cape as well as the broad edge. Add the bows, and the cloak is complete. It is very easy and very simple to make. The trimming may be of silk instead of llama, and quilted instead of plain; no braid is then needed.

In cutting the newspaper pattern, we should call the reader's attention to the fact that it must be doubled after cutting to see that both sides are alike. Indeed, it will be as well to cut it in half from A to B at the dotted line down the centre. The cashmere is cut in two pieces, the seam coming down the back of the cloak, unless it is wide enough to get the whole cloak without a seam. Pin the pattern thoroughly on the material; double, before cutting.

To make a cloak, as before named, the same directions must be followed, and the cape and collar cut on a similar plan, but smaller. The cloak is trimmed down the front,

as shown in Fig. 25, the trimming becoming wider, and rounded off at the end. The cape is ornamented all round, and so is the collar. The cloak may be of white, grey, scarlet, crimson, or blue cashmere, and the trimming of sarcenet, either white, or of the same colour as the cloak, lined with a little wadding, and quilted. The wadding is tacked to the silk, and the quilting done, the silk being shaped and the breadths joined before it is applied to the cloak. In using a sewing-machine keep the wadding uppermost.

Fig. 27 offers a pretty design for a baby's cloak; the edges scalloped and pointed, and trimmed with a small tassel at every point.

It is decidedly best to buy the baby's hood. The cap worn under the hood is a caul with a full lace edge. The lace must be removed to wash it, and requilled each time. A boy's hood is distinguished from a girl's by a rosette. A hood, as soft as possible, is a better covering for a baby than any fancy kind of hat, however pretty it may look. The stiffness of a hat is unsuited to the tender softness of a baby's head; neither is it any protection to the child. Caps are only worn under hoods, and not indoors.

In Fig. 26, under the cloak, a pretty design is given for a handsome frock. It is made with two flounces and work between; one row over the first flounce and two over the second. The flounces may be worked, or of plain fine muslin edged with work or lace. Fig. 14 is a design for a body to wear with this skirt. The braces match the flounces. The stomacher is embroidered; and bows tie the shoulders.

INMATES OF THE HOUSE—LEGAL.

III.—LAW OF WILL-MAKING.

What is a Will?—A will or testament is the legal expression of a man's wishes in respect of matters that he desires to have attended to after his death. If the dispositions to be made by a will are very complicated or numerous, the wisest plan is to have the will drawn by a lawyer, whose charges it is far better to incur than to run the chance of the will being disputed or set aside after the testator's death. But in cases of simple bequest, whether of land or movable goods, and even in difficult cases if the testator is quite sure he can express his meaning simply and clearly, there is not any need for the intervention of a lawyer. Sudden necessity, remoteness from professional help, desire to keep within one breast the particulars as to property and to bequests—these and other causes might render it desirable that one should know how to make a will for oneself.

How to Make a Will.—There is not any prescribed form in which a will must necessarily be made, and when an unprofessional person is going to make a will he must carefully get rid of the idea that any form is possible. Let him write his wishes down as simply and easily as if he were writing a note, avoiding the use of all technical expressions, and aiming only at making himself intelligible. Many persons have frustrated their own intentions by introducing into wills made by themselves technical terms of the exact meaning of which they were ignorant, and which had to be construed according to the technical signification. Formerly it was of the highest importance that wills should be so worded that no other meaning than that intended should by any possibility be placed upon them. Then it was almost indispensable that the services of a lawyer should be retained. Now, however, a will is construed according to the evident intention of the testator, however badly he may have expressed himself, so that the simpler the wording of the document the better. The whole law of wills was remodelled on this principle in the first year of the reign of her present Majesty. The only conditions imposed upon testators are

conditions which are meant solely to guard them against the mischief of fraud, and to prevent their being subjected to undue influence in the making of wills. They are :—

1. The testator must be of sound mind, and not less than twenty-one years of age.
2. His will must be written, the only exceptions to this rule being soldiers and sailors, who may, in consideration of the service in which they are engaged, make verbal assignments of their property.
3. The will must be signed by the testator, or some one acting for him at his request, in the presence of two witnesses, both present at the time, who must also attest the testator's signature.

The testator's signature must be placed at the end, or at the side of the will, or, indeed, in any place where it will be apparent on the face of the will that the signature was intended to give effect to the writing signed as his will. The signature will not give effect to any bequests *underneath or following it, or inserted after the signature is made*. These are the only essential conditions. With regard to the last it is sufficient if the signature is made under the required circumstances, which can be sworn to by the witnesses, but it is better to have a memorandum to the effect that the conditions have been complied with. Such a memorandum saves much trouble. The usual form of it runs thus :—

Signed by the testator, *John Hopkins*,
and acknowledged by him to be his
last will and testament, in the presence
of us present at the same time, and
subscribed by us in the presence of
the said testator and of each other.)

Who may Make a Will.—Any man or unmarried woman of sound mind, and of the age of twenty-one years and upwards, may make a will. Ordinarily, married women cannot make wills, because they have not anything to bequeath, their property, by a rule of law, becoming the property of the husband on marriage. Where, however, a woman has property settled upon her for her own use and benefit, with power to dispose of it by will, she may dispose of the same by will made in the same way as any other will.

Witnesses to a Will.—Any one capable of understanding what he is about, and able to write his name, may witness the signature of a testator; but it must be remembered that *a witness cannot receive any benefit under the will*. Should a bequest have been made to him it is taken away by the mere fact of his being a witness, and the portion he would have taken goes to the residuary legatee. If, therefore, it be intended to give anything, let it not be to him who is to witness the signature. An executor or trustee may be a witness, subject to the above rule about bequests. The witnesses may be as many more than two as the fancy suggests, but two there must be. They must both, and at the same time, see the testator sign the will; and they must, unless there be good reason why not, sign a memorandum to the effect that they have done so. There is not any precise clause of attestation, but it will be as well to use that already given.

Unwritten Wills.—The only persons who are allowed to make wills orally are soldiers actually engaged on some expedition, or sailors actually at sea. To them it is permitted to make wills orally in consideration of their being, by the nature of their calling, constantly in the face of death, which may surprise them at any moment. So far as sailors, however, are concerned, there is a rule of the Admiralty that any will disposing of pay, prize money, or anything else which would have to pass through the Admiralty Office, shall be reduced to writing, either by the testator, or some one writing at his request.

What may be Bequeathed by Will.—Anything and everything that a man possesses or is entitled to may be bequeathed by will. Formerly this was not so. It was a rule of law, founded on the Roman code, that a man could not leave the whole of his property away from his family. The Roman law obliged him to leave a fourth, at least, to those who were naturally dependent upon him, and the English law gave to the children of a testator their "reasonable part," which was calculated with reference to the man's position in the world. Now, however, a man may do just what he likes with land or money, with this one restriction—he may not bequeath land, or money to be spent in buying land, to any religious or charitable institution. If he do, the dead hand (or mortmain) shall recover the bequest for his family. The object of these restrictions is to prevent people from making death-bed dispositions, perhaps under undue influence, in favour of charities to the disherison of their lawful heirs. A gift of land to a charity must be preceded by a licence from the Crown authorising the gift, and must be by deed executed in the presence of two witnesses twelve calendar months before the death of the donor, and enrolled in the Court of Chancery six months after its execution. Money, however, may be left to a charity or a religious institution so long as it is not directed to be spent in the purchase of land.

Codicils, or "little writings," are the expressions of a man's wishes conceived after his will is complete. By their means he can revoke the whole or part of his will, make fresh dispositions, or re-arrange the dispositions already made. They are made in exactly the same way, and under the same conditions, as wills, but instead of being described as "the last will and testament," they are called "codicil" or "codicils" to "the last will and testament."

Revocation and Nullification of Will.—A will is considered to be revoked by another subsequently dated, and is of course so by any codicil, memorandum, or writing made as and for a fresh will, in which the former will is expressly declared to be revoked. The only act by which, *ipso facto*, a will is nullified, except as above, is by the marriage of the testator. Formerly a number of events, as the birth of a child, an alteration in the condition of a man's estate, nullified a will; marriage is now the only revoker.

Probate of a Will.—When the will-maker is dead his executors, if they mean to act, should prove the will; to do this, they must make an inventory of all the property of the deceased, and have it valued. Knowing the total amount of the property, they should go to the registrar of the Probate Court (local registries exist all over the kingdom), before whom they must swear to their belief in the signature to the will being the signature of the testator, and that the amount of the property does not exceed the sum estimated. If the will be not disputed this is sufficient proof, the will is given up to the Court of Probate, and an official copy is made of it, which is delivered to the executors, and is called the probate copy. This is the warrant for the executors to act in the administration of the estate. Probate duty, which varies according to the amount of the property, is charged and paid before the delivery of the probate copy. If the will be disputed it must be proved *in solemn form*; the witnesses to the will, and any other witnesses whom it may be thought necessary to summon, are examined and cross-examined in the Court of Probate, and the will is admitted to proof or not, according to what may appear. A will once proved in solemn form cannot be disputed afterwards; the executors to a will proved only in common form are liable to be called upon at any time within thirty years to prove it in solemn form.

Executors and Trustees.—The persons appointed by a testator to be his executors, or to be trustees in any trust

provided for in his will, may, if they choose, renounce the office, either at the time of their appointment becoming known, or afterwards. In such cases the Court of Chancery, administering the prerogative of the Crown as father of the country, takes the vacated places, and the will is administered by the officers of the Court. If the executors accept office, they are to all purposes the representatives of the deceased testator. They may even before receiving probate do all necessary offices for the deceased; thus they may incur charges for burying him, and for supplying the immediate wants of his family; they may seal up his papers and take possession of all his goods, for the purpose of protecting them. Having received probate, they may do all things that their testator might himself have done; they may bring actions to recover debts due to him, and they are the proper defendants in actions for debts, &c., due from him. It is their duty, *within a reasonable time*, to get in the whole of his estate, and to pay, 1st, the reasonable funeral expenses, and the cost of proving the will; 2nd, debts due to the Crown for taxes, &c.; 3rd, debts due on judgments obtained at law, or on decrees made by the Court of Chancery, and debts due on recognisances; 4th, debts on bonds, covenants, and the like, not under seal, and debts for rent of any kind; 5th, simple contract debts, that is to say, debts on contracts written but not sealed, and debts incurred without any writing to prove them, as tradesmen's bills, or wages; 6th, the legacies; 7th, the residuary legatee. An executor is bound to pay away the estate in the order mentioned. If there should not be enough to pay all, he must pay the higher classes of claimants as far as the money will go, leaving the rest; *and he is personally responsible to a higher class creditor* if he has paid, through neglect or inadvertence, a creditor of the lower class, and have not money left to pay the higher claim. If he have complied with these conditions in administering the estate, he is protected against all the world on proving his plea of *plene administravit*. It is competent for an executor to renounce *after* he has begun to administer. In that case he must account for what he has done so far to the Chancery Court, which will then take over the charge for him.

Intestacy—Administration.—A man dying without a will is said to be intestate. In such case, and in the case of a will being set aside as having been made when the testator was insane, or under undue influence, the Court of Probate will grant power to the widow, or the next of kin, to administer the estate, according to certain known rules of law. The court must be satisfied as to who is next of kin, and also as to the amount of the intestate's property, then it will on application grant letters of administration. Landed property will go to the heir-at-law, and personal property will be divided according to directions laid down in an Act of Parliament called the Statute of Distributions. Where a widow and children are left, one-third of the personal property goes to the widow, and two-thirds go to the children; where there is a widow and no children, half goes to the former, and half to the next of kin; where neither widow nor children, the whole goes to the heirs of the intestate's father, who divide it equally, females as well as males. In dividing personal property the law makes no distinction of sex, but gives to all equal shares. Where a man dies intestate, and no claimant at all appears, the Crown, as the ideal owner of everything in the kingdom, or belonging to any subject of the same, puts in its claim, and takes the whole of the property. Where a person dies under circumstances that cause his property to be forfeited, as when he dies by the hand of the law, for treason or murder, any will he may have made is void, and the Crown takes his goods. On petition, however, the family of such a man are allowed the property.

HOUSEHOLD DECORATIVE ART.

II.—DIAPHANIE.

DIAPHANIE is the art of imitating the most beautiful and costly stained glass by the inexpensive and exceedingly simple process of transferring a species of chromo-lithograph in transparent colours to the surface of an ordinary pane of glass, and may be used not only as an embellishment, but as a method of shutting out, and hiding an unsightly view, such as black walls, chimneys, &c., so frequently eye-sores in a town residence.

The art was first practised in France; the original method consisting in printing the subject in colours upon tissue-paper, which paper was permanently fixed upon the glass, by which means the light was intercepted, and the brilliancy and transparency of the colouring destroyed. This system has been improved upon, and by the method now practised, the colours themselves are transferred to the surface of the glass, while the paper is removed, leaving a most perfect imitation of stained glass, upon which neither the violence of the summer sun nor winter frost has any effect. Nor is the art applicable only to windows; it may be used to ornament fire-screens, lamp-shades, Chinese lanterns, and fancy panes in conservatories, and is in fact available for every purpose in which the combination of transparency and ornament enter. The designs used for diaphanic are produced by a new process of lithography, and are mostly copies from well-known and valuable subjects; these you purchase in sheets, and arrange at pleasure, taking care, however, not to mix up designs belonging to different periods. Numbers of beautiful designs are sold at all the paint and oil warehouses, where there is always to be found an extensive choice of subjects, sacred, mediæval, and picturesque, according to the device and subject required. The simplest plan of proceeding is to have a pane of glass to work upon the exact

size of that in your window; this, with the design, a few sheets of lead-foil, a bottle of each transferring varnish, clearing liquid, washable varnish, a roller, and a flat brush, is all that is required.*

In the first place, the artist must be very sure that the pane of glass is free from imperfections, such as specks and bubbles, and scrupulously cleansed; of course, if it be already fixed in window frames, you must take it as you find it.

Being assured the glass is all right, lay it flat upon a folded cloth; then trace the outline with a pencil line; those portions where the border ground-work and subject join to serve as a guide for the laying on the lead-foil and the designs which should have previously been cut out. The lead-foil should be cut into strips the width of one-eighth of an inch, though they may be a little wider or narrower, according to the size of the window you desire to decorate, or to the taste of the operator. The lead-foil is to give the effect of the white glass which forms the borders of most coloured glass windows, and when put on the glass it looks quite transparent.

In making the pattern, the designs may be cut out and arranged to show the effect of the composition. Next lay the glass upon the pattern according to the method shown in Fig. 1, and cement upon it the tin-foil previously cut in strips to the proper width; gum is found to be the best cement for laying on the tin-foil. For circles and other shapes the straight strips of foil are cemented, and when nearly dry, stretched with the fingers of one hand, and pressed down with the thumb of the other. No attention need be shown to the creases which may come in the foil, as the smooth handle of a knife or paper

cutter, slightly wetted and rubbed over them, flattens and

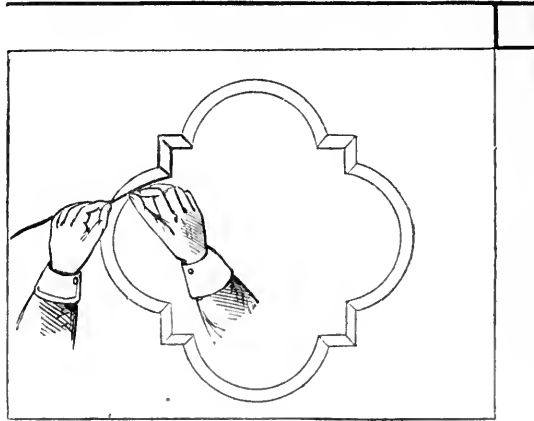

Fig. 1.

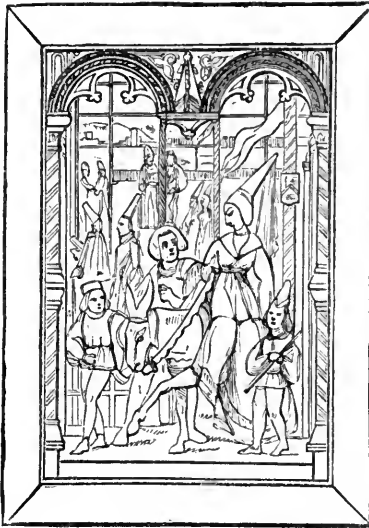

Fig. 2.



Fig. 3.

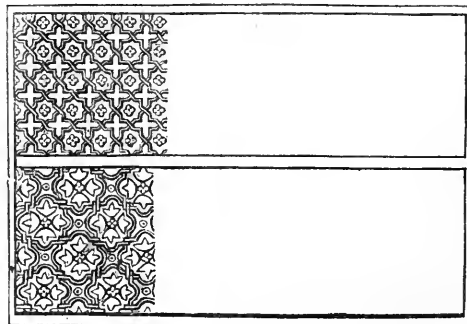

Fig. 4.

* Rollers of the best description, 2s. 6d.; transferring varnish (per bottle), 1s. and 1s. 6d.; clearing liquid (per bottle), 1s. 6d.; washable varnish (per bottle), 1s.; brush, 2d.

makes the foil flat and even. Having arranged and allowed the foil to be firmly fixed, you can proceed with the laying on of the designs, which should be a little larger than the foiled spaces made ready for their reception, so that the foil may overlap the edges. We cannot enjoin on the beginner too much neatness and care in this operation.

In laying on the designs; the uncoloured part of the paper must be made quite damp with a sponge; then put on the glass and the painted surface a thin coating of the cement. Care must be taken that no air bubbles remain between the glass and the prints; and the papers must be kept damp while the operation is being carried on, for if the cement be allowed to dry, the transparency will be destroyed when the clearing liquid is used. It is a good plan to commence rolling in the centre and working outwards, by which method any superfluity of varnish will ooze out at the edges, and not damage or destroy the surface of the picture. The work having advanced thus far, it should be carefully laid aside for two days at least, or even for three, after which you may begin to remove the paper.

The next operation is to remove the paper; this is done by once more wetting it, then rubbing it gently and evenly with the hand, a sponge, or piece of cloth, the work being kept damp all the while, and great circumspection used, lest by undue pressure any blemish be caused; this must be specially guarded against when, the greater part of the paper having been removed, the painted surface alone is exposed to the hand or cloth, and is liable to scratch or rub off. After the glass has been allowed to dry thoroughly, a thin coating of the clearing liquid is to be applied, and when this has become dry and hard, the work should be re-foiled, over the edges of the transferred picture, following the lines of the first foiling, and proceeding in the manner described before; after which, one or two coatings of the washable varnish completes the work, which must dry and harden thoroughly before it is inserted in the frame-work of the window.

This same art may be applied for the adornment of window blinds, &c., upon muslin or silk. The operation consists in stretching either material tightly on a frame, taking the sheets of design, laying the plain side upwards to receive the diaphanous liquid which is put on with a brush; when dry, another coating should be given. A coating of cement should now be applied to the coloured side of the paper, taking great care to press it equally with the roller. There is now nothing left to the completion of the transparency but to varnish it. If the picture be misty, the diaphanous, or clearing liquid, should be used again. Ordinary engravings can be printed on glass in the same manner as the painted designs. The engravings which are to be used should contain no size. The plain side of the picture should be damped with a sponge. Apply to the other a coating of washable varnish; then warm the glass, lay on the print, press with the roller, and place it at some distance from the fire to dry. The next process requires great care, or the beauty of the engraving will be injured. Damp the print again with water, and rub off the superfluous paper after this, and when the miniature has been absorbed, apply the clearing liquid with a camel's-hair brush; and lastly, when it is thoroughly hardened, the washable varnish can be applied, and the work is then finished.

If the learner of the art of diaphanic pays close attention to the exact rules laid down in this article, there will be no difficulty in becoming proficient in this very elegant art, by which every house may be improved in its decorations. Of the diagrams with which this paper is illustrated, Figs. 2 and 3 are designs suitable for a hall window. Fig. 4 shows two patterns for groundwork or

COTTAGE FARMING.

I.—DRAINAGE (*continued*).

IN draining roads, a drain at each side is more effectual than one in the middle. If the road is broad, and the ground wet below, an additional drain in the middle may be necessary; but if there is much traffic on the road, so that the surface becomes consolidated and close, the water will not sink to the middle drain, and hence, if without side drains, will flow at the sides, wash away light material, and keep the road unsightly. But with a drain at each side, as shown in section, Fig. 1, the road may be kept dry without either flowing or stagnant water, if attention is properly paid to the side-drainage by the removal of silt and the cutting close of the grassy edge.

Thus, in the section, *a b* is the ground on either side, *c* the middle of the road, *m* and *n* the two sides, and *e e* the two drains, filled with porous material to the top immediately below the grassy sward at each side. As fast as the rain falls upon *c*, it flows to *m* and *n*, and thus percolates into the drains before it has had time to accumulate.

Another plan, well adapted for a cottage road, is a light tramway of stone sunk an inch or two inches below the general surface, the two trams serving the double purpose of ways for the cart-wheels, and for rain-water.

When the meadow is flat, with a moist or wet bottom, it is naturally very liable to rut in the spring time while carting and top dressing are in progress; or if you have wet weather, then in harvest time. To obviate this as much as possible a road is formed across the middle, but of such a character, as to yield grass and hay in as great abundance as the rest of the field. This is done by opening two drains, as in Fig. 1, and digging out a shallow spit, the turf having been previously removed by a banking or paring tool. Brickbats, broken stones, gravel, and any rubbish capable of supporting the cart-wheels and horses' feet are carted in, and laid in such a manner as to encourage the roots of the grass to penetrate downwards. This is rolled, or made flat and smooth, and the turf relaid and copiously watered, if the work has been done in the summer time. Such a road, although it would not stand much continuous carting, is amply sufficient for the purposes of the meadow.

Levelling.—This, in small farms, is generally done with the barrow and spade, during such spare time as the cottager may have. Stagnant waters being highly injurious to cattle, and unsightly and cumbersome to the ground, should be removed by draining off and filling in the pond. It will be seen if the earth formerly dug out to form the pond has been laid on the margin; if so, you have the material to fill in at hand. This also applies to superfluous ditches and hedges, there being sufficient material to do the work of levelling, without seeking it from a distance. In the case, however, of filling in a ravine, the cottager must look out for a knoll or ridge as near as possible to the sphere of operations, and attend carefully to the following rules:—Take all the rich earth from the bed of the ravine and throw it up on either side, for coming back, as surface soil; do this also with the upper layer of soil on the ridge, and then cart or wheel into the bottom of the ravine the under strata and the ridge, and having done this, spread the two surface layers again uppermost, in order to give the richest soil to yield grass. If the ground thus to be levelled is of a regular shape, make a trench four feet wide, throw the top spit to the opposite side, and then dig out the bottom to the depth required, and wheel it into the ravine you wish to fill up. Place the top spit of the second trench at the bottom of the first trench, leaving the grassy side uppermost, then wheel out the bottom of the second trench to the proper depth of the ravine, turn down the top spit of the third trench into the bottom of

the second one, the grassy side, as before, being uppermost, and so on until the levelling is complete.

Claying Peaty, Open, Porous, Gravelly, and Sandy Lands greatly improves their productivity—

“ Lay clay on sand
And you buy land ”

is an old farming proverb, founded upon successful practice. When from 200 to 400 cart-loads of clay per acre are applied to lands lying in grass or heath, it is better to break them up to aeration until the clay is thoroughly incorporated with the staple. They may then be laid down to grass if desirable, but it is more profitable to keep such soils under arable husbandry.

Chalking and Marling.—A very great breadth of meadow land is subject to permanent improvement by the application of chalk and marl; and whenever the cottager has the command of such, every opportunity should be embraced to apply them as required. Like clay they, in some cases, are lying at a lower level than the meadow; in other places, at a higher level; sometimes so close at hand as to render the expense of carting a secondary consideration; then at others, so far off, that liming the land may come cheaper. The object of their application is to supply lime to the land. Marl is of an extremely diversified character; but we shall treat of this when we come to Arable Husbandry.

Liming is best done by a compost made of vegetable mould and quicklime, and when lime is naturally deficient in the soil, it may often be more cheaply and efficaciously applied in this manner than in the form of artificial compounds, in which lime is the chief element.

Fencing is another important point, where every foot of ground is so much lost or gained. The favourite live-

fences are not well adapted for cottage farms, for which, in our opinion, there can be nothing so good as stone or brick walls, where they can be had. At the outset walls cost more money than many other sorts of fences, but their many advantages soon make them pay. Firstly, they are ready for use as soon as they are built; secondly, the grass grows healthily close up to them; thirdly, if properly tempered mortar be used in the building, they will not harbour insects or vermin. Taking these advantages, it will be seen that a stone or brick wall is an investment of capital which increases the annual productive value of the farm, apart from its purpose as a substantial durable fence. A thorn hedge takes more space, and requires to be protected, at the outset, by two rail fences—one on each side. These harbour insects, which, as the rails decay, attack the young hedge, and in process of time kill plant after plant, leaving those gaps which are the torment of the farmer's life, and occupy a most unreasonable time in filling up; so much, indeed, that it is in the aggregate doubtful whether the stone and mortar wall is not the cheapest even for the short leased farm. Subdivision is best effected by a wire fence, although partially dependent upon the nature of the boundary line, number of acres, and the object to be followed in keeping the land in grass or arable.

Liquid Manure.—Great economy of time and capital has been attained by the new systems employed for the application of liquid manure—viz., 1, irrigation; 2, warping; 3, the liquid manure cart; and 4, the hydrant hose and jet.

Irrigation, according to the modern acceptance of the word, is now generally understood to mean the application of town sewage to meadow or arable land on the principle of gravitation; but the practice itself is identically that of the old plan of applying river water to grass land. In point of fact, the more closely the modern sewage practice complies with the details of the old water practice, the more successful it proves. According to the plan described and illustrated in most old works on agriculture, the land was laid up into ridges somewhat higher at the crown than at the sides. Thus, Fig. 2 may be taken as an illustration of one ridge, of which *ab* is the crown, and *cd* and *ef* the two sides. *a* is the highest end of the ridge, *ce* the headland, and *b* the lowest end or footland. Along the headland the water is conveyed in an open ditch, not shown, and down the crown of each ridge a channel is opened with the spade or plough as shown at *ab*, and into this the water for irrigation is directed. As the ridge has a slight inclination, the water does not flow out of the channel *ab* at a right angle, but obliquely. It need hardly be said that the water does not

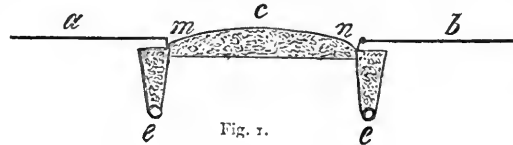

Fig. 1.

flow in parallel lines, the object of the waterman in charge of the work being to spread the water as evenly over both sides of the ridges as possible. Town sewage is now being applied in a similar manner; but as the solid portion of the sewage cannot be equally distributed, it is better to filter it out, and apply only the clarified liquid or soluble portion of the sewage. The chief objection to this plan, as now practised, is the waste of fertilising element in the application, as water flowing in an open ditch in contact with the atmosphere rapidly purifies itself of animal and vegetable matter held in solution. In this respect the practice is capable of much improvement, as will be shown under the improvement of a subsequent practice—viz., hydrant hose and jet.

Warping.—Flowing water is capable of conveying a large percentage of its weight of solid matter, as clay, in a state of suspension, which it deposits equally over land into which it has been directed and allowed to subside. Thus, if a small farm is surrounded with a temporary embankment, and water carrying clay in suspension pumped or turned in from a higher source, so as to fill the enclosure to the top of the embankment, and if the water is then allowed to settle, it will deposit the greater portion of the clay equally over the surface of the small farm. The pure water is then drawn slowly off, and the work is termed warping. In this manner from six inches to a foot in depth of clay may be laid on poor fenny soils, so as wholly to change their character, and the work is one in successful operation, and increasing in adaptation with recent improvements in hydraulic machinery and apparatus. On small farms it is generally done by contract, at so much per acre for a given depth of warp. Warping is also applied to dry, gravelly, and sandy lands by irrigation. In this case the water is drained off below, and the warp remains upon the surface; and when one ridge is done, the muddy water is turned on to another. The channel *ab*, Fig. 2, has to be clayed to prevent the water sinking. The porous soil gradually fills up from *a*, *b*, *c*, *d*, and *e*, *f*. This work may likewise be done by contract, by means of movable pipes, hydrants, and hose, or by fixed pipes, &c.

In a future number it is our intention to give further illustrations of this subject.

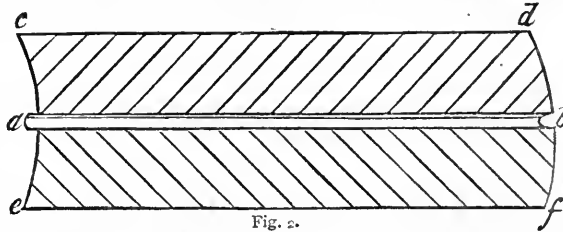

Fig. 2.

ANIMALS KEPT FOR PROFIT.

III.—INCUBATION OF POULTRY.

MUCH disappointment in the hatching and rearing of young broods would be prevented if more care were taken that the eggs selected for setting were of good quality—not only likely to be fertile, but the produce of strong and hardy birds. This remark applies to common barn-door poultry quite as much as to the pure breeds. A friend once complained to us, that out of a dozen eggs only four or five had hatched; and on inquiry, we found that the sitting had been procured from an inn-yard, where, to our knowledge, only one cock was running with about twenty hens; from which, of course, no better result could be expected. When the eggs have to be procured from elsewhere, therefore, whatever be the class of fowls required, it should first of all be ascertained that there is at least one cock to every six or eight hens, and that he be a strong and lively bird; and next, that the fowls be not only of the kind desired, but that they are well fed and taken care of. From scraggy, half-starved birds, it is impossible to rear a large brood, as the greater number even of those hatched will die in infancy. It only remains to ensure that the eggs be fresh, and a successful hatching may be anticipated.

With regard to this latter point, eggs have been known to hatch when two months old, or even more; but we would never ourselves set, from choice, any egg which had been laid more than a fortnight; and after a month, or less, it is useless trouble. Fresh eggs, if all be well, hatch out in good time, and the chicks are strong and lively; the stale ones always hatch last, being, perhaps, as much as two days later than new-laid, and the chickens are often too weak to break the shell. We have also invariably noticed, when compelled to take a portion of stale eggs to make up a sitting, that even when such eggs have hatched, the subsequent deaths have principally occurred in this portion of the brood; and that if none of the eggs were more than four or five days old, they not only hatched nearly every one, and within an hour or two of each other, but the losses in any ordinary season were very few.

When the eggs are from the home stock, their quality should, of course, be above suspicion. It is scarcely necessary to say, that in order to ensure this, every egg before storing should have legibly written upon it in pencil the date on which it was laid. Eggs intended for setting are best kept in bran, the large end downward, and should never be exposed to concussion. Another very good plan is to have a large board pierced with a number of round holes in regular rows to receive the eggs.

Hundreds of years ago it was thought that the sex of eggs could be distinguished by the shape—the cocks being produced from those of elongated shape, and hens from the short or round. Others have pretended to discern the future sex from the position of the air-bubble at the large end. We need scarcely say, that these and all other fancies have, hundreds of times, been proved to be erroneous. There is not a breeder of prize poultry in England who would not gladly give twenty pounds for the coveted knowledge, and thenceforth breed no more cockerels than he really wanted; but the secret has never been discovered yet, and it is even impossible to tell before the egg has been sat upon a short time whether it will produce a chicken or not.

We have already mentioned that the sitting hens ought to have a separate shed and run provided for them, in order that the other hens may not occupy their nests during absence, or they themselves go back to the wrong ones, as they will often do if allowed to sit in the fowl-house. Even in a very small domestic establishment we strongly recommend that the small additional space requisite be devoted to this purpose, for all our experience has proved

that, whatever success may be obtained otherwise by constant care and watchfulness, it is never so great as when the sitter can be shut into a separate run, and be entirely unmolested. An extensive run is neither necessary nor desirable, as it only entices the birds to wander, whereas, in a limited space, they will go back to their nests as soon as their wants are satisfied. A shed five feet square, with a run the same width for ten feet out in front, is quite sufficient for three hens.

If the hen must be set on the ordinary nest in the fowl-house, unless she can be watched every day to see that all goes right, it is best to take her off at a regular time every morning, and after seeing to her wants and due return, to shut her in so that she cannot be annoyed. She should be lifted by taking hold under the wings, gently raising them first to see that no eggs are enclosed. Very fair success may be attained by this method of management, which is obviously almost imperative in very large establishments, where numerous hens must be sitting at one time; but where such large numbers do not allow of a special poultry attendant it is rather troublesome, and on an average there will be a chicken or two less than if the hens can be put quite apart, where they need neither be watched nor interfered with. Since we adopted this plan we have, from good eggs, always hatched at least nine out of twelve, and generally more; and have had no trouble or anxiety till the broods were actually hatched, which is anything but the case on the other system.

With respect to the arrangement of the hatching run, it should, if possible, be in sight of the other fowls, as it will keep the sitter from becoming strange to her companions, and prevent an otherwise inevitable fight on her restoration, to the possible damage of the brood. We prefer ourselves, as stated in the first chapter, a shed five feet wide and five deep, open in front to a small gravel or grass run. Under the shed must be, besides the nests, a good-sized shallow box of sand, dry earth, or fine coal ashes, for the hen to cleanse herself in, which she specially needs at this time; and food and water must be always ready for her. With these precautions the hen may, and should, in every case, with the exceptions presently mentioned, be left entirely to herself. There are, however, some birds which, if not removed, would starve upon their nests sooner than leave them; and, therefore, if the hen has not been off for two or three days (we would test her for that time first), we should certainly remove the poor thing for her own preservation. To feed upon the nest is a cruel practice, which has crippled many a fowl for life, and cannot be too strongly condemned.

Of all mothers we prefer Cochins or Brahmans. Their abundant "fluff" and feathering is of inestimable advantage to the young chicks, and their tame and gentle disposition makes them submit to any amount of handling or management with great docility. Cochins certainly appear clumsy with their feet, but we have never found more chickens actually trodden upon by them than with any other breed. Many complain that they leave their chickens too soon, but we have not found it so ourselves. If they are kept cooped instead of being set at liberty, they will generally brood their chickens for two months, even till they have laid a second batch of eggs, and desire to sit again; and by that time any but very early broods are able to do without a mother's care. With regard to Brahmans as mothers, they have a peculiarity we never observed in any other fowl—they appear actually to look behind them when moving, lest they should tread upon their little ones. Dorkings, also, are exemplary mothers, and go with their chickens a long time, which recommends them strongly for very early broods. And lastly, a Game hen has qualities which often make her most valuable. She is not only exemplary in her care, and a super-excellent forager for her young brood, but will defend them to the last gasp, and render a good account of the most determined cat

that ever existed; indeed, it would be a difficult matter in any case to steal a chick in daylight from a well-bred Game hen. But whatever be the hen chosen, she should be well feathered, moderately short-legged, and tolerably tame. A very high authority* has affirmed that none but mature hens should be allowed to sit, and that pullets are not to be trusted; but our own experience and that of very many large breeders does not confirm this. We have constantly set pullets, and have rarely had any more reason to complain of them than of older birds.

The nests may be arranged under the shed any way so that no one can see into them, with the one proviso that they be actually upon the ground. Chicks thus obtained always show more constitution than those hatched on a

the hen will be in the strictest privacy, will be both perfectly sheltered and kept cool, and will never mistake her own nest for the one which may be placed in the other corner. If a third must be made room for, let her nest be placed the same distance from the wall midway between the others, and like them, with the front of the nest to the back of the shed. There will then be still nearly a foot between each two nests for the birds to pass.

A damp situation is best for the sitting shed, and will ensure good hatching in hot weather, when, perhaps, all the neighbours are complaining that their chicks are dead in the shells. Attempting to keep the nest and eggs very *dry* has ruined many a brood. It is not so in nature; every morning the hen leaves her nest, and has to seek her

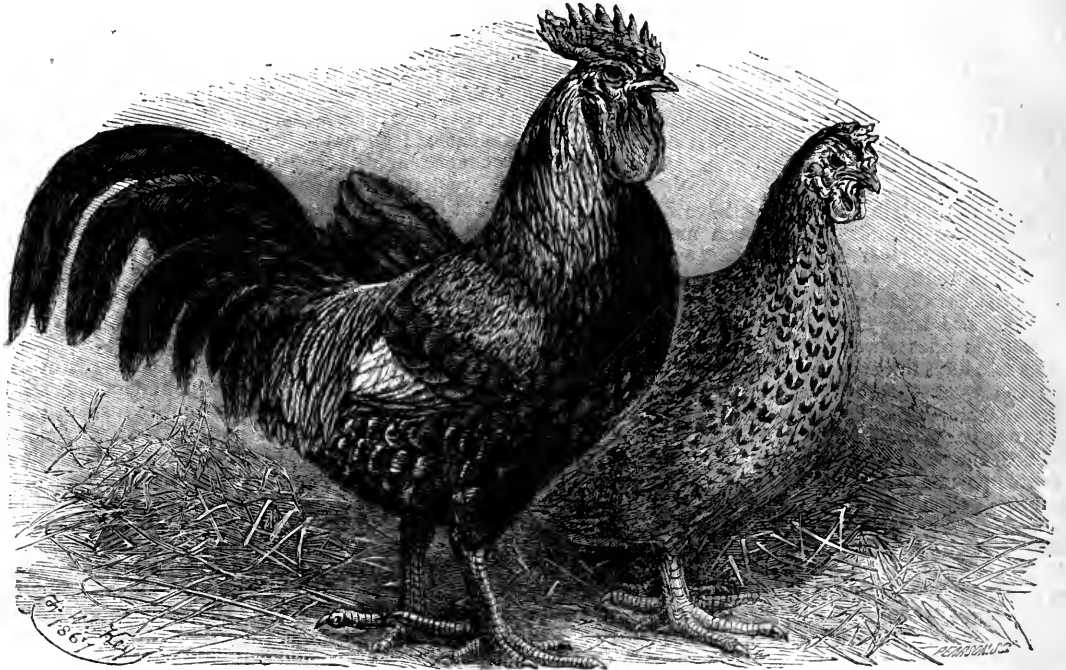

DORKINGS.

wooden bottom at a higher level. This holds good even at all times of the year. We are aware that eminent authorities who recommend ground-nests in summer, prefer a warm, wooden box in winter for the sake of the hen; but she will rarely suffer. The heat of her body whilst sitting is so great that a cool situation seems grateful to her—at least, a hen set on the ground rarely forsakes her nest, which is otherwise no uncommon case. We knew of a hen which, during the month of January, made her nest on the top of a rock in one of the highest and most exposed situations in the Peak of Derbyshire, and brought a large brood of strong chickens into the yard. It is only necessary that the birds should be protected from wind and rain, in order to avoid rheumatism; and this is most effectually done by employing for the nest a tight wooden box like Fig. 6, open at the bottom, and also at front, with the exceptions of a strip three inches high to contain the straw. Let one of these boxes be placed in the back corner of the shed, touching the side, the front being turned to the back wall, and about nine inches from it; and

* Mrs. Fergusson Blair.

precarious meal through the long, wet grass, which drenches her as if she had been ducked in a pond. With this saturated breast she returns, and the eggs are duly moistened. But if the nest be dry, the hen be kept dry, and the weather happen to be hot and dry also, the

moisture within the egg itself becomes dried to the consistency of glue, and the poor little chick, being unable to move round within the shell, cannot fracture it, and perishes. Such a mishap will not happen if the ground under the nest be damp and cool. All that is necessary in such a case is to scrape a slight hollow in the bare earth, place the nest-box, already described, over it, and put in a moderate quantity of straw cut into two-inch lengths; or, still better, some fresh-cut damp grass may be put in first, and the straw over. Shape the

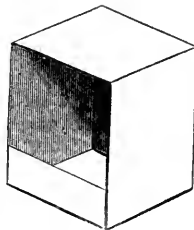

Fig. 6.

nest is made; but care must be taken to well fill up the corners of the box, or the eggs may be rolled into them and get addled. Some people prefer to put in first a fresh turf; but if the nest be placed on the bare ground, as we recommend, this is useless. The rest of our remarks upon this subject must be postponed to a future number.

HOUSEHOLD DECORATIVE ART.

III.—CHRISTMAS DECORATIONS OF THE HOME.

THE materials to be used include all kinds of evergreens, everlasting flowers, and coloured and gilt papers. It is a strange thing that, though *mistletoe* is used in the decoration of houses, not a sprig of it is put into a church. But in house-decoration no Christmas would be thought complete if there did not hang in hall or dining-room a bunch of its curiously-forked

leaves may be applied with excellent effect in wreaths, or overlapping one another in borders. The variegated *ancuba* makes a pleasing variety in the colour.

Yews and *arbor vite* are useful, especially the small sprays of them, for covering the framework of devices.

Myrtle and *box* also are pretty in narrow borderings, into which coloured everlasting flowers may be introduced.

The black bunches of ivy berries may sometimes be used with advantage, to give points of contrast in the decorations. Of course if chrysanthemums,



Fig. 1.



Fig. 2.



Fig. 3.

branches, with their terminal pairs of nerveless pale-green leaves, and white crystalline berries.

Holly is of course the special tree of the season. Its leaves bent into various curves, its thorny points, and its bunches of coral-red berries, make it the prince of evergreens. Let it be conspicuous throughout the decorations. It is a good plan to strip off the berries, and use them strung in bunches, as the berries get hidden when the sprigs are worked into wreaths and devices, and the berries, bent into little bunches, dotted about the festoons here and there, look very effective.

Ivy must be introduced with care. Small single leaves come in with good effect in small devices, or to relieve a background of sombre *yew* or *arbor vite*. The young shoots of the common ivy are best, or of the kind which grows up trees and old walls, which are very dark and glossy, with a network of light-coloured veins.

Laurel is a very useful green in sprays, and the single



Fig. 4.

Christmas roses, primulas, and camellias can be obtained, the general effect is heightened and the decoration becomes more elaborate and more elegant.

The best wreaths for decorating the banisters of a house, or any pedestals, pillars, or columns, are those made in a rope of evergreen sprigs. There are several ways in which such wreaths are made. One way is as follows:—Get a rope or stout cord of proper length, and a quantity of twine and a handful of evergreen twigs. Begin at one

end of the rope, which should be attached firmly to something. Dispose a bunch of the twigs round the rope, and tie them on with the twine; then dispose another bunch so that the leaves may conceal the stalks of those already on, and give the twine a turn round them, fastening it with a running knot, and so on until the rope is finished. This must be done at the fastening of each bunch of twigs. Another way very frequently adopted is, in place of a rope, to use only a piece of stout twine to run

through the wreath, so as to prevent its falling to pieces, and, instead of twine to tie the twigs on, to use fine wire, which must be firmly twisted round the twigs.

In all kinds of wreaths the thickness of the wreath must be carefully regulated at the outset, and evenly maintained throughout, and care should be taken that all the foliage is turned in one direction, especially where two persons are working at the same rope. The wreaths may be made of one kind of evergreen only, or of any number of kinds mixed: the latter has the better effect. There should be an equal mixture of the fine kinds, as yew, box, &c., to keep the wreath light and sprayey. Whether the berries be left on the holly twigs, or threaded and attached at intervals, is, of course, according to the taste of the decorator. If threaded, they are best fastened among the holly leaves in bunches about as large as the natural clusters, so as to imitate their natural effect.

In fastening the wreath to the pillars, take care not to put it on upside down, as foliage must never be placed in a direction contrary to that of its growth. When small chaplets or wreaths are constructed, each should be made by one person, as the effect is frequently spoilt by the two ends not matching, or it is otherwise wanting in uniformity. When the wreaths are finished, and before they are hung up, they should be kept in some cool place, or else they shrivel up; if necessary, a *little* water may be sprinkled over them.

If holly berries are scarce, a good substitute may be found in rose hips, which may have a small piece of wire passed through them as a stalk, and several twisted together. The fallen holly berries, strung on wire, made into rings, and slipped over the leaves, are very effective, also split peas, glued on here and there in the shape of small rosettes, look like golden flowers, and they may be made to resemble holly berries by pouring over them red sealing-wax melted in spirits of wine.

Where definite shapes are required there are several methods of accomplishing the desired effect. Some use a groundwork of tin or perforated zinc.

If outline forms are employed, to be covered with leaves or flowers, these will be best coloured black. The method of arranging the leaves and flowers will depend in a great measure upon individual taste. If it is required to use masses of berries in such a manner that it would be inconvenient or difficult to fasten them together by any other means, paint the places required to be filled in with a stiff coat of glue, very hot, and drop the berries upon it. When the glue is dry they will be found to adhere.

Holly strung has a very good effect. It is very quickly done, and looks like a rich cord when finished, and all the banisters in a house may be draped in holly. It is made by threading a packing-needle with the required length of twine, and stringing upon it the largest and most curly-looking holly leaves, taking care to pass the needle through the exact centre of each leaf. Flat borderings, to lie flat along panels of cabinets, doorways, mirrors, and the backs of sideboards, should be made of leaves sewn in strips on brown paper, or yards of buckram, cut in strips and sewn together to the required lengths. Garlands or half-wreaths (Fig. 1) are best made on barrel hoops for their foundation. For making letters there is nothing that lends to the shape of the letters so well as crinoline wires. Single letters are best cut out in brown paper, and the leaves sewn on with a needle and thread.

Rice decoration is very effective, and looks like carved ivory. The required shape should be cut out in cartridge-paper, and firmly glued down to its intended foundation, and then covered with a coating of thick warm paste, or very strong white gum, into which the rice grains must be dropped, and arranged so as to lie closely and regularly together, and the whole left until it is perfectly stiff and dry. Immortelles, and other coloured dried flowers, may be used in the same manner. The best plan of applying

the rice is first to take a small quantity in a paper funnel and scatter it over the design till dry. Pour on more gum, then scatter the rice on again, and repeat the process till the proper thickness and evenness is obtained. When finished a sharp penknife will remove all superfluous grains. Monograms made in this way, if the shadows are picked out with Indian ink, roughly put on, give a very good effect. Alternate letters of rice and sealing-wax berries look very fanciful and gay.

Mottoes and monograms in white cotton wool have the effect of snow. They are produced by cutting out the letters in thick white paper, and pasting over them an even piece of clean white cotton wool, which is, when dry, pulled out so as to give it a fluffy or snowy appearance. The letters should afterwards be carefully trimmed with a sharp pair of scissors, and mounted on a ground of coloured paper.

If there is a lamp in the dining-room, supported by chains, holly wreaths twisted round the chains look well; while a chaplet round the base, and a small basket filled with mistletoe, suspended from the centre of the base, look very effective. Borders of evergreens may be placed along the back of the sideboard, and if there be a mirror in it a small chaplet in the centre, and seeming to join the borders, looks very pretty. Pictures and mirrors can be framed with made-up borders of evergreens. Where these are square, borders arranged in the shape of Oxford frames look very pretty. If the entrance-hall be in panels, narrow borderings of box and ivy look well, laid on all round, and in the centre half hoops or chaplets, or a monogram. Scrolls, with mottoes, bidding people to be welcome and happy, either laid on bright-coloured calicoes, with holly borderings, or else merely the word "Christmas," done in laurel leaves, and variegated with immortal flowers. Even in the bedrooms the frames of pictures and mirrors can be edged with wreaths.

In Fig. 4 will be found a bold and effective device for a large space, as, for example, the end wall of an entrance-hall or landing. The cross pieces are stout sticks, the size of which must be regulated by the space intended to be filled; and it will be found advisable to join them in the centre by a cross joint, otherwise they will be very awkward to manage. They can then be wreathed with holly and mistletoe, as shown in the figure. The legend surrounding them is made of letters in gilt paper, pasted on to coloured cardboard, and the figure of the robin is cut out in cardboard and painted.

The monogram in Fig. 2, signifies Christmas, and is very pretty made either of leaves and berries, or moss, glued on cardboard, and edged with three different shades of immortelles. The border is made of bosses of different coloured immortelles, and the outside row of star points with fern fronds. Fig. 1 is a bordering for the cornice of a hall, or large room, and is made of laurel leaves and rosettes of coloured paper or immortelles. In Fig. 3 the trefoil is made of holly leaves, and the border of laurel.

In our decorations we must not forget the dining-room table when our guests gather round it. A very pretty centre-piece is made by covering an inverted basin with moss, into which insert sprigs of holly quite thick until it forms a pyramid of holly. On the top place a figure of Old Father Christmas (which may be bought at any bazaar or sugar-plum shop), and instead of the holly sprig he generally holds in his hand, place a spray of mistletoe.

A great many lights are required, where fir and holly are much used, in table decoration, otherwise the effect is heavy and gloomy.

These hints will make it an easy task to adorn the house for Christmas; but half the pleasure consists in inventing new devices, and giving scope to one's taste and ingenuity, new ideas springing up and developing themselves as the occasion arises, till the worker finds delight in the work, and is thus best rewarded for the toil.

THE HOUSE.

HOUSE-HUNTING.

THE word "home" has in our language a force and a beauty which it scarcely has in any other, and which makes it pleasant to the ears of every Englishman. The house is not the whole of home, but, inasmuch as a good and comfortable and well-ordered house contributes greatly to the happiness of home, we propose to say something upon that subject. At one time or another it is the lot of most of us to have to seek a house as our place of residence, and also to deal with inconveniences in our actual dwellings. With regard to the first point, no absolute rules can be laid down which shall be applicable in all cases, although some hints will be found of general utility. We cannot always determine where we will live, as that is often very much controlled by circumstances. Some have to select their dwellings in large towns and cities, where the conditions of salubrity may be less favourable than is desirable. But even then it is not seldom possible to make a selection, and when it is possible, every precaution ought to be taken to secure as airy and healthy a situation as may be. Supposing we have so much liberty, we should endeavour to avoid close and narrow streets and densely-populated districts; we should seek for a residence which does not lie low, or on soil which is at all swampy and ill-drained, and we should try to get a house built upon gravel, sand, chalk, or rock. We must also aim at having a good share of sunshine, and light, and air. Even if we can choose our home in the suburbs, we shall be wise to look out for an open situation, and neither too closely hemmed in by trees, nor standing upon a bad soil. A very large number of speculative builders will remove from the ground they build upon every particle of gravel, or other useful subsoil, in the neighbourhood of London, and will have the excavations filled in with all kinds of refuse and rubbish. It is needless to say that one's house might as well stand in a marsh as upon such materials, for unwholesome exhalations will arise, and various forms of disease be induced in consequence. This is not all: the houses erected upon such ground are liable to be damp, and apt to settle down, causing cracks in the walls and partitions, bulging out in some places, and shrinking in others; hence windows and doors get out of order, and do not shut and open properly, and expose the inhabitants to draughts.

In the case of newly-built houses it is usually possible to find out whether they have been honestly erected from the foundation to the top. If old and worthless materials have been largely used in the construction, and if the work has been executed in a slight and slovenly manner, it will soon become apparent.

All these are matters to be inquired into, even if we are about to take a house favourably located; and of course it is suicidal not to make inquiry if we are going to purchase a house. But even these points are not all, because the drainage, lighting, ventilating, and internal arrangements have to be looked to. An ill-drained house is a nuisance, and yet, because proper drainage is apt to be expensive, builders are often tempted to sin in this matter. As for the lighting by means of windows, the windows should neither be too few nor too small, nor should they be badly placed. The ventilating is a matter which is not always so readily determined, though in general there will be cause of complaint if the rooms are small and the ceilings low, and if the halls and passages are narrow and confined. For the internal arrangements there will need to be a careful inspection. It should be seen that every door and window opens and closes properly, and has appropriate fastenings; that cupboards, shelves, and closets are fixed in suitable positions; that ranges and fire-grates are adapted to the places they occupy; that the

floors are sound and level, and not full of great cracks, and with wide spaces between them and the skirting boards round the rooms. If gas is laid on, the meter ought to be sufficient for the number of lights, and the pipes should not be too small, nor limited to too few rooms. If there are Venetian blinds, they must be inspected and tested, and care taken that they are in proper condition and order. Water, of course, will be laid on, and it must be looked to. Inquire if the pipe is of sufficient bore; whether the taps are in good state, sound and strong; whether the water is on the main, or only let in at certain hours of the day; whether the cistern—of which there must be one in any case—is out of doors or indoors; and of what material and capacity it is. If the cistern is out of doors you will be without water when severe frost sets in, and you will perhaps be annoyed by the bursting of the leaden pipes when the thaw comes. There is no need really to have the cistern out of doors, and it is a nuisance when it is so. Should it not be properly covered over, the water will be contaminated with what are termed "blacks," in and near large towns and cities. Then, as for the material, a leaden tank or cistern is not wholesome, but mischievous, and therefore one of slate, or some such material, is in all respects preferable. The sink-stone in the back kitchen should be large enough for your requirements, and should be properly provided with a waste-pipe to carry off the water. Such things as copper or boiler, oven and boiler, and well-constructed water-closets, in proper positions, will also all have to be looked after. Finally, a coal-cellar of adequate capacity, and into which coals can be readily conveyed from the street, without filling the house with dust, begriming everything, and causing endless confusion, is to be regarded as a necessary.

There will be less to look after out of doors, but something demands attention even there. If there is no foot-pavement with good kerbing, there will be annoyance in wet weather, and the steps will get very dirty. A lofty and a narrow flight of steps is undesirable on many accounts. If steps are numerous, they are inconvenient to ascend in bad weather, and require much extra cleaning, while, if they are narrow, they look mean, and do not supply good accommodation. In front of some houses there is an area, with an entrance to the basement under the ground-floor. Although this construction has some advantages, it is open to serious objections. Should the door be left open, a draught like a hurricane will sometimes sweep through the whole house. These areas offer a temptation to dishonest persons, who by their means may get access to an unwatched kitchen or breakfast-room, and carry away a plate-basket or other valuables. The messengers of tradesmen, the milkman, the butcher, the hearth-stone boy, and others, may, and do, at these area entrances, waste time in idle gossip. Anyhow, they furnish frequently too ready exit or admission to such as one would rather keep out or in, as the case may be. The house-hunter will be wise to look at this, and, if he takes such a house, to decide whether he will keep that entrance regularly locked or unlocked. Where houses are in terraces, this construction may be the only one that allows of a second entrance. In some terraces, the back doors open into a lane at the rear of the gardens behind, in which case no prudent housekeeper will forget the lock. Semi-detached houses most commonly have a side door leading round to the back, and it is a good arrangement, probably the best, for town dwellings. Such a door should, however, have good fastenings, like all others, because it will not be wise to leave it always open.

A small garden in front of the house looks well, unless in close neighbourhoods where nothing flourishes, or in a north aspect. Under favourable circumstances, such a little garden is a desirable adjunct, provided it is well kept. London dwellings of moderate size seldom have gardens

all round, and yet in the suburbs few need be without a garden in the rear. As everybody loves flowers, everybody will desire such a garden. We say "loves flowers," for a kitchen-garden is not in every case possible near the metropolis. Flowers and evergreens and ornamental trees can be selected for all situations, and a small garden is not necessarily expensive, while it may afford pleasure and opportunities for exercise. If a house has a garden, its condition should be noted, and it will be borne in mind that a garden to a new house is too often a mass of rubbish. There may be no paths, or none properly made and gravelled; or there may be no flower-beds, or none with more than a sprinkling of soil over brickbats and mortar, and the like. Now, if a garden does not cost much to keep, it costs something to make, and he who has to pay for the first laying-out of such a garden as we have described, will be suffering for others' faults. "A pound saved is a pound gained," and this is never more true than in the matter of a garden. Surely it is as much the duty of a landlord to provide gravel paths to a garden as floors to a house, and it is nothing short of dishonesty to carry away the soil, and thus to force a tenant to buy more to put in its place.

If there are any out-offices, see that they are what they profess to be; that the so-called stable and coach-house, for example, are fit to contain a horse and a vehicle larger than a perambulator or a bicycle. The cabins which are advertised for stables and coach-houses are too often ridiculous.

Without going further into these details, it must be a fundamental principle with one who seeks a house in or near a great city, or anywhere else, to ascertain what he requires and can afford. If in business, the house must not be at too great a distance, nor of difficult access, involving serious outlay of time or of money, or of both. If with limited income, or quiet and domestic habits, a house is not to be too large. Nobody ought to take a smaller house than he requires for comfortable occupation, if he can afford to pay for it. As a general rule, it should be borne in mind that it is bad to get a house either too large or too small.

Another question which house-seekers should put is as to the character of particular localities. They may, if they like, ask whether such a street is fashionable or unfashionable, but they will surely ascertain whether it is respectable or not. Everybody knows that some neighbourhoods are not in good odour, and that, in consequence, they are gradually deserted by persons of real respectability, and commodious houses become inhabited by an inferior class at a lower rent. However, it is to be observed that the scale of rental varies in localities respecting the character of which no objection is raised. Some of the suburbs of London are more expensive for rent and living than others, although not more healthy and respectable. Parishes in which rents are moderate, and living cheap, very often contain an additional number of poor, and in actual practice it may be found that what is gained in rent and other items—especially provisions—is lost in rates and taxes.

The inequality in taxes is remarkable, and therefore every man who is about to take a house should obtain, in writing, a list of the taxes to which it is liable, the amount at which it is assessed, and the actual sums it has paid or would have paid for a year past. Many persons get annoyed by discoveries in this direction which might have been made earlier, and avoided. Those who go to buy a house may fall into even greater mistakes. For instance, a house is to be sold for £750 in one place, and elsewhere the same, or one very similar, can be bought for £600. Supposing the houses are equal, and the localities equal, and the leases equal, the house at £600 may be the dearest. The purchaser may discover that his extra ground rent alone is more than interest upon the differ-

ence between the prices of the houses. Attention will have to be given, therefore, to other points than rent and price when houses are taken for a term, or the lease purchased. Long as our list of precautions has been, it is by no means complete, and those who study the papers which will appear in the course of this work upon house construction, and a multitude of accompanying topics, will know what we mean. Our object in specifying these has been to exhibit a summary view of the points to which house-seekers should direct their attention. We have had in our mind rather thus far those who would rent than those who would buy a residence, although we have dropped a few hints which the would-be buyers may turn to account.

Far less need be said about choosing a residence in a small town or village, although even there, there are sundry evils to be guarded against. The reputation of the place generally should be ascertained, and if it be not considered a healthy one it should be avoided. In any case, the situation selected should not be too low or confined; it ought not to be damp, to be in close proximity to standing waters, nor to be near any manufacture or occupation from which noxious gases and bad smells might rise. To choose a house on the top of a hill is not always wise; for, unless the constitution be strong, exposure to cold winds and fogs and rapid changes of temperature will be hard to bear, and productive of mischief. A moderate elevation is best, and if there be a slope it should be gradual and not steep. Much also depends upon the subsoil; if tenacious, like clay, the water which falls will not percolate through it, but run off near the surface, and a house upon such a slope will suffer, of necessity. If, however, the side of the hill be sand, gravel, or stratified rock, there will be less danger. But in all cases, the soil in the immediate vicinity of the house should be flat; not higher at the back walls than at the front, and properly drained, especially at the rear of the building.

It is always well for ordinary persons to secure themselves against violent and cold winds, as the north, north-east, and east. Therefore, houses exposed to these winds should not be chosen; those with an aspect ranging from south-east to west are usually preferable, especially if sheltered on the other side by high ground or trees. When gardens and orchards either slope towards the south, or are open on that side, they will produce earlier and better crops. Houses at the sea-side are to be chosen with regard to corresponding advantages, although when they are only visited for a temporary sojourn little is thought of the house, the greatest part of the time being spent out of doors.

Wherever a permanent residence is in view in a small town or the open country, it will be necessary not only to ascertain in general all the peculiarities of soil, climate, aspect, &c., but also facilities of access. Good roads are important; and now that travelling is so common, it is of importance to be within convenient distance of a railway-station. Another point is the cost and ready procurableness of coal, provisions, and whatever else is required for domestic consumption, and not produced in the garden. Water is simply a necessity, and cannot be dispensed with, and it ought to be abundant at all seasons, and good. In some places, otherwise desirable, water is plentiful in autumn and on to mid-summer, and then so scanty as almost to fail. With regard to the quality, nothing need be said to prove that bad water, as mere surface drainage, or springs charged with certain mineral substances, is an unmitigated evil; you cannot be too particular in this matter. Finally, wherever a residence is erected or provided, care should be taken that it is supplied with all needful domestic offices, that it should have a pleasant look-out, and that it should neither be in a lonely wilderness nor in a close and

crowded thoroughfare. As already observed, the house is not the whole of home, but it goes far to make one; and it is our duty to do all we can to have a bright and healthy dwelling, and as many domestic conveniences as we can get.

THE HOUSEHOLD MECHANIC.

THE CARPENTER'S BENCH.

FIG. 48 shows the simplest possible kind of carpenter's bench, but it is almost needless to state that it is not an absolute necessity. Any solid old table, or wide shelf, about two feet nine inches or three feet from the ground, can be used to plane up a piece of wood upon if a screw or nail be driven in as a stop for the wood; but there would then be no means of holding a board on edge for the purpose of planing it, and we shall therefore describe the figure for the benefit of those who wish to *make* a bench for themselves.

A bench may be made either as a fixture or movable; the former, of course, will be preferable. It consists of a strong frame, firmly morticed and screwed together, and strengthened by a thick plank along the front, and in width two to three feet across the top, which should be of planks not less than two inches thick. In front, and at the head of the bench Fig. 48, is the bench vice, consisting of the board B, which screws in and out by means of the screw C, which works in a wooden nut fastened behind A, the further end being supported by the rod D, which projects from the sliding board through A, in which it slides loose. The screw C is turned by the handle F, and the vice is opened or shut according to the direction. The wooden

spike at M falls into a small groove in the screw C, and keeps the shifting board close up to the head of the screw when turned outwards. The slide D is often replaced by a screw like C, and this, perhaps, is a better arrangement. The stop E may be simply a square log, fitting tightly into a hole in the bench top, and having a few sharp teeth at its edge, which bury themselves into the wood required to be held and keep it in its place. The stop is knocked up or down with a mallet, but soon works loose. A better form of stop is that of which we give an illustration in Fig. 49. It consists of a plate, B, to which is hinged at D the knife C, which is screwed down by the screw E, and the edge K being cut into teeth, which stick into the wood, as in diagram. The spring F, coiled in the box underneath, keeps the plate well up to the head of the screw, but the top plate C can be screwed down quite level with the bench top, which is a great advantage, as it then cannot be at all in the way. The lower plate is let into a hole morticed in the wood of the bench, to which the whole is fastened by the screws H I. The screw principle introduced here gives great advantages over the hammering up or down of a plain block, from the fineness of the adjustment obtainable, enabling the workman to plane the thinnest boards without danger of taking a piece out of his plane-iron. The price of this dog is about three shillings. There are several other patent stops, but this seems the simplest. The bench

hook H is useful for holding down blocks to be morticed, and other purposes. It is nothing but a piece of strong iron bent something like a crook, and fitting loosely into the hole in the bench at K. The block to be held is placed under the part H, and a sharp blow with a mallet on the top of the crook fixes it. A blow on the back at I releases the work.

HINTS TO LETTER-WRITERS.—II.

OF all faults in letter-writing the most important to be avoided is bad grammar. Those who are not in the habit of writing much are very apt to blunder in their grammar, although well and correctly-expressed sentences are among the chief excellencies of a letter. Everything should be said in as easy and natural a style as possible, without any attempt at quaintness and originality. A letter is not a fine oration, to be adorned with rhetorical flourishes; nor a poem, to be filled up with pompous and high-sounding phrases. The choice of words is very important. They should in no case be low and vulgar, and any approach to what is called "slang" is to be avoided most carefully. On the other hand there must be no foolish ambition to use uncommon and pretentious words, the meanings of which have to be sought out in a dictionary. It is necessary to vary the style according to the persons addressed. To relatives and intimate acquaintances the style may be more lively, cheerful, and unrestrained. Playful and affectionate epithets can in such cases be properly introduced. When, however, one writes to superiors or strangers, all that is written should be in as calm and dignified a manner as can be adopted, provided only that the language be always simple and intelligible. We

advise persons who keep a diary, or put down notes of occurrences, or write memoranda, to adopt the style in which they ought to write to strangers and superiors.

Now and then letters have to be addressed to persons of rank and title, or to others, in speaking to whom society requires attention to certain formalities. There is an etiquette in these things, inattention to which is nothing but a breach of good manners. It is therefore very desirable that we should learn how to address persons of rank and title, and, in fact, everybody we write to. In addressing ordinary gentlemen it is enough to style them Sir, at the beginning and end of letters. If we have some knowledge of them, we may say Dear Sir; and if we are intimate with them we may say My dear Sir. A similar rule applies to ladies, who, under corresponding circumstances, are addressed as Madam, Dear Madam, or My dear Madam. It is a custom with some, who feel that they need not be quite so formal, to head and end their letters by saying My dear Mr. Jones, or Dear Mr. Jones; a still greater familiarity is allowed in addressing very intimate friends, and it is not rude to say in such a case, My dear Jones. Nay, there are cases in which personal names can be employed, but prudence must dictate concerning these: they may safely be admitted in writing to brothers, and sisters, and cousins, and also in addressing playmates and school-fellows. We reserve to another occasion the forms employed in addressing titled persons.

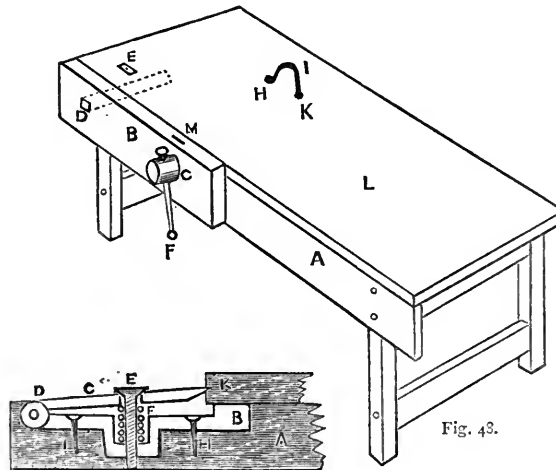

Fig. 49.

Fig. 48.

INMATES OF THE HOUSE—DOMESTIC.

IV.—DOMESTIC SERVANTS AND THEIR DUTIES.

THE servant grievance is being constantly discussed to very little purpose, simply because more people are capable of deploring an evil than suggesting a remedy. Admitting that the class of domestic servants has generally become more deficient in ability than any other body of labourers in the social scale, some allowances should be made for their shortcomings owing to the exceptional circumstances to which of late years they have been exposed. To cite only one cause, the increased facilities of locomotion. Formerly country girls were content to live from one year's end to another in the same situations from sheer inability to defray the expenses of travelling any distance. Now-a-days, railway trains have thrown the servant-market open, and, consequently, even remote provinces are drained of household help. The rush is to large towns, and especially to London, where wages are high, and dress and pleasures plentiful and cheap. Arrived at their destination, servant girls very likely find their mistresses unable or unwilling to help them.

It used not to be so. Middle-class employers did not always consider it beneath them to engage practically in the work of housekeeping. But since the frenzy for display and excitement has seized upon all classes alike, mistresses are apt to impose upon their servants responsibilities which the latter are unfitted by previous training to discharge. Nothing is more natural than that vexations and disappointments should be the result.

It is not to be expected that any sensible change for the better will take place yet awhile. Not until education proper has corrected the existing false notions of employer and employed, may we hope for a happier state. In the meanwhile, every mistress has it in her power to help the good time in coming, by fulfilling her own part of the contract with her servants scrupulously and diligently.

The first step in this direction is, as far as possible, to make no engagements which do not promise to be of a lasting nature. By this is meant, not to engage a servant with a known unfitness for the place. Many ladies are prone to take young women into their service, just to stop a gap, or to tide over a difficulty. All that they want is, to find some one to fill the place for a time, whilst they are suiting themselves at leisure.

Of course it will be remarked, that it is impossible to do the work oneself, and that the risk must be run. To this it may be replied, that it should be every mistress's endeavour to acquaint herself with "servants' work" generally, in order to meet such emergencies. If ladies were supposed to possess this knowledge more generally than is commonly believed, servants would be less independent. And for this reason: like other workers, they have to live by the demand for their services. As it is at present, cooks that know nothing of cookery, and nurses that are ignorant of the nurture of childhood, get as good places, and oftentimes higher wages, than women who really know their business, and are high principled enough to do what they undertake.

Apropos of wages. It is a very prevalent notion that high wages secure efficient service. The assumption, however, is far from being well-founded. As a general rule, the best servants are satisfied with the average rate of wages, and care more for a comfortable situation, where the payments are fair and certain, than for higher remuneration than is customary. Exceptionally high wages are apt to be regarded as a bribe rather than as a well-earned reward. It is better to pay for length of service than for the qualities naturally supposed to be possessed by servants in their respective places. Thus, if a servant enters a situation, say at twelve pounds a year, it is a better plan to increase her wages yearly one pound, than to pay a higher rate at the outset with no prospect of a rise. Many

servants leave good places for the sole reason that they have no such encouragement to remain. The policy of refusing a similar increase is short-sighted, for "changing" is generally a costly experiment. It is not to be supposed that wages are to go on continually increasing; a limit has to be arrived at at last; but the limit should be the full extent of the employer's means, and somewhat over and above the possible worth of the servant's labours to a stranger. By this means, there is some very great possibility of securing personal interest, if not attachment, in those who serve.

Intimately connected with wages is the finding of extras. For some reason or other, which it is difficult to account for, many housekeepers do not undertake to find grocery and beer, but allow money for those articles of consumption. Either such things are necessary to the diet of servants, or they are not. If they are necessary, it is better by far to provide tea, sugar, and beer, than to give money which may not be applied to its proper use. In point of economy, the money payment is a losing one, because a housekeeper having to feed a certain number of persons daily, the better all the meals are supplied, the more regular is the consumption likely to be. A girl that goes without a good tea is more likely to prove an inordinate supper-eater than one who has previously enjoyed a good meal.

With regard to beer money. If beer be a necessary, the money ought to be spent in buying the required nourishment; if not, there is no sense in giving wages in lieu of it.

Perquisites are happily going out of fashion; but a certain class of servants still stipulate for them. The principle is bad, and tends more to promote dishonesty than any other flaw in our social habits. When a mistress once allows her servants of their own accord to dispose of any articles, it is almost impossible to draw a line between what is a rightful perquisite or what is a misappropriation, not to say a theft. The articles may be of small worth, and, perhaps, useless to the owner; but the power of disposing of such things is a temptation to swell the profits by unfair means.

In a well-managed household every remnant of food and clothing should be disposed of by the mistress's hand. If she pleases to give away things that are useless to herself, the gift is acknowledged as such. On the other hand, if a servant has the power of taking certain articles as a right, no thanks are due. Dripping, bones, rags, and worn-out apparel all have their uses, as we shall endeavour to prove in the course of subsequent articles on this subject.

With regard to a plan of household work. Whether an establishment be large or small, positive rules should be laid down for observance in all that relates to the comfort of the family and the despatch of work. The best plan is to have the order of work and rules for the in-coming and out-going of the servants legibly and tersely written, and pasted on the walls of the kitchen. A little ornamental bordering and varnish makes the placard appear both pleasing and permanent. Any express duty required of the servant should be particularised thereon.

In order to carry out the above plan successfully, the mistress should have a corresponding table at hand for her own reference, so as not to give contrary orders inadvertently, and thereby nullify the rules.

Whether "followers" are allowed is a question often put by a servant on applying for a situation. Except under very rare circumstances, it is better to disallow the privilege. While speaking on this subject, we may add that the word "followers" has a very elastic meaning, and as it is difficult to draw a line between those that are unobjectionable and otherwise, no hardship can be felt in refusing to admit visitors to the kitchen save upon express

permission. The arrangement to the effect that periodically a servant shall be permitted to go out and see her friends, does away with the necessity for having them to call on her. At the same time, a mistress should be careful not to bind herself to spare her servant on a certain day in every month, as is sometimes demanded. "Once in a month when convenient" is a better understanding.

Most servants, in addition to the monthly holiday, ask to be allowed to go to church of a Sunday once in the day. This request is reasonable; and if a servant really goes to a place of worship, some inconvenience should be borne by her employers to secure her this liberty, but if she goes instead to see her friends, it should be a matter for consideration whether she shall go out or not. At any rate, the absence ought not to extend beyond the time occupied in the church service.

Dress is a very disputed point in these days between mistress and maid. Any attempt to restrict young women in the choice of their garments will be found fruitless. Certain fashions, however, which are likely to be destructive to the employer's property, or unfitted for the performance of a servant's duties, a lady has a right to prohibit—for instance; crinoline.

Caps and white aprons for answering the door and waiting at table, are befitting to young women in service. Those little crochet caps, now so cheap and becoming, are the best head-gear to stipulate for. Chignons ought to be strictly forbidden in the house. Large holland aprons, to be worn whilst bed-making and dusting furniture; are necessary garments; also, cotton gowns for morning wear.

If ladies would be at a little pains to mention their wishes on this subject, young women in service would supply themselves with suitable wardrobes. Whatever clothing a servant chooses to wear when out for a holiday is beyond a mistress's rule.

COOKING.

SOUPS AND MEAT DISHES AT MODERATE COST.

Pea Soup.—The quality of this will much depend upon the water with which it is made. The peas are often found fault with when it is the water which is really to blame. Nevertheless, some peas are good boilers—others not; but unfortunately there are no means of knowing them beforehand. Split peas, when good boilers, are cooked sooner than whole ones; but split peas will often behave as badly as the worst whole peas. The water to cook dry peas, either white or blue, should be *soft*—rain or river-water, without a particle of salt. Soak them for a night in some of this, and then set them on the fire separately (*i.e.*, not with the meat nor with the meat-broth to make the soup), in a saucepan with the water cold. Let them come to a boil gradually, and simmer slowly till they are quite tender. Then pour them into a cullender placed over a bowl, and squeeze them through it with the back of a wooden spoon, so as to retain the skins (if the peas are whole) in the cullender. The crushed peas which have passed through the cullender are what is called the *purée* of peas. Take any good meat-broth or stock you have, not too salt. When it boils, throw into it a good quantity of celery cut into short lengths, and a smaller quantity of chopped carrot and turnip. The flavour of the celery ought to prevail; when it is not to be had, a little celery seed crushed will be a good substitute. When the vegetables are tender, stir in your purée, and serve accompanied by toasted bread, cut into squares, to soak in it. Another flavour much approved with pea soup is that of sage. Dry the leaves before a gentle fire, rub them to powder between your hands, and serve in a saucer for each person to dust into his plate of soup

as much as he chooses. Pea soup, a good thing in itself, may be made still better by taking one or two hocks of pork, slightly salted (or, if much salted, well steeped in tepid water to draw out the brine), and making the broth for the soup with them, and when the soup is made, by cutting up the pork into small pieces and adding it thereto. Your pea soup then becomes victuals and drink in one—substantial diet for a hard-working man. Peas are a valuable article of food, and their use might be extended with great advantage. For instance, if you bake your bread at home, sometimes add one pound of pea-meal to every stone of flour, and it will make the bread all the more nutritious. Peas are a very supporting food both for grown people and for children. They should be eaten—we are told on medical authority—once or twice a week all the year round.

Vegetable Soup.—Slice into a pail of cold water two or three lettuces, a leek or two, a few onions and potatoes, and one turnip. Any garden vegetables you have may be added to the above. Put a good lump of dripping into a saucepan with a close-fitting lid; when it is melted, put in the vegetables, with no more water than hangs to them; shut down the lid, and let them stew gently, shaking them about to avoid burning. When they are half done, stir in enough broth or water to make the quantity of soup you want, add a few leaves of celery and sorrel (if to be had), and a teacupful of green peas, or, cook half a pint of dry peas, and mash them through a cullender into your soup. Let it boil till the vegetables are done enough; season with pepper and salt; stir in a little bit of butter. Put slices of toasted bread into your tureen, and pour the soup over them.

Shin of Beef Soup.—A departed humorist has said, "Of all the birds that fly in the air, commend me to the shin of beef. There's marrow for the master, meat for the mistress, gristle for the servants, and bones for the dogs." By successive stewings and warmings-up, it becomes better and better every day, until it is all of it consumed. It may be cooked as follows:—Take three or four pounds of shin of beef, cut the meat into two or three slices down to the bone, which should remain undivided and still enclosed in the flesh. Plug up each end of the bone with a stiff paste made of flour and water, to keep in the marrow. Set it on the fire in a boiler of cold water, with six or eight peppercorns and three or four cloves. Skim as long as any scum rises. If you season with salt, it must be very slightly; otherwise, by continued boiling and warming-up, the broth will be so reduced as to become too salt. Let it boil gently for four hours, then make it boil fast, and throw in a few peeled turnips, carrots, and onions, with a small bunch of thyme and parsley. When the vegetables are tender, you may serve the soup with bits of toasted bread floating in it. When the soup has been served, take up your beef, remove the slices of meat from the bone, separate them, if needed, with a knife and fork, put them in the middle of a hot dish, and arrange the vegetables round them, cutting the carrots and turnips into shapely bits. For sauce, fry chopped onions brown, stir in amongst them a dessert-spoonful of flour, dilute with a little of the soup, add two dessert-spoonfuls of mushroom catchup (for the making of which we will give a recipe in due course), pepper and salt, stir all together, and pour it over your slices of shin, then serve. For the marrow: toast a large round of bread, lay it on a hot plate, spread the marrow roughly on it, season with pepper, salt, and a little mustard, cut it into as many pieces as there are persons sitting at the table, and serve.

Sauces and Cabbage.—Shred a fine-hearted cabbage or savoy into a pail of cold water, picking it over leaf by leaf to see that no impurities are left; rinse the shred cabbage well therein, then put it into a deep saucepan of boiling soft water, without salt. Let it boil, with the

lid off, and with only just water enough to cover it, till the cabbage is tender. Stir now and then, to prevent its sticking to the bottom, and if the liquor evaporates too much, fill up with hot water. Contrive, when the cabbage is done, to have just enough liquor left to moisten it. Then bury in the cooked cabbage a pound or more of uncooked sausages. Put the lid close down on the saucepan, to keep in the heat and vapour; let them stew, not too slowly, shaking them now and then, for twenty or five-and-twenty minutes. Have ready, on a hot dish, a thickish round of toasted bread. Take the sausages out of the cabbage with a spoon, and arrange them in a row on the toast. Squeeze the cabbage in the saucepan with the back of your spoon, and pour the liquor over the sausages and toast. Then serve the cabbage, neatly piled on another hot dish. This dish has the advantage of being easily heated up again, when it is quite as good as at first. If no-sausages are left when the cabbage is warmed-up again, spread it in a layer on a dish, and on it put a few poached or fried eggs, or three or four slices of toasted bacon.

Epping Sausages.—Take sage, thyme, and especially knotted marjoram, if you can get it. If they have been splashed with earth or sand by the rain, as often happens, you must wash them thoroughly clean, and let them dry in a current of air. When quite dry, strip the leaves from the stalks, and chop them very fine together. Mix a small quantity of this thoroughly with the chopped sausage-meat (which should be seasoned with allspice and nutmeg) before putting it into the skins. The dose of this will depend upon taste; at the first trial, it is better not to overdo it. These aromatic herbs can be dried in a *slow* oven, rubbed between the palms to a powder, and kept in bottles for future use. In a fresh state, a very small proportion of parsley and chervil may be mixed with them.

Roast Pork and Potatoes, Fried Whole.—The pig must be scalded, not singed. Take a good piece of the loin or spare rib, score the skin, to make nice "crackle," and let out the fat. Roast it before the fire, over a catch-pan. Take middle-sized or small potatoes; first wash and dry, then peel them, so as not to have to wash them after peeling; wipe them dry with a napkin. When the pork is roasted, pour the fat into a small deep saucepan; set it on the fire; when quite hot, fry the potatoes in it to a light clear brown. The fat will serve again, or for other purposes.

Haricot Mutton.—Take the chump end of the neck, or the breast, of mutton; cut it up into small pieces, of a size to be helped with a spoon. Set them on the fire, in just enough water to keep them from burning. Keep turning them about in this, till they are half-cooked and nicely browned. Then take them out and lay them on a dish. To the gravy remaining in the saucepan, add more water, with flour, pepper, salt, and a sprig of thyme and parsley. Stir these well together, then return your mutton to the saucepan. After it has boiled a few minutes, put in some peeled potatoes (whole, if small, halved, if large), a carrot sliced, a turnip the same, and either small onions whole, or large ones sliced. When the vegetables are cooked, your mutton is ready. Serve the whole together on the same dish. You may lay slices of toasted bread, as sippets, at the bottom of, or round, the dish. They will make it both more sightly and more plentiful.

Pigs' Fry is much nicer, tenderer, and more economical, baked than fried. Into a large pudding-basin, put slices of the heart and liver, pieces of the chitterling "frill," and spleen, intermixed with sliced onions, and seasoned with pepper, salt, and allspice. Cover them with water, in which a little flour has been carefully mixed; put a plate on the top, and set in the oven till done enough.

Pigs' Liver.—Open the liver, by cutting it in halves horizontally, but without detaching the separate portions. Lay it thus open on a dish, season it with pepper and salt, and pour over it a little oiled butter; let it so remain a quarter of an hour. Then spread over it equally a stuffing made of bacon, chopped parsley, and shalot, or whatever other stuffing suits your taste and judgment. Then close the liver, and wrap it in caul, or "leaf," or thin internal sheet-fat of a pig or calf. Lay this in a deep dish, with a slice of bacon under and upon it; cover it closely with another dish over it, and set in a gentle oven. When done, take it out of the leaf-fat, and serve it with its own gravy, relieved by a little vinegar.

Black Pudding (a much-approved recipe).—Have ready well-cleansed pigs' entrails, exactly the same as are used for containing sausages. Keep them steeped in cold water, until you want them. To one pint of fresh-drawn pigs' blood, take three pints of onions; chop them tolerably fine, and cook them till they are nearly or three-quarters done, in a saucepan, with the least drop of water at the bottom, stirring them all the while, to prevent them from browning. Take two pounds of fresh pork, without bone, fat and lean in equal proportions; chop it up fine. Mix well together the minced pork, the onions, and the pigs' blood, seasoning with salt, pepper, and allspice, or mixed spices ground together. Tie one end of your sausage-skin, and, by means of a funnel or sausage-stuffer, fill it at the other with the mixed ingredients. Then tie the upper end of your pudding, coil it in the desired shape, or tie it into short lengths, and throw it into boiling water, which you will keep galloping for twenty or five-and-twenty minutes, according to the thickness of the pudding. Then take it out, and set aside to cool. So prepared, it will keep good two or three days in summer, a week in winter. When wanted to serve, you may broil it gently over a slow fire; but this requires care, to prevent the skin from cracking. A better way is to set it a few minutes in the oven of a cooking-stove, or in a Dutch or American oven, in front of an open kitchen-range.

Pigs' Head, Boiled with Vegetables.—Take half a pig's head (without the brains and tongue), put it into an earthen vessel, with half a pound of coarse salt, and leave it three or four days, turning it frequently, and basting it with the brine that forms. Put it into a soup-kettle, with six quarts of cold water; bring it to a boil, skim, add pepper, shred onions, cabbage, and celery; let it simmer over a gentle fire, and add potatoes three-quarters of an hour before serving dinner. Then taste if the broth is salt enough; soak with it some bread in your soup-tureen; pour the broth over it. Drain the head, and serve it, accompanied by the cabbage and potatoes. With a little pea-powder, previously steeped, and a boil up after mixing it, you can convert the broth into pea-soup.

Pumpkin and Rice Soup.—Wash in cold water the quantity of rice required to make your soup; set it on the fire in cold water, let it boil till nearly done enough, set it aside. Pare your pumpkin, and cut it into bits as big as a walnut; put it in a saucepan with two or three sliced onions, one or two cloves, a leaf each of celery and parsley, a trifle each of pepper, salt, and sugar, and amply sufficient water to make your soup. Boil till you can crush the onions and pumpkin to a mash; mash them well with a large wooden ladle; pour all through a cullender, to strain off the fibrous portions. Then set the strained purée on the fire again; add to it the boiled rice and a good bit of butter, and keep stirring (to mix well, and prevent sticking to the bottom) until the rice is tender. Then serve, and you will have an excellent autumnal soup. There is no reason why, instead of water, you should not use any good meat or poultry-broth (not salt) which you happen to have.

THE AQUARIUM.

MARINE AQUARIUM.

IN a former number instructions were given for the management of the fresh-water aquarium. These, as far as regards the admission of light and regulation of temperature, apply equally to salt-water aquaria; but in other respects, the marine collection requires greater attention to detail, and therefore must be treated independently. In localities near the coast there is, of course, little difficulty in obtaining the objects necessary to furnish an aquarium; but at a distance from the sea it is not always easy to get even a supply of water, and therefore it becomes a matter of considerable importance, at starting, to know how to proceed in the manner least likely to result in disappointment.

The first step to be taken is to choose the vessel. The best form is the oblong square tank, with the back sloping inwards towards the bottom, all except the glass front being made of slate. But as this is not easily procurable, the confectioner's cover inverted, and fixed on a stand, will answer the purpose. As it is advisable to present as large a surface of water as possible to the action of the air, the vessel chosen should not be deep, but the greater the circumference the better. It should be provided with a glass cover having a circular hole cut in the centre. This will check evaporation, keep out the dust, prevent anything getting out, and yet admit sufficient air.

The water is the next matter to be considered. Some writers have recommended the use of artificial sea-water, prepared by dissolving a mixture of salts in rain water; but the risk of failure is too great to make the experiment worthy of trial. There are certain ingredients and living organisms in natural sea-water that would be absent from the imitation, and upon the presence of these success may possibly depend.* The easiest method of procuring real sea-water, is to take advan-

tage of a visit to a watering-place, and make an agreement with a fisherman to fill a small cask or large jar, and transmit it to you by rail. In giving him instructions, tell him to procure the water not less than a mile from the shore, in order to avoid the importation of impurities. By this means the writer has succeeded in obtaining water from Weymouth, Broadstairs, and Harwich, the vessel used being a nine-gallon cask, and the total expense not exceeding sixpence per gallon. It is scarcely necessary to remark that the vessel should be new, or, if a stone jar, carefully cleaned.

There are a very large quantity of beautiful objects that may be kept in a marine aquarium; but as the most attractive are not easily procured, and require some care in their management, the beginner should first try his "prentice hand" upon such as can be most readily obtained; these fortunately are the least likely to perish from neglect.

Presuming that a vessel has been provided before leaving home, and that a few gallons of water (twice the quantity actually required for the aquarium) can be forwarded or taken back as luggage, the visitor to the seaside may easily obtain all that he requires by taking a ramble over the rocks at low tide.

The speediest method of gathering the objects is as follows: Take a tin can, as shown in Fig. 1, a net with a long handle, Fig. 2, and a hammer,

and go to the beach about half an hour before low water. Choose the spot where the rocks stretch out farthest from the shore, and make your way over them to the water's edge. To do this some care is required, for the wrack that covers the rocks is exceedingly slippery, and a false step may launch you into a pool. As salt water is not beneficial to shoe-leather, those who are not provided with sand-slippers should rub a little tallow over their boots, especially in the crevice above the sole, before starting out. First dip your can half full of water, and then wriggle the net quickly round the edges of the rock pools within reach. There are several kinds of small fish that may thus be caught, but as they do not live long in confinement, you need not feel greatly disappointed if you fail. You will have no difficulty, however, in capturing a few shrimps or prawns, although it requires a practised eye to see them. When in the water, they are almost transparent, and thus easily elude detection, and when caught in a net they are scarcely observable, unless they force themselves into notice by jumping about.

You will have discovered that the rocks on which you stand are intersected by fissures, which are concealed by the sea-weed. Take the handle of your net and throw



Fig. 1.



Fig. 2.

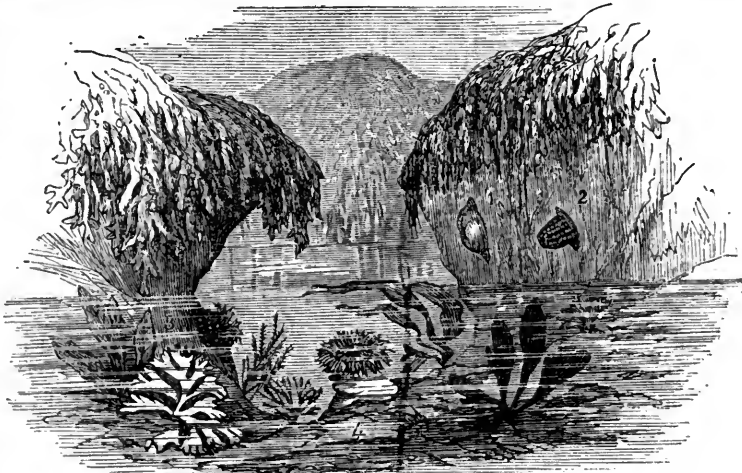

ROCK POOL WITH SEAWEED AND ANEMONES.

[1, 2, 3, 4.—*Actinia mesembryanthemum* in different stages of expansion.]



SHRIMP.



SCUD PRAWN.

* An analysis of 100 parts of the water of the Channel gives the following result:—

Water	96.470
Chloride of sodium (salt)	2.700
Magnesium	0.360
Sulphate of magnesium	0.230
Sulphate of calcium	0.140
Potassium	0.070
Carbonate of lime	0.003
Bromide of magnesium	0.002
Residuum	0.025
			100.000	

Besides very small quantities of iodine, sulphur, silica, and ammonia.

the weed back, so as to expose the crevices to view. Here, clinging against the sides of the rocks, you will see convex-shaped spots of a jelly-like substance, the colours being either brown, olive green, or red. These are the commonest kind of sea-anemones—the most curious, and at the same time the most hardy, of the objects you will find. But there they are likely to remain, unless you know how to dislodge them. Place your finger upon one, and it will throw up a jet of water, and at the same time tighten its hold, so that it cannot be removed without being mutilated; but approach it cautiously, and quickly force the thumb-nail under the edge of its base, and it may be peeled off unhurt without difficulty. If you do not succeed in the first attempt, leave the creature alone, and try another. This smooth anemone (*Actinia mesembryanthemum*) will well repay you for the trouble of taking, for it will need less care and yet outlive everything else that you may happen to get.

CORRESPONDENCE.

WAYS AND MEANS.

"J. B.," writing to us for further information on this subject, says:—

At the shop where I am employed there are 500 workmen, all males, chiefly young men, but not many boys. Three only of these are in receipt of £3 per week; three only are in receipt of £2 per week; sixty-three in receipt of 30s.; 184 in receipt of £1 per week; and the remaining 250 under £1 per week. You will thus see that one-half are not receiving even £50 per year. Now, if you could possibly, in some forthcoming number of the HOUSEHOLD GUIDE, show these 434, or those in receipt of 30s. and under, how to spend their weekly earnings to the best advantage, and give them a plan, as you have done for the higher salaries, you would then confer a great boon upon the hard-working classes of this country.

[We hope to be able to comply with our correspondent's request in an early number.—ED.]

"H. B.," Oxford, sends us the following on the same subject:—

I will endeavour to explain how I have been thinking to make my income of £1 per week cash, keep, &c., myself, wife, and nine children—eleven in number. I have a six-roomed house, and about thirty poles of ground at home, and I rent about forty poles more away from home—paying £14 per year for all. I consume eight sacks of flour per year, for which I am paying, for good wholesome seconds, 35s. per sack.

52 lbs. of butter (1 lb. per week) ...	£5	4	0	per year.
14 lbs. of tea (3s.) ...	2	2	0	"
1 cwt. of sugar ...	1	17	4	"
2½ tons of coals (inlands, 16s. per ton)	2	0	0	"
Four pigs (£1 each) ...	4	0	0	"
4 qrs. of barley-meal (30s. per qr.) ...	6	0	0	"

When the pigs have eaten these eight sacks of barley-meal, with the wash we make, and all the refuse from the garden, I reckon to have about 10 cwt. of meat per year to sell or eat. Of vegetables we get all we want of every kind; and I calculate that we sell (I have not kept an accurate account) of fruit, vegetables, &c., at least £26 worth per year. The pigs I reckon to be worth £20, so there is £10 profit on them.

	Per Year.	Expenditure—	Per Year.
Income ...	£52 0 0	Rent ...	£14 0 0
Profit on Garden ...	26 0 0	Flour ...	14 0 0
Profit on Pigs ...	10 0 0	Butter ...	5 4 0
Own Vegetables ...	7 16 0	Tea ...	2 2 0
		Sugar ...	1 17 4
		Coals ...	2 0 0
Equal to an income of	95 16 0	Pigs ...	4 0 0
Expenditure ...	49 3 4	Barley-meal ...	6 0 0
Balance ...	46 12 0		

So now you see, if I am right in my calculations, I have £46 12s. od. for sundries, such as clothes, &c., but I have to pay myself for vegetables out of it.

ANIMALS KEPT FOR PLEASURE.

III.—THE DOG: TRAINING.

If a dog be kept for actual service, such as minding sheep, or assisting the sportsman, he will generally be more efficient and valuable if trained up from birth by his owner, than if purchased when professedly "broken" by another. The animal will not only be much more under control, but will understand his master's peculiar signs, and gestures in a degree he will not do if broken by a stranger. In fact, even when you have trained your own dog, if you lend him a few days to another person, the chances are that, on his return, it will be some little time before he is quite as useful as before—so rapidly and strongly do even individual idiosyncrasies become reflected in the intelligent animal.

Training dogs is much facilitated by the fact that habits handed down through successive generations are transmitted almost as strongly to the offspring as natural instincts. Thus, a Newfoundland may be as intelligent in general as a Scotch collie; but the most careful training would fail in making him so good a sheep-dog as the other becomes with very little trouble, for the simple reason that his ancestors for generations have been trained to that duty, and he takes to it almost as a second nature. It is the same with sporting dogs; and hence the great importance of obtaining, if possible, puppies from a well-bred strain—they do not give one quarter the trouble in training. They are, in fact, naturally disposed to do what is required of them, and their inclinations often need little beyond controlling and directing. It has been said, indeed, that a cross-bred, or otherwise slow and dull dog, when trained, will be more reliable and useful than a better-bred and more docile animal; but we do not think such an opinion was ever held by any one who had really tried both.

For the training of the *Sheep-dog* very little definite instruction can be laid down, success depending almost entirely on the intelligence, patience, and, we may add, kindness of the shepherd. An impatient, ill-tempered man will never train a good dog; while with a good master a well-bred collie may be taught to do almost anything. The education of the pup should commence as soon as he can run faster than the sheep, so as to "head" them: till then it is useless to begin, though he should be taken out with them in order to become friendly with them, and to understand the most common words of command, which he will soon do if in company with a steady old dog. Indeed, an old, well-trained animal is almost essential to the training of a *first-rate* sheep-dog with any ordinary trouble, though they may be trained without, if the shepherd have time and patience to persevere. If, however, there be a sagacious old dog to assist, the task is very easy. As soon as the pup can go fast enough, he should be sent in company with the old dog to fetch in stragglers. After two or three times he will do this by himself, when he should be most sedulously taught to *leave them alone* when he has performed the duty. The next lesson is to "go round them" and keep the flock together; and the old dog again will do half the teaching; without him, patience and good temper is the only method. The young dog must next be trained to obey not only the voice, but the waving of the hand in any direction. When, in addition to this, the pup can keep up the flock behind while his master walks before, he is as well trained as ordinary shepherds have any idea of; but is very far short of what he ought to be, to the incalculable saving of time and labour. He can be taught by dividing the flock and putting him in the middle, to drive different flocks without mixing one animal; to jump over a hedge in order to head the flock in a lane, and in fact can be made, and in Scotland often is, so perfect in his business as to be trusted with the sole oversight of thousands of sheep during the whole day, keeping all in their proper

feeding-grounds, and showing a sagacity and fertility of invention in cases of emergency which is sometimes enough to stagger belief. In mountainous countries, such as Scotland and Wales, it is surprising to see the skill which the sheep-dogs will evince in collecting the flock together. They appear to the full as eager in their task as the shepherd, and rarely, if ever, fail to collect all the stragglers, in spite of the formidable difficulties which very frequently lie in their way.

The English rough sheep-dog is rarely capable of such perfect education as the collie, but will perform all the ordinary work required of him with steadiness and skill, if carefully trained.

In the training of *Pointers* the greatest patience and constant watchfulness are necessary, and the first lessons cannot begin too soon. We have already remarked on the strong instincts of this breed, and it is often so developed that puppies still suckling will point on seeing chickens, or finding bits of meat, or coming on the track of a mouse. Where the dog is too highly bred, in fact, the propensity sometimes is so exaggerated as to make him useless, causing the animal to point at valueless birds, or stale scent which the game has left for hours before. In order to prevent this, an occasional cross of the fox-hound is often used, and some of the very best dogs, such as have been sold for 200 guineas, are thus bred. This cross also much improves the endurance of the animal without injury to his powers of scent, but it must always be employed with judgment, and only the best of the offspring should be preserved.

At a few weeks old, as soon, in fact, as they feed apart from the mother, the pups—not only of pointers, but all sporting dogs intended for breaking—should be called to their meals by the firing of a gun, commencing for a few days whilst actually engaged in devouring their food. At first, they will be more or less terrified, but will soon associate the sound with pleasurable enjoyment. It is best to leave off when this object is attained. They must also be taught from the first to come to heel at a call or whistle, being invariably, as soon as they evidently *understand* the command, made to *obey* it by a sufficient but temperate chastisement for every neglect.

When old enough to walk out into the fields, the pups must be well practised in coming to heel, and when tolerably perfect in it, taught to obey the word "*down*." At first the command should be uttered with the whelp at the feet, forcing it down at the same time by the pressure of the hand; repetition of this will soon teach the pup what is meant, and cause obedience, which may be occasionally rewarded by a bit of bread. When obedient at the feet, the pup should be ordered "*down*" when at some distance, and if a steady old pointer can assist, will soon obey; but, if it does not, the trainer must walk quickly up to it and repeat the command in a stern voice. On the second disobedience a good scolding is added, and if a third time the order be neglected, a smart cut with the whip accompanies the "*down*," and probably impresses it on the youngster's memory. This lesson is of very great consequence, and must be well attended to, teaching the dog by degrees to drop at the mere wave of the hand, as speaking much in the field would spoil the sport. The animal must never be allowed to rise till ordered to "*hold up*," or simply "*up*," or directed by some expression of the kind.

The next step is to teach the pups to drop at the report of the piece by ordering them "*down*" immediately after discharging it, by degrees omitting the command, and meeting any consequent neglect, at first by rebuke, and the second time by slight chastisement. On no account must they be allowed to rise until the piece is reloaded, checking any attempt to do so by an imperious "*down*." This lesson also is of the utmost importance, thoroughly teaching a dog to "*down charge*" being of

more influence than almost anything else in securing good sport; but if the various stages have been attended to as described, there will be little of either difficulty or punishment about the process, and the whelps may be trained to perfect obedience in regard to all the foregoing sports by the time they have reached the age of four or five months.

The young dogs may now be taken to the game, if possible, in company with an old one. Their incessant chasing of the small birds should not be checked, as it will make them eager, and the calm disdain of the old dog for such small deer will, as soon as they meet with real game, soon make them ashamed. The example of the old dog will also speedily teach them to point and hunt with the greatest eagerness; and as soon as this is accomplished, he should be kept at home and the pups taken out by themselves for the final stage of training, which consists in bringing their eager delight in hunting under perfect control. And here will be found the benefit of teaching them to "*down charge*," or to drop at a wave of the hand, *before* they have been allowed to scent game. If this lesson be deferred till after, when all the dogs' hunting instincts are in full exercise, the task of subduing them will be long and difficult; but, with the habits of obedience to signals and watching the loading of the gun thoroughly taught first, it will not take long after to turn out a thoroughly good pointer.

The first lesson is to prevent the other dogs, when a comrade has found game, from rushing in upon the scent—to teach them, in fact, to *back* his point. The trainer must wait till the first dog has made a decided and tolerably steady point, and then, if another dog runs in, his name, and the word "*soho!*" or other word of caution, must be shouted in a stern voice, at the same time waving the hand. Of course, if the preceding lessons have been attended to he will know that he ought to drop at the well-known signal; and if he does not, he *must* have both a good scolding and enough of the whip to impress the fault upon his memory pretty sharply. We repeat here, once for all, that the great majority of dogs may be trained with very little correction, which should never be administered wantonly or unmercifully; but still, when needed, to give less than shall be well *remembered* will be useless, and therefore is nothing but mere cruelty. Generally from two to half-a-dozen smart cuts with the whip will be found quite sufficient for the purpose.

Again, if the game should run, and the dog follows, the others will naturally approach, and they may be allowed at first to follow on the scent in order to increase their ardour. But if any pup attempts to go before the one that found, he must be at once checked, and punished if he disobeys; for the first dog would feel it keenly if his scent were taken from him, and probably prove quite unruly for the rest of the day.

Young dogs should be allowed to play with the first game they see killed. They enjoy this greatly, and with every successive bird they mouth, their ardour in the sport seems to increase, while they rarely injure it much if left to drop it themselves. On no account should it be torn or snatched from them, as it might teach them to *tear* it, and such a habit makes a dog almost useless.

Having thus got the pups to back each other's point, there remains only to perfect them in observing the "*down charge*" when in actual sight of the game. The best way is to fire when the birds rise, but at first not hitting them. Still the dogs will endeavour, in all probability, to give chase, but probably an angry "*down charge*" will induce them to obedience; if not, the whip must again be used. If any dog is peculiarly obstinate, it is best to fasten a light but strong line to his collar, and, just when he has gathered full speed, to fetch him up sharply, which will send him tumbling over in a way he will much dislike, and with a few sharp cuts of the whip

will soon bring him to order. The same experiment may be employed to teach an obstinate dog that he must not chase rabbits, hares, or birds. We may here remark that, unless towards the latter part of their training the dogs are allowed to find plenty of their proper game, it will be very difficult to prevent them hunting and pointing small birds, for a good dog *must* hunt something; but if taken among game they soon learn the difference.

A pointer thoroughly obedient in all the foregoing may be considered a well-trained dog, and any other special points of training for sport it will be found comparatively easy to teach him. He must, however, be taught, as far as possible, to receive his orders by motions of the hand, in order that he may avoid any noise which might scare the game; and he must be made to keep sufficiently near the sportsman for the birds he springs to rise within shot.

If it is desired to use the pointer as a retriever also, the pup should be taught to "seek" while in the house by throwing bits of bread or meat. After awhile a small carcass may be constructed out of a rabbit or hare-skin, stuffing it with cotton-wool and briars mixed. This will soon teach him to seize tenderly, without breaking the plumage. Then, when they are being trained in actual pursuit of game, the only thing to observe will be that the dogs do not run in and seize the game until ordered to "seek dead." Pointers which retrieve seldom do so well when in company, as they tend to spoil the other dogs which have not been so trained; but when alone will often perform in both capacities to perfection.

The *Setter* is trained in very much the same manner as the pointer, the principal difference being that he "sets," or crouches, instead of "pointing," on finding his game. In endurance the setter will surpass the pointer, having harder feet and more power of limb. A setter has also more fire and dash, which often enables a quick shot to bag more birds within a given time, and to get over more ground; but these very qualities tend to make him a less perfectly obedient animal, his impulsive disposition seeking to break out, as it were, on every occasion. Some sportsmen, indeed, affirm that a setter can never be thoroughly broken; but this is contradicted by many dogs of this breed, whose behaviour in the field is quite unexceptionable. It is, however, essential, even more than in the case of pointers, that their training should commence when yet little pups, and that they be kept from the first thoroughly under control, so far as they have been taught; but if this be attended to they will usually turn out most useful assistants, whilst to our fancy they are about the handsomest of all the dog family.

The *Retriever* almost invariably contains a cross of the Newfoundland, whatever the other parentage may be, and his training is comparatively a very simple matter, though

it should be commenced, like that of all other dogs, when very young. As with other sporting dogs, he must first be taught to pay implicit obedience in the way of coming to heel, and dropping every time the piece is fired—in fact, *never to leave* his master when "on business," except ordered to do so. He should also be taught, from the very milk, to "seek" articles thrown about, and to carry tenderly, by carcasses stuffed with briars, as already described. Such a dog is more than half trained. Very often, retrievers are not sufficiently taught to "down charge," and the consequence is, that they break away after the shot, whether it be a hit or miss, frighten the game, and spoil the chance of a great many other shots by their impetuosity. Having, therefore, trained the retriever to "down charge," and, in fact, to remain perfectly quiet in the field, except ordered to "seek," little remains, except the teaching him to bring the game to your very hand, and to deliver it in no other way. Nothing can be more annoying than to see your dog *find* the game and bring it, perhaps, within a dozen yards, and then drop it in some heavy crop, such as a thick field of turnips, which very effectually secures you from ever finding it also. The retriever must likewise be



THE SCOTCH COLLIE.

taught to do his work without loss of time, by occasionally giving him food as a reward, but never until he has carried the game by your side a little while, and you have taken it from his mouth with *your own hand*. This is highly necessary, or he will get the habit of dropping the game to eat the food, of which we have already spoken. In training a retriever

for water-fowl shooting, it is best to begin in summer, in order that the dog may not have to face the cold water all at once; and it is necessary to check him if he ever attempts to catch rats or other vermin, as he will often waste his time in hunting on his own account.

Spaniels are much used for shooting in cover, and are seldom so obedient as field dogs, being necessarily often out of sight. To be of much use, they must be early accustomed to the game they are intended for, otherwise they will gad about after anything alive, or open on a stale scent, either of which makes a dog of little value. They may be easily taught to hunt in any direction, according to a wave of the hand, and to drop on the report of the piece; but it is difficult to get them to thoroughly "down charge;" they *will* generally rush to seize the game, if it falls. If the dog can be taught to "down charge," like a setter, it is better; but, if he is too impetuous for this, the sportsman may be well content with making him retrieve properly, by bringing it tenderly to the hand. Few spaniels will do more. Most spaniels open on the scent, and pretty loudly too; but some breeds are mute on certain scents, and the well-known Clumber spaniel is perfectly so.

In training all sporting dogs, a command of temper is

indispensable, for an unnecessary lash, or even rebuke, ought never to be given. One object only should be sought at a time, or the dog will get confused; neither should he be trained too long at one period, lest he become tired and disgusted. When he behaves properly, he should be patted and encouraged—in fact, made a *friend* of throughout, and only corrected when really necessary.

Having trained your dog to your own satisfaction, and got him to understand and obey your signals, you will do well never to *lend* him on any consideration, except to a person both trustworthy and not very unlike yourself in conduct and habits when in the field. To lend a good dog to a bad sportsman, is infallibly to spoil him for at least several days. If you have shot in company, and your friend and the dog mutually understand and respect each other, no harm can ensue; the great point undoubtedly is that the dog must be thoroughly familiar with the sportsman who uses him, and in the hands of a bad sportsman a good dog is very soon spoiled.

In training *Greyhounds* for coursing, the great point is to exercise their power by slow degrees, so as to develop without overtasking them. The exercise should, therefore, commence with a little, gradually increasing as the young dog's strength grows. The forenoon is always best, if the weather is fine. Daily rubbing or scrubbing, with a tolerably hard brush, is very beneficial, giving firmness to the muscles, and keeping the skin in good order. Sometimes the limbs are fired to increase their power, but we question if any advantage is gained by this cruel operation. The feeding is very important; it usually consists of oatmeal and flesh; but the training of all hounds is now so reduced to method, and comprehends so many details, that it is utterly impossible to enter upon it here.

In training dogs for performance no method can be laid down; but kindness, firmness, and indomitable patience will always succeed. No other rules can be needed, for no boy ever yet failed in training his dog to do anything he desired. We do not think severity is ever needed in this branch of training, but we never look at the poor wretch who performs in some penny show at a fair, without commiserating him for the brutality he has probably had to suffer.

HOME GARDENING.

GARDENS must necessarily vary in extent and shape. We will take as an example a plot of ground ninety feet long by forty wide, and although this will afford very fair scope for carrying out a nice arrangement with economy, still simplicity of design will be necessary. We do not advocate intricate plans on a small scale, as they only entail extra labour without an equivalent return. Suppose, then, that the frontage is laid out as a lawn and flower garden, we will proceed to give a few hints to enable our readers to follow out our plan with such variations as their own inclination may suggest. As a rule, let all walks in this department be curved rather than straight, sharp angles being very objectionable and harsh to the eye. Let the

beds and borders be oval, round, or simply curved, rather than angular. If you have room for a grass plot, all well and good; but we do not like to see a lawn too small to be effective. It will be seen by the following plan that we have provided for one in this instance. On this lawn we would plant a few miniature ornamental trees, such, for instance, as copper beech, silver birch, red or black thorn; or some of the better kinds of conifers, as cypress, pines, &c. The plots marked 2 may be planted with flowers; 3 is shrubbery. A deodar would form a very good centre, as it is not of rapid growth, and it would be some years before it would overgrow the place. For kitchen and fruit garden, we have set apart two-thirds of the entire plot. On the wall *a* let a peach, nectarine, apricot, or vine be planted, or one of each, if the aspect and situation allow of it. If the produce is more than

required for home, the surplus will always find a ready sale. The centre, or main portion of the ground, may be cropped with vegetables; and if you follow a system of rotation in cropping, and have due regard to the application of manure, you cannot fail to make your garden pay. Let herbs occupy the border, *b*, cover the wall *c* with plum, cherry, and pear trees. The wall *d* will do for tomatoes, and the border *e* for smaller crops, such as lettuces, radishes, and the like. The centre of the garden can be divided into eight plots, as represented in the engraving, for the purpose of carrying out a complete system of rotation cropping, full directions for which we intend giving in a future number.

CALENDAR FOR DECEMBER.

At this period of the year all teasers in exposed situations should be taken up at once and laid in by the heels, in a shed or outhouse, or wherever they will be beyond the reach of frost. Every description of bulb should be planted by this time, though it is better if they are got into the ground by the latter end of November. Fuchsias intended to remain out of doors all the winter should be cut down, and their roots should be covered with long litter or coal ashes. Pinks, pansies, and other choice things in open beds and borders, should be covered with light

litter in frosty weather, or with hoops and mats. Tulips and other bulbs require protection from frost if they occupy an out-door situation. Plantations of sea-kale, rhubarb, and horse-radish may be made. Now is the time for making new drains, improving water-courses, and planting edges, if you have not had an earlier opportunity of doing it. Early peas and beans may be sown on a warm border, or where they can have the necessary protection during frosty or very wet weather. Strawberry-beds may be made, but it is not the best time for planting the strawberries. Gooseberry and currant trees may be still planted, pruned, and manured. They may afterwards have a slight forking between the rows, taking care to incorporate the manure with the soil during the operation. Aged fruit trees will be much improved by the soil being well dug round and about their roots, and a six or seven inch thickness of old manure laid in a ring at least three feet round the stem of each. Trees of a younger description, that are

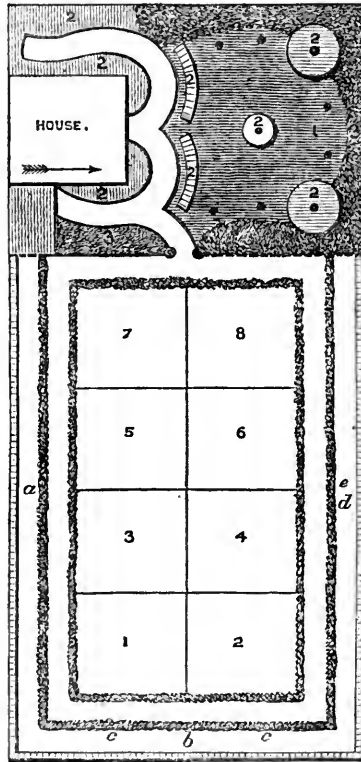

necessarily of a luxuriant growth, should have no manure. Stir the surface of the ground between advancing crops of vegetables whenever the weather will permit. Make a sowing of small salading at least twice a week on a warm border, or under cover, as most convenient.

THE REARING AND MANAGEMENT OF CHILDREN.

III.—THE NURSERY.

THE aspect of a day-nursery should be light, airy, and, if attainable, exposed to the south. It is impossible to over-estimate the worth of this situation in the attempt to rear children in full health and buoyancy of spirit. The ruddy bloom of a well-trained child betokens something more than a sound constitution—it indicates a joyous temperament and keen enjoyment of life. Children immured in gloomy apartments never wear this look. In all save their clothing, they are liable to resemble the ill-fed population of crowded cities, whose playground is the nearest gutter.

Doctors agree that the best place for children is the upper part of a house, where the air circulates more freely, and the odours of the basement are less penetrating. Not that nurseries should be in what is termed the "roof of the house;" still less should a child's playroom have a sloping ceiling, such as attic apartments too often have. What children require is, a cheerful prospect without, and an airy, roomy space to romp in. The custom, which is gradually gaining ground, of converting the breakfast-room on the basement-floor of suburban villas into day-nurseries, is very objectionable. One can quite understand that want of space and insufficiency of attendance often render these arrangements arbitrary; but the error invariably discovers itself in time in the increased want felt for stimulating food tonics, and other remedies for enfeebled constitutions.

The *Furniture* of nurseries requires a few words of comment. The bare necessities of comfortable living are all that should be admitted into apartments where space and cleanliness are indispensable. A large room full of furniture is less healthy than a small one scantily fitted up.

Beginning with the walls. It would perhaps shock most people to tell them that the very best walls for a nursery are those which are simply plastered and whitewashed. Every year, in the spring, the whitewash may be renewed at trifling cost, doing away with the harbour for fleas and more objectionable insects. Next in fitness is a painted wall, admitting of easy cleansing with soap and water when required. Equal in excellence is marbled paper varnished, like that of halls and staircases of modern houses.

Bedding is an important question, particularly if there are many children to provide for. If possible, each child should sleep alone; never with its nurse. Small iron bedsteads are best; but if there are many children, especially little ones, it will be a good plan to have wickerwork cradles, made in the shape of the bassinet without the hood. A basket of this description, measuring three feet two inches at the bottom and two feet two inches wide, will be capable of containing a child till three years of age, at which time he may be quartered in some other apartment. The advantage these basket-work bedsteads have is that the bedding may be removed from the nursery by day, and put elsewhere to air, and the baskets themselves stowed away one upon another till wanted.

Horsehair mattresses are the best if the expense can be afforded. They are best because they admit of being easily unpicked and put together again. It is only necessary to unpick the "tabs," and empty the horsehair

into a washing-tub filled with soap and water. When it has been thoroughly washed, together with the casing, it is as good and sweet as new. Every one acquainted with nursery management will be aware of the necessity for such cleansing.

India-rubber sheeting is very much used; but unless several folds of good thick blanket are laid beneath an infant, the bed is cold, comfortless, and injurious to the tiny body.

An excellent addition to the amount of bedding allowed will be under-mattresses of dry chaff. These are very inexpensive, can be made at home, and may be easily renewed. They are warm and springy. Here and there a tab will add to their evenness. Bolsters made of the same are comfortable and economical. For very young infants, especially when teething, a cot-pillow-case of wash-leather, filled with horsehair, will be most suitable.

Nursery bedding should not be aired in the same room as that occupied by the children. If, however, no other means exist, the mattresses and clothes should be laid before the fire whilst the little ones are out walking, the windows and doors being left open during the process.

The *fittings* of a nursery should be few and washable. Plain chintz curtains are preferable on this account to woollen materials. Sand-bags are requisite along the windows, in severe weather, because children cannot be kept from looking out and tapping at the panes, thereby exposing themselves to draughts. The bags should be movable easily.

Pictures, illustrative of Scripture subjects, domestic animals, and familiar scenes, are admirable for ornamental purposes. Mounted on card-board and covered with varnish, they last a long time, and may be safely washed without destroying their beauty.

It is not advisable to completely cover a nursery with carpet. A square of felt, bound at the edges, and fastened at the corners and sides with a few carpet-nails (those made with large flat brass heads are the best), is easily removed, and light to shake. The felt should be taken up one day in every week, and the room thoroughly scrubbed. An excellent addition to the ordinary means of cleansing consists of a lump of lime in the pail of water used for scrubbing. The lime not only whitens but disinfects the boards. Whilst the nursery is scrubbed, the windows should be left open a few inches top and bottom, and a fire kept brightly burning, except in the height of summer.

Chests of drawers, wardrobes, and the like, are out of place in the nursery. The sharp angles of the furniture make playing in the room dangerous; and such receptacles add to the impurity of the air. A hamper for toys is better than the cupboards usually appropriated for the purpose. Children love to make a litter, and to be able to get at their possessions without much trouble. Cupboard doors are better off their hinges.

If the house is large, and the nursery distant from the main supplies of provisions, a safe should be established on a landing or in a spare room, wherein bread, milk, butter, and nurse's grocery may be kept. One or two saucepans for warming infants' food, and a kettle for the nursery tea, add greatly to the nurse's comfort in busy households.

Another nursery fitting should be a small kitchen-range, instead of the ordinary fire-place. These nursery-ranges, fitted with a boiler, are a great saving of time and trouble, when hot water is frequently wanted, as in the case of the morning and evening bath.

Nursery fenders are in such general use, that it seems almost unnecessary to recommend them. No room appropriated to children is safe without such a protection from fire. To be perfectly safe, however, and beyond the reach of long sticks, it is needful that a wire guard should be suspended on the grate within. With this addition,

the outer fender may be used as a clothes-horse for airing small articles of linen.

In planning the arrangements of a nursery, the utmost forethought should be displayed to make the little establishment as independent of the rest of the household as possible.

With regard to ventilation: the well-being of children much depends on a plentiful supply of fresh air, and dangerous diseases are generated by breathing over and over again the same atmosphere. If a child wakes languid in the morning, instead of being sprightly and refreshed, it may be taken as a tolerable indication of inadequate ventilation of the sleeping-room during night. Some provision for the admittance of fresh air is indispensable. An open stair-case (provided the door of the sleeping-room be left open) will generally supply a current of fresh air. The register of the fire-place in the sleeping-room must also be left open.

SEASONABLE FOOD.

EVERY housekeeper is aware that many articles of food are considered in season or out of season at certain times of the year. It is needless to inquire into the reasons for this, though a satisfactory explanation could be given in most cases. Bearing the circumstance in mind, we propose to give from month to month a list of the principal articles in meat, game, and poultry, fish, vegetables, and fruit, which are in season. It will be observed that some things, as beef, veal, and mutton, are always in season; but they may nevertheless be repeated in the monthly lists.

DECEMBER.—*Meat*.—Beef, veal, mutton, pork, doe venison.

Poultry and Game.—Hares, rabbits, pheasants, grouse, partridges, woodcocks, snipe, fowls, chickens, pullets, turkeys, geese, wild geese, ducks, wild ducks, teal, widgeon, larks.

Fish.—Sturgeon, turbot, soles, skate, codfish, haddocks, smelts, dorys, gurnet, herrings, sprats, oysters, mussels, cockles, lobsters, crabs, and shell fish in general, perch, carp, eels.

Vegetables.—Cabbages, broccoli, savoys, Brussels sprouts, Scotch kale, sea-kale, spinach, endive, cardoons, lettuces, skirret, salsify, scorzonera, sorrel, potatoes, turnips, parsnips, carrots, beetroot, Jerusalem artichokes, celery, peas, haricot beans, leeks, onions, shalots, mushrooms, horse-radish, parsley, thyme, tarragon, chervil, mint, sage, small salads. Garden herbs, or pot herbs, which are chiefly used for stuffings, in soups, and for flavouring dishes, or for garnishing, are always in season, and can be procured at any time, either green or dried.

Fruits.—Apples, pears, medlars, grapes, figs, chestnuts, almonds, filberts, nuts, walnuts, raisins, currants, prunes, and all sorts of preserved and dried fruits, jams, marmalades, and fruit jellies.

DOMESTIC SURGERY.

SUSPENDED ANIMATION.

UNDER the head of suspended animation are included all those cases of apparent death in which, by the judicious application of appropriate remedies, the patient may be restored to vitality and health. The simplest form of suspended animation is that seen in *fainting*, when, from the effects of heat or over-exertion (combined possibly with tight lacing), a young lady becomes pale, falls down insensible, and appears scarcely to breathe. The admission of fresh air is of the first importance, and she should be immediately placed near an open window, and in the recumbent position, so that the flow of blood to the head

may be accelerated. At the same time, any tightness of dress should be at once remedied, and a little cold water sprinkled in the face. The use of smelling-salts is occasionally of service in rousing a patient, but care must be taken not to apply them too vigorously, for fear of irritating the nose. If, as sometimes happens, a fainting-fit is only the prelude to a fit of hysterics, the patient should be thoroughly roused by the free application of cold water, so soon as the hysterical sobbings begin to show themselves, and a brisk walk up and down the room, between two not too sympathising friends, will then probably avert a domestic catastrophe which is always annoying to all concerned. Persons with a feeble circulation, and, therefore, more liable to faintness, may be glad to know that they can often avert a fainting-fit when they feel it coming on, by at once lying down flat on a sofa; or, if from position—as in church—this is impossible, then that bowing the head well down on the knees will have the same effect.

Drowning is the most common cause of serious suspended animation, and, as accidents may happen at any moment, every well-educated person should know what to do on the emergency. In cases of drowning, every moment is of importance, and the attempts at resuscitation should, therefore, be begun as soon as the sufferer is drawn from the water, and without conveying him any distance to a house. The great object of treatment is to rouse the heart by inducing respiration, as in the case of fainting, and, if all efforts at this have ceased, recourse must be had at once to "artificial respiration," by the following method, known as "Sylvester's." The mouth being cleared of any dirt or saliva which may be in it, the tongue should be drawn forward, and held with the finger and thumb, or secured with a piece of ribbon or an elastic band passed over the tongue and under the chin. This drawing forward of the tongue is very important, as it opens the wind-pipe, and must never be omitted. The patient being then laid on his back, with the shoulders and head slightly raised, the operator kneels behind his head, grasps the arms just above the elbows, and draws them steadily and gently upwards (as shown in Fig. 21) until they meet above the head. By this means, the walls of the chest are expanded, and air is drawn into the lungs, and a second or two should be allowed for this to take place. The operator should then lower the patient's arms to his side, and press them against his chest (as seen in Fig. 22), so as to force out the air from the lungs, and thus imitate respiration. This series of movements should be repeated twenty times a minute—not more—and the time should be taken from the watch of a bystander, or it will be found in practice that anxiety will lead to hurry and consequent damage. As it will be impossible for one person to keep up the exertion necessary for many minutes, from the fatigue consequent upon it, he should be relieved as often as may be necessary by another, who should have watched and learnt the method of proceeding; but it is important that all directions should be given by one person, since confusion and delay is sure otherwise to occur. Whilst efforts at restoring respiration are being thus unceasingly carried out, the attention of other assistants should be given to restoring the warmth of the body of the drowned person, by removing wet clothes, applying hot blankets and bottles, and by using friction assiduously to the limbs, in an upward direction, so as to favour the flow of blood towards the heart. The utility of a warm bath is questioned by many authorities, and should only be resorted to when the patient is suffering from extreme cold. Even in this case, it is well to dash cold water over the face and chest, so as to excite respiration, and the use of the warm bath should not be continued more than five minutes, without medical sanction. Efforts at resuscitation should be continued for at least an hour, even in unfavourable cases, unless, indeed,

a medical man is able to certify that the sufferer is undoubtedly dead. Patients recovered from drowning generally require careful after-treatment for a few days, but this is best left in the hands of the medical attendant.

Cases of *Hanging*, with suicidal intention, may unhappily be met with, and require treatment very similar to that appropriate for drowned cases. Of course, the first step is to cut the sufferer down, and loose the ligature round the neck. Cold water should then be dashed over the head and chest, and if no breathing is thereby excited, recourse should be had at once to artificial respiration, as above described. In cases of hanging, it may be necessary to bleed the patient from the jugular vein or femoral artery, in order to relieve the congestion of the head, but neither of these operations can be safely undertaken except by a medical man.

Suspended animation from *Foul Gases* is most commonly met with in connection with breweries, where the carbonic acid gas is apt to collect in the large vats used for brewing; or in wells, where the same gas collects and is dangerous to any workmen descending to repair pump-tubes, &c. As in these accidents several lives are often unnecessarily sacrificed; in the well-meant but ignorant efforts made to rescue the first sufferer, it may not be out of place to say a few words as to the best method of dispersing the noxious gases, and removing those who are suffering from their influence. When one man has fallen insensible under the influence of the carbonic acid, it is simply suicide for another to attempt to rescue him without proper precautions. These consist in having a strong rope securely fastened round his waist, so that he may be drawn up at once if overcome, and another similar rope to be carried in the hand and to be attached to the first victim. The mouth and nose should be thoroughly muffled with a woollen comforter or handkerchief, and the rescuer should breathe as seldom as he can whilst attaching the rope to his fallen comrade. If sufficient assistance is at hand, efforts should at the same time be made to disperse

the carbonic acid gas by throwing down buckets of water. By this means the ordinary atmospheric air will to a certain degree be mixed with the deleterious vapour, which being heavy will speedily find its way through an opening in the bottom of a vat, if such can be rapidly made

by opening a trap or cutting out a plank. A garden-engine and hose, if at hand, may be used to pump fresh air to the sufferers, and a fire-engine, if obtainable, would be a still more efficient instrument. When the sufferer is at last placed in safety, every effort must be made to establish respiration in the manner already explained under the head of drowning. It is most important that a free access of fresh air should



Fig. 21.

be allowed to him by avoiding all crowding of anxious relations and friends around the patient.

Insensibility from *Sun-stroke* is occasionally met with in the summer months, from exposure in the hay-field, &c. The patient complains of violent pain in the head, and in bad cases becomes rapidly insensible, the face being flushed and the head hot. The treatment is to remove the sufferer into the shade and to apply cold water

freely to the head and nape of the neck. The head should be supported and cold water (iced if possible) poured from a height upon it. At the same time mustard poultices may be applied to the calves of the legs, and medical aid should be immediately summoned.

The same treatment would be appropriate to a case of apoplexy, care being taken, however,

not to prolong the cold effusion, as the patient's strength might not be able to bear it.

Cases of insensibility from *Intoxication* or *Poisoning* should be seen by a medical man as early as possible. No harm, however, can be done in any case by inducing vomiting, and this is most readily accomplished by tickling the interior of the throat with a feather, if the patient is unable to swallow, or if he is able, by the administration of an emetic of warm mustard and water. All constriction about the neck and chest should be removed, and the patient be placed on his side with the head slightly raised.



Fig. 22.

GARDENING.

THE WINDOW GARDEN.

FERNS are among the most beautiful of the plants adapted to window culture. The graceful forms of the foliage more than compensate for the absence of flowers when they are used alone; but when they are employed together with flowering plants, in some such contrivance as the bulb case engraved in our last paper, the effect is extremely pleasing. They may be placed as a centre, with dwarf flowers around, according to their size and habit of growth. But they are also useful for hanging-baskets, the drooping fronds falling naturally over the sides, and making a handsome base either for the flowers or taller ferns which may be grown in the centre.

With regard to the baskets used for such purposes as this, we may remind our readers that it is not at all necessary that they should be of a very ornamental character; so long as they are neat in outline, and adapted to the purpose by being sufficiently roomy to admit the soil and the free growth of the plants, it is immaterial what amount of decoration may be displayed upon the sides. As the plants grow, these will be covered and hidden from view; and, therefore, the elaborate and expensive affairs which are sometimes sold for hanging-baskets, are practically worth no more than the plain and unpretending articles which may be purchased for a quarter of the sum. A good example of the hanging-basket has been included in our previous illustrations.

When ferns are employed alone in the basket, it should be fitted with a zinc pan, in which to place the soil, as it will be necessary to keep this constantly moist, and without the pan an unpleasant dripping would be experienced.

Ferns for the purpose of indoor culture may be found in abundance in any wood, and in most of our country lanes. They may occasionally be seen growing in chinks of rocks, upon old walls, &c. A good variety might thus be obtained with very little search, including the common maidenhair, the hart's tongue, spleenwort, lady fern, and many others. The locality will in many cases decide the examples which may be thus selected for growth, as each district has some kinds more or less peculiar to itself. The plants chosen should be small—the smaller the better—as the more pleasure will be found in watching their gradual development; and when they have grown somewhat too large for the pot or basket, they may be removed to the garden, where they will help to make a pleasing variety among the shrubs and flowering plants.

If ferns be procured from a nurseryman or seedsman, the hardy native kinds should be chiefly chosen for window gardening, and they may be seen in numbers and variety to suit any individual taste. Many of the other

species are apt to require too much heat and moisture to render them desirable subjects, especially for growing in baskets. A few good healthy ferns to start with, will enable you to keep up a constant supply, as they may be propagated with ease by division of roots, and by raising from the spores. The spores are the seeds which are found on the under surface of the frond, and they are most easily collected by cutting off the frond entirely when the spore-cases become brown, and laying it by in a warm place, wrapped in a piece of paper. In a few days the cases will have burst, and the spores may be collected and sown. They may be sown in a pot, which should be half or three parts full of material for drainage, and the soil should be light and fine. A little moss placed underneath the soil will keep it sufficiently moist, and assist the growth. A small piece of window-glass should be put over the pot, and left there until the shoots begin to appear above the surface, when it must be raised occasionally for the admission of air. When the plants have grown large

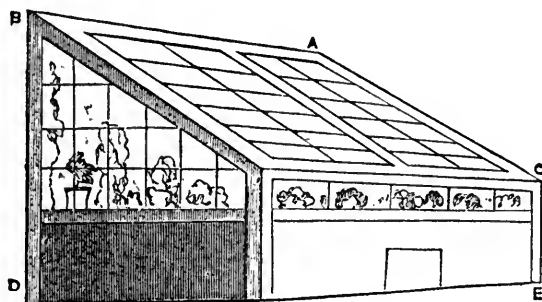

Fig. 1.—SMALL GREENHOUSE WITHOUT HEATING APPARATUS. (A B, hinged cross-beam; C, movable sash; D E, uprights.)

enough to handle, they should be transplanted immediately.

▷ Drooping plants, which will flower freely in the basket, may be had in great variety and at very little cost. Among the most popular favourites of this kind are the nasturtium family, tropeolum, canariensis, and other varieties, convolvulus major, honeysuckle, and trailing mesembryanthemum; but

there is scarcely any limit to the number of plants that may be grown in this way. The verbenas, heliotropes, petunias, nemophilas, lobelias, mimuluses, &c., may be trained to cover the sides of the hanging-basket, and thus each spring or summer an entire change may be made in the character of the plants so grown.

We will conclude these papers on the window garden with some hints on the raising and keeping of plants which require something more than the slight degree of attention which

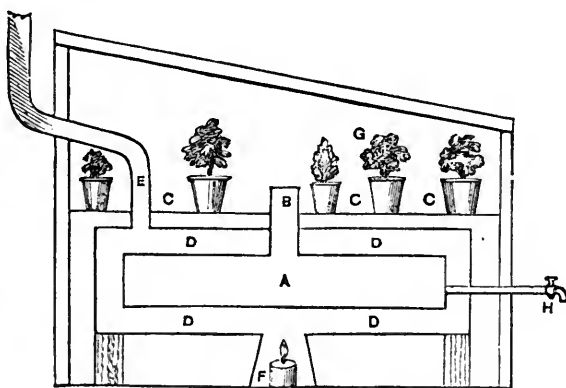

Fig. 2.—SMALL GREENHOUSE WITH HEATING APPARATUS.

is sufficient for many of the kinds described in our last paper. It will be found advantageous to stimulate the growth of certain seeds by artificial means, some of which may be carried into effect simply and inexpensively. Bell glasses are useful, and not expensive. A cracked tumbler will answer the purpose in some cases; and in others, a flower-pot turned upside down. In a cottager's garden we once saw a very neat contrivance: a tray was filled with sawdust, and placed in an east window; on this the pots with their seedlings were placed, and over them was a frame of glass. The sawdust, by being kept wet, moistened the soil, and at the same time generated a sort of bottom heat, which materially helped the seeds to germinate on cold days. The master and inventor of this little forcing establishment sprinkled the sawdust with warm water.

The pots must be filled one-third with cinders for drainage; we then divide the remaining space into three parts—laying first a layer of lumpy, rough soil; then a layer of finer soil, mixed with sand; next, and lastly, finely powdered soil, containing a greater quantity of sand. The surface soil must be sandy and light. If you cannot obtain heath soil, a little powdered charcoal is a good substitute.

Water the pots so as to thoroughly damp the soil, and let them stand for a day to drain in a dry shaded place.

Level the surface of the soil and then thinly scatter in the seeds, top-dressing them with a layer of fine soil of a thickness in proportion to the size of the seeds used; press the soil down, and lay over the top of the pot a square of window-glass; sometimes, in case the plants are delicate, or the sun scorching, it will be found advisable to shade with a piece of paper.

For small seeds, such as *calceolaria*, *lobelia*, &c., a slight dressing of dry silver-sand is best. *Mignonette* requires dusty dry earth, lightly laid on. Balsams will take the tenth of an inch, and *convolvulus* one-fourth, to cover them. It is a very common mistake to plant seeds a great deal too deep.

The difficulty of cultivating seeds in pots begins when the plants want singling or thinning out—one source of trouble being watering, as you are apt to drown and break the tender young stems. To avoid this, flood the pot, by holding a piece of broken pot against the rim, and pouring over it a supply of water. Another method, and perhaps the best, is to immerse the pot up to the rim, but not over it, in a pail of water, leaving it until completely moistened. The water will rise gradually through the earth in the pot, and thus the chance of damaging the plants is entirely avoided.

For bringing on tender plants, and keeping the less hardy kinds in winter, the miniature greenhouse is a most useful contrivance. Any ingenious person possessed of a few tools may make one for himself. The size and kind of the house must depend upon the number and nature of the plants he wishes to provide for, and it may be either little more than the ordinary garden-frame in character and appearance, or so constructed and fitted as to keep stove-plants in health in a severe season. Our illustrations will afford an idea both of the more simple and the more elaborate contrivances of this kind, and they may be of very moderate dimensions—in fact, in length from four feet upwards.

Fig. 1 represents a small house, which may be placed in the corner of a garden or yard, to act as a receptacle for the window-plants when they have ceased to flower, a training-house for young plants raised from seed or cuttings, and a shelter for fuchsias, *calceolarias*, *verbenas*, &c., in the winter. It should be erected with the back on the north side of the garden, and the roof sloping towards the south, so as to receive as much as possible of the sun's rays. A good layer of fermenting dung, placed underneath the soil, and removed from time to time, will generate heat; but in fine and temperate weather the roof should be lifted for the admission of the air, which is necessary to keep the plants thoroughly dry and healthy. At night, if the weather be frosty, the structure should be covered with a cloth or mat to prevent radiation.

Our next illustration represents an arrangement for the supply of heat by artificial means without much expense or trouble, and this also is adapted to a greenhouse on a very small scale. The means used is a hot-air chamber, kept at a certain temperature by means of a spirit-lamp placed under a water-reservoir. A is here the reservoir, and B the opening for the water supply, covered by a lid when the lower portion of the reservoir is full. C may be either a stand for pots, or the soil in which the plants are embedded. D D represents the air chamber surrounding the reservoir, and which moderates the heat before it

reaches the plants; while E is the flue through which the heat is allowed to make its escape when it becomes excessive. F is the spirit-lamp, G the movable sash by which the outer air is freely admitted in temperate weather, and H the tap by which the water may be drawn off. Either of these plans is capable of adaptation to any corner of ground that may be available for the purpose, and the amateur gardener, who has but little space at his disposal, will find an apparatus of this sort of immense assistance to him.

HINTS ON ARRANGING THE DINNER-TABLE.

SO much of the general comfort of a dinner depends upon the neatness and taste with which it is served, that a few hints regarding the proper arrangement of the table will probably be useful to our readers. Of course, the actual laying out of the table must depend upon circumstances—the viands to be served, the number of the family, or guests expected, and the means of the host. The cleanliness of the linen, and the knives, forks, spoons, &c., should, of course, always be scrupulously regarded. A very clever writer on this subject says, "Everything should be brilliantly clean, and nothing should be placed on it except what is wanted." It is desirable, if possible, not to have lights upon the table or anything in the shape of flowers, raised dishes, or the like, which may interrupt the freest communication between the guests. It is also important that the salt should look neat. Most persons use prepared salt. This will cake in cellars, and should be removed at least once a week into a pie-dish, crushed and replaced. Common salt must be grated fine after it has been placed in the oven to dry; then laid between a folded paper, and pressed with a rolling-pin till perfectly smooth. Bread for table should be cut in thick squares very evenly. The napkins, when used for the first time, should be neatly folded, enclosing the bread, and afterwards brought to table in rings.

Joins which require carving should always be placed on commodiously large dishes, otherwise they give a great deal of trouble, and splash the gravy. However crowded the table may be, the carver must have plenty of room, and it is most important that the knives should be in good order. Nothing is more irritating to a carver, or more indicative of bad household management, than the unpleasant necessity of sharpening knives before meat can be helped. One or more sets of cruets should be placed upon the table, according to the size of the party, containing the different sauces, flavours, &c., that are continually wanted.

Space at table can be gained by placing entremets which do not need carving, in small dishes, to be renewed if needed, or handing them. The vegetables also may be placed on a sideboard, if there is insufficient room. It is a common practice now-a-days to hand all dishes round, but there are still some people who like to have everything upon the table, in order, as far as possible, to dispense with attendance, and the necessity of continually asking for something.

DOMESTIC MEDICINE.

DISEASES INCIDENTAL TO CHILDREN (*continued*).

Teething.—The process of teething is a natural one, and should be unattended with any particular symptoms of ailment. It generally begins about the sixth or seventh month, though in some children, especially those of a rickety constitution, its commencement is often long deferred. There are two sets of teeth in the human body, the first or temporary set, and the second or permanent. The first teeth to appear are generally the front teeth of

the lower jaw, and then the two corresponding teeth of the upper. Although teething is a natural process, it is often accompanied with certain ailments; the most common of these are diarrhoea and bronchitis, especially the former. Diarrhoea is so common an accompaniment of the process of teething, that by some it is considered natural. In any great degree, however, it is weakening, and should not be disregarded. We shall treat of the various ailments which are apt to happen during teething, under the heads of their various names, such as Diarrhoea, Bronchitis, Convulsions, &c. We shall only here remark that the child during teething is unusually sensitive, and requires to be preserved from extremes of heat and cold; to be fed regularly and very simply. When a tooth is obviously pressing on the gum, and the gum is swollen or red, and the child disordered in any way, no objection should be offered by parents to having the gum lanced. The relief afforded by this measure is often most marked.

Bronchitis and Diseases of the Breathing Apparatus.—Few diseases are more common in young children than some degree of bronchitis, especially, perhaps, in the earlier or teething years of life. This complaint is not only common, but it is attended with some danger, and, unless speedily relieved, a doctor should be sent for. The disease consists in an inflammation of the bronchial tubes leading to the lungs. The wind-pipe divides into two tubes, these two divide into other two, and these again subdivide into two more, and so on until they attain a great minuteness, and on the minutest air-tubes the cells of the lungs are placed. Bronchitis, or inflammation of these tubes, is one of the most fatal diseases in our climate, especially to young children and old people. The symptoms of bronchitis vary according to the extent of the disease, and as the disease affects more the smaller or the larger bronchial tubes. The child is quickly bereft of its usual liveliness, and shows the following symptoms:—It is feverish; the breathing is quick, and the nostrils expand more or less; there is cough, which at the first is probably hard and painful, often making the little patient cry; a wheezing sound may be heard with the breathing. All these symptoms are apt to be worse at night, the breathing getting shorter and the child getting hotter. If the smaller tubes are much affected, the inconvenience in breathing, and the fever, and the danger of the disease are the greater. All such symptoms are more serious when they occur in delicate children, or in such children as have large heads, or who have their teeth slowly and late. If these symptoms occur only in a slight degree, they may yield to a little domestic treatment. If the weather be cold, the child must be kept in a room comfortably warm. Large linseed poultices should be applied to the chest, the first of which may contain a few grains of mustard. The following mixture may be given:—

Ipecacuanha wine...	1	drachm.
Spirits of nitre	1	drachm.
Syrup	2	drachms.
Bicarbonate of potash	6	grains.
Water	1½	ounce.

A teaspoonful may be given to a child nine months old, a little more or less to older or younger children, or according to the severity of the symptoms. If the first few doses cause a little sickness, they will do no harm. The above mixture is very good for feverish coughs in children. The symptoms which indicate danger, and the propriety of regular medical advice, are great feverishness, quick or laboured breathing, and any duskiness or blueness of the colour of the face.

Croup and Nervous Croup.—We will treat first of real croup, which consists of inflammation in the upper part of the wind-pipe. It occurs for the most part in children between the ages of two and five years, and is more common in boys than girls. It is noticed that the children of

certain families are more liable to croup than the children of other families. The disease often comes on in the night. It may set in with symptoms of a common cold, with more or less hoarseness and soreness about the top of the wind-pipe; the child becomes feverish and coughs quite peculiarly—the peculiarity consisting in the cough having a dry, hoarse, harsh, ringing sound, the “clangey” or “brassy” cough described by Dr. Cullen. The cough does not acquire this brassy sound all at once, probably not before twenty-four or thirty-six hours. It is very characteristic, and needs only to be heard, and to be associated with a feverish state of the child, to teach us that croup is present. More or less coincidentally with this cough, occurs a peculiarity of breathing. The child breathes with a crowing or barking sound. This crowing or barking sound in breathing, together with the brassy cough, the restlessness and feverishness, and the general difficulty in breathing, get worse at times, and especially they all tend to be worse at night. The severity of the case is to be judged of by the degree of fever and the amount of the peculiar noises in coughing and breathing which we have described. These sounds are caused by the swelling and inflammation at the upper part of the wind-pipe, which may be so great as almost to block it up, in which case the child becomes blue, and breathes with painful struggles and difficulty. We need not say that in such a case as this, medical assistance should be sought as soon as possible. In the meantime, the child should be put into a warm bath. After this a large linseed poultice should be put upon the chest, and a sponge dipped in hot water (as hot as can comfortably be borne by the child) should be applied to the neck of the patient for a quarter of an hour or twenty minutes at a time; on discontinuing the sponge, a little dry flannel should be wrapped round the neck. The child should be in a warm room, in which a kettle should be kept boiling, sending out steam into the apartment, as moisture in the air is very agreeable and beneficial in this disease. If any difficulty or delay is experienced in getting a doctor, and the cough is brassy and the breathing of the crowing kind described above, a little ipecacuanha wine should be procured at the chemist's, and of this, a third, or a half, or the whole of a tea-spoonful may be given every quarter of an hour, in a very little water, until vomiting is produced. The smaller doses will do for children about two years, even lesser ones for younger children, and the largest dose for older ones. The hotter the child, the older it is, and the more ringing the cough, the more ipecacuanha wine will it take and need. After vomiting has been brought about, ten drops of the wine may be given in two tea-spoonfuls of water every three or four hours, till relief is obtained. Children liable to croup should not sleep in cold bedrooms. Ipecacuanha wine should always be kept in the house.

False or Nervous Croup (Child-crowing).—This disease is liable to be confounded with true croup, but it is quite different in its nature. Like true croup, it is most apt to occur in the night. It may occur quite suddenly. It is a nervous disease and not an inflammatory one. It is characterised by a sudden difficulty—almost a suspension—of breathing. When breathing does take place, it is accompanied by a loud crowing sound, which gives the name to the disease. It is really a spasm of the muscles of respiration, and may be accompanied by twitches of the thumbs or face, and even by general convulsions. It differs from true croup in that it occurs to younger children, often between the ages of six and nine months. It often comes on while the child is getting a tooth. It is not attended with fever, like true croup, and comes on and goes off suddenly. A warm bath should be given, and a medical man sent for. The child might be suffocated in one of the attacks. If a tooth is pressing on the gum, it should be lanced, and this measure often relieves wonderfully.

THE REARING AND MANAGEMENT OF CHILDREN.

IV.—CHILDREN'S CLOTHING.

We promised in our last number to lay before our readers practical directions for making babies' long frocks and petticoats. These are not worn so long in the skirt as they were formerly. For full-dress toilette for a baby the

eighths of an inch wide. The long-cloth *not dressed* should be procured. It can always be had by inquiring for it at a really good shop. The thrifty housewife will find that she saves ten or twenty per cent. by going to a large, well-established shop, and the trouble and fatigue of a long walk, or the expense of an omnibus, will be amply repaid to her in the end. When a lady has to go a distance to a shop she should try and make all the purchases needed

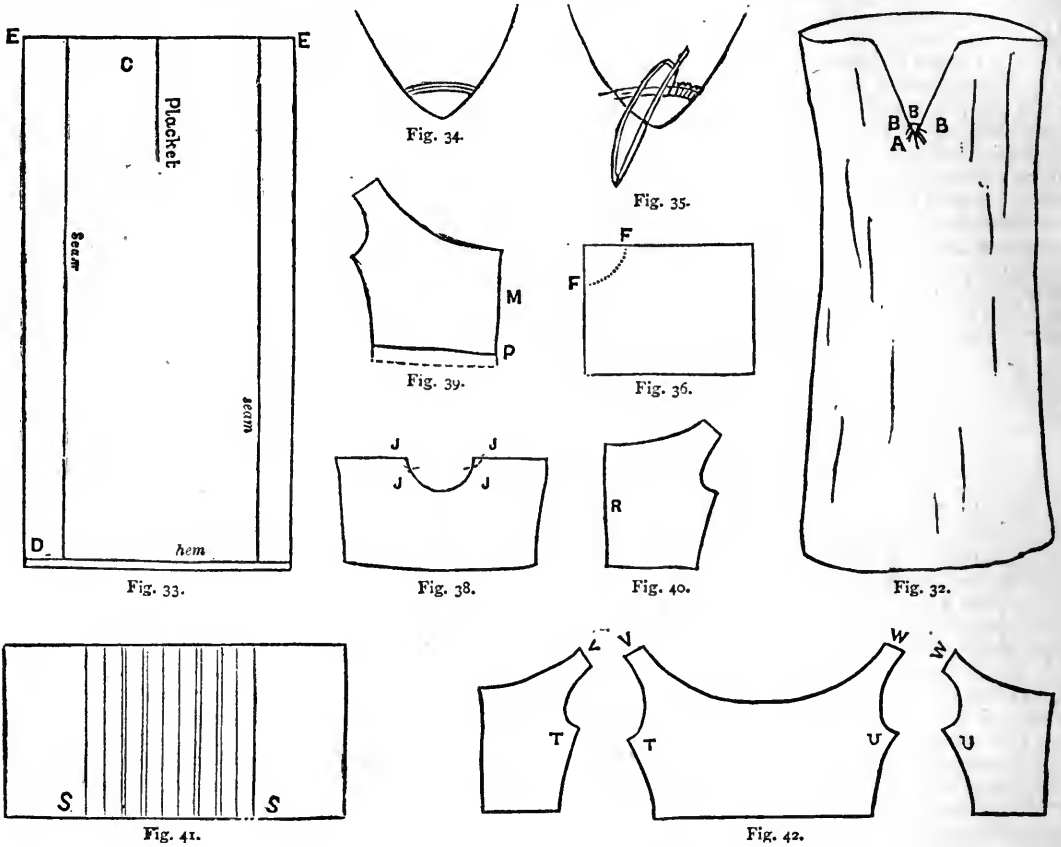

skirt of the robe, however, is still very long; and as the body, including the band, is two and a half inches deeper than the old-fashioned ones, the difference in the length is not very great. The length of the skirt of a robe thirty or forty years ago was forty inches, and the body three inches. A full-dress robe is now made thirty-six inches long in the skirt, and five and a half in the body. It will be the best plan for the young mother to commence by making the petticoats before she attempts the frocks, by which arrangement she will get her hand accustomed to the work.

Half a dozen white petticoats and half a dozen plain frocks, with one or two handsomer for best, will be sufficient; but where means allow of frequent change, double the number can be made, and the every-day frocks embroidered also. For the petticoats, a fine, thin, soft long-cloth should be chosen, and will cost ninepence or a shilling a yard. Eleven yards will be sufficient for six petticoats; a very wide material is not needed. Also two pieces of tape, one a quarter of an inch, the other three-

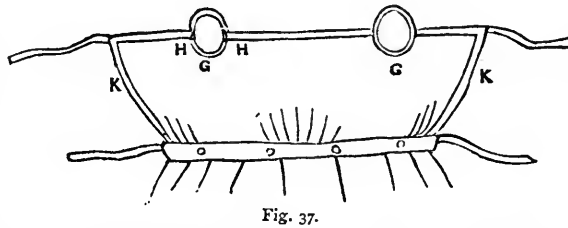

Fig. 37.

inches each. Split three of these in half lengthways, to make half breadths. Each skirt consists of a breadth and a half.

If the material is undressed, soaking is necessary. Rubbing between the hands, or soaping the work with dry soap, is sometimes sufficient preparation if it is dressed. It should always be soaped for the sewing-machine. Any dress in the material clogs the teeth of the feeder, and impedes the motion. If the work is soaked it should be ironed whilst damp, and made very smooth, otherwise it is not easy to work evenly upon it. Where the selvidges come the breadth and half-breadth of the skirt need only be run together neatly. The other seam must be run and felled.

Make a cut down the centre of the half-breadth, seven

and a half inches long, as shown at C in Fig. 33, and hem it round with the narrowest hem that can be turned down, neatly button-hole stitching the angle A, Fig. 32, and then making a loop across, shown at B B B. In case any of our readers are not acquainted with the correct mode of making a loop, we will describe it in detail, with the help of the diagram, Fig. 34. Pass the cotton across from side

to break in the drawing. However the body is made, the skirt is always constructed in the same way. To make the simple body, Fig. 32, cut a strip of long-cloth five inches wide and twenty-six long. Fold it in four, and hollow out a piece for the arms, as shown in Fig. 36 by the dotted line between F and F. How these arm-holes look when the piece of long-cloth is opened up may be seen by

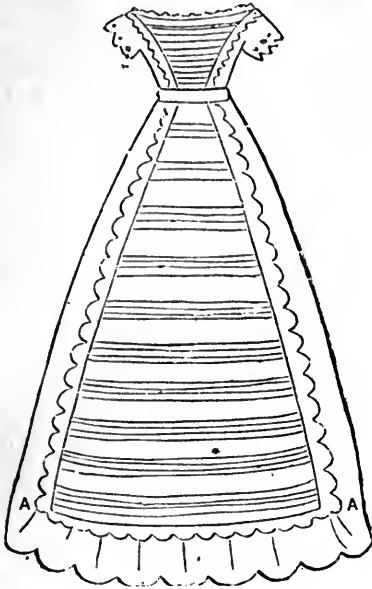

Fig. 48.

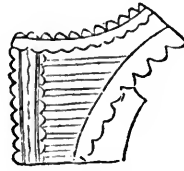

Fig. 49.



Fig. 46.

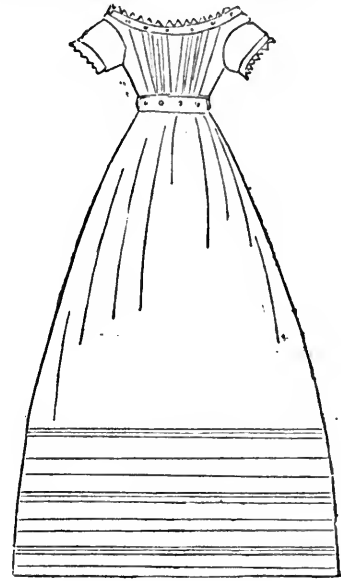

Fig. 45.

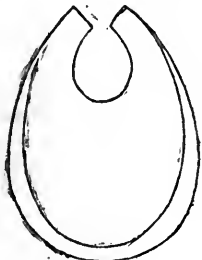

Fig. 51.

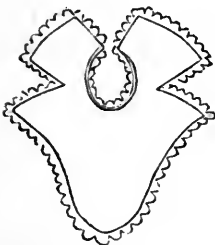

Fig. 52.

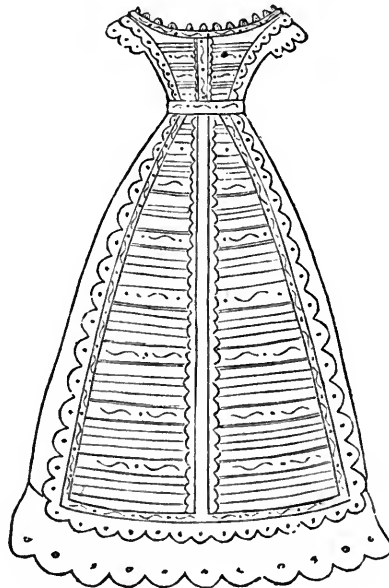

Fig. 50.

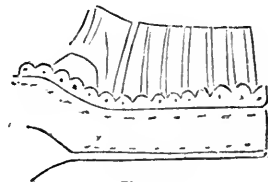

Fig. 43.



Fig. 44.

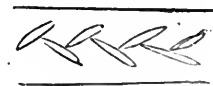

Fig. 47.

to side two or three times, taking an imperceptible stitch through the material, and keeping the three bars of cotton as close together and as much like one as possible. Then work over them closely in button-hole stitch, as shown in Fig. 35. The object of this loop is to prevent the placket-hole from tearing down, and must be made to all the frocks as well as the petticoats.

Next hem round the skirt, as shown at D in Fig. 33, and then gather it finely at the top (E and E) all round. Gathering is simply running, and drawing up the thread. It will be necessary to use rather coarse cotton for this purpose, because a fine thread is always exceedingly liable

referring to the diagram of the completed body (Fig. 37) at G and G. Cut two little strips of long-cloth (cutting *down* the stuff, not across), each four inches long and one inch and the sixteenth of an inch wide. These are to form shoulder-straps, run and felled on at H and H in Fig. 37, having first just nipped off the corners with the scissors, as shown at J J in Fig. 38, treating both arm-holes alike. Then hem all round the arm-hole, and inside the shoulder-strap, making the hem no wider than the sixteenth of an inch, which is the smallest division you will find marked on an English yard-measure. [The French, who are much neater workers, preciser copyists, and better fitters, divide

their inches into thirty parts.] Then hem the backs (K and K in Fig. 37) a quarter of an inch deep. Next hem all along the top, shoulder-straps included, a quarter of an inch deep, and run the narrowest tape in for a band. Cut two strips of long-cloth (down the material) half an inch wide and nineteen inches long. Gather the waist of the body a little at each side of the back and in the centre of the front, as shown in Fig. 37, the limit of the gathers marked by four o's. Measure if the strips just cut exactly, and run it to the body on the wrong side, and turn it over. Join the other end of the band to the gathers of the skirt. The second band strip is used to line this, turning it down at both edges, and hemming it on the wrong side, taking care not to let the stitches show through on the right side. This completes the petticoat.

The second or cheaper petticoat bodice is made like a dress body, and the same illustration will serve for both. Take a piece of long-cloth six and a half inches wide and thirteen inches long, double it exactly in half, the short way, and cut out the front of the bodice like Fig. 39, the fold coming in the centre, at M. Pencil the shape on the stuff, before cutting it out, into a one inch wide band, marked at P, which is put on afterwards, and with ends. Next take long-cloth eight inches wide and fourteen long, double it the narrow way, the fold at R, and cut it the shape illustrated by Fig. 40; afterwards cut it in half at R, as the back is in two pieces. The two back pieces and the front will resemble Fig. 42. Join the pieces together, T to T, running and felling the seam from the arm-hole to the waist. Do the same at the other side, at U and U. Then also run and fell the shoulders, V to V and W to W. Cut a strip band half an inch wide, and turn it down to make a narrow false hem round the top, in which a tape must be run. Hem the arm-hole, and let the waist into a band. A petticoat bodice needs no sleeves. Whip the skirt instead of gathering it, and sew it to the bodice when the bodice itself is quite completed. Whipping is done by rolling the edge of the calico very finely between the fingers, and sewing over the roll in rather long stitches, but such as will draw up into fine gathers. The rolling is done piece by piece, as you sew it along. It is less trouble to turn down about a quarter of an inch of the material, instead of rolling it, but it is less neat. Some persons stroke the gathers down with the point of the needle, which gives them a regular finished appearance, but it is better not to do this, especially to the fine muslin of the frocks, because it helps to wear out the fabric.

For the frocks, plain cambric muslin, at eighteenpence a yard, is all that is needed, and about three yards will be wanted for each frock. There are two breadths in each skirt, a yard and a quarter long, the body is nearly a quarter of a yard deep, and the sleeves and band cut into another quarter width way. Eighteen yards will therefore be wanted for six frocks. The addition of embroidery is entirely optional, except round the top and sleeves, where a little fancy work cannot be dispensed with. The embroidery used for the purpose should be very narrow. A simple scallop and dot is pretty enough.

To make the skirt, cut two breadths (these should not be less and need not be more than twenty-six inches wide), each breadth a yard and a quarter long. Run and fell them together with as narrow a turning as possible, and very fine cotton and small stitches. Hem the bottom, and reduce the length of the skirt to thirty-six inches (that is, a yard) by making a number of tucks. The hem must be of the same width as the tucks.

There are different ways of tucking the skirts, which give variety to the plainest frocks. We will describe two or three ways. First, a half-inch wide hem, and a number of half-inch wide tucks, each half an inch apart. Second, half-inch hem and half-inch tucks, each one inch apart. Third, half-inch hem and one tuck, half an inch apart. Leave two inches, and make two more tucks, half

an inch apart. Leave two inches again, and repeat making the tucks in the same way till you have sufficient. Fourth, a number of tucks the sixteenth of an inch wide, with the same space between each, and the hem to correspond. Fifth, a hem and two tucks the sixteenth of an inch wide, and the same space between; miss half an inch, three tucks again; miss another half inch, and repeat once more. Either of these patterns will look well with a single row of embroidery added at the bottom, but it is not necessary. Wide tucks may also be run in threes, with a wide space between. Sixth, an inch wide hem, three quarter inch tucks, each a quarter of an inch apart. Miss an inch, and make an inch wide tuck and three quarter inch ones, a quarter of an inch apart. Repeat the tucking once or twice more in the same way.

A plain body can be made with tucks to correspond, perpendicularly down the body. To make a tucked body, a piece of muslin eight inches wide and the whole length of the material should be cut and tucked across, commencing the tucks three inches from the end; when the tucked piece measures four and a half inches from S to S in Fig. 41, allow three more inches, and cut it off. This piece resembles Fig. 41. Fold it in the centre, and carefully pin it together; then pencil, and afterwards cut it to the shape of Fig. 39, having the folded part at M. The back should be made quite plain, and cut in two pieces, like Fig. 40; join it in the same way at the sides and shoulders, as shown in Fig. 42. Set the top into a quarter wide band, the front of embroidery, or worked with dots or corals, which we will presently describe. The band for the top is made in two pieces; cut each half an inch wide, and allow for turning in. First run the embroidery to the band; then lay the body on the table, the right side up, towards you. Put the band on it, the wrong side upwards, so that the right side of the band lays face to face with the right side of the body, as shown in Fig. 43, where the tucks on the wrong side of the band can be seen. Pin it, and run it to the top of the body, then turn it up, and you have the right side of both facing you. Line the band by running on the second strip of muslin. Run a tape in. Let the waist into an inch wide band, made of embroidery or worked with coral or dots. The sleeve is cut on the cross, like Fig. 44, nine inches long and three and a half wide. Y Y is the piece for the hem, which is made after it has been run and felled together at Z Z. Run and fell it into the arm-hole. The skirt must have a placket-hole made, and be drawn into gathers in the same way as the petticoat, and then sewn to the body. Fig. 45 shows a plain frock completed—the neck, waist, and sleeve edges set in bands worked with dots.

To Work the Dots.—Fill a needle with rather coarse embroidery cotton; commence with a stitch, just as if you were about stitching a waistband. You have thrust your needle in the stuff thus—but do not take it through—leave it so, as shown in Fig. 46; twist the cotton round it, close up to where it comes out of the stuff (the place is marked by the letter A); twist it a second time in the same way. Bring the needle through; if the worsted cotton is not close up to the stuff, pull the thread, and set it with your fingers. Take a second stitch through the very same holes—B and A—and the dot is formed. When dots of graduated sizes are required, take a small stitch, and twist the cotton once, for the first size; a larger stitch, and twist the cotton twice, for the second; a still larger, and twist it thrice for a larger dot. Two stitches taken in the same place (from B to A) raise the work still more.

Coral Stitch.—Coral stitch is simply a number of long stitches worked at right angles with very coarse embroidery cotton, in the way shown in Fig. 47.

A pretty Baby's Robe (Fig. 48).—A very pretty baby's

robe may be made with the help of the sewing machine, with a front *en table*. A very fine muslin should be chosen for this purpose. The tucks will require a breadth about two yards long. It is best to work the tucks before cutting the material, as if there is any variation in the width, the length will not be exact. First leave five inches the sixteenth of an inch wide, and work a similar one between. Miss two inches, and repeat till the work is a yard long. Then cut it off. This tucked piece must be gored on both sides. Fold it in the middle and pin it well together and cut both sides together. The half width as it lies doubled must be gored off to five inches across the top. It is better also not to let it measure more than fourteen inches at the bottom. The five inches left are to come at the bottom, one of which is allowed for the hem. Join a plain width to this to make the skirt; but before joining, run down each side of the gored breadth a piece of embroidery—simply a scalloped edge—carry it also across the bottom of the skirt just below the tucks, marked A to A in Fig. 48. When the skirt is completed, add a three and a half inch flounce, to be fluted all round the bottom, the edge scalloped in button-hole stitch. For the body, tuck a straight piece horizontally with small tucks close together, and cut it stomacher shape, as shown in Fig. 49, inserting it into the remainder of the body, with a brace of the scalloped muslin added each side, and straight round the back like a berthe. The sleeves are made the same as Fig. 44, but over them is a frill of the scallops. The waist and neck-band are slightly embroidered, and a simple edging placed round the neck.

To obtain the stomacher pattern is not difficult: cut the bodice pattern, Fig. 39, in paper, with a pencil mark off the line of the stomacher shown in Fig. 49; cut the tucked piece stomacher-shape, and the side pieces form the remaining portion of the pattern.

A Christening Robe (Fig. 50).—To make this dress, take half a width of muslin and run tucks three and three with about four inches between each. Cut them apart. In paper cut the pattern of the front of the robe, which is to be a gore twenty-eight inches at the bottom, and ten at the top. Cut the half of it in paper, and allow three inches for the centre and outside insertion. Between every three tucks place a row of insertion, laying each on the paper pattern, so as to cut them the right length and not waste the embroidery, which is expensive. Between every three tucks there must be a piece of inch wide embroidered insertion. Cut both tucks and insertion a little longer than the pattern to allow for working up, then neatly join them. Down the centre there is a row of embroidery, bordered each side by edging, and this is repeated at each side and carried round the bottom. A plain breadth of wide muslin completes the skirt, which is bordered all round by an embroidered flounce four inches deep. The body is composed of a stomacher of two tucks and one insertion, placed alternately. An insertion double edged, occupies the centre, and the braces, which form a berthe behind, are of the flouncing embroidery that robes the front of the skirt. The sleeves are plain, like Fig. 44; but covered with a frill of the flouncing. The waist and neck-band are made of insertion, and a narrow edge finishes the top. Christening robes for babes are sometimes made of lace instead of embroidery; but of course this requires everything *en suite* in richness and costliness, and is by no means necessary. Many parents prefer to use a plain robe for the christening.

A baby's bib is commonly made of a piece of piqué or fine marsella, shaped like Fig. 51, and made braided or plain. If braided, the edge is button-stitched and cut out. If plain, it should be piped round, and then a tape run over the piping on the wrong side. To keep a baby nice, six bibs should be made, and one every other day used. A fresh one every day is still nicer. Fig. 52 is a pretty fancy design for a bib. It should be made in fine piqué,

white, piped with long-cloth, edged all round with narrow embroidery, and run down on the wrong side with a false hem of tape.

COOKING.

MEAT DISHES AT MODERATE COST.

Sheep's Trotters.—When these can be bought, as in many large towns, ready scalded and with the hair removed, they are not dear. Keep them steeped in cold water till you set them on the fire to boil, which will take at least three or four hours. When done, they may be eaten with pepper, salt, and vinegar. A nice sauce for them is, to put some fat and flour in a stewpan, to mix in smoothly some of the broth, to throw in a little chopped parsley, and season with salt and a dash of vinegar. Cold sheep's trotters can be covered with melted fat, rolled in bread-crumbs, and broiled over a clear fire.

Sheep's Feet Pâté—(French).—Have a coarse earthen pot or pâté-dish, with a well-fitting cover. Get at the tripe-shop, or of your butcher, three gangs of sheep's feet (twelve) ready cleaned and scalded. Divide them at the joints into two or more pieces; boil them a couple of hours; then pack them closely in the pâté-dish, interspersing with them equally, as seasoning, sprigs of thyme and parsley, a few bay leaves, cloves, pepper, allspice, salt, and button-onions, whole. Put in the liquor in which the feet were boiled; then put on the cover; tie it in its place with string passed over it round the dish; cover it down closely all round with paste, and send the pâté to pass the night in a baker's oven after the bread is drawn. Next morning, the pâté will be done, and may be either eaten hot or allowed to get cold. The oven being slow, the feet will be cooked to a jelly. If the oven is too fierce, they will of course be dried up, burnt, and rendered good for nothing. When properly done, this is an excellent dish; but success entirely depends on the moderate temperature of the oven, the close fastening down of the lid with paste, and care on the part of the baker to prevent its drying up.

Pigs' feet and pettoes may be dressed in exactly the same way.

Calf's Liver, Stewed.—Choose it fresh killed, of a clear bright colour, *without spots*. Dr. Edward Smith, a high authority, says,* "Liver should be cut into thin slices, and boiled or fried with bacon. Cook it well, but not with a hot fire, and do not make it dry and hard. See that it looks healthy." It is perhaps the part of our butchers' meat which is most liable to be affected by disease. By our mode of dressing liver, it is just as good warmed up again as it was at first; indeed, nobody would know, unless they were told, that this was the second, or even "the third time of asking." Having as much calf's liver as your family want, cut it into pieces the size of a hen's egg, season them with pepper and salt, roll them in flour, and let them so remain on a dish while you are doing what follows. Peel potatoes, halve or quarter them, if large; do the same with onions; slice two or three carrots. Put some fat or dripping into a broad shallow saucepan or stewpan, and when it is melted, brown in it a soup-spoonful of flour. Stir in a little water; mix well; then put in your liver, shaking it about; then enough warm water to cover it. When it boils, put in your vegetables; when they have boiled a few minutes, draw the saucepan aside, and let them simmer till they are done enough. Taste if sufficiently seasoned. It will be a great improvement if you can put in with the vegetables a sprig of parsley, celery leaf, and thyme. Lay the pieces of liver in the middle of your dish, put the vegetables round them, and pour the gravy over all.

If you *fry* slices of liver and bacon, thicken the grease

* "Practical Dietary," p. 256.

left in the pan with flour and water, season with pepper, allspice, and vinegar, and pour it over them for gravy.

Sliced Calf's or Sheep's Liver Fried.—Cut up the liver into small thin slices. Cut some onions crosswise into very thin slices. Brown them in a stewpan with a lump of butter; dust in a little flour; stir in enough boiling water to cook them tender; season with pepper and salt. In your frying-pan fry the sliced liver in butter, taking care not to do them too much. Grate a little nutmeg over them, and add a dash of vinegar; then put them to the onions in the stewpan; mix them together; let them stew gently for five or six minutes, and serve with the gravy poured over them, which may be further thickened, if too greasy, with a little flour and hot water.

Calf's Liver Cheese.—Chop fine a couple of pounds of calf's liver, half a pound of beef suet, half a pound of white bacon, and a few mushrooms, if there happen to be any. Mix these well together, then add to them three or four good-sized onions chopped and browned in butter in the frying-pan, six egg-yolks, a small glass of brandy, pepper, salt, and grated nutmeg, and lastly, stir in the whites of six eggs beaten to a froth. Line the bottom and sides of a well-tinned iron saucepan with very thin slices of white bacon; put in the minced liver, &c., and cover with thin slices of bacon. Close the saucepan tightly with a lid on which you can heap hot cinders or ashes. Cook over a very gentle fire. It does very well on a hearth where wood is burnt, with the hot ashes piled round it. Let it remain in the saucepan till quite cold and stiff. To turn it out, set the saucepan a minute or two in boiling water; place the dish over it, and then reverse it.

Bullock's Heart à la Mode.—Split open the heart at its thinnest side, without cutting it in two; take out the arterial cartilage and the coagulated blood left in it; fill its inside with bacon cut into dice, seasoned with pepper, salt, and chopped parsley. Tie it round with string into its original shape. Stew it in a saucepan, covered with broth, and half as much cider, if it comes handy; add a bunch of sweet herbs, and as many onions and carrots as there is room for. When it has simmered gently full four hours, lay it on a dish; put the carrots and onions round it; let the liquor boil a few minutes longer to thicken, then pour some of it over the heart, and serve the rest in a sauce-boat. If you like it, you may flavour the latter with mushroom catchup and a little red wine, which will give the heart the flavour of hare.

Bullock's Kidney.—This is often cut up into dice, and made into kidney pudding, exactly as we have directed above for beef pudding. The crust helps it out very well; but it is less agreeable cold, and the kidney is very apt to be hard. As a change from this, cut up the kidney into very thin slices, dust them plentifully with flour, and season with pepper and salt. Put a lump of butter into a saucepan; as soon as it begins to melt, put your sliced and seasoned kidney to it; add a little cold water, just enough to prevent burning; if you live in a cider country, use cider instead. You may add a table-spoonful of catchup. Keep shaking and stirring over a gentle fire without ever letting it come to a boil. If it does, your kidney will be hard and leathery. The secret of success consists in not letting it cook too much, too fast, nor too long. Lay bits of toasted bread round the edge of a dish. With a spoon put the kidney in the middle; give the gravy a boil up, and pour it over it. Some cooks would garnish with sliced lemon, and stew in red wine, or even in champagne; for the latter, the cider is not a bad substitute, and is often more obtainable. If any is left, let it be warmed up over a very gentle fire.

Tripe Normandy Fashion.—Wash your tripe, scald it; wash it again, scald it again; scrape it, wash it, re-scrape, and re-wash it in several waters; then cut it in pieces,

and put it to cook in a boiler with chopped bacon, carrots, onions, garlic, cloves, thyme, bay-leaf, parsley, and peppercorns. Moisten with white wine or cider, and the fat skimmed from the *pot-au-feu*, or family soup-kettle. Instead of these, you may use good soft water, setting on cold. Let it simmer gently for about eight hours (we say, till tender, which will probably come to pass in a little less time). Before cooking tripe to serve it in any way, cut it into neat pieces two or three inches square. Tripe has been recommended to invalids, stewed with beef, seasoned to taste, and with thickened gravy poured over it. It may also be stewed with onions and milk, seasoned with pepper, salt, and nutmeg. It can be fricasseed brown with fried onions and gravy or good broth, and heightened, just before serving, with allspice and tarragon vinegar. In all these cases the tripe must have long stewing, unless it has been done very nearly enough by the regular tripe-dresser of whom it was bought. One of the nicest ways of cooking tripe so prepared is to fry it in batter in the way already directed for other things. It then requires no sauce whatever; if any is wished for, make it with water, flour, butter, a little vinegar, and still less mustard.

Lady Harriet St. Clair, in her "Dainty Dishes," gives three recipes for tripe, of which we borrow two, on account of their excellence and simplicity.

Stewed Tripe.—Select two pounds of double tripe well cleaned and blanched, cut in pieces of rather less than a quarter of a pound each; put in a clean stew-pan with a pint of milk and one of water, two teaspoonfuls of salt, one of pepper, eight middle-sized onions carefully peeled. Set it on to boil, which it should do at first rather fast, then simmer till done, which will be in rather more than half an hour. Put it into a deep dish or tureen, and serve with the milk and onions.

Tripe à la Lyonnaise (Lyons Fashion).—When any cold tripe remains, cut it in thin slices about an inch square, and wipe it very dry. Mince two onions, put some butter (in the proportion of three ounces to a pound of tripe) into a frying-pan with the onions. When they are about half done put in the tripe, and let all fry for about ten minutes; season with pepper and salt, and three table-spoonfuls of vinegar to each pound of tripe. Serve very hot. This is a favourite dish in Lyons with all classes.

Besides these ways, French cooks serve tripe broiled in oiled paper, bread-crumbed, white, with sauce piquante; with sauce Robert, *au gratin*, or browned in the oven, like fricasseed fowl; in flat sausages after chopping, with skate sauce, like ox-palates; Provençal way, plenty of garlic and oil; Milanese way, with grated cheese; Italian way, stewed with macaroni, &c. &c.

Neat's Foot or Cow Heel.—The feet are mostly sold so nearly cooked as only to require a warming-up; but the substance of neat's feet consists of so little else besides gelatine and bone (the oil, strong in flavour, being extracted in their preparation), that we consider them more fit to enrich other dishes—soups, stews, fricassees, &c.—than to be served as a dish by themselves.

Neat's Foot with Parsley Sauce.—Warm up or finish cooking your neat's foot in as little water as may be. When ready to serve, make sauce with a little of the liquor, flour, butter, chopped parsley, and a dash of vinegar. Pour this over the foot, and serve.

Breast of Pork with Rice (Economical).—Wash and scald a pound of rice. Wash and cut up into dice half or three-quarters of a pound of breast of pork, fat and lean together; then add to it a little butter in a stew-pan. When nicely browned, add the rice; stir in gradually three pints of water or broth and a little pepper. Let it stew for five-and-twenty minutes, stirring now and then, to keep it from sticking to the bottom. When done, serve it in a heap in the middle of a dish. A few boiled or fried sausages laid round it make a very pleasant addition.

ANIMALS KEPT FOR PROFIT.

IV.—POULTRY.

It will always be found a desirable plan to cut the straw into short lengths for a hatching nest, and the neglect of this precaution is the most frequent cause of breakage; the hen, during her twenty-four hours' stay, gets her claws entangled in the long straws, and on leaving for her daily meal is very likely to drag one or two with her, fracturing one or more eggs, or even jerking them quite out of the nest.

Should such a mishap occur (and the nest should be examined every two or three days when the hen is absent, to ascertain this), the eggs must be removed, clean straw substituted, and every sound egg at all soiled by the broken

sprinkle the eggs slightly with water every day while she is off. This is done best by dipping a small brush in tepid water; and is always necessary to success in dry weather, when a hen is set in a box at a distance from the ground, as is the case in large sitting-houses. But, where it can be had, we prefer the natural moisture of a damp soil: it never fails, and avoids the need of going near the hen.

When the number of eggs set yearly is considerable, it is worth while to withdraw the unfertile ones at an early period. About the eighth day let the hen be removed by candlelight, and each egg be held between the eye and the light, in the manner represented, Fig. 8. If the egg be fertile, it will appear opaque, or dark all over, except perhaps, a small portion towards the top; but if it be

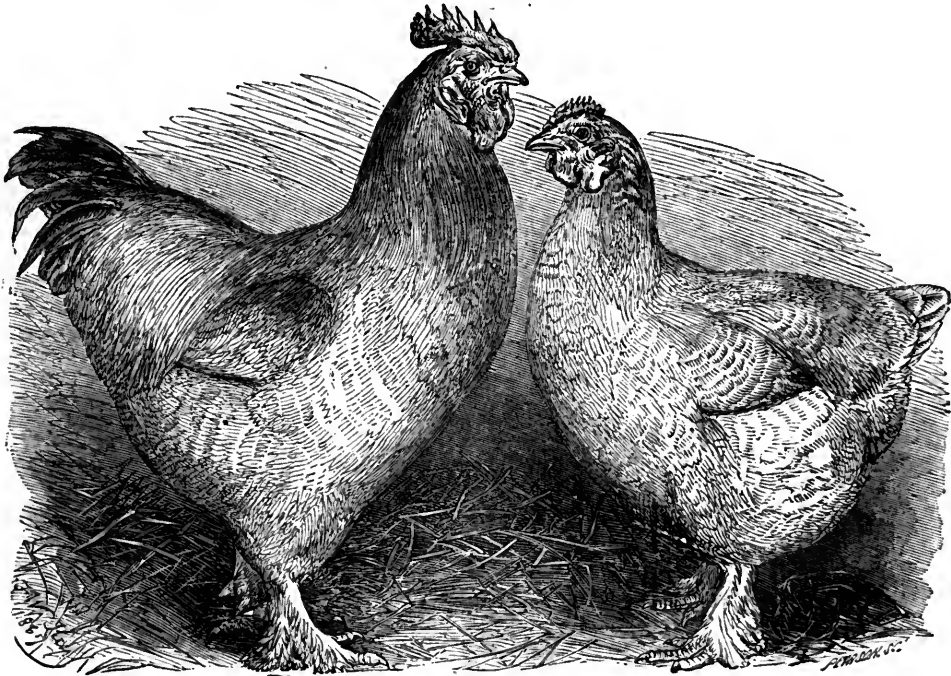

Fig. 7.—WHITE COCHIN CHINA FOWLS.

one be washed with a sponge and warm water, gently but quickly drying after with a cloth. The hen, if very dirty, should also have her breast cleansed, and the whole replaced immediately, that the eggs may not be chilled. A moderate hatch may still be expected, though the number of chicks is always more or less reduced by an accident of this kind. If, however, the cleansing be neglected for more than a couple of days after a breakage, or less at the latter period of incubation, probably not a single chick will be obtained; whether from the pores of the shell being stopped by the viscid matter, or from the noxious smell of the putrefying egg, it is not very material to inquire.

Every egg should also be marked quite round with ink or pencil, so that if any be subsequently laid in the nest they may be at once detected and removed. Hens will sometimes lay several eggs after beginning to sit.

In ordinary winters the hen should be set as in summer, giving her, however, rather more straw. Only in severe weather should she be brought into the house; and in that case, or in summer if the ground be very dry, it will be necessary during the last half of the hatching period to

unimpregnated, it will be still translucent, the light passing through it almost as if new laid. After some experience the eggs can be distinguished at an earlier period, and a practised hand can tell the unfertile eggs even at the fourth day. Should the number withdrawn be considerable, four batches set the same day may be given to three hens, or even two, and the remainder given fresh eggs; and if not, the fertile eggs will get more heat, and the brood come out all the stronger. The sterile eggs are also worth saving, as they are quite good enough for cooking purposes.

It is a common mistake to set too many eggs. In summer, a large hen may have thirteen, or a Cochin fifteen (of her own); but in early spring eleven are quite enough. We have not only to consider how many chickens the hen can hatch, but how many she can cover when they are partly grown. If a hen be set in January, she should not have more than seven or eight eggs, or the poor little things, as soon as they begin to get large, will have no shelter, and soon die off. It is far better to hatch only six and rear five, or maybe all, to health and vigour, than to hatch ten and only probably rear three puny little creatures, good for nothing but to make broth.

In April and May broods, such a limitation is not needed; but even then eleven or twelve chickens are quite as many as a large, well-feathered hen can properly nourish, and the eggs should only be one or two in excess of that number.

A good hen will not remain more than half an hour away from her nest, unless she has been deprived of a dust-bath, and so become infested with lice, which sometimes causes hens thus neglected to forsake their eggs altogether. When a hen at the proper time shows no disposition to return, she should be quietly driven towards her nest; if she be caught, and replaced by hand, she is often so frightened and excited as to break the eggs. A longer absence is not, however, necessarily fatal to the brood. We have had hens repeatedly absent more than an hour, which still hatched seven or eight chicks; and on one occasion a hen sitting in the fowl-house returned to the wrong nest, and was absent from her own more than five hours. We of course considered all chances of hatching at an end; but as the hen had been sitting for a fortnight, concluded to let her finish her time, and she hatched five chickens. We have heard of a few hatching even after *nine* hours' absence, and therefore would never, on account of such an occurrence, abandon valuable eggs without a trial.

The chickens break the shell at the end of the twenty-first day, on an average; but if the eggs are new-laid, it will often lessen the time by as much as five or six hours, while stale eggs are always more or less behind.

We never ourselves now attempt to assist a chick from the shell. If the eggs are fresh, and proper care has been taken to preserve moisture during incubation, no assistance is ever needed. To fuss about the nest frets the hen exceedingly; and we have always found that even where the poor little creature survived at the time, it never lived to maturity. Should the reader attempt such assistance, in cases where an egg has been long "chipped," and no further progress made, let the shell be cracked gently all round, without tearing the inside membrane; if that be perforated, the viscid fluid inside dries, and glues the chick to the shell. Should this happen, or should both shell and membrane be perforated at first, introduce the point of a pair of scissors, and cut up the egg towards the large end, where there will be an empty space, remembering that if blood flow all hope is at an end. Then put the chick back under the hen; she will probably squeeze it to death, it is true, it being so very weak; but it will never live if put by the fire—at least, we always found it so. Indeed, as we have said, we consider it quite useless to make the attempt at all.

Cleanliness in the house and run has already been insisted upon, and is only again alluded to on account of the value of the manure. This, collected daily, should be put in any convenient receptacle where it can be kept dry, and either used in the garden, if there is one, or sold. It pays best to use it, where possible; it should always be mixed with earth, being very strong, and is especially valuable for all plants of the cabbage kind; it is also excellent for growing strawberries, or, indeed, almost anything, if sufficiently diluted. If there be no possibility of so using it, it is *worth* about seven shillings per cwt. to sell, and is greatly valued by all nurserymen and gardeners who know its value; but there is often difficulty in finding

those who do, and getting a fair price. At seven shillings (which we believe to be about a fair value, compared with that of guano, on account of the moisture contained), or when it can be used in the garden, we consider the value of the manure equal to fully one-fifth—perhaps one-fourth would be nearer the mark—of the total profit from the fowls. It is, therefore, an item too important to be neglected.

Where a considerable number of fowls are killed annually the feathers also become of value, and should be preserved. They are very easily dressed at home. Strip the plumage from the quills of the larger feathers, and mix with the small ones, putting the whole loosely in paper bags, which should be hung up in the kitchen, or some other warm place, for a few days to dry. Then let the bags be baked three or four times, for half an hour each time, in a cool oven, drying for two days between each baking, and the process will be completed.

Eggs should be collected regularly, if possible twice every day; and if any chickens are to be reared from the home stock, the owner or attendant should learn to recognise the egg of each particular hen.

Before concluding this article, it may be expected that something definite should be said respecting the actual profit of what may be called domestic poultry-keeping. It is extremely difficult to make any such statement, so much depends upon the price of food, upon the management, selection of stock, and value of eggs. But in general we have found the average cost of fowls, when properly fed, to be about 1d. per week each for ordinary sorts, and not exceeding 1½d. per week for the larger breeds; when the cost is more we should suspect waste. A good ordinary hen ought to lay 120 eggs in a year, and if good laying breeds are selected, there ought to be an average of 150, not reckoning the cock.

Of course, good management is supposed, and a regular renewal of *young* stock, as already insisted upon. For domestic purposes eggs ought to be valued at the price of new-laid, and from these data each can make his own calculation. The value of the manure, when it can be sold or used, we consider is about 9d. to 1s. per annum for each fowl.

The whole undertaking—be it large or small—must be conducted as a real matter of business. If more than three or four hens are kept, buy the food wholesale, and in the best market; let the grain be purchased a sack at a time, potatoes by the cart-load or hundred-weight, and so on; and let a fair and strict account be kept of the whole concern. The scraps of the house may be thrown in, and the cost of the original stock, and of their habitations, may be kept separate, and reckoned as capital invested; but let everything afterwards for which cash is paid be rigorously set down, and, on the other side, with equal strictness, let every egg or chicken eaten or sold be also valued and recorded. This is of great importance. The young beginner may, perhaps, manage his laying stock well, but succeed badly with his chickens, or *vice versa*; and it is no small matter in poultry-keeping, as in any other mercantile concern, to be able to see from recorded facts where has been the profit or where the loss. The discovery will lead to reflection; and the waste, neglect, or other defective management being amended, the hitherto faulty department will also contribute its quota to the general weal. We shall deal with the rearing of chickens in our next paper.



Fig. 8.

A WORD OR TWO ABOUT CAMEOS.

THE term *cameo* is popularly applied to precious stones and shells, the surfaces of which are covered with raised figures, mostly of a different colour from the ground, and mounted as brooches, bracelets, pins, ear-rings, finger-rings, and other personal ornaments. What are called stone cameos are most valuable and durable; but the actual cost varies greatly, owing to differences of material and workmanship. Very often fraud is practised by unprincipled artists, who cut out the figures separately and attach them by cement to the flat surface of stones prepared for them. Many cheap imitations of cameos are formed in moulds and fastened to glass or some other common material. A splendid Roman cameo for a brooch may cost fifteen or twenty pounds, while one of the same size and inferior work in shell will cost but a few shillings. We gather the following from an interesting essay on this subject:—"There are antiques, to produce which the chemical skill of the artist had to be exercised. A species of enamel was made, and with this cornelians of the required grain and density were covered by the application of fluxes and intense heat, thus forming, artificially, the much-desired layer of clear hard substance, out of which to cut the wished-for design. Many works which rank amongst the stone or true cameos, although of comparatively simple design, moderate size, and not antique specialities, are worth £50 and upwards; whilst *shell cameos*, well executed, and representing precisely the same subjects, may be bought for £2 10s. or £3. The reason for this immense difference in value lies, first, in the intrinsic worth of the material operated on; next, in the great facilities afforded to the artist, who works on the soft and yielding shell with instruments and appliances of ordinary power; and lastly, in the almost indestructible qualities of the stone cameos when finished." Cameos in onyx, agate, cornelian, and some others are particularly beautiful when the colours of the layers of the stone or veins are strongly contrasted. The oriental onyx is black and white; the cornelian, brown and white; the agates vary. Shell cameos are chiefly of two sorts, some having a reddish ground, others a brownish ground, both with white or whitish figures. Those with a vivid reddish-tinted ground and pure white figures are best. There are antique cameos which are very expensive. Many modern pieces with classical subjects are also costly, though, when of inferior materials and finish, they are often cheap. The settings, of course, are of all kinds, and should correspond in material and value with the cameos they display.

THE TOILETTE.

I.—MANAGEMENT OF THE SKIN (*continued*).

Discharging Eruptions.—These are generally matters that cannot be trifled with, and it may possibly lead to more harm than good if we do more than indicate what may be done for the simpler cases, or for those instances in which it is inconvenient or impossible to obtain medical advice at the moment. In all cases, the parts attacked about the trunk of the body should be kept at rest and very cleanly, but without any rough usage. If the diseased part is very red and tender, it may be as well to apply a little water dressing; or if this do not agree, as is the case in some instances, the surface may be covered over with a little whitening paste; this may be removed by warm water fomentation each day or so. A variety of scabbed eruptions occur about the heads of children, and constitute scald-head; and mothers are by far too fond of putting a host of messes recommended them as cures, upon the discharging surface, or the scabs which form; the hair then becomes matted together

with the scabs, and the whole presents a most uncomfortable appearance. The great thing in these cases is to keep the head perfectly free from scabs by judicious poulticing (bread and water), and then to apply to the surface, at least at the outset, a little oxide of zinc ointment, which can be got from any chemist. The surface should be cleansed every day with sponging or poulticing, but only just sufficient to loosen the scabs and not to sodden the scalp. These cases of free discharge about the head (and the remarks just made may apply to those about the face) are generally contingent upon the existence of distinct conditions of ill-health or mal-nutrition, that require cod liver-oil and steel wine, with alteratives; and for that reason it is best at once to seek medical advice, if the simple plans of treatment just mentioned do not answer.

Chilblains.—These are the result of the action of cold upon the skin of weakly individuals; and they occur on the parts of the body most distant from the centres of life, so to speak—viz., the nervous centre and the heart. The cold benumbs the foot or hand, heel or ear, or whatever part may be attacked, arrests its circulation and disorders its sensibility. Then, when the chilled part is brought near the fire, or becomes warm, inflammation sets in with troublesome sensations. Every one knows, by common report, if not by experience, what chilblains are, how they itch, and thereby torment the sufferer, and how they crop up in fresh places from time to time, in those who suffer from them, in the winter-time. It is a very bad plan to bring the feet or hands too near the fire after being out in the cold, as the heat, acting after the chill, induces chilblains. In some cases the inflammation is severe, and there is effusion beneath the skin, which gives way, so that what is called a "broken" chilblain is produced. Now the treatment of chilblains involves the employment of means for their prevention, in the first place; these consist in the use of garments to keep the feet and hands protected from the cold—such as woollen socks, proper exercise, and, if there is a threatening of mischief, friction, with some slight stimulant, such as camphor liniment. If the subject is weak, tonics must be given. When chilblains have formed, however, it is necessary to relieve the intolerable itching by sedatives applied locally, and then to use stimulating friction. When they are not broken, any of the following recipes may be employed:—

- | | | | |
|----------------------------|-----|-----|------------|
| No. 1. | | | |
| Soap liniment ... | ... | ... | 2 ounces. |
| Oil of Cajeput ... | ... | ... | 2 drachms. |
| Tincture of belladonna ... | ... | ... | 2 drachms. |

- | | | | |
|------------------------------|-----|-----|-----------|
| No. 2. | | | |
| Two yolks and whites of egg. | | | |
| Spirits of turpentine ... | ... | ... | 2 ounces. |
| Distilled vinegar ... | ... | ... | 2 ounces. |

To be well shaken together; and if there be very much itching add half an ounce of laudanum.

- | | | | |
|-----------------------------|-----|-----|-------------|
| No. 3. | | | |
| Strong ammonia solution ... | ... | ... | ½ an ounce. |
| Camphor liniment ... | ... | ... | 2 ounces. |
| Laudanum ... | ... | ... | 1 ounce. |

- | | | | |
|----------------------------|-----|-----|------------|
| No. 4. | | | |
| Soap liniment ... | ... | ... | 2 ounces. |
| Tincture of belladonna ... | ... | ... | 2 drachms. |
| Friar's balsam ... | ... | ... | 1 drachm. |
| Tincture of aconite ... | ... | ... | 2 drachms. |
| Camphor ... | ... | ... | 10 grains. |

This is useful in allaying itching.

No. 5.—Dr. Balfour, of the Royal Military Asylum at Chelsea, uses with success amongst the boys there equal parts of compound tincture of iodine and strong solution of ammonia; painting it in night and morning gently with a brush.

N.B.—The above are not to be used to broken chilblains.

For broken chilblains the following application is perhaps the best. It should be applied on strips of lint :—

Calamine cerate	1 ounce.
Carbonate of lead	1 drachm.
Camphor	5 grains.

Warts.—These occur mostly about the hands, also the wrists, the forehead, and the scalp, particularly in the young and aged. They may be congenital, solitary, or in the form of a regular crop of extensive nature. In the latter case a long course of arsenic is needed for their removal. When they are few, they may be got rid of readily by caustics. Mason Good, an eminent writer, says that in Sweden they are destroyed by the wart-eating grasshopper—the *Gryllus verrucivorus*—with green wings, spotted brown; the common people catching it for this purpose : and it is reported to bite off the wart, and discharge into the root which is left behind a corrosive liquid. In some parts of our own country the juice of the *Chelidonium majus* is used with more or less success; but our readers had better trust to none of such things, but use caustic potash, or acid nitrate of mercury—both, however, powerful things, to be used with caution. The wart should be soaked in warm water, then touched each day at its centre with a solution of caustic potash and water in equal parts until it becomes sore. The solution is to be applied with a piece of wood. After a few applications the wart will shrivel and come away. When the acid nitrate of mercury is used, the same system of application is to be followed, but the acid should be carefully rubbed on to the wart until it smart; this must be repeated several times, and care must be taken that the acid does not trickle over the skin so as to ulcerate it.

Corns.—These always arise from pressure. They are of two kinds, soft and hard. The former occur between the toes, from the pressure of the joints of the smaller toes against the skin opposite. Corns are not limited to the feet, but are seen on the hands of workmen who use tools that press much on the palm of the hand. The effect of pressure is to stimulate the skin, then to cause an increased flow of blood to the part whose activity is excited, so that the cells of the cuticle are more rapidly produced than natural, and become pressed together into what we know as corns. In the soft corn there is a collection of fluid under the cuticle, and the corn is constantly bathed in perspiration; so that we have a more or less circular white softish elevation, exuding a moisture. Now the cure of corns is really an easy matter. The first thing is to have an easy soft boot, with a good broad square toe, so that the toes of the feet are in no degree pressed together. Small-toed boots and corns go together. Then corns must be soaked in warm water, scraped or shaved down, touched with a little acetic acid now and again, whilst a corn-plaster should be worn—we mean a circular one with the hole in the centre, so as to take off the pressure from the centre of the corn. The sufferer should never wear a boot which is in the least worn away at the heel. The extraction of a corn is only a temporary palliative. It does not remove the cause. In the case of a soft corn we must take care to be very cleanly, to remove as much of the white loose cuticle as we can, to keep the toes betwixt which it is, separate by a bit of cotton wool; then we may use a little “glyceric tannin,” which can be got at the chemist’s, painting it in each night for a week or so, and when it has become less tender and moist we may apply caustic gently. This will generally, if we keep pressure off it, remove the corn.

Moles and Mothers’ Marks.—These may usually be removed by caustics, or by ligaturing, and it is best that they be destroyed at the earliest possible time, because they frequently increase with some rapidity, and fill with blood to an extent which makes their removal the

more difficult. It is of no use giving further details. In all cases they must be left to professional treatment.

Discolorations of the Skin.—These are of various kinds. We shall only speak of the more common. First we have freckles, or the little brown specks developed about the face and hands in the summer-time by the action of the sun upon the skin in hot weather. There is a second form, which occurs on the covered parts of those who are of a bilious temperament. This latter form requires careful medical treatment. The former may be more or less removed by the use of local remedies :—

No. 1.

Elder-flower ointment	1 ounce.
Sulphate of zinc, finely powdered	25 grains.

To be applied with the finger night and morning.

No. 2.

Sal-ammoniac	60 grains.
Distilled water	1 pint.
Lavender water	½ ounce.
Bichloride of mercury	2 grains.

To be used with a sponge every night and morning.

No 3 is an elegant form :—

Red rose-leaves	¼ ounce.
Fresh lemon-juice	¼ pint.
Rum	¼ pint.

Digest these for a day, and squeeze away the fluid, to be used by means of a piece of sponge, night and morning.

No. 4.

Carbonate of potash	5 grains.
Citrine ointment	1 drachm.
Otto of roses	1 drop.
Simple cerate	1 ounce.

To be smeared on every night.

It not unfrequently happens that persons are attacked with a discoloration about the chest, especially where flannel is worn. The parts become itchy—slightly red, perhaps—and then little light pale straw-coloured spots appear on the front of the chest; they itch, and a few bran-like scales can be scratched from off the patches, which gradually join, and form a pale, fawn-coloured eruption. This is due to the presence of a vegetable parasite, and is called *Chloasma*. It is readily cured by first washing the skin with soap and water, in order to get away the natural fatty matter, and then applying freely what are called parasiticides, viz., agents that destroy vegetable life. The recipe No. 2, recommended above for discolorations, may be given a trial. This should be applied night and morning after the use of soap, and be continued for three weeks or so. If this do not radically cure the affection, medical advice must be sought, and stronger remedies of an active kind will be needed, and most likely internal medicines.

Chapped Hands and Lips.—These are well known, and equally simple to cure. Those persons whose hands are constantly in the wet in cold weather, get chapped hands because they make the skin thereby moist and soft, and remove the natural fatty secretion, which is protective against cold. It is said that those who work amongst tallow and oil never get chaps of any kind; and this simple fact is in keeping with the proper mode of curing chapped hands, which is to keep the hands as dry as possible, and to apply a layer of grease night and morning. Cold cream, or a little weak zinc or camphor ointment, will do. Where the hands are livid and cold, it will be well to use the camphor-balls sold in the shops. Occasionally an ugly and obstinate crack occurs. This may be cured by applying a little friar’s balsam once or twice, or if it be in the middle of the lip, by drawing the two sides together and keeping them in close apposition, when the crack heals. The muscles about the mouth in constant action tend to stretch open the crack, and to prevent it healing.

FURNITURE.

II.—THE GENERAL FURNITURE OF THE HOUSE.

FROM the kitchens we proceed upwards to the passage, by custom termed a hall, but which is either a large room at the entrance to the dining and other rooms, or, as is most frequently the case in modern houses, a passage more or less narrow. It is certainly bad taste to crowd into what is generally a narrow space the furniture fitting only for a large one; but how often are seen pictures crowded on to the walls as if it were the entrance to a photographer's studio, and heavy chairs and tables that have perhaps seen service in a more appropriate place! In small houses the passages are generally so narrow as to admit only of one chair, a table, and a hat-rack—these are all inexpensive matters; but where means will permit, a hat and umbrella stand, with table, and looking-glass above it, and all arranged in one piece of furniture, makes the most compact, completest, and handsomest piece of furniture. Some of these have the framework made in painted iron, the paint being a mixture of colours resembling a grey agate stone more than any other tint, and which really looks light and elegant. An oak—that is, wood painted and grained as oak—hat and umbrella stand can be purchased for 30s.; but oak furniture is out of place except in large halls. Mahogany is best for passages. A mahogany hat-rack, with brass hangers tipped with white china, will cost 10s. 6d. There are some long narrow tables with legs turned in pattern, but without a drawer for hat and clothes brushes, that can be purchased for a guinea. A plain mahogany hall-table, with drawers, will cost £2. A mahogany hall-chair can be had for 15s. A folding iron chair, with cane seat and back, is an excellent substitute for the usual chair seen in passages, as it is cheaper, more comfortable to sit in, does not require so much cleaning, and may be pressed into instant service, either in a room or in a garden where a heavy hall-chair could not be carried about. Heaviness, as regards weight, seems to be a characteristic of much modern furniture, but without any advantage—lightness, with strength of joint, glue, and screw being generally attainable.

A gas-light in a passage should spring from the wall opposite to and between the doors of the two sitting-rooms, the projecting gas-pipe having a movable joint. Thus one gas-jet will light a portion of the staircase, the passage in its whole length, and prevent a stranger from stumbling into either room when both are unlighted. Also, the gas can be turned back against the wall, as far as the ground-glass globe will permit, to allow of the removal of furniture or boxes. In large halls the arrangement would not be suitable. The floor-cloth should be the width of the passage, but if it be not, the floor on each side should be painted of the same colour as the ground of the floor-cloth—by no means of a different tint. The most useful colour for wear is a very light yellow-brown, having a dark brown pattern upon it. The cloth is primed with much the same tint, hence if the pattern wears off the defect is not so much seen. When there is much walking over it, a narrow strip of stair-carpet, which may be of bordered felt, inexpensive and efficient, should be laid down; it will save the oil-cloth very much; but this, however, must be taken up every day and swept under, otherwise the grit and dust will very soon abrade the surface of the cloth underneath it. Oil-cloth is very quickly destroyed by cleaning it with soap and soda, which, in taking off the dirt, remove the paint also. The use of warm water and a clean flannel, with a clean cloth afterwards to wipe it dry, once a week, will keep it fresh without injury. Once a month a scrubbing-brush may be used, but no soap or soda.

In houses where the passage is large enough to be termed a hall, a design on the oil-cloth in imitation of

encaustic tiles looks very well, and in one of large dimensions the real tiles instead of oil-cloth at all. These are occasionally troublesome by getting loose, and a man-servant should know what cement or mortar to use to reset them; but when the tiles, or their imitation, are used the surroundings should harmonise. The staircase generally faces the door, and plays an important part in the look and degree of respectability which attach to a house; but there is one especial nuisance in modern houses of moderate rental—say from twenty to sixty pounds—that the staircases are usually exceedingly narrow and mean-looking—a defect which cannot be remedied.

The landlord generally leaves the sides of the stairs unpainted or painted white. Now if the stairs were made of white deal they need never be painted, because they could be kept clean and white with hot water, sand, and soda; but when of red deal, they have, if unpainted, an unsightly appearance. Yet where there is much use of the stairs, the clothes brushing on the sides rapidly wear off the paint, leaving the edges of a dirty hue. To grain them and varnish them is at first an expensive process, but it is the most lasting, inasmuch as they can be re-varnished every six months, by any one in the house, with but very little expense of material and of labour. An oil-man will always recommend the proper varnish, but oak varnish has been found to answer extremely well.

In the matter of stair-carpets, as a rule the softest texture is the best. The hard Dutch carpets wear out directly. The real Venetian is the best, but is now rarely to be obtained. We cannot point out particularly the kind of carpet which should be bought, other than the best Brussels, if it can be had; this lasts a very long time with care—that is, care in sweeping it with a soft brush—not scrubbing it with the hard side of a baluster brush, as most servants will if they are let alone. Much injury arises to all carpets from servants being allowed to run about with high-heeled, and sometimes nailed boots. The only way to get over the difficulty is, when engaging them, to mention that only house slippers can be allowed to be worn by them in the house.

Stair carpets should be in length a yard longer than is needful for each flight of stairs, so that when they are taken up for shaking (not beating), they may not be put down again in the same creases, and thus at a trifling expense the carpets will wear as long again as by the usual method of exact measurement. The length required is ascertained by allowing half a yard for each stair, and adding to this the length needed for the landings. Brass stair-rods of the ordinary kind are not expensive, and the stair-eyes are purchased by the dozen. Parlours with folding doors are the most convenient for a small house, as the doors may be closed at pleasure; but both rooms should be similarly furnished as far as the carpet, chairs, and curtains are concerned. The patent "felt" carpet is to be had in suitable tints; it is not expensive, and is easily made, and, when good, will wear tolerably well. There are many advantages in a felt carpet: not among the least is that when it is worn out in the centre, the sides which are good can be cut off, bound, and arranged for bedside carpets; and that which is very much worn serves instead of buying house-flannel for cleaning doorsteps, kitchen hearths, and other rough work. But if a carpet be cut through the worn part, and the two unworn sides be joined together, and so the worn part be placed against the wall, it will have the most undesirable look of flue and dust, and never being swept underneath the chairs. For this reason felt carpets are not convertible for the same rooms, and this is a disadvantage. Also, when taken up for shaking, the felt shrinks, and cannot without trouble be stretched to fit the same room again; and even if pieces have been turned down all round to allow of this shrinking, yet the bright colours of the unworn edges contrast unfavourably with the worn portion.

Kidderminster carpets of a good quality are almost indestructible, because they have two surfaces, thus are really double. They are soft to the touch, being all wool; if hard, the wool is mixed with hemp or other harsh substance, and will then quickly wear out. They will wash well—a process neither difficult nor troublesome when done at home—and wear better after the process than previously; but allowance will have to be made in the quantity of carpet purchased for the shrinking occasioned by this cleansing. The designs on Kidderminster carpets are rarely ever suitable for parlours, the green moss or small green-and-black coral pattern excepted. These are in good taste, but cannot everywhere be met with, and are expensive. Some really good woven imitations of this kind of carpet, in pattern and quality, are to be met with in wide width for 3s. 6d. or 4s. a yard.

The quality of Brussels or velvet-pile carpets may be ascertained in the same way that a lady tests the excellence of her velvets—by bending down the surface of the fabric with the lines running lengthways; it will then be seen how close the lines of wool are to each other, and upon this degree of closeness depends the quality of the carpeting. Also, if the back of the carpet—that is, the foundation upon which the wool is woven in—looks coarse and loose it will wear badly.

Tapestry carpeting is distinguished from Brussels by each colour of the latter being woven in separately, the wool never being cut, but carried over or underneath another colour: while tapestry is woven entirely of one tint, and then the brightest, most seductive colours are printed upon it. Of course this cannot wear like Brussels, neither can the gradation of shade of colour or luxuriance of tint be found in the latter as in tapestry; so a purchaser has to choose between strength and beauty. A Brussels carpet having many colours is very expensive, but it wears well.

Finger-plates of white china are easily put on, and prevent finger-marks; but they should be fixed both above and below the key-hole, and as close to it and the edge of the door as possible.

In the two rooms there will need to be—a couch, one or two easy-chairs, eight other chairs, and a chiffoinier, one centre-table, also one to form a dining-table in the back room. In most houses, low-rented ones excepted, the useful low cupboards have gone much out of fashion; the upper part of these, where they exist, above the top slab, should be utilised as book-cases, which are not difficult to make, nor expensive to have made, consisting entirely of shelves; but whatever number there may be, each should have a strip of leather or leather-cloth two inches in depth, to protect the upper part of the books from dust.

A *Chiffoinier* is one of the most useful pieces of furniture in every room. When made plainly of mahogany it does duty for a sideboard where the latter would be too expensive an article, or the room too small to admit one. If it be placed in the front and superior room, the addition of glass in the doors and back makes a room look lighter and gayer, but the expense is something considerably more than a plain one would be. Glass does not look well set in mahogany; it should have rose-wood or walnut, in which woods a very pretty one can be obtained from six to eight pounds, but then the tables and chairs should match.

Chairs.—The best material to cover chairs is Utrecht plush, which will last excessive wear for twenty years; it

has never been made popular in England by furniture makers, but it is the most economical, even if the expense be greater in the first instance than woollen rep, which is the next best thing to it. The latter must be all wool, otherwise there is no wear in it; very good can be had for 6s. a yard, double width. It is best to purchase the chairs ready covered; still, old ones may be made to look like new, and be covered at home with comparatively little expense. In the back parlour there should be a dining-table, which may have a deal top if expense is an object. Its size must depend upon that of the room. And here we recommend that, as far as possible, the meals of the family should be taken in the back parlour.

Easy Chairs.—There is more care required in the selection of these necessary articles than in almost any other. Some appear as if they were arranged rather for penitential chairs than anything else. The back aches, or the neck becomes stiff, when sitting in them, although perhaps they look truly comfortable till they are tried. The cane-seated arm-chairs are useful and inexpensive, but are a nuisance if they creak. The very best of them may be had for 17s. 6d.; also one of the same kind,

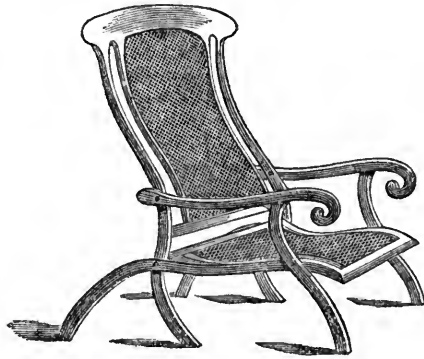

Fig. 1.

termed the Derby chair, which is without arms, and if not cane-seated to match the arm-chair, is made of laths, the cost being about 4s. 6d. This can be padded, cushioned, and covered in chintz or worsted rep, and thus it makes a most comfortable easy-chair for a lady, in which she can work or read; quite as pleasant to sit in as many of the expensive kind. Our engraving will show the kind that is meant.

Window-curtains.—For these the best material is good woollen damask; it wears well and keeps its colour, and may be after four years re-dipped and calendered, and will look like new. Very good

quality can be purchased for less than 3s. a yard, double width. Rep will cost double the price, and is not suitable but for lofty and large rooms.

A *Chimney-glass*, by its shape or size, gives either a common or a refined aspect to a room. If it be possible to afford one higher than it is broad, but having it nearly the breadth of the chimney-piece, it will look far better than one which is wider than it is high. Very good ones indeed may be purchased for £5; and it is better to sacrifice something else in the room, and expend the money on a good glass. One with a neat-patterned frame, gilt all round, with scrolls at the bottom of the two sides, always looks well and appropriate; while glasses with a nondescript gilt ornament in the centre of the top, look pretentious and vulgar.

Fenders and Fire-irons, more in their shape than their quality, give a look of refinement and culture about the room. The pretty twisted irons, neither too small nor too large for the grate, should be chosen rather than those with a plain surface. The first are more easily kept clean than the last, and do not look so shabby if they have been neglected in the cleaning; but if they are cleaned daily, and the bright poker and shovel are used as much as they need to be, they are easily kept bright, unless the dangerous practice of putting the poker into the fire, and letting it remain till red-hot be resorted to. A plain fender, bronzed, with a flat steel rim, upon which the feet may be put to warm if needed, looks better than one of a more elaborate pattern, which is difficult to keep free from dust.

It would be quite useless, in these days of "follow my leader," to suggest how very comfortable and convenient

the old squab sofa is, with its square mattress and cushions, to the more modern but unmeaning couch, with a scroll end, very pretty to look at, but not convertible, nor so pleasant for use. In France couches look their best, and do duty for sofas during the day, not in the least assuming to be other than they are; but at night they can be carried into any bedroom, be uncovered, the two scrolls at the end turned down, and the cushions taken off, when a luxurious spring mattress is revealed, upon which the cushions are replaced, and a good, comfortable bed is at once arranged. However, this contrivance has not yet been introduced into England. As a covering for a couch, the American leather-cloth wears badly, but it is rapidly superseding the use of horse-hair. But better than the former is a good dark green Coburg cloth; it wears well, does not look obtrusive, and can be replaced when shabby at small expense.

HOUSEHOLD AMUSEMENTS.

IT is related of one of England's greatest statesmen, that some one calling to see him unexpectedly on grave political affairs, found him, not absorbed in state papers and official documents, but on all fours in his nursery, with his children romping upon and around him. And of another eminent man, the late Earl of Derby, it has been recorded, in a graceful tribute paid to his memory, that while at times he would seek recreation from political labours in the translation of Homer, at others he loved to find it in

"Making some wonder for a happy child."

Many other instances might be quoted to prove that the busiest and greatest men, as well as the humblest, have often found delight and solace in participation in the amusements of youth in their own households. Not, therefore, to the young only, but to those in more advanced life, the best among us feel that it is desirable to cultivate the recreations of home, and to be ready at times for frolic and the innocent enjoyment of household pastimes. We shall try, in a series of papers, to guide all who may read this work in the choice of such recreations, by giving a description of many which are familiar, and of others less generally known; sometimes choosing the simplest in-door games, and at others, commenting on pastimes of a more intricate character, and thus enabling all to select the amusement which is most suited to the tastes and circumstances both of themselves and those around them.

The winter season, bringing Christmas with it, calls into request games for round parties, and we shall devote the present paper to some of these. To commence with a very simple one, we will describe a game of German origin, known as

The Ball of Wool.—The party are seated round a table, from which the cloth must be drawn. A little wool is rolled up into the form of a ball, and placed in the middle of the table. The company then commence to blow upon it, each one trying to drive it away from his own direction, and the object of all being to blow it off, so that the person by whose right side it falls may pay a forfeit. The longer the ball is kept on the table by the opposing puffs of the surrounding party, the more amusing the game becomes, as the distended cheeks and zealous exertions of the players afford mirth to lookers-on as well as to themselves.

Similar to this is a game called "Blowing the Feather," in which a small feather set floating in the air answers the same purpose as the ball upon the table. The forfeit falls to the individual whose puff is ineffectual in keeping the feather afloat, or who suffers it to drop when it reaches him.

Of a different character, and still more comic in its results, is a game called

Shadows.—This game, sometimes called "Shadow Buff," is productive of much amusement in a round party. It consists in the detection of the individuals who compose the company by their shadows; but these they are at liberty to disguise as much as possible. The following is the method pursued:—

A white tablecloth or a sheet is suspended on one side of the apartment, and, at a short distance before this sheet, one of the party, chosen for the purpose, is seated upon either the ground or a low stool, with his face directed towards the cloth. Behind him, on the farther side of the apartment, the table is placed, and upon it a lamp or taper, all other lights in the apartment being extinguished. Each of the company in turn passes before the lamp, and behind the person who is gazing upon the cloth, which thus receives a strong shadow. If the individual seated can name the person whose shadow is thus thrown, the latter has to pay a forfeit, or to take the place of the guesser, as may be agreed upon. It would be easy, in playing this game, to detect particular individuals if they passed in their natural attitude; but they are free to change this as much as lies in their power, by stooping, standing more erect than usual, bending the limbs, or using the arms in any way calculated to obscure the outline of the shadow and render it difficult of detection. An alteration in costume, such as turning up the collar or changing the coat, if a gentleman, and enveloping the head in a hood, in the case of a lady, is also allowable. The game gives rise to a good deal of ingenuity in this fashion, and may often proceed for some time before many forfeits have resulted.

The Messenger.—The party are seated in line, or round the sides of the room, and some one previously appointed enters with the message, "My master sends me to you, madam," or "sir," as the case may be, directed to any individual he may select at his option. "What for?" is the natural inquiry. "To do as I do;" and with this the messenger commences to perform some antic, which the lady or gentleman must imitate—say he wags his head from side to side, or taps with one foot incessantly on the floor. The person whose duty it is to obey commands his neighbour to the right or to the left to "Do as I do," also; and so on until the whole company are in motion, when the messenger leaves the room, re-entering it with fresh injunctions. While the messenger is in the room he must see his master's will obeyed, and no one must stop from the movement without suffering a forfeit. The messenger should be some one ingenious in making the antics ludicrous, and yet kept within moderate bounds, and the game will not fail to produce shouts of laughter.

Among the other tricks which may be commended are such as rocking the body to and fro, wiping the eyes with a pocket-handkerchief, yawning, whistling, stroking the chin or the beard, and making any grimace.

Another game, of much the same character, is known by the title, "Thus says the Grand Seigneur." The chief difference is that the first player is stationed in the centre of the room, and prefaces his movements, which the others must all follow, by the above words. If he varies his command by framing it, "So says the Grand Seigneur," the party must remain still, and decline to follow his example. Any one who moves when he begins with "So," or does not follow him when he commences with "Thus," has to pay a forfeit.

Magic Music.—In this game a player is seated at the piano, and one of the others leaves the room, while the company decides what the last-mentioned is to do on his return. When called in, he is given a hint, but only a hint, of what he is expected to do. We will suppose that he is told that he is to "make an offering to a certain lady." He is left to himself as to what the offering may be, but

he must guess the lady to whom it is to be offered, and offer to each in succession until he discovers the individual selected. The musical part of the performance is this: When he re-enters the room, the person at the piano commences to play some piece, with a moderate degree of vigour. As the guesser approaches the right lady, or the right thing to be done, whatever its nature, the music becomes louder or quicker; but if he appears to be going farther and farther from his appointed task, the music becomes softer and softer, until it is scarcely heard. This gives him a clue as to whether he is on the right scent, or otherwise. If there is no piano in the room, the "magic music" may be of another character. It may consist in the tinkling or clashing together of any articles that will emit either a harmonious or a discordant sound, according to the degree of hilarity or boisterousness to which the age and other circumstances of the company dispose them. But, played with a little tact, the game in any of its forms will be found amusing.

We have had occasion to mention forfeits; and as those form an important element in many in-door games, we shall have something to say about them in our next paper, in which we hope, at the same time, to introduce to the notice of our younger readers several novel amusements, which in the long winter evenings they may find especially acceptable.

THE HOUSEHOLD MECHANIC.

DOORS.

AN ordinary frame door will supply good practice chiefly in the mortice and tenon joint, and will be a capital example of the principle of joinery—to build up of separate pieces a fabric of lighter weight and greater strength than if solid, and also so pieced together as not to be affected to any extent by changes in the atmosphere.

It will be seen by reference to the article on Wood that the tendency of boards to shrink or expand is in the direction of the width and not of length. If a door is made up of boards simply fastened edge to edge, the expansion of its width will be very considerable, while its length remains the same. Therefore, if a "ledge" door, as it is termed, fits in damp weather, in dry it will be smaller and too loose. Ledge doors are made by placing boards together edge to edge, and strengthened with two or three ledges or battens nailed across the back, but these are only suited for common work.

Fig. 50 shows that the essential principle in the proper construction of an ordinary frame and panel door is such a combination of length and width of grain as reduces the possibility of expansion or contraction to a minimum. The frame consists of the styles or vertical pieces, DEGF, and the rails or horizontal bars, ABC. The method by

which they are firmly united is seen in Fig. 51, in which each piece is detached and lettered to show where each joint is made. The styles, DEGF should be about four inches wide, and from one and a quarter to two inches in thickness, and the rails of the same thickness, but only the top rail, A, of the same width; the middle and lower rails, B C, being about double the width of the styles. The middle styles are tenoned into the middle rail at *d* and *i*, and into the upper and lower at *b* and *j*. The side styles are then morticed at *a e g, c f h*, to fit the tenons corresponding on the rails.

H I J K show the panels, which are of much thinner material, usually about one-third, and which are, as will be seen, larger than the spaces in the frame which they occupy visibly. On the inner edges of both styles and frames, a groove is planed out with a plough of the exact width of the thickness of the panel, and about half an inch in depth. Into these grooves the panels are loosely fitted, and the outer styles are driven into their respective mortices, and wedged up as usual. The panels not quite filling up the groove in their width, have a slight amount of

room for expansion. The dotted line *lmno*, Fig. 50, shows the room occupied by the panel. The corners formed between the frame edge and panel are

to be filled in with a bead or moulding, which must be cut to the exact size, and accurately bevelled at each corner. These mouldings are fitted by means of brads to one or both sides of the door, according to circumstances, and are merely ornamental. Fig. 52 is a section across the door in the middle of the panels, and shows the whole arrangement very clearly, D E F being the styles, and H I the panels. Fig. 53 shows enlarged section of the joint of the style A and panel B, and shows the moulding C fitted in the corner. This panel is used for light doors for inside work, a stronger variety being needed for the outside doors, which require much greater strength. This panel is of double thickness, and is tongued to fit the groove in the styles and rails, as in Fig. 54, and is indented only on the front or outside, the back being flush with the surface of the frame; the edges of the panel at the back are usually beaded, as at D. The corners in the front are filled in with the moulding, C. We have taken as an example a four-panelled door, for the sake of simplicity, the construction being similar for six, the usual number. In a six-panel door the top rail is known by that name, the next is the frieze rail, the next the middle or lock rail, and the last the bottom rail. The panels are also distinguished by the same names. The lock is let into the door at either *e* or *f*, and does not show, except from the edge. The hinges are fixed near the top and bottom of the styles, on the side opposite to the lock, but, of course, must not be placed at a part where the style is weakened by the mortice.

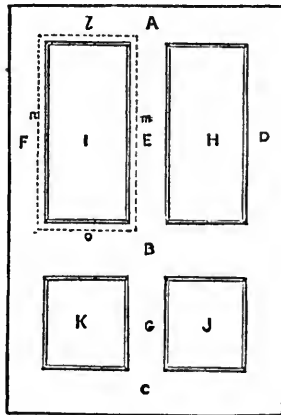

Fig. 50.

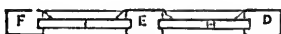

Fig. 52.

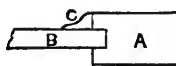

Fig. 53.

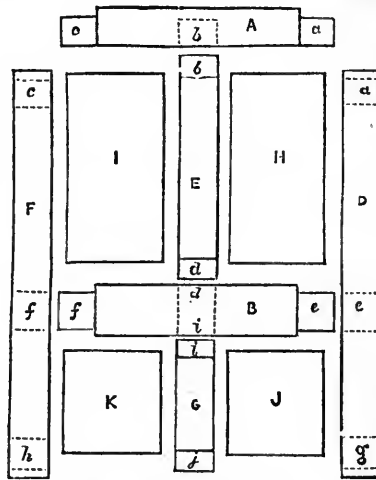

Fig. 51.

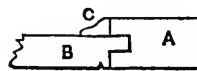

Fig. 54.

HOUSEHOLD DECORATIVE ART.

IV.—RECREATIONS FOR LONG EVENINGS.

MANY useful and amusing occupations can be recommended for long evenings, and among such occupations we reckon especially those which result in the production of something at once permanent and ornamental. It is our intention to describe several for the benefit of our readers.

Screen-making.—Preparing scraps to cover a screen is an employment that fills up a good deal of spare time, entails no mental exertion, and may be done at small expense, beyond that for the mere frame of the screen, which, with a simple covering of black paper will cost about a pound, and if the scraps are arranged upon it with any amount of taste and judgment, a very attractive addition will have been made to the furniture of the room, and one that at the same time may be found exceedingly useful, as a protection against draughts, or the excessive heat of a fire. The work admits of endless variety, and will serve at the same time to display the skill and taste of the worker. It would be useless to lay down any very accurate rules

landscapes. All the corners and angles left uncovered by this arrangement, must be filled in with portions of pictures, for which purpose torn and damaged ones will come in useful. Another way of covering a screen is by cutting out the outlines of prints and sticking them on. Comic arrangements may be got in this way, as, for instance, by putting into a landscape small figures grouped in a valley as a pic-nic party, or climbing a mountain, or walking about the features of other figures much larger. One may cut out an umbrella and place it as if held by

a duck, or transfer a pair of spectacles to the countenance of a lion. Of course, these arrangements may be varied infinitely. Perhaps no screen is handsomer than one made of elegant coloured scraps of all shapes, hues, and sizes. For one of these screens, take the pictures from sheets of music, garlands of flowers from Christmas cards, coloured prints, landscapes, figures, heads, flowers—in fact, anything and of any size that can be pressed into the service. Coloured lithographic prints are now-a-days so common that there will be little difficulty in obtaining materials suitable for the purpose. It



Fig. 2.



Fig. 3.

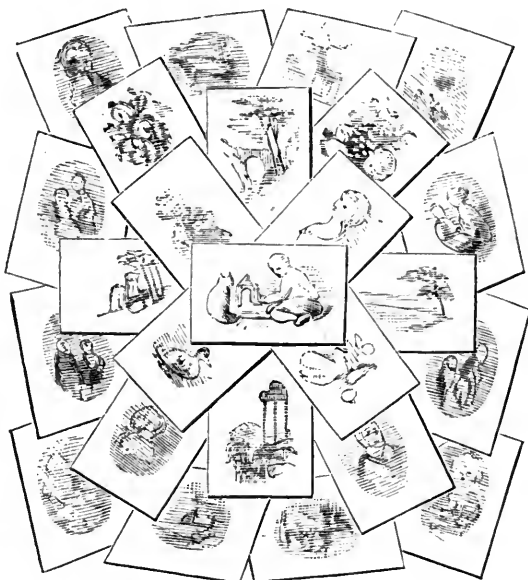

Fig. 1.

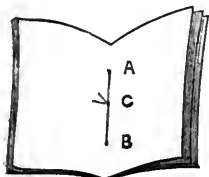

Fig. 5.

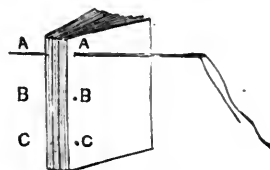

Fig. 6.

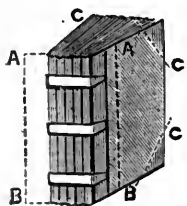

Fig. 8.



Fig. 7.

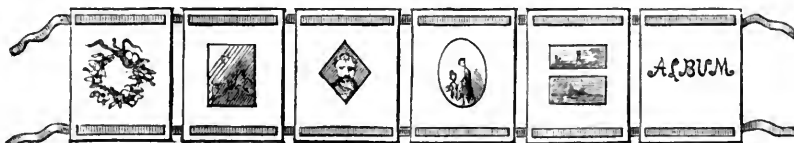

Fig. 4.

where so much must be left to taste, but the general instructions in this paper will, with ordinary good taste and a little practice, enable the reader to become quite proficient. There are different ways of covering a screen. The first and simplest, as regards preparation, is the sticking on of prints from which the margins have been removed. Pictures for such purposes may be collected from various friends and laid on according to taste. Sometimes all kinds of pictures, of all shapes and sizes, are arranged as it were pell-mell upon a screen, every cranny and nook being filled up. At other times they are arranged in studied confusion, as in Fig. 1. This requires materials all of one size, and is most fitted for

will be found desirable ~~not~~ to choose too many pictures representing the same class of subjects; there should be a judicious assortment of figure subjects, landscapes, animals, fruit, and flowers. Cut these all in outline with a sharp pair of scissors, but avoid touching the finer portions at first, such as the features of the face, or the rigging of a vessel: and only at the last moment cut out the minute details with a penknife. After the last fine cutting is done, you must not handle them more than is absolutely necessary, as they are very liable to tear. First arrange the coloured scraps, according to your taste, on a table, and afterwards gum every one of them slightly by one point, and then hang them temporarily on the screen to see the

general effect. The arrangement ought to appear perfectly careless and hap-hazard, all sizes and all shapes turning in every possible way; but the eye must be satisfied and the colours contrasted, so as to give a good general effect. The black ground is left distinct between these, the pictures never touching. They are afterwards firmly pasted on, and finally the screen is varnished. The best varnish for the purpose is the ordinary spirit varnish. In pasting the pictures, one side is done at a time. After varnishing, the screen must be left where it can remain undisturbed. It will require two or three coats of varnish, each of which must dry thoroughly before another is applied. When the surface is quite smooth and even, the work is finished. A great deal of previous consideration is required to produce a felicitous result. For instance, the light and shade of the prints must be studied. If they are laid on in straight rows, alternately light and dark, as some lay them, a chess-board effect is produced which is most undesirable; or again, if they are placed in stars, a light one in the centre of a group of dark ones stands out too prominently. Effects like these may be observed in patchwork where they are purposely done, such as the box pattern. Pictures that are all square, or can be cut in squares, may be arranged in stars, as in Fig. 2, but the lights and shadows must be carefully varied. If they are cut in diamond shape they may be arranged as in Fig. 3. Having laid them on the table to try the effect before pasting them on, retire to a distance, so as to be able to judge of the result. A strong solution of gum mixed with a little flour, is the best cement.

Albums.—Albums and scrap-books may be made in almost endless variety. For a gift-book especially, nothing could be prettier or better, than one devised on the Chinese plan. Get a set of strong cards, of whatever size you like; they may be as much as twelve inches square. Lance holes with a penknife at each of the corners, and run a piece of coloured ribbon through, after the fashion of a fan, having first bound the edges all round with ribbon, put on with a strong solution of gum. Fig. 4 shows the manner of doing this. The ribbon is gummed to each card where it crosses it. Make your solution of gum very strong, but do not use it profusely; gum securely the cards together, but merely so as to attach the ribbon. After gumming down the ribbon, the cards not being more than the least possible space apart, leave them spread upon a table, covered with clean paper, and press them under a heavy weight. The next day the gum will be dry. One or more pictures can be arranged on each side of every card, and the covers may be ornamented with silk or moire antique, sewn together at the edges, and put on after the ribbon joints. The merit of this book is, that it will open like a common book either way, back and front, or unfold like a panorama. It forms a pretty case for photographic portraits, which may be thus inserted:—Soak a portrait in cold water till it comes off the card. Let it dry, and then attach it with gum to your album. *Passe-partouts* containing photographs may be made to form an album of this kind. Beautiful photograph albums have been made, by taking a number of cards of one size and mounting various sized photographs of fancy subjects upon them, and then designing borders appropriate with a pen and Indian ink; for example, round "Moses found by Pharaoh's daughter," a border of bulrushes; around heads, the outline of a mirror or a frame of beads will have a pretty effect. Round the well-known subject of the Christian Martyr, a border of lilies would be appropriate. In filling scrap-books, if the book is not already so prepared, every other leaf must be cut out, because the pictures pasted in will otherwise swell the book beyond the dimensions of the binding. To make a book for yourself, in a homely style, take six sheets of paper folded one inside the other. Stitch them through the centre, putting in the needle at C, taking it through A and B, back

to C, and there knotting the two ends together, Fig. 5. Then take another set of six sheets, and so on until you have enough for a book, stitch the whole of them through in three places, as shown in Fig. 6, first at A, knotting it together behind, then at B and at C. The book ought now to be pressed in a carpenter's bench, or press, the back upwards. Next glue the backs well, and attach three strips of linen rags, also well glued, as shown in Fig. 7. Afterwards glue the outside of them and attach the covers, in the way shown in Fig. 8. After the sides have been pressed and dried twenty-four hours, a strip of fancy paper, or leather, or velvet is put over the back, as shown by the dotted line A, covering over the sides and corners of the covers, as shown by the dotted line B. These are turned down inside the covers and finished off neatly. The paper or silk to cover the sides is now to be put on. Albums may also be made very pretty by binding them in embossed cards, or cards covered with silk. The way to manage this is to put the back of velvet on the book, before you put on the sides; or velvet enough to line the cover may be carried across the whole side of the book. The fly-leaf, or first leaf of a book ought to be nicely gummed or pasted down to the inside of the cover as soon as the binding is otherwise finished, and dried again. There is a great variety of fancy work which is quite as easy, and which will conveniently fill up a long evening, and we propose to give some further instructions in a future paper.

INMATES OF THE HOUSE.—LEGAL.

V.—RATES AND TAXES.

WHEN Dr. Johnson in his Dictionary defined excise as a hateful impost, he did but express towards one tax in particular what the majority of people feel against taxes in general. There seems at all times to have existed a hostility towards taxes, of whatever sort, though it is obvious that without contributions from the people the business of the country could not be carried on. This is true, not only of taxes which fill the imperial coffers, but of rates which are levied for the purposes of local government. Perhaps the hostility has proceeded rather from the manner in which the taxes have been levied than from hatred to the taxes themselves. Down to a comparatively recent period of the world's history, the practice was general of farming the revenues of the state to persons who paid a sum down to the government in return for permission to collect the taxes on their own account, a practice which, from the very nature of it, was likely to prove oppressive, and which did, in fact, provoke many a rebellion. It was the brutality of an unpopular tax-collector, it may be remembered, that caused the outbreak of Wat Tyler's rebellion. It was the tax upon salt, imposed in the interests of the rapacious revenue farmers of a profligate government, that broke the back of the French people's patience before the Revolution. Something of the publican and the tax-farmer still clings to collectors of public revenue, or there is a prevalent idea that it does, working the same result, and the probability is that if government, local as well as imperial, collected its own taxes, its income would be more readily paid, and the process of collecting rendered less disagreeable to the taxpayer.

There are two kinds of taxes which the modern household is liable to pay—the queen's taxes and the parochial rates. These, again, are subdivided into several heads.

The queen's taxes, or, as they are often called, the assessed taxes, include those charges which are imposed by parliament upon the country generally. Among them are the income tax, the property tax, the house tax, the tax on armorial bearings, on servants, horses, and carriages. These taxes are variable, both in amount and in the objects to which they are applicable. Parliament

at the instance of the chancellor of the exchequer, modifies, remits, or imposes a tax. To the chancellor of the exchequer is usually left the decision of the taxable articles, and the amount of tax to be levied; but parliament reserves to itself the right—which it sometimes exercises—of setting aside the chancellor's proposals, and of changing his financial policy. But the taxes, once agreed to, are laws of the land until the power which created them sees fit to annul or to alter them.

For the purpose of collecting the queen's taxes an expensive and elaborate machinery is in existence. There are collectors and surveyors of taxes, and there is a Board of Inland Revenue at Somerset House, to which appeal is to be made in the event of any complaint against the acts of the subordinate agents. The way in which most of the assessed taxes, including income tax, are raised is by means of declarations to printed schedules, which are left at each house. A statement is printed, with blank spaces to be filled in, respecting each tax authorised, and the person to whom it is addressed is required to fill up the blanks with written answers as to his liability or alleged exemption from the taxes in question. To the statement he affixes his signature in full, the signature being taken as a guarantee that the declaration is a truthful one. A note at the foot of the paper intimates in pretty significant terms the pains and penalties to which the false declarator is liable.

Taxes upon household servants, carriages, horses, &c., are to be calculated upon the largest number of the taxable objects in possession during the past year; so that though at the time of signing the declaration a man may not have more than one horse, yet if he has had three horses during the past year, he must pay upon three. If, at the time of making the return, he has three horses, and last year had but two, he will pay upon two only.

Dogs are no longer taxable under assessment, but by means of licence, the cost of which is the same for every kind of dog.

Income tax is regulated either by the actual income for the past year, or, if income is fluctuating, as it is in business, or other uncertain sources of revenue, by an average of the income of the last three years.

Property tax is identical with income tax, and tenants of houses or lands who may be called upon to pay landlord's property tax upon the value of their holdings, are empowered by act of parliament to recoup themselves out of the next rent that may fall due; and the landlord is bound, under a penalty of £50, to allow the same to the tenant.

House tax is levied, partly on the statement of the tenant as to the rent he pays—this statement being verified by production of lease or agreement—chiefly on estimate by the government surveyor of the value of the house. In estimating value, it is the practice of the government surveyor to reckon what is called the rack rent, or the highest possible value of the house. Thus it may happen sometimes that a house of which the rent is £50 is assessed for the house tax at £60, the surveyor being of opinion that, under certain circumstances, the house might be expected to command that rent. Should a householder be assessed, as he may think, at too high a rate, he will do well, in the first instance, to remonstrate with the district surveyor, and if he refuse to abate, and the tenant be still of opinion that the assessment is too high, he should lodge a formal complaint with the Board of Inland Revenue, who will grant him a hearing, and decide finally upon his case. Houses improve or diminish in value according to neighbourhood; re-adjustments of the assessment may therefore be made from time to time, either at the instance of the surveyor or the tenant. It is, of course, to be borne in mind that improvements to a house increase its value, and render it liable to increased assessment.

In the next article a description will be given of compounding for rates—a practice which affects tenants in their political function.

Debts due to the Crown are recoverable by summary process before a magistrate; they are also the first charge upon the estate of a man, taking precedence of all other claims.

Parochial Rates are those taxes which are levied upon parishes by and with the consent of the representatives of the parish, and they vary in different localities, according to the different expenses which have to be defrayed. In London they include poor's rate, lighting rate, police rate, the general rate for repairing and making roads, cleaning the parish, and defraying the expenses of the acts for the better local management of the metropolis; and the metropolis main-drainage rate. In the extra-metropolitan districts the last-named rates are, of course, omitted.

The Poor Rate.—This rate, in its present form, is as old as Queen Elizabeth's reign, during the latter years of which it was called into existence, in order to supply, to some extent, the want occasioned by the abolition of the monasteries. While the monasteries lasted they were charged, or rather they considered themselves charged, with the duty of seeing that no one needed the necessaries of life, or went poor, and naked, and hungry. They gave indiscriminate relief to all comers, and, while relieving many doubtless deserving and unfortunate persons, encouraged also the idle and the lazy. When these institutions were abolished by Henry VIII., the grantees of their lands were charged with the duty of maintaining hospitality, and of relieving the poor hitherto relieved by the religious houses. As a matter of fact they disregarded this condition of their grant, and there was not any disposition, if there was any power, to make them observe it. The poor and aged, the infirm and the destitute, wandered about the country till death relieved their sufferings; the more desperate of them, impelled by the hard master hunger, being sometimes driven to acts of violence and lawlessness, filling the ways with rapine, and terrifying wayfarers by the imperious character of their mendicency. Various acts of parliament were passed against "valiant and sturdy beggars," and punishments were provided for those who could not find means of living independent lives; but as these proved, of course, ineffectual to check the stream of human misery, and as the old means of relief were taken away, it became necessary for the legislature to do something towards providing relief for the poor of the kingdom. The first poor law was passed towards the end of Elizabeth's reign, and has served as the basis of all the poor laws since agreed to. Each parish in the country was bound to maintain its poor in some sort of decency, and to prevent the exhibition of the squalid misery which was so patent everywhere. Rates were ordered to be levied by those who were constituted guardians of the poor, and legislative sanction was given to the principle that the poor are not to be allowed to starve. The poor rate is the basis on which all other rates are made, so that if anything is wrong with the poor rate it behoves one to get it rectified at once. Considerable difficulty having arisen in the matter of assessment, various acts of parliament have been passed to regulate the conduct of guardians in respect of it, the general rule, however, being that from ten to fifteen per cent. off the average rent of a house is the proper sum at which the house ought to be assessed. The act under which the parish authorities are authorised to levy rates declares that the assessment shall be made "on an estimate of the net annual value of the several hereditaments" held by the parishioner, and defines "the net annual value" to be "the rent at which the same may reasonably be expected to be let from year to year, free of all usual tenant rates and taxes, and deducting therefrom the probable average annual

cost of the repairs, insurance, and other expenses necessary to maintain them in a state to command such rent."

Such being the basis of calculation for rates, it follows that if improvements be made by the tenant, or other person, so that the house is really worth more than formerly, the assessment rate will be increased in proportion. In case of dispute as to the amount of the rate, complaint should be made by letter to the guardians of the poor, their agent, the local surveyor, having originally fixed the amount.

On certain days, which are appointed by the guardians, appeals are heard, and every one having an appeal to prosecute should attend on the day named for him, taking with him his lease, agreement, or other sign of his tenancy, to prove the value set upon his house by the landlord and himself. Any other evidence, such as that of the surveyor of queen's taxes, in support of his statements, should also be adduced. The appeal is heard in person, and if the board are not satisfied, after hearing the appellant and their own surveyor and agent, they depute a committee of their own body to inspect the premises in question, and to report to them in the capacity of judges between the parishioner and the parish officer. From the decision of the board, whatever it may be, an appeal lies to the magistrates in petty and in quarter sessions; but the appeal must be made within twelve months from the time of the rate being made, or the appellant is remitted to the next occasion of the objectionable assessment being acted on. On the other hand, if a parishioner will not pay his rates, he is liable to be summoned, and the amount due from him may be recovered on summary process. Except where the landlord agrees or is bound to pay the rates, a person leaving his house without paying rates, and without leaving furniture enough to pay for them on execution, is liable to a fine of £50, besides being still bound to pay the rates due from him.

The machinery provided for the assessment and levy of poor rates was thought to be adaptable for other purposes of local self-government, and the administrative functions of vestrymen were moulded upon those of guardians of the poor. Vestrymen—representatives chosen by the parishes, and originally holding their meetings in the vestry of the parish church—are persons charged with the duty of local government, apart from magisterial duties. In the metropolis, and in all large towns, they are the makers of roads, of new streets, the furnishers of means for cleansing the parish, for paying police, organising sanitary regulations, and generally discharging the functions of self-government. They are all accountable to the Poor Law Board for their conduct as regards the poor, and to the home secretary as regards some other duties. In London they are also responsible in some things to the Metropolitan Board of Works. But, subject to these superior powers, they have authority to make and levy rates, which the parishioners are bound to pay. Church rates, not being compulsory, are not now really rates at all.

The amount of the rates varies very much. In some parishes, where there are many poor, and but few persons able to contribute towards their maintenance, the weight of the taxes is very heavy; in some cases equalling more than half the rent. In other parishes, as some of the city of London parishes, there is only a nominal poor rate, while the incidence of the other rates, except perhaps the metropolitan main-drainage rate, is very light also. There is some prospect of an equalisation of poor rates all over the metropolis, so as to make the parishes bear one another's burden, but at present the distinctive system prevails. A step in this direction has been already taken by an Act passed in the session 1867-8, to amend the Metropolitan Poor Law providing for the better relief of sick persons, by equalising throughout the district the local charges incurred in their behalf. We subjoin a list of the Assessed Taxes as fixed by recent legislation—

Armorial Bearings.—For any person chargeable with duty for any carriage.....	£	s.	d.
Not being so chargeable	2	2	0
Carriages.—For every carriage with four wheels, weighing 4 cwt.	1	1	0
For every carriage with less than four wheels, if less than 4 cwt.	2	2	0
Drawn by 1 horse or mule only	0	15	0
Drawn by 1 pony or mule only, not exceeding 13 hands	0	15	0
[When kept and used solely for the purpose of being let for hire without horses, one-half of the above-mentioned duties respectively.]			
Carriages used by common carriers, principally for the carriage of goods, but occasionally for the conveyance of passengers, when such carriages have 4 wheels	2	6	8
When less than four wheels	1	6	8
Horses.—For every horse or mule used for riding, or drawing a carriage	0	10	6
Horse Dealers' Duty.....	12	10	0
House Duty.—On each inhabited dwelling-house of the annual value of £20 or upwards, occupied as a farm-house by a tenant or farm-servant, or in which articles are exposed for sale, a duty of 6d. per per pound; all others	0	0	9
Male Servants.—Every Male servant	0	15	0

THE AQUARIUM.

MARINE AQUARIUM (continued).

As you proceed with your search among the rocks and turn over the sea-weed, some yellow shells will very probably be found adhering to the under surface, and occasionally a small whelk or periwinkle. A few of these should be gathered for the sake of variety. Upon the rocks will be noticed round patches of sea grass, varying in size from a shilling to that of a crown piece. Underneath these will be found the limpet (*Patella vulgaris*), to the shell of which the grass grows. There is the same difficulty with the dislodgment of the limpet as with the anemone. It no sooner feels the touch than it clings tightly to the rock, and as the edge of the shell is embedded in the chalk it is not an easy task to remove it. By selecting one the shell of which is slightly raised, and putting the blade of a pocket-knife beneath the edge, it may be jerked off without injury.

Some limpets are covered with a shelly parasite, called the acorn barnacle (*Balanus*); one of these should be secured, care being taken that none of the shells are broken. When these are placed in a glass of clear sea-water, and looked at through a magnifying-glass, they will be seen to open a door in the roof of the shell, and protrude a feathery fan, by means of which food is caught and conveyed through the aperture. Unfortunately, they have a tendency to die after a brief confinement; they should therefore be carefully examined in a separate vessel, before being introduced.

Some of the rock-pools, on close examination, present an exceedingly pretty sight. Sea-weeds of various colours cover the bottoms, and give them the appearance of miniature forests. As a rule, imported sea-weed does not grow well in an aquarium, but as it looks pretty for a time, and may easily be removed when it begins to show signs of decay, a few pieces should be secured. The way to obtain these is to chip off pieces of the rock upon which it grows, for which purpose a hammer is required. Sea-weed is of no use for aquarium purposes unless attached to a stone or piece of rock. Vegetable growth is necessary to the healthy maintenance of the aquarium, but this will soon develop itself from the germs contained in the water, and gradually cover the stones and rockwork.

The next curiosity to be sought after is the hermit crab, which you will certainly not find unless you know how to go about it. This creature may be described

as half a Lilliputian lobster and half a periwinkle. The fore part of the body is crustacean, but at the waist it changes into a molluscous animal, having a soft tail, which it inserts into an empty whelk-shell. When all is quiet, the shell containing the hermit may be seen moving slowly along the sand between the rocks, but

you mean farmers—that's what we call them." The tide by this time had come up beyond the line where the hermits were to be found, so the boatman undertook to find some, to put them into a jar, and send them to London.

There will be no difficulty in finding two or three common edible crabs (*Cancer pagurus*) such as that

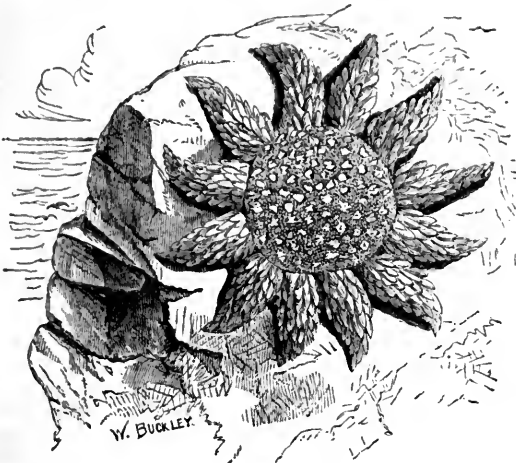

SUN STAR.



SERPULA.

the moment the sound of a foot is heard the cautious inhabitant darts back into the shell and remains motionless, so that it is not easy to discover it.

On one occasion the writer failed in his endeavour to find a hermit, but knowing them to be plentiful at Broadstairs, he continued his search till he met a native boatman, with whom he got into conversation. After

shown in our illustration. Those chosen should be small, say from an inch to an inch-and-a-half across. If larger, they prove troublesome to the anemones; if smaller, the anemones will devour them. The crab is an especially valuable creature in an aquarium, for he acts as a scavenger and appropriates odd morsels of food that may have been rejected by his more dainty neighbours.

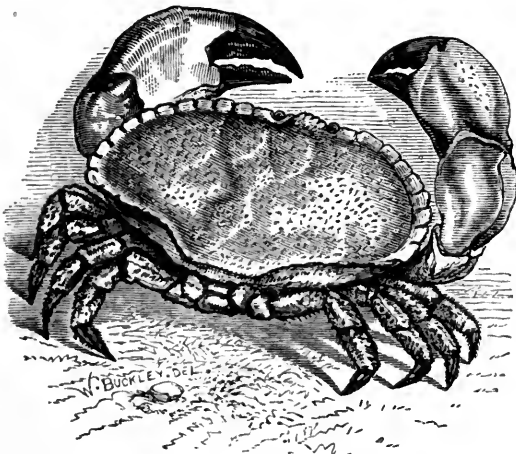

THE CRAB.



ACORN BARNACLES ON A LIMPET SHELL.

listening to a yarn about wrecks and life-boats, and inspecting three medals which had been worthily bestowed upon him for saving life, an attempt was made to enlist his services in the search after the coveted *Pagurus Bernhardus*. "I dare say, now, you can tell me where I shall be likely to find a hermit crab." "Oh," said he, "you'll find plenty of little crabs about, but I never heard them called by that name before." "I mean those crabs that carry whelk-shells on their backs." "Oh, I know now,

Another recommendation is, that he will become exceedingly tame, and even allow himself to be petted. An edible crab from Broadstairs, not much larger than a man's thumb-nail, became so tame that he would take food from the fingers, and though at first viewed as the least valuable in the collection, soon grew to be an especial favourite, and was rewarded by having a glass house furnished exclusively for his accommodation. After a while, however, he became shy, and fears were entertained

that he was pining for companionship. He forced himself beneath a stone apparently heavy enough to crush him, and shrank back whenever any attempt was made to get at him. In a day or two his anxious friends were pleased to see him come from his hiding-place, but Jack was no longer the same hard-skinned crustacean that he was before his retirement. In the first place, he had grown considerably; in the next, instead of presenting a shelly coat to be stroked, his back was as soft as that of a frog, and he shrank from the touch as if he were afraid of being hurt. The fact was, that he had undergone the natural process of exuviation, and had shuffled off his shelly coil, which he had left beneath the stone that had lain upon him during his temporary withdrawal from society. In about a week his skin began to harden, and he became more familiar than before. Each morning, at breakfast time, he came to the front of the glass and tapped against it till he was fed. On his seeing any one approaching the glass he scrambled out of the water on to the stones that rose in the centre, and held out his claws for food, which he took from the fingers, and then scampered away like a monkey to eat it in a corner. On another occasion the crab's decease was reported. An inquest was immediately held, and the body inspected in due form. There could be apparently no reasonable doubt that he was dead. The *post-mortem* examination was made by means of a common magnifying-glass, through which could be seen his eyes, feelers, &c., and the unanimous verdict was "Found dead." His habitation was of itself a pretty window ornament, for the miniature rocks were nearly covered with bright green confervæ, and around the sides were several tufts of sea-weed in a healthy condition; it was, therefore, left undisturbed. After the lapse of several days, the familiar tapping sound in the glass was again heard; several pairs of eyes, staring with wonder, were directed towards the residence of the late lamented crab, and behold, there he stood, in his accustomed attitude of supplication, awaiting his breakfast. He had grown considerably, and was once more in a soft condition. This led to the examination of the supposed dead body, which had been placed in a box as a relic. On further examination, it proved to be nothing but an empty shell, a fact which was not at first discovered, owing to its containing sand. No one who has not had an opportunity of witnessing the exuviated shell in a perfect condition can believe the possibility of the creature getting out of its old coat and appendages, including head, eyes, antennæ, and claws, and leaving it in one complete piece.

Very small shell-fish, such as young mussels and cockles, may sometimes be found on the shore near low-water mark. The mussels grow in clusters, and are attached to the rocks by threads called the byssus. Do not pull them away, but take your hammer and chip off a piece of the substance to which they cling.

After a rough sea, the tide leaves numerous star-fishes in the crevices of the rocks. These are of various kinds, the prettiest being the sun-star, such as is shown in our illustration, which has twelve rays, and is best adapted for the aquarium. The commoner kind has but five fingers; as this creature is voracious, it is advisable to select the smallest that can be found.

The objects above mentioned, which afford sufficient variety, and are not difficult to keep with an ordinary amount of care, may all be obtained on the shore at Broadstairs, or at any place on the same coast where the rocks stretch out into the sea. There are, however, other localities where much more beautiful objects may be found. The coast of Dorset, Devonshire, and Cornwall is especially rich in zoophytes, some of which are as beautiful in form and colour as the choicest flowers in the conservatory. There are certain methods of gathering that yield less common specimens of marine animals than those already described. For obtaining such as are not

amphibious, the best plan is to engage a fishing boat and use the dredge. By this means you may obtain a greater variety of crabs (including the curious and interesting spider) and shells covered with tube-worms (*serpula*). These latter are well worth keeping in an aquarium. The tubes of the *serpula* are generally attached to oyster-shells, and overlay each other in a serpentine form. On taking them out of the water, a blood-red spot will be seen at the mouth of each tube; but after exposure it sinks down out of sight. On replacing it in water, the worm will protrude a feathery coronet, with a kind of stopper in the centre; but will instantly withdraw it if the hand be passed across so as to suddenly intercept the light. The illustration shows a group of these singularly-shaped creatures.

THE HOUSE.

LIFE ASSURANCE.

WE will now assume that, after a careful examination of the various published statements of the Assurance Companies, an office has been selected by the applicant, and that he has been provided with the form of declaration which is the basis of the contract between himself and the company. In this document he is called upon to set forth his name, description, and age next birthday—evidence of which should be furnished by the registrar's certificate of birth, by an extract from a family Bible, or otherwise, when the age is admitted by the company, and no question can thereafter arise with reference thereto. He is required, also, to state whether he has suffered from gout, spitting of blood, or from any disorder tending to shorten life; and he has to give the names of two persons, to be referred to as to his health and habits of life, and generally to reply to the questions as to his health and family history that may be asked him by the medical officer of the company, before whom he has to appear for examination as to his health. Persons in decidedly bad health are not eligible for life assurance; but for any trifling deviation from the usual standard, an extra premium may, perhaps, be required, varying, with the circumstances of the case, according to the report of the medical examiner of the company.

This ordeal having been gone through, and the life having been "passed" by the doctor, the risk is accepted by the directors, the premium is fixed, and the amount thereof announced to the applicant, which he has to pay in the course of a month from the date of acceptance. On the premium being paid, the policy is prepared, and in due course issued. It is a legal document, signed by three directors of the company, and impressed with the necessary government stamp, at the expense of the office, and binds the company, in consideration of the regular payment to them of the annual premium, to pay to the legal representative of the policy-holder the sum contracted for, at the expiration of three months from the death of the person assured.

The policy recites the conditions as to foreign residence, death by suicide, duelling, or the hands of justice, &c.; and declares the contract to be void if the declaration upon which the policy is based be untrue. Too great care, therefore, cannot be exercised in filling up the necessary forms, and in replying fully and honestly to the inquiries of the medical examiner. The policy must be carefully preserved for production to the office by the legal representative of the assured upon the claim arising. Formal notice of the annual premiums becoming due is regularly given by the office in writing; and they must be paid within a month of their becoming due, otherwise the policy becomes void—or "lapses," as it is termed—and all advantage from the previous payments is lost to the holder.

After the expiration of five, or, in some offices, seven years, the policy, if effected on the participating scale of

premiums, will become entitled to a *bonus*, or addition to the sum assured, arising from the profits of the concern, and payable at death with the amount of the policy.

The bonuses periodically allotted by life assurance companies owe their origin to the impossibility of assessing in anticipation the exact amount of premium required for each particular risk undertaken, and they depend in amount upon the success of the company, and the method of allotment, which varies greatly in different societies. To be on the safe side, therefore, it is usual to charge a larger premium than may ultimately be found to be necessary, so that due provision may be made for excessive mortality, and for other fluctuations in the business. A periodical return of profit is, therefore, made, which may be received as an addition to the sum assured at death, in a present cash payment, or in the shape of a corresponding annual reduction of the premium throughout life. The profits of a life assurance company depend upon the careful selection of lives (all bad lives admitted to participation in the benefits of the company naturally tending to reduce the rate of profit by their premature death), moderation in the expenditure, and particularly on the careful investment of the premiums at an adequate but safe rate of interest.

And here we may give an illustration of the extraordinary increase of money at compound interest, by the operation of which principle alone the claims are provided for as they become due.

Upon reference to a table of interest, we find, that at 4 per cent.—the least rate likely to be obtained by an assurance office—the amount of £1 per annum in thirty years is £56; in forty years, £95; in fifty years, £152; in sixty years, £238, and so on. At 5 per cent. these amounts are increased respectively to £66, £120, £209, and £353. Again, £1 set aside at compound interest, at 4 per cent., more than doubles itself in eighteen years; or, in fifteen years at 5 per cent., while in one hundred years, at 4 per cent interest, £1 becomes £50, and at 5 per cent., £131.

These plain figures will be sufficient to show the way in which the comparatively small annual payments made by the assured in life assurance companies, are swollen in the course of years by the operation of interest to the large sums paid as claims under the policies and as bonus additions thereon.

It was explained above that the proportion of profits divided, by way of bonus, by the different companies, varies considerably. In the mutual societies, the whole of the profits belong to and are divided among the policy-holders. In the proprietary companies, the proportion allotted may be two-thirds, three-quarters, or four-fifths, or in other words, sixty-six, seventy-five, or eighty per cent.; but it should be remarked, that these proportions are not sufficient indications by themselves to decide the choice of an office, for it may easily be seen that two-thirds of a large amount of surplus, may exceed three-quarters, four-fifths, or even the whole of a lesser amount.

It was explained above that the bonus system originally arose from the impossibility, in the early days of assurance business, of assessing the exact amount of addition to the net premium for profit, bonuses, expenses of management, and to provide a certain margin for safety, so as to guard against fluctuations in the mortality, which often differs greatly from year to year, and in the rate of interest the company is enabled to obtain for its investments, which is also an element that fluctuates with the ever-changing state of the money market, &c. &c. After some years' experience, actuaries were enabled to determine with very considerable accuracy the amount of addition to the net premium that was really necessary; but, by that time, the assured public having been led to look for these periodical additions to their policies, it was not easy to abolish the system of charging a larger premium than is commensurate

with the risk, for the purpose of returning a proportion thereof, in the shape of a bonus addition to the policies; and the constantly increasing competition among rival companies has tended to perpetuate the practice, which there is little expectation of now being changed. The bonus system has, at least, the advantage of benefiting the families of the assured, at the expense, it is true, of the larger outlay made by the policy-holder during his life. Most companies have, however, a non-participating scale of premiums, by which an additional sum can be assured in the first instance, being in fact, the sum that the difference between the participating and non-participating rates of premium would assure, and thus an immediate reversionary bonus payable with the sum assured is provided, even if the death happens in the first year; while, upon the bonus plan, the term of five or seven years, as the case may be, is required to be survived before the policy comes into participation at all.

For example:—supposing the participating rate at the age of forty to be £3 7s. 11d., and the corresponding non-participating rate £2 17s. 11d. for every £100 assured. The difference between these rates, viz.: 10s., would assure an additional £18. So that an *immediate* reversionary bonus of that amount would be secured to the policy-holder, payable whenever death might occur. This is not, however, a favourite method of assurance with the public, who do not avail themselves of the plan to any great extent, and probably for these two reasons, one being the fact that the non-profit rates are not generally as low as they should be, if they were equitably adjusted, as compared with those on the participating scale, and the other because the element of uncertainty and speculation is lost, which to so many persons has a great charm; and certainly, though in the case of an early death, the interests of the policy-holder would be best met by the payment of the minimum premium, still, in the event of a life assured attaining an advanced age, the bonuses of the old-established companies, which are frequently of very large amount, would, probably, fully compensate for the excess of premium paid. It is far from unusual for more than £300 to be paid to the family of a deceased policy-holder for every £100 assured, the annual premium having, in fact, been paid throughout the duration of the assurance for £100 only.

So valuable, indeed, have these bonuses on old policies of large amounts become, that a system of *assuring the bonus itself* has arisen in the practice of assurance companies. In order to participate in each successive division of profits, it is required that the life assured should be living on a certain fixed day, and the failure of the life before that day—at any time, in fact, between two bonus periods—would involve the loss of the bonus to the family of the policy-holder. An assurance on his life for the amount of the anticipated bonus for the term of years required to be survived, is accordingly frequently effected, the premium for which is often very high, as it is usual only in cases of extremely advanced age that this system is had recourse to. The older the life assured, the greater the risk of his losing the bonus, and the greater also his reluctance to run any risk in the matter. He therefore makes a sacrifice of a portion of the expected bonus, to secure the balance, as men do in some other precarious transactions.

This assurance of the prospective bonus, is chiefly resorted to in those companies whose practice it is to allot the reversionary bonuses at each distribution of profit from the date of the policy, in each case—that is to say, at the rate of so much per cent. per annum—from the commencement of the assurance. It will be seen that upon this system the bonuses increase very largely from term to term, and that they may eventually become of extraordinary magnitude upon large assurances of long duration. At such advanced ages the premium is, of course,

proportionably high. Probably after the age of seventy-five the mortality tables can scarcely be much depended on, and the correct premium for the risk can, consequently, only be approximated to. In fact, it may be said to be an even chance whether a person of that age will survive the short term prior to the bonus, or not, the assurance of bonuses being generally deferred until the day to be survived is not very far distant, say a year or two. It becomes then a toss-up, so to speak, whether the life survive the necessary period, or not, and a premium of £50 per cent. has been quoted and paid in such cases for an assurance for a short term. An arrangement in some cases of this sort is occasionally entered into for a return of a proportion of this high rate, if the life survives the required term.

Such an assurance as this is a perfectly fair and a wise

HOME GARDENING.

THE TOOL-HOUSE.

A TOOL-HOUSE of some kind or other must be provided in every garden, or you will invariably find your implements out of order, and a great deal of time will be wasted in looking for them when they are required for use. Such a structure need only be of the very simplest kind; all that you want is to keep out the wet, and if you have no little outhouse convertible for the purpose, you may put up at a trifling expense, a small lean-to shed against the garden wall, in any odd corner, which may be covered with thatch or tile, or even felt, which, if of good quality, will keep out the wet for a considerable time.

The shed should be fitted up inside with shelves and

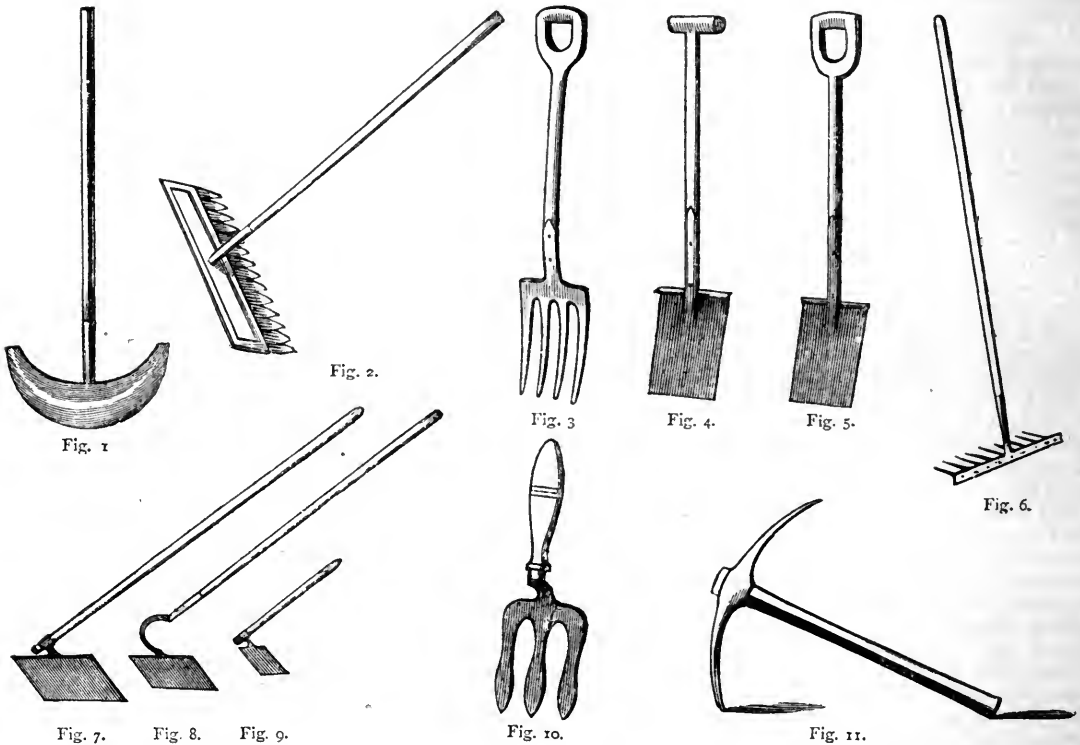

one on the part of the policy-holder, who thus makes sure of receiving half of his expected bonus, instead of running the risk of the whole being lost to his family, but on the part of the company such a transaction becomes almost tantamount to gambling, and seems to be beyond the pale of legitimate assurance business.

Many persons will naturally be very curious to know how it comes to pass that such heavy bonuses as those referred to above can be paid by any company. That they are paid is, however, matter of undoubted fact, and the cause is not to be found, as some might imagine, in any unfair calculations as the basis of individual premiums, nor to any great extent, in the advantages gained by adopting only selected lives, or lives of the better class. What the principles are which are involved in the computations by which profits are estimated and assessed, although somewhat complicated, we shall endeavour to explain in our next. Considering the practical importance of the whole subject, we trust that our readers will not shrink from a careful study of the somewhat obscure and complicated topics which it involves.

drawers for stowing away mats, netting, and the like when out of use, as well as for keeping together shreds, nails, flower-sticks, and so forth, all ready for use at a moment's notice. Then again, the walls or sides should be furnished with nails, hooks, pegs, brackets, and supports, upon which every tool may be hung, or put away, when not in use. Each tool should be carefully cleaned and returned to this house as soon as it is done with, for nothing is more destructive than to permit them to lie about wherever they were last used, with dirt adhering to them, and exposed to the destroying influences of the weather. It is important to keep the shed as dry as possible, for the damp soon rots the mats, and nets, and covers iron and steel tools with rust, especially knives and scissors. The larger implements, such as the mowing-machine, barrow, &c., might stand in the centre of the building.

Our illustrations show the best forms of several of the most ordinary garden tools, the uses of which we proceed briefly to describe, employing in our description only the simplest terms.

The Spade.—This implement is made of three sizes, and it is advisable to have two for a moderate sized garden; the largest, or second size, to be used for trenching purposes, and the smallest for digging amongst the flowering plants in crowded borders. There are two kinds of handles, as shown in Figs. 4 and 5, the second being preferred by many on account of its being more easily welded. This implement is one which every amateur gardener should carefully select.

The Digging Fork, Fig. 3, as its name implies, is used for turning up the soil, and to be really useful should have four prongs. We generally prefer the fork to the spade where the ground is hard, as the points enter with greater ease, and do the work of pulverising or breaking up the clods with better effect.

The Small Weeding Fork.—This is invaluable for weeding, and lifting bulbous and fibrous roots from one spot to another without injury. A convenient shape is shown in Fig. 10.

The Rake, Fig. 6, is used for levelling newly turned up ground, removing, or rather collecting in a body for

walls, for the purpose of pruning and training; and the latter, Fig. 13, which is a kind of double ladder, will stand without any other support. This will be of great use for pruning, or gathering fruit from standard trees, against which it is undesirable to rear a ladder, for fear of breaking the young shoots, and injuring the bark.

The Daisy Rake, Fig. 2.—This is a very useful instrument on a small lawn. By drawing it over lawns studded with daisies the heads or flowers become fixed between the teeth, and thus the lawn can be cleared in a very short time. It may be used also for clearing away dead leaves from the grass.

The *Hammer* for the garden should be furnished with claws, such as we have described in our paper on the Domestic Tool Chest (page 24), for the purpose of drawing out old rusty nails, and training trees and plants on walls.

The *Roller* is, or should be, called into use for keeping the surface of gravel walks smooth, as well as for levelling grass-plots, both of which operations should be performed in clammy and cloudy weather. Iron rollers have quite superseded the stone rollers of former days; they are

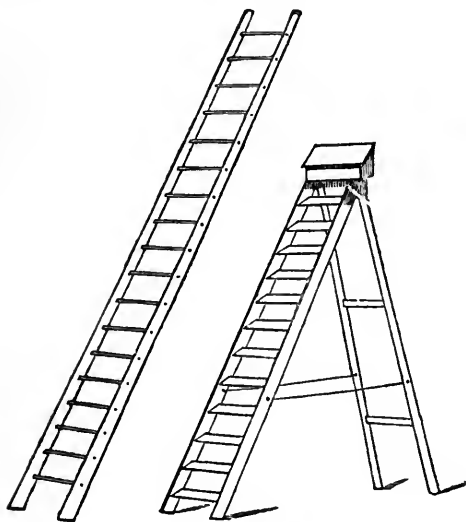

Fig. 12.

Fig. 13.

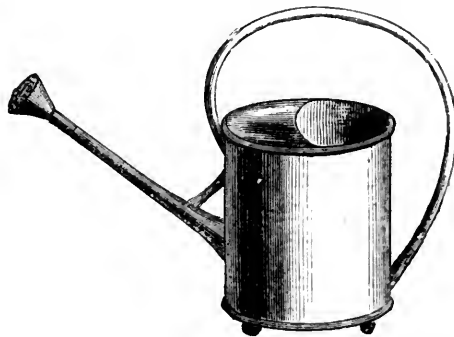

Fig. 14.



Fig. 15.

removal, weeds and rubbish, burying seeds and the like by a series of forward and backward movements. To perform this kind of work, lightness of hand is very essential, as, if clumsily done, an even surface may very soon be made rough. This implement is made of several sizes.

The Hoe is of great service for clearing away weeds, thinning the various crops, loosening the surface of the soil, drawing drills, earthing up, &c. It should be handled (when weeding or loosening the soil) something like a chopper, bringing the blade towards you in a slanting position at each blow; of this tool there are several forms and sizes. That shown in Fig. 7 is useful for rough weeding and drill drawing; Fig. 8 for lighter kinds of work, and Fig. 9 for weeding and thinning such small crops as onions, &c.

The Turf-cutter, Fig. 1, is a handy tool, and is used for cutting grass turfs, paring, or rather regulating, the edges of lawns, and other similar work. It should be kept sharp all round.

The Pick-axe, Fig. 11, although not likely to be used to any great extent in a small garden, is nevertheless useful, and necessary for turning gravel walks, and loosening rubbish that has become too hard for removal by any other means.

The Ladder and Garden Steps.—The former, Fig. 12, will be found useful for getting up to tall trees, and climbers on

more lasting, casier to draw, and much more effective. The size of your roller must be regulated by the width of your walks and grass-plots. It is well to have one as large in circumference as you can conveniently manage. Clean it carefully after using, and put it in the shed, or somewhere under cover. The axle must be kept well oiled, or it will soon wear and work loosely.

The *Watering Pot,* of which there are several sizes, is for giving moisture to plants in dry, hot weather, without which they would certainly suffer severely at times, and occasionally perish altogether. The one which we figure above, Fig. 14, will be found as convenient in shape as any.

The *Axe,* for felling trees, pointing stakes, and such work, is a necessary item among garden requirements. In buying an axe take care to select one that you are able to use with ease, not too heavy, and well balanced. Nothing is so fatiguing as to work with an awkwardly-made axe, which requires all your strength to wield it. The edge must be well steeled, and the handle of ash. It should not be ground to too fine an edge, and should be kept in order with a smooth, hard rubbing-stone.

The Hand-Barrow, Fig. 15.—The chief use of this is to remove potted plants from place to place. The only

drawback to it is that it requires two to use it. No other implement, however, will do so well for the purpose.

In our next paper we will describe some more of the most ordinary garden tools; at present the following list of the prices of tools may be found useful to some of our readers:—

	£	s.	d.		£	s.	d.
Spade	0	2	0	Brought forward	2	2	1
Shovel	0	2	0	Billhook	0	2	6
Spud	0	0	6	Wheelbarrow ...	1	5	0
Digging Fork ...	0	2	0	Handbarrow ...	0	10	0
Three-pronged Fork	0	1	3	Roller	5	0	0
Pitchfork	0	1	6	Ladder	1	0	0
Weeding Fork ...	0	1	3	Steps	0	5	6
Draw Hoe, 6d., 1s.				Garden Line ...	0	1	6
and 1s. 6d. ...	0	3	0	Pruning Scissors	0	4	6
Drill Hoe	0	1	0	Daisy Rake ...	0	4	0
Rake, 1s. 2d. and 2s.	0	3	2	Scythe	0	10	6
Dibber	0	0	8	Mowing Machine	3	10	0
Trowel	0	0	9	Turf Cutter ...	0	1	6
Potato Dibber ...	0	2	0	Dock Spud ...	0	1	6
Shears, short handles	0	2	6	Dutch Hoe ...	0	1	2
Do. long handles	0	5	0	Pick-axe	0	2	6
Basket	0	2	6	Fumigator ...	0	9	6
Pruning Knife ...	0	1	6	Axe	0	2	0
Budding Knife ...	0	2	6	Syringe	0	10	6
Water Pots, 1s. 3d.				Water Barrow ...	2	0	0
and 5s. 9d. ...	0	7	0	Measuring Tape	0	1	6
Carried forward	£2	2	1		£18	5	9

ROTATION CROPPING OF A SMALL GARDEN.

In our last article on Home Gardening (page 109), we gave a plan for laying out a small villa garden. In the present and subsequent papers, we propose to give directions for cropping to the best advantage the eight beds into which the kitchen garden was divided. The numbers refer to the beds in the plan.

January.—1. This bed is planted with strawberries and raspberries—the former must be protected from frost, and the stakes of the latter attended to. 2. Manure and dig this compartment as soon as vacant; half of it may be cropped with potatoes, the remainder to be left for cauliflowers, to be planted in March or April. 3. This plot is laid down with permanent crops of sea-kale, rhubarb, and globe artichokes. All that can be done now is to cover the roots of the artichokes with stable manure. 4. Let this plot be well manured and dug as soon as empty, so that it may be ready for the reception of onions early in March. 5. Early peas may be sown to succeed those sown in November, and such greens and other crops as are of no further use removed to make room for a succession of peas. 6. If celery, Brussels sprouts, or other winter crops, have been grown here, you may clear them off as soon as possible, and manure and dig the ground for the reception of scarlet runner beans. 7. If this plot is empty, as it should be, get it ready for carrots and other roots by trenching the ground to the depth of eighteen inches at least. 8. This is supposed to serve for odds and ends. All you can do is to manure and trench such portions as become vacant, leaving the surface to be penetrated by frost.

February.—1. Remove covering from strawberries, and fasten raspberries to their stakes. 2. If potatoes were planted here last month, no particular attention will be required, save getting in readiness the space left for cauliflowers. 3. Sea-kale and rhubarb for succession should be covered with leaves or dung. 4. Give this a slight forking over on a frosty day. Radishes may be sown with the onions in March. 5. Another sowing of peas may be made for succession. Remove spent broccoli, and dig the ground at once. 6. Continue to manure and dig the ground as it becomes vacant, for it will be required

for dwarf and runner beans. 7. Expose the surface of the ground to frost as much as possible by digging and leaving it in rough trenches, and sow a row or two of broad beans. 8. Take up winter turnips, and have the ground manured and trenched for the reception of future crops.

March.—1. If the covering was not removed from strawberries last month, remove it at once, and stir the soil between the rows. Prune raspberries left untouched last month, and stir the soil between them, but not deep enough to injure the roots. 2. Plant cauliflowers here. Potatoes planted last month will make their appearance above ground, and will require protection from frost; any portion of this plot that has become vacant by the removal of any winter crop, should be removed and dug up at once. 3. Make a fresh plantation of globe artichokes, and keep up a succession of rhubarb and sea-kale. 4. Sow onions here, either broadcast or in rows; if the former method is adopted, radishes may be sown with them. 5. Sow peas, and get any vacant ground cleared, manured, and trenched for the reception of future crops. Round-leaved spinach may be sown between the rows of peas. 6. Very little can be done with this plot as yet, it being too early for dwarf and runner beans, but it must be well weeded, and the surface of the soil occasionally stirred. 7. If a few broad beans were sown here last month you may get the remainder of the plot ready for the reception of a crop of carrots, with parsnips if you wish them. 8. This plot being intended for growing various things not mentioned above, it may be got into order for whatever things the cultivator may have occasion to grow hereafter.

April.—1. As this contains the strawberries and raspberries only, there will be little to do save forking over the ground between the rows of the former, and pruning and tying up the latter, if not already done. 2. A portion of this may be planted with cauliflowers, if not done last month. Potatoes may occupy another portion, and, if desirable, the remaining ground filled up with later cauliflowers. 3. This being laid down with permanent crops, will require, during the present month, little or no care, save putting the ground in order for the season. 4. Presuming that you sowed radishes and onions here last month, there will be nothing to do but to stir the soil between the young plants with a hoe. 5. Two lots of peas may be sown at different periods this month. Clear the ground of green stuff that is done with, and manure and dig the vacant space. Stick the early sown peas as they advance in growth. 6. This plot, which has been kept vacant may be sown with dwarf and runner beans, at the commencement, and against the end of the month. 7. Early horn and long Surrey carrots may be sown early in the month, and beet at the end of it. Thin out the parsnips as soon as they are large enough to handle. Stir the surface between advancing beans and sow more for a second crop towards the end of the month. 8. Turnips may be sown on a portion of this plot, about the second week in the month, and any other crop that is likely to be required may be sown or planted in the remaining space.

May.—1. Attention will be required here, for if the season proves dry it will be necessary to water the strawberry plants liberally. The raspberries will require little or no attention for the present. 2. Earth up the potatoes towards the end of the month, and keep down weeds. Stir the soil between the first planted cauliflowers, and put out a row or two more in the space reserved for a second lot. 3. Give the sea-kale beds a good dressing, and the ground between the plants a slight digging or forking over. 4. Keep onions clear of weeds, and draw radishes as soon as possible, to give the onions ample room to grow. 5. Place stakes to the different crops of peas as they seem to need it, and sow a

row or two of a later sort for succession, and reserve a portion of the plot for another and final sowing in June. 6. Should the crop of dwarf kidney beans have failed, as is quite possible, make another sowing directly, and continue to do so as long as you have room for the same, bearing in mind that they will require protection when first they make their appearance, as they are very tender. Scarlet runners may be sown the first week in the month. 7. The carrots sown here will require thinning as soon as large enough to handle. Another sowing of broad beans may be made, and the early sown ones earthed up. Stir the soil between the growing rows of beet. 8. The first sowing of turnips may be preserved from frost by covering with a layer of clean straw or mat. Remove the remnants of greens and broccoli, and manure and dig the ground afterwards. A few lettuces may be planted or perhaps a row of celery, and for this purpose a spare corner should be reserved.

June.—1. Dry litter should be laid down between the strawberry rows to keep the fruit from the ground, and it will be necessary to water the plants occasionally in dry weather. 2. By the second week in the month this plot will be quite full, the second row or two of cauliflowers having been planted; but as the potatoes will be almost ready for taking up, there will soon be room for something else. As soon as the potatoes are removed from the ground, add a little dung if necessary, and turn up the ground that it may be fit to receive the next crop. 3. Very little attention need be paid to sea-kale, except to prevent the plants from producing too much flower and seed. 4. Thin the onions in this bed by means of a small hoe, if you want fine bulbs; taking care, however, to leave no footmarks upon the ground. Celery plants ready for planting, should be got out at once on a vacant portion of this plot: a foot wide and ten inches deep will be sufficient for the drills, at the bottom of which a little well-rotted manure should be put previous to planting. 5. Make the final sowing of peas about the middle of the month, and place sticks to such advancing crops as may require support. 6. Dwarf kidney beans may be sown once or twice more this month, and any imperfections in the rows may be made good by transplanting from places where they have come up too thick and are choking each other. Stick scarlet runners as they advance in growth, and keep weeds down by frequent hoeing. 7. Thin the carrots in this compartment, and also the turnips as soon as large enough, and sow more for succession. Put in another crop of broad beans, and earth up the previous sowing. 8. Let your celery trenches be prepared for the reception of the plants, and on the top of the ridge between the trenches, lettuces may be planted with advantage, as they will come up in time to allow of the crop being earthed up. The portion of this plot that has been occupied with winter broccoli should, as soon as cleared of the stumps, be well manured and trenched.

In our next paper we propose to continue these remarks upon rotation cropping, and when they are concluded, we shall proceed to give detailed information on the three great departments of gardening—the cultivation of vegetables, fruits, and flowers.

COOKING.

MEAT DISHES AT MODERATE COST (*continued*).

Calf's Cheek, and the Soup from it.—Get your butcher to cut the calf's cheek in halves, just below the cheek-bone, so as to leave the fleshy part of the cheek and the nape of the neck entire. The fresher slain it is, the better. Remove the eye-ball and the cartilage of the nose; shorten the jawbones, so as to get rid of the teeth, but leaving the meat which covered them, and throw them away. You

would get no good out of them, they only take up room in the boiler. Let the cheek so prepared, after being well washed and rubbed with the hand, steep an hour or two in a pail of cold water. Set it on the fire in plenty of cold water; as it is coming to a boil, keep constantly skimming till no more scum rises. Peel onions, peel and slice carrots and turnips, cut leeks into two inch lengths. Throw these, till wanted, into a pail of cold water to keep them fresh. When the cheek has boiled three hours, throw in the vegetables, with a little salt, half a dozen pepper-corns, and two or three cloves. Put in also a sprig or two of parsley and thyme. The cheek will take about four hours to cook. When done, take it up, and raise the flesh of the cheek and the part containing the glands of the neck off the bones, keeping them entire. Trim this lump of meat freely into shape, and set it aside for another day. The trimmings, the eye, and the fore part of the head, served with the vegetables, will make a nice dish. The broth will turn out excellent soup, which may be eaten with toasted bread soaked in it. When the liquor is cold, skim the fat off the top, and put it into your frying-pan, with the addition of a little dripping, if the quantity is scanty. Slice onions into this, and fry them brown; add a little of the liquor, and stir in gradually a couple of table-spoonfuls of flour and a quarter of a herring, prepared as directed for mock anchovy, chopped fine, if you have not the means of pounding it. Dust in a little pepper, and add more liquor; and when all is mixed well and smooth, stir it into the broth. If any of the trimmings of the head or vegetables are left, cut them in pieces and add them also. When heated up, the second day's soup will be better than the first, different in flavour, and more substantial. Serve toasted bread to soak in it. Save a little of it to warm up the cold piece of cheek meat in, to which it will also serve as gravy. You can garnish it round with fresh-boiled vegetables—carrots, turnips, onions, potatoes.

Sheep's Heads.—Open the heads, take out the brains whole, and the tongues; throw them into cold water and wash the latter well. Divide the heads into halves. Take out the eyes, shorten the jaw-bones where there is no flesh, cut out the gristle inside the nose, and wash the heads well in two or three waters. Put the halved heads and the tongues into a kettle of cold water with a little salt in it. Skim till it boils; then throw in the brains, and let them boil a quarter of an hour. At the same time with the brains, throw in some large onions and two or three carrots halved lengthwise. When the flesh on the heads is tender, serve them on a dish with the onions and carrots laid round them; or you may mash the former into onion sauce, with pepper and salt, a bit of butter, and a spoonful of milk. If you do not want the tongues immediately, let them boil a few minutes longer, and even leave them to cool in the broth. When you want them, warm them up (if cold) in the same; cut them in halves without separating them, lay them open on a dish, and pour over them some sharp sauce made with the broth, as directed for cods' heads. Warm the brains in the broth, lay them on a dish, sprinkle them with sage powder, made by drying sage leaves before the fire, and then rubbing them between your hands, and pour over them a little of the brown sauce already described. The addition of a little rice or prepared oatmeal groats converts the broth into capital soup.

Fried Fowl.—The fowl must be young, a cockerel or a pullet. Cut it up into joints, divide them, if large; also cut the carcase in pieces, use the heart, liver, and the gizzard properly cleansed. Put them all in a frying-pan with some bacon chopped small, a slice or two of ham, a few onions sliced very thin, pepper and salt. Fry all together; when they are done, arrange them on a hot dish. Dust a little flour into the gravy in your frying-pan; when browned, stir in a little vinegar and water; when nicely

smooth and well mixed together, pour it over your fried fowl, and serve.

Boiled Fowl.—Truss it as before; put inside it, with the liver, heart, and gizzard, a slice of white bacon half an inch thick; tie round it, outside, a broad slice of bacon a quarter of an inch thick. Take a bullock's bladder, slit open the orifice wide enough to admit the fowl. After rinsing out the bladder with hot water two or three times, put the fowl in it, and tie it up in such a way that no water can get in. After patient and careful boiling, take it out of its envelope, lay it on the dish surrounded by its gravy and sprinkle over it a teaspoonful of salt. You may serve it accompanied by

Parsley Sauce.—Chop a little parsley very fine. Into a saucepan containing a breakfast-cupful of cold water, put a lump of butter as big as a large walnut, into which you have rubbed a dessert-spoonful of flour. Keep stirring one way all the while these are melting, and until it boils. Then throw in the chopped parsley. Let it boil one minute, still stirring; then pour it into your sauceboat. If any of the fowl is left, the best way will be to cut it up into joints, arrange them neatly in the dish with the gravy (which will jelly when cold), and pour the rest of the parsley sauce over them. They will thus be presentable at another meal. A fowl thus secured from loss or injury may be steamed with good results; but this is a very tedious operation.

Fowl Stewed with Rice.—When your fowl is drawn, singed, and trussed (tied with string), with the legs cut off at the drumstick joint, and the heart, liver, and gizzard either fastened to the wings, English fashion, or put inside it, as they do abroad, put it into a saucepan not larger than will hold it conveniently, and allow it to be well covered with cold water. Set it on the fire; as soon as no more scum rises, cover it down close with the lid, and set it where it will stew gently until quite tender, which you will easily ascertain upon inspection. You may reckon upon its taking three or four hours, perhaps longer, to do. At the same time that you set your fowl to cook, put half or three-quarters of a pound of rice to steep in cold soft water. When the fowl is on the point of turning tender, chop one or two onions small, and put them to the fowl with the steeped rice, a little salt, and a small quantity of pepper and grated nutmeg. Let them boil with frequent stirring, some twenty minutes. If the rice is a little mashy, never mind; it will combine all the better with the fat and gravy from the fowl. Lay the fowl in the centre of a hot dish, and pour the rice round and under it.

Ends of the Ribs, or Breast of Beef, Stewed with Vegetables.—When the ends of the ribs, or the breast, from a well-fed beast are to be had of a respectable butcher at a fairly reduced price, they are well worth purchasing, to be cooked as follows:—For convenience, divide the bit into two or three pieces; salt them two or three days, according to the weather. Rinse them in cold water, to clear them from the salt sticking to them, and set them on the fire in cold water (not quite so much as if for soup) in a small boiler. After skimming, season with two or three cloves and peppercorns. Let the meat boil an hour; then put in as many carrots, whole onions, turnips, potatoes, and hearts of cabbage, as will be fairly covered by the broth; then let it simmer gently until the vegetables are cooked. On serving, put the beef in the middle of a large dish, and lay the vegetables round it, pouring some of the broth over all. Or, if you want to season more highly, you may brown butter, onions, and flour, in a frying-pan, season with pepper, salt, and catchup, stir all smooth, and pour that over your beef and vegetables.

THE CHEAPER SHELL-FISH.

The Common Limpet (Patella).—The limpet is sometimes eaten raw, though in this state it is said to be

poisonous to some people, and it is certainly best cooked. Boiled in salt and water, it makes a coarse but not unwholesome food.

Periwinkles.—Wash them in several waters, to get rid of mud and sand. Leave them quite half an hour in another water to cleanse; shake them up to make them draw into their shells; put them into a saucepan and pour over them boiling sea-water that has stood to settle; boil galloping twenty minutes, and serve accompanied by brown bread and butter.

Whelks (Buccinum undatum).—Put your whelks (alive, if possible) for a few hours into fresh or brackish water to cleanse. Boil them in salt and water, the smaller ones, to be eaten as periwinkles, three-quarters of an hour; the larger ones, with shells as big as hens' eggs, an hour and a quarter. They take a great deal of cooking, being hard and leathery in substance. As large whelks are hardly eatable, even after this preliminary boiling, take them out of their shells, dip them in flour or bread crumbs, and fry them in plenty of very hot fat. On serving, pepper and vinegar may be sprinkled over them. Soyer, in his "Modern Housewife," says, "Whelks have become plentiful in London, and are exceedingly wholesome fish. They are eaten, also, like the oyster." By which he probably means made into soup like clams, or cooked in the same way as oysters are cooked.

Mussels and Rice (an Algerian Recipe).—Wash your mussels well; set them on the fire in a saucepan without any water, but with a close-fitting lid. Shake them up from time to time, so as to bring them all in turn to the bottom. They will gradually open and give out their liquor, in which, and in the steam from it, they will cook. When they are all well opened and detach easily from the shell, turn them out into a large-holed cullender placed over a vessel to catch the liquor, which strain and set aside to settle. Take the mussels out of their shells, rejecting the weed attached to their inside, and any little parasitical crabs within them, and put them aside. Boil rice as if for a curry, so as to be as dry as possible when done. To this put a good lump of butter and a few table-spoonfuls of the mussel liquor; season with pepper, salt, and grated nutmeg. Put in the mussels, heat up all together, mixing them without breaking them. Or, you may heat the warmed-up mussels in the middle of your dish, surrounding them with the seasoned rice, as some cooks serve a curry.

Hustled Mussels, Plain.—Cook the mussels as before. When done, simply turn them out into a large open dish, and serve them in their shells as they are.

Pickled Mussels.—Cook and pick them clean as above. Put them into a preserve jar, seasoning as you proceed with salt, ground pepper, whole pepper, and cloves. When the jar is nearly full, pour vinegar over them till they are quite covered. If the vinegar is very strong, dilute it with a little of the liquor that came from the mussels. They are ready for use the day after pickling, and will keep good for some little time if closely covered.

THE HOUSEHOLD MECHANIC.

WINDOWS.

THE glazed contrivances in houses which we call windows—having for their duty not only the admission of light to the inmates, but also protection against weather, and the optional admission of air—are too well known to need any description except just to distinguish between the varieties. For instance, the one we illustrate in Fig. 56 is known as a suspended sash window. The sashes which open outwards or inwards, after the same manner as doors, are called casements, and are variously contrived to suit various requirements. It is not, therefore, our intention to even enumerate these differences, but to

simply look into the hidden part of the most common of all, in order that such a calamity as a broken sash-line need not in future make a visit of the carpenter necessary.

The frame into which the glazed sashes fit is composed of the perpendiculars, or styles, H I, the lintel J, and sill K, and this frame may almost be considered a part of the framework of the house, as it is fixed firmly in the brickwork, and in many cases has to carry weight. Fig. 55 is an enlarged section of one side of the frame and sash, and clearly shows the exact arrangement of the guides which keep the sashes in place. B is the sash which carries the glass. In the plan a groove, D, is shown in the edge of this sash, the object of which is the receipt of the line which runs up to the top of the style and then disappears over a pulley, P, into the weight-box, w. Now let us suppose the cord supporting B, Fig. 55, is broken, and we will proceed to mend it. On the inside of the frame is a beading, C, which runs all the way round the window. This must be removed on the side

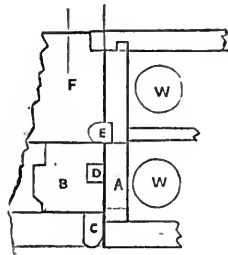

Fig. 55.

where the break is by levering it from its fastening with a screw-driver or chisel, great care being observed to prevent damage to the paint. This done, the sash must be first pushed upwards far enough to bring it over the bottom bead, and it will then come bodily out of its place. The broken rope must then be unnailed from the groove D. The sash out of the way, the style A will be exposed, and in the lower part a portion of this board, as shown by the dotted lines, is found to be movable. Take out the piece, A, and the weight, w, can be got at, and the broken line taken from it. Get a small piece of lead, or anything heavy but small, and tie to the end of a thin piece of twine, and insert this "mouse," as it is called, over the pulley at the top, and let it drop down to the hole, A, and fasten it to the new sash line end, which can then be pulled back over the pulley. The weight, w, is threaded by this rope from the top, and a knot tied and pulled well into the place sunk in the weight to receive it, so that there shall be no danger of its getting wedged up in the box. Replace the loose piece, A, and fasten it, and cut off the sash-line to the proper length. The proper length will be arrived at by pulling the weight up to the pulley, P, and bringing down the end of the cord to the top of the sash, allowing three or four inches for the nailing into the groove, D. Of course the weight must not come quite up to the pulley, but just within an inch or so. Secure the cord into the groove firmly, with two or three clouts or round-headed nails. Replace the sash, and nail on the beading, C, and the job is done. Supposing the top sash, which slides down F, to be the one requiring repair, it will be necessary to remove the front, or lower sash, and then, by taking out the beading, E, the back sash can be got out also. Otherwise the process is the same as above described. The weights, w w, Fig. 55, should exactly counterpoise the sashes; and two are required for each. They are usually made of cast iron, as cheaper; but for situations where space is short, lead weights are

used, the specific gravity of lead being so much greater than iron.

Fig. 57 shows the plan of a complete window. In old-fashioned window-frames the entrance to the weight-box is often from the front, as shown by the dotted lines, N, but this plan is most objectionable, because the paint-work is so much more pulled about whenever a breakage occurs in the line.

Ordinary rope is not suitable for windows, because, being twisted, it is liable to stretch, and to spin the weight round every time the window is opened or shut, in a noisy way; and it is not strong or durable enough. The cord to be used is known as sash line, and should be plaited of good hemp instead of being twisted. Of course the cost of it is greater, but not more than its advantages would warrant.

Shutters are often suspended exactly like sashes; but the modern windows, which go down to the ground, do not admit of these, there being no space into which they can slide away.

Various arrangements of folding and hinged shutters supply their place, but these will need detailed description, as a careful examination of a few varieties existing in nearly every house will, if conducted with a little common sense, familiarise the inquirer much more than a most elaborate description, which could not possibly meet every case.

The fastenings of windows are important if the outsides are accessible to the incursions of burglars, the ordinary form, as shown in Fig. 56, being liable to the objection that a thin knife inserted up the crack between the sashes will force it open. The best remedy is a screw sent through the two frames; but there are many other patent arrangements by which security is to be attained.

This being the first time we have done such a thing as to mend a sash line, it is lucky if we have not broken one of the panes of glass. For practice we will suppose we have done so, and now we must go and mend it.

The channel which receives the glass is invariably on the outside of the sash, i.e., the side exposed to wind and weather. The reason for this is that the pressure of the wind may tend to keep the glass the more firmly in its place, there never being pressure from the inside.

With a strong-backed knife, something like Fig. 58,



Fig. 58.



Fig. 59.

if we have not a regular glazier's hacking-knife, hack out the old, dry putty which holds the remains of the glass, and clean out right down to the wood, using the point of the knife, and knocking it on its thick back with a hammer.

If we have not a diamond, we shall have to take an exact

measure of the size, and get the pane cut at a glass shop. The price varies with the size, quality, and thickness of the glass, and would be from 2d. to 6d. per foot. Sixteen ounces to the foot would be the right thickness. Twenty ounces is the thickness for large panes, or for skylights. Of course the above prices are for crown or sheet glass; plate being very much thicker, and ground and polished perfectly true, is very much more expensive. The

measure of the size, and get the pane cut at a glass shop. The price varies with the size, quality, and thickness of the glass, and would be from 2d. to 6d. per foot. Sixteen ounces to the foot would be the right thickness. Twenty ounces is the thickness for large panes, or for skylights. Of course the above prices are for crown or sheet glass; plate being very much thicker, and ground and polished perfectly true, is very much more expensive. The

next requirement is the putty, which we make as follows:—Take a lump of whitening, and cut or bruise it up quite fine, and then gradually add, a little at a time, linseed oil, which must be thoroughly incorporated and mixed by beating it until a stiff dough-like material is obtained. Remember, the more putty is mauled about the better it becomes; and before using it should be kneaded with the hand, the warmth of which will render it still more pliable. If sticky, add more whitening; if too stiff, more oil.

Take a lump of putty in the left hand, and with the putty-knife, Fig. 59—an ordinary oyster-knife answers the purpose—press in a thin layer of putty into the corner of the channel which is to receive the glass, and all round, drop in the pane and press evenly all round, and gradually force it well down until it will not go farther. Now press more putty into the angle round the edge of the glass, and with the knife press and smooth it into a neat bevel, which must thoroughly adhere to both wood and glass. If either of these are wet it will not do so, on account of the fact that water repels oil. A previous coat of paint is necessary if the sash is of new wood, to make the putty adhere properly. Trim off the superfluous putty from both sides of the glass, and when thoroughly hard—which it will be in a few days—paint it of a dark colour outside, and grain to match inside. Some use white lead in their putty, but this is liable to the objection that it is very difficult to remove, in the event of future breakage, as it adheres to the wood, and becomes so very hard that in hacking out, the frame is often injured. For use in mahogany frames it is common to colour putty by adding red lead to tint as required. This does not set so hard as white lead. Putty is only about a penny a pound; but we have given the directions for making it for cases where it is not readily procurable.

THE REARING AND MANAGEMENT OF CHILDREN.

V.—SLEEP.

AN infant of sound health will sleep almost continually during the first four or five weeks of its life. All that is necessary in the interval is to guard against accidents likely to create disturbance. Of these, injudicious feeding, deficiency of warmth, want of cleanliness, and over-fatigue, are the most liable to occur, converting the happiest period of development into a restless state of being, alike pernicious to parent and child.

As though to indicate the necessity for this lengthy repose, the sense of hearing in a new-born babe is very dull. Ordinary conversation does not disturb an infant's slumbers, although loud sudden noises may have that effect. In most instances, a baby does not appear to be conscious of sounds until about the fifth or sixth week. In the meanwhile, the necessary disturbances are confined to being suckled, washed, and changed; for which duties occasion should be taken during the short wakeful intervals which happen when hunger prevails.

So valuable is the repose which sleep affords throughout the whole period of early childhood, that too much pains cannot be taken to cultivate the habit from the earliest moment; for, be it observed, sleep is essentially a habit of our nature, and its recurrence depends chiefly on regularity of living and good health. At appointed times, and in certain places, infants should be encouraged to submit to sleep. Let them understand, by constant repetition of the necessary arrangements, that after food and exercise it is time to go to bed, and a lesson will have been learnt which will require no undue force to put into practice during the term of nursery life.

Infants born in the winter, and during the cold months of spring, may sometimes require to sleep at the mother's side for the first few weeks; but if a babe be strong, and

the position in life of its parents such as to afford a fire in the bed-room by night, infants may at once be accustomed to sleep in their own beds. Those that are thus trained, thrive better than others who sleep and suckle the night through at the mother's breast. Nor does the mischief of the latter habit end with the over-taxed digestion of the child. Few mothers are able to bear the drain thus made upon their strength, and, in consequence, "nursing" has to be given up much sooner than would otherwise be necessary.

The natural time for slumber, in very early life, is immediately after taking food. As the young of almost all creatures show this disposition, there can be no harm in following the dictate. Opportunity, then, should be taken to lay the child in its bed, *whether awake or not*, after having been fed. A little later in life, when digestion is stronger, and better able to dispose of a heavier meal, an interval is necessary between taking nourishment and going to sleep.

The utmost vigilance is generally necessary to prevent the habit of sleeping in the nurse's arms from being contracted. Most monthly nurses enjoy a doze in front of the fire—a luxury well earned by, perchance, a broken night's rest; but with infants no such necessity is felt. Still, if they are once allowed to feel the soothing influence of the fire's warmth, combined with the soft and pleasant mechanical movement of the nurse's knees, they speedily get rebellious against attempts to make them lie alone in the bassinet. In engaging a monthly nurse, it is advisable to have it clearly understood that the babe is not to be nursed on the lap when asleep.

To the above error, more than any other, may be traced the wretched, sleepless nights which some parents are doomed to pass when the monthly nurse has gone. Suddenly the infant seems to have changed its nature; the tranquil repose by day is naturally at an end, and continuance of the bad habit of sleeping by the fire in the nurse's lap is contested for. To the inexperienced mother there seems to be no help for it, but to get up and pace the room until irresistible slumber shall have fallen on the eyelids of her wakeful infant. For the unhappy father the case is worse. He has possibly to encounter a hard day's work the following morning, for which a disturbed night's rest may bring positive incapacity. This constantly complained of grievance may be safely prevented by a little firmness at the outset. Children that are accustomed from the commencement to be put awake into their beds, find no difference of treatment when the monthly nurse has left. In a short time they may be even heard to crow with delight at the fancies their small imaginations picture in the dimly-lighted chamber.

The best trained child, however, will not return peacefully to its cot, if the bedding be not perfectly dry and comfortable. After the child has been lifted out, "changed," and fed, the pillow and mattress should be well shaken and, if necessary, wet blankets replaced by dry ones. Having put the infant back, the light should be partly screened or extinguished. These arrangements require to be made in a very methodical manner, and will only have to be repeated a few times to be fully understood by the child. If, at the outset, a cry of resistance should be heard when it is time to go back to bed, a wise mother will conceal herself from sight, and turn a deaf ear. Sooner or later this breaking in will have to take place, and the longer it is delayed, the greater will be the trouble.

In families where upper servants are kept, the nurse usually takes charge of the infant by night, only taking the babe to its mother's room when requiring to be suckled, and returning to the nursery afterwards.

About the age of three months, an infant does not usually require night-feeding more frequently than when

the mother retires to rest, and again towards five or six in the morning. At this age the faculty of observation begins generally to show itself, and affords a golden opportunity for conveying right impressions to the plastic infant mind. The first objects a child takes notice of are those which are employed in supplying its personal wants. Thus the sight of a feeding-bottle will generally set a babe crying for food. In like manner it is a good plan to appropriate certain coverings to the use of an infant when "sleeping-time" is in question. The writer has known a gaily-coloured knitted rug set the tiny inmates of a nursery yawning, from the sheer associations the familiar wrapper suggested. Each infant had been in turn enveloped in that rug preparatory to going to sleep, and they had not a thought of resisting its influence.

By these and similar appeals to the infant mind, time is gained in imparting true principles of obedience, which might be too long delayed, if deferred till the age of more advanced reason.

The habit of taking a mid-day nap may be advantageously observed till the age of three or four years. Even if the child be not sleepy it is advisable to let it lie in its cot for a certain time after having taken exercise, and before dinner. If any inducement to lie down be needed, there is no reason that a few toys or a picture-book may not be allowed in bed. Pretending to hush a doll to sleep, for instance, will often send the child itself to sleep, and is as good a *ruse* as can be adopted.

Before putting the inmates of a nursery to bed, the room should be darkened, and the nurse should betake herself, if possible, to an adjoining room for any occupation she may have to fulfil.

Care is needed not to arouse a child suddenly from its slumbers. Drawing up blinds, stirring gently a fire, or imprinting a gentle kiss on the lips, will generally cause the sleeper to wake in a good humour.

A notion is prevalent that much sleeping by day lessens the power of sleeping by night; but this is an error. As a general rule, *the more a child sleeps the more it wants to sleep*. Wakefulness is mostly caused by over-fatigue and excitement, and is a positively painful state to the sensitive organism of a young child. This description of suffering admits of no alleviation but from sleep; reprimands and additional food do but increase the torment.

It ought not to be necessary to point out the danger of giving narcotics to young children. But so long as such remedies are recommended as "teething powders," &c., we must not be supposed to ignore that the true nature of such drugs is not to facilitate the process of cutting teeth, but to lull restless infants into an unnatural sleep. Long before any disturbance of a child's health is likely to occur from teething, these compounds are apt to be administered simply to secure a quiet night's rest. The restlessness complained of arises, nine times out of ten, from flatulence and indigestion. The general question of teething will be treated in our papers on Domestic Medicine and Surgery.

A fit of sleeplessness may often be terminated by wrapping the infant in a warm covering, and exercising it in an apartment of lower temperature than the nursery.

In more advanced childhood than we have hitherto spoken of, the importance of sleep is undiminished, and should be observed with regularity. No invariable rule can be laid down for general observance, but most children between the ages of four and seven years require, at least, twelve hours' sleep. Ten hours are supposed to be needful for schoolboys, and eight for adults. Few children under ten years of age can be kept out of their beds after seven o'clock without injury to their health. When once awake in the morning they should be accustomed to rise without delay.

Most parents go to their children's rooms before re-

tiring to rest themselves. The chief observation to make on these visits is whether the little ones are sufficiently covered, and that no draughts are felt from open windows and doors. In the winter, a few hours after having been in bed, most young children require a little additional covering, owing to the body having lost some of its temperature during sleep. Another precaution to take is, that the children's heads are sufficiently raised to prevent their breathing the air emitted from their lungs. This habit, if not necessarily fatal, is certainly liable to lay the seeds of a consumptive state, and to produce an impaired constitution.

A single bolster is generally sufficient for raising a child's head. This should be rolled over and over in the under sheet, and the ends of the sheet should be firmly tucked between the mattresses to prevent the bolster slipping out of its place. One blanket should always be placed with the selvage ends across the bed, in order to allow plenty to turn in under the mattress. Children generally sleep more comfortably, and suffer less from cold feet, if their bedding is slightly raised at the foot.

HINTS ON CARVING.

Ham.—A ham is one of those dishes which one is constantly requested to dispense, even when not occupying the important post of carver. It is usual to commence cutting beyond the knuckle, but not quite in the centre, just where the ham begins to grow thicker, and to cut it across, leaning downwards, so as gradually to encroach upon the fat, till the slice slopes very much from the fat to the bone. Slice after slice is cut off in this way till the ham is finished. The thinner the meat can be cut the better it is considered. It may be remarked that the ham is brought to table with that part uppermost which in a leg of mutton is called the back. A trimming is always to be put on round the knuckle. In the diagram, Fig. 16, the first cut of the ham is shown from A to B. It is to be observed that the slices are not cut through to the bone, but rather shaved off the ham, always bearing towards the fat.

There is another method of serving this joint, which some people who like the hock, prefer. This is managed by taking off several thin slices at A to B, in Fig. 17, and carving the rest of the ham lengthwise from D to C, also thin.

Neck of Mutton.—First divide the short bones from the long, by cutting quite through them, across the joint, at the dotted line A to B, Fig. 14. Then insert the knife at C, plunge it down, feel the joint, press it in, turn it over, as you do the leg of a fowl, to snap it, and then cut the chop off. Cut one of the small bones and serve with each chop. It is usual to cut two chops, and add two small bones to each helping, not previously severing them, but removing them from the joint together. If loin and neck of mutton are not very well jointed before they are cooked, they can never be properly carved at table, and there is a great deal of waste in consequence. Butchers must be instructed to separate the bones well. The cook also should further divide them, before dressing.

Loin of Mutton is generally cut through between every two chops, which are served together.

Neck of Veal.—A neck of veal cannot be treated like a neck of mutton, for the chops it yields are far too large to serve entire. Therefore, first divide the small bones by cutting through (Fig. 15, from A to B), as with the neck of mutton, and then take off slanting slices from D to C, from the bones, cutting down to them.

Loin of Veal.—With a loin of veal a slice of toast is sent to table, on a small dish. Turn over the loin, and cut out the kidney, with the surrounding fat, and place it

on the dish upon the toast. Then turn back the veal to its former position, and cut off slices from D to C, Fig. 15.

Pheasant.—A pheasant and a partridge are birds not rare on any country table, and partridges especially are plentiful enough in London to be easily obtained by all classes during the season. The skewers must first be taken from the pheasant. The legs are to be then removed in the same way as those of a fowl. The wings are next

removing the skewers, as shown from A to B in Fig. 18. Treat the other side the same. The piece consisting of a leg and wing thus cut off is to be served whole and not divided. Separate the breast from the back, as in carving a fowl, by cutting through the small side bones. The breast makes one plate, and the back is given with either of the other three, but cannot be served alone. Another way of serving partridge is to split the bird in two through the breast and back, Fig. 19, and place the halves on separate

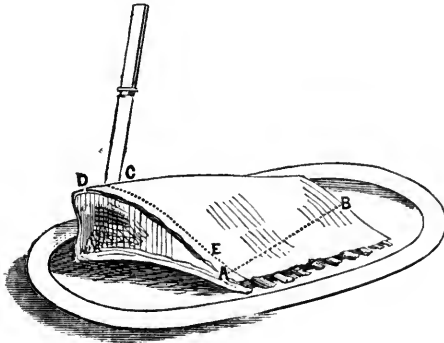

Fig. 14.

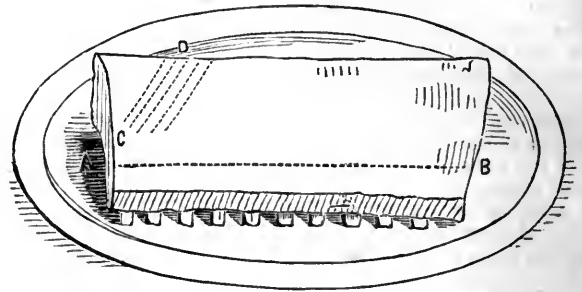

Fig. 15.

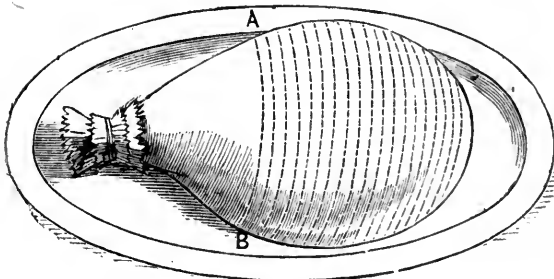

Fig. 16.

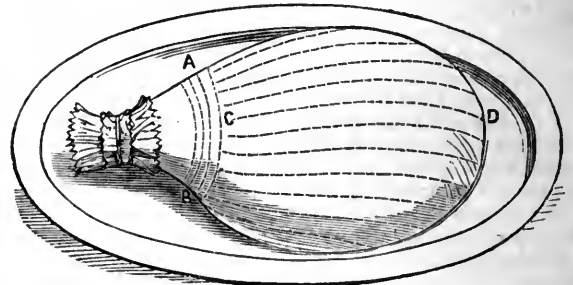

Fig. 17.

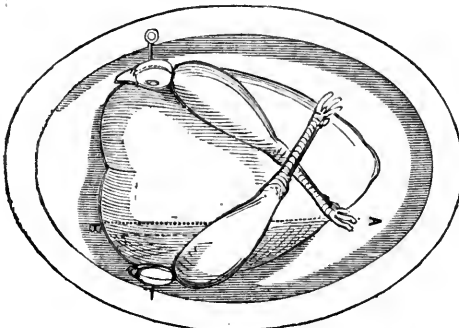

Fig. 18.

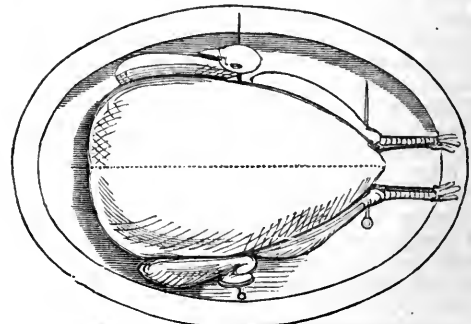

Fig. 19.

to be taken off, also as in carving a fowl, observing only that very little of the breast is served with them. The breast affords several delicate slices, which are considered the best part. The wings are preferred next, and then the merry thought; game eaters like the legs. The rest of the bird is carved like a fowl. A pheasant always comes to table with the head on one side, and a large bunch of the liver on the other (Fig. 18). It is usual to leave the tail on when plucking it, or to tie it up and skewer it on afterwards, and send it to table with the bird.

Partridges.—Cut off the leg and wing together, after

plates. Although the methods of carving a partridge are two, as we have already described, it must be observed that special circumstances must decide in which way a particular bird shall be divided and allotted. There are differences in the size and condition of birds brought at one and the same time to table. There are differences also in the proportion of the rations, which a judicious carver will know under all circumstances how to arrange for. But there is one rule which may be laid down with tolerable propriety, and it is to help a gentleman to half a bird. When gentlemen only are at table, the second method of carving partridges is always followed.

ANIMALS KEPT FOR PROFIT.

V.—THE REARING AND FATTENING OF CHICKENS.

FOR nearly twenty-four hours after hatching, chickens require no food at all; and though we do not think it best to leave them quite so long as this without it, we should let them remain for at least twelve hours undisturbed. We say undisturbed, because it is a very common practice to take those first hatched away from the hen, and put them in a basket by the fire till the whole brood is out. When the eggs have varied much in

age, this course must be adopted; for some chickens will be perhaps a whole day or more behind the others, and the hen, if she felt the little things moving beneath her, would not stay long enough to hatch the rest. But we have explained in the last chapter that this should not be, and that if the eggs are all fresh, the chicks will all appear within a few hours of each other. In that case they are much better *left with their mother*: the heat of her body appears to strengthen and nourish them in a far better manner than any other warmth, and they are happy and contented, instead of moving restlessly about as they always do whilst away from her.

Our own plan is to set the eggs in the evening, when the chicks will break the shell in the evening also, or perhaps the afternoon. Then at night let the state of the brood be once only examined, all egg-shells removed from the nest, and the hen, if she be tame enough to receive it, given food and water. Let her afterwards be so shut in that she cannot leave her nest, and all may be left safely till the morning. By that time the chicks will be strong and lively, quite ready for their first meal; and unless some of the eggs are known to be very stale, any not hatched then are little likely to hatch at all. If this be so, the chicks may be removed and put in flannel by the fire, and another day patiently waited, to see if any more will appear. We should not do so, however, if a fair number had hatched well; for they never thrive so well away from the hen, and it is scarcely worth while to injure the healthy portion of the brood for the sake of one or two which very probably may not live after all.

The first meal should be given on the nest, and the best

material for it is an equal mixture of hard-boiled yolk of egg and stale bread-crumbs, the latter slightly moistened with milk. Let the hen be allowed to partake of this also—*she* needs it; and then give her besides as much barley as she will eat, and offer her water, which she will drink greedily. To satisfy the hen *at first* saves much restlessness and trouble with her afterwards.

There is a stupid practice adopted by many, of removing the little horny scale which appears on all chickens' beaks, with the idea of enabling them to peck better, and then put food of pepper-corns down

their throats, and dip their bills in water to make them drink. It is a mistake to say that if this does no good it can do no harm: the little beaks are very soft and tender, and are often injured by such barbarous treatment. *Leave them alone.* If they do not eat or drink (and chickens seldom drink the first day), it only shows they do not wish it; for to fill an empty stomach is the first and universal instinct of all living things.

The brood having been fed, the next step will depend upon circumstances. If, as we recommend, the chickens were hatched the night before, or be well upon their legs, and the weather be fine and warm, they may be at once moved out, and the hen cooped where her little ones can get the sun. If it be winter, or settled wet weather or cold, the hen must, if possible, be kept on her nest this day also, and when removed be cooped in a dry shed or outhouse.

The best arrangement, where there is convenience for it, is that shown in Fig. 9. A shed, six feet square, is reared against the wall, with a southern exposure, and the coop placed under it. This coop is best made on a plan very common in some parts of France, and consists of two compartments, separated by a partition of bars; one compartment being closed in front, the other fronted with bars like the partition. Each set of bars should have a sliding one to serve as a door, and the

whole coop should be tight and sound. It is best to have no bottom, but to put it on loose dry earth or ashes, an inch or two deep. Each half of the coop must be about two feet six inches square, and may or may not be lighted from the top by a small pane of glass.

The advantage of such a coop and shed is, that except in

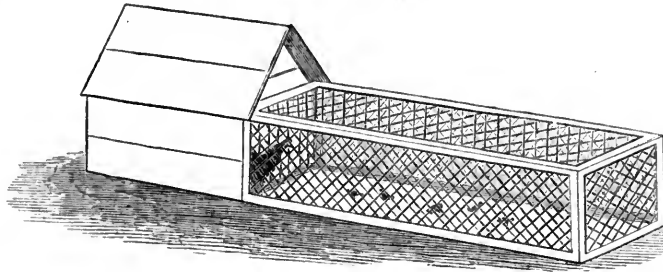

Fig. 10.

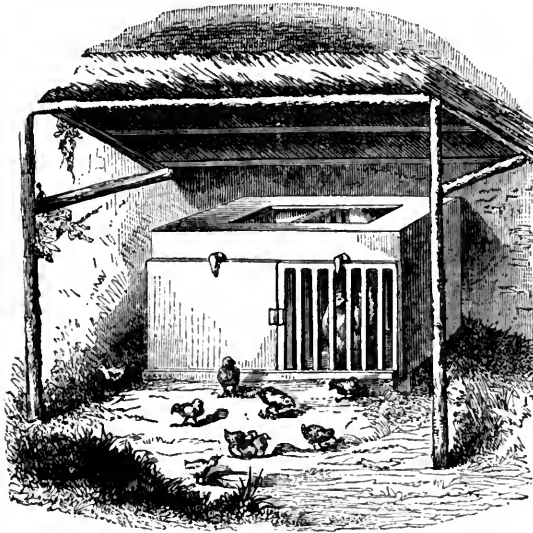

Fig. 9.



Fig. 11.

very severe weather, no further shelter is required even at night. During the day the hen is kept in the outer compartment, the chickens having liberty, and the food and water being placed outside; whilst at night she is put in the inner portion of the coop, and a piece of canvas or sacking hung over the bars of the outer half. If the top be glazed, a little food and the water vessel may be placed in the outer compartment at night, and the chicks will be able to run out and feed early in the morning, being prevented by the canvas from going out into the cold air. It will be only needful to remove the coop every two days for a few minutes, to take away the tainted earth and replace it with fresh. There should, if possible, be a grass-plot in front of the shed, the floor of which should be covered with dry loose dust or earth.

Under such a shed, chickens will thrive well; but if such cannot be obtained, sufficient shelter during ordinary breeding seasons may be obtained by the use of a well-made board coop, with a gabled roof covered with felt. This coop should be open in front only, and be two feet six or two feet three inches square. At night let a thick canvas wrapper be hung over the front. The ordinary basket coop is only fit to be used in perfectly fine weather, when it is convenient to place it on a lawn. Some straw, weighted by a stone, or other covering, should, however, be placed on the top, to give shelter from the mid-day sun.

Chickens should always, *if possible*, be cooped near grass. No single circumstance is so conducive to health, size, and vigour, supposing them to be decently well cared for, as even a small grass run. Absolute cleanliness is also essential, even more than for grown fowls; and the reason why difficulty is often experienced in rearing large numbers is, that the ground becomes so tainted with their excrement. The coop should therefore either be moved to a fresh place every day, or the dry earth under be carefully removed. A very good plan, and one we have found in a limited space to answer remarkably well, is to have a wooden gable-roofed coop made with a wooden bottom, and to cover this an *inch deep* with perfectly dry earth, or fine sifted ashes. The ashes are renewed every evening in five minutes, and form a nice warm bed for the chicks, clean and sweet, and much better than straw.

Cats sometimes make sad inroads on the broods. If this nuisance is feared, it is well to confine the coveted prey while young within a wire-covered run. And the best way of forming such a run, is to stretch some inch-mesh wire-netting, two feet wide, upon a light wooden frame, so as to form two wire hurdles, two feet wide and about six feet long, with another three feet long. These are easily lashed together with string to form a run six feet by three, and may be covered by a similar hurdle of two-inch mesh three feet wide, as represented on the preceding page (Fig. 10). In such a run all animal depredations may be defied, and in any case we should recommend its use until the chicks are a fortnight old; it saves a world of trouble and anxiety, and prevents the brood wandering and getting over-tired. By having an assortment of such hurdles, portable runs can be constructed in a few minutes of any extent required, and will be found of great advantage until the broods are strong. The hen may also be given her liberty within the prescribed bounds.

With regard to feeding, if the question be asked what is the *best* food for chickens, irrespective of price, the answer must decidedly be oatmeal. After the first meal of bread-crumbs and egg, no food is equal to it, if *coarsely* ground, and only moistened so much as to remain crumbly. The price of oatmeal is, however, so high as to forbid its use in general, except for valuable broods; but we should still advise it for the first week, in order to lay a good foundation. It may be moistened either with water or milk, but in the latter case only sufficient must be

mixed for each feeding, as it will turn sour within an hour in the sun, and in that condition is very injurious to the chickens.

For the first three or four days the yolk of an egg boiled hard should also be chopped up small, and daily given to each dozen chicks; and when this is discontinued, a little cooked meat, minced fine, should be given once a day till they are about three weeks old. The cost of this will be inappreciable, as a piece the size of a good walnut is sufficient for a whole brood, and the chickens will have more constitution and fledge better than if no animal food is supplied.

Food must be given very often. For the first week every hour is not too much, though less will do; the next three weeks, every two hours; from one to two months old, every three hours; and after that, three times a day will be sufficient. To feed *very often*, giving just enough *fresh* food to be entirely eaten each time, is the one great secret of getting fine birds. If the meals are fewer, and food is left, it gets sour, the chicks do not like it, and will not take as much as they ought to have.

After the first week, the oatmeal can be changed for cheaper food. We can well recommend any of the following, and it is best to change from one to another, say about every fortnight. An equal mixture of "sharps" and barley-meal, or of "sharps" and buckwheat meal, or bran and Indian meal; or of bran, oatmeal, and Indian meal. The last our own chickens like best of all, and as the cheap bran balances the oatmeal, it is not a dear food, and the chicks will grow upon it rapidly. Potatoes mashed with bran are also most excellent food for a change.

The above will form the staple food, but after a day or two some grain should be given in addition. Groats chopped up with a knife are excellent; so is crushed wheat or bruised oats. Chickens seem to prefer groats to anything, but it is not equal to meal as a permanent diet. They are also fond of buckwheat. A little of either the one or the other should, however, be given once or twice a day, and in particular should form the last meal at night, for the reasons already given.

Bread sopped in water is the worst possible food for chickens, causing weakness and general diarrhoea. With milk it is better, but not equal to meal.

Green food is even more necessary to chickens than to adult fowls. Whilst very young, it is best to cut some grass into very small morsels for them with a pair of scissors; afterwards they will crop it for themselves, if allowed. Should there be no grass available, cabbage or lettuce-leaves must be regularly given—minced small.

In winter or very early spring the chickens must, in addition to the above feeding, have more stimulating diet. Some underdone meat or egg should be continued regularly, and it is generally necessary to give also, two or three times a day, some stale bread soaked in ale. They should also be fed about eight or nine o'clock, by candle-light, and early in the morning. In no other way can Dorkings or Spanish be successfully reared in an inclement season, though the hardier breeds will often get along very well with the ordinary feeding. Ale and meat, with liberal feeding otherwise, will rear chickens at the coldest seasons; and the extra cost is more than met by the extra prices then obtained in the market. But shelter they must have; and those who have not at command a large outhouse or shed to keep them in while tender, should not attempt to raise winter or early spring chickens—if they do, the result will only be disappointment and loss. The broods should only be let out on the open gravel or grass in bright, or at least clear dry weather.

At the age of four months the chickens, if of the larger breeds, should be grown enough for the table; and if they have been well fed, and come of good stock, they will be. For ourselves, we say, let them be eaten as they are—they

will be quite fat enough; and fattening is a very delicate process, success in which it takes some experience to acquire. For market, however, a fatted fowl is more valuable; and the birds should be penned up for a further fortnight or three weeks, which ought to add at least two pounds to their weight. For a limited number of chickens it will be sufficient to provide a small number of simply-constructed pens, such as are represented in Fig. 11. Each compartment should measure about nine by eighteen inches, by about eighteen inches high; and the bottom should not consist of board, but be formed of bars two inches wide, placed two inches apart, the top corners being rounded off. The partitions, top and back, are board, as the birds should not see each other. These pens ought to be placed about two inches from the ground, in a darkish but not cold or draughty place, and a shallow tray be introduced underneath, filled with fresh dry earth every day, to catch the droppings. This is the best and least troublesome method of keeping the birds clean and in good health. As fast as each occupant of a pen is withdrawn for execution, its pen should be whitewashed all over inside, and allowed to get perfectly dry before another is introduced. This will usually prevent much trouble from insect vermin; but if a bird appears restless from that cause, some powdered sulphur, rubbed well into the roots of the feathers, will give immediate relief.

INMATES OF THE HOUSE.—DOMESTIC

I.—THE GENERAL SERVANT.

THE servant of all work, as the old-fashioned term used to be, is fast becoming extinct. The designation is now generally applied to female servants possessing no particular aptitude for any special branch.

"General servants" have mostly had experience of more branches of service than one. They know something of cooking—many are very fair cooks—they understand housemaids' work, and have almost always begun by being nursemaids. Their wages vary, according to attainments and locality, number of family, size of house, &c., from seven or eight, to sixteen pounds a year. Sometimes the wages are modified by arrangements which require them to find their own tea and sugar, beer, &c., as well as by a variety of special circumstances which cannot well be enumerated. The higher wages are usually asked by good plain cooks, and managers willing to assist in housework if help be given in rough cleaning such as boots, knives, washing, &c.

For all purposes of comfort, a good servant, even though her wages should be high, is the cheapest and most likely to settle in her place. It should be borne in mind that a good servant consumes no more than a bad one. She destroys less, and is less liable to throw herself out of place, arguing rightly that twenty situations can be had at twelve pounds a year, against one of fifteen and upwards. Besides, a shrewd servant is sensible enough to know, that in a single-handed place a number of comforts are enjoyed which would be denied where there are several servants. Many families are prevented from engaging one good general servant, because they consider their position requires that two domestics should be kept. We think, however, that in this, as in everything else concerning life, the rule holds good, that true happiness does not consist in our regulating our household according to the supposed fancies of our neighbours; but according to what we know to be our own tastes and requirements.

The duties of a general servant being numerous, it is desirable that a well-considered plan embodying the principal work of the house, should be provided. The rules of the house and order of work should be legibly and tersely written on cardboard, suspended on the kitchen wall.

Early rising is an essential quality in a servant who has

to do any amount of housework before breakfast. Six o'clock is the latest hour at which she should rise.

By getting her work ready in the evening before going to bed, she is enabled to set about it at once on coming down in the morning. In order to do so, she should put everything in its place overnight, wash up plates and dishes, hang up jugs, and tidy her kitchen. If, after having raked out the fire, she lays it with fresh coals and dry firewood, a great point will be gained. All except the front bars of the range can be polished whilst the fire is drawing up. Twice a week a thorough cleaning of the range, boiler, and oven will do more to keep it bright than the hasty brushing generally given when time is short. If a stove is in use, the flues require brushing out with the proper utensils. If not, the soot from the mouth of the chimney should be cleared away with the sweep's brush, as far as an arm can reach. Many a good roast joint is sent to table covered with smuts, from neglect of this precaution.

Whilst the fire is drawing up, the servant should remain near to give it a timely stir before setting the kettle on, employing her time in the meanwhile in cleaning boots, knives, or any other occupation of the kind.

Her next proceeding should be to wash her hands and open the window curtains of the breakfast-room, if she has not already opened all the shutters and drawn up the blinds of the house, on her way down-stairs. She should then take a large sweeping cloth, and cover up any ornaments or furniture likely to be spoilt by dust. The hearth-rug should be folded up and laid aside to be shaken. A coarse cloth should then be laid in its place, on which the black-lead box, the cinder sifter, and fire-irons should rest whilst in use. To clean a parlour grate, fire-irons, and bright fender thoroughly, will take about twenty minutes.

Sweeping the carpet, or brushing up the scraps of litter in a dustpan, is the next proceeding. A good manager will never commence this work without having a plentiful supply of tea-leaves at hand to strew on the floor. These collect the dust which would otherwise settle on the hangings. To sweep without tea leaves, is simply time wasted and destruction.

Having proceeded so far in the breakfast-room, the hall and entrance claim attention. Even if there be not time to whiten the doorsteps before breakfast, sweeping should be done, and the mats and rugs thoroughly shaken outside.

The above portion of the work being accomplished, all the cinders left from the day before should be collected and sifted. These are useful for burning in copper flues, or they may be used to bank up a kitchen fire when a steady heat is wanted.

The dirty work of the morning now being at an end, the servant should change her gown for a cleaner cotton one, put on a tidy apron and clean cap, and dust the breakfast-room. She is now ready to lay the cloth, bring in breakfast, and do her up-stairs work generally. If there be sufficient time, this is the best opportunity she will have for her own breakfast. If not, she should manage to have her meal as soon as possible afterwards. Nothing tends to good humour so much as sound digestion, and servants cannot be healthy if they snatch their food whilst running about.

Directly breakfast is finished and cleared away, the first thing to do is, to open the windows of the bedrooms, if they have been left closed, and to strip the clothes off the beds, piece by piece. The feather beds should be well shaken and turned, and the mattresses raised for a current of air to pass through. The chamber crockery must be emptied, and such articles as require particular cleansing rinsed out with hot water and soda. Two old cloths should be kept for this purpose—old chamber towels are the best—one for the actual cleansing, and the other for wiping dry. The water bottles and tumblers should be emptied, and wiped with a clean glass cloth. At evening,

when the beds are turned down, the bottles should be refilled with fresh water.

In most families where there are daughters, the general servant gets help in making the beds. Sometimes the mistress of the house assists. The rooms that are to be specially cleaned should afterwards be made ready for the work, and the toilet appendages laid on the bed, together with any books or movables that may require protecting from the dust. A sweeping-sheet should then be thrown over the whole. The valances of the bed should be tucked up, and the bed curtains folded neatly across the bolster.

If no special cleaning is to be done, the bedroom should be quickly dusted and put in order, the servant collecting lamps, candlesticks, and other articles that have to be cleaned in the kitchen. When the up-stairs work is so far done, a general washing up in the kitchen should begin. The mistress or daughters will probably in the meanwhile dust the ornaments in the drawing-room, and aid in giving an air of order and refinement to the room.

Throughout the morning the tradesmen's bell causes serious interruption to a servant. It is a good plan to let certain tradesmen call on certain days only. The orders should be given early by the mistress on those days, and so diminish the number of times the servant has to answer the bell. A ticket may be placed in the front window to indicate the days on which different tradesmen should call.

The hour at which the family dines determines whether the servant shall do the principal house-cleaning in the morning or afternoon. If the hour is late, the morning is best; if early, the contrary. In any case a servant should not be allowed to leave the kitchen while a joint is roasting, as many are apt to do, thinking that the meat need only swing round and round till dinner-time to be properly cooked. Afternoon dinners will generally be found more suitable to the thorough dispatch of house-work, than a mid-day meal, though of course, when there are children in the family, this is impossible. Some forethought is required to set a servant free to do special cleaning without neglecting the dinner.

If a general servant is required to wait at table, it is unreasonable to expect that she can be very tidy at mid-day. But if the dinner hour is late, she may be able to dress herself before dishing up, having previously cleared her kitchen. No washing up beyond china and glass should be expected afterwards. The plates and dishes should be cleared of scraps, and stacked away in an orderly manner in the washhouse till the following morning, when time for washing them, together with the saucepans, &c., should be allowed. Under these circumstances the servant can wait upon the family in the evening, and employ the rest of her time in repairing or making her clothes.

Before laying the dinner cloth, the servant should tidy the room. The hearth may require sweeping up, and, with the mistress's permission, the cinders may be carried cut and burnt in the kitchen in the evening. A bright tidy hearth is a comfort easily secured by this means without waste.

At dusk, it is the servant's business to draw down the blinds of the house, close the shutters, and prepare the bedrooms for the night.

If any washing is done at home, the work of the house should be so arranged that Saturday afternoon may be reserved for looking up the articles to be washed, and putting them into soak. We shall have occasion to speak more particularly about washing hereafter; meanwhile, observe that there is great saving of time in washing on Mondays. In order to begin early on that day, the clothes should be all sorted and in soak (flannels and coloured things excepted) on Saturday evening.

The closing of the basement and turning off of the gas

is generally left to the general servant, but the master or mistress of the house goes round to see that all is safe.

Finally, before going to bed the servant should inquire if anything more is wanted. She should also count up the plate in use, and, if required to do so, place the basket in her master's room, together with a can of water.

SEASONABLE FOOD.

JANUARY.

Meat.—Beef, veal, mutton, pork, house lamb, doe venison.
Game and Poultry.—Hares, rabbits, pheasants, partridges, woodcocks, snipes, fowls, chickens, capons, pullets, turkeys, tame pigeons.

Fish.—Turbot, soles, flounders, plaice, skate, whittings, cod, haddocks, herrings, smelts, lampreys, oysters, lobsters, crabs, prawns, eels, carp, tench, perch.

Vegetables.—Cabbages, broccoli, savoys, sprouts, endive, Scotch kale, sea-kale, spinach, lettuces, celery, cardoons, carrots, parsnips, beetroot, salsify, turnips, potatoes, Jerusalem artichokes, onions, leeks, garlic, shalots, mustard and cress, cucumbers, asparagus, mushrooms. Garden herbs, both dry and green, being chiefly used in stuffing and soups, and for flavouring and garnishing certain dishes, are always in season. Such are tarragon, chervil, savory, mint, sage, thyme, and parsley, which can be procured all the year round.

Fruits.—Apples, pears, medlars, figs, raisins, currants, prunes, grapes, walnuts, nuts, filberts, almonds, oranges, lemons. Preserved and dried fruits of all kinds may be used throughout the winter, as also jams, marmalade, and fruit jellies.

HOME GARDENING.

THE TOOL HOUSE (*continued*).

Pruning Scissors will be found handier than the knife at times, and for this reason we would include them in our catalogue of garden requisites. They are especially useful for trimming small currant and gooseberry bushes.

The *Hand-saw* and *Tenon-saw* we have already described (p. 43); the former will be found useful in the garden for the removal of such branches as are too thick for the knife to separate; the latter is frequently needed in grafting where the stock is of too tough a nature, or of too large a size to admit of the use of the pruning-knife.

The *Scythe-stone, or Rubber.*—This is essential for keeping up a good edge to the blade of the scythe, which necessarily gets dulled by use, or injured by coming in contact with stones, &c., and requires sharpening. Most people know the old kind of stone or rubber used by mowers, which is of a very rough texture; but there is now a better kind for garden purposes, that puts on a smoother edge, and consequently enables the mower to do his work cleaner and quicker. The above is usually carried in a kind of leather satchel or sling, supported by a strap over the shoulder. The rubber must never be used when wet, and must be handled gently, as it is very brittle. It is a good plan to wash it carefully when you have done with it, but you must remember to dry it before using.

Shears (Fig. 8), which are neither more nor less than a large pair of scissors with long wooden handles in place of loops for the fingers, will be found of great service for clipping the borders of grass, box edgings, quick, and other hedges.

The *Dutch Hoe* (Fig. 1) is very useful for cutting up, or rather under-cutting weeds, and at the same time loosening the surface of the soil. This implement should, however, be pushed before you at the depth of from one to two inches, so that it may cut up any weeds. Fig. 2 shows a *drill hoe* used for making shallow trenches for small seeds.

The *Pruning Knife*, as its name indicates, is used for the purpose of keeping fruit and other trees and shrubs in order by cutting back the shoots at the proper time. A good form of pruning-knife is shown in Fig. 10.

The *Dibbler* or *Dibble*, of which there are two kinds (Figs. 5 and 6), is used for various things; the small one for planting stocks, cabbages, lettuces; and the large one, with a projecting piece of iron for the foot to rest on, for dibbling in potatoes. Either of these may, if necessary, be made out of an old spade-handle, with a little contrivance, although it is better that you have such things properly shod with iron, as they do the work cleaner and with greater expedition.

The *Pitchfork* (Fig. 3) is an exceedingly handy implement in a garden, as it is often required for turning over manure, making up hot-beds, shaking out dry litter, and distributing such dressing or manure as is spread over the ground previous to its being dug.

The *Budding Knife* is of small dimensions, and is used in preparing the bud and stock for budding. It has a bone or ivory handle tapering towards the end, which is used for raising the bark so that the bud may be inserted easily. There are blades of several shapes, but the one represented in Fig. 9 is the best for ordinary work.

The *Trowel* (Fig. 4) is a tool no gardener should be without, as it is most useful for the removal of plants from one spot to another, where it is necessary to retain a ball of earth to their roots, and whenever the spade could not conveniently be used.

Baskets (Fig. 7).—These will be found useful for collecting weeds, vegetable refuse, roots, &c., in small quantities, for removal from one place to another in lieu of the barrow. The size and number of these entirely depend upon circumstances.

ROTATION CROPPING OF A SMALL GARDEN.

(Continued from p. 138.)

July.—1. As raspberries and strawberries are the only occupants of this department, little care will be needed, with the exception of removing suckers of the former and runners of the latter, in the event of their not being required—and they will not be unless the family is particularly partial to them, at the expense of other things. If, however, a few plants are wanted, some of the strongest runners may be permitted to ramble at will over the ground, on the outside row, and these should be either pegged down into pots, or into the ground. 2. As soon as the potatoes in this quarter have been taken up, the ground should be dug over, and some early turnips sown for a winter supply. We prefer sowing a small quantity often,

rather than wait till the entire spot becomes vacant. As it is almost too late to plant cauliflowers, a portion of the ground may be reserved for early or autumn broccoli. 3. Liquid manure supplied to sea-kale now will prove far more beneficial than dung heaped upon their crowns in winter time. Rhubarb will require no further care than cutting away all but one of the flower stems, and this one may be considerably reduced. If, however, no seed is required, it may be cut down close towards the end of the month. Use the hoe continually for the purpose of keeping weeds under, and the soil in a healthy condition.

4. The hoe may be used between onions, provided you can use it without injuring the leaves, but not otherwise, as this crop will or should have had a final thinning last month. If perchance a row or two of celery was planted in this department last month, it will be necessary to earth up the same; but a dry day must be chosen for the work. Any vacant ground should have a slight raking over, just to make it look neat until such time as you can plant it.

5. Place sticks to such peas as require support, and see to the immediate removal of those past bearing, taking care not to injure broccoli and other things planted between them. 6. Very little attention will be required here, with the exception of keeping the kidney-beans clear of weeds, and seeing that high winds do not injure either the dwarf or runner varieties, for it is alike detrimental to both. 7. There is just a chance that carrots may prove a failure, and if so, as it will be too late to sow again, the best plan will be to fill up the gaps in the beds with lettuces; or a sowing of turnips may be made to come in in the autumn;

but do not fill the ground with anything that is likely to occupy it in the winter, as such an arrangement would interfere with your future plans. Such broad beans as are making rapid progress must have their tops nipped off, and the soil should be afterwards stirred between them, and, indeed, between every other crop. 8. This compartment being principally intended for the growth of celery, and the time having arrived for planting the general or main crop, a few words on its management will doubtless be acceptable. Here we will only say that, to ensure good and fine sticks, abundance of room will be necessary. Single and shallow trenches suit best for a small supply, but for a larger quantity broad ones should be made. Fuller directions on the growth of celery will be given as our work proceeds. As endive and other odds and ends will partly occupy this plot, the requisite attention must be paid to each at the right time.

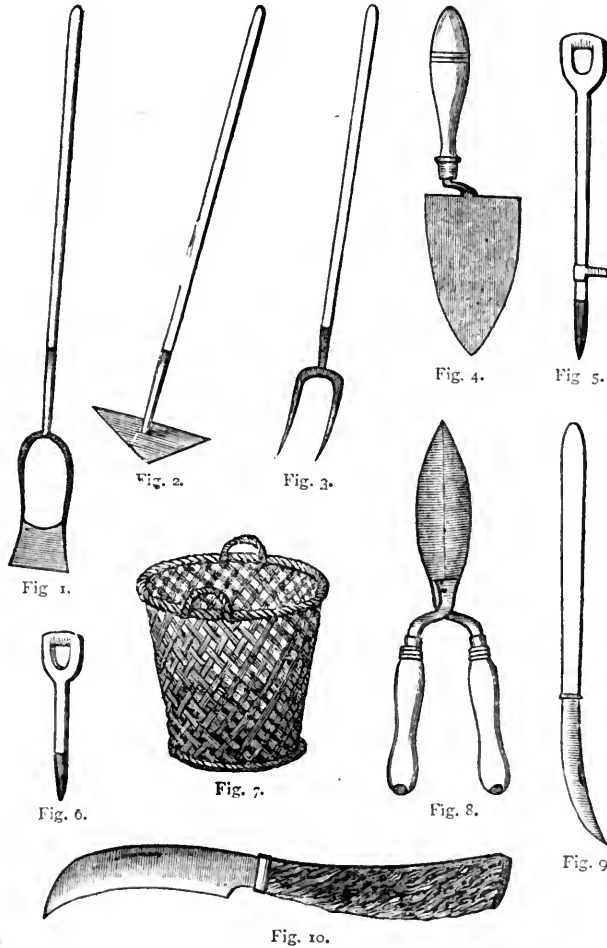

CHRISTMAS FARE.

CHRISTMAS time has always been associated in this country with feasting and merry-making. As far back as we have any records of the social life of our ancestors, we find accounts of the feasts they were wont to make at this season; and the family archives of many of our oldest families contain the particulars and the bills of fare of the good eating and drinking provided for the entertainment of themselves and their retainers at Christmas. It is also worthy of note, that many of the dishes with which we are accustomed to supply our tables at the present time are the same as those which pleased the palates of our forefathers; while many other items of their Christmas dinners, which figure no longer in our bills of fare, are still found in some places where Christmas is kept after the good old fashion, in some old country houses, and in the colleges of our universities. It is our intention in this paper to give a short account of Christmas fare in the olden time, which will no doubt prove as interesting to the general reader as to the antiquary; while our next paper on Cookery will be devoted to a series of recipes for the making and preparation of the dishes which still form the staple of our Christmas dinners.

Curious particulars have come down to us of the great feasts with which our sovereigns in early times kept their Christmases; and in some cases we find even their favourite dishes at these royal celebrations. Thus, cranes were the favourite dish with Henry II.; and on one occasion we are informed that Henry III. directed the Sheriff of Gloucester to buy twenty salmon, to be put into pies for his Christmas.

"The sammon, king of fish,
Fills with good cheer the Christmas dish;"

and the Sheriff of Sussex had to provide ten brawns, with the heads, and ten peacocks, for the same feast, in Westminster Hall. Richard II. kept his Christmas at Lichfield, in 1398, where two hundred tuns of wine and two thousand oxen were consumed! Edward III. was a right royal provider of Christmas cheer. In his time the art of cookery was well understood, and the making of blanchmanges, tarts, and pies, and the preparing of rich soups of the brawn of capons, was among the cook's duties at this period. French cooks were employed by the nobility; and in the merchants' feasts we find jellies of all colours, and in all figures—flowers, trees, beasts, fish, fowl, and fruit. The wines were spiced; and cinnamon, grains of paradise, and ginger were in the dessert confections. Richard II. feasted 10,000 persons at his house-warming of Westminster Hall. This king is stated to have kept 2,000 cooks, and there is a "Roll of English Cookery," by the master cook of Richard II. In the Salters' Company's books is the following receipt to make a game pie for Christmas, in the reign of Richard II.:—Take a pheasant, a hare, a capon, two partridges, two pigeons, and two rabbits; bone them, and put them into paste the shape of a bird, with the livers and hearts, two mutton kidneys, forcemeats, sage balls, seasoning, spice, catchup, and pickled mushrooms, filled up with gravy made from the various bones. A pie was so made by the Salters' Company's cook, a few years ago, and was found to be excellent. Richard III. kept Christmas most splendidly, and paid "two hundred marks for certain new year's gifts, against the feast of Christmas." By ancient custom the city of Gloucester, as a token of their loyalty, present a lamprey pie annually at Christmas to the sovereign. This is sometimes a costly gift, as it often happens that lampreys at that season can scarcely be procured at a guinea apiece.

At Oxford the celebration of Christmas was, before the Reformation, performed with a pageant. At Merton College he bore the title of King of Christmas; at St. John's he was styled lord; and at Trinity he was emperor. At Jesus College is a huge silver-gilt wassail-bowl, which

will hold at least ten gallons, and the ladle half a pint. This huge vessel was formerly used in Christmas celebrations.

Of Christmas dishes the first was the boar's head, "the rarest dish in all the lande." It was pickled, boiled, or roasted, laid in a great charger, covered with a garland of bay, and served with a lemon in its mouth, and mustard. Sometimes the boar's head was given as a wrestling-prize. At Queen's College, Oxford, bringing up a boar's head in great state to the table is an interesting sight to this day. It is carried on the head in a large dish, and the scholars sing an ancient carol.

Brawn is, probably, as old a Christmas dish as boar's head. We read of brawn and mustard at the coronation feasts of Katherine, queen of Henry V., and of Henry VII. At the latter was "brawne royal" for the king's table. At the royal palace, and at the revels of the Inns of Court, it was a constant dish at a Christmas breakfast. Kent has long been celebrated for its brawn; and Canterbury brawn is to this day sent to all parts of the kingdom for Christmas presents.

The peacock was the next Christmas dish. To prepare it for the table the skin was first carefully stripped off, with the plumage adhering; the bird was then roasted, and when done it was sewed up again in its feathers, its beak gilt, and so sent to table. Sometimes the whole body was covered with gold leaf, and a piece of cotton, saturated with spirits, placed in its beak, and lighted before it was carved. It was stuffed with spices and sweet-herbs, basted with yolk of egg, and served with gravy. It is related that a peacock dressed in this fashion was served in a dinner given to William IV., when Duke of Clarence, by the Governor of Grenada.

Fruментy at Christmas was another noted dish. It consisted of boiled wheat, broth, almonds, milk, and yolks of eggs, and was sweetened with sugar.

The turkey has graced the Christmas table from the date of its introduction into England, about 1524, and we find it forming part of the farmer's Christmas dinner in 1578.

Swans were standard dishes formerly at great houses at Christmas. Chaucer's monk, no doubt a good judge—

"A fat swan loved he best of any rost."

In the Household Book of the Duke of Northumberland five swans are dished for Christmas-day, three for New Year's-day, and four for Twelfth-day. Except in the state of a cygnet, and that rarely, the bird is not met with at table.

The bustard has almost disappeared, but within memory it might be seen in Christmas larders of large inns; now six or seven guineas are sometimes paid for a foreign bustard.

The fat capon, from seven to ten pounds, is another luxury of the season; and in some places a couple of fat capons is a corporation present.

The goose is a favourite Christmas dish with the people here, as well as in various parts of the Continent.

Roast beef has been for ages the great Christmas fare. The sirloin of beef is said to have been named from a loin of beef being knighted by King Charles II., and at Friday Hill, in Essex, is shown a table as that upon which the ceremony was performed; but it is also related, by a great historical authority, that at the Abbey of Reading "a *sirloin of beef* was set before Henry VIII., so knighted." [The real meaning of this word, however, is "that which is upon the loin," and the truest spelling would be *sur-loin*, just as we now write *surname* and not *sirname*.—Ed. H. G.] Still, the great Christmas roast is the baron of beef, *i.e.*, two sirloins, not cut asunder, but joined together by the end of the backbone. Such a joint is roasted for Her Majesty's table on every Christmas-day dinner; and a baron of beef is one of the boasts of the Lord Mayor's dinner in the Guildhall.

Plum-pudding is first mentioned in a cookery book of the year 1675; but it is thought to have originated from plum-broth, boiled in a basin, whence it became solid. This plum-broth, or porridge, also called *hackin*, until the time of Charles II., was made by boiling beef and veal with sack, old hock, and sherry, lemon and orange-juice, double refined sugar, raisins, currants and prunes, cochineal, nutmeg, cinnamon, and cloves; the whole thickened with brown bread, and served at table in a tureen. It was eaten at Christmas, at St. James's Palace, during the reign of George III., and portions of it were sent to different officers of the royal household. The Rev. Mr. Brand tells us that when he dined at the chaplain's table, at St. James's Palace, on Christmas-day, 1806, the first dish served was a tureen of this rich, luscious plum-porridge.

Mince or *shred* pies are said to be in imitation of the paste images and sweetmeats given away at Rome on Christmas-*evc*. Two centuries ago a traveller in England described every family making a Christmas pie, "the composition of the pastry being a most learned mixture of meats, tongues, chicken, eggs, sugar, currants, lemon and orange-peel, with various spices." The paste case should be oblong, in imitation of the manger wherein our Saviour was laid, the ingredients themselves having been said to refer, especially the spices, to the offerings of the Wise Men. By some the paste-case was called "the coffin." There is a superstition that as many houses as you eat mince-pies in during Christmas, so many happy months will you have in the ensuing year. Mince pies are served at the lord mayor's dinner, at Guildhall, on the 9th of November. In various parts of the country a substitute is made of the lights, &c., of a pig, chopped fine, with apples, currants, sugar, and spice. It is often sent by farmers as a present, with a pork-pie, on killing a pig.

The bakers at this season used to present their customers with the yule dough, paste images, as the chandlers gave Christmas candles in our time.

A very humble observance of Christmas was formerly made on the Paddington Charity Estates, which had been bequeathed by two maiden gentlewomen, for the purpose of their supplying the poor with *bread and cheese*; and the gift is a very ancient one. With the rents of these lands were purchased the bread and cheese, which, on the Sunday before Christmas-day, was thrown down from the tower of St. Mary's Church among the people assembled in the churchyard; but the scramble grew uproarious, and bread and coals are now given instead to poor families inhabiting the parish.

The Christmas-tree is commonly thought to be an addition of late years to our celebration of the season; but it was seen in our metropolis more than four centuries since, when holm, holly, ivy, and bay were made into a standard tree in Cornhill; and in a pageant before Henry VIII., at Richmond, was "a tree of gold, with branches and boughs fringed with gold, spreading on every side, with roses and pomegranates; when it was drawn back the wassail, or bauket, was brought in, and so brake up Christmas." However, these ancient sights have been comparatively little read of, and our present Christmas-trees are traceable to a German in the household of Caroline, queen of George IV., having made a Christmas-tree for a juvenile party in London. This tree was a branch of evergreen, fastened on a board, and hung with gilt oranges, almonds, &c.; and beneath it were a model of a farmhouse, figures of animals, &c. The making of Christmas-trees was then described as a common custom in Germany, and as a relic of the pageants got up in ancient days. In the Berlin market there are provided for Christmas monster boxes of toys, tons of gingerbread, and acres of marchpane—a sort of sweet biscuit of sugar and almonds baked together. It is curious to find that in Prussia, where the Christmas-tree is common, holly is only known in the gardens of scientific horticulturists.

Christmas-boxes is a term now applied to *gifts of money* at Christmas, whereas anciently it signified the boxes in which such gifts were deposited. The Romans used these boxes to collect contributions at rural festivals, the money being slipped through an aperture in the box. One has been found filled with Roman coins. Their general name was "thrift boxes;" but being much employed at Christmas, they were called "Christmas-boxes," and thus gave name to the money itself. A gilt nutmeg was formerly a common gift at Christmas.

In the songs of various periods the custom of keeping Christmas is best preserved. A ballad of the time of the Restoration—about two centuries ago—gives this picture:—

"All you that to feasting and mirth are inclin'd
Come, here is good news for to pleasure your mind;
Old Christmas is come for to keep open house;
He scorns to be guilty of starving a mouse:
Then come, boys, and welcome, for diet the chief,
Plum-pudding, goose, capon, minc'd pies, and roast beef.

"A long time together he hath been forgot;
They scarce could afford to hang on the pot:
Such miserly sneaking in England hath been,
As, by our forefathers, ne'er was to be seen;
But now he's returned you shall have, in brief,
Plum-pudding, goose, capon, minc'd pies, and roast beef."

Long before the date of this ballad a fuller catalogue had been sung:—

"Brawn, pudding, and sauces, and good mustard withal,
Beef, mutton, and pork, shred pies of the best,
Pig, veal, goose, and capon, and turkey well dressed;
Cheese, apples, and nuts, jolly carols to hear,
As then in the country is counted good cheer."

The following, from a carol of the thirteenth century, shows that unrestrained indulgence in drinking at Christmas was unfortunately a bad habit with our forefathers:—

"Lordlings, Christmas loves good drinking,
Wines of Gascoigne, France, Anjou,
English ale, that drives out thinking,
Prince of liquors, old and new,
Every neighbour shares the bowl,
Drinks of the spicy liquor deep;
Drinks his fill without control,
Till he drowns his care in sleep."

As might be expected, "Christmas broached the mightiest ale," and a very old wassailing cry was—

"Bryng us in good ale, and bryng us in good ale;
For our blyssd lady, bryng us in good ale."

The singers always expected a black-jack of ale and a Christmas-pie. A favourite draught, also, was spiced with a toast, stirred up with a sprig of rosemary:—"A pot of ale consists of four parts—imprimis, the ale; the toast; the ginger; and the nutmeg." Mead, or metheglin, was another Christmas drink.

About three centuries ago a dinner of the Christmas season—a moderate dinner, too—consisted of this profusion:—The first course of "sixteen full dishes; that is, dishes of meat that are of substance, and not empty, or for show; as thus, for example: first, a shield of brawn, with mustard; secondly, a boy'd capon; thirdly, a boy'd piece of beef; fourthly, a chine of beef, roasted; fifthly, a neat's tongue, roasted; sixthly, a pig, roasted; seventhly, chews, baked; eighthly, a goose, roasted; ninthly, a swan, roasted; tenthly, a turkey, roasted; the eleventh, a haunch of venison, roasted; the twelfth, a pasty of venison; the thirteenth, a kid, with a pudding in the belly; the fourteenth, an olive-pye; the fifteenth, a couple of capons; the sixteenth, a custard, or dowset. Now, to these full dishes may be added sallets, fricassees, *quelques choses*, and devised paste, as many dishes more, which make the full service no less than two-and-thirty dishes, which is as much as conveniently can stand on one table, and in one mess. And after this manner you may proportion both your second and third courses, holding fulness on one half of the dishes, and show in the other, which will be both frugal in the splendour, contentment to the guest, and much pleasure and delight to the beholder."

COTTAGE FARMING.

II.—MANURING OF GRASS LANDS (continued).

The *Liquid Manure Cart* has recently undergone some important improvements. The old plan on the principle of a shower of rain was, in the application of pond or river water to grass, comparatively free from objection, if a sufficient dose was applied at one operation. But the distribution of liquid manure on this plan over meadows is highly objectionable, as the showering process wastes the fertilising elements from the manner in which they come in contact with the atmosphere.

By the recent improvements the perforated distributor is removed, and a simple hose, the mouth of which is allowed to trail over the surface, applies the liquid manure in a body, with very little contact with the atmosphere and loss of fertilising matters. The use of the jet is very detrimental to the successful working of this plan, of applying liquid manure of any kind, for the reason already given—viz., waste of fertilising elements from contact with the atmosphere. Even for pond or river water the objection is not wholly removed, although it is less.

To imitate practically a shower of rain, the water must be as pure and free from organic and inorganic matter as rain-water. The jet, however, is a superfluous adjunct to the system, analogous to the perforated distributor of the old liquid manure cart; so that the system itself can be simplified and improved, as the liquid manure cart has been improved, by simply using the hydrants and hose.

Thus, if Fig. 1 be taken to represent a small farm of about ten acres of meadow land, the whole may be watered or irrigated, with sewage or river water, by twenty-two chains of piping and six hydrants, with a hose over two chains in length. The pipe at *a* communicates with the cistern into which the liquid has been pumped, or into which it flows by gravitation. The distribution of the liquid to the hydrants is not new in principle, having been successfully in use under the old practice, so that the only thing which modern improvement can lay claim to as novelty is the use of the hose in the place of the old wooden water-runs and furrows, for distributing the water from the hydrants. The diameter of the pipes need not be

over three inches in favourable situations, and four inches in less favourable, for a farm of ten acres, assuming that it has a full command of town sewage or river water for irrigation. The pipes should be enamelled inside, the better to obviate friction, and rusting when not in use. Angular bends are to be avoided, as shown in the engraving, and provision requires to be made for washing out the pipes when the work of irrigation is finished for a time. The hose should lie on the ground as the old wooden water-runs, purposely to discharge the liquid with as little force and agitation as possible. This is an essential to success, and therefore it must be attended to. For a similar reason, no more head pressure should be applied than what is necessary to overcome friction and produce the proper discharge. In uneven

ground another old plan will be requisite to attain these results—viz., a wooden box or tub, into which the liquid from the hose is discharged, and out of which it flows gently in shallow wooden runs. These were made by nailing two boards an inch or two in depth to a bottom board three inches in breadth, and about twelve feet in length, and so shaped at the ends that the water flowed out of one pipe into another, when more than one length was required on either side of the box or tub.

By March or April at the farthest, in southern provinces, a portion of the meadow should be forced forward so as to be fit for mowing, and on to November milch cows should have a daily supply of green food. At first the young grass should be mixed with old hay and cut into chaff, adding less and less hay as the cows take to the succulent grass, which is very strong in spring.

For cutting this daily supply of fodder the scythe is to be used, but for the general hay harvest,

of which afterwards we shall treat fully, we strongly advise the mowing machine. In the first place, there is an economy of labour; in the second, the crop can be stacked sooner, and so run fewer risks of change in the weather.

Having thus described the principal operations necessary for the general management of grass land, we will now proceed to consider in detail what sorts of grass it is most desirable and profitable to cultivate on the cottage farm.

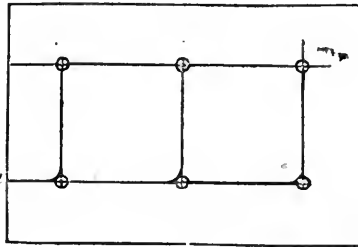

Fig. 1.

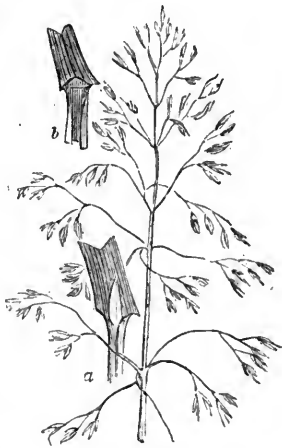

Fig. 2.



Fig. 3.



Fig. 4.



Fig. 5.



Fig. 6.



Fig. 7.

ON THE GRASSES BEST ADAPTED FOR MEADOW AND PASTURAGE.

The next question for consideration after the permanent improvement of the land under grass farming, is the mixture of grasses best suited for the soil, climate, and system of husbandry to be practised. For sewage manuring, the question is easily answered, as Italian rye-grass is the only kind adapted for it. But although a gross feeder, it is, under the forcing system, a short-lived plant, and therefore better adapted for forage over arable or mixed husbandry, than for permanent meadow and pasture. For such, other kinds are to be preferred, and these we shall proceed to notice. In almost every locality there are meadows and pastures naturally rich, and the grasses to be found on them are generally considered the safest guide as to what suits soil and climate. The following selection of grasses, clovers, &c., with the soil and climate natural to each, and eight illustrations, will enable the cottager to examine the meadows and pastures of the neighbourhood, and judge for himself as to what best suits his own peculiar soil and climate. The illustrations are only intended for practical guidance.

Sweet-scented Vernal Grass (*Anthoxanthum odoratum*), Fig. 5.—This is one of the earliest grasses: it flowers in May, and grows freely on most soils. It is permanent in most meadows and pastures. Its rich

aromatic scent, as its botanical name implies, gives that peculiarly delicious fragrance which so frequently strikes us in newly-made hay, as well as in the newly-mown grass before it has undergone the process of being made into hay.

Cocksfoot (*Dactylus glomerata*), Fig. 4, is one of our best meadow and pasture grasses. It is well adapted for deep, retentive, loamy soils, but does not grow so freely on sandy land, or thin soils with a hard bottom. In America it is termed orchard grass, as it grows well under the shade of fruit trees.

Golden or Yellow Oat Grass (*Avena flavescens*), Fig. 7, is a late grass, growing freely on calcareous soils, especially in pastures and meadows of considerable altitude. When kept down and fresh in pastures, milch cows are fond of it; but it should not be allowed to run to seed.

Crested Dogtail (*Cynosurus cristatus*), Fig. 9, is another upland hay and pasture grass. It is a hard grass good for pasture on loams, but should not be allowed to run to seed, as "the bents so brown" are not browsed by cows, or eaten by cattle of any kind. One of the spikelets magnified, is shown at *a*. Its time of flowering is between the middle and end of July, so that if not cropped short before this period by cattle, it should be mown close with the scythe.

Meadow Foxtail (*Alopecurus pratensis*), Fig. 6, is an early grass, which flowers in May, and is commonly met with in hay meadows and pastures, for both of which it is well adapted on medium loamy soils. Like Fig. 9, it should be prevented from running to seed

in pasture. It grows rapidly after being cropped, and is much relished by cattle.

Rough-stalked Meadow Grass (*Poa trivialis*), Fig. 2, and *Smooth-stalked Meadow Grass* (*Poa pratense*), are two of our best hay and pasture grasses. In their outward appearance they closely resemble each other, but their culms differ, as their names imply. Thus the ligule or small tongue of the leaf of the rough-stalked grass, *a*, is pointed, whereas, in the smooth-stalked grass, *b*, it is round and blunt. They both flower in June, and prefer a deep, moist, and rich soil, to a dry, poor one, and sheltered rather than exposed situations. And when growing in their natural habitat, they are greedily eaten by milch cows.

Perennial Rye-grass (*Folium perenne*), Fig. 3, is valuable both for hay and permanent pasturage. There are several varieties besides the one in Fig. 3, and Italian rye-grass already alluded to, as one of our best grasses for sewage manuring, because a gross feeder and rapid grower. The Devon heaver, or evergreen variety, is, as its name im-

plies, a rich pasture grass throughout the year. The annual, which is more truly a biennial kind, yields a heavy crop of hay, but it is only fit for alternate arable husbandry.

The American "Rocky Mountain Bromus Grass" (*Bromus Schraderii*), Fig. 8, sometimes termed "prairie grass," has of late found much favour amongst the cottage farmers of France. Of course



Fig. 8.



Fig. 9.

this must not be confounded with the ornamental "prairie grass" so frequent in gardens. The "Rocky Mountain grass" is, however, only a sub-perennial, and therefore requires special management when it is employed for exclusive grass farming. It grows best on rich dry soils; but will bear high manuring, and produce heavy crops, on poor soils if dry; but it dislikes wet soils, and the chilling frosts of winter to which they are subject. The yield is large and coarse, but relished by cows, both as green forage and hay. "M. Lavelle reports that at the end of some days, every one of his family was astonished at the improvement which had taken place in the milk, and still more in the butter." Its natural habitat is said to be the Rocky Mountains of central North America, but it has been found in other places. It promises well in Australia, where it has been introduced, and may suit a French climate better, perhaps, than an English one generally; but for some small farms in our southern provinces, it merits attention, as half an acre or so of it would yield abundance of rich green meadow forage for milch cows.

All our large agricultural seedsmen supply mixtures of seeds for laying down land to permanent meadow or pasture, and for renovating the same, adapted for different climates and geological formations; but the difficulty experienced in practice in ordering seeds arises from the fact that the staple soil consists of drifted and warp materials of several formations, so that the farm of the cottager, small as it is, may consist of two or more different kinds of soil. His safest course, therefore, when he examines the grasses actually growing in his meadows or pastures, is to com-

pare them with others on similar soils in his neighbourhood. To assist him further in doing so, a few more grasses adapted for different soils may be enumerated without illustrations. Staple soils will be discussed under Arable Husbandry.

In addition to the two *poa* grasses above, Fig. 2, the narrow-leaved meadow (*Poa angustifolia*) is an excellent hay and pasture grass, and found in most brown, friable, sandy clay soils. The fertile meadow grass (*Poa fertilis*) is rather early and fine, but not so productive for hay and pasture as the last. It grows in light and sandy clays. Water meadow grass (*Poa aquatica*) thrives on moist clays and embankments where it gets water, and produces coarse but heavy crops. The Alpine meadow grass (*Poa alpina*) is best suited for elevated pastures. It is relished by cattle, and grows freely at considerable elevations. Wood meadow grass (*Poa nemoralis*) forms rich pasture under trees. All these meadow grasses have a kindred resemblance to Fig. 2, and may be easily recognised in the meadows and pastures.

DOMESTIC SURGERY.

Frost-Bite.—The effects of cold, if severe, are scarcely less dangerous than those of heat, though not so frequently met with, in this country, at least. Probably the commonest form of frost-bite is the ordinary *chilblain*, and its close resemblance to a burn is shown by the fact of a vesicle forming and leaving a sore behind it just as if the part had been burnt. As the worst thing for a burn is to apply cold, so the worst thing for a frost-bite is to apply heat, and this is frequently seen in the case of people who put their cold feet to the fire, and so produce the chilblains of which mention has been made. A frost-bitten part loses its natural colour, becomes of a tallowy white, feels numbed and insensible, and, if not judiciously treated, may mortify and drop off. The proper treatment is to restore the circulation in the part, *very* slowly and gradually, and for this purpose, friction should be used with the hand, containing snow or dipped in ice-water. The patient should be kept from the fire, and in an airy room, until the sensation in the limb and its colour are fully restored. When a limb is really severely frost-bitten, immediate recourse should be had to medical advice, as the patient may lose a part of it, or hardly escape with his life. A person who has been long exposed to a low temperature, particularly if either very young or very aged, or in feeble health, may be so completely overcome as to be in very considerable danger. The first evidencé of this is a drowsiness, which becomes after a time perfectly irresistible, but which, if indulged, is equally fatal. Every effort should be made to rouse the patient, and to keep him awake until shelter is reached, when, if already passed into an insensible condition, medical aid should be at once summoned. In the meantime, the patient should be stripped and wrapped in a blanket, and friction of the limbs with the hands should be carefully and steadily carried on. A little warm milk may be cautiously administered with a spoon pushed well back into the throat, and, if an enema is at hand, some warm water or milk may be thrown up into the bowels. Recourse should be had to artificial respiration, if the patient does not breathe even slightly; but for instructions how to carry out this recommendation, the reader is referred to the chapter on the treatment of drowning, a much more common casualty than severe frost-bite.

Gunpowder Accidents, though similarly treated to burns and scalds, must be confided to professional hands, if possible. The effect of the explosion of gunpowder upon the patient differs according to the proximity and the force of the explosion. Loose or slightly compressed gunpowder, as in a "squib," scorches the patient by its explosion, and is apt to carry un-

burnt grains of the powder into the skin. These leave an ugly and almost indelible mark; for though it is true that the grains of powder may be picked out with a needle, few sufferers will endure the operation, which is necessarily painful. The explosion of tightly-compressed powder, as when contained in a powder-flask, is of a most violent character, and is sure to lead to such injury of the hand which holds it as to require immediate surgical attention. This accident is, in fact, only mentioned here in the hope that a hand may be saved by calling attention to the fool-hardy feat which so often occurs with the same disastrous result—the pouring powder from a flask into an open fire. Of course a complete train is thus established from the fire to the flask, with the most dreadful results to the foolish performer of the experiment.

Gun-shot Injuries, and particularly those occurring in civil practice from the incautious use of fowling-pieces, are always most serious in their nature, and require most skilful professional treatment. As some time must ordinarily elapse between the occurrence of the accident and the arrival of the surgeon, it may be well, however, to indicate the treatment to be pursued. In the first place, the bleeding should be arrested by binding up the wound in the manner already described. Secondly, as the patient will be certain to be suffering severely from "shock," it will be advisable to keep him in the recumbent position, to apply warmth to the extremities, and—if the bleeding has been controlled—to give stimulants cautiously. We take this opportunity of calling attention to the folly—we may almost say wickedness—of pointing any weapon, whether believed to be loaded or otherwise, at another person in jest. Such jests have so frequently turned out to be miserable and irremediable mistakes, from the gun being unexpectedly loaded, that we very strongly maintain that from earliest childhood every boy should be forbidden to point even a pop-gun at a living person.

Injuries from Chemicals are comparatively rare accidents, though they may prove most serious in their results. The application of any of the strong mineral acids—nitric, sulphuric, or hydrochloric—to the surface of the body will char the cuticle, and, if not immediately washed off, or neutralised with an alkali—soda, potash, or lime—will eat into the part, giving rise to excruciating pain and destruction of the tissue. In the same way the application of the *caustic* alkalis will destroy the surface, and require to be neutralised with some diluted acid, of which vinegar is a convenient form. The most serious form of accident from chemical substances is when they are swallowed by mistake, and these cases require immediate and active medical treatment. Pending the arrival of a medical man, no harm can be done in any case by administering olive oil or uncooked eggs; but the surgeon will of course use his discretion as to the means to be subsequently adopted.

Particles of *quick-lime* are occasionally blown into the eye, and produce very serious mischief if not immediately attended to. Since it is the contact with the tears which produces the caustic effect, it is of no use to merely bathe the eye with water, and fortunately an antidote is at hand in vinegar, which, when mixed with water and applied to the eye, produces an insoluble salt of lime, and arrests the mischief. When all pain has been allayed by the use of the vinegar and water, a drop of castor-oil, placed between the lids, will give great comfort to the patient; but medical advice should be sought if there are, as will frequently be the case, white marks left upon the surface of the eye-ball.

Foreign Bodies introduced into various parts of the body cause more or less mischief; and, as a rule, the earlier they are removed the better for the patient.

Dust in the Eye is a familiar example, and is very distressing from the irritation in that sensitive organ which it immediately excites. When the foreign body is merely lying beneath the eye-lid it can often be

immediately removed by drawing the upper lid well down over the lower, and then allowing the eye to be slowly opened, when very generally the intruder will be entangled in the lower lashes and thus removed. If this little manoeuvre, repeated once or twice, does not prove successful, it will be necessary to turn the upper lid up, so as to expose its under surface. This can be accomplished by a non-professional person with a little care, and without any risk of injuring the eye, as follows:—The patient being seated, and leaning his head back against the operator's breast, the latter, holding an ordinary bodkin in one hand, presses it gently on the outside of the lid, and about half-way down. With the fingers of the other hand he then seizes the eye-lashes, and, drawing the lid a little forward, turns it up over the bodkin. This will be accomplished readily enough if the operator is steady and the patient willing, and the whole surface of the eye will then be exposed, when the foreign body can be seen and removed. If, however, the particle is of a pointed character—*e.g.*, a piece of steel—and is embedded in the cornea, or transparent covering of the eye-ball, the assistance of a surgeon should be at once obtained to ensure its safe and early removal. In any case of injury to the surface of the eye the application of a drop of castor or other oil, as recommended in the previous section, will be found of great service.

Foreign bodies are often introduced by children into the *nose or ear*, in sport, and are generally of a more or less globular form, such as beads, pebbles, cherry-stones, or beans. These, if near the orifice, may be readily hooked out with one of the common ear-picks found in ladies' dressing-cases, or with the loop of a common hair-pin; but if more deeply placed, injudicious poking with instruments may do harm, especially in the ear, and it is better to have recourse to the injection of a stream of warm water with a good-sized syringe, by which the interloper may be washed out. In the case of the nostril, a violent sneeze, induced by the inhalation of a pinch of snuff or pepper, will often dislodge the obstacle, but if recourse is had to syringing, the best method is to inject the water through the *opposite* nostril, when, if the patient leans forward, and keeps the mouth open, the water will run round the back of the nose and out at the affected nostril, bringing the foreign body with it. The vulgar notion that "earwigs" have a tendency to find their way into the ear, is a popular delusion, but as it occasionally happens that an ant or other small insect enters the ear, and gives rise to pain and irritation, it may be well to mention that the simplest way of relieving the sufferer is to place the head horizontally and to fill the ear with water, when the insect will be at once floated out of the cavity.

Foreign bodies in any part of the *wind-pipe* are always serious, and may be immediately fatal. The accident commonly happens from a child having some plaything, such as a bean, small marble, bead, or nut-shell, in its mouth and being desired to take it out, when, either in the hurry to obey, or possibly from its disinclination to do so being quickened by a cuff, the foreign body slips into the wind-pipe, and produces serious mischief. In the well-known case of the late Mr. Brunel, the eminent engineer, whose life was endangered by an accident of this kind, it arose from his performing a conjuring-trick with a half-sovereign in his mouth, and the coin slipping into his wind-pipe. When the foreign body becomes fixed in the upper part of the wind-pipe or larynx, so as to obstruct the breathing, the patient becomes black in the face, and falls back apparently dead. This sometimes happens during a meal, from a child or grown-up person happening to cough while eating, and thus drawing a piece of food into the air-passages. Whatever the cause, a by-stander should, without hesitation, thrust his forefinger to the back of the throat, and endeavour to hook up with it the offending body, and this can often be done,

when the patient will at once breathe again. If this method is not successful, the patient, if a child, should be held up by the legs and be smartly thumped between the shoulders, when not improbably the foreign body will drop on to the floor, and the child will then begin to respire and cry; but if respiration is still suspended, cold water dashed on the chest will probably rouse it, or, if not, recourse must be had to artificial respiration, as described under the head of Suspended Animation (page 111). Of course, medical aid will be summoned at once in any case of serious choking, if possible, but the majority of these cases do well without it. If, however, the foreign body is not dislodged by the efforts of by-standers, an operation will be necessary to save life, and every moment will be of importance. Even if the urgent symptoms have passed off, and the child appears to be restored to health, yet, if the foreign body has not been *found*, the advice of a surgeon should, nevertheless, be sought at once, as it may still be lodged in the deeper air-passages, where it may cause fatal mischief if not dislodged at an early period.

Foreign bodies seldom lodge in the *gullet*, and such obstacles as fish-bones can generally be got down safely into the stomach by swallowing a large mouthful of well-masticated bread. In cases where this does not succeed in removing the bone, a medical man should be sent for, who can, by a very simple treatment, get rid of the obstruction. The most serious obstruction is a set of false teeth, since the plate upon which they are fixed is apt to become entangled in the mucous membrane, and necessitate a serious surgical operation. The best way to avoid such an accident is for the wearers of artificial teeth on no account to go to bed with them in their mouths, since it is usually during sleep that the accident happens.

Foreign bodies, such as coins, often pass into the *stomachs* of children, and give unnecessary alarm to their friends. In the great majority of cases, such articles would pass through the intestines without any treatment, but certainly the worst treatment possible is to give the child purgative medicine, as is so often done. Either an emetic of mustard and water should be administered at once, so as to bring up the foreign body, or, if the case is seen too late for this, every effort should be made to cover it over with more or less adhesive food, so that it may pass readily through the bowels. Pins or needles, when swallowed, should always be treated in this latter way. The best regimen for a child, under these circumstances, is plenty of bread and milk, with common hard dumplings and bread and cheese for his dinner, and a careful avoidance of fruit, &c., until the indigestible body has come away.

FURNITURE.

III.—BEDROOM FURNITURE.

THE furnishing of bedrooms affords scope for great taste in selecting expensive articles, or for much ingenuity in fitting and adapting materials to the limits of small means, yet such as shall not be devoid of beauty or elegance. Mahogany now takes the place of the dark well-polished oak of former days. The silver fir and enamelled furniture are specialities of different makers, the one being polished or varnished deal, white or stained, and the other painted in delicate colours, and varnished, or japanned, as it is termed by the trade. Of the two, the deal is the most useful, and is not inelegant. The only drawback to the beauty of enamelled wood is that it shows every spot and finger-mark, and cannot be cleaned without some tarnish. A carefully-trained housemaid will not soil it with uncleanly touch; but splashings will show on the washstand. Mahogany is certainly the best wood for bedroom furniture, and is not expensive. Birchwood is excellent also, and when of good grain in tint resembles satin-wood, formerly so much prized. Chairs, tables, and

washstands are made of it. It never stains nor spots, nor do water drops show on it so much as on mahogany. There is little, if any difference in the price of these woods. Full-sized Arabian bedsteads may be had of either from £2 17s. 6d. to twelve guineas. A bedroom may be furnished for £120, and yet not have anything in it excessively costly, or for £38, or for £20, and less; all depends upon material, workmanship, and design. There is little difficulty in selecting furniture when expense is no object, but when means are limited it is another affair. It may be asked what kind of bedsteads will best repel insects. Experience has shown that wood and iron are invaded without distinction, and that no wood is known to be safe from them except one, and this is quassia, or the bitter-wood of commerce.

As a wood for bedroom furniture which shall look well to the eye, and be really useful, mahogany, even for limited means, is in the end the cheapest, because it never wears shabby, and it can be cleaned and polished. Beechwood bedsteads, when painted in imitation of oak, and varnished, look clean and even handsome, but in three years they require cleaning and fresh japanning, as it is termed. Japanned imitations of maple look as if spotted by flies or other insects. There is very little difference in the price between a plain mahogany and a painted Arabian, or half-tester bedstead; but a very handsome mahogany would, of course, be considerably dearer; still, a good-looking bedstead of mahogany is attainable for a moderate price.

In cheap bedsteads there are generally some defects. They are as showy as others more expensive, but the blemishes have to be discovered. If a bedstead is displayed in an upholsterer's shop, and it be chosen, probably the intending purchaser will be told that one equally good, if not better, can be sent. The one shown is only a specimen, and cannot readily be taken down. However, examine well the uprights which support the head, see that there are no cracks or warp of wood, also observe the places where the casters are screwed on; see that the mid-rib—if it may be so called, the piece of wood which underneath the laths extends from head to foot of the bedstead—is strong and unwarped, and that the laths fit in easily. It would be a most desirable thing if makers of bedsteads would introduce narrow laths of some flexible material, instead of the miserable deal laths now prevalent, and which necessitate a straw palliasse, a wool mattress, and a bed; better have the entire space between the sides filled with plain wood, not laths, for then the palliasse can be dispensed with.

Spring mattresses are excellent so far as they go, but these, too, have their discomforts. In some the springs are set on strong strips of wood, and are entirely open to inspection, so that if one spring gets out of order, it can be replaced without trouble, and at little expense; but the failing is that the surface material being drawn over the springs at the head and foot, the mattress is sunk when it should be higher at the head, or at least level with the centre. To obviate this defect a bolster stuffed with cotton flock should be placed at the head and foot.

There is no doubt that spring mattresses are the best for comfort and cleanliness, but should have an additional mattress on the top, to prevent unequal pressure on the springs. The mattress may be of horsehair, of wool, or of three or four coarse blankets, quilted not too closely together. The last contrivance has great advantages, inasmuch as blankets are easily detached from each other, washed, and put together again. A wool mattress must be understood as one not of cotton flocks—which lump quickly in hard masses—but of sheep's wool. The variety in the prices of this kind arises from the quality and length of wool. The best are of pure wool, and will cost at least £4 10s. For the same price an excellent hair mattress can be purchased; an inferior one, which,

in appearance, thickness, and softness of wool, is equal to the first, will cost about £1 7s. The one will be made of long wool, either pure from the sheep, or the combings from blankets in one process of their manufacture, and in their wear will not readily "felt," or the fibres separate into lumps. The inferior kind are made of wool picked from old carpets, worn blankets, &c., which is generally short, and of various colours, or brown only, and "felts," or masses, readily into lumps. In France wool mattresses are opened once a year. The wool is picked loose with the hand, the dust is beaten out with sticks, and when thus cleansed the mattress is re-made. In England it is the fashion to have what is termed a bordered style of mattress, and which only an upholsterer can re-make. In France the envelope of the wool is cotton, and in shape like a sheet, but with a line or mark down the centre. The women who re-make them lay the beaten wool in even layers on the half of the covering, then turn the remaining half over, sew the sides securely, and with a mattress-needle fasten the wool in its place at regular intervals, as is done in English mattresses.

Feather beds are not now in such general use as formerly. After they have been in use for some time, they should be purified by steam. There are several qualities of feathers, and of course a difference in the price; as also of the ticking and the shape of the bed. A bordered bed is more expensive than a plain one, because there is more labour in making the casing. Excellent bed, bolster, and pillows, may be had for six pounds five shillings, and the very best for ten pounds.

There are various qualities of goose feathers, distinguished by different names, though to the uninitiated they appear very nearly alike in everything but colour. The best feathers are fluffy, with down on the stems, and are curved, or curled as it is termed—the fluffier the better—and the best white feathers have this fluffiness in perfection: they are also cleaned and bleached. The difference of quality mainly consists in the feathers having a more or less degree of down on them. A good bed may easily be recognised if, on pressing it, the feathers rise quickly, forcing the ticking up with them. If, on the other hand, they do not rise, the feathers are old or of very inferior quality, more likely old because, if feathers are subjected to a steam process, they are thereby cleaner and their down and other filaments rendered light and elastic.

Much difference of opinion has arisen about the wholesomeness of sleeping upon feather beds. There is no doubt that spring mattresses will, when they can be cheaply made, supersede in a great measure feather beds, as being less liable to take infection, and more easy to arrange, and occasion less dust than feather beds. The dust which often arises in shaking feather beds, is due to a process used to prevent the feathers from coming through the ticking; a cheating process, which respectable upholsterers ought not to adopt. It was formerly, and ought to be so now, the universal practice to rub the inside of the ticking with beeswax, which was wholesome and answered the desired end. Now, even the ticking of a good bed is painted over on the inside with whitening and size, or some equivalent; the result is, that when it is quite dry, the dust comes through. In purchasing a bed, have a portion of it ripped open, that no mistake may be made in the matter.

In reference to wardrobes or their equivalents, the weight of the purse must determine which, some few hints may be given. Wardrobes may be had at any price, from five pounds to one hundred guineas, with a looking-glass in the centre door, or without. The straight glass is an excellent arrangement. A well-made winged wardrobe is a splendid piece of furniture, always provided that the ornamentations be not too elaborate and minute. In these dust soon gathers and makes the whole thing look shabby and worn. A winged wardrobe, means a centre door, with or without plate glass in it; this opens and

reveals four or five drawers, and above these is generally a small recess with two doors on each side. On each side this centre arrangement is a door which on opening presents a hanging closet; also at the bottom, generally a deep drawer: sometimes the drawers here are omitted. A japanned wardrobe of this description can be purchased without the glass for nine guineas, with it, for eleven guineas. A smaller wardrobe of japanned wood, with a hanging recess only, enclosed by a door and with two deep drawers, will cost about five guineas. Mahogany and walnut wardrobes can be had at any intermediate price from eight guineas to eighty and upwards. Walnut-wood is a trifle more expensive than mahogany. Very good substitutes for hanging closets may be made by utilising the recesses which are to be found in every modern house, instead of the capacious cupboards and closets with which an old one abounds. A deal shelf should be placed six feet from the ground in one of the recesses, and a foot or two above this a second shelf. Underneath the lowest shelf should be inserted wooden pegs, or a bronzed iron rod, with five bronzed hooks which slide along the rod, or one of the portable mahogany "hanging wardrobes," as they are termed, supported by two strong brass-headed nails; this arrangement covered by ample dimity or chintz curtains, or lace over pink cambric, at once improvises a hanging closet. There should be double curtains, one short one, or two meeting in the centre, arranged with curtain-rings, on an iron rod, the two ends slipped into two iron staples. The lower curtains are managed in the same way, but so that they may be drawn or undrawn, without materially interfering with the upper one. White dimity curtains, which may be made ornamental by bordering them with dimity of coloured stripes, are the best kind and the least trouble in "getting up."

Two very useful articles in a room, are a tray-press for dresses, and a boot and shoe press with a tray. That for dresses should be a box as long as the bedstead is wide; any packing-box will do, covered both on the outside and inside. When the cover is lifted, the front should unhook and fall down on hinges, and reveal inside three trays, made to slide in and out; the trays are of course taped in the usual manner, so that when any dress deposited upon them is wanted, it can be removed without disturbing the others. The lid should have strong hinges and a lock, and a cushion made square at the edges (like a bordered bed), stuffed with worsted wool, and nailed on at the edges with tin tacks. The inside paper should be blue. The outside may be covered with black leather-cloth glued on, so that, if needed, the box will bear a journey or a voyage. To make it look handsome in the room, it must have a chintz covering lined with unbleached calico, or any other strong and cheap material, and this slipped over the box, so that it is readily removable for access to its contents.

Bedroom chairs are to be bought at all prices, and of all descriptions, but mahogany, rosewood, and walnut are rarely, and excepting by desire, sold as bedroom chairs. Birch, sycamore, and bamboo are used. The old-fashioned rush-seated chair has given place to interlaced cane, which is to be preferred for appearance and cleanliness, as rush seats hold the dust. Chairs painted in blue, or pink and white, match similarly painted furniture; all others vary in price from 3s. 6d. to 8s.

A sofa, or an easy-chair, is desirable in a bedroom (though a very serviceable reclining couch may be improvised from the *garde-robe* box above described, with the addition of a pillow). An excellent sofa, convertible into a bed, if needed, and soft enough, is attainable for 65s., and even a less sum. Bedroom sofas and easy-chairs should not exhibit much of wood, and should be well stuffed with *woorsted* wool. Some of them are miserable affairs, and to be avoided.

It is common to have mahogany wash-stands with marble tops, yet when the other furniture is of polished

deal, certainly the wash-stand should be the same; but as marble would be out of place on deal, the top should be painted a plain white, not marbled. It is not difficult to renew this. A good way to keep the top of a wash-stand always fresh-looking, is to cover it with a fringed cloth of white damask or thin towelling. A portion of the centre should be cut out, if needed, to admit the basin. Marble tops are liable to get very discoloured and spotted. Many recipes have been published for cleaning marble; but stains made by chemicals are usually indelible. A mistress will need to be very particular in observing that a marble top is kept clean by being wiped every day, and at least twice a week it should be scrubbed with hot water and soda, without soap. Acids destroy the polish.

There are points about chests of drawers which, if furniture be desired to last, should be looked to. One set will appear outwardly as good as another, though at a much lower price, and, of course, much inferior in quality. Inferior chests of drawers are made of common white deal, the drawers are roughly dove-tailed together, and the backs of the chests, not of the drawers, so thin and rough that they will, after a time, scarcely bear removal from one room to another; the locks are badly put in, and are of the commonest description; moreover, the drawers are with difficulty pulled out or pushed in, from the wood being green and unseasoned, old, or otherwise of inferior quality.

THE TOILETTE.

I.—MANAGEMENT OF THE SKIN (*continued*).

The Shingles.—Every mother ought to be able to recognise this form of eruption. The shingles attacks one side only—it may be the face, the trunk, or the limbs, generally it is the side of the chest. The disease is often preceded by sharp neuralgic pain—it may be severe—followed by an eruption of little bladders, the size of millet-seeds or small peas, in clusters of some ten, twenty, or more, on a red base. The pain is relieved by the eruption. Fresh crops appear, so that the eruption, after a few days, is observed to extend in a band-like form from the spine behind round the side to the middle line of the chest before—that is, encircling half the chest. The band of eruption is not continuous, but made up of several patches. After a few days, the little bladders dry, and scabs succeed. In ten or fourteen days all trace is gone, save a little pitting and redness. The disease must not be meddled with. We should take care not to let it be irritated by the clothes, or by any rubbing; but apply at first a little starch powder, and after a day or so a little zinc ointment spread on linen. If there be much pain after the rash has come out, special remedies will be needed, which the medical man must prescribe; but in the majority of cases the treatment is to be a let-alone one. When shingles occurs in the face, it attacks one side; and when in the arms or legs, it does not encircle them, but runs down the limb parallel to its long axis. On the trunk, the eruption is, so to speak, horizontally disposed.

Sore Nipples.—These chiefly result, first, from the sucking of the child at nipples that have been flattened, so to speak, or pressed upon by tight dresses; and, secondly, by the want of cleanliness. Mothers should, therefore, always take care to prevent any pressure by the dress. The nipple, after nursing, where there is a tendency to soreness, should be sponged with warm water and washed with a little weak rum and water, or borax and glycerine, and this should be removed before the child is put to the breast. On no account should milk be permitted to remain about the nipple, for when it gets sour it causes irritation. Another good plan is to get very thin leaden shields, to wear when the child is not at the breast.

If the nipples are actually sore, nothing is better than the application of a little glycerol tannin, applied night and morning with a camel's hair pencil. It must be removed with a sponge and warm water when the child sucks. If the child's mouth is hot, it should be washed each time after being put to the breast with a little borax and honey.

Nettle-rash.—This is a very troublesome affair, sometimes, in children. It is known by the sudden appearance of little places, like those produced by the sting of the nettle, after itching in a part; and the special feature of the spots is, that they rapidly vanish—in a few minutes, oftentimes. They are excited by scratching, and appear specially at night, when the child gets warm. Mothers should be careful to examine in these cases for bugs about the room and bed in which the child sleeps, for they very often produce the disease in irritable skins. Flannel should not be worn next the skin. The child should take a little aperient, and be placed each night in a tepid bath for five or ten minutes, in which is dissolved three ounces of carbonate of soda and two pounds of size; after which it should be dried by gentle "dabbing," and should have "whitening" applied to the irritable parts, with a brush. Several lumps of whitening may be softened up with water into a semi-liquid paste. The powder is allowed to dry on at night, and it is sponged off in the morning. This plan is good for simple cases of nettle-rash.

The Itch.—This unpleasant disease is very common, and often occurs in the most cleanly person. It is caused by the burrowing under the skin of a little insect called the *Acarus scabiei*. These acari prefer to attack the thin skin between the fingers, and hence itch most commonly—in fact, practically always in adults—begins between the fingers. It then spreads to the wrists and the front of the arm. The irritation set up by the acari, together with the scratching, induces a pimply rash pretty generally over the front of the body. The pimples are always separate. Between the fingers, they look like little pointed watery bladders, the size of a pin's head, and the most characteristic appearance is the presence of a little black line the breadth of a human hair, and in length about two or three lines, running away from the little vesicle, as the bladdery pimple is called. This is the *burrow* of the insect. Those who are accustomed to the disease can at once pick out the insect from the end of the burrow, which looks like a minute white speck but just discernible to the naked eye. In many cases it has been scratched out, and its burrow opened by the finger-nails. The itching is bad at night when the patient gets warm in bed, or at any time when the sufferer remains too near the fire, because the itch insects then become active and lively. The annexed is the representation of the itch

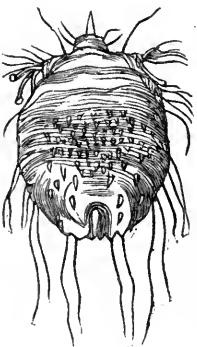

insect. But how are mothers and others to know when the itch is amongst members of the family?—whenever a minute rash occurs between the fingers in the form of small watery pimples, spreading on to the front part of the arms, and is accompanied by itching, especially at night. When the rash spreads to the front part of the body, and more than one member of the family is attacked, the suspicion of itch should at once be entertained. The rash of itch does not occur on the outside of the arms, or on the back, except in very severe cases, and these should at once be taken to a doctor. Now

the itch commences chiefly about the hands in adults; in young children it may be absent from these parts, and may commence about the seat, whilst it also attacks the feet. It leads in children to places like little boils, besides a pimply rash. When, therefore, a

child comes out with an itchy rash about the seat, and this is followed by little boil-like scabbed spots on the same place and about the feet, it probably is troubled with the itch; and this is all the more likely to be the case if the nurse has a pimply rash about the hands or on the arms. There are many pimply rashes which occur about the child's back, but then these are, in every case, uniform, whereas in itch the rash is multiform. There are red pimples, vesicles, and boil-like eruptions, together with great itching; and sometimes the irritation is sufficient to induce spots like those produced by the sting of the nettle. Now the itch if it be recognised at an early date, is very easily cured, and the remedy is sulphur, which kills the acari. The general mistake which is made is in the too long-continued and too extensive use of a much too strong sulphur ointment. The acari, or itch insects, are found chiefly about the hands, and it is to this part that the sulphur should be applied. Once kill the acari here, and the general irritation and rash subside. It is quite sufficient to use the sulphur for about three days, and to rub in an ointment, composed of thirty grains of sulphur, five drops of oil of camomile, five grains of white precipitate, and five of carbonate of potash, with an ounce of lard, to the parts between the fingers, and about the wrists, if there are any pimples, night and morning freely. Smear the ointment very gently over other pimply places for three days. At the end of that time, the whole body should be thoroughly washed with soap and water, and the disease, if it is of recent origin, will be well. If the itching do not then cease, it may be advisable to continue the ointment for a couple of days, using it gently, and *rubbing* it in only to any little bladdery pimples that appear about the hands. An eminent authority recommends this simple treatment; he condemns sulphur baths, or the ordinary sulphur ointment of the shops, and he says that he is often consulted about cases in which the too free use of sulphur has cured the itch, but has set up an artificial irritation and inflammation of the skin, which is even more tormenting than the original disease, and is sometimes troublesome to cure. The clothes worn by persons attacked with itch should be thoroughly well baked, or scalded in the hottest water.

Ringworm of the Body.—This is a very common and often a troublesome complaint. It generally occurs in little circular red scurfy itching patches; indeed, we may say that any patch which is quite round, of the size of from a sixpence to a five-shilling piece, which does not discharge or weep, which is covered, not by crusts, but thin scales, and which "clears" in the centre, is ringworm. If it occur in one member of a family in connection with ringworm of the head in other members, we have no doubt of its nature. There is a circular form of eruption, in which there are red hard elevations of a dull red tint, much like ringworm; but true ringworm is never elevated—never much raised above the level of the skin. The disease mostly occurs about the back of the neck, the forehead, or the arms. It is caused by a vegetable fungus with roots between the cells of the scarf-skin, and sets up the irritation we notice. The cure is easy in the early stage. Ink, repeatedly applied, is a favourite and useful remedy. If severe, the application of acetic acid is of service; it will blister, and must not, therefore, be rubbed in too strongly. The following ointment may be recommended for general use:—White precipitate, 3 grains; creasote, 3 drops; citrine ointment, 1 drachm; adeps, or cerate, 1 ounce. Rub in night and morning pretty freely, till all itching or scaliness disappears. The other forms of ringworm will be described in speaking of the hair.

Lice, or Pediculi.—These unpleasant visitors sometimes make their appearance in the heads of those children who are either uncleanly, or who are debilitated by severe disease. If they are numerous, it is best to cut the hair short, to wash the head very thoroughly with soap and

water, and to apply, under a cap, a little benzine, so as to confine the vapour. This will destroy all the live creatures. Ordinary stavesacre ointment may be used, or an ointment smeared over the scalp for a day or two—not rubbed in—of ten grains of white precipitate, to an ounce and a half of lard, scented strongly; for pediculi hate scents as much as they do soap and water. Tonics must be given to the weak, and pomade scented with oil of lavender should be constantly used to prevent their reappearance. In those who are uncleanly, the remedy is obvious.

HOUSEHOLD AMUSEMENTS.—II.

Prussian Exercises.—The players are drawn up in line along one side of the apartment, and are supposed to represent a regiment. On the extreme right of the party a corporal is stationed, and the captain, selected for his knowledge of the game, takes his place in front. It is his duty to give the word of command for the movements of the line, and he must do this with mock solemnity, however absurd the antics which he orders to be performed. Thus, he commences with the ordinary "Attention! Eyes right!" at which all are bound to look straight at the commander; and he then gives such orders as his own will and experience may dictate. "Fold arms;" "Extend arms!" "Slap cheeks!" "Tweak noses!" "Ground knees!" and similar evolutions, are all to be performed at the same instant by the whole company, under penalty of a forfeit; and the corporal on the right, who has had a previous consultation with the captain, sets the example for the guidance of the rest, where the meaning of the order is not clear. At the word "March!" the party must move one foot after the other, as in walking, but without changing position; at "Right march!" they move the right leg only, backwards and forwards; "Left March!" they do the same with the left. "Ground knees!" may be varied by "Ground right knee!" or "left," and in this case the regiment sinks with that knee to the ground. This is a favourable position for bringing the amusement to a climax, as follows:—When the party are on one or both knees, the order is given, "Present arms!" which they do by stretching them straight out in front. The next command is "Fire!" and the corporal who is in the secret, then gives his next neighbour a nudge with the shoulder. This causes him, as he is already kneeling, to lose his equilibrium; and falling sidewise, he brings down the next person to him, and so on along the whole line, which is thus "floored" in a moment. When young ladies and gentlemen are playing together, and it is thought desirable to wind up the exercises in more polite fashion, the word may be given to "Salute!" The players having been stationed alternately according to sex, each gentleman then salutes his neighbour to the right, to the left, or on both sides, as the captain may order.

The Courtiers.—One of the company is selected to be king or queen, and occupies a chair in the centre of the room, the rest being seated round the sides of the apartment. Whatever movement may be made by the monarch must be imitated by the courtiers; and it is the gist of the game that this should be done without any one losing that assumption of decorous gravity which becomes the scene. The monarch may yawn, sneeze, blow his nose, or wipe his eye, and the courtiers must all do the same; but if any one of them is so deficient in self-control or so presumptuous as to grin or to laugh, he or she must pay the penalty of a forfeit. It is rarely, however, that penalties are few or far between.

The Dumb Orator.—This is a very amusing performance, enacted by two persons for the benefit of the rest of the company. One of the two recites a speech, or any popular piece of declamation—"My name is Norval," or the like—keeping all the while perfectly motionless, and

without a quiver upon his countenance, while the other, standing silent by his side, gesticulates furiously, according to the emotions called up by the passage recited. Of course, the more closely he follows and burlesques the action natural to the words throughout, the greater the amusement created. There is another way of performing the same oratorical show, namely, by the two players enveloping themselves in the same cloak or wrapper, and the arms of the one—which are all the company are allowed to see of him—keeping up an action suited to the narrative of the other; but this is more awkward in the performance, and less effective than the method first described.

Speaking Buff.—At this game, the eyes of one of the players are bandaged, as in "blind man," and he is seated in the centre of the room, the party then taking their places. "Buff" holds a wand or stick in one hand, and, when all are seated, he points with this to one side of the room, or touches one of the players, at the same time uttering three words according to his fancy. The person towards whom he points must then repeat these words; and if "Buff" can discover his or her identity by the tones of the voice, he is released from his position, and the person detected takes his place.

The Shopkeepers.—This is a good game to exercise a knowledge of the various productions of nature. Each person in the company represents a shopkeeper or merchant, who has some goods on hand which he wishes to dispose of; but no two persons may choose the same trade. Any one may start the game—say, for instance, the draper—and he commences, we will suppose, by observing to his next neighbour, "I have some *silk* for sale; is it animal, vegetable, or mineral?" To this the reply would be, "Animal, for it is the production of the silkworm." The correct answer having been given—we will assume by the chemist—the latter turns to the person next him, with an inquiry suited to his trade; say, "I have some *glycerine* for sale; is it animal, vegetable, or mineral?" The rejoinder would be, "Either animal or vegetable, for it may be obtained from either vegetable or animal fat." The merchant, in his turn, may say, "I have some *shell-lac* for sale; is it animal, vegetable, or mineral?" and should receive the reply, "Animal, for it is obtained from an insect." So the game goes on, the ingenuity of each, as it proceeds, being taxed to mention some article of his stock, the origin of which may not be within the knowledge of the person addressed. A round or two of the game will rarely proceed without some of the company finding that they have added to their store of general knowledge, as well as derived amusement. Any such information as that contained in the series of papers on *The Natural History of Commerce*, which appears in the "Popular Educator," may be turned to account in sport, as well as in matters of graver moment. The game may be played, either with forfeits as the penalty of an incorrect reply, or by simply restricting the person who does not answer correctly from disposing of any of his own articles—that is, from putting any question in his turn—during that round.

Twirling the Trencher.—This is a brisk game, requiring activity without ingenuity. A circle is formed in the room, and a good space is left clear in the midst. A trencher or round wooden platter is obtained, or, if such a thing is not available, a small round tray or waiter will best answer the purpose. When all the party are seated, one of the company stands up in the centre and twirls the tray round upon the floor, at the same time calling out the name of any other person present, who must rise and pick up the trencher before it falls to the ground, otherwise he or she pays a forfeit. The person who twirls the trencher returns to his own seat immediately, and the one who picks it up, or has been called upon to do so, has the privilege of making a call afterwards.

Proverbs is a game of a more intellectual character. In this, one person volunteers, or is chosen by the company, to leave the room, and in his or her absence a proverb is fixed upon by the remaining party. The person outside is then called in, and the first person whom he addresses with any remark or inquiry, is bound to reply to him with an answer in which the *first* word of the proverb is introduced. The second person to whom he goes must reply in such a way as to bring in the *second* word; and so on, until the proverb has been repeated. He is then informed that he need not proceed further, and is left to guess the proverb chosen. If he fails in three attempts, he must again retire, and his ingenuity is tried by the selection and repetition of another proverb. Any one making an answer in which the right word in turn is not introduced, pays the penalty of a forfeit, and the company are, therefore, on the watch to see that each person addressed duly performs, the part. The great art of the game is in so wrapping up the word in the course of the reply as to make it difficult to the guesser to discover the proverb which was chosen. Some proverbs are far more easy of detection than others, from the forcible or peculiar words comprised in them, or the difficulty which the answerers find in concealing the words which fall to them in rotation. "Still waters run deep" may be taken as an example of the class difficult of concealment, for "waters" and "deep" are awkward words to introduce, and will easily connect themselves in the mind of the guesser, who is on the watch for his clue. "Where there's a will there's a way" is more capable of disguise, but "will" and "way" will reveal themselves to a person quick of apprehension. None of the proverbs chosen should consist of very many words, or the guessing may become tedious. When the proverb is detected, the guesser is entitled to claim that some one else shall take his place, and may, if he pleases, select for that purpose the person whose insufficient disguise of the allotted word gave him his first clue. Or he may name any one else in the company for the purpose. If the guesser tries his skill two or three times without success, he may claim relief from his office, and some one else may be appointed. In this, as in all other games, it must be remembered that when weariness on any side commences, amusement is at an end; and where there are symptoms of a game reaching that point, it should be relinquished for another.

WEIGHTS AND MEASURES.

A KNOWLEDGE of customary weights and measures is very desirable, and, therefore, the following tables have been drawn up in the most simple form. No. 1 is the most extensively used of all weights, being that by which we buy and sell nearly everything that is weighed. No. 2 is used principally for weighing gold and silver. No. 3 is often met with in physicians' prescriptions, although drugs are now sold by avoirdupois weight. No. 4 is that by which diamonds and other gems are weighed. The grain is divisible into sixteen parts. No. 5 represents the most frequently used of measures of length. The articles marked with a star (*) are of less common occurrence, and are, in fact, only employed for special purposes, when they are used. The degree consists of only sixty geographical miles, which are equal to sixty-nine and a half statute miles. No. 6 is used for measuring surfaces, and is employed by carpenters, glaziers, land-surveyors, &c. No. 7 is for measuring stone, marble, timber, and other solid bodies. No. 8 is used for measuring a great variety of goods, both dry and liquid.

Numerous other measures were formerly in use, but are not here given, as being out of date. There are also certain articles of commerce, as wool, cheese and butter, hay and straw, firewood, &c., for which peculiar weights are used, but, as these are principally employed in wholesale

trade, they also are omitted. Coals were once sold by measure, but must now be sold by weight. In London and elsewhere, a ton of coals consists of ten sacks, each sack containing two hundredweights. Potatoes are now commonly sold by weight, though measures are still used in some places.

1.—AVOIRDUPOIS WEIGHT.

1 Grain (gr.)			
1 Scruple	equals	10 Grains.
1 Dram	"	3 Scruples.
1 Ounce (oz.)	"	16 Drams.
1 Pound (lb.)	"	16 Ounces.
1 Stone (for meat or fish)	"	8 Pounds.
1 Stone (for general purposes)	...	"	14 Pounds.
1 Hundredweight (cwt.)	...	"	112 Pounds.
1 Ton	"	20 Cwt.

2.—TROY WEIGHT.

1 Grain (gr.)			
1 Pennyweight (dwt.)	equals	24 Grains.
1 Ounce (oz.)	"	20 Dwt.
1 Pound (lb.)	"	12 Ounces.

3.—APOTHECARIES' WEIGHT.

1 Grain.			
1 Scruple	equals	20 Grains.
1 Dram	"	3 Scruples.
1 Ounce	"	8 Drams.
1 Pound	"	12 Ounces.

4.—DIAMOND MEASURE.

1 Carat	equals	4 Grains.
1 Carat	"	3½ Gr. Troy.

5.—LONG MEASURE.

1 Inch.			
1 Nail *	equals	2½ Inches.
1 Palm *	"	3 Inches.
1 Hand *	"	4 Inches.
1 Span *	"	9 Inches.
1 Foot	"	12 Inches.
1 Yard	"	3 Feet.
1 Ell *	"	1½ Yards.
1 Fathom *	"	2 Yards.
1 Pole or Rod	"	5½ Yards.
1 Furlong	"	40 Poles.
1 Mile (statute)	"	8 Furlongs.
1 League	"	3 Miles.
1 Degree	"	69 Miles.

6.—SUPERFICIAL MEASURE.

1 Square Inch.			
1 Square Foot	equals	144 Square Inches.
1 Square Yard	"	9 Square Feet.
1 Square Pole	"	30½ Square Yards.
1 Rood	"	40 Square Poles.
1 Acre	"	4 Roods.

7.—CUBIC OR SOLID MEASURE.

1 Cubic Inch.			
1 Cubic Foot equals	1,728	Cubic Inches.	
1 Cubic Yard	"	27 Cubic Feet.
1 Load or Ton	}	40 Feet of Rough Timber,	
1 Ton Shipping		or	50 Feet of Hewn Timber.
		42 Cubic Feet.	

8.—HOLLOW MEASURE

1 Gill.			
1 Pint	equals	4 Gills.
1 Quart	"	2 Pints.
1 Pottle	"	2 Quarts.
1 Gallon	"	4 Quarts.
1 Peck	"	2 Gallons.
1 Bushel	"	8 Gallons.
1 Coom	"	4 Bushels.
1 Quarter	"	8 Bushels.

THE AQUARIUM.

MARINE AQUARIUM (*continued*).

THE selection of objects suitable for the aquarium having been made, upon reaching home they should at once be placed in as many vessels as you may happen to have at hand, and left to recover from the effects of their journey before being placed in the aquarium. The crabs will require to be secured by a perforated cover, otherwise they will be sure to find their way out.

As the introduction of a dead animal is especially to be avoided, every object should be carefully examined with a magnifying glass, and well rinsed in sea water before being put into the aquarium. If there be any suspicious indications, keep the creature in water by itself until you are satisfied that it is, or is not, in a healthy condition.

In arranging the rockwork of a marine aquarium, care should be taken to avoid the formation of hiding-places. The stones or pieces of granite should be piled up to

Begin the furnishing of your aquarium by arranging the sea-weed at the sides, leaving the space in front quite clear. The limpet-shells may either be embedded in the shingle at the bottom, or placed on the rocks, according as they may appear to the best advantage.

The crabs should next be dropped in, and supplied with food. The best food for crabs and anemones is the flesh of the mussel or oyster, cut into very small shreds with a pair of scissors. If this is not to be had, raw beef is a good substitute, but shell-fish should always be procured if possible. The edible crab before referred to is a very peaceable fellow; but the shore crab, though very like it in outward appearance, betrays a pugnacious disposition. The hermit is also fond of a little warlike exercise, from which circumstance he has acquired the common name of the soldier crab; but as the other kinds are fleeters of foot he will have no opportunity for the display of his pugnacity, unless placed in company with one of his own species. When the hermit grows too large for

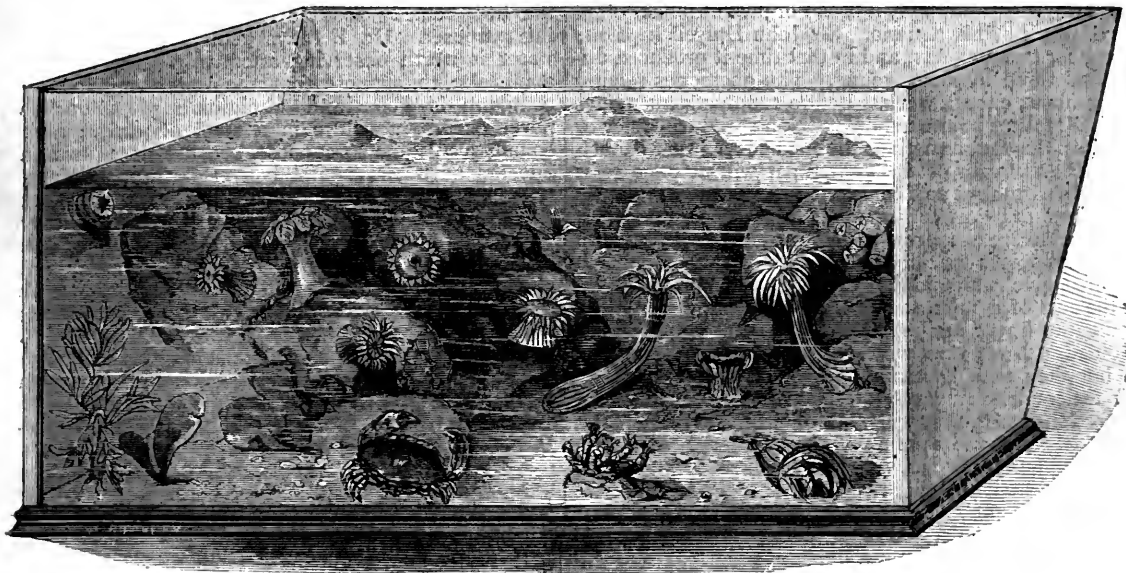

A MARINE AQUARIUM.

form a shelving background, which will shade the light, and at the same time prevent the creatures from getting out of sight. Immovable objects, such as serpulæ, should be placed so as to be easily seen. Mussels, if deposited against the glass, will cling to it and creep up the side, thus revealing the suckers of the byssus, and affording an opportunity for observation by the magnifying glass.

If the aquarium has been in preparation for some time, and green growth has commenced to germinate upon the stones, the live stock may be introduced at once. If not, the water will require to be aerated. This may be done by taking some out with a cup and pouring it back from a distance, or by emptying about one-third of the water into a watering-pot and returning it in a shower through the rose. All the creatures you have collected are accustomed to shallow water, which is well aerated by the splashing of the waves; it is therefore advisable to imitate this natural operation every day for a time, by moving a stick quickly backwards and forwards in the water, say for five minutes continuously. When indigenous vegetation has fairly set in, small air globules will be generated upon its surface, and these will rise so plentifully through the water as to give it a frothy appearance. This may be taken as a sign that other means of aeration may be discontinued.

the shell he occupies, he goes in search of another that will afford him more room, and if he fails to discover an empty one to his taste, he will attempt to dislodge any other hermit that he may chance to meet. Then comes the tug of war, the end of which is that the vanquished generally loses a claw, and not unfrequently his life. By placing in the aquarium an empty shell, a little larger than the one inhabited, the hermit may be tempted to change his cell, which he does in this wise. He first inspects the shell, walks round it, and turns it about; having made up his mind that it will answer his purpose, he withdraws his tail, which has no coating to protect it, but terminates in a pincer-like formation, pushes it into its new abode, and walks off with an evident feeling of pride at his achievement. The pincers enable him to keep tight hold of the shell, without which no hermit crab can be considered complete. On close examination it will be noticed that one claw is larger than the other; the smaller one is always drawn in first, and the larger one is laid across the mouth of the shell. Sometimes, however, the hermit does not alone occupy the shell, but will submit to accommodate a colony of serpulæ or a parasitic anemone on the outside, and a worm (the Laminated Nereus) within. Should the hermit forsake his abode and limp about in an uncomfortable manner, he will require looking after, for

that is a sure indication of ill-health, and if he does not speedily die a natural death, the more lively crabs will make a meal of his unprotected extremity.

If you have a group of serpulæ, the shell to which they are attached should be placed near the front of the glass, where they can be readily examined. If at any time one of the worms should be seen hanging helplessly out of its tube, take a needle and remove it. If a milky film be seen at the mouth of any of the tubes, its inhabitant is in a state of decomposition. To remove it, under these circumstances, the use of a crochet-needle, which has a hook at the end of it, will be found necessary.

The anemones may be dropped in one by one without regard to arrangement, for they will invariably choose some other resting-place than the spot they are wanted to occupy. There is no occasion for any anxiety as to their health, for they seem competent to resist the most adverse influences, and to exist under almost any conditions. The writer has never experienced any difficulty in keeping smooth anemones; some have lived for years without change of water, and many a brood of juveniles has dotted the rockwork of his aquaria. Sir John Dalyell kept one of these for twenty years, and in that time it produced upwards of three hundred young. The anemones require feeding about once a week. Before supplying anemones with food, take a pointed splint, stick a shred of oyster or mussel on the end, and place the food so as just to touch one of the tentacles of the animal; it will at once seize the proffered morsel and convey it into its mouth, at the same time drawing in its tentacles. These tentacles possess adhesive properties which enable the creature to catch animalcules that come in its way; and though the hairs that give it this power are too fine to be seen without the aid of a microscope, their effect may be felt by placing the finger against them when the tentacles are expanded. Anemones will remain alive without being fed, but they then generally decrease in size, and display their feelers less frequently. If you do not at the same time feed the crabs, they will walk round the aquarium, put their claws into the mouths of the anemones, and steal their food before it has had time to get beyond their reach. After a meal, the anemones eject the indigestible matter, which should be removed with a camel-hair pencil. They also occasionally exude a film, which covers the whole body, and gives it a dull appearance; this also should be removed by the same means.

The remaining specimens may now be introduced in any order; the fish, however, last.

When once furnished, the marine aquarium should not require any change of water, although it is as well to have a supply in reserve. A mark should be made on the glass where the water reaches, and when evaporation causes the water-level to descend below the mark, fresh rain-water should be poured in to make up the deficiency.

In course of time, the length of which will depend upon the amount of light admitted, a green film of minute vegetation will cover the sides of the glass. This should be wiped gently off the front by means of a small sponge tied to a stick, care being taken not to disseminate it through the water. That at the back and sides may be allowed to remain, as it is of value both in purifying the water and moderating the light.

The foregoing instructions will enable any person to furnish a marine aquarium at a small cost, and to maintain it with little trouble. Care must, however, be taken that the necessary operations are not performed hurriedly, and that everything is cleansed before being placed in the vessel. After the furnishing is complete, it will scarcely require more attention than a fern-case, while it will afford a source of constant amusement to those who are interested in watching the movements and studying the habits of the animal kingdom, to say nothing of the wide field it displays for the use of the microscope.

THE HOUSE.

WATER SUPPLY.

THE importance of a regular and sufficient supply of pure and wholesome water in every house, has been abundantly acknowledged by all intelligent people, has been proved by experience, and insisted upon by scientific men. Water enters into the composition of all our food, it is the chief ingredient in all our drinks, and it is largely present in the air we breathe. Its absence for a short time only would be followed by the extinction of our very life. In the present article we shall confine our remarks chiefly to the different qualities of water, and the modes of treating it in given circumstances. The supply of water should be constant, as it contracts impurities when stored; and water may be contaminated readily by any effluvia arising from the sink during the night, when a kitchen has no air admitted. Pure water is not possible with an intermittent supply. As to the quality of the water, one must take it as the water companies provide it, and use the best remedy possible for its purification for drinking purposes. Dr. Bernays' remark upon the purity of water is worth observing attentively. He says, "It is a mistake to suppose that the water supplied by any company is good and wholesome *if filtered*—water never occurs in nature in a state of purity; and it is equally a mistake to suppose, because water from a well appears pure and is not conveyed through pipes, that it is necessarily fit to drink. Pure water has neither smell nor taste, is colourless in small quantities, but when viewed in a mass is of a more or less blue tint; poured into a glass, it should be bright, clear, and crystal, and sparkle with the gases it contains." The same authority recommends the use of filtered rain-water for cooking and household purposes, the impurities of this water being removable by filtration, while the animal and vegetable matter which it still contains, in spite of this filtration, can be rendered harmless by boiling the water.

As a safeguard against all impurities in water—lead excepted, the presence of which is detected by a sweet, mawkish taste—the water should be boiled in a kettle, *allowed to rest*, then carefully drawn off from the sediment into a jug or pitcher, and aerated by being poured three or four times at a slight elevation from one jug into another.

It is of the most vital importance to health to ascertain the quality of the well-water if the house depends upon that for its supply. Be certain that it does not contain salts of lime in excess, which render the water hard and unwholesome, nor soluble animal matter, either of which may be largely present, and yet the water be excessively brilliant. If the water but slightly curdles soap, it is good, but if the lather separates into flakes, the water is injurious to health if drunk without first precipitating—in the form of rock or *fur* in kettles—the lime salts which it contains, and which, when drunk, are by the heat of the stomach deposited instead of being taken into the system. Soft water is a solvent of food; hard water, on the contrary, in which there is an excessive proportion of salts of lime, occasions indigestion, though that is a minor evil when compared with the mischief it brings about in other ways.

Rain-water is, next to distilled and boiled water, the best for cooking or drinking, because it very readily dissolves food in the stomach. If it be filtered, it is then as bright as any other water. Science asserts that pure water is not at all requisite for maintaining health; only it must have no putrefactive matter in it to induce disease. It is said that even the presence of certain animalculæ in the water does not injure the system, excepting when they are dead and putrid. If it be true—and there is no reason to doubt it—it is a providential arrangement, for millions must take their drink from ponds and rivers in which animalculæ abound.

There are numerous organic impurities, both of animal and vegetable matter, existing in water, which have their source in the percolations of water through cultivated lands, and consists of deposits of sewage matter. Their presence can only be detected by an analytical chemist, excepting when it is found that putrefaction readily commences if the cistern or reservoir be covered. Matters in a state of decay possess but little, if any, oxygen; and if deprived of what they have, they form themselves into new life; but if once the air be freely admitted, the process often stops, and the deleterious matter passes off in gases. Thames water, when it is taken to sea in casks, soon becomes intolerably putrescent from the gases generated in it; but on rocking them, and exposing it to the atmosphere, the water becomes perfectly sweet and wholesome. All these organic impurities (that is, those which arise from the growth and decay of vegetable and animal life) can be rendered harmless or be consumed by the filtration of water through animal charcoal. Wood charcoal, according to Professor Frankland, has not this property. Dr. Bernays, on the contrary, asserts that wood charcoal removes both smell and taste from foul water, and it is therefore well adapted to serve as a filter. It is a well-known fact that meat which has turned putrid from heat or a thunder-storm, if it be boiled for ten minutes in boiling water, with a lump of charcoal, is thereby rendered as good as ever.

Dr. Edward Rivers agrees with Professor Frankland in stating that "charcoal obtained from animal matter alone appears to possess the power of removing matter from solution in water to any extent. Wood charcoal has, however, been very much used, but with the result, consequently, of only aiding in mechanically filtering the water." But even animal charcoal after a time loses most of its purifying power, and when this is the case it will have to be renewed.

In a lecture—one of a series—delivered by Professor Frankland at the Royal Institution, he stated that lead, poisonous as it was, did not contaminate hard water, and that "soft water, circulating through leaden pipes, is soon entirely protected by the formation of an insoluble coating on the interior of the pipes;" that "tinning the interior of the pipes is dangerous, inasmuch as abrasions would lead to the formation of a voltaic circuit, and a more rapid solution of the lead." Dr. Bernays affirms that spring water may be kept with safety in leaden cisterns, provided the covers be of wood, unleaded; otherwise the pure water which rises in vapour, and settles in drops on the lid, would, if it were of lead, slowly dissolve the latter in small quantities, which would then drop into the water.

It appears, then, that water is best contained in uncovered cisterns, because the air prevents or annihilates putrefaction; that the cisterns or reservoirs should not contain much more water than is needed for daily consumption, or it becomes stagnant from the want of oxygen, and its organic matter putrefies; that putrid water can be rendered sweet and wholesome by filtering it through animal charcoal, made by strongly heating bones in vessels from which air is excluded; though, according to Dr. Bernays, simple wood charcoal will purify water equally as well.

Water should never be allowed to stagnate; the air should be admitted to it freely, by leaving exposed cisterns and reservoirs uncovered. Water which is hard from excess of carbonate of lime (chalk) can be rendered soft by long and fast boiling, by sulphate of lime (gypsum), by carbonate of soda, or by potash added twenty-four hours before the water is needed, or by exposing it in shallow tanks two or three days to the air. The remedy being so simple, persons living where the mountain-limestone or chalk abounds need not use hard water, nor need they drink it where gypsum is found.

Nitrates—that is, combinations of nitric acid with the other constituents of water—are injurious in drinking-waters. Dr. Lankester, during a lecture at the Royal Institution, analysed the water from a well-known favourite pump. It was found to be bright, cool, fresh, and tasteless to the palate, but, owing to a peculiar combination of nitric acid with the water, upon a chemical test being applied, it yielded a large amount of deleterious matter. Nitric acid decomposes all vegetable solutions, and when it exists in impure water, is highly detrimental to health; nevertheless, in a diluted form, taken in distilled water, it is not only one of the most refreshing of beverages, but is also a good tonic, and has been found useful in asthma and whooping-cough.

If a cistern or reservoir of drinking-water be placed in a scullery, or where offensive smells arise from any cause, it should be closely covered, for the reason that water quickly absorbs offensive gases, and is thereby rendered totally unfit for drinking purposes. It is a well-known fact that if a pail of water be set in a newly-painted room, the smell of the paint is rapidly absorbed by the water; and in the same way water standing for a night in an occupied sleeping-room is rendered unwholesome for drinking.

It is always advisable to have the water-pipes and cisterns brought inside the house, to prevent the water from freezing and the pipes from bursting. Exposed pipes should be covered with straw bands, which is the least permanent, effective, and troublesome method of protection.

The Board of Health enumerates several qualities which water should possess—namely, Softness; freedom from animal and vegetable matter; aëration by a pure atmosphere; freedom from earthy and mineral matter; medium temperature; limpidity or clearness; absence of special flavour or taste. These desiderata cannot be all had; but, as we have before observed, most if not all the evils complained of in water ordinarily supplied or obtained from wells can be remedied by boiling it for a long time, then aërating it, when cold, by pouring it at a height from one jug to another; by this means the flatness and deadness, usually the characteristics of boiled water, will be entirely got rid of, and the water will be as fresh and bright as ever. The safest, and indeed the only thorough remedy for all impurities, is distillation; but this is of course a more tedious and troublesome operation.

In a future article it is our intention to give some further information respecting pipes for the conveyance of water, cisterns for containing it, and other matters bearing upon our water supply

HOUSEHOLD AMUSEMENTS.—III.

FORFEITS.

IT will have been observed that many of the games already described lead up to the payment of forfeits, and that some appear to be designed for the express purpose of extracting as many as possible from the various members of the company. This is really the case, for "crying the forfeits," as it is called, often forms the most amusing part of an evening's entertainment, and is, therefore, usually reserved until the last. It is conducted in the following manner:—

Each player who has to pay a forfeit deposits some small article, or trinket, in the hands of one of the company appointed as collector—say a handkerchief, a knife, a pencil-case, or anything which can be readily identified. One article is given for every forfeit incurred, and it is redeemed when the particular task assigned to the owner has been duly performed. It is not desirable that very many forfeits should accumulate before they are

"cried," as this often takes up a considerable time; but when an average of one to each member of the party has been reached, if the number is between a dozen and twenty, it is time to stop the collection.

Two persons, chosen from the rest of the company for their knowledge of a good number of suitable and amusing forfeits, and generally ladies, cry the forfeits thus:—One is seated, and the various articles collected are placed in her lap. The other is blindfolded, and kneels down before her companion. The object of the blindfolding is to prevent the recognition of any of the articles as belonging to particular members of the company, and thus to assure something like impartiality in the allotment of the various tasks.

The person seated takes one of the articles from the collection before her, and, holding it up so that the company may recognise the owner, usually cries, "Here is a thing, and a very pretty thing; what shall be done by the owner of this very pretty thing?" This established form of words, which dates farther back than the memory of man, may, however, be reduced to the latter clause alone, if that plan is preferred. The blindfolded lady asks, "Is it fine, or superfine?" or "Is it a lady's or a gentleman's?" for this much she is allowed to know, that she may name a suitable forfeit. Having received an answer, she declares the task which the owner must perform. The following are examples of the forfeits which may be allotted.

For a Gentleman.—1. To kiss every lady in the room Spanish fashion. The person to whom this forfeit is assigned usually imagines that an agreeable task is before him; but he is thus enlightened. A lady rises from her seat to conduct him round the room, and she proceeds to each lady in turn, kisses her, and then wipes the gentleman's mouth with her pocket handkerchief.

2. To make a Grecian Statue. To do this the gentleman must stand upon a chair, and take his *pose* according to the pleasure of the company. One person may stick his arm out, or bend it into an awkward position; another may do the same by a leg; a third may incline his head backward, with the chin elevated in the air; and so they may proceed, until his figure is sufficiently removed from the "Grecian" to satisfy the party. He is bound to be as plastic as possible while the statue is moulded.

3. To perform the Dumb Orator. How to do this was described in our last paper. The forfeit may either be allotted to one person, who is to go through the action while either a lady or a gentleman volunteer recites, or two forfeits may be coupled, and both reciter and actor may take their parts as a penalty.

4. Say Half-a-dozen Flattering Things to a Lady, without using the Letter *L*. This may be done by such phrases as "You are pretty," "You are entertaining," &c., but such words as graceful, beautiful, and charitable are, of course, inadmissible.

5. To try the Cold Water Cure, the gentleman is first blindfolded, and then a tumbler filled with cold water, and a teaspoon, are produced. Not to be too hard upon him, he is allowed to take a seat. Each member of the company is then privileged to give him a spoonful; but if he can guess at any time the name of the person who is "curing" him, he is at once released from a further infliction of the remedy.

6. To play the Learned Pig. To do this, the gentleman must first put himself as nearly as possible in the attitude of one. He must go on all fours, and he is then to answer questions that may be put to him either by the company or by somebody who may volunteer as his master, to show his attainments. The questions asked are something like the following: "Show us the most agreeable person in the company," or, "the most charming," "the greatest flirt," &c. After each question, the victim is to proceed to any one whom he may select and signify his

choice by a grunt. The learning as well as the docility of a pig has its limits, and the game must, therefore, not be prolonged too far.

For a Lady.—1. To Choose Partners for a Quadrille. In this the lady, after making her choice, is informed that the quadrille must be performed *blindfold*. The gentlemen selected must be satisfied with that honour, and go through the performance which devolves upon them; but the second lady may be allowed to reclaim her forfeiture, if she has one, as compensation. All stand up, blindfolded as we have said, and go through the first figure of a set, as best they may.

2. To repeat a Proverb Backwards. Any proverb may be chosen by the lady for the purpose.

3. To stand in the Middle of the Room, and spell "Opportunity." If, after the lady has spelt the word, a gentleman can reach her before she regains her seat, he may avail himself of the "opportunity" offered, under the mistletoe.

4. To say "Yes" or "No" to Three Questions by the Company. The lady must go out of the room, while the company agree as to each of the questions to be asked. To each of these the lady must give one or other of the plain monosyllables. Ladies of experience say the safe answer is always "no;" but this hint must be reserved to readers of these papers.

HOUSEHOLD DECORATIVE ART.

V.—TO IMITATE BUSTS AND STATUETTES IN MARBLE BY MEANS OF WAX.

VERY beautiful imitations of marble or Parian statuettes may be made at a small cost by the following simple process:—

Let the experimenter begin with any well-shaped busts. Choose plaster casts measuring eleven inches high and seven broad—these can be bought for very little from the itinerant vendors; we have so purchased them for less than a shilling each; at the shops they will be charged from eighteen-pence to half-a-crown (on account of a difference in the quality), but they are worth the extra cost if you wish to have them nicely done, and a close imitation of marble.

Procure a pound of perfectly white wax candles (six to the pound), break up and melt three of these in a small saucepan—a pint one is about the size, it should be deep enough well to contain the wax.* Also have ready a basin, about eight inches in circumference, if shallow and spread at the mouth the better; put the basin on a large dish to catch any droppings of wax. The kitchen table will be a convenient place, as the work must be done where it is tolerably warm, especially if in winter. The operator begins with the pedestal, takes the head of the cast next, and finishes with the bust. As soon as the wax is melted, hold the *pedestal* of the statue over the basin, and pour the wax all over it in a full wash, so as to get it quite smooth. Return the wax from the basin to the saucepan, and pour it again over the pedestal (this may be repeated three or four times, but directly the wax begins to thicken melt it again, because as it cools it will leave guttering marks). Completely cover the pedestal, but do not let any of the wax touch the bust. If the back is not quite perfect it can be left till the last. Next take the *head*, hold it, face upwards, over the basin, and pour the wax over it, beginning near the chin: the throat, head, and

* Paraffin candles are excellent for this purpose, being very white, hard, and admitting of a high polish; and its cheapness is a recommendation, but the material is dangerous. To use it in safety, the candles must be melted and used instantly, not left on the fire to get over-heated, or the paraffin will ignite. In finishing a certain bust with paraffin candles we let the melted material remain over a gas stove after it was melted, and it caught fire; some one threw water on it, which caused an explosion, nearly filling the kitchen and singeing the eyebrows and hair of the operator. The safest way in such accident is to let the fire quietly burn itself out.

face ought to be covered each time. When you have given these several coats of wax, so that the work is about half finished, hold the *bust* across the basin, and cover it in the same way, moving the saucepan from side to side so as to cover it well with each coat. After this you will probably find that the whole figure needs more wax. The thickness of the wax when finished should be about the sixteenth of an inch, measured by a rule, but judgment is the best guide.

The things it is most necessary to guard against are irregularities in pouring on the wax, dust, smuts, and dirt. The hands and all utensils must be kept very clean. There may be black marks in the cast which show very prominently when the first coat of wax is put on, but which become obscured before the figure is finished. Do not touch these, but from time to time you may remove any droppings or prominent blemishes carefully, either *before the wax sets* or *after it is hard*, as when it begins to set, the whole thickness of coatings will peel off in large blotches if disturbed. When the final wash has been poured on, and the whole is partially set, you may carefully cut away all excrescences, and model your figure (placed near the fire so as to be warm, but not to melt the wax) in every part by degrees, with the hands and fingers, rubbing the rounded parts if not quite smooth, and pressing out improper marks by repeated manipulation. If the back have any parts not covered with wax, these may be made good by patching on and moulding in any small pieces of half-melted wax there may be about.

On the following day, when the wax is thoroughly hardened, polish it all over by rubbing it lightly and quickly with the fingers and palm of the hand. It will take a very high polish, and this finishing admits of the exercise of considerable skill and patience, which will be rewarded if the work is done well enough, as it may be, to deserve putting under a glass shade.

The work may be done at different times; a coat of wax may be laid on one day and another the next, or when it is all laid on and modelled the polishing may be delayed for some days; but the modelling must be done while the wax is almost warm from the last coat.

The quantity of wax needed to cover a bust of the size mentioned is five candles out of a pound of six. It would be less trouble to have a deep pipkin full of melted wax and dip the figure repeatedly into it; but this would require a great deal more wax, and therefore be more expensive. This would, however,

be worth while if it is intended to operate upon many busts and statuettes. A quantity of wax will melt best in a large glazed pipkin with a lid, placed in a hot oven.

COLOURED TRANSPARENCIES.

Trace the subjoined design on a large square of moderately stout cardboard; or, instead of a square, say a piece fourteen inches by eleven. The tracing should be as light as possible. With a sharp penknife cut round the entire outline, leaving the vase and flowers attached only at the base, A to A. It will be perceived that none of the pieces are entirely severed from one another, every one being joined at some place to the

whole. Thus there is one continuous outline, but none of the other lines must touch it, or each other. The centres of the leaves are cut through in the middle, but the cut does not extend to the sides. Colour the portion of the card indicated by the dotted lines E to G, on the opposite side of the card from which it is to be looked at, from B to C, and from D to E, with a smear of strong carmine, from C to D with sap green, from F to F cobalt blue, and all the rest of the edges within the dotted lines with a paler tint of green. The part round the vase is left uncoloured. Let the colours be both deep and full. They must be put on very strong in tint; no skill is needed; any one can do it well with a paint-brush. When completed, bend the

group of flowers and vase the very least bit possible backwards through the aperture. In this state hold it up towards the light of a candle or single gas-burner, the coloured part turned towards the light. The effect is beautiful. Wall papers with floral designs will furnish ample models, or any vase or group of flowers, only in cutting them the operator

must remember never to sever them entirely one from another. The best way to trace a pattern for this purpose is to prick the design all over and dot through the pricked holes in pencil; or use a tracing-paper made by scraping a quantity of black chalk or charcoal on a piece of writing-paper, and rubbing it well into the paper. Place this face downwards on the card. Having previously traced the design you wish to produce on transparent tracing-paper, place it on the black, and with a sharp pencil mark the outline hard. Enough will remain on the card for the experimenter to lightly draw in the subject when the papers are removed. The less the outline which is drawn is visible, the better the effect. Busts and statues also form charming subjects, and may easily be traced from photographs.



DESIGN FOR A TRANSPARENCY.

COOKING.

CHRISTMAS FARE.

IN the present paper, we propose to give recipes and directions for the making and preparing of some of the dishes which usually form the staple of an English dinner at Christmas.

Roast Beef.—For roasting, the sirloin of beef is considered the prime joint. Before it is put upon the spit, the meat must be washed, then dried with a clean cloth; cover the fat with a piece of white paper fastened on with string. Make up a good strong fire, with plenty of coals put on at the back. When the joint is first put down, it should be about ten inches from the fire, and then gradually drawn nearer. Baste it continually all the time it is roasting, at first with a little butter or fresh dripping, afterwards its own fat will be sufficient. About ten minutes before it is to be taken up, sprinkle over it a little salt, dredge it with flour, and baste it until it is nicely frothed. The time it will take in roasting depends upon the thickness of the piece; a piece of sirloin weighing about fifteen pounds, should be roasted for three hours and a half, while a thinner piece, though of the same weight, may be done in three hours. It must also be remembered that it takes longer to roast when newly killed than when it has been kept, and longer in cold weather than in warm.

Roast Turkey.—For preparing a turkey for cooking, be careful to remove all the plugs, and singe off the hairs. Put into the breast a stuffing made of sausage-meat, with the addition of bread-crumbs mixed together with the yolks of two eggs beaten up; rub the whole bird with flour and set it down to roast. It should be continually basted with butter, and when nearly done, which may be known by seeing the steam drawing towards the fire, it must be dredged with flour, and again basted. Serve in a dish with gravy, garnished with sausage or forcemeat balls. Bread sauce, which is served in a sauce tureen, is eaten with it.

Plum Pudding without Eggs.—Take a table-spoonful of flour, a quarter of a pound of suet finely minced, half a pound of grated bread, about a couple of ounces of brown sugar, and half a pound of currants cleaned and dried; a glass of brandy may, if you choose, be added. Mix the ingredients with sufficient milk to make them into a stiff batter, and boil in a cloth for four hours. With the addition of half a pound of stoned raisins and a little candied peel, the same pudding will be very nice baked.

Plum Pudding.—Take one pound of currants carefully cleaned and dried, one pound of raisins stoned and chopped, one pound of flour, one pound of beef suet finely minced, six eggs well beaten up, one ounce of candied orange-peel, half an ounce of candied lemon-peel chopped small, half a pound of brown sugar, and a tea-cupful of cream, the grated peel of one lemon, and half a large nutmeg grated; one glass of brandy may also be added. Mix the solid ingredients well together in the flour, adding the liquids afterwards. Tie the pudding in a cloth or mould, put it into a copper of boiling water, and keep it boiling for seven hours. When it is taken out, strew grated loaf sugar over the top and serve. If a mould is used, it should be as deep and narrow as possible.

Another Recipe.—Half a pound of currants, half a pound of raisins stoned, three table-spoonfuls of flour, three table-spoonfuls of bread grated fine, six ounces of beef suet minced, eight eggs beaten up, five ounces of brown sugar, a small grated nutmeg, a pinch of salt, three cloves pounded, and half a tea-spoonful of ground allspice; a glass of brandy may be added, if it be liked; mix all the ingredients carefully together, and boil for three or four hours.

A Plum Pudding (economical).—Take one pound of raisins opened and stoned, six eggs, a claret-glass of rum or brandy, a quarter of a pound of minced beef suet, a

pound of flour, half a pound of sugar, a teaspoonful of salt, the peel of a lemon shred fine or chopped, and a quarter of a pound of bread-crumbs. Half a pound of well-washed currants will make your pudding still better. Stir in with these as much new milk as will bring the paste to the proper consistency. Then lay a pudding-cloth in a basin, dust the inside well with flour, pour the pudding into it, tie it up with string, not too tight, leaving a little room for it to swell; throw it into a large boiler, or small copper full of boiling water, let it boil galloping not less than four hours, though five are better. Do not turn it out of the napkin on to the dish, until immediately before it is wanted, in order that it may go to table *light*. If sauce is required, make some melted butter, and stir into it a table-spoonful of sugar, and a glass of brandy, if you like the flavour. This quantity made into *two* puddings, will cook more speedily and thoroughly.

A smaller Plum Pudding (reasonable).—Mix together three eggs beaten well, one teaspoonful of salt, half a pint of new milk, a quarter of a pound of chopped beef suet, half a pound of raisins stoned and chopped, two ounces of well-washed currants, two ounces of powdered sugar, half a nutmeg grated, and ten cloves, an ounce and a half of candied citron-peel; one wine-glass of brandy is an optional addition. The quantity of flour and bread-crumbs added will depend upon the richness which you wish your pudding to be of.

Family Plum Pudding (very palatable)—from "Wholesome Fare."—Beat up four eggs well, add to them, first, half a pint of new milk and a teaspoonful of salt. Then mix in half a pound of beef suet, chopped very fine; a pound of raisins stoned and chopped; a quarter of a pound of currants; a quarter of a pound of brown sugar; one nutmeg grated; one ounce of candied peel, out into thin small strips. Stir all well together, and add another half-pint of new milk; then beat in sufficient flour to make it a stiff paste. You may add a glass of brandy and a glass of white wine. Tie it up and boil it—in a mould or basin five hours, if in a cloth, four; but the pudding is better, as well as more shapely, when boiled in a mould or basin. It may be enriched by blanched almonds, and a larger proportion of currants and candied peel; but *too* rich a pudding will hardly hold together, and is apt to fall to pieces when turned out on the dish. For sauce, make some good melted butter; put in some loaf-sugar, and, for those who are fond of it, a glass each of white wine and brandy, and a dessert-spoonful of noyau or any other favourite liqueur at hand. Let it just boil up after mixing, then pour half of it over the pudding, and serve the rest in a hot sauce-boat. This pudding may be made with the grated crumb of household bread, as well as with flour. It is better so, if to be eaten cold. Plum-puddings may be made a fortnight, or longer, before they are wanted, and will be all the mellow for the keeping, if hung up in a dry place where they will not mould.

Plum Pudding with Apples.—Stone and chop fine two ounces of raisins, take four ounces of apples minced very small, four ounces of currants cleaned and dried, four ounces of grated bread, two of loaf sugar pounded, half a nutmeg grated, and a small quantity of candied orange and lemon peel. Mix all these well together with four eggs beaten up, and an ounce and a half of melted butter just warm.

Sauce for Plum Pudding.—Warm about two or three table-spoonfuls of sweet cream, and mix it with the yolks of two eggs, add a table-spoonful of sugar, season with grated nutmeg and stir over the fire till it is quite hot, but take care not to let it boil. For those who like it, wine, brandy, or rum, about three table-spoonfuls of either, may be added.

Mince Meat, for Mince Pies.—Mix well together half a pound of raisins, stoned and chopped small; half a pound

of currants washed; half a pound of chopped beef suet; ten or a dozen apples peeled, cored, and chopped; a quarter of a pound of lean beef without skin or fat, boiled and chopped; one nutmeg grated, and a teaspoonful of allspice; a quarter or half a pound of candied peel, according to the richness desired, chopped. Put them into an earthen jar with a close-fitting cover, and pour a pint of brandy over them. Stir up these ingredients from time to time. Mince-meat is best made a fortnight or three weeks before it is wanted.

Mince Pies.—Of suet, chopped very fine and sifted, two pounds; currants, two pounds; raisins, one pound; apples, two pounds; bread, half a pound; moist sugar, one and a quarter pounds; red and white wine, mixed, three-quarters of a pint; a glass of brandy (these two last according to taste); the peel of two small lemons, and the juice of one; four ounces of candied orange-peel, cut. Mix, with cinnamon, mace, nutmeg, and salt, to the taste. If preferred, omit the bread, substituting two biscuits.

Old-fashioned Mince-meat.—Take a pound of beef, a pound of apples, two pounds of suet, two pounds of sugar, two pounds of currants, one pound of candied lemon or orange-peel, a quarter of a pound of citron, and an ounce of fine spices; mix all these together, with half an ounce of salt, and the rinds of six lemons shred fine. See that the ingredients are thoroughly incorporated, and add brandy or wine according to your taste.

HOT DISHES EASILY SERVED AT SHORT NOTICE.

All Soups; but note that mouthful soups, as turtle, mock turtle, peas and pork, giblet, ox-tail, hare soup, &c., are best warmed up or kept hot in an earthen jar plunged in a saucepan of boiling water, both to avoid burning, and to diminish the amount of evaporation from the soup, and so keep it from becoming too thick. Tapioca, vermicelli, macaroni, and pastes in general, thrown into clear stock or *consommé*, take time to cook, and must therefore be prepared, though apparently so simple.

All Boiled Fish: Large fish, as cod, turbot, halibut, skate, salmon, John Dory, sturgeon, conger, &c., to be cut in steaks, or slices, as served in portions by the Paris restaurants; small flat fish to be simply cleaned; small long-shaped fish, as whiting, haddock, jack, &c., to have their tails thrust through their gills, or tied in their mouths. To stuff fish takes longer time; but balls of ready-cooked stuffing can be heated up with them in the salted water in which they boil. Of course the fish are ready cleaned, prepared, or trussed, to be thrown at a moment's notice into the boiling water. Simple sauces, as melted butter, caper, ready-opened oyster, essence of anchovy or shrimp, &c., can easily be made while the fish is boiling. Fish not usually divided, like large mackerel, and which take a good half-hour to boil, are best split open at the belly, flattened, and fried.

All Fried Fish and Broiled Fish, when a suitable fire—as charcoal, which is speedily lighted, and always clear—is at command. Large fish must be cut into steaks like cod, or squares, like pike. Smaller fish need only be well scaled and cleaned inside, leaving on the fins and head for show. The smallest, as gudgeons, smelts, sprats, and whitebait, only require a good wiping and drying. When the cook is supplied with the *proper means*—i.e., a *deep frying-pan* and *plenty* of good fat, a large fish, as a mackerel, haddock, gurnard, pike, or carp, will fry in much less time than it will boil, and, if nicely done, make a greater show. The fish will be ready wiped, dried, floured, or bread-crumbed, lying on a dish fit for immediate use; the fat dissolved in the deep pan, covered to keep out blacks, &c., and only requiring to be set on the fire, to bring it up to frying heat.

Small Things.—These must be the housekeeper's main dependence for a *hot* repast served in a hurry; and some of them are difficult to class separately from what she is

obliged to serve as roasts. Tossed or sautéed mutton or beef kidneys, in gravy or wine. Savoury omelettes, of sweet herbs, grated cheese, chopped bacon or ham, containing a ragout of veal kidney, sweetbread, salmon, green peas, asparagus tips. Matelotes of fish and meat, combined or separate, half fried previously with the onions. Fricassees of veal and chicken, ditto. Curries of various things, ditto. Vol-au-vents; ragout made previously. Sweetbreads; served white or brown. Calf's head à la tortue, not whole, but in portions. Plain boiled ditto. Black pudding.

Boils.—The list of these is very short. With the exception of sausages, most meat articles of food are both too large and too solid to cook in that way in a short space of time, besides being spoiled by *quick* boiling. Hens' eggs, in the shell, if fresh, and done to half a minute, are excellent. Choice and remarkable eggs may be served boiled in the shell. All require boiling as long as hens' eggs; some longer. There is the egg of the common duck, the nearly black one of the East Indian duck, the brown one of the cochon china and other breeds of fowls, the small thick-shelled buff one of the guinea-fowl, and the pinky-brown speckled one of the turkey. The pea-fowl's egg very much resembles that of the ostrich in miniature, being smooth, but indented all over with dimples. It is somewhat bigger than a turkey's, of a dull, yellowish white, and occasionally freckled with a few small reddish-brown marks. Pheasants' eggs are delicate; so are lapwings', rooks', and waterhens'. The eggs of various gulls and other sea-fowl are full-flavoured, rich, and peculiarly grateful to many palates. A goose's egg, poached without breaking, makes quite a little dish, enough to set before three or four persons. Plovers' eggs are also esteemed a great delicacy.

Vegetables.—Ready-mashed potatoes, browned in the oven in *small* basins or tin moulds. Cold boiled potatoes warmed up maître d'hotel way. Souffléed potatoes. Sliced or quartered potatoes, done in a hot bath of fat. Green peas, French way, or à la bourgeoise, warmed up. French beans, French way, idem. Dried haricots, either plain, boiled, with parsley and butter, or Breton fashion. Stewed tomatoes. Stewed, broiled, or ovened mushrooms. Fried cardoons, celery, and salsify. Stewed artichoke bottoms, cooked beforehand. Spinach, either true or patience dock, the better for a second or third heating-up. Chopped cabbage, ditto, to support pork chops. Purée of sorrel, ditto, for warmed-up fricandeau of veal. Broad beans, with melted butter and summer savory, ditto; old Windsor beans, skinned and stewed, ditto. Asparagus, half-cooked before; sea-kale, ditto; both of these served with melted butter poured over them.

Roasts.—Pork or mutton kidneys, fried, broiled, or roasted before the fire in a Dutch oven. Veal kidney, sliced and fried. Lamb chops, with cucumber sauce. All sorts of chops and cutlets, whether fried, broiled, plain, or bread-crumbed; half-cooked, and finished off in a ready-made ragout à la jardinière. Fried or roasted sausages. Beef steaks from the rump and the under-part of the loin. Broiled fowl, with mushroom sauce. Broiled pigeons. Small birds, as larks, thrushes, wheatears, rails—land and water—lapwings, knots, stints, &c., roasted in a saucepan. Civet of rabbit, hare, or venison, is a substantial meat dish quickly served: the same may also be said of hashes of various roast meats. Calf's liver and bacon, fried à la mode beef, and stewed ox-cheek, may be kept hot for hours, and ready for serving at a moment's notice.

Third Course.—Pancakes, with sugar and orange to squeeze over them; apple fritters; bread fritters; plum pudding, or sweet suet pudding, sliced, toasted, and sauced with brandy; sweet omelette, filled with various preserves—strawberry, ripe gooseberry, raspberry, currant jelly black or red; rum omelette; anchovy toast; welsh rabbit; curry omelette.

ANIMALS KEPT FOR PROFIT.—POULTRY.

V.—THE FATTENING OF CHICKENS (*continued*).

IN front of each compartment, as described in our last paper, there should be a ledge three inches wide, on which to place the food and water-tins. The latter must be replenished once, the former three times a day; and after each meal the pens should be darkened for half the time until the next, by hanging a cloth over the front. This cloth is best tacked along at the top, when it can be conveniently hung over or folded back as required. The two hours' darkness ensures quiet and thorough digestion; but it is not desirable, though often done, to keep the birds thus the *whole* time till the next meal, as the chickens will have a much better appetite on the plan we recommend.

The best food for fattening is buckwheat-meal, when

on a small scale, everything must go upon system; and that system is, to kill the chickens the very day they are ready for it.

If extra weight and fat is wanted, the birds may be crammed during the last ten days of the fattening period, but not before. The meal is to be rolled up the thickness of a finger, and then cut up into pellets an inch and a half long. Each morsel must be dipped in water before it is put into the bird's throat, when there will be no difficulty in swallowing. The quantity to be given can only be learnt by experience.

For home use, however, nothing can equal a chicken never fattened at all, but just taken out of the yard. If well fed, there will be plenty of good meat, and the fat of a fowl is to most persons no particular delicacy. In any case, however, the chicken must be kept without food twelve hours before it is killed.

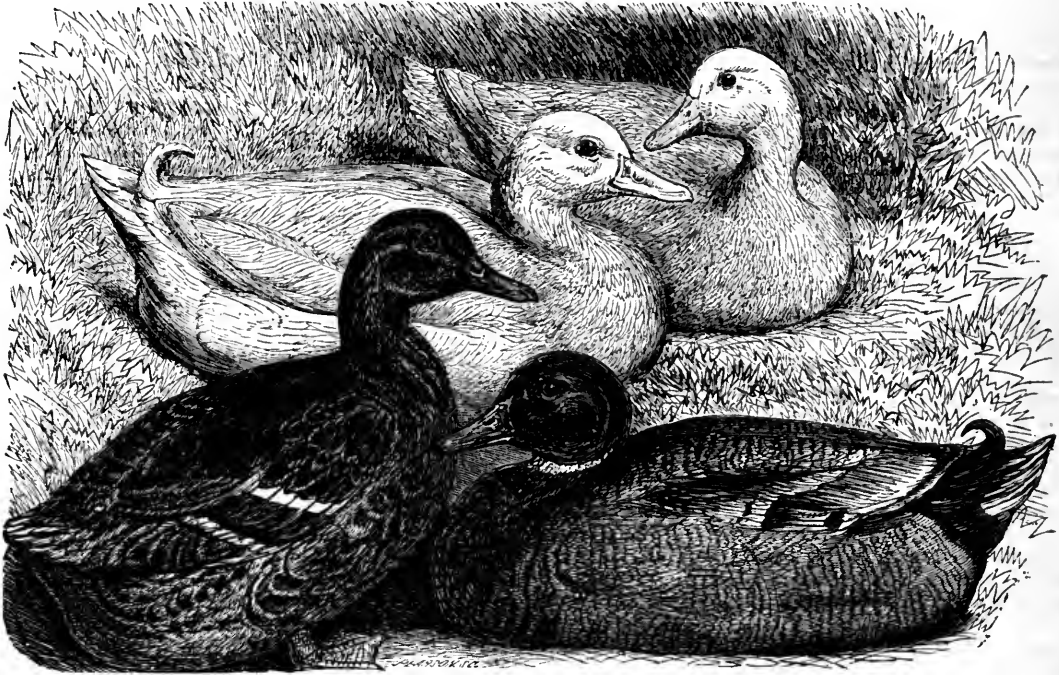

ROUEN AND AYLESBURY DUCKS.

it can be obtained; and it is to the use of this grain that the French owe, in a great measure, the splendid fowls they send to market. If it cannot be procured, the best substitute is an equal mixture of Indian and barley-meal. Each bird should have as much as it will eat at one time, but no food must be left to become sour: a little barley may, however, be scattered on the ledge. The meal may be mixed with skim milk, if available. A little minced green food should be given daily, to keep the bowels in proper order.

In three weeks the process ought to be completed. It must be borne in mind that fat only is added by thus penning a chicken; the lean or flesh must be made before, and unless the chicken has attained the proper standard in this respect, it is useless even to attempt to fatten it. Hence the importance of high feeding from the very shell. The secret of rearing chickens profitably is, to get them ready for the table at the earliest possible period, and not let them live a *single day after*. Every such day is a dead loss, for they cannot be *kept fat*. Once up to the mark, if not killed they get feverish, and begin to waste away again. To make poultry profitable, even

There are various modes of killing—all of them very effectual in practised hands. One is to give the bird a very sharp blow, with a short but heavy stick, behind the neck, about the second joint from the head, which will, if properly done, sever the spine and cause death very speedily. Another is to clasp the bird's head in the hand, and swing the body round by it—a process which also kills by parting the vertebrae. M. Soyer recommends that the joints be pulled apart, which can easily be effected by seizing the head in the right hand, placing the thumb just at the back of the skull, and giving a smart jerk of the hand, the other, of course, holding the neck of the fowl. And, lastly, there is the knife, which we consider the most merciful plan, as it causes no more pain to the bird than that occasioned by the momentary operation itself.

Fowls are easiest plucked at once, while still warm, and should be afterwards scalded by dipping them for just one instant in boiling water. This process will make any decent fowl look plump and nice, and poor ones, of course, ought not to be killed at all. They should not be "drawn" until the day they are wanted, as they will

keep much longer without. We now pass on to the other inmates of the poultry-yard.

DUCKS AND GEESE.

Ducks will do well in a garden or any other tolerably wide range where they can procure plenty of slugs and worms, with a pond or cistern only a few feet across. Kept in this manner, they will not only be found profitable, but very serviceable; keeping the place almost free of those slugs which are the gardener's great plague, and doing but little damage, except to strawberries, for which they have a peculiar partiality, and which must be carefully protected from their ravages. Other fruit is too high to be in much danger from them. In such circumstances there can be no doubt whatever that ducks are profitable poultry; and where many fowls are kept, a few ducks should be added, as they will keep themselves, very nearly, on what the hens refuse; but where every atom of the food they consume has to be paid for in cash, our own opinion is that ducks do not pay to rear except for town markets, their appetites are so everlasting and voracious. This point, however, we must leave to the experience of the reader. The Aylesbury duck is of the purest snow white all over. The head should be full, and the bill well set on to the skull, so that the beak should seem to be almost *in a line* from the top of the head to the tip. The bill should be long, and when viewed in front appear much like a woodcock's. Eye, full, bright, and *quite black*. The legs should be strong, with the claws well webbed, and in colour of a rich dark yellow or orange. Immense numbers of these ducks are bred around Aylesbury. It is not at all unusual to see around one small cottage 2,000 ducklings, and it has been computed that upwards of £20,000 per annum is returned to the town and neighbourhood in exchange, whilst the railway not uncommonly carries a ton weight of the birds up to the London market in a single night. The Aylesbury duck often begins to lay before Christmas. Rouen ducks are not nearly so forward, rarely laying till February or March, but they make better layers. They are very handsome, and will weigh eight or nine pounds each; and, *as a rule*, do much better in most parts of England than the Aylesburs. Their flesh is excellent. The best general description of the Rouens are those which in plumage are precisely like the wild mallard, but larger. The drake should have a commanding appearance, with a rich green and purple head, and a fine long bill of a yellow ground, with a very pale wash of green over it, and the "bean" at the end of it jet black. His neck should have a sharp, clearly-marked white ring round it, not quite meeting at the back. Breast, a deep rich claret brown to well below the water-line, then passing into the under body-colour, which is a beautiful French grey, shading into white near the tail. The back ought to be a rich greenish black quite up to the tail-feathers, the curls in which are a rich dark green. Wings, a greyish brown, with distinct purple and white ribbon-mark well developed. The flight-feathers must be grey and brown; any approach to white in them is a fatal disqualification, not to be compensated by any other beauty or merit. Legs, a rich orange. Nothing can exceed the beauty of a drake possessing the above colours in perfection. The bill of the duck should not be so long as in the drake, and orange brown as a ground colour, shading off at the edges to yellow, and on the top a distinct splash or mark of a dark colour approaching black, two-thirds down from the top; it should there be rounded off, and on no account reach the sides. The head of the duck is dark brown, with two distinct light brown lines running along each side of the face, and shading away to the upper part of the neck. Breast, a pale brown, delicately pencilled with dark brown; the back is exquisitely pencilled with black upon a moderately dark brown ground. The

shoulder of the wing is also beautifully pencilled with black and grey; flight-feathers, dark grey, and ribbon-mark as in the drake. Belly, up to the tail, light brown, with every feather delicately pencilled to the tip. Legs, orange, often, however, with a brown tinge. The Muscovy, or Musk duck, appears to be a totally distinct breed, the cross between it and other ducks being, at least usually, infertile. The drake is very large, often weighing ten pounds, and looking far more on account of the loose feathering; but the female is less than the Aylesbury, not exceeding about six pounds. The plumage of this species varies greatly from all white to a deep blue-black, but usually contains both. The face is naked, and the base of the bill is greatly carunculated. The drake is very quarrelsome, and we well remember the injuries inflicted by an old tyrant of this breed belonging to a relative, upon a fine Dorking cock in the same yard. The flesh of the Musk duck is very good eating; but it is far inferior as a layer to either the Rouen or the Aylesbury, and cannot be considered a very useful variety. Call ducks are principally kept as ornamental fowl. The flesh is good; but there is too little to repay breeding them for the table, and their only proper place is on the lake. The East Indian, or Buenos Ayres black duck, is a most beautiful bird. The plumage is black, with a rich green lustre, and any white, grey, or brown feathers are fatal. They are bred as small as possible, never exceeding four and five pounds. As they usually pair, equal numbers should be kept of both sexes. The flesh of this duck is more delicious than that of any other variety, in our estimation. The Cayuga, or large black duck of America, is a breed well worth naturalising in this country, being hardy and a good layer. The plumage is black, approaching brown, with a white collar or neck. Weight, from six to eight pounds each, being thus inferior to the Aylesbury and Rouen, but with better flavour, and greater aptitude to fatten. The common duck needs no description. We believe it to be the Rouen more or less degenerated, or rather, perhaps, not bred up to the perfection of that breed. It should be remembered in keeping ducks that the *wild* birds are monogamous, and not more than two or three should be given to one drake, if eggs are wanted for sitting. The duck usually sits well, and always covers her eggs with loose straw when leaving them, a supply of which should therefore be left near her. The usual number laid is fifty or sixty in one year; but ducks have laid as many as two hundred and fifty; and we believe with care this faculty might be greatly developed, and their value much increased as producers of eggs. At present they are mostly kept for table. Ducks should have a separate house, with a brick or stone floor, as it requires to be frequently washed down. Clean straw should be given them at least every alternate night. Other attention they need none, beyond the precaution of keeping them in until they have laid every morning. This is necessary, as the duck is very careless about laying, and if left at liberty will often drop her eggs in the water whilst swimming. When intended for *fattening*, ducks should only have a trough of water instead of their usual pond, and should then be fed on barley-meal. Celery will add a delicious flavour. In ordinary rearing the ducklings should be left with the hen, or mother-duck, and kept from the water entirely for a week or ten days; then only allowed to swim for half an hour at a time, till the feathers begin to grow, else they will be liable to die of cramp. They will soon be totally independent of their mother, and may then be left entirely to themselves; only taking precautions against *rats*, to which ducklings fall victims far oftener than any other poultry.

Geese.—Of the two principal breeds of geese, the grey or Toulouse is larger and handsomer than the Embden or white; they are also better shaped, as a rule, and every

way the more profitable variety. The forehead should be flat, and the bill a clear orange red. The plumage is a rich brown, passing into white on the under parts and tail coverts. The Embden goose is pure white in every feather, and the eye should show a peculiar blue colour in the iris in all well-bred birds. We should recommend for market to cross the Toulouse goose with the white, by which greater weight is gained than in either variety pure-bred; but much will depend upon circumstances. White or cross-bred geese require a pond, but the Toulouse, with a good grass run, will do well with only a trough of water, and will require no extra feeding, except for fattening or exhibition. With regard to the general management of geese little need be said. More than four or five should not be allowed to one gander, and such a family will require a house about eight feet square; but to secure fine stock three geese are better to one male. Each nest must be about two feet six inches square, and, as the goose will always lay where she has deposited her first egg, there must be a nest for each bird. If they each lay in a separate nest the eggs may be left; otherwise they should be removed daily. Geese should be set in March or early in April, as it is very difficult to rear the young in hot weather. The time is thirty to thirty-four days. The goose sits very steadily, but should be induced to come off daily and take a bath. Besides this she should have in reach a good supply of food and water, or hunger will compel her, one by one, to eat all her eggs. The gander is usually kept away; but this is not very needful, as he not only has no enmity to the eggs or goslings, but takes very great interest in the hatching, often sitting by his mate for hours. The goslings should be allowed to hatch out entirely by themselves. When put out they should have a fresh turf daily for a few days, and be fed on boiled oatmeal and rice, with water from a pond, in a very shallow dish, as they should not be allowed to swim for a fortnight, for which time the goose is better kept under a very large crate. After two weeks they will be able to shift for themselves, only requiring to be protected from very heavy rain till fledged, and to have one or two feeds of grain daily, in addition to what they pick up. For fattening they should be penned up half-a-dozen together in a dark shed and fed on barley-meal, being let out several hours for a last bath before being killed, in order to clean their feathers.

INMATES OF THE HOUSE.—DOMESTIC.

II.—THE COOK.

In small households, where only one kitchen servant is kept, the duties of the cook comprise those which devolve on the kitchen and scullery-maids of larger establishments. Whether the domestics be few or many, however, the cook's position is second in importance to none save that of the housekeeper.

The only portion of housework which a cook in a moderate-sized family is generally expected to undertake is the cleaning of the hall, the entrance, and the dining-room—work which can be done before breakfast, and consequently without hindrance to her special vocation of cooking. In very few instances will a good plain cook consent to clean boots and knives. If she does, a knife machine is generally stipulated for, and is not an unreasonable request when the interruption knife-cleaning occasions is taken into consideration. Cinder-sifting, likewise, belongs to cook's work in small families, and is much facilitated by the use of a patent sifter, of which more anon.

The principal qualities to seek in a cook are early rising, cleanliness, punctuality, and sobriety. Honesty is, of course, essential in every department of domestic service, but the want of this virtue is apt to display itself

in cooks less in acts of commission than of omission. By failing to make the most of the stores entrusted to her care, or by disposing of articles of food for her own profit, what is indulgently termed "want of economy" becomes actual dishonesty, and tends considerably to impoverish the means of employers. Therefore, in taking the character of a cook, it is important to ascertain whether she has the practice of turning every article of consumption—remnants, &c.—to the best account for her employer's sake. A servant that possesses such knowledge, and is willing to apply it to its right use, deserves better wages than one who recklessly squanders her master's substance. If the pounds annually saved by an intelligent and faithful servant were remunerated by a reward of so many shillings, there is no doubt that a spirit of economy would be more often displayed than is the case where no note is taken of similar virtues.

A great point would be gained towards securing more efficient cooks than now usually fill situations of the kind, if every mistress of an establishment would prosecute her inquiries as to the applicant's fitness for the place beyond the regular stereotyped questions relative to the reasons for leaving the last situation, wages, &c. Suppose, for instance—a satisfactory account of moral character having been given—the employer were to test the servant's knowledge of cooking by a few practical questions, such as: How long do you make up your fire before roasting? What time do you allow for boiling a leg of mutton of a certain weight? What use do you put cold vegetables to? What do you do with bones and dripping? How much fresh meat do you require per week to supply soup in a given number of days? How much meat do you consider should be consumed weekly in the kitchen? How many loaves do you think are sufficient for a family of so many persons? &c.

By similar inquiries, the good opinion of a well-informed servant, far from being diminished, would increase in favour of the employer; and the bane of ignorance would cease to characterise the present body of cooks as a class. As much for the benefit of the inexperienced employer as the employed, the following directions are given.

First, with regard to the kitchen fire. A good manager will keep the winder of the range close handy, in order to enlarge or narrow the opening according to the culinary operations required. This cannot be easily done if the grooves are suffered to become choked with cinders and dust. The only way to obviate this difficulty is never to light the kitchen fire before first sweeping out every portion of fuel.

A fire for roasting requires a somewhat wider opening than the length of the joint about to be suspended in front. Meat should always be put down before a "mending fire"—that is, one which has been made up of coals still unconsumed. It is bad economy to throw up the cinders for a roasting fire until the joint is done. A well-made fire should burn steadily with very little stirring until the joint is half cooked, when the meat-screen or dripping-pan should be moved from the front of the fire; the lower bars of the range should be thoroughly raked out from dust, the burning coals should be brought gently to the front, and the back filled in with fresh, surmounting the top with a few pieces of coke and small lumps of coal mixed. By this means the progress of the joint in getting too rapidly cooked on the outside is arrested, and gives the heat a chance of penetrating to the centre. A fire thus made will burn briskly by the time when the appetising browning of the joint is needed. Half the failures in roasting are attributable to putting a joint down before a fierce fire, and finishing with a slack one.

Slow roasting at the commencement is indispensable to the preservation of the flavour of the meat. This may be effected by regulating the distance from the fire. About

fourteen inches will be found a good distance, admitting of the joint being "neared," towards the end of the cooking process.

Fresh killed meat requires longer to roast than when "hung." Meat a little frozen should be put into cold water till thawed, and will be improved by being hung in the kitchen over-night. This rule applies especially to Christmas joints, such as sirloin of beef, and turkeys of all sizes. Fat meat takes rather longer to roast than lean; about twenty minutes to half an hour extra on a large joint will be sufficient. The usual time allowed for roasting is from fifteen to twenty minutes to every pound, according to the strength of the fire and size of joint.

Some cooks are partial to frothing their roasts, by using flour. A well-cooked joint needs no such addition to its natural appearance, the streaks of gravy which flow from the centre, when the joint is well done, being ornament sufficient. If any flour be used, it should be very lightly dusted on from the dredger, about half an hour before the joint is taken up.

Made gravies are generally considered objectionable with roast meat. Every joint should be made to supply its gravy in its own trimmings. Pieces of flap, shanks of mutton, &c., which are not usually sent to table, should be put into a small saucepan, with some water or plain stock, when the joint is set down. These should be afterwards strained, and either poured over the burnt ends, or added to the gravy which has flowed from the joint into the dripping-pan. A pinch of burnt sugar will supply the browning. The best gravy of all for roasts is that which is cleared from the dripping saved from a former roast joint, to which may be added some boiling water and a little salt. Gravy should never be poured *over* a roast joint. It is a good plan to send the gravy to table in a sauce-boat, or tureen.

Poultry requires to be put down before a brisk fire, and should be previously lightly dredged with flour, and covered with clarified beef dripping. Hares will eat more tender if, for the first half hour of roasting, they are basted with salt and water in the proportion of a dessert-spoonful of salt to half a pint of water. When basted the above time, the salt and water should be removed, and fresh dripping laid in the pan. Some people recommend water and salt as a first basting for all joints. The mixture certainly improves the colour of the roast, but we fancy at the cost of its flavour, the salt exciting a too hasty flow of the gravy.

Now that the use of close stoves and kitcheners has become so general, the art of roasting in front of a fire is in danger of being lost. "Roasting in the oven," as the new method is termed, to be successful, requires a jar of boiling water to be put into the oven with the joint. The steam keeps the meat from becoming dry on the outside, and prevents the objectionable flavour of burnt fat. The water should not be removed till the joint is ready to brown. *This practice holds good for all baking in the side ovens of the ordinary kitchen-range.*

Boiling is a more simple process of cooking than roasting, and fails generally from being too hastily performed. A steady simmering is all that is necessary to maintain during this mode of cooking, for which purpose cinders mixed with a little coal, and the refuse from the trimmings of vegetables will be found to answer best. Boiling is not an economical method of dressing meat, if the liquor in which the joint is boiled is afterwards thrown away; therefore, not more water should be used for the purpose than will just cover the meat. When the water is near boiling, scum will rise to the surface, and should be carefully removed as fast as it is formed. When the scum no longer rises, the pot may be set aside to simmer until the end. Wrapping meat in a cloth and boiling in milk or lemon-juice is often recommended to secure a whiteness of appearance, but no mode is so effectual as the patient

removal of the scum itself which causes the unsightly aspect. From twenty minutes to half an hour per pound of meat, will not be found too long to boil a joint slowly and well.

Cold water should be used for boiling, whenever the liquor is to be afterwards converted into soup.

All kinds of fish with the skin on should be put into cold water, with about a dessert-spoonful of salt to a quart of water. Crimped cod, slices of salmon, and other cut fish, must be put into boiling water containing the above proportion of salt. The water should barely cover cut fish. A whole fish, weighing about four pounds, will take about half an hour to cook, *after the water has come to a boil*. Skimming is as necessary for fish when boiling, as for meat. As soon as the water has boiled, the cover of the fish-kettle should be tilted on one side, to prevent the skin of the fish from cracking. Some kinds of fresh-water fish are considered to be improved by boiling a few herbs in the water, such as sprigs of thyme, bay-leaf, &c., according to taste.

Frying, being an expeditious mode of cooking, is in general favour with inferior cooks, but, if carefully performed, is both economical and wholesome. Of all modes of cooking, however, none are so liable to prove unsatisfactory as that of frying, unless the nicest discernment is exercised as to what articles will fry well, or not. The chief drawback to success in this branch of cookery, in England, is the shape of the ordinary frying-pan. Although one is constantly told in cookery books that "frying is simply boiling in fat," the vessel in which the process is usually performed precludes the possibility of complete immersion. In France, where frying is most successfully practised, the frying-pan is generally from seven to eight inches deep, rendering the first principle of the art easy to be carried out. Too little fat, insufficient heat, and want of careful preparation, are apt to make fried dishes in English households wasteful and indigestible.

Before putting whatever is to be fried into the pan, sufficient fat should, if possible, be put into the vessel to cover the article. The pan should be scrupulously clean. If there is any doubt upon this score, it is best to melt a little fat in it over the fire, and wipe the pan out with the fat, which should afterwards be put aside. The great art of good frying is to know when the fat is hot enough. This may be ascertained by sprinkling a few drops of cold water into the fat when supposed to be nearly boiling. If the water hisses, the fat is hot enough. A piece of bread dipped in hot fat will be the best test as to whether it is over-heated or not. If the bread just browns, the fat will do; if it blackens, the fat should be thrown away, as it will destroy whatever is put in it.

It is essential to a good colour of fried food that the articles should be perfectly dry. The only exception to having things perfectly dry before frying is parsley, which, to look green and crisp, should be shaken through cold water immediately before it is plunged into the pan.

Lard is excellent for frying fish, and, if not burnt, may serve for several times. Beef and mutton dripping are better for meat. Oil is much used by foreigners, but if not of the finest quality gives a disagreeable flavour to viands. Butter is the least desirable of all fats for the purpose, on account of the salt and water in it; and it has besides a disposition to blacken, unless great skill be used.

Broiling is a favourite mode of English cookery, and is especially adapted to our taste for plain meat. In order to broil successfully the gridiron must be perfectly clean. It should previously to being used be heated over the fire, and wiped between the bars with mutton or beef suet, or fat. A clear fire is needful, but not necessarily a large fire. The gridiron should be raised slightly at the back. A good cook will never leave the fire when broiling is in progress, the chief art being to keep the meat constantly turned in order to prevent the pieces from settling. Forks

should never be used for turning meat. A small pair of steak tongs soon defray their cost in the amount of nourishment they save. If a fork *must* be used, the cook should avoid sticking it in the prime part of the meat.

Broiled meats should not be sent to table in gravy, still less should the meat be slashed to supply a gravy. A little pepper and salt, just before removing the meat from the fire, is all the relish usually necessary. The plates and dishes cannot well be too hot on which a broil is served.

The above are the simple rudiments of plain cooking, and should be familiar to every servant who undertakes a cook's situation in an English household. It is not possible here to give full details of the duties of a cook, who should, however, understand the making of pies, puddings, pastry, and bread in general; she must also know how to prepare sauces, gravies, and soups; she must be competent to dress vegetables, and prepare all ordinary herbs; she is to know the value and importance of her stock-pot, and to see that it is never forgotten; she is expected to be acquainted with the most effectual methods of keeping provisions, uncooked or cooked; she must look well to all the arrangements of her larder, kitchen, and kitchen utensils, and must know how to serve up all ordinary dishes. In many families some of the duties of the housekeeper fall to the cook's share of work, and will form the subject of another chapter.

DOMESTIC SURGERY.

TEETHING.

The Gums and Teeth.—The proper care of the teeth as organs most essential for the preservation of health, cannot be too strongly impressed upon parents. Many of the illnesses of childhood are directly connected with the eruption and development of the teeth; and these will be more particularly referred to in other papers, the object of the present article being only to point out those facts in connection with the teeth which every well-educated father and mother should be acquainted with. Each individual has two sets of teeth, the temporary and the permanent; the former being contained in the jaws at birth, and taking their proper positions within the first three years of childhood, the latter being at the same time developed in the jaws and appearing from the sixth to the twenty-first years. The temporary teeth are twenty, and the permanent thirty-two in number. In the illustration (Fig. 23), taken from the jaws of a child of from six to seven years old, the whole of the temporary teeth are seen in their proper positions, and in addition, the crowns of four of the permanent teeth have appeared through the gum at the back of the temporary set. The remaining permanent teeth are those embedded in the jaws, and at present imperfectly developed.

The teeth of the two jaws correspond in number and form, and the temporary teeth are as follows:—In the centre of each jaw are four cutting or incisor teeth; on each side of these is a pointed canine or eye tooth; and beyond these again two grinding or molar teeth. In the permanent set the teeth are of course larger, and are the following:—There are four incisors, two canine, and four small pre-molar or bicuspid teeth, as in the child; but, in addition, there are on each side three large grinding or molar teeth, the last of which is called the wisdom-tooth, from its being cut only when years of discretion are supposed to have been reached.

The period at which each tooth makes its appearance through the gum is pretty constant, though it will depend somewhat upon the growth and health of the child. On an average, the central incisors are cut about the seventh month; the lateral incisors from the seventh to the tenth month; the front molars from the twelfth to the fourteenth

month; the canines from the fourteenth to the twentieth month; and the back molars from the eighteenth to the thirty-sixth month. The permanent teeth appear in a different order, the earliest being the first molars; and these appear in the sixth year, and take their places immediately behind the temporary teeth. The two middle incisors are cut about the seventh year, and these necessarily displace all four of the temporary teeth; the two lateral incisors appear in the eighth year; the first bicuspid in the ninth year; the second bicuspid in the tenth year; the canines from the eleventh to the twelfth year; the second molars from the twelfth to the thirteenth year; and the wisdom-teeth from the seventeenth to the twenty-first year. It is to be understood that the above enumeration applies to both jaws, but that the teeth of the lower jaw are usually a little earlier in their appearance than those of the upper jaw.

Lancing the Gums.—When an infant is cutting its teeth its mouth is hot, and the gum is swollen and tender. Great relief may be afforded, and even its life may be saved, should it be subject to convulsions, by freely lancing the gums. This operation should of course be performed by a medical man, if one can be procured, but, in case of urgent need, a parent would be justified in performing it himself, if provided with a proper instrument, and having some knowledge of the subject. The gum-lancet is a steel instrument of the shape shown in Fig. 24, and may be procured of any surgical instrument-maker. In lancing the gums of the lower jaw it will be most convenient to have the infant held against the breast of a nurse, and in the sitting position, when the operator, sitting or kneeling in front, must steady the jaw with the left hand, as shown in Fig. 25, and with the right make a steady cut on the top of the inflamed gum down to the crown of the tooth, against which the edge of the lancet should be made to grate. In lancing the gum of the upper jaw, the infant may be most conveniently held on the knees of a nurse, and with the head fixed between the knees of the operator, who can then lean over and see clearly what he is about. Lancing of the gums should only be resorted to when the tooth makes a prominence through the gum, and it will therefore usually make its appearance in a day or two. If, however, the gum has been lanced a little prematurely, no harm will have been done, the gum being more yielding after than before the operation, and the hæmorrhage, which is never of any amount, serving to relieve the over-distension of the part.

Care of the Teeth.—The temporary teeth require some supervision on the part of the parent, as the child is too young to do more than complain if he is in pain. Children who have suffered much from infantile diseases almost invariably have badly-developed and unsound first teeth, but may, if well cared for, grow up strong and vigorous, and with sound permanent teeth. It is a common error to suppose that the administration of medicine has caused the early decay of the first set, or the unsightly markings sometimes present on the second set of teeth; whereas it is the disease for which the remedies were given which has left its trace behind. The molar teeth, both of the first and second set, are most liable to decay, and a child's mouth should be carefully examined from time to time to see if any of these teeth are discoloured or hollowed out. If they are, the child should be at once taken to a dentist, to have the diseased tooth stopped before it becomes painful, so that it may not become necessary to extract it before its full time. As the permanent molar teeth take up their position behind the temporary teeth, it is most important, for the full development of the jaw and the proper arrangement of the teeth, that the temporary teeth should not be extracted too early. At the same time, if the jaw should be small, and the teeth are taking up irregular, and perhaps too prominent positions, it may be necessary to extract even some of the permanent teeth at

once, in order to allow the others to take their proper places. For this purpose a parent should consult some respectable dentist, carefully avoiding all unqualified practitioners, and should be careful to see that all the directions he gives are carried out, and particularly that any mechanical arrangement which may be necessary in order to bring irregular teeth into position, is fairly and fully attended to.

Later in life, in addition to the ordinary cleaning of the teeth with tooth-brush and powder, or soap, it is well to pay an occasional visit to the dentist to have the "tartar," or earthy matter deposited by the saliva, removed from the front teeth. Even in the most cleanly mouths this is apt to collect and injure the gums, if it does not the teeth also; and, as it is very tenacious, it requires some skill for its removal. At the same time the dentist should be requested to inspect all the teeth, in order to detect the first inroads of disease, so that by careful "stopping" the mischief may be arrested. The nature of the stopping to be applied in each case must of course be left to the discretion of the dentist, but a patient should on no account consent to the insertion of a cheap "amalgam" stopping into any of the front teeth, since this always leads to great discoloration of the teeth, and consequent disfigurement. When toothache supervenes upon decayed teeth, recourse must of course be had to the dentist, who may, in favourable cases, contrive to save the tooth by destroying the nerve and then carefully stopping the cavity. Extraction is the last remedy, and has recently been robbed of nearly all its horrors by the introduction into dental practice of the administration of the nitrous-oxide gas as an anæsthetic. This gas, when carefully administered in its pure state, has the power, like chloroform, of rendering the patient perfectly insensible, but has this advantage over chloroform, that the insensibility is much shorter, and that recovery from its influence is immediate, and unattended with sickness. Many dentists are in the habit of administering this agent for all cases of extraction of teeth, but no person should take this, or any other anæsthetic, without first consulting his ordinary medical attendant.

Toothache is perhaps the most agonising pain to which one can be subject. If, from circumstances, immediate recourse cannot be had to a dentist, relief may sometimes be obtained temporarily by the insertion of a pledget of cotton-wool soaked in laudanum into the hollow tooth, and by the application of warm fomentations to the face. Several specific remedies are sold, which are certainly efficacious as a temporary application in cases of toothache, and the introduction of a few drops of warm laudanum into the ear often does good. The formation of an abscess around a tooth may be known by the deep-seated throbbing

pain it gives rise to, and the extraction of the tooth is the only certain way of obtaining relief.

False Teeth are exceedingly healthful, by supplying the lost power of mastication; and no one who has lost his back teeth should hesitate to have the want supplied artificially, both for his own comfort and also for the preservation of the front teeth, upon which an undue amount of work would otherwise be thrown. Artificial teeth can be had of every price, but here, as elsewhere, we would say, avoid an unqualified dentist, whose cheap teeth would be dear at any price, since the purchaser would have no comfort in wearing them. The question of the necessity for extracting the stumps of teeth must be left to the judgment of the dentist; but if, as often happens, it is advisable to remove some, it will be necessary to wait some weeks before the model of the mouth can be properly taken so as to ensure a proper fit. One caution only need be given with regard to false teeth, that they should always be removable at will, and should invariably be removed from the mouth when the wearer goes to bed.

Inflammation of the Tonsils constitutes one of the common varieties of "sore throat." The sufferer experiences pain and difficulty in swallowing, and talks with a peculiar thick voice, which is very characteristic. On looking

into the throat the back part of it is seen to be red and inflamed, and the tonsils are found to be almost blocking up the passage. If there is much fever and constitutional disturbance a medical man should be consulted at once, but the best domestic treatment consists in frequently gargling the throat with hot milk and water, and the application of linseed-meal poultices round the throat. The bowels should be thoroughly relieved with an ordinary aperient, and the patient should be fed with nourishing food, in the form of soup or broth, and will probably be the better for a glass or two of port wine. If an abscess forms in the tonsil, it may produce alarming symptoms of suffocation by its presence, and a surgeon should be at once called in to open it. An

abscess may burst of itself into the throat, and thus give relief, but only after many hours' suffering.

Enlarged Tonsils are often found in young persons of delicate health, and give a peculiarly vacant appearance to the countenance by obliging the sufferer to keep the mouth constantly open, and to breathe heavily. A more serious consequence of enlarged tonsils is, however, the effect upon the chest produced by the imperfect admission of air to the lungs, the tendency to the deformity called "pigeon-chest" being common in these cases. The only effectual treatment is for the surgeon to remove a portion of each tonsil; and this can be safely done even in young children.

ERRATUM IN SOME COPIES.—On page 112, Part II., line 30 from top, for "femoral" read "temporal."



Fig. 25.

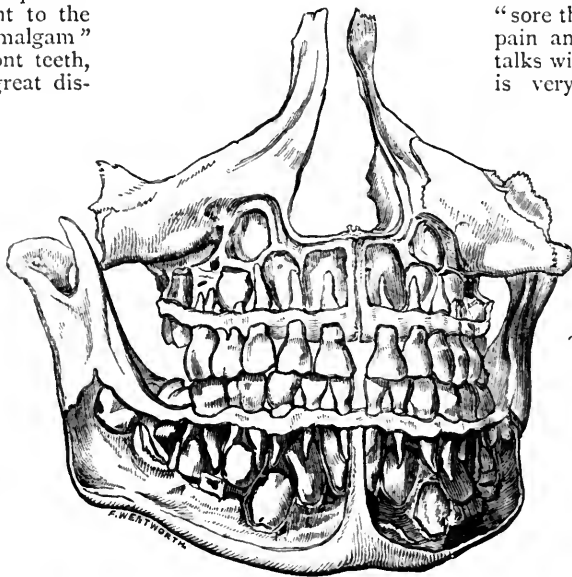

Fig. 23.



Fig. 24.

HOME GARDENING.

ROTATION CROPPING (*continued*).

August.—1. Early strawberries will have completed their work in the producing line, and the late kinds be making progress, and therefore it will be necessary to give them their summer dressing, by clearing away all weeds, runners, and whatever material was laid down for the purpose of keeping the fruit free from grit and dirt. A good watering with liquid manure will prove very beneficial both to those that have done bearing and those that are coming into fruit. Raspberries will be in full bearing now, and as much depends on the gathering, we would advise daily recourse to the trees for that purpose, until they have ceased to yield. These, like strawberries, should be kept entirely free from weeds and other litter, and be occasionally supplied with liquid manure. 2. The whole of this plot, if properly managed, will be under winter crop, with the exception of that portion occupied by a few potatoes intended for seed. Under good management, broccoli will have been planted, and turnips sown by this time, and, if so, little remains to be done, except the making up of deficiencies, of which our readers will be the best judges. 3. This department being of a permanent nature, little need be said, save to recommend salt to be sparingly scattered over sea-kale; but rhubarb will need a more generous food, and must have its full quantum. Weeds must be in all cases kept at bay, and neither crop must be permitted to extend beyond its proper boundary. 4. As the onions in this plot will have made considerable progress, a vigilant watch must be kept upon them, so that as soon as they are ripe they may be pulled up, dried, and stored away in some dry, airy place. The ground thus rendered vacant should be at once planted with celery, in single trenches, forty-two inches asunder from centre to centre, and not deeper than eighteen inches. A six inch layer of well-rotted stable dung should be mixed up with the soil at the bottom of each trench, previous to planting. The first row planted will require earthing-up by this time, and this operation you cannot do better than see to at once. A good watering will also prove beneficial in dry weather. 5. Such peas as are over should be removed without delay, to make room for future crops, or for the broccoli planted between them. Any gaps in the rows of savoys, Brussels sprouts, &c., should be filled up at once, and as soon as the whole of the peas have done their work for the season, remove the haulms, stir the surface of the ground, and give it a good soaking with liquid manure, for the purpose of encouraging the growth of the broccoli and other green crops, which will require earthing-up shortly. 6. As this plot is at present entirely occupied by kidney beans, both dwarf and runners, you will merely have to keep the ground clear of weeds, and see that the latter have proper support. 7. Provided the requisite quantity of beans were planted here, and the carrots were properly thinned last month, all you will have to do for the present is to remove the haulms of the first crop of beans as soon as done with, and keep the compartment tidy in all other respects. 8. As some of the early celery is still in this quarter, due attention must be given to it, so far as earthing-up, watering with liquid manure, and weeding, is concerned. A moderate quantity of endive may be planted out here, and a few lettuces might very well be planted upon the celery ridges, provided it can be done early in the month, because, if left later, the ridges will be required for earthing-up before the celery can be cleared away.

September.—1. No time should be lost in giving this plot the dressing advised last month, provided you have hitherto omitted to do so, and there will be little required afterwards save keeping weeds under, and getting rid of any litter that may perchance accumulate thereon. As the raspberries—that is to say, the earlier ones—will have done

bearing by the end of the month, you may cut away the old canes, and thus strengthen the young ones, and thereby increase their fruitfulness next year. Place stakes to the autumn-bearing ones, to which secure them from time to time, as required. A few of these late-bearing kinds should be cultivated in every garden. 2. This compartment, provided it has been properly treated, will be filled entirely with winter crops, and all the attention they will require at present is earthing up. Such of these vegetables, however, as are at all backward will be greatly assisted by one or two applications of liquid manure. Not that we approve of gross growth, as that only tends to make them more susceptible of injury from frost and so forth; but in moderation assistance of this kind will be found very beneficial. 3. The chief attention required here is to keep the ground entirely clear of weeds, with the exception of gathering seed of sea-kale that has been permitted to ripen. 4. The growth of celery must be hastened by every legitimate means, because the onion crop will have prevented your putting in the plants so early as you would otherwise have done. Earth up such as are ready for the operation, but not otherwise, as we are no advocates for performing this kind of work too hastily. Where lettuces or the celery ridges have been cut for the table you may remove the old stalks, for two reasons—first, to promote the growth of the celery, and, secondly, for the purpose of giving the plot a neat and orderly appearance. 5. The peas in this plot will soon be done with, and the removal of their haulms will give more room to the savoys, broccoli, and other winter stuff planted between them. In a word, as soon as you have cleared away the former, give the soil a moderate digging, and a slight allowance of liquid manure. In a little time the latter may be earthed up a little, that is to say, as soon as they have taken advantage of the additional space accorded them, which their roots will have done in a week or so; and fill up all gaps in the rows, and keep the weeds under by the continual use of the hoe. 6. As soon as the kidney beans have given over bearing, the ground they occupied should be cleared, manured, and trenched for a supply of spring cabbages, which may be planted as soon as the ground is ready for their reception. Let the rows be two feet apart, and the plants one foot asunder in each row, so that every other one may be drawn early, and the others left to heart. 7. The broad beans occupying a portion of this plot should be removed as soon as they have completed their work of bearing; and, having manured and dug the ground, it will be ready to receive cauliflowers or some similar crop. The carrots in this compartment will need little or no attention till the end of the month, when they will be ready for taking up and storing away. The parsnips and beetroots, as a rule, should be left in the ground until March, with the exception of such as you may require for use between now and that time. 8. It will be necessary to earth up the celery several times during this month, taking care, however, not to commence the work too early, nor to allow a particle of earth to enter the hearts of the plants. Coal-ashes will be found beneficial for blanching the latest crop, provided they are placed against the plants and an additional outer lining of soil is added. Endive, which should be advancing rapidly on this ground, must be kept perfectly free from weeds, and on no account must anything be allowed to enter the hearts of any one of the plants.

October.—1. Little or nothing will be required here for the present, with the exception of putting a stop to the growth of weeds by rooting them up with the hoe, and the removal of every description of litter. The late raspberries will most probably still continue to bear, and as they do not like dry weather you will be doing them a good turn by supplying them with a little moisture. Suckers may, and indeed should, be removed as soon as they are

ripe, but the pruning may be postponed till the spring with advantage. 2. This compartment, if filled with winter crops, will need very little care save earthing up such of them as have not yet been attended to. 3. The seakale in this plot will be ready for forcing towards the end of the month, which can be accomplished in two ways, namely, on the ground with the aid of inverted flower-pots and long litter, and by taking the roots or stools up and bringing them forward in a heated structure of some kind. 4. Every attention should be paid to the earthing up of celery on this plot, and provided dry weather continues, a good watering with liquid manure will be found to improve its growth. 5. In a general way the peas on this quarter will have been gathered long ere this, and in that case the sooner their haulms are cleared off the better it will be for the broccoli and other green stuff that has occupied the intervening spaces. Of course, it will be some time before they resume, or rather acquire, their natural colour, but the air will enable them to do so. 6. Provided you did not put in the cabbage plants as advised last month, you should do so now, on the spot from which the kidney beans came. The ground, however, must be well manured and dug or trenched previously, and the strongest plants alone used. 7. The carrots may now be taken up and stored, but the parsnips and beetroots should be left in the ground for the present. The portion of the plot just cleared of the carrots should be at once well dug, and, provided it is moderately sheltered, it will do for the first crop of early cauliflowers. 8. If necessary, thin out the late-sown turnips, but this must be done in moderation the first time. See that such things as lettuce and endive be fully exposed for the present, and that celery be earthed up when requisite, if a dry day be chosen for the work.

CAGE-BIRDS: THEIR HOMES AND TREATMENT IN WINTER.

THE annual mortality of cage-birds in autumn and winter is far greater than that of other seasons; this is very much due to the houses in which they live. They require exercise and warmth, and they are often destitute of both to a sufficient degree. The rooms in which their cages hang are frequently hot by day and cold by night; and as for exercise, how can an active bird get what is worth the name in his little circular wire prison and low narrow cell, which forbids all free use of his wings? Men of judgment and experience have long since condemned all the little cages of a circular form, not only because their limits are so confined, but because they supply the bird with no shelter whatever. Why should birds in confinement have no chance of hiding their heads, when they have so strong a liking for the practice in a state of nature? In winter especially, the best cage is oblong, and only open in front. It can be made handsome, and such small birds as goldfinches, linnets, and canaries, will be all the better and happier for one. The ends of such a cage may be formed of wire as usual, and covered in with a sheet of glass. In a cage so made, birds may be kept safe from the effects of the sudden changes of temperature which are so injurious. Proper attention to this one particular will stop half the gaping, panting, and wheezing which distress our birds so commonly now. To add to their dangers, in this country it begins to get extremely cold very often while our captive warblers are partly denuded of their feathers by moulting. This renders it all the more needful to look well to the lodgings of cage birds, for it is hardly possible for them to get through the winter well if they begin it either without their winter coat or an equivalent. The process of moulting in birds, like that of dentition in children, is trying, and calls for special care, and this is another reason for urging our plea.

When moulting in winter they require plenty of air, as well as green food, and generous diet generally. *Seed birds*, which we have mostly in mind, should not be limited to one sort of seed, but should have flax, canary, and bird-turnip seed, as well as groats. They do not want a bath in winter, though requisite in summer; but if the claws become encrusted gently, put them in warm water to cleanse, and as gently dry them afterwards. Keep their cages very clean, and their trays, and all that pertains to them. Let their nicely sanded floor be a credit to you. See that vermin are extirpated. Let the birds have a little *old* mortar, broken up, to keep them in lime. Cover up their cages at night, but not so as to stifle them. Generally do your utmost to feed them with varied and nutritious diet, as green herbs, chopped boiled egg, crushed bread and butter, and the seeds above named, and you will see your birds prosperous and happy.

Our remarks are not wholly inapplicable to other birds, but chiefly refer to those which are named. The same general principle may be extended to all cage birds, to the full details of whose general treatment we intend to devote a paper in a future number.

THE HOUSEHOLD MECHANIC.

BLINDS.

FIG. 60 shows the commonest form of blind—the common roller blind. It is almost too well known to need description. The roller, A, is made from a square strip of one and a quarter or one and a half inch wood, with the corners planed off until the piece is octagonal. On one end, usually the right hand, is fastened a little grooved wheel, B, and through the centre of both, the pivot, C, a piece of stout iron or steel wire, is driven. At the other end of the roller a similar pivot is driven through a sort of flange, D, which is just to keep the blind from running over the end. The pivots at each end are supported in two brackets, of hard wood or metal, something like E F, one having only a hole, as F, through it, the other a hole and an oblique cut from the top, into which to drop the pulley-end pivot, after the other pivot has been thrust into the hole F. Over the pulley, B an endless cord, G, runs, which cord also runs round the pulley, H, which may be fastened in any convenient position on the side of the window-frame. This pulley is in a small brass frame, which works in the slide, I, the back of which is formed into steps like a ratchet. Into this a spring on the frame of H catches, and in such a manner as to allow the frame to slide downwards only. The object of this movement is the tightening of the cord, G, in order to keep the blind wherever it is wanted. The material of which the blind is composed is tacked to the wooden roller, and in a wide hem at the bottom a lath is slipped, and a tassel and cord are fastened to the middle with a screw-ring, for the convenience of pulling the blind down. This form of blind, however, has many disadvantages; for instance, as its firmness is dependent on friction entirely, it is subjected to an unusual amount of strain at its working parts, which working parts are often of too soft a material and of too hasty a manufacture. The process of pulling up is also tedious and inconvenient, the edges of the slide, I, often scratching the fingers. It is not wonderful, therefore, that many devices have been thought of and patented to remedy these evils. We illustrate one of these plans, not as being superior to many we have seen, but simply to show the principle on which they are most of them based, it being quite impossible to mention all. Fig. 61 shows a front view of this arrangement. The frame, A, is screwed on to the window-frame, in the same position as the wood brackets before mentioned, and has in its edge a hole at C, to carry the blind pivot. So far, there is no material difference. The roller is also just the same, but at each end it is let into a hollow iron end,

which terminates in a pivot fitting into the hole C. On the end of this box is a sort of drum, D, and further out still a ratchet-wheel, E (Figs. 62 and 63). Round the edge of this ratchet-wheel is found a sort of band of brass, which is liged to the bracket, A, at F, and on this band is a small drop-tooth, G, which takes into the ratchet. The lower end of the band terminates in a projection, H, in which is a small hole. The bracket supporting the other end of the roller (Fig. 64) is quite simple, the catch A falling over the oblique slit by its own weight, thereby preventing the pivot from jumping out of its place.

Now suppose we have the blind coiled round the roller, as in the last case, and slipped into its place in the brackets, the band G falls over the ratchet, which cannot move because of the tooth in G. Fasten a thin cord to the hole in the side of the drum, and pass it through the eye, H, and let a sufficient length hang down. The stick in the bottom of the blind requires to be heavier than usual, because its weight has to bring the blind down.

To let the blind down, take hold of the string, I, and raise it backward, as shown in Fig. 63. This will bring up the band G, and with it release the tooth from the ratchet; and the cord, being allowed to slip through the fingers, will be coiled on the drum by the descent of the blind. To draw it up it is only necessary to pull the string, I, thereby drawing from the drum the cord coiled on it, the back of the teeth in the ratchet raising up the little catch in G, which falls into its place by its own weight. When all the cord is drawn off the drum, the blind should exactly reach the top, so that the possibility of over-winding the blind is prevented. No tassel is necessary to this arrangement.

The spring-blind consists of a hollow cylinder of metal (tin-plate), in which a spiral spring is coiled. The act of pulling down the blind by the tassel, winds up the spring; but a spring lever catch falls into a ratchet at one end, and prevents it from flying up again. The lever is pulled up by a string fastened to it, and the blind goes up. It is necessary

to steady it up with the tassel, to prevent too sudden jerks. These arrangements can hardly be recommended, because, from their construction, they are rather liable to get out of order, and should the spring break, the cost of its renewal is considerable.

We now come to the most elaborate, though decidedly the most complete of all—the Venetian blind. This consists of a series of thin flat laths, the full length of the width of the window sashes, and about three inches wide,

suspended by means of tapes at about two inches apart. These laths are capable of being turned obliquely, either outwards or inwards, or of being altogether raised out of the way. The advantage of thus being able to modify the light afforded, while, at the same time, free ventilation between the laths is in no degree impeded, is such as to need no comment or recommendation.

The method by which these varied required adjustments are attained will be seen by reference to Fig. 65, which shows a two-tape light Venetian blind. A series of thin laths are strung by means of tapes, D, at intervals of about two inches, as before stated. The bottom lath, C, being much thicker and stronger than the others, and the top lath, B, the same. The wide tapes run from the top lath, B, to the bottom, C, on both sides, and hold the thin laths in their places by means of thin tapes sewn to the wide ones alternately on the right and left edges. From one edge of the lath E, on the outside of the tapes D D, are two wide tapes running up to the top board, A, and round two wide

pulleys, E E, in it to the other edge, so making a triangular sling, which suspends the top lath from which the whole set hangs. The board A is screwed to the lintel or top of the window-frame. By referring to the end view, Fig. 66, the whole plan by which the laths are turned obliquely to diminish or increase the admission of light, will be evident, by pulling the cord H on either side. So far for the adjustment, now we have to show the drawing up. The limit of length to which the blind descends is, of course, the length of the tapes, D D, but by raising the bottom lath, C, by means of cords passing through holes in each lath, or behind the tapes, D, each successive lath takes up the one above it, until the whole are accumulated in a bundle at the top of the window, all being supported on the thick bottom one, C. The cords which accomplish this end pass from the board, C, to which they are knotted, up through a hole in each lath to the fixed board, A, over small pulleys, K K, in this board, and thence to each end

of this board, and down over a pair of pulleys, L, to the hand at I. The two, or, in other cases, three or more, cords are here knotted together, to prevent the laths going up one side at a time, instead of quite horizontally, as they should do. The blind is fastened up by winding the cords round two hooks in the window-frame. It is absolutely necessary that the laths composing Venetian blinds should be very thin and well made, or the weight would be too great to allow of their being conveniently pulled up.

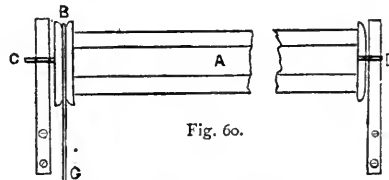

Fig. 60.

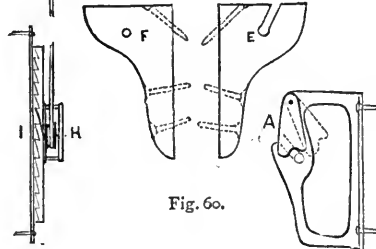

Fig. 60.

Fig. 60.

Fig. 64.

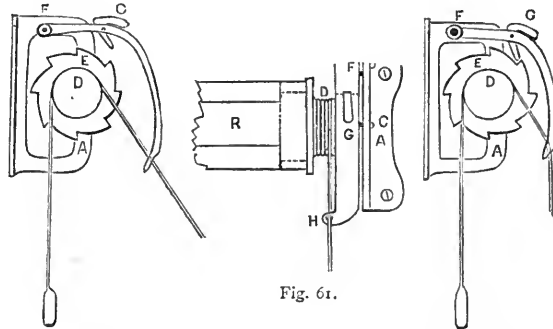

Fig. 61.

Fig. 63.

Fig. 62.

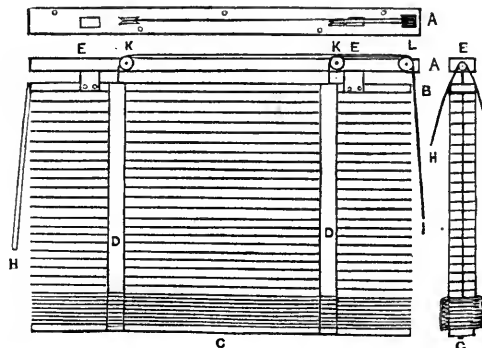
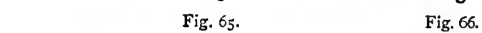

Fig. 65.

Fig. 66.



THE REARING AND MANAGEMENT OF CHILDREN.

VI.—CHILDREN'S CLOTHING (continued).

Short-coating the Baby.—There are two important things that should never be forgotten in dressing infants

profuse perspiration, predisposes them to take cold. Colds are the commencement of all kinds of diseases, and sometimes establish a permanent constitutional derangement. Secondly, the clothes of babies and little children should never restrict them. All strings and buttons should be loose; bodies, waists, and armholes roomy, and to spare.

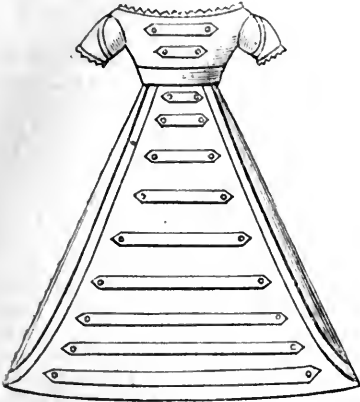

Fig. 53.



Fig. 54.



Fig. 55.

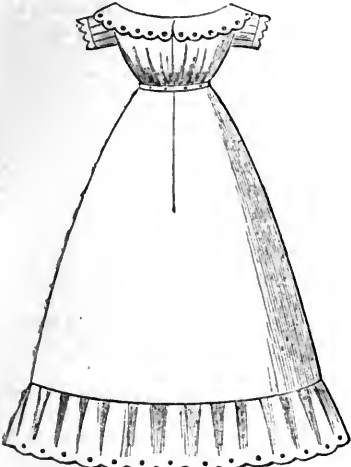

Fig. 56.

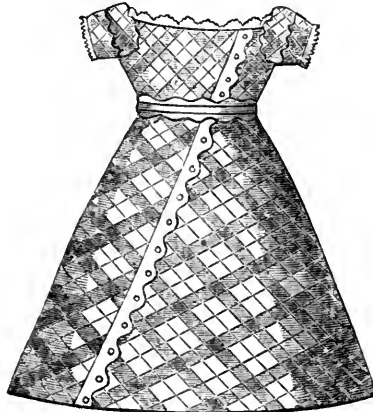

Fig. 57.

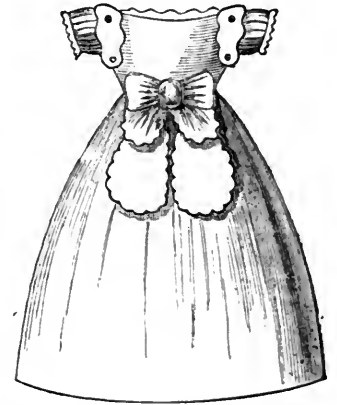

Fig. 58.

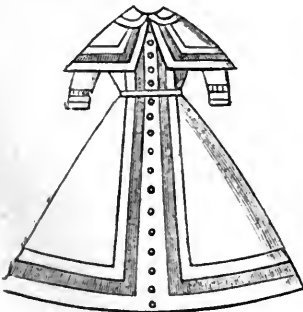

Fig. 59.



Fig. 60.



Fig. 61.



Fig. 62.

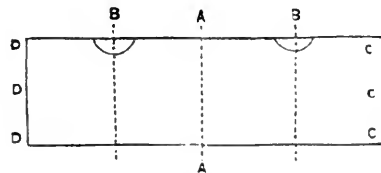

Fig. 63.

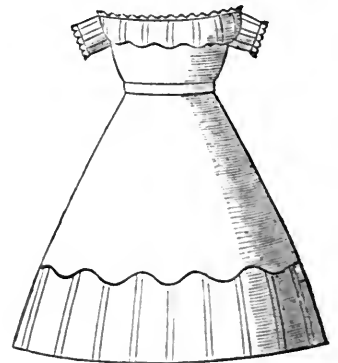

Fig. 64.

and children: neither to load them with clothes, nor to let them, on the other hand, be exposed to cold insufficiently protected. With a young child, care to shield it from draughts and to wrap it in a comfortable cloak, and not to expose it to inclement weather, is most necessary. Over-heating clothing weakens children, and by causing

There must be no compressing ligatures anywhere. Boots, such as we often see adopted for babies, are unfit for them. The shoemaker produces a narrow case that cramps up the little creature's toes, and deforms them; it is tightly laced up the middle, and cruelly confines the ankle, that actually swells round it, often the occasion

of weak joints and thick and unshapely limbs in after life. Up to a year old, the little knitted sock all of soft wool is the best foot-covering for the infant human being. After that, when the child begins to walk a little, and toddles from chair to chair, a similar knitted sock, with a cork sole to it, is all that is needed. As soon as it begins to get about on its feet let it have little shoes—very small pieces of silk merino, or llama, will make a baby's quilted shoes. Place a piece of thin flannel next the silk, and line with cambric muslin; tack all together, and quilt it. Any shoemaker will cut the mother a pattern for her shoe, and also a pair of cork soles or thin soft leather to sew them to. It is easy, and takes little time to make such a pair of shoes. They must be bound with ribbon round the top and straps; have buttons on the straps, and rosettes on the toes. Many ladies make such shoes for fancy bazaars. When the child is carried out, a little pair of woollen gaiters, with soles, must be drawn over them and up the legs. When the baby begins to walk out of doors, let it have easy black kid shoes with straps; these may be followed by very loose cashmere.

It is, generally speaking, an unthrifty plan for a young mother to cut up her baby's long robing and underskirts to short-coat it. If her family increases these long garments will be ready for new visitors, and it only takes two-thirds of the material to make the little frocks and petticoats afterwards. It is one comfort, where economy is needed, to know that the expense of clothing the first baby will cover the cost of two or even three more, and the first trouble, too, will be sufficient for all; and only a few renewals will be wanted in the wardrobe. The expediency of keeping the flannels is doubtful, because new flannel is better than old for this purpose.

There is a better way of making babies' flannels than either of those we have yet given; but many mothers object to the pleated flannel body as too warm and weakening for the infant. The body is a plain piece, fifteen inches long and eight wide; double it in half the narrow way at A A, Fig. 63, and cut out the half circles for arm-holes at B B. Bind it all round with white ribbon or flannel binding, and after the skirt has been added, sew on strings at C C C, about three inches from the edge, and the other side at the edge at D D D. This allows the body to wrap over in front. The back breadth of the skirt of the flannel is gored away each side to six and a-half inches at the top, the half allowed for the skirt seam and the front breadth to nine and a half inches. The front breadth is split open down the centre. The two breadths of flannel are run and felled together before this slit is made. Next bind it all round, waist and all, and then sew the waist of the flannel to the waist of the body. Tie the skirt together, with ends of ribbon sewn on for the purpose. Flannel can be bought with the edge worked with coloured silk to use for babies' clothing.

The cape of the baby's cloak may also be used alone when the child is short-coated. Most likely the entire cloak will require remaking and cleaning for a new baby, and therefore it is well to wear out the cape in this manner.

Short frocks, or as they are called three-quarter frocks, which are first used for babies, measure about half-a-yard long in the skirt, and are added to eight-inch deep bodies. After a month or two, a few more tucks are run in these skirts, to enable the child to walk freely. A very delicate infant in cold weather will be better studied by having its first "short coat" frocks five-eighths long in the skirt and gradually, but not too quickly, reduced.

Plain muslin frocks neatly hemmed are quite sufficient for short frocks, but where it is desired to have them handsomer in appearance they may be made like long frocks as regards the embroidery.

Both for the three-quarter dresses and the quite short

ones, many mothers use pretty light fine-printed cambrics, or scarlet tulle, or in winter merino or plaid. All babies' frocks are now completely gored on both sides of the front breadth, which is set into the body perfectly plain at the waist. The back breadth may be plain, and set into the waist gathered. Two widths generally suffice to form an infant's dress, but should more be employed, the side one would also be sloped away in the seams towards the front.

A very handsome frock for a baby may be made of muslin, the gored front breadths made of rows of machine tucks upright, and placed between bars of embroidered insertion. This *entablier* front, as it is called, is edged all round with insertion, outside which there is a robing of vandyked work, also carried all round, and forming a robing continued from the braces on the body. These braces go straight across the back of the body like a berthe, as shown in Fig. 56. The back of the body is simply plain, a little full, and drawn slightly at the neck and waist into the worked bands. It is a plain unsloped piece of muslin. All round the hem of the skirt there is a deep embroidered flounce. The front of this dress is shown in the illustration marked Fig. 55. The sleeves cannot be very well seen in the entire drawing, but Figs. 60 and 61 show two ways in which they may be made. A plain sleeve entirely of narrow machine ruches may be set in an embroidered band, and edged with a frill of vandyke, worked and headed with an epaulette with a lappet, like Fig. 61, the lappet falling behind; or it may be merely trimmed with a narrow edge and set in under a graduated frill, like Fig. 60; or it may be a plain tucked sleeve edged with a narrow band of work and a frill like Fig. 61, without the lappet epaulette. This frock, made of very fine Swiss muslin, with Swiss muslin or lace trimmings, is an elegant dress, either run with blue ribbon under every part of the insertion or worn over a blue saracen slip. A sash can be tied behind of pinked-out blue *gros grains*, with short ends and four bows similar to the sash drawn in Fig. 58; bows to correspond should tie up the shoulders, and silk or fine thread lace socks and blue silk quilted shoes cover the little feet. Silk quilted shoes are very soft, comfortable, and pretty for a baby's best wear up to a year and a half old.

Winter frocks for children short coated are exceedingly pretty made of plaid. The Rob Roy, that is scarlet and black; the Robertson, also scarlet and black, dice of scarlet and white; and the scarlet Stuart plaid are particularly appropriate for children. So is the dress Stuart, the scarlet plaid, in which a little green, yellow, and black is mixed, mounted on a white ground. Fig. 57 illustrates a pretty way of making a boy's frock of this plaid. A yard-and-a-half makes a child's frock. Cut the body and sleeves first, using about a quarter-of-a-yard for the purpose; fold the rest in half. The front width is gored on both sides to about eight inches across the waist. For a boy's frock gore a little off each side of the back also, but not for a girl's frock. Cut the front breadth in half where the slanting pattern is observed. Mitre one side and bind it with black ribbon, velvet, or braid. Bind the under edge straight, to prevent its fraying. Sew the mitred edge about an inch over the other, and put a small black or a gilt button in every scollop. The mitres continue up the body. The body is piped at the top and the mitres added. The sleeves are plain, and mitred bands are laid round them with lappet ends behind, as shown in the figure. The belt is mitred, and so is the sash of two short ends and four bows and a knot. The edge of the skirt is merely hemmed. Lace must be tacked round the top and sleeves of this and all coloured frocks.

Fig. 53 is suitable for a girl or boy. It may be made up of plaid, merino, or cashmere, or of white piqué, the trimming of velvet or braid. A robing of the trimming is brought down each side of the front, and goes all round

the back of the skirt above the hem; or it may, after traversing the hem at the sides of the frock, again be carried up behind, and the back of the skirt be trimmed up with straps like the front; but if this is done the skirt must be so gored in both breadths as to be plain behind as well as in front at the waist, with only a couple of pleats just at the back of the hips. Every strap up the skirt and body is pointed at each end and run on with a fancy button in every point.

Fig. 64 is a baby girl's short frock. The tunic and lower part of the bodice can be made of plaid, and the rest of the frock of plain cashmere. It is also pretty if with the tunic and corset of grey cashmere and the petticoat and bodice top of scarlet. The tunic is gored quite plain to the waist in front, and slightly gored at the sides of the back, which is pleated at the waist. The edge is mitred and bound with black braid. The petticoat is only a piece put on under the mitres of either plain scarlet cashmere or with upright small pleatings. The top of the body and sleeves are scarlet, plain or pleated, according to the petticoat. For a dress frock blue llama over white alpaca is very pretty, and the alpaca petticoat trimmed with two rows of blue ribbon. Instead of the mitred edge two rows of white ribbon can be used to trim the tunic, or instead of two plain rows a twisted row, like Fig. 54. The tunic must of course correspond with the petticoat in the style of trimming, only blue trimming is laid on the white, and white on the blue. The sleeves are epaulettes, the shape of which may be seen in Fig. 62.

In winter, children from the time they are short coated generally wear a pelisse made exactly like a frock with a high body and long sleeves, and a cape and collar of the same material. The capes are now made very short, and do not quite reach to the waist. Black velveteen, brown, or blue merino are very suitable for such a purpose. Trim with a broad military braid and a narrow one of the same colour as the pelisse, and a row of buttons down the front in the manner illustrated by the cut, Fig. 59. Many people use white worsted braid for such a purpose. In very cold weather the pelisse can be worn over the frock, which is, however, generally removed.

THE HOUSE.

LIFE ASSURANCE.

It will be rather difficult to explain, in a popular manner, the principles involved in the computations by which the profits of a life assurance company are assessed, and from which are derived the large bonuses referred to in our last paper. Let us, however, see what we can do.

By certain methods of calculation known to actuaries, an estimate is periodically made, usually every five or seven years, of the present value, at the time of the investigation, of all the sums assured and bonus additions to the policies for which the company have made themselves liable, as well as of all annuities and other liabilities. Against this is set the value, also computed in present money, at the same date, of all the assets or funds in hand to meet such liabilities. The difference between these two amounts—both, observe, estimated in present money—is the surplus or profit of the company; and supposing the estimates to have been made upon true principles of valuation, this surplus should be the sum that has been actually realised during the preceding five or seven years.

It would be quite out of place here to attempt any investigation or even explanation of what these true principles are. Indeed, even well-informed actuaries are far from being agreed on the subject, and a great variety of practice necessarily prevails among the different companies in connection with the periodical valuations.

We shall confine ourselves to stating generally that as

regards the liabilities, the estimate should be made upon a table that may fairly be considered to represent the mortality of the company under investigation; and the rate of interest should be less, probably by 1 per cent., than the interest actually realised on the investments. The method of dealing with the "loading," or per centage for profit added to the net rate of premium, should be indicated, to show that the valuation has not been made upon an erroneous and dangerous principle, by which the future profit is anticipated, instead of the actually realised profit during the preceding quinquennial or septennial term being shown. It is most important to bear in mind that if in the valuation of the future premiums the "loading" be included, the effect will be to treat as a present asset, available for division, what is, in fact, the reserve for future expenses of management, to provide for bonuses which, as we have before pointed out, the assured public *will* have, and to guard against possible fluctuations in the rate of interest and mortality; for it will easily be seen that the one may diminish and the other increase from financial and sanitary conditions over which the most prudent company can have no control. And as regards the assets, it should be made apparent that their present value is set down at such a sum only as they might reasonably be expected to realise if they had to be sold at the date of the estimate. To deal with this important subject, and with others bearing upon it in connection with the affairs of life assurance companies, in which so many thousands of persons are vitally interested, is admitted to be one of the most difficult of the social problems of the day.

The surplus or profit being arrived at by one or other of the methods adopted by actuaries, is, in the case of a mutual company, divided among the policy-holders by an addition to the sum assured payable at death, which is termed a reversionary bonus, by a cash payment, or by an equivalent reduction in the annual premium payable, according to the arrangements of the society.

In a proprietary company a certain proportion only—which may be two-thirds, three-quarters, or four-fifths—is divided among the recipients entitled to share therein, according to the provisions of the deed of settlement, while the remaining one-third, one-quarter, or one-fifth, as the case may be, goes to the proprietors or shareholders, to remunerate them for the use of their capital, which is an important security to the assured body.

Another very difficult and much-discussed question relates to the principles of division as regards the relative rights of the different recipients. Each office will probably be prepared to show that its own method of distribution is the only correct and equitable one. As, however, scarcely two offices adopt the same plan of division of the surplus among individual policy-holders, and as they cannot all be right, we can only counsel our readers, as they cannot alter the matter, to assure their lives in a good office, to take all they can get in the way of a bonus, and to hope that, to some extent at least, they will participate in the profits of the business in proportion to their several contributions to those profits, remembering that the chief thing to be considered on their parts is the security offered by the office of their choice, and the certainty that the sum contracted for, and the bonus, whatever it may amount to, will be duly paid upon a claim arising.

And now we shall probably be expected to define what we mean by the expression a "good office." We can only reply briefly, that in our opinion an office that merits this appellation is one that will be able to give satisfactory information on the following points, viz:—

1. *Publication of Accounts*, comprising annual balance-sheets and valuation returns, stating the principles of valuation, and showing clearly the amount at risk, and the present or cash value of assets in hand to meet it, how invested, and at what rate of interest.

2. *Expenditure*.—It should be shown that the value of the "loading," or of the proportion thereof, whatever it may be that is reserved, is sufficient to cover expenses of management, and to provide for the bonuses which in the present day the assured insist upon having. If the expenditure exceeds the "loading," the office cannot be solvent. The working expenses in twelve first-class offices vary from seven and a half to ten and three-quarters per cent. on the premium income of the year.

3. *Amalgamations*.—It would be satisfactory, as a rule, to find that there had been none, though cases may arise in which an amalgamation between two companies might have taken place to the advantage of both, provided no undue amount were paid for the business.

4. *Caution in the Acceptance of Risks*, so that the assumed rate of mortality is not exceeded. This requires very careful watching, as will be apparent when we state that the mortality experience recently collected and published by the Institute of Actuaries (which embodies the experience of twenty important assurance companies, ranging over 160,426 lives), shows that the duration of life, even among the selected lives upon which assurances have been effected, differs very little, at all events, from that shown by the Carlisle table of mortality, a table in very general use among life assurance companies. The reason why the benefit of selection (from which at first sight it would appear that the office must derive great advantage, all the lives being subjected to a strict medical examination) is not greater than it appears in fact by these tables to be, is probably that there is always a contrary influence at work against the company to induce the acceptance of lives known to be doubtful, if not altogether diseased, and the unsoundness of which the company's medical examiner cannot always detect.

5. *Safe Investment* of the assets, at a remunerative rate of interest.

6. *Careful Management* generally, by an efficient actuary.

GOLD AND SILVER MARKS.

MANY articles of gold, and nearly all of silver, and even electro-plate, bear certain marks, some acquaintance with which everybody ought to possess. The marks upon the precious metals are called "hall marks"—probably because, in London, they are put on at the Goldsmiths' Hall. Only one quality of silver is hall-marked, viz., standard silver, in the proportion of eleven ounces and two pennyweights of pure silver and eighteen pennyweights of alloy to every twelve ounces troy weight. With gold, the case is different, and a person may purchase hall-marked gold of many values from about eighty shillings per ounce, although gold worth less than about one pound eleven shillings and sixpence per ounce is very seldom marked. In 1869 the Goldsmiths' Company in London discontinued marking gold chains of inferior quality; and gold watch cases must be of eighteen carat gold. Some foreign watches marked as eighteen carat gold, have the cases in part made of silver or other inferior metal. In England also, sometimes, rings marked as gold of superior quality are partly of inferior gold. This is the result of fraud: unprincipled makers sometimes taking rings to be hall-marked, after which they cut out the portion marked and insert it in rings of lower value. This is also done with silver, but to a less extent. Assuming that articles bearing the hall marks of the United Kingdom are what they profess to be, we will describe those marks. They are of five sorts, as follow:—

1. The *hall mark* proper, denoting the place where the articles were stamped. For Birmingham there is an anchor; for London, a leopard's head; for Chester, a dagger and three wheat sheaves; for Sheffield, a crown; for York, five lions' heads and a cross; for Newcastle-on-Tyne, three castles; for Exeter, a castle with three towers;

for Edinburgh, a castle and lion; for Glasgow, a tree and a fish with a ring in its mouth; for Dublin, a figure of Hibernia.

2. The *duty mark*, which is the head of the reigning monarch, and shows that duty has been paid.

3. The *standard mark* is, for England, a lion passant; for Edinburgh, a thistle; for Glasgow, a lion rampant; for Ireland, a crowned harp. Gold is also marked with figures, as 22 for gold of twenty-two carats, 18 for gold of eighteen carats, 9 for gold of nine carats; and these figures are the only guide the purchaser has to the quality of the metal.

4. The *maker's mark* is the initials of the maker in common capital letters.

5. The *date mark*, which varies yearly, and shows when the stamps were impressed. By this mark, therefore, the age of an article can be ascertained. It will be sufficient to give the explanations of the date marks of the Goldsmiths' Company for two hundred years. 1656 to 1675, old English capitals; 1676 to 1695, small Roman letters; 1696 to 1715, the court alphabet; 1716 to 1735, Roman capitals; 1736 to 1755, small Roman letters; 1756 to 1775, old English capitals; 1776 to 1795, small Roman letters; 1796 to 1815, Roman capitals; 1816 to 1835, small Roman letters; 1836 to 1855, old English capitals; 1856 to 1875, old English small letters. The head of the sovereign will aid in explaining the dates.

Inasmuch as many articles of jewellery go into the market without any of the above marks, the public have no guarantee beyond the word of the dealer. Under the circumstances, it is desirable that people should take the advice of a leading manufacturer, who says they ought—1, to learn the various qualities and prices of gold; 2, inquire at time of purchase what quality of gold they are buying; 3, have the quality plainly stated on an invoice; and 4, pay in proportion to quality.

THE HOUSEHOLD MECHANIC.

BELL-HANGING.

THE simplest way to look into the mystery of bells and bell-hanging, as known in ordinary houses, will be perhaps to trace a wire from the pull at one end to the bell at the other. Fig. 68 is a diagram of a bell-pull such as is usually found at the side of the fireplace, and in this, as in nearly all, the principle of action is leverage. The lever A is pivoted on the screw C, and has on its upper end a knob, B, to take hold of. The nose of the screw being prolonged and screwed to take on the ornamental plate which hides the working part, both plate and knob being of various patterns and qualities, according to the situation. Fastened to A, and also hanging on C, is the drum D, round a part of which runs a flat chain, of which there is just enough to encircle about one-half of the drum, to which it is fastened on the top. The lever is only free to move between the gap in the ring, or about a quarter of a circle. This movement, however, is quite sufficient. A small hole at G in the ring, allows the chain to move out or in with each movement of the handle. The wire, W, is fastened to the lowest link, and proceeds to the crank, H, the form of which is that of a simple triangle hinging on a pivot at the apex, I, the opposite corners having holes to receive the wires. In the course of the wire, if the bell is a long way off, and not in a direct line, perhaps several of these cranks will be found, and they also vary in form according to the direction of the motion required. Should the wire have to traverse long distances horizontally, it is passed through small staples of galvanised wire to prevent its weight from dragging it down. The wire used is copper, and the price per ounce about 2d.; but in large quantities it is much cheaper. The hanging of the bell itself is shown at Fig. 67. A is a flat brass frame, which fastens to the wall, and having a lever arm, B, pivoted on it, to the

end of which lever, opposite the pivot, the wire, w, and the spiral spring, s, are fastened on a little boss, or drum, round the pivot. But hanging with B is a long, flat spring, C, to the end of which is fastened the bell, D. The spiral spring, s, is nailed to the wall at T, and is fastened at sufficient tension to pull back the lever, B, to its stop, H, after it has been moved by the wire, w. The spring, s, has, however, to the whole length of the wire through all its various bends and turnings, strained tight right up to the handle, A, Fig. 68, and upon it the balance necessary depends. The flat spring, C, to which the bell, D, appends, has for its purpose only the prolonging of the swing motion of the bell, for it is well known that a single movement of A will produce a ring continued in proportion to the delicacy of the balance. Should, however, any bell fail to act, the cause will most probably be that the length of wire between two of the cranks has got stretched or broken, in which case the handle, A, Fig. 68, will hang down loose.

Where a number of bells from different parts of an establishment are all brought together, they should be arranged on the bell-board in a regular and systematic order—that is, the smallest, or highest toned, should be at one end, and gradually range up to the largest, or deepest toned, each succeeding bell a trifle higher than the former. The reason for this arrangement is obvious—the smaller bells allowing the wires to the others to pass over them without touching them. With large numbers of bells together, it would be often difficult to tell which had been rung, from the slight variation in tone, so the following arrangement is adopted:—Each wire passes in as usual to its respective bell, affixed to which is a small catch, having at the bottom a pendulum, which continues to swing a considerable time after the bell has ceased to ring; or, better still, after setting in motion their respective pendulums, all the wires proceed to a single gong, which only utters one note, and leaves the pendulum to show which room requires attention. The great advantage of the latter plan is too evident to require even mentioning.

The numerous forms of bell-pull contrived to suit the varied requirements of households, are all more or less on the same principle as we have illustrated. The wires themselves are often passed through tubes of thin zinc let into the plaster of the wall, several wires sometimes passing through one tube; but the cranks and connections should, if possible, be where they are accessible when repairs are necessary. In hotels and large buildings, electricity is rapidly superseding the old system of bell-hanging, and it is now being gradually introduced into ordinary houses. In another paper, we shall treat fully of electric bells. Speaking-tubes, again, are very useful, and easily contrived, ordinary iron gas-pipe answering the purpose nearly as well as gutta-percha, and at a much less price, and the flexible ends and whistles can be purchased sufficiently handsome for the most elegant apartment, and sufficiently cheap to be within the reach of the most ordinary purse.

When several pipes terminate in the same place, the whistles are fitted with indicators—little ivory rods which are blown out when the whistle is used, thereby showing where the attention is required.

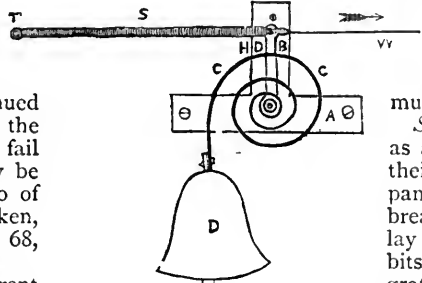

Fig. 67.

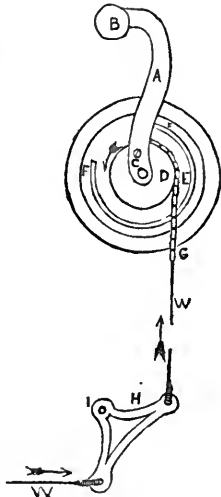

Fig. 68.

COOKING.

SHELL-FISH.

Mussels with Sharp Sauce.—Cook the mussels as already directed; turn them out, and set the liquor aside to settle. Leave each mussel in the valve or half-shell to which it is attached, removing the other half-shell. Take out the weeds and the parasitic crabs. Neatly arrange or pile the mussels in the half-shells in the centre of a dish. A soup-plate will serve for a small quantity. Take some of the mussel-liquor, and with it, instead of water, make melted butter, using the butter liberally. Add pepper and a good dash of vinegar. When it boils, pour it over your mussels, and serve.

Scalloped Mussels.—Cook the mussels as above; pick and take them out of their shells. Have scallop-shells or tin pans made of that shape. Put grated bread-crumbs at the bottom; on these lay mussels, putting amongst them little bits of butter; season with pepper and grated nutmeg; sprinkle more bread-crumbs over them, and so on till the shells are full, covering all with bread-crumbs at the top. Moisten with a small quantity of the mussel liquor. Set in the oven of your cooking-stove, or in an American oven, till they are well heated through, and the top nicely browned.

Fried Mussels (Grande Cuisine).—Shake your mussels in a saucepan with the lid on without water. When well opened take them out of the shells, remove the weed attached to the root of the tongue (really the foot) and the crabs which nestle inside the mussel. Lay them on a napkin to cool and drain. Make a batter to dip them in with a little of their own liquor, flour, butter, and an egg; season with salt, pepper, and what else you please. When this is smooth and well thickened over the fire, it is ready. Dip the mussels one by one in this; lay them on a board so as not to touch each other. When cold, with the sauce sticking to them firmly, roll them separately in bread-crumbs, and fry them light brown in a deep small saucepan containing plenty of hot fat. They may be served heaped on a dish garnished with fried parsley, or they make an elegant garnish for fried fish served on a napkin. Large oysters (scalded before dipping in the batter) may be fried and served in the same way.

Cockles.—Cockles, especially those from shores overlying a stratum of clay, after a thorough washing in two or three waters, and draining awhile, should be put into salt and water—less salt than sea-water, which may be easily ascertained by tasting—to cleanse themselves. Let them lie there all night, changing the water if you can. Cockles are nicest roasted on the bars of a grate, or a tin laid on the flat top of a cooking stove, or in an iron dish set into the oven, and eaten hot with bread and butter. As soon as they open wide they are done enough; or they may be shaken in a closed saucepan, with no water, over a brisk fire, till they are done. Cockles may be dressed in all the ways—except frying—practised with oysters and mussels. They are good pickled, scalloped, stewed, and in sauce to go with any boiled fish.

Scallops.—On opening your scallops, before detaching them from the shell, trim away and reject the beards, keeping the white, red, and black parts of the fish; wash them in several waters; then boil them an hour or more

till tender, in no more water than will cover them; then serve them as a stew, thickening their liquor with flour and butter, and seasoning with pepper, salt, and vinegar; or scallop them in their own shells with bread-crumbs, butter, pepper, moistened with a little of their own juice, and browned on the top in an oven or before the fire. They may be added, chopped to oyster or lobster patties, and, with hard-boiled eggs, may enter appropriately into any fish pie, but in every case, the scallops must be well boiled previously.

Stewed Oysters.—A light dish for invalids who find uncooked oysters too cold and difficult of digestion. As you open the oysters, put them and the liquor from the shells into a small basin, leaving the beards on them; these are not left for the sake of being eaten, unless liked, but for the juice that comes from them. For a dozen middle-sized oysters, put into a small saucepan a lump of butter as big as an egg; over this, pour the oysters and their juice; dredge a very little flour over them, season moderately with pepper and grated nutmeg, add two or three table-spoonfuls of cold water; set the saucepan on a gentle fire, keep shaking the oysters round and round; as soon as the butter is melted and the liquor hot, set the saucepan on the side of the stove to let the oysters get warm through—they must never *boil*, which would make them hard and shrunken. Continue shaking or stirring from time to time. On a hot dish, lay a large slice of toasted bread; on this deposit the oysters with a spoon; then pour over them nearly all the gravy, leaving in the saucepan a table-spoonful or so, into which the grit and sediment will have settled.

The Razor Fish or Solen should also be cooked like oysters, and makes most excellent and strengthening soup.

Clams figure very conspicuously in American bills of fare. We have never seen them sent to table in Great Britain, though they are to be had for the gathering on many spots. "Clams," observes Soyer, "are a species of cockle, only found in Devonshire, Cornwall, parts of Wales, and on the west coast of Ireland and Scotland." "The fish," he adds, "is much superior in flavour to the oyster, and if eaten raw, should be about the same size; but if larger, should be made into soup, or cooked in the same way as the oyster."

Stewed Clams (American).—Put the clams in a stewpan, with about the same quantity of water as the juice of the clams. Boil twenty-five or thirty minutes; remove all the scum that rises, and season with butter and a dust of pepper.

Hashed Clams.—Chop clams fine; stew them in their own juice and a little water. Boil fifteen minutes, and season with butter and pepper. After taking up the hash, thicken the gravy with one or two egg yolks, and lay bits of toasted bread round the dish. Clams may also be fried in batter, or with egg and bread-crumbs.

VEGETABLES.

Boiling is the ordinary mode of cooking vegetables. The *rule* is to throw them (whether roots, foliage, flowers, or unripe seeds) into cold water; after trimming or other preparation; to let them lie there, if shrivelled or drooping, until they have recovered their natural crispness; then to throw them into rain or river water, or other water made soft artificially by the addition of a small pinch of carbonate of soda; to keep them boiling without the lid (with roots this is immaterial, though it is one means of keeping greens a good colour); to remove all scum as it rises; to cook them enough; and to take them up as soon as they are done through, instead of leaving them to seethe, and lose their natural juices in the water.

To this there are exceptions. Peas and beans may be thrown into cold water when they are dried, but when green

are best not thrown into cold water; and the former should be boiled in the least quantity of water possible. Potatoes require different treatment, according to their kind and the soil in which they grew. Very mealy or large potatoes, if thrown into boiling water, will fall to pieces outside, while still raw in the centre; while small firm or waxy varieties (like the old Dutch) are best thrown into boiling salt water. If you buy potatoes of the grower, he will often tell you what treatment suits them. At any rate, an experiment both ways will soon settle the difficulty. But the qualities of potatoes vary, not only with soil and kind, but also with the period in the season. We have known potatoes, waxy and watery when first dug up, become light and floury in February or March, after the eyes had sprouted perhaps three or four inches. The reason is plain: superabundant moisture had been drawn off, and the starch, which forms one of its component elements, had had time to mature itself.

How to cook Potatoes.—It is well known that a good potato may be spoiled by bad cooking; and, by good management, a bad one may be rendered comparatively good. In fact, no vegetable depends more on the cooking than a potato. In the first place, if the skin is taken off them before boiling, it should not be peeled, but scraped, for the following reason: if peeled, it is reduced in size considerably; besides, the outside removed is the very best portion of the root. An iron saucepan is preferable to a tin one for cooking them, as it prevents their boiling so fast; but the best way is, first to wash them very clean, then to put them on the fire with just cold water enough to cover them; when it has begun to boil, throw in a handful of salt, and add a pint of cold water, which checks their boiling, and gives them time to be done through, without allowing them to crack. As soon as done, rather under than over, which may be ascertained with a fork, pour the water off them, and replace the pan on the fire for a short time, until the remaining moisture is evaporated. If not immediately wanted, do not place the lid upon them, or the steam will be confined, but cover them with a cloth. New potatoes require great caution not to over-boil them, or they will be tasteless and watery.

Mashed Potatoes.—After boiling as above, peel them into a bowl, mash them immediately with a wooden spoon, adding salt, a small quantity of hot milk, and a little bit of butter oiled. When served on the dish, it will be an improvement to brown their surface before the fire, or in a gentle oven; or they may be put in a buttered tin or pudding-basin, set into the oven, and then turned out on to the dish.

Stewed Onions (Oignons en Matelote).—Peel some large onions, taking care not to cut their tops too short, in order that they may not fall to pieces. Throw them into boiling water, and let them boil a minute or two. Take out and drain them; lay them side by side in a stew-pan, with a lump of butter, a bunch of sweet herbs, pepper and salt. In another saucepan, brown flour in butter, with a little chopped onion; when nicely coloured, moisten with common claret, Burgundy, or cider; let the sauce thicken, and then pour it through a strainer over the onions in the stew-pan, which you will set upon the fire, and let them stew gently. Give the finishing touch with a gherkin chopped small, and a dash of vinegar. In your dish lay as many slices of toast as there are onions; put an onion on each, and pour the sauce, over the whole. The sauce should be thick, and is improved by the addition of strong stock or good gravy to the wine or cider, on mixing it with the browned flour and butter.

Stewed Turnips (Mitonnage aux Navets).—A French form of mashed turnips, which might be called with propriety, turnip sauce, and is very nice with boiled mutton, veal, or poultry. Peel turnips, cut them in pieces, and set them on to boil in salted water. When they are

tender, take them out, and in the water in which they have been boiled, simmer some crumbs of bread over a gentle fire. Mash the turnips, warm them in another saucepan with butter and pepper, then mix them up with the boiled bread. Stir two or three egg-yolks in a little milk, mix these and another bit of butter with the bread and turnips. Let the whole stew gently a minute or two to thicken, and serve.

Turnip Tops.—In spring an excellent vegetable is furnished by the shoots of turnips. The time to take them is the moment they show signs of running to seed, because their season is very short, especially if the weather is dry and sunny. When once sticky and thready, they are over. They are never dear, and in the country may often be had for the gathering. In gardens, it is worth while making a small late sowing, or leaving a patch of turnips, to make "tops," because they come in when other greens are scarce. After freshening up the turnip tops in cold water, throw them into a large kettle of boiling soft water, and keep boiling, uncovered, until quite tender. When done, put them into a cullender to drain, squeezing them gently with your ladle. Then transfer them to a vegetable-dish; press them with the bottom of a plate, holding the dish upright, to let the water run out. Dust the surface with a little pepper, and spread a lump of butter over it. Cut the flattened turnip tops across both ways with a knife, so as to divide them into small squares, and serve. Any left cold may be heated up next day in a saucepan, after being chopped fine with a little butter and salt; they are even better so than they are the first day.

There are other garden roots whose spring shoots, on starting up to seed, are not only available but good as vegetables; those of salsify for instance, if soaked and served exactly like asparagus, are delicious.

Celery is a most useful and agreeable plant; the imperfectly blanched portions give a tempting flavour to stews and broths, while the brittle leaf-stalks are the Englishman's favourite accompaniment to bread and cheese. The following is an approved American recipe for its use:—Cut blanched celery as fine as possible, add salt, and send it to table, where vinegar and egg can be added if desired. Unless served as soon as prepared, it will be apt to turn brown. Ornament the dish with green celery leaves. Onions can be prepared in the same manner, and make a fine salad for those who relish them. *Cooked celery* is more digestible and equally palatable.

Celery stewed Brown.—Cut the white part of celery into three inch lengths, tie them with thread into little bundles, after a good rinsing in a pail of cold water, and throw them into boiling broth to cook till tender, which will take some twenty or five-and-twenty minutes. Untie the bundles as you take them out and arrange them neatly in the middle of a dish. Brown a little butter and flour in a saucepan, dilute with the broth which boiled the celery, stir in a little mushroom catchup, pour it over the celery, and serve.

Celery stewed White.—Prepare as before, and tie in bundles, throw them into as much boiling water or veal broth as will just cover them. As it diminishes by evaporation, fill up with milk, taking care to prevent its boiling over or burning. Keep the quantity of the boilings as small as possible. When the celery is tender, arrange it on the dish, thicken the liquor with flour and butter (not too much of the former), season lightly with pepper and salt, and pour it over the celery. The flavour of the vegetable should not be overpowered by the sauce.

Cauliflowers and Broccoli.—These vegetables are distinguished more by the season at which they come, than by any distinctive quality in the nature of their substance. The cauliflower is tender and cannot resist our winters; whereas, broccoli stand mild winters, although they too are cut off by our severer frosts. Consequently the

cauliflower season lasts from about the middle of June to the middle of November. Some broccoli, planted early in May will show their faces in autumn, and continue coming in (according to the weather and the variety cultivated) from that time till May, or even June. Green and purple broccoli are delicious, but small; they are also rather a late summer and autumn than a spring crop. The usual plan is, to throw the heads trimmed, leaving a narrow circlet of shortened leaf-stalks round them into a pail of salt and water, to draw out the insects. The heads are then boiled and served whole.

A better plan is to cut up your cauliflower heads into sprigs, leaving to each sprig its portion of stalk, and to the outer sprigs their little bit of green. As you do so, throw them into a pail of cold water, without salt. After leaving them there awhile to freshen, put them into a large saucepan containing plenty of boiling soft water. Let them boil fast, with the lid off, till the fork tells you they are tender, which will take from five-and-twenty minutes to three-quarters of an hour. Then take them up with a perforated ladle or strainer, in which you will let each lot of sprigs drain a few seconds before depositing them in their dish. When the whole are neatly piled therein, put a lump of butter the size of an egg with a breakfast-cupful of cold water into a saucepan, dust in gradually a bumping teaspoonful of flour, stirring continually all the while. When smooth, add a dessert-spoonful of vinegar and a dust of pepper. Let this sauce boil up once, pour it over the cauliflower in the dish, and serve.

Cauliflowers and Cheese.—Arrange the cooked sprigs on the dish, as above. Put into the sauce instead of vinegar, a table-spoonful of grated cheese. Pour this over the cauliflowers. Sprinkle the surface with a mixture of bread-crumbs and grated cheese, and set it before the fire, or in the oven, to be slightly browned.

FURNITURE.

WHEN articles of furniture are offered at a very low price defects should be sought for; the cheapest are not always the best. Chests of drawers, with a deep drawer at bottom, and without feet, are more convenient than the usual make; nevertheless, the feet are useful in keeping the drawers dry if they are placed on the ground-floor. Those with a deep drawer are only fit for upper bedrooms, but they are most useful for holding bonnets and light articles.

It is a disputed point whether the use of bed-furniture is detrimental, or not, to health. When draught is occasioned by ill-fitting doors and windows, some protection to the sides of a bedstead is necessary; but where there is no draught, it is better to have no hangings. The old-fashioned four-post bedstead, with its array of draperies, was suited to the times in which it originated; yet, even now by some persons these cumbersome four-posters are preferred, as giving a grand and imposing appearance to the room. We give, on the next page, an engraving of one of the four-post bedsteads (Fig. 1), with the chair, toilette-table, and glass, of the time of Queen Anne. The table, chair, and mirror are very elegant; but in the latter, utility is sacrificed to appearance; the glass is very small compared with the size of the frame, underneath which is a time-piece. The recumbent figures on each side the mirror are of Dresden china, and contain essences, perfumes, and cosmetics.

The Arabians, Figs. 2 and 3, are excellent substitutes for four-post bedsteads, as they admit of curtains without entirely excluding the air. The top—usually called the tester—should not be covered excepting by net-work. The upright posts of an Arabian bedstead should be polished or painted; but they are often left rough and unsightly, to be covered with dimity or other material, whereas this should hang from the tester down the head

part, and at the *back* of the uprights, not be wound round them. If furniture is preferred, it should never be of woollen.

The same objections might be made to covering the floor with a carpet; but the draught underneath the door and the ventilation caused by the open chimney, prevent the carpet from retaining foul air. For sanitary purposes, nothing is more unhealthy than stopping up the chimney. The ventilating aperture of a bedroom should be above the level of the head of a person who is lying on the bed, consequently, the bedstead should not be high.

A carpet under a bedstead is objectionable; it receives all the dust and flue, which, not being easily removable, creates a fine nursery for fleas. Yet it is often economical

carpet, excepting in places where a person would stand, so that the floor could be washed once a week with sand and water, *never with soap*. When this is adopted, the boards should be laid even and be closely joined, and the bed-side carpets selected be the close-cut pile, which are sold erroneously for hearth-rugs. Three of these carpets

round a bedstead, and a fourth before a looking-glass, make a room look exceedingly well at a small cost—say, thirty shillings, not more. A piece of Indian matting, well bound at the two ends, is better than carpet or thin oil-cloth for laying down before the wash-stand. Some persons prefer "mitred" carpets of Kidderminster make joined at the corners, and placed round the bedstead in one piece. This plan entails the losing half a square of

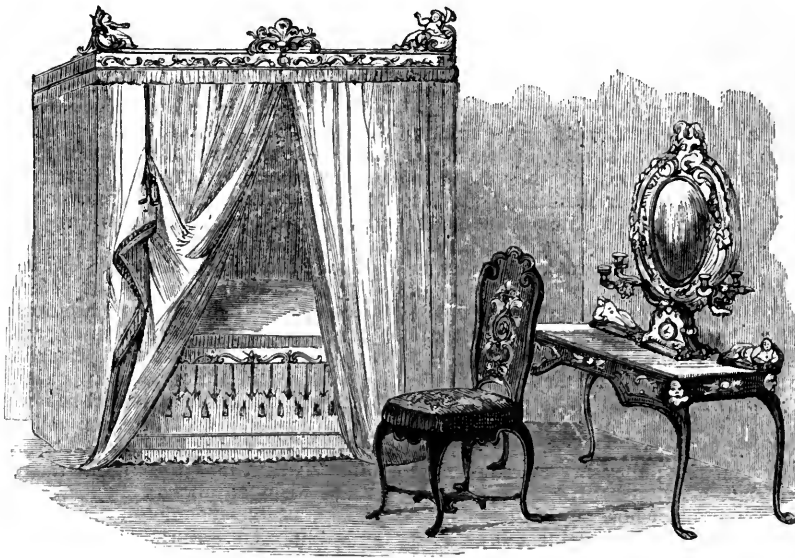

Fig. 1.



Fig. 2.

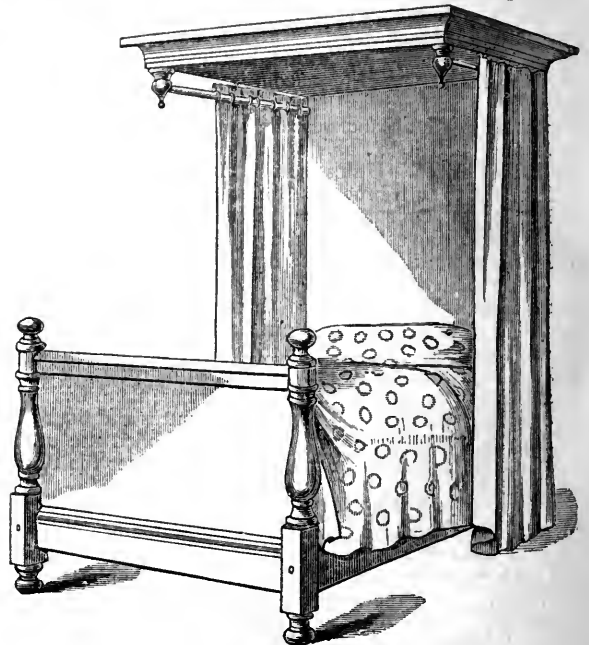

Fig. 3.

to carpet the whole of a room, so that when the carpet is somewhat worn it may be turned, that which was at the opposite end of the room to underneath the bedstead; but to keep the flue from penetrating, there should be a piece of floor-cloth the size of the bedstead, placed under it; and this looks well, can be wiped with a damp cloth every day, and lasts for years. It is most certainly healthier to have a bedroom entirely uncovered with

material at each corner, or nearly a yard of carpet; and besides, a servant cannot so well shake carpets of such a form. The great objection to an uncarpeted floor is, that the latter is constructed too often of green wood, and thus shrinking and warping, after a time the interstices require filling up with laths of wood.

Swing-glasses of a cheap kind are a source of vexation to a housekeeper, from their tendency to come loose at

the screws, so that the glasses swing without check. Common looking-glasses have for their backs a thin veneer of wood, set in with brads. Those of a better kind are made with backs to slide in like the sliding lid of a box, and are then fixed with a screw. It is best to give a high price, and have the frames of the glass better finished. It is true that at first the screws appear firm, but in a short time a slight rattle is heard between the glass and the wood at the back, occasioned by the nuts of the screws falling off. It may seem easy enough to put these on again, and it certainly is so with proper tools; but these are not always at hand, and the work requires the most delicate handling, to prevent the nuts from scratching, or the finger tips from rubbing off the quick-silver. Some glasses are fastened in such a way that only a cabinet-maker can remedy their defects. Many schemes have been adopted for the greater perfection of this fastening, but none are wholly successful in glasses of moderate cost; but, as looking-glasses are rarely purchased more than once in a lifetime, the price for a good article should not be an object. Oval looking-glasses have one defect, they show only the face and head, the remaining part of the figure being cut off; therefore, however handsome they look, they are not desirable for persons with small means, who cannot afford a cheval glass.

There are a great variety of toilette-tables, from the simple table with one drawer, to the duchess table with many drawers and with swing-glass fixed and standing on pedestals, which are really small nests of drawers. Others have, in addition, from three to five drawers below the top of the table on each side; this style is termed knee-hole drawers, and is most useful. A japanned toilette-table with one drawer can be had for 9s. One unpainted, without drawers, but with turned legs, oval-shaped in front, and four feet long, may be had for the same price; the one requires only a toilette-cloth over the top, the last must have pink cambric surrounding it, and be covered again with book muslin gathered like a full skirt round the table; or with dimity, bordered with one stripe of coloured bordering taken from the coloured striped dimity. This is a cheap and excellent method of bordering curtains hung before a recess to simulate a wardrobe, or for the coverings of a toilette-table. Three yards of coloured striped dimity cost 3s., and from this twenty-one yards of bordering can be rent.

It must be recollected that, inexpensive as these tables and coverings appear to be, they are ultimately rendered

very dear by the cost of washing the coverings. Moreover, there is something to be considered in their great danger of taking fire.

A mahogany toilette-table, a yard long, surrounded by a rim, and having two drawers, can be purchased for 24s.; one four feet long—and this is of ample size for any ordinary room—for 38s.; but with an increased number of drawers, seven instead of two, and arranged on each side, to leave a vacant space in the centre, thus forming a knee-hole table, it will cost from 90s. to £6 or £8. Every toilette-table should move on casters; the cheap ones are without them, and their addition increases the expense, unless the matter be arranged between the intending buyer and seller, before purchasing. Marble-topped tables are not desirable. Articles of glass and china may be placed on them with careless hands, and in a hurry such wares are often broken.

A servant's bed-room should have as few articles in it as are consistent with comfort. A bed and bedstead, with two soft mattresses, a pillow, three blankets, two soft unbleached sheets and pillow-slip, a soft and inexpensive coloured counterpane, a chest of drawers, a looking-glass, wash-stand, with the usual requisites of white ware, and a chair, are all that is needed. One of the most comfortable bedsteads is the truckle or cross bedstead. These have gone very much out of fashion,

but they are portable, inexpensive, and desirable to sleep on. The next in point of comfort is the iron bedstead, because the interlacing laths are flexible. In the matter of cleanliness, wood and iron bedsteads are equal; the latter do not prevent bed insects from congregating, but the iron is easily cleaned and painted. From wooden bedsteads insects may also be wholly extirpated by washing in strong brine and boiling water. The skirtings and cracks in the walls, doors, and window-frames, also need the same process. Figs. 4, 5, 6, and 7, are patterns of furniture for a servant's room.

The less carpet laid on the floor of a servant's room, the healthier and freer from dirt it will be. Once a week, the boards should be washed with salt and water, in winter and summer. A clock is essential in the bedroom, but it should be an eight-day brass clock, which is inexpensive, and this clock should be locked in a box having a glass cover, the box being placed so that the cover opens like a cupboard door. An alarum clock is useless; the sleeper, after a morning or two, gets accustomed to the sound, and sleeps on regardless of her excellent friend.

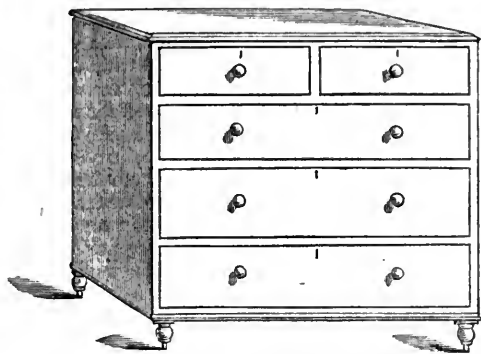

Fig. 4.

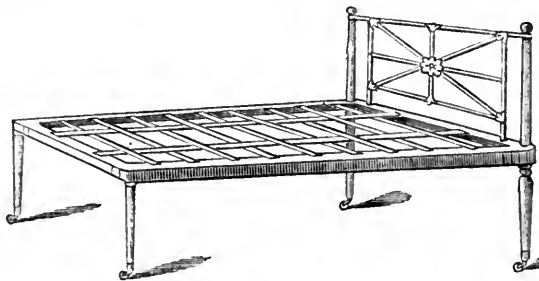

Fig. 5.

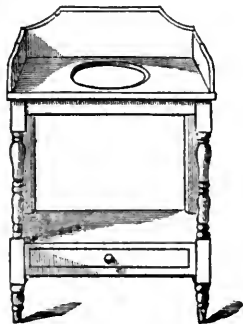

Fig. 6.



Fig. 7.

DOMESTIC MEDICINE.

ERUPTIVE FEVERS.

WE shall, under this head, treat only of the more common forms of eruptive fevers, such as scarlet fever—or, as it is the fashion now to call it, scarlatina—measles, small-pox, and typhoid and typhus fevers. These diseases constitute the principal epidemics, and cause a large proportion of the deaths in any community, especially in large towns. At the moment at which we write, scarlet fever is very fatal; it is causing over 200 deaths a week in London. We shall treat of it first.

Scarlet Fever, or Scarlatina, used for a long time to be confounded with measles; but it is a very distinct disease in its symptoms and in its importance. Sometimes it occurs in such mild forms as to be of no consequence; at other times it is a very serious disease indeed, and comes nearer to a plague than any common disease we have. It is not only serious in itself, but apt to be followed, after the lapse of weeks, by dropsy, rheumatism, and other consequences that are in themselves dangerous. All we shall do, therefore, is to point out the general character of the disease, and the general and domestic treatment of the patient. We take it for granted that the doctor will be called in. If we insert a few more specific instructions, it will be for those who are beyond the reach of medical advice.

Scarlet fever begins, like other eruptive fevers, with symptoms of ailment—shivering, sickness, lassitude, and headache. In addition to these symptoms, there is more or less of sore throat, and the back of the mouth and throat are generally reddish in colour. The soreness of the throat is a very characteristic feature of scarlet fever. On the second day of the disease the eruption appears in the form of a red rash; it comes on nearly everywhere at about the same time, but is generally visible on the neck and chest before it shows itself on the face. Like the sore throat and the rash, the appearance of the tongue is very characteristic in scarlet fever; it is covered with a white fur, through which appear little red papillæ or points, giving the appearance described as the “strawberry tongue.” There is generally a good deal of fever present, the temperature of the skin is high, and the higher it is, generally speaking, the more serious is the case.

Supposing the case to be a mild one, all these symptoms are present in a moderate degree. The throat is not very sore, the swelling of the neck is not very great, the fever is moderate, and the amount of eruption moderate. It is common to say that when the eruption comes well out, the patient is in less danger, but this is not the case. The more intense and extensive the eruption, the more severe is the disease.

The worst cases of scarlet fever are those in which the disease begins with great severity; as when it sets in with delirium or convulsions, when the throat is very sore, and there is great and quick swelling of the neck, making swallowing and breathing difficult, and when the temperature is very high. According to the severity of the disease is likely to be the course of it. The very mild cases go on very well. About the fifth day, the skin, which has been the seat of the rash, begins to peel off. This process is called desquamation, and it may extend over several weeks, during which the patient must be considered to need care, especially protection from cold.

But, even in mild cases, recovery is apt to be interrupted by some unsatisfactory symptoms. Of these, the most common is swelling of the eyelids and face generally, and other parts of the body, accompanied with a remarkable paleness of the skin. This is the dropsy after scarlet fever, and it occurs, to say the least, as frequently after mild attacks as after severe ones. It may be accompanied by sickness or headache, or, still worse, by convulsions. It does not generally happen till fifteen or twenty days after the eruption, and may be a month after it. Coinci-

dently with this dropsy, the urine may become scanty, and darker in colour.

Very bad cases of scarlet fever are apt to terminate fatally, at a very early period, and in a different way. Breathing becomes loud and difficult, there is a heaviness and stupor about the mind, and a tendency to wander; and the patient may die in two or three days, and before the appearance of much eruption.

A child with scarlet fever should be kept in bed; and, even in mild cases, if the weather is cold, he should be kept in bed for a considerable time after the eruption has disappeared, so as to avoid exposure to cold. Even when he gets up, he should be kept in a comfortable temperature, so as not to be chilled. The throat should be gargled with warm water. A little sponge mop, dipped in pleasantly warm water, may be frequently used for cleansing it, with great relief and advantage. A very good mixture for the first few days of the disease is the following:—

Chlorate of potash...	1 drachm.
Spirits of nitre	1½ drachms.
Simple syrup	4 drachms.
Water	4 ounces.

Mix one table-spoonful every four hours in as much water. For children below four years, a dessert-spoonful.

If dropsy sets in, the child should be kept warm in bed. Generally speaking, a little purging is good, and five or ten grains of the compound powder of jalap may be given every morning, or every other morning, unless there is diarrhœa, which should not be checked; and if there is not much fever, the following mixture may be given:—

Tincture of the perchloride of iron	1 drachm.
Simple syrup...	3 drachms.
Distilled water	6 ounces.

One table-spoonful every six hours. Children under four years, a dessert-spoonful, or two tea-spoonfuls.

In very bad cases of scarlet fever, and in the unavoidable absence of medical advice, keep the throat clear with the mop, as advised above, and give the following mixture:—

Sesquicarbonate of ammonia	...	36 grains.
Simple syrup	...	½ ounce.
Water	...	6 ounces.

One table-spoonful every three hours. Children under four, a dessert-spoonful.

To Prevent the Spread of the Disease.—When scarlet fever occurs in a house, the child affected should be kept in a large room, and separated from the rest of the family as far as may be. The patient's chamber should be divested, as far as possible, of curtains, clothing, and articles of furniture to which the contagion is apt to stick. The patient's linen, bed-clothes, &c., as used, ought to be well boiled, or exposed to a dry heat, 200° Fahrenheit. A solution of chloride of lime (one pound to eight gallons of water) ought to be kept in the room in plates or basins, or in cloths hung on a screen. Another measure which tends to prevent the spread of the disease is to oil the patient's skin well and daily, while it is peeling off. A little of the solution of chloride of lime should be mixed with the various discharges from the patient's body.

Measles.—The next very common eruptive fever which we have to describe, is measles. Few complaints are better known in the domestic sphere, because it affects nearly every one once in their lifetime, generally in their childhood, and, also, because it has well-marked and easily recognised symptoms.

Supposing measles to be abroad, it may, perhaps, be suspected that a child is going to have them if it has a hard croupy cough, fever, loss of appetite and thirst, and if these symptoms are accompanied with sneezing and red-looking eyes, and other signs of a cold. The patient, if old enough, may complain of weight and heaviness, and pain in the forehead. Sometimes vomiting occurs, but

not so often as in scarlet fever. This stage may last from two to five days. Then, at the end of from two to five days the eruption occurs, first on the forehead and neck, then the face, and then gradually in from twenty-four to thirty-six hours, extends over the trunk. It consists of little red points, slightly elevated, which run into each other so as to have the appearance of circular, or crescentic, patches of eruption. The eruption disappears on pressure, but soon returns again. When the eruption appears, the severity of the symptoms increases. Often the cough is much relieved by the appearance of the eruption, and on the second day of it, the symptoms begin to abate. By the close of the third or fourth day after the eruption, it has well nigh disappeared in the order in which it came out. Simple cases soon get well; but a few complications may arise, and a few consequences may give trouble, such as eruptions on the skin.

The most serious complication likely to arise, or to attend upon an attack of measles, is inflammation of the chest, and in winter this is most likely to be troublesome and even dangerous. The symptoms of this are the continuance of cough and feverishness, and quick breathing after the eruption has been out for a few days, by which time, in simple cases, all the symptoms should be undergoing abatement. Whether the inflammation affects the substance of the lung, or only the bronchial tubes, is a matter that can only be determined by a medical man. Generally speaking, in mild weather and in tolerably healthy children, measles is not a fatal disease.

Treatment.—The domestic treatment of measles, consists in keeping the patient in bed, in a room with a comfortable temperature, and in administering light diet. If the case is mild, that is, if the feverishness is not great, and the breathing is but little quickened, little more treatment is required. The following mixture would tend to cool the patient and relieve the hard or croupy cough:—

Citrate of potash	2	scruples.
Ipecacuanha wine	1½	drachms.
Simple syrup	3	drachms.
Water	4	ounces.

One table-spoonful to be taken every four hours by a child from three to five years old. More or less to older or younger children, and according to the fever and hardness of the cough.

If the case is at all severe, a doctor should be called in. Indeed, in any case of measles this should be done; for the chest is apt to be seriously and insidiously affected, and the disease is apt to leave "dregs" as they are called, or consequences which require judicious treatment. To prevent the disease spreading, the same measures must be adopted as in the case of scarlet fever. There is not quite the same urgency, inasmuch as the disease is not generally so fatal.

It is very curious that scarlet fever and measles were confounded until comparatively recently. Our tabulated description will sufficiently indicate the difference of the diseases.

SCARLET FEVER.

1. In the early symptoms, vomiting is a prominent feature. There is an inflamed state of the throat.
2. The eruption occurs on second day of the fever.
3. The colour of the eruption bright scarlet. The eruption is in large patches extensively diffused.
4. The skin peels off freely.
5. Dropsy often follows.

MEASLES.

1. In the early symptoms, sneezing, cough, and other symptoms of a cold are prominent. Throat not affected.
2. The eruption does not generally occur so soon; generally on the fourth day.
3. Eruption is darker, and occurs in small circular or crescentic patches.
4. Slight casting off of skin.
5. Dropsy does not follow.

space over small-pox, for it has no business to trouble anyone now. Vaccination if well done, and repeated once or twice in the course of life, is practically a complete protection against this most horrible disease. The law of the land, in the shape of the Compulsory Vaccination Act, wisely requires every child to be vaccinated before it is three months old, unless a certificate of its unfitness be produced from a medical man. Some dissatisfaction has been at times expressed with this most beneficent law; but most unreasonably so. Vaccination is a most simple operation, it seldom causes much inconvenience, though now and then in children disposed to have skin eruptions, it occasions one. It is still more seldom, or never, the medium of transmitting serious disease, and it practically, as we have said, is a protection against one of the most loathsome and deadly diseases to which the body is subject. The protective power of vaccination may be judged of by the fact, that at the Small-Pox Hospital they have not had a case of small-pox among the nurses or attendants for a period of twenty years or more. Every nurse on entering the hospital is *re-vaccinated*. The safety of these nurses, not after the vaccination, but after the re-vaccination, shows that vaccination only needs to be repeated to be a perfect protection against small-pox even in a small-pox hospital. There is nothing grander, and yet nothing more simple, nothing more beneficent in the whole history of medicine than vaccination, and nothing can be more unreasonable than the prejudice which it is attempted just now to create against it. If it occasionally gives activity to an eruptive tendency in a child, this is of slight importance, compared with the awful eruption of small-pox from which the child is saved, involving the risk, be it remembered, of permanent disfigurement, of blindness, and other consequences. It should also be explicitly stated that small-pox is followed by eruptions much more frequently, and much more troublesome, than in the case of vaccination. As regards the risk of the transmission of serious disease from child to another, it is so rare as never to have been seen by many surgeons of great experience; and even if this peril has to be incurred, it is by no means so great as that of the loathsome disease from which it saves. Driven from every other stronghold, the anti-vaccinationists have tried to show that while small-pox has been prevented by vaccination other diseases have in consequence become more rife. Well, there is no proof of this. It is a baseless piece of assumption, and even if there was any ground for the idea, most people would prefer anything to small-pox. To object to be saved from small-pox because you may incur some other disease, would be about as reasonable as to refuse to be saved from a railway collision, because you might at some future day sprain your ankle in getting out of an omnibus. On the whole, nothing can be more unreasonable than the objection to be vaccinated. It is not only unreasonable, but it is selfish, for an unvaccinated person is apt to get small-pox and may then convey a dreadful disease to others. Twenty persons have been known to get the small-pox from one person recovering from it. In the light of these facts, it is clear that all persons should submit cheerfully, nay, thankfully, to the Compulsory Vaccination Act, and have their children vaccinated. Not only so, all wise persons will be revaccinated, at least once in their lifetime, and have their children revaccinated as they grow up to maturity. The operation should be done with matter in a moist state and direct from arm to arm. Much has been said lately about having matter direct from the cow; but this is of little consequence, provided that matter be taken from a healthy child. At the surgeries of public vaccinators, parents can judge for themselves of the healthiness of children, but this does not lessen the responsibility of vaccinators, who must consider the selection of good and safe matter a point of the most vital importance.

Vaccination and Small-Pox.—We shall not spend much

ANIMALS KEPT FOR PROFIT.—CATTLE.

I.—THE VARIETIES AND BREEDING OF CATTLE.

BEFORE entering upon the general management of cattle, it will be well to describe shortly the principal breeds, pointing out their special merits and principal defects, as adapted either for the fattening stall or the dairy.

The *Shorthorn* is an animal of magnificent shape, being very large and full in the body, and low on the leg, with fine bones. The back and belly should form nearly straight lines; indeed, in the best animals the body, when viewed sideways, forms nearly a parallelogram, whose length is twice its breadth. The fore-quarters are very deep, and the head fine and small, while the disposition is particularly mild and gentle.

The *Shorthorn* is confessedly the most valuable breed of cattle we have, and combines *all* the useful qualities

The *Ayrshire* is another splendid dairy breed. While the *Shorthorn* is peculiar for the *quantity* of the milk, and is hence adapted to town supply, the *Ayrshire* seems pre-eminently suited for the production of butter and cheese, the milk being not only plentiful, but of a richer quality. It does not, however, fatten so well as the *Shorthorn* when dried.

The *Ayrshire* cow is under the middle size, but of singularly handsome proportions. The head is small and fine, rather long and narrow at the muzzle, which is black; the horns are small and short, the eye very clear and lively. The neck is somewhat long and slender, the fore-quarters light, and the limbs fine and delicate-looking; the back, however, is very broad over the hips, and the carcass rather deep. The udder is large and well-shaped, as might be expected. The usual colour is sandy-red, distributed in patches, mingled with white.

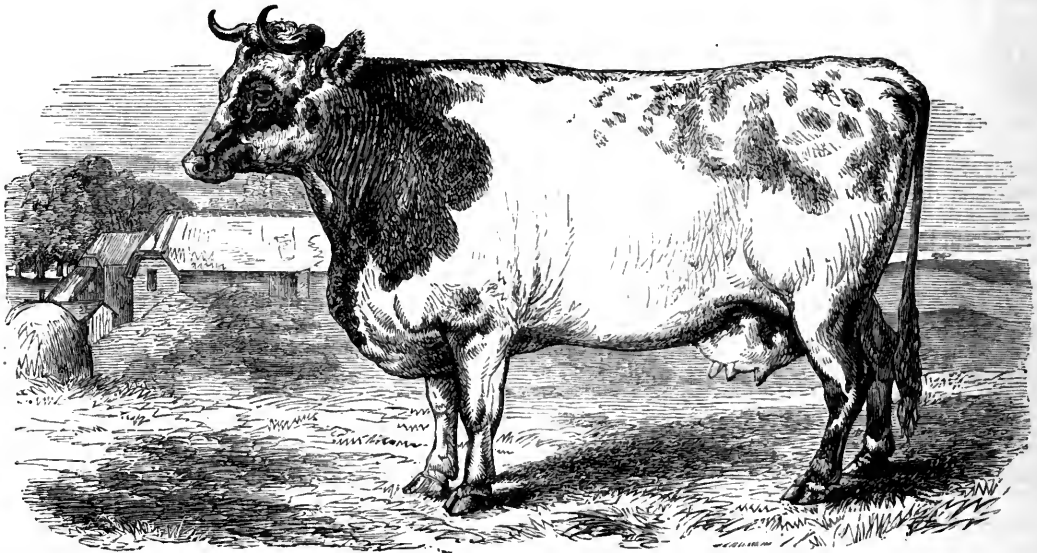

SHORTHORN COW.

in a greater proportion than any other animal. It seems originally to have been founded upon a rather coarse breed, still known as the *Yorkshire*, and celebrated for its milking qualities beyond the memory of man, but comparatively faulty in the carcass. The pedigree of this breed is now three-quarters of a century old, and hence a well-bred animal stamps its own valuable qualities with remarkable certainty upon its progeny, so that the purchaser, for instance, of a good bull, obtains an actual return for his money in the greater weight and better quality of meat throughout a numerous offspring. Every breed almost has been crossed and more or less influenced by the *Shorthorn*, and always with advantage.

Of late some breeders have paid more attention to the fattening than the milking qualities of the *Shorthorn*, and hence the coarser variety, known as the *Yorkshire*, is generally preferred by London dairymen. These latter cows have been known to give sixteen quarts of milk per day; but even the improved *Shorthorn* cow will generally yield sixteen quarts daily, many of them much more. Lately the *Yorkshire* cows have been crossed with improved *Shorthorn* bulls, and the result is a cow which can hardly be equalled where a large quantity of milk is desired, while it fattens well when dried. It is this latter property which helps to make the breed so valuable, as not only do the calves become fit for the butcher at an early age, but the cow herself fetches a good sum when finally dried and fattened off.

The principal drawback to this breed is the rather small size, which involves more labour for the same produce. Hence this is essentially a *country* dairy cow, but is extending more and more as its merits become known. Singularly enough, however, it does not always thrive in the rich pastures of England, but in some cases the yield of milk diminishes, and the animal lays in fat instead. In other situations it answers well, but it is best to try one or two animals before venturing on a herd.

Ayrshire cattle can be readily procured at any of the fairs in the south-west counties of Scotland.

The *Alderney*, a Channel Island cow, does not, as is popularly supposed, yield any extraordinary *quantity* of milk, but is remarkable for its very rich quality. Hence, an *Alderney* cow is often kept in dairies to enrich the produce of the stock. It is a small animal, of very angular form, as generally met with, looking, in fact, as if starved, from the great projection of the bones. When dried, however, it often fattens well. On the whole, this cannot be considered a very *profitable* cow, the return of milk not being commensurate in quality with its great appetite; hence, very many purchasers of this celebrated breed have been greatly disappointed. Its place is rather to supply the gentleman's table with the very richest quality of dairy produce, where pecuniary profit is not so much desired.

The *Alderney* cow is generally very hollow behind, with high shoulders, and a very thin neck, and is also remark-

able for very long and thick hair. The colour is generally white and fawn colour. The Guernsey animals are often thought to be rather superior; but this is a doubtful point. Probably the very choicest stock is that of Mr. Dauncey, in Bucks, who has done much to improve the breed. Many of the animals in his herd have very few of the usual defects, but are models of symmetry; while their milking qualities also have been improved.

Alderney cattle are very easily obtainable at Southampton.

A more profitable animal in most circumstances is the *Breton*, or Brittany cow, which has rapidly grown in popularity since its introduction a few years ago. This breed is very small—even diminutive—rarely standing more than forty-two inches high at the shoulder, and often eight or ten inches less; but it is remarkable for its symmetry, hardihood, very great milk-producing quali-

The *Suffolk* is a polled or hornless breed, long celebrated for its milking qualities. The hips are very high and prominent, and the loins usually inclined to be narrow; but this fault might be easily remedied by a little careful selection in breeding. The best milkers are very spare animals, with light and narrow heads. As a fattening beast, however, the *Suffolk* is inferior, though the meat is of very good quality. When dried, the cow fattens, perhaps, we might say, tolerably well; but her great merit is as a milker. One animal *has* been known to yield thirty-two quarts per day, and twenty-four quarts is not an unusual quantity. The quality of the milk is not, of course, equal to that of some breeds which yield less; but is very good, and makes excellent butter, though it is said to be inferior for cheese.

There is a *Welsh* breed of black cattle, which often produces very good milkers.

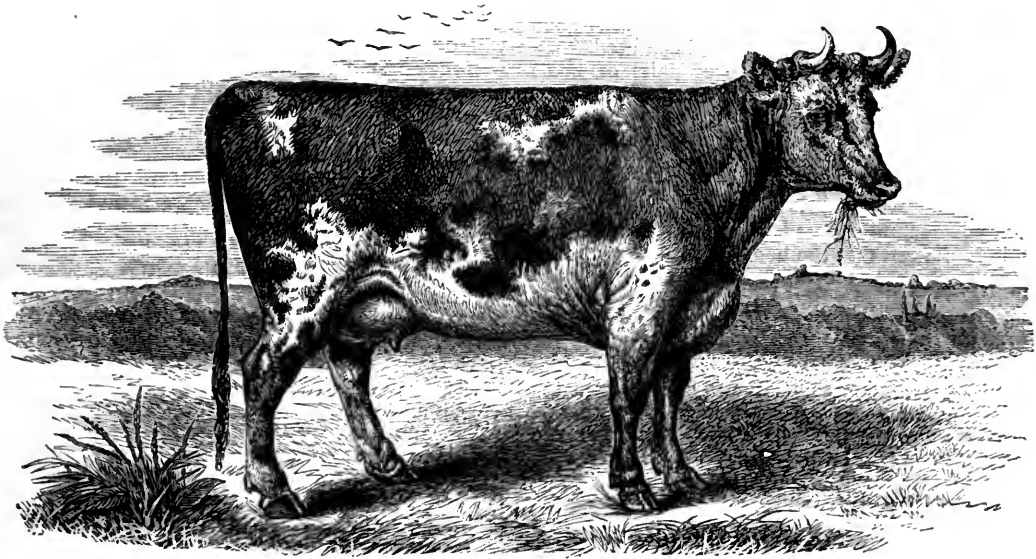

AVRSHIRE COW.

ties relative to its size, and peculiar aptitude for laying on flesh with very moderate, or even coarse, feeding. The head is short, sharp, and fine; the muzzle small, with beautifully cut nostrils; eye quick and lively; ears small and neat; and horns slender, curving at first upwards and downwards, the points afterwards turning into each other. The slenderness of the horns is a great point, and is always looked for as an indication of good blood. The neck is slender, the back straight, loins long and of good width, with hip bones rather prominent. The limbs should be short, straight, and slender. The udder of this species is large in proportion, with the "milk-vein" well developed.

The colour of the Brittany cow is usually white and black, or all black, but sometimes yellow and red. In France, according to Professor Gamgee, a mixture of red and white is most valued; but if other points are good, the colour is purely matter of fancy. Take it altogether, this cow is just the one for a lady's dairy, and almost fit to be a lady's pet, being small, gentle, pretty, hardy, and productive. For the cottager it is equally adapted, having somewhat of the ability of the ass to forage for itself. The milk is not only plentiful, but of great richness. The small size is the principal drawback to its perfection, as it makes it unsuitable for large dairies; but in cases where this objection does not apply, it may fairly be said that the breed can hardly be surpassed for milking purposes.

The *Kerry* cow is also well known for its milking qualities. It is rather small, but hardy, and has very much of the foraging abilities of the Breton. The cow varies greatly, and so do its distinguishing points of excellence. In fact, many of the Irish cattle have lately been crossed with the Shorthorn breed, and it is very doubtful if distinctness of race can be established. The *Kerry* cow adds to its other merits that of being *cheap*. It can be easily obtained at almost any town where Irish cattle are imported.

The cows we have described in this paper are especially good for dairy purposes, and as such are especially valuable to the cottage farmer who has not sufficient fodder available for fattening cattle for the butcher; while even those farmers who have space to maintain a large stock, often find it convenient to keep some cows especially for milking. In our next paper we shall pass on to a consideration of the cattle that are best adapted for fattening purposes; and having thus noticed all the principal breeds of cattle kept in this country, we shall proceed to give such practical directions for their keeping and management as the farmer may be able to carry out for himself, without having the trouble to call in professional assistance. It must be understood that our papers are not at all intended to supersede professional medical advice; but in country places this is not always accessible at once, and we may at least indicate the best course to be taken until it can be procured.

ODDS AND ENDS.

Polishing Paste.—Half a pound of mottled soap cut into pieces, mixed with half a pound of rotten-stone in powder: put them into a saucepan with enough of cold water to cover the mixture (about three pints); boil slowly till dissolved to a paste.

Cement for mending Broken Vessels.—To half a pint of milk put a sufficient quantity of vinegar in order to curdle it; separate the curd from the whey, and mix the whey with the whites of four eggs, beating the whole well together; when mixed, add a little quick-lime through a sieve, until it acquires the consistency of a paste. With this cement broken vessels or cracks can be repaired; it dries quickly, and resists the action of fire and water.

To mend China.—Mix together equal parts of fine glue, white of eggs, and white lead, and with it anoint the edges of the article to be mended; press them together, and when hard and dry scrape off as much of the cement as sticks about the joint. The juice of garlic is another good cement, and leaves no mark where it has been used.

Waterproof Boots.—I have had three pairs of boots for the last six years (no shoes), and I think I shall not require any more for the next six years to come. The reason is, that I treat them in the following manner:—I put a pound of tallow and half a pound of rosin in a pot on the fire: when melted and mixed, I warm the boots and apply the hot stuff with a painter's brush, until neither the sole nor the upper leather will suck in any more. If it is desired that the boots should immediately take a polish, melt an ounce of wax with a tea-spoonful of lamp-black. A day after the boots have been treated with tallow and rosin, rub over them this wax in turpentine, but not before the fire. The exterior will then have a coat of wax alone, and will shine like a mirror. Tallow, or any other grease becomes rancid and rots the stitching as well as leather; but the rosin gives it an antiseptic quality which preserves the whole. Boots and shoes should be so large as to admit of wearing cork soles.

Moths.—If furs or apparel be enclosed in a box with a little oil of turpentine, they will remain free from the larvæ of moths.

American Receipt for Corn Bread.—Take half a pint, *good measure*, of white Indian meal, which should be rather coarsely ground. Mix it thoroughly in a large bowl, with one pint of fresh milk, and do not imagine, because it seems so thin, that I have made a mistake, or suspect the printer, but do as you are bid. Put in what salt is necessary, and into the batter break one fresh egg, and with a kitchen fork beat the whole together quickly and thoroughly. Have your oven pretty hot, but not scorching. Into a splay-sided round tin pan, of say four inches diameter at the bottom, and two and a half to three inches deep, pour your batter (which will about half fill the pan), and put it into the oven instantly. It ought to bake, if the oven is properly regulated, in about half an hour. It must be perfectly *done* to be good. It is to be eaten hot, before the upper crust falls, and buttered to taste.

To erase Stains of Ink, Grease, &c.—A very weak solution of sulphuric acid will readily take ink-stains from the hands, but must on no account be used with textile fabrics. For the latter, the best preparation we have tried is Perry's ink-eraser, which can safely be recommended. The same manufacturer has also produced a preparation for removing grease stains, cleaning gloves, and similar operations, which may thus be readily and satisfactorily done at home.

Shoes.—However worn and full of holes the soles may be, if the upper leathers are whole, or soundly mended, and the stitching firm, the soles may be covered with gutta-percha, and at a very small expense the shoes will be fitted for a new term of service. We have seen shoes,

in appearance not worth carrying home, made quite sound and respectable, and to serve many months in constant wear, by being thus soled for the outlay of a few pence. Thin shoes that have been worn only in-doors, and which are laid aside on account of the tops being shabby, perhaps worn out, while the sewing is sound, may be made very tidy by covering with woollen cloth, or with a bit of thick knitting, or platted list, stitched on as close as possible to the regular seam. I have seen a pair of boots covered with black jean so neatly that without very close inspection they might easily be mistaken for new boots bought of a regular maker. This is surely better than wearing them in slatternly holes till they drop off the feet and are thrown away as good for nothing.

HOME GARDENING.

ROTATION CROPPING (*continued*).

November.—1. The strawberries in this compartment will be greatly improved by having a moderate layer of well-rotted stable dung carefully put down between the rows. The raspberries will likewise be benefited by being treated in a similar manner, and in both cases the manure may be slightly pointed in—that is to say, turned into the soil with a fork. The former will require no further care than the removal of any runners that have hitherto escaped your notice, taking care to avoid cutting away any leaves, while the latter need merely have the old canes removed for the present. 2. This being all under winter crops in a state of progression, it is only necessary to say that where two or more varieties of broccoli are planted, notice should be taken of the periods at which each one comes into use, as a guide for a future season. In the event of very severe weather setting in, it would be advisable to have all the Cape broccoli that are ready for use cut and suspended in a damp cellar or outhouse, as by this means you may keep them for several days, whereas if they were left exposed in the open ground a sharp frost would render them useless in as many hours. 3. Now is the time to force any sea-kale you may have to spare, but not otherwise, for, remember, the plants or stools you take up for that purpose will be of no further use for out-door purposes. The way to accomplish this, is to take up a few, plant them in deep pots, and remove them to a warm place, where light can be entirely excluded. This can be easily managed by putting an inverted flower-pot over that in which the plants are inserted. This method, of course, will produce a much earlier supply, but we prefer the old mode of covering each plant with an inverted pot, and these receptacles, ground and all, with some kind of fermenting material—such, for instance, as a mixture of dung and leaves, or old dung from a half-spent melon or cucumber frame. 4. But very little attention need be paid to celery in this compartment during the present month, with the exception of earthing up the later kinds as they may seem to require it. It will be found a good plan to level down and afterwards fork over the ridges on which the early celery has been grown as soon as it is at liberty, to give frosts an opportunity of pulverising it, and thereby prepare it for a future crop. 5. As the removal of the peas will afford the broccoli planted between them more room to grow, we may naturally expect that they will begin to look considerably better, both as regards uniformity and compactness. The only attention requisite just at present, therefore, is to clear the plants of dead and dying leaves, and of vermin where prevalent. 6. As cabbage plants will occupy the greater portion of this plot, the work required will necessarily be chiefly that of searching for and destroying slugs, either by picking them off by hand or dusting the plants with lime, earthing them up from time to time as required, and manuring and digging the remaining portion as soon

as it can be conveniently cleared. 7. By this time you will have taken up and stored away the carrots, and thus rendered the space previously occupied by them ready for the reception of some other crop. Should this position be suitable for peas, a row or two might be put in with advantage, about the sixteenth of the month. In any case, let the ground be ridged up as soon as possible, so that it may be well pulverised by the time you mean to make use of it. Any beets, celery, or parsnips may be taken up before severe weather sets in, and stored away in a cool place; but they must be covered over with earth or silver sand—the latter is preferable. 8. Endive, lettuce, and turnips occupying the main portion of this department, there will be a good deal of care required, inasmuch as the endive will need blanching by covering over with an inverted flower-saucer or a board, for want of a better contrivance. The lettuce will require tying-up slightly, while the turnips will merely want thinning out and keeping free from weeds.

HYACINTHS

cultivated in the open air, require soil of a light and rich nature—such, for instance, as a mixture of one-third sandy loam and two-thirds well-decomposed manure; and therefore, where the bed or border is of a damp and heavy description, it will be necessary to add at least a third of silver sand, or light mould, to overcome the injurious effects of cold, clayey soil, or otherwise the bulbs would be sure to get mouldy, if not rotten. As it is most important that the soil be fresh and sweet, the moment bedding plants are done with see that the ground be properly ridged up, so as to permit the air to pulverise it thoroughly prior to the bulbs being planted. The said bulbs should be planted four inches deep, and from seven to eight inches asunder in every direction; and as soon as they give indication of having made good root, let them have a liberal supply of moisture, but not before.

From the middle of October to the end of November is the best time to plant in the open air, as, if put in earlier in the season, they are very apt to receive injury from frost and wet.

Those who contemplate rearing this much-admired flower in pots should plant them singly, in pots four inches in diameter, and six inches deep. Our reason for advising this method is because, where several are planted together in a large pot, one or two may fail, and thereby spoil the effect; whereas, if they are grown singly, it is easy enough to mass perfect and healthy ones together without any risk of a failure, for the turning out or transplanting will in no way injure them.

As soon as you have potted as many as you are likely to require, place them in a dry and level place, and cover them with a six or eight inch layer of cocoa-nut fibre, tanners' bark, sand, or decayed leaves, and over this lay a bast mat, or something of the kind to keep the rain off. They will require no water for eight or ten weeks, as the soil on which they stand contains sufficient moisture to serve them until uncovered at the expiration of that time, when they will have thrown out an ample supply of roots, and may then be gradually supplied with water. Such of the bulbs as show their flower truss through this temporary covering should be at once selected, and placed in a shady spot for a day or two; but if required for forcing into bloom by Christmas, it will be necessary to remove them to a forcing pit, where they should be plunged up to the rims in a bottom heat of from seventy to seventy-five degrees. Many persons who attempt to force these bulbs fail, simply because they do not place them on a hard substance, and thereby prevent the roots shooting through the pots into the forcing material, and also because they do not shade them until the leaves have assumed a bright green hue. Where the stems have been too much forced it will be necessary to remove them to a cooler

temperature; while, on the other hand, should the flower truss grow squatty, or close to the foliage, it will be necessary to increase the top heat, and place an inverted flower-pot over the plant; but as soon as the truss shows signs of flowering properly, the said pot may be raised out of the bottom heat, and have an ample supply of fresh air and moisture. These plants, after remaining on the surface of the bed for two or three days, should be removed to the greenhouse, or, for want of that, the sitting-room. If you do not want to force the plants into bloom before March, you need merely keep them in a dark place until such time as they have made good roots, without which fine blooms cannot be expected.

To rear these bulbs successfully in glasses it will be necessary to fill the receptacles with rain water, just high enough to touch the base or bottom of the bulbs, and no more; and, having done so, remove them to a dark cupboard, or cellar, where light can be entirely excluded, and there let them remain for four or five weeks. At the expiration of that time they may be removed to the greenhouse or sitting-room, where an ample supply of light can be ensured, and a sudden change of temperature guarded against. So long as the roots are kept in the dark, there will be no necessity to change the water; but as soon as they are exposed to the light it will be advisable to remove one half the water once a week, and fill up the glasses with fresh without disturbing the roots. A little guano added to the water will tend to strengthen the plants, and thus improve their blooms. As a preventive against their growing spindly, and producing meagre trusses of flower, the room in which they are kept must not be too warm.

HOUSEHOLD AMUSEMENTS.—IV.

NOVELTIES IN TOYS AND TRICKS.

EVERY winter season brings with it a new series of ingenious contrivances for the entertainment of long evenings and dull hours, and in the present paper we propose to notice some of the novelties which have been lately brought before the public.

The Siamese Link is probably by this time known to most of our readers. It is a very simple contrivance, but a fruitful source of merriment on its first introduction into a juvenile or other company. It derives its name from the "Siamese Twins," lately exhibited in London. It consists of a hollow tube, about three-quarters of an inch in diameter, and formed of narrow rushes interlaced together. This is handed to one of the party to insert a finger in one end, and a second person in the company is afterwards requested to do the same in the other. The person who has the link should see that each finger is inserted well down into the end, to ensure a firm grip. The individuals attached by the link are then told that they may release themselves, which each, of course, attempts to do by withdrawing the finger. But this effort causes the link to become elongated, and consequently narrows its diameter in proportion; the more tightly it is pulled the narrower it becomes, and the firmer is the hold it keeps. Nor can it be detached by any amount of pulling, even with the other hands. The secret of release is compression of the link *lengthwise*, which brings its diameter to the greatest possible width, and consequently affords sufficient opening for first one and then the other finger to become detached. When a lady and a gentleman have been prevailed on to try the experiment together, the trick is very amusing to the company, as well as to themselves. When children are trying the link, two fingers may be inserted in each end.

The Chamclcon Top.—This is something like the "gyroscopic top," which was brought out a few years ago, but is much more elaborate and amusing. The top is wound and spun in the same way, but the revolving disc

comprises a series of colours, which, passing rapidly round, appear to form continuous circles, varied in hue according to the pleasure of the operator. Besides this arrangement, the apparatus includes a number of pieces of wire, bent in various shapes, and when one of these is inserted into the disc, it appears, as it revolves with it, to form a glass, an egg, a cup and saucer, the human face, &c., according to the shape of the wire. To make a further change, a smaller disc is attached to one of these wires, which is fixed into the socket of the top, and this disc being touched with the finger while spinning round, produces a second series of brilliant colours. The most novel feature in these tops is the elegant and perfect shapes which the simple pieces of wire are made to assume by their revolutions. Of course, these appearances are owing to the well-known law of optics, that the retina of the eye retains, for something like the twelfth part, of a second, an image produced upon it; and the rapidly succeeding positions of the wire consequently produce upon the eye the impression of an unbroken figure. Schoolboys are familiar with an illustration of the same law in the stick lighted at one end and twirled round by a string, which gives the appearance of a complete fiery circle. The chameleon top is sold by Perry and Co., 37, Red Lion Square, and 3, Cheapside.

The London Stereoscopic Company, of 54, Cheapside, and Regent Street, have annually issued a budget of novelties at Christmas time, some of which—such as the Wheel of Life and the Magic Wand—have acquired a wide popularity. Their series for the present season is likely to prove at least as attractive as any former issue. Among them are one or two so extremely ingenious as to afford much amusement and speculation, even in well-informed circles, and to defy the detection of ordinary observers in their *modus operandi*. The chief of these is called the *Scientific Mystery*. The apparatus consists, first, of twelve separate blocks or tablets enclosed in three sliding cases, some of these blocks having upon them photographs of the Royal Family, and others, figures, letters, and conundrums. The person performing hands these cases to the company, with permission to select from them any of the blocks they contain, and arrange them in what order they may please, while he retires from the room, returning them to their cases when they have done. Thus, with the lettered blocks they may form words; with the figured tablets, a row of numerals; with the portraits, a re-arrangement into compartments according to fancy; and from the conundrums they may select any question or questions to be answered. Having arranged the blocks and shut up the cases, they invite the performer to return, and then challenge him to inform them exactly what has been done. He must repeat the figures, spell the word, name the order of the portraits, or give the right answers to conundrums, *without seeing any of the blocks*. The task would appear impossible, but he is provided with a method of performing it with ease. He holds a paper tube, in which is the figure of a magician, whom he is supposed to consult; and, by simply looking at the outside of the cases through this tube, to the astonishment of the company, he repeats the figures, or answers the questions, exactly. The mode in which he is enabled to do this involves scientific principles, to which we are not at present at liberty to allude, as the wonder created by the trick

would necessarily vanish; but we must commend the entire invention as one of the most ingenious which have ever been brought before our notice, and it cannot fail to have a great success.

Among the other novelties issued by the Company are the following:—

The Obedient Ball.—This is made of boxwood, with a hole drilled through the centre, and the operator is provided with a cord, to each end of which a handle is attached. One handle is passed through the aperture in the ball, drawing the cord with it; and the performer, taking a handle in each hand, holds the line perpendicularly, but lets it hang rather slack. The ball then runs freely down to the bottom. But the apparatus is so contrived that if he tightens the cord by stretching it as he grasps the handles, the ball will be made to obey his commands in its descent. Thus, “go down half way,” “three-quarters,” and the like, is answered in each case by the precise degree of movement demanded.

The Magic Bottles.—Two small bottles are placed before the company, and appear to possess the remarkable property that it is impossible to upset them. Do what you will with them, incline them, or even lay them flat on the table, and they rise to the perpendicular immediately you release your hold. But, in performing the trick, while the company are examining one, you take up the other,

breathe gently upon it, and then, to the general surprise, it will so far lose its first qualities as to remain a-tilt on the extreme edge of the bottom, inclining, in fact, upon the table at an angle, as when a glass of wine is poured from a bottle. You then offer your bottle to another person, who also breathes upon it as you have done, but without the same effect. The bottle steadfastly persists in the upright course it at first adopted, and all his efforts to change it are

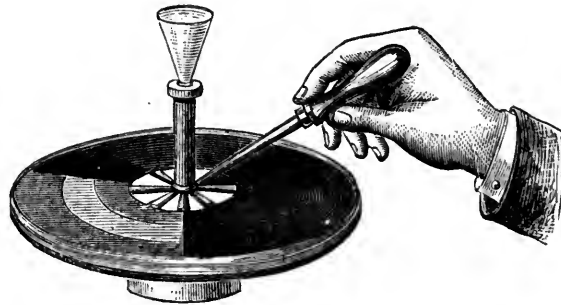

THE CHAMELEON TOP.

without success. You can, if you please, perform this rather surprising trick with both the bottles.

Then there are the *Invisible Gift* and the *Vanishing Coin*. The former is a way of making a present—say a “tip” to a schoolboy—and puzzling him greatly as to how to reach it, although he has it actually in his hand. It is enclosed in a little box, which, finding the lid, he presently opens, but perceives that he is then no nearer the discovery than before. When you have shown him how to get at it, he thinks it the simplest thing in the world. In the trick called the “vanishing coin,” a penny piece appears to pass through a box with a solid bottom.

It is not our purpose to spoil the fun of Christmas parties, but rather to increase it, by pointing out novelties adapted to introduction among them, leaving our readers to puzzle out the mysteries attending them for themselves.

The “Scientific Mystery” and the other novelties just enumerated are comprised in a guinea box sent out by the Stereoscopic Company, which also includes “Scientific Experiments for Juveniles,” the “Coruscating Metallic Wheel,” and a Permanent Photograph in Crystal of any subject that may be chosen, the latter forming a paper-weight. Either of these articles may be had separately, at prices ranging from one shilling upwards. Of the Coruscating Wheel, we may add that it is designed to illustrate the various colours and coruscations of metals in combustion, and that it has been prepared for the Stereoscopic Company by the Messrs. Brock, the pyrotechnists to the Crystal Palace.

HOUSEHOLD DECORATIVE ART.

VI.—PAPER FLOWER MAKING.

THE art of paper flower making is an elegant one, and capable of very high perfection. It has also this merit, that, unlike many accomplishments, the very earliest attempts of amateurs are at least pretty, even if unfit to decorate the drawing-room. Paper flowers, when entirely made by hand, are not very expensive. The component

white paper models of every size of petal which it bears. Mark on every sized petal you take as a pattern how many of that size the flower contains. Then cut them out in paper of corresponding colour, and make them up, as closely imitating the real flower as you possibly can.

At first it will be well to make up a few flowers from the outlined patterns we shall give. If these are practised through the winter months, the learner will be able by the

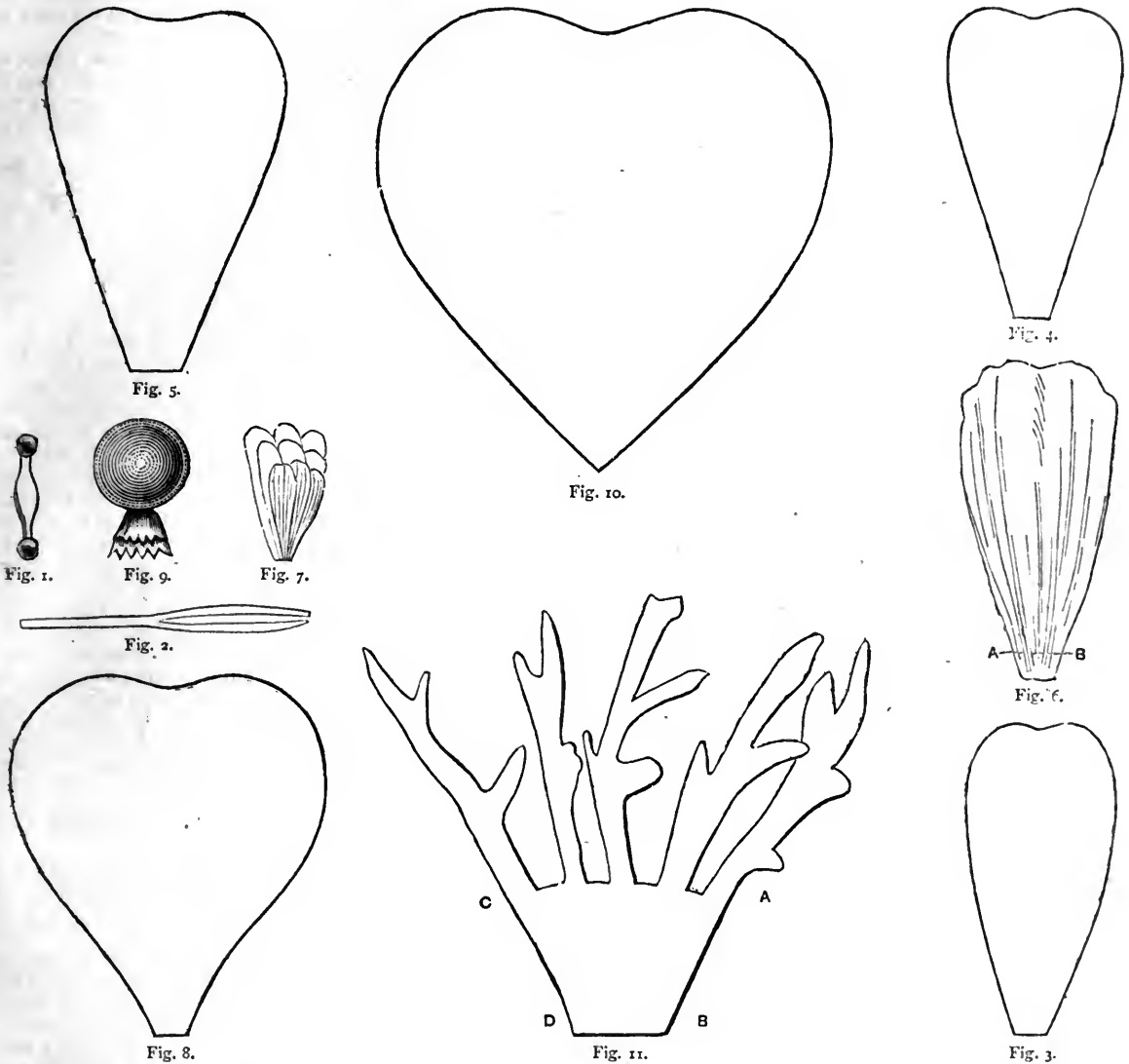

parts for forming most of the flowers can be purchased prepared, and in that case, of course, become more costly. A little skill is needed to put them together rightly, they do not cost a third what the finished flowers do.

A rose is one of those flowers the parts of which cannot be had ready to purchase, and is not a difficult flower to make, and therefore we will first give our readers directions to construct it.

It must not be forgotten that the object of the paper flower maker is to imitate nature as closely as possible; therefore the learner should observe flowers well. Whenever it is possible, obtain a fine specimen of whatever flower you desire to copy from the garden or conservatory. Examine it well, and then pick it to pieces. Cut out in

summer to copy from nature, and keep by her her own patterns taken from the flowers of her own garden.

To make paper flowers a few tools will be required. A pair of wooden goffers, which will form bowls of four different sizes, and resemble the illustration, Fig. 1; a pair of steel pincers, Fig. 2; a fine pair of scissors, with long points; some cement; a reel of very fine green flower-wire, and some strong wire for the stems.

It is easier for a beginner to fill a basket than a vase, because in a basket the flowers are closer packed and less critically observed. Rather stiff stems suit best for a basket; but for a vase the finer and more flexible wire is needed. The stems are not seen in a basket, and may be made stronger. Choose plain wire, uncovered. Either for

a vase or basket artificial moss will be needed; for the latter about half a pound. Fill a basket-well closely, and heaped up with a rise in the centre. A vase must be filled nearly to the top. This is to hold the flowers in their places. The moss must be well pulled out, and should be two parts green and one part brown.

French tissue-paper must be used for flowers. Common tissue will not crimp or goffer well, nor is it sufficiently transparent and bright hued. The French paper seems dear—from 2d. to 6d. a small sheet—but many roses can be made out of sixpennyworth of the paper. The pink sheets are about 6d. each. You can also buy variegated sheets of pink, yellow, buff, and red and yellow-streaked sheets, made up admirably for roses, and tulips, and crocuses, imitating nature very closely.

A large square pincushion, with only a calico cover, is necessary.

To make the Cement.—Take an ounce of gum tragacanth, and a little bit of alum the size of two peas. Put this in a wide-mouthed small bottle, or small pomatum-pot. Mix a little flour and cold water. Pour it on the gum, and let it stand in the oven till dissolved, assisting it if necessary by kneading it with a piece of wood. Melt it to a strong jelly that will not harden for a few weeks. One of the flower wires, eight inches long, is the best thing to use for applying the cement.

To make a Cabbage Rose, three sheets of three different shades of deep pink paper are needed, and one of green; also a very little cotton wool, and a reel of green sewing silk.

There are five different-sized leaves used for a cabbage-rose, and a square piece. Take a little piece of wool, and covering it with the square of paper, make it into a little ball, and tie it round. You will need two more of these. Then begin to cut out the petals. Fold the paper so as to cut eight each time. If the paper is folded too thick it can never be cut well, but on the contrary the scissors are spoiled. Out of the darkest shade cut Figs. 3 and 4, nine of each, and nine of Fig. 5 in the middle shade. These petals are to be crimped, which is done by laying one at a time on the cushion, and also bring them down lengthways with the pincers, which are held between the fingers, bringing the prongs nearly together, and pinching up the paper between them, so as to make the irregular crisp-looking creases noticed in the heart of a rose. The marks must be very strong, and the leaves quite crimped up, working the strokes from A to B, Fig. 6, which represents Fig. 6 when crimped. The pincers are held in the right hand, and the petal on the cushion by the left.

Stick together with cement by their narrow ends three petals of Fig. 4, three of Fig. 5, and three of Fig. 6, as shown in Fig. 8. Make two more groups in the same way, which will use up all the petals you have.

Cut out in the middle shade of paper nine petals like Fig. 10. Lay each separately on the cushion, and with the second-sized goffer rub it gently, pressing it in the middle till it curls all round the bowl of the goffer; then curl it still smaller with the third-sized goffer, and turn back the extreme edges very slightly with the point of the pincers. Put three of these leaves on the outside of each of the three groups of leaves. Then with the cement fix one of each of the three groups of leaves upon one of the three balls shown full size in Fig. 9. Cut off next three more petals of Fig. 3, three of Fig. 4, and three of Fig. 5, and crimp them as you did the first. Cement these together in three little groups, one of Fig. 3, one Fig. 4, and one Fig. 5. Then tie the three little balls, with the three groups of leaves upon them, to the top of a wire stem, eight inches long. Be sure it is tied on very firmly. If the top of the wire has a tiny crook made, it will be more secure. Tie the balls so that the groups of leaves attached form a close and well-shaped heart for the rose. The balls must be entirely hidden by the petals.

Then in the three spaces between these three groups cement the three little groups of three petals which you have just crimped. Next cut out twenty-four petals like Fig. 10. Goffer them on the cushion, using the largest and the second goffer to sixteen of them, and the third goffer to the other eight. Curl them all back at the edges with the point of the pincers. Hold the rose in your hand downwards, and put on, by touching the lower point of each leaf with cement, the eight leaves first, and then the other sixteen of the twenty-four, laying them regularly all round, one a little over the other. Now leave the rose to dry, having finished by cementing the base well.

The reason why it is best to cut out a few petals at a time and place them on, and then return to the task of making more petals, is because, if the first leaves are yet wet when the next are applied, they will all come off in patches before the flower is finished, and spoil it.

The calyx must be added as soon as the rose is dry. The easiest and best way is to buy rose calyxes by the dozen. If, however, the amateur wishes to make them herself, she must purchase a sheet of bright pale-green paper, not tissue, and cut out the calyx like Fig. 11, keeping the spikes as sharp and natural as possible. It must then be covered thickly with cement and left to dry. Afterwards it must be united by fastening the side A B to C D by the little bit seen projecting from A to B. Let this dry. Then thoroughly cement the inside, put in a very little wool, enough to fill the cup of the calyx, and slip it up the wire with the part from A to C meeting the swell of the petals to which the cement is attached. If the petals drop too much, the spires of the calyx may be fastened to them with a touch of cement to support them.

Cut a long strip of green tissue-paper, half an inch wide, and very even. Gum it slightly from A to B, and attach this to the calyx. Hold the wire stem in one hand, and by passing it nimbly through the fingers of the other hand roll the paper tightly and smoothly all down the stalk. Leave the flower upside down, to dry completely. It is best to place it in a box till the next day. Then with the points of the goffers set and turn the rose petals and curl them any way you like, to imitate nature as closely as possible. If the flower is for a basket, use it as it is. For a vase, it had better be made into a sprig, by adding a bud with a leaf to it, tying the stems of these to the rose stem with the green silk, or fine wire, and covering it again with paper. Then lower down on the rose stem add another leaf in the same way, and again cover that join with green paper. Bend the stems gracefully and naturally, and bend the leaves also.

Leaves are never made in the paper. They must be bought, which they can be for the purpose, in dozens or half-dozens, and are made of muslin. Vary them in colour as much as possible.

These roses may be made in any shade of pink, from a pale tint to a deep rose colour. Yellow roses can also be formed from the same pattern, but are better cut a mere shade smaller in every petal. The yellow need three shades—the lightest for the petals Figs. 3 and 4; the middle for Figs. 5 and 8; and the darkest for Fig. 10. For a damask rose cut the patterns visibly smaller.

To cut the patterns, first trace the diagrams from the HOUSEHOLD GUIDE on any thin paper; cut them out, and cut thin card patterns from them. Having made a set for the pink cabbage-roses, mark them in ink "cabbage rose." Cut another set, and make them slightly smaller, and label them "yellow rose." Then another set, cutting them away all round the edge decidedly smaller, and label "damask rose." If you also put on them how many petals of each are wanted, you have your patterns ready for use.

The yellow and the damask rose are both made with this difference to the cabbage-rose, that in the centre of each there is a heart of stamens and pistils, and the petals made into little groups as before described, are attached

to this instead of to three balls. The way of making these centres will soon be given. When the damask-rose petals are cut out, they must be all of the deepest and brightest red paper, and of one colour. Before crimping or goffering them, mix some powder carmine with a little gum in a saucer, and with a camel's-hair brush of medium size paint them well, the three first sizes entirely on the right side, and the two largest half way down; after which they must be allowed to dry thoroughly.

COOKING.

MUSHROOMS AND PICKLES.

Broiled Mushrooms are best done in a dish, in the oven of a cooking-stove, or before a brisk fire in an American oven. On the gridiron, they are difficult to keep from breaking and losing their juice before they are done enough. Select mushrooms completely opened, free from grit and maggots, and yet nearly arrived at maturity. Respecting these, Mr. Alexander Forsyth says, "The small mushrooms so much prized in noblemen's families for bottling, are by no means thrifty as food for working people, bearing as they do the same relation to full-grown mushrooms that well-fed veal does to beef. When the gill of the mushroom has got its rich colour and its delicious odour, and whilst the curtain hangs round the outer edge like a fringe, the mushroom is in perfection, and all that it then requires is heat enough to cook it, and a little salt to eat it with; and with such a sauce as this, dry bread or boiled potatoes are able to do the work of a rich meal at a very small cost. If you look at some fields in autumn, the crop of mushrooms reminds you of the manna that the people gathered every morning; and, at the present high prices of flesh-meat, a good dish of savoury mushrooms would be to many a poor person as if the windows of heaven had indeed been opened to them. The common field-mushroom is easily known by its flesh-coloured gill and its sweet smell. The Scotch bonnets (*Agaricus oreades*) are easily told; and although they look a little coarse, they are quite safe to be eaten." Peel off the upper thin skin from your mushrooms, remove the stalks, and lay them in your dish flat on their backs. On each lay, according to their size, several little bits of butter as big as hazel-nuts, dust slightly with pepper and salt, and set into the oven. As soon as the gills drop and their juice runs from them (in from seven to fifteen minutes) they are done enough; serve in the dish in which they are cooked. If the oven is fierce you may cover that dish with another on setting in.

Stewed Mushrooms.—Mushrooms in any eatable stage make good stews; we prefer a mixture for the sake of the catchup from the elderlies, and of the pleasant fleshiness of the younger samples, amongst which a fair proportion of buttons may be admitted. Prepare as before, removing the stalks from the advanced mushrooms only. Put them in a saucepan with a little good broth and its floating fat, a bit of butter, and a parsimonious sprinkling of pepper and salt. Set them on the fire; when they begin to warm, close down the lid to keep in the steam; give a toss and a shake from time to time. In about ten minutes they will be tender and juicy; serve garnished with buttered toast in small squares or triangles.

Mushroom Catchup (Practical and Good).—The quantity of catchup yielded by mushrooms, and the proportion of salt to make it with, depend entirely on the weather: if rainy, they will be full of juice; if dry, they may contain very little. Over half a bushel of mushrooms throw, say, three handfuls of salt, and break them up with a wooden spoon; taste them the second day to know if they are salt enough. If you have more mushrooms come in, you may add them to the first from time to time. Leave them in salt two, three, and four

days, frequently stirring, *i.e.*, three or four times a day. Then squeeze them through a cloth, so as to get *all* the liquor from them. Boil this liquor half an hour. When you set it on the fire, add for each half-bushel of mushrooms two ounces of bruised ginger, the same each of whole pepper and allspice, four ounces of cloves, a quarter of an ounce of mace, six shalots, and two or three cloves of garlic, both chopped small. The object of these last is to give a relish without their being actually tasted; some cooks overdose their catchup with cloves, but if it is to taste of nothing but spice, the mushrooms, in point of fact, might be omitted. After the half-hour's boiling strain off the spice, and let the catchup stand to settle; when cool, bottle it off into bottles containing half a pint at the very most, and seal the corks in the way to be shortly indicated. When you are able to gather mushrooms yourself, do not pull them up by the root, but cut them off just above it with a very sharp knife, for two reasons: first, the mould adhering to the root will fall amongst the gills of your mushrooms, and render them too gritty for eating—you cannot cleanse them from that grit. Secondly, mushrooms mostly grow in clusters, especially when cultivated; by pulling up a mushroom you disturb the roots of the whole cluster, and prevent the development of several that would otherwise come on; whereas, by cutting, there is no disturbance of the roots, and the successional mushrooms follow in due course. Do not throw mushrooms pell-mell into a basket, but deposit them in regular layers with the top downwards and the gills and stalk uppermost; they will carry much better so, and make fresher-looking specimens.

Mushroom Toast.—Peel off the thin upper skin from your mushrooms, and cut short the stalks. Set them on the fire in hot vinegar and water. As soon as they have boiled up once or twice, take them out, let drain, set them on the fire in a saucepan with a lump of butter, toss them well in it, dust in flour, moisten sparingly with good stock broth, season with pepper, salt, chopped parsley, and a morsel of garlic. When the stew boils take it off the fire, thicken with egg-yolks and a teaspoonful of vinegar. Pour the whole over a large round of buttered toast, and serve hot.

Pickled Mushrooms.—Housekeepers often complain of the difficulty of keeping pickled mushrooms, especially middle-sized ones (not buttons), from moulding; nevertheless, while the season lasts, it is convenient to lay in a stock of both, using the larger mushrooms first, and reserving the pickled buttons. Procure either of them as fresh as may be; cut off the root only of the stalks of the buttons, and wipe off with a cloth any soil that may adhere to them. Set on the fire enough vinegar to cover them, with salt and spices; as with catchup, the latter must not be in excess, or they will completely extinguish the mushroom flavour. When the vinegar approaches boiling, throw in the buttons, and let them boil two or three minutes; then take them out, put them in small, *warmed*, wide-mouthed bottles, pour the hot spiced vinegar over them, and cork them provisionally. Next day fill up with some of the reserved vinegar, till it will all but touch the bottom of the cork; the second day do the same, if there is any vacancy, so as to *leave as little air in the bottles as possible*. Then cork down for good and all, and hermetically seal the tops of the corks. When a bottle is once opened it should be speedily consumed; you may therefore, without wastefulness, liberally dose your mushroom sauce with buttons. For open mushrooms, which should not be too forward (pink or liver-coloured rather than black), peel off the thin outer skin, remove the stalk, cut the top into convenient sized pieces, put them into *warmed*, open-mouthed bottles, and pour over them hot vinegar, salted and spiced. Then treat as above.

Wax for sealing Pickle-jars and Bottles.—In an

earthen vessel, over a gentle fire, mix two pounds of resin with a quarter of a pound of yellow bees-wax or a couple of ounces of tallow, to soften the composition; a tallow dip answers perfectly, as it is better the wax should be a little too soft than a little too brittle. When well combined let it cool so as to be only just liquid, when you may dip the necks of the bottles in it up to the rim round the neck. It may be coloured with yellow ochre, red lead, washerwoman's blue ball, or ivory black. Great care is requisite not to dip the bottles in the wax until it has cooled sufficiently, for if too hot it will cause the necks of the bottles to split.

Pickled Walnuts.—The great point with these is to gather the green nuts at the exact time, neither too soon nor too late. A few sunny days, by solidifying the carbon imbibed by the tree, will make all the difference. If the nuts are gathered too young they will melt in the pickle: if too old, the shells will be formed, and will resist the dissolving action of the vinegar for years. The test of their fitness is when a large pin (not a needle) can without difficulty be thrust through the walnuts in any direction; if it cannot, they are too forward. Of the two, it is better to be a little before time than a little after time. In the former case, the walnuts are good so long as they last; in the latter, they are often quite useless. After gathering, wipe the green walnuts, one by one, with a coarse cloth which you are not afraid of staining. Lay them in the sun, or at a distance from a slow fire, two or three hours to dry, turning them occasionally. This will cause them to absorb the pickle more readily. Then put them into a brine of salt and water, strong enough to float an egg, remembering that a stale egg floats in weaker brine than a fresh one. Turn them about in this brine once a day, with a wooden spoon, and let them remain there several days, or a week, till they are quite black all over. When their complexion is what could be wished, take them out of the brine, put them, in single layers, in sieves, or on coarse sackcloth, to dry and drain in the sun; turn them once or twice, handling them gently. When tolerably dry, arrange them in the pickle-jars, or wide-mouthed bottles, in which they are to be kept. Put the requisite quantity of vinegar to cover them in a well-tinned saucepan, with the approved spices—whole pepper, bruised ginger, cloves, mace, &c. When wanted very hot, capsicums and scraped horse-radish are added, but they destroy the natural flavour of the pickle. Set the saucepan on the fire, and as soon as the vinegar begins to boil, take it off. When nearly cool pour it over the walnuts, giving to each jar its share of spice, and covering them completely. When cold, tie down the jars with moistened bladder, or cork the bottles, and dip their heads and necks in the mixture of resin, &c., for sealing them hermetically, already given. If a few pickled walnuts are wanted for speedy use, pierce each one throughout with a needle, crosswise and lengthwise, before putting them into the jar, and pour the vinegar and spice over them *hot*, after warming the jar to prevent it cracking. Walnuts not only make a pleasant pickle to be eaten with cold roast meat, but a little bit, say the quarter of a walnut, crushed smooth, with a dessert-spoonful of the vinegar, greatly relieves a hash of mutton, beef, goose, duck, or wild fowl, besides improving the colour of the gravy.

Pickled Onions.—With pickles, as with every other object in life, it is well to make up your mind what you wish for. Some like pickled onions soft, some hard and nutty; they are pretty when white, and bottled in colourless vinegar, but often taste of nothing but of that and hot spice; in brown vinegar, with less fiery condiments, you can *taste* as well as see that you are eating pickled onions. Gather the onions dry; expose them to sun and air for a fortnight or so. Peel them without too much waste. For soft pickled onions (brown), throw them into boiling

salt and water; after another boil up take them off the fire, and let stand till nearly cool. Drain well on a napkin, put them in jars or bottles, and pour over them hot vinegar with spice boiled in it. When they are cold, it will be well to fill up with vinegar if required, and cork or tie down close.

For hard, hot, white pickled onions, after peeling, salt them, and leave them there two or three days. Take out, drain, pack in bottles, and pour over them white vinegar or pyroligneous acid, in which plenty of capsicums have been steeped.

Pickled Red Cabbage.—Cut the cabbage, leaving it with a stalk, in dry weather; remove all the outer leaves, till there is nothing remaining except the central hard ball which you mean to pickle. Hang the cabbages singly, if there be more than one, by the stalks, in a current of air in the shade. A draughty passage answers well. At the end of a fortnight or three weeks, take down the cabbages, and shred them with a carving-knife to the proper thinness, into a shallow earthen vessel. Some housekeepers then sprinkle the cabbage with plenty of salt, and leave it in it several days. The result is that the salt draws out a good deal of the sap of the cabbage (and with it the natural flavour), leaving room in the sap-vessels for the vinegar to replace it. It is not this salt, but the vinegar and spices, which make the pickle *keep*. We ourselves do not salt pickled red cabbage, but put a little salt into the vinegar instead. Pack the shredded (and salted) cabbage in the jars as tightly as possible. Boil the spices in the vinegar, and pour them over the cabbage *hot*. A small quantity of cabbage for immediate use may be boiled in the vinegar three or four minutes. Those who like red cabbage *firm in substance*, should pour the vinegar over it *cold*.

Pickled French Beans.—These, which we consider among the poorest of pickles, more frequently appear in company as mixed pickles, than alone. They are associated with cauliflower sprigs, radish pods, gherkins, small green capsicums, and others. Gather them young, leaving a bit of the stalk, and not pinching off the pointed end. Salt them in brine, drain them, pack them in their jar with bruised ginger and other spices, and pour scalding hot vinegar over them. Those who have gardens do well, towards the close of summer, to keep an *omnium-gatherum* pickle-pot containing vinegar, in which to throw any of the articles which make up mixed pickle, as they become fit. When the collection is large enough to fill a jar, it can be packed therein in approved disorder; hot vinegar, with or without spice (for several pickles, as tarragon, nasturtiums, and capsicums, require no spice), can be poured over the medley, and the jar made air-tight for future use. Note that when a mixed pickle jar is opened, the cauliflower and the French beans are sure to be left the last.

Pickled Radish Pods.—In most gardens a few radishes remain which have grown too big and sticky to eat. Let them stand, if not for seed at least for pickle. Gather the pods when the seeds within them are full grown but soft—*i.e.*, in the condition of green peas. Pour over them scalding salt and water, and let them stand in it till cold; then take out, and drain. When drained, pack them in their bottle, and pour over them hot pickled vinegar. Tie down the cover provisionally. In a few days a good deal of vinegar will have been absorbed by the pods, and must be replaced by more. When there is no more shrinking of the vinegar, the jar may be corked or tied down for good.

In our next paper we shall go on with the subject of pickles and preserves, and having thus come to an end of our recipes in plain cookery, we shall go on to the more advanced branches of the art, commencing with a list and description of the implements which are most necessary in a kitchen.

HINTS ON CARVING.

Goose.—A goose, Fig. 20, is a very awkward bird to carve, because the joints are difficult to separate. The carving of an old goose is certainly a tough job enough, and is very apt, unless carefully managed, to endanger

but as many people object to the flavour of these, each person should be asked whether or no he desires "seasoning"—which is preferable to the term stuffing—and the carver should help a little, along with the meat, to those who like it. The seasoning, or stuffing, is found by cutting open what is called the apron, at C, from C to E, at the

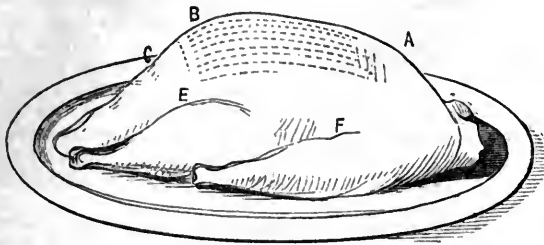

Fig. 20.

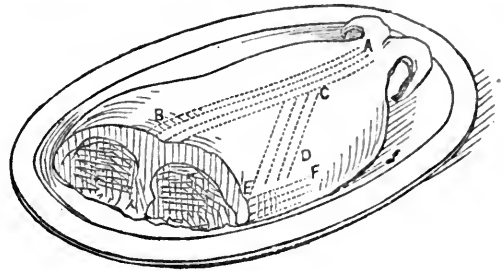

Fig. 21.

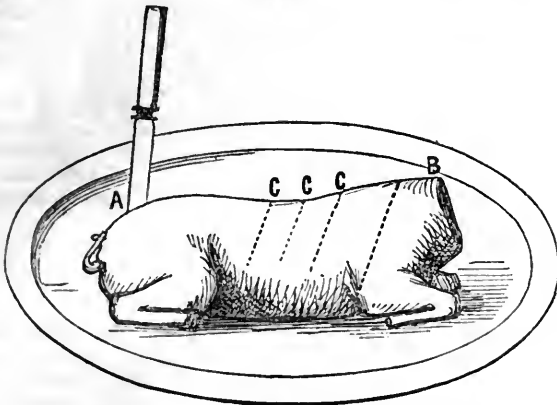

Fig. 22.

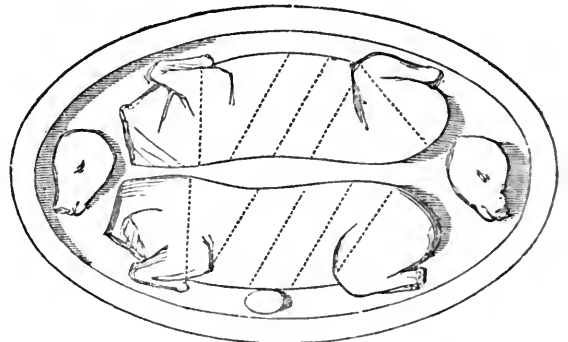

Fig. 23.

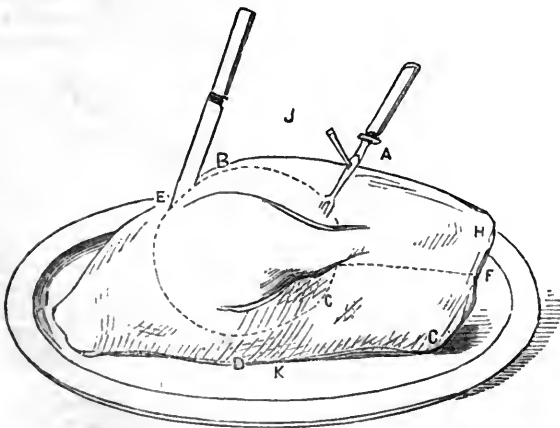

Fig. 24.



Fig. 25.

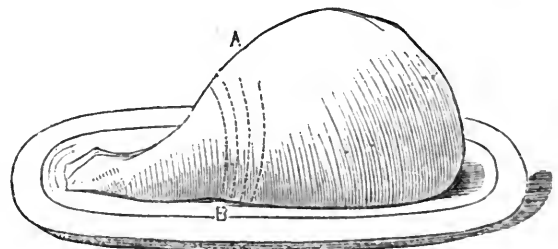

Fig. 26.

the cleanliness of the table linen. However, if the bird be young, there is no very great difficulty likely to occur, and to attain the art of carving a goose nicely is very desirable, for it is a bird that literally goes twice as far when ably cut up as when awkwardly served. To commence, insert the fork a little on one side of the breast, and cut off thin slices from end to end of the bird at the dotted lines marked from A to B, treating both sides alike. It is usual to stuff geese with sage and onions,

dotted line. Next take off the wings and legs, as in a fowl, inserting the knife at E for the wing, feeling the joint, pressing it down very firmly, and when the knife is felt in the centre of the joint, turning it over outwards with some strength. As soon as it snaps apart cut forward with one slice, and take the wing completely off. The knife is inserted at F for removing the leg. Cut the leg in half again, and serve the pieces separately, perhaps with a slice or two of the breast, according to the size of

the bird, and the consequent sufficiency or otherwise of the portion tendered. The breast and back are then cut in half through the side bones, as in a fowl, the breast-bone removed, and the back served whole. It is seldom necessary to cut up a goose entirely the first day. In that case the carving can be finished in the kitchen, previous to making a hash of the bird. Many people who are not particular about the look of the bird, always make a practice of having it cut up before coming to table.

Sucking Pig.—A sucking pig is a very common dish in the country. Unless the family is very small, it is usual to serve two, which are placed on one dish, the heads previously cut off and laid at the ends, as is shown in Fig. 23. Turn the pig upright with the fork, and hold it so. To take off the leg, set the knife in upright at A, Fig. 22, and divide the joint, and then cut it off. Make a slanting slice under the shoulder, as shown at B, and cut boldly through the joint when you meet it. Cut right through the back and ribs in slanting strokes at C C C. The ear and the jaw are considered delicacies. The ears are sent to table already cut off, and will be observed garnishing the dish in Fig. 23.

A Saddle of Mutton.—A saddle of mutton is a dish not unfrequently set on table where there is a large family, or on festive occasions, for it is a particularly handsome joint. It is simply two entire loins undivided, and is considered by many people to be the choicest part of the meat. A saddle of mutton is sent to table in two different ways—either with the tail dressed whole, or with it split in half, each half curled diverse ways over one of the kidneys, and fastened in that position by means of a very small skewer. This fashion our illustration, Fig. 21, represents. Carve thin slices from end to end of the centre of the saddle, beginning a little distance from the tail, as shown in the dotted lines from A to B. Cut quite down to the bone. Make three or four slices, each with a single movement of the hand, drawing the knife quietly along the joint, feeling the bone with the point. In making the last slice, slope the knife slightly to the right side, and cut right through all the previous slices, completely detaching them. The slanting slices from C to D, and the cross ones from E to F, may then be taken, and furnish a palatable mixture of fat and lean. Each guest should be consulted as to whether he or she desires the kidney, and when the answer is obtained in the affirmative, a slice of the kidney is to be served with the meat. Saddle of mutton is not cut so thin as beef, but moderately thick.

Fore Quarter of Lamb.—This joint is open to much the same remarks as a saddle of mutton, being esteemed fit for a guest dish, and also suitable for a numerous party. But it requires quite different carving. It is simply a breast and shoulder in one. When placed on table the carver's first duty is to remove the shoulder, which is not at all difficult. The fork is inserted at A, Fig. 24; the dish is so placed that F is next you, I points directly to the other side of the table, J is on your right hand, and K on your left. Then, with your fork at A, take the knife, hold it at B, and boldly slice away right round to C, raising the shoulder, as you cut it from the breast, and as it severs in the process, with the fork. Go on cutting from C to D, and D to E. You keep your knife with the point as far down as shown in the illustration, and take a circular cut, as shown by the dotted line, and by this means the shoulder will be quite cut off when you have completed the circle, or at best a slight cut will quite sever it. The moment this is done take a lemon or Seville orange, cut in half and sprinkled with salt and pepper, and placed in a plate ready, and squeeze it under the shoulder, which you support still by the fork, an inch or so above the breast, sloping and touching it on the lower side; put in a slice of butter, and let the shoulder rest on the breast, removing the fork. Allow a couple of minutes to melt the butter.

Meanwhile a fresh hot dish is brought. Transfer the shoulder to this, and send it to the other end of the table, or to some other person to be served as a separate joint. The breast is now carved as a breast, and the shoulder as a shoulder, in the ordinary way.

A Leg of Pork.—Pork is a favourite dish with very many, and a leg of pork frequently appears on the family board, though it is not generally esteemed a dish for a formal occasion. It must be placed on the table with the back upwards, and the crackling taken off in a large coat before any attempt is made to cut the meat. Unless the joint is sufficiently cooked, it will not be easy to displace the hard and savoury skin. Cut the joint in rather thick slices across the back at the dotted lines marked A to B in Fig. 26. Slices of the crackling—which, if properly scored before cooking, are easily made by placing the point of the knife in the cuts, and snapping it asunder—should be tendered with each serving of meat, if desired.

Tongue.—Tongue should be helped in very thin, even slices. It is first cut through downwards, a little way from the tip, where a good thickness is attained, at the line marked from A to B, Fig. 25. With each serving cut a slice from the root, D to E, and a little of the fat and kernels which will be found underneath, between E and F. The tip, C, is by many considered a delicacy.

Bacon, when it is a large piece, is generally cut the narrow way, very thin indeed, straight down from the top to the dish, like the cut in the tongue, but beginning from the very end of the bacon, not serving the first slice, but laying that aside on the dish. Small pieces of bacon are usually cut lengthways.

THE HOUSE.

LIFE ASSURANCE (*continued*).

IN continuation of the suggestions in our last article on this subject, as to the means to be adopted by an intending applicant to a life assurance company, to ascertain the position of the office, we ought perhaps to point out the danger of trusting to any empirical tests of soundness, such, for instance, that the accumulated fund of a life assurance society should be at least eight times the amount of the annual premiums, or one-fourth of the sum assured. If such a requirement were to be made an inflexible condition, how, we would ask, could any company commence business at all?

The fact is, the widely varying circumstances which tend to modify the conditions of the numerous totally differently constituted companies, render it impossible to lay down any general test of solvency of this kind, and all attempts at generalising upon results—which, as actuaries well know, can only be deduced by laborious computations, based upon well-defined mathematical processes, to which there is no royal road—are, as a rule, mischievous, as tending very much to mislead the public, though at the same time, it is at once the duty and the interest of every assurance office to give every possible facility to persons anxious to insure, for ascertaining the actual position of their affairs, and the system on which their business is conducted.

We have hitherto referred only to life assurance as a means of family provision; the system is, however, equally adapted to securing debts, by assurances effected by creditors on the lives of their debtors, as well as by partners in mercantile firms, who, by taking out policies on the lives of each other, may prevent the frequently inconvenient necessity of withdrawing capital from the firm, in the event of the death of one or other of its members.

It is usual in some parts of the country, particularly in Devon and Cornwall, for leases of property to be granted depending on the duration of one or more lives, subject to certain fines for the substitution of a new life as an old one fails. These fines may be advantageously provided for by

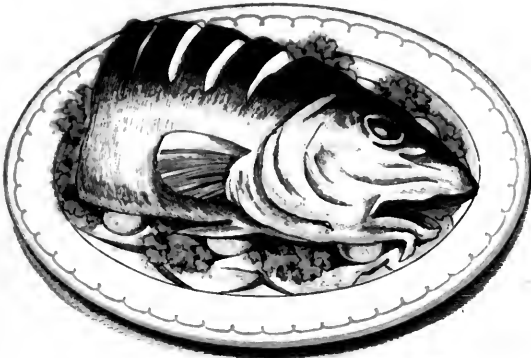

1

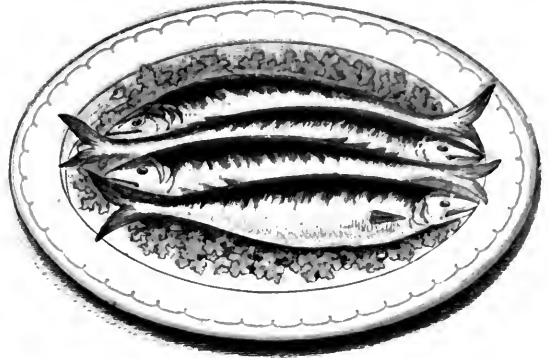

2

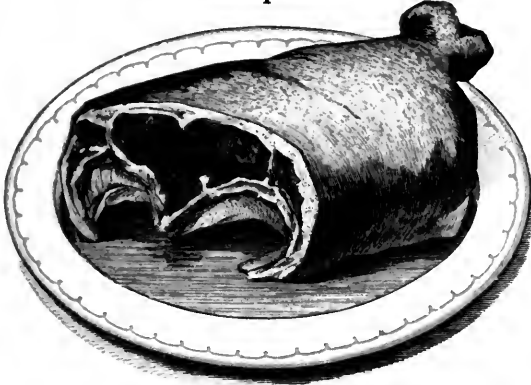

3

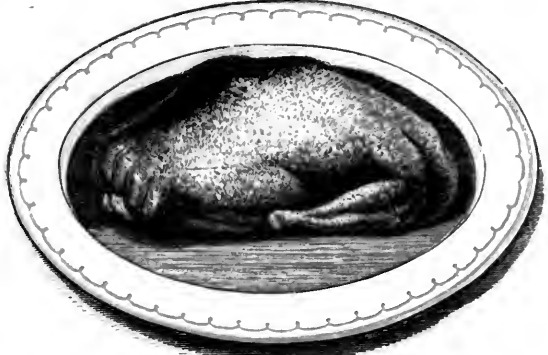

4



5

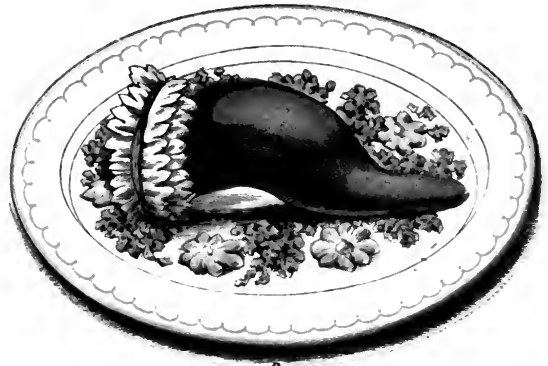

6

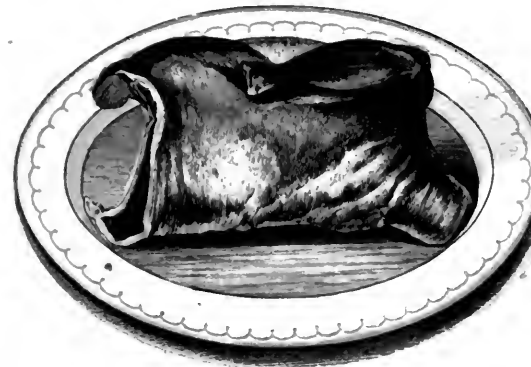

7

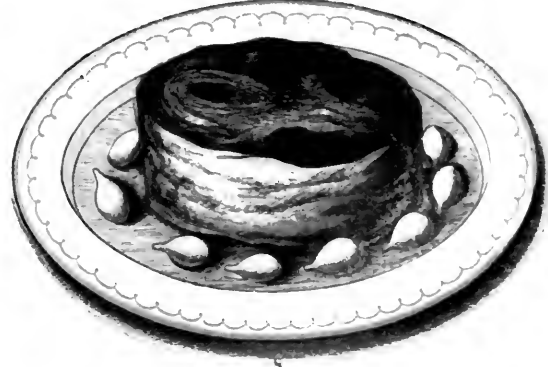

8

1. God's Head and Sea-dart.
3. Saddle of Mutton
5. Ham.

2. Mutton.
4. Goose
6. Tongue
8. Roast of P. 1



assurance, and when the lease is dependent upon the joint life and the life of the survivor of two, three, or more lives, the annual premium is comparatively very small; and generally it may be said that recourse may be had to life assurance in the numerous legal complications that arise in connection with commercial affairs.

No assurance is allowed by law to be effected by one person on the life of another, unless the person proposing the assurance has a *pecuniary* interest in the life of the assured. This enactment was instituted by the legislature during the reign of George III., with the view to prevent gaming or wagering assurances, which had become very prevalent at that period, and it is manifestly highly unwise to place the temptation in the hands of any one of having a direct money interest in the death of another.

We may here mention that in order to encourage life assurance by all legitimate means, it is provided by the Income Tax Acts that any person who has effected an assurance on his own life, or on the life of his wife, is entitled to deduct from any profits or gains in respect of which he may be liable to be assessed, under Schedules D and E of the said Acts, the amount of annual premiums paid by him for such assurance, to the extent of one-sixth part of the whole amount of his profits or gains. The amount of premiums, however, must be paid to the office in full, and the return claimed from the Government.

Policies of life assurance are exempted from payment under the Succession Duty Act, which duty can be conveniently provided for by assurance.

If the information on the points referred to in our last paper be clearly furnished by the printed returns of the office, an intelligent person should have no great difficulty—we will not go so far as to say, in satisfying himself as to the financial stability of the company, but at least in forming a tolerably safe estimate as to its position and standing; and if he mistrust his own judgment in a matter which may be of so much ultimate importance to his future interests, he would do well to consult some friend who has made himself acquainted with matters connected with the business of life assurance, instead of being induced, probably by an interested agent, blindly to entrust his savings to a society which may not merit his confidence.

However little satisfactory our advice in this matter may appear to be, it is, we fear, all we can suggest for the protection of the interests of an intending applicant for assurance, until the Government shall have been induced to take steps to assist him in the matter by some stringent legislation on the subject; and as it is a matter of such general interest and vital importance to the public, it is earnestly to be hoped that some such alteration in the law may be effected at a not very distant period, which will have the effect not only of giving security and confidence to intending assurers, but also of improving the position of all honestly conducted insurance offices.

Some companies supplement their ordinary business by the grant of *Endowments to Children* and of *Life Annuities*.

Endowments to children are sums payable on a child attaining a certain age, as may be agreed upon, and are useful for educational purposes, for providing marriage settlement for girls, and fees for the apprenticeship of boys, as well as the premiums required for young men who intend to enter the legal or medical profession; also to provide business capital, sums for the purchase of commissions in the army, and for a variety of purposes of a like nature.

Endowments may be contracted for to be paid in a single sum, or by an annual premium payable up to the specified age; and it is sometimes arranged that the premiums shall be returned if the child die before attaining the age fixed upon. This is not, however, a favourite species of business with Life Assurance Companies, and probably for this reason, that the chance of death among

the young lives with which this class of business usually has to deal is very small, and the company is almost certain to have to pay the amount at the date fixed upon. The profits of the company accordingly must depend almost entirely upon the interest realised on the payments received, and to make it worth while, therefore, to enter into these transactions, a company must not only assume a sufficiently remunerative rate of interest, but must make a considerable addition for profit to the net rate, so that an intelligent purchaser would be able easily to see that he might accordingly do better with his money by investing it himself, and hence the disinclination of many offices to quote terms for this description of contract, which, however, some companies do nevertheless enter into.

In a table of rates for Endowments now before us, we find that the consideration required for an endowment of £100, payable on a child aged one year attaining twenty-one, would be a single sum of £42 11s. 11d., or an annual premium of £3 5s. 10d. Upon reference to a table of compound interest, the force of our remarks will be at once apparent, and the intending purchaser of the endowment in question will see that he has to pay very dearly for his bargain.

Life annuities are not now granted by many life assurance companies, as they have not been usually found to be profitable, owing to the fact of the annuitants exceeding the expectation of life according to the tables, due possibly to the benefit of selection by the purchaser of the annuity *against* the company. Instances are known in which speculators have selected healthy lives of advanced age belonging to families remarkable for longevity, on which large amounts of annuities have been purchased from the Government to the manifest detriment of the public purse, and possibly the same influence may have been at work in the case of assurance companies, which, moreover, cannot attempt to compete with the Government, whose rates are computed entirely without view to profit, and with the object only of converting permanent annuities—namely, those derivable from the public funds—into terminable annuities depending upon life, and so to some small extent diminishing the National Debt of the country. Attempts have been made by the Government to check this system of speculation by declining to grant any annuity on the life of a nominee above the age of sixty-five, unless the nominee shall have *bonâ fide* a *beneficial* interest in such annuity.

Government annuities for amounts not exceeding £50 may be advantageously purchased through the Post-office Savings Banks, and life assurances for sums of not less than £20 or more than £100 may be effected through the same medium. (See *British Postal Guide*.)

The effect of this benefit of selection against the company has been that the grant of life annuities by joint-stock companies has proved for the most part a losing financial speculation, and has accordingly been, in a very great measure, confined to a class of companies in need of ready money to carry on and extend their more legitimate business, which the sums paid for the purchase of these annuities very satisfactorily supply. That there is this anxiety to add to their resources is apparent from the fact that the rates quoted for annuities by some of these companies are not only temptingly high, but are in excess of those offered by the Government, and for the reason just given it is highly improbable that any trading company can fairly compete with the Government in the sale of life annuities.

The principal object of all life assurance being for the purpose of a family provision, it becomes important that as soon as a policy is effected, the proper legal steps should be taken to secure the proceeds to the widow of the assured, or to trustees for the benefit of the children, or otherwise, according to the circumstances of the case.

A policy of assurance may either be bequeathed by

will, which in that case, if not already made, should at once be executed—and a marriage, it should be observed, renders a new will necessary, a fact often lost sight of—or the policy can be assigned to trustees, to be received by them and applied for the benefit of the widow and children according to the wishes and intentions of the assured. The advantage of this course over the other is that a duly executed legal settlement by a person in perfectly solvent circumstances would be good against creditors in case of bankruptcy.

The great importance of having wills and marriage settlements, and indeed all documents of a like nature, drawn out in a strictly legal manner, makes it our duty to counsel our readers—bearing in mind the old adage, that “he that is his own lawyer, has a fool for his client”—to apply to a respectable solicitor in all matters of this kind, and to act entirely under his advice. A few pounds expended in securing good legal advice may save much expense, anxiety, and even litigation at a future period. (See article on the law of will-making at page 90 of the HOUSEHOLD GUIDE.)

Policies of assurance can be mortgaged, like other property, for securing temporary advances of money, or can be made the subject of absolute sale; in both cases by proper legal deeds. In case of any such dealing with policies, it is necessary for the protection of the interests of the parties concerned, that due notice in writing should be given to the office of the charge affecting the security. Upon a claim arising under a life policy, it is usual to require evidence of age to be furnished, if not previously admitted on the policy, which it is now very usual to do when that document is issued; also a certificate of burial, or the registrar's certificate of death. Upon receipt of these documents at the office, the claim is allowed, and is payable generally three months thereafter. In the meantime, the *title* to the policy has to be established.

The claim may be made under probate of will, or letters of administration, if the assured die intestate, or by mortgage deed, or by deed of absolute assignment, one or other of which documents has to be left at the office for inspection, and if found satisfactory, a form of receipt, to be endorsed on the policy, is furnished ready for execution by the holder thereof, on the day the claim becomes payable.

Having now done our best to explain some of the more prominent features of life assurance, it only remains for us to add a few words of earnest recommendation to our readers not to delay taking advantage of the benefits which are offered by the many highly respectable and prosperous companies of the day, to all persons in possession of incomes ceasing with their lives. We must repeat that there is no other possible method by which those so circumstanced—and such form the great bulk of the population of this country—can make a similar provision for those who are dear to them, and who, in the course of nature, they may pre-decease. Although it is very true that we act, many of us, as if we really *did* believe that “all men think all men mortal but themselves,” we must in our hearts know that the day of reckoning must come for us all. The first annual premium once paid, remember, the sum assured is secured at death, whenever that event may happen.

The earlier our assurance and testamentary arrangements are made, the better for those we leave behind us—and we die no sooner for duly settling our affairs—the premium increasing so much with the age, to say nothing of the fact that the health of the strongest may fail, and the advantages of life assurance are reserved, for the most part, for the healthy, or, at all events, for those who are not seriously out of health.

It is often objected by those who wish to find excuses for deferring what is so obviously an undoubted high moral duty, that they can do better by investing their savings in

a bank, friendly society, or building club. Undoubtedly, all provident investments of this class are highly commendable and advantageous in their way, but they do not, cannot, compare with the system we have been advocating, which provides a constantly increasing sum, payable on the death of a strong man, if he be struck down by disease or accident *at any moment*.

We greatly doubt if any better investment can be made, even if the life assured survive to extreme old age, for he obtains his compensation in the operation of the bonus system, by which large sums are certain to be allotted to a policy in any first-class office, and no individual can so well invest from year to year the small amounts which are paid as premiums of assurance, at a high rate of compound interest, as life assurance companies are enabled to do for them. Besides, in all ordinary investment the temptation is constantly likely to arise to *defer* setting the money aside for some reason or other, which may appear a good one at the time, owing to the pressure of some temporary pecuniary difficulty or otherwise, while the payment of a life assurance premium is about the last thing a man is likely to defer, knowing that if he does so he relinquishes all benefit from his policy, and he knows that the anticipated provision for his family is gone for ever, and the whole of his payments—except the comparatively small proportion thereof that he may receive back as the surrender value of his policy—are altogether sacrificed. He will accordingly make the greatest effort to keep up his payments, and the feeling of satisfaction in having made due provision for his widow and orphans will sustain him in what may be often a severe effort of self-denial, and will be a constant source of gratification to a man who feels—and who should not?—that it is no less his moral duty to provide for those of his own house after his death than during his life.

It may, perhaps, hardly be considered part of our work to criticise the existing machinery of any assurance offices, that being a matter rather for the offices themselves than for the public outside. Still, when an office becomes embarrassed, people very naturally call in question arrangements, the advisability of which, if the office had remained in a satisfactory state, would never have been disputed. It is too often found on examination that the working expenses are enormously high, and that a large proportion of the expense is owing to the practice of maintaining agents at high salaries in different parts of the country, and giving them a large percentage on any business they may bring in. It would be well if assurance offices, instead of inducing people to seek for information from an interested agent, would publish, as clearly as possible, through the various channels of communication with the public, such information as may enable the ordinary reader, with the aid of such remarks as we have made upon this subject, to form some reliable judgment for himself on their stability. That they should be able to do this for themselves is, of course, most important, and the more intelligible and straightforward the accounts given by assurance offices of their position and method of working, either in their own circulars or in their advertisements in the widely circulated newspapers and magazines, the more ready will intending assurers be to have recourse to this method of acquainting themselves with the representations made. Considering the important benefit of life assurance to the public at large, it is most desirable that the clearest possible understanding should exist upon the subject.

It will be observed that in the papers which we have just brought to a conclusion, we have only dealt with life assurance. In future numbers of the HOUSEHOLD GUIDE it is our intention to go fully into the subject of insurance against all kinds of risks, whether by fire, rail, or accidents, the importance of which topics we feel sure our readers will fully realise.

DOMESTIC SURGERY.

BUNIONS, AND AFFECTIONS OF THE FEET AND LEGS.

Bunion is a painful deformity of the joint of the great toe, due to the wearing of narrow and ill-made boots, by which the toes are crushed together, and the great toe bent out of its proper position. If the affection is quite recent, and no alteration has been caused in the joint by the pressure, it will be sufficient to wear wide boots, and, in addition, to place a small piece of cotton wool between the great toe and that one next, in order to restore the foot to its natural condition. Circular bunion-plasters of either leather or felt are very serviceable in such cases, as also with corns, in taking off the pressure of the boot. If, however, the pressure upon the joint has been of long continuance, the joint will be found to have become more or less chronically inflamed and swollen, and if so, the application of the tincture of iodine to the skin for some time may be necessary in addition to the plaster, in order to restore the healthy state of the part. Occasionally acute inflammation of the part affected is set up, even running on to the formation of abscess, and as this may be serious as regards the whole foot, the advice of a surgeon should, without delay, be obtained. Of corns we have already spoken in our articles on the Management of the Skin, p. 124.

Ingrowing Toe-nail is another result of sacrificing health and comfort to fashion, in the form of tight boots. The great toe-nail, when healthy, is very slightly curved, and is broad and thin, and this condition may be maintained by carefully cutting the nail from time to time straight across, provided sufficiently wide boots are

the nail on each side should be removed, without going down to the *matrix*, or "quick." In many persons this occasional removal of a slip of nail is a necessary and painless operation, though some prefer to scrape away the centre of the nail, so as to thin it until it bends readily, which in our experience is both a painful and useless operation. A better plan is to let the nail grow long and to cut a notch in the centre of it—as shown in the illustration, Fig. 26—when the growth takes place chiefly at

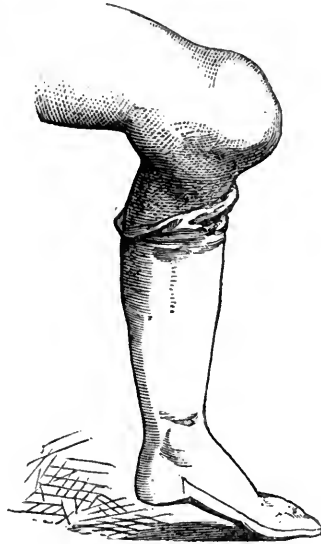

Fig. 28.

this spot, and the edges do not appear to encroach so rapidly upon the soft tissues. When the irritation has been allowed to go to the extent which we have shown in the illustration, the advice of a surgeon should be immediately sought, as it may possibly be necessary to remove part of the nail in its whole length—an excessively painful operation, for which the administration of chloroform, or some other anæsthetic, will be found necessary.

Flat Foot occurs very generally in young persons who have had their strength overtaxed in carrying weights—for example, among nursemaids and errand-boys—though it may occur later in life, as is seen in the case of soldiers and policemen, and others who are on their feet during many consecutive hours. The sufferer finds the feet remarkably tender and painful after walking, and if it be neglected the distortion becomes so confirmed as to render him quite lame. In a flat-footed person, if he be made to stand up with bare feet, it will be seen that the arch of the foot has been more or less broken

down, as shown in Fig. 27, so that instead of the weight of the body coming upon the extremities of the arch—the heel and the ball of the great toe—the centre bones have fallen down and touch the ground, and hence the pain.

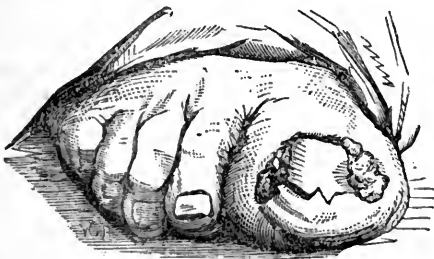

Fig. 26.

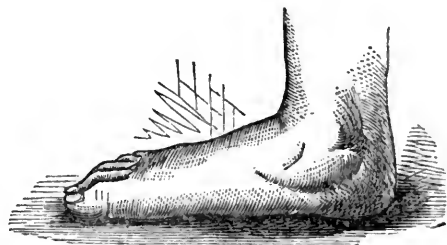

Fig. 27.

habitually worn. When, however, the toes are crushed together, the nail of the great toe becomes more curved than natural, and presses into the tender skin on each side, and if the slight inconvenience at first experienced does not warn the sufferer to seek relief, he will find matters rapidly going from bad to worse, inflammation being set up on each side, and exuberant painful granulations springing up and overlapping the edges of the nail, as seen in Fig. 26. In the early stage of this disorder, when the nail first begins to excite irritation, the immediate abandonment of narrow boots and the careful insertion of a small pledget of cotton wool in the groove on each side of the nail will generally effect a cure; but if this is not enough, with a sharp pair of nail-scissors a small slip of

The great object of treatment is to support the bones of the foot until the ligaments which have become relaxed shall have again become braced up. With this object in view, the sufferer should avoid much walking, and especially the carrying of heavy weights, and should have his foot carefully bandaged, as shown in a preceding paper. In order to restore the arch of the foot, the best plan is to have a piece of cork fitted to the inside of the boot so as to press up the fallen bones as much as the patient can bear without pain. After a time, as the foot improves, this can be increased in thickness, and so eventually the arch of the foot will be restored. When this has been done, a metal spring in the "waist" of the boot is useful in preventing a return of the complaint.

Weak Ankles are common accompaniments of "flat foot," or may exist alone. The sufferer is found to "tread over" considerably in walking, and is often conscious that the ankles yield during walking, the foot having a tendency to turn on its side. The best remedy is well-made lace-up boots, with the sides made stiffer than usual, those with elastic sides giving no efficient support. In children where there is often enlargement of the ankle-bones, bathing with Tidman's sea-salt and water, or sea-water, and the administration of cod-liver oil are very useful remedies.

Bow Legs are common in "rickety" children who have been put upon their feet too soon, and are, therefore, more common among the poorer classes than among those who have attendants to carry them when young. The earthy material of the bones of these children being deficient in quantity, their legs bend with the weight of the body, and if not attended to the deformity will be permanent. The great point is to improve the little patient's health by sufficient and proper food, and particularly by supplying it with genuine and unadulterated milk and wheaten bread, both of which articles of diet contain the earthy salts necessary for the formation of bone. Fresh air and, if possible, the sea-side, are very advisable if they can be procured, and the medical treatment must be carefully carried out under the direction of a competent adviser. As regards the use of apparatus for the treatment of this and every other form of deformity, the parent should be guided by the advice of a surgeon, and not by that of a self-interested instrument-maker. Many slight cases of bow-legs do perfectly well without any apparatus at all, and in most cases a simple lath on the inside of the leg, with broad webbing straps and buckles, is as efficacious for the treatment, and better, because lighter, for the child, than complicated and expensive steel and leather supports.

Knock Knees occur generally in youths who have somewhat overgrown their strength, and particularly in those who have been in the habit of walking or running a good deal. The ligaments of the knee-joints become weakened and gradually yield, and the lad finds that his knees are apt to touch in walking, causing the trousers to wear out on the insides of the legs, and giving to the individual a very ungainly appearance, with more or less pain in the knees themselves. The patient's health should be improved, and he should avoid walking; but if able to obtain horse exercise may avail himself of it with advantage, as it will tend to bow the knees out, as is seen in an exaggerated form in grooms and jockeys. With the same object in view, he may sleep with a pillow between his knees, and with the ankles fastened together by a silk handkerchief. A simple alteration in the sole of the boot is very useful in slight cases of this kind. It consists in having the heels of the boots prolonged on the inner side along the "waist" of the boot, the effect of which is to throw the foot slightly on one side, and thus counteract the in-bowing of the knees; the boots should be strong lace-up ones, so as to well support the ankles, which might otherwise yield. In severe cases of knock knee, it will be necessary for the patient to be confined to the sofa, and wear proper apparatus under the direction of a surgeon.

Housemaid's Knee is, as its name implies, an affection common among domestic servants who kneel to scrub floors, &c. The little bag, or "bursa," beneath the skin of the knee and in front of the knee-cap is apt to get inflamed and swollen from the pressure it sustains, and is then often very painful, and the part looks red and swollen. Hot fomentations and poulticing, with rest for a day or two, will generally effect a cure; but if not, and the part throbs, the advice of a surgeon should be at once obtained, as possibly an abscess may have formed. In some cases there is no pain or heat, but a swelling is formed in front of the knee (as seen in Fig. 28), which gives incon-

venience in kneeling. This will often subside by avoiding the practice which has given rise to it, and by painting the skin over it daily with tincture of iodine; but if it does not disappear it should be shown to a medical man. In all cases the sufferer should provide herself with a soft pad of carpet, or matting, to kneel upon, and should entirely eschew the use of a crinoline when so occupied, since the wires are frequent causes of injury to the knees.

Hip Disease is only mentioned here because its onset is so insidious as often to be overlooked until the disease has made considerable progress; and as treatment, to be efficacious, must be early, it is important that parents should have their attention called to the first symptoms of the disorder. The disease generally occurs in weakly children, and may date from a fall which gave rise to no special symptoms at the time. The child is noticed to have a slight limp, and complains very probably of pain in the *knee* and not in the hip itself, unless that part is touched. These symptoms are quite sufficient to justify recourse to the surgeon, whose directions should be strictly carried out for many weeks, or even months, if necessary to effect a cure.

HOUSEHOLD AMUSEMENTS.—V.

FORFEITS (*continued*).

FORFEITS are in such general demand during the season when round and merry games are in vogue, that we add a few more to the list given in a previous paper. Before doing so, however, we may be allowed to remind our readers that the spirit in which forfeit games should be conducted is to extract as much harmless fun from them as possible, avoiding everything rough and unseemly, or in which a mind exceptionally sensitive can find a cause of offence. With those which are simply boisterous in character, or have any element calculated to cause a feeling of annoyance or pain, we have nothing to do. But at the same time, all who enter on games of this kind should be prepared to give as well as to receive amusement.

We will continue first our list of forfeits suited to a gentleman.

1. *To go round the Room Blindfolded, and kiss all the Ladies.*—The company, of course, are seated, but as soon as the gentleman is blindfolded they change positions, with as little commotion as possible. He consequently finds, in his progress, that he as often attempts to kiss one of his own as one of the opposite sex; or a lady may reverse the position of her chair, so that the gentleman kisses the back of her head.

2. *To choose One of Three Signs.*—To do this, he is to stand with his face to the wall, while any lady present makes three signs behind him—of a kiss, of a pinch, and of a box on the ear. He is then asked whether he chooses the first, the second, or the third, not knowing the order in which they have been made, and receives the corresponding action.

3. *To imitate any Animal that may be named.*—If the company call upon him to imitate a goat, a donkey, &c., he must do it; but if the forfeit happens to fall upon any one who, from age or other reasons, may be excused from such performance, "a man" is named as the animal, and a bow will suffice.

4. *To kiss a Lady through the Back of a Chair.*—He must wait, with his visage inserted in the chair-back, until some lady comes to his rescue; but if the chair be of a fancy pattern, she may dodge him through the framework before giving him his release.

5. *To blow the Candle out.*—He is blindfolded, and the candle held near his face, until he happens to give a puff in the right direction.

6. *To perform the Clown's Pantomime.*—This consists

in rubbing the forehead with one hand while you strike the breast with the other, standing up in the room for the performance. If correct time is not kept, in the judgment of the company, another forfeit is to be paid.

To the forfeits for a lady given in the previous paper may be added—

1. *To kiss a Gentleman "Rabbit Fashion."*—This is usually a source of great amusement to the rest of the party. The lady has the privilege of choosing any gentleman present. A piece is broken off a reel of cotton, and the lady takes one end of the piece in her mouth, while the gentleman takes the other in the same way. They then both nibble the cotton until the kiss ensues, as a matter of course. If the gentleman is sufficiently gallant, he will perform the chief part of the "nibbling" process. The company may exercise their discretion as to the length of the cotton.

2. *To sing a Song, or play a Piece of Music.*—This is given either to elicit the musical capabilities of a lady who may be shy, or to make an agreeable interlude in the round of other forfeits. If the lady called upon can really do neither, another forfeit is allotted to her.

3. *Ask a Question to which "Yes" must be the Answer.*—This is a great puzzle to any one who is not in the secret. The unfortunate forfeiter may ask all kinds of questions, without eliciting the answer required for her release. But if she simply inquires, "What does y-e-s spell?" there cannot be any other reply.

4. *To kiss the Gentleman you love best in the Company, without any one knowing it.*—There is only one way of paying this penalty, and that is, to kiss every gentleman in the room, leaving them to settle the question as to "loving best" amongst them.

5. *To put yourself through the Keyhole.*—This is one of those quibbles upon words, for which persons called upon to pay forfeits should watch, as they are often in use. We give this as an example. The forfeit is paid by writing "yourself" upon a piece of paper, and passing that through the keyhole.

6. *To kiss each Corner of the Room.*—When this forfeit is declared, a gentleman stations himself in each corner, and the lady has to pay an unexpected penalty.

7. *To spell "Constantinople."*—This must be done in the old schoolmistress's fashion—"C-o-n, Con, with a Con, s-t-a-n, stan, with a stan," &c.; but, after the third syllable, the company attempt to embarrass the speller by crying out, "No! No!" as if a mistake had been made. To this, the proper reply is, "Thank you;" the fourth syllable is then spelt, and the fifth completes the task.

8. *To form a Rifle Corps.*—The lady goes to one end of the room, and calls up a gentleman, who stands opposite to her. The gentleman then calls a lady, who stands at his side; and she in turn names a gentleman, who places himself opposite to her. So the calling goes on, until all present are included. If the number of ladies and of gentlemen present is unequal, the more mirth is created by the last persons called standing opposite one of their own sex. When all are called, the word is given by the first gentleman in the rank, "Present arms." All then join hands with the persons opposite; and the next command is "Salute," which is done in osculatory fashion.

We conclude our list of forfeits with a few contrived to include more than one member of the company.

1. Either a lady or a gentleman may be called upon to "sit on the Stool of Repentance." He or she must then sit in the centre of the room, while one of the party goes round to inquire, in a whisper, of each person present, what the repentant individual "looks like." The reply may be "wise," "silly," "pitiable," "beautiful," &c., according to circumstances. The answers are repeated openly to the forfeiter, with the question after each, "Who said that?" If the right name is guessed, as is often the case, the person who made the particular observation

must then sit on the "stool" in turn, and so on until the company are satisfied with the round.

2. A lady is required to "be Postman." She is to go outside the room, and rap on the door, when one of the company inquires, "Who's there?" The answer is, "The postman, with a letter for —," any gentleman she likes to name. "How many seals?" Whatever the answer may be, the gentleman may exact so many kisses; and he in turn remains outside, and declares he has a letter for a lady. So the forfeit proceeds, a lady calling a gentleman, and a gentleman a lady, until the company have all been called, but no person present is bound to answer twice.

3. When the calling of forfeits has been continued long enough, and several remain, which it is desired to clear off together, the forfeiters may be called upon to perform a "Musical Medley." Each one must then sing some verse or stanza of a song, no two choosing the same melody, but all commencing and singing together. The effect is generally so grotesque as to produce shouts of laughter.

ODDS AND ENDS.

To loosen Glass Stoppers.—A very common source of trouble and vexation is the fixed stopper of a smelling-bottle, or of a decanter; and as in the case of all frequent evils many methods have been devised for its remedy. Some of these methods we shall enumerate. 1. Hold the bottle or decanter firmly in the hand, or between the knees, and gently tap the stopper on alternate sides, using for the purpose a small piece of wood, and directing the strokes upward. 2. Plunge the neck of the vessel into hot water, taking care that the water is not hot enough to split the glass. If after some immersion the stopper is still fixed, recur to the first process. 3. Pass a piece of list round the neck of the vessel, which must be held fast while two persons draw the list backwards and forwards. This will warm the glass, and often enable the hand to turn the stopper. 4. Warm the neck of the vessel before the fire, and when it is nearly hot, the stopper can be generally moved. 5. Put a few drops of oil round the stopper where it enters the glass vessel, which may then be warmed before the fire. Next take the decanter or bottle, and employ the process No. 1, described above. If it continues fixed, add another drop of oil to the stopper, and place the vessel again before the fire. Then repeat the tapping with the wood. If the stopper continues still immovable, give it more oil, warm it afresh, and rub it anew, until it gives way, which it is almost sure to do in the end. 6. Take a steel pen or a needle, and run it round the top of the stopper in the angle formed by it and the bottle. Then hold the vessel in your left hand, and give it a steady twist towards you with the right, and it will very often be effectual, as the adhesion is frequently caused by the solidification of matter only at the point nearest the air. If this does not succeed, try process No. 5, which will be facilitated by it. By combining the two methods numbered 5 and 6, we have extracted stoppers which had been long fixed, and given up in despair after trying the usual plans. Broken stoppers are best left to professional hands.

Liquid Glue and Cement.—Take of crushed orange-shellac four ounces, of rectified spirit of wine (strong), or rectified wood naphtha, three ounces. The rectified spirit of wine makes a far superior composition, but the other is good enough for all ordinary work. Dissolve the shellac in the spirit, in a corked bottle in a warm place; frequent shaking will assist it in dissolving, and it should also be shaken before use. This composition may be used as a varnish for unpainted wood.

Perpetual Paste.—Take one ounce of gum tragacanth or gum dragon; pick it clean, and put it into a wide-mouthed vessel of glass or white ware capable of con-

taining a quart. Add as much corrosive sublimate as will lie on a fourpenny-piece. Then pour on a pint and a half of clean soft water, cold. Cover the vessel and leave it till next day, when the gum will be dissolved, and will nearly fill the vessel. Stir the mass well with a piece of stick—not with metal, because the corrosive sublimate will blacken it. Repeat the stirring several times during the day, when it must be left, and it will form a thick white jelly. It must be kept closely covered, and under lock and key, as the corrosive sublimate is poisonous. It will keep for any length of time if the air is excluded, and if it is not put into a vessel of metal. For paper and many other things it forms a strong and colourless cement; and since it may be always at hand, it may tend to induce persons to do a number of small useful jobs, which would be neglected if paste had to be made. If the above rules are followed, especially about not allowing continued exposure to the air, and not keeping it in metal, it will be very slow to spoil.

Blue Wash for Walls.—Take two quarts of lime, a pound of blue vitriol, and half a pound of glue. Thoroughly melt the glue in a quart of soft water. Reduce the vitriol to powder in a mortar, and put it into a wooden pail. When the glue-water is about cold, pour it on the vitriol, and mix the two well with a stick. Then stir in the lime by degrees. Try the colour by dipping into it a piece of white paper, which, when dry, will show the tint. If too dark, add more lime; and if too light, add more powdered vitriol. The proper consistency can be secured by means of soft water. It is used like whitewash.

ANIMALS KEPT FOR PLEASURE.

IV.—THE DOG: FEEDING AND GENERAL MANAGEMENT.

WHEN it has been determined to keep a dog, it is very much better to procure a fine pup than to purchase a full-grown animal. It will involve some trouble, certainly; for bad habits will have to be checked and corrected, more attention will be needed, and there will be the possibility of having to nurse it through the distemper; but in no other way can the full pleasure of the connection be obtained, and the full affection of the noble creature be secured. Moreover, the pleasure of training a young dog is very great to *both* parties, and it is much more satisfactory to possess an animal whose habits you have formed, whose disposition you know, and whose fidelity to you may be implicitly trusted. Such a dog is also much less liable to be lost or stolen.

The animal's *lodging* is a matter of no small importance, but is very seldom ordered as it should be; too often any old box is made to do duty, and the consequence is a weakly constitution, if not actual disease. The best material is deal or pine, which has a very strong resinous smell, and contains well-marked veins of turpentine, over all its surface. The wood ought to be a full inch thick, and be well and tightly joined in the well-known shape, but with what is very seldom seen, the gable roof projecting, at the very least, six inches, both at the sides and back, while the front should project a foot or more, in order to throw off the rain. Of course, if the kennel is to stand under a shed, this will not be necessary; but it is highly needful in the open air. The whole should be well painted, and, in very wet weather, it is well to throw a large tarpaulin over all. Many people seem to think the dog can withstand any weather with impunity, and if left at full liberty, it might perhaps be so; but when chained up, it is positive cruelty not to afford the faithful guardian comfortable shelter. For the same reason, the kennel should stand on four small blocks or bricks, to raise it from the ground and keep it dry.

Should the dog become infested with fleas or other ver-

min, several *bucketfuls* of boiling water should be dashed into the kennel, to sluice-it thoroughly, and, when dry, it should be painted over with turpentine or paraffin. The animal itself should have powdered sulphur well dredged and rubbed into its coat, which will usually eradicate insects; powdered camphor will do the same. Another method much approved of, is a good washing with soap and warm water, followed by careful combing; or a little benzine introduced to the skin of the animal wherever the fleas congregate, will drive them out, and if it touches them, will kill them. Tobacco water has been often recommended, but should never be used, as it always makes the dog sick, and spoils the appearance of the coat. There will, however, be little trouble from vermin, if the kennel is made of resinous wood, and deal shavings are given for the bed. It is also worth remarking that the discovery of any such annoyance need not occasion the commotion in a household which it often does. It is to be removed, certainly; but the species, both of fleas and lice, which infest the dog, will not live more than a few hours upon a human being, and, consequently, need not be dreaded.

Feeding.—If few dogs are properly housed, still fewer are properly fed. Some people seem to think they can live with hardly any food at all; others, on the contrary, think that nothing can be too good for them. Ladies' pets are, as a rule, worst treated of all, if the health of the animal, and not the fancy of the mistress, is the point to be considered. They get their share of every meal, and no exercise after it. When their over-loaded stomachs at last reject further additions, their appetites are coaxed with every delicacy, until at last the poor beasts either go to the dog doctor, or perish in their misery.

Dogs are carnivorous animals, and in a state of nature they would have to hunt down their prey with severe exertion. It should also be remembered that their digestive system is very easily deranged. We play all sorts of tricks with *our* stomachs; our poor dog cannot. Bad feeding is the sole cause of the strong and offensive odour so often complained of in the parlour; a properly fed dog is never a nuisance in this way. When, therefore, a few simple rules will preserve his health and make him a credit to all concerned, it is surely worth while to observe them.

And first, a dog should only have one daily allowance. It may be added, that no dog can possibly remain in health if present at every meal with an ordinary family. The head of the house may forbid anything to be given him, but it is of no avail, bits *will* find their way to his jaws. Indeed, *what else is he there for?* if he is to have nothing, he might as well be outside the door. The fact is, if he is in the room, he *will* have something; who can resist the poor beggar's pleading eyes? who can withstand that touching wag of his tail, as he goes round the table? and the result is, that while each thinks *he* has given him nothing at all, the dog has really eaten as much in proportion as any one at the table. Probably, too, it has been chiefly meat, which a house dog should very rarely have. No: if our dog is to be kept in health, with a glossy coat and entirely inoffensive presence, we *must* make one condition, that, whatever else be his privileges, he be rigorously excluded at meal-times.

What, then, should be his food? That will depend upon what he is. For house dogs, the food should be almost entirely vegetable. Oatmeal is good; so is coarse biscuit, so is boiled rice soaked in gravy. A good plan is to let the staple food consist of oatmeal, or biscuit, and once a week, or even once a fortnight, to boil a piece of liver of the size the dog will eat, and let that be his food for *one day* only, giving him rice boiled in the liquor for the next. It is best given in the evening, when he can have a good sleep after to digest his repast; but whatever time is fixed should be kept with the utmost punctuality. At first, it is best for a few days to put more than enough before the

animal, and watch him carefully. For a while you will see that he evidently "means business;" steadily and briskly he keeps to work, giving no attention to anything but his food. At last he raises himself, and either walks away, or, if he again stoops, is evidently picking over or playing with his food. *That is the signal to stop*, and after a few days, if he is full grown, you will know what he requires, and need take no further notice. He should, in fact, have quite enough to satisfy his hunger, but not more.

Pointers or other sporting dogs need very different diet when in work. They should have meat every day, and if worked hard it ought to be raw, while the animal should have as much as it will eat at a single meal. Pointers are often *under-fed*. They ought to be put on full working diet at least a fortnight before commencement, in order to get up their strength, for it is a great mistake to suppose that one feed of meat will at once create strength for the work of the day. When the season is over, their meat should either be boiled, or, if kept about the house, a partially vegetable diet should gradually be substituted.

Horse flesh, unless known to be of good quality and fresh, should never be given, as it is apt to cause diseases of the skin. Pot liquor also should never be given to dogs; it often purges them, and, if salt, sometimes makes the hair come off. Paunch is the best animal food for a house dog, and may be given boiled like tripe. Liver must be used with discretion, as it is a laxative, hence we recommend it to be followed by rice with the liquor, rice having a contrary effect. Sporting dogs do best with the coarse parts of beef, or liver; but for *all dogs*, warm, choice meat is *most injurious*: it causes rank odours, foul teeth, and various digestive diseases. It should always be given perfectly cold. The food is best thrown on the bare earth, as for feeding poultry. Dogs thus fed always preserve their teeth whiter and cleaner than those to whom it is given on plates or dishes. Throw the dog's allowance, therefore, on the ground; it will be better for him, and he will enjoy it more. Every possible consideration confirms our demand, that dogs of all kinds, from the lady's pet to the mastiff, should be fed out of doors. Keep them from the kitchen for the same reason as you do from the dining-room.

A word is necessary with regard to bones. A dog should not have more than at most one a day, and care should be taken that there be scarcely any meat upon it. Dogs naturally prefer some bones and parts of bones to others. Rib and marrow bones are dangerous, although the latter may be safely given if split open before thrown down, as dogs will seldom gnaw them when their marrow is gone. Fish and fowl bones are often dangerous, and it is not worth while to chance losing a valuable dog by bone-splinters causing inflammation of the bowels, or sticking in the throat.

So much for your dog's diet; if you would have him thrive, you must also see that he has *exercise*. He was made to be a most active animal, and it is cruel to keep him always chained to his kennel. Let him have a good walk out whenever possible, and as often as you can, let it be with *you*; you will then be identified with his greatest pleasure, and his queer antics will sometimes almost make the tears come into your eyes. If you cannot take him yourself, let a servant take him on an errand, or send him out with a child. Dogs take to children as naturally as ducks to the water, and we have known a great bull-terrier which it would have been dangerous for any stranger to approach, suffer the little children of the family—under three years old—to sprawl over and about him with evident *pride and enjoyment*. To keep a dog always chained, of

itself sours his temper. Let him see the world: use him to a collar and chain, and keep them bright with constant wear.

Ladies' pet dogs, more than almost any others, suffer from want of exercise—the more so from the delicate and constant feeding they have to undergo—so opposed to all dog nature. All the walking the wretched creature knows is between his plate of meat and the ottoman which forms his bed. What wonder if he snaps and snarls at every visitor? His fond mistress thinks and says, "Poor Fido is so sensitive;" the real fact is, the unhappy wretch is always suffering from indigestion. Cut him down (by degrees of course) to one meal a day, of oatmeal, or rice and gravy; send the servant out with him for two hours every morning, and deny any scraps; and if not too far gone, he will in a month be a different creature.

Washing.—If the animal is healthy and kept as we have recommended, washing will be seldom necessary. A mere *cold bath* is well enough every morning, provided he is kept active afterwards till thoroughly dry, although in very warm weather this precaution is not so necessary, at other seasons he should on no account be allowed to lie down or go to the fire till all the moisture is gone. Thus treated, a mere cold bath whenever convenient will do him good, except in severe weather. Let the hair be combed and brushed every day—always waiting to remove mud splashes till the coat is dry—and the animal, if in health, will always look respectable.

General Treatment.—Be kind to your dog, but make him feel that you are his *master*; be gentle and considerate, but always firm. Dogs will presume, if allowed: their intellect is undoubtedly higher than that of most other animals, and they know how to take advantage of weakness or indecision. We hate to see a dog kicked and abused; but we also dislike to see him pampered and spoiled. Such

dogs are never so fond of their masters as those which are kept in proper subjection.

Also study your dog's character. Be sure he has one. He knows when he is praised; he knows when he is blamed; he is quite aware when he is even ridiculed! This we are certain of; indeed ridicule—in plain words *laughing at him*—is a potent agency in the training of a dog; no dog can bear to be laughed at. He even has a sort of conscience. Apart from mere fear of punishment, he knows there is a *right and a wrong*. We have often marked a half-bred retriever, after doing what he had never done before, and therefore never been punished for, but which he knew to be wrong, slink in with his tail between his legs, the very picture of guilt.

In approaching strange dogs, it is best to notice the eyes. The highest authority we are acquainted with states, that when a dog is angry or excited the pupil is always dilated, and that with ordinary animals this sign may be implicitly depended on, and that by waiting till the pupil is again contracted they may be approached with safety. Some breeds, however, such as the bull-terrier and St. Bernard, are of very uncertain temper, and will sometimes snap without any warning. With all such it is well to be cautious; but when approaches become necessary, coolness without presumption is the best policy. If you are afraid, do not appear to be so if you can help it, and the probability is that the brute will submit. But it is best never to approach a large strange dog till you know his disposition; we have known sad results from want of caution in this respect. Savage dogs are best killed out of the way. But they are the exception; the rule is affection the most unbounded, devotion the most absolute, fidelity the most inviolable, obedience the most perfect; and all this, if you will, you may have in your dog.

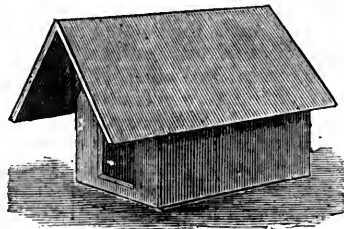

INMATES OF THE HOUSE.—LEGAL.

V.—RATES AND TAXES (*continued*).

IN the last paper on this subject, it was stated that payment of rates conferred political rights, which would be described under the title of Rights of Citizenship. It is found more convenient, however, to describe the political rights so conferred in a second paper on rates and taxes. Before giving an account of the compound householder, it may be as well to mention one or two points omitted from the last paper.

Unions.—For the purpose of relief of the poor, as well as of concentration of general parochial machinery, it has been deemed advisable by the Legislature to authorise the Poor Law Commissioners to compel parishes to combine, and to exercise collectively the functions imposed upon them by acts of Parliament. Parishes are thus formed into unions, under the government of a single board of guardians of the poor, to be elected by the owners and ratepayers of the component parishes. The guardians are chosen by the individual parishes, in number according to the comparative importance of the parish with the other parishes composing the union; the united parishes have a common workhouse, provided and maintained at the common expense; but each parish remains (unless expressly provided against) separately chargeable with the expense of its own poor, whether relieved in or out of the common workhouse. Where such an arrangement exists, the union board have to determine what funds are necessary for the support of the poor of the union district, and to assign to individual parishes their relative quota of contribution. The quota being assigned, it is for the parish concerned to say by what rate or other means the amount shall be raised. It is even competent to such parish to protest against the amount laid upon it, and to appeal from the decision of the board to that of the justices, or the Commissioners of the Poor Law Board. The amount of contribution being ascertained by consent, or some competent authority, it is for the parish in vestry assembled to say how it shall be defrayed. But powers are given by act of Parliament to unions to go farther than this towards consolidation of machinery for relief of the poor, and the component parishes of a union may, under sanction of the Poor Law Commissioners, by their own act, be united for the purposes of settlement and of rating, as well as that of relief and management, so as to include the united parishes in one local government. It does not follow, however, that because parishes are united for poor relief purposes, they are therefore united for other purposes as well. The taxes necessary for local management, and the administration of those taxes, may still be in the hands of representatives from the individual parishes; but, at the same time, it is competent to the members of a union to combine for these objects also.

Persons chargeable to Parishes.—It is not possible in the limits permissible to an article of this kind to enter upon a description of the complicated law of settlement—that is, to state the circumstances under which the original right to be relieved by the parish in which one was born, or apprenticed, or to which one has paid taxes, may be modified or lost. It may be as well to state, however, that the parish is not bound to relieve any who have certain relations competent, or by law compellable, to maintain them. The relations so compellable are—father and grandfather, mother and grandmother, and children, of the pauper. These are liable to maintain him at such rate as may be assessed by the justices at general, quarter, or petty sessions; and sums so assessed are recoverable in summary process before two justices of the peace, and may be levied by distress and sale of the goods and chattels of the offenders. Persons able to work and refusing to do so, so that they and theirs become charge-

able to a parish, may be punished as idle and disorderly persons, by imprisonment for a month with hard labour in a house of correction. Paupers set to work and refusing to do it, are punishable by committal to gaol with hard labour.

Compound Householders.—The class of persons thus named came into prominent notice during the debates on the Reform Act of 1867. They came into existence (in regard to the payment of rates) on the passing of the Small Tenements Act of 1850. Shortly they may be described thus:—Holders of small tenements, the rents of which are usually collected at less intervals than quarterly, being liable, as other people, to the payment of parochial rates, it was frequently found that they neglected or were unable to pay, and that parishes lost large sums of money, which had to be defrayed by the less needy householders. Even where the rates on these small holdings were paid, the expense of realising made it very questionable whether the parish gained or lost, and the matter became a serious one for all ratepaying districts. On the other hand, it was a serious thing for a small tenement-holder, with perhaps just sufficient means to pay his way, to be called upon at certain intervals to pay a sum for rates equivalent, it might be, to a whole week's wages. By the Small Tenements Act of 1850, small tenants were enabled to compound for rates in the following manner—viz., the landlord undertook to settle with the parish for rates payable by his small tenements, and was allowed for his trouble in recouping himself by extra rent, a commission in the shape of an abatement, which often ran to twenty-five per cent. The tenants paid rates without feeling much of this weight, and became entitled to the advantages secured by ratepaying. Their names, however, did not appear on the rate register. This arrangement worked well enough for both parties—the small tenement-holder and the parish—until Mr. Disraeli brought in his Reform Bill. The principle upon which that bill was based was alleged to be that a share in the government should be given only to those who shared in the burdens of government, and in carrying out this principle it seemed convenient to take payment of rates as a proof of contribution towards the general charges. Payment of rates accordingly was made the condition of receiving a vote at elections for Parliament. But as soon as this principle was adopted, the question arose, "Are compound householders entitled to vote? They cannot be said to pay rates in the strict acceptance of the words, and their names are not on the rate register," which was ordered to be the basis of the list of voters for electoral purposes. Compound householders were practically disfranchised, or rather, being enfranchised, according to the principle of the bill, they were not permitted to exercise their rights owing to defective machinery for carrying out the principle. The Liberal party would not consent to the omission from the franchise of persons in the position of compounders, and the Reform Bill was in peril, when a proposition was made to abolish compound householders, and to make everybody pay the rates chargeable upon his holding. Mr. Disraeli embodied the suggestion in his bill, carried it with the Reform Act of 1867, and was supposed to have established household suffrage in its widest extent. But it was soon found that small tenement holders were no better able to pay rates in 1867 than they had been before 1850; that landlords would not lower rents in proportion to the relief they themselves had from rate-paying; and that the compound householder with his name on the register, was practically as much excluded from voting, his rates being unpaid, as he was before his name was enrolled. In Birmingham alone sixteen thousand summonses were taken out for non-payment of rates, the parishes suffered, and the small householders were disfranchised. In these circumstances Mr. Gladstone's Government came into power, and, unwilling to re-open the question of

principle on which the Reform Bill had been based, but determined to admit the small holder to the franchise, introduced a bill authorising the landlord to pay rates for his tenants, receiving a commission from the parish for doing so. The tenants' names remained on the register as paying rates, though the money was actually paid by the landlord, who, on the other hand, was empowered to receive by instalments what he had paid by small additions to the weekly rent. By this means the compound householder was virtually restored without being deprived of his vote.

On this basis the law now rests, payment of rates giving a title to vote for members of Parliament.

Annexed is a *résumé* of the chief provisions of the important act of Parliament (32 and 33 Victoria, c. 41) which restored the compound householder to existence, and gave him safeguards for his political rights.

1. Occupiers of tenements let for a term not exceeding three months, may deduct the poor rate paid by them from their rents.

2. No such occupier to be obliged to pay at one time, or within four weeks, a greater amount than a quarter's rate.

3. In case the rateable value of the tenement do not, in London, exceed £20; or within the borough of Liverpool, £13; or within the city of Manchester or the borough of Birmingham, £10; or elsewhere, £8, the owner may agree with the overseers, subject to the vestry, to pay the rates for a year certain, and whether the tenement be occupied or not, and to receive a commission of not more than twenty-five per cent.

4. Vestries may order the owner to be rated, instead of the occupier, abating a certain amount of the rate.

5. Owners omitting to pay rates due on the 5th January, before the 5th June, to lose commission.

6. Where owners omit to pay rates, the occupiers paying the same may deduct the amount from the rent.

7. Owners agreeing to pay rates, to give lists of occupiers when required to do so, under penalty of £2.

8. Occupiers to receive notice of rates being in arrear, that they may protect themselves.

9. Rates unpaid by owner may be recovered by distraint on occupier's goods, but no distress to be put in until default after notice to occupier, and no greater levy to be made than for the amount of rent due. The occupier buying out a distress, to be free to abate amount from his rent.

Brothers and sisters of the father and mother of the predecessor, and their descendants	£5 per cent.
Brothers and sisters of a grandfather or grandmother of the predecessor, and their descendants	£6 per cent.
Any other person	£10 per cent.
Legacy to husband or wife exempt.		

HINTS TO LETTER-WRITERS.—III.

The majority of people are not often required to write letters to persons of rank and title; but all who have to do it should know the forms which are used in polite society. The nobility and others in high official positions are addressed in a style which is peculiar to them, and any deviation from the recognised phraseology is considered unbecoming. Everything of the nature of a letter addressed to exalted personages requires attention in four particulars:—

1. The address, commonly so called.
2. The heading, or what answers to "Sir," "Madam," &c., in ordinary letters.
3. The mode of speaking to the person in the body of the letter; or the personal address.
4. The conclusion, or subscription.

Attention to these details is important, and we proceed to give such information as will enable any one to fulfil the principal requirements.

THE QUEEN. *Address:* "To the Queen's Most Excellent Majesty;" or, "To Her Most Gracious Majesty Queen Victoria." *Heading:* "Madam;" or, "May it please your Majesty." *Personal Address:* "Your Majesty;" or, "Madam." *Conclusion:* "I remain, with the profoundest veneration, your Majesty's most faithful subject and dutiful servant."

THE PRINCE OF WALES. *Address:* "To His Royal Highness the Prince of Wales." *Heading:* "Sir;" or, "May it please your Royal Highness." *Personal Address:* "Your Royal Highness." *Conclusion:* "I remain, with the greatest respect, Sir, your Royal Highness's most dutiful and most obedient humble servant."

Other princes and royal dukes require similar forms. For the Princess of Wales the forms are the same, only "Princess" is put for "Prince," and "Madam" for "Sir." In addressing other princesses and royal duchesses, also, the same rules are to be observed, except that in the conclusion for "Most dutiful and most obedient humble servant," we say, "Most obedient and devoted humble servant."

ARCHBISHOP. *Address:* "To the Most Reverend Father in God, by Divine Providence Lord Archbishop of —." This however applies to official documents; letters are addressed, "To His Grace the Lord Archbishop of —." *Heading:* "My Lord Archbishop." The words, "by Divine Providence," are only used of the Archbishop of Canterbury; to other Archbishops we say, "by Divine permission," and the same to suffragan bishops. The Archbishop of Armagh is styled, "His Grace the Lord Primate of all Ireland." In the body of a letter, and in conversation, an archbishop is addressed as "Your Grace." The wife of an archbishop is addressed as any other untitled lady.

DUKE. *Address:* "To His Grace the Duke of —." *Heading:* "My Lord Duke." *Personal Address:* "Your Grace." *Conclusion:* "I have the honour to be, my Lord Duke, your Grace's most devoted and obedient servant."

For a duchess the address and personal address correspond with those for a duke; the heading is "Madam," and the conclusion, "I have the honour to be, Madam, your Grace's most obedient and most humble servant." A duke's younger son is addressed as "The Lord William —;" or, "The Right Honourable Lord William —."

TABLE OF DUTIES CHARGEABLE UPON INSURANCE POLICIES AND LEGACIES.

<i>Insurance Policies—Life:—</i>		£	s.	d.
For any sum not exceeding £25	0	0	3
Exceeding £25 and not above £500, for every £50 and any fractional part of £50	0	0	6
Exceeding £500 and not exceeding £1,000, for every £100 and any fractional part of £100	0	1	0
Exceeding £1,000, for every £1,000 and any fractional part of £1,000	1	10	0
Accidental Death, or Personal Injury, or Insurance from Loss or Damage upon Property of any kind, when the premium shall not exceed 2s. 6d.	0	0	1
Exceeding 2s. 6d. and not exceeding 5s.	0	0	3
Exceeding 5s., and for every 5s. or fractional part of 5s.	0	0	3
Sea—Upon any voyage whatever, for every full sum of £100, and for any fractional part of £100, thereby insured	0	0	3
For every policy for Time, for every £100, and any fractional part of £100 thereby insured, for any time not exceeding six months	0	0	3
Exceeding six and not exceeding twelve months	0	0	6
<i>Legacy and Succession Duty:—</i>				
Lineal issue or lineal ancestor	£1	per cent.	
Brothers and sisters of the predecessor and their descendants	£3	per cent.	

Heading: "My Lord." *Personal Address*: "Your Lordship." *Conclusion*: "I have the honour to be, my Lord, your Lordship's most humble and obedient servant."

The wife of a duke's younger son is styled "The Lady William ——" and addressed as "Madam" at the head of a letter, but as "Your Ladyship" in the body of a letter. The conclusion, in this case, corresponds with that of a letter to her husband; of course writing "My Lady," and "Your Ladyship's," for "My Lord" and "Your Lordship's."

The daughter of a duke is also addressed by her Christian name, "The Lady Augusta;" or, more formally, "The Right Honourable Lady Augusta." She is styled "Madam," in the heading, and "Your Ladyship" in the body of a letter. The conclusion must be, "I have the honour to be, Madam, your Ladyship's most humble and most obedient servant."

BISHOP. *Address*: "The Right Reverend Father in God, John, by Divine permission, Lord Bishop of ——" This is for formal documents; letters have, "To the Right Rev. the Lord Bishop of ——" *Heading*: "My Lord." *Personal Address*: "Your Lordship." *Conclusion*: "I have the honour to be, my Lord, your Lordship's most humble and obedient servant." The wife of a bishop is addressed as an untitled lady.

MARQUESS. *Address*: "To the most Honourable the Marquess of ——" *Heading*: "My Lord Marquess." *Personal Address*: "Your Lordship." *Conclusion*: "I have the honour to be, my Lord Marquess, your Lordship's most obedient," &c.

MARCHIONESS. *Address*: "To the most Honourable the Marchioness of ——" *Heading*: "Madam;" or, from persons in ordinary stations, "My Lady;" so also in the body of a letter. *Conclusion*: "I have the honour to be, Madam, your Ladyship's most obedient," &c.

The younger sons and the daughters of a Marquess, are addressed as those of a duke.

EARL. *Address*: "To the Right Honourable the Earl of ——" *Heading*: "My Lord." *Personal Address*: "Your Lordship." *Conclusion*: "I have the honour to be, my Lord, your Lordship's most obedient and very humble servant."

VISCOUNT. "To the Right Honourable Lord Viscount ——" In other respects as an earl.

BARON. "To the Right Honourable Lord ——" In other respects as an earl.

A countess is addressed as earl, a viscountess as a viscount, and a baroness as a baron, only changing the titles into their feminine equivalents.

The son of a baron, a viscount, or an earl, is addressed as "The Honourable," and spoken to as "Sir." The daughter of a baron, or a viscount, is likewise addressed as "The Honourable," and spoken to as "Madam." In concluding letters to these, therefore, "Sir," or, "Madam," is a sufficient title. "I am, Sir (or Madam), your very obedient," &c. An earl's daughter is addressed as a duke's daughter.

BARONET. *Address*: "To Sir ———, Bart." *Heading*: and throughout the letter, "Sir." *Conclusion*: "I have the honour to be, Sir, your most humble and obedient servant."

KNIGHT. *Address*: "To Sir ———, Knt." *Heading*, and throughout, as in writing to a baronet. The letters "Knt." may be omitted after the name in the address, and if the person is a Knight of the Garter, Thistle, &c., the proper initials are appended to his name: "K.G.," "K.T.," "G.C.B.," &c., as the case may be.

The wife of a baronet, or of a knight, is styled "Lady," and letters are addressed "To Lady Johnson," or whatever her husband's name is. She is addressed as "Madam" in all parts of a letter.

MAIDS OF HONOUR. *Address*: "To the Honourable Miss ——" *Heading*: "Madam."

PRIVY COUNCILLORS. *Address*: "To the Right Honourable ——" The style of the *Heading* is to be varied according to the rank of the individual. The title of Right Honourable is possessed by all Privy Councillors, the Lord Mayors of London, York, and Dublin, and the Lord Provost of Edinburgh.

THE HOUSEHOLD MECHANIC.

CURTAINS.

AKIN, and properly belonging to, the chapter on blinds, would be the very little machinery which can appear in connection with curtains. The ordinary window curtain is suspended by hooks to rings, which slide backwards and forwards on a pole or rod fixed at the top of the window. This pole is of either wood or metal, generally brass; and if of the former material, its diameter should be slightly smaller in proportion to the internal diameter of the rings, than if of metal, because the friction is greater, and a more oblique position is necessary to get the rings to slide easily. In this arrangement, or rather want of arrangement, the curtain has to be dragged across the window from the ground, and the rings on the pole follow in a jerky and unsatisfactory manner, often

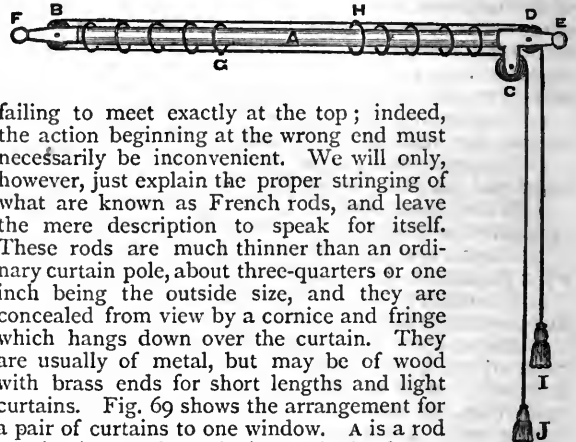

Fig. 69.

failing to meet exactly at the top; indeed, the action beginning at the wrong end must necessarily be inconvenient. We will only, however, just explain the proper stringing of what are known as French rods, and leave the mere description to speak for itself. These rods are much thinner than an ordinary curtain pole, about three-quarters or one inch being the outside size, and they are concealed from view by a cornice and fringe which hangs down over the curtain. They are usually of metal, but may be of wood with brass ends for short lengths and light curtains. Fig. 69 shows the arrangement for a pair of curtains to one window. A is a rod terminating at the end with a single sheave or pulley B, and the other by the pulleys C and D, the ends of the pulley-boxes being prolonged into eyes, E and F, by which the rod is supported to the cornice-board. The rings must be of brass, and just large enough to slip over B, and are strung on and fastened to the curtains in the ordinary way. We show five rings to each curtain, and in the position in the figure, each curtain would be about three-quarters drawn. A length of blind-cord is passed over D and over B, returning through all the rings to C and down the tassel I. The first or inner ring H, if the right curtain, is fastened to the upper cord at H, and the first of the left curtain to the lower cord at G. Now it is obvious that as G and H are the opposite sides of a practically endless cord, any motion of either will pull the other the reverse way, so that by pulling the tassel I, we shall open both curtains simultaneously; or, vice versa, should J be pulled. In the cut, we leave out the curtain altogether, to prevent confusion. In some cases it is preferred to use two rods side by side, in order that the curtains may overlap slightly, and so shut closer; but the principle of stringing is precisely the same as in the case we describe. If preferred, the line may be carried round a pulley, instead of terminating in the tassels I J; but this difference is quite immaterial. It must be borne in mind in all cases, that the simpler our arrangement of cords can possibly be made, the less the liability to get out of order.

COTTAGE FARMING.

III.—GRASSES ADAPTED FOR A COTTAGE FARM.

(Continued from page 154.)

THE fescue grasses are another tribe relished by cattle, and abundantly established in all our meadows and permanent pastures. In moist weather, or with a naturally moist bottom, barley fescue (*Festuca hordeiformis*) grows abundantly in richly-manured sandy soils. Sheep's fescue (*Festuca ovina*) and hard fescue (*Festuca duriuscula*) also produce well on sandy soils, but of a heavier loamy character. The former is best for pasturage, the latter grows freely both on meadow and pasture. Red fescue (*Festuca rubra*) is also a light sandy loam grass, growing with sheep's fescue in permanent pasture. Meadow fescue (*Festuca pratensis*) is an excellent hay and pasture grass on mossy and black soils, but grows freely, also, on rich moist soils. The variety known as tall fescue grass, the Andes grass of America (*Festuca elatior*), is one of our best hay and pasture grasses on rich black loams, rising quickly in pastures after it has been cropped by cattle. Floating fescue (*Festuca fluitans*) is less productive than *Poa aquatica*, but similar in character, the two generally growing together in marshy land on the edge of water-courses. Of the oat and brome grasses, other varieties of each are abundant in woody and shaded pastures, and also in open ground; but, with the exception of downy oat grass, which yields good pasture on open ground, when cropped close and kept from seeding, the others should only be grown in woods, or under trees in pastures.

"The couch grasses grow abundantly everywhere," it is said; but the popular credence is founded on the large family of them, every soil having its own peculiar kind of couch grass. In some places they are termed twitch grasses. The wheat-grass (*Triticum repens*), when in flower, has some resemblance to rye-grass; but when closely examined the two are easily distinguished, especially their roots. But their seeds are not so easily distinguished, and this accounts for the presence of this couch grass in many meadows and pastures. The bent grasses (*Agrostis*) are more numerous, growing freely in some cold clay and poor sandy soils, where hardly any other grass can live. The firvin grass (*Agrostis stolonifera*) grows abundantly on some of the bog-meadows of Ireland, where its roots give a firmness and stability to the surface of bogs very soft below, that enables it to carry carts and horses, which otherwise it would not do. These couch grasses also improve the mechanical texture of soil which is either marshy or sand. But in rich meadow and pasture lands it is otherwise, for their creeping roots accumulate, both in the soil and on the surface, producing an amount of effete vegetable matter in which they themselves can neither grow luxuriantly nor in a healthy state, while they kill out the finer grasses. From rich soils, therefore, all the couch grasses should be eradicated, and their place filled by others.

When the meadows and pastures are in a healthy, thriving state, clover is also found growing freely. Alsike,

or hybrid clover (*Trifolium hybridum*) appears getting into favour, producing largely on most soils. Red clover (*Trifolium pratense*), with Dutch or white clover (*Trifolium repens*), are also adapted for a variety of soils. Zig-zag clover (*Trifolium medium*), and bird's-foot clover (*Lotus corniculatus*), cow-clover (*Trifolium pratense-perenne*), and trefoil (*Medicago lupulina*), and yarrow (*Achillea millefolia*) are also less or more abundant in good pastures. Sainfoin is natural in chalky soils. When the soil suits them they all keep a firm hold of it, but cattle are apt to pull them up, especially sheep, when the bite becomes short.

The plantain, or rib grass (*Plantago*), also grows plentifully in some permanent meadows; and even the ribbed leaves grow erect with the other grasses. They are slightly blanched and tender, and greedily eaten by milch cows, and most kinds of stock; but when the leaves spread out in the sun they become more tough, and are not so well liked, while the plant itself is liable to shoot and run to seed.

The grasses with which our meadows and pastures are stocked, require a daily supply of food during the period of their growth, and this they abstract from the soil and atmosphere. When once the land is put into a proper state of fertility, the yield is very remunerating, and the duty of the cottager afterwards is to keep it in this productive state by an application of manure. It may not require much to maintain some naturally rich soils at the highest degree of productiveness, but if this little is not supplied, the richest meadows and pastures will lose less or more of their fertility by every crop removed, whether hay or pasture-grass; and if neglected one season, the loss the second will be greater than that sustained the first. It follows that the whole of the land should be manured with such manure as it requires—the meadow land after every cutting for hay or soiling, and pasture once at least every year, with occasional waterings during the dry weather of summer.

MANURES.

The next subject to be considered is the composition and preparation of the various kinds of ordinary manures and other compounds useful for the fertilising of grass land. Into the composition of artificial manures we do not at present intend to enter, though there is no doubt that their application to grass lands is found of the greatest benefit.

Composts may be defined as refuse of every kind that contains organic and inorganic food suitable to the wants of the grasses grown, and in a state fit for being applied to meadow or pasture land. Thus, the scrapings of the roadway, the parings and cleanings of the open ditches on either side, the cleanings of other open ditches, the cuttings of hedges, weeds, and vegetable mould, ashes, and all sorts of gatherings from the cottage and out-buildings, when collected together in a heap, and allowed to lie until sufficiently rotten for application, form compost. If mixed with the manure from the stables, cow-house, piggeries, and poultry-house, and allowed to lie until the whole is thoroughly incorporated and rotten,

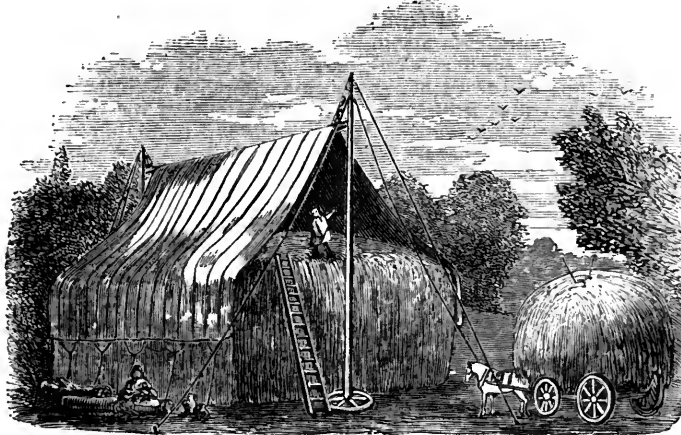

HAYSTACK AND RICK CLOTH.

the compound thus made is termed a *rich compost*. But with wall and wire fences, the land and roads drained and properly kept, open ditches filled in, and no weeds grown, as there should be none, very little compost of this kind can be made upon a cottage farm on this old plan, the collection being too small to form a *compost hill*. It is better, therefore, to utilise all such gatherings that can possibly be collected otherwise, as follows :-

Farm-yard Manure.—The long manure from the stable, cow-house, and piggeries, should be mixed together and used in the garden. If the garden is too small for this purpose, a sufficiency of ground outside should be enclosed to do so; and if the produce grown is more than meets the requirements of the family, any extras may be given to milch cows, pigs, and poultry.

Farm Sewage.—There are three ways of utilising the sewage from the cottage and outbuildings; two in making compost, the one by allowing the sewage to flow into a pit containing earth, or to pump it over a compost hill, and the other to absorb the sewage by means of dry earth in-doors, on what has recently been termed the earth-closet system; and the third plan is to apply it in a liquid form.

Manure pits are not so well adapted for small farms as for large ones, and least of all for cottage farms in grass, there being seldom a sufficiency of earth at command to utilise the whole of the sewage; and as it requires more earth, and is less economical than the earth-closet, the latter is to be preferred.

Dry Earth Compost and Sewage-tank combined—the former for earth-closets, stables, cow-houses and poultry-house, and the latter for the slops and washings from the cottage, scullery, laundry, and dairy—is what will best suit the generality of small grass farms. From time immemorial the sewage of the stable and cow-house, and sometimes the whole of the droppings of the piggeries and poultry-house, have been profitably utilised by means of dry ashes, vegetable mould, and peat-earth; and the *modus operandi* is exceedingly simple. Vegetable mould and peat-earth are dried in the sun, pounded or broken down by rollers, or passed through a cake or malt mill and sifted, and the fine dry earth put just under cover for daily use. It is daily strewed behind the horses and cows in quantity sufficient to absorb the whole of the liquid, and keep the stable and cow-house comparatively dry, clean, and free from smell; and all the sweepings are put under cover daily. The poultry-house is wholly littered with it, and the sweepings daily put by, and sometimes the piggery. Pigs should have straw in their beds, but they are easily trained to go to their own earth-closet, which they prefer to the old plans. Of the application of this system to dwelling-houses, we shall treat in our articles on the construction of the house. The wet earth from the different places should be well mixed together in the store or barn. It is not necessary that it should be stored dry, for it may be broken down sufficiently fine for being applied to the meadow or pasture by means of a broadcast distributor, with a large percentage of moisture; and as it may be applied at all seasons of the year in open weather, it should never be allowed to lie long in store to waste. The rains of winter and spring will wash it into the land. In the summer-time it may be applied before rain; but by means of hydrants and hose, it may be washed in during dry weather, the dry earth having been previously *bush-harrowed* into the grass. And so free is it from smell, that it may be applied to lawns in front of a mansion without perceptibly tainting the atmosphere. It may also be washed in with diluted sewage from the tank, but in this case the smell is perceptible; but if the wind is blowing off the cottage, it will not be felt, or do harm to the dairy.

Top-dressings, applied as above after the first hay crop has been removed, may be done for the twofold

purpose of getting the compost more effectually bush-harrowed into the land, so as to change its mechanical character, and thus improve its permanent fertility; and in the second place, to force forward an abundance of autumn and early spring food for milch cows. Some tenacious meadows fissure and crack very much in dry weather when the crop is removed, and even before. This is much against their natural productiveness, and the growth of the finer grasses. If, therefore, a heavy dose of rich compost is applied, and the cracks filled up with it, and the whole bush-harrowed, rolled, and washed in, the change produced is so great as hardly to be credited by those who have no experience of the practice. In the poorer, because more tenacious and wet clays, the application of dry road scrapings or pure sand from a pit, and the filling up of the fissures with such, will produce almost incredible improvements, both as to drainage and fertility. In autumn, before the weather breaks, heavy dressings of compost are easily applied to meadow and pasture land, which then carries both the feet of the horses and the wheels of the carts and manure distributors without rutting. At this time, when fissures exist and remain open, they may be filled up with the compost, as in summer, to change the mechanical texture and fertility of the land for the production of a finer quality of grasses. Where fresh grass seeds are needed, these may yet be sown and bush-harrowed in with the compost, as the young grasses have time to take root and establish themselves before the killing and uprooting effects of winter set in. They will also be in a sufficiently far advanced stage to be forced forward in early spring for cow-feed in March and April.

Summer and autumn top-dressing does not do away with the practice of rolling the meadow in spring, and the prior operation of bush-harrowing, so as to get an even smooth surface for the scythe or mowing-machine. On the contrary, they rather stimulate moles, worms, and other insects in the ground to greater activity in early spring, and thus increase the necessity for the bush or chain harrow and roller. High farming, however, has for its ultimate effects a reduction in the number of insects in the meadows, and moles and field-mice should be extirpated if possible.

The old plan of dressing the meadow in spring was to apply the compost early, and at a later period to employ women and children to pick up sticks, stones, and everything which should not be there prior to rolling. But the preparation of compost on sounder principles, as above, and the mixing of artificial manures with the same, so as the better to adapt them to the requirements of grasses, has greatly abridged and improved the old practice. In gravelly soils, winter frosts raise many small stones to the surface, so that they require to be gathered off in the spring before rolling. But in soils free from stones, and where no stones are carted on in the compost, none are to be removed. Finely prepared compost is more easily applied, whether spread from heaps or out of the cart, or by manure distributors. Few cottagers can afford to keep the latter, but they may hire them, and do the work in less time and at less money than on either of the other two old plans, as machines distribute the compost more evenly and better than it can be done by the hand and spade. The old bush-harrow and stone roller are being superseded by chain-harrows and iron rollers of improved construction, which will be treated of when we come to speak of *implements*. And when the cottage-farmer has a horse of his own, these should be kept on the inventory, and also broadcast solid and liquid manure distributors and seed-sowers, the use and advantage of which will also be shown in our paper on *implements*.

Liquid Manuring.—When grass farms, commercial dairy farms, and the detached meadows of domestic

dairy farms have the command of town sewage, it should be applied after every cutting for hay or forage grass—as explained below under *Soiling*—no more being applied at a time than what the land will retain. If the sewage is too diluted, guano and superphosphate of lime may be added to bring it to the proper strength. If the sewage is sufficiently strong, but defective in quality, it may be tempered by adding artificial manure and water; or a rich liquid manure may be made by dissolving artificial manure in water. For the kind of grasses under consideration, the liquid manure requires to be much more diluted than for Italian rye-grass, otherwise the continuous application would rot out many of the finer grasses, more especially if the quality is defective. The application of water to pasture lands in the summer time has, from time immemorial, been acknowledged a manurial process second to no other, water entering largely into the food of the grasses. In the olden times irrigated meadows were generally mown, but there were exceptions to this rule; and the success which is now beginning to crown irrigation with results far greater than were ever known under the old practice, is bidding fair to make the exception the rule of no distant period. The old practice was this:—The grazing ground, large or small, was divided into two or three fields. When the cattle had eaten the first field close down, they were turned into the second field, and the water into the first, and when it was thoroughly soaked the water was then turned off. This set up an immediate growth of grass. When the third was eaten close, the cattle were turned into the first, which by this time was dry, and offering a full bite, and the water was turned into the third, and so on for the whole of the grazing season.

Soiling is the technical phrase for feeding cattle with green forage in-doors. By March, or April at the farthest in southern provinces, a portion of the irrigated meadow should be sufficiently forward to supply daily mowings to the cottager's milch cows. As the mowings are small, this is best done with the scythe, and the daily work continues on to November. At first, the young grass should be mixed with old hay, and cut with chaff, adding less and less hay as the cows take to the succulent herbage; and when first given without hay, the grass should be allowed to dry for a short time on the swathe.

Hay Harvest.—A two-horse mowing machine will cut down one to two acres per hour, so that if cottagers club together and hire a machine, they can cut their grass cheaper and better than with the scythe, and get their hay safer and sooner into the stack or barn. Haymaking machines, horse-collectors, and horse-rakes likewise effect each a corresponding economy of time and labour, avoiding at the same time the risks of change in the weather. With bright sunshine and a brisk breeze, the hay may be in the barn the second day, though this is exceptionally quick, even if no rain falls. The first process is to shake the hay about thoroughly, so as to expose it as much as possible to the sun's rays; then it should be made up into light ridges, or, as they are called, "wind-rows." Towards the close of the first day it will be necessary to form the wind-rows into rough cocks, and shake them out evenly next morning with the fork or haymaking machine, the latter with back action, shaking up the wind-rows far better than can be done by the hand; and the pitching of the hay on to the cart concludes the manual labour of the cottager in the hay-field. If he has a horse and cart of his own, and gets his grass early cut in the morning, a small portion—if the weather is very forcing—may be carted the first day, as the hay can be put into rather small stacks with rather more sap than into large ones; but the difference, after all, is not much, so that care must be taken not to overheat the stack, as a slight fermentation improves, but an excess deteriorates the quality of the hay, turning it black and mouldy. The hay-

stack requires to be covered by a rick-cloth, as shown in the illustration (page 209). At each end of the stack a pole is raised, and fixed by means of three stay ropes. A cross-pole, raised and lowered by blocks and tackle, extends between the two upright poles, for carrying the cloth. In the woodcut the cloth is shown down, but during the operation of stacking it is lashed up to the cross-pole by the small cords seen on one side. In our next paper we propose to say a few words as to the most convenient shape and size for making hay-stacks.

A *Hay-barn* for a small farm is far preferable to all other contrivances for housing hay and other crops. In Holland the small farmer would not think of doing without his hay-barn; and in this country the hay is found to keep equally well in a barn as out of doors, and the waste of hay, so great in small stacks, is obviated when stacked in a barn. They are equally well adapted for corn crops, and when we come to treat of this department of cottage farming an engraving of one will be given.

Manuring follows the mowings, and as soon as there is a sufficient area of ground cleared of grass. If liquid manure from the tank, the hose is laid on to the spot from the nearest hydrant—it may be across the grass. If compost and water, the former may be taken to the meadow by the cart in which the grass was carried home, and evenly strewn over the stubble, bush-harrowed, and washed in by the water or diluted sewage from the hose, no more water being applied than the absorbent power of the land is capable of retaining.

Some apply the compost immediately after the first hay crop is removed; others in autumn, on the stubble of the aftermath crop; but the more common practice is in spring, and as early as the weather will permit, and without regard to out-door food for cattle; for cattle ought not to be allowed to set a hoof upon the meadow in spring time, however luxuriant the grass may be.

Renovating Grass Lands is done in three different ways. First, the meadow or pasture is carefully gone over, and all the weeds and coarse grasses are pulled, spudded, or dug up with a spade. If this is done in early autumn, and the land then top-dressed heavily with compost, and sown with fresh seeds, the young grasses and clovers will be established before winter, and present in spring a fine, fresh, promising appearance. The second method is by paring and burning, and the third, trenching—works which belong to arable husbandry, and under which they will be described. After the land has been got into a proper state of tillage and fertility, it is again laid down to grass, which is best done in early autumn by the sowing of grass seeds, as in the first plan. The grass should be kept short the first season by frequent mowings, care being taken to prevent scorching during the drought of summer by copious waterings. Instead of burning the thin surface sods, they may be collected and converted into dry vegetable mould.

ADVICE TO LODGERS.

IN England a lodger may be generally defined as an under-tenant, who is responsible for only a part of the rent of the house he lives in, and who is not called upon to pay the taxes levied upon it. His liabilities as a tenant are limited to the householder, who is accountable to the owner for the rent of the whole tenement, to the parish for all the parochial rates, and to the Crown for the Queen's taxes. Many persons take houses the whole of which they cannot, need not, or will not occupy, and they usually do this for the sake of some advantage to themselves. So, also, many persons for divers reasons prefer to rent only part of a house, and to become lodgers. To multitudes of unmarried men and women, professional persons, small families, and families with limited resources,

apartments are a convenience, if not a necessity. On the other hand, a large class finds in the letting of apartments either a means of livelihood or a certain addition to a restricted income. It is very important that persons who come into the relation of landlord and lodger—that is, of landlord and tenant—should know their duties and obligations; we shall, therefore, state a few facts which will be useful to both parties, though they will, perhaps, be most so to the lodger.

When apartments are taken for a short limited period, and it is understood that the tenancy expires at the close of it, a notice to quit is unnecessary; though, without an agreement to the contrary, a regular tenancy is established if the holding is continued beyond the specified time. Even a person who takes lodgings at an hotel for a night ought to give reasonable notice the next day of his intention to depart, or of his wish to remain: much more should this be done if apartments are taken for a longer, though a limited, term. Irrespective of all legal consequences, those who let or take lodgings will do well to avoid neglect. With regard to an hotel or boarding-house, we need say no more than that the engagements entered into for a night or so are of a fugitive character, and are fulfilled by a lodger who is courteous and otherwise well conducted, and who pays his bill and the customary fees. Our main concern is with arrangements of a more private and permanent character than such as fall within the ordinary category of good entertainment in hotels of all sorts, though even there it is becoming more common for people among us to fix their quarters as on the Continent.

Private apartments, as usually understood, are either furnished or unfurnished. Furnished lodgings may involve the partial use of some rooms and the sole use of others, partial or complete attendance, partial or complete cooking, lodging only, or board and lodging; in fact, it would be difficult to enumerate all the possible variations. Even in the matter of furniture and so forth there is room for considerable diversity, and it is necessary to know what the lodger is expected to provide for himself, as well as what he is expected to do for himself. Differences of requirement and provision will, of course, influence money terms as really as differences of accommodation and locality.

Agreements are usually verbal only, but it is better for security that they should be in writing. A written agreement must specify the date of entry, the amount of rent to be paid, how often payment is to be made, and the length of notice to quit, with all other details required by the particular case. Appended to the written agreement should be an inventory of every article belonging to the landlord, and a specification of every defect and imperfection in the furniture, fittings, &c. Where the apartments comprise an entire floor, or suite of rooms, it will be best to proceed as in the case of a furnished house, and to employ an experienced and trustworthy house-agent to go over the inventory, and to see that everything is properly done.

To constitute the agreement a regular legal document, it had better be drawn up in some orderly form.

Memorandum of agreement entered into this day of _____, 18____, between _____ of _____ of the one part, and _____ of _____ of the other part.

The said _____ hereby agrees to let, and the said _____ hereby agrees to rent and take all those apartments on the _____ floor (or floors) of the house of the said _____, situate and being No. _____, street (or as the case may be), in the parish of _____, in the county of _____, with the use and enjoyment of all easements, appurtenances, furniture, effects, and other things severally set forth and enumerated in the schedule or inventory hereunto annexed. To hold the same from the day of _____, unto the said _____, as tenant thereof, from

to _____, at the clear rent of _____, payable on the _____ free from any deduction; the first payment to be made on the _____ day of _____ next; the said tenancy to be determinable by either party on giving the other notice in writing to quit. And the said _____ hereby agrees to leave on the premises hereby agreed to be let, at the termination of the tenancy hereby created, all the several furniture, effects, fixtures, and other things enumerated in the schedule or inventory hereunto annexed, and which are now in or upon the said premises, and are the property of the said _____; and also all the glass windows whole and unbroken, except such as are specified in the said schedule. And the said _____ hereby agrees to pay all taxes and outgoings in respect of the premises hereby agreed to be let, to execute all needful repairs, and to indemnify the goods and chattels of the said _____ from and against the same.

In witness whereof the said parties }
have hereunto set their hands the }
day and year aforesaid.

To such an agreement a witness may be had if thought desirable.

Where there is no written agreement, the length of a notice to quit is usually settled by the form of letting or payment of rent. Thus, when let at so much per week, month, or quarter, the notice will be for the same periods, unless custom to the contrary can be proved.

A lodger has the right to use the knocker and door bell, the lights and windows in the approaches to his apartments, and the water-closet and other conveniences. If he has any doubt about some things, he had better stipulate for their reasonable use, as a garden or outer yard. He cannot claim to affix a plate, nor to have his name painted or exhibited upon the house without his landlord's consent. A landlord has no right without permission or just cause to enter his lodger's apartments; and if he intrudes upon their use or possession he forfeits his power to recover the rent. A weekly tenant can require a quarter's notice if the landlord allows his rent to accrue for a quarter and receives it as a quarter's rent. The landlord can recover arrears of rent if his tenant leaves without notice, even if he advertises for another tenant; but if he re-lets his apartments, he cannot recover subsequent rent. Where there are no goods, rent and arrears can be recovered in the county court.

All persons who take apartments, whether furnished or not, will be prudent to make various inquiries before entering upon an agreement. These inquiries may include the solvency of the landlord, the character of his house and of its inmates, the respectability and healthiness of the locality, the proper supply of good water, and the condition of all the fittings and fixtures, and furniture, if there is any.

With respect to unfurnished apartments, it is especially needful to be cautious, because the lodger may find himself liable for actual or future arrears of rent or taxes, due by his landlord. It is particularly annoying if a lodger finds that through his want of caution his goods are distrained for the rent, parochial rates, or other charges upon the whole house.

A magistrate in the metropolis can award compensation to the amount of fifteen pounds for wilful damage done by tenants to their apartments. Again, a landlord is not responsible if his tenant loses his goods by fire or theft, unless the lodger can prove the loss due to want of proper precaution on the landlord's part. If a lodger refuses to leave after the expiration of his term, his landlord can eject him under warrant from a magistrate, or by authority of a county court. Of course, a lodger cannot remove any fixtures when he leaves, though erected by himself, except those which are known in law as removable fixtures. The lodger is not responsible for ordinary wear and tear

either of his rooms or of the landlord's furniture, &c., but for all beyond ordinary wear and tear he is liable. As his goods may be distrained for the rent of the house, so they may be distrained for his own rent.

Formidable as the foregoing enumeration may appear at first sight, it will on consideration be found to include little to terrify those who intend to live in lodgings. People must live somewhere, and wherever it is, they will, if they inquire, find themselves surrounded with liabilities. There are many who are well able to rent houses for themselves who prefer to live in lodgings, and it is not uncommon for them to remain years in the same place. These usually do not keep their own servants, but sometimes they do, and there are houses so arranged that two or more families can live in them without inconvenience. In Scotland, what are called "lands," comprising on separate floors, called "flats," all the conveniences of a house, are much preferred to "self-contained houses." In the metropolis, also, there are springing up blocks of buildings with a common stair, and occupied by separate households. Such examples, however, scarcely come under the head of lodgings as commonly understood, but they are mentioned here as a sort of compromise, which deserves to be advocated in the case of crowded cities.

In ordinary cases a single man or woman will do best in unfurnished apartments, but whether they shall board with the family or not must depend upon circumstances. This will be less difficult in a strictly private house than in one more properly called a lodging house.

A man and his wife, or any two ladies or gentlemen living together, will commonly do best if they board themselves. Where there are more than two, or if there are children, a separate table is altogether desirable. When lodgers provide their own food, and only one kitchen is available, fixed hours will be necessary, whether they have their own cook or not. If lodgers find their own bed-linen and table-linen, or other articles, they will pay less for furnished apartments. Lodgers must have free ingress and egress, and should possess a latch-key or other facilities for those purposes. They should have keys also to their rooms, cupboards, boxes, drawers, &c., and should use them, and not leave them about as a temptation. They should, of course, be models of regularity, quietness, good order, and so forth, and will usually find their account in it.

As for the price of apartments, it varies with position and a hundred other circumstances, so that while two comfortable little rooms may be got for a few shillings a week, the wealthy and ambitious may pay as many pounds for two or three large rooms, and everything in an aristocratic style.

The question whether it is best to lodge in a house kept by one who is a professed lodging-house or boarding-house keeper, or with a really private family, is not to be easily settled. Some are violently prejudiced against lodging-house keepers, and others against private families. In truth, there are good and bad of all sorts, and prudent people will look after the good by whatever name they are

known. Lodgers are not always perfect, and perhaps their discontent and misery are as often due to themselves as to their landlord or landlady.

THE HOUSEHOLD MECHANIC.

LOCKS AND DOOR FITTINGS.

BEFORE going into the description of the more complete modern locks it will, perhaps, be advisable to touch upon the simpler methods of fastening and securing doors. Perhaps the most primitive, but at the same time most useful for outdoor work, is the staple and hasp fastening, which, being of very rough and ready application, and not requiring much fit, is a sort of thing anybody can put up. Suppose a fastening of this kind is required on a garden gate, it is only necessary to screw in the hasp to the gate, and then, holding it up over its place on the gate-post, drive a large staple into the post; a peg, secured by a string or a chain, is slipped into the staple over the hasp, and so secures the gate. Fig. 70 shows the arrangement complete; it is too simple to require detailed description.

We come next to the common, or latch fastening, shown at Fig. 71. A bar A, about eight inches or less in length, pivots on the screw B, being kept in its place and limited to a small upward or downward movement by the guard C, constitute the fittings on the inside of the door. Into the post D the latch E is driven; this latch consists of a small piece of iron pointed at the end which drives into the wood, the other end being expanded; as is shown in the drawing, the upper edge is formed into a bevel upwards for a short distance, when the piece is suddenly contracted, thus forming a notch. The action is evident. The door being shut, brings the end

of the bar A in contact with the bevel F of E, and thereby raises it until it falls into the notch, when the door is quite shut. To open the door from the inside, it is necessary to raise the bar A by the knob or the lever at H; this lever is carried through the door and terminates on the outside in a broad, flat sort of plate, on which the pressure of the thumb is exerted to raise the bar inside. In cases where this projection of the thumb-plate would be objectionable, a sunk iron plate is substituted, in the centre of which is a knob, which being pressed by the finger or thumb, attains the same end.

Let us now look into a common cupboard lock, one of the simplest forms of lock used in this country. It consists of only a bar A (Fig. 72) sliding across the framework of the lock, and part of one side being split up into a rude substitute for a spring, B, which has just flexibility enough to allow the notches in the bar at C to rise out of the frame on pressure upwards being used with the key. The key to this lock is a barrel key, that is, it is tubular, and pivots on a wire in the lock; and on being thrust on this wire, and turned round into the notch in the bar A, the pressure of the key compresses the spring B, and allows the bar to slip over into the other notch. The key will then complete the circle, and come out of the hole.

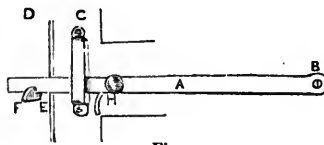

Fig. 71.

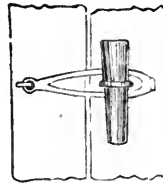

Fig. 70.

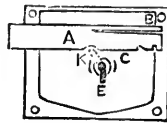

Fig. 72.

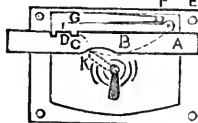

Fig. 73.

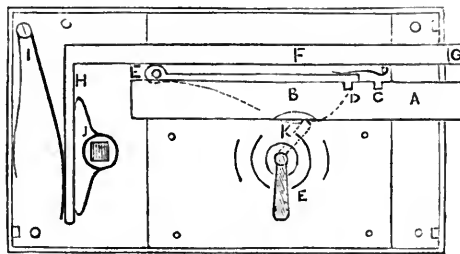

Fig. 74.

To prevent the opening of the lock by any key but its own, a number of iron or brass rings, or "wards," as shown at E, are fitted inside the lock, to prevent the key from being turned round, unless the slits in the key exactly correspond with the wards.

The action of the tumbler lock is, however, quite different. The bolt A (Fig. 73) is made to slide easily in the slots in the frame of the lock, but this bolt is not solid, except at the end which shoots out, its thickness being reduced in the middle to make room for the tumbler B to go behind it. This tumbler is hinged at E, and is pressed downwards by the spring F. On the end of the tumbler furthest from E, is a little projection, G, which exactly fits a notch in the bar A, as shown. The tumbler goes behind the bolt, as shown by the dotted lines. Now take the key, insert it into its place, and turn it round; one edge coming in contact with the lower edge of the tumbler, will raise it from the notch C, and free the bolt; a further movement driving the bolt out, or shooting it, as it is termed; the tumbler then drops into the notch D, and holds it secure. The reverse action of the key produces exactly the reverse result. The bolt A shoots into channels in the door-frame, the forms of which are quite immaterial.

We now come to the latch and lock combined (Fig 74), which, as far as the lock is concerned, is just what we have now described in the tumbler lock, but looks more complicated on account of its combination. In the lock part of the arrangement, the same letters are used as with Fig. 73, and the same description exactly applies. The latch is a long bar, F, sliding easily for about half an inch, and projecting that distance from the end, terminating in the bevel G at that end. The other end is turned at right angles to the bar, and prolonged into a smaller bar H. A spring, I, keeps the whole bolt out, and a lever, J, acts on H, on its being turned either way, and forces the bolt back. Into the square hole in J a square rod fits, and on to each end of this rod the handles are fastened. One handle is usually permanently fixed, the other is fastened by a screw in the handle, which catches into holes in the rod, so arranged on each side as to allow any adjustment required by the thickness of the door through which the handle goes. Such locks as are here illustrated will be found on most doors. They are arranged as "mortice" or as "rim" locks. The former are made to slide in a hole or mortice in the edge of the door, and are, therefore, out of sight. Rim locks are screwed on to the inner side of the door, and, of course, are not so neat as mortice locks. On the outside of the door in the case of rim locks, and on both sides with the other kind, the handle works in a plate, known as the "rose," which is bradded on to the door; the plate ornamenting the key-hole is known as the escutcheon. The handles, escutcheons, and finger-plates of doors are known as the furniture, and can be had of various patterns and qualities, according to desire or taste, and are therefore sold quite independently of the locks.

The complicated and beautiful latch locks, patented by various makers, are mostly on the tumbler principle, and in some cases the sliding bolt has six or eight of these tumblers to be raised before it can be moved from its position; the number and diversity of form in the tumblers rendering it nearly impossible that any but the right key will shoot the bolt. In these door latches, the lock tumbler is combined with the lifting latch, the principle of action being the same.

Locks should occasionally be taken to pieces, cleaned, and oiled, when the stiff way in which they work shows they require it. Where much exposed to damp and change of weather, locks should be made entirely of brass, as iron locks will rust and become useless; nor is any amount of oiling sufficient to prevent it.

In our next paper we propose to give such information on the subject of gas-fittings as will fall within the scope of the Household Mechanic.

GUTTA-PERCHA FOR MENDING SHOES.

GUTTA-PERCHA was scarcely known in this country until 1843, when Dr. Montgomerie, of Singapore, called attention to its valuable properties. It soon won its way to popular favour, and has continued to be an article of immense importance. One of the many applications made of it at the outset was the soling of shoes, which seems to have been first practised by a Mr. Mapple. It was found to be a bad conductor of heat, a repellant of moisture, a non-conductor of electricity, and, in the form of shoe soles, both durable and cheap, added to which it could be easily applied. Objections were made to it, but its use for shoe soles was established, and has continued ever since. One of the great difficulties at first was to make gutta-percha soles adhere firmly to leather, but this difficulty was overcome by various contrivances. Some attached the soles by means of a solution of gutta-percha in gas tar; others fastened them by first making holes in the leather, and squeezing the soft gutta-percha down with pressure enough to drive it into the holes. When the gutta-percha was in a manner glued on to a new upper leather as first practised, the soles came away from the oily leather, as a matter of course. However, we only recommend gutta-percha either as a middle sole between two others, or as an affix to the outer sole. The soles may be affixed by any person with ordinary skill, which is an important recommendation where saving is almost as necessary as comfort. We discard all solutions and cements, and have done so for years.

Our mode of operation is regularly now the following:—When our boots or shoes require a new pair of soles, we take them and dry them well before the fire. We scrape the soles thoroughly all over, so as not to leave any grit upon them; we then take a small piece of gutta-percha and rub it into the leather soles with a hot iron, usually a screwdriver, covering the soles with a thin coat or plaster of gutta-percha. We lay the boot thus prepared before the fire, where it will keep hot. Then we take a gutta-percha sole, put a brad-awl through it an inch or so from one end, and hold it thus before the fire as if we were toasting it.

When the surface is thoroughly hot and adhesive, we lay the new sole, the cool side down, on a piece of paper upon a board, and immediately place upon it in a proper position the boot which we have kept hot. If the paper sticks, never mind, it can easily be removed afterwards; we then press the new sole on equally with our fingers, until it is well fixed and properly shaped. It may then be allowed to cool, and afterwards be trimmed with a knife.

If the process is correctly gone through according to the directions above given, the gutta-percha sole will wear out without being detached. Leather or gutta-percha soles with holes in them, or worn away in part, may be made good by simply melting upon them with the hot screwdriver pieces of gutta-percha, old or new; any fragments will do. But in this case, also, the boots must be dry, and all grit and dirt be removed from the places to be operated upon; in fact, dryness and freedom from dirt are the essentials to success. Warmth in the soles is desirable, but a good hot iron will enable a clever hand to spread the gutta-percha in any form or degree of thickness that may be desired. These are the methods which we have followed for twenty winters, and it is in winter especially that gutta-percha soles are desirable.

It will be seen, from our description, that the operation of applying the gutta-percha is a remarkably simple one, and one, moreover, which may easily be done at home. When it has once been tried, we are confident that our readers will value the information we have given. An old pair of boots or shoes may, by this means, readily be made water-tight.

DOMESTIC MEDICINE.

ERUPTIVE FEVERS (*continued*).

Small-Pox would occur in childhood even more frequently than the other diseases, but for vaccination. Hence we may notice it here. Supposing an epidemic of small-pox to be abroad, all un-vaccinated children should be vaccinated, grown up persons, who have not been re-vaccinated, should be re-vaccinated, and should avoid, in the meantime, contact with persons affected with small-pox. We shall first describe the symptoms of an attack, and then give some general account of its course and treatment. It is not easy, while a person is sickening for small-pox, to be quite sure about the fact. About twelve days elapse after the poison of small-pox has been received, before decided symptoms show themselves. At the end of this time there is shivering, often severe, and vomiting, and a general feeling of lassitude and illness. Another significant symptom is pain in the back, often so acute as to absorb the patient's attention, and lead him to think that his back has been hurt. There is also heat of skin, thirst, and loss of appetite. About two days after the shivering, the eruption begins to appear; first as little red points, which gradually ripen into the spots of small-pox. These points enlarge, in three or four days a little fluid begins to appear at the top of them, and they go on to ripen into the fully developed vesicle of small-pox, containing first a clear fluid, and then small-pox matter. The spots appear first in the face, neck, and wrists, secondly on the trunk, and lastly on the lower extremities; they fill and ripen by the ninth day, at which time the pustules break and crusts or scabs form, which begin to fall off in four or five days more. The severity of the disease depends on the amount of the eruption, which is as a rule less when small-pox occurs after vaccination; and it has been observed that the more vaccination marks there are, and the deeper they are, the less severe is the disease. If the small-pox is slight, the spots remain distinct; if, on the other hand, the spots are numerous, they run into each other. The case is then said to be one of *confluent* small-pox. Occurring in the unvaccinated it is a horrible disease, and fatal in about one in three cases.

Treatment.—The domestic treatment of a patient with small-pox consists in the administration of light pleasant drinks and simple diet, such as gruel, weak beef tea, milk and tea, barley-water, plain water, tepid sponging; in frequent changes of well-aired linen, and in keeping the patient in a well ventilated room, and in a bed without curtains and that does not unduly heat the patient. The room should be as thinly furnished and as free from curtains and carpets as possible, as the *contagion* of small-pox is very intense, and gathers about such things. For the relief of irritation in the eruption, olive oil may be applied, or equal parts of glycerine and rose-water, after bathing with tepid water. The medical treatment will of course devolve upon a medical man. In places where a medical man is not to be had, the above treatment is the most important. Violent purging should be abstained from. If the patient has been unvaccinated—and, indeed, in any severe case—the greatest danger sets in about the eleventh day of the disease, and the eighth of the eruption. The fever then increases, and the swelling of the skin and face is greatest, and renders the patient both uncomfortable and most unseemly to behold. Delirium, twitchings, or diarrhoea are bad symptoms at this stage. If the anti-vaccinationists could see a case at this stage of the disease often, they would talk more gratefully and sensibly about vaccination. The patient now requires to be well supported by strong beef tea, and if much depressed, and the spots do not fill well, by wine.

To prevent the Disease spreading.—Let every person in the house be re-vaccinated, and the patient isolated as

much as possible. Clothes must either be destroyed or dealt with as we have recommended in the case of scarlet fever, and exposed thereafter for a considerable time to the air. The scabs contain the matter of the disease, and, as they fall off, should be collected and burnt or disinfected.

TYPHOID AND TYPHUS, AND INFANTILE INTERMITTENT FEVERS.

Before leaving the eruptive fevers, we must notice typhoid and typhus fevers, not because they occur so frequently in childhood as the fevers we have already noticed, but because they are accompanied with an eruption, and will be better understood, perhaps, if treated in this connection. They resemble the other eruptive diseases of which we have treated, not only in having eruptions attended with fever, but in the fact that persons do not, as a rule, suffer twice from them. It is well to impress on the readers of a popular book on diseases, that typhoid and typhus fevers are essentially different diseases; that they are different in their causes, different in their symptoms, different in their duration, different in their risks, and especially different in the degree of their contagiousness. The difference of these diseases has been made out in a great measure by our own distinguished countryman, Sir William Jenner, physician to Her Majesty Queen Victoria. As typhoid is the more common disease of the two, especially in childhood, we shall treat of it first.

Typhoid Fever—or, as it is called when it affects children, *Infantile Remittent Fever*—often sets in insidiously, with general signs of illness, such as headache, great muscular weakness and soreness, heat of skin, and furred tongue. If these symptoms persist for several days without cough, or rheumatic pains in joints, or sore throat to give them explanation; and if to these symptoms is added more or less diarrhoea, and in the course of eight or ten days a slight eruption of red spots or pimples, which disappear under pressure, then it is pretty clear that the case is one of typhoid fever. The spots occur on the abdomen, chest, and back. They may be very few in number, not more than two or three, or they may be as many as thirty or forty. If the spots are very numerous, and the eruption continues, the disease is generally severe, or at least prolonged. The eruption does not come out all at once, but spots show themselves generally about the eighth day, and on the following days others appear. Each spot has a duration of from three to fifteen days. Muscular weakness, fever or heat of skin, diarrhoea and the eruption of rose or red spots, and a furred tongue tending to become dry, constitute the principal features of this disease. As the disease proceeds, more or less delirium occurs. The diarrhoea is a very important and peculiar symptom. It depends upon the fact, that in this disease the small intestine is almost invariably affected. The little glands in it are either swollen or inflamed, or actually ulcerated. In this way diarrhoea is caused, and the absorption of food into the system is interfered with. Hence, the patients lose flesh fast, and often become extremely emaciated. The appearance of the motions is almost always unhealthy and relaxed; they are very offensive, of a peculiar yellow-ochrey colour, and they separate on standing into a supernatant fluid and a flaky sediment. The intestine is sometimes so much ulcerated as to bleed freely—the blood appearing in the motions. Consistently with this state of the bowels, there is generally tenderness and some swelling of the abdomen (stomach). When the disease occurs in children, it is not so fatal as in adults, and it is characterised by remarkable remissions of—that is to say, improvements in—the symptoms. The child who has been hot and restless, and perhaps slightly delirious in the night, is comparatively well about nine or ten in the morning, and remains so for three or four hours. The fever is essentially connected with the state of the intestine: but there may be cough and other complica-

tions. It is a disease which extends over several weeks. In the case of children it is not a very fatal disease; though a disease of great importance and severity, often leading to extreme emaciation, which suggests fears that there is some other complaint about the child. It will be readily understood that with such a sensitive condition of the intestine, the child or even the adult passing through or recovering from this disease is apt to be hurt by irritating or injudicious diet.

We should not fail to say, that bed sores are not uncommon in this disease, owing to the patient lying so long on his back, and this in a prostrate condition.

Causes.—In the great majority of cases typhoid fever seems to arise from a very particular cause—namely, from animal or vegetable matter in a state of decay or putrefaction, and especially from sewage matter. In every house in which cases occur, drains should be looked to, to see if there is any escape of sewage matter or of sewage gases. A very common cause of the disease in badly drained towns or villages, is the admixture of sewage matter with drinking water. This is very apt to happen if well water is used. Every now and then we hear of wholesale epidemics of this disease occurring in the line of a certain set of water-pipes, houses supplied by other water-pipes being exempt amid prevailing disease. The motions of persons affected with this disease are charged with the power of conveying it, so they should be at once disinfected and completely removed. All drains of the house should be disinfected also. For this purpose a teaspoonful or two of crude carbolic acid should be mixed with every motion; and the same should be frequently put into the water-closet pan. Motions should not be allowed to remain long in the room.

Treatment.—We need scarcely say that typhoid fever is not a disease for domestic treatment only. The domestic treatment will consist chiefly in the administration of proper food; in anticipating the natural wants of the patient independent of suggestions from him; in looking for any redness or sore of the back, and in keeping the patient as clean as possible consistently with not disturbing or raising him too much. Beef tea, broth, and milk will be the best diet; but towards the second or third week the patient may require stimulants. The exact degree and kind of these must be determined by a medical man. There has been a tendency of late years to administer too many stimulants both in fever and other diseases; but used moderately and judiciously, they are undoubtedly beneficial in this disease. We should repeat here the caution about giving animal or other solid food during convalescence from typhoid fever. Great care should be taken in consideration of the fact that the intestine is only recovering from a state of ulceration. Relapses may be induced, and other harm done by giving solid food too soon. The apartment of the patient should be kept airy, without exposing him to draughts of air. The skin of the back should be frequently looked to. Inflamed spots may be bathed with a little spirits of camphor, and a water or an air cushion should be placed under the part on which the patient lies constantly. If the disease is infectious or contagious at all, it is only slightly so—unlike typhus, which we shall immediately describe; and if proper care be taken to remove and disinfect all the discharges of the patient, especially the motions, to rectify and disinfect the drains, and to purify the water supply, there is little fear of its spreading. The rest of the treatment must devolve on a medical man, and requires much judgment.

Typhus is not so common in children as in adults; nor, probably, is it so common in children as typhoid. It is a disease arising out of a state of poverty; want and overcrowding are the conditions in which it arises. But when it occurs, it is intensely contagious, and may affect any one who has much to do with the patient. It often prevails epidemically during seasons of general

scarcity. Its chief centres are large towns, especially Glasgow and Liverpool. Its chief victims are the poor, and those who have unavoidable or kind relations with them—unlike typhoid, which attacks rich and poor indiscriminately.

The symptoms of the disease somewhat resemble those of typhoid fever—that is to say, it sets in with heaviness, muscular weakness, headache accompanied with fever, and furred tongue, which soon becomes dry. There is great prostration of nervous and muscular strength. The points of distinction between this disease and typhoid are principally two or three: first, in the nature of the eruption; secondly, in the absence generally of diarrhoea and of that tenderness of some parts of the abdomen which are so common in typhoid; thirdly, in the disease being of shorter duration, and more apt to come to a height and change definitely on a given day in the way of a crisis, such as the fourteenth day. A favourable crisis is shown by a decided fall in the temperature of the patient, or by a fall in the pulse, or by the recurrence of sleep after prolonged watchfulness, or by the concurrence of a number of these favourable symptoms. Relapse is not common in typhus.

When fatal, it is usually so between the twelfth and twentieth days. The greater the age of the patient, the greater the danger of the disease.

The eruption, or rash of typhus, appears about the seventh day, or earlier; it consists of irregular spots of a *dusky* or *mulberry hue*, and after the first two or three days scarcely disappears under pressure. The spots do not come and go, as is the case with the rose spots of typhoid; they all appear in the course of three or four days, and remain throughout the disease.

Treatment.—The general and more domestic treatment of typhus does not differ from that of typhoid. The nervous prostration is greater, the weakness of the circulation is greater, and hence stimulants form a more indispensable part of the treatment, but their use must, of course, be dictated by medical judgment. Good ventilation, plenty of simple nourishment, such as beef tea, milk, &c.; attention to the wants of the patient; looking closely to the state of the back for redness or sores, and being ready with an air or a water cushion, and doing everything for the patient with as little disturbance or movement of him as possible, are the principal points in the domestic management of cases of typhus fever.

But there is another point of great importance; it is this: to remember that the disease is very contagious, and that therefore the number of persons exposed to the risk should not be greater than is proper or unavoidable. The room should be freed from carpets and curtains, and have a comfortable amount of fire in it. Above all, it should be well aired. All the discharges of the patient should be disinfected, as directed in the case of typhoid. Clothes should be disinfected by prolonged boiling, or by exposure to a dry heat of 200 degrees.

It will be understood how significant and important is the occurrence of such diseases as typhoid and typhus. On any large scale they are matters of public interest, for they imply errors in the social conditions of the people, such as it is the duty of good government, local and imperial, to prevent. Epidemics of typhoid happen so often, and on such a huge scale, in connection with palpable faults and flaws in the water supply of towns and villages, that the head of the Medical Department of the Privy Council thinks the time has come for making water companies responsible in damages to the sufferers or their survivors. Often, of course, the fault is more that of the individual householder than of the water companies.

Epidemics of *typhus* suggest extensive destitution and the crowding of the poor into ill-ventilated houses, or rather hovels, in which the disease spreads extensively.

ANIMALS KEPT FOR PROFIT.—POULTRY.

VI.—TURKEYS AND GUINEA-FOWL.

THE most opposite opinions have been expressed by different breeders as to whether or not the rearing of turkeys in England can be made profitable; and the *general* judgment, we are bound to say, seems to be that they can barely be made to repay the cost of their food. There are not wanting, however, those who from their own experience maintain the contrary; and we believe that where the balance-sheet is unsatisfactory, the cause will generally be found in heavy losses from want of care. The usual mortality in turkey-chicks is tremendous, and quite sufficient to eat up any possible amount of profit; but there are persons who for years have reared *every chick*; and, under these circumstances, they will yield a fair return.

several after commencing incubation. In a state of nature, the turkey-cock is constantly seeking to destroy both the eggs and the chickens, which the female as sedulously endeavours to conceal from him. There is generally more or less of the same disposition when domesticated, and, when it appears, it must be carefully provided against. The turkey-hen is very prudish, but gives scarcely any trouble while sitting. She sits so constantly that it is needful to remove her daily from her nest to feed, or she would absolutely starve. Nevertheless, when absent she is apt to be forgetful, and therefore, if allowed to range at liberty, care should be taken that she returns in time—twenty minutes. Besides her daily feed, a water vessel and some soft food should be always within her reach. No one must visit the hatching-house but the regular attendant, or the hens will get startled, and pro-

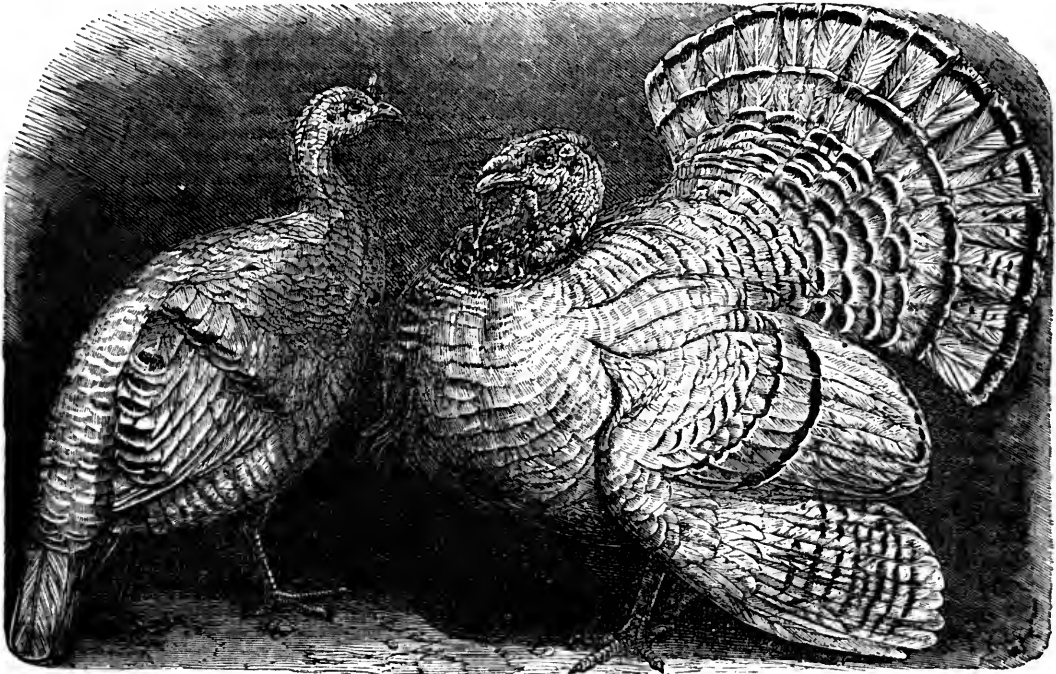

VARIEGATED CAMBRIDGE TURKEYS.

The number of hens allowed to a turkey-cock ought to be limited to twelve or fifteen—quite enough brood stock for even a large establishment. The turkey-cock may be used for breeding at two years old, and the hen at twelve months, but are not in their prime till a year older. They will be first-class breeding stock, as a rule, for at least two years later, and many cocks will breed splendid chickens for considerably longer; a *good* bird should not therefore be discarded till his progeny show symptoms of degeneracy. The size of the hens is of special importance, much more than that of the cock, in whom good shape, strength, and spirit are of more value, if combined with a fair good size. The turkey-hen generally lays about eighteen eggs—sometimes only ten or a dozen, and when each egg has been taken away when laid, it may be more. We once heard of ninety eggs being laid by a turkey-hen, but can scarcely credit such a statement. A very good plan is to give a turkey's first seven eggs to a common hen—quite as many as she can cover—when there will be just about enough laid subsequently to be hatched by the turkey herself. The best time to hatch the chicks out is in the months of May and June, or even July; and all eggs set should be marked, as the turkey often lays

ably break many eggs, which easily happens, from the great weight of the birds. The chicks break the shell from the twenty-sixth to the twenty-ninth day, scarcely ever later. The day but one before the hatching is expected, the hen should be plentifully fed, the nest cleaned of any dung or feathers during her absence, and an ample supply of food and water placed where she can reach it, as she *must not again be disturbed* till the chicks are out. In dry weather, if the nest be in a dry place, the eggs will have been daily sprinkled as described under hatching. The egg-shells may be cleared away after hatching has proceeded some hours, but the chicks should never be taken away from the hen, and never be *forced to eat*. The latter practice is very general, as turkey-chicks are very stupid, and do not seem to know how to peck. But a much better plan is to put two ordinary hen's eggs under the turkey, five or six days after she began to sit, which will then hatch about the same time as her own, and the little chickens will teach the young turkeys, quite soon enough, what they should do. Water or milk may be given, however, by dipping the tips of the finger, or a camel-hair pencil, in the fluid, and applying it to the end of their beaks. The best feeding at first—say for a

week—is hard-boiled eggs, chopped small, mixed with nothing but minced dandelion. When dandelions cannot be obtained—and it is well worth while to grow them where turkeys are reared—boiled nettles chopped fine are perhaps the best substitute. At the end of a week or ten days some bread-crumbs and barley-meal may gradually be added to the egg, which may be by degrees lessened, until quite discontinued at the end of three weeks. About this time, a portion of boiled potato forms an excellent addition to the food, and by degrees some small grain may be added also—in fact, assimilating the diet very much to that of other poultry. Curds also are excellent as a portion of the dietary, but must be squeezed very dry before they are given. They are easiest prepared by adding a pinch of alum to a quart of milk slightly warmed. By this feeding, the little chicks will get well through their *first* great danger—the tendency to diarrhoea already alluded to; and the cost of the egg will be repaid by the extra number reared. The *second* peril to be guarded against is cold and damp: a wetting is absolutely fatal. The chicks should be kept entirely under a shed, on a board floor kept scrupulously clean and nicely sanded, except during *settled* sunny weather, when they may be allowed a little liberty on the grass, after the dew is quite dry. But in cold or windy weather, however fine, they must be kept in the shed, and well screened from the wind. If there be a one-storey building, their best place will be the top floor, the bottom being devoted to the sitting hens and other adult stock. Their water also must be so supplied that they cannot wet themselves by any possibility; and these precautions must be continued till they are nine or ten weeks old, when they will begin to “put out the red,” as it is called, or to develop the singular red excrescences on the neck so characteristic of the turkey breed. This process will last some little time, and when completed the birds will be pretty fully fledged. They are now hardy, but must not be suddenly exposed to rain or cold winds. Take reasonable care of them for awhile longer, and very soon they will have become the hardiest birds known in the poultry-yard, braving with impunity the fiercest storms, and even preferring, if permitted, to roost on high trees through the depth of winter. In fact, turkeys will rarely roost in a fowl-house; and a very high open shed should therefore be provided—the higher the better—the perches being placed as high as possible. The ordinary domestic turkey is of two kinds—the Norfolk (black all over) and the Cambridge. The latter is of all colours—the best, to our fancy, being a dark copper bronze; but fawn colour and pure white are often seen, as are also variegated birds, which occasionally present a very magnificent appearance. The dark Cambridge usually attains the greatest size.

The *Guinea-fowl* mates in pairs, and an equal number of males and females must therefore be provided, to prevent disappointment. In commencing, it is needful to procure some eggs and set them under a common hen; for if old birds be purchased they will wander off for miles as soon as they are set at liberty, and never return; indeed, no fowl gives such trouble from its wandering habits. If hatched in the poultry-yard, however, and regularly fed, they will remain; but must always have one meal regularly at night, or they will scarcely ever roost at home. Nothing, however, will persuade them to sleep in the fowl-house, and they usually roost in the lower branches of a tree. The hen lays pretty freely from May or June to about August. She is a very shy bird, and if eggs are taken from her nest with her knowledge, will forsake it altogether, and seek another, which she conceals with the most sedulous care. A few should therefore always be left, and the nest never be visited when she is in sight. It is best to give the earliest eggs to a common hen, as the *Guinea-fowl* herself frequently sits too late to rear a brood. If

“broody” in due season, however, she rarely fails to hatch nearly all. Incubation is from twenty-six to twenty-nine or thirty days. The chicks require food almost immediately—within, at most, six hours after hatching—and should be fed and cared for in the same manner as young turkeys, though they may be allowed rather more liberty. It should be observed, however, that they require more *constant* feeding than any other chickens, a few hours’ abstinence being fatal to them; and they need also rather more animal food to rear them successfully and keep them in good condition, especially in the winter. The flesh of the *Guinea-fowl* is of exquisite flavour, much like that of the pheasant. The body about equals in size an ordinary Dorking, and is very plump and well-proportioned.

DISEASES OF POULTRY.

When the stock is provided, let it be not only attended to as described in our last paper, but carefully observed occasionally for symptoms of disease.

Loss of Feathers is almost always caused either by want of green food, or having no dust-bath. Let these wants therefore be properly supplied, removing the fowls, if possible, to a grass run. For local application, we prefer an unguent composed of sulphur and creosote, but nothing will bring back the feathers before the next moult.

Roup is always caused by wet, or very cold winds. It begins with a common cold, and terminates in an offensive discharge from the nostrils and eyes, often hanging in froth about them. It is *highly contagious*, the disease being, as we believe, communicated by the sickly fowl’s beak contaminating the drinking water; therefore, let all fowls affected by it be at once put by themselves, and have a separate water-vessel. Keep them warm, and feed with meal only, mixed with hot ale instead of water; add sulphate of iron to the water, and give daily, in a bolus of meal, half a grain of cayenne pepper, with half a grain of powdered allspice, or a roup pill. Give also half a cabbage-leaf every day, and wash the head and eyes morning and evening with very diluted vinegar, or a five-grain solution of sulphate of zinc. Roup runs its course rapidly, and in a week the bird will either be almost well, or so nearly dead that it had better be killed at once. It is *the* disease of poultry, and to be dreaded accordingly; fortunately, the symptoms are specific, and the treatment equally so.

Diarrhoea may be caused either by cold, wet weather, with inadequate shelter; neglect in cleansing the house and run; or from the reaction after constipation caused by too little green food. In this case, feed on warm *barley* meal; give some green food, but not very much; and at first administer, four times a day, three drops of camphorated spirit on a pill of meal. This will usually effect a cure. If the evacuations become coloured with blood, the diarrhoea has passed into *dysentery*, and recovery is almost hopeless. Another prescription is one grain each of opium and ipecacuanha, with five grains of chalk; but the camphorated spirit we consider a better remedy.

Soft Eggs are generally caused by over-feeding the hens, in which case the remedy is self-evident. It may, however, occur from want of lime, which must then be supplied, the best form being calcined and pounded oyster-shells. Occasionally it is occasioned by fright, from being driven about, but in that case will right itself in a day or two. If *perfect* eggs are habitually dropped on the ground, the proprietor should see whether the nests do not need purifying. This leads us to

Insect Vermin, which can only be troublesome from gross neglect, either of the fowls or their habitations. In the one case, the remedy is a dust-bath, mixed with powdered coke or sulphur; in the other, an energetic

lime-washing of the houses and sheds will get rid of the annoyance.

It will be seen that by far the greater proportion of poultry diseases arise either from cold and wet, or neglect in preserving cleanliness—often both combined. It should be noted also, that the first general symptom of nearly all such diseases is diarrhoea, which we have observed usually manifests itself even in roup, before any discharge from the nostrils is perceptible. At this stage much evil may be warded off. Whenever a fowl hangs its wings, and looks drooping, let it be seen at once whether it appears purged, and if so, give immediately, in a table-spoonful of warm water, a tea-spoonful of strong brandy saturated with camphor. Repeat this next morning, and in most cases the disease, whatever it is, will be checked; care being of course taken to give the invalid warmth and good shelter, with ale in its food. If the evacuation continues, administer the stronger prescription given for diarrhoea. Chickens will have little or no disease if treated as we shall direct in a future number.

COOKING.

PICKLES (continued).

Pickled Gherkins.—One of the few pickles in esteem in France, where a peculiar sort—the *cornichon*, short and thick—is grown exclusively for pickling; cucumbers being rarely eaten sliced, as with us. The smaller the gherkins (from an inch to an inch and a half long), the more they are esteemed: to insure which smallness, they are daily gathered from the beds, and thrown immediately into strong salt and water. When you have enough to fill your jar or jars, take them out of the brine, and drain them. Peel shalots (or small onions), in the proportion of about one in ten to the number of gherkins. Have a few sprigs of fresh tarragon. Pack the gherkins in the jar, interspersing with them the shalots and a few tarragon leaves. When the jar is nearly full, lay on the top some sprigs of tarragon. Pour boiling vinegar over all. Spice may be boiled with it, but is not needful. If the gherkins are not green enough, you may pour off the vinegar after awhile, and return it to them boiling hot. Our neighbours themselves care little about the colour; though, to please their customers, they sell gherkins in bottles made of green-tinted glass.

Pickled Cucumbers, Tomatoes, and Beet-root.—We put these three articles together, on account of the difficulty of keeping them (especially the two last) pickled, without moulding. The remedy is, to extract the natural juices by the application of salt, which also robs them of their flavour. Cucumbers are cut, without peeling them, either into lengths across, and the seeds removed with an apple-scoop; or lengthwise, also removing the seeds. After several saltings, they are put into a jar, and covered with hot vinegar, seasoned with spice. Green tomatoes, left whole, are treated similarly. The addition of either of the three to other pickles, is apt to mould them. They require attention, for the moment mould appears, they must be taken out of the jar, wiped, put into a fresh jar, and their vinegar poured over them, after boiling up. Garden beet alone hardly makes a pickle. The best way of using it is to bake it in a very slow oven, and then to slice it as wanted for incorporating with salads, &c. Green potato berries have been pickled to pass for tomatoes, which is a very dangerous practice.

Pickled Samphire.—The true samphire (Shakespeare's *Crithmum maritimum*) is now a rare plant. When you are so fortunate as to come into possession of it, divide it into small sprigs, rinse them well, lay them to drain in the sun, and leave them there till the leaves begin to flag a little; which, being succulent, they are in no very great hurry to do. Place them in

their jar, and cover them with hot vinegar containing a little salt but no spice, so as not to overpower their natural aromatic flavour. This plant is an umbellifer—*i.e.*, bears flowers arranged like those in celery, parsley, &c. What ordinarily passes for samphire is a glasswort (*Salicornia herbacea*) common enough in salt marshes and on low muddy shores not often covered with the tide. It is not aromatic, but is full of soda; whence its English name, derived from its having at one time been employed in the manufacture of glass. It has even assumed the true samphire's name of *passe-pierre*, from the belief prevalent amongst some people that the latter relieved patients troubled with gravel and stone. Pull glasswort into sprigs; wash and drain them, and pour over them hot vinegar well charged with salt and spice. We have known glasswort to be boiled and eaten as a vegetable, from faith in its healing virtues.

Pickled Nasturtium Buds and Seeds.—The first make the more delicate pickle, the latter are the more highly flavoured. Both must be gathered daily; the buds before the petals protrude beyond the calyx, the seeds while they are still as soft as green peas. It suffices to throw either into good strong cold vinegar, and when the harvest is over, to cork them down tightly. To say that nasturtium (properly, *tropaeolum*) sauce makes a good substitute for caper sauce, is scarcely fair, because it is so good in itself, and the flavour so different to that of capers, that it may be left to stand upon its own merits. Other pretended substitutes for capers are the flower-buds of the marsh marigold (*Caltha palustris*), a ranunculus, and the unripe seeds of a garden species of spurge (*Euphorbia*), falsely called by country folks the caper plant. We mention them only to warn the reader against both.

PRESERVES, ETC.

Baked Apples for Children.—Take a large earthen pot, and fill it to within three inches of the top with well-wiped apples of any sort you may have, but it is best they should be all of the same sort, in order to cook equally. Neither peel them nor remove the stalks. Pour over them, so as to cover them completely, a mixture of treacle or brown sugar and water. If the apples are windfalls, you may allow a little extra sweetening. It will be an improvement if you can put here and there amongst them some pieces of orange or lemon-peel, and a few cloves. Cover the pot with a lid, or with doubled brown paper tied over it with string. Set it to pass the night in a spent baker's oven. If the oven is too hot, the liquid in the pot will boil over or evaporate, and the apples be dried up or burnt.

Baked Apples.—Take a flat, earthen dish, on this place, so close as just not to touch each other, a layer of apples which have received no other preparation than careful wiping. Set them in a gentle oven, in which they must be watched from first to last in order to cook them as slowly as possible, and prevent their bursting more than can be avoided. Much will depend upon the oven, something on the kind of apple. Serve, after cooling, on the same dish on which they were baked.

Baked Apples.—Proceed as above, using a silver or a plated dish instead of an earthen one. When cold, sprinkle over them, for show, a slight dusting of finely-powdered lump sugar.

Stewed Apples.—Take a large shallow stew-pan that will hold six or eight apples, enough, in short, to make a dish. Peel the apples and take out the cores with a scoop, leaving the fruit whole. Pour a film of water over the bottom of the stew-pan to prevent sticking and burning, then place the apples in it side by side in a single layer as closely as they will pack, drop in lump sugar to give the degree of sweetness liked, a few cloves, the rind of a lemon, and the juice of the same. Pour in enough water to cover them,

stew till tender on a gentle fire, but not one minute longer. Take them out one by one, with a large spoon, without breaking them, and arrange them in the dish in which they are to appear. Let the juice boil a few minutes longer, to reduce it, remove the lemon-peel and cloves; when almost cold pour it over the apples. Added *hot* it might crack the dish if of glass or china. Invalids find apples so stewed much more tempting than if mashed to a jam.

Dried Normandy Pippins.—A convenient resource in invalid cookery, because they store well, and are to be had when apples with their skins whole are not. These, to turn out good, should be previously steeped in tepid water—if all night so much the better, if not, several hours. The time they take to stew will much depend on the length of their steeping. For stewing use the water in which they have been steeped, with the addition of more if necessary. Season, flavour, and serve as in the preceding recipe for stewed apples, applying the fire heat with even greater gentleness.

Dried Apples (not Normandy Pippins).—The kind most in use for this preparation (for which Norwich has long been celebrated) is the Norfolk biffin (*beau fin*), a very late, hard-fleshed apple. Drying apples in this way is a work of patience, and is a specialty with certain confectioners. The apples, by pressure between weighted boards and the slow but long-continued application of heat, become perfectly circular cakes of dark brown flesh, enclosed in an unbroken skin.

Apple Jam.—Peel, core, and quarter apples; flavour as above; put them into a stew-pan with enough water to keep them from burning, continue stirring and mashing with a fork until the whole mass is reduced to a smooth pulp. You may then either stop and put the jam into pots for present use—indeed, this is never intended for keeping—or, by slow evaporation, you may bring it to such a thickness that, put into shapes, it will stiffen when cold and so turn out an apple cheese.

Apple Jelly.—Peel, quarter, and cut up into small pieces a quantity of pippin apples. Put them in a stew-pan with a teacupful of water. When cooked to a mash put them in a jelly-bag, and let them drain all night; they must not be squeezed. Next morning put the juice in a saucepan, taking care not to put the sediment into it, in order that the apple juice may remain clear; put in sufficient sugar to bring it to the sweetness of currant jelly. Boil until it will jelly when cold, and put away in pots or glasses.

Orange Apple Jelly (Excellent).—When the apple juice, as above, is put into the saucepan to be boiled down with the sugar, throw in slices of orange with the peel on, and the pips removed; let all cook together. On potting it off let each pot of jelly contain a slice or two of orange. Both of the above are delicate sweet relishes to eat with bread.

Blackberry Jam.—For people living in the country in the neighbourhood of woods, although the fruit varies in abundance with the year, blackberry jam will be one of the cheapest. Its flatness and insipidity may be relieved by the mixture with it of a portion of apples, which will raise it to the rank of a second-rate jam. Any brisk-flavoured apple will do, but the Wellington or Dumelow's seedling is particularly recommended for the purpose. Several jams and preserves are the better for being mixed, and the mixture often assumes quite a character of its own. Thus apple and orange jelly (just given) is an excellent compound; rhubarb and strawberry jam also combine advantageously.

Strawberry Jam.—With jams and other fruit preserves, exactly as with wines, there are good, indifferent, and bad years. In a cold, wet, and sunless summer, it is difficult to make jams with the real perfume, although they may be made to keep by longer boiling, and an

extra allowance of sugar. On the other hand, in fine summers, although it is false economy to diminish the prescribed allowance of sugar, the high flavour and firmness of the jam will testify to the influence of the genial season. In all cases the fruit should be gathered after one, two, or three dry days; never after a spell of rain. Over-ripe fruit is as much to be avoided as under-ripe. The former is vapid, has lost its flavour, and is often tainted with bitterness and the elements of decay. Gather your strawberries on a sunshiny afternoon, handle them gently, pick only handsome, well-ripened specimens, and do not commit the mistake of supposing that "any fruit is good enough for jam." Pick them from the stalks with equal care, the object being that the preserved strawberries shall remain *whole*. In this state they will be much more sightly in sweet omelettes, lay tarts, with creams, &c. Weigh your strawberries, and for every pound of fruit allow three-quarters of a pound of lump sugar, well broken up into small pieces or coarse powder. Put a layer of strawberries at the bottom of your stew-pan, then a thin layer of sugar, then more strawberries; and so on till all are in the pan. Set it on a gentle fire. Shake and stir with a spoon to prevent burning, taking care not to break the fruit. As scum rises, remove it till there is no more. Let the jam *boil*, with all due precaution, from thirty to forty minutes, or even a little longer, according to the proportion of moisture contained in the fruit, and requiring to be driven off by evaporation. When you judge the proper consistency to be attained, remove the stew-pan from the fire, and let its contents stand to cool a little; then distribute them into your jam-pots or glasses. Carry these on a tray into a cool, dry store-room, and let them stand all night. Next day you will be able to decide whether the jam is in a fit state to be tied down. Sometimes in wet, inclement seasons, you will find it desirable to give the jam a second boiling to insure its keeping. If all is right, cut circles of white paper which will exactly cover the surface of the jam in the pots. Steep them in brandy, and apply them to it. Then tie down with doubled or trebled paper and string, and write on the top the name of the jam and the date of the year. Store the pots in a dry closet, to avoid mouldiness, and in a cool one to prevent fermentation.

Raspberry Jam.—Take the same proportions of fruit and sugar, and observe the same precautions as in gathering, except that, as the fruit cannot be kept whole, this jam being really a *jam*, small and imperfectly-shaped fruit, if good in every other respect, may be employed. Then proceed, finish off, and store exactly as with strawberry jam.

Ripe Gooseberry Jam may be made either with the red, yellow, or white varieties of the fruit, but separately, unless a medley is wished for. Thick-skinned varieties are good, for the same reason that citrons are preferable to lemons for supplying candied peel. Wet weather is, if possible, even more unpropitious for gooseberry jam than for the preceding. Reject all cracked fruits, they are insipid and worthless. Remove the withered flower at the top of each, and the stalk at the bottom with a small, sharp pair of seissors. If you attempt to do it with your thumb and finger nails, you will in many cases tear the skin of the fruit. Weigh the fruit, and for each pound allow an equal weight (a pound) of broken lump sugar. Then proceed as with strawberry jam. You cannot keep the fruit *whole*—*i.e.*, you cannot prevent the skins from bursting; nor is it desirable that you should, because too large a proportion of water enters into their contents, and a great part of this must be evaporated. But break the skins as little as may be, then finish off as before. Gooseberry jam, properly prepared keeps well. In 1869 we were using some dated 1865, as good as on the day when it was made.

Black Currant Jam.—Exactly as above. If you have the patience, cut off the withered flowers and stalks, which

is a great improvement. Black currant jam eats well in a rolled pudding; it is also useful to mix with water, as a cooling drink for invalids. Red and white currants are not often made into jam, but are rather reserved for jelly-making. Some people, however, have a preference for red currant jam, as there is a pleasant acid in the flavour of it; others, again, mix equal quantities of red currants and raspberries.

Apricot Jam.—The apricots should be ripe enough to halve with your fingers. Crack the stones and blanch the kernels in boiling water. Allow equal weights of sugar and fruit. In the stew-pan add the blanched kernels to the fruit, and proceed as before.

Greengage and Plum Jam.—Wipe the fruit, weigh it, set it on the fire in a stew-pan covered with a lid, taking the usual precautions to avoid burning. When soft enough, crush the fruit with a spoon, and remove the kernels. Then add the sugar; three-quarters of a pound to each pound of fruit *will do*, but a pound is better. Let it boil slowly for forty minutes. If sufficient moisture is not driven off, all plum jams are apt to ferment. You may blanch the kernels of the plums, and incorporate them with some of the jam, on whose paper covers it will be found advisable to note the addition.

Quince Marmalade.—The strong odour emitted by quinces is a sign of their being fit for use. Peel, quarter, and core them, but save the pips. Put the quinces and their pips into a stew-pan, with a little less lump sugar than is directed for the preceding preserves, and just enough water to keep them from burning. As the sugar dissolves and the liquor boils, continue stirring the whole mass. When the fruit becomes tender break and mash it with a spoon. In about an hour it will be done enough. It may then be turned out into preserve-jars. The next morning it ought to be perfectly stiff, from the strong mucilage of the pips being thoroughly incorporated with it. Tied down in the usual way, it will keep good for a long time.

Damson or Bullace Cheese.—Let the fruit be quite ripe and sound, and any that is at all damaged must be carefully picked out. For every pound of fruit set aside a quarter of a pound of sugar. Put the fruit, without water, into a deep stone jar. Set the jar, nearly up to the neck, in a vessel of boiling water, after tying double paper over the top to keep out the steam. Or you may set it in a *very* slow oven. When the fruit is tender pour it into a bowl; remove the stones with a fork, but leave the skins. Then pour all into a stew-pan. Add the sugar, and boil, with care not to burn, until the whole is reduced to a thick pulp. The time required depends on circumstances. A dessert-spoonful set out of doors to cool, will tell you if your cheese is stiff enough; if not, it must be boiled a little longer. When done put it into small shapes or moulds, in which it may be kept until wanted to be turned out, to appear at luncheon or dessert.

Currant Jelly.—Jellies from currants (red, black, or white) are all prepared in the same way. Strip the currants from the stalks, and for every pound of fruit set aside three-quarters of a pound of sugar. Some cooks allow as much as a pound of sugar to a pound of fruit or a pint of juice. Or, after the juice is extracted, you may allow three-quarters of a pound of sugar to every pint of juice. Put the stripped currants into a stew-pan, and let them boil for twenty minutes. The juice from red and black currants can then be squeezed through a cloth; that from white currants had better only drain, with very gentle pressure, to keep it clear. Return the juice to the stew-pan, add the sugar, boil up and skim. After cooling a little, your jelly will be ready to pour off into jars or glasses. The sugar is added to the juice, because it is clear that by boiling it *with the fruit* you lose all which remains adhering to the skins and pips of the currants when the juice is strained away.

INMATES OF THE HOUSE.—DOMESTIC.

III.—THE HOUSEMAID.

IN many English households two servants only are kept—cook and housemaid—a small domestic staff, but one capable, under able supervision, of getting through a considerable amount of work. In order to effect this, it is necessary that each servant should be efficient in her duties, and that a regular plan of household labour be laid down, by which, instead of impeding each other's progress, mutual help may be rendered to facilitate a thorough dispatch of work. As a general rule, however, the less a cook has to do out of her kitchen the better will she be enabled to cook, and the more time a housemaid bestows on house cleaning, the greater will be the comfort of the family. Dusty furniture and a close atmosphere are evils which are apt to generate ailments in establishments where sufficient domestic labour cannot be afforded. Ailments of the kind should have no existence where sufficient servants are employed to keep every part of a house clean and wholesome.

One of the chief obstacles to the better discharge of housemaids' work than generally obtains is, not only the notion on the part of the servant herself, that her duties are of a semi-laborious nature, but the too ready acquiescence in this view by employers. Many ladies, when engaging a housemaid, hold out the "lightness of the work" as an inducement to get the place filled. Consequently, no sphere of domestic service is so crowded with young women in delicate health as that of the housemaid. Good health is, nevertheless, indispensable to the fit discharge of all kinds of labour.

A housemaid's place is no sinecure if properly filled. Early rising is indispensable; much physical strength is required for scrubbing, carrying trays, and answering bells, and if, as it often happens, there are children and invalids in the family, her powers of patience are considerably tried.

A good constitution and a willing disposition are amongst the principal qualities to seek in a housemaid, to which may be added a quiet, pleasing manner and cleanly appearance. Her dress is of some importance. When engaged in her morning work, washable materials are the best; a wide holland apron should always be worn over one of white material whenever house-cleaning is going on. If the servant be required to appear at the front door, or wait upon the family whilst at dirty work, by casting aside the outer apron she is able to appear at a moment's notice in a presentable manner. For afternoon wear in the winter, very dark or black French twill dresses are suitable, inexpensive, and easily washed. In the summer light cotton materials look best. At all seasons a neat white crochet cap is the best head-gear. Thick boots, especially with nails, are destructive to stair carpets, and steel petticoats are ruinous to painted skirtings. Instead of the latter garment, the ordinary corded petticoat should be worn. Housemaid's gloves should be found by the mistress of the house.

As the duties of a housemaid are very numerous, and liable to vary in different households, it is advisable in this place to explain only those which are of general application.

A good housemaid will rise at six, and have her grates cleaned and rooms swept by seven. She will then go upstairs, wash her hands, and make herself tidy for taking to the bedroom hot water if required to do so. In the meanwhile the dust will have settled, and the rooms will be ready on her return to be finished by eight. By nine o'clock breakfast ought to be cleared away and the housemaid ready to strip the beds, empty slops, and set the bedrooms in order. By eleven o'clock the up-stairs work ought to be done, unless extra cleaning is in question. Washing up china and glass, dusting the drawing-room,

and other light labour of the kind may take till twelve or one o'clock, by which time a housemaid ought to be dressed for the day, fit to answer the door, wait on the family, and do needlework. Any work required of the servant after mid-day should be of a nature not to soil her garments. At dusk, it is a housemaid's place to close all the windows at the upper part of the house. Before going to bed she has to turn down all the beds of the family, replenish cwers and water bottles, empty slops, and put everything in its place. If she has the charge of the plate-basket she carries it to the master's room, together with hot water. Considerate employers will dispense with a housemaid's attendance by ten o'clock, bearing in mind her morning duties.

The usual plan of housemaid's work, when no washing is done at home, is to clean the drawing-room thoroughly on Mondays, and one or two other rooms, according to their size, on each successive day during the week. Saturday should be a tolerably clear day from house-cleaning, beyond general dusting and setting in order for Sunday, cleaning plate, airing clean linen from the wash, &c. Any spare time left beyond these duties is generally allowed the housemaid for repairing or making her own clothes. If washing is done at home, the household work must necessarily be delayed in its course.

The following directions are written for the guidance of housemaids.

Sweeping and Dusting.—Before sweeping a room remove all light articles of furniture out of the way, and cover up those which would be spoiled by dust. Draw back the window-curtains and pin them up as high as you can reach. Open the windows a few inches top and bottom, and shut the door. Turn the front of picture-frames to the wall, hang a sweeping-sheet over looking-glass frames, mirrors, &c. Then sprinkle tea-leaves, drained, but not dry, all over the carpet, especially in the corners. Sweep all carpets the way of the pile, whether it be in one direction or in another. If the fireplace is in use, all the ashes should be removed from the grate before sweeping the carpet. Whilst the dust settles, clean the grate. Having done so, tie a soft clean cloth over a hair broom and sweep the cornice and ceiling, also the walls. A turk's-head broom answers better for this purpose, if you have one. In like manner sweep the curtain-poles, hangings, &c. In the absence of tea-leaves, some pieces of coarse brown paper, moistened with clean water, will answer the purpose. Without something of the kind you simply drive the dust from one part of the room to another.

Dusting.—Remove all articles from the place to be dusted, and do not wipe round them. Put everything back in its place. Use a painter's brush for dusting skirtings, and wipe glass and china ornaments with a fine soft cloth. White dusters are best for chintz furniture. A small feather broom should be used for raised china and gilt work. Never wipe picture frames with a duster. Carved woodwork should be dusted with a short-haired furniture brush, which likewise polishes. Pianoforte keys should be dusted with an old silk pocket-handkerchief, kept for the purpose.

Scrubbing.—Neglected boards will not come clean without extra pains. If of a very bad colour a mixture of three parts of powdered pipeclay with one of chloride of lime, about the thickness of cream, will be useful. This should be laid on to dry in some time before scrubbing. Or some white sand laid on the brush when scrubbing will remove the dirt. Grease will only yield to fuller's earth spread on the spots for several hours. Well kept boards, especially in country houses, require nothing but cold water. *Soap and soda in hot water make boards black.* In scrubbing, only arm's length should be wetted at the time, taking care that the flannel is wrung each time dry of the soiled water. Good bass scrubbing-

brushes are more cleansing than those of hair. Vulcanised india-rubber scrubbing-brushes are the best of all, but are rather expensive at the first outlay.

To clean Grates.—It is a good plan to cover new grates with a coating of copal varnish lightly; polishing afterwards with a black-lead brush will keep them in good condition with very little trouble. Once a year the varnish may be renewed, and the saving will be found considerable, both in black-lead and labour. Neglected grates are troublesome to restore. The only effectual way is to scrub off all the accumulation of dust and grease with a hard brush and soft soap. Afterwards go over them with some Brunswick black, to be had at most oil-shops. They will only require dusting afterwards for some time. Bright polished steel, if neglected, may be improved by mixing sweet oil to the thickness of cream with fine emery knife-powder. Cover the steel with this mixture, and, when dry, rub it off with a leather dipped in the same powder. For coarse bright metal a mixture of a little fine brick-dust with the knife powder and oil will answer. *Burnished* fire-irons and mouldings should never be touched with emery or sand-paper. If spotted with rust, the best plan is to get a "buff"—i.e., a thick piece of soft leather fastened on a stick sold at tool warehouses. Dip the buff into a little oil, and afterwards into fine crocus powder, and rub the rusty places till they become bright.

To clean Brass and Copper.—A mixture of oil and rotten-stone, applied with a piece of leather and afterwards rubbed bright, will give a good polish.

Ormolu articles should be washed with plain soap and water, and polished with a wash leather.

Lacquered Work the same. All acids and soda are liable to destroy lacquer.

To clean Marble.—Ordinary cleansing of marble may be done by simply washing the surface with warm soap and water, polishing afterwards with a fine dry cloth or leather. Stained and much soiled marble may be much improved by boiling equal parts of soft soap and powdered whitening, say four ounces of each with one ounce of soda. When thoroughly blended, lay the mixture on whilst hot, and let it remain for a day or so. Afterwards wash off with clean water, and dry with a leather. Grease stains may sometimes be removed by applying fuller's earth in the usual manner.

To wash Glass.—Cold water, in which a small quantity of soda has been dissolved, is the best mode of washing tumblers, wine glasses, &c. They should afterwards be turned down to drain, and then be polished with a soft, dry cloth. The same plan applies to chandelier glasses. If the dust is much worked into ground glass, a soft nail-brush should be used, polishing afterwards with a wash leather. Decanters are best cleaned with tea-leaves or pieces of brown paper saturated with water. Potato parings, sometimes recommended, may scratch the glass. A wash-leather is the best thing for washing and drying looking-glasses. Powdered blue and whitening if used are apt to get into the mouldings, and prove troublesome to remove.

To clean Oil-cloth.—Sitting-rooms are now frequently bordered with oil-cloth, and consequently the cleaning falls to the housemaid. Scrubbing oil-cloth with soda and soap is a destructive process, and there is no necessity for doing so, if ordinary care be used to keep the oil-cloth clean by daily sweeping and dusting. If any spots appear they are easily removed by rubbing with a little oil laid on with flannel. When it is necessary to wash oil-cloth it should be gone over with a flannel moistened with milk. If the latter is not easily to be had, a small quantity of olive oil added to weak table-beer will answer. This should be rubbed in with a flannel, a small space at a time, and dried with a wash leather.

To clean Paint.—There is one description of paint which a housemaid should be careful not to clean. This

is what is termed *flaked paint*. None but glaziers should be expected to do this work, as it requires especial treatment. Soda ought never to be used for paint cleaning, and very little soap. Paint is best dried with a leather, as the latter polishes as well as dries. Grease spots on paint may be easily removed by dipping the flannel into a little finely powdered gilders' whitening worked into a paste with water. The parts only which are soiled should be touched with the whitening, but if the white surface of the paint is very dirty the mixture may be applied all over, wetting only as much as can be dried off at a time.

By this means the finest paint may be preserved in beauty for a very long time. Varnished paint should only be washed occasionally with plain cold water, applied and dried with a wash leather.

To clean Paper-hangings.—A split stale loaf rubbed over the walls with a circular movement is the cheapest and best plan.

To clean Stone Staircases.—A mixture of powdered pipe-clay, soap lees, and unslaked lime, will remove all grease spots if left to dry on. The mixture should afterwards be washed off in the ordinary way.

The above are some of the chief daily duties of a housemaid. Directions for other portions of her work, sometimes performed by the parlour-maid, page, and laundry-maid, will be considered in subsequent chapters.

ODDS AND ENDS.

Liquid Glue.—Take a pint of water, a pound of good glue, and gradually dissolve the glue in the water, which may be done by setting the vessel containing them in another containing hot water, and keeping all hot. As it cools add, little by little, three ounces of nitric acid. Bottle it when cold in stoppered bottles. It will not set, will keep for a very long time, and may be used for any purpose almost, for which gum arabic is used as a cement.

Lime-wash.—Put new quick-lime into a pail with cold water to cover it. Add one pint of boiled linseed-oil to each gallon of the mixture; stir well. Almost any fat or grease will do for common work. Thin it to a proper consistency, and lay it on with a brush. Half a pound of green vitriol to one gallon will produce a nice stone colour.

A few Facts about Water.—The temperature at which water is drunk greatly influences the health. Below 45° it is an astringent, highly tonic if pure; at 60° it is a diluent for dissolving crudities of food and other obstructions in the stomach: this temperature will give relief to those suffering from indigestion. Above 60° water relaxes the system, but drunk from 70° to 80°, the first thing in the morning, it is an excellent antibilious medicine. The following registration by Fahrenheit's thermometer is adopted, under medical advice, for bathers:—At 70° water is cold to the skin of the hand. A bath of 80° would be termed a cold bath. From 86° to 90° a bath is tepid; 100° is a warm bath; a vapour bath from 100° to 130°. The following tests for water are useful if applied in the proportion of a few drops of each to one or two ounces of water:—A solution of nitrate of barytes will cause a turbid appearance if any alkaline carbonates and sulphates exist in the water. A solution of acetate of lead will do the same. A solution of oxalate of ammonia precipitates lime, if there be any. A solution of carbonate of ammonia and, directly afterwards, a solution of phosphate of soda will produce milkiness if magnesia be present in the water. Free carbonic acid is detected by a very slight milkiness being produced by adding an equal portion of lime water with the water tested. A solution of soap in alcohol detects lime, and shows, by the greater or lesser flakiness of the soap, the degree of hardness of the water.

Saline waters contain salts of lime, muriate of soda and magnesia, sulphate of magnesia, carbonate of soda, and other alkaline earths. *Magnesian waters* are those possessing the taste and properties of magnesia. Water is called *chalybeate* when carbonate of iron abounds, and *hepatic, or sulphurous*, when impregnated with sulphuretted hydrogen.

Tarragon Vinegar.—Fill a pickle-bottle one-quarter or one-third full of sprigs of tarragon, or merely with the leaves picked off the stalks. Fill the bottle with good vinegar, and stop it down with a cork. Let it stand a few days to make a cold infusion, and it is fit for use. No salt, spice, or boiling are needed. The leaves are so full of their peculiar flavour, that, after the first brewing of vinegar has been used, a second may be poured over them. This simple relish is exceedingly useful to have in store.

Treacle Toffy.—Rub your pan with a little butter, and pour in as much treacle as may be wanted. Let it boil slowly for about an hour, and then pour it into a warm basin rubbed over inside with butter. When it is cool enough, roll it up into sticks, and fold it in clean white paper. The treacle may be flavoured with a little essence of peppermint before it is put into the pan.

Veneering is the art of covering a cheap and solid material with a thin layer or leaf of a more costly and more ornamental material, so as to convey the impression that the whole is formed of that which meets the eye. According to Pliny, veneering was invented, and made use of, to obviate the extravagance of the Romans of his day—a day in which an emperor thought nothing of giving a thousand pounds for a table, and rare woods were worth almost their weight in gold. The veneer-mill, or saw, is a beautiful and ingenious invention, by which a solid block of wood may be peeled or shaved into sheets, some only of the consistency of brown paper. Thus a solid square foot of wood will supply material for a large table. The veneer is sent to the cabinet-maker, by the veneer manufacturer, rough upon both sides; nor does it assume the beautiful polish so ornamental to good furniture, until the whole operation of laying on the veneer is completed, an operation which requires great skill, and time, and care.

Inlaying is a species of veneering. A pattern is to be followed; so the material is cut up and arranged either in scrolls or according to the design required.

Marquetry is another form of inlaying, the difference being that woods of a variety of shades and colours are employed, and formed by a skilful workman into a landscape or picture of some sort. Originally the woods used were always self-coloured. Of late years dyed woods have been introduced, and that, too, with great economy, and no loss of beauty.

Buhl-work comprises the use of various ornamental materials, such as metal, ivory, tortoiseshell, &c., all of which are in this branch of the art, employed as inlaying materials, or to be inlaid upon with coloured woods. The designs now used in buhl-work are usually lines or bordering.

Parquetry is a coarser kind of buhl-work, made serviceable for flooring, and of course executed in a bolder style.

HOME GARDENING.

THE VEGETABLE GARDEN.

THE chapters hitherto given on the subject of gardening must be regarded as merely preliminary. We shall now take up in order, and describe in detail, the three great divisions of the garden, as comprising vegetables, fruits, and flowers. Of these the vegetables claim our first attention, because of their constant use as articles of diet, in which respect they occupy a more prominent position

than fruits, and are even more necessary than animal food.

We shall commence with the formation of the kitchen garden, a topic which involves a variety of considerations, among others the situation, exposure, aspect, extent, shelter, shade, soil, water, form, &c. The *situation* of a kitchen garden is very important. It should be as near the dwelling-house as is consistent with convenience. If possible, it should be either to the back or at the side of the house, but never in front, as, independent of its appearance, the necessary garden operations would be at times unpleasant. It frequently happens that gardeners are guided by circumstances; but, if possible, low situations and the bottom of valleys should be avoided, as, in the first instance, there is a natural sourness in the soil that cannot be removed; and, in the second, there is liability to damps and fogs, which are very prejudicial to plants, in spring evenings, by moistening the young tops, and exposing them to injuries from frosty nights, which often succeed them. Neither should the situation be so high as to be exposed to boisterous winds, which are equally hurtful; but a situation between these extremes is the most desirable.

The next consideration is *exposure*. The garden should not be surrounded by close woods or plantations, because a foul stagnant air is frequent in such confined situations, which is very prejudicial to growing plants, but should be open and free, to admit the sun and air, with an inclination of the ground of about one foot in thirty.

The *aspect* is another consideration of great importance in the laying out of a garden; it should lie to the south-east if possible, but there is no objection to its being a point or two more to the east, as the sun will still be upon it soon after rising, and its influence will increase regularly as the day advances, which will be found to have a very beneficial effect in dissolving hoar-frost.

When the sun is excluded from a garden till ten or eleven o'clock in the morning, and then darts upon it with all its full heat derived from considerable elevation, the aspect is bad; the powerful rays of heat melt the icy particles at once, and, acting upon the moisture thus created, scald the tender tops of the most delicate plants and greatly injure them. The covering of the hoar-frost is otherwise particularly preservative to vegetables from frosty winds.

In respect to the *extent* of a garden, but little can be said, depending as it does either upon the demands of the family, or the amount of land actually at disposal for the purpose. Few gentlemen's gardens in the country contain less than three roods, and sometimes they extend to ten or twelve acres. The farmer and cottager have generally small portions allotted in the most convenient part or corner of the homestead, in which they grow the most common kitchen garden crops, as potatoes, turnips, carrots, &c. For a family of four persons (exclusive of servants) a rood is about enough, and so on in proportion, allowing it to be larger rather than too small. In order to bring the produce of the soil to perfection, the garden should be sheltered from the east, north, and west winds by hills and rising ground; but these should be at such a distance on all sides as not to prevent the sun's rays in the spring, when warmth is of immense value.

In the next place the *soil* of a garden is obviously of the greatest moment. This should be a moderately light mellow loam, and if mixed with silvery grit so much the better. It should not be of a binding nature in summer, nor retentive of an undue quantity of wet in winter, but of such a texture as may be worked at any season of the year. The soil of a garden should be at least eighteen inches deep; but if it be two feet so much the better, for when the plants are in a state of maturity, if the roots of most kinds are minutely traced, they will be found to penetrate into the earth in search of food to that depth or more, providing the soil be of such a nature as to admit

them. The very worst soil is a heavy clay, and the next a light loose sand; a moderate clay, however, is preferable to a very light soil, though not so pleasant to work, yet the former may be made good garden soil with a little trouble and expense, but the latter will require a good deal of both. It will very rarely happen that the soil is exactly suitable, inasmuch as it will either prove too poor, too strong, or too light, and in either case it must be carefully improved without delay; in the performing of which our readers must be guided by its nature, so as, if possible, to render it subservient to most general purposes. Hence our duty is to endeavour to hit on that medium which suits the generality of vegetables grown in kitchen gardens. If the bottom or subsoil be of a wet, cankering nature, judicious draining (which we shall describe in a future paper) is the most eligible means; but where the soil is stubborn, small gravel, sand, coal ashes, lime, and the like, are very appropriate substances to be applied, and will, if carefully and well worked into the ground by digging in the winter months, or indeed at all times when the ground is not in crop, soon bring it to a proper texture for most purposes. The ground should be laid in ridges, in order to give the greatest possible extent of surface for the weather to act upon. Where the soil is poor sand or gravel, clay or clayey loam, the scourings of ditches, which run on a clayey subsoil, pond-mud from a similar situation, or scrapings of roads which lie in a clayey district will be found great improvers; but all, or any of these, are of little use unless the ground be well worked and pulverised, which is of itself a very obvious improvement, and which, indeed, is applicable to most soils in proportion to their adhesive texture. Even free siliceous soils will, if not moved, soon become too compact for the admission of heat, air, and rain, and the free growth of the tender fibres of plants.

Our next consideration is *water*, a copious supply of which is essential to a good kitchen garden, it being necessary both to the commencement and progress of vegetation, as it is, so to speak, the vehicle which conveys to vegetables all the substances useful to their support, and without it no one will continue to vegetate; and if kept long without, the leaves will droop and assume a withered appearance; and for want of it many kitchen garden crops are lost, or the produce is of very inferior quality. From whatever source water is obtained, it should be conducted to, and reserved in, an open pond or basin, as near the centre of the garden as possible. The best plan, however, is to have a square tank built in the ground with bricks, which if composed over, will last for years, and may be kept constantly filled from a pump, by means of a sufficient length of hose (fitted to the spout) to reach from the former to the latter. Well water, recently drawn, is very improper for watering any kind of vegetable; yet if it has stood in a pond or basin until warmed by the sun's rays it may be used; but soft or rain water is much more conducive to vegetation. The garden should be situated near a river, pond, or brook, if possible, from which the water may be conducted to it by drains or pipes, being careful to lay them low enough to receive the water in the driest season, when it is generally most wanted.

Our next consideration is as to *form*, and none to our notion is more proper than a square or a parallelogram; but we decidedly give the preference to the former. Kitchen gardens are mostly, or should be, bounded by lines of walling, the chief reason for which is for the production of fruit, as a kitchen garden destined solely for the production of vegetables may be as well fenced by hedges as walls, and indeed, where hedges are good, they are more secure from trespassers. In laying out a kitchen garden with walls the principal considerations are as to height, aspect, construction, and materials, all of which we shall take into consideration in a future paper.

POINT LACE WORK.

THE longer we live in this world the more we find that there is indeed nothing new under the sun, and each successive day only brings us back to the works and devices of our ancestors.

It is even so with the employments, or rather amusements, in which ladies spend their hours of leisure from more important occupations; and the point lace, on which so much time was spent in days when it was used for ecclesiastical purposes, as well as for every orna-

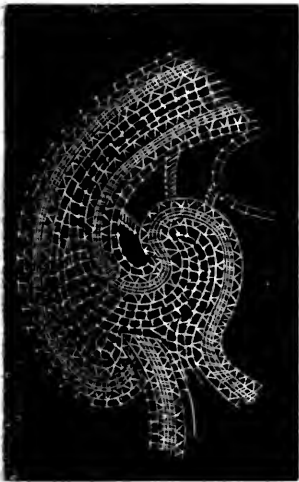

Fig. 1.

mental part of woman's dress, has again become a fashionable pursuit, many a female finger being now busy in imitating, although it cannot excel, the handiwork of those long since gathered to their fathers.

Innumerable are the uses to which this imitation of the old point lace may be made serviceable in a lady's dress, to say nothing of the ornamental articles of juvenile apparel, and the adornment of furniture, to which it may be applied. We therefore propose to dedicate a few chapters to this favourite occupation, and, to commence with, we present an effective but simply worked pattern, Fig. 2.

The materials required will be some tracing linen, which can be purchased at a good stationer's, some *toile cirée*, green on one side, several yards (say a dozen) of point

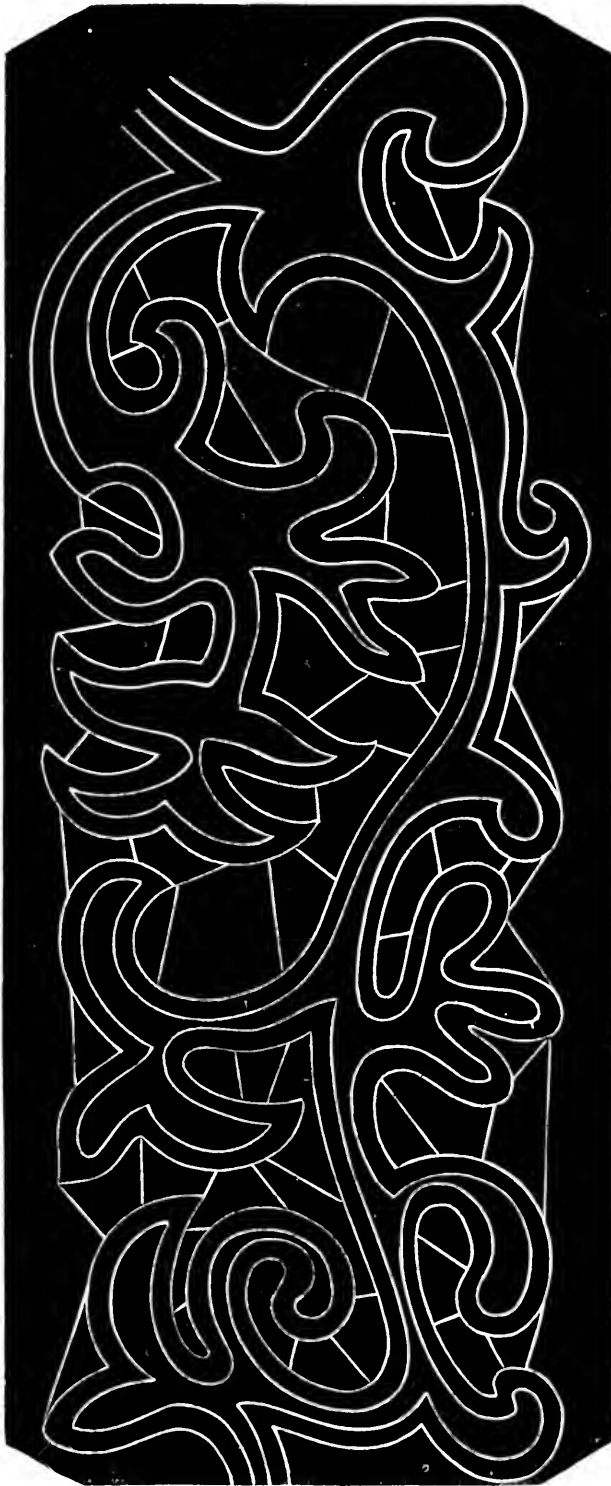

Fig. 2.

lace braid, some fine linen thread, and a large needle (No. 6). All these can be procured at a Berlin wool shop. The tracing linen must be cut about half an inch larger than the design, and kept quite flat and very steady while the pattern is traced off with pen and ink upon it; next, a piece of the *toile cirée* should be cut to the same size exactly, and the linen with the design closely tacked to it all round the edge, so as to ensure the flatness and firmness of both.

The braid employed may be of two kinds, the plain, with an open edge, *a*, or one with a round opening at intervals in the centre, *b*, Fig. 3, giving a



Fig. 3.

Fig. 4.

more decidedly lace-like appearance to the work. To avoid joining, which is very important, the braid should be wound *double* on a card, leaving the two ends to commence the work with; by this means cutting is avoided. The braid must be carefully sewn on with middle-sized reel cotton, taking the stitches (of which there should not be too many) quite through both linen and *toile cirée*, and following the design in all its meanderings as exactly as possible. In those parts where the leaves are pointed, great care should be taken to keep them as flat as possible at the point, and the braid should be

folded and kept to the shape, in turning it, with much nicety.

When the whole design has been braided, the outside edge of the braid has an open stitch worked into it, which we will call the "open over-cast," and it is thus accom-

plished:—With the fine linen thread the needle must be passed through one of the openings in the edging of the braid, as if for over-casting, but the stitch must not be drawn tighter than is required to make it about the same size as the edging of the braid, then the needle being passed through the single part of the stitch, still in the manner of over-casting, the thread is drawn tightly and fastens the stitch; this must be repeated in every second or third loop of the braid-edge, and forms another edging upon it, which greatly improves the work. This double over-cast is repeated on the inside of the braid, and each leaf and open part of the design is filled up with a succession of rows of this stitch, which need *not*, however, be done with great preciseness in the filling up, as a slight irregularity in the size and tightness rather adds to the *genuine* appearance of the point. Care must, nevertheless, be taken that the work be close enough to secure the braid in the pattern traced, as this will be found of great importance when the threads at the back of the design are cut away at the last. The details of the work are shown in Fig. 1.

With this open over-cast a great deal may be done towards making the braid lie well to the pattern; in the curves, for instance—where the inner edge will naturally be slightly fuller than the outer, or *vice versa*—by omitting one or two stitches of the open-work, in one case, or putting two stitches into one, in the other, it will be made right. The bars, Fig. 4, joining the various parts of the design are done when all the filling up is completed. To make them, the needle with the fine thread, after being darned in and out of the centre of the braid, to make the end secure, is brought out at the edge and passed across and across three or four times to the opposite opening, and upon these threads, thus made up, a close plain over-cast is worked. On reaching the end of the bar, the thread worked with may be fastened off in the braid, or carefully darned along it until the next bar is reached. In those parts of the design where the braid on the one side comes very near to that on the other, it will not be requisite to work the double over-cast on the inside edge, but the two inner open edges of the braid on each side may be drawn together by passing the needle from one to the other.

It is almost needless to add that in the braiding *only* must the needle be taken through the linen, &c., all the rest of the work must be done on the surface, and care must be taken not to catch up the linen with it. To prevent all chance of this, and also to avoid splitting the thread, it will be found advisable to work as much as possible with the head of the needle and not with the point. The threads of the braiding must be cut when all is finished, and the work taken off with the greatest care. The braid not having been cut off, the design may be continued to any length required, as it will be found that the end of the work, when detached, will correspond with the beginning of the design, and can then be proceeded with as at first.

Some persons trace out the design for point work on pink glazed calico, and, before braiding, sew it down on a piece of strong paper. The pink colour enables the worker in some instances to see the pattern more easily by gas-light.

In our next paper on this subject we hope to give directions for some open stitches, so as to vary the filling-in of the leaves, and also a slightly different mode of working the bars.

DOMESTIC MEDICINE.

RELAPSING FEVER.

THIS is a disease suggestive of extensive destitution. It often occurs in populous towns. It differs from typhus in being not at all fatal, and in the fact that the sufferers are liable to relapse. After being ill for a week, they

seem to be getting pretty well for another week, and then they have a return of all the symptoms. Like typhus it is very contagious, and seems to affect nearly all the members of the poor homes in which, for the most part, it occurs.

The symptoms are shiverings, headache, muscular pains followed by fever, rapid pulse, thirst, pains in the epigastrium, and vomiting. Blood-stains like bruises may appear, but there is no proper eruption. There is considerable prostration. On the fifth or the seventh day there is great improvement, till about the fourteenth, when the patient relapses. On the third or fourth day after this, the patient again improves and gradually gets well. The disease is seldom fatal.

The patient should be isolated or sent to the fever hospital. Little treatment is required, other than simple nourishing food and rest in bed.

HOOPING-COUGH.

This disease is like the diseases discussed in our last papers in two respects: it is intensely contagious, and it seldom occurs more than once. The main features of it are very palpable and very familiar. It is from time to time extensively prevalent throughout the country.

Hooping-cough generally begins with symptoms of a common catarrh or cold, such as sneezing, cough, and feverishness. After these symptoms have lasted for about a week, the cough begins to show the peculiar characteristics of hooping-cough, which may be said to be two: first, *it is paroxysmal*—that is, *it comes on in severe fits*, with intervals of comparative freedom; secondly, *it is attended with a hoop*. In the majority of cases the paroxysms or fits of coughing are worse in the night. There is every variety in the severity of the symptoms of cold which usher in hooping-cough. They may be quite mild, or they may be very sharp.

The peculiar character of this disease is the *hoop*, which we shall try to explain. It arises from the spasmodic closing of the upper part of the windpipe. The child affected with hooping-cough, at the end of a fit of coughing severe and prolonged, is apparently in a state of impending suffocation. The air has been all, or nearly all, expelled from the lungs by the successive acts of coughing. The face is red or blue; the nose, or any part of the mucous membrane of the head or chest, may bleed; and the whole frame seems shaken and terrified. To all appearances the child is in extremity for want of air. The only comfort is that, as a matter of fact, here, at least, when matters are at their worst they mend. Just when the child seems on the point of suffocation, it draws in a long breath through the closed *glottis*, or upper part of the windpipe. It is the passage of air through this narrow chink that gives rise to the sound with which we are all so familiar. This, so far from alarming us, may reassure us that air is getting in where it is badly wanted. The fit of coughing may now terminate, but generally it begins again after the hoop, which is again followed by a number of short, hurried coughs, until some glairy phlegm is coughed or vomited up, and the child breathes again like other people.

Occurring in its simplest form, hooping-cough is a nervous or spasmodic disease, coming on in fits of coughing, and leaving the patient in the interval pretty well. But it is seldom that it is altogether so simple as this, and we may specify two or three ways in which the disease is apt to be complicated.

First, the child is apt to have inflammation of the chest. Generally there is more or less of bronchitis; but in a considerable number of cases there is a good deal of bronchitis, which alters the character of the cough, and which may be known by feverishness, quick breathing, wheezing sounds, and the other symptoms which we have described under the head of bronchitis. Bronchitis alters the sound of the cough. After a day or two it prevents

the hoop. As the bronchitis subsides the hoop returns. If the child is of a healthy constitution, the probability is, that with proper treatment the bronchitis will terminate favourably; but it is an important complication, requiring good medical judgment. Inflammation of the lungs itself may occur, and may be known by similar symptoms to those of bronchitis, and especially a very hot skin.

Another complication of whooping-cough is *convulsions*. They may come on suddenly, or be preceded by drowsiness. They are more apt to happen in teething children, or in children of a certain delicate constitution, characterised by a large head, large stomach, small limbs, late teething, late walking, &c. Frequent vomiting, occurring independently of fits of coughing, in connection with any tendency to convulsions, is a serious symptom.

Another effect of whooping-cough sometimes causes anxiety—a great loss of flesh and flabbiness of the child. This occurs often quite independently of serious disease, probably from weakness and exhaustion, consequent on the harassing nature of the disease. If this loss of flesh concurs with a feverish temperature of the body, it is more serious than when the body is cool.

Treatment.—There are few diseases for which more various remedies have been prescribed than whooping-cough, from which we may learn that it is a difficult disease to treat, or make any very favourable impression on. Only in very simple cases would it be right to trust to domestic treatment—that is to say, in cases where the fits of coughing are not very severe; where the patient is little thinned by the disease, and breathes well in the intervals of the fits. In these cases a few simple remedies may be tried. Amongst these a very safe remedy is Roche's embrocation. The following is the recipe for compounding this famous, though somewhat dear, liniment:—

Olive oil	1 part.
Oil of cloves	$\frac{1}{2}$ part.
Oil of amber	$\frac{1}{2}$ part.

Among internal remedies that may be tried are alum. Three or four grains may be given to a child a year and a half or two years old every four or six hours in water. It is most likely to be useful in cases in which there is a great accumulation of phlegm, and in which the skin is cool. Another valuable remedy is dilute nitric acid, in the following form:—

Dilute nitric acid	1 drachm.
Spirits of nitre	2 drachms.
Simple syrup	$\frac{1}{2}$ ounce.
Water	6 ounces.

A child five years old may take a table-spoonful every four or six hours in as much water, according to the frequency of the cough. Younger children can take one, two, or three teaspoonfuls every four or six hours.

During the actual fit of coughing let air be admitted freely to the child, whose mouth should be kept clean. Everything tight about the dress should be removed. For the emaciation which is apt to occur in whooping-cough a little cod-liver oil is a good remedy. A teaspoonful night and morning to begin with, increasing the dose gradually.

Supposing all other remedies to fail, a change of air is a most powerful one, and often cures the disease. In all cases, as recovery begins, it is a valuable means of restoring the child to complete health. In moving about with whooping-cough, or any other infectious disease, it is not only in accordance with the requirements of the law, but with those of common sense and consideration, that all possible precautions be taken not to carry the disease to other persons.

The diet of a child suffering from whooping-cough should be simple, unstimulating, and nourishing; milk, especially, is good.

If symptoms of inflammation of the chest set in, the case is, of course, past domestic treatment, and therefore need not be further discussed.

MUMPS.

Here we have another disease that may seem very different from the eruptive fevers we have discussed, and yet has many points of resemblance. It is often epidemic; it is very infectious; it seldom attacks persons more than once in a lifetime; it is seldom propagated except by infection—that is to say, by communication with some other child or person who has had the disease. It is like the fevers in another respect—that it is attended for a time with smart feverishness.

The disease consists essentially in a kind of inflammation, rather an enlargement, of the large gland, called the parotid, which lies between the jaw and the ear; the other glands under the jaw and under the tongue are likewise sometimes affected. Every swelling of these glands must not be called mumps, but the name must be restricted to that large and painful swelling which occurs in the above situation, and which affects a great number of persons at one time—in other words, is contagious. The swelling is tender and painful, and has a bruised feeling, and renders the jaws stiff; the tongue is white, and the patient generally feverish and unwell. As the saliva which moistens the mouth and food proceeds mainly from the gland affected, the secretion of it is often much lessened, causing the mouth to be dry, which adds farther to the difficulty in chewing occasioned by the stiffness of the jaws.

As a general rule, the older the patient the more painful is the mumps. The disease is most common in children over five years. It is not very serious in itself, for it has a strong natural tendency to get well in seven or eight days, leaving the patient somewhat pale. But there is a peculiarity about the disease that sometimes adds to the danger of it, and greatly to the alarm or pain that it occasions. The brunt of the disease may be more or less suddenly transferred from the parotid gland to other parts, especially to the breasts in girls or to the testicles in boys. This change is shown by severe pain and swelling in those parts, and a rapid subsidence of the swelling between the jaw and the ear. Sometimes the transference of the disease is to the head, which then gives rise to nervous symptoms, drowsiness, or delirium. Occasionally the swelling at the angle of the jaw has not made much impression on the patient or his friends, and may quickly disappear, so that the swellings in other parts, or the nervous symptoms, are the first things noticed, and may occasion a greater alarm than if they occurred in clear connection with mumps. Still, these cases are very exceptional, and mumps generally is not a dangerous or serious disease, though a painful one.

Treatment.—Though the disease tends to subside in a few days, like most other diseases, it is the better for a little judicious medical treatment. If the case is acute and severe, a medical man should be sent for. In cases which are simpler, or advice is difficult to be got, the following measures will tend to help the patient, and diminish the pain. Poppy fomentations should be used frequently to the swellings—three or four times a day; after using these, a warm piece of flannel should be applied to the part. The following mixture may be given to children at or about five years old:—

Chlorate of potash	1 drachm.
Tincture of perchloride of iron	24 to 36 minims.
Simple syrup	$\frac{1}{2}$ ounce.
Water	6 ounces.

Mix thoroughly, and take one table-spoonful every four or six hours.

The diet of the patient should be simple, and such as can easily be swallowed, as milk, broths, beef tea, &c., and the like.

ANIMALS KEPT FOR PROFIT.—CATTLE.

I.—THE VARIETIES AND BREEDING OF CATTLE (*cont.*).
 PASSING from the dairy to what must be called rather the flesh-producing breeds, the first place, after the Shorthorn, must be given to the *Hereford*. This breed is characterised by an almost invariably red colour, with a white face. It has lately been much improved, and now almost equals the Shorthorn in size and early maturity; while many think the quality of the meat is a shade superior. As milkers, however, the cows are decidedly inferior.

The *Devon* is a smaller breed, and was a great favourite with the late Prince Consort. The horns are rather long, and turned upwards. Like the Hereford, the pure breed is inferior for the dairy, but fattens well, and produces meat of very juicy quality. It has, however, another recommendation to very many parties: being remarkably

The *Galloway* is a somewhat similar breed, but of the polled or hornless tribe, and the hair is smoother, and not so long as in the West Highland; the animal also attains a larger size. This must be described as one of the very best built and most symmetrical of all our breeds of cattle. All is beautifully compact, with a broad and straight back which cannot be surpassed.

The *Angus* is also a polled breed, and the largest of all the Scotch varieties. It is of a black or sometimes red colour, and of very great fattening capacities—perhaps, indeed, a cross between the Angus and the Shorthorn produces the very best animal for the feeding-stall which is possible to be had. The pure breed itself has, however, been very much improved of late, and has come into much notoriety since Mr. M'Combie's black ox distanced all competition at the Birmingham Show of 1867, even Herefords and Shorthorns failing to equal this noble

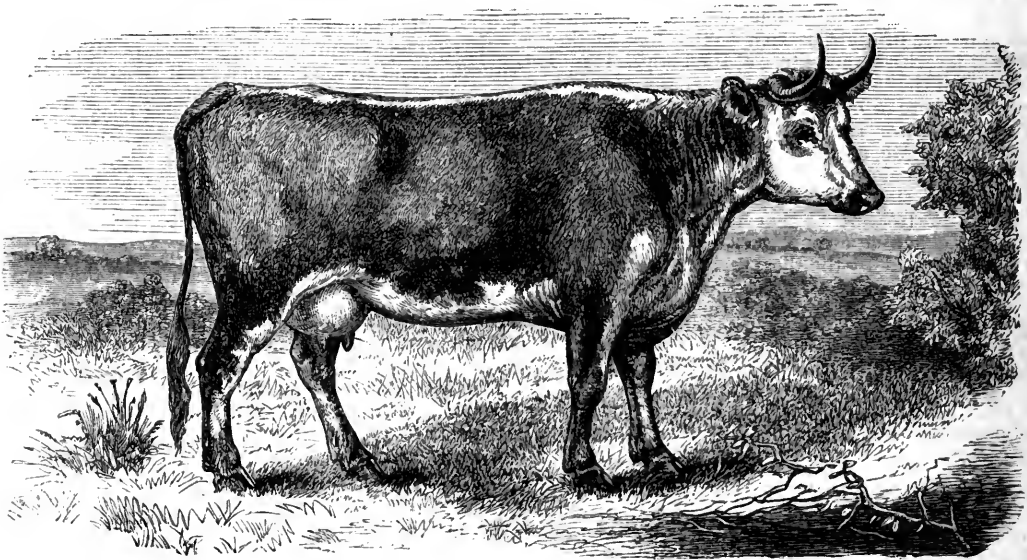

HEREFORD COW.

light and active, it is more than any other breed suitable for *farm work* on light land, and in many places the oxen are accordingly worked in harness till five or six years old, after which they are fattened, which process is very readily accomplished, the bones being small and fine. On light soil, two Devon oxen will do as much work at the plough as one horse, but its lighter make is unsuitable for working on heavy land.

The colour of the Devon is red or bay. Although, as we have hinted, inferior in point of quantity of milk, what there is of it is of unusual richness, so that the cow will yield much more butter than might be supposed. A Devon cow, crossed with a Shorthorn bull, generally produces a cow excellent for milking, with a good tendency to fatten when dried.

The *Sussex* breed much resembles the Devon, but it is larger and coarser; hence the oxen are better adapted for labour on heavy land. Many prizes have lately been awarded to this breed, which is gaining ground as a meat-producer.

The *West Highland* or *Kyloe* breed is largely reared in Scotland, to be driven south, and fattened for the English butcher. They are symmetrical animals, especially the bulls, very hardy, and their meat is of fine quality. The colour is generally black, but sometimes reddish or dun, and the hair is long and shaggy. The cows do not yield much milk, but it is of a very great richness.

animal. It does not seem, however, to do so well in England as in its native climate.

There are numerous other breeds, sub-varieties, and crosses, but which scarcely demand special attention; and we conclude this article with a few practical remarks of a general character.

We have endeavoured to give, shortly, the usual qualities of the principal breeds; but it will be easily understood that different individuals of the same race may vary greatly in their milking qualities. Yet, while this point may make all the difference, how very seldom it is investigated. One cow will give twelve quarts at a milking, while another of the same breed may only give six. Very likely the price of each animal will be the same, while the return is widely different.

When the parentage can be traced, it is generally safe to buy a cow which comes of a good *milking family*—that is, if the dam is a good milker, and the sire also bred from a good milker, it is many chances to one the animal herself will be valuable in the same way, and it is surely worth some trouble to ascertain. Great consideration must, however, be given to what the cow is wanted for. If it is intended to sell milk, animals must be kept which will give the largest quantity; but if butter be the object, this rule may lead to disastrous mistakes, for eight quarts of milk from one cow will yield more butter than twelve quarts from another. Again, the milk of some cows will make

good butter, but very bad cheese, and all these circumstances should be taken into account.

Generally speaking, the hind quarters of a good milking cow are much heavier than the fore, and, according to many careful and scientific observers, the spinous processes of the lumbar vertebræ generally bend well forward, so as to leave a good space between the last spine and the sacrum. The udder also should be long and wide, but not too deep (which shows debility), and it is very important for *all* the teats to be able to pass milk without difficulty. Dealers sometimes affirm this is no matter, but the fact is, that each teat is the outlet of an entirely distinct and separate secretory organ, so that a faulty one is equivalent to the absolute loss of its due proportion of milk.

But probably the best criterion of a good milker is that pointed out by M. Guenon, which consists mainly in the appearance of the hair on the animal's buttocks. The

Farmers generally prefer to buy young cows when in calf, but in commencing a small family dairy it is less trouble, when possible, to obtain the animal after her calf has been separated. When old, the most profitable plan is to dry her, fatten her in her own stall, and sell her for immediate slaughter; she will then often realise nearly her original value; but if this cannot be done, some pounds loss on this head is of course inevitable. It is in connection with this point that the importance will be seen of selecting a breed which has a good tendency to fatten, such as the Shorthorn; for while a bony, angular, lean-looking cow will often give a good quantity of milk, if she will not fatten when finally dried, there must be a considerable loss on her sale, which might have been avoided by a better choice.

If stock are bred for home use, the same reflection must be carried through all the operations. Breeding pure

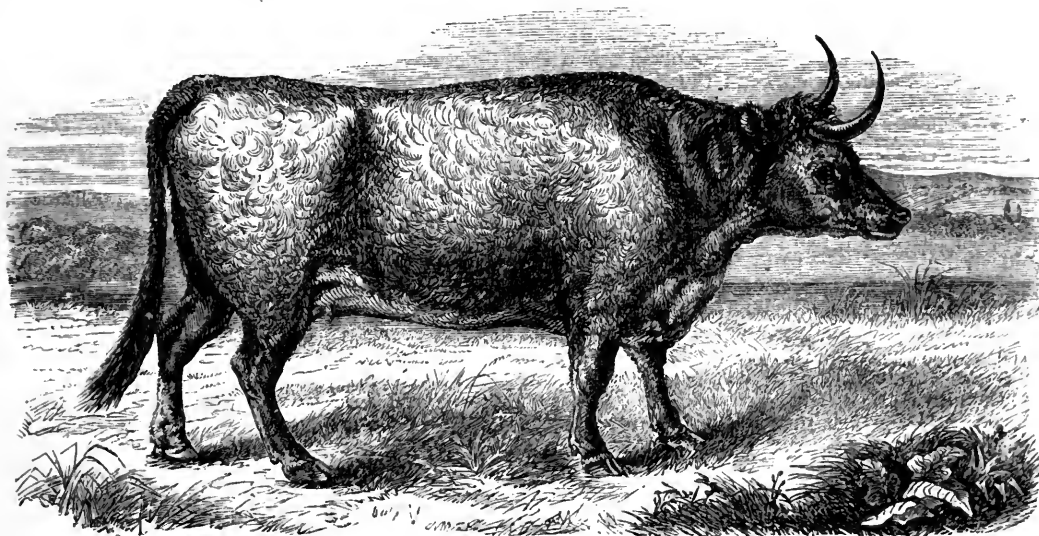

WEST HIGHLAND COW.

coat in this locality grows partly upwards and partly downwards, producing at the juncture a ridge or fringe of hair which is called technically the *escutcheon*. Now supposing that in different cows other characteristics appear equal, observation proves that in nearly every case an animal with a large escutcheon is a better milker than a cow with a small one.

The veins called "milk-veins," which run along the belly, are not really connected with the supply of milk at all, but it nevertheless appears in practice to be of importance that they are large and well developed. Professor Gamgee also insists on the importance of the network of veins on the fore-quarters of the udder itself, being large and conspicuous, which is generally seen on a good milking cow.

After all, it is sometimes found that a cow, bad by nearly every rule, turns out a capital milker, so that we again insist on careful inquiry or observation of the parentage. Disposition also is a great point to notice, the best animals being always quiet and contented.

A cow is in her prime after her second calf, and remains profitable to the age of six or seven years. The chief means of judging the age is by the horns, which form a fresh ring at the root every year; but only the third year's circle is obvious to ordinary inspection. After six or seven years the produce rapidly diminishes, so that it is very important to get rid of the animals when they reach that age.

stock is a science of itself, and even its bare outlines could not be given in our limited space. Success in this pursuit is always the reward of sound judgment in the liberal expenditure of capital, but requires both. For ordinary purposes, however, cross-breeding generally yields most return in both beef and milk; but even here it is very important to get the service of the very best pure-bred bull that can be managed, especially if he be a Shorthorn. It is the *first* cross that always yields the best results, and breeding between the mongrels always deteriorates the stock. By putting the best half-bred animals, however, the second time to the *pure-bred* males, very magnificent animals are often obtained, and by perseverance in this way, hiring the service of a pedigree bull, a splendid herd may often be formed at very moderate expense, and capable of transmitting its own good qualities to other animals.

In breeding for the growth of beef, it is best to choose a cow, whatever the breed, with a large, roomy frame, capacious pelvis and ribs, and fairly *good* milking qualities, that the calf may have room to grow, and plenty of nourishment after birth. With these conditions the breed matters little; but the bull should be the very *best* that can be had of some pure-bred strain, that he may stamp his own valuable qualities on the progeny; and on the whole the Shorthorn or the Hereford will generally give most satisfaction in this respect.

In breeding for milking stock some attention should also be paid to the quality of the bull's strain in point of beef, but the milking powers of the mothers are the chief things to be considered. So completely is this usually neglected, that in nearly any district a vast improvement may be effected by a cross with a good bull; but so far as milking only is concerned equal progress might be made in a few years by the simple plan of selecting exclusively the calves of *the best milking cows*. Often the produce might easily be thus doubled, and it is matter for amazement that so simple a means of increasing wealth is not universally followed by the small farmers of Great Britain, whose means will not allow the purchase of high-priced, pure-bred animals.

ODDS AND ENDS.

Red Ink.—Take of white wine vinegar one quart, powdered Brazil-wood two ounces, and alum half an ounce; infuse them together for ten days, then let them gently simmer over a slow fire, after which add a good half ounce of gum arabic. When the gum is dissolved strain the mixture and bottle it for use. Ink thus prepared will keep its colour for many years.

Violet Ink.—Boil a good quantity of logwood chips in vinegar, and add to the mixture a little alum and gum arabic. The depth of the tint may be modified by varying the proportions of logwood and vinegar.

Black Ink.—Heat a quart of rain water till it almost boils, and then put into it two ounces of green copperas; when cold strain it, and add to the liquor five ounces of powdered galls and two ounces of loaf sugar. This ink keeps its colour well.

Paste for Moulding.—Melt some glue in water, and let it be tolerably strong. Mix with this whiting until it is as firm as dough; then work it into the moulds, which must be previously oiled.

Polish for Marble.—Melt over a slow fire four ounces of white wax, and while it is warm stir into it with a wooden spatula an equal weight of oil of turpentine; when thoroughly incorporated, put the mixture into a bottle or other vessel, which must be well corked whenever not in use. A little of the above is put upon a piece of flannel and well rubbed upon the marble. *Another.*—Fine rotten-stone, with olive oil, rubbed upon the marble till the desired lustre is attained.

Polish for Furniture.—White wax and oil of turpentine, as in the directions for polish for marble. A small quantity applied with flannel or other woollen cloth, and well rubbed, is excellent for mahogany and walnut. If it is desired to give a yellowish tint for light coloured wood, the turpentine should have infused into it for forty-eight hours before mixing, a small quantity of quercitron, or dyer's oak. To give it a reddish tinge a little alkanet may be used in the same way as the quercitron.

Gregory's Powder.—Half an ounce of ginger, one ounce and a half of rhubarb, four ounces of calcined magnesia. Mix. Dose: from twenty to thirty grains. Stomachic, antacid, and laxative.

India-rubber Varnish for Boots.—Dissolve half an ounce of asphaltum in one ounce of oil of turpentine, also dissolve quarter-of-an-ounce of caoutchouc in two ounces of mineral naphtha. The two solutions are to be mixed before application.

Opodeldoc.—Opodeldoc and soap liniment are the same thing. It is a popular external application for local pains and swellings, bruises, sprains, and rheumatism. There are several ways of making it. One recipe is: one ounce of camphor, five ounces of Castile soap, one dram of oil of rosemary, one-and-a-quarter pints of rectified spirits of wine, and one-and-a-quarter pints of water. This requires to digest for a week and to be occasionally stirred. When ready, filter and bottle for use.

INMATES OF THE HOUSE.—LEGAL.

VI.—RIGHTS OF CITIZENSHIP.

In the last paper an attempt was made to describe the way in which rates are assessed upon householders. In the present paper, it is proposed to give some account of the rights conferred by payment of rates, and of those other rights which belong to a citizen.

Electoral Rights are the highest, seeing that the exercise of them gives a man a share in the government of the country. Until the Reform Act of 1832, the representation of the people was most imperfect, the distribution of seats being wholly out of proportion to the numbers that ought to have been represented, and the power of voting being for the most part confined to those few whose supposed interest lay in returning members opposed to the popular aspirations. In the counties the wealthy landlords returned members of their own body, and in the towns the franchise was vested in the hands of those whose supposed interest lay in siding with the landlords. After domestic troubles and domestic dangers which at times threatened the very existence of the constitution, the Government in 1832 was induced to carry a Reform Bill which materially altered the relative position of classes, and gave a new life to the political institutions of the kingdom.

Between the year in which certain members were added to the House of Commons by Queen Elizabeth, and the year 1832, no change took place in the numerical strength of the popular assembly, and the distribution of seats also remained *in statu quo*. But by the Act of 1832—which was not passed without great difficulty, and until after the ministers, having resigned, were induced by the king to return on condition that they might create peers enough to pass the Bill—many important changes were made. The number of members in the House of Commons was placed at 660; fifty-six boroughs in England were disfranchised; thirty were reduced to one member only; twenty-two new boroughs were created to send two members; and twenty to send one member. The number of county members was increased from 95 to 159 for England and Wales. The qualification of a voter for the county was, that he should have a forty-shilling freehold; but copyholders of £10 a year, lessees of leases for twenty years to the yearly value of £50, and of leases for sixty years to the yearly value of £10, were also admitted to vote. In cities and boroughs resident householders paying £10 of rent were allowed the franchise.

Several attempts were made, beginning with Lord John Russell's Bill in 1854, to improve upon the electoral basis laid down in this Bill; but no decided action was taken till 1865, when Mr. Baines' £6 Borough Franchise Bill was discussed and thrown out. From that time till 1867 the question of reform was warmly debated, and in 1866 led to the resignation of Mr. Gladstone's Government. In 1867 Mr. Disraeli's Bill was introduced, and after much debate passed, receiving the royal assent on the 15th of August of that year. Of this Act we will give as succinct a summary as possible. It is divided into three parts:—

I. **FRANCHISE.**—*Boroughs*: All householders rated for relief of the poor; lodgers, resident for twelve months, and paying £10 a year. *Counties*: Holders of property of the clear annual value of £5, and occupiers of lands or tenements paying £12 a year. At a contested election for any county or borough represented by three members, no person to vote for more than two candidates; in London to vote for three only.

II. **DISTRIBUTION OF SEATS.**—Boroughs with less than ten thousand population to return one member only. Manchester, Liverpool, Birmingham, and Leeds to have three members each instead of two. Certain new boroughs were created, a representative was given to the University

of London, and the members taken from petty boroughs (with populations of less than ten thousand) were given to the new constituencies, and to supplement the number of members in boroughs not yet adequately represented.

III. SUPPLEMENTARY PROVISIONS included arrangements for ascertaining the boundaries of electoral districts by means of boundary commissioners, who were required to determine on inspection the limits of particular districts; for the registration of voters on the basis of the list of ratepayers, and for increasing, where necessary, the number of revising barristers—officers created by the Act of 1832 for the purpose of scrutinising the names on the register, and striking them off or allowing them after complaint heard and determined. It was also provided by this Act that Parliament should not be dissolved on any future demise of the Crown; and that members holding offices of profit from the Crown, need not vacate their seats on acceptance of another office.

By this Act "household suffrage, pure and simple," the passing of which had been looked upon as an impossibility, was established. The manner in which the compound householder was abolished under this Act, and restored by the present Government, was described in the last paper.

It remains only to observe that the franchise is given to all male subjects of the Queen satisfying the conditions stated in the Act, without reference to rank or creed. The disabilities which at one time attached to persons professing certain religious beliefs have been abolished, and there is now no impediment in the way of either elector or candidate for the post of member of Parliament. In 1829 the Roman Catholic Emancipation Bill was carried, and persons belonging to the Church of Rome were relieved from all those disabilities which had hitherto debarred them from seats in the Legislature, commissions in the army or navy, and from any post under Government. In 1828 Dissenters received a like measure of justice, and in 1859 Jews were allowed—the oath of abjuration having been altered—to sit in the House of Commons.

Freedom of Conscience, that is to say, freedom to profess and exercise any religious belief, has, since the dates above mentioned, been accorded to all persons, whatever their creed may be. The sovereign is by the Act of Settlement precluded from being anything but a Protestant, but all subjects, from the highest to the lowest, may profess what they think fit, so long as their religion does not in practice violate the laws of the land, *e.g.*, require them to offer human sacrifices. There is nothing to prevent Jew, Christian of whatever church, deist, or atheist from practising rites or neglecting rites; the utmost freedom of conscience prevails, and is secured by Acts of Parliament. A very few disabilities remain. The church patronage of Roman Catholics is exercised for them by the Universities, and the House of Lords still requiring its members to swear "on the true faith of a Christian," is shut to Jews; the admission of Nonconformists of whatever kind to fellowships and part in the government of the universities is also awhile delayed; but even these disabilities, especially the last, are likely to disappear.

Freedom of Speech follows naturally upon freedom of thought, but it has at all times been more circumscribed. The tongue is a little member and boasteth great things. It has been found absolutely necessary to restrict its operation by laws of slander and libel, but within these laws the tongue has free ambit. This privilege has been one of gradual growth, and one which has not been won without the most sustained and strenuous exertions. Slander is an injurious speech spoken; libel is an injurious statement written. The basis of the law in either case is the maxim that no one shall use his freedom to another's hurt, and if he does, the injured man shall have his remedy against the injurer. Thus it is legally slanderous, and therefore actionable, to say anything of a man

that shall put him in peril of the law, as to accuse him of some crime, to say he has committed murder or felony; to say that which is likely to exclude him from society, as to report that he has an infectious disease; anything that may injure him in his trade or profession, as to call a tradesman a bankrupt, a physician a quack, a lawyer a pettifogger, a judge corrupt. Mere abuse the law will not notice, as when a man is called a thief, a fool, or a humbug, but with no intention to impute actual theft or fraud; mere scandal, also, the law will not regard, unless special damage can be proved. In that case the person injured has an action. So that if a woman can show she has lost a marriage through an imputation of unchastity, or a man can show that he lost business through some one calling him a fool or humbug, the law will give redress. For the rest, however, the law says, "Hard words break no bones."

When injurious statements are written, the law looks upon them with great disfavour, and allows less margin than in the case of slander. People are not supposed to write in a passion, and words which if spoken might be excused on the ground of hastiness, assume a malicious complexion when deliberately written down. All matter actionable as slander is actionable as libel, and in addition all contumelious matter which tends to degrade a man in the opinion of his neighbours, or to make him ridiculous, is reckoned libellous. Some of the decisions have gone very far; thus, it was held libellous to have written of Lord Redesdale that he was a "stout-built special pleader," and of Lord Hardwicke that he was "a sheep-feeder from Cambridge;" but, as a rule, the limits of the law are narrower than these. It was held to be a libel when Colonel Calthorpe wrote of Lord Cardigan that the earl's horse at the Balaklava charge, "galloped off with him to the rear," under circumstances which made it apparent that the writer meant to say Lord Cardigan fled intentionally. To write of an officer that he is a coward is libellous, because that is injurious to him in his profession, but it is not necessarily so of an unmilitary person, *e.g.*, a clergyman. Certain matters are prohibited—by the laws of sedition and treason—from finding utterances either orally or in writing; and blasphemous statements are also forbidden as contrary to public morality, and derogatory to the honour of the Most High.

Bounded by these restrictions, which have been found salutary, the utterances, whether oral or written, of all British subjects are protected by the law, and may take place at the bar, in the pulpit, on the platform, through the press, or by manuscript communication.

Certain matters are privileged from the operation of the libel and slander laws, if good faith have been observed. Thus, in giving the character of a servant, defamatory words are privileged if spoken in good faith, but if malice can be shown, then an action will lie. Words spoken in Parliament are absolutely privileged, however injurious they may be, and words spoken by judge or counsel in the course of a trial are equally covered.

Till within a few years, it was not allowed to plead in defence on an action for libel that the matter complained of was true. The courts held that "the greater the truth the greater the libel," and directed the jury that the statement being true was no justification to the defendant. Now, however, such a plea if proved is valid, provided, also, it can be shown that it was for the public advantage the libel should have been uttered.

The jury is now judge of whether the words complained of come within the meaning of libel as defined by the court. Formerly the court adjudged a thing to be libel or no libel, the jury being only judges of whether the defendant used the words.

There are two ways of proceeding against a libeller—at the civil court by action for damages, or at the criminal bar by indictment with a view to fine and imprisonment.

COOKING.

KITCHEN REQUISITES.

IT may surprise many readers to learn that in France, which enjoys the greatest reputation for its throughout the whole of many extensive regions a simple wood fire, composed of logs lighted on the hearth, and supported at one or at each end by "dogs" (*chenets*), is made to cook most excellent dinners, not only of much variety, but even in places where numerous guests have to be provided for, as in inns and like establishments. A wood fire on the hearth makes capital roasts by means of horizontal spits turned by clockwork. The cauldron, supported on a tripod, or hung from the pothook—a complicated contrivance called a *crémaillère*—furnishes broths, soups, and boils vegetables. Stewpans at the skirts of the fire concoct dainty small side-dishes. The glowing embers, drawn on one side, serve to broil chops and steaks, and to make any sauce that is quickly dished up. Tarts and pastry, cakes and patés, are baked in the oven used for bread. Even in Paris, almost all the *rotisseurs*, who sell roast meat and fowls either whole or in portions, and who often also carry on the trade of *restaurateurs*, do all their roasting on horizontal spits before wood fires. Even where the fire is small in appearance, when it is kept up all day long, and the spit in front of it is never empty, it is astonishing what a quantity of food it can be made to cook in the course of twelve hours.

The great merit of the old English range is its capability of cooking large joints perfectly, roasts especially. In a baker's oven a large joint is spoilt; in the oven of a cooking-stove it is apt to be burnt, or unequally done. An open range, extensible at the sides, will roast anything well, from a spitfull of larks to a haunch of venison or a baron of beef. For a numerous household requiring few dishes and those solid—such as the twelve or fourteen pound pike boiled whole, the haunch of four year old mutton, the potatoes and greens, and the huge plum-pudding—the open range answered admirably. It has done good service in its day, and if circumstances induce us to put it on one side, we should be unjust not to mention it, although it was a great consumer of coals; also the circular swinging trivets at its sides often supplied excellent melted butter and first-rate mashed potatoes.

The open range is not a jack-of-all-trades, but it is master of several much-approved specialities. For instance, it admits of roasting with a jack and a spit, which makes the best of all possible roasts, especially with cradle or basket spits, which roast a joint without piercing it. With very little assistance the meat bastes itself, whereas with the bottle-jack there is a constant tendency to drain it of its juices, which no basting can completely remedy. The chimney of an open range requires frequent sweeping; but it is better to sweep it often than to have the contents of a frying-pan spoiled by a downfall of soot.

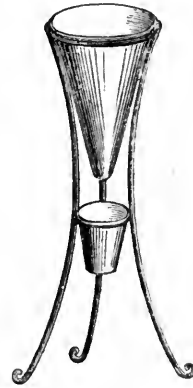

Fig. 1.

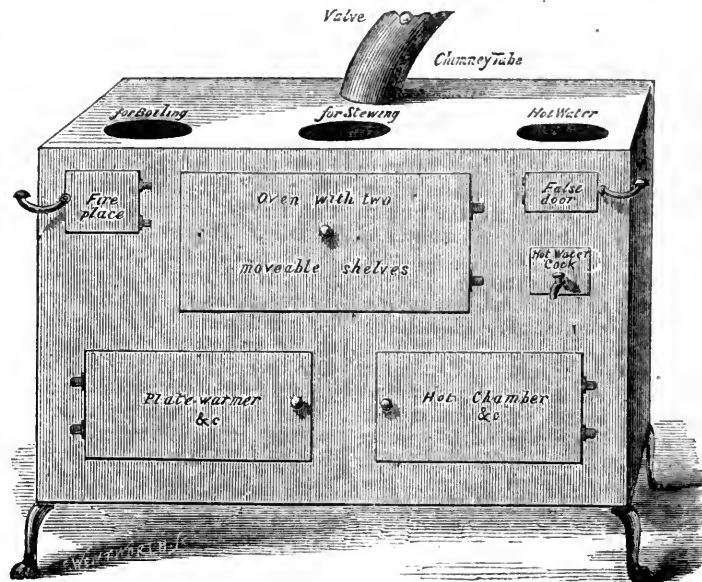

Fig. 2.

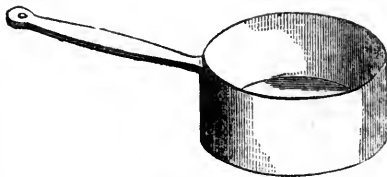

Fig. 3.

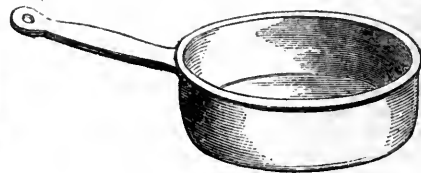

Fig. 4.

For middle-sized families of modest pretensions, who prefer comfort to show, and variety in their meals to monotonous abundance, the most useful apparatus is the cooking stove, of which there are different forms made both by English and foreign manufacturers. Amongst cooking stoves, the choice lies between one with an open fireplace and one with a closed or concealed one. Many manufacturers make both. We prefer a cooking-stove with a closed fireplace, for the following reasons:—

In a cooking-stove with an open fireplace, the fire, not extensible by movable cheeks, is not large enough to roast large joints. At the same time the consumption of coal is considerable; the larger fire engenders greater heat, which radiates both from the open grate and the iron surface of the closed stove. The ventilation certainly is good, but the kitchen is apt to be extremely hot.

With a closed fireplace, there is a great economy of fuel, and it roasts, *i.e.*, bakes, small joints and poultry nearly as well as before an open fire. A small stove of this kind will perfectly suffice for the wants of a small family, while its dimensions can be increased to suit a larger one.

On this page we give a sketch of a French *cuisinière*, Fig. 2, which is very convenient and serviceable. The kitchen chimney must be stopped

by a flat partition, with a hole exactly big enough to allow the chimney tube of the stove to pass. The draught through the tube is regulated by a valve. The tube is easily taken down, as it must be cleaned as soon as it begins to be choked with soot.

The stove shown in Fig. 9 is very convenient for broiling chops and steaks, but requires the use of charcoal, a few handfuls of which are spread beneath the gridiron, and lighted. In a few minutes the fire is ready

to do its work, and can be let out as soon as it has done it. This apparatus is usually placed near the main chimney, but a pipe from it can be carried outside through a hole in a wall or a window.

For outdoor cooking, as at picnics or on exploring parties, we recommend either of the *réchauds* or camp-stoves represented, especially Fig. 7. When of small size, Fig. 8, they must burn charcoal; if of larger dimensions, coal and coke will do. They are also useful in houses which have a back yard or court, when only a few small things are to be cooked, and it is wished to avoid lighting the kitchen fire, as in unusually hot and oppressive weather. They will heat water for tea or coffee, boil eggs, warm up soups or stews, fry chops, sausages, or omelettes, make sauces, and render good service by supplementing a cold dinner with sundry hot things. And, this being performed in the open air, all heat, smoke, and smell are avoided indoors.

Toasting is akin to roasting, and may be done (as with cheese and other articles that melt) in a Dutch oven, Fig. 5, or with a fork. Large forks should not be admitted into modern kitchens, where they only do mischief. Certainly, meat that is being boiled for broth or soup, may be pricked and its gravy let out as much as the cook pleases; but she will obtain her end better by having her soup, meat, and bones well divided at the butcher's, into pieces small enough for the boiling water to exert its action throughout their substance. But meat, fowls, or vegetables, that are to be served as "boils" in distinction to "roasts," should never be pierced with a fork or any other culinary utensil, until they are carved in their dish at table. The gravy which runs from them then, and the juiciness of the meat, will show the difference of their treatment.

Small joints, fowls, whole cabbages or cauliflowers, &c., may easily be removed from the boiler by a broad, flat ladle, pierced with holes, in one hand, and a long-handled kitchen spoon in the other. Large joints of salt beef, legs of mutton, turkeys, calves' heads, &c., should be tied with broad tape before putting in to boil. This will not only keep them in shape, but aid in getting them out of the

boiler (perhaps with the help of an assistant), neat and entire, without receiving a puncture.

There is the toasting-fork, of which the cook may be allowed more than one, with handles of different lengths, to keep the fire at its distance on all occasions. There are toasting-forks with telescopic handles, composed of joints slipping one into the other; but they are rather for breakfast-room than for kitchen use. The common cheap toasting-forks made of iron wire have only three prongs, whose insufficient hold often lets the half-done slice fall into the cinders—an accident which is still more vexatious when the object toasted is a kidney, a rasher of bacon, or a slice of underdone meat. A five-pronged fork, like that in the woodcut, Fig. 6, will hold the toast more securely. The bend in the handle allows it to be toasted by the side of, instead of in front of the fire.

A pastry oven, heated with charcoal, is useful in country houses not within easy reach of the pastry-cook or confectioner.

Amongst the articles occasionally used in a kitchen, a *gaufrier*, or iron for making *gaufres*, or wafers, may be reckoned. There may even be two irons; one for making thick

gaufres, resembling pancakes in quality, the other for wafers proper. *Gaufre* tongs are made of cast iron. Any ironmonger doing business with France could easily procure them, which might be cheaper than ordering them to be made here.

The cook must have nut-crackers to prepare almonds and walnuts for dessert; lobster and crab-crackers for breaking the claws of those crustaceans; also a lemon-squeezer, a similar instrument, only made of wood, for pressing the greatest possible quantity of juice out of oranges and lemons. The inside of the squeezer has an oval hollow to keep the fruit under pressure from slipping aside.

To have clear jellies, either savoury or sweet, a flannel jellybag is indispensable. Instead of being hung on a peg in the wall, or on the back of a chair, it is better put to drain on a three-footed stand, with a support beneath to hold the vessel which receives the liquid as it strains away. We have shown this in Fig. 1.

One, two, or three shallow saucepans, made of stout

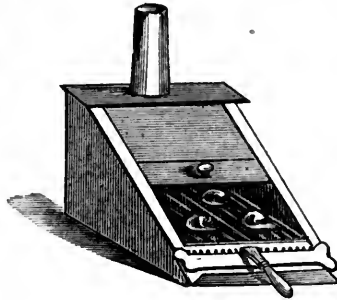

Fig. 5.

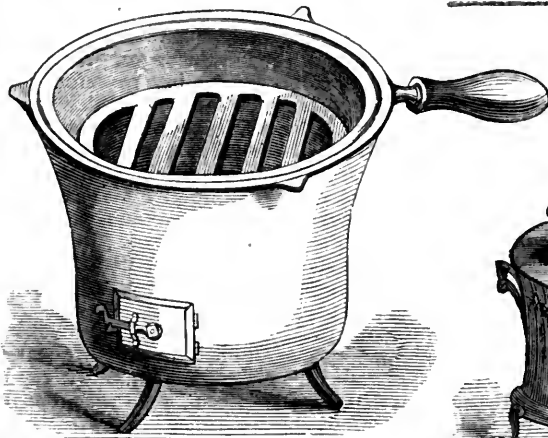

Fig. 7.

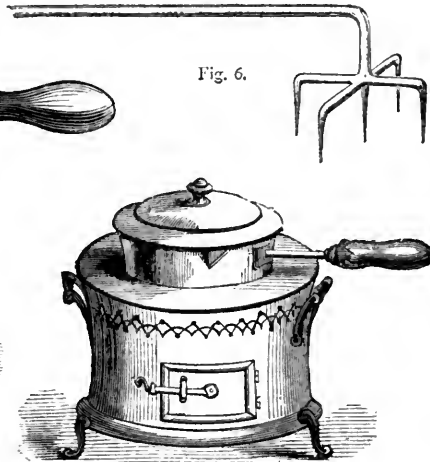

Fig. 6.

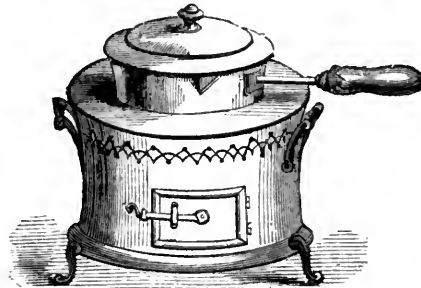

Fig. 8.

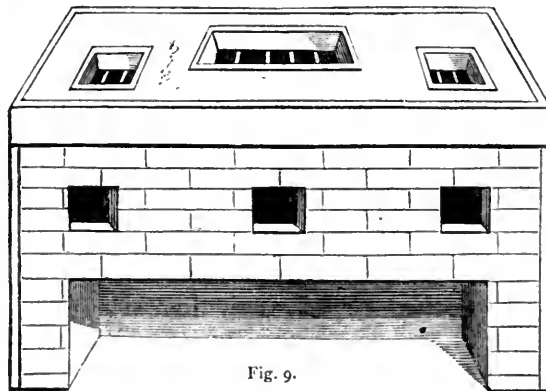

Fig. 9.

copper or iron, well tinned inside, are extremely useful and convenient *for roasting in*; on the Continent they are considered indispensable in a kitchen. They will be of different sizes in respect to breadth; the saucepan is large enough if the joint or fowl can be easily turned in it. A depth of six or eight inches will suffice for the largest; less for the smallest size. Fig. 3, with a flat bottom, must be used when it has to stand on a trivet belonging to a range; but Fig. 4, with the rounded bottom, will fit into the circular hole over the fire of a cooking-stove, which hole should be provided with flat rings of different breadths, movable at pleasure, suited to receive different-sized saucepans, and also to regulate the direct fire-heat applied to the bottom of *large* boilers or stewpans. The rounded bottom has the advantage of allowing every part of its surface being brought into contact with the joint to be so roasted; none of the fat or gravy remains unemployed in the corner at the bottom. In preserve-making, the whole of the jam is more easily scraped out, and the inside of the saucepan itself is more readily cleaned.

This mode of roasting is very generally employed by Continental cooks for small things, such as a leg or shoulder of lamb, a moderate sized fillet of veal, ducks, wild fowl, &c. Small birds, especially—larks, thrushes, and the like—are generally done that way. And a mere handful of fire suffices. At the bottom of the saucepan enough butter or sweet dripping is put to keep the joint from burning. As soon as the fat is hot, the joint is put in and kept constantly turned, until it is browned all over evenly, and thoroughly done. This, of course, requires constant watching. A roast in a saucepan cannot be left to itself. If the fat dries up, more must be added. When carefully done, a roast in a saucepan is not to be distinguished, either in appearance or flavour, from a roast done before the fire. Many even prefer the former. The convenience of the mode, the economy of fuel, and the escape of the cook from exposure to a great blazing fire, are obvious. Those who once try it will continue the plan, if only for the sake of its providing them with a succession of nice little fresh roasts, instead of having to get through heaps of cold meat. Saucepans for roasting in need no lid; still, the lid will be useful when stews are to be done in them.

MISCELLANEOUS RECIPES.

Lemon Mince Pies.—Squeeze a large lemon, boil the outside till tender enough to beat to a mash; add to it three large apples, chopped, and four ounces of suet, half a pound of currants, four ounces of sugar; put the juice of the lemon and candied fruit as for other pies.

Egg Mince Pies.—Boil six eggs hard, shred them small, shred double the quantity of suet; then put currants, washed and picked, one pound, or more, if the eggs were large; the peel of one lemon shred very fine, and the juice; six spoonfuls of sweet wine, mace, nutmeg, sugar, and a very little suet; orange, lemon, and citron candied.

Orange Cheesecakes.—When you have blanched half a pound of almonds, beat them very fine, with orange-flower water, and half a pound of fine sugar, beaten and sifted, a pound of butter that has been melted carefully without oiling, and which must be nearly cold before using it; then beat the yolks of ten, and whites of four eggs; pound two candied oranges, and a fresh one with the bitterness boiled out, in a mortar, till as tender as marmalade, without any lumps; and beat the whole together, and put into patty-pans.

Orange Biscuits, or Little Cakes.—Boil whole Seville oranges in two or three waters till most of the bitterness is gone; cut them, and take out the pulp and juice; then beat the outside very fine in a mortar, and put it to an equal weight of double-refined sugar, beaten and sifted. When extremely well minced to a paste, spread it thin on

china dishes, and set them in the sun or before the fire; when half dry, cut it into what form you please, turn the other side up, and dry that. Keep them in a box, with layers of paper. They are for desserts, and are also used as a stomachic, to carry in the pocket on journeys, or for gentlemen when shooting, and for gouty stomachs.

French Rolls.—Rub an ounce of butter into a pound of flour; mix one egg beaten, a little yeast that is not bitter, and as much milk as will make a dough of a middling stiffness. Beat it well, but do not knead; let it rise and bake on tins.

Sponge Cake.—One pound of butter, one pound of loaf sugar, nine eggs, one ounce caraway seeds, one pound and a half of flour. Wash the butter, and beat it up with the hands ten minutes before the fire; break the sugar to powder, then add it to the butter. Drop one egg in at a time without first beating them, but beat the ingredients all together all the time you are mixing. Add the seeds, then the flour; no beating after flour is put in.

Macaroni Pudding.—Simmer an ounce or two of the pipe macaroni in a pint of milk, and a bit of lemon and cinnamon, till tender; put it into a dish with milk, two or three eggs, but only one white, sugar, nutmeg, a spoonful of peach water, and half a glass of raisin wine. Bake with a paste round the edges. A layer of orange marmalade or raspberry-jam in a macaroni pudding, for change, is a great improvement; in which case omit the almond water ratafia, which you should otherwise flavour it with.

Queen Cakes.—Mix a pound of dried flour, the same of sifted sugar, and of washed clean currants. Wash a pound of butter in rose-water, beat it well, then mix with it eight eggs, yolks and whites beaten separately, and put in the dry ingredients by degrees; beat the whole an hour; butter little tins, tea-cups, or saucers, and bake the batter in, filling only half. Sift a little fine sugar over, just as you put it into the oven.

American White Cake.—The following is said to be a good recipe, and it is a simple one:—Two cups sugar, two and a half cups flour, half a cup butter, three-quarter cup milk, whites of eight eggs, one teaspoonful cream of tartar, half a teaspoonful soda.

Yeast.—This may be made without having any recourse to any product of alcoholic liquors. To prepare flour yeast, boil one pound of good flour, a quarter of a pound of brown sugar, and a little salt, in two gallons of water for an hour. When milk warm, bottle the mixture and cork it close. It will be fit for use in twenty-four hours. A pint of this will make eighteen pounds of bread.

Barley Water.—Put two ounces of pearl barley into two quarts of water. Set the mixture on the fire, and when it boils, strain it well. Then add a little more water, and a bit of lemon-peel, and let it boil slowly until it is reduced nearly one half. It may then be removed, and again strained, and flavoured with sugar and lemon-juice.

Everton Toffy.—The pan must be warmed and rubbed with a little butter, after which put in one pound of brown sugar, and two table-spoonfuls of water. Let the sugar boil over a slow fire until it becomes a smooth thick syrup, when half a pound of butter is to be stirred into it. After boiling another half hour, drop a little on a plate, and if it sets hard, and comes off clean, it is done enough. Pour it out into a wide dish or tin well buttered, so as to form a cake about half an inch thick. It may be flavoured with twenty or thirty drops of essence of lemon, stirred in as soon as it is taken off the fire.

Oatmeal Porridge.—Place some water on the fire, and as soon as it boils, throw in a little salt. Then take some coarse oatmeal, and sprinkle it in the water by degrees, stirring it all the time with a large spoon, until it thickens like hasty pudding. It should then be removed from the fire, and poured upon plates at once.

It may be eaten with cold milk, treacle, or butter, and is an excellent food for breakfast.

Fruity or Furmenty.—Boil a quart of wheat until the grains are well swollen. Take two quarts of milk, a quarter of a pound of currants or raisins, picked clean and mashed; stir these together and boil them. Then beat up the yolks of three or four eggs with a little milk, adding suet and nutmeg to flavour them. Add these to the boiled wheat, place the whole upon a moderate fire, stir it well for a few minutes, and then sweeten it with sugar. It may be poured out and eaten hot, though some like it as well cold.

Arrowroot with Milk.—Set a pint of milk on the fire, and when it almost boils, pour it upon a dessert-spoonful of arrowroot which has been well mixed in a little cold water. The milk must be poured in gradually, stirring it all the time, after which it is to be placed upon the fire again, and stirred for a couple of minutes. The arrowroot mixes better if sugar is stirred into it before it is moistened with water. Patent barley and sago may be treated in a similar manner.

To Pot Veal.—Cold fillet makes the finest potted veal, or it may be done as follows: Season a large slice of the fillet, before it is dressed, with some mace, peppercorns, and two or three cloves; lay it close into a potting-pan that will just hold it, fill it up with water, and bake it three hours; then pound it quite small in a mortar, and salt to taste; put a little gravy that was baked to it in pounding, if to be eaten soon, otherwise, only a little butter just melted; when done, cover it over with butter.

Veal Sausages.—Chop equal quantities of lean veal and fat bacon, a handful of sage, a little salt, pepper, and a few anchovies. Beat all in a mortar; and, when used, roll and fry it, and serve with fried sippets, or on stewed vegetables, or on white collops.

SEASONABLE FOOD.

FEBRUARY.

Meal.—Beef, veal, mutton, house-lamb, venison.

Game and Poultry.—Hares, rabbits, pheasants, partridges, woodcocks, snipes, pigeons, turkeys, fowls, pullets, capons, chickens, geese, ducks, ducklings, wild ducks, wild geese.

Fish.—Flounders, brill, plaice, skate, soles, turbot, cod-fish, whittings, smelts, sturgeon, herrings, haddocks, sprats, oysters, mussels, cockles, crabs, cray-fish, prawns, shrimps, barbels, carp, eels, perch, pike, tench, trout, salmon-trout.

Vegetables.—Broccoli, cabbages, Brussels sprouts, savoy, celery, cardoons, endive, spinach, lettuces, sorrel, forced French beans, asparagus, potatoes, carrots, parsnips, turnips, beet-root, chervil, cresses, and all small salads, tarragon, scorzonera, cucumbers, mushrooms, onions, parsley, sage, shalots, thyme, mint, and all garden herbs, fresh or dried, Jerusalem artichokes, dried peas, and beans.

Fruits.—Apples, pears, grapes, oranges, almonds, nuts, chestnuts, walnuts, figs, raisins, currants, filberts, prunes, all sorts of preserved and dried fruits, jams, marmalades, and fruit jellies, and forced strawberries.

HINTS TO LETTER-WRITERS.—IV.

THE title of esquire, though now applied to any person in a respectable sphere of life, is properly a title of courtesy, and denoted originally the attendant upon a knight, his armour-bearer, or shield-bearer. While, therefore, in addressing letters and other documents it is customary to add Esq. to the name of the person to whom they are sent, if he be a person of some consideration, these three letters must be appended to the names of those who claim

the title as a reality. Everyone should know, as observed in Debrett, that the title of esquire is of right due to "all noblemen's younger sons, and the elder sons of such younger sons; the eldest sons of knights, and their eldest sons; the officers of the sovereign's court and household; naval and military officers from the rank of captain upwards; barristers or counsellors-at-law, royal academicians, medical men holding degrees, justices of the peace, &c. It is contended, however, that justices of the peace are only esquires in reputation; besides, a justice of the peace holds this title no longer than he is in the commission of the peace, in case he be not otherwise qualified to bear it; but a sheriff of a county, who is a superior officer, retains the title of esquire during his life, in consequence of the trust once reposed in him."

The title of esquire is in like manner accorded to all who claim to be "gentlemen," a word which includes all degrees of high rank, but which is supposed not to descend below a certain level as a designation, hence some claim to be "gentlemen," as others to be esquires, knights, &c. It is, however, now much less customary to write addresses as to "Thomas Fisher, gent.," instead of which we write "Thomas Fisher, Esq." In the course of our life we have met with some curious mistakes in connection with Esq. We once saw a letter directed by an eminent foreigner to "Sir A. B., Esq.," and several times we have seen letters addressed "Mr. A. B., Esq." Now, though "Sir" may and should head a letter which has "A. B., Esq." for the superscription, the combination of the two, as above, is ludicrous. In like manner, although "Sir" may and should head the letter which is addressed to "Mr. A. B.," or to "A. B., Esq.," the combination "Mr. A. B., Esq.," on an address is at once ludicrous and vulgar. The rule in writing to any gentleman by courtesy who has no knightly or other dignity, is to address a letter to him thus: "To Theophilus Brown, Esq." If Mr. Brown is a man of some distinction, and fills good offices, or is member of certain learned societies, write "&c. &c.," between his name and residence. It is not necessary to prefix "to" to this or any other address, and it is only in special cases that "esquire" is written at full length, the abbreviation "Esq." being deemed generally sufficient. In addressing such a person, and, indeed, when writing to others who are members of Parliament, doctors of medicine or of laws, &c., it is proper to append the requisite initials. Thus, if Theophilus Brown, Esq., is a member of Parliament, it is right to place "M.P." after "Esq.," if he be a doctor of medicine, "M.D." must be added to "Esq.;" if he is a doctor of laws, "LL.D." must follow "Esq.;" and if he is a fellow of the Royal Society, or some such honourable institution, we must, after "Esq.," add "F.R.S.," or whatever initials are correct. When a gentleman has an academical degree, it may be indicated, though this is by no means necessary. That of a master of arts is shown by "M.A." after "Esq.," or "D.D." for a doctor of divinity even when a layman. But while "Esq." may be used in connection with such honours as have been enumerated, it is not placed in the superscription of a letter, &c., with such designations as captain, general, colonel, right honourable, &c. The heading of a letter to an esquire should, as above hinted, always be "Sir," and by that name he must be personally addressed in the body of the document. The concluding form is similar in all cases—"I have the honour to be, sir, your very obedient, humble servant." Where less form is required, the conclusion may be modified—"I am, sir, your obedient, humble servant"—"I am, sir, your obedient servant"—"I am, sir, your very humble servant"—"I am, sir, your obedient and faithful servant," &c. With regard to the word "gentleman," it may be added that although attorneys-at-law, and persons in sundry other positions, are personally entitled to the addendum of "gentleman" to their names, it is an honour which few people would care to exact.

THE REARING AND MANAGEMENT OF CHILDREN.

VI.—CHILDREN'S CLOTHING (*continued*).

WHEN the babe is short-coated it may either wear the little chemises it already has, joined up the back, or have a set of six new ones, made in fine cambric muslin, ten inches wide (doubled), allowing another half inch for the seams at the side. This is cut like Fig. 75, ten inches long, allowing another half inch for hems. Fold the muslin, so as to have it double on the shoulders at A A. Cut the slanting lines close beside the A A's which divide the shoulders from the flaps. Cut the flaps apart, and hem them and the shoulders all round, button-holing the corners. But the seams should first be sewn and felled

to the back and secured by a button in front. The little flannel petticoat is generally plaited at the waist and sewn on the body. The breadth of flannel is sufficient; the length, guided by the size of the child, should be an inch less than the white petticoat. The prettiest flannels for infants are those sold by the yard, scalloped and embroidered in blue or scarlet.

Further on we give full details for making a flannel petticoat, which, with the exception that it is longer, is the same as the baby's.

We now pass on to clothing for children of two or three years old. The directions are equally applicable for those of a year and upwards, but are a little longer and larger, perhaps. First of all, for children of both sexes little flannel jackets of fine Welsh flannel are needed. The shape resembles Fig. 77, measuring eleven inches and a half

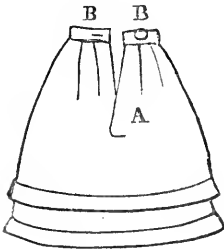

Fig. 65.

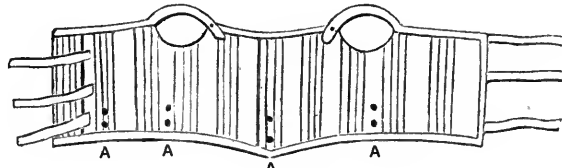

Fig. 66.

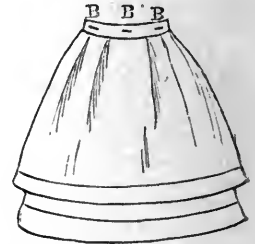

Fig. 67.

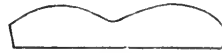

Fig. 68.



Fig. 69.

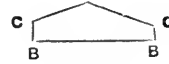

Fig. 70.

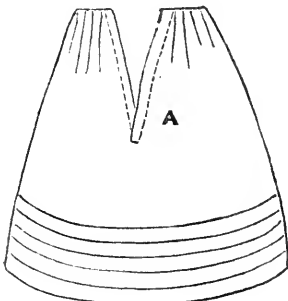

Fig. 71.

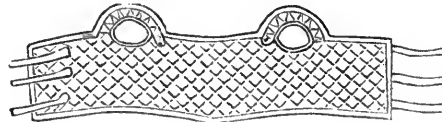

Fig. 72.

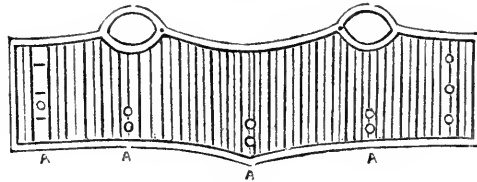

Fig. 73.

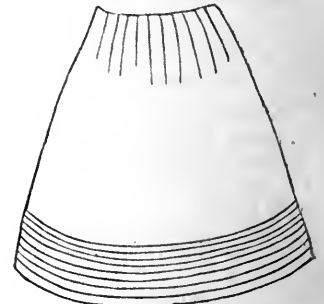

Fig. 74.

with very fine cotton. The bottom may then be hemmed round a quarter of an inch deep. Make the sleeves, cutting them like Fig. 70, six and a half inches long, the straight side. Sew together at B and C. Then turn down and stitch the straight side, and sew and fell the other side into the chemise. At the corners of the flaps marked E and E sew on strings, which are tied under the arm, the strings of the front to those at the back. A button is placed on the sleeve, and a button-hole for it is made at the point of the shoulder. This fastens over the little one's many shoulder-straps, and keeps them neat. Edge the sleeves with Valenciennes lace. Fig. 70 is a design for the chemise sleeve, to be made seven inches long.

The short-coat stay body is illustrated by Fig. 72. It is made of fine jean or of stout fine linen, faced with twilled muslin, and quilted: with a machine this is easy to do. The size is five inches deep and twenty-two long. It is then bound all round. The shoulder-straps are of the same material, a quarter of an inch wide and about four inches long, quilted and bound all round. They are sewn

(double) under the arms from A to A, and thirteen at the bottom from B to B. The length is nine inches. It is well, however, to make it three or four inches longer and three inches wider (double) each side. We measure from one which has been worn some time, and consequently shrunk.

Run and fell the side seams from A to B, and the shoulder seams. Hem the top and bottom narrow, and also the armholes. When the shoulders wear out cut them away, and put broad tape straps an inch wide. Never use narrow straps for children, because they drag and cut the skin. It is well to have four flannels, for children often need a change, and these little things do not cut into much stuff. They should be worn all the year round, for they are even more needed in summer than winter.

Next make six chemises. Very fine longcloth is generally used for such young children; a shilling a yard is not too much to give. Some persons lay out one shilling and sixpence on it. Half a yard is more than sufficient for one. Two yards and a half of thirty-two

inches wide longcloth (actual measure) will make six. Each one is fifteen and a half inches long, and sixteen wide at the bottom. Cut the shape like Fig. 81, that is, in the same way at the top as the short-coating chemise, but a little more sloped at the waist. The sleeves, too, are cut as before, but measure eight inches long when cut out like Fig. 70, which, of course, is double, and is reduced to four before it is inserted in the form of a sleeve. The apparent gaps between the shoulders and flaps are only the result of the narrow hem. Run and fell the side seams, A to B, and hem the bottom half an inch wide. Run and fell the sleeve together, and also into the armhole. Turn down and stitch the edge of the sleeve and trim it with lace—a good but fine tape-lace serves the purpose. Our readers must not confound the tape-lace with tape trimming, which is quite another thing.

ming both sides all the way to the edge. The armhole of the shirt must next be finished:—Take a strip of longcloth, cut down, not across, the material, two inches wide; put it on the sleeve inside at the dotted line, A to B and E, in Fig. 78, running it first to the edge of the hole, turning it over, and hemming it down finely; afterwards stitch the edge of the armhole marked by the dotted line, A to B, on the other side of the diagram, Fig. 78. Small children may not need such large armholes or sleeves, and three inches doubled or six long in the cutting will suffice.

The next thing is the stay body, which may be made alike for boys and girls. The bodice is generally seven or eight inches deep and twenty-four long, and the backs wrap over; some children, however, are small, and do not take them larger than the short coat bodies, five inches deep and twenty-two long. These are made of jean, lined with soft

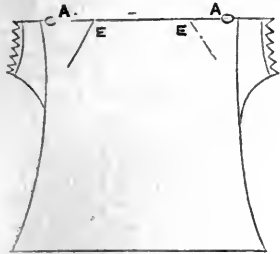

Fig. 75.

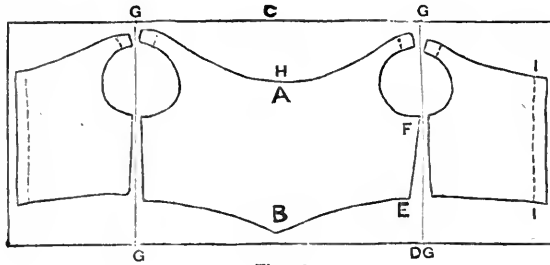

Fig. 76.

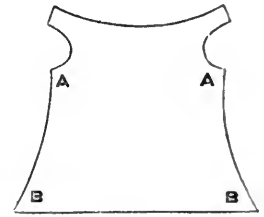

Fig. 77.

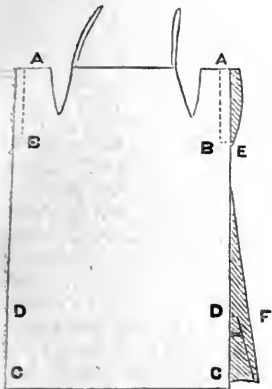

Fig. 78.

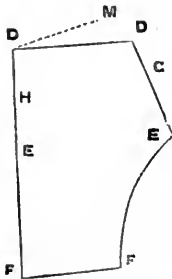

Fig. 79.

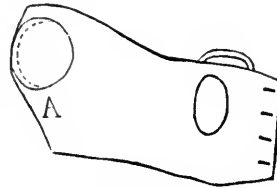

Fig. 80.

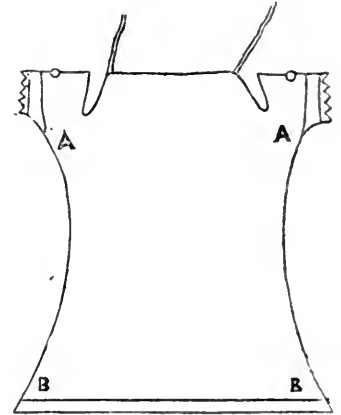

Fig. 81.

Tape trimmings are very pretty to look at, but do not get up easily.

Figure 78 shows the shape of a shirt for a little boy of the same age; it takes the same quantity of material as the girl's chemise; it is sixteen inches wide all the way down. Cut it with the longcloth double on the shoulders, A A; leave the sides open as far as B B (three inches and three-quarters or four inches); run and fell the rest of the seam to D D, and leave it open again from D D to C C at each side. Let in a little three-cornered gusset at F, each side (E to F shows the side of the shirt). The gusset is double, run and felled in very narrowly and neatly, and stitched across the double edge, where a line may be noticed; then hem very neatly, and as narrowly as possible, each side of the open seam from D to F; afterwards hem the bottom of the shirt half an inch wide. Hem round the flaps and shoulders very fine, button-hole the corners, and sew on tapes long enough to tie under the arms. Do not tie these so as to confine the garment to the child, but loosely, merely to keep down the flaps. Tapes are sewn on quite half an inch down the flap, hem-

lined, and run together the short way with cords. Tack jean and linen together, when cut out, all round with coloured cotton, and then tack the places to be run between the cords with another colour; pull out the first coloured cotton, that fixes jean and linen together, as it is not now needed, and is in the way of running the cords between the tacking. Put in the first cord with a bodkin; finely run with white cotton over the tacking; put in another cord, and run the next line, and so on till all the cord is in; then cut it even at the edges and bind the body all round with twilled binding. Make the straps half an inch wide, of jean and linen, bound, and sew them on. There are various ways of running the bodies. Fig. 73 is regularly corded close together; Fig. 66 in alternate groups of three cords and a space. Either tapes or buttons may be used to fasten the body, but tapes are best, as other buttons must be sewn on, as shown by four A's, both in Figs. 73 and 66. The lower and smaller row of these is for the drawers; the upper for the flannel petticoat. When the drawers or petticoat are new and full long, place these buttons higher up; as the garments get short for the child.

lower the buttons. The petticoat is buttoned on higher up than the drawers.

Cut the drawers from Fig. 79. Each leg is cut separately, measuring four and a half inches across, from D to D (doubled, or nine inches open), five inches and three-quarters, or six inches, from E to E (doubled), and four inches (doubled) from F to F, sixteen and a half long from D to F, nine inches from D to G, and on to E. Run and fell each leg together on the sloped side, from E to F; then join them together down three-fourths of the length of the front, leaving the rest of the front and all of the back open, hemmed each side as narrow as possible. Cut open the sides from D to H and hem them narrowly, putting in a little gusset at the corner. Make a hem and four tucks, each a quarter of an inch wide, with scarcely any space between; then set the front, in a band twelve and a half inches long, the half inch to be turned in at the ends, and two inches wide, the half inch to make the two turnings. To do this pin the top of the drawers to one edge of the band, run together, fulling it a little to get it in; then turn down the opposite edge of the band, turn it over and pin down on the wrong side of the drawers, turning in the ends also; hem it neatly down, and sew the edges. Cut two bands, each six and a half inches long and two wide; run and hem them on to the two halves of the back, in the same way as with the front band; make large button-holes at seven places, to fasten the drawers to the stay bodice. Stout children may require the drawers longer in the body from the slanting line, D to E, in Fig. 79, or only longer at the back; in either case the back only, or both pieces, are cut by the dotted line, D to M, in Fig. 79, which slopes upward. If they are wanted wider, the width must be allowed from D to D and E to E; and the leg also, F to F, it will be well to increase in proportion. This may be done by taking the sloping and curved lines on one side of the leg, D to E and E to F, an inch or an inch and a half longer (doubled).

The flannel petticoat is the next article of clothing. This should measure nine or ten inches long made up, allowing two inches for a tuck and one for a hem, that is, twelve inches in all. It is well to make a new one with two tucks, or fourteen inches long. One width of flannel suffices. Run and fell the back together, Fig. 65, half way up; make a wide hem on one side and a narrow one on the other for the rest of the seam, folding the wide one over the other, and stitching it down across at A. Make an inch-wide hem and then one or two tucks, according as the material has been allowed. The child's waist, over the stay bodice, must be measured, and the shirt box-plaited into a two-inch wide band, half an inch of which is allowed for turnings. Five button-holes are made in the band at the five B's in Figs. 65 and 67, which also show the plaiting. There is one button-hole in the centre in front, one exactly over each hip, and two at the two ends behind; these last two are fastened on the one button at the back. A yard and three-quarters of fine Welsh flannel is sufficient to make four flannel shirts, which will be needed. It must be sloped a little in front before setting it into the band.

The next items in the child's wardrobe are its white petticoats. Two widths of longcloth, of a fine quality, measuring thirty-seven inches long, will be required. The exact width of the long-cloth to an inch does not signify, but it should not be much wider. The length of the skirt is ten inches. To each breadth allowance must be made for the width of the hem; for a half-inch hem, half an inch; a half-inch tuck an inch, because the tuck is double. The simplest way to make the skirt is with a hem and three tucks, each an inch wide. That, with the turning in of the hem and at the top, makes eighteen inches, or half a yard; that is, a yard for each skirt; half a yard for the body and sleeves will probably be sufficient. Either run

and fell, or sew the skirt seams together. For tucks, sewing is the neatest and best. Make the hem and tucks with half an inch space between each. Cut open a slit down the back for the placket-hole, half the length of the skirt. Make a broad and a narrow hem on the respective sides, as shown in Fig. 71. Stitch the broad over the narrow where they meet at A. Petticoats may be made with a number of narrow tucks, like Fig. 74, and three narrow and a broad one alternately, for variety. Sew the gathers larger at the back and closer, and finest of all and plainest in front. Over the hips they are between the two in size and fullness. They are sewn to the body, after being first pinned to it. To make the body, cut the fronts and two backs like Fig. 76. From A to B the body measures six inches.

To make the size of the body more easily intelligible, we give the following instructions: draw an oblong on paper, measuring nine and a half inches wide, by twelve long, G G G G. From C to H, down the centre, there is a space of three inches; measure and mark this with a large dot. The shoulders rise to the top. It is easy to draw the undulating line thus assisted. From the side at D to the line E there is a space of an inch. Dot it, and get the curve of the waist. From G G to I I, under the arm, the length is five inches. The backs are cut from first drawing the oblong of nine and a half inches high, and six and a half inches wide. The slope at the neck is two and a half inches, the shoulder meeting the top line G. Draw the slope at the waist; the back measures five inches under the arm, and five and a half at the back. Having drawn these pictures on paper, cut them out, and the longcloth by them. Both backs are alike, but reversed, lefts and rights, as with shoes and gloves. In longcloth, which has no right or wrong side, this does not matter. Run and fell the side seams and shoulders of the body together. Hem the back an inch wide. Hem the top and waist each half an inch wide, and run strings to draw in both. A few buttons should be placed up the back also. The sleeve, Fig. 68, is eight and a quarter inches long and two inches and a half wide in the broadest part, and two inches at the narrowest. Run and fell it together underneath, run and fell it into the armhole, using a quarter of an inch for this purpose, and make a hem at the edge, a quarter of an inch wide, and edge it with narrow work or lace. Be sure in cutting the body not to shape the armholes too large. They can always be increased from every side but the shoulder, which must not be made too narrow. An inch should be allowed in cutting for the shoulder width, one quarter to fell to the sleeve, one quarter to turn down for the hem, one quarter for the inner turn of the hem, and a quarter left for the strap when completed. The quantities for turning were allowed in the measurement given in Fig. 76 and Fig. 78. Fig. 69 shows the sleeve ready to be felled in. A in Fig. 80 illustrates the manner of putting in the sleeve. The right side of the sleeve is outwards, and put in at the right side of the body, as it would be if worn. But it is run and afterwards felled from the back, according to the diagram at A.

HOUSEHOLD AMUSEMENTS.—VI.

AMONG games well suited to a mixed company, and capable of giving rise to considerable merriment, a place must be accorded to that known as

The Newspaper.—This may be played either as a forfeit game or otherwise. One of the party is appointed to "read the newspaper;" the others, seated before him, assume to be members of different trades and professions—lawyer, doctor, draper, grocer, &c. The reader takes up any paper that may be at hand, and selects some passage for perusal. The peculiarity of the game is, that whenever he pauses and looks at any member of the company, that

person must make some suitable observation appropriate to his particular trade—the more incongruous to the narrative or dissertation which is being read by the first player, the better. The penalty of a forfeit may be exacted from any person who does not reply when appealed to, or who makes a remark not connected with his own pursuit.

To give our readers a clear idea of the mode of playing the game, we will suppose the reader lights upon a narrative of the visit of the Duke of Edinburgh to Calcutta. He proceeds thus—

“A guard of honour composed of” (here he looks, say, at the Oilman)—

Oilman.—“Tallow candles”

“Was drawn up on the quay, and his Royal Highness on landing was received with a round of”—

Butcher.—“Marrow bones.”

“Delivered in true British fashion. A salute of twenty-one guns was fired from the”—

Draper.—“Band-box,”

“And the ships and forts hoisted their”—

Lawyer.—“Affidavits.”

“Every house in the vicinity was decorated with”—

Grocer.—“Treachle,”

“And the windows were filled with elegantly dressed”—

Surgeon.—“Compound fractures.”

“Escorted by the Governor General, his Royal Highness proceeded to the”—

Confectioner.—“Mince-pies,”

“And gracefully bowed his acknowledgments to the”—

Ironmonger.—“Fire-shovel.”

So the reading continues, until each member of the company has responded, or the paragraph is closed, when another extract may be commenced. The passages most suited for perusal are those which possess some degree of gravity in tone, without being too serious to serve as a foundation for the ridiculous interpolations to which the game will naturally give rise.

Of games which are played chiefly to extract forfeits from the company, a very good one is known as—

The Picnic.—One of the players volunteers to perform the principal part, by giving an account or description of an imaginary picnic. The rest allot among themselves the names of the individuals supposed to be present at this picnic, or the catables and other articles which are taken thereto. Thus, “Mr. Smith,” “the Misses Brown,” “Mr. Jones,” and “Mrs. Robinson,” with as many more names as may conveniently be shared by the company, may figure in the narrative, which becomes the more graphic if “the pie,” “the champagne,” “the salt,” “the spoons,” &c., are also represented by different members of the company. Every time mention is made of the name allotted to one of the party, he or she must rise from the chair, turn round, and then resume the seat. At the mention of the word “picnic,” however, every one of the party must do the same. Any person failing to rise and turn when mentioned, pays a forfeit.

The narrator need not draw very highly upon his imagination in the recital, for any commonplace story in which the names are brought in, so as to keep the different members of the party moving, and elicit forfeits from some of them, will sufficiently answer the purpose. He may proceed something in the following fashion. The reader must suppose that the names italicised have all been allotted among the company, and that their representatives rise and turn each time they are mentioned:—

“Mrs. Jones and Mrs. Robinson, having several marriageable daughters, laid their heads together to get up a picnic. They took into their confidence *Uncle John*, Mrs. Jones's brother, and asked him to invite some of his young friends from the Waste Paper Office, such as *Mr. Brilliantspark*, *Mr. Waltzington*, and *Mr. Softspeeche Ogle*. To make the affair look more natural, the *Misses Jones* invited their friends *Miss Simpersweet* and *Miss*

Twinkletoe, while there were also present, &c. &c. Mrs. Robinson provided the *game pie*, Mrs. Jones the *custard*, and *Uncle John* brought down the *champagne*, the *knives* and *forks*, the *pepper* and *salt*, and so on. A beautiful meadow near the river was chosen as the scene of the picnic, and when the party arrived a dance was proposed and carried unanimously. The partners were (here the names may be called over). All went merry as several marriage bells, and Mrs. Robinson was just remarking to Mrs. Jones that she thought *Mr. Brilliantspark* was very much taken with her *Seraphina*, but that *Miss Simpersweet* really gave *Mr. Ogle* too much encouragement, when the proceedings were interrupted by a very unwelcome visitor. This was no other than *Farmer Beetroot's cow*, which had been leisurely surveying the company over a stile, and now, pushing through the hedge, seemed determined to make one of the picnic party. The ladies screamed, and ran towards the other end of the field, while *Mr. Waltzington* put up his eye-glass and remarked, “What a bo-aw!” “No,” cried *Uncle John*, who was reputed to be a wit, “not a boar, my dear fellow, it's a cow!” “Weally?” said *Softspeeche Ogle*. “How vewy wediculous!”

The narrator may continue the narrative in a similar strain, until some of the company, less on the alert than others, have incurred forfeits enough for the time being.

Similar to the *Picnic* is another game called *The Coach*, in which the party represent among them the chief parts and appendages of a coach, with the driver, guard, and passengers. Every time either person or thing is mentioned, its representative rises and turns, as in the game last described. The narrator gives an account of the incidents of a coach journey, interspersing it with such episodes as an attack by highwaymen or a toss over in the snow. A third game of a very similar description is known as *The Traveller*, the story in this case relating to the arrival of a traveller at an inn, and the various orders he gives, with their execution.

HOME GARDENING.

THE VEGETABLE GARDEN (*continued*).

Garden Walls.—The height of walls is more commonly determined by the size of the garden and the slope of its surface, than with a view to the training of fruit trees. A small spot enclosed with high walls has a gloomy appearance, but if the walls are built of different heights, this will be considerably relieved. In a garden of an acre, or thereabouts, square in shape, and slightly elevated, the north wall may be raised to fourteen feet; the east and west walls to twelve feet; and the south wall to ten feet above the surface of the ground. If the garden is larger, the walls may be a trifle higher. The extreme height of the north wall of any garden should not exceed eighteen feet, the east and west walls fifteen, and the south wall twelve. The terms north and south wall denote the north and south sides of the garden; but in speaking of wall-fruit, if it be said a tree requires a south wall, it must be understood to mean a wall with a south aspect. The north wall, by being raised higher, shelters the garden from the northern blast, and it affords ample space for training the finer sorts of fruit trees on the south side of the wall. South aspects are generally deemed the best for fruit trees, but we prefer an aspect a few points to the east. It may possibly be argued by some that the hottest part of the day is the afternoon, and that the sun shines stronger at that time than in the morning, and so it does, but it is not so healthy, as the great heat of the sun causes the trees to exhale their juices faster than their roots can absorb them, which will cause the fruit to be smaller, the pulp harder and worse flavoured. On the other hand, an aspect towards the south-east will catch the sun's rays

earlier, by which the cold night dews will be sooner and more gently dissipated, and the scorching effects of the afternoon's sun earlier off the trees.

The next consideration is the construction of these walls; so far as we have been able to judge, the upright form is preferable to any other. The foundation for them should be dug out no deeper than the thickness of the soil upon the surface, in order that no more of the wall may be lost than necessary, or, in other words, that economy may be studied in rearing or building of them. It is necessary that they should be built solid, that is to say, on a good foundation, and not upon arches, as advised by some, for when so built, it gives the roots of the trees liberty to grow out at the back of the wall.

When walls are of any length, and the foundation not of first-rate quality, they may be strengthened by projecting buttresses, set at stated intervals, but unless such support be absolutely necessary, the face of the wall presents a very much better appearance without them, and is much more convenient for wall fruit if it be perfectly smooth and even.

As regards copings, there are many opinions. There can, however, in our opinion, be no objection to a temporary coping of boards, projecting a foot or eighteen inches.

We come to another point, and that is, the materials necessary for the construction of them. Bricks should be chosen for the superstructure, and stone for the foundation and basement. If the wall is not entirely built of brick, it should at least be faced with it on the south-east and west aspects. If durable stone can be obtained, the basement of the wall should be built of it, in preference to bricks. The basement of all walls should be some inches thicker than the superstructure.

Wooden walls are sometimes adopted in small gardens, but, although good fruit may be produced from them, they are not durable, and on that account we do not undertake to recommend them.

Trenching, Ridging, Manuring.—The kitchen garden

should include herbs and vegetables enough to furnish an ample supply at every season; and it must also be kept in good order. The soil of a garden should be frequently pulverised, to render it sweet, free, and rich; or it will not produce early, well-flavoured, and handsome plants. The soil must be *sweet*, that the nutriment which the roots receive may be wholesome; *free*, that they may be at full liberty to range in quest of it; and *rich*, that there may be no defect in the food produced. Vegetables cannot wander in search of food, which must, therefore, be provided for them, in accordance with their habits and constitutions. The fibres of roots take up the nutriment which they find in the soil, and the freer the soil is, the more the absorbing fibres will increase, to the consequently greater vigour of the plants. Hence the soil is to be pulverised, not only before planting or sowing, but during the growth of vegetables, if space permits. The depth of pulverisation will depend on the nature of the soil; in clayey land it can hardly be too deep.

Soils are greatly improved by exposure to air, hence the importance of ridging and trenching. *Ridges* form a series of nearly equilateral triangles connected at their bases, thus doubling the surface exposed to the atmosphere. (Fig. 2.) *Trenching* is appropriate on all soils,

and helps to mix and pulverise the ground, as well as to change the surface. (Fig. 1.) Gardeners complain that their ground is worn out, or will not produce certain kinds of vegetables, when it is neither poor nor unmanured. The real cause is neglecting to change the surface. The best method with which we are acquainted for the preservation of the fertility of the soil, is this: to take three crops off the first surface, and then trench the ground three spits (or spades) deep, which operation is performed by first opening a trench two or three feet wide, carrying the soil so taken out to the other end of the plot, where the work will necessarily finish; then another strip the same width is to be begun, and one spit of the top surface (*a*, Fig. 1) is to be thrown to the bottom of the first trench (*a*). The next spit under (*b*), must be cast upon the first in the same way, and the third (*c*) upon the second, by which means the top and bottom spits are reversed, and the middle remains in the centre as previously, only somewhat displaced. Three

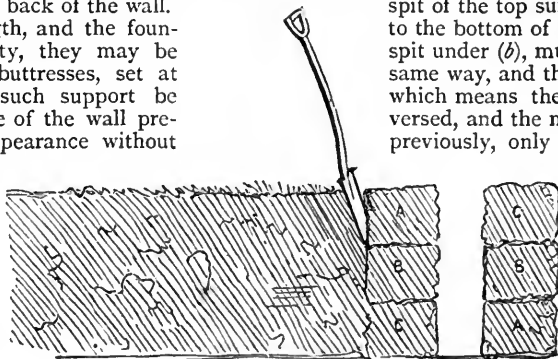

Fig. 1.

crops should be taken off this surface also, and then trenched two spits deep, as before, turning the surface spit to the bottom, and the second to the top, by which the middle becomes the top, and the top the middle. Take also three crops off this surface, and then trench three spits, by doing which,

that which has been the middle and the top, becomes the bottom, and the original surface now becomes surface again, after having had six years' rest. Proceed in this manner alternately, trenching one time two spits deep, and the next three, by which means the surface will always be changed, and will rest six years and produce three. The next thing to claim our attention is *manure*, the use of which is of so much importance that almost everything in culture may be said to depend upon it. When manure is applied, the ground



Fig. 2.

should never be overdone with it; a little at a time, and often, is much better than an abundance at once, and only now and then applied; for when used in great quantities, and lying in lumps, it encourages

worms, grubs, and other insects, and forces the plants to grow too rampant and rank. Vegetables are always sweetest where least dung is used at once. There are various ways of applying manure, depending chiefly upon the season of the year, the sort to be used, and the condition it is in. When the superficial soil is much exhausted, it is a good way to dig it over late in the autumn, and spread some good rotten manure on the surface, and to let it lie till towards spring, or till the ground is wanted, before it is dug in. This method is particularly suitable for land on which superficial growing crops, such as leeks, onions, radishes, and the like are. When the ground is to be manured at the time of planting, the best way is to spread the manure on the surface, previous to digging, and to dig it in immediately, and particularly so in spring and summer, for if left exposed to the action of the sun and air, the greater portion of its nutritive matter will be lost by evaporation, or otherwise. Manure may be applied either as a simple or as a compound, but the latter is the most eligible where a well-flavoured crop is the leading consideration, for if it has not undergone a proper fermentation, its effects will necessarily give the vegetables a rank and disagreeable flavour.

THE TOILETTE.

II.—THE HAIR AND ITS MANAGEMENT.

HAIR always has been accounted an ornament. It is surprising, however, considering how much time, trouble, and money are lavished upon it, that the public are so utterly at sea in the nineteenth century, not only as to its structure and its physiology, but the mode in which the commonest agencies act upon it for good or for evil. The general idea seems to be that the hair is a tube which can imbibe nutritious material presented to it from within the body through the blood, or without, through the medium of pomades or washes; that it can also, if cut across, let out the nutrient juices it contains, so that it subsequently dries and falls out. This is about the best description that could be given of hair-dressers' physiology, and upon such hypothetical assumptions are based many preparations, which too frequently do an infinity of harm to the hair of those who use them. It would matter very little if the prevailing fashions of dyeing, bleaching, and curling, and the widespread employment of spirituous and stimulating lotions and pomades were in all cases devoid of harm, but the reverse is the case; for these things are often most injudiciously and unfitly used and done, both as regards time and the nature of the hair disorder. The existence of so much ignorance in regard to the management of the hair is readily accounted for by the fact that it has as yet received no care or attention at the hands of those who are possessed of scientific knowledge. The physician deems it a topic scarcely fit to employ his time and thought, and hence it is left to be discussed by men who, nine cases out of ten, know nothing of the true structure of hair, and certainly less of its life under different conditions, both of health and disease, and who consequently cannot be acquainted with the way in which its vigour may be promoted, or its decay stopped. Now and again a man may make what is generally termed a "lucky hit," but lucky hitters are not always right; and often by their free and easy handling of remedies of which they know little, do an infinity of harm.

The hair, and the mode in which it has been arranged, has had its political, its religious, and its social significance. It would be interesting, but out of place, to go into that subject here. Suffice it to say, that our purpose is to give an account as brief as possible of what the hair really is, what should be done to it in health to keep it in a healthy condition, what are the more common diseases to which it is liable, and the means to be adopted to prevent these diseases, or bring back the hair to its proper state of healthfulness when it deviates therefrom.

Now, as regards the structure of the hair, a short description may suffice. The hairs, seated in little depres-



Fig. 1.

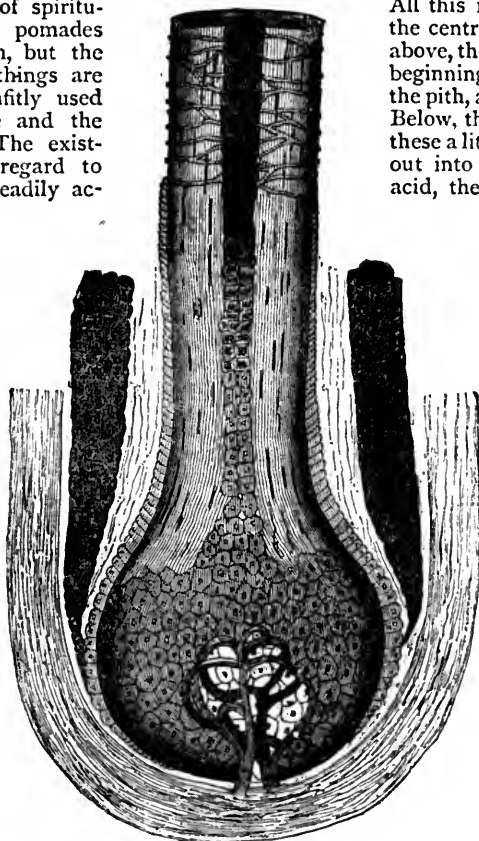

Fig. 2.

sions of the skin called follicles, are made up of cells and fibres, the latter being formed by the flattening out of the former. Human hair is not hollow, though the central portion is less dense than the outer portion. In each hair follicle at its upper part, two little fat glands open, so that the hair shaft is lubricated by the fatty matter secreted by the glands. The cut annexed, Fig. 1, represents a section of skin a good deal magnified, so as to show the hair in its follicle, with the two glands, which look like bunches of grapes, opening into its upper part, and also a sweat gland running by its side.

Hairs are technically said to have a shaft, which is the part external to the follicle; a root, which is buried in the skin; and a knob, or the termination of the root, which is attached to a little projection at the very bottom of the follicle from whence the material out of which the hair cells are formed comes. The hair shaft is further made up of a central portion or pith, where the cells are loosely packed together, and an outer portion, where the cells are flattened out into fibres very closely packed together.

All this may be seen in the cut, Fig. 2. In the centre is the hair with its root and knob; above, the hair is cut across, so that only the beginning of the shaft is seen; in the centre is the pith, and outside the cortex, as it is termed. Below, the cells are very plainly visible, and these a little higher up are seen to be flattening out into fibres. If we boil a hair in strong acid, the fibres separate very quickly. In

the pith a little air is contained, as a rule. The colour of the hair depends upon the presence of very minute particles of pigment scattered in varying amount throughout its substance. Now it will at once be perceived that the hair does not grow by the reception of nourishment through its centre part; but the cells which go to form the pith and the fibres of the outer portion, are originally manufactured at the very bottom of the hair follicle, and are pushed up from below—being flattened out more or less into fibres as they advance—by others which continuously form in succession. If, therefore, we desire to increase the growth of the hair, or to repair damage done to it, we must operate—so to speak—upon that portion of the hair follicle where the hair cells are formed. It is of little use to try and rub nourishing material into the head, rather must we improve the blood which supplies the material out of which the hair cells are originally formed. The hair grows at the

rate of about one to one and a-half lines a week, or six or seven inches in the year. The average length of hair in women is perhaps between two and three feet. It has been calculated that if the beard of a man continued to grow from its first appearance till death, at seventy years of age it would be about twenty-seven feet in length. As a matter of fact, however, such a length could never be reached, owing to the continual falling away of separate

hairs, and their replacement by others, in accordance with the principles already laid down. Few persons have any correct notion of the number of hairs on their bodies. In every square inch on the head it is said that on an average 1,000 hairs are present, or 120,000 in the whole head. Red hair is coarser and thicker than brown or black. Red-haired people, for instance, have on an average but 80,000; black, 103,000; brown, 110,000; and blonde, 140,000 hairs in the scalp. Curly hair is in great measure due to its flatness, the deficiency of gelatine, and the action of heat and dryness. The hair, when free from fat, absorbs and evaporates moisture very rapidly, according as the air is dry, or impregnated with vapoury matter. The natural fatty matter which is secreted by the glands, prevents any sudden change in this respect, and pomade takes the place of the natural oily secretion when this latter is deficient in amount.

There are one or two other points in physiology which we need to be acquainted with, in order to understand the every-day management of the hair. Hair is regularly shed; not all at once, but whilst some follicles are devoid of hairs, others are filled with hairs in various stages of growth, so that the shedding which continually goes on is unperceived by us in a state of health. The hair offers no exception to the rule that each part of the human body has a definite period of existence, and having done its work, it is cast off as useless. We are not speaking of disease now. Hence it is that when the shedding is excessive only, we can regard it as the result of a disordered health. There are some persons who are very anxious if the least particle of hair comes away with the comb; let them know then that, in moderation, continuous shedding of the hair is natural. The amount of hair varies in different individuals, as we all know, but it is of importance to remember that, both in regard to character and amount, hair is a family peculiarity. Luxuriance or deficiency of hair supply may be traced through successive generations, as much as peculiarities of feature, colour, or mental conformation. This being the case, it is not to be expected that nature can be so far altered by pomades and washes as to run counter to a strong inheritance, and agree to the artificial production of good crops of hair in those who have no ancestral claim to it, but the reverse. Yet, how pertinaciously do men trust in the thousand and one vaunted panaceas, under these very circumstances! And it is the more necessary to notice the point, because the stimulation usually employed is likely to, and indeed actually does, produce harm in many cases; over-taxing the naturally enfeebled powers of the hair-forming apparatus, and leading to more decided baldness or thinning of the hair.

Our readers must likewise remember that the healthy growth of the hair is distinctly influenced by the state of the bodily powers, so that anything which weakens on the one hand or makes strong on the other, is, as a rule, the cause in the one case of ill-nourishment of the hair, and in the other of its vigorous development. It follows, consequently, that one of the most common causes, both of thinning out and absolute loss of hair, is disorder of the general system, accompanied by debility; and it needs the knowledge of the physician surely to detect and to correct those errors of nutrition upon which loss or disease of hair depends. What those conditions are which lead, through impairment of the general health, to disease of the hair, will be specially referred to hereafter. So far only will we enter into the structure and physiology of the hair. Our object in this paper is to show that every healthy head of hair is undergoing a continual but gradual shedding, and that, in a moderate degree, this is to be welcomed, because it shows that the scalp is getting rid of that which is worthless, and possesses the power of producing that which will serve as well, and it may be better; that, under certain conditions, a deficient supply

of hair, especially in men, is a family peculiarity, against which the arts of man are practically powerless; and lastly, that there are a host of disorders which indicate that the blood and general state of nutrition is at fault, and which require not local treatment so much as the use of internal tonic and other remedies for their cure. The only one plan of treatment for all hair disorders at present in vogue amongst hair doctors, is stimulation. But it must be recollected that to provoke the hair follicles to extraordinary activity, when the general powers are exhausted, is often to produce harm.

We shall next take up the daily treatment of hair in a healthy person.

THE REARING AND MANAGEMENT OF CHILDREN.

VII.—EXERCISE.

DURING the first few weeks of life, the disposition to sleep indicates the necessity for avoiding anything like excitement to premature activity. With limbs and muscles undeveloped, and mental powers unformed, the only exertion which a very young infant ought to be subject to is that which is occasioned by being washed and dressed. Gentle chafing of the limbs before a fire may be practised morning and evening with benefit and pleasure to the babe. Not until an infant voluntarily seeks movement, or the dawning intelligence evinces pleasure in passing objects, should any attempt be made to disturb the order of things established by nature. This change may generally be observed about the third month. In the meantime, the more tranquil an infant can be kept, both in mind and body, the greater are the chances of unchecked development at the proper period.

The practice of too many nurses is at variance with these simple rules. Uninformed, generally, respecting the structure of the human frame, they are apt to apply principles of exercise which are totally unfitted to the tender organism of infancy. Hence the objectionable habit of jog-trotting on the knee, and rocking the body to and fro with an infant in arms, together with the still more pernicious practice of inducing the babe to support its head before the spine is strong enough to bear the weight. For some time after the rest of the body moves freely, the head is unequal to sustain an erect posture. The period when it is safe to encourage an infant to sit upright, is at the age of seven months. Previous to that time the body should be held only in a semi-erect posture, either by resting across the nurse's shoulder, or by her placing the distended palm of her hand against the child's chest. It is the more necessary to observe these precautions against spinal weakness in time, because children that have been injudiciously managed at the outset, become restless when it is attempted to keep them in a reclining posture.

An exercise very congenial to the inclination of a baby, consists in spreading cushions upon the floor for it, upon which to stretch itself. If no cushions are at hand, a clean cot mattress will answer equally well. All little ones revel in the freedom the change affords from the restrained posture in the nurse's arms.

The above exercise is the first step towards learning to crawl—the most healthful and natural mode of progression in babyhood. Some over-anxious parents check this habit, lest it should bring the infant into danger. Harm, however, seldom results, provided common precautions be taken. Another prejudice sometimes entertained against crawling is, that if a child finds how easy it is to get along on the hands and knees, it will not try to walk. Here, again, the fears are unfounded. All children are anxious to get upon their feet as soon as they feel themselves strong enough to do so; and the surest way to

ensure timely walking is not to force the practice. Many children do not walk before they are from twelve to fourteen months old. In the interim, crawling exercises all the muscles, and brings every limb into play in a manner proportionate to an infant's strength.

The best dress for the crawling age is one in which little French children are usually attired—a sort of knickerbocker suit, warm and loose, with trousers and vest all in one piece. The overall pinafore, so much in favour in our nurseries, is a capital contrivance for keeping the under-garments clean, but sadly impedes the free movement of the limbs by being apt to get twisted round the child's legs. Usefulness, not fashion, should be the characteristic of all infant attire, especially such as is worn in the nursery.

The stage at which infants begin to walk is an anxious one, and demands the exercise of a considerable amount of self-control on the part of a parent, inasmuch as falls are inevitable. These appear to a looker-on to be of a more serious nature than they really are. Provided a child does not fall from a greater elevation than its own height, injury very seldom occurs from such tumbles. The most dangerous falls are those which happen from tumbling off spring mattresses and seats. The suddenness of the jerk prevents a child from saving itself by the exercise of the momentary instinct which is usually displayed in other cases of impending danger. Left to themselves, little folks generally fall neatly, and manage to keep their heads uppermost. The cry which is heard after these accidents arises, more often than not, from surprise and mortification, and the trouble is best treated as a joke. If, instead of catching the child up in her arms and smothering it with caresses, accompanied with expressions of sympathy, the nurse said, in a cheerful voice, "Jump up, and see where you sat last," the child's mind would be diverted from its grief, and braced to fresh exertion.

As soon as a child is able to leave the house it should pass as much time as possible in the open air. Even sleeping out of doors does no harm, provided proper clothing be worn. Warm covering for the chest, arms, legs, feet, and loins is essential. The head should be kept cool, and the face covered with a light gauzy material only. Cambric handkerchiefs for veils, and felt hats are objectionable. As a general rule, the head-gear of an infant should admit of the free passage of the air inhaled and exhaled both by day and night.

Perambulators, under careful guidance, are a real boon to both nurse and child. If a babe be healthy, and the weather suitable, there is no reason that infants should not from the commencement take daily exercise in a perambulator. For this purpose the little carriage should be fitted up with a movable compartment, admitting of a horsehair mattress and pillow being placed within. Any light frame-work, if wood, will suffice. The bottom of the compartment should be made of perforated zinc. From the writer's own experience children from the age of six weeks thrive better when exercised in the open air in the manner described than when carried in the nurse's arms. Less fatigue in carrying ensures less risk from the nurse sitting down to rest. It is seldom that cold is taken when passing briskly through the air; standing still in draughty places is always most carefully to be guarded against. The portable bed has also the advantage of enabling two little ones to be exercised in a double perambulator at an age when two nurses would be required to afford separate exercise to each child.

When the exercise of walking alone ceases to be a pleasurable excitement, some inducement is generally needful to get little folks along. The daily walk consequently becomes a trial of pastime to nurse and child. The best way to obviate this difficulty is to make the walk a secondary object, and some attendant amusement

the ostensible one. Playing at horses is an excellent game, and so likewise is the wearing of a bell harness, composed of broad woollen webbing across the shoulders, laced in front, and fastened with a buckle at the back. Pressure upon any one part of the body is thus avoided, and by means of the front-lacing the harness may be worn by children of various sizes. The glitter and jingle of the small sledge bells, and the gaily-coloured reins, prove irresistibly attractive to both horse and driver.

Muscular exercise, adapted to more advanced childhood, has received an important accessory in the form of gymnastic apparatuses, of great variety and simplicity. They are made for different classes of strength, and are designed to bring every muscle into play.

A small ranelagh will also be found very useful for expanding the chests of children after long sitting over their books or writing, or needlework, and possesses the advantage of being easily suspended on a hook in any room. Girls as well as boys should be accustomed daily to use the ranelagh for a few minutes at a time. Ranelaghs may be purchased at very trifling cost at most india-rubber warehouses.

FURNITURE.

III.—BEDROOM FURNITURE (*continued*).

MEDICAL men consider it the more healthy plan to sleep on beds with as few draperies as possible. With a view to promote healthy slumber, and yet have ornamental surroundings, furniture-makers have again brought into general use the Arabian bedstead, in wood, iron, and brass, which they term "half-tester," and "canopy," according to the pattern. No matter what draperies or hangings these bedsteads have, they always look well. Some draperies are enormously expensive, others by no means costly, and with the slightest addition of fringe or band of pattern of colour may be made very pleasing to the eye. Of the latter, undoubtedly white dimity—or its equivalent in an inwoven pattern of white with alternate stripes of dimity—is the best. It is easily washed, and then looks like new; and it lasts many years. The outside head valance should have a deep white bullion fringe, or netted lace; the inner one should be quite plain.

Another variety is of dimity, with a chintz or coloured cambric border, about three inches wide, to the valance and curtains, either of scarlet Turkey-twill or washing-mauve cambric. Moreover, these white hangings are helps to cleanliness; not a speck or an insect can sully their purity without a chance of speedy discovery.

Chintz furniture lined with a complementary colour is handsome and fresh-looking. The expense of both chintz and lining will not exceed that of a good quality of dimity. In towns, and places where white rapidly changes to a dingy yellow, chintz is to be preferred. A bedstead of iron, similar to that in page 184 (Fig. 2), and ornamented in colours and gold, can be purchased for £2 8s. Chintz furniture, lined and made for the same, would cost £3 17s. 6d. This expense would of course vary more or less according to the colour and quality of the material. A chintz with several colours is costly; one with two or three comparatively less so. Care should be exercised, in selecting lining to a chintz, to have a tint that will contrast well with the complexion. A pale green will impart the cadaverous hue of sickness; a buff has no contrast with the skin. A pale pink or blue suits well, but strong dark colours are to be avoided. When chintz hangings are soiled they should be sent to a cleaner's, to be washed and calendered; but if this process be too expensive—about 2½d. or 3d. a yard—they may be washed at home in a lather made with hot water, ox-gall, and curd soap, and afterward rinsed in alum-water, and dried in a shady place. The ox-gall preserves all colours, but articles

washed with it require to be exposed for some time to the air to destroy the peculiar odour of the gall, but not in the sun, or where there is a very strong light. As calendered or glazed articles last three times as long as when unglazed, the expense is not really so great as it at first seems.

Brass bedsteads are many of them to be greatly admired for their exquisite beauty and lightness of appearance. They are sometimes lacquered to prevent tarnishing. They are somewhat expensive, varying in cost from £4 15s. to £20 for one of full size. The difference in price arises not altogether from the more or less artistic beauty or elaboration of design, but from the quantity of iron, instead of the more costly metal, which is used in their construction, and also the greater or smaller diameter of the head and foot pillars. A five feet wide bedstead—all brass—without much ornament, would cost



Fig. 1.

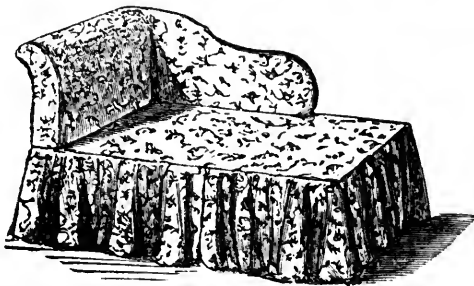

Fig. 2.

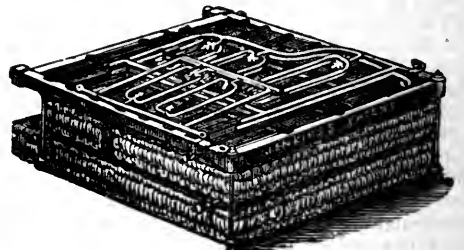

Fig. 3.

about £12 10s.; but with only the foot rail of brass, and the remaining part of iron, the difference less in expense would be £4.

One word may be said here about the foot-rail of a bedstead—never to purchase one without it, if comfort be studied.

For entire brass bedsteads, hangings of rich striped chintz, with pink lining, seem to be the silk and lace, with cords and elaborate tassels, or a only appropriate furniture to contrast well with the brilliant brass-work. The illustration, Fig. 1, shows such a bedstead with hangings complete.

A French pattern brass bedstead, with hangings, is elegant when the hangings are disposed artistically by

being drawn through two united rings of some fanciful flat device, or as a true-lover's knot, or any other quaint design, so that it be not a single ring. This support for the drapery is screwed into the ceiling, in the same position and distance from the wall as the centre front of a tester would be in a half-tester bedstead. The hangings or drapery, in two pieces, cut of four breadths wide, are measured, slanting over the bedstead, from the screwed ornament slanting to the ground, and three-quarters of a yard, or more, of extra material to be allowed on each piece beyond the actual measurement. This is now drawn up in a bunch—not on the selvage side—and thrust through one of the rings, where it is secured by tying a tape round the material and fastening it to the ring, but concealing the tape. The second piece is arranged in the same manner, and then the

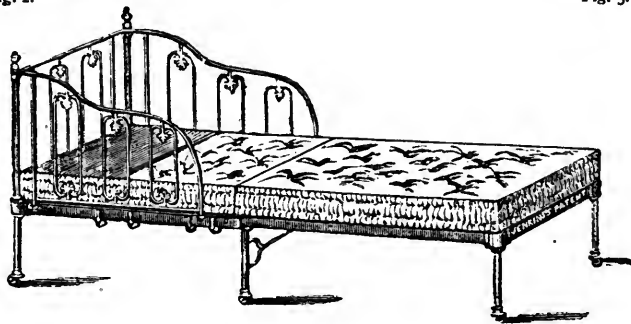

Fig. 4.

two puffs are pulled out in front as full as possible. Two sides of the curtains fall down at the back, and are then trimmed to form a head-piece. The remaining portion falls over the sides of the bedstead in two curtains, which are looped back in the day time, each by a broad band of ribbon bordered with silk

gimp, mounted on stiff buckram, and looped with a concealed cord, the colour of the ribbon, to each pillar of the bedstead.

The material for this furniture may be of a broad-striped chintz, lined with pale pink, or of white dimity, or damask dimity bordered with a handsome stripe of chintz—of course bordered only on three sides, but not those which

are drawn through the rings. This is very graceful, is inexpensive, and when washed and ironed, always looks as good as new.

In France great taste is shown in the arrangement of the drapery of a bedstead. It is often placed in an alcove in a sitting-room, one side of the bedstead not projecting beyond the walls, which are level with it. Overhead hangs a drapery of silk, relieved with lace or white muslin.

A most convenient form of bedstead, and which takes up but little room, is convertible into a couch by day, and can be shortened or lengthened at pleasure, to form either a child's cot, or, at night, a bed for an adult. The mattresses and pillows necessary for this arrangement are sold with the bedstead, which is two feet six inches wide. It can also be folded into a small compass, and be placed away, or taken as a part of travelling equipment.

The best form we have seen of corresponding good taste, with the advantages of English manufacture, is that figured in the accompanying cuts, Figs. 2, 3, 4. They are manufactured by Messrs. Burton, of Oxford Street, the well-known ironmongers and general furnishers, who have certainly attained a high degree of perfection in every department of bedroom furniture.

In a long and narrow apartment—if means are limited, so that one room only can be used for both bed and sitting-room—the space at the end of it can be utilised, and the greater equality of proportion will make the room appear more square, and longer even than its original size. We will imagine that one side of a bedstead, whether of brass or iron, is placed against the centre of the wall, at the head a portable closet, Figs. 5 and 6, with shelves and a deep drawer; at the foot an enclosed washstand, and the whole hidden by a damask curtain of the width of the room; the curtain, hung upon a brass or mahogany rod, supported by three iron staples screwed into the joists of the ceiling. The whole affair, bedstead, press, washstand, and curtain, will not cost more than £10.

Four-post Bedsteads.—The materials composing these are wood, brass, and iron, or a combination of the latter two. They are of two shapes—the oblong tester and the tent. For the latter, the whole of the hangings, including the curtains, are generally made in one piece, but in this way the furniture is troublesome to wash. It

is better to sew the curtains on to the head, foot, and sides of the bedstead. The curved iron of its roof is to be covered with list or strips of old flannel; tapes are not thick enough. Each curtain, of which there are four, is made of three breadths of wide or four of narrow dimity. The measurement for the hangings commences at the bottom of the head part, a little below the laths, and is continued over the tester or domed roof to the foot. As dimity shrinks much in the washing, a half yard extra must be allowed for it, and it may be folded in at the head or foot. The lining should be measured in the same way, the position of the bars of iron marked in it by creases. Upon the end of these, four strings of two ends each, should be sewed, that the lining may be tied to the bars. A covered button on the right side conceals the sewing on of the

strings. The white dimity is now put on outside of this. The curtains must each have a deep hem, to allow of the material shrinking, and be measured from the highest part of the bedstead, and after the first is cut and sloped, the remaining curtains can be cut from the dimity so as to save the material, by utilising the space occasioned by the slope of one curtain to the slope of another. The curtains should be sewed on to be easily removable, but must be first gathered to the right size, and bound with red lace, a white binding sold for the purpose, and a plain band of the same sewed inside the binding, and by this the curtains are sewed on. As the bed-lace shrinks in the washing, it must not be strained in sewing it, but rather put on full.

The canopy bedstead is an extremely pretty and inexpensive style. One six feet six in length, by five feet, can be had for less than forty shillings; with this the drapery is in one length, and secured to the centre top bar by strings of ribbon. All hangings of this kind should have a deep bullion fringe at each end, to keep the furniture even and heavy where most needed. The width of it should be four times that of the bedstead, and this will admit of its falling over on each side, thus forming a curtain. A lining may be added in the same way as directed for the tent shape.

Four-post bedsteads, of mahogany or other wood, are even now by many persons preferred to a less heavy form. Those who take pride in a large and imposing-looking bedroom will find a handsomely-carved bedstead of this description add much to the appearance of the apartment, provided it be furnished with damask hangings of wool or silk, the valances trimmed with deep fringe of the same colour as the damask, and relieved by silken cords and tassels of a well-contrasting colour. The foot curtains, too, may be useful in shutting out the light, if it be too intrusive, instead of using very dark blinds, which always cast a gloom over everything. The entire absence of bed furniture from the tester will effectually prevent that closeness in the atmosphere which would occur if the tester were covered, and the omission will detract little if any, from the beauty of the bedstead. Crimson or green damask should have a bullion fringe of the same shade of tint as the material, but this should be relieved by maize-coloured silken hangers, which are sold from ninepence each, and upwards. The binding also should be a mixture of the two colours. Such would cost from £12 to £20. Whether the furniture be white or coloured, it is well at all times to place and fasten a calico sheet, or an equivalent for it, entirely over the tester, if there be one, and down the back of the head of the bed, for the purpose of effectually excluding the dust; also, for the same purpose, the bottom valance should be lined with dark glazed lining.

Instead of iron rods, formerly in use for the curtains to run on, when attached to small brass rings, and which were concealed by the double valance, which is now dispensed with, large and handsome-looking rods or poles of the same wood as the bedstead, are now used. On these are slid wooden rings having brass eyelets, through which



Fig. 5.

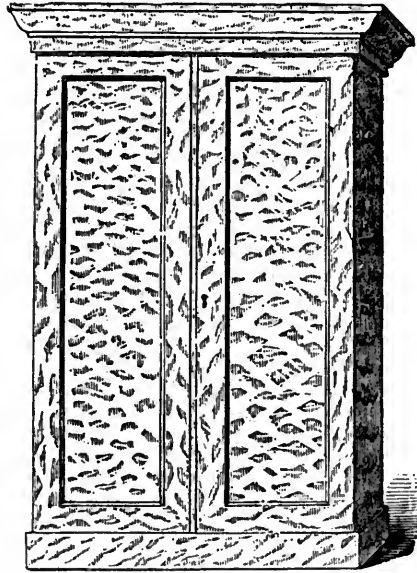

Fig. 6.

the hooks in the curtains are passed. One great disadvantage of these wooden rings is, that with a slight motion, even that caused by a person walking overhead, the rings, if close together, rattle, which is an annoyance even to an ordinary sleeper, and is a weariness to an invalid. An improvement upon wooden rings is to have them of india-rubber. Metal rings should never be used.

HOME GARDENING.

THE VEGETABLE GARDEN (*continued*).

ROTATION, or change of crops, is a matter of much importance, as it is well known that each sort of plant requires a somewhat different nourishment, so that one crop may immediately succeed another, but it should be contrived that a wide crop should follow a close one, or a close crop a wide one. The seasons for planting or sowing the different vegetables should be particularly attended to, in order that each may be obtained as early as its nature will permit. Another very important subject is the selection of seeds of the best kind. The quantity of ground to be sown or planted with each kind of vegetable must be determined not only by the size of the garden, but by the demands of the family. At the same time, it is advisable to sow or plant rather more of each sort than you are likely to want. No exact rule can be laid down in order to proportion the crops properly, or as we could really wish, and therefore the cultivator must, to a certain extent, use his own judgment.

The duration of crops varies to a very great extent. The principal or best time for propagating the different kinds of vegetables is in the spring months—namely, February, March, and April, for crops to come on in summer; while smaller portions for succession during summer and autumn may be sown or planted between the months of April and October. The season for pricking out and planting each crop must be well attended to, doing it as soon as the seedlings or plants are sufficiently large for the purpose, and allowing ample room between each, without which they will neither grow large nor be well flavoured. The thinning out of the various seedling crops should likewise be attended to before the young plants have drawn each other up too high. All kinds of vegetables grow stronger, and arrive at greater perfection when there is a free circulation of air between them, and the sun is not impeded; and for this reason we advise a bountiful supply of both, as soon after the plants make their appearance above ground as possible. As a rule, people are afraid of taking out a sufficient number of seedling plants, excusing themselves by exclaiming, "What a pity to pull them up; what a waste!" and so forth; but they little think that by overlooking or neglecting such a precaution they frequently lose half or two-thirds of their crops. But we consider it a much greater pity to permit any crop to grow at will, so that plants choke or destroy one another. Of course such a state of things does not exist with those who have had any experience, and for this reason we wish to impress upon other minds the importance of timely thinning in all cases. The eradication of weeds is of equal importance; at all events, where beauty and order is the first consideration; and it should be, both as regards appearance and the health of the plants. Very many gardens promise to supply abundant crops, and would do so if the cultivator, either from negligence or fear of expense, did not expose them to destruction by obnoxious weeds, and his ground to be robbed by them of its richness. The best way to get rid of weeds is either by hoeing or pulling them up by hand, and either to expose them to the sun and air to wither, or, what we consider much better, to burn them on the spot, or throw them on the refuse heap and kill them by fermentation—so long as they are deprived of vitality it does not matter by what means. Watering is a matter of much import-

ance, as it not only affords a proper degree of moisture but is of service in bringing the soil into a right condition for performing its various functions or offices—in a word, dry earth of itself has little effect, but when moistened it has the property of decomposing atmospheric air, and of conveying its oxygen (the air we breathe, and which is alike essential to the support of both animal and vegetable life) to the roots of those plants which vegetate within it. It also performs an important part in most of the changes which take place both in the animal and vegetable kingdoms. Watering, however, in some cases, we look upon as productive of more harm than good; as in using hard or calcareous water, which if abundantly applied will taint the vegetables, and, to a certain extent, injure the surface of the ground. Rain water should always be used, if possible, but when it cannot be obtained, resort must be had to pump or spring water that has been exposed long enough to become impregnated with the sun's rays. The time of watering must be regulated according as the weather is cold or warm—that is to say, water in the evening from the commencement of June to the end of September; but at any other time of year we prefer the morning for the operation, although it is safe to moisten anything after sunset. Vegetable crops generally are gathered by degrees, or we may say the gathering should be commenced as early as possible, and be continued as long as there is any produce left. At the same time no portion of a crop should be touched until it has attained a certain or proper degree of maturity, nor after it has begun to decay. In respect to the degree of maturity, a line must be drawn, as it very much depends upon the particular taste of the growers; as in the case of cabbages, some esteeming them most while open and green, and others not until they are fully headed and blanched. The operation of gathering vegetables is performed either by cutting, as in the case of cabbages; by pulling or breaking, as in the case of peas, beans, and similar productions; or by drawing or digging up, as in the case of turnips, onions, carrots, parsnips, potatoes, celery, and the like. In the performance of these operations due regard should be had to those roots that will ultimately have to be stored away for future use—such as carrots, parsnips, potatoes, &c., so as not to bruise them, as in such case they will either rot or lose their flavour. As soon as each crop is over, the roots and other remains, which domestic animals will not eat, should be removed to the compost heap or dung yard, as such refuse is unsightly on the ground, but invaluable as manure.

Manure.—This is one of the most important requisites for the garden; the productive power of the soil is continually weakened, and its nutriment extracted by the crops grown upon it, and it is necessary to replace this by artificial means. Any substance which, by being mixed with soil, promotes vegetable growth, is called a manure. Various substances are so employed; some in their natural state, others in a manufactured condition, and act upon the productive power of the soil with different degrees of intensity. For the ordinary vegetable garden the simplest manures are most generally used, as being most easily obtainable, and satisfying every requirement. Horse manure is the most generally used of these fertilising substances, and it is generally found most advantageous to use in a half-rotted condition. As a rule, the better the horses are fed the more valuable is the manure. It is certainly most economical to use it as fresh as possible; but it is very difficult to work it into the ground satisfactorily, as it is apt to clog the spade, and render the digging a difficult process. Where possible, the best mode of applying horse manure is to dig it in an inch or two below the surface of the soil along each side of the plants it is intended to benefit. Cow manure is frequently employed in the garden; but its fertilising powers are by no means so great as

that of horse manure. It is most frequently used as an ingredient in composts for potted plants. Cow manure should be gathered fresh, kept in a dry place, often turned over, and broken into small pieces before using. The other unmanufactured manures generally available, are those from the piggery and hen-roost, which are very valuable, and often the only manures obtainable by the cottager. Liquid manure, either specially manufactured from fertilising substances in a dry state, or merely as the drainings from the manure heap, is most generally used for stimulating the growth of fruit and flowers. Of the special application of other manures and fertilisers, such as lime, salt, guano, sand, peat, and the like, we shall speak when we have to discuss the treatment of the various plants, for which they are specially valuable. It is only of late years that attention has been turned to the employment of sewage as a manure—in this country, at least, for in many others its value has long been recognised. Its disagreeable odour long prevented its being generally employed; but great ingenuity was brought to bear upon the subject of deodorising it. Mr. Moule, by his simple invention of the earth closet, has at last succeeded in reducing all the drawbacks of sewage manure to a minimum, utilising valuable substances hitherto wasted, and removing from our houses noxious smells which poisoned fresh air, and produced diseases innumerable. Mr. Moule thus states his case:—

“The earth of the garden, if dried—or dried and powdered clay—will suck up the liquid part of the privy-soil; and, if applied *at once and carefully mixed*, will destroy all bad smell and all nasty appearance in the solid part, and will keep all the value of the manure. Three half-pints of earth, or even one pint, will be enough for each time. And earth thus mixed *even once* is very good manure. But if, after mixing, you throw it into a shed and dry it, you may use it again and again; and the oftener you use it, the stronger the manure will be. I have used some seven, and even eight times; and yet, even after being so often mixed, there is no bad smell with the substance; and no one, if not told, would know what it is.

“The proper way to apply it to your garden is either to powder or sift it, and scatter it in small quantities over your seed beds of cabbage, turnips, onions, or lettuces. Or, if you are putting in peas or beans, then mix with water about half a pound, according to its strength and the length of your drill, and put it in with five or six gallons of water. If you are putting in plants, use water in the same way. Make a good hole with your setter, and fill it with the thin mud. One pound weight of that which has been mixed five times is quite enough, if used in this way, for six dozen broccoli or cabbage plants.

“But now, how is this plan to be worked out? At once fill up your privy vault. Let the seat be made in the common way, only without any vault beneath. Under the seat place a large bucket or box, or, if you have nothing else, an old washing-pan. A bucket is the best, because it is more easily handled, only let it have a good sized bail or handle. By the side of the seat have a box that will hold (say) a bushel of dried earth, and a scoop or old basin that will take up a pint or a pint and a half, and let that quantity of earth be thrown into the bucket or pan every time it is used. The bucket may be put in or taken out from above by having the whole cover moved with hinges, or else through a door in front or at the back.

“If you can make a place into which you could go from your upstairs room, there would be no need of a bucket or pan; earth and all might fall into the place below (which would of course be enclosed), and there it might at once be mixed and dried.”

In our articles on the Construction of the House we shall have occasion to allude again to the employment of this valuable invention.

THE HOUSE.

DRAINAGE.

In building or purchasing a house in London and other large towns, we usually find some system of general drainage, if the roads have been formed, and therefore we may confine our attention solely to the proper drainage of the house.

In country places where there is no system of drainage, each house has to be drained separately, and the subject being more complicated, professional advice should be taken as to the best mode of disposing of the drainage.

There are two systems of drainage generally adopted in the country—viz., by draining into some adjacent water, or by cesspools and liquid manure tanks. The first mode of getting rid of the drainage is generally considered preferable to that of cesspools, provided that the water we drain into is some river or running stream of sufficient depth and velocity to carry off the drainage; for if the water be shallow, or merely a pond that is likely to become stagnant, we are in danger of poisoning not only the water but the air of the neighbourhood, and so of becoming a serious nuisance to our neighbours.

Cesspools should be carefully constructed of good substantial brickwork, built perfectly impervious, so as to prevent the possibility of escape of liquid sewage; for this reason they should be sufficiently far removed from the nearest point of any dwelling-house—at least, a hundred feet—to allow of the cesspool being periodically opened for the purpose of cleansing or emptying. Care should also be taken that the cesspool is not constructed near any well, where water might become contaminated by any percolation of drainage matter from the cesspool. The drain-pipes from the house in connection with the cesspool should not be laid along the walks in the garden, or in any position where it may be inconvenient to open up the ground for the purpose of examining them. If possible, every cesspool should have an overflow pipe to take off the surplus liquid matter, which is comparatively innocuous, and can be drained off into some neighbouring ditch or water or liquid manure tank. By this means the contents of the cesspool can always be maintained at the same level, and all danger of an overflow is avoided; moreover, the necessity of frequent emptying is obviated, a practice always to be avoided as much as possible.

The uses of cesspools in conjunction with open privies in London and other large towns, is, we are thankful to say, now almost unknown; and, indeed, where there is a general system of drainage, such a practice is illegal, and cannot exist. But where such things do still exist, every precaution should be taken not only that the privy is properly trapped, but that it should be supplied with water, and the cesspool substantially constructed of brickwork with an overflow. For cottages in rural districts the cesspool might take the form of a liquid manure tank, one of which might be made large enough to serve two or three cottages. The liquid contents can be drawn up by means of a well and pump, but whether a cesspool or manure tank be employed to take the soilage, in both cases the water-closet should be trapped with an ordinary syphon trap, and if constructed over the cesspool or tank, an extra length of pipe should be affixed to dip into the sewage. By this means the air of the cottage in the immediate vicinity is kept comparatively pure.

Construction of House Drains.—House drains are generally constructed of two materials—viz., of brick, or earthenware and stoneware. The chief point to be considered in the construction of drains is, that they should be perfectly air tight and thoroughly efficient—that is to say, they should offer no impediment of any kind to the easy passage of any sewage matter that may have to pass through them. Drains constructed wholly of brick or on this account are unsuitable for ordinary drainage, par-

ticularly in small houses, as, from their mode of construction (of rectangular bricks and mortar or cement) they cannot efficiently fulfil these requirements; they cannot be made perfectly air tight, thus allowing the escape of noxious gases and perhaps liquid matter, and the imperfections and irregularities which necessarily occur in the construction of the joints, seriously interfere with the easy and free passage of sewage matter, particularly when it is reduced to small quantities of semi-liquid matter. There is no portion of ordinary house building so likely to be neglected and carelessly done as the construction of the drains, and unless the workmen are thoroughly superintended, constant mistakes will occur which cannot be rectified after the drains are covered in and the house inhabited, without great annoyance and discomfort to the inmates; thus, we have known instances where drains have become choked up, causing, of course, the most unpleasant smells in the house (which are very often put down to other causes), merely through the carelessness of the workmen, who in building the drains, have allowed large pieces of mortar to tumble into the drain—this is a very common occurrence in brick drains. For these and other reasons we confidently recommend pipe drainage as being in every way preferable to brick, particularly for ordinary sized houses; great care, however, should also be taken in their construction. We think the best drain-pipes that are now made are the vitrified stoneware; these are to be preferred to the glazed earthenware pipes which are cheaper, but are neither so strong nor durable as the vitrified, and the inside is apt to become corroded with the sewage matter, which, when removed, causes the half-burnt earthenware to absorb the foul water, and thus the pipe soon becomes decayed and worthless. There can be no falser economy than the use of inferior materials for drains, for if they are not properly constructed in the first instance and of good materials, they are sure to become an endless source of annoyance. Soil pipes from water-closets when possible should be of lead, not iron or earthenware, the latter are of course cheaper than lead, and galvanised iron pipes are therefore very commonly used in cheaply built houses. They are not, however, to be recommended, as they are sure to corrode in the inside and require repair, which, from the ordinary position of soil pipes inside houses, either in angles or in chases in the walls, is always to be avoided as much as possible. Waste water-pipes from sinks may be of lead or earthenware, though lead are of course preferable; great care should be taken that they are not made too small, as from the greasy matters that are sure to pass through them, they are soon apt to get choked.

Size of Drains.—With respect to the size of drains, the chief point to be remembered is that, whilst they are made sufficiently large to ensure an immediate discharge of all the matter that may have to pass through them, at the same time care should be taken that they are not made too large to ensure this object. There is quite as much danger in having the drains too large as too small, as in the former case, when the sewage matter is reduced in quantity it is apt to become sluggish, and will not pass

freely through the drains, particularly when the fall is very small, as is but too often the case.

Fall.—House drains should not have a fall from their head to the junction with the sewer of less than one inch in every ten feet, and more than this where possible; unfortunately, however, from the prevailing custom, particularly in London, of having all the kitchen offices in the basement of the house, and below the level of the streets, there is great difficulty in getting a good fall for the house drains, which are often laid with little or no fall at all. We think, however, that for small houses containing from eight to twelve rooms, a six-inch pipe drain (if laid to a proper fall) will be found amply sufficient, whilst a nine-inch drain will suffice for houses of the largest size. Pipes of larger size than this can only be required in very exceptional cases, such as schools,

hospitals, and manufactories, or where there may be large quantities of water used. A five-inch soil pipe will be found sufficient for water-closets, and from one and a half to three inches for the waste pipes of sinks. Care should be taken to see that the joints of the drain pipes are properly executed in cement of the best quality, and not in clay or mortar, it being of the greatest importance to prevent the possibility of any escape of effluvia or liquid matter through the joints. The pipes should be laid with their socket joints in the direction of the fall. In cheaply built houses it is not an uncommon practice for workmen to connect together drain pipes of unequal diameter, concealing the ill-fitting joints by cement. We need not say that such a dangerous practice will be sure to attract attention sooner or later, as, in truth, all the dodges that may be resorted to by careless workmen in indifferently built houses. The connection be-

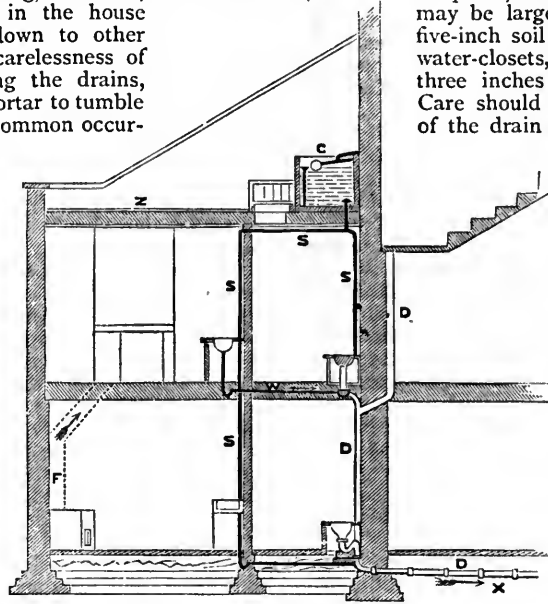

Fig. 1.

tween the house drain and the public sewer is a matter of such importance that it is now generally undertaken by the district board of works, under the direction of their own surveyor and workmen; and in London and most towns it is the duty of the board of works to see that all house drains are properly constructed and trapped, and they have power to compel the owners to have the same altered and improved when not so done. We may add that the level of the drains should always be kept as high as possible, so that the connection with the main sewer may be above the invert. It is not an uncommon practice to find houses built in new districts before the roads are properly formed and the main drainage completed, and in such cases cesspools are made in the rear of the houses to receive the drainage until the main sewer is formed; and when the connection is made between the house drainage and the sewer, the cesspool is apt to be forgotten or not properly emptied and filled up, thus causing great annoyance.

Traps.—We come now to perhaps the most important portion of our subject—viz., the trapping of drains or the means that are generally taken to prevent the escape of foul air from the drains or sewers into houses or yards. The preservation of the purity of air in every house, and therefore to a great extent the health and comfort of the inmates, depends very much upon this apparently simple question. In the first place, as simplicity should be the

guiding principle in everything connected with house drains, so the number of connections that may have to be formed with the drain should be as few as possible, as each junction will require to be separately trapped in addition to the connection between the drain and the main sewer. The traps should be of the simplest form, and the least expensive; perhaps the best form of trap and the least liable to get out of order or require cleaning is the common syphon trap, made of the same material and of the same length as the drain-pipe. One of these traps should be inserted at the foot of every soil or waste-water pipe where it is connected with the house drain, and also at the junction with the sewer.

Should there be only one water-closet to the house, it may be situated near to the sink, so that the refuse water may enter the same trap as the water-closet, and so help to flush the drain. In all cases, however, the drain should be flushed with water along its entire course, and where the waste from the sink or a rain-water pipe may not be sufficient, a supply must be procured from the cistern by means of the over-flow pipe, of which we shall speak presently. With respect to the ordinary bell traps for sinks and areas, much objection has been found in consequence of the facility with which they are apt to get out of order; this more often arises, however, from their misuse than from any great fault in their construction. Thus, through the carelessness of servants, the waste pipes often get choked up with grease and other matter which should not be trapped at all. The bell trap is then, of course, removed in order to clear away the obstruction, and put on one side for a time (perhaps gets broken), allowing, of course, the free ingress of foul air into the house not only from the house drain, but the sewer.

The remedy adopted in some cases of soldering the top of the bell trap down is, perhaps, worse than the disease, as this will not prevent the accumulation of grease. Various improvements have been made in the ordinary bell traps.

The accompanying drawings show the complete arrangement of the drainage for water-closets, lavatory, sink, and yard for an ordinary house, in which the chief object has been to collect all the waste-water pipes at the head of the drain behind the water-closets, in order to flush the drains along their entire length.

The basement plan, Fig. 4, shows a scullery twelve feet by eight feet six inches, with copper and sink; behind this there is a water-closet for servants; on the ground floor above, Fig. 3, a smoking or gentleman's room, with fireplace and lavatory; and another water-closet above the one below. The other plan, Fig. 2, shows the lead or zinc flat above, with a cistern to supply the two water-closets, lavatory, and sink, also a small skylight to light the water-closet. The section, as shown in Fig. 1, is taken through the two rooms and both the water-closets, and is intended to show the various soil and water pipes with their connections, &c. The waste pipes from the lavatory and sink are intended to

lead into the water-closets to assist in flushing the pipes. There is also a junction between the rain-water pipe and the drain. In addition to this the head of the drain would be ventilated by the rain-water pipe, of which we shall speak presently. All the traps are indicated on the plans by the letter T. The water-closet on the ground floor is trapped with a D trap (as being a superior closet), while the other water-closet in the basement would have a stoneware pan and syphon trap; there would be a syphon trap also at the foot of the rain-water pipe, and there should also be a cast-lead syphon trap to the lavatory and sink, but no bell traps are used, the sink having merely a grating to prevent the passage of rubbish. Underneath the foot of the rain-water

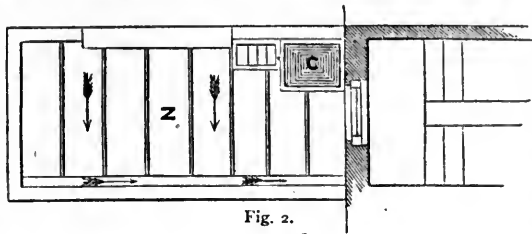

Fig. 2.

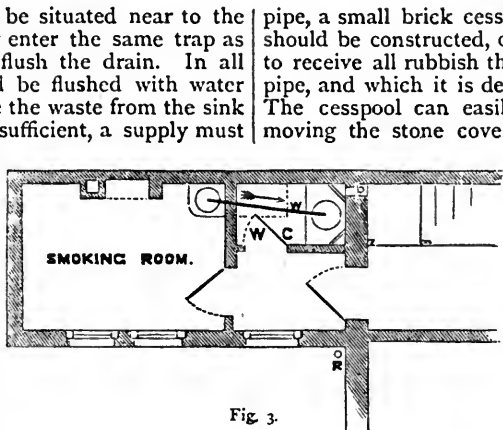

Fig. 3.

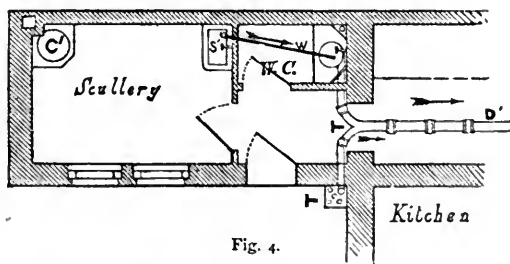

Fig. 4.

pipe, a small brick cesspool about fourteen inches square should be constructed, covered with a five-hole sink stone to receive all rubbish that is sure to be washed down the pipe, and which it is desirable to exclude from the drain. The cesspool can easily be cleaned out by merely removing the stone covering. A syphon trap is fixed in the same, and connected with the drain. This arrangement is shown in the illustration, Fig. 4.

The *Ventilation of Drains* is another matter that is not so generally attended to as its importance deserves. In most houses the only mode of ventilating the drains is by means of the rain-water pipes; when this is the case, the head of the rain-water pipe should on no account be situated near any window (as is very often the case), thus allowing the entry of foul air direct from the drains into the bedrooms. The better plan is to construct a proper ventilating pipe or shaft direct from the drains, and terminating above the roof, where the foul air is perfectly harmless; another plan would be to utilise tall chimneys as ventilating shafts; in any case the ventilation of drains is a most important matter, and should be as near the head of the drain as possible. Traps, however good may be their construction, are always liable to get out of order, and cannot be implicitly relied upon to prevent the passage of foul air, as the water in them may become dried up by evaporation.

Inspection of Drains.—In concluding these remarks upon drainage, we would add that it is most important to have ready access to the drains for the purpose of inspecting or cleansing them. Most people are acquainted with the serious inconvenience of being obliged to have the drains uncovered; thus it is most important, in the first place, that the drains should be so laid as to cause the least possible inconvenience when this is required to be done; and we should very strongly urge every one who rents or purchases a house to procure from the builder a rough plan, the preparation of which need cost but very little, showing the complete system of the drainage. Some people are of opinion that drains should never be laid inside the house at all, and that all water-closets and sinks should be situated close to an external wall, so that the soil and refuse water may be

inspected or cleansed them. Most people are acquainted with the serious inconvenience of being obliged to have the drains uncovered; thus it is most important, in the first place, that the drains should be so laid as to cause the least possible inconvenience when this is required to be done; and we should very strongly urge every one who rents or purchases a house to procure from the builder a rough plan, the preparation of which need cost but very little, showing the complete system of the drainage. Some people are of opinion that drains should never be laid inside the house at all, and that all water-closets and sinks should be situated close to an external wall, so that the soil and refuse water may be

discharged into the drain outside the house. No doubt this would be an excellent plan, as it would, in a great measure, prevent much annoyance to the inmates of a house; but, unfortunately for many reasons, it is very difficult to carry out, more particularly in towns, where the water-closet is often placed in the yard, or in the rear of the house, and has to be connected with the main sewer which runs along the street in front. We think, however, that the inconvenience of the plan now generally adopted in towns, viz., of carrying the drain through the house, is capable of being reduced to a minimum by simply adopting ordinary precautions, and seeing that the work is *thoroughly* and *efficiently* carried out.

We have endeavoured in these remarks upon drainage to render the subject as intelligible as possible to our readers. In conclusion, we would again say that it is a matter that should never be neglected, and we earnestly recommend any of our readers who may intend purchasing, renting, or building a house, to ascertain that at least three conditions have been fulfilled with regard to the drainage:—

1. That the house has a separate and distinct drainage, properly connected with the main sewer.
2. That the house drain is efficiently constructed of proper stoneware pipes laid to a sufficient fall.
3. That *all* connections with the drain are properly *trapped* to prevent the escape of foul air.

THE HOUSEHOLD MECHANIC.

GAS.

A PROPER and correct understanding of the composition of gas, and the best appliances for the obtaining of artificial light and heat from it, is one of the most important branches of domestic economy; and when we consider the frightful waste resulting from a want of appreciation of its principles, and of the danger of fire or explosion which may arise to a community from ignorance or carelessness on the part of any single individual, we feel sure that it is impossible to make the subject too plain, or to bestow too much attention upon it. How many lamentable accidents would have been avoided, even by a most superficial knowledge, it is needless to mention; but we feel that few people appreciate the necessity of economy of gas as its real importance and magnitude would warrant. Coal gas is obtained from various kinds of coal by distillation at a great heat, different varieties of that mineral producing more or less economical results. We do not, however, intend even to touch on the manufacture of gas in the present paper, although we may in some future paper give sufficiently clear instructions to enable those of our correspondents who live in neighbourhoods where gas is not procurable, to make it for themselves. We have here to deal with the consumption of the manufactured article in the best possible way. Nor is it for us here to deal with the chemical composition of gas, except just so far as is absolutely necessary in order to understand the principles of its combustion, though we shall have, in the course of our article, to consider the use of gas in the house, whether for warming or lighting, and its bearing on the health of the occupants.

Coal gas, or carburetted hydrogen, is a certain known combination of the gaseous element hydrogen and particles of carbon in a volatile form. Other elements mixed with the gas in its first stage of manufacture are, to a certain extent, although not altogether, cleared away in the after process of purification. Pure hydrogen, by itself, is incombustible, and will only burn when in combination with oxygen gas or atmospheric air containing oxygen. Again, pure hydrogen, when burnt in combination with air, gives only a very small amount of light, yet it evolves great heat; but when a proper amount of carboniferous particles are mixed up and burnt with a suffi-

cient quantity of hydrogen to make them perfectly incandescent—that is, white hot—the greatest possible light is obtained. We therefore see that we can burn gas in two totally opposite ways, the object being to produce perfect combustion, and the utter consumption of the carbon therein contained, thereby obtaining the greatest possible amount of heat; the other being the burning of hydrogen and oxygen in just such proportions as will produce the greatest incandescence in the particles of carbon, and consequently the greatest light. Let us illustrate this by a simple experiment. Light an ordinary burner, turn it up to the best light it will give, and examine it closely. At the lower portion of the flame an intense blue colour appears for some distance up, where the heat of the combustion has been sufficient to liberate the innumerable solid particles of carbon, and to make them white hot. Now turn up the burner to its highest extent, and, if the pressure is sufficient, the gas will rush out with violence, combining with the air imperfectly, the carbon not being exposed to the heating action sufficiently long to become incandescent. It will thus be seen that the quantity of gas consumed is no criterion to the amount of light produced. If this fact is borne in mind, it will explain the reason for the precise forms of gas-burners we shall have to refer to hereafter.

It will be necessary, for distinction's sake, to divide the whole subject into two heads—viz., lighting by gas and heating by gas. Let us, however, first look into the more practical question of getting a supply of gas to burn, and examine the network of pipes which bring it to us, before we go too deeply into theory. We will suppose that our reader has taken a house into which gas is not laid, and we will trace through each detail he will have to look to in order to get it. First find out the gas company who have mains on the road, to whom write and state the number of burners required. The company will then take the expense and responsibility of bringing in a *service* from their main into the house. It is necessary for them to communicate with the parish authorities before disturbing the roadway; but the householder has no trouble whatever in the matter. The company will also supply a meter (properly tested and attested by a Government inspector) at a certain fixed charge, or, if the consumer desires it, at a regular yearly rental; or the consumer may supply his own meter if he likes, but in any case the inspector's seal is necessary before fixing. The service-pipe once inside the house, and the meter brought, the responsibility falls on the householder, whose gas-fitter now takes up the matter. A tap should be fixed on the service-pipe as soon after its entry into the house as possible, as, in case of fire or escape of gas, it should be altogether turned off at the tap. From the tap proceeds a pipe, usually of lead, to the inlet hole of the meter, and from the outlet another pipe of lead communicates with the in-door service of pipes. The reason for these pipes being of lead seems to be for the convenience of bending them into the curves almost always required; but where the substitution of iron pipes is possible, such a course would be desirable. Concerning meters we will say nothing at all now, as we intend to devote a chapter entirely to the subject. The *service* consists of a series of pipes of various dimensions, and should be contrived after the manner of the arteries and veins in the human body—viz., that each set of pipes should be diminished in size as successive branches off on either side reduce the work it has to do. In an ordinary-sized house of twenty-five or thirty burners, a one-inch main would be ample, and a twenty-light meter; but it would only be necessary to continue such a size and bore a small portion of the whole length, the pipe gradually tapering down to the smallest size of composition pipe, which is about one-eighth of an inch internal, and the bore must be in proportion as the successive points of consumption are supplied.

HOUSEHOLD AMUSEMENTS.—VII.

Impromptu Romance.—This is a pastime well suited to "children of a larger growth," and a company of intelligent young men and women may find it very attractive. The person who commences the game undertakes to relate a story, or rather to begin the narrative, for the story must be taken up and continued by other members of the party. The first narrator assigns to others different characters in the tale, or objects to be incidentally mentioned in it; and whenever one of these characters or objects is named, the person who represents it must immediately take the narrator's place and proceed with the relation as best he may, until he can shift the burden in like manner. If his imagination is not very fertile, or he is unpractised at the game, he can relieve himself of the task by mentioning, as soon as possible, an object which has its representative before him; but whenever somebody more ready or more experienced is called upon, he will do well to keep the narrative up for a short time, by some play of his fancy, before passing it on by the introduction of another name.

Throughout the game some degree of consistency must be preserved by the various impromptu reciters, so that the so-called story may be connected in its various parts, however ludicrous may be some of the turns in the tale during its passage from mouth to mouth.

The rules of the game are, first, that any one who fails to take up the relation immediately the name he has adopted is uttered, incurs a forfeit. Next, that the narrator may at any time pause and point to one of the company to supply him with a word, *contrary to the sense of what has gone before*, which must be immediately done, under penalty of a forfeit; but the word given must at once be introduced into the narration, and this must go on smoothly notwithstanding, or a forfeit is paid by the narrator. To call for a word is therefore an experiment which should not be tried by an unpractised story-teller, but, in the hands of an expert who has sufficient dexterity to turn an awkward word to good use, adds greatly to the general amusement.

To make our description more clear by illustration, we will suppose one of a company to commence a romance, which he entitles, "The Lovely Pettina; or, the Merchant, the Prince, and the Pirate Chief." He allots some of the characters, assuming to himself, say, the *merchant*, while the company suggest others, and also objects to be introduced, such as *sea, ships, bales, black flag, cutlass, dagger, &c.*, until every one present is provided with a name, to which he must respond. The first narrator then proceeds in something like the following strain:—

"Once upon a time there dwelt, in the city of Nowhere-in-Particular, a merchant, who traded with all parts of the world, and was renowned for his wealth. Besides heaps of money, he had vast stores of Indian shawls, nose-rings, tomahawks, jews'-harps, guano, and anchovies, with diamonds, rubies, macadamised flints, and other precious stones. But, above all his possessions, he prized his only daughter, *Pettina*,"—

Pettina.—"The fame of whose beauty had gone wherever his ships"—

Ships.—"Had sailed. She was believed to be the loveliest girl in the world. When she walked in the garden the flowers turned their heads to look at her, and drooped their own afterwards, while the birds admiringly called after her, "Sweet, sweet, sweet!" The *merchant*"—

Merchant.—"Loved her even more for her amiable qualities than for her beauty, and when he looked at her he felt—(here he nods at some one for a word, and receives "disgusted") disgusted at the thought that she had attained twenty summers without some sovereign having offered to share with her his throne. At length the news came one day across the *sea*"—

Sea.—"That her fame had reached the court of the Emperor of all the Indies and of several other places besides, and that his eldest son was on his way to seek her for his wife. The name of this *prince*"—

Prince.—"Was Ramjamjee Howareyoumabhoy, and when he heard of her charms he had (looks for a word, and gets "skedaddled") skedaddled as quickly as possible into his father's presence, and, knocking his head twelve times on the floor, according to the custom of the country, humbly asked permission to go and pay court to the beautiful *Pettina*,"—

Pettina.—"The Emperor was in one of his most amiable moods. The *merchant*"—

Merchant.—"Had just sent him twelve tons of explosive lollipops, of which he was very fond, but they had narrowly escaped falling into the hands of Crossbones, the *pirate chief*,"—

Pirate Chief.—"Waving his sceptre three times round his head, the emperor looked at the *prince*"—

Prince.—"And, smiling affectionately, pointed to the door with the simple remark, 'Hook it!' Ramjamjee obeyed, and as he vanished, the emperor, with great dignity, took off his slipper, richly adorned with jewels, and threw it after him, for luck. The prudent lad hastily picked it up, and put it in his pocket to help to pay expenses, for it was his intention to take with him several *bales*"—

Bales.—"Of Cashmere nightcaps for the giants of Patagonia, where he intended to touch on his way. As soon as possible he started, but not without taking with him a wonderful *dagger*,"—

Dagger.—"Which had been given to him by his grandmother, and which was said to have been fashioned by a great magician. This dagger had the peculiar power of twisting itself up into three knots in the body of a person struck with it, so that it made a very—(looks for a word, and has given him "beautiful") beautiful case for a doctor, and few people who ran against it wished to try it a second time. Very proud of it was the *prince*,"—

Prince.—"And he had made some verses upon it, which were set to music by a composer, very celebrated in those countries, and known by the name of Oftenbark. He had gone some distance of his journey, and was one evening whistling 'The Dagger of my Grandmother' on the quarter-deck of his *ship*,"—

Ship.—"When, low on the horizon, there appeared a (nods for a word, and "porcupine" is given him) porcupine-like object, which proved to be the vessel, bristling with masts, of the *pirate chief*,"—

Pirate Chief.—"He had heard of the sailing of Ramjamjee Howareyoumabhoy, and had sharpened his *cutlass*,"—

Cutlass.—"Making a solemn vow to take his vessel, kill him, and sell all his treasures for the improvement of his own model farm. So now, hoisting the *black flag*,"—

Black flag.—"He made all sail after his prey, and a terrific combat ensued."

Here we may leave the story, as the reader will guess how the prince would probably be made, in the course of the narrative, to vanquish the pirate, and to be successful in his suit for the hand of the fair Pettina. We have given no indication of the incidental forfeits, but the game would scarcely proceed so far as this without giving rise to several. It will be observed, too, that the character of Pettina, for instance, is supposed to have been assigned to a lady unfamiliar with the game, who is therefore anxious, as soon as the narration comes to her turn, to pass it on to some one else.

Any degree of humour or gravity may be imported into the pastime, according to the disposition of the company, who may, if they please, choose some sentimental, historical, or fairy-tale subject, as that of their "romance."

DOMESTIC SURGERY.

VARIOUS LOCAL AILMENTS.

A Cold in the Eye.—This is a very common affection, and consists in an inflamed condition of the membrane covering the eye-ball and lining the eye-lids, and is often due, as the name implies, to exposure to a draught. The patient feels as if some dust had got into the eye, and can sometimes be hardly persuaded to the contrary; the white of the eye itself is seen to be reddened, and there is a constant flow of blinding scalding tears. The best treatment is to foment the eyes with pure warm water, or better, with water in which two or three crushed poppy-heads have been boiled for half an hour, to extract their sedative qualities. A shade should be worn over the eyes in the intervals of fomenting, and a dose of rhubarb and magnesia should be administered. If the inflammation does not subside in a day or two, a doctor should be consulted, if possible; but, if this is not possible, good will probably be done by dropping into the eyes, two or three times a day, some solution of sulphate of zinc or white vitriol, in the proportion of one grain to two table-spoonfuls of water.

Strumous children, especially when improperly fed, often suffer from another form of inflammation of the eye, in which the chief symptom is intolerance of light, the child using its hands to exclude the light as much as possible, or, if in bed, burying its head beneath the clothes. These cases require careful local and constitutional treatment, for which medical advice should be sought; but, wanting this, the little patient will be much relieved by having its eyes frequently bathed with cold water, and wearing a green shade over them.

New-born children occasionally suffer from another disease of the eye, of which the chief symptom is a discharge of yellow fluid or *pus* from beneath the lids, which are apt to be glued together by the discharge drying on them. This is a very serious affection, since the sight of the eye may be utterly lost if it is neglected, and medical advice should, therefore, be obtained. In its absence, the eye should be carefully washed out several times a day with warm water, and a lotion of alum, in the proportion of ten grains to an ounce of water, be thoroughly applied. In doing this, the greatest care must be taken not to convey any of the yellow fluid into the eye of another person, since it is highly contagious, and will certainly lead to violent inflammation of any eye it happens to touch.

In washing a child's eye, the best plan is for one person to hold it firmly on its back with its head secured between the knees of the nurse who is to wash it, and its body resting on the knees of the assistant. Gently separating the eye-lids with the fore-finger and thumb, the nurse then lets the water or lotion trickle in between them from a small, clean, and soft sponge, then wipes the lids gently with the sponge, and repeats the operation on the opposite eye. When eye-drops have to be applied, the same position should be adopted, and the drops may be conveniently extracted from the phial and inserted between the lids with an ordinary quill-pen, the nib of which has been rounded off. In making a shade for the eye, a piece of card-board large enough to cover both eyes, and shaped out so as to fit the forehead, should be covered with green silk, and attached by a ribbon round the forehead.

A Stye in the Eye is a little abscess formed at the edge of the eye-lid by the inflammation of one of the little follicles which lubricate its edge. It generally occurs in persons out of health, or in strumous children, and is apt to occur again and again until the health is improved. At the commencement of the disorder, the part is sure to be swollen and red, and feels hot and uncomfortable to the patient; then it begins to throb, and matter forms, as is shown by the yellow point in the centre of the "stye." When this is let out, or discharges itself, the inflammation subsides, and the lid gets well rapidly. In the early

stage, the only treatment is to bathe the eye frequently with hot water, and at night to put a bread and water poultice over it. When the matter forms, it may be pricked and let out with a needle, if the patient will be steady enough to allow this to be done without danger to the eye, though there is a popular but unfounded prejudice that any interference with a stye leads to the formation of others.

The formation of an abscess on the inner side of the eye, close to the nose, is a much more serious thing, as it involves the passage by which the tears reach the nose, and will require early and careful surgical treatment, or a very disfiguring scar may result.

Whitlow is a very common affection, and one which, in its simpler forms, may be treated domestically without danger. The simplest kind of whitlow is that which forms about the root of the nail, and which may or may not depend upon some trifling injury, or upon the introduction of some irritating substance beneath the skin. At first the finger is found to be tender and hot, and soon a sense of throbbing is experienced in it. This is relieved by holding the inflamed part in hot water, and by poulticing; but, in all probability, matter will form, and will be seen as a white fluid, either beneath the nail itself, or raising the skin around its root. The pain is now severe, owing to the matter being pent up, and immediate relief will be obtained as soon as it is evacuated. If beneath the nail, the best plan is to remove a small wedge-shaped piece of the nail with sharp pointed scissors, so as to reach the point where the matter lies, and this can be generally effected without pain to the patient. If the skin around the nail is distended with the matter, it should be freely incised with a lancet or sharp and clean penknife, and this operation, though much dreaded by the patient, is absolutely painless, the skin having already lost its sensibility.

The more severe forms of whitlow require prompt surgical attendance. In one, the end of the finger becomes violently inflamed and swollen, the mischief beginning in the membrane covering the bone. Then an early and free incision down to the bone is absolutely necessary, in order to save it from destruction; but fortunately, even in neglected cases, it is seldom, if ever, necessary to perform amputation for this complaint, the surgeon being able to extract the piece of dead bone, and leave a very useful though somewhat shortened finger. In another and more severe form of whitlow, the matter forms in the finger and palm of the hand, both of which become immensely swollen; and here a skilful incision is necessary, in order to evacuate the matter without damaging the important structures of the palm of the hand, or leading to stiffness of one or more of the fingers. In case the assistance of a surgeon cannot be obtained, it may be mentioned that the proper place to incise this form of whitlow is in the central line of a finger, and just at the point where it joins the hand. The incision should be not more than half an inch long, and should always be on the palmar surface, or under side of the finger.

Abscesses may form in any part of the body, and are often only evidences of deeper-seated mischief, for which medical advice should be at once procured. In cases of disease of the spine, leading to projection of the bone, and what is commonly called "broken back," an abscess very commonly forms, without any special pain, in the upper part of the thigh, and the same kind of thing may be witnessed in other parts, the patient experiencing no pain, but having an elastic swelling, in which the peculiar and characteristic sensation due to the fluctuation of the contained fluid, may be readily felt with the fingers. These chronic or cold abscesses should always be submitted to a medical man, as they may be of great importance, and their treatment requires skill and attention. The more acute abscesses have much the same symptoms

as whitlows, there being heat, redness, and tenderness of the part, followed by a throbbing pain, and tension of the skin from the presence of matter within. Poulticing and fomentations form the appropriate treatment, and, if pursued long enough, will no doubt lead to the breaking of the abscess and the relief of the patient. Many days will, however, be consumed in the process, during all which the patient will be worn out with pain and want of rest, whilst a momentary incision by a surgeon's skilful hand will give immediate and permanent relief. It is very mistaken kindness for the friends to abet a patient in refusing to submit to a moment's pain in order to obtain a cure; and the patient is usually ready enough to express gratitude to those who have been "cruel only to be kind," the moment the relief is experienced.

Milk Abscess is one of the most common forms of abscess, and is met with in mothers who either have been obliged to wean their child suddenly, or who suffer from "sore nipples," which incapacitate them from nursing. Sore or chapped nipples are more apt to arise after a first than after a subsequent confinement, and may be generally avoided by taking the precaution to harden the nipple by bathing it with weak brandy and water for a few days before the birth of the child. If the nipple is very much flattened, it should be drawn out with a breast-pump or glass, or a healthy child of a few months old may be put to the breast as soon as there is any milk. When the nipple has unfortunately become sore, the best plan is to protect it with a nipple-shield of glass, and to dry it thoroughly after being used. Almost any stimulating lotion will then effect a cure: borax, alum, or white vitriol, in solution, are all favourite remedies; but perhaps the most successful is the application of a solution of nitrate of silver (two grains to the ounce of water) with a camel's-hair brush, three or four times during the day.

When from any cause a mother is unable to nurse her child, the breast is apt to become gorged with milk, and unless this is got rid of, inflammation and abscess are pretty sure to follow. By the use of the breast-pump, or gentle and equable pressure with the hands, much relief can be afforded, and attention must then be directed to diminishing the flow of milk to the breast by rubbing it with warm sweet oil, or better, by smearing it with extract of belladonna mixed with equal parts of glycerine. At the same time the diet of the patient should be reduced, and a dose of Epsom salts given every morning. By these means a milk-abscess may often be averted, particularly if the breast is well supported in a sling, arranged as follows:—A large handkerchief being folded so as to form a triangle, should be applied obliquely across the chest, with the straight part immediately below the breast, one end passing over the opposite shoulder, and the other through the armpit of the same side, and the two being tied behind the back. The handkerchief being now slightly unfolded, can be made to support the breast comfortably at any height desired, and the top corner can be brought up over the shoulder, and fastened round the neck, as shown in the illustration. But if an abscess unfortunately forms, as will be known by the occurrence of a shivering fit and the throbbing pain in the breast, the advice of a surgeon should be immediately sought, if it has not been before, in order that he may give relief by an early incision. The

patient is often so much reduced by the pain she has undergone as to be unable to nerve herself to sustain this necessary operation, unless her friends are very firm in supporting the surgeon in doing his duty. A milk-abscess, like any other, may, as already mentioned, break under prolonged poulticing, but only at the expense of great suffering and very considerable permanent damage to the breast, owing to the matter burrowing in several directions. In some cases it may be advisable to administer chloroform to the patient before interfering surgically, but the necessity and advisability of this must be left entirely to the medical man.

Boils are very common, and very painful affections, and are usually found in persons who have got into a low state of health. A boil very generally begins in a little pimple, and if this is protected from irritation by being covered with a piece of soap-plaster, whilst the general health is improved by change of air and altered diet, very probably there will be no further trouble. If, however, a regular boil forms with a red surface and great tenderness, it had

better be poulticed, and either allowed to break, or—a great saving of time and pain—a narrow knife or a sharp blade of a pair of slender scissors being pushed into the centre of it, and to the depth of half an inch, will allow the matter to escape with immediate relief. Prolonged poulticing of a boil is apt to bring out a crop of troublesome pimples around it, and it is well, therefore, to protect the surrounding parts with a piece of linen in which a hole is cut to fit the inflamed surface and allow of the poultice reaching it. When a boil has broken, it heals up readily enough under any simple dressing—either a little spermaceti ointment or a piece of wet lint under oil-silk. The nostrums vulgarly employed to "bring boils to a head"—such as soap and sugar, or the yellow basilicon ointment—are useless, and much better avoided, as they only serve to irritate the skin.

Carbuncles are much more serious affections than boils, which, however, they much resemble, except in being

larger, and therefore more dangerous to the patient. Carbuncles usually attack the nape of the neck, the back, &c., in old people, and as the most careful treatment of these affections is required from their very commencement, no time should be lost in consulting a medical man.

COOKING.

BROTHS.

IN England, a large quantity of good wholesome broth is thrown away, or given to the pigs. The poor will hardly accept it as an addition to their usual fare; they only care to have it when they are ill, to be taken medicinally, as a sudorific. On the other hand, in the south of France especially, no broth that is eatable is wasted. Even after boiling fish, the liquor is carefully set aside, for the purpose of making *bouilli-baisse* and other fish-soups.

It is on account of the uneatableness of the broth and its consequent loss, that smoked and salted meats are less economical for family use than fresh meats. Through the peculiar manner in which they must be boiled, a great quantity of nutriment passes into the broth, which is therefore absolutely unusable. Not only is the liquid too



heavily charged with salt, but it has taken from the smoked meat rancid particles which render it unwholesome. Even with our moderately salted boiled beef and legs of pork, the boilings, otherwise good, are so salt that only a small proportion of them can be used for making pea-soup, &c. Better soups of that class are made by using fresh meat, and salting them to taste. *Dried* meats not salted, are not open to the same objection.

It cannot be denied that a slice of corned beef or of salted, unsmoked boiled leg of pork, makes now and then a very pleasant morsel to eat. But families whose means are not too ample, but who still wish to support their health and strength by a plentiful supply of nutriment, might do well to consider whether they should not make that savoury morsel only an occasional treat, and boil their beef unsalted, as is customary over a great part of the Continent. The boiled beef need not be always an insipid dish, and the nutriment contained in the broth is very considerable.

Amongst other offices which our food has to fulfil, is the very important one of *warming* our bodies. Now the heat taken in—to say nothing of the nourishment—in broths, soups, and warm beverages, is a saving of just so much fuel-food; apropos of which, we will quote the following from the appendix to Dr. Edward Smith's "Practical Dietary":—

"There is less waste in boiling than in roasting food, and still less in gently stewing than in boiling or roasting it, since the fluid in which it is stewed contains the nourishment which has been drawn out of the food, and is eaten. Do not purchase salted meat. Hot food is both more agreeable and digestible than cold food. Eat hot food generally, and particularly in cold weather, except in the case of bread, where it would be wasteful to do so. Children, and old and feeble people need hot food more than strong adults. When you are very poor, and have not enough to eat, do not drink cold fluids."

French cooks occasionally put a bit of salt pork into their *pot-au-feu*, always into their cabbage soup; but it is quite a small piece, just big enough to render the seasoning with salt unnecessary. A good deal of the salt given out by the bacon is absorbed during the long process of cooking, by the much larger proportion of fresh meat and vegetables which attract it.

When such things as a leg, neck, or shoulder of mutton, a breast or knuckle of veal, or a couple of fowls are served as "boils," the boilings may be converted into stock broth for diluting sauces, and forming the groundwork of many soups. Those from calf's head and ox cheek require peculiar treatment, which will be indicated. Those from turkey have a decided flavour of the bird, which, however, is not distasteful to many. The stock-pot may also receive any lean trimmings of meat, giblets of poultry and game, bones in general (crushed or chopped) if sweet, and any other well-flavoured remnants. Many butchers sell bones for soup making, but it is not an economical plan to buy them.

Stock broth should be kept simmering as long as the kitchen fire is in. It is improved by the addition of good vegetables, and slight yet perceptible seasoning. It lends its aid to all kinds of soups, from pea-soup to mock-turtle. Many things cannot be done without it; it lends an additional charm to many more. And yet broth is held to be only the A B C of cookery.

If, instead of using for broth what you happen to have, you set to work to make it with fresh materials, you cannot do better than adopt the *pot-au-feu*.

The *Pot-au-Feu* (or the pot on the fire) is the name of a mode of making soup and cooking meat and vegetables, which is practised in France by every family which is raised above absolute poverty. Beef is generally the foundation of the *pot-au-feu*. Choose a fresh-killed piece, weighing three or four pounds, of the "round," in default

of which, the shoulder is to be taken, or a couple of thick slices of the shin. We often use the loin, cutting out the fillet for steaks or roasting, and making soup with the bone and upper portion boiled entire. Now, although the *pot-au-feu* may be made with beef alone, other things may be added, as the size of the vessel admits, as a small joint of lean mutton, a little bit of salt pork, and a fowl—which latter should be old; an old partridge or pigeon, or both, give the finishing touch as far as meat is concerned. A wild rabbit is quite admissible. If you have fresh bones, put them in, too. Put these on in your soup-kettle, allowing not more than one quart of cold water to each pound of meat. While it is coming to a boil, or before, peel and prepare your vegetables, and throw them into cold water; three or four carrots halved lengthwise; from four to six whole onions; three or four leeks; a stick of celery; one bay-leaf; a small bunch of parsley and thyme. You may add two or three turnips sliced; but note that turnips put into soups or stews cause them to turn sour sooner than they otherwise would. Skim the pot as it comes to a boil (the slower the better); when no more scum rises and it boils, throw in your vegetables, then skim again if necessary. You may put in a few cloves and peppercorns, but a *pot-au-feu* should not be highly seasoned. Colour with some sort of browning—caramel or burnt sugar is sometimes used. Burnt onions are better. A bit the size of half a walnut suffices. A nice browning for soup may be made from pea-shells. After shelling peas, choose the cleanest and freshest looking shells, and put them (not heaped) on a coarse earthen dish into a slow oven, and bake them gently till they are crisp and brown. They will then keep for some time in paper bags in a dry place. From four to six pea-shells will brown a pot of soup. Five or six hours of slow but constant boiling are requisite to bring the broth to perfection. Some epicures let it simmer as long as seven or eight. It should then be clear, limpid, of a golden amber colour, exhaling pleasantly the combined aromas of the various meats and vegetables. This is the true French *bouillon*. At the bottom of the soup-tureen put two or three crusts, or some toasted bread, or a penny roll cut in halves lengthwise and re-baked. Over the top of the tureen hold a fine-holed cullender, and into this ladle the soup till the tureen is full. All floating scraps or shreds will thus be strained off. Before serving, let the tureen stand near the fire until the bread is thoroughly soaked. Some prefer the *bouillon* the first day, some the second. In the south of France it is often slightly flavoured with garlic, which has the same inconvenient effect as turnips, of making the broth turn sour sooner. If other meats besides beef are used, they are reserved to make their appearance under different disguises. After the soup, the boiled beef is served alone—the *bouilli*—accompanied by the vegetables cooked with it handed round in a separate dish. As condiments for this simple dish, mustard, gherkins, and other pickles may be used; during the season, slices of melon; and in the South, ripe fresh figs. It is understood that as soon as the skimming is done, the *pot-au-feu* is to be covered down close with the lid; that it is always kept boiling gently, and never galloped; and that both meat and vegetables are the freshest that can be had. One tainted bone or strong stale turnip would spoil the soup to-day, and make it still worse to-morrow.

Ratouille.—This is a popular French mode of making a savoury mess out of remnants of cold meat, especially of cold *bouilli*, or beef which has passed through the *pot-au-feu*. It is not essential that the meat should be all of the same kind, or of the same date; but it must be perfectly sweet. If the cold meat has little or no fat of its own, procure a small quantity of uncooked fat meat, such as the thin ends of the ribs of beef, or a cut out of a loin of veal. Cut all the meat into pieces of a size to be

helped as portions with a spoon. At the bottom of a stewpan (or better, of an iron round-bottomed pan) put a good lump of butter, or roast-meat dripping, on it slice one or two large onions, brown them, then put in your uncooked meat, if any, and brown it. Dust in a dessert-spoonful of flour, brown it also with the meat and onions, stirring all the while. Then pour in gradually, continually stirring, as much water or broth as will nearly cover the whole. Have ready, freshening in cold water, a few peeled potatoes, whole if very small, or otherwise halved, quartered, or sliced; half-a-dozen or more middle-sized onions; a turnip sliced; a sliced carrot; a small stick of celery; a bay-leaf and a bunch of sweet herbs. In fact, you may use almost any vegetables, only avoiding those which discolour or give a bad flavour to the water in which they are boiled. When green vegetables are scarce, you may help them out with dry, as haricots steeped overnight and perhaps ready cooked. Put all these into the preparatory stew in the *fait-tout*, and stir from time to time, to prevent burning, and to bring them all successively in contact with the heat. When done, season sparingly with salt, but rather liberally with pepper, to give a decided relish. Then put in your cold meat, stirring till it is equally distributed amongst the vegetables. Take the *fait-tout* off the fire, as it must not boil any more. Stir now and then, to help the meat to get impregnated with the sauce. Let it stand simmering at the side of the stove until the liquor is so reduced by evaporation, that the dish in which the *ratatouille* is to be served will contain it all, vegetables, meat, and gravy. You may then dish it up.

Ratatouille Curry.—Some persons do not like curry; those who do, are not agreed as to its degree of heat. To please all tastes, before reducing the gravy of your *ratatouille*, take out a teacupful and stir into it gradually a dessert-spoon or more, of curry powder. You can keep this warm in a sauce-boat plunged in hot water. At the time of serving your *ratatouille*, send up with it this curry sauce, and a vegetable-dish containing boiled rice. Those who like curry, can make one on their plate with the meat and vegetables from the stew.

Chicken Broth.—This is best made from an old cock or hen, but quickest from a young one. In either case let the fowl be fresh; it may be used immediately after killing. Empty and singe it. Save the heart and liver, clean the gizzard, cut off the neck close to the body, and the legs at the knee-joints; cut the neck into three pieces, split the head, cut off the beak, take out the eyes. If you do not mind the trouble, cut off the claws, and scald the feet and legs to remove the outer scaly skin. If you mean to throw away the fowl afterwards (which no French cook would do), you may cut it up into joints; if not, truss the wings, and tie it into a presentable shape with string previously rinsed in warm water. Set on the fowl and its appendages, in a boiler or large saucepan, with plenty of cold soft water without salt. As it comes to a boil, skim carefully. Afterwards let your fowl boil or simmer over a gentle fire for six hours if the bird was old; for a less time if younger. Take out the liver after half an hour's boiling. Steep a coffee-cupful of rice in cold soft water, set it on the fire in cold water; as soon as it begins to boil, strain off the water, and throw the rice into the broth a good hour before the broth is done. Instead of rice, a little pearl barley or oatmeal groats may be used. Besides rendering the broth more nutritious, they will absorb or mechanically combine with a portion of the chicken fat, thus making it smoother, less oily, and consequently lighter of digestion. When the fowl is tender, without being boiled to rags, take it out whole; if not, let it boil to rags. Take the broth off the fire, let it stand an hour to settle, then skim off the surface fat and set it aside with a small quantity of the broth. Pour it off, leaving only the sediment at the bottom: broths for invalids are not the better for being

clear. It is then ready either for immediate use in the shape of broth, or to serve as the basis of a variety of soups. Season with salt (and pepper, if wished) at the time of serving. Catchup may be added at the rate of a teaspoonful to each half-pint of broth.

Boiled Fowl and Rice.—When your fowl is done tender, take it out. Fasten the liver and heart to one wing, the gizzard to the other. Have steeped a good quantity of rice. Boil it in water, beginning cold. When all but cooked, or in about a quarter of an hour, pour off the water, let the saucepan stand at the side of the stove with its lid raised to dry the rice, shaking it occasionally. Then add to it a portion of the broth and its surface fat which you had set aside, together with a good lump of butter. Stew the rice in this till it is completely done, moistening with broth if it become too thick. Season with salt, a little pepper, and a very little grated nutmeg. A boiled white onion mashed to a pulp may also be stirred up with it. When thoroughly hot and the rice quite tender, lay it on a dish under and around your fowl, saving a little to spread over its upper surface to mask any breakage in the skin or flesh.

N.B.—Butter or some other form of fat should always enter liberally in the sauces or accompaniments for meats which have been deprived of it, as well as of other parts of their constituents, *by boiling*, for the case is not the same with stewing. This is important, not merely as a question of taste, but as an essential of sound nourishment.

ODDS AND ENDS.

To Clean Alabaster.—Brush the alabaster with warm soap and water, and wash it afterwards with clean water. Finish with clean dry flannel. Alabaster may be brightened up with a paste of milk, whiting, and soap. After rubbing it with this composition, finish with clean dry flannel.

Cheese Cement.—Take some good fresh cheese and pound it, wash it with warm water until all the soluble matter is removed. Strain it thoroughly, and it will then crumble like stale bread. Dry it upon blotting-paper, and it will keep good for a long time. When required for use, a portion of the prepared cheese is pounded with a little quicklime, which changes it into a sticky mass. It may then be brought to a proper consistence by means of warm water. When ready it must be applied at once, as it soon dries, and cannot be melted again. This is a strong and valuable cement for china, earthenware, glass, wood, &c. The quicklime and prepared cheese can be kept together in a well-stoppered vessel, if mixed quite dry and in a fine powder: or they may be kept in separate vessels ready for amalgamation.

Whitewash.—Whiting is to be mixed with warm water to the consistence of cream. A little melted size is then stirred into the mixture. The addition of two-and-a-half pounds of powdered alum to every pailful of whitewash will make it bind better and go farther.

Wax for Modelling.—To prepare this, take equal quantities of bees-wax, Burgundy pitch, and diachylon; melt them together, and incorporate as much chalk as will form the mixture into a stiff paste. It is rolled into sticks of convenient size and kept for use as wanted.

Putty and Paint, to soften.—Mix with a solution of caustic, soda, or potash, some soft soap, and lay it over old putty or paint, and it will soon soften them. A paste of pearlsh and slacked lime, with a little water, will have the same effect.

Iron Pipes, to preserve.—It is well known how rapidly iron pipes rust in the ground, or when exposed unprotected to the damp of the atmosphere. Many may be glad to learn that iron pipes coated with gas tar have lain for twenty years in the ground without being rusted. The iron should be quite dry when the gas tar is applied.

HINTS ON CARVING.

Whiting.—Whiting are correctly brought to table fried in egg and bread-crumbs, with the tail in the mouth, secured by means of a tiny wooden skewer. These are served whole, one to each guest, who must be careful at once to remove the wooden skewer.

Pike.—Pike are split open if baked, and as few bones as possible served with each piece.

Cod.—Cod deserves a place of honour next to turbot, if we observe precedence amongst the dishes. A cod's head and shoulders is a noble dish, and a very wholesome one, Fig. 29. First sever the slices that are already partly cut, and marked by five A's to the five corresponding B's. At least cut as many of them as you have friends to supply. Then sever them completely by a transverse stroke of the fish-knife from D to C. A little of the light gelatinous substance, called sounds, should be served to each person. This will be found at E, just inside the fish under the back-bone. Care must be observed not to break the flakes in serving the fish.

Flat Fish.—A turbot, a large plaice, a brill, and a John dory, are in all cases carved in the same manner. The use of the fish-slice will now be needed. First of all long cuts are made from end to end of the fish, as marked in Fig. 28, A to B. Cut the fish quite down to the bone. Then make a number of slices from C to D, shown by dotted lines. A steel knife must next be used, and sever completely through the bones at every cut made where it is necessary. Resign it again, and resuming the fish-slice, cut quite through the other side down to the napkin on which the fish is laid, and serve the pieces, bones and all. A little of the parsley, which will be observed lying on the fish and round the dish, must be laid on each plate. The bones are regarded as dainties. When flat fish are too small to serve in this way they are cut in three across the short way, shown at the dotted lines A to B and C to D, in Fig. 28, which represents a sole. The centre-piece is considered the best. Smaller soles are cut only in half, and very small ones, and flounders, served whole.

Pigeons, &c.—Pigeons, when roasted, afford a delicious and savoury though but a slight dish. Cut each pigeon in half exactly through the middle, as shown by the line from A to B, in Fig. 28. It is easier to cut a pigeon in half when laid flat on its back upon the dish, going boldly quite through the breast with sufficient weight of hand to divide the bones at once. Other birds, when about the size of the pigeon, may be carved in a similar way, by simple division. Small birds, such as snipes, landrails, wheatears, and larks, are served whole. A great deal, however, depends on the size of the birds.

Mackerel.—To carve mackerel, divide them down the bone from head to tail, taking the slice of meat entirely off the upper side of the bone. Cut this slice in half before removing it, and serve the pieces separately, the upper being esteemed preferable to the tail end. Then put the bone aside, and cut the other portion in half also. The fish-slice, or a silver knife, must be used.

Pilchards, Herrings, Smelts, White-bait, Sprats.—All such small fish as these are served whole; the very small ones several at a time. Eels and conger-eels are divided before they are cooked. If stewed, they are served with a spoon; and when fried, with a slice.

Loin of Pork is served by simply cutting off the chops as a loin of mutton is cut, only there is no top part to remove. If the pork is not well scored before dressing, it can never be properly managed at table.

Aitch-bone of Beef is the only joint which now remains to be mentioned: this is simply cut from end to end of the joint in thin slices, serving fat with the lean. A single, though rather thick, slice is cut off first from the centre of the top of the joint, and laid aside in the dish till it becomes cold. The gravy will be found in the succeeding slices.

Round of Beef, which is generally salted, is cut in thin slices the entire size of the meat; a little of the fat cut thicker, and a trifle on the slant, is placed on each slice of the lean. Carrots are usually ranged round the dish cut in short pieces. One or two of these are also placed in every plate.

Ribs of Beef rolled are carved in the same way as the round of beef, with this exception, that there is no fat to cut separately; the fat is streaked with the lean. Neither are carrots served up, as ribs of beef is a roast joint. There is gravy in the dish, which should be served over each slice of meat, and if there is any garnishing of horse-radish, a little may be gathered up between the carving-knife and fork, and, if desired, furnished to the guests.

Several of the dishes, for the carving of which we have set forth directions in this and previous papers, will be found represented in the coloured plate opposite page 193. A reference to this will enable our readers to see at once what ought to be the appearance of such dishes when brought to table, and

also assist them in practically carrying out the instructions and hints embodied in our observations on this subject. The flat fish, Fig. 28, is shown in Fig. 7 of the coloured-frontispiece to the work. In our next article upon this subject we hope to complete our remarks upon this very important branch of domestic art, which is in too many instances disregarded, as if it were a matter of no importance.

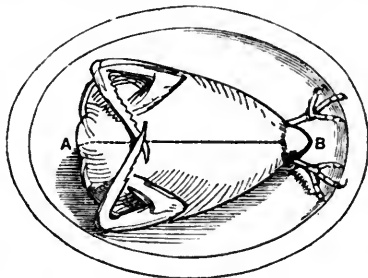

Fig. 27.

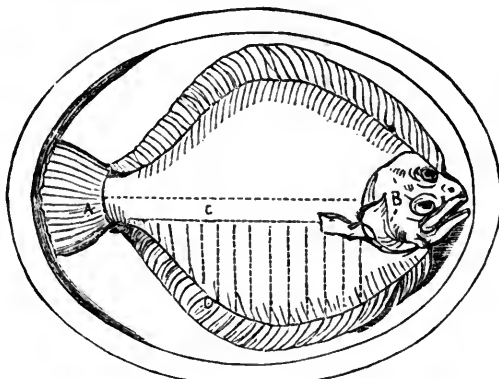

Fig. 28.

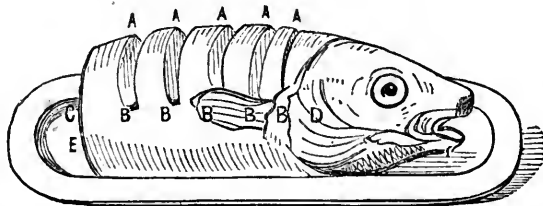

Fig. 29.

THE HOUSE.

WATER SUPPLY (continued).

It is somewhat strange that, notwithstanding the number of valuable discoveries in metallurgical chemistry which are day by day brought to the notice of the scientific world, lead, as a material for the manufacture of water-pipes, cisterns, conduits, &c., remains un-superseded. Its unfitness for such a purpose is beyond dispute, and there can be no doubt that a great number of obscure ailments and protracted diseases (which, although combated with all the appliances and remedies at the command of medical science, obstinately retain their hold on the constitution of the sufferer) might be, by the aid of careful analysis, traced to minute proportions of the salts of lead held in solution by the water in common use, and with it passed into the system. The quantities of metallic salt thus held and borne onwards by water are not unfrequently so infinitesimal that ordinary tests for its detection fail, until large quantities of the water to be experimented on are reduced and concentrated by the process of evaporation. Yet it is by the continued introduction of homœopathic doses of metallic poison, that the strongest constitutions are gradually broken down by causes which lie beyond the ken of friends, or even medical men of average attainments.

The ease with which the metal lead can be bent, converted into tubes, fused, cut, soldered, and jointed, tends greatly to induce those engaged in laying down a water-supply to make use

of it in preference to other materials, and so long as lead water-pipes can, without a breach of the law, be cramped to our walls and made to invade our dwellings, so long shall we have to contend with the evils they bring with them. And here we may repeat a remark made in a former paper that the widespread notion that filters possess the power of freeing water from mineral impurities, is entirely erroneous. Gaseous and some other contaminations are to be removed by carefully-conducted filtration, but solutions of mineral salts remain as such, and are unacted on by any filter properly so called. However, it is not our intention here to enter into a discussion on filters, as their mode of construction and management will be fully considered as we proceed with our subject. Earthenware, iron, wood, glass, and zinc are all, in addition to lead, more or less made use of as materials for the manufacture of water-pipes, according to the position, &c., in which they are to be

placed. Hollow bamboos are extensively used in tropical countries in lieu of artificial tubing, for the conveyance and protection of water for both domestic and agricultural purposes. In this country much outlay of money, inconvenience, and uncertainty are saved by the enterprise of public water-companies, who do that for the householder which, in a colony or partially-settled district he would have to do for himself—viz., discover a source from which a supply of moderately pure water can be obtained, and then, by the use of pipes, tubes, or other contrivances, bring it to his own door.

We will leave a consideration of the sources from which water is best obtained for a future paper, and deal with a case in which water has been laid on in the usual manner, subject to the periodical turnings on and off by the water company's servants. In order that a sufficient supply should be collected during the influx to last until the time arrives for a further supply, cisterns, barrels, tanks, and a whole host of other reservoirs are had recourse to. In bygone days it was the custom to watch the supply-pipe during the period of inflow, and when the store vessel was filled, a tap was turned, in order to prevent overflow, waste, and inconvenience. This system, although efficient enough when strictly carried out, led to endless domestic strife when neglected. Water turned on during the absence or slumbers of the watcher overflowed the barrels or cisterns, deluged the house or court,

and caused confusion worse confounded. The labours of the ingenious were therefore directed to the manufacture of an automaton, or self-acting water-

watcher, which should be always on the alert and prepared to govern the supply, come when it would. This important duty is to some extent performed by the common form of ball-cock. This arrangement, although extremely simple in its mode of action, is so little understood by the majority of house-keepers, that it may be well to make its performances and shortcomings clear to even the most unmechanical. In order to do this, we must refer the reader to Fig. 1 in the annexed illustration. This shows the cistern at a low ebb, the surface of the water having sunk to a low level. The hollow metal-ball, A, which floats on and is supported by it, sinks also and, as it drops lower and lower, its stern or lever B is also depressed, and, like a long powerful cross handle, gradually turns the barrel of the cock, or tap, to which it is secured by a square and pin, and thus causes the water to flow. It will be observed that in Fig. 1 the cistern is shown as nearly empty, the ball being sunk

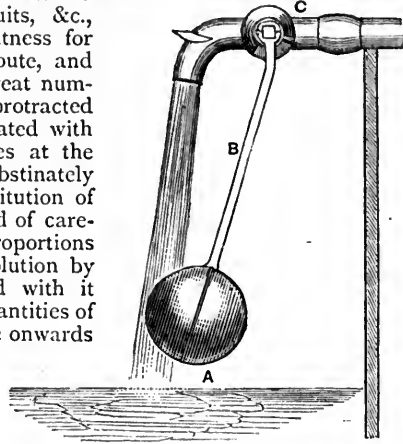

Fig. 1.

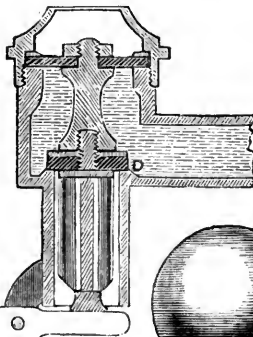

Fig. 3.

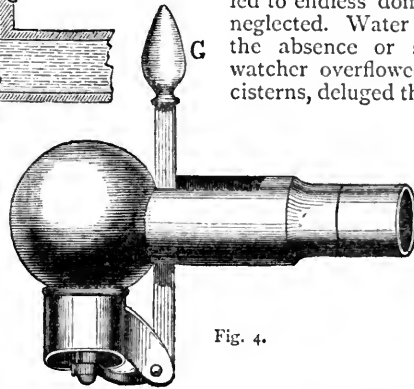

Fig. 4.

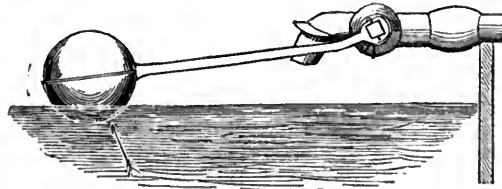

Fig. 2.

as low as it is possible for it to go. This tap, C, although placed sideways, is, in internal arrangement, exactly like a common beer or spirit-cock

As the supply of water increases in bulk, and height of surface, the ball, like a metal bubble, forces its way upwards with the rising tide, until at length, on reaching the position, as shown in Fig. 2, the inward flow is stopped by the turning of the tap to the shut position. So it will be at once seen that, high or low, the ball follows the line of surface. This condition of affairs would be satisfactory enough, provided it would always last. Unfortunately, however, certain chemical laws step in and upset mechanical arrangements. Constant exposure to air, moisture, and the acid impurities held in solution by water, causes oxidation of the metal composing the ball to take place. Minute pin-hole-like orifices rapidly form, and through these water freely passes. The ball, instead of a float becomes a sinker, keeping the supply-tap always open, and if a capacious waste-pipe, as a precaution in event of accidents, has not been thoughtfully provided, not only unnecessary expenditure of water, but destruction of valuable property by wet may be the result.

Not only the metal globe, but the tap as well, is not infrequently so much oxidised as to become inefficient. The barrel of the tap at times becomes so tight in its cylinder from this cause that the lever is not powerful enough to turn it. In this case, too much or too little water may be suffered to pass through it, just as the orifice in the barrel happened to be turned large or small when motion ceased. So it will be seen that the ball-cock is liable to derangement from several causes, which, being familiar to the reader, admit, in many cases, of remedy, or at least palliation. Modern engineering skill has, however, stepped in to the aid of the consumer of water, and a far more perfect form of both supply and expense tap than that just described has lately been introduced to our notice. This arrangement, appropriately named the "Economiser," is represented in the accompanying illustrations. Fig. 3 is a sectional view of the supply-regulating apparatus. Instead of acting as a tap, the Economiser works as a valve, which-drops by its own weight and is raised by a floating cup, E, placed at the end of the lever, instead of a hollow ball. The advantages gained over the old arrangement by the new one are as follows:—Perfect freedom from the chance of the float becoming a sinker by oxidation and perforation; self-power of closing the valve in event of the lever being broken; freedom from liability to become fixed, or "stuck," as it is called; and rapidity and delicacy of regulating power, which is so great that on a decrease of three-fourths of an inch of water taking place in the cistern the Economiser is in a position to pour in a supply to the extent of its full-bore capacity as a compensation. Instead of metal bearing against metal, as in a common tap, the bearing-flange of the Economiser rests on a thick seating of india-rubber, as shown at D, in Fig. 3—which is a sectional view of the Economiser as applied to the inflow—F, its lever, shown broken on account of its length. Fig. 4 represents the arrangement as used for drawing off liquids by hand. On the lever, G, being pressed backward, the valve is opened, and when the pressure is reversed, it falls back to its closed position by self-action, thus guarding against all loss by waste.

The subject of cisterns and water-reservoirs, to which contrivances such as those just described can be applied, will be treated of in a future paper.

We shall thus exhaust the subject, as far as those of our readers are concerned who have to depend upon a public company for their water supply. We shall then pass on to the consideration of wells and pumps, and the sources from which water is best obtained, both as regards its quantity and purity.

COOKING.

BROTHS AND SOUPS.

Roast Boiled Fowl (after Chicken Broth).—If the fowl is hot, take cold butter; if it is cold, melt some butter in a cup. Smear the fowl all over with this, dredge it with flour, and put it to roast with a bottle-jack before a brisk fire. As soon as it begins to brown, baste it well with a little of the reserved broth and surface fat. A lump of butter rolled in flour and laid in the catchpan will greatly help the effect of the basting. Have ready a warm dish, in the middle of which you place a bed of the freshest, well-drained watercress. As soon as the fowl is nicely browned, and frothing all over, lay it on the watercresses, and serve, after pouring over it the contents of the catchpan. For sauce to be sent up at the same time: To a breakfast-cup-full of rich melted butter, put two dessert-spoonfuls of pickled button mushrooms (if you have not them, one pickled walnut, or a few gherkins cut in pieces, may be used instead), one dessert-spoonful of the pickle vinegar, and two ditto of catchup.

Mutton Broth.—Take a pound of neck of mutton without the outer layer of fat; cut it, bone and all, into thin slices or cutlets. Set it on the fire in a quart of cold water, and let it boil gently for six hours. When it is reduced to a pint, prevent its further diminution by filling up with hot water from time to time. When presented to the patient, he will season it with pepper and salt to taste. The fat may be partially removed by skimming while hot, and entirely when cold; but the broth will be more nourishing if it is made to combine during the cooking with some farinaceous substance, as pearl barley or oatmeal groats.

Another Recipe.—To three quarts of cold soft water, put two pounds of scrag of mutton, cut up with the bones into pieces half the size of a walnut, two table-spoonfuls of pearl barley, a dessert-spoonful of washed rice, a large teaspoonful of oatmeal groats, an onion sliced, a leek cut into lengths, a leaf of celery (the green tip as well as the blanched stalk), half a turnip and a small carrot, or half a large one cut into dice, a teaspoonful of salt, and a sprig of thyme. Boil gently till all the solid substances have fallen to pieces, then strain through a coarse cullender.

White Veal Broth.—Take either neck or knuckle of veal, and treat exactly as for mutton broth. Veal is not usually put into the pot-au-feu, its broth being reserved for invalids.

Brown Veal Broth.—Fry sliced onions in butter till they are browned, not burnt. For three quarts of water, take two pounds of veal in slices with a fair proportion of cartilage and bone; brown them on both sides in the butter and the frying-pan which cooked the onions. If you have a cold (fresh, not stale) roast meat bone (not mutton nor pork) or a few remains of cold roast fowl or game, you may add them. Then proceed as for the mutton broth, maintaining the quantity at two quarts. When done, a tablespoonful of catchup is a nice addition.

Dr. Dobell's Beef Tea.—Put one pound of minced rumpsteak into an equal weight (one pound) of water; macerate it for two hours at a temperature not exceeding one hundred and fifty degrees Fahrenheit, to yield one pint of beef tea.

Beef Tea.—Use for this, not an iron saucepan, but an earthen pot with a well-fitting lid, which will stand without cracking the heat of the iron plate on the top of the cooking-stove. Fill it from one-third to a quarter full of good lean beef cut into shapely pieces the size of a small walnut, in order that they may be presentable afterwards in a *ratatouille*, or as potted beef, seasoning slightly with salt and a few whole peppercorns. Then pour on cold water nearly to the brim, and set it on the plate or top of a cooking-stove to simmer gently several hours, taking off any scum and fat that may rise. The beef is not to be

overdone, but is to be left in the pot until all the beef-tea from it is finished. Stir with a spoon before serving a portion, in order to have the nutritious particles suspended in the tea which have sunk to the bottom. Where there is no cooking-stove, the beef-tea may be slowly cooked by setting the earthen pot containing it in a large iron vessel of boiling water (as "jugged hare" is cooked), or, if the lid is luted down with paste, it may be made in a very slow oven.

Van Abbot's Invalid's Soup.—Into three quarts of cold water, cut small one pound of gravy beef, one pound of scrag of mutton, and a half or quarter of a calf's foot (for which two ounces of isinglass may be substituted). Gradually boil, skimming well. Then add three ounces of vermicelli, three tablespoonfuls of mushroom catchup, twenty-four corns of allspice, and a sprig of sage. Simmer four or five hours, till reduced to one quart. Strain through a fine hair sieve, and carefully remove all fat; add salt to taste. This soup may be taken either cold as a jelly, or warm as a soup; but note the importance of *warm* food for all persons of weakly constitution.

Meagre Soup (Soupe Maigre).—Before beginning, wash thoroughly all your green vegetables, peel your roots, and throw them into cold water. The proportions of each must depend very much upon what you can get. The soup, when finished, should be of the thickness of ordinary pea-soup. Take five or six handfuls of common sorrel, two large lettuces, from which the withered leaves only have been removed, a small bunch of chervil, and two or three sprigs of parsley. Shred all these very fine. Slice and chop onions, carrots, and leeks, very fine. Throw all these into your soup-kettle of boiling water with some whole potatoes of a mealy sort, a bay-leaf, a sprig of thyme, and a good lump of butter. Season with pepper and salt. Stir from time to time, to prevent any of the ingredients from sticking to the bottom. When they are all thoroughly cooked, crush as many potatoes as you want to thicken the soup; the others, if it is a meagre day, may be served up with fish or eggs; if not, with meat. The soup may be also thickened with bread—which makes it more nourishing—steeped in a little of the liquor, and then broken up and mixed with the soup.

Sorrel and Potato Soup.—Stew a couple of handfuls of sorrel in butter, then add enough water to make your soup, and mealy potatoes cut in slices. Stir frequently. When the potatoes are cooked, crush and mix them with the soup. Season with pepper and salt. Throw in a few very thin slices of bread. When they have soaked and boiled up once, serve your soup.

Small White Onion Soup.—Take a soup-plate full of small onions such as you would pickle. Peel them, throw them into boiling water, and let boil a minute. Then fry them in butter with a dust of sugar sprinkled over them. Brown a little flour in the butter. Fry also a few slices of bread, and pour over all a sufficiency of stock broth.

Leek and Potato Soup (Meagre).—Cut eight fine leeks into pieces an inch long. Peel and slice an equal quantity (by measurement, not number) of white, mealy potatoes. Set them on the fire in a saucepan with water, salt, and pepper. Boil until the leeks are quite tender and the potatoes can be easily crushed with a spoon. Add a good lump of butter, and stir well together. Put a few very thin slices of bread at the bottom of your soup-tureen. Pour the soup over them, and serve.

Turnip and Potato Soup (Meagre).—Put a lump of butter at the bottom of your stew-pan, and in it brown a couple of sliced onions. Stir in as much water as you want to have soup. Add an equal quantity of sliced turnips and mealy potatoes and a few slices of bread. When all is thoroughly cooked, pass it through a cullender, season with pepper and salt; give it a boil up, and serve.—N.B. This soup is not certain to keep good beyond the second day.

Carrot Soup.—Made as above, only the carrots take longer to cook. Besides pepper and salt, flavour with a couple of bay leaves, a bunch of sweet herbs, and two or three cloves.

Onion Soup.—Cut a dozen middle-sized onions into shreds. Brown them over the fire with a good lump of butter, turning them constantly till they are tender and nicely browned. Add a dessert-spoonful of flour; let it brown too. Stir in water gradually (or broth, if meagre soup be not preferred). Season with pepper and salt, and let it boil up a little while; then add a little sliced bread; let it soak for awhile, and serve.

Rice and Onion Soup, Brown.—Prepare your onions as before; stir in hot water or broth. Boil till the onions are quite tender; season, crush all through a cullender. Set it on the fire again, with the addition of rice that has been previously steeped in cold water. When the rice is tender, the soup is cooked.

Rice and Onion Soup, White.—Take an equal quantity of chopped onions and steeped rice. Boil them till tender in water, or veal or chicken broth. Season with pepper, salt, and a blade of mace. Add new milk to your soup in the proportion of one-third. As soon as it boils up (not over), it is ready. All the above soups require assiduous stirring.

Green-Pea Soup (French way).—Fry or brown in the saucepan in butter, some sorrel, and chervil—a handful of each. Stir in the required quantity of water. Season with salt, pepper, and a lump of sugar. When it boils, throw in your green peas. Put a few thin slices of bread at the bottom of your tureen, and when the peas are cooked, pour the soup over them.

Pumpkin Soup.—Take half or quarter of a pumpkin, according to size. Peel it, and remove the pips. Cut it into pieces the size of a walnut, and set them on the fire with water in a soup-kettle. When the pumpkin is completely reduced to a pulp, add four ounces of butter and a little salt. Stir it while it boils a minute or two longer. Boil a quart of milk with a little sugar and a pinch of salt, and then mix it with your pumpkin purée. Put bread dice (toasted or not) at the bottom of your soup-tureen, and pour over them the mixture of pumpkin and milk. This soup may be further flavoured with a dessert-spoonful of orange-flower water.

Cauliflower Soup is a very striking instance of continental economy in "boilings." After boiling cauliflowers, add to the water a pinch of chopped parsley and a lump of fresh butter. Season with pepper and salt, and boil for a few minutes. Put bread at the bottom of your tureen and pour the soup over them. It will be still better if you brown sliced onions and flour and stir in your soup on them as a foundation after proceeding as before. When the soup is quite done, it is usual to throw in a few sprigs of cauliflower.

Provençal Soup.—Boil six or eight cloves of garlic in water with a little salt, and a sprig of summer savory (*Satureija hortensis*). Cut thin slices of bread into your soup-tureen, dust them with a pinch of pepper, pour over them olive oil in proportion to their quantity, and pour the broth over them, leaving out the garlic and the savory.

A Garbure is another southern dish, which is something between a soup, a stew, and a bake. It is one of those messes into which you may put *anything*; only there must be meat, there must be vegetables, and there should be brown rye-bread. To make such a dish properly a very large vessel is required. It is seldom made in this country.

Garbure à la Béarnaise (after the fashion of Béarn).—Scald the hearts of four cabbages and of a dozen cabbage-lettuces. Take a good bit of bacon, lay it on its back, and slice it down to the rind without cutting through it; put it, with the cabbages and lettuces, into a soup-kettle,

with a thick sausage made with the legs of a goose, and a thick slice of ham, well steeped to draw the salt out. Do not use garlic. Cover with good fresh broth, and stew the whole together, adding two onions, each stuck with a couple of cloves, a few slices of turnip and carrot, and a bunch of parsley. When cooked, take up your vegetables and meats, and keep them separate. Strain the liquor through a cullender. Take a deep dish that will stand the fire; arrange the vegetables round its bottom; fill up the interstices with grated rye-bread; moisten with your liquor; put green peas, crushed to a purée, in the middle; on them lay your ham, bacon, and legs of goose; cut the sausage into slices and lay it round the edge of the dish. Set it into a slow oven until it is slightly browned. Send it up, accompanied by the broth, served separately.

Tomato Soup.—Boil a few tomatoes ten minutes in a little broth, and then pass them through a cullender to strain away the skins and the seeds. Add this purée to your broth, with a few chopped onions and a bunch of sweet herbs. In default of tomatoes use tomato sauce. When the onions are tender, season with pepper and salt; a nice addition is a little chopped cabbage or a few sprigs of cauliflower, previously boiled separately. If you want it more substantial, as for a family meal in cold weather, you can throw in a few dice or neat-looking pieces of cold meat, game, or poultry, stewed quite tender, and with the bones removed. In this latter case, dice of toasted or fried bread should be sent up in or with it.

Gravy Soup.—Put into a stewpan any brown gravy and dripping you have left from roast beef or veal, or both; in it brown chopped onions and a little flour. Stir in gradually any good stock you may have, seasoning with salt, pepper, and mushroom catchup. Serve, accompanied by dice of fried or toasted bread.

Cheese Soup (Meagre).—Take about half a pound of rather dry Gruyère cheese; if not to be had, any good, light-coloured (not red) English or other cheese, not too strong in flavour, will do; pare off the rind, and grate the cheese. At the bottom of your soup-tureen strew a thin layer of this grated cheese; over it lay a very few slices of crumb of stale bread, cut excessively thin; then more grated cheese, and more thinly-sliced bread, until all the cheese is in the tureen. The whole of this should occupy one-fourth of the depth of the tureen at most, to allow for its swelling, which it does considerably. Into a stewpan (a round-bottomed one is preferable) put a good lump of butter, without being afraid of using too much; dust in a little flour, and stir it over the fire until it browns; then throw in a good quantity of chopped onions. When they are browned, gradually stir in enough water to nearly fill your soup-tureen; add a little burnt onion (sold either in cakes or bottled in balls) for browning; season with pepper and salt; let it boil, stirring all the while. Pour it, boiling, over the layers of cheese and bread in the tureen, put on the cover, let it stand two or three minutes before the fire, to soak and swell the bread and cheese; that done, serve at once. The contents of the tureen are not to be disturbed till it is set on the table and the cover removed.

FISH SOUPS.

The following is a soup which has its merits, and is really better than it reads:—Take plaice, small conger eels, and whiting, in equal quantity; *i.e.*, equal weights of each when cleaned; wash, drain, and cut them into convenient sized pieces—in truth, any kind of sea fish will do, only excluding those whose skin is particularly strong and rank in flavour. Put water and olive-oil into a saucepan, in the proportion of half a pound of oil to a quart of water—those who have an insuperable prejudice against oil may substitute butter; add a clove of garlic, some chopped parsley and fennel, a bay leaf, and a few

small onions. When it boils, throw in the fish, and leave it till it is cooked, which will take about a quarter of an hour. Take out the fish, to be served separately; put slices of bread at the bottom of the tureen, and ladle your broth over it through a small-holed cullender.

Shrimp-tail and Tomato Soup.—You have ready any good broth or stock, that from beef or veal to be preferred. Light at the same time a couple of fire-places in your range; on the one set a saucepan of salted water for your shrimps; add a bunch of sweet herbs and two slices of lemon. When it boils throw in the shrimps. On the other a dozen tomatoes (fewer will do; if scarce, three or four will communicate their peculiar flavour), four large white onions cut in slices, a lump of butter, a clove of garlic, a bunch of sweet herbs, and just enough water to cook them in. When the shrimps are cooked, take them out, strain the liquor through a sieve, and set it aside. Peel the shrimps and set the tails aside. When your tomatoes and onions are cooked, press them through a cullender; set them on the fire again, with a bit of meat jelly, or a little roast beef or roast veal gravy, a pinch of cayenne pepper, and let them thicken a little over the fire. Then stir in your broth or stock and half a tumbler of the liquor in which the shrimps were boiled; mix well together as it is coming to a boil. At the third or fourth bubbling, throw in the shrimp-tails, and the soup is made.

Oyster Soup.—For each guest allow six or eight oysters, according to size. In opening them, save all the liquor, with which you put the beards, setting the oysters aside; add rather more than one equal quantity of water to the beards and liquor, and boil them ten minutes. Strain away the beards, which you will then reject; let the liquor stand to settle; pour it off from the sediment at the bottom of the vessel. Fry chopped onions to a very light yellow in fresh butter; add a little flour; stir in gradually the liquor from the oysters; make up the required quantity of soup with veal broth or other light-coloured stock; season with pepper, salt, and mace or grated nutmeg. When it boils up, take it off the fire; throw in your uncooked oysters. You may thicken further, if you like, by stirring one or two egg-yolks in a little of the soup, and then incorporating it with the rest. As soon as the oysters are quite hot through (they must not boil), you may serve the soup, accompanied by fried bread.

Mussel, or other Shell-Fish Soup, is made in the same way. The mussels or other shell-fish must be *well* washed, then put into a covered saucepan without water, and repeatedly hustled over the fire until they open. Mussels will take longer cooking to make them come away easily from the shells than cockles. Either will yield a larger quantity of liquor than oysters. After tasting it, you will judge of the proportion you think fit to put into your soup. If you prepare your shell-fish over night, the liquor will have all the longer time to stand and get clear. Shell-fish soup may be made as above, with several kinds at once and together. It may be varied by the addition of a dust of cayenne, a large teaspoonful of essence of shrimps or anchovy, and a tablespoonful of finely-chopped parsley, thrown in when the soup boils. Our native shell-fish may also be treated in the way the Americans dress their clams.

Clam Soup (Mrs. E. F. Haskell).—Wash clean as many clams as are needed for the family; put them in just boiling water enough to prevent their burning. The water must be boiling hard when the clams are put in the kettle. In a short time the shells will open, and the liquor in them run out. Take the clams from their shells and chop them very fine. Strain the liquor in which they were boiled through a thin cloth, and stir into it the chopped clams. Season with pepper; add salt, if needed. Thicken the soup with butter rolled thin in flour; let it boil fifteen minutes. Toast bread and cut it in small squares, lay it

in the tureen, and pour over the soup. If the family like onions, they can be added; if celery, it can be varied by the addition of a little celery cut fine. Another change can be made by adding the yolks of well-beaten eggs stirred slowly into it, or rich cream can be added. Persons living on the sea-shore can make several dishes thus varied with little expense.

Eel Soup.—Select for this middle-sized eels, not thicker than a medium joint of ox-tail, nor thinner than a man's thumb. Buy them *alive*; kill by stunning them on the head. Skin, empty, and cut them into two-inch lengths, which throw into salt and water to purify and whiten for an hour or so.

MARKETING.

BEFORE going to market it is a very good rule to determine what shall be purchased and in what quantity. This is especially needful when the butcher is to be visited. Another rule is to deal at shops where good articles only are sold, and if possible to take your money with you, because a ready-money customer will, as a rule, be the best served. It is not always safe to let the butcher, poulterer, fishmonger, or other provision dealer choose for you, because he may be over anxious to sell what is not in the best condition, or what is for some other cause hardly saleable. Experienced persons will not fail to observe carefully the quality of what they buy, and they will reflect upon the quantity of bone, gristle, or other waste in it. They will also consider the requirements of the family, and the uses to which they can put what is not consumed as soon as cooked. At the butcher's see the meat cut and weighed, and placed ready to be sent home: you will then know what you have bought. Always buy good meat rather than inferior, and if possible, from the best parts of the animal. To aid the inexperienced, we will now enter somewhat into detail. We commence with *Beef*, Fig. 2, the principal joints of which are as follow:—

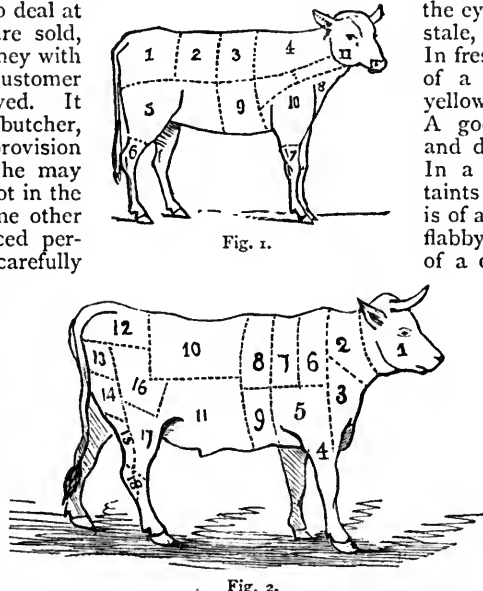

Fig. 1.

Fig. 2.

- Fore Quarter.*
1. Check.
 2. Neck, or sticking-piece.
 3. Clod.
 4. Shin.
 5. Shoulder, or leg of mutton piece.
 6. Chuck ribs.
 7. Middle ribs.
 8. Fore ribs.
 9. Brisket.

- Hind Quarter.*
10. Sirloin.
 11. Thin flank.
 12. Rump.
 13. Aitchbone.
 14. Round, or buttock.
 15. Mouse-buttock.
 16. Veiny piece.
 17. Thick flank.
 18. Leg.

Besides the above, there are the kidneys, heart, tripe, heels, sweetbreads, tongue, and palate.

Quality of Beef.—Young and well-fed ox beef is the best. It may be known by the lean being of a fine, smooth, or open grain, and the fat of a yellowish white. When the fat is either a mottled yellow or white, the meat is doubtful. The suet, however, must be very white. Cow beef is inferior, its fat is whiter, the lean closer in the grain and not of so bright a red. Bull beef has white and skinny fat, closer-grained lean of a dark red, and a stronger smell than other beef. Good beef is more elastic to the touch than that which is old or in bad condition, so

that when pressed with the finger the impression will not be permanent. In poor meat, the lean is usually dark, the fat skinny, and the sinewy portions distinctly shown, especially a horny texture in the ribs. Beef should be perfectly sound, sweet, and fresh, as taint rapidly spreads, and if frosted it will not cook properly. It is, perhaps, scarcely needful to say, that several of the joints which are enumerated above, are readily and commonly divided by the butcher, and sold in portions for the convenience of small families and slender purses. If at any time more is bought than is wanted for present use, care should be taken to let it be from such parts as may be cut into two, the one for roasting and the other for salting and boiling; or let it be such as may be easily warmed afresh, or otherwise presented hot again at table, which will be the case with such parts as are stewed, and such cheap portions as the heart. A cold roasted ox-heart cut into slices and warmed in gravy, is as good as when first cooked.

Qualities of Veal.—If the head is fresh, the eyes will be plump and full; but if stale, they will be sunk and wrinkled. In fresh meat, the vein of the shoulder is of a bright and clear red. Green or yellow spots prove the meat to be bad. A good neck and breast will be white and dry, and not at all clammy or soft. In a loin, the kidney is the part which taints the soonest. Generally, good veal is of a bright colour, and firm, and neither flabby nor of a sickly smell. The meat of a cow calf is not considered the best.

All veal should be cooked when quite fresh, as it rapidly deteriorates; nor will it keep long even after it is cooked. It must, therefore, be not only purchased fresh, but in such quantities as will be soon consumed. Until recently the whiteness of veal was enhanced by the mode of killing, which drew all the blood from the animal. This mode has, however, been prohibited by law, and consequently veal is not so white as it was formerly expected to be; but has a very slight rosy

tinge in the lean, even when of the finest quality. The following are the joints into which *Veal*, Fig. 1, is usually divided:—

- | | |
|---------------------|-------------------------|
| 1. Loin, chump end. | 7. Fore knuckle |
| 2. " best end. | 8. Breast, brisket end, |
| 3. Neck, best end. | 9. " best end. |
| 4. " scrag end. | 10. Blade-bone. |
| 5. Fillet. | 11. Head. |
| 6. Hind knuckle. | |

Besides the above there are the kidneys, liver, heart, feet, and sweetbread.

HOUSEHOLD AMUSEMENTS.—VIII.

CARD GAMES.

PLAYING with cards is in many households interdicted, as it is thought to lead to gambling, while in many others it is countenanced as an innocent amusement, greatly promoting sociality.

It is scarcely necessary to point out that playing for money is by no means a necessary adjunct to such pastimes: if it were, they would find no mention in these pages, for we hold gambling in any of its shapes in as much abhorrence as any of our readers. But there are many card games which possess quite sufficient merit in themselves to afford interest and recreation, without the

introduction of such an objectionable element in the family circle, and many persons who play—at whist, for instance—would no more think of staking money on the game than they would do so if sitting down to chess.

As it is our endeavour to consult the wishes and the tastes of all readers of the HOUSEHOLD GUIDE, we have determined to give a few papers on card games for the benefit of those who would wish to know something of such amusements, or to have some guide to the established laws to be observed in playing. It is not our purpose to go deeply into these games, or to aim at making anyone a scientific player; but simply to impart such general knowledge on the subject as may in some cases open up a new field of harmless recreation, and in others enable unpractised persons to acquit themselves with sufficient dexterity if disposed to take a part when in company where cards are introduced.

Cards are of very great antiquity, and, like chess, were invented in the East, but when, or in what country, is unknown. They are sometimes said to have been introduced into Europe in the fourteenth century, for the diversion of Charles VI. of France; but they are now proved to have been known before his time. Their use was almost universal in England two centuries ago, and the good old knight, Sir Roger de Coverley, is represented in the *Spectator* as having made it his practice, every Christmas, to send a string of hogs' puddings and a pack of cards to every poor family in his parish.

Most of our readers know the nature of a modern pack of cards. The number of the cards is fifty-two, divided into four suits, thirteen cards in each. These suits are called respectively hearts, diamonds, spades, and clubs; the two former being printed with red, and the latter with black ink. Ten of the cards in each suit have on them figures, from one to ten successively, of a heart or a diamond, &c.; and these cards, with the exception of that which bears a single figure, are known as the two, the three, or the four, and so on, of that suit. The card on which only *one* heart, &c., is imprinted is known as the *ace* of the suit, and in most games of cards is the most valuable of the thirteen, having the power to take any of the rest. Three other cards in each suit are known as *king*, *queen*, and *knave*, and bear quaint heraldic figures answering to these names respectively. The queens are easily distinguished from the other figures, but the novice requires to have it pointed out that the kings may be known from the knaves by a crown on the head, the latter wearing only a plain red cap.

THE GAME OF WHIST.

Of all card games Whist is acknowledged to be by far the best. As a combination of chance with skill, and therefore affording the interest found in games of both descriptions, whist has no competitor in the whole round of amusements of this nature. The most unskilful person who knows the game at all, may by ordinary good fortune be placed on a par with a very experienced player, and it has been computed by one authority that the difference between two of the best and two of the worst players is practically no more than five per cent. in favour of the former. To this comparative equalisation of the chances of success the popularity of the game is no doubt largely due.

Whist is said to receive its name from an interjection commanding silence, which is particularly enjoined by the laws of the game; but this appears doubtful, as "whisk" is one of its oldest titles, and from this "whist" may easily have come.

We shall now give an account of the principles of the game, and afterwards of the laws by which it is regulated.

The usual and perfect game of whist is played by four persons, divided into two opposing sides. The partners on each side are generally determined by each person

drawing or "cutting" a card from the pack—the drawers of the two highest and the two lowest cards playing together, and the person who picks the lowest of all being entitled to *deal* the cards for the first time. In cutting, the ace always counts as the lowest card in the pack.

In taking position round the table the partners sit facing each other, each player being between his two opponents. The cards are taken by the dealer, backs uppermost, and handed to the player sitting next him on the left, to *shuffle*; that is, keeping their backs towards him, to mix them up promiscuously. They are then again placed on the table, and the player on the dealer's right *cuts* them, by lifting off a part of the pack and laying it down, when the dealer picks up those cards which were at the bottom of the pack before cutting, places them on the top of the others, and commences to deal.

Each player has a right to shuffle the cards before the deal, if he pleases to do so; but in practice it is usual, as we have said, for the *eldest hand*, or player to the left of the dealer, to perform the operation. The dealer may always shuffle the cards again before they are cut, if he thinks proper.

The cards are dealt by placing one face downwards before each of the players successively, commencing on the left hand, until the pack is exhausted. The last card will come to the dealer unless there is a miscal, which will be treated of when we come to the laws of the game. This card is turned face upward on the table for all the players to see, and is known as the *trump* card. It determines the suit which is to be of the greatest value during that hand; if a spade, for instance, is turned up, spades are trumps, and can take a card of any other suit on the table. The word "trump" is supposed to be a corruption of "triumph." The trump suit is, or may be, changed at every deal, according to the card which happens to remain at the bottom of the pack.

When the deal is complete, but not before, each of the players takes up his cards, and, holding them in his hand with the backs towards the other players, inspects the assortment which has fallen to him. The best plan, for a learner at least, is, before playing, to arrange the cards according to the suits and their value, so that he may see at one glance what he has in his hand, and find any card without hesitation. Then, spreading the cards out something like a fan, he is ready to follow the play.

The play commences by the eldest hand laying down a card face uppermost; the player next him lays down another, then the third person in order, the dealer last. The card highest in value among the four takes them all, and the four collectively are called a *trick*. The value of the cards is according to the number of the "pips" or figures printed upon them, from the *deuce*, or two, which is the lowest of a suit, up to the ten; the next best is the knave, then the queen, then the king, the ace being highest of all. The trick is gathered up by the person who takes it, or by his partner, and placed face downwards on the table, where it remains until the counting takes place at the end of the hand.

Whatever suit may be led by the first player, the others are bound to play a card of the same suit, if they have one. If not, they may play anything they please; if a trump, it takes the trick, unless a higher one is played by another person. But if a player omits or refuses to follow suit when he is able to do so, his side incurs the penalty for a revoke, and loses three tricks, under the laws to be given hereafter.

No matter how high the cards may be of any ordinary suit, the lowest trump card has the power to take them all. And if a person cannot follow suit, whatever card he may play is taken, unless it be a trump. The ace of trumps is necessarily the highest card in the pack.

Whoever wins a trick becomes first player for the next, the others following from left to right in order; so the

play continues until all the cards are played, when the number of tricks gained by each side is counted. All made *beyond six* are scored towards the game—thus, if one party has made seven tricks during that hand, they count one towards game, but the side which has taken the other six count nothing.

The game consists of ten points, made either by tricks or *honours*. Honours are the four highest trumps—the ace, king, queen, and knave. Each of these counts one to the side which gets it in the deal; but in practice the players do not score any for honours unless two partners possess either three or four between them. Thus, supposing each side to hold two honours, neither adds anything to the score, because “honours are divided,” and neutralise each other. Three honours, by the same rule, count only two towards game, the one held by the opponents being deducted. But if one side holds all the honours, it is allowed to score four for them, the value towards game being precisely the same as if four tricks had been made. In counting, however, tricks take precedence of honours; so that if each side stands at eight, and one is entitled to score two by tricks, while the other side has won two by honours, the former, having the privilege of counting first, make up their ten, and so win the game.

When either side has scored nine towards game, it is not allowed to count honours. When the score of either party stands at eight, one of the partners, holding two honours in his hand after a fresh deal, may ask the other, “Have you an honour?” or “Can you one?” and if the reply is “Yes,” the three honours are exhibited, and that side is allowed to count out at once. But after the first trick has been played the question cannot be asked. The other side, if they can make sufficient tricks, will consequently win the game in spite of their opponents' honours.

The dealer leaves the trump, or turn-up card, face uppermost on the table until the first trick is played to, so as to give every one full opportunity of knowing what is the trump suit. He then withdraws it to his own hand. The dealer thus has the advantage of always holding one trump at least, besides the chance that this one may be an honour.

It is usual at whist to play, not single games only, but *rubbers* of three games, the conquerors in two out of the three winning, as it is called, “the rub.” The game of ten points is known as *long whist*, and is that usually played where amusement and recreation are the objects. *Short whist* is an invention of modern days, and consists of five points only. A rubber is consequently much sooner over than when the long game is played, which is a recommendation to some persons, but a disadvantage in the minds of others.

Honours count the same at short as at long whist, but they cannot be scored when the players have reached *four* points.

The game of whist should be played in silence. Any remarks by a player as to the nature of the cards which have fallen to him, &c., are contrary to the spirit of the game, and, although not forbidden expressly by its laws, are considered irregular and objectionable, where the game is played with strictness.

The following are recognised as exceptions to this rule. At any time, while a hand is being played, the question may be asked, “What are trumps?” And when a player, either through momentary inattention, or through the rest having followed each other very quickly in their play, is in doubt as to what card was played by his partner, he may say, before playing, “Draw your card, partner,” which the latter does by placing his hand upon it. Further, any one before a trick is lifted—*i.e.*, taken up and turned upon the table—may demand that the cards shall be “placed,” each before the person who played it. And, lastly, any one may demand to see the last trick

played—that is, to have the cards comprising it shown to him; but he is not then entitled to inquire who played them.

Lookers-on at the game are not allowed to make any remarks; but they may be appealed to as referees to decide a doubtful question, as to who played a particular card, what is the law of the game upon a certain point, and similar matters.

In our next paper we shall give the laws usually recognised, together with some general rules and advice for the guidance of young players.

ODDS AND ENDS.

Baking Powders.—1. Take four ounces of corn-flour and dry it well before the fire, or in the oven. Mix with it two ounces of bicarbonate of soda; add one ounce and a-quarter of tartaric acid. Well mix the whole by passing it through a coarse sieve.

2. Take four ounces of tartaric acid, four ounces and a half of bicarbonate of soda, and five ounces of rice-flour or arrow-root, let them all be well dried before used, and mix as before.

3. Take two ounces of tartaric acid, three ounces of bicarbonate of soda, and three ounces of potato-flour or arrow-root, dry them separately, and mix as before.

4. Take five ounces of tartaric acid, eight ounces of sesquicarbonate of soda, and sixteen ounces of potato-flour, dry them separately, and mix as before.

All baking powders should be kept in wide-mouthed bottles well corked, so as to exclude all air and damp. They are used for making bread, buns, and cakes. Half a teaspoonful added to a pound of flour in making pastry is a great improvement, and will render a less quantity of butter or lard necessary. When bread is made, the loaves should not weigh above two pounds each, and these require about two teaspoonfuls of powder. The powder is to be well mixed with the flour, after which cold water is used for kneading, and the dough is at once placed in tins and put in the oven. Quick work is most successful, but it must be thorough.

To make Alum-baskets and other Ornaments.—You first form the basket, vase, tree, grotto, or other object, in wire, taking due care to leave sufficient room for the formation of the crystals, so that they may have their due effect. Over the wire twist some worsted thread, so that it is completely covered in every part. If, in a grotto or other similar object, fantastic forms are desired, pieces of coke may be fastened to the wire and covered in the same way. This done, dissolve one pound of alum in a quart of water by boiling in a tin vessel, not too fast; half a pound in a pint, or a quarter of a pound in a half-pint of water, preserving the same proportions whatever the quantities employed may be. Keep stirring the solution with a piece of wood until the process is complete. Remove the liquid from the fire, and, placing a piece of wood across the top of a deep, glazed, earthen jar, suspend the wire basket, or other article in it, from the stick with a piece of stout thread. When the alum solution is about the warmth of new milk, pour it into the jar, and leave your subject or subjects suspended in it about four-and-twenty hours; after which remove the same to dry in the shade. To obtain coloured crystals it is only necessary to put some dyeing material into the alum solution—turmeric gives the transparent yellow crystals, logwood purple, &c.

Stuffing Mattresses.—In the North of England the cottagers use chaff to stuff their mattresses, and a very clean, wholesome stuffing it makes, as once every year the old chaff is taken out and fresh put in. In Wales we have seen well-dried moss used for the same purpose; while in the Highlands of Scotland the people stuff their beds with dried birch-leaves.

HOUSEHOLD DECORATIVE ART.

VI.—PAPER FLOWER MAKING (continued).

Making the Stamens and Pistils.—Our next instructions will be how to make the hearts, as they are commonly called, but which are known botanically as stamens and pistils. It is by far the best plan, and the usual one, to purchase these, for the making of them is in itself a business. It is usual also to buy the calyxes. Persons may fancy that when all these portions are purchased, the art of flower making becomes simply mechanical. This it is not: a good deal of patience, nice manipulation, and taste, are needed to produce flowers worthy of admiration. However, for those who desire to do so, we give instructions which will enable them to construct these portions of the flowers at home.

Very fine wire is used for the main stem of the stamen, otherwise, when it comes to be added to the flower-stalk, the result would be too bulky. Exceedingly fine wire, bristles, or a fine strong glacé thread, can be used for the fine thread-like stamens; in fact, many people prefer cotton to any other material for this purpose. If wire or fine bristle is used, it must be dipped in whiting mixed to a thin paste, with a very little gum in it. When dry, dip the tips in the cement, to make knobs at the end. When these are nearly, but not quite dry, dip them into a pill-box filled with bright yellow paint powder which can be bought at any oil-shop for a penny or two-pence. Bright green (emerald), rich brown, and orange paint, will also be needed. A small quantity of powder carmine, and powder cobalt will be wanted for the flowers, and in moist paints, carmine, prussian blue, cobalt, and a small piece of gamboge.

Having prepared the thread-like stamens as described, take the wire meant for their support, and dip the top into the cement, repeating the process till you have a knob at the top (like that shown in Fig. 17). Cut one of your stamens in half and insert it at the top whilst the cement is wet. Also, before it is dry, coat it evenly all over with the emerald green powder, which is put on with a dry brush. You must use a separate brush for each colour. A quicker mode of making the pistil,

is by putting a little cotton wool on the stem, by means of cement, shaping it properly, and then dipping it into the cement. Tie six more of the stamens to the pistil, with green silk. This completes the centre (Fig. 17) for azaleas.

Fig. 14 is the pistil for a carnation. It is made with a knob of cement like the last, the long centre is a single strand of white ostrich feather.

Fig. 7 is a geranium centre, the stamens made like the azalea stamens, only longer, and seven in number. The pistil consists of three filaments joined together in one, with gum; but having them separate just at the top. They are not tipped with any pollen, as the coloured dust is called.

Fig. 11 is for rhododendrons. The stamens, nine in number, like the azalea stamens, but much longer and tipped with yellow. The pistil is of thick wire, neatly wrapped round with yellow paper, as stalks are wrapped. Dip the tip in strong gum, and whilst wet, into the brown powder.

Fig. 1 is a rose centre. On the fine wire used for the basis of the centre, tie a few loops of pea-green Berlin wool or thick filoselle. Then cut them close down, so that they look like a little close tuft of velvet pile. Make twenty-six stamens like the azalea centres, but much shorter, and tip them with yellow.

Fig. 15 is a heartsease centre. Take wire like that you have used to form the centres on. Coat it with whiting, as already described. Make a knob of cement nearly at the tip, and colour it orange by dipping it in the powder. The orange is to be almost a scarlet. In the figure we

have shown a knob at each end of the wire; each of these is for a separate heart.

Fig. 8 is a China-aster heart. Take a common linen button, cover it with net so as to fasten it flat to a wire crooked at the top. Raise it to the required height with cement, and before the last coat is dry, put closely all over it a number of yellow seed beads. When dry, dip it in gum, and then tip it with yellow powder. The daisy centre is made in a similar way, with a smaller round of cardboard and not raised, but the beads just gummed on and dipped in yellow powder, Fig. 10. A daisy may also be made with a centre of yellow wool like the rose centre, Fig. 3.



Fig. 1.

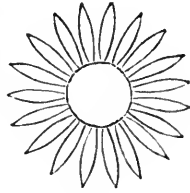

Fig. 2.



Fig. 3.

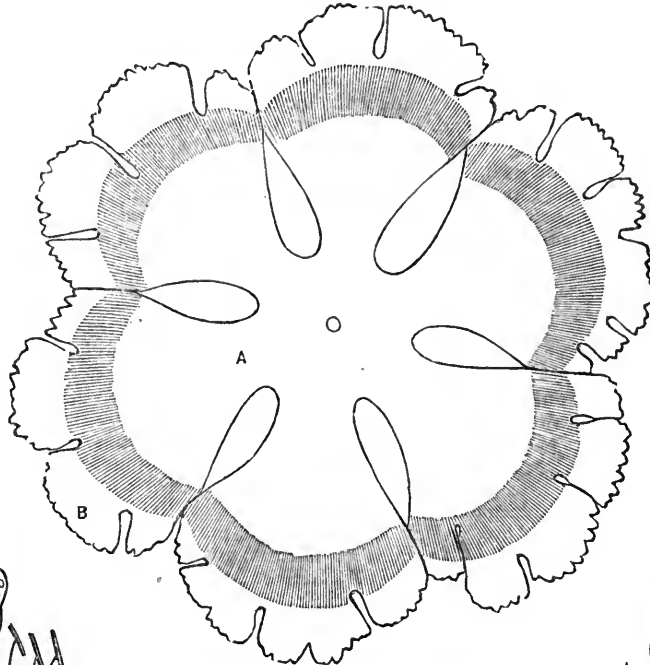

Fig. 4.



Fig. 5.

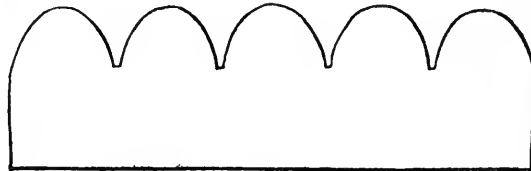

Fig. 6.



Fig. 7.

Fig. 5 is a lily centre. The pistil is formed of white wax, painted green with a knob at the top, marked with carmine spots. The stamens are of wire dipped in wax, or covered with tissue paper, white, finest at the tip, and large anthers of wax, coloured brown, upon them.

Calyxes.—Gum together three thicknesses of dark green tissue-paper, and let them dry before cutting the calyxes. Afterwards glaze them with gum. It would be endless to give patterns of the different forms of calyxes, the artist must go to Nature for patterns. We give three, in Figs. 2, 6, and 9. They should be traced in tissue and then cut in card. Lay the card on the green paper and pencil the outline.

The Azalea and the Rhododendron.—

Fig. 12 represents the azalea. Cut the blossoms in white paper, the dark marks at the tips are made by tinting them with a little of the moist carmine, diluted to a delicate rose pink and laid on with a clean camel's-hair brush. Let it be quite dry before being crimped. It is laid on a cushion and carefully and deeply veined in the manner shown in the illustration.

Then touching it with cement from A to B, unite it. Tie with silk or wire a heart to a stem. Then slip it through the azalea, having first touched the lower part of the heart all round with cement. The azalea needs no calyx. Take a very little wadding, and put it round the stem where the flower joins, drawing it down: then cover the stem with paper. A little wadding is used in this way to all flowers, to give the stem the thickness observable towards the blossom. The merest atom is needed for such flowers as azaleas, not much more for roses. About three azaleas form a group. Other azaleas may have a margin all round the edge of deep rose, and others may be cut from pink or rose-coloured paper, and just tipped or touched round a little darker. Rhododendrons are made exactly the same, but coloured with a broad margin of mauve round every petal; the extreme edges touched again when the first tint is dry, to make them darker. Mix on a clean plate, carmine and cobalt for this; dilute it with water, but do not use it very wet to the flower, nor yet dry enough to look smeared. It must be

washed on lightly and easily with one stroke. The rhododendron centres are distinct, and the blossoms in groups of five or more, of equal height, forming one head. The azaleas, on the contrary, grow one above the other and fewer in a spray.

If you wish to place a single spray of any flower in a vase, a few leaves of the right kind must be set on the stem. For a basket, rose and camellia leaves are enough.

For a table stand, rose-leaves, grass, and ferns.

A half-blown Rosebud.—Half-blown buds are very effective. Make them in white paper slightly tipped with pale pink, or in pink or rose paper, or in orange paper streaked with red, cutting the outsides

of the darkest shades, and the darkest towards the stalk. To make one of these deep yellow buds, use four petals of the largest size but one of the cabbage rose, cut in the palest tint from shaded paper. Goffer them inwards. Close two over a bud centre, and two more over that. Then cut eleven of the largest-sized petals, a still darker shade, and another

eleven of the darkest of all. Goffer and cut them outwards, and let the darker shade be the outer one.

A bud centre is made by cutting a three-cornered piece of paper the shape of the rose. Take a piece of cotton wool, tie it to a stalk, and cover it with the paper as in Fig. 13. Tie it down. This cone must not be visible. For an ordinary bud, cut three of the second largest-sized petals of the darkest tint, goffer them inwards and close them over the cone.

Cut three more of the largest size, goffer them and curl them outwards. Place these round the bud like opening leaves.

Carnation.—The carnation is a beautiful flower, and easy to make. Cut it in white paper like Fig. 4, and with powder carmine and a little weak gum water, mixed together well on a plate, colour a brilliant red the dark band with streaky edges. When quite dry, place it on the cushion and vein every petal from A to B, drawing the pincers down in deep irregular marks. Six of these circles are used for every flower. It is easiest to cut them out plain first and vandyke the edges, and cut the irregular marks

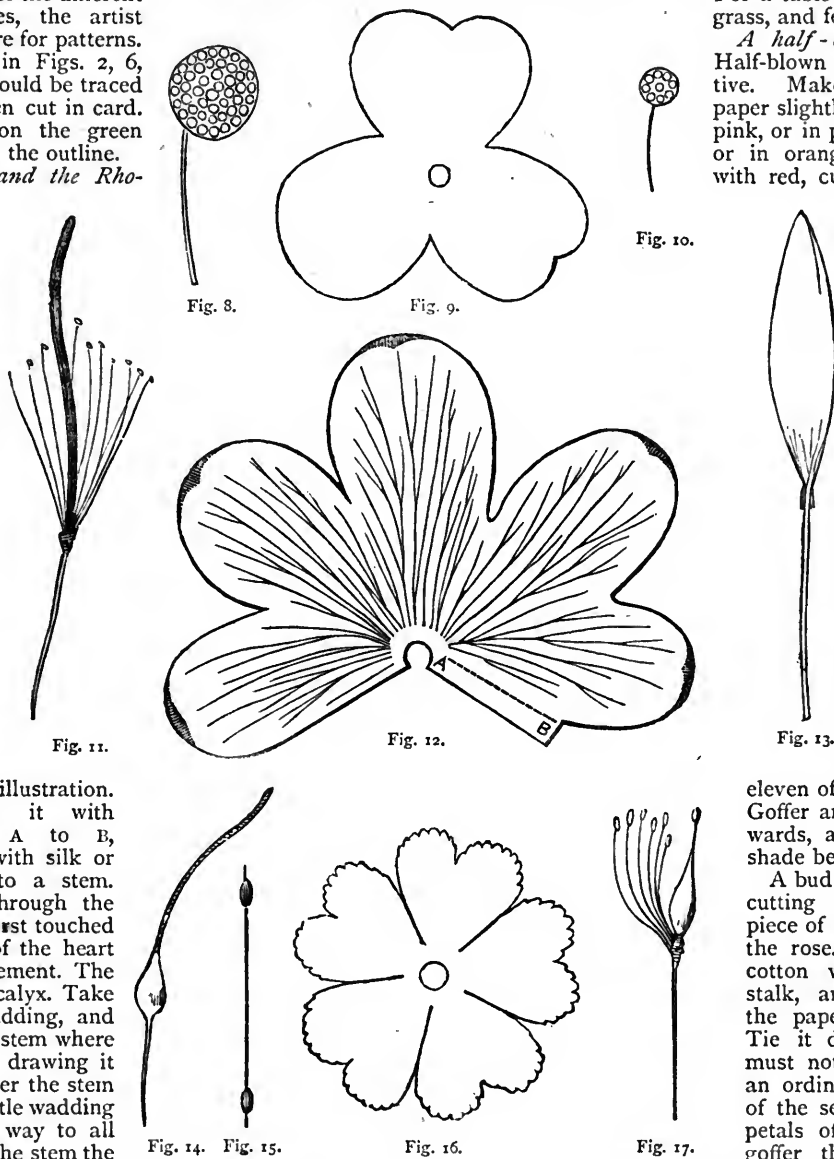

that characterise the flower afterwards. To make them up, cement each all round the centre as far as where the petals divide. Crumple the first one quite close up all round the heart, hiding it entirely, and squeezing the paper as much as possible. Make the next one close, and each future one looser and looser. Finish with the calyx. If you make your own calyx, it ought to be formed and dry ready for use, and a little wool secured inside by cement. After it is made, gum over the outside.

Primrose (Fig. 16).—This is made with three rounds, either of pale yellow paper over the Michaelmas daisy heart, the first paper crumpled well up to conceal all the heart, the second partly closed and the outer one flat. Or it may be of mauve, cut in white paper and coloured at the edge like the rhododendron, or tinted pale pink.

ANIMALS KEPT FOR PLEASURE.

V.—THE DOG: DISEASES OF DOGS.

IN giving a few general outlines of the symptoms and treatment of the ordinary complaints to which dogs are liable, we may make one introductory remark. If you keep a dog which is either of unusual value intrinsically, or is much prized as a pet, ascertain, whilst the animal is *yet in health*, the whereabouts of the very best canine physician in the neighbourhood. In most large towns there is some dog practitioner of high repute, and, in the absence of such, it may be needful to consult a veterinary surgeon, huntsman, or gamekeeper; but these latter are only to be trusted in the case of large, hardy dogs, such as they are chiefly accustomed to, and the former are very often totally ignorant of the dog's nature. In fact, very many drugs have upon the dog an *entirely different* action from that they exert upon man or other animals. To give one or two familiar instances: aloe is a violent purge to the human subject, while castor-oil is a gentle laxative justly valued; to the dog, on the contrary, castor-oil is a most violent purgative, while aloe produce little or no effect whatever. Again, salt is almost necessary to preserve health in man; but with the dog small quantities cause nausea and vomiting, while in larger doses the condiment deserves to be called a poison. It may be generally stated that dog-practice, during the last twenty years, has undergone a radical change, much akin to that in the higher walks of medicine. Tonic treatment has taken the place of depletive medicine, and much greater faith is placed in the powers of nature, with great gain to all concerned. Foremost in this beneficial and mild school of treatment is Mr. Edward Mayhew; and wherever we have given actual prescriptions in this and the following paper, we have followed the proportions laid down by him.

Diminutive bitches can seldom rear more than two pups, and few pet dogs more than three; robust animals may be able to suckle all their litter. If more valuable pups must be reared than the mother can nourish, either a cat or a foster-bitch of some common breed should be provided, or fits will be the consequence. Should such occur, the best treatment will be an enema of ether and laudanum in gruel, followed by a spoonful of wine, and tonic treatment, as we shall describe in speaking of distemper, when consciousness is restored; the mother must be kept away at night, but may be allowed to suckle her pups in the day, after they have been *well fed* with cow's milk from a bottle such as is used for children, only the nipple should be made with the old-fashioned wash-leather, pricked with holes, and filled with a bit of sponge or cotton to give it substance. To rear pups by hand is not difficult, but very troublesome, as they want feeding at night. They should be suckled about a quarter of an hour, and it will only be needful to keep the teat from becoming sour. In less than a month, however, they may be taught to lap,

when they should get a little meat scraped to pulp, and a week after tasting this they will feed themselves.

It often happens that the smallest pup is, for that very reason, the most valuable. In that case the owner will have to see it has its share, or in the general scramble at every meal it will get crowded out and starved. If no other means avail, the bitch should be held while the pup sucks its fair allowance.

As they grow up they will probably have to pass through the dreaded *distemper*, which, as a rule, affects young dogs, though it is a mistake to say it is universal, as there are many dogs which escape it altogether, while others only suffer late in life. Still, the usual period is towards the end of dentition, and the most frequent seasons of the year are spring and autumn. At these times young dogs should be carefully examined occasionally for symptoms. And as it is always found that dogs fed upon flesh, highly fed in any way, or kept in confinement, suffer far more than those fed on plain and rather spare diet, with plenty of exercise, common sense will dictate the treatment best suited for all such animals.

The earliest symptoms are indefinite, dulness and loss of appetite being sometimes all that can be remarked, while, on other occasions, the appetite may be voracious. In most cases, however, the inner edges of the eyelids will soon be observed to be redder than usual, while the pulse is increased. Still, distemper may not be present, but if the animal speedily begins to seek the fire, and is felt to shiver with cold, the case is nearly certain. When confirmed, however, the white round the eye is covered with small bright red veins, tending towards the centre, while a purulent discharge begins to appear, and also a little yellowish discharge from the nostrils, while the nose remains dry and hard. A bad cough often sets in, and the dog frequently vomits, and some digestive disorder is always apparent. In a week the symptoms often subside, and sometimes disappear altogether; perhaps, indeed, this is generally the case, and the owner is apt to believe the disease has run its course. It may, indeed, be so, for many dogs only suffer very slightly. If such be the case, the dog will rapidly make flesh, or fatten, and recover condition, while the eyes look healthy, and the morbid symptoms disappear; but if the *emaciation continues*, or the animal makes no progress, and especially if the white of the eye presents the appearance of *minute blood-vessels* in a *radial* direction, the disease is only slumbering, and will break out again with tenfold force.

In aggravated cases, the discharge from the eyes and nose becomes excessive, completely stopping up the nostrils, and sometimes ulcerating the eye itself. One of the worst signs is a great and rapid loss of flesh, especially if the appetite be good. A filthy, fœtid coat, suddenly swarming with vermin, is also a very unfavourable sign, and so is a very foul and coated tongue, dry at the tip, with a marked foulness of the breath. On the contrary, an evident amendment in the eyes, a marked improvement in the condition, and the return of the tongue to a healthy state, hold out every reasonable hope of recovery.

The first thing in the treatment is to regulate the diet. Meat must be taken away, and the generality of dogs put upon bread and milk—a ship-biscuit and milk. Weakly dogs may have boiled rice, with a little broth free from fat; and as they will frequently refuse this at first, a little good underdone meat may be minced fine and mixed with it, gradually lessening the quantity till none be given, for all meat, sweets, and delicacies *must* be denied. The water must be often changed. The dog should be put in a good sheltered kennel, but in the *open air*; all blankets and such pampering beds taken away, but plenty of good hay and straw allowed instead. This is needed, because the dog will burrow in it when the shivering fit is on him; and the bed, moreover, must be shaken and cleansed every day, and entirely changed every two days.

In mild cases, when the first symptoms have been marked, and consist perhaps of only a redness about the eyes, and great inclination for the fire, give for two or three days, in the morning, a mild emetic, such as half a tea-spoonful to a dessert-spoonful of antimonial wine. About the fourth or fifth day, give a gentle purgative. From one to four tea-spoonfuls of the following mixture is much recommended, and if mixed with a little sugar or simple syrup, will be readily taken :—

Castor oil	4 drachms.
Olive oil	2 drachms.
Oil of anise	$\frac{1}{2}$ drachm.

Mix.

Or a pill may be compounded of:—

Extract of colocynth	10 grains.
Colchicum, in powder	6 grains.
Blue pill	5 grains.

This last is best, and is for a small dog. Three such pills, or one three times the quantity, would be needed for a mastiff or Newfoundland. At the same time, make up the following pills, choosing from the quantities named, according to the size of the dog :—

Extract of belladonna	6 to 24 grains.
Nitre	20 to 80 grains.
Extract of gentian	1 to 4 drachms.
Powdered quassia	quantum sufficit.

Make the above into twenty-four pills, and administer three daily. Often this treatment seems to cure. If so, the belladonna has done its work, and the following tonic is substituted :—

Di-sulphate of quinine	1 to 4 scruples.
Sulphate of iron	1 to 4 scruples.
Extract of gentian	2 to 8 drachms.
Powdered quassia	quantum sufficit.

This is for twenty pills, three to be given daily, with *Liquor arsenicalis*, prepared by adding ten to twenty drops of the pharmaceutical preparation to an ounce of water, with a little simple syrup, and giving a tea-spoonful thrice daily.

If the case be more severe, and the bowels very costive, no laxatives must be used, but an enema made up of four drachms sulphuric ether, and a scruple of laudanum, added to a quart of cold gruel, (one-eighth for a small dog), will greatly relieve the animal in its distress. The tonics and diet are to be as before. Should the lungs be affected, the diet must be kept spare, giving food often, but very little, and discontinue the tonics for—

Extract of belladonna	$\frac{1}{4}$ to 1 grain.
Nitre	1 to 4 grains.
James's powder	$\frac{1}{4}$ to 1 grain.
Conserve of roses	quantum sufficit

In making, add one drop of tincture of aconite to every four pills, and give one pill every hour. When better, resume the tonics, even though the lungs be not well.

HINTS TO LETTER-WRITERS.—V.

IN writing to a member of Parliament who has neither hereditary rank nor honorary degree, a letter must be addressed as to "Robinson Jones, Esq., M.P." If he is a baronet, the address must be, "Sir Robinson Jones, Bart., M.P." If he is a knight, it will be, "Sir Robinson Jones, Knt., M.P." If he is a viscount, or lord, he is addressed in accordance with the rules already laid down for his rank, with the simple addition of "M.P."

The general principle for addressing persons bearing academical and similar honours has been explained in the previous article; but the following examples may be useful. To a bachelor of arts, who is a layman, "John Warren, Esq., B.A." or "A.B." To a master of arts

who is a layman, "John Smith, Esq., M.A.," or "A.M." A bachelor of laws, "LL.B.;" a doctor of laws, "LL.D.;" a doctor of medicine, "M.D.;" a doctor of divinity, "D.D.," and others with like honorary and professional titles must, if laymen, be addressed in agreement with the foregoing specimens. Yet it is not uncommon for those who have a doctor's diploma of any kind, if laymen, to be addressed merely as "Dr. So-and-so." It may be noted, however, that in addressing gentlemen with ordinary academical degrees, it is not a breach of civility to omit the mention of such degrees on the envelope of a letter. Ordinary degrees are also often omitted in addressing clergymen.

Clergymen who have no other official or professional honour are addressed as "Rev." Every clergyman is a reverend, and, when addressed in writing, must be so styled; thus: "The Rev. George Jones." If a clergyman holds a doctor's degree, he is addressed either as "The Rev. Dr. So-and-so," or as "The Rev. Samuel Oliver, D.D." Should he be D.D. and LL.D., both these abbreviations may follow his name. So of other degrees, though it is not common for D.D., LL.D., and other doctorships to have mentioned with them lesser degrees, as M.A. and B.A.

Professors in colleges, universities, &c., if laymen, are addressed as "Prof.," or "Professor," without "Esq.;" but if they are clergymen, they are styled, "The Rev. Prof." There are cases in which the professorship is mentioned after the name and other titles, and then "Professor of —" is simply added. Where the professor is the principal of a college, this word "principal" may be used instead of "professor;" and, as the principal is usually a clergyman, the address will be "The Rev. Principal —." The "master" of a college in a university can be addressed as "The Rev. the Master," and his name omitted if the college is added; or thus: "The Rev. The Master of — College." Where the heads of colleges, &c., have to be addressed collectively, their official titles only need be inserted in an address, and their proper names may be left out.

A privy councillor is addressed as "The Right Honourable," with such other titles as he would have if not a privy councillor. The same title of "Right Honourable" is also given to the Lord Mayors of London, York, and Dublin, and to the Lord Provost of Edinburgh, while in office. Thus, "To the Right Hon. the Lord Mayor of London," is a sufficient address.

The Lord Lieutenant of Ireland is styled, "His Excellency the Lord Lieutenant;" but when he is a duke he is called "His Grace the Lord Lieutenant." The lady of the Lord Lieutenant derives no accession of title from her husband's office in this case.

A secretary of state is addressed according to circumstances: "To Her Majesty's Principal Secretary of State for the (Home, Foreign, or Colonial) Department." He may also be addressed as "The Right Hon. Such-a-one, Her Majesty's Principal Secretary of State for the (Home, Foreign, or Colonial) Department."

Generals in the army are addressed thus: "To General the Right Hon. Lord Such-a-one," the word "General" being prefixed to his ordinary designation. To a Lieutenant-General it is sufficient to say, "To Lieut.-General Such-a-one." A Major-General is simply styled thus: "To Major-Gen. Blank." In like manner we write, "To Col. Jones," "Lieut.-Col. Jones," and "Capt." or "Captain Jones;" but the latter may be "George Jones, Esq., Captain" of such-and-such a regiment. Generally speaking, subalterns are addressed as "Esq." or "Mr. —," 48th Regiment." When military officers are knights or baronets, &c., they should be addressed as such, thus: "Major-General Sir Thomas Napier, Knt., &c." the official rank being named first.

An admiral may be addressed simply as "Admiral

Such-a-one," or as "The Right Hon. Lord Such-a-one, Admiral of the —, K.C.B." &c., according to circumstances. A captain in the navy is "Captain Such-a-one, R.N." A lieutenant is, "Lieut. —, of H.M.S. Fury." If officers of the navy are knights, baronets, &c., they are addressed as such, according to the rule laid down for military officers.

Inferior officers may be addressed as private individuals, with the addition of the rank they occupy, the regiment they belong to, or the ship to which they are attached. In some cases it is highly desirable to mention details even more minute, in order that a letter may not fail to reach its destination. Thus, it may be well to mention the company, or the battalion, &c., to which the person addressed belongs. In all cases in which soldiers and marines are written to, it is proper to say what rank they occupy, and to state whatever else may assist in their identification or discovery, especially when they are engaged on foreign service. An insufficient address often prevents a letter from reaching those it is intended for, and is the cause of great disappointment, annoyance, and distress.

INMATES OF THE HOUSE.—DOMESTIC.

IV.—THE PARLOUR-MAID.

IN most establishments where a parlour-maid is kept, many of the lighter duties of the housemaid and footman fall to her share of work; to which is not unfrequently added some of the attendance on the mistress of the house, usually performed by the lady's maid. These combined duties include dusting and polishing furniture, answering bells, cleaning plate, waiting at table, and filling up spare time with needlework.

None of the above are, strictly speaking, laborious duties; but in order to discharge them effectually, methodical working is indispensable. Early rising is a cardinal virtue in every branch of domestic work, and is especially desirable where a cleanly personal appearance is a first requisite. Any employment likely to soil the hands and dress of a parlour-maid should be done before breakfast, the attendance of the servant at that meal being generally required.

The carpets having been swept and the grates cleaned by the housemaid, the dusting of the furniture and arranging of the rooms should be done by the parlour-maid. A good memory is needful on her part, to remember where every article is kept, and she should be careful to consult her employers' convenience in regard to the placing of books, writing-materials, needlework, &c. As a general rule, each piece of furniture has its appointed place, but whenever the arrangement is disturbed, it is the parlour-maid's duty to reinstate order, unless desired not to do so. A vigilant servant will take the opportunity of the family's absence from an apartment to make up the fire, sweep the hearth, and clear away any litter. All sitting-rooms occupied throughout the day require dusting twice, *i.e.*, before breakfast, and also before the family return to the apartment from the dining-room. If the weather is favourable, opening the windows a few inches from the top and bottom sashes, freshens the room, and proves a grateful change to its occupants.

The hour at which a parlour-maid should be what is termed "dressed for the day," must depend upon the ever-varying nature of the work required in different families. Perhaps the best way to decide the question is, to be guided by the hour at which visitors are likely to call. In most professional men's houses for instance, the business of the day begins at ten o'clock, by which time if the parlour-maid answers the door, she should be neatly attired, and ready at a moment's notice to present herself creditably before strangers. A servant of good address at a professional man's door, is as much a matter of per-

sonal recommendation of the employer as the situation of his residence. Some amount of forethought on the part of the mistress is necessary to ensure cleanly appearance in a door-servant; but the attempt is worth making, if only for the sake of favourable first impressions on the part of strangers. The description of dress already given for housemaid's wear, applies to the parlour-maid. The following are some of the parlour-maid's chief duties.

Answering the Door.—When answering a door, the servant should open it wide enough to afford free entrance, herself standing back. Having replied to the question whether the person inquired for is at home or not, the door should be gently closed, and the question, "Your name, if you please?" or, "What name shall I say?" should be asked. To prevent mistakes, the caller, if a stranger, usually presents his or her card. Upon giving the card, the visitor should be shown into the drawing-room, or some unoccupied apartment. The servant should then place a chair for the visitor, raise the blinds, stir the fire or make any alteration needed to secure the comfort of the caller, in the interval of waiting. All cards and letters should be handed to the person for whom they are intended, on a salver or small tray kept in the hall for the purpose.

If the interview is likely to be short, a parlour-maid should be prepared to go to the door to let out the visitor, on the signal of the drawing-room bell ringing. She should stand with her hand upon the lock until the caller comes in sight, when the door should be opened wide, and gently closed when the visitor has left the doorstep. If a carriage is in question, the door should not be closed until the vehicle has driven off.

Waiting at Table is a very important branch of domestic knowledge, and although the principles are much the same in all good society, most servants require a little initiation into the particular ways of each family. We subjoin the most general rules.

Breakfast.—At the end of the table, where the lady presides, the cups and saucers should be arranged on either side, having her plate in the centre. The teapot should stand just behind, and the milk-ewer, slop-basin, and sugar-basin at the back of the teapot. If an urn or bright kettle is used, it should be placed within easy reach of the mistress's hand. In most families the loaf and butter are placed on the breakfast table, also a rack of toast, a stand of eggs, and some plates of cut bread and butter. Hot meat is likewise set on the table opposite the master of the house, and cold meat on the sideboard. Some people like to have the loaf and butter also on the sideboard. The parlour-maid generally waits in the breakfast-room until all the family is served with tea, and eatables. Having done so, her attendance is usually dispensed with, the members of the family waiting on themselves during the rest of the repast.

At *Luncheon*, much the same order of things is to be observed, with the exception that both hot and cold meats are then placed on the table, the servant retiring when the family has been served, as at breakfast. This rule is generally observed, as it is customary for the servants to dine whilst the family take lunch. Any unavoidable disturbance at that time should be guarded against. It is usual to put a supply of clean plates, glasses, &c., on the sideboard, in order that persons may change their own plates after the servant has left the room. Dirty plates are then carried by the users to the side-board.

Dinner.—Some time before dinner, the parlour-maid should get everything in readiness preparatory to laying the cloth. Knives should be dusted and laid in their appointed box, silver and plated articles should be rubbed lightly with the plate-leather, and laid in the plate-basket, and wine-glasses, tumblers, water-bottles, and salt-cellars should be arranged upon a separate tray. The table-napkins and cloth, if untidily put aside, may require

passing through the linen-press, Fig. 1, or mangle. Bradford's Mangle, No. 1, shown in the illustration, Fig. 2, is suitable for this purpose, and takes up little room. Before laying the cloth, the parlour-maid should sweep up the hearth, if fires are used, and put on fresh coals, so that there may be a cheerful blaze by the time dinner is served. Any papers, books, or other articles that may be dispersed about the room, should be tidily put away, leaving the sideboard clear for table requisites. The sideboard cloth should be laid flush with the edge of the sideboard, not hanging over the front as is sometimes seen. The same rule should be observed in covering all tables used as sideboards. At the back of the sideboards should be placed salvers, bronzes, lamps, or any ornaments belonging to the sideboard. On the right side should be put clean glasses, arranged according to size and kind; and on the left, spoons and forks tastefully set out. The middle of the sideboard should be left unencumbered for sauces, vegetables, or anything not wanted on the table. The dinner-cloth should be laid with the middle fold down the centre of the table. Whether the damask has been mangled on the right side or not, the parlour-maid must observe that the raised creases should be on the top. Some prominent design in the fabric generally indicates the centre of the cloth, which should of course be laid in the middle of the table. A lamp, cruet-stand, or vase of flowers, is generally put to mark the centre, and the distances of the respective dishes are regulated from that object.

The fashion of dining *à la Russe*, so general at formal dinners, requires a separate notice. For the present we will confine our observations to the usual arrangement of a table in well-conducted households. By the latter system, the master sits at one end of the table, and the mistress of the house at the other. Carving knives and forks, together with dinner knives placed nearest the plate, mark their places. According to the number of persons to dine, knives and forks are placed for each. A tumbler and one or more wine-glasses should be put at the right of each guest, just above the dinner knife. When clean dinner-napkins are laid, it is customary to place a piece of bread in the folds of the napkin.

Whether cut bread or rolls should be placed at the right hand or left, is sometimes a disputed point. We decide in favour of the right, for this reason: When a guest wishes to have his plate removed, he is supposed to rest his fork on the plate. A well-trained servant observes no other rule in making the change, sadly to the grievance occasionally of an inexperienced diner, who inadvertently drops his fork. As in breaking bread it is not considered well-mannered to use both hands, there is no occasion to relinquish the fork until a change of plate is desired. Between

the courses, the crust of bread may be divided with both hands, if desired. Now that knives are beginning to be used for eating fish, the last claim of the bread to be laid on the left of the diner, appears to have been disposed of.

Directly a person drops his fork, or lays both knife and fork together on the right-hand side of the plate, the servant in attendance should bring another plate on which are laid knife, fork, or spoon, appropriate to the dish which is to follow. All meats, vegetables, and sauces, should be handed on the left side of the diner.

Serving wine, &c., should always be done at the right-hand side of the guest *without removing the glasses from the table, except in the case of beer, which is served at the left hand.* The reason is obvious. Beer requires to be frothed into the glass; consequently, it prevents accidents if the servant presents a tray to the guest on his left to receive the glass, into which the beer should be poured, at the distance of a step behind the guest. The full tumbler should then be handed on the left, as it would be inconvenient for the guest to receive it over the right shoulder. Servants should avoid handling wine glasses. If they must do so, they should only touch the stem. Water-bottles are placed on the table within reach of the guests.

Before setting dessert on the table, the parlour-maid should brush off the crumbs into a small tray with a curved cloth-brush or similar contrivance made for the purpose.

Carving knives and forks after being used should be removed before taking the dish containing meat from the table. A long narrow knife-tray with a clean coarse cloth laid at the bottom, is the proper receptacle for these articles.

During the intervals which occur in waiting on the guests, the parlour-maid should remove all things which have been used outside the dining-room, where one of the under-servants usually conveys them to the kitchen. The servant waiting should contrive to have all soiled vessels out of the room by the time dessert is put on the table, her attendance not being wanted after that time.

Tea.—After a late dinner, tea is generally a very simple repast, requiring only a tray on which teacups and saucers, with other tea appendages, are set. If tea is made in the drawing-

room, the parlour-maid waits on her mistress until the tea is handed round. A set tea, *i.e.*, a meal, with tea as a beverage, is served in the same manner as breakfast. It is now the fashion to cover the tea table with a white cloth, as for breakfast.

Supper is usually served in the same manner as luncheon.

Washing up china and glass, cleaning plate, and trimming lamps, being equally the work of the parlour-maid or page, will be described in another place.

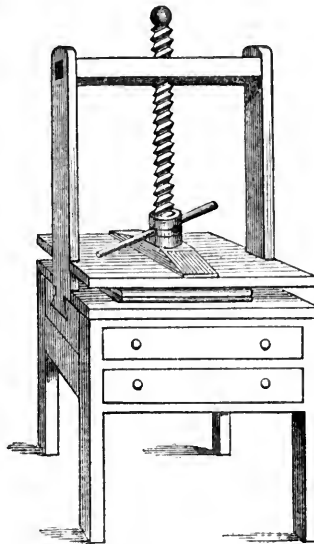

Fig. 1.

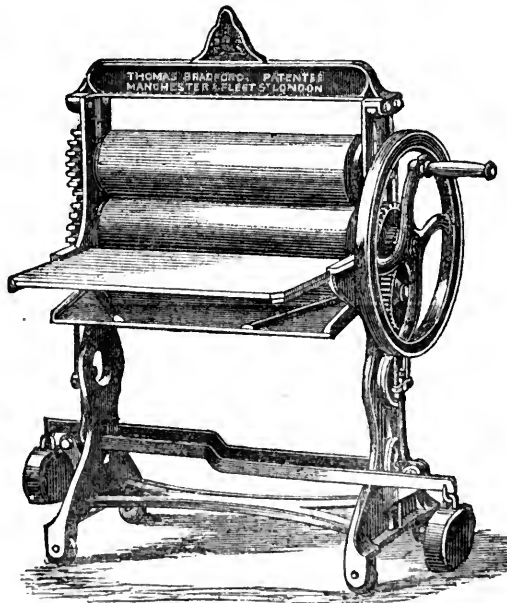

Fig. 2.

THE REARING AND MANAGEMENT OF CHILDREN.

VIII.—FOOD IN INFANCY.

THE most suitable food for infants is that of Nature's own providing—mothers' milk. In very exceptional instances is this supply shortcoming during the first few weeks after child-birth. If, unhappily, the contrary should be the case, a delicate infant can seldom be successfully reared without the aid of a wet-nurse.

The only circumstances which should prevent a mother from suckling her offspring are a too excitable temperament, or a consumptive state of constitution. Ordinary debility, consequent on recent confinement, is rarely an impediment to the fulfilment of one of the highest instincts of human nature, and one no less productive of moral than physical benefits. During the time a child receives nourishment at its mother's breast the earliest bond of sympathy, destined to influence a lifetime, of parent and child is mutually formed. Without endorsing to the full the assertion, that every passion to which our race is subject may be communicated through the medium of a wet-nurse, it is certain that the affection of a child for its parent is vastly increased if nourished exclusively by herself.

Whatever changes it may be necessary to make in the dietary of an infant after the age of six weeks, absolute necessity alone should induce the substitution of artificial food in lieu of the natural food. The first milk is of a purgative character, and is admirably adapted to cleanse the system of a new-born babe. In this particular the most desirable wet-nurse might fail to prove a fitting deputy for the mother. Likewise, throughout the period of nursing, it is a point of great importance that the quality of the nourishment should be proportionate to the age of the infant. If the services of a wet-nurse are inevitable, it should be sought to engage one who has been a mother about the same length of time as the parent of the infant to be brought up. In selecting a wet-nurse a medical man is the best medium.

During the first two or three weeks—the powers of suction and the organs of digestion being alike weak—an infant, *if awake*, may be suckled at intervals of from one to two hours. The sooner, however, the babe can be brought into the habit of being fed once every two hours the greater will be the benefit derived from the nourishment, and the more speedily will the mother be enabled to regain her own strength. A determination to attain regularity in feeding is all that is needed at the outset to secure the desired end. When this plan is steadily pursued, the digestion of a child will work with the precision of the clock by which its meals are regulated. Any cry that may be heard in the interval should not be supposed to arise from craving for food. Numberless causes of irritation may occasion a fretful cry: cold feet, pressure of clothing, wet linen, a flea, or other discomfort, may excite the piteous sound. Instead, therefore, of giving food instantly, it is advisable to open the clothing, warm the tiny feet, chafe the limbs, or, if possible, take the infant for a little walk out of doors. If, after having tried similar remedies, the fretfulness continues, the cause should be sought in the condition of the child's stools. If signs of griping pains or colic are evident, less instead of more food should be given, and the interval between the meals lengthened instead of diminished.

Sometimes a continual cry of distress prevails, from the mother's milk being not sufficiently nourishing to satisfy the appetite of the babe. In such case it is advisable to give, every alternate two hours, a meal of cow's milk and water, prepared in the following manner:—The milk must be boiled as soon as it comes in, and left to settle till a scum has formed on the top. Remove

the scum, and add two tablespoonfuls of boiled water to one of milk, sweetened with a little loaf sugar. The above directions are applicable to milk known to be pure. If the milk has passed through several hands the quantity of milk may be insufficient to the proportion of water.

A lactometer (a small instrument to test the quality of milk) may be had at very trifling cost, and affords some indication of the genuineness of milk. At the same time we must confess to being very sceptical as to the nourishing properties of milk usually sold in towns, and would suggest, where any doubt exists, that condensed milk be substituted for the article usually obtained at metropolitan milk-shops. The condensed milk (which has lately been introduced into this country) is one of the greatest boons placed within the reach of dwellers in crowded cities. All children like it, and thrive on its use.

The practice of giving thickened food to infants at too tender an age is a source of endless trouble. In one of Dr. Edward Smith's admirable articles on dietary he remarks that the feeding of young infants on bread, flour, biscuits, and other substances than milk, is a "constant source of derangement of the liver, and a frequent cause of fits." The organism of a young babe is not designed to convert such food into a healthy form of nourishment. However considerable the quantity of such food passed into the stomach of a young infant may be, the body is not thereby nourished, but irritated. A babe, like an adult, is only nourished by what it has power to digest. Where the powers are weak the form of nourishment should be correspondingly easy of digestion.

As a general rule a babe may be well nourished on milk, or milk thickened to the consistence of cream, until the first tooth appears. Even after that period milk should for a considerable time form the staple article of food. Larger quantities should then be given, and greater intervals between the meals observed. It is estimated that a babe three months of age will consume at least three pints of milk in twenty-four hours.

Weak beef-tea, veal, chicken, or mutton broth, are excellent additions to meals composed of rusks, rice, or other farinaceous articles. Careful feeling of the way, however, should be observed in every change of infants' diet, especially if teething be in operation.

A needless source of alarm is sometimes excited by an infant throwing up milk in a curdled state. The fact is that this appearance is perfectly natural in milk rejected from the stomach of a healthy child. The quantity rejected is simply that which was in excess of the child's want, and is Nature's special mode of relief in infancy. If the milk is rejected in a dense mass, it is a sign either that less would be sufficient for a meal, or that the interval between taking nourishment should be lengthened. But if, immediately on being put to the breast, or on beginning to suck a bottle of food, the stomach throws off the food, the condition of the parent or child should receive attention.

A very necessary treatment after a meal consists in lifting the babe across the nurse's left shoulder, *whether awake or asleep*, and gently patting the infant's back until the wind displaced by food is thrown off the stomach. Wherever this simple precaution is used gripes and windy colic are seldom heard of. So great is the relief, that infants once accustomed to the treatment struggle to lift themselves up after having been fed.

The period of weaning is justly regarded as one of great anxiety to a parent. The only way to lessen the trial is to make the change gradually. A little self-restraint in keeping out of sight when the child may naturally be supposed to be hungry, is the greatest act of kindness the mother can confer on the little one. The most favourable time for weaning is in the warm weather, when the infant can be amused and kept much out of doors.

The kind of feeding-bottle used is an important con-

sideration. Those with cloth tubes and india-rubber tops are in most general favour, and for liquid or semi-liquid food are decidedly the best. If the food be thicker than semi-fluid, feeding with a spoon is preferable.

The time an infant should take to imbibe half a pint of some liquid food should not be less than from twenty minutes to half an hour. In order to secure the necessary delay, the elastic top should be examined before each meal, to see whether the hole through which the food passes has extended with use. If so, a tie-knot with a fine needle and sewing silk should be made across the hole. It should be borne in mind that only such food as has been thoroughly mixed with saliva proves easy of digestion. The temperature of an infant's food should be that of its body. This may be maintained during feeding-time by placing the main quantity in a vessel containing hot water, within reach of the nurse's hand for replenishing.

Throughout the period of early infancy, the best time for giving food is before the child is laid down to sleep; indeed, the act of taking food induces slumber. The importance of sleep being pre-eminent, it is better to waste the remnant of a meal, if need be, than to keep a sleepy child awake to eat.

The utmost cleanliness should be observed in every detail connected with the keeping of all utensils for nursery use. When removed from the bottle, the india-rubber top should be immediately cleansed and thrown into a glass of clean water. The bottle should be cleansed from every trace of food, and twice a day rinsed out with tea-leaves and water, usually at hand in the nursery. When not in use, the bottle should be hidden from the infant's sight.

Not more food than is likely to be consumed at a meal should be prepared at a time, owing to the tendency of milk and farinaceous articles to turn rapidly sour, especially in close rooms and in warm weather. Any portion of liquid food that it is necessary to set aside, should be boiled afresh, and not left after having been warmed.

Farinaceous articles for night-feeding should not be kept over a lamp; diluting such articles with boiling water is a safer plan. Water is easily kept at boiling heat in an ordinary Etna.

The nurse should avoid the unpleasant habit of testing the temperature of the infant's food by putting it to her own mouth. A little sugar sprinkled over the top of a feeding-bottle will often induce an infant to take the artificial food.

Diet for more advanced childhood will receive attention in a subsequent number.

DOMESTIC MEDICINE.

CHICKEN-POX.

BESIDES the eruptive fevers, already noticed, we must treat of chicken-pox, one of the most frequent of the diseases of children. It is familiar to mothers and nurses, and consists in the appearance of little spots, round, not depressed in the centre like those of small-pox—very much the same kind of appearance as we might conceive to be produced by dipping a brush into boiling water and sprinkling it over the body. This eruption is preceded by slight indications—generally very slight—of indisposition, such as chilliness, headache, weariness, and sometimes aching in the back and limbs. Often nothing particular is noticed in the child till the eruption appears as little spots, first over the trunk, and then over the face and limbs. They soon fill with clear, or very slightly turbid fluid. They do not extend deeply into the skin, and they do not destroy its substance as the spots of small-pox do. On the third day of the disease the spots begin to dry up. On the fourth day this drying progresses rapidly, and

soon after leaves a scab, which in a few days falls off and little trace of the spots is left but slight redness.

Chicken-pox has been thought by some to be a modification of small-pox. But it is not so. It is quite a distinct disease. Neither vaccination nor small-pox protects from chicken-pox. Chicken-pox occurs almost exclusively in childhood. The spots are of a different shape, not being depressed in the centre, and containing only one compartment, not many. The disease cannot be given by inoculation, as small-pox is, and it is altogether slighter than small-pox.

It is of little importance itself, excepting that it is very infectious, and pretty sure to affect children exposed to it. Occasionally, like any other eruptive fever, it leaves in some children a tendency to other eruptions for a time. It occurs for the most part in very young children.

Treatment.—But little else than domestic treatment is required, though, if there is any undue degree of feverishness or indisposition, it will be well to consult a doctor. A very light diet of milk, and general quietness, are all that are necessary. A little cooling medicine, however, does good, such as the following for a child a year old:—

Citrate of potash	18 grains.
Simple syrup	1 drachm.
Water	1½ ounces.

Mix. A teaspoonful three or four times a day.

For older children a mixture in twice the quantity might be made up, and a proportionate dose given.

HOME GARDENING.

WE here conclude our system of rotation cropping of a small vegetable garden for one year.

December.—1. As raspberries and strawberries are the chief occupants of this quarter, there will be little to do, with the exception of removing weeds and such rubbish as will accumulate from time to time amongst them. The gooseberry and currant bushes surrounding this or any other department, should be pruned at once, and the cuttings removed directly afterwards, so as to keep up a neat and orderly appearance. 2. Examine the broccoli here repeatedly, for the purpose of having such as are fit for use cut and stored away in a cool place where it will keep good for many days. Should this situation be a very cold one, we should advise you by all means to have a portion of the winter variety laid down on their sides, in the following manner:—Commence at the west side of the plot, taking a spit or spadeful of soil from that side of the plant, bend the same down in that direction, then take a spit of earth from the next plant and lay it, as it were, on the back of the first to keep it down, and continue to do the same until the entire piece is completed. The reason for treating them in this manner is, because it enables them to endure a much harder frost with greater ease, and at the same time does not cause the heads to deteriorate in the least, so far as shape and flavour is concerned. 3. Previous to very severe weather setting in, it will be advisable to cover up the Globe artichokes so as to keep them from all possibility of danger. The forcing of seakale is the most important operation just now in this department, and there is no better way of accomplishing the work than covering the plants with inverted flower-pots or proper pans, having first scraped away a little of the soil from the collar of each plant and filled the vacancy thus made with coal-ashes which will keep away slugs and other vermin. As a fermenting material tree leaves will be found as serviceable as anything, the heat being so gentle and yet so regular, that sea-kale seems to thrive with it better than anything else we know of. Rhubarb may be forced in the same manner, but it takes a much longer time to start, although when it has once made a move it continues to grow with great rapidity.

4. The eelery in this plot must be well covered up with dry litter in the event of severe weather setting in. Ridge up the ground as fast as it becomes vacant, that it may have the full benefit of frost; but in doing so avoid as much as possible treading on the surrounding ground in wet weather. 5. As late broccoli and other winter greens are the sole occupants of this division, no particular directions are necessary just now, save that of laying a few of them down as already described in compartment No. 2. 6. Such cabbage plants as become loosened by wind, or raised up out of the ground by frost, must be replaced by pressing the soil round about their stems on a dry day. Likewise point over with a fork the ground between the early-planted ones, for the purpose of destroying all weeds as soon as they make their appearance, for, upon the principle that "a stitch in time saves nine," these wild plants if destroyed early will save no end of labour at a future time, to say nothing of the benefit that will accrue from the soil being loosened. 7. The peas sown here last month should be vigilantly watched, for the purpose of preventing the depredations of mice and birds, both of which do no end of mischief when left to feast unmolested. The beet here may be left in the ground until wanted. And lastly, ground that has become vacant by the removal of carrots and other roots, should be dug up at once, unless the soil be of a heavy nature, when ridging would be preferable. 8. A few lettuces should be taken up with balls of earth, and housed previous to severe weather setting in, when it might be difficult, if not impossible, to get at them.

THE CULTURE OF VEGETABLES.

Having now concluded our preliminary remarks on the formation, cultivation, and management of the kitchen garden, we shall proceed in this and following papers, to treat separately of the different vegetables usually cultivated.

The Globe Artichoke.—Of this plant there are two varieties in cultivation, the conical or French, and the Globe; the former having an oval head with scales, open and not turned in at the top as in the latter, which are turned in at the top and have the receptacle more succulent than the former. This plant is propagated by offsets from the root, in March or April, when they will be from five to ten inches high. In performing this work, open the ground round and about the old stool, and slip them off clean to the root, leaving three or more of the strongest to the parent plant to bear the next summer crop. Prepare the offsets for planting by clearing away all the under decayed or broken leaves, as well as any hard or ragged part at the bottom of the root. Those about to plant, should bear in mind that this vegetable delights in a rich light soil of a good depth, as well as in an open and exposed aspect. The ground should likewise be well manured, and dug or trenched. Plant them with a dibble in rows, three feet and a half asunder, and three feet apart in each row. Water them immediately after planting, and should the weather prove dry, and continue so, repeat the operation until such time as they have made good root, when they will be able to do without help. Hoe the ground over frequently during the summer months, in order to check weeds and keep the surface soil loose about the plants; this is really all the management necessary until the season of production is over, with the exception of giving them moisture in dry weather. These roots will, as a rule, under favourable circumstances, produce middling-sized heads the same year, from August to November, and the following year be in full perfection. It not infrequently happens, that several young shoots or heads spring from the sides of the chief or main stem, but in order to encourage the principal head to attain a full size, detach them from the parent plant as soon as they can be applied to use, which they may be as soon as they are the size of a hen's egg. The main or chief heads

are not in perfection until the scales diverge considerably, but should be gathered before the flower appears, cutting two or three inches of the stalk to each head. As soon as the entire crop is gathered from the stem, cut it down close to the ground, in order to give the plant more strength to enable it to throw up superior new shoots next summer. They will now require their winter dressing, and for this purpose it will be necessary to first of all cut away all the large leaves, being careful not to injure the small central ones or new shoots. Then dig the ground between each row, raising the soil gradually, ridgewise, over the root and close about the plant. In frosty weather cover the ground with from four to six inches of good rotten manure, taking care to lay it close about each plant. The spring dressing should be given between the months of March and April, according as the weather proves favourable, but previous to doing so, it will be necessary, not only to clear away all litter, but to examine the stocks, and select two or three of the best shoots for growing and producing the next summer crop, removing the rest by pressing them off either with the finger and thumb, which we prefer, or with a knife; then dig the ground level, loosening it well about the crowns of the roots of each plant. In the course of seven or eight years, even with the very best management, the heads will degenerate or, in other words, become smaller and less succulent, consequently it is essential that a new plantation be made about once in six years. Those desirous of saving seed must attend strictly to the following advice. Early in the summer select some of the first and largest heads, and when the flowerets are about to show symptoms of decay, turn the head down in a pendulous or drooping manner, in order that the calyx may throw off the wet.

Jerusalem Artichokes.—The tubers of the root, which are generally abundant, are the only portion used. Before potatoes were known as well as they are now, they were highly esteemed, and are yet considered a nutritious food, and when boiled and mashed with butter they are excellent eating. The best way to propagate this root is by using middling-sized tubers and planting them entire. We select for this purpose moderate-sized roots, those about as big as a shilling, plant them, and when the shoots show above ground remove all but one, or two at the most, of the strongest. The best time for planting is from the beginning of March to the end of April. Having prepared the ground by digging, plant them with a dibble in rows three feet asunder, eighteen inches apart. They should not be planted more than four or five inches deep, and when you have finished this portion of the work, rake the ground over, filling in the ground regularly as you proceed. The only care or culture needed, is when the plants are up—and they will be in about six weeks after planting—to hoe the surface of the ground over for the double purpose of destroying weeds and loosening the surface of the soil. As soon as the weeds have been cleared off the ground, you may draw a little soil up to the bottoms of the stems. This, as we have already said, is all the attention required until the time of taking up the crop arrives. The tubers will be ripe between the months of October and November, at which time the stems should be cut down, and the produce dug up as wanted, or the whole may be removed from the soil (and this is the best plan), and laid in sand under cover, in order that they may be ready in frosty weather, when, if left in the ground, they could not be got at very easily. The roots of this plant, if not carefully taken up, so as not to leave the smallest tuber, or portion thereof, will prove very troublesome, as the least particle, so to speak, will come up the following season, and for years to come, pestering and disfiguring the ground without yielding sufficient produce for a crop. Finally, make it a rule to plant, or form a new plantation every year, making up a bed in a different spot, if possible, each time.

THE HOUSEHOLD MECHANIC.

GAS (continued).

THE iron service-pipes are made in lengths of from two to ten or twelve feet, and are of wrought-iron welded over on a mandrel; one end bears a socket and the other a screw, the interior of the socket being the converse of the screw. The sizes and pitches of these screws are now universally the same for each given diameter of pipe, so that any screw is sure to fit into any socket. The sockets are either straight, plain, or diminishing, for the purpose of uniting two pipes of different diameters. Where it is necessary to turn corners, either bends or elbow sockets are used, which may be also plain or diminishing, and when one pipe branches out from another, cross or tee-sockets are required. In connections of iron tubing all that is necessary to be done is to smear the screwed end of the pipe with some thin white-lead, and then screw it forcibly into the socket with the gas-tongs, two pairs of which are used at one time—one to hold, the other to screw up. These tongs are constructed with long handles, and are so contrived that almost any amount of grip can be obtained with them. Each different size of pipe requires two pairs of tongs, there being only a slight adjustment possible. The junction of iron and composition-pipe is effected by means of unions of brass, which screw into the iron pipes and to which the composition pipes are soldered by means of a blow-pipe. The junctions between these latter pipes and the bracket or pendant burners are made by means of small brass pipes called nose-pieces, which are bent into various forms, as required.

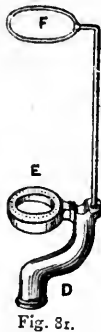

Fig. 8r.

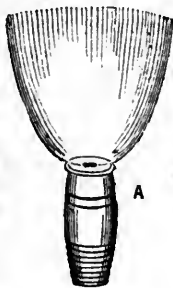

Fig. 78.

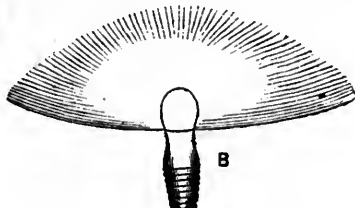

Fig. 79.

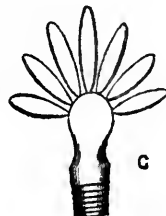

Fig. 80.



Fig. 77.

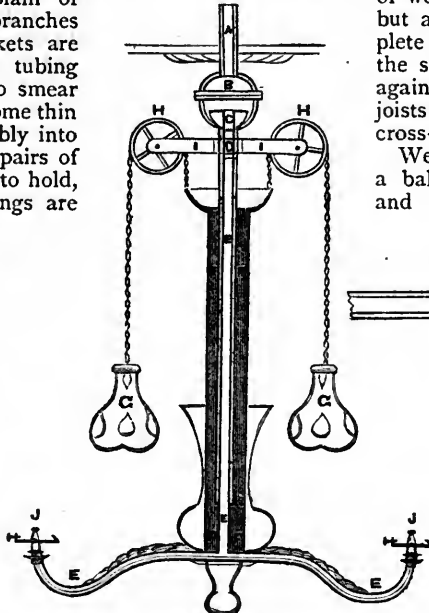

Fig. 76.

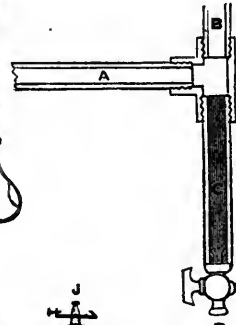

Fig. 75.

meter, B is the rising main, C the syphon, which is a short piece of the same pipe, in which the water can accumulate, at the bottom of which is a small tap to let it out when the bobbing or jumping of the gas shows the water to have risen to such a height as to obstruct the passage of the gas. This will not occur more than once or twice a year in ordinary cases. Where a wet meter is used it will happen perhaps a little oftener, the gas absorbing moisture during its passage through the water.

The methods of fastening up the pendants, or brackets, carrying the burners, must of course be suggested by the necessities of each individual case. We can only say that brackets may be securely screwed to the walls by means of wooden plugs driven into the brickwork; but a very good plan is to take out a complete brick and insert a piece of wood of the same size into the hole, and plaster up again. Pendants must not be fixed to the joists if it can be avoided, but to a small cross-beam.

We will now describe the construction of a balanced pendant two-light chandelier, and show how, by keeping the water-chamber full, the escape of gas is prevented, while the chandelier may be pulled down or up with perfect ease.

In Fig. 76, A shows the pipe from the floor above, which usually comes through a central flower or ornament. This pipe expands into the chamber B, which has a hole in the bottom. Accurately fitted to this hole is the ball C, which is the top of,

and pierced by, a down pipe D. The lower part of the ball is ground to fit the hole in the cup B, perfectly airtight; but leakage sometimes occurs at the joint, when the heat has dried up the grease. A little tallow smeared round

The horizontal pipes should be laid between the floor and the ceiling, and the boards laid over them should be screwed down again to make the access to them, when required, as easy as possible. A slight inclination towards the main-pipes is advisable to prevent the accumulation of water formed from the gas by condensation; and this inclination allows any water so formed to run down to the lowest part of the service, where a syphon should be fixed to receive it.

The best position for this syphon is at the bottom of the rising main, or upright pipe, communicating from the lower floors to the ones above. The rising main is often fixed outside the house—a plan which is advisable, except when the gas-pipes are fixed as a part of the building of a house, as such a plan prevents a great deal of mess and expense, with knocking ceilings about.

Fig. 75 shows the arrangement. A is the pipe from the

and worked in will stop it. A frame, II, carrying two pulleys, H H, and a length of pipe down to K, complete the top and fixed part of the chandelier. The cup and ball, B C, enable the arms of the chandelier to be twisted round and give considerable play and freedom of motion. The lower part, or chandelier proper, consists of a small inner tube E, small enough to slide up through D, which communicates with the burners, J J, and a larger tube F, into which D will slide. F is closed at the lower part and filled with water, which effectually prevents the gas from escaping.

The lower part is exactly counterpoised by the weights G G, which hang over the pulleys H H by chains. These weights are often made hollow, with lead or shot run in to make the balancing more exact. The water in F will, in time, become evaporated, and will need renewing. Evaporation is prevented by a teaspoonful of oil being

poored on the surface of the water. The proper way to do this is to push the lower part up as high as it will go, and then fill it up to the top, for if filled when the chandelier is down (a practice, we know, often adopted) the pushing up will cause an overflow, because of the displacement of the water by the middle tube. We have purposely exaggerated the dimensions of the tubes for greater distinctness. Fig. 77 shows the joint of the telescope pendant; A is the down-pipe, B the telescope-tube, which slides through a brass gland C, packed either with greased tow, or with cork or leather. If the joint is too loose, screw up D, and so tighten the packing of the gland. This joint is on exactly the same principle as the stuffing-box of the piston-rod of a steam-engine. Telescope pendants often swing by a joint at the ceiling, so that they can be hooked up to the roof, out of the way.

A word here on the subject of ventilation will not be out of place. To burn gas constantly in any living-room without providing for the escape of the effluvia, is to ensure the breathing of a most hurtful and pernicious atmosphere, and such a practice cannot be too strongly condemned. A grating should be concealed in the central flower, and a pipe, not less than two inches in bore, carried from it to an air-brick in the wall, or into a chimney. This pipe will convey away not only the air destroyed by the gas, but a current will be created which will carry off all the foul air produced by the breathing of the inmates of the room. The sun-lights fixed in the roofs of public buildings are always provided with large tubes leading through the roof, and they form an extremely important and efficient means of ventilation.

We come now to the burners. Fig. 78 is the commonest form, the fish-tail burner. It consists of a hollow cylinder or barrel screwed to fit the nozzle of the pipe. The top of this barrel is closed over, but has two small holes pointing diagonally across each other in such a manner that the two streams of gas impinge upon each other, and spread out in the form of a fish's tail, whence the name. Where the pressure of the gas is high it is a good thing to unscrew the burner and put a little loose cotton wool inside to reduce it, as gas at a low pressure burns much more economically. Fish-tail burners become corroded in time, and require pricking out with a stout pin. Fig. 79 is the flame of a batwing burner, which is similar to the last, but instead of a flat top pierced by two holes, it is shaped into a dome, which has a thin slit cut through the middle of it. The gas issues through this slit and forms a wide-spreading flame as shown. It takes its name from its resemblance to the outstretched wing of a bat. The packing recommended for the fish-tail will sometimes be found good for this form, but as it requires the passage of a larger quantity of gas, the wool must be put in more loosely. The batwing is not an economical form of burner, for while it will give more light than one fish-tail, it will consume more gas in proportion. The object of a burner is to produce a sheet of flame as thin as possible, in order that the oxygen of the air may combine with the hydrogen in the gas in the freest manner, and wherever the flame appears to have a visible thickness, loss of light is the result. Fig. 80 is a cockspur jet, which is of a fanciful character, and not much used for house illumination. It is a dome like the batwing, but pierced with holes instead of being slit. The Argand burner, Fig. 81, consists of a hollow ring E, which is pierced with minute holes in its upper surface, and supplied with gas through D. From a shoulder to the ring a wire, F, springs, to form a support for a glass chimney, which must be invariably used. From its formation this burner produces a hollow cylindrical flame, to which a current of air is admitted, both internally and externally, and by reason of the draught created up the chimney by the natural tendency of heated

air to ascend, the contact between the air and the gas is very complete, the greatest possible oxygenation of the gas being the result.

It has been found very beneficial to pass the stream of gas about to be consumed through liquids containing carbon in large quantities, such as naphtha or petroleum, some of the particles thereby being absorbed by the gas, and retained a short time, and there can be no doubt that the brilliancy and purity of the light is consequently considerably increased, but, the economy depending in a great measure upon a chemical understanding of the process, and some trouble being necessary in its manipulation, it is doubtful whether small consumers would find it worth while to adopt it. We should most decidedly advocate, however, the more general adoption of mercurial regulators as certain preventatives of a great amount of waste. These regulators are so contrived that no matter how few or how many burners are used at a time, an even and unalterable pressure is steadily maintained, and that an adjustable pressure. To illustrate the matter more plainly, suppose a number of burners have been used, and all but one or two turned out, these last will have the pressure so much increased, as often to cause the gas to rush violently out, and thereby be in danger of breaking glasses, or perhaps even of shooting so high as to set fire to wood-work or inflammable material not otherwise within reach. But the mercurial regulator obviates such a possibility, and whether fifty or only one jet is on at once, the pressure is invariable. We have been assured by those who have given them an impartial trial that the saving effected in gas alone has been sufficient to pay their cost in a few months.

In our next article we propose to treat of gas as applied to purposes of heating, and more especially of cooking.

THE TOILETTE.

II.—THE HAIR AND ITS MANAGEMENT (*continued*).

WE now come to the consideration of the question of how best to keep hair in a good and healthy condition. There are one or two special considerations that must be attended to, to this end. In the first place it is as necessary to observe cleanliness in regard to the hair as much as in the case of the skin. The scalp itself should be kept properly freed from all dust, scalliness, discoloration from dirt, and so on. But we shall remark on this point specially under the head of washing. Secondly, in making the toilette (and this applies with special force to the case of ladies) care should be taken to arrange the hair in the direction in which it naturally grows: It is very much the fashion now-a-days to turn and twist the hair about in the most diverse ways. The front hair will be turned backward and upward over the scalp, and the hair at the back of the head brought upwards on the stretch on to the scalp at the top of the head, and so on. Now if the hair is at all put upon the stretch, there is a strain upon the roots which acts very injuriously upon the vigorous growth of the hair, and if there be any tendency to loss of hair it will be all the more likely to develop itself. As far as possible therefore, those who wish to do the utmost to prevent damage to their hair must avoid any prevalent fashion of putting it upon the stretch in a direction contrary to that which it naturally assumes. Thirdly, it is very necessary that no tight bands be permitted to press upon the scalp, or to rub constantly over the hair, for these not unfrequently lead to baldness of the part pressed. Fourthly, only the most ordinary and simple applications should be used to the hair and scalp. In the first place stimulating washes and the like should not be used to healthy heads, but to those which are diseased or defective in their power of forming hair. Then pomades and the like should be fresh and free from

all rancidity. Fifthly, dyes should, when used at all, be selected with much caution, some being very injurious to the texture of the hair. Sixthly, there should be a systematic manner of dealing with the hair in reference to cutting, washing, and such-like things. What we mean is, that no change in the manner of treating the hair should be made suddenly, or at irregular intervals. It should not be washed now with hot, now with cold water, now without, now with soap; cut very short at one time after a long interval and then snipped at other times at short intervals; but our behaviour towards it should be uniform and constant. In that way we get an even and constant growth, so to speak. Fifthly, all excesses should be avoided as regards the actual growth of the hair. There are some mothers who fondly delight in the ample and golden locks that adorn the shoulders and backs of their little ones, and very naturally so; but we are quite sure that in some of these fair-haired children the after results are bad; the powers of the scalp are taxed in childhood and young life to produce a luxuriant crop, only to be exhausted the more speedily as years pass on. Certainly it is safer to keep the hair in the young of moderate length; it is not only more cleanly in every sense, but more conducive to a strong growth of hair. Lastly, the scalp should be kept moderately cool. Some ladies bedizen themselves with an enormous amount of head-gear that makes their head hot, deranges the local circulation, and leads to debility in the hair-forming apparatus. In the case of boys it is by no means injurious to the hair to let them be a good deal with the head uncovered: of course in cold, damp weather this cannot be permitted, but in fair and mild weather a good blow in the wind, especially if exercise is being taken, is rather good than otherwise; on the same principle it is bad to wrap up the head in hot night-caps and wrappers at night, better by far sleep with the head cool and uncovered.

Washing.—This is an operation that is most beneficial. At least it should be practised once a week by adults and the young. In the case of babies it may be done every morning before they go into their bath. But there are one or two things necessary to be observed. No strong soap should be used, but a very mild one. We have already spoken highly of Pears' transparent soap, and indeed it is the best. The scalp should be fairly rubbed with the points of the fingers, when the head is in a lather. If soap is objected to, white of egg may supply its place. Tepid water should be used, with a douche of cold water to finish off with, for this gives tone to the scalp. The hair should then be very well dried, the scalp slightly greased with pomade, the finger being used to apply it in partings made here and there over the scalp, and then a brushing will apply as much grease to the hair itself as will prevent any too much evaporation through the hair. The use of the grease after washing is a preventive to too much evaporation. Those who are afraid of catching cold will find that the use of some pomade in the way just indicated will save them from the evil they fear. The truth is, that in many cases after the natural fatty matter is removed from the scalp and hair by the soap used, there is so much chilling of the head from the evaporation, that cold results; but the use of grease defeats this occurrence. There is no objection to the addition of a little Eau de Cologne to the water with which the head is washed; we do not approve, as a rule, of the use of any spirituous liquid, for the simple reason, that its evaporation takes place very rapidly and may chill the scalp. There are some persons who like sponging the head with cold water, or who allow their shower bath to fall upon their head. Others prefer a tepid douche over the head. There can be no objection to these practices if they are habitual, if a glow is felt in the scalp after their use, or if they are not followed by the occurrence of any headache or the like.

Brushing.—Different opinions are often given upon this

matter. Some advise very hard brushes, others soft, some "electrical" brushes, others those that are "magnetic," and so on. Now what is the object of brushing? In the first place, to remove the dust or dirt that gets entangled in the hair, and secondly to stimulate the circulation of the head to a moderate degree, so as to keep the hair follicles up to their work. Now, for the mere freeing of the hair from dust, and this applies particularly to the case of ladies, a soft brush is as good as a hard one; but as regards the gentle stimulation of the scalp, the brush should be as stiff as can be used with *comfort* to the possessor. The scalp should never be so vigorously brushed as to make it tender or painful. There are many who cause pain by the way in which they brush the scalp, and they think they stir up the hair bulbs to increased vigour; but they do the reverse, they really irritate. The scalp after brushing should be gently stimulated, nothing more than this. Hence each man or woman must use that kind of brush as regards stiffness or softness, and that amount of brushing which makes the head feel "glowing;" but decidedly not painful, or hot and tender. We do not give our reason in any detail for proving that what we say is true, but we speak emphatically and dogmatically from extensive experience, and our readers will do well to follow the course we lay down for them. Electric and magnetic brushes are very well in their way, but they have no particular virtue in them for healthy heads of hair.

Cutting.—A few words will suffice for our notice of this. If cutting is to be of real use, it should be had recourse to at regular intervals; we think it much better that a small amount should be removed at short intervals, than a good deal at one sitting after a long period of waiting. It would certainly be best that everyone should, to use a barber's expression, "have the ends trimmed" every fortnight if this were possible, at least once a month. If, in the case of ladies, the hair shows a disposition to split, the cutting of a tiny portion off the hair every fortnight or so is really beneficial. Some hairdressers dilate eloquently upon the advantages of singeing the hair; they say that this operation seals up the ends of the hair, and prevents the escape of the nutrient juices; which is so much nonsense, because the hair is not a tube, nor does it, when cut across, let out any of its juices.

Curling is not a procedure which we can commend. It, perhaps, does not have very much influence, when done moderately, in checking or damaging the growth of the hair, but if frequently and extensively practised, it no doubt would do so. At the same time, it does alter the texture of the hair somewhat at the part which comes into contact with the iron. But, happily, curling is not a thing much in fashion at present.

Pomades.—We must confess that we have never been able to understand the reason why some hairdressers decry the use of pomades. Nature herself has provided two little pomade-makers, or fatty glands, that open into the hair follicle, one on each side of the hair, for the express purpose of greasing the hair and the scalp. This teaches us that a certain amount of fatty matter is necessary and beneficial to the proper growth of the hair. Let us add that pomades are to be used in those cases where the natural fatty secretion of the scalp is deficient—where the head is dry and tending to be scurfy. Some persons do not require them. When pomades are used, there are three things to be observed. The head must be washed frequently, or, at least, once a week, to remove the old greasy material which must be present; the pomade must be applied to the scalp in different places—in various partings—and brushed out into the hair; and, thirdly, the pomades must never be used if they are in the least degree rancid, or approaching thereto. Pomades are infinitely to be preferred to spirituous lotions and washes, and they are needed in our variable climate.

A few words as to the preparation of pomades. Cooley, who is a great authority in this matter, says, that in the preparation of pomades one of the first objects is to obtain the fatty basis in as fresh and pure a state as possible. Lard, beef or mutton suet, either singly or together, are generally used. The fat, carefully selected and freed from skin and other foreign matter, is pounded in a mortar until all the membranes are completely torn asunder. It is next placed in a covered porcelain or polished metal pan, and submitted to the heat of a water bath, which is continued till its fatty portion has liquefied, and the other matters have subsided and separated. The liquid fat is then carefully skimmed, and at once passed through a clean filter. In this state it can be perfumed at will; after which, when it is intended that the pomade shall be opaque and white, it is kept stirred or beaten with a glass or wooden knife until it concretes; but when it is desired to be transparent and crystalline, it is allowed to cool very slowly, and without being disturbed. To prevent rancidity, a little benzoic acid or gum benjamin is added when in the liquid state. Sometimes a little bees'-wax, or white wax, is melted with the fat to give it greater solidity. We will give the recipes for several kinds of pomatums and oils which housewives can manufacture for themselves.

Ordinary Scented Pomatum.

The pomatum prepared in the way
above described 1 pound.
Melt with a gentle heat, and add
essence of lemon... .. 2 teaspoonfuls
Stir till it solidifies.

Castor-Oil Pomade.

Castor-oil 1 pound.
White wax 4 ounces.
Melt these together, and when cooling add any scent—
bergamot or oil of lavender—with a few drops of oil of
ambergris.

Crystallised Pomade.

Olive oil 1 pound.
Spermaceti 3 ounces.
Melt together, and then add to it essence of bergamot
60 drops, and 30 drops of each of the oils of verbena,
lavender, and rosemary. Pour it into a rather wide-
mouthed glass bottle, and leave the whole perfectly quiet,
to cool undisturbed.

Marrow Pomade.

Prepared beef marrow 1 pound.
Beef suet $\frac{1}{2}$ pound.
Palm oil $\frac{1}{2}$ ounce.
Melt together, and add scent.

"Macassar" Pomade.

Castor oil 5 ounces.
White wax 1 ounce.
Alkanet root 30 grains.
To be heated together and mixed; then strain and add
oil of origanum and oil of rosemary, of each 60 drops,
oil of nutmeg 30 drops, otto of roses 10 drops.

East India Pomade.

Suet 3 pounds.
Lard 2 pounds.
Bees'-wax $\frac{1}{2}$ pound.
Palm oil 2 ounces.
Powdered gum benzoin ... 3 ounces.
Musk rubbed up with a little sugar... 20 grains.
Heat up the whole by means of a water bath for two
hours, pour off the clear liquid, and add to it
Essence of lemon $\frac{1}{2}$ ounce.
Oil of lavender $\frac{1}{4}$ ounce.
Oil of cloves, cassia, verbena, of each 30 drops.
A great favourite.

Macassar Oil.

Oil of almonds, coloured by alkanet root 1 pint.
Oil of rosemary and origanum, of each 60 drops.
Oil of nutmeg and otto of roses, of each 15 drops.
Neroli 6 drops.
Essence of Musk 3 drops.
Mix.

Marrow Oil.

Take clarified beef marrow one part, oil of almonds
three parts. Melt together, and strain through muslin,
and then scent in any way desired. This may also be
coloured with alkanet root or palm oil.

COTTAGE FARMING.

IV.—HOUSING HAY.—FENCING.

Stack Stands.—Hay-stacks are built upon frames supported by capped pillars to keep the hay free from damp and vermin. In plentiful years the hay may be built from one to two feet farther over the stack stand than in ordinary or bad seasons, and proportionally higher. The height of the stack to the eaves, after settling down, should about equal the breadth at the eaves; and the breadth at the eaves should be from two to four feet more than at the base, in order to carry the drip from the roof over the sides. The height of the roof should not be less than the breadth at the base. A cubic yard of newly-stacked hay usually weighs eight or ten stones of fourteen pounds each, and of old hay from fourteen to eighteen stones. Owing to this difference of weight between new and old hay, the hay-stack, when newly built, requires to be proportionally higher in order that it may have the proper shape when it settles down.

Dutch Hay Barns are made either round or long, and the rules for calculating the size required to hold a given quantity of hay are the same as those for round and long stack stands. Fig. 2 shows a round one built on a brick stand, the coping of which projects a few inches to prevent the ascent of vermin. The roof is of corrugated iron. In building the stack the roof is raised by means of a handspike and pin. In each of the upright posts there are two rows of holes—one for the pin that supports the roof, and the other for the lever-pin. In raising the roof the labourer goes round with his handspike and pin raising it at each post the distance between two pin holes; and in the winter time, when the hay is being consumed, he lets down the roof close on the hay in a similar way. A long barn, twenty feet by ten, would require three standards at each side, and the roof is raised and lowered in the same way as the roof of a round one. In taking in hay for cattle a uniform thickness is taken from the top, so as to let down the roof close, and thus keep out rain, &c.

The Modern English Hay Barn is built on a stack stand with the coping projecting to keep out vermin, the roof being fixed and supported by pillars of brick, stone, iron, or wood. Under able husbandry the barn should be of sufficient length to hold not only the hay, but corn crops also. The corn crops are built in mows, but the hay crop is built the whole length of the stack, and in taking in hay for consumption, it is cut down with a hay knife in narrow mows the length of a truss, vertically from top to bottom, beginning at one end. The hay in the barn should be covered with a sufficient thickness of straw to keep it clean, and when overtaken by rainy weather in harvest, a rickcloth or straw mat may be needed at one side to keep the hay dry. The straw mat thus used would do for covering. Some large farmers thatch the sides of hay and pea stacks—also oat and barley stacks—when carried loose, and for this purpose straw matting is the best, and the small stacks of the cottager stand greatly in need of side thatching.

Fencing.—In stubbing out an old or superfluous

hedge, first clean out the ditch on one or both sides, a spit deep, with the bottom draining spade, put in a pipe, cover lightly to protect it, and then undermine the hedge with a pickaxe. Begin at the lower end to level in, and as you come up to the undermined plants they will fall over and may be pulled up with little trouble. Sometimes the healthiest plants are used for filling up gaps in other hedges, and such should be carefully taken up in order not to injure the roots. And as gaps should be filled between October and March in the north, and between November and February in the south, it follows that the work of stubbing should be done at the same time, and the planting effected as subsequently directed.

The work of planting a thorn or quick hedge is more or less modified by the character of the soil, climate, and exposure to blasting winds, or the depredation of animals. If the land requires artificial drainage, a drain 4 feet deep should run along each side. It is common to have an open ditch on one or both sides—partly to drain the hedge, and partly to defend it from cattle. But open ditches occupy a large area of land, which is highly objectionable, more especially on a small farm, while they expose the roots of the hedge to the drought of summer and frost of winter, and are besides liable to crumble in and thus impede drainage and lay bare the roots. An under drain, 4 feet deep on each side of the line intended for the hedge, and from 4 to 6 feet from it, will drain the hedge better than an open ditch from 2½ to 3 feet deep; while a narrow ditch, 2 feet wide and 1 to 1½ in depth, will defend the young quicks, and after they are up the bottom of the ditch may be cultivated close up to the hedge-bank. But before opening this shallow ditch the ground between the underground drains should be trenched, at the very least, 2 feet in depth before winter, to gain the benefit of the frost; then fallowed, limed, and manured the following summer prior to planting. If the land is a wet stubborn clay, the narrow strip thus trenched will be 8 feet in breadth from drain to drain, if more manageable 12 feet in breadth. Dry soils that are naturally drained require to be trenched, limed, and manured in the same way. The hedge row will occupy about 3 feet in breadth, and in poor, sandy, and gravelly soils this breadth should be heavily clayed before winter so as to get the clay properly incorporated; and in rocky soils earth, to form sufficient depth of soil, may have to be carted on where too shallow, otherwise the young plants will be stunted in growth, and soon cease to prove a fence.

There are three modes of planting: one row of plants laid flat, one row planted upright, and two rows planted upright. The annexed engravings, Figs. 1 and 3, will illustrate the three plans.

According to the first plan, Fig. 1, the line of the ditch *x* is staked out the whole length of the hedge, and the top

spit thrown up to form the "hedge-bank," or "mound" *a*. This mound is next levelled smooth by means of a tight line, the back of the spade, and the feet, a straight edge being at the same time formed at *a*. The young plants are headed or cut down to within 2 inches of the root. This should be done in the

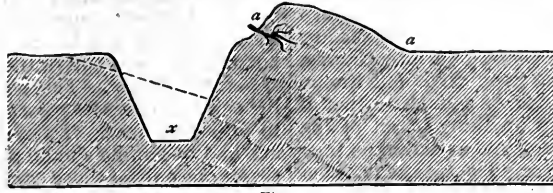

Fig. 1.

nursery, or before they come to the field, with a sharp knife, unhealthy plants being thrown aside. The small bundles of 50 or 100 are laid down at regular intervals. The plants are then laid flat upon the bank at *a* in a line six inches asunder; a narrow piece of railing being laid upon the cut ends to keep them in their places while the roots are being covered. Another spit is then dug from the ditch *x* to cover the roots, the earth being trampled down firm with the foot; this done the rail is shifted on to another length and so on, and the remainder of the earth dug out to form the hedge-bank which is rounded over as illustrated; about an inch of the plants being out of the ground, and from 3 to 10 inches from the slope of the ditch slightly rounded off to prevent stagnation of water.

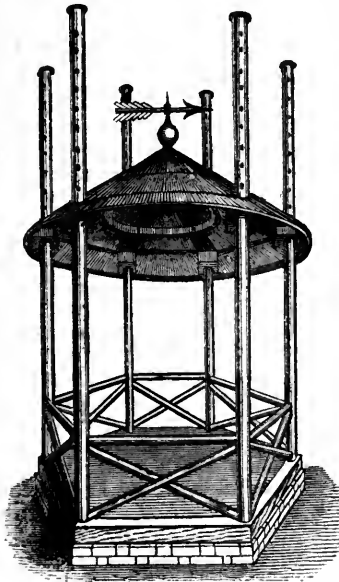

Fig. 2.

Fig. 3 shows two rows of quicks planted on the top of the hedge-bank, between two small ditches, 2 feet by 1½ feet. The ditches are laid off, and the mound levelled, as in the preceding plan; the plants also come to the field headed down to within 2 inches of the roots, but in this case more attention requires to be paid to the trimming of the roots, so as to have them of uniform length. Two trenches are then opened, 10 inches asunder, and in them the plants are set 8 inches apart; the plants in one line being opposite the open spaces in the other. The roots are then covered, and the bank finished up, leaving the top of the plants about an inch above the surface. If the hedge is intended to enclose a plantation, there will be no need of a ditch inside, so that in this case the mound inside will be as in the preceding example.

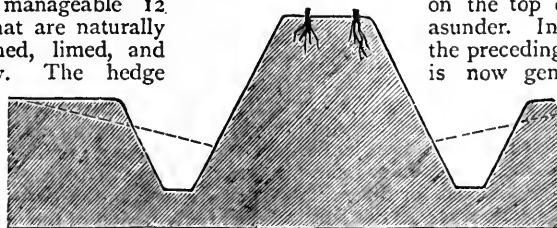

Fig. 3.

The other plan has only a single row of plants on the top of the bank, planted 6 inches asunder. In other respects it is similar to the preceding plan. The double row hedge is now generally preferred, and when the land is naturally dry, or properly drained artificially, the hedge will grow better on the flat, without a side ditch or mound, provided two things are granted, *first*, a sufficient depth of earth for the roots, and *second*, protection from cattle. In the above illustrations, we have assumed a small ditch and mound to be necessary for protection, at the outset; but when the hedge is up, the side ditches may be filled in, as shown by the dotted lines, and the land cultivated close up to the mound or hedge.

A row of railings on each side of the newly-planted hedge is necessary, to protect it from cattle, and in exposed places the railing may be wattled with brush-wood of any kind.

HOUSEHOLD AMUSEMENTS.—IX.

THE GAME OF WHIST (*continued*).

WE have at present described the mere routine of whist—the apportionment of the cards, the order in which they are played, and the ultimate object of the game, namely, to score a certain number of points before your opponents. This object, it will have been seen by those who have followed us attentively, may be gained either by chance or by skill, or by both combined. It may be gained by chance, when an extraordinary number of good cards fall to one player; or to one side, in the course of a deal, so that if the partners on that side known anything at all of the game, they must win, be their opponents as skilful as they may. For instance, we have twice, in actual play, seen all the honours and the two next best cards fall to a single player, enabling him, apart from any help by his partner, or from any assistance derived from his seven other cards, to secure six tricks to a certainty, and to count four towards game by honours after tricks were reckoned, but such an incident is rare. On the whole, the cards fall to each side with tolerable equality, and skill as a rule gets the best of the game.

Skill at whist may be reduced to two primary principles—*judgment*, when to play out and when to keep in such cards as you may have in your hand, and *memory*, of what cards have already been played, and by whom; more or less of the latter quality being indispensable for the direction of the former. Other faculties, such as quick observation, and the power to draw from what is played a correct inference as to the object and the resources of the player, have also an important part to perform; making whist, to those who study it for its own sake, a highly intellectual exercise, and profitable in its place, as a means of drawing out and quickening the mental powers.

As regards the inferences to be drawn, there are certain rules, hereafter to be mentioned, the knowledge of which will greatly assist the most inexperienced. As to judgment and memory, a player must learn to cultivate his own natural gifts by practice. Some persons have been known to recollect, at any part of a hand, every card that was played, and who played it; and to be able to tell by inference, before the last trick is played, who holds each of the remaining cards. But we do not recommend anyone to attempt to perform such feats of intellectual gymnastics. Whist, we hold, like all other games, should be kept in its proper place as a recreation, and not made to absorb an amount of time and study which is better devoted to other purposes.

We will now give a few instructions as to playing out the cards in a hand, according to the learner's position at the table.

First Player.—The first player, at the commencement of the hand, having what is called the "original lead," should lead a card from his strongest suit; namely, that in which he finds the most or the highest cards. If he has a *sequence* of high cards; that is, a succession of ace, king, queen, &c., he should lead from it, beginning with the highest. If he holds several small ones he should begin with the lowest. If he has ace, and four or more small cards of a suit, he should play the ace, for that will probably make the trick; but if he reserves it, the suit may be trumped in the second round, and his ace will be useless. The lead of the first player is understood to be an indication to his partner as to where his strength lies; and his partner, if an experienced player, will consequently return the lead; that is, play a card of the same suit when he gets the opportunity. The same rule holds good as to leads later in the game: always lead to your partner's hand when your own strength is doubtful or exhausted. Do not return the leads of your opponents, and do not change the suit with which you or your partner commenced until

compelled to do so. If you have ace and queen in your hand, do not lead from that suit if you can avoid it. The reason is that, in the course of the play, you may be able to take a trick with the queen, and afterwards play the ace, or to capture the opponents' king with your ace, and then play the queen; but if you have ace, queen, knave, you may lead the ace and afterwards the queen. If your opponents have trumped your strong suit or your partner's, lead trumps, if you have four or more. Do not lead the last card left of a suit until all the trumps are played.

Second Player.—The second plays his lowest card of the suit led, unless he possesses strength which it is desirable to utilise at once. Thus, if he hold king and queen, or ace and queen, he should play the queen; but if he possesses one only of those cards, he should retain it and leave the chance of taking the trick to his partner. If he hold a sequence of two or more winning cards in the suit led, he should play *the lowest*. This is of consequence, as his partner will thereby be able to infer that he possesses a higher, and play accordingly; whereas, if the second played his highest, there would be no clue as to where the next highest might be. To make this the more clear, we will suppose A, the eldest hand, to have played a low diamond; B, second player, having king and queen, plays the queen. C may have the ace, and if he plays it on the queen, he still leaves B in possession of the winning card for the next round of that suit. But D may have the ace, and in that case he withholds it, as his partner will already have won the trick with the queen. In any case D sees that the king cannot be in the hand of C, or he would have played it; and hence, he infers positively that it must be with his partner B, or he would not have played out his queen so early. Considerations like these are important, making all the difference between skill in the game and the want of it. If you cannot follow the suit led, throw out one of your worst cards in another suit, unless you have reason to believe that your partner cannot take the trick, when you will do well to play a trump.

Third Player.—The general rule for the third player is to play his highest card, unless a higher is played before him. Thus he not only stands a good chance of winning the trick, but also assists his partner in his game, for he makes known to him where the strength of the suit lies. An exception to this rule is when the third hand holds ace and queen, or king and knave after ace has been played. He may then, if he think proper, *finess*—that is, put on the lower of the two, risking the possibility of the trick being taken by the last player, as the chances are that the intermediate card is not in his but in one of the other hands.

Fourth Player.—Of him little need be said, for his task is easy. If his partner has already secured the trick he can play a worthless card, if not, he wins it if he can, and by the lowest card that will suffice for the purpose. The case that gives frequent room for doubt in the mind of the fourth player is when he has none of the suit left, the trick being against him, and hesitates to sacrifice a good trump to win the trick before him; or when a high trump has been played by an opponent, and he must play a still higher one to take it; for he may desire to retain his trumps in order to bring in a strong suit, or may hold one or two—such as ace and king—which he knows will secure tricks at any period of the game. In such a case, as well as in many others which occur at whist, the old rule of Hoyle is the best guide—"When in doubt, *win the trick*;" and this rule should be observed at any period of the game.

The following are other general rules for the guidance of the player, whatever his position, in playing to a trick:—

General Rules.—When you have only two or three small trumps in your hand, make them as soon as you can get the opportunity—that is, if your opponents lead a suit which you cannot follow, play one of your small trumps

upon it; but be very careful *not to trump your partner's trick*—i.e., not to play a trump upon it when he has already secured it, or when he has played the best remaining card of a suit. When you "discard," or throw out a worthless card upon a suit which you cannot follow, let it be the *lowest* of its suit, or you will mislead your partner. But if you have only the second best card of a suit and one small one, do not discard the latter, but keep it to protect your second best in case the best should be played. If you have five trumps, lead one as soon as you can; if four, keep them in for a time, to establish your strong suit. Narrowly watch the fall of trumps—who plays them, what cards they are, and how many have been played—so that you may be able to use your own to the best advantage. Do not play out your high cards of a suit in which your adversaries have shown strength; but of any suit in which your partner appears strong, play them at the first opportunity. Secure the odd trick—that is, the seventh—if you possibly can, for it makes a difference of two to the score. It puts you forward one point, and keeps your opponents one back. Consequently, when you have the chance of gaining it by playing a winning trump, do so without hesitation. But if your side has made six tricks, and you hold the ace of trumps, you are secure of the odd trick at any time, and consequently need not play it out until other considerations render it advisable to do.

Inferences.—Now as to some of the inferences which you have to draw in the progress of the game. The rules we have just given must be taken as the foundation of them, for you must suppose that your partner, if anything of a player, observes these, and plays accordingly. If, for instance, having an original lead, he plays trumps, you have a right to presume that he is very strong in them; and the same if he leads trumps early in the game. You must also conclude that when he takes a trick he does so with the lowest card he holds that will suffice for the purpose; and thus, if he takes knave with ace, he can have neither queen nor king. It is most important thus to watch the play of your partner, and to play to his hand, as if yours and his were one. The chief feature of modern practice in whist, which distinguishes it from old-fashioned modes of playing the game, is that it aims to establish a code of signals between partner and partner, so that each may have a clue, in the play, to what the other holds, and play to help him; the advantage thus gained being considered to more than counterbalance the disadvantage of your opponents judging, by the same rules, what is held between you. Hence the importance of playing according to strict rule, so that your partner may infer correctly. The rules which lead you to inferences as to what your partner has in his hand will, of course, guide you in guessing what is held by your opponents.

The maxim, however, that every rule has its exceptions, holds good with regard to whist. There are periods and crises in the play in which a player may be justified in disregarding recognised rules, for an exceptional hand or an exceptional case may obviously warrant play that is not countenanced by general law. To those who wish to understand what may be these exceptions, or to go more fully than we have space to do into the proper play of the game as applicable to various chances, we must commend the perusal of some of the modern treatises on whist, as it is played in the London clubs. We will now give a concise summary of the principal recognised

LAWS OF THE GAME.

Dealing.—The dealer must not shuffle the cards after the pack is cut; if he does, he loses the deal. If a card be faced—i.e., turned up on its face—during the deal, a new deal (by the same person) may be demanded. If the dealer look at the trump card before it is properly dealt, a new deal may be requested. The dealer forfeits his deal

(which passes to the player on the left) under the following circumstances:—1. If the last card does not fall to the dealer; unless it be found that the pack is imperfect. 2. Should one player have fourteen cards and another twelve. 3. Should the dealer place the trump-card face downwards on the table. 4. Should he deal two cards to one player and then a third to the next; but if he discovers the first error, he is allowed to alter it, by giving the two cards to the persons to whom they would properly have fallen.

The Last or Trump Card.—The dealer must allow this to remain on the table, face upward, until he is called on to play to the first trick, when he should remove it to his own hand. No one may afterwards ask what was the turn-up card, but any one may inquire what is the trump suit.

Exposed Cards.—A card dropped on the table, or exhibited, out of the order of play, is liable to be called; that is, the adversaries may demand that it shall be played at any period of the game when it would not cause the holder to "revoke." If two cards are played instead of one, the adversaries may demand which they please to be played to that trick, and afterwards call for the other. If a player throw down his cards face upwards, they may all be called by his opponents. If a player lead out of his turn, the card thus exposed may be called for when it is his right turn to play; or the adversaries may, instead, demand that either he or his partner, when it is his turn to lead, shall lead a particular suit.

THE QUALITIES AND VALUES OF GOLD AND SILVER.

THE extent to which gold and silver are used, and the variations in their quality and fineness, render it desirable to supply some information on the subject. Both these metals are almost invariably mixed with some other of inferior worth called alloy, and the value of them is determined by the amount of alloy. In electro-plating, the pure metal has to be used. For gold coins, what is called standard gold is employed, containing one-twelfth, or two parts in twenty-four, alloy. If, therefore, an ounce of standard gold is divided into twenty-four parts, it contains twenty-two parts of pure gold, and two parts of alloy; and it is called twenty-two carat gold. This is the gold of which English sovereigns and half-sovereigns are coined. Standard silver, of which our silver coinage is made, consists of thirty-seven parts silver and three parts copper. Of this silver, all articles of plate bearing the hall mark are made, no inferior quality being marked. In France the standard is lower, being nine parts silver to one copper, and therefore worth a smaller sum per ounce. In Prussia a still lower standard is adopted, and one-fourth of alloy is allowed. An ounce of English standard silver is worth five shillings and twopence as metal; an ounce of pure metal is worth about five shillings and sixpence; one ounce of French standard silver is worth a little over five shillings; one ounce of silver of the Prussian standard is only worth about four shillings and three halfpence. English standard silver is, however, that with which we have chiefly to do. Of this, one ounce troy consists of twenty pennyweights, and it may be valued as in the following table:—

	s.	d.
1 dwt. of standard silver ...	0	3
5 " " " ...	1	3½
10 " " " ...	2	7
15 " " " ...	3	10½
20 " (1 oz.) " ...	5	2

Silver of an inferior quality is made up into watch-chains and a great many ornaments, and is of less value. If this inferior metal contains one-fourth alloy, it will be worth only about four shillings and three halfpence per ounce; if it contains one-third alloy, its value will be

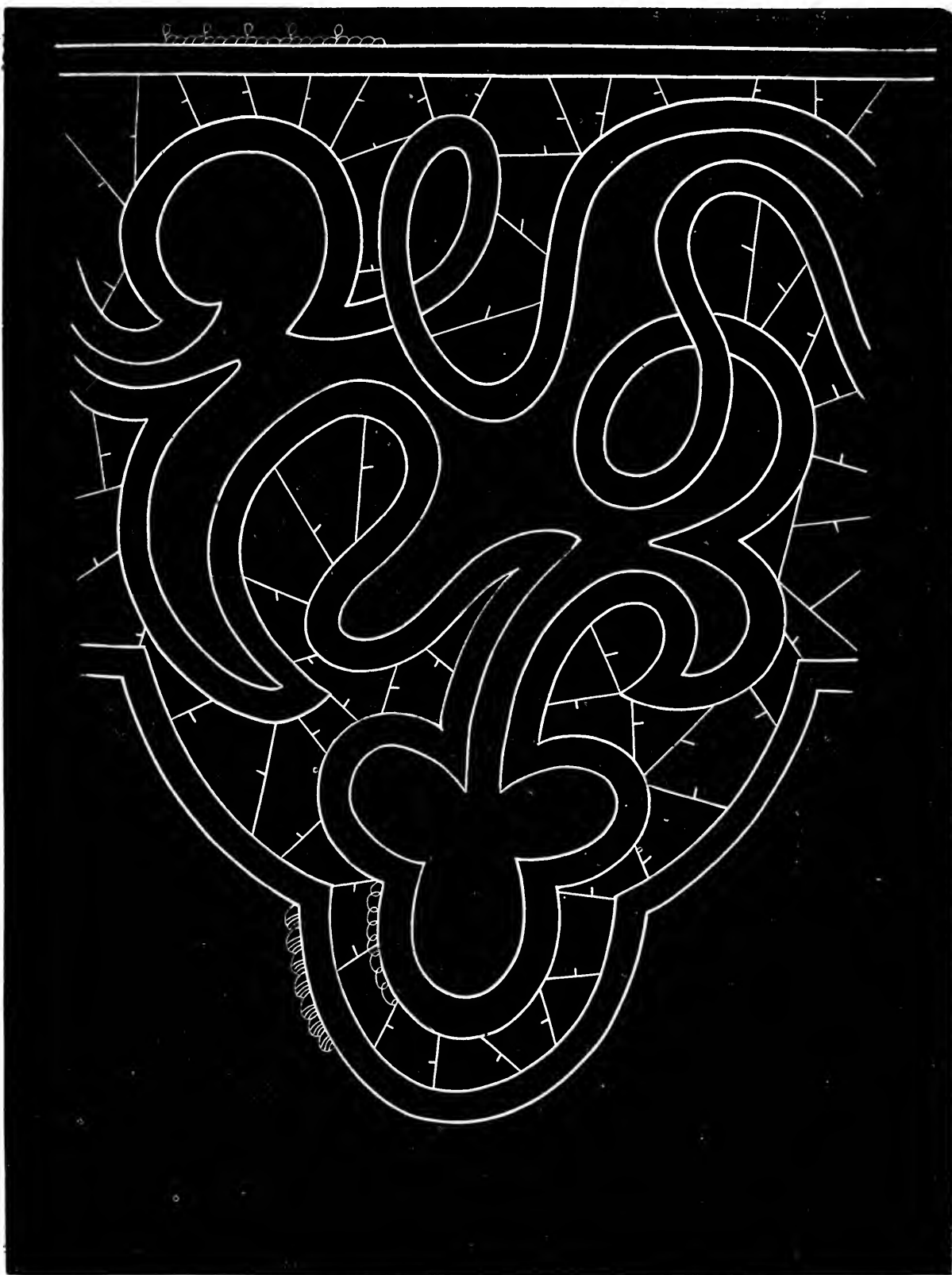

LACE WORK. PATTERN IN SPANISH POINT TREFOIL.

fourth the stitch is kept under the thumb-nail, but quite short, and one tight overcast is made *across* it, close to the braid, thus fastening it and making a sort of pearl-stitch, like that in a pearl-edging; this is repeated to the end of the straight braid.

Next, all the open portions of the design must be filled up with fancy stitches, and of these there is such a variety as almost to baffle description. However, we will attempt to particularise some, and hope, with the aid of the designs, to make them tolerably intelligible.

Fig. 4. This may be used for the trefoil, and is done by stretching threads across from one inner edge of the braid to the other, in lines at right angles to each other, the one set being done all one way first, at about the distance given in the pattern; the other, all the other way afterwards: then are commenced diagonal lines, and at the meeting of the lines, or where they intersect each other, after doing one overcast to keep the threads together, the needle and thread are passed under and over the threads, until a tiny wheel is formed, after which the thread is proceeded with diagonally to the next intersecting or meeting point, where a wheel is again worked and the thread continued as before, until the opposite braid is reached, beginning again at the next point with the diagonal lines and wheels as before. A second set of diagonal lines may be made in the opposite

direction, so as to cross those already done, and in this case, when the wheel is reached, the needle must be passed under it, just catching it lightly at the back. In those parts where the two braids lie near to each other, it will be

best to work plain bars of fine thread at intervals of about a quarter of an inch, as at Fig. 3. A very pretty and simple open stitch for filling in is Fig. 1. This is merely the single overcast, done quite loosely and without the fastening stitch, in rows, one underneath the other. This may be varied by Fig. 5, in which three "open overcasts" are worked together on the plain thread, which is rather longer than the usual stitch, so as to make a larger space for the reception of the three stitches alternating with it. This may be worked backwards and forwards, or the thread may be sewn over, to take it back to the left side each time a row is commenced, and in that case a sewing-over or seam stitch, should come between each of the three overcasts, and three seam stitches on the plain thread. A variety in Fig. 2 may be made by using only the intersections of the threads stretched at right angles for the wheels, and entirely leaving out the diagonal lines, and then the intersections must be reached by seam stitches on the single parts of the thread. In the larger spaces for open work in this design, two or three different stitches may be introduced, but care must be taken that the joining be neat, and the stitches fitted into each other as well as may be. We should recommend that three vandykes be traced out for each pattern required, which may, of course, be continued to any desired length, as the design will be found to fit, so as to be easily pro-

ceeded with. This style of pattern is very suitable for a chimney-piece trimming, the flat slab being concealed by a board to fit it, covered with crimson cloth or furniture-velvet, and the work forming the border which hangs down round the edge of the board on a plain piece of crimson velvet; the latter should be cut up between each vandyke, and tacked underneath to form the same shape as the lace. If about three or four vandykes be worked, a handsome bracket may be made by nailing the lace round the edge of it, over crimson velvet arranged in the same manner as for the *bordure de cheminée*, and a banner-screen of the same material looks remarkably handsome with this lace laid upon it at the lower edge, also cut up to fit it. As a border for a table-cover, it is very effective when placed over crimson velvet. It may again be used as a trimming for curtains, or *portieres* of velvet or wool *reps*. In working a length of it, the fancy stitches should, in each repetition of the design, be varied, to prevent entire sameness. We may in a future article give another vandyke of the same dimensions as the present one, and which may be used alternately with the latter for any of the purposes we have mentioned; our space prevents its appearing in this paper. Considerable variety may be allowed in the working of this pattern, and very much must be left to the taste and fancy of the worker. Instead of working the "open over-

cast," an open-edged braid may be used for this design; but it is rather difficult to procure one sufficiently wide and close in texture to look well. In fact, in this, as in many kinds of fancy work, the learner will find that, after a little practice,

she will be able herself to vary successfully many patterns from which she has copied, and, indeed, to invent patterns for herself, suitable in size and character to the place they are intended to decorate. The opportunity which lace-work thus affords for the exercise of individual ingenuity and taste is certainly not the least of its recommendations. We propose to give further hints upon this subject in a future paper, introducing several other patterns and different kinds of stitches, and showing more in detail than we

have done already the different ends to which this accomplishment may be turned, whether on the decoration of the home or the adorning of the person.

COOKING.

FISH SOUPS (continued).

For White Eel Soup.—Set a saucepan of water on the fire; season with salt, whole pepper, a blade of mace, a strip of lemon-peel, and a bunch of the most fragrant sweet herbs at your command. When it boils, throw in the eels. As soon as they are done *enough* (and they are spoiled if done too much), just enough to let the flesh come away from the bone, take them out, split them in two, and remove the bone. Each length of eel will thus make two pieces, which should be left entire. Set them aside. Chop fine three or four white onions. Roll a

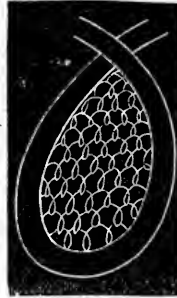

Fig. 1

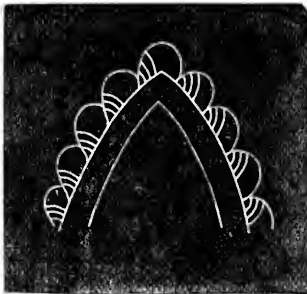

Fig. 2.

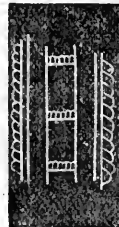

Fig. 3.

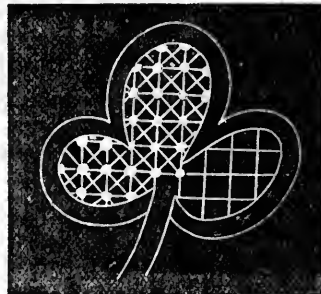

Fig. 4.

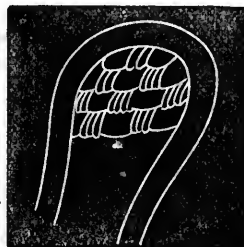

Fig. 5.

lump of butter in flour. Put it in a stewpan with the onions; moisten gradually with a little of your eel broth. When the onions are tender, add the rest of the liquor (removing the herbs and the lemon-peel), stirring it in gradually, with a teacupful of fresh milk. Throw in your eel meats, and set the soup aside until they are hot through. While they are so heating, you may further thicken with a couple of egg-yolks, well worked into a little of the liquor. Taste if sufficiently seasoned. You will find an almost imperceptible dust of sugar an improvement. In fact, most white soups, even when seasoned with salt, are the better for a sprinkling with sugar.

Brown Eel Soup.—Proceed as before; only, instead of boiling the eels, fry them brown, after rolling them in flour, bread-crumbs, or batter. Open, take out the bones, and set aside. Fry chopped onions brown in butter, browning afterwards enough flour to thicken your soup without egg-yolks. Stir in gradually either water or stock; during the process, season as before. When it has had a good boil, remove the herbs, &c. Put in your eel, and if you will, you may add at the same time a glass of white wine. After one boil up, serve, accompanied by bread dice toasted or fried.

Similar soups can be made with other firm-fleshed, middle-sized fish, as small conger, soles, &c. By the same treatment, cold remnants of fish, of various kinds, both boiled and fried, may be economised by appearing in novel and palatable forms of soup. They can be enriched by any lobster, oyster, or anchovy sauce that is left. If you happen to have a few shrimps, pick a handful; boil their shells; with a little of the liquor give a slight flavour of shrimps to the soup, at the same time that you throw in your shrimp meats. These soups bear a dust of cayenne and sugar, and should be accompanied by bread or rolls.

Salmon Soup may also be made with the remains of a fish that has appeared at table. As soon as removed, and while still hot, take all the flesh from the bones and skin. The entire quantity should be something between one and two pounds. Divide it into two portions. One half, consisting of handsome bits and flakes, you set aside; the other, broken odds and ends, you pound in a mortar with a little cream, any remnants of lobster (the coral especially), a teaspoonful of anchovy sauce, and two hard yolks of egg. Have ready a sufficiency of good veal or chicken broth, flavoured with vegetables, to make your soup. Put butter in a stewpan; brown flour in it; stir in a little broth; then mix in your pounded salmon, &c.; then the rest of your broth. Season with pepper, salt, and perhaps cayenne. Throw in your reserved flakes of salmon, and, if you like, a few force-meat balls. After one boil up, serve.—N.B. This soup may be made, partly at least, with the boilings of the salmon, if the fish were very fresh.

Bouille-à-baisse, or Bouillabesse.—Allow a pound of fish and four or five mussels or oysters (if used) per head; six pounds of fish for a dinner of six guests. Red and grey gurnards, haddocks, whittings, codlings, mackerel, ling, carp, red and grey mullet, plaice, soles, weevers, small craw-fish, or lobsters, figure admirably in a Bouillabesse. Cut your fish into pieces of a size convenient to help with a spoon. Chop onions fine, and toss them over the fire in butter without browning them. Arrange all the pieces of fish (mixing the different kinds) in a little cauldron or wide shallow stewpan. Pour over them a liberal allowance of the best olive-oil. Add the chopped and tossed-up onions, a clove or more of garlic, a bay-leaf or two, a few slices of lemon, two or three tomatoes, or a little tomato-sauce, salt, a very small pinch of saffron (try, first, a single thread, or dried pistil of the flower; the flavour is so peculiar that it must not predominate, and yet there must be saffron), and a glass of white wine. Fill up with cold water until the fish is entirely covered, and set the stew-pan on a brisk fire. Skim as it comes to

a boil; let it boil from ten to fifteen minutes (*i.e.*, take it off the fire when the fish is cooked enough—just before it is enough), and throw in a dessert-spoonful of chopped parsley, which will turn to a beautiful bright green. Arrange the pieces of fish on a dish by themselves. At the bottom of a deep dish, or soup-tureen, lay slices of bread a quarter of an inch thick, and over them pour the liquor of the Bouillabesse, removing the garlic, the lemon, and the bay-leaves. The two dishes are sent to table together, and the guests ought to help themselves at the same time to the contents of each.

MISCELLANEOUS SOUPS.

Tapioca Soup.—Wash the required quantity of tapioca in cold water. Let it steep therein a few minutes. Drain it; set it on the fire in a saucepan with a little more of the cold stock than will cover it; let it come to a boil slowly, then boil about ten minutes. When the tapioca is quite clear and tender, put it into the rest of your hot stock, and serve. Large-grained tapioca looks best in soup. Sago and semolina soups are prepared in the same way.

Vermicelli Soup.—Break the vermicelli into three-inch lengths, or thereabouts. It is unnecessary to steep it; but rinsing it in cold water will get rid of dust, floury particles, &c., and often be the means of keeping the soup clear. Put on your vermicelli in a little more of your stock, cold, than will cover it, and let it boil till quite tender without dissolving. It will take from a quarter of an hour to twenty minutes, according to its degree of dryness. Add this to your hot stock, and serve. Vermicelli soup and the following may be accompanied by grated white or yellow cheese, for the guests who like it to dust over the soup in their plates.

Macaroni Soup.—As above, only break into shorter lengths, and steep an hour or two in cold water before boiling the macaroni in the stock.

Fulienne Soup (Potage à la Fulienne).—Take an equal quantity of turnips and carrots; a much smaller quantity of onions, leeks, and celery. Cut all these into little strips two or three inches long, and not more than an eighth of an inch broad. To save time, there are instruments for cutting roots rapidly into strips for *Fulienne*, so highly is this soup esteemed. The vegetables may also be bought ready cut, preserved, and dried, which is convenient at certain seasons of the year (*Fulienne* is really a spring and summer soup), and for sailors and other travellers. Add to these a small proportion of chopped lettuce, chervil, and sorrel. Toss the roots first in very fresh butter, then add the herbs, and moisten the whole with good clear stock. Boil an hour. Either pour the whole over crusts in your tureen, or omit the bread altogether, which is the more usual and modern practice. In that case, the proportion of vegetables ought to be greater, and you may add to those already mentioned green peas, kidney beans (boiled separately), sliced artichoke bottoms (ditto), green asparagus chopped short, &c. This soup is the better for a lump or two of sugar—just little enough not to betray itself.

White Soups can be made by employing milk, with rice, vermicelli, macaroni, arrowroot, sago, semolina, tapioca, and pearl barley. The process is the same as when broth is used, only greater care must be taken to prevent burning and boiling over. Add a little sugar and a dessert-spoonful of orange-flower water. Note that in all soups to which sugar is added, there still requires a dust of salt. These soups may also be thickened by raw yolks of egg, carefully and gradually stirred into a little of the liquor, which must not boil. Half milk and half stock is a good proportion for white soups.

INVALID BROTHS AND BEVERAGES.

Hasty Broth.—Of the fleshy parts of beef and veal, with a fair proportion of fat, take a pound each, and chop

them into pieces not much larger than a haricot bean. Chop, nearly as small, carrots, turnips, onions, and leeks. Mix all together with a little flour. At the bottom of a large stewpan put a lump of butter well worked in flour and a pint of water. In this, half-stew, half-toss-up, your chopped meat and vegetables, stirring continually, and separating the bits of meat which stick together. Do this for twenty minutes. You may either let them take a little colour in the floured butter before adding the water, or you may brown with a bit of burnt onion afterwards. Then add three pints of hot water, and let it boil for half an hour, stirring occasionally, that nothing sticks to the bottom. Season lightly with pepper and salt. You may either strain the broth away from the meat and vegetables, or serve them in it; when it will be a veritable ragout soup, especially if enriched with a bunch of sweet herbs, a glass of white wine, and a table-spoonful of mushroom catchup.

Porridge.—Put a pint of water into a stewpan. When it boils, with one hand dredge into it two ounces of oatmeal, and with the other stir it with a spoon. Pour it out into a basin or soup-plate; add salt or sugar according to taste, and pour over it half a pint of cold milk, mixing the milk and boiled oatmeal together little by little with a spoon. This will be found to make an exceedingly nutritious breakfast for children.

Gruel is usually made by pouring gradually a pint of cold water over two table-spoonfuls of oatmeal groats, and keeping it stirred till it has boiled two minutes. Mix one table-spoonful of the groats with two of cold water. Pour to it a pint of boiling water, and boil from five to ten minutes, keeping it well stirred. Increase or diminish the quantity according to the thickness of the gruel required. No straining is necessary. Pour it into a basin, and, to make it more palatable, add a pinch of salt, a dust of sugar, a bit of butter.

Barley Water.—Put a quart of cold water into a saucepan; throw into it a teacupful of pearl-barley; let it come slowly to a boil, and then boil it gently for ten minutes. Pour it, barley and all, into a jug; when cold it is fit for use. Leave the barley in the water until it is all drunk. Barley water may also be slightly flavoured according to taste.

ODDS AND ENDS.

Cheese Cement.—Grated cheese one ounce, quicklime half an ounce. These are to be beaten into a paste with as much white of egg as may be needed. It is very good for joining china and earthenware, but should be used fresh.

Solid Ink.—Letters and figures carved upon white marble, metal, or stone, may be filled in with the following mixture:—One pound of pitch is to be melted over a fire, and with it four ounces of lampblack must be incorporated. This composition must be applied while hot, and the work must be dry, as also must be the following:—Trinidad asphalt four ounces, dissolved in an equal weight of oil of turpentine. Both the above preparations are said to be very durable.

Ground Colour for Walls before Painting.—Mix one gallon of water with one pound of glue, and thicken it with red lead. Lay on the colour hot with a paint-brush.

Gouffrey's Cordial.—This is commonly given to infants as a sedative, but as its active ingredient is opium, and its strength very unequal, it is a thing to be avoided. No true mother or nurse should venture to administer it. Mr. Cooley truly says: "Its frequent and excessive use has sent many infants prematurely to the grave." Beasley says: "No terms are sufficiently strong to express the culpability of those who would place in the hands of ignorant persons, for administration to infants and children, compounds containing opium."

Spermaceti Ointment.—Take spermaceti five ounces,

white wax fourteen drams, olive oil one pint, or thereabouts. These ingredients are to be melted together by a gentle heat, and afterwards stirred until cold.

Another Recipe.—Take spermaceti four ounces, white wax two ounces, pure lard twelve ounces, and melt and incorporate as before. For private use, smaller quantities in the same proportions are desirable, as the ointment is best not kept too long. Let it be made in very clean vessels, and preserved in pots well closed.

A French Paint.—Purified yellow wax two and a half pounds, linseed oil two and a half pounds, turpentine two pounds, and common rosin one pound. Dissolve the wax in the linseed oil, and the rosin in the turpentine, separately, over a slow fire. When the ingredients are quite melted, mix them by stirring. The result may be used as a transparent priming. To give it colour, mix with it about three pounds of ordinary paint, and enough turpentine to reduce it to a proper consistency. This paint dries soon, hardens gradually, and is very durable.

Paint for Out-door Work.—Take as much Parker's cement—a powder very similar to fine Roman cement—as may be necessary, and let it be quite dry. Mix it with prepared oil, or with boiled and raw linseed oil, in equal proportions. When of a proper consistency it may be used for wood or iron. It is both durable and cheap.

To cleanse Gold.—Wash the article in warm suds made of delicate soap and water, with ten or fifteen drops of sal-volatile. (The sal-volatile makes the metal brittle.)

Precautions against Wet and Colds.—If a person getting wet through were to try the experiment of rolling a blanket round himself, or of putting on an india-rubber or any other entirely waterproof covering, in a quarter of an hour he would find himself quite warm. The wet-sheet process of the water cure is but an exemplification of this fact. When a cold attacks any one, it is but the heat of the body carried too quickly away from it, and becomes chilled by the rush of cold air from the outside; the moment a shivering fit is felt, if the victim would undress and lie down between blankets—the newer the better—and then take a few drops of spirits of camphor on moist sugar, heat would be almost instantly generated in the system, and be prevented by the blankets from escaping; but if the same process had been adopted with linen or cotton fabrics, the result would have been different.

Weights of Bread and Flour.—What is called a four-pound loaf should weigh as much, and the purchaser may require it, or any other loaf not called fancy bread, to be weighed before him. A quartern loaf must weigh four pounds five and a half ounces; a half-peck loaf, eight pounds eleven ounces. A peck or stone of flour is fourteen pounds, a bushel fifty-six pounds, and a sack or five bushels is two hundred and eighty pounds, or two and a half cwt. The baker is not required to sell fancy bread by weight.

SEASONABLE FOOD.

MARCH.

Meat.—Beef, veal, mutton, house-lamb, pork, doevenison.

Poultry and Game.—Fowls, chickens, turkeys, ducks, pigeons, rabbits, guinea-fowl, woodcocks, and snipe.

Fish.—Turbot, whiting, soles, plaice, flounders, skate, oysters, lobsters, crabs, prawns, cray-fish, cod, smelts, eels, carp, tench, mullet.

Fruits.—Apples, pears, oranges, forced strawberries, dried and preserved fruits as in February.

Vegetables.—Savoys, cabbages, sprouts, spinach, lettuce, radishes, turnips, carrots, parsnips, Jerusalem artichokes, potatoes, mushrooms, parsley and other garden herbs, onions, leeks, Scotch kale, broccoli, scorzonera, beet, salsify, sea-kale, chives, celery, cress, mustard, sorrel, horse-radish, rhubarb, shalots, cucumbers.

FURNITURE.

III.—BEDROOM FURNITURE (*continued*).

Mattresses.—In a previous chapter a brief allusion is made to this necessary article of bedding. Formerly, and even now in some countries when the bedstead has a good sacking instead of laths or iron, a mattress was not deemed necessary, but when this was dispensed with, the feather bed was one of fifty pounds of good goose feathers, or mixed with other poultry feathers. Such a couch needed no mattress, but now it is considered almost indispensable to the comfort of the sleeper, and is by many persons preferred to a bed. Of mattresses there are many kinds, and made of various materials. Among the first in estimation, the spring mattress holds its place. This is formed of a succession of coils of stout copper wire, either galvanised or otherwise, each coil somewhat resembling an hourglass. These are often set in a solid box-like frame; but when completely covered it is difficult to replace a weak spring or repair any damaged part. A newer and much better form is where the bottom framework consists of stout laths, resembling those of an ordinary wooden bedstead, but much thicker, and having one or two transverse bars running from head to foot, according as the width needs them. The springs are fastened to the laths, and on the top are secured with stout twine to strong canvas, upon which is laid a padding of wool, and the whole is then covered with the ordinary checked covering. The advantage of this make is, that should a spring become weak, or in any way injured, it can be seen at once by anybody where the mischief lies, and can be repaired most readily.

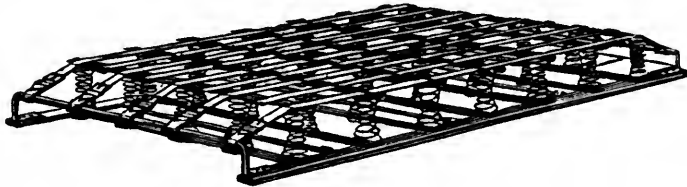

A mattress of three feet wide and six feet in length is purchasable for 27s., and one five feet wide for 50s. A mattress or bed on the top of this is necessary for the protection of the springs beneath. A horsehair mattress five feet six inches wide would cost 74s.; a brown wool, 45s.; and a superior one of white wool for 55s. to 90s.; but all wool mattresses require to be pulled to pieces, the wool purified, and then be re-made, every year, or, at the farthest, every two years.

For putting on the top of spring mattresses, nothing exceeds the comfort of six blankets quilted as a mattress would be, and which can be readily taken apart, washed, and put together again; neither need this substitute be expensive, because six of the kind known as "Aldershot" blankets can be placed together and be covered with a cotton ticking and quilted; the expense of such a mattress would not exceed 23s. The advantages of it over those of the ordinary kind is, that it can readily be taken to pieces, washed, and put together again, is much softer than a mattress made of any best sheep's wool, and it will not "mat" or get into lumps.

Whatever mattresses are needed, those of cotton flock should not be chosen, on account of their tendency to become lumpy.

One of the best forms of spring mattresses is that shown in our illustration; it is called the "Rheiocline," and may be seen at Messrs. Burton's, in Oxford Street.

Quilts and Counterpanes.—The warmest, lightest, best, and consequently most expensive bed covering is an eider down quilt, made of the best down put into a silken covering. One for a full-sized bedstead would cost £5 5s.; but one of the same size made of coloured goose down, termed "Arctic down," and in a coloured cotton covering, would not be more than 35s. A number of cotton

counterpanes piled one on the other would but fatigue the sleeper, and not impart a tithe of the warmth of down or sheep's wool. It is a mistake to imagine that a pile of clothes, simply as clothes, will impart heat. Warmth is produced in the human body, and the object should be to retain that heat, by adopting such clothes as will, with a due regard to ventilation, prevent much of it from escaping. Sheep's wool, either as blankets, flannel, or woollen damask, will do this; also feathers, down, and furs. All textures of wool and silk are non-conductors of heat—that is, they do not allow the heat of the body to escape, consequently beds furnished with three blankets, two upper and one under, and a down quilt, or with an extra blanket instead of a quilt, will be found to be both comfortable and healthy.

The next counterpane to notice is the Massilian quilt, sometimes termed Marseilles and Marcella. These, on the surface, are made in imitation of the old-fashioned quilting of old blankets between chintz and white linen, which were formerly so prized. These Massilian quilts are comfortable, light, and elegant, and are purchasable at prices varying from 17s. to 40s. for a full-sized bedstead.

It has been, and is, much the fashion to knit or crochet quilts with cotton. The material, as we have shown, is not suitable for such purposes; if fleecy wool were used instead of cotton, the weight of the work would be much less, and the handsome appearance and comfort considerably greater. For extra quilts the material should be invariably of wool. As many blankets and as much flannel as needful, should be employed, but no cotton unless for show.

Servants' coloured cotton quilts, if of tolerable quality, are both soft and warm. They are not so finely woven as others, and the material being less dressed in the manufacture, is more fluffy and warmer.

Supposing that economy is strictly necessary, and that a quilt, however poor, cannot be purchased, and yet warmth in bed be absolutely necessary, it may be obtained in the following manner:—Line a sheet or other calico article, no matter how old, with brown paper—first well crumpled and rubbed to render it soft—and then let the sheets of paper be pasted together and tacked on to the calico. The warmth this produces is almost incredible, because it does not allow the heat of the body to escape.

Another warm and economical coverlet is one made of flannel "list" cut into narrow strips and knitted on somewhat coarse needles into strips, each of a finger's breadth, every alternate strip to be sewed on to a plain strip of tailor's "list," and then afterwards the whole sewn together. The advantage of the cloth list is, that it keeps the flannel list in place, and the coverlet is easily ripped in two or three places for the purpose of washing, and is readily put together again.

A warm and useful quilt can be made by stripping the down off poultry or goose feathers, which may be purchased for 1s. and 1s. 4d. per pound. Then take some strips of glazed calico, coloured or white, each strip two yards long and nine inches wide; sew the sides of each strip together to form a long tube; sew up one end securely; into each tube put three ounces of feather strip-pings, but gradually—that is, sew a quarter of a yard of the tubing, then put in a few strippings, and pin them in while proceeding to sew another portion. Thus, when the sewing of a tube is completed, the filling will be also. These tubings are now to be sewed together, as many as

are needed for the length of the bedstead; and will form a warm and pretty quilt—the pattern being a succession of ridges—and the expense is almost nominal in a family where poultry is kept. Care only is required in the matter of cleaning and drying the feathers. When a duck, fowl, or goose is plucked, the feathers should be put into plenty of warm water, and a little soda be well stirred about; then taken out and thrown into cold water; then lifted and put to drain on a cloth over a large pan, or in any other convenient mode, such as a large net, which may be made for the purpose. When drained, spread the feathers between cloths to absorb the moisture; and, finally, tie them up loosely in two or three very coarse bags of muslin, such as is sold for fourpence the yard. Then put the bags in a warm oven, leaving the oven door open, and thus for a succession of nights, till the feathers are quite dry; then they may be put away in proper bags. If this be done at each poultry-picking, the affair is one of little trouble, the stripping being done at any leisure time.

Feather Beds.—A bed, bolster, and two pillows complete, for a full-sized bedstead, may be had at from three to twelve guineas, the difference in price being regulated by the quality of the feathers, the make, quality, and description of bed-tick, and the weight of the bed. The unbordered beds of merely two surfaces of tick sewn together within the band round, which is termed the border, seem to be fitting beds for the nursery, but they are not so. Moreover, they are not comfortable. If poultry feathers, clean and sweet, as above said, cost 1s. a pound, an unbordered bed, containing thirty-four pounds of feathers, a bolster with six pounds, and two pillows each containing one and a half pounds, in a cotton tick, will cost £3 ready-made; and this mode of purchasing is the cheapest. The cost of the feathers being £2 7s., the price of the tick, and workmanship for it and the bolster and pillows will be only 16s. This is for the cheapest kind of full-sized unbordered bed. The next description of feather is English grey goose, at 1s. 4d. per pound; superior realises as much as 1s. 10d. and 2s. 2d. per pound; and, lastly, the very best white goose, at 3s. per pound.

In purchasing a new bed, it will be necessary to see the feathers; and if they have a tolerable quantity of fluff or down at the ends of them, the stems small, and the feathers well curled, they are good. White goose feathers are the highest priced; they are handsome, and are not so apt to be mixed with fowls' feathers, which have much less down upon them. For a bedstead five feet six inches wide, and a proportionate length, not less than forty-seven pounds of feathers should be apportioned to the bed, seven pounds to the bolster, and two and a half pounds for each of two pillows; thus fifty-nine pounds of feathers will make the bed complete. In giving an order for a bed, state the weight, size, and quality required, also whether to be of cotton or linen tick, and mention the price desirable to give for the feathers per pound. A cotton tick, instead of one of linen, would considerably lessen the price, but in either case a waxed tick should be stipulated for, seeing that in many instances nothing is done to prevent the feathers coming through excepting to cover it on the inside with a coat of white-wash, or other inferior matter, which, after a little time, comes through the tick in clouds of dust, and which cannot be remedied but by emptying the tick, washing, and waxing it.

The quality of the feathers of a bed ready made can be pretty well judged by pressing them down; if they rise up *quickly*, the feathers are new and downy; if, on the contrary, the rise is but slow or not at all, then they are old, and however well they have been cleaned, have from age lost the greater portion of their down, and are worthless.

Purchasing beds at public auctions and private sales

entails some risk of purchasing with them the seeds of disease. These sales are often consequent upon a bereavement, which causes a home to be broken up, and if the fatal stroke was fever, those who afterwards lie on the bed of a fever-stricken patient are likely to get the disease. As the cost of purifying feathers is not more than 3d. per pound, it is scarcely worth while running any risk of this kind.

DOMESTIC SURGERY.

VARIOUS LOCAL AILMENTS.

Rupture or Hernia means the protrusion of a small portion of the bowels through an opening in the groin or at the navel. It occurs in children from violent efforts in crying, and in older persons from lifting heavy weights, coughing, &c. If a mother notices any swelling in the neighbourhood of the groin in her child (boys being much more liable than girls to this affection), she should lose no time in consulting a medical man, and ascertaining whether this is due to a rupture or to some other disease. In order to effect a cure of a rupture, it will be necessary for the child to wear a properly-fitted truss for some months, and it will be well worth a mother's while to pay every attention to this matter, so as to bring about a cure as soon as possible. It is not necessary that a truss should be worn at night, except in the case of an infant who cries as much at night as in the day, but the mother should see that the child never runs about before the truss is put on in the morning, and must be particularly careful to see that the rupture is pushed back thoroughly before the truss is applied, which is most readily accomplished when the child is lying down. It is convenient in children to cover the truss with a linen cover, which can be changed when soiled, and the greatest care must be taken to prevent the instrument chafing the skin by powdering it thoroughly. In grown-up persons the occurrence of a hernia is of even more importance than in children, since it is more likely in them to become "strangulated," *i.e.*, it cannot be pushed back by the patient himself, obstruction of the bowels results, and this is followed by vomiting, and even by death, unless promptly relieved by the surgeon. In any case, therefore, where a rupture cannot be returned, or when after any exertion a lump has appeared in the groin, the advice of a surgeon should be sought. It unfortunately happens every now and then that a patient suffering from the bilious vomiting caused by a strangulated hernia conceals the real cause of the disease, either from ignorance of the connection between the two affections, or from a feeling of false delicacy. No one is justified in trifling with his or her own life in such a matter, and a medical man will rightly insist upon making the necessary examination if his suspicions are aroused by the symptoms, as they probably will be. When a surgeon finds that he is unable to return a rupture, it will be necessary for him to perform a slight operation in order to save the patient's life, and neither patient nor friends should have any scruple in consenting to this being done at once. Every minute is of importance in these cases, and though it is perfectly true that patients die after the operation for strangulated hernia, it is equally certain that they die in consequence of the operation having been delayed too late, rather than from the proceeding itself.

Started Navel.—This is a not uncommon affection in young children, and if not properly attended to will lead to the formation of a rupture. The treatment consists in preventing the protrusion from taking place until the parts are in process of time restored to their natural condition, and this can only be effected by care and attention on the part of the nurse and mother. The child being laid on its back, and the protrusion carefully returned with the finger, a pad made of a slice of a wine-cork half-an-inch thick, or a farthing, should be wrapped in a piece of soft

linen and applied over the spot, and bound on firmly with strips of plaster half-an-inch wide. The strips of plaster (the common white strapping) should be about twelve inches long, and should be arranged star fashion; they should be dipped in hot water in order to warm them, as they then stick much more firmly than if held to the fire. A roller of linen or fine flannel should be applied round the infant's navel over this. In cases of larger protrusion either in children or grown-up persons, a suitable abdominal support should be procured from an instrument maker, and should be worn with the same precautions as have been given for the use of a truss.

Piles are often a very troublesome and painful affection, and are of various kinds, each of which requires a different treatment, for which a surgeon should be consulted. They are mentioned here principally in order to impress upon those who suffer from them and go on for years bearing pain, or even having their health undermined by constant loss of blood, that their disease is curable, and that they should not allow feelings of false delicacy to prevent their applying for relief. As a temporary means of relief, a sufferer may regulate the bowels with occasional doses of "lenitive electuary," and may employ an enema of cold water. Habitual sufferers from affections of the bowels frequently derive very great comfort from relieving the bowels at night rather than in the morning, so as to obtain some hours' rest in the horizontal position after its occurrence.

Prolapse of the bowel in children should be gently returned after sponging with cold water. It may be simply the result of debility, or may be a symptom, in boys especially, of a much more serious affection—stone in the bladder—and the advice of a surgeon should therefore be obtained.

Incontinence of Urine in Sleep is very common among weakly children, and is often the cause of great suffering to a child at school, when he is punished for what he is quite unable to help. Careful supervision will often effect a cure by avoiding too long intervals of unbroken sleep, and the use of a night-light will obviate the fear of rising in the night or early morning, which is often a cause of the disaster. As this affection may be only the evidence of more important diseases, it will be well to have medical advice if the occurrence appears to be becoming habitual. The opposite condition of things—retention of urine—is much too serious an affection to be treated domestically, and *immediate* surgical attendance should be obtained for it, at whatever age it may occur.

HOME GARDENING.

THE VEGETABLE GARDEN (*continued*).

Asparagus.—The young shoots, when grown about two inches above ground, are the parts to be used; but of this we shall speak more explicitly as we proceed.

There are only two varieties cultivated—the red topped and the green topped; the former rising with a very large, full, close head, of a reddish-green colour, and the latter not so plump and close, but generally considered better in flavour. Of these the former are the most esteemed by market gardeners; the latter by private cultivators. One mode of culture is applicable to both. There are several sub-varieties, as, for instance, the Battersea, Deptford, Gravesend, early Mortlake, Dutch, and large Reading.

This plant may be propagated by dividing the root, but the most general and best way is by seed, which should be sown in March, broadcast, not very thickly, on beds four feet wide, or thereabouts, and in length according to the quantity required. Many gardeners make it a practice to tread the ground after sowing the seed, but we object to this method, and, instead of it, make it a rule,

after sowing the seed, to rake the ground smooth and even, being careful that the seed is all well covered; and, when the plants have made their appearance, to keep them perfectly clear of weeds, and stir the ground about them twice or three times during the summer. Should the weather prove dry at the time, a little water should be given once a week. In October protect the roots by covering the ground with well-rotted stable manure or litter, which must remain on until all danger from frost is over.

In the formation of new plantations the first thing necessary for our consideration is the situation, which should be open and unsheltered by trees or bushes; as, unless the spot is fully exposed to the sun, success is next to an impossibility. Damp or wet ground, or where the subsoil is retentive of an undue quantity of wet, should, under any circumstances, be rejected, as being very prejudicial to this plant.

The soil should be from two to two and a half feet deep, and of a light sandy loam. Some months previous to commencing planting see to the preparation of the ground, by trenching it, if possible, at least two and a half feet deep, at the same time mixing a good quantity of well-rotted manure with the soil. When it has lain in this state a month or more, if the weather permit, work the ground over again to the same depth, and repeat this two or three times, in order that the manure and soil may become well incorporated with each other. At the last turning over, before planting, lay a solid foundation of rich well-rotted manure in every trench, as no more can be applied for several years, or, indeed, so long as the beds stand. Make it a practice to perform this work in the best weather that can be commanded during the winter months, as such an operation should never be attempted during rainy or showery weather, inasmuch as it would only tend to make the soil heavy and cold. This portion of the work should be particularly attended to, as the preparation of the soil is of more moment than anything else during the whole course of its culture.

In the removal of the plants from the seed-bed, and final planting, take especial care to perform the work of taking them up by means of a fork, being very careful not to break or cut the roots, or to leave them a longer time exposed to the sun and air than you can help, as very few plants feel a hurt more severely than this; the roots, being brittle, are easily broken, and do not readily shoot out again.

Although you may plant from the beginning of March to the end of May, the operation will not always be followed with the same success.

The best time, so far as our own experience goes, is just when the plants are beginning to grow; for when they are removed earlier the plants lie for some time in the ground in a dormant state, and consequently the roots, being of a succulent nature, absorb a considerable quantity of moisture, which, in nine cases out of every ten, causes them to rot, and then the destruction of the plant becomes inevitable. On the other hand, if removed too late, the power of the sun and air will greatly injure them, unless very great care be taken, and the roots put into a basket, or some other receptacle, with sand, as they are taken up.

When your plants are ready, and the ground having been previously prepared as above, stretch a line lengthwise nine inches from the edge, as at Fig. 2, and with a spade cut down a trench six inches deep, perpendicular next to the line, turning the soil to the outer or other side of the trench; then, having the plants in readiness, set a row along the trench, nine inches apart, with the crowns of the roots two inches below the surface; then move the line a foot further on, as shown at 2, Fig. 2, and open a second trench, turning the soil taken out of this into the first, over the roots just planted; and so proceed, making an allowance of three feet between every four rows for alleys. Should the weather prove dry at the time, give a little water to

settle the soil to the roots, and repeat the application until such time as the plants become well established. Fig. 1 shows a section of the bed. As a rule an asparagus bed should not contain less than a rod, as it very frequently takes more than this to make up a dish at one time; but for a large family twenty poles would not be too much.

Never gather any buds for the first three years after planting; but, on the contrary, permit them to run up to seed, and keep the beds clear of weeds, stirring the soil at each weeding, in order to keep it in a loose state.

It is the practice of some gardeners to throw out the alleys at every autumn dressing, and cover the beds with the soil so taken out. Now this may be done the first year after planting, but never afterwards; instead of which give a good coat of rotten dung, and fork it evenly, both into the beds and alleys, every season. It is, or should be, well known that this plant forms a new crown every year, and it frequently happens that in a few years the crown extends itself into the alleys, so that by digging them out the plant is certain to be destroyed. We therefore advise that nothing at all be done to them rather than they should be treated according to this too general practice. The first two years a little celery and lettuce seed may be sown on the beds, and a few cauliflower plants may be planted at the distance of two feet asunder, in the alleys, but never after, as it would to a certainty rob the asparagus of a great portion of nourishment.

At the end of October, or beginning of November, the stalks will have done growing and begun to decay, when they must be cut down close to the ground and cleared away, taking off all weeds and other litter at the same time; then give the ground a good three-inch coat of well-rotted manure, and fork it in quite down to the crowns, as above advised, by which means the winter rains, &c., will wash the manure down amongst the roots, which will be greatly benefited thereby. Many people have a notion that by merely covering the beds with litter or recent dung from the stable, they have done all that is necessary, but we maintain that such treatment does far more harm than good, as it only prevents the winter frost from having any influence over the soil without doing the least in the shape of enriching it.

At the end of March, or beginning of April, just before the buds begin to rise, loosen the surface of the beds with a three-tined or pronged fork, being careful not to wound the crowns with the points of the tines; then rake the surface neatly level, drawing off all large stones and hard clods, leaving the beds as loose as possible, which will not only enable the buds to rise freely, but admit sun, air, and rain into the soil, and thus encourage the roots to throw up buds of a superior size and flavour.

By the way, we may mention that the shoots, or buds, come up but weak and slender the first year, stronger the second, and still stronger the third, when some old buds may be gathered, and in the fourth year the buds will be in full perfection.

So far as cutting and gathering is concerned, we say never begin to cut till the plants come to mature growth—that is, three or four years after planting, at which time, and not till then, they are of proper strength to produce full-sized buds. The buds are in the greatest perfec-

tion when they have risen above ground from two to three inches, as they are then close and plump. In gathering the buds, scrape an inch or two of the earth from the shoot, 1, Fig. 3, and then slip the knife down, as at 2, drawing it up in a slanting direction towards you, which will separate the head or shoot from the stool easily. Fig. 4 shows the best shape of knife for this purpose. This implement should be thrust into the soil, after having nearly bared the shoot down to the root, and with a saw-like motion sever the same in a slanting direction towards you. The same plan must be resorted to in each instance, until you have entirely cleared the bed.

Never cut much after the middle of June, but permit it to run up; in fact, the weak shoots should not be cut at all. If on any particular occasion cutting should be required later than the above time, be careful to leave one or two shoots on each stool, in order to draw the nourishment to it; for

if left destitute of growing shoots they would perish, and thus fill the bed with vacant spots. A plantation of asparagus, under judicious management, will generally continue to afford plentiful crops for twelve or fourteen years, after which time the shoots begin to decay, or, at all events, begin to decline in fertility, and the shoots are

much inferior in quality, even if they do vegetate as long; so that to ensure a permanent supply every year a bed or two should be planted every now and then, so as to get them in readiness for cutting in three or four years' time, in order that they may come to a productive state before the old ones are thoroughly worn out. Some people continue their beds for twenty years or more, but, in our opinion, by so doing they lose much to gain little.

Those desirous of saving seed—which we scarcely think necessary, considering how cheaply it can be purchased—should select some of the largest and earliest buds as soon as they rise in the spring, to which place sticks or stakes, by which to tie them to during the summer, taking care not to injure the crown of the plant when driving the said supports into the ground. As soon as the berries are ripe, gather and spread them in a dry, airy situation, keeping them in the berry until the time of sowing.

To force Asparagus.—Plants about five or six years old should be chosen, if they appear strong enough to produce vigorous shoots for insertion into the hotbed. The first plantation for forcing should be made about the latter end of September, and if the bed goes on favourably a crop may be expected in four or five weeks' time. The bed will afford a gathering every two or three days, and will continue in bearing about three weeks. The hotbed for the reception of the plants is constructed of stable-dung or other material in the ordinary fashion. This should be covered with about five or six inches of tan, or other light material sufficiently porous to admit the heat from the bed to the roots, which are planted in mould laid upon the tan. The bed must then be covered with six or eight inches of rich light soil. The plants may be inserted as close together as possible, several hundred under an ordinary-sized frame. In planting draw a furrow against it, covering their roots with soil, and proceed in the same way throughout. More soil is gradually to be added as the bed acquires a steady and regular heat.



Fig. 1.

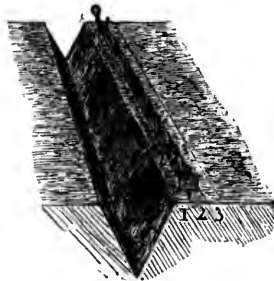

Fig. 2.

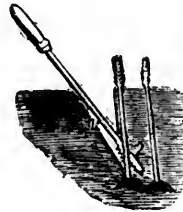

Fig. 3.



Fig. 4.

HOUSEHOLD DECORATIVE ART.

VII.—FEATHER SCREENS.

MOST of our readers have seen, no doubt, in the windows of bird-stuffers' shops, screens made of the wings and head, with more or less of the breast feathers, and often the tails of different kinds of birds; but few perhaps know how easily they are made by amateurs, and what exceedingly pretty screens may be produced with a comparatively small amount of trouble and practice (see Fig. 1). The work is not beyond ordinary skill, and we have seen some very good ones made by ladies, though the sight of raw flesh, and the necessity of getting over scruples about touching it with the fingers, often deters them from attempting the necessary operations. We shall now give the result of our practical experience, and explain the details of the manufacture step by step, assuming that the reader is totally ignorant of the art of bird-stuffing.

The implements required are very simple, viz., a good strong penknife, very sharp at the point, a quill pen, a small quantity of flowers of sulphur, arsenical soap, wadding, or cotton wool, or tow, a smooth board, some twine, a darning-needle, some strong pins, a hammer, and some copper bell-wire. The pen is to be cut in the shape of a scoop or narrow spoon, and is used for removing the brains from the head of the bird, and for pressing the cotton wool or other material when saturated with arsenical soap, into the skull and other places. Arsenical soap can be obtained at almost any chemist's, and there are numerous recipes, all more or less valuable; but the following is all that is really requisite for our present purpose:—Cut into thin slices or pieces three-quarters of a pound of common brown soap, put it into a pipkin or earthen jar with a little water, and stir it on the hob till it becomes of the consistency of paste or thick cream, then stir into it about half a pound of powdered white arsenic, and the mixture is ready for use.

The first thing is to select a bird, and we need hardly say that it is useless (at any rate for a beginner) to attempt to do anything with a bird whose wing-feathers have been torn by shot, or whose head or neck is disfigured by blood.

Some birds are, of course, more suitable for making screens than others, and some require a different treatment from others, and are more difficult to manage. There is also a particular season of the year when wild birds are in their best plumage, which does not apply to tame birds, but these are points we cannot now enter into. One of the birds most easily obtained is the common house-pigeon, and if carefully selected he will form as pretty a screen as any British bird we know of. Generally speaking, a male bird should be selected, the plumage being brighter.

Assuming, then, that we have got our pigeon dead, and that he lies on his back on the table before us, the first thing to be done is to remove the wings, and this is done

by severing the muscles at the elbow-joint, and is most conveniently done from the inside of the wing. Fig. 2 will show the direction the cut should take, so as to get rid, as much as possible, of those portions which we do not want, and retain those we do want.

In some birds, and for the purpose of making screens of a more fanciful shape, the wings may be taken off nearer the body of the bird; but, we are assuming that this is a first attempt, therefore propose the easiest shape. The wings may now be laid aside for some days (if necessary), as it is not so important that they should be quite fresh for the purposes of our operations, as that the head should be in that state.

Place the bird on its back with its head towards you, and a lead pincushion or other weight across its tail and feet to keep it steady; then raise the breast feathers about the place where you would expect to find the top of the merry-thought (as the *furcula* bone is called) and carefully holding back the feathers, cut the skin across with the point of your knife, taking care not to cut too deeply. Continue this cut on each side, slanting it downwards towards the head, so as to escape the wings; then turn the bird over, and join the two cuts straight across the back. After this, replace the bird in its former position, and by gentle pulling and cutting, the skin will come off very easily, inside out, over the head of the bird. A little stretching of the skin will be required, and a little further use of the knife, when the skin of the neck has to be brought over the head, and care must be taken when you approach the ears of the bird, to cut the skin as deeply down into the orifice of the ear as possible, thus leaving only a very small hole. Immediately succeeding the ears the eyes will appear, and here also care must be taken to avoid cutting the eyelids, while the muscles which attach the lids to the circumference of the eyes will re-

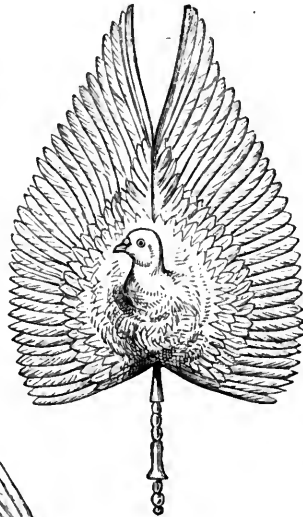

Fig. 1.



Fig. 2.

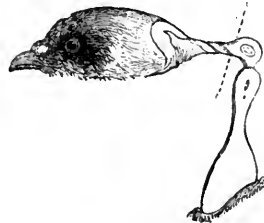

Fig. 3.

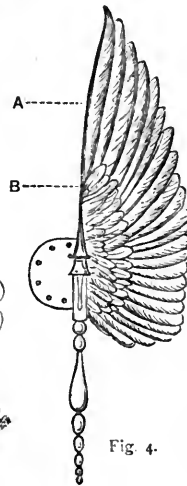

Fig. 4.

quire some sharp cuts with the point of the knife. During the whole of this operation, the skin, and, indeed, the flesh of the neck, may all from time to time be dusted with flowers of sulphur, which will prevent the feathers from getting spoilt by curling over and coming in contact with the flesh. If the bird has been shot, and the neck or skin shows traces of blood, it may be necessary to have a cloth at hand to wipe off the exudations as much as possible, or a piece of soft paper may be wrapped round the neck where the skin has been removed, and thus avoid any chance of spoiling your work. Having skinned down as far as the base of the beak, your bird will present an appearance like that seen in Fig. 3.

The neck should now be severed from the head at the base of the skull, and all pieces of flesh or skin on the skull and jaws should, as far as possible, be scraped or cut off, taking care not to sever the joints where the lower jaw-bones are fixed to the head. The eyes must be carefully cut round and taken out whole, and the brain scooped

out from the hole at the base of the skull, where the neck has been taken off—this hole may be a little enlarged for the purpose. When this has been done, the cavity of the skull should be firmly stuffed full of the wool, with sufficient arsenical soap to completely wet it, and the eyes should be replaced by little balls of the same material, made as solid as possible, and rather larger than the natural eye-ball. The reason for filling the skull *firmly* with this mixture will appear hereafter. Little bits of the same should also be poked into the palate, where divided (taking care to let no arsenical soap run down into the beak, or the feathers will be damaged), and the space between the jaws should also be filled with the soaked wool. When this is done, the skull may be rubbed over with arsenical soap, and the skin then re-drawn over the skull—this is easily done by feeling for the end of the beak, and holding it firmly, gently pulling the skin back into its natural place. Special care must be taken that the openings for the eyes are over the centre of the balls of cotton wool.

The next thing that should be done, is to stuff the exterior nostrils of the bird (especially if prominent, as is the case with many pigeons) with the soaked wool, for which purpose two little pieces of the size of a grain of rice each will generally suffice. The mouth must then be opened, and as much soaked wool as it will hold, in lieu of the tongue, put in, carefully plastering it down with your penknife, so as not to show when the beak is shut.

The eyes (or rather eye, for one will generally suffice) is the next thing, and the bird should now be carefully examined to see which side is the most presentable, and which eye is most perfect as to feathering and eyelid. Artificial birds' eyes can be bought of bird-stuffers at 1d., or sometimes 2d., a pair, and you have only to specify the colour and the kind of bird, to obtain what you want. Of course, you should endeavour to match the natural colour as nearly as possible. To put the eye in nicely is an art that experience alone can teach. A little hole or indentation, should be made in the centre of the spurious eye-ball with the knife or the darning-needle to receive the wire at the back of the eye, and the rest can only be described as a process of putting a button through a very limp button-hole with the aid of the darning-needle.

The darning-needle, or some implement of this sort, is also useful to bring up the eyelid over the edge of the eyeball, and to arrange it in its natural shape, taking care to tuck back any stray hairs of wool that may come into sight. We are aware that some bird-stuffers do not put in the eyes while the lids are fresh and soft, but we hold to our plan notwithstanding.

The inside of the skin may now be liberally daubed with arsenical soap, with the finger or a brush, and then stuffed with plain wool, inserted in small pieces, and pressed closely up to the skull. Here we depart from the ordinary practice (so far as dealing with pigeons is concerned), by not inserting any wire to support the head at this period, and the benefit obtained is that the natural *pose* of the bird can be obtained without difficulty in this way, and the wire can be inserted afterwards, when the skin is hard.

The stuffed head is to be now arranged on a board, and a good way to fix it is to fasten a piece of cork, about an inch in height, or rather less, down to the board with a pin, and then with a fine needle pierce through the upper part of the bird's beak, or nostril, down into the cork. This assumes, of course, that you have put in one eye only, and that the head is to be put on the screen in profile. A little stroking and smoothing of the feathers, and perhaps a little more stuffing with wool, so as to bring up the breast of the bird into its natural shape, will be all that is required—possibly, aided by a pin or two being stuck through the edge of the skin of the breast into the board, and the head thus fastened is complete for the present.

The wings have now to be taken in hand, and the only thing required before stretching them out on the board, is to remove all the flesh and sinews that lie between the pinion and the elbow-joints, taking care not to cut the connection between the two bones at these joints. No care need be taken to preserve the skin and feathers that cover the edges of the wings from the pinions downwards, as this part will be all covered by the head when the screen is made up. When all the flesh has been removed, rub the skin and bones well over with arsenical soap, taking care not to soil the feathers. The best way of stretching both wings so as exactly to match each other is to draw a straight line with a pencil across the board, and then laying each wing inside downwards on it, stretch it out straight, up to the line. Begin by confining the bone close to the elbow-joint by strong pins hammered into the board, one on each side; then confine the pinion-joint in like manner; and then take hold of the first pinion-feather, and, with a single pin put in close to the stalk of the feather and about three inches from the end, bring it up to the pencil line; and each succeeding feather (where they do not naturally come to their proper places) must be pinned in like manner. Many of the feathers will not lie flat to the board when this is done, and to make them do so, strips of card or mill-board, may be pinned down across the whole wing in such a way as to make them lie quite flat. Take care in stretching the wings that they are placed opposite one another, and by this means you will be able to get them exactly to match. The tail or the wing coverts may then be taken off (one or the other will be required, and the latter is the easier managed), and we have done with the pigeon, which may then be sent downstairs, and, if all sulphur be removed, may be put into to-morrow's pie, or otherwise profitably disposed of. The wing coverts are tufts of strong feathers that grow on the back or shoulders of the pigeon, and should be taken off with the piece of skin on which they grew, and (after being rubbed with arsenical soap) pinned down flat on the board. When this is done, the board should be put away in a warm, dry place, where it will be free from dust for three weeks, or even longer; and the screen-handles may now be prepared. These may be made in a variety of ways, and of numberless materials, but we will assume that we have to deal with one of the ordinary old-fashioned gilt wooden handles (costing about 2s. 6d. a pair), cleft at the top for the reception of the ordinary fancy hand-screen. First fill up the cleft by cutting $\frac{1}{4}$ a bit of wood to fit, and let it project two inches or more beyond the top; glue this in and let it dry, or bind it firmly, before proceeding; then cut a bit of stout millboard about three or four inches square or round, but taking care that it is well within the space that will be covered by the head of the bird (or, rather, by the breast feathers, as arranged on the board), and having pared off a piece from the side of the handle, so as to fit flat to the millboard, glue, and tie (by means of holes bored in the millboard) the handle firmly to it, as will be seen in Fig. 4, p. 289. Holes should also be made in the millboard, as drawn, to assist in fastening the wings, which is our next job. The wings being now taken off the board, will be found quite stiff and flat, and do not require any additional support. Lay them side by side, as they were on the board; glue the millboard and the space on the outside of each wing that it will cover; and tie, with a darning-needle and some twine, the wings into their proper position. The drawing, Fig. 4, shows the handle with the cleft filled up, the piece of millboard attached, and, on one side, the wing, as fixed, covering half of it.

When both wings have thus been fixed, they should be tied together at points A and B. At the point A, by using the darning-needle and twine, but keeping under the short

feathers on the outside of the wing; and at the point B, by using a fine needle, and passing it through the stalk of each first feather. In this way, nothing will be seen from the outside. This last tie will also form a means of hanging the screen up, if desired, by means of a pin driven into the wall. The head should now be put on, and for this purpose, take it off the board, and pull out all the wool as far as the skull, taking care not to soften the hardened skin, or displace the feathers; sharpen a piece of copper bell-wire to a fine point, and inserting it up the neck-bore through the skull, holding the pigeon's head in the palm of your hand, until the wire comes out at the top of the head. The advantage of stuffing the skull firmly will now appear, as it will give it solidity, and, though it may add to the labour of boring, will make the head more compact and secure than if left empty. The extreme end of the wire may now be turned down with a small pair of pincers, and the wire withdrawn, till the turned end is hidden amongst the feathers. Then replace the cotton wool, taking care to bend the wire to the shape, and, as far as possible, to keep it in the centre of the neck; and, having bored a hole in the millboard to match the position of the wire, glue the millboard and the edges of the skin of the breast, pass the wire through, press the head close down, and then turn the wire on the other side, tying it also to one of the wing-bones, or to some of the strings by which the wings were fastened on.

To complete the screen, the wing coverts are glued on, side by side, on the inside of the wings, to cover the bones and fastenings, making their upper ends just cover the tie A; and at the other ends, if they are not quite neat in themselves, a small bow of ribbon may be glued on afterwards.

All this may seem difficult, but very little practice will soon render it easy.

At a future time we may have something to say on the kinds of birds best fitted for screens, and their different treatment from the above; on the way of obtaining them, and killing them, if obtained alive; and the season of the year when they are in their best plumage.

MAKING SWEETMEATS.

Candied Horehound.—Take some horehound and boil it till the juice is extracted, when sugar, which has been previously boiled until candied, must be added to it. Stir the compound over the fire until it thickens. Pour it out into a paper case dusted over with fine sugar, and cut it into squares or any other shapes desired.

Peppermint Drops.—A brass or block-tin saucepan must be rubbed over inside with a little butter. Put into it half a pound of crushed lump sugar with a table-spoonful or so of water. Place it over the fire, and let it boil briskly for ten minutes, when a dessert-spoonful of essence of peppermint is to be stirred into it. It may then be let fall in drops upon writing paper, or poured out upon plates which have been rubbed over with butter.

Ginger Drops.—Mix one ounce of prepared ginger with one pound of loaf sugar; beat to a paste two ounces of fresh candied orange in a mortar, with a little sugar. Put the above into a brass or block-tin saucepan with a little water. Stir them all well, and boil until they are sufficiently amalgamated, which will be when the mixture thickens like ordinary candied sugar. Pour out on writing paper in drops, or on plates as for peppermint drops.

Lemon Drops.—Grate three large lemons; then take a large piece of best lump sugar and reduce it to a powder. Mix the sugar and lemon on a plate with half a tea-spoonful of flour, and beat the compound with the white of an egg until it forms a light paste. It must then be placed in drops on a clean sheet of writing paper, and placed before the fire—to dry hard rather than to bake.

Damson Drops.—Take some damsons and bake them without breaking them. Remove the skins and stones, and reduce them to a fine pulp by pressing them through a sieve. Sift upon the pulp some crushed lump sugar, and mix it with a knife or spatula until it becomes stiff. Place it upon writing paper in the form of drops; put them in a gentle oven to dry, and when dry take them out and turn them on a sieve. Then wet the paper, and the drops will separate from it, after which they are again to be placed in a very slack oven, and dried until they are hard. They are placed in layers in a box with paper between each layer, and in that way will keep well, if air and damp are excluded.

Raspberry Drops.—Gently boil some raspberries with a little water, and then remove the skins and seeds, after which a pulpy juice will remain. To one pound of this juice add the whites of two eggs and one pound of sifted lump sugar, well beat up together. The addition must be gradually made, and the mixture well beat up for a couple of hours. When arrived at a proper degree of consistency, the composition is to be placed in large drops upon paper slightly rubbed over with butter. They may be dried either in a warm sun or before a slow fire, but not hastily. A larger raspberry drop or lozenge is made as follows:—Take of raspberries two or three pounds, and boil them slowly, stirring them until there is little or no juice left; then put into the saucepan as much moist or crusted sugar as there was fruit at first; mix the two off the fire, and when thoroughly incorporated spread the compound upon plates—china or ironstone are best—and let it dry either in the sun or before a slow fire. When the top is dried, stamp or cut into small cakes of any shape you choose; set these again down to dry, and when ready lay them in boxes, with a sheet of paper between each layer. Like all similar preparations, they are best kept quite free from all damp; and, therefore, tin boxes, with closely-fitting lids, are better than any other. At the same time more depends upon the dryness of the place they are kept in than upon the material of the box.

THE REARING AND MANAGEMENT OF CHILDREN.

IX.—CHILDREN'S CLOTHING (*continued*).

THE best out-door dress for a child two years to four years old is a pelisse and cape. In winter it is warm and comfortable, and it always has this advantage—if a child makes its frock dirty in the house, the pelisse is fresh and clean for out of doors. In very cold weather it is put on over the frock, or frock and pinafore; in warmer weather the frock is removed. In winter, serge or merino or velveteen are good substances for pelisses; in spring, fancy mixtures of wool and cotton; and in summer, pretty prints, brown holland, plain linen, and checked muslins and white *pique's*.

To take a pattern for a child's pelisse and dress.

To cut a Cape.—Take a small newspaper, as it lies, folded in four. We assume it to measure twelve and a half inches long from A to B, Fig. 82, page 293. Fold the corner B back to C. The fold will come at the dotted line A to D. Cut the paper at the dotted line from D to C. Turn the paper over, and cut another piece like the first, or, rather, continue the cut from D to C along the back of the paper, as shown in Fig. 83, at the dotted line E to F. You now have two squares in one, marked G and H in Fig. 83. Fold these exactly together, as at Fig. 84, page 292, one square; fold again I to J, at the dotted line K to L. The piece of paper is now the shape of Fig. 85. Cut it with a slight circular slope from O to P and M to N, taking care that it is as long from O to M as from P to N. Then open it, and it will resemble a half-circle (Fig. 86). It may be folded in half again, and sloped by

the slanting line shown by dots at A and R from the centre S very slightly. The pattern is, of course, much smaller than a child's cape, but it instructs the mother how to cut a cape. She can afterwards easily cut one any size desired.

The Pelisse.—The cape of a pelisse should half cover the skirt, and, indeed, be an inch over the half-measure at the centre behind. The length of the pelisse must be determined by the size of the child, and the cape by the pelisse. The pelisse for an infant in arms should be made long enough to cover the feet, and just touch the ground. If the child walks, it should come half-way between the sock and the top of the boot, which it will do, when worn, if the measure is taken from the waist to the top of the boot. For the body, measure the length of the child from the neck to the waist, and round the waist very loosely. Take a piece of double paper as long as the length from neck to waist, and a quarter the width of the waist (doubled paper). Measure the size of the child round the neck, at the place where the top of the pelisse would come, not tightly. Then, from the top of the piece of paper, measure from the centre a quarter of the size of the neck (from A to B, Fig. 87), and just cut off the corner by a little slope, exactly to the measure. Then measure the length of the child's shoulder from the neck to the arm, and mark the length on the paper, beginning at B and measuring to C. You will then cut off the piece there at the slanting line dotted. Measure the child's arm at the top of it, loosely. Make a mark on the paper from C to D, a quarter of the size of the arm. Make another mark from half-way between C and D to E also as long as a quarter the size round of the child's arm. Now, by the help of these marks, cut out a small half-circle from C to D and to E. Measure the length of the child's side under the arm from the arm-pit to the waist. The paper from E to F ought to be as long as this measure. If it is shorter, you must pin a piece as much longer as is needed across the end of the pattern, from F to G exactly equal. Your pattern is now complete. There is no slope under the arm of a young child's body from E to F. Your paper being double, you can now open it, and leave the front of the body entire, like Fig. 88. Double it to cut by, and double the material. Cut the material doubled from the paper for the front. The same pattern will do for the back, cutting from the material also doubled, but allowing two inches larger at the doubled part (C D, Fig. 89), as a hem for the backs, and leaving half an inch at top and bottom to pipe and to turn in on the shoulder and side. Put pins in the material along the edge of the paper pattern to indicate how much is allowed to turn in. For the fronts allow an inch at the

side and shoulder. Allow nothing where the material is doubled. Allow half an inch top and bottom and round the arm-hole. Cut the body on the straight of the stuff—that is, the sides level with the selvage; the width of this is to be taken the narrow way of the stuff—that is, with the selvage on a level with H and I, Fig. 88.

To make a frock body, cut a paper pattern first from the one like Fig. 88, and then mark the dotted line at H in Fig. 87 on it, and cut it across there. This makes it a low body, that will serve for a petticoat or frock. The bodies of any material are best cut as directed, with the stuff double, backs as well as fronts, because otherwise tyros are apt to fashion both backs for one side, and discover the error too late, after the fabric has been wasted.

To cut the sleeve, Fig. 90, measure the length of the outside of the arm. Mark it on a piece of paper from E to F. Measure the length of the inside of the arm. The length outside is measured from the arm-hole in the frock behind, with the arm bent, and the inside from

the arm-hole in front with the arm straight. The inside measure is an inch or two shorter than the outside. Mark the inside length on the paper from C to D, Fig. 90, allowing equal space to each end. Measure the

arm loosely at the top. Mark half the size round from C to E. Measure the wrist large enough for the hand to slip through easily. Take half of this and measure from D, sloping it as low as F, Fig. 90. Make a dot for the elbow exactly half-way down the pattern, at G. Then

draw a curved line (like the dotted line in Fig. 90) from E. to F, a well-rounded line from C to E, and a straight line from D to F. Cut out the pattern as you have drawn it.

Cut two pieces alike for each sleeve, doubling the stuff first, or else taking care to reverse the pattern. Sleeves like this are cut straight—down the material—as it is called; the selvage is level with C and D on the straight side. The

shape of the curve at the outside makes that part of the sleeve in effect on the cross, although the inner side is straight and level with the selvage. This is shape enough for a young child's sleeve. Allow half an inch in cutting all round the paper pattern. Take

the dotted line, K, for a pattern for a short sleeve for a frock or petticoat. If the petticoat is first cut from this pattern, cut the body and sleeves of the dress a little wider—a quarter of an inch on each side. Short sleeves are not cut in two pieces like the long ones, but in one, at the side E, and joined once at the side C.

Measure the child to cut the skirt. Allow half an inch for gathers. The hem had better be two inches deep, therefore allow two and a half for it, as it has a turning in. A tuck is well in a growing child's skirt. As a tuck is double, allow double the depth. Four inches is wanted

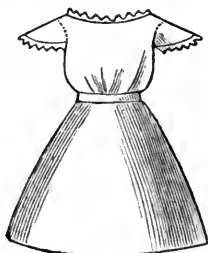

Fig. 96.

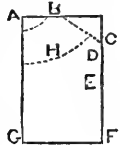

Fig. 87.

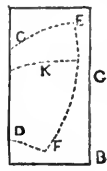

Fig. 90.

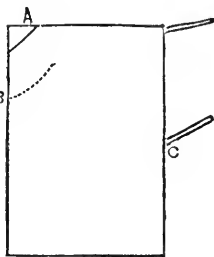

Fig. 95.

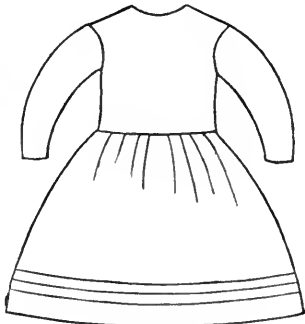

Fig. 92.

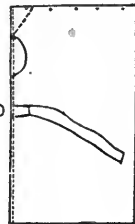

Fig. 94.

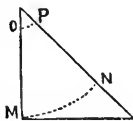

Fig. 85.

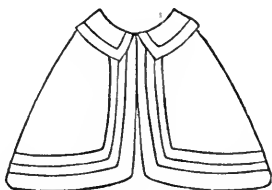

Fig. 93.

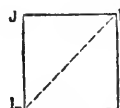

Fig. 84.

for a two-inch tuck, which is best with a two-inch wide hem. A skirt for a child of two should not measure less than two yards round. Often three yards is allowed.

To make up the Pelisse.—Cut a lining of thin calico, or cambric muslin, the same size as the pieces of the body and sleeves. Tack each piece of the body and sleeves to the lining, half an inch in from the edge. To do this, lay the material on the lining, on a bare table (always cut out and tack on a bare clean table), using a rather large needle charged with a long thread of very fine white cotton, such as you would use to mend lace. Tack the body and sleeves together at the places marked by the pins for turning in, and try them on. Any alteration desired can now be made. Then stitch together the sides and shoulders neatly with cotton the colour of the material. Pippings are cut from the material on the cross, and first run. As soon as the backs are hemmed, run a piping round the neck, waist, and arm-holes of the body. Run the piping on the right side, the cord downwards, half an inch in. This is afterwards turned down at the back and hemmed. It is neater, however, to run a narrow white ribbon (or twilled tape) on after the piping, still on the right side, and then turn down piping and ribbon. If the ends of the piping are too wide, cut them away, and run down the ribbon to the body on the wrong side. The pippings round the arm-hole must not have the ribbon run on, nor yet be turned down and hemmed. The sleeves are stitched in, and the ends cut away close and overcast. Stitch the sleeves together first, and pipe the cuffs, turning them down with ribbon. Overcast the sleeves.

A neater way is to stitch the sleeves separate from the lining, and run the lining. Then slip the lining into the sleeve, the turnings of both inside face to face. Pin them together by the seams. Pipe the edge as described before. Tack the top of sleeve and lining together before stitching it into the arm-hole. This way there are no raw edges in the sleeve to irritate the child's arm.

To put the sleeve into the arm-hole, fix the seam of the sleeve quite an inch behind the shoulder-seam of the body.

The skirt is not generally lined. Hem the bottom, and make the tuck if there is one. For a trimmed pelisse there had better be no tuck, only a deep hem. Cut a slit in the centre of the breadth behind for a placket hole; hem one side inch-wide, the other quite narrow. Fold the broad over the narrow hem, and stitch the fold across at the bottom. When the trimming is on, turn down half an inch at the top of the skirt, and pleat it in small pleats, turning towards the front, and beginning two inches apart in front; these pleats are closer and larger towards the back.

Dressmakers always write this word "pleat" (though

"plait" is the correct spelling), because "plait" also spells that kind of trimming used in millinery and dress-making made like plaits of hair, and confusion might arise if no distinction were made.

The cape must be lined with fine cambric muslin, or twilled muslin, to match it in colour. Cut it out from the same pattern, and tack it to the cape when trimmed, both lining and material face to face, and the wrong sides outwards. Run these nicely together half an inch in. Take out the tacking threads and turn. The cape is run all round the edge and sides, the throat only left. It is turned through the opening at the throat. Tack it together all round again. If the cape is to be faced with silk, cut the silk the shape of the dotted line T in Fig. 86; run the edge next T on the wrong side of the silk to the right side of the lining; turn it over and tack it down before tacking the whole of the lining to the material. Cut a small collar, and also line it after it is trimmed. Turn the lining as the cape lining was turned. Run the neck of the collar to the material of the cape, not taking up the lining.

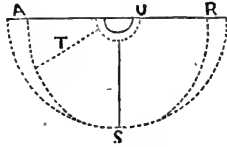

Fig. 86.

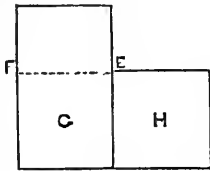

Fig. 83.

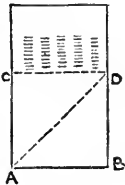

Fig. 82.

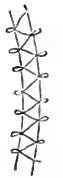

Fig. 91.



Fig. 98.

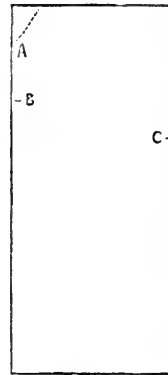

Fig. 97.

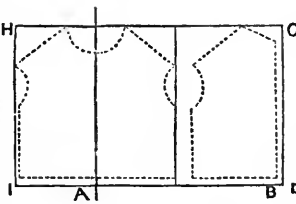

Fig. 88.

Fig. 89.

Then turn in as much of the lining of the cape as you have run into the collar (about half an inch), and hem it neatly to the collar, taking care the stitches do not come through.

The Trimming.—The trimming is put on the cape and collar before they are lined; on the cuffs of the sleeves before the straight or under seam is closed so that the ends may be turned in; on the skirt it is set before the pleats are made. Lay

the cape, &c., flat on a table, and tack the trimming first, not pulling it tight, but letting it go easy. Lay the trimming down on the material the way it is to be, then put a pin or two to steady it, and afterwards tack it; lastly, run it on neatly, taking a back stitch every time the needle is inserted afresh. The skirt may be either trimmed before the last seam is run up—leaving the ends of the hem open an inch each way, and closing them after—or half the skirt

can be laid on the table, the trimming tacked, then turned, and the other half tacked. In that case, open a bit of the seam, and let in the ends of the braid or velvet. Fringes and muslin edges are put on last, when the cape is lined.

Capes of muslin or piqué are not lined, but piped at the edge, and the pippings hemmed down. Some of the piqué ones, with muslin-worked edges, have the muslin hemmed down over the pippings; others are cut rather close, left loose, and overcast neatly. This stiffens out the embroidered edge well. Piqué is piped with cambric muslin.

It is better not to attempt to put elaborate trimmings on pelisses made at home, for it needs much practice to carry these out well. Crimson, bright blue, and violet cashmere pelisses are pretty for children, trimmed with one straight deep row of velvet ribbon, or one deep and

one narrow above the hem of the skirt, round the cape, collar, and cuffs. An edging of piece velvet round the cape and collar makes a handsome trimming to a cashmere pelisse, but is more difficult to put on. It is cut on the cross, shaped to the slope of the cape, and joined in breadths, and run on the wrong side and turned over on the cape, and tacked down before the lining is added. There is then no trimming on the skirt, which may have a tuck if plain. Sable, chinchilla, &c., make pretty edges for capes for children in winter.

Velveteen has been very much in fashion with a broad and narrow white braid as a trimming, and wears well, but has become very common, which is an objection to some mothers. In that case we recommend them to trim the cape only with two rows of inch-wide black military braid.

For a costly toilette, a silk velvet pelisse is handsome, either black, dark blue, or dark green. In winter, a narrow tip edge of sable, chinchilla, or a band of ermine or minever, is appropriate. For any time of year, nothing can be handsomer than a rich lace of Irish crochet on the cape and collar, and robing the sides or round the hem of the skirt.

Brown holland pelisses look well with capes edged by embroidery, and a row of white washing braid above. Plain linen pelisses can be merely trimmed with embroidery, or braided in patterns. White piqués are now braided in elaborate patterns, and trimmed with embroidered edges. A neat, and pretty, and easy way is to place a narrow ornamental braid on a cape like herringbone, wide enough apart to admit a ribbon an inch wide through it, which can be removed to be washed (see Fig. 91). Checked thick muslins, and sprigged Swiss muslins, are pretty for summer. The checked may merely be trimmed on the cape with an embroidered edge, or have an insertion let in, run with coloured ribbon, and be worn with a sash, the hat or bonnet corresponding in colour. The Swiss muslin may be made the same, or for *grande toilette* worn over a silken slip of pink or blue; the cape trimmed with ribbon, and the waist with a sash.

Fig. 92 shows a plain pelisse for a child from two to four years old. Fig. 93 is the cape.

Little boys of two years old wear velvet hats—a plain buckram shape of the turban or “pork pie” make, covered with a piece of velvet hemmed to the crown, the edges turned down in reversed pleats round the brim and inside. Tack it down with small stitches, that are not seen, on the right side, and long ones inside. Line it with silk, run on the wrong side over the tacking stitches, and then turned over and into the crown. A short, curled white feather commences in front, under a velvet bow or rosette, not coming beyond the margin of the brim, and the feather lies round the brim to the left. Little girls wear bonnets like hoods. The Marie Antoinette shape is pretty, made in quilted white or coloured silk or satin, edged with a narrow scanty *ruche* of ribbon, and a ribbon bow or rosette on one side. In summer, satin or silk hats, or even straw ones, may be used for boys, and crinoline bonnets for little girls. Some mothers like the white straw sailor hats, with blue ribbon, for little boys; but these better suit older children, say about four years old.

There are many mothers who prefer jackets to pelisses. There are several objections to jackets. The frock must be fresh. They are not warm in winter. They are less ladylike than pelisses. We shall, however, give directions for making jackets for girls and boys of more advanced age, which can also be used for younger children by cutting the patterns a little smaller. In summer, capes without pelisses are worn. Fig. 92 shows a pelisse, and Fig. 93 a cape made up. Fig. 98 is a dummy showing a velvet pelisse trimmed with crochet lace, suitable for a child of two years of age.

Pinafores are made various ways. A piece of diaper may be folded in half, lengthwise, and then in half again lengthwise, taking from the second folds a slope off the top at A (Fig. 95) for the shoulders to be run and felled together, and a circular slope at B to form an arm-hole and epaulette with the narrowest hem possible, the epaulette edged with muslin work; at the top a wide hem and a string to draw, a hem at the sides and bottom, and a second pair of strings at C, completes it. Fig. 97 shows another way of cutting a pinafore. The slope on the shoulders can be made, but the pinafore looks quite as well without it. The arm-hole is cut and hemmed round; the front is gathered on to a band at D, shown better in Fig. 94, with ends to tie behind. This pinafore is more ornamental made of embroidered muslin or diaper, with epaulettes with worked edges and work round the neck. Brown holland braided is pretty. Some make pinafores of coloured print, but these are very common. Many children wear pinafores which are really little frocks; for girls a skirt and body, for boys a plain piece of holland wide enough to go round them over their clothing, is sloped over the shoulders like A in Fig. 95, and then the whole of the front set in three box pleats, and the whole of the back in three box pleats at the top, sloped a little for the neck, and set in a narrow band. Arm-holes are cut, and the rest left loose. Epaulettes are set in the top halves of the arm-holes, and the rest hemmed narrow. The opening of the pinafore is behind, between the second and third pleat. The skirt has a deep hem. A two-inch broad belt, with a button behind, is put on over the pinafore, but separate. It is very easy to wash and iron, and keeps the child entirely clean. It may be plain, or with a half-inch wide braid, white, scarlet, or black, over the neck band, edging the epaulettes and waist belt, and at the top of the hem. Where style is wished, use white cotton braid, and edge such epaulettes and belt both sides with narrow muslin work.

Day frocks may be made quite plain, with a simple edge of lace to the neck and sleeves which can be washed and renewed. A good imitation Valenciennes does well for such a purpose and is not dear. An inch wide is sufficient. The lining of the sleeve can be cut plain, and the material cut wider and longer, and gathered over it in a puff. Pipe the edge and tack the top before stitching it in.

For common wear, wool plaids, merinos, and velveteens are very warm in winter. A mother can often make warm frocks out of her own store, but not always. Sometimes she can utilise her old dresses for herself, and then it would be extravagance to cut them up for a child. The holland pinafore may be worn over winter frocks, and alone in summer. Light cotton, as well as other frocks for every day, are best made full large in the body, and with tucks in the skirt. Boys and girls at this early age need little or no distinction in frocks.

COFFEE MAKING.

COFFEE in English middle-class houses is often badly served. It should not be *boiled*, nor made in quantity twice a week, to be heated up when wanted. The kernels should be sufficiently and equally roasted. As it is the roasting which develops the aroma, under-roasted coffee is so much lost; whilst over-roasted is so much driven off and wasted or lost in another direction. Of the two faults, the former is the worst. Unroasted coffee is useless. Most of us remember the cruel cheat of sending unroasted coffee to the Crimea, the purveyors of which might as well have sent horse-beans to our besieging army. Indeed, *roasted* beans or wheat would have been far better. Circumstances often compel the buying of coffee ready ground, almost always ready roasted; but more recently coffee is used after both roasting and grinding.

the better. It is only a healthy amusement to give a coffee-mill a few turns. Coffee is easily roasted at home (it should be done in the open air) in an iron cylinder or barrel of small diameter, standing on two feet, over a coke and cinder or, better, a charcoal fire, turned by a handle like that of a grindstone. The turning must be slow and continuous from beginning to end. A little intelligent practice will teach the exact moment when the coffee is done to a turn and must be taken out to cool. Make your coffee in a biggin, the well-known form of filter which allows the water to drain slowly through. Have different-sized biggins, according to the number of persons you have to serve with coffee. Putting a spoonful or two of ground coffee into a full-sized biggin is like giving a dinner-party of three in Westminster Hall. Be liberal and allow for each person a good dessert-spoonful of the very best. When you have put it into the filter of your biggin, *pour on it two or three spoonfuls of boiling water, just enough to soak it without draining through, and let it stand in a warm place a quarter of an hour or twenty minutes.* Then pour on the rest of your boiling water, and let it gradually percolate. The time to take coffee is either in the morning (with milk mixed in due proportion) or after lunch or an early dinner. In the evening it is to be avoided, unless you intend, like Lady Macbeth, to "murder sleep;" for which you are sure to be punished next morning.

ANIMALS KEPT FOR PLEASURE AND PROFIT.—THE HORSE.

INTRODUCTION.

OF all animals, excepting those which serve for man's sustenance, none equal the horse in importance. He is at once a valuable servant and a trusty companion, and he is never more a companion than when he is our servant. It is the business of our superior intelligence, therefore, to make him a useful servant, and to keep him so. We desire, in these articles, to give horse-owners the greatest amount of practical knowledge of the horse, with all things pertaining to his stabling, food, equipment, and management, conveyed in the most concise and intelligible language. Where technicalities occur, we shall explain them, but we shall endeavour to steer clear of stable expressions and horse-dealers' slang, so far as the peculiarities of our subject will allow.

The first object in a treatise of this sort should be to give that information of which the majority stand most in need. For this purpose, when we come to consider the horse himself, as a beast of burden or of draught, we shall begin with the requirements of those who are able to keep one horse for general purposes of saddle and harness. Keeping distinct their uses, our first practical article will be written on the hack and harness horse of ordinary price and of extraordinary utility; for it is somewhat remarkable that in the horse, as in some other animals we know, the useful and the ornamental are frequently found in an inverse ratio to one another. The hunter serves a more limited class, as do all horses used purely for pleasure, or kept, as many are, for show; while the race-horse—unhappily being now little more than a medium for gambling—will only be considered in his capacity as the thorough-bred sire for the improvement of his race. The agricultural or cart-horse, being of a distinct breed, and belonging to the most useful and profitable class, will receive very early attention.

OF THE DIFFERENT BREEDS OF HORSES.

But before going to these divisions of our subject, it becomes those who wish to have a proper knowledge of the horse to consider it from a point of view which will

enable them to become gradually acquainted with his perfect symmetry of form, and adaptation for his work; and with his higher qualities—sagacity, docility, and courage. For this purpose we must regard the principal breeds from which the ordinary horse of this country has, by various crossings, been derived. It is not possible to determine accurately which breed was the original stock, but for our purpose of investigation, we may classify the prominent divisions under three heads:—the Eastern, the Western, and the European breeds. The question is far too deep and too full to be satisfied by the hasty inquiry which we can afford to give it.

It seems at first impossible to regard the sleek, blood-like Arab as being derived from the same stock as the rough, under-sized Shetland, the London dray-horse, and the lady's hack; and yet it is more difficult to believe that they are not. Nature is pliant, and accommodates herself to circumstances of climate and of food; and in the case of the Arab and the Shetland she has acted the part she acts, in changing "wool to fur, and hair to down."

THE HORSE IN SCRIPTURE.

The first mention made of the horse is in Scripture; and without quoting from passages in Genesis, we refer our readers to Job, who lived before Moses, and after Jacob; but as Moses described in Genesis the habits of life of the days of the patriarchs, we may conclude that no horses swelled the retinue of Jacob's goats, camels, sheep, and asses, and that it was not till after they came into Egypt that they had any personal knowledge of the horse. Jacob, on his death-bed, speaks of the "horse and his rider;" and Pharaoh, with chariots and "horses," pursued the Israelites to the Red Sea. Therefore, the question may naturally arise as to the indigenous nature of the breeds of Arabia. There is no description given of these horses to assist us; and 1,000 years before the Christian era, Solomon was importing them, 40,000 at a time, from Egypt. The description given by Job is less definite than that of Homer or Virgil, whose horses may be better seen in the *relievi* in the British Museum. We doubt very much whether the inspired writer intended to convey any physical identification of the horse at all, but rather to express his spirit and disposition, when he wrote, "His neck is thunder, the glory of his nostrils is terrible, he swalloweth the ground, he smelleth the battle," these being poetical symbols of his strength, power, and courage; but they give us no more idea of the original breed of the horse than do the virtues of the man of the size of his body. The probability is, that the original horse was a native of Africa, improved by slow degrees, by crossing, by care, by feeding, by domestication; and that the Arabian of the desert is another form of the African of the desert, which, as civilisation and mutual intercourse increased, had its antitype in many parts of the globe, improved or degraded, according to external circumstances, into the English race-horse or the Irish "hobby."

OF EASTERN BREEDS.

The principal of these is the *Arabian*, of which there are at least six varieties, different in value and in appearance. The best of these is the "Kochlaini," said by the Arabs to be descended from the horse of the prophet Mahomet. This is a breed almost unpurchasable, from the dislike of the Arabs to part with it; we believe there is a law *forbidding* the exportation of the mare. Some have said that from the money value of the horse, he seldom finds his way to this country; but there are plenty of Englishmen to whom price for a horse they want is no object whatever. The peculiarities of the Arab of high class, one of which we once possessed, are a head very light, wide in the forehead, small in the jaw, nostrils expanded, and very red and transparent when in motion; neck short, and full

where it enters the *fauces*, or what horsemen call the "*vivres*;" ears small and pricked; shoulders oblique, but not fine; legs peculiarly flat, and the bone as hard and heavy as can be conceived; "arms" large and muscular, as are the thighs; the quarters are most beautifully rounded; and though the "barrel" is not large, the horse is deep in the girth, which gives him endurance, wind, and a capacity for carrying weight. His absolute pace with our own thorough-bred race-horse has not been fairly tried, as we have not had a first-class Arab in condition on any of our courses. Their performances in their own country, and according to the statements of their own people, are past all credibility. Their endurance of thirst and hunger is beyond anything we dream of, and we have well-authenticated accounts of their travelling from sixty to a hundred miles over the desert without food or water, and almost without a halt. The height of the Arab does not exceed

ing on the deck. The horses bred at the Cape, or at Pietermaritzburg in Natal, might be very serviceable as soldiers' remounts, and would reach India at a moderate expense.

We give below a portrait of "Varna," the Arab alluded to as having been in the possession of the writer. The reader will notice one peculiarity: the unusual way in which the animal carried his tail—so much out.

WESTERN BREEDS.

Of Western breeds—meaning Egypt and westward—the principal is the Barb. His peculiarities are the fullness of his crest, the fineness of his shoulders, and the sudden fall of his quarters or haunches. He is larger than the Arab in some respects, but in height is about the same. The country of the Barb is Morocco. His is one of the breeds which is credited with the ancestry of the

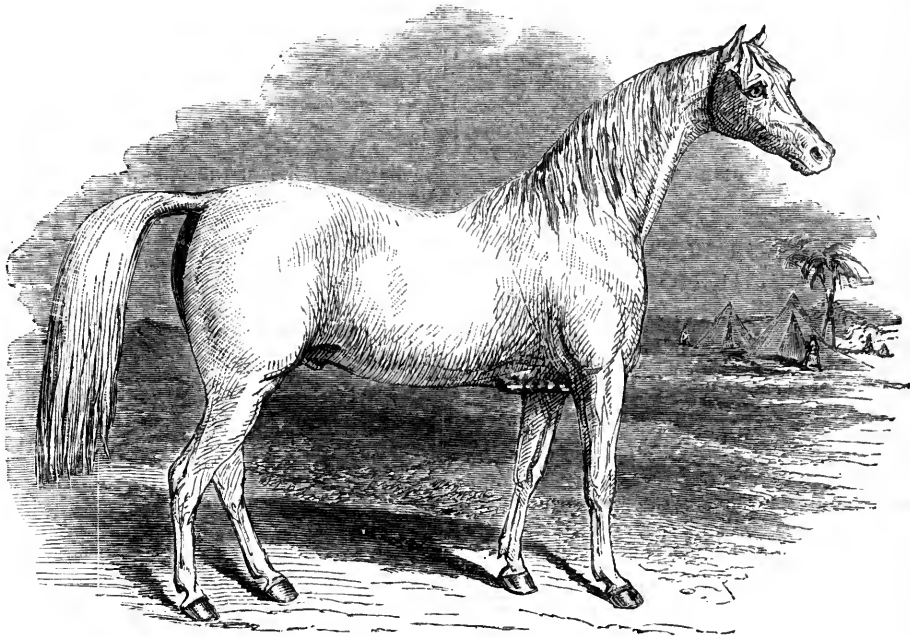

"VARNA," A HIGH-BRED ARAB.

fifteen hands, and he is usually about fourteen hands two inches. He has the finest temper in the world, till ill-treated, but when roused he is indomitable.

The Persian Horse is larger in every respect, and not so handsome as the Arab; and the description given by Sir John Malcolm is much the same as that of Xenophon. They are, when roused, and loose among themselves, furious and vicious beyond measure.

The Turkoman is of the Tartar breed, but of a very superior class. Instead of small, awkward, heavy-shouldered, wild horses, which are hunted for the flesh, on which the Tartars live, the horses used by the Turks are from fifteen to sixteen hands high, held in high estimation, of considerable value, and exhibiting much of the fire and form of the Arab, for which he is sometimes mistaken. He is, however, most likely a cross between the last-named and the Barb.

India has some native breeds, but none of any importance. The climate is said to be unsuitable, save in the north of Bahar and Orissa; and the importation of European blood was found to be absolutely necessary. Good Arabs are very expensive; and frequently suffer from the sea voyage, disembarking with foot lameness from stamp-

English thorough-bred horse—the Godolphin Arabian, of which our readers have probably heard or read, being, in all probability, a Barb, sent direct from Barbary to Louis XIV. The ups and downs of life are pictured in his history, for he was bought from a water-cart in Paris by an English gentleman, and found his way into the hands of Lord Godolphin. He died in 1752. He was brown in colour, and rather better than fifteen hands high; and so truly remarkable are the peculiarities of his head and neck, that we add a sketch from an authentic likeness.

Egyptian Horses.—Egypt as a breeding country is far inferior to those we have already mentioned, and certainly to its own reputation in the days of Pharaoh and Solomon. The docility of these horses is the theme of praise with writers at the beginning of the sixteenth century, and interesting facts are recorded of the exercises, ridden by the Mamelukes of the Sultan of Egypt, which remind us of the ancient Persians, as described by classical writers. They possess, however, very little interest for us, as they are entirely unconnected with those breeds which have so greatly assisted in improving our own.

South and North American Horses.—South America possesses herds of wild horses, which are caught and subdued by the horse-hunters; but whose skill, although truly admirable, as it is described by Sir Francis Head, instance, but transmitted, as other acquired qualities may be. A mile has been done in 2 min. 20 sec., and ten miles in 28 min. 10 sec., in harness. We are satisfied with ten miles an hour, and consider that fast work.



HEAD AND NECK OF THE GODOLPHIN ARABIAN.

is certainly far less than that of the professional breaker of the artificial horse. These South American horses are rather diminutive, clumsy, and "tricksical," in all Great improvements in the American studs are being wrought by constant crossings with the best of our own.



THE SHETLAND.

probability acquiring this property from their breakers or rough-riders.

The North American breed are chiefly crosses with the European horse—French, Flemish, and English—and no man who has not seen it can have the slightest idea of their powers of trotting—an acquired quality in the first

EUROPEAN HORSES.

Of European horses the first we shall mention is the *Flemish* breed. This enjoyed a great reputation in our country, and in the reign of John were imported in great numbers. They improved very much our agricultural and war horses, and many of them found their way

during the Crusades to the East, from which cause mutual benefit was derived both to England and Flanders, Arabs doubtless returning to both countries. The rest of the Continental breeds from which we have gained most benefit, but which we have long ago repaid in kind, are the Norman, Hanoverian, and Spanish. It does not appear that we owe anything to Prussia or Austria; they, on the contrary, are greatly our debtors for the best horses they possess.

The Flemish Horse is generically a heavy horse, with a magnificent crest, broad chest, small head, and round "barrel." His legs are small for the weight he has to carry. He has high and good action, and properly crossed, makes a valuable carriage horse. We have travelled in Flemish diligences, which were very heavy, nearly as fast as on our own stage-coaches—certainly eight miles an hour.

The Norman Horse came to us in great numbers with William the Conqueror. He was pre-eminently the war-horse of that period, and must have been used for all purposes of state. He was occasionally mixed with French and Spanish breeds; the latter adding quickness to his great strength. Considering what he had to carry in the way of armour and heavy arms, the latter quality was the less indispensable of the two.

The Hanoverian Horses are very large, and, covered with harness, look handsome and showy. They have high crests, small heads, and very luxuriant manes and tails, and are almost invariably black and sleek in coat. But they have great faults; bad shoulders and small back ribs, and their muscular development is very light. We have seen the Queen's, which are not free from the national imperfections. Those which are in this country are usually met with in the hands of the undertakers.

The Spanish Jennet was (and is, we believe) a very quick and useful little horse, combining great courage with extreme good temper, which makes it so valuable as a lady's horse. Many of these horses are said to have found their way into this country at the time of the Spanish Armada, A.D. 1588, having been cast ashore and secured by the English. The cross is said to have been most serviceable, as, indeed, it must have been while horsemanship was in high repute, and race-courses were being established both in this country and Scotland, at a time when the Arab was not introduced—that attempt not being made until the following reign, when James I. obtained what is known as the Markham Arabian, and Place's White Turk, so called from his original owner. The Spanish horse, however, has long ceased to influence the English breed, but is too prominent in romance and history to be passed over.

The British Horse, with something of his history and varieties, must form a part of our introductory article. The earliest notice of any kind of British horse is to be found in Cæsar's description of the invasion of these islands, for even then the Briton was a horseman, and, according to a partial judge, a good one. This horse could not have been, as he is sometimes represented, small, and similar to the Shetland or mountain pony of Wales, because he was manifestly capable of drawing the chariots of war on unmade roads, heavy and cumbersome as they were, and of carrying the warrior. He had certainly not yet attained the strength and size which later cultivation gave him, but he must have been much more like our galloway or cob. Cæsar is reported to have taken back several with him to Rome. Roman cavalry was not a strong arm of the service, and when England was garrisoned by Roman soldiers the advantage of the crosses was about mutual. Athelstane improved the English breed by presents of French horses which he accepted from Hugh Capet, King of France. William I., as we have seen, introduced the Norman, and John the Flemish elements in our breed; and the first Arab

had been previously brought in by Henry I., A.D. 1120. The encouragement given to horse-breeding by the Edwards arose from their love of tournaments and their talents for war; and during this period the native breeds increased in size and strength, as well as by the judicious introduction of Spanish and French blood. They had increased in value from 30s., in the reign of Athelstane, to £3 6s. 8d. in that of Edward III. Henry VIII. enacted arbitrary but salutary laws for the encouragement of our horses, and despotically forbade the use of all inferior classes for breeding. We can give, too, some idea of the size of our horses at this time by telling the reader that the nobility and gentry were compelled to keep a certain number of entire horses of not less than *fourteen hands high*, obviously for the propagation of larger stock than the ponies and galloways, which were considered indigenous. There happened then what we fear is happening now, a great exportation of the best horses by the foreigners—for in Elizabeth's reign it was with difficulty that a supply equal to the demand could be obtained; and as coaches were invented, increased substance and increased numbers were called for. The Stuarts and Cromwell both encouraged the promotion of sport, we believe, from different causes; but there can be no doubt that after the civil war the great impetus, which we feel to the present day, was given to improvement in breeding. Newmarket became the centre of racing, and in Anne's reign the last seal was set upon it by the introduction of the Darley Arabian. He was bought from a merchant of that name in Aleppo, and became the sire of Flying Childers. This is said to have been the fastest and most enduring horse that ever ran. He did the round course at Newmarket (3 miles 6 furlongs and 93 yards) in 6 minutes and 40 seconds; and the Beacon course (4 miles 1 furlong and 138 yards) in 7 minutes and 30 seconds. The royal mares imported by Charles II. with Place's White Turk, laid the foundation of our thorough-bred stock, and through it of our pre-eminence as horsemen and horse-breeders. From that time the descent of our best horses has to be recorded from the Byerley Turk through Herod; from the Godolphin Arabian through Matchem; and from the Darley Arabian through Eclipse. In this blood, or strain, is to be found that of all the great horses of this country, and, consequently, from them are descended, by provincial sires, the ordinary classes of hacks, hunters, and harness horses, which do not claim to be pure descendants from other Eastern, Western, or Continental breeds.

The Scotch Galloway was by some writers supposed to be indigenous to Scotland. He has existed there as long as we have any records of the horse in the British Isles at all. Those who refer him to Spanish origin can have no knowledge of the Spanish horse. He is now seldom to be met with, though a clever useful sort of pony.

The Shetland, or Sheltie, of which we give an engraving, is very small, but very handsome; short on the leg, muscular, active, and intelligent. Horses of this breed have small heads, very long manes and tails; are tractable and courageous. They were formerly to be met with frequently at country fairs. We have seen them sold for £3 and for £40. Another sort, called the Highland pony, is mentioned; but he differs little from the Shetlander. He is rather taller, but not stronger. As he is a clever jumper and creeper, he is valuable for the moors and the stubbles.

The New Forest Pony, and the *Exmoor or Devonshire Pony*, are both good in their way—the latter is especially esteemed in his own county—but they are too small for general riding, excepting by very short men, or children. They are docile, and the latter is fast under a heavy weight.

The Welshman is the most useful of all these little horses. He is usually from thirteen to fourteen hands

high, and we have known them to grow, by good keep, nearly a hand higher. They are well made and active, and make excellent hunters for boys and light weights, and we may say more about them when we come to the details of horse-dealing.

For the present we have said enough of the different breeds to give our readers a fair amount of information on a subject which is almost inexhaustible. We shall next consider the various classes (not breeds) of English horses, with their adaptability to our service.

ODDS AND ENDS.

Keeping Liquids Warm.—To keep liquids warm for any length of time, it is usually said that vessels of polished metal should be used, and that such vessels should always be kept perfectly bright, in which condition they are estimated to radiate (or part with) heat as one, although if tarnished they will radiate it as nearly two and a half. But polished metals are good conductors of heat, and by contact part readily with it. The best vessels for such a purpose are, therefore, vessels made with earthenware and coated with metal, earthenware being a bad conductor of heat, and polished metal a bad radiator.

Back Windows.—To shut out a disagreeable view from a back window, the glass may be rendered ornamental, and the obnoxious objects shut out, by a very simple plan, which makes a fair imitation of ground glass. This is effected by cutting out stars or diamonds upon a piece of white muslin, tarlatan, or common tissue-paper, which is then gummed or pasted on to each pane of glass, the great point being to get the gum or paste as colourless as possible. By washing the glass over with a hot saturated solution of Epsom salts, or sal ammoniac, or Glauber's salts, or blue stone, very beautiful effects of crystallisation

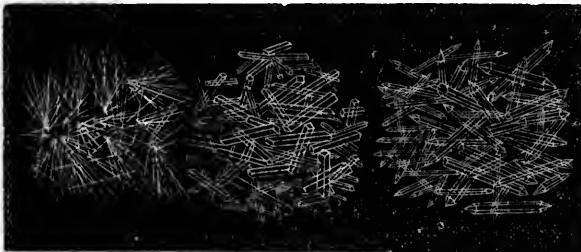

Fig. 1.

Fig. 2.

Fig. 3.

can be obtained, by which also the above purpose is served in shutting out an obnoxious view, and the window has also a very ornamental appearance. By a saturated solution is meant one containing as much of the salt as the water will dissolve. The solution must be applied while hot, and with a brush. Be careful not to use salts of a deliquescent nature. To aid our readers in making their choice of crystals, we give a diagram, in which Fig. 1 represents the crystals formed by the sal ammoniac, Fig. 2 those formed by Epsom salts (four-sided prisms); Fig. 3, the crystals of Glauber's salts (six-sided prisms).

Stools for Children.—Children should have stools low enough to let them rest their feet upon the ground; and these stools, if made after the manner of the north country "cricket," are easily knocked together at home. The seat is round, made of a thick piece of deal; three holes are drilled or burnt within this with a red-hot poker, and into these the legs are fixed.

Hyposulphite of Soda (a Hint for the Laundry).—We are informed that the above is an excellent substitute for common washing soda, by the adoption of which the laundry would be really benefited. It does not appear to injure the texture of linen and cotton articles as the

coarse soda commonly employed does: clothes come from the wash-tub in which it is used softer and cleaner, and they dry whiter.

Washing Blankets.—We append a few hints on the best way of washing blankets. In the first place use tepid water with a little soda in it. The blankets, first rubbed well over with soap, then put into the water and kneaded with the fists, as in kneading dough. If a little ox-gall—a very little—be put in the first water, the impurities soon mingle with it. Scotch lasses jump on blankets when in the tub, and so tread out the dirt. The water must be changed often, or until it looks clean; but the blankets must be soaped each time, or put in a lather of soap and a little soda, prepared in a copper. The rinsing water must also be soapy, or the wool will dry harsh, and the blankets shrink. They must be wrung as dry as possible, and after hanging on the drying-line for an hour, be taken down and be pulled on all sides by two persons, to prevent them "felting." Blankets will "felt," or "mat," if the water they are washed in be very hot—tepid water only should be used—or if much water be left in them when hung up to dry.

Pearl White.—This is an oxide of bismuth, and, though very clear, is very evanescent. If it comes into contact with sulphuretted hydrogen gas it at once turns black. Ladies inclined to use it as a cosmetic, ought to be made aware of its liability to change colour under circumstances which might lead to unpleasant consequences.

THE HOUSEHOLD MECHANIC.

GAS (continued).

WE now come to the second division of the subject, viz., the burning of gas for heating purposes. The principle to be observed with regard to the use of gas as a heating medium, is that any emission of light from the flame will result in a corresponding loss of heat, a blue non-luminous flame giving the best result. Such a flame will be produced by allowing the stream of gas from an ordinary jet to pass through a sheet of fine gauze. The gas being lighted above it, it will be thoroughly mixed up with a larger amount of air than it could come in contact with as a simple flame. Again, an ordinary gas flame being interrupted by striking upon a surface of any object, the heating and incandescence of the carbon particles will be disturbed, and in consequence of the imperfect combustion these particles, instead of being wholly consumed, will become condensed and deposited in the form of soot. In this case, as before, every particle of soot or smoke produced is the positive waste and loss of heat. It is to prevent this loss of heat and production of soot and smoke that the gas and air burner now so generally known and used is contrived. Fig. 82 is a rude embodiment of the principle on which its action is dependent, shown in section (p. 300). A jet of gas from the main service through the pipe A shoots into the larger pipe B, at a part of which tube B, lower than the nozzle of A, are holes, C C, open to the air. The force of the gas through A is sufficient to draw in through the holes C C a considerable amount of air, which mixes with the gas, and is consumed at the flame D, which becomes exposed to the outer air at that end in addition. The principle is embodied into all sorts of shapes and sizes of pipes, and for all sorts of purposes and requirements, but it remains the same, being a jet of gas forced into a pipe open at the end behind which the gas enters, the force of which draws after it a large quantity of air, which mixing with it escapes at the holes, where it is burnt. These holes are very much larger than the ring burner as usually made—a great advantage, as the very small holes soon become corroded and stopped up by the gas, and the vapour which is always the product of combustion of mixtures of hydrogen and oxygen gases.

Messrs. Pettit and Co., of New Oxford Street, are the patentees of this very excellent system of air and gas burners, and have carried it to the utmost perfection, adapting it to all the requirements for warming and cooking purposes, from a small burner to keep a kettle boiling, neat enough to stand upon a drawing-room table, up to a complete range suitable for the most extensive kitchen. The objections urged against an ordinary gas cooking-stove—viz., the tendency to make meat cooked with it acquire a decided flavour of gas, and also their manifest extravagance—are no mere myths; but the above-mentioned firm have completely overcome all these defects. The same burners are fitted by them to their patent asbestos fires, which, for the purposes they are intended to serve, are most decidedly a success.

An ordinary grate is fitted with lumps of clay and asbestos (a practically incombustible material), and a series of burners ranged under the bottom grating, so that four or five streams of gas and air are allowed to flow up among the asbestos, which becomes red-hot in a few minutes after the fire is lighted, and the carbon of the gas being wholly oxidised by the admixture of the air, no soot is formed, as would be the case were an unmixed jet of gas poured through. The comfort of a bright and clear fire which requires no attention whatever, but which is capable of the most delicate regulation, is too obvious to require anything but the mere mention. These stoves will be found especially useful for bedrooms, for invalids and others, where the constant attention required by coal fires seriously prejudices the benefit to be derived from their warmth.

By having a pipe to supply the gas jet so contrived as to be controllable by a tap within reach, a patient, without the necessity of getting out of bed, can regulate the fire to the greatest nicety, or, if left alone, it remains in exactly the same state for any length of time. We can testify from positive ocular experience, that these fires are as cheerful and comfortable as coal fires, and the heat evolved is certainly not less than would come from a bright clear coke fire, which, in fact, they so closely resemble as to be undistinguishable by a casual observer. Of course we do not say that the use of gas for this purpose is more economical than the use of coal, but the advantages gained are, in our opinion, fully equal to any possible apparent difference in cost; we say apparent, because the facility of almost instantly producing or putting-out a gas-jet must be set against the fact that a coal fire takes a considerable time to become of any use, and must be allowed to die out of its own accord, at a large waste of material. We should strongly advise any person requiring such a fire to visit Messrs. Pettit's establishment, where one may be seen in action, and also a large number of useful contrivances introduced by that firm. A small air and gas-stove for cooking chops, steaks, &c., by means of heat thrown downwards by radiation from asbestos bricks deserves especial notice, because of the impossibility of smoking or burning the meat by the fat falling into the fire.

In our next paper we shall pass on to the treatment of gas-meters, and conclude with the consideration of a question of importance to all who use gas for household purposes—namely, the effects its burning produces upon the atmosphere of our apartments. However convenient or pleasant gas-light may be, its use should always be adopted with a full knowledge of the serious evils which accompany it, evils which can only be guarded against by proper ventilation. In ill-ventilated rooms pains in the head, nausea, languor, and bronchial irritation are

frequently experienced by those who occupy them for any length of time. The serious consequence of inhaling unburnt gas are but too often forgotten, and there are thousands now burning it who never heard or read a word upon the subject. We should ill deserve the title HOUSEHOLD GUIDE if we did not set up our warning here, and point out not only what to do, but also what to avoid.

COTTAGE FARMING.

IV.—FENCING (*continued*).

THE more common plan, perhaps, is not to prune the young hedge until the second year, but there is no general rule observed. Much depends upon the season and growth. When the plants grow uniformly thick and bushy at the bottom, then prune the second year; but otherwise prune down rambling plants the first year. When the plants grow rapidly in height, but not in breadth, cut down, the second year, to 10 inches or a foot, so as to make the hedge fill out below. When fully grown, it should be about 2 feet wide at the bottom, tapering up to a few inches round at the top; 5 feet high when grown on the flat, and from 3½ to 4½ feet on mounds. Some prune twice a year—July and November; others only once; we prefer twice. Always prune with a sharp hedge-bill or switching-knife, the sharper the better, and with an upright stroke, so as to make a clean cut; and remember that a quick smart stroke will make a clean cut, when a slow lazy one will not keep hedges free from weeds.

Beech and hornbeam hedges are planted and treated in the same way as white thorn, and they will grow on soils of lower fertility. Furze, gorse, or whin fences will grow on some poor ferruginous soils, where neither of the above will rise to make a fence. And a gorse hedge has this to commend

it to the cottager in such places, that the annual cuttings, when bruised, make excellent forage for milch cows during the winter months. In this case, no other preparation of the ground is necessary than to raise a narrow mound about 4 feet high, and of no greater breadth at the base than the earth will lie, until the seed has taken root; afterwards the roots will bind the earth together in a body. Some sow in three tiers, or rows, along the bank, but the better plan is to dibble in all over the sides of the bank, 6 inches or so asunder, so as to have a close briard and crop. Keep the bank clear of weeds, and mow close every year, beginning about November. And on poor land where gorse thrives, the space occupied by the hedge will be the best paying land on the farm. About 10 lbs. of seed will sow an acre of hedge-bank, if the seed is good and well put in.

There are three ways of renewing or renovating thorn hedges, according to the state they are in. 1. If the plants are healthy, but the hedge overgrown from inattention to pruning, cut them down, leaving the stumps about 6 inches high. Dig, and apply lime and manure to the land on both sides. 2. If the plants are healthy, and have been pruned, but begin to be open at the bottom, cut off the lateral branches on one side, close to the upright wood, and when the young shoots grow so as to fill up the hedge on that side, then prune the other side close to the wood. 3. If the hedge is full of gaps, clear away all the dead wood, then drive in hedge-stakes, 3 feet apart in the line of the fence, and 3 feet above ground. Sometimes old stumps may be left to form the hedge-stakes. This done, the standing wood is then cut by two slanting strokes about two-thirds through, the first cut

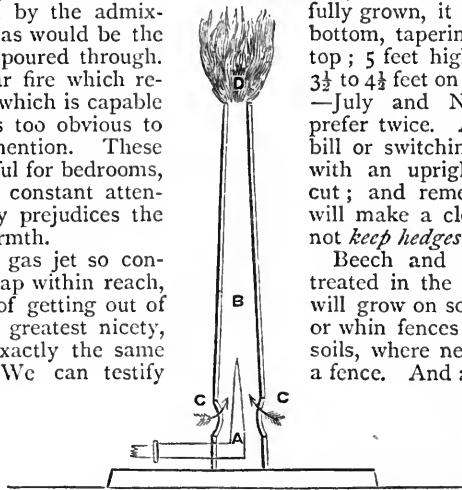

Fig. 82.

near the bottom, and the other 8 or 10 inches above. The growing wood thus cut is gently bent over, and wattled or woven in between the stakes, and so on for the others, dead wood being wattled at the gaps, where required. The stakes are then "eddered" at the top, to keep down the cut thorn and dead wood, by planting hazel, elm, ash, &c., saplings. The operation is technically termed "plashing." No more dead wood should be used in plashing than is necessary to form a fence, until such time as the young shoots grow up through the bent boughs. If gaps are so wide as to require more dead wood than this, they should be filled up, either from old hedges stubbed out, or by stubbing out part of the fence under repair, and then by planting the part thus stubbed with young quicks, as previously directed. The gaps should also be trenched, limed, and manured, before the plants from the old hedge are put in to fill them up. If carefully transplanted, they will bear plashing, but when there is a sufficient supply of them, it is better to head down to 6 inches from the ground, and plant close, so as to insure a thick hedge of young shoots.

Subdivision fences are not economical on a small farm, and as the ring fence is a march fence, it may jointly belong to two proprietors or two tenants; or the ditch outside the hedge may be the march fence. In practice, the several questions thus raised are settled on the spot. Where a straight subdivision fence runs the length of a 10 or 20 acre farm, it may not, however, be advisable to remove it, as the removal of cross fences will allow the land to be profitably cultivated by steam.

In such examples, iron hurdles may be profitably used in the place of the cross hedges removed, as they can easily be shifted during the operation of ploughing; but as the hurdles would not be required on land under crop, one length of hurdles would supply the place of two or three cross hedges removed, while the produce of the extra land thus under crop would pay remunerating interest on the outlay invested in the hurdles. The annexed engraving shows one of the St. Pancras Iron Work Company's patent hurdles, highly recommended by the Royal Agricultural Society and other societies. It is furnished with a rabbit screen, of which there are a variety of patterns; or hurdles may be had without the screen. That which gives the hurdle its high merit is the ring on the cross-bar, at the central upright, which by its being placed alternately, strengthens the hurdle far more effectually than diagonal stays, and at less cost and weight of iron.

ARABLE HUSBANDRY.

Roads on arable farms are made and kept in repair in a similar way to those already described for grass farms; but where the land is either soft naturally, or liable to poach in wet weather, a greater length of road may be required. Much will depend upon the nature of the land, its extent and how it is laid out, the situation of the homestead, and the accommodation afforded by public roads. The expense of hired carting on small farms of from two to five acres is a serious drawback—so much so that the manure is often wheeled out and the bulk of the crops brought home by wheelbarrows. The corn and hay are not unfrequently carried on the back of the cottager to avoid injury to the land in wheeling. To obviate harm to

the land, and reduce the labour of wheeling, a narrow walk is made up through the smaller-sized farms by digging out a trench eighteen inches wide and about twelve inches deep, and filling it with small stones, gathered off the land, or with gravel or burnt clay, in the absence of small stones. A stone tramway, in districts where quarries are at hand, is much better. Wooden planks and iron trams are also used. A long light skeleton-framed barrow, without sides, is used for wheeling home the sheaves and hay; and the common garden-wheelbarrow for wheeling out the manure, and home the potatoes, turnips, &c. (We shall return to details under Spade Husbandry.)

On five-acre farms and upwards cottagers generally contrive to get the carting done at as few hirings as possible; but the losses sustained are often heavy. If the cottager keeps a horse accustomed to heavy carting at other jobs, a road up the middle of his farm may not be necessary on dry gravelly soils; but on soft or hilly land, where the feet of the horse in hauling do immense harm, a road about seven feet in breadth, is advisable, especially under high farming, where from forty to eighty tons of root and forage crops are grown per acre, and

from one hundred to four hundred tons of water applied. If the horse is used for saddle, carriage, or dog-cart, heavy carting on land is objectionable, as it breaks the pace of the animal on the road; but by means of a stone tramway, or the artificial rail now in use, and a light spring market-cart, all the light carting may be done without any harm—much less than on newly-metalled roads. It should also be borne

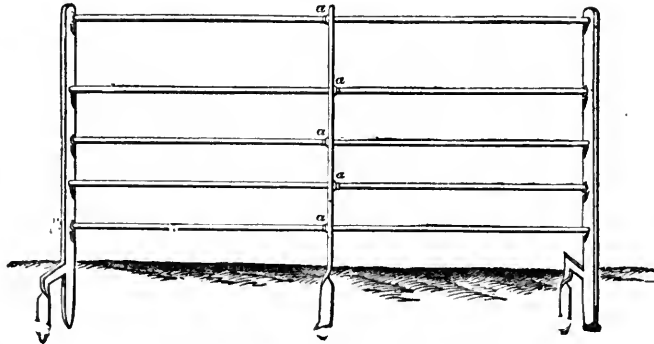

in mind that when the carting has to be done by hiring, a good road will greatly reduce the expense—often more than half. There is an old proverb which says that "A good road is the best paying land on the farm;" so that in cases of country demesnes where the lawns and pleasure-grounds are being converted into cottage farms, it may be advisable to preserve the old gravel-walks for roads. In other examples the materials of the old walk will make a new road. Such farms are mostly kept in grass; but some are partly and others wholly broken up for aeration. There is another class of mixed examples, partly gardening and partly park farming, where a gravel-walk, with a belt of garden-land, surrounds a few acres of permanent grass laid out in the form of a park, and fenced in, either with strained wire or iron hurdles, or some kind of rustic wooden fence; but the former—iron hurdles and strained wire fences—are objectionable, as they induce most milch cows to walk alongside and thus trample out the grass. A wire screen upon the hurdle will sometimes do much to obviate harm, and when this fails a few hurdles placed across the path, at short distances asunder, will turn the cows from the fence-side. The yearly routine for a few acres of grass laid out in the form of a park, will be treated in our paper under the head of Park Farming.

Cottage Farm Buildings.—In a few of the old small country demesnes converted into cottage-farms, and also in many small freeholds, of from two to twenty acres, there is ample household accommodation for cattle; but in the vast majority of examples milch cows, pigs, and poultry, are not well provided for—so much so that it would be cheaper in the end to build new ones than alter

the old, and this applies to very many of the new buildings recently erected, where the different kinds of live stock are housed on the old plan. The different kinds of crops and cattle should all be housed separately; the corn, hay, and root crops in their respective barns, and so on for the cottage cow and pig.

Information for the ordinary management of farm cattle will be found in another section of the HOUSEHOLD GUIDE; we, therefore, refrain from dwelling upon the necessities of cleanliness, ventilation, &c. in buildings of this description.

DOMESTIC MEDICINE.

WORMS.

WE now come to a disease in which domestic medicine is apt to be thought quite sufficient. The symptoms of worms are often very equivocal and doubtful, and the cause of worms is a still more difficult question. Yet every old lady thinks herself a judge of when a child has worms, and often puts aside the fine speculations of embarrassed doctors, by exclaiming, "That child is troubled with worms." Nevertheless, the question of worms, and the cure of them, when their presence is ascertained, are among the things that require judgment; and it may here be said that, probably, worms are not so common in human beings, even in children, as is generally supposed. They are very rarely met with in young children under a year. They are more frequently met with in the children of the poor, which is probably due to the fact of their being ill-fed, and to their houses being badly ventilated and unhealthy. The principal worms which affect the human body are of three kinds: the first, the small threadworm (*Ascaris vermicularis*); secondly, the round-worm (*Lumbrici*); thirdly, the long tapeworm, which is flat, and made up of links or segments (*Tania*).

The Small Thread-worm, so called from the fact that it is like pieces of white thread, is very common in young children, and exists low down in the bowel, very near the seat. Hence it often causes much itching here, and sometimes also in the neighbouring passages, especially of female children. The child is apt also to pick its nose, and grind its teeth at night; to have a variable appetite; to look pale and pinched. These symptoms are quite sufficient to make us suspect the presence of worms; but they have other causes, and there is only one proof of our suspicions being right—and that is actually *seeing* worms.

The Round-worm is not unlike a garden worm, and is narrow at both ends. It is of a light yellow or brown colour. It infests a higher part of the intestine than the thread-worms, and not the large intestine, but the small. It may even crawl up into the stomach and be vomited, or it may crawl up higher and enter the nostrils, or even the windpipe; but such cases are very rare. It may exist singly or in great numbers. The mucous membrane in contact with the worm may be inflamed from the movements of the worm or worms. They occasionally wriggle their way into all the recesses of the bowels. They give rise locally to colicky, gnawing pains about the navel, and often to a kind of diarrhoea; and occasionally serious nervous symptoms are caused by round-worms, such as squinting, twitching of the muscles, or actual convulsions, heaviness, headache, grinding the teeth in sleep, and picking the nose; but, as we have said, these symptoms may have other causes, and we cannot be sure that they arise from worms unless we see the worms; and even when worms are known to co-exist with serious symptoms, it does not follow that they are the cause of the symptoms. In addition to these symptoms, the child is often pale, and has a fetid breath and a quickened pulse. At the same time the child's general health may be little impaired.

The Tape-worm (Tenia solium) is a long flat worm consisting of many segments, or four-sided pieces. It is of a white colour, and has a length of five to fifteen feet. It has its abode in the smaller intestine; and is rare in early life. The symptoms are not in themselves characteristic apart from the presence of links, or pieces of the worm in the motion; but in a patient who by this sign is known to have had tapeworms, its presence may be again suspected if he is depressed, and has uncomfortable or gnawing feelings about the stomach, irregular appetite, and the other symptoms which we have described as often caused by worms.

Worms may cause severity or irregularity in the symptoms of other diseases.

Causes.—Worm disease is much more common in some places than others; thus, in Paris there are few cases; while in the provinces, and other parts of France, it is a common affection; it is more common, as we have said, among the poor than the rich. Good food, thoroughly cooked, tends to prevent the disease. Certain unhealthy states of the constitution favour worms, as paleness, indigestion, &c. Too much fruit and too much sugar are favourable to worm disease, and underdone bad meat, probably, often contains the germs of worms, especially of tape-worm. It is often observed that people who are troubled with tape-worms, are fond of meat underdone or half-cooked, especially of pork.

Treatment and Remedies.—The treatment depends largely on the kind of worm. *For the small thread-worm* a local remedy is the best in the form of an injection. It comes directly into contact with the worms, and destroys them. The following injection may be used:—

Tincture of perchloride of iron	½ drachm.
Infusion of quassia	8 ounces.
Mix.				

A sixth part of this may be injected every other night into the bowel till the symptoms are relieved.

Injections of three or four ounces of lime-water, too, containing ten or fifteen drops of tincture of perchloride of iron, are also very useful for the cure of these small worms.

For the Round-worms, two or three grains of santonine for one or two nights, followed next morning by a dose of castor oil, is a good remedy; but it should be given only by a medical man.

For Tape-worm there is one remedy that is generally most effective, the oil of male fern in some such form as the following:—

Oil of male fern	½ to 1 drachm.
Mucilage of acacia	1 ounce.
Peppermint water	1 ounce.
Mix.				

To be taken early in the morning; the stomach having been cleared by light feeding the day before on broths, beef tea, &c. &c. It is very seldom that this remedy fails to bring away the worm either at once, or after a second dose. A few days' interval should be observed between the doses. A dose of castor oil may be given the day before the dose of fern oil is given, and, if necessary, the day after. In addition to worm medicines, care should be taken to give the patient good air, good, sound, well-cooked food, and a little tonic medicine containing iron, such as the following, for a child five years old:—

Tincture of perchloride of iron	1 drachm.
Simple syrup	1 ounce.
Infusion of quassia	6 ounces.
Mix.				

One table-spoonful night and morning, in water, after meals.

Leaving this subject and turning to other common diseases, we shall adopt the following alphabetical arrangement in treating of the common diseases that we mean to describe; and when we have reached the end of our list, should space remain, we shall treat, by way of supplement, of any subjects that we may have omitted:—

Abscess.	Faintness.
Ague.	Flatulence.
Apoplexy.	Goitre.
Asthma. <i>See</i> Bronchitis.	Gout.
Bilious Disorders, including Jaundice.	Gravel.
Bladder, Diseases of.	Heart, Diseases of.
Boils.	Influenza. <i>See</i> Common Cold.
Bronchitis, including Asthma.	Insanity.
Carbuncle.	Jaundice.
Colic.	Kidney, Diseases of.
Common Cold, including Influenza.	Hysterics.
Constipation.	Lead Poisoning.
Consumption.	Liver. <i>See</i> Bilious Disorders.
Deafness.	Lungs, Inflammation of.
Debility.	Lumbago.
Diabetes.	Menstruation, and Diseases of.
Diarrhœa.	Paralysis.
Diphtheria.	Piles.
Dropsies.	Pleurisy.
Drunkennes.	Rheumatic Fever.
Dysentery.	Rheumatism.
Dyspepsia, including Flatulence, Constipation, and Bilious Disorders.	Scurvy.
Epilepsy.	Sore Throat.
Erysipelas.	St. Vitus's Dance.
	Styes.
	Water in the Head.
	Womb, Diseases of the.

ABSCESS.

An abscess means any collection of matter within a circumscribed cavity. This may vary in size from a common boil to those large collections of matter which are connected, for the most part, with diseases of the glands or of the bones. Boils will be treated of by themselves; and larger collections of matter, either in the neck or, still more, in the groin, are generally attended with some fault of the system which requires medical consideration. Such collections in the neck often occur in teething children. They should not be poulticed too long, and the matter should be let out almost as soon as it is certain that it is there; for, if the opening of the abscess by a lancet is deferred too long, the skin gets thin, and is destroyed by pressure. In this way ugly scars of the neck are often left, which would be prevented by an early small opening. The same remarks hold equally true of collections of matter in the groin. In the groin and in the arm-pit swellings of the glands often occur in which matter is formed. These generally depend on sores in the neighbourhood, as in the foot or leg in the one case and in the fingers or arm in the other. Such sore places should be poulticed. Patients with abscesses require good support. [*See* BOILS.]

AGUE.

Ague is a disease not much seen in England now, except in some marshy parts, chiefly along the eastern coast—in parts of Kent, Essex, Cambridgeshire, Norfolk, Lincolnshire, and the East Riding of Yorkshire. Agues used to be very frequent and fatal, even in London. James I. and Cromwell both died of ague contracted in the metropolis. Doubtless the decline of the disease is due to the improved drainage of the country. It is still very common in some countries, as along the low and level coast of Holland; in parts of Italy, especially the Pontine Marshes, near Rome; in parts of America, as North and South Carolina and Virginia; in various parts of India and Africa. The ague is a fine specimen of a

periodical disease. It comes on in fits at a particular time, as if it kept a watch, goes through distinct stages, and then leaves the patient pretty well, as he continues to be until the next fit returns. An ague-fit consists of three well-marked stages:—1st, the cold stage; 2nd, the hot stage; and 3rd, the sweating stage. There are different kinds of ague—the quotidian (daily), the tertian (third day), the quartan (fourth day ague). In the first kind there is an interval of twenty-four hours between the fits; in the second of forty-eight hours; and in the third of seventy-two. In the daily form the fit occurs for the most part in the morning; in the tertian form at noon; in the quartan form in the afternoon.

Symptoms.—As we have said, the ague has three stages—the cold, the hot, and the sweating. The cold begins by the patient feeling very shivery, until he shakes and chatters with his teeth and looks the picture of cold and misery. It lasts from half an hour to three hours. It then gives place to the second or hot stage, in which the patient gets as uncomfortably hot as he was previously cold. This stage may last from three to twelve hours—generally not less than three—it is succeeded by the sweating stage, which does not last more than a few hours, and ends in complete relief. The patient is left comparatively well in the interval. But if the disease is not treated with the wonderful remedy for it, various internal discomfords and congestions are apt to arise. The internal organs—especially the spleen and the liver—seem to get loaded with blood during the cold stage, and sometimes remain for a time congested and enlarged.

Treatment.—The treatment of ague is perhaps the most successful thing in the practice of medicine, for we have a remedy that is almost a specific for it, and cures it like a charm. We mean quinine. If the value of quinine, or bark—for quinine is just the active part of bark—had been discovered in time, probably the lives of both James I. and Cromwell would have been saved. It is curious to think what might have been the political consequences of the earlier discovery of this medicine. As will be readily imagined, the treatment of the disease varies in its stages. When a patient is in the first stage the only thing to do is to promote the return of warmth by covering him over with warm blankets, putting warm bottles to the feet, stomach, &c., and giving warm drinks. In the hot stage, on the other hand, the heat must be moderated by light clothing, cooling or effervescent drinks; and in the sweating stage the chief thing to do is to administer freely pleasant drinks, and to let the patient be still and comfortably covered. It is in the interval of the fits that the great remedy must be administered; and the administration of it in any particular case should be regulated according to medical advice. Where this cannot be had we may lay down the following rules:—Two or three grains of quinine should be given in water containing a few drops of dilute sulphuric acid every four or six hours. Sometimes a dose of opening medicine greatly helps the favourable action of the quinine. If the disease occurs in a very severe form, or in a tropical country, larger quantities of quinine will very likely be required; and the patient should begin to take it in the sweating stage. If the quinine does not soon take effect, it is probable that there is some internal congestion hindering the patient's recovery, about which he should take advice. If he cannot get this he may take a purgative, put large mustard plasters over the liver and spleen—that is to say, at and below the edge of the ribs—on both sides, and then resume the quinine.

There are other diseases in marshy countries which are very apt to have the feature of periodicity, and the treatment of them is often rendered much more successful by the addition of quinine to other medicines, as all who have had experience in this direction know.

COOKING.

SOUPS AND PURÉES.

Mock-Turtle.—Half a calf's head, with the skin on, scalded, will be enough for a middle-sized family. As soon as the head is received, remove the cartilage of the nostril, and put it to steep and draw the blood, &c., out in a pail of cold water with a handful of salt in it. Set it on the fire, well covered with cold soft water, without salt in it. Let it come slowly to a boil; remove the scum as fast as it rises. As soon as it really boils, let it have a bubble or two, and then take it out. Reject the water in which it was boiled. This is done to get rid of certain impurities, which might prejudice people against the calf's head boilings being used in the soup. After rinsing the boiler, return the calf's head to it, and set it to boil again in hot water with a little salt in it.

When the calf's head is done, which will take from two hours to two and a half (for it should be still firm and not fall to pieces), take it up, and set it aside to cool. When cold, take out the brains, and set it aside. Cut the flesh into handsome mouthful pieces, removing the white skin of the palate; do the same with the tongue, and set all these pieces aside. The remaining trimmings may either be returned to the broth to enrich the soup, or, if there is enough, they may be made into a small calf's head cheese.

To make the stock for your soup. To the calf's head broth add as much water as you are likely to want, allowing for boiling down. Put to it a calf's foot neatly prepared and split, or a neat's foot idem; three pounds of knuckle of veal, cut across in slices, is better than either. Put in also two pounds of shin of beef ditto. Add carrots and onions peeled and sliced; you yourself must judge how highly you wish your soup to be flavoured with vegetables, as well as of its richness in gelatine and extract of meat. Skim scrupulously; let it boil slowly several hours, till the meat falls to pieces. Half an hour before that time season with pepper, salt, cayenne (if approved), a blade of mace, a stick of celery, a browning ball, or a bit of burnt onion, a bay leaf or two, a bit of lemon-peel, and a bunch of the sweetest herbs at your command, including sweet basil and knotted marjoram, if possible. When the soup is well impregnated with their perfume, strain it through an ordinary cullender, and set it aside to cool. This soup being *thick*, not clear, straining it through a sieve or five-holed cullender would only rob it of many nutritive particles.

To thicken your soup. Roll a good lump of butter in as much flour as you can make it take up. Put it into a stew-pan, and when it begins to brown, dust in more flour, and stir in gradually some of your stock, adding more and more as it incorporates, and so on, until you have sufficient thickening to bring your soup to the desired consistency. Then warm up the whole together, and if you will, stir in a couple of glasses of madeira or good marsala, or any other good white wine. Now add your dice of calf's head and tongue to the soup, as also forcemeat balls, brain cakes, and egg balls, if you use them. Though liked by many, they are not indispensable. We add instructions for their making.

For Forcemeat Balls.—Make some turkey stuffing thus:—Chop fine separately a bit of beef or veal suet as big as an egg, the rind of half a lemon, sprigs of parsley, thyme, and chervil. Mix these in a bowl with a large breakfast-cup-full of grated bread-crumbs; season with pepper and grated nutmeg; break into them a couple of eggs, and work all together into a stiff paste. Roll portions of this paste into the size and shape of the forcemeat balls required; roll them in flour, and bake them brown and crisp outside in your Dutch oven, or the oven of your stove.

For Egg Balls.—To one egg put just as little flour as will make it into a paste that you can pinch into shape with your fingers. Season with pepper, a little grated

nutmeg, and with less chopped lemon-peel cut very thin. Work these into pellets the size of marbles, making a few of them long like miniature sausages. Throw them into boiling broth, and let them boil galloping till their substance is set.

Mock-turtle will keep several days, being the better for it, and will even travel in jars. It is best warmed up by setting the jar in boiling water. If only a portion of it is taken at a time, it must be well stirred up to get your share of the meat which has settled at the bottom.

Potage à la Tortue.—This potage is so substantial that it may supply the place of an entire repast. Half boil in salt and water a piece of a calf's head, taking only the lean. Cut it into little pieces, the shape of playing dice. Brown them in butter, with the addition of parsley, thyme, basil, bay-leaf, small onions, mushrooms, cloves, pepper, nutmeg, ginger, and lean ham also cut into dice. When your meat and ham are fried enough, take them out and set them aside. Put a good lump of butter in a stew-pan, brown in it a dessert-spoonful or more of flour for thickening; stir in gradually the quantity of water or broth necessary to make your soup; season with salt, lemon-juice, and allspice. Add glazing, or gravy reduced to a jelly, if you have any. Let it boil up; skim, and pass it through a coarse strainer or cullender. Then return to the soup the fried bits of calf's head and ham and a few forcemeat balls made as above, only with an equal quantity of minced cold meat (veal or fowl is preferable) and bread-crumbs.

Ox-Tail Soup.—Take two fresh ox-tails; stale ones would infallibly spoil your soup; see that they are quite clean; cut them into their separate joints. Wash them well in salt and water, but do not leave them in it. Set them on the fire with a good quantity of cold soft water, to allow for reduction by evaporation. Add to them sliced carrots, onions, leeks, a few peppercorns, and a couple of cloves. Skim well as they come to a boil. When the tails are nearly tender (which will take from three to four hours of gentle stewing), add a bunch of sweet herbs, a bay-leaf, and half a stick of celery. When the tails are cooked, take them out and set them aside. Skim the fat from the top of the broth and set it aside. Crush the vegetables through a middle-sized holed cullender, and add to the broth all that passes through in the shape of mash or purée. To increase the quantity of your soup, you may prepare at the same time, or previously, a strong stock made with two pounds of shin of beef, and one pound of knuckle of veal boiled down with carrots, leeks, and onions (with careful skimming) until their goodness is all extracted. Pour the liquor from the meat, skim off the fat, and set it aside. With this fat, and that from the tails, make a brown thickening with flour; mix it with the soup, add the jointed tails, and season with salt and a tablespoonful or two of mushroom catchup. It is usual to eat, not toasted bread dice, but fresh rolls, with this and mock-turtle soup. By serving the joints of ox-tail with a small quantity of the thickened soup more highly seasoned (with pepper, and if you will, half a glass of red wine), and surrounded with the cooked vegetables left unbroken, you produce excellent stewed ox-tail, which you may further garnish by triangles of toasted bread laid round the dish.

Cherry Soup (German Recipe).—Pluck the cherries from their stalks, and boil them sufficiently in water, with cinnamon, lemon-peel, and lemon-juice. Then add wine and sugar, and serve it poured over bread cut into dice and fried in butter. You may also pound a few cherries small, boil them in water, and pass them through a sieve. This soup may likewise be made with dried cherries, or prunes, and pearl barley, boiled several hours in water, passed through a sieve, and then served as above. In German bills of fare sweet soups are frequent, and cinnamon is a favourite condiment.

INMATES OF THE HOUSE.—DOMESTIC.

V.—THE PAGE, OR OCCASIONAL BOY.

THE duties of the page vary in their nature according to the class of establishment in which such servants are kept. In households consisting of many domestics the page, as a juvenile servant, executes most of the light miscellaneous tasks which the upper men-servants are unable to discharge without hindrance to more important work. Going of errands constitutes a very important portion of a young page's work in large families; and in order to fulfil this requirement efficiently, promptness and an intelligent mind are first essentials. Aptness in reading and writing is a great recommendation, added to which, if a lad has a good address, a well-formed figure, and a correct manner of speaking, he cannot fail to rise in his calling, and may ultimately hold the highest position of confidence a servant can attain in domestic service.

As the duties of a page are multifarious, many have already been treated of in the preceding articles on housemaids' and parlourmaids' work. We shall therefore only speak in this place of those branches of work which constitute the basis of general knowledge indispensable to indoor men-servants generally.

Beginning with early morning work, whatever labour is dirty in its nature should be done early, *i.e.* before breakfast. A suit of old clothes should then be worn, and changed for better by the time the family comes down. Cinder-sifting may be cited as an instance of the work which should be done early and in old clothes. Therefore, the master of the house should impress on the various servants the necessity of their letting the page have all the cinders from the respective rooms throughout the house as soon as possible. Whatever cinders may be left unsifted by a given time on one day should be collected for the following morning's sifting. Knife and boot-cleaning, being also dirty work, should, as far as possible, be prepared for quick despatch by the articles being locked up over night, and brought to one place in readiness for the morning. Wherever these orderly arrangements are despised the page's life is one of incessant worry, and his untidy appearance is an indication of the disorder which prevails in the household.

The inevitable dust and dirt attending cinder-sifting is much obviated by the use of improved sifters. These are of various kinds and excellence. Perhaps the "Phoenix" sifter for ordinary household use is the best; its trifling cost is soon defrayed by the undoubted saving of coals its use effects. The cost is about fifteen shillings; and as by its use the time required to sift a coal-scuttle of cinders is less than half a minute, it will be seen that the economy of time is considerable.

A larger patent cinder-sifter, or revolving machine, is equally well adapted to the wants of large establishments, especially if a garden be attached to the house; used also in connection with Moule's earth closets, the well-sifted cinders become an article of high economy and value.

Even in town residences preference should be given to some improved sifter over the untidy and wasteful habit of riddling the cinders over a dust-hole. The only means by which the latter mode can be made effectual is by placing bars across the top of the dust-bin, on which the sifter may be rested, and shaken to and fro.

Most "housemaids' boxes" are filled with a small grating for parlour cinders. A cinder-pail, also fitted with a movable wire sieve over the top, is a very useful contrivance for sifting small quantities of cinders, especially if the cinders be thrown on a newly-laid fire for immediate use.

Boot-cleaning almost invariably falls to a page's share of work. At present the numberless inventions which have successfully assisted the despatch of household work seem to have fallen short of perfection in this branch of labour. The latest and best improvement is described in the accompanying illustration (Fig. 1). Its obvious benefit consists in preserving the inside of the boots from being soiled by dirty hands, which are almost inseparable from the employment, and setting both hands free for polishing. The machine is inexpensive, costing about ten shillings, and, as far as its design extends, answers well. Lasts for any size of boot may be fitted to order.

In the absence of a patent boot-holder, the first care of the page should be to pass a soft clean duster over the left hand before he puts the boot on it. If the boots are not very dirty, rubbing them over with a hard brush will be sufficient, but if they are very muddy, a piece of ordinary fire-wood, shaped at the end in the form of a chisel, should be passed round the welt and between the upper leather. Knives are often employed for this process, but the practice cannot be too strictly forbidden, the liability of cutting the leather being very great. If boots be exceedingly wet and soiled, a coarse piece of wetted sponge (stable sponge), should be passed over them to remove the first dirt. Boots should never be put near a fire to dry. A moderately warm room, at a distance from the fire, generally suffices, if the soles be turned upwards for a night.

In laying on the blacking, very little should be used, and whilst damp the first polishing-brush should be briskly passed over, finishing with the finest brush. The stroke to secure a polish should be light and springy, not hard and with force. Three brushes are required for successful boot-cleaning.

Patent leather boots simply require washing in the soiled places, and afterwards polishing with a piece of old



Fig. 1.

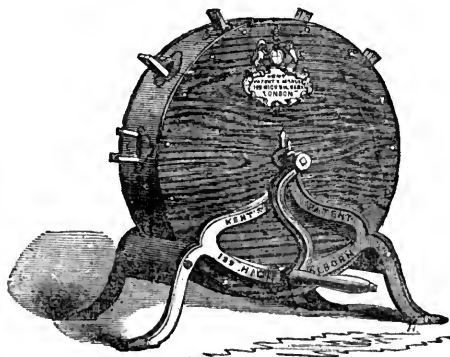

Fig. 2.

cloth. The black kid tops may be preserved for a long time in a good state by occasionally using a mixture composed of the sediment of ink and a few drops of olive oil. This should be laid on sparingly, and whilst still damp the kid should be lightly rubbed with an old silk handkerchief, or a piece of worn-out table-linen.

Blacking sold in cakes is now generally used for ordinary leather boots. Instead of mixing the cake with water, a little sour beer, or a few drops of vinegar, will be found a great improvement.

In very wet weather, boots may be rendered temporarily waterproof by being rubbed over with finely-shredded suet, especially in the wetting.

Knife-cleaning is a simple process, but apt to be destructive if care be not taken to prevent undue wear. In the first place, knives should not be laid in hot water when washing them. They should be whisked round in a jug of soda and lukewarm-water, barely deep enough to cover the blade. If the handles are suffered to touch the hot water, they are liable to become loose. Having washed and wiped the knives, the usual process is to polish them on a board over which a Bath brick has been passed a few times, and afterwards to rub the knife to and fro till a polish is obtained. The knife-handle is then dusted. Unless very carefully done, this plan is seldom so successful as using a "buff-board" is. The latter, if somewhat less lasting than the plain deal board, preserves the knives for a longer time in good condition. The emery-powder, also, used on the buff-board, is not equally destructive with brickdust, and the former gives a higher polish.

Davis's excelsior knife-cleaner is admirably adapted to its purpose, and is spoken highly of by such of our friends as have used it.

Kent's improved machine, patented in January, 1870, is described as an advance upon most other machines, and it is stated to be so contrived as to prevent all possibility of the knives being injured, or careless treatment putting the machine out of order.

Some people are under the impression that knife-machines must be destructive, but the experience of many years convinces us that such is not the case. Knives cleaned with good machines wear evenly and keep a fine edge—qualities which the old-fashioned knife-boards, unless in very experienced hands, seldom secure. The saving of time by the use of these machines is very considerable.

Plate-cleaning requires time and patience to perform nicely; a portion of a leisure day in each week should be devoted to it. Oakley's non-mercurial silversmiths' soap is cheap and effective for this purpose, for which it is extensively used.

The plate should be first washed in warm soap and water. If very greasy, or used in eating fish, a little soda will be necessary. When wiped dry, a mixture composed of fine whitening-water (gilders' whitening, sold in balls, is best) and a few drops of spirits of wine or gin should be laid on the plate with a piece of flannel or rag. The mixture should be of the consistency of good batter, and when dry on the plate should be rubbed off with a plate-brush. Instead of the ordinary plate-brush sold at oil-shops, use those termed jewellers' brushes for the finer kinds of plate, they do not cost any more. A brush should only be used for the embossed work of plate. Simply rubbing with wash leather is sufficient to ensure the brightness of plain plate.

Plated articles are liable to injury if left for any length

of time damp. After forks, spoons, &c., have been used for eating vinegar salads and the like, they should be immediately cleansed.

Although cleaning with whitening, or plate-powder composed of rouge, is, as a general rule, only necessary once a week, plate looks better for being daily rubbed over after washing with a leather that may be kept in the plate-basket for the purpose. Towels boiled in a mixture of hartshorn powder and water are an excellent rubber for plate in daily use. Rags—old chamber-towels of huckaback are best—boiled in a solution of a quart of water to six ounces of hartshorn powder, are excellent for the purpose.

Window-cleaning is essentially the work of a page or footboy. Having taken due precaution against the chance of accident by falling, the first part of the process consists in dusting the window-sashes with a round brush, called a painter's brush. One pane at a time should then be wetted with a wash-leather dipped in soda and cold water. When the leather has been wrung out and passed over again, the polishing should be done with a piece of dry wash-leather. Many other plans are recommended for window-cleaning, but the above answers every purpose, and is infinitely preferable to the use of any description of "window-rags," all linen and cotton fabrics being more or less fleecy in their nature.

Powdering a window with whitening tied in a piece of cotton cloth is sometimes necessary, if the windows are unusually greasy or soiled; but for ordinary occasions cold water and soda will be found sufficient, if a wash-leather be used for drying.

Trimming lamps is part of the morning work of a page. Once a week every lamp in use should be taken to pieces and thoroughly cleansed. The works of oil lamps of every description should be soaked in hot water and soda, and rubbed perfectly dry whilst hot with a soft rag, and afterwards polished with a plate-leather. In trimming the cotton wicks of moderator lamps the greatest evenness is requisite. The wicks of paraffin lamps should only be dusted until the charred portions are removed. By this means a wick one-third of a yard in length lasts several months. All rags in use for lamp-cleaning should be washed at least once a week in strong soda and soapsuds.

Washing glass, and sending it to table in the highest state of brilliancy, is an act worth striving to accomplish, from the great pleasure the sight of bright glass affords. Two wooden bowls are required to secure this end—one containing warm water and a little soda, and the other plain cold water for rinsing. Bowls used for washing glass should be used for no other purpose. After the glass has been washed, it should be laid on a coarse cloth to drain, and afterwards polished with a glass-cloth, *i.e.*, a soft linen cloth.

Soiled decanters may be easily cleaned either by rinsing them out with tea-leaves, or, if very dirty, finely-shred brown paper, soaked in soap and water. They will require good rinsing afterwards.

Stoppers may be removed in various ways, if unfortunately they have become fixed. The most successful plan is generally to steam them over boiling water. A better endeavour is to prevent their becoming fixed. This may be done by twisting the stopper slightly between the forefinger and thumb as it is put into the decanter.

Brushing the master's clothes is the page's business where no other man-servant is kept. In doing so, the greatest care should be taken not to soil the garments by brushing on a place of doubtful cleanliness. All cloth should be brushed the way of the pile, *i.e.*, from the neck to the skirts downwards. Having brushed the clothes, they should be neatly folded according to the size of the drawer or wardrobe in which they are to be laid. The fewer folds the better. A small bottle of water, containing a few drops of ammonia spirit, is useful to remove any grease spots that may be seen in brushing.

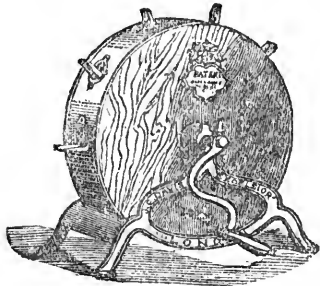

Fig. 3.

CHOOSING A TRADE.

WHEN a boy is about thirteen years old he is generally asked what trade he would like to follow; and as the time approaches when he is to leave school he is seriously admonished to make up his mind whether he will be this, that, or the other. Nothing can be more unreasonable than to expect a lad to be able to answer at once a question on which it requires a great deal of experience to form an opinion; and yet it is too frequently the case that such an answer is demanded within a certain time, even though no opportunities are given for seeing the operations in different manufactures, or for learning under what conditions those who work at them are placed, what will be the length of time required for becoming acquainted with the business, and how much may afterwards be earned by the skilled workman. We also mean to give instructions as to how the most important callings and professions are to be entered.

Of course, all these things should be known to parents and guardians in recommending any particular business; and any particular talent and inclination displayed by the boy should also have due consideration. It is certainly of the utmost importance that an intelligent lad should be placed in some calling in the operations of which he is likely to feel an interest; and care should be taken that it is also one suited to his health, his bodily strength, and event to his temper and disposition. In order to help not only those who have the direction of boys, and can in some measure influence their choice, but also to give boys themselves an opportunity of learning something of the various processes of ordinary manufactures, we intend to give a few papers describing the tools, materials, and operations employed in some of the most general handicrafts, as well as in a few of those that are less common, and it may be hoped that our descriptions will be interesting to the general reader.

WATCHMAKING.

One of the first things in which a child takes an interest, because of its wonderful mechanism, is a watch. It is almost like a live creature; and for a long time the marvel of how its wheels and pinions keep moving, and what strange power causes the hands to move, and the seconds to be marked by "ticks," is a puzzle to a little boy. When he grows older he wishes he had a watch of his own, that he might take it to pieces, and so find out the mystery, and if there happens to be an old brass Dutch clock in the house, he keeps his eye on it, in the hope that some day he may be permitted to take out the toothed wheels, and the rest of the apparatus, and then put it together again, so that he may learn how it is made. Watchmaking, then, may be regarded as one of the first trades to which a boy's attention is directed, and with that we will begin our short series.

A watch consists of seventy-five parts. This is rather a startling beginning, but it may be explained by remembering that in such a delicate machine every portion of each wheel and spring, pin and axle, must have its distinct name, in order to prevent confusion when the parts are spoken of separately, and to enable the workman to understand the relation of every minute piece to the whole mechanism when it is put together. The principal parts of the works of a watch, however, are the pillar and upper plates, the barrel, the barrel-cover, and arbor, the fusee, with its cap, ratchet, and clicks, the going-spring and wheel, the main-spring and wheel; the centre, third, fourth, and escape-wheels; the chain, the lever, the balance, the pendulum spring, the index, and index scale, the minute and hour-wheels, the cap, the dial, and the hands. Then there is the case of the watch, which also consists of several parts. The chain is composed of 800 pieces, and the springs are formed of steel of such exqui-

site fineness that 4,000 of them weigh only an ounce, and are worth about £1,000. Of course, if the watchmaker were required to form each portion of the watch from the metal, and himself manufacture the wheels, springs, pinions, and so on, the business would be one requiring the skill of the metal turner, the whitesmith, the brass-founder, and some others; but although in chronometers and watches of the very best description, the makers fashion a large portion of the works at the forge and anvil, and finish them with the file and other tools in their own workshop, the separate pieces of the works of ordinary watches are supplied ready made to the watchmaker, whose only business is to adjust them to each other, and form them into a timepiece. This is a business requiring great skill, patience, and delicacy of touch, and the least inaccuracy, either in any portion of the works or in fitting them together, deteriorates the watch, and prevents its keeping time, so that it is necessary to work with a strong magnifying glass when the finer portions are being adjusted. An immense number of the ordinary watches sold in London, as well as some of superior quality, are sent from Geneva and other places in Switzerland, where whole colonies of men, women, and even children, are employed in the trade. Many of these watches are examined and regulated by English watchmakers, and even then can be sold at a price which is much lower than must be charged for a thoroughly good watch made in this country, although many of the different portions of the works of which most English watches are made are also sent from Switzerland and put together here. The reason of this is that common "Geneva watches," as they are called, are passed from hand to hand, one person doing one part and another another, and the want of unity in the workmanship often renders them defective; whereas, in England, a first-rate watch is begun and finished frequently by one person, and generally by not more than two, so that it is, as it were, all of a piece, and is so adapted as to go without deviation. A good workman will take a watch to pieces and re-make it twenty times, in order to discover in what part of it is the slight imperfection that causes it to gain or lose two or three seconds in a day; but it is only reasonable to suppose that he must be paid for this patient labour, as indeed he is, by the best kinds of watches still fetching a very high price, since no machinery can ensure the complete accuracy to be obtained by a keen eye, a skilful hand, and a thoughtful observation of causes and effects in so delicate a construction.

The trade of the watchmaker is, in this respect, a laborious one, because of the intense application it requires in order to attain the requisite skill, and though, when the various parts are made in the workshop, there is a change of occupation, the actual business of fitting the parts together often requires long sitting in a fatiguing position, and very close attention, both of which may be borne, however, by those who are interested in fine mechanical operations.

Of course the wages of the journeyman watchmaker vary according to his ability. When employed in some of the workshops where an inferior watch is made, or Geneva watches re-adjusted, the earnings are often not more than from twenty to twenty-five shillings a week; but in other descriptions of work, thirty to forty-five shillings may be earned; and there are so few who can undertake the really fine work, that good wages may be obtained by a first-rate hand, most of them, however, preferring to go into business for themselves, and to depend on private trade, which they unite with piece-work obtained from larger manufacturers.

To give any idea of the manner in which the works of a watch are set in motion, in order to mark the divisions of time and record the hour, we must imitate the boy of whom we spoke, and go back to the clock—in fact, a watch is only a small clock put in a case, and having a wheel for a pendulum, and a spring for a weight. Of

course there are contrivances for obtaining greater accuracy and regularity of motion, by removing friction from the pivots, and causing one wheel to relieve another; but the principle is the same, as we will endeavour to show in our next paper.

Before quitting the subject, moreover, we shall also briefly pass in review the gradual improvements made in the manufacture of clocks, so as to give a clearer insight into the nature of the principles on which they work, and enable our readers to fully appreciate those characteristic qualities which are essential to the successful following of watchmaking as a trade.

ANIMALS KEPT FOR PLEASURE.

V.—THE DOG: DISEASES OF DOGS (*continued*).

Affections of the eyes are best *let alone*, however severe, even if deep-seated ulcers. They should, however, be occasionally cleansed with a sponge and warm water.

If severely diarrhœa sets in, add two ounces of ether and eighty grains of tincture of opium to a pint of gruel, and administer very gently an enema, according to the size of the dog, giving every hour from one to four tablespoonfuls of the same as a dose. Should it still continue, add five to twenty drops of liquor potassæ to each dose, with a little powdered chalk. During the whole, however, continue the tonics. If the severity of this symptom, however, continues unabated, and especially if fits supervene, there is very little hope of recovery, and none whatever except in the care of a really skilled practitioner. Mere *fainting* fits at the close, however, are of little consequence, if treated with the ethereal injection and tonic mixture already given.

During convalescence let the diet be rather spare and almost entirely vegetable, in two or three meals a day, or even more, till the recovery be advanced. Let exercise be regular and moderate. The skin often peels off; and sometimes mange will break out, but is easily mastered by the treatment which will be described in our next paper.

Fits in the dog often cause much alarm, as they are not unfrequently mistaken for rabies or madness, respecting the real symptoms of which latter most people are profoundly ignorant. The most marked difference between the two is, that whilst hydrophobia is *always* preceded by symptoms of disorder, fits commonly occur with little or no previous warning. The animal suddenly stands still and seems stupid, then, with a guttural cry in the throat, falls over and probably emits involuntarily its fæces or urine, or both, while the limbs become rigid, the eyes seem starting from the head, and the dog foams at the mouth, while it will probably bite any one who attempts to touch it. Nothing could be nearer the popular idea of "a mad dog," and nothing further from the reality. When the fit is over, the dog, if left alone, will run off with all its might, and may then be hounded to certain death by a terror-stricken rabble.

The treatment of fits is simple. While the dog is insensible he must be secured by the neck or collar, and when recovered caressed till quiet again, then got home as quickly as possible in the first vehicle that can be procured, as walking would probably bring on another attack. Put the animal into a quiet, darkish, and if possible, empty room, and make an enema as follows:—

Sulph. ether	3 drachms.
Laudanum	2 drachms.
Cold water	5 ounces.

For a small dog inject two ounces or less of this mixture, but a large one may have the whole. Then leave the animal entirely alone, whatever be the symptoms, for an hour, when the injection is to be repeated, and so on, till

the dog gives evidence of final recovery by coiling itself up for sleep. It will do no harm to administer one more injection, even then, when the animal should be left. This treatment is simple, safe, and rarely fails.

Fits are caused, as a rule, by too high a flesh feeding; and after recovery the diet and stomach generally should be attended to. The dog for some time should only be allowed out for short distances, and be always held in hand by a chain till there seems no chance of a relapse; but exercise, though moderate, must be regular, in order to insure a good recovery.

Rabies or *Hydrophobia* commences very differently. For some days the dog appears moody and irritable, or even snappish, and seeks solitude and darkness, often drinking eagerly, but not seeming to care much for food. Indeed, his appetite is usually altogether depraved, and straws, stones, and filth of all kinds are devoured. The light seems to give him actual pain. By degrees his restlessness increases, and he starts off, neither walking nor galloping, but in a drooping, miserable trot, his tongue hanging out, but dry. *The mad dog does not foam*. If no one comes in his way, he will pass on; if any one does, he will give an impatient snap—the deadly bite of a mad dog—and then pass on. But it is blind agony, not malice; he does not mangle, he never tears; but snap—snap—snap—he does his fearful work, impelled by an inward agony, which is evidently insupportable, if, indeed, he knows *what* he does, for many people think he is utterly insensible to all but his misery: he will bite the live coals from a grate without appearing to feel the heat.

Again, he seeks darkness. The thirst increases upon him, but at length comes that dreadful swelling of the throat which prevents his swallowing; though still, so far from dreading water, he will bury his miserable head in it, as if to cool his raging fever. And then, at last, the end comes; he gets furious, flies in blind fury at everything in reach, utters the most hideous and appalling cries, till strength fails, and death ends the misery and danger.

No treatment is of the slightest use—let the poor creature be mercifully destroyed when the case is beyond reasonable doubt. So far from the popular idea being correct, let it be always remembered that the leading and characteristic symptoms of rabies are *not* foaming at the mouth or dread of water, but, on the contrary, snappishness for some longer or shorter time previous, dislike to *light* and company, *depraved appetite*, and intolerable *thirst*. Very often the animal is perfectly under control all through; but of course this ought never to be risked, and a doubtful case should always be confined in an empty room till its real character be known, when execution should be immediate.

Fortunately, rabies is very rare; there are seldom more than three or four cases in a year, and these are *not* caused by heat, for they occur oftener in winter than in summer. Hence there is *very* little to be dreaded from hydrophobia; but, when bitten by a supposed mad dog, the only certain remedy is *cauterisation*, which *never fails*. It may be applied hours, or even days, after the wound; indeed, many think that any time previous to the development of the secondary symptoms is efficacious; for as these always begin again at the wound, whether healed or not, before the general system seems affected, it is thought that till then the virus remains local and can be destroyed. The cautery may be either actual, as applied by hot iron (the hotter it is, the *less* pain, though of course the best is bad) or the galvanic battery, or when the patient's courage is not equal to either, by cutting a stick of lunar caustic to a pencil point, and thoroughly working it about in the wound till *every point* has been well treated. Excision is effectual if done immediately, but requires more nerve than most people possess, as it must usually be done by the sufferer himself.

ANIMALS KEPT FOR PROFIT.—CATTLE.

II.—THE HOUSING, FEEDING, AND MANAGEMENT OF DAIRY COWS.

NOTHING differs more than the average produce of each cow in the various dairy districts of the United Kingdom; and between different individual dairies the variation is still more striking. Much of this may be accounted for on the ground of good or bad judgment in the selection of the stock, as pointed out in our last paper; but still more depends upon the system of management, which in all old districts is still opposed to every conclusion of reason and science, and diminishes the profit accordingly. In fact, there is, in most quarters, an actual jealousy against any improved system which is very difficult to overcome, and which at first is puzzling to account for. But we think the reason is not far to seek. More improved systems have usually been seen or worked out on what are known as "model" farms, in many cases by costly, and sometimes disastrous, experiments, and nearly always under expensive buildings, and with appliances beyond the means of the plain man who has to "make his living" out of his dairy or farm; and hence the whole becomes jumbled up in his mind as a "new-fangled theory," to which he prefers his own plain though faulty practice. Still, by degrees, certain undesirable principles and facts get indisputably established and adopted one after another by the most successful agriculturists; and at length the plainest and most plodding practical man finds that he *must* adopt them also, or be left behind. This has, of late years, been eminently the case in regard to the economy and management of all kinds of live stock; and we are endeavouring to give, in these papers, such practical rules as have been, after trial, conclusively established as the soundest and best, at the same time bearing in mind the ease and economy of their practical application.

With regard to the management of all cattle, three grand principles have now been thoroughly established by the conclusive test of *facts*. 1. That any given area of green crops, be it grass, clover, or roots, will support nearly double the number of animals if *cut* and carried to them elsewhere than if grazed. 2. That within reasonable limits *warmth* is equivalent to so much food, which would otherwise be required to keep up the natural heat of the animal. 3. That manure made under cover is better than manure made in the open yard, whilst if dropped upon the land itself it is most wasteful of all. It is obvious that each of these principles condemns at once the old system of managing dairy farms, which consisted in keeping the cows in the open fields, killing a number at the approach of winter, and getting along in any possible way with the rest. By this system the animals injured the crops as much by the poaching of their feet as by what they actually ate; they never yielded much in severe weather, and by spring were nearly starving; while the manure was nearly wasted, and three or four acres were required for every cow. On the modern system, at least double the animals can be kept on the same quantity of land, while the milk per head is much

increased in quantity, and the return is increased proportionately.

Still there are circumstances which may make a system composed chiefly of grazing the cheapest and most advisable. If the pasture land be very rich, producing, say, 12 tons to the acre yearly, with no further expense or labour than weeding, keeping up fences, and supplying manure; if these advantages be combined with a moderate rental, and if, finally, the dairy is the main object of all the operations of the year, it may answer better to depend almost altogether on the natural produce of the land, which will thus probably produce as much, *for the money spent on it*, as it can do in any other way. Even in such a case, however, the cows should be housed in all severe weather, and some addition to the food will be required at night if the supply of milk is to be kept up during the winter. But if the dairy be part of the regular economy of the farm, the advantages are all in favour of

of stall-feeding, more or less thoroughly carried out, as the greater number of animals kept under cover, with the consequent increase in quantity and improvement in the quality of their manure, will have a great influence upon the other crops. For it is obvious that, supposing by spending on this system twenty shillings per season extra in wages and food the produce be only increased by the same amount, the additional manure will be a very great gain to the farmer. In fact, in many districts, bullocks are fattened for this purpose alone, the profit on the sale only paying for the bought food consumed, and all the farm produce given them being considered to be repaid by the manure thus manufactured.

The first great point to attend to is to provide sheds or cow-houses which are at once sufficiently light and well ventilated, but free from any direct draught, which is apt to cause many diseases. Very few, compar-

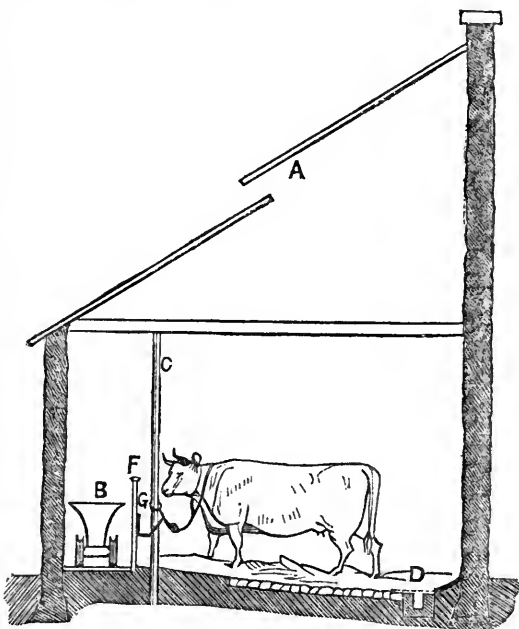

Fig. 1.

tively, of the covered yards or sheds hitherto erected are quite satisfactory in this respect, the most usual fault being draught, arising from the admission of air in the lower part of the building. Indeed, no entirely satisfactory place, that we are aware of, was ever proposed to avoid this defect, and at the same time give thorough ventilation, until that invented by Mr. H. S. Thompson, of Kirkley Hall, Yorkshire, for his own farm buildings, and recently described by Mr. Morcross in the *Journal of the Royal Agricultural Society*. By this plan, the whole of the ventilation is carried on *through the roof*; the provision for that purpose is ample, and the animals are kept in a temperature equable and healthy; whilst, at the same time, the plan of construction is the simplest possible, and adapted to any scale. In a future paper, on fattening stock, we shall give an illustration of Mr. Thompson's principle as adapted to the general covering-in of the homestead in order to shelter the cattle, but we have here only to consider it as applied to a single building or range as a cow-shed or stall, which may be built on Mr. Thompson's plan without one farthing's additional expense. Instead of the rafters reaching, as usual, from the eaves to the ridge, they are divided in two. The lower length is spiked, as usual, on to the eaves and middle rafter or parlin, but the upper ones, instead of being with

them, as usual, are spiked at the lower end *over* the lower rafters. The laths and tiles are then laid as usual, and the effect, as seen in the section, is an opening for ventilation half-way up the roof, along its whole length, equal to the depth of the rafters. The upper set of tiles should overlap about twelve inches, which will quite prevent the driving in of rain, and any necessity for louvre boards, &c., is avoided. To prevent the air from stagnating in a crowded shed, openings may be made in the walls nearer the ground, as far as possible from the animals, and covered with perforated zinc. Plenty of light is easily given by the use of a glass tile at intervals, and the whole of the work is therefore of the cheapest description possible.

The most convenient arrangement for the interior of the sheds is also shown in the section. It is best divided by wooden partitions into stalls about eight feet wide, which will contain two cows; but they may be kept without any partitions at all with no difficulty. Along the lightest side of the shed should run a clear passage four or five feet wide, for the passage of the attendant with the food and water; and if the number of cows be more than half a dozen, it will be a great saving of labour to lay down a line of rails, as shown, when the food can be all carried at once in a large truck (B); and by having a tank mounted with a small pump, water can be supplied in the same way, but a long pipe running along all the troughs with a tap over each, is preferable. If only a few cows are kept the railway is not needed. At the end of the passage should be the room or house where the food is prepared.

The animals are most conveniently fastened to posts (C), over which is slipped a ring sliding up and down, having attached to it a chain long enough to allow the cow sufficient liberty. If other modes of fastening are adopted, the cow cannot turn round to lick herself when irritated. The floor should be very *slightly* inclined towards the back, that the liquid portion of the manure may run into the drain (D), and may be pitched, all but the upper portion, which should be of hard trodden earth or concrete (H), lest the cows should injure their knees. If the posts are placed about a foot from the rail (F) which parts off the passages, the space between is convenient for fixing the food and water troughs (G), as shown in the section. These should be raised about 18 inches from the ground.

In large dairies the cows are often placed in double rows with a passage between. This has been thought injurious, from the animals breathing on each other; but we think if the passage be wide enough the evil must be small, unless in the case of pleuro-pneumonia, or other infectious disease.

Small sheds are easily arranged on a similar system; and where a ready-made building has to be made available, it is only needful to see that the ventilation be perfectly provided somewhere *above* the level of the animals, which should be screened from draughts, and the floor be arranged in some such way as can be easily cleansed.

In such sheds—be they large or small—the cows may be housed at night all through the year with great advantage. The free use of the curry comb is needful, of course, and when followed by a good brushing, especially down the legs, will keep the skin in beautiful condition, and the animal will be contented and happy.

Cows require, in an ordinary way, decidedly gentle treatment; and the importance of keeping them clean and their house well ventilated, cannot very easily be over-estimated. A good cow well treated is often a fortune to a poor man, and to the rich man its possession is as often a source of special satisfaction, from the various ways in which it may be made to minister to the family wants. Some of these we shall point out in a future number, and in another section of our work.

COOKING.

SOUPS (*continued*).

Mulligatawny Soup is a name that may be applied to any brown thickened soup highly seasoned with curry powder. It probably originated in the demand for soup at short notice and the necessity of cooking meat *fresh* in a hot climate. Kill, singe, and empty, a chicken, which should be young and tender. While it is still warm cut it up into small joints, and fry them immediately in plenty of butter. When nearly done enough, take them out and set aside. In the same butter fry six or more large onions sliced. When done, put them with the bits of chicken. If there is not butter enough, add more, and in it brown flour for thickening. Stir in a little good veal stock, or chicken, or other broth; if convenient, if not, you must be content with water. Then stir in a dessert-spoonful of curry powder or more, according to the degree of heat approved of. Then add the rest of your broth to make up the required quantity of soup. Put in your onions and bits of chicken, and stew up till the latter are quite tender. Season with salt and a little lemon-juice. Other spices are sometimes added, but they are overpowered by the flavour of the curry powder. Garlic (to be fried with the onions) is admissible. You may send up boiled rice in a vegetable-dish as an accompaniment to mulligatawny soup.—N.B. A chicken killed yesterday, or even the day before, will do. A rabbit may be substituted for the chicken, and even veal or mutton chops.

All the Year Round's Mulligatawny.—Take two quarts of water, and boil a fowl; then add to it a white onion, a chili, two teaspoonfuls of pounded ginger, two of curry powder, one teaspoonful of turmeric, and half a spoonful of black pepper. Boil these for half an hour. Then fry some small onions and add to the soup. Season with salt, and serve up.

Giblet Soup.—Procure two sets of goose giblets, scald the feet and legs to remove the outer skin, cut off the claws. Cut off the head, remove the bill and eyes, split it. Cut the neck into three, the pinion-bones into two, the liver into two, the heart into two, and the gizzard into four pieces. Set them on the fire in cold water to stew, remembering that the liver takes less time, the gizzard longer, to cook thoroughly, than the other portions. Then proceed exactly as directed for ox-tail soup. In some markets goose and duck giblets are sold ready for use, except the division above directed. Turkey giblets might be used, but it is not customary to truss the bird without them. The best giblet soup is from those of the cygnet, which is not often to be had.

Cabbage Soup.—Put into your soup-kettle (three parts full of cold water) a couple of pounds of sweet bacon or pork that has not been too long in salt. This is indispensable. You may add a bit of knuckle of veal, of mutton, of gravy beef, or all three. Skim well as they come to a boil. Shred into a pail of cold water the hearts of one or two cabbages, some carrots, turnips, celery, and leeks. When the soup boils, throw all these in, and skim again if necessary. When the vegetables are tender without falling to pieces the soup is cooked. You may thicken with a few crushed boiled potatoes.

For a true *Purée of Green Peas*.—If the season is advanced, take a quart or more of *old* (not *dry*) peas; boil them quite tender, or to a mash, in no more water than will cover them, with care not to burn. Squeeze them through a cullender, keeping back the skins. If old peas are not to be had, you must use young ones. Boil down a quantity of the juiciest pea shells, squeeze their liquor through a cullender, and add it to the *purée* of old peas; stir in the required quantity of good veal stock. Season with salt and pepper. Throw in a pint of young green peas boiled tender, a few fried or toasted bread dice, and serve.

Hare Soup.—Take a fine hare, skin and empty it, saving the blood, the liver, and the heart. Cut it up into joints, take the eyes from the head, and split it. Cut two pounds of shin of beef into pieces; put these with the marrow-bone, the jointed hare, its blood, &c., into a boiler containing a gallon of cold water. Set it on the fire, and skim. When it boils throw in three or four onions halved across, two or three carrots sliced, a few peppercorns and cloves. As soon as the hare is tender, take out all the best joints, remove the meat from the bones, cut them into shapely mouthful-pieces, return the bones to the soup, and let it boil till all the goodness is got out of them and the beef. Half an hour before that time, throw in a bunch of sweet herbs and a small stick of celery. By putting in aromatic seasonings too soon, they are driven off with the vapour and are lost to the soup. While the sweet herbs are communicating their flavour, fry chopped onions in butter, brown and thicken with a little flour, moisten with a ladleful of soup, and add it to the rest. Then ladle the whole through a large-holed cullender, so as to remove bones, remains of meat and vegetables, &c. Add the bits of hare-meat, and let them simmer in the soup till heated through. Season with salt, and serve. A little red wine may be added; if so, it should be mixed in at the last moment. If soup is salted at an early period, it is apt to become too salt by boiling down, by which it is spoiled and made uneatable. Hare soup may be heightened either with a little anchovy sauce mixed in a basin with a ladleful of soup, or with a couple of tablespoonfuls of mushroom catchup. People who object to the "blood" mentioned in this receipt, will not know it is there unless you tell them. In Northern Italy, when poultry are killed the blood that comes from them is caught in cups, and sold for making soups and ragouts.

Pea Soup, Purée of Dried Peas.—Steep the peas (whether whole or split) overnight in soft water (rain water if you can get it); set them on to boil in the soft water, cold. When tender, crush them with a wooden spoon through a cullender.

For broth you may take almost any—beef, veal, or fowl. The boilings from salt meats are often employed, but we do not recommend them. Take rather a couple of hocks of pork that have been salted not more than three or four days. Use their boilings with the addition of other stock. To this put the *purée* of peas, with a turnip chopped small and plenty of shredded celery. Boil till these are nearly tender. Then put in a good bunch of sweet herbs, and season with pepper. Before serving, remove the sweet herbs only. Send up accompanied by toasted bread-dice. Dry sage leaves in a very slow oven; rub them to a powder between your hands. Send up this powder in a small dish, for each guest to dust into his soup. It will keep for some time in a well-corked bottle. You may cut spoon-meat pieces of the hocks of pork, and throw them into the soup, like the calf's head in mock turtle.

There are prepared pea-flours for making Hasty Pea Soup. They are convenient, and save considerable trouble, but the soup is smoother if the pea-flour is steeped overnight.

Green Pea Soup.—Green pea soup may be only a simplification of Julienne, *i.e.*, green peas cooked in a good stock or consommé.

Cabbage Soup (Maigre).—Put your shredded cabbage and other vegetables into a soup-kettle of boiling water, with a few peppercorns and cloves; add a couple of handfuls of chopped sorrel. Fry onions light brown in butter, and mix them with the soup. When all is quite tender, season with salt. You may make it milk cabbage soup, by adding one-half, one-third, or less than that quantity of milk. Put a large teacupful of bread-crumbs at the bottom of your tureen. After the last boil up, ladle the soup over it, and serve.

Small Onion Soup.—Take a large soup-plateful of small onions, such as you would use for pickling; peel them carefully, then toss them in a stewpan in butter, with a dust of sugar. When they are nicely browned, gradually stir in over them the necessary quantity of stock-broth. Give them a boil, season with pepper and salt, put fried bread into your tureen, and pour the soup over them. This is one of the soups which has the advantage of not taking a long time to make when once the onions are peeled.

Broth from Essences and Extracts of Meat.—As preparations of meat called *essences* or *extracts* are now largely introduced, and are attracting considerable public attention, we should be wrong in omitting to mention them here. Their great merit is their convenience, and the almost instantaneous promptness with which a basin of soup can be served. The essence must be selected and prepared with some care and judgment. If the dose is too large, the broth becomes unpalatable. This subject has recently received much attention from members of the medical profession and others, various opinions having been expressed, but we nevertheless think our readers, like ourselves, will prefer relying on an able medical opinion like that of Dr. Edward Smith than on their own unsupported. These essences are prepared from fresh meat in such a manner that the fibre and fat are left behind, only the ozmazome (or flavouring property), certain salts, and a very small quantity of albumen, remain. The quality of this food is determined by the first-mentioned substance, and with a teaspoonful of the essence about a pint of broth may be made, which, although *thin* to the palate, is as full of the flavour of meat as when beef-tea is prepared at home. The salts are not perceptible to the senses, but they consist, in part, of phosphates, and are very valuable. The albumen is necessarily in very small quantity, from the small amount of the extract of meat which is used. Liebig's essence of meat, however, is a valuable addition to a traveller's stores, since it occupies a very small space, and with hot water he may at any time prepare a basin of soup in two minutes which would be more useful to him than any other fluid. It is particularly suited to those who abstain from intoxicating drinks. But when it is affirmed that one ounce of the essence, although derived from thirty ounces of beef, contains, nevertheless, the nutritive parts of the larger quantity, we hesitate to endorse the statement. A considerable amount of fibre, with fibrin, gelatine, fat, and some albumen, is left behind. That fibre is digestible is proved by the fact that in fresh meat it is nearly all digested; that it is highly nutritious is proved by its chemical composition. Hence, where health exists it is best not to throw away this material. That it will not *alone* support life is true; the salts necessary to life, and fat highly important to life, are absent from it; but that does not in the least prove that it is not of great value as *part* of a dietary. When one teaspoonful of the essence has been dissolved in about a pint of hot water, and seasoned with pepper and salt, it forms an agreeable and stimulating beverage, but should not be regarded as food for every-day use. In this respect it must be ranked with tea and coffee. It may be advantageously thickened by adding a little sago; and vermicelli, macaroni, and various Italian pastes, are agreeable and proper additions. Its proper place is that of a luxury, and in some states of disease it is also a valuable food; but in health, the quantity of nutriment is too small to be computed, and its action upon nutrition is rather indirect, by stimulating the vital actions, than direct, by supplying food. For ordinary use it is better for the housewife to make beef-tea from shins of beef, so as to obtain much gelatine, or from gravy beef, and to serve up the solid part as food at the same meal. Our continental neighbours eat their *bouilli* and *potage* at the same meal; and so should we.

SOME CHEAP HOME COMFORTS.

Stopping Draughts.—There are many little things that can be done at a small cost to render home comfortable and home-like; little things that only want a small amount of patience, goodwill, and energy to execute, and which amply repay the trouble they give—not merely in the imperceptible but palpable comfort bestowed by them, but by the occupation they give to the mind, filling up those odd moments of time that are too often listlessly dawdled or idly gossiped away, and affording that constant round of useful employment that keeps the mind cheerful, and thus helps materially the health of the body.

It is remarkable how handy a lady can be with a hammer and nails, as well as with a thread and needle, if she will but try. For carpentering she should use a good firm hammer, not too slight, and yet not too heavy for her strength, and not hold it near the head, but from the end, when she strikes. Such a tool will cost about ninepence.

The small houses in the suburbs of London, and also in the country, are generally very slightly built, and abound in crevices and draughts. One of the first things to be done on entering a new house is to remedy this in the best way we can.

To remedy draughts, first fortify the spaces round the usually ill-fitting doors of a new house. This is once for all. If you have felt carpets, there is usually a quantity of white margin cut off sufficient for part of the process. If not, buy about three yards of felt carpet. One shilling and ninepence a yard is enough to give for a wide width. Cut inch wide strips—indeed, they may be a little narrower. With tin tacks place these strips all round the part of the door that closes into the doorway. If it is possible to get the door taken off the hinges, place it underneath too; it will be a great comfort there. Afterwards nail a protection all round the door where it opens, and over the hinges. For this purpose black oil-cloth—about one shilling and tenpence a yard—cut in inch and a half wide strips, may be used; or, what looks still better, scarlet twilled binding, inch wide. Fasten this with tacks also round the windows, but not so as to interfere with their free opening. The street and area doors must not be forgotten.

Mats.—Mats should be laid outside all doors to stop draughts. These mats ought to fit the doors exactly and completely. If they do not they are ornamental and not useful. The old square mat is now seldom in requisition in any save large houses with spacious landings. The narrow mat, twelve inches wide, not only serves all purposes of use, but looks best in limited space. Those of sheepskin are handsome and efficient; but for upper bed-room doors excellent mats may be made of cloth cuttings, sewn on to canvas in innumerable loops as closely as possible. List, cuttings of felt carpet, or even old stuff dresses, can be utilised. If old material is used, wash it quite clean first, then cut it in inch-wide strips six inches long, and sew them to the foundation as close together as possible. Fig. 1 shows the loop, and where the stitches are made to sew it on; Fig. 2, how the rows of loops are sewn close, one over the other. The next row is, of course, placed as close upon the last as possible.



Fig. 1.

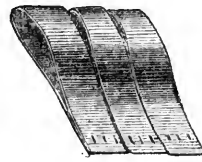

Fig. 2.

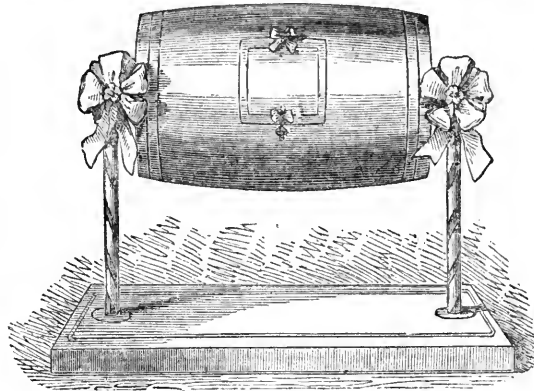

Fig. 1.

ODDS AND ENDS.

To make a Wheel of Fortune for a Raffle.—For small children's parties and for fancy bazaars wheels of fortune are often in request. A small old muff-box is a very good thing to use for making a wheel of fortune. Sew it together if torn. Take the lid off and the top out of the lid. Sew this on to the box. Cut a small square out of the box on one side, just large enough to admit the hand. Entirely cover the box and the square cut out with coloured paper. The square must be covered both sides. The box must have a straight piece pasted round it, and turned down at the ends, and over this, at the ends, two rounds of paper pasted on. Scarlet morocco paper is the best to use, or yellow morocco paper. Cut out the paper covering the hole when the paste is dry. Bind the hole and the square of card both round with ribbon of one colour. Fix the square to the top of the hole with a ribbon bow. At the opposite side sew a loop of elastic under a bow of ribbon to the square and a nook on the box, over which the loop can be fastened to shut the door over the hole. For the stand a square of wood larger than the round is needed.

Get two bill-files—those without wooden ends, but only wire rings, are best—nail these down to the two ends of the piece of wood with tin tacks, so that they can have the hooks thrust through the sides of the barrel, and that it can turn on them. Before adding the barrel, however, cut strips of the paper and cover the wires of the bill-files spirally, and run gold paper at distances over this; then cover the stand with the morocco paper, and put handsome bows of ribbon on each of the hooks of the files, just to hide the hole in the barrel. Both barrel and stand may be ornamented with gold. Strips of embossed gold paper laid on both a little way in from the edges, and stars or other objects stamped in gold tinsel, may be used according to fancy. When a muff-box cannot be had, make the barrel of bonnet-board, cutting the round ends by a bow pencil or a cheese-plate. To use the wheel, fill it inside with square inches of card, blank and figured. Hold the stand with the hands on the table. Whilst the company gently turn the barrel by a playful stroke, open the door and draw. It must not be used roughly, of course. We fix it on the table by the help of a screw pin-cushion.

Hiring Furniture.—Sometimes, where people cannot be sure of permanent employment in the same place, it may be advisable to hire, not purchase, furniture. This can always be done by applying to a broker, who, for new articles, will charge 20 per cent. on the value, for second-hand about 10; the repairs come out of his pocket, but the owner bears the loss of the ordinary wear and tear. This plan of hiring is more economical than purchasing furniture for an uncertain or limited residence—it being a well-known fact that sales never realise half the original outlay. Again, it is better to hire than run in debt—to hire, however, with the intention of furnishing by degrees, laying by a settled sum for the purpose, and buying for ready money, always the cheapest and best way. In this way, setting their wits together to economise from the first, and taking every opportunity of

learning the art of home manufacture, many a young couple might start in life with lighter hearts, and free from the anxiety of a first debt. The very necessity for economy, and for setting aside a portion of the weekly wages, would conduce to habits of regularity and self-sacrifice. As each article was bought, its fellow amongst the hired furniture could be returned to the broker; and thus, bit by bit, the expense be lessened.

To remove Grease from Carpets.—Scrape and pound together equal quantities of magnesia and fullers-earth, and mix them into a paste with boiling water. Lay this as hot as possible on the grease spots, and leave it to dry. When it is quite dry brush it off, and the grease will be found to have disappeared.

Hot Buttered Toast.—The art of making really good toast is little understood, and this is largely the reason why it is so often denounced as unwholesome. A slice of bread burnt on the two outer surfaces, with its interior in a moist,

waxy condition, has no right to be called toast, but is rather a compound of charcoal and tough, heavy, sodden dough, in which condition it is certainly and seriously unwholesome. But a slice of bread, not too thick, just browned on the outside, but thoroughly baked through, is wholesome and pleasant food, which may be fearlessly eaten.

The way to toast bread thus is to keep it at the right distance from the fire, so that it may be toasted throughout before the outer surface is overdone—in other words, not to toast it too fast. Concerning the buttering of hot toast we may add another hint or two. An ill-toasted slice of bread does not absorb the butter, but allows it to remain in a mass on the surface. A slice of properly-toasted bread, on the contrary, allows the butter to permeate every part of it, and to all parts equally. Butter in the one case is too heavy for the stomach; but when thus intimately associated with the whole mass of the food, in finely divided and proper proportions, its character is entirely changed, and it becomes wholesomely nutritious.

Superfluous Boxes might always be converted into *settees* in the bed-rooms, on the landings, or even in sitting-rooms; what are otherwise nuisances, in this way becoming ornaments and of great use. Covers may be made of chintz or damask. Make a piece the shape of the top, and add a box-pleated flounce round it. The top, if stuffed as a cushion with a little flock, is improved.

Blacking.—Take of ivory black and treacle of each three ounces, of spermaceti oil one ounce, and of vinegar one pint. Mix all well together, and let it stand for some time before using. This has been recommended to us as an excellent blacking.

How to make some very pretty and cheap Table and other Ornaments.—To complete our present instalment of "Odds and Ends," we add some instructions suggested whilst writing our recent articles on paper flower-making. It struck us that the alabaster vases and other ornaments

generally purchased to show such bouquets were very costly, and beyond the reach of many of our readers. Not long ago we saw a beautiful and choice group of wax flowers, mounted under a glass shade, in a vase apparently of white coral, which had been made for a very trifling sum and without much trouble, as follows:—Take a long-necked wine-bottle, with a rounded bowl, and with a coil of flexible white cap-wire twine it all over to resemble coral, like Fig. 2, interlacing it in every way. The *spikes* on the coral are merely loops twisted together. Fig. 3 shows the effect round the bottle. It must not be joined below the line indicated by A and B, but the coral work

continued, only not fastened on one side, so that the bottle can be slipped out. Afterwards link this part together. Cover it all over closely with white Berlin wool, twisted round and round. Melt enough white virgin wax in a pipkin to dip the vase in, holding it by a wool thread; or pour the wax over and over it, melting it afresh as it coagulates, till you have a good imitation of branch coral. When quite hard, fill the inside entirely with dried moss. The flowers

are placed in the usual way in it. A basket constructed on the same principle is also very pretty. Baskets are now generally adopted for flowers without handles; but, if the coral is skilfully made, the handle will prove a charming addition.

The work may be varied by covering the wire with scarlet Berlin wool instead of white, and mixing some powdered vermilion with the wax, stirring it up just before pouring on the basket.

An ornament for the dinner-table is not difficult to contrive in the same way. Make three plates of different sizes in the coral; half a garden stick is to be used for the stem, coated with wax. Get a round of wood, half an inch thick, an inch wider than the coral stand at the base; cover it with crimson velvet, and put a wreath round the top; arrange a wreath round the stem.

Put a little dried moss very lightly in each coral-plate at the centre, leaving the edges free, and arrange flowers on them. The coral cup at the top can be made separate from the stand, and added last. Fill these well with moss and flowers. Fig. 5 shows the stand; Fig. 6 one of the plates. The cup at the top can be made over a jelly-glass. Fig. 7 shows the stand dressed. White coral is the best for this purpose.

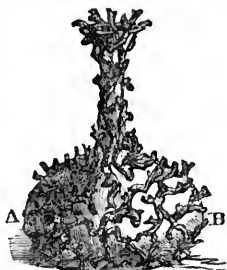

Fig. 3.

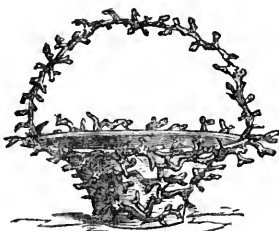

Fig. 4.

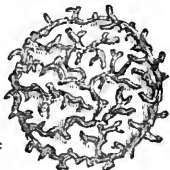

Fig. 6.

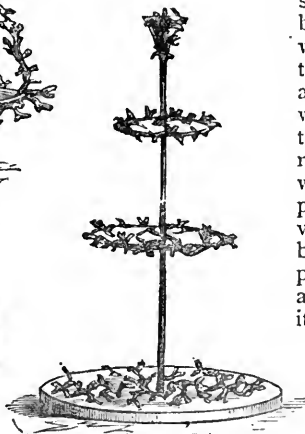

Fig. 5.



Fig. 7.



Fig. 2.

THE REARING AND MANAGEMENT OF CHILDREN.

X.—DIETARY IN EARLY CHILDHOOD.

As a general rule the appearance of the different kinds of teeth may be taken as an indication of the description of nourishment most suitable to the growing frame. Thus, till about the age of from five to eight months—*i.e.*, while the gums are in a toothless state—milk should constitute the food of a healthy babe. Between the tenth and sixteenth month the teeth next the front, and also the first double teeth, are generally cut. About that time the food may be made to assume a more substantial nature, gradually increasing in quality and quantity until about the twentieth month, when the canine teeth may be expected to appear. At this period, if the child be healthy, an evident want of some sort of animal food will generally be apparent. Weak beef-tea, mutton, veal, or chicken-broth thickened with rusks, will then be found excellent nourishment. Not, however, until between the twentieth and thirty-sixth month, when the second molar teeth are generally cut, is it advisable to give solid meat in the form consumed by adults.

The above is the order of diet suggested by the structure of the teeth and the time of their appearance. Deviations must, of course, occur in the varied circumstances of life under which children are liable to be brought up; but the nearer we can follow Nature's dictates in the rearing of the young the greater are the chances of securing the inestimable boon of a sound mind in a healthy body. Later in life, when the pressure of necessity compels young men and women to live under conditions adverse to the true principles of health, little choice may be left as to the mode of living to observe. Throughout childhood, however, the first care of the guardians of the young should be to approach as nearly as possible to the highest standards of dietary.

The circumstance which is most liable to frustrate true nourishment in food is the habit of pampering the appetite of children by the giving of sweetmeats. Plain sugar is not an unhealthy article of food. On the contrary, sugar is with many children an indispensable item in their diet. The natural food of infants is very sweet, and many substitutes would probably be rejected if it were not for the appetising presence of sugar. The notion that sugar has the effect of decaying teeth is not well founded. In order to be a healthful addition to a meal, however, sugar should be taken in its *simple form*, and should not be eaten at intervals between meals. The inevitable result of giving sweetmeats, chocolate, bon-bons, &c., is to disincite the appetite for plain wholesome food. If such treats must be given, a lump of plain loaf-sugar answers the purpose of a gift or reward, and can do no injury.

Salt is a necessary as well as a welcome seasoning in infants' food. A few grains should be in every kind of food—always intermixed.

Farinaceous articles being especially adapted to the digestive powers of young children, may constitute a large proportion of their dietary. The variety is almost endless, but only those should be selected as staple articles of food which contain the principal elements of nourishment. Of these the chief is plain wheaten flour. It is worth taking some pains to procure unadulterated flour for nursery use. Having done so, a good mode of preparing the meal is to boil a handful of flour, tied up in a cloth, till perfectly cooked, which may be known by the flour appearing like a hard ball. Turn the flour out of the cloth, and, whenever wanted, add about a dessert-spoonful of flour to half a pint of milk, mixed together gradually, and afterwards boiled for a few minutes. Some persons recommend baked flour. The only objection against the latter is that baked flour is liable to get burnt in the oven, and becomes, consequently, much less

digestible. Baked flour used in the manner above described is very useful to arrest excessive relaxation of the bowels, to which many children are subject.

Oatmeal porridge is excellent food for children of advanced growth. Owing, however, to the flinty particles of the husk of the grain, which have an irritating effect on the bowels of most young children, oatmeal is less generally used than wheat flour. Oatmeal, to be easily digested, requires to be well boiled. If made with milk, oatmeal porridge is a highly nutritious meal, and is well adapted for a school-boy's breakfast.

Properly prepared barley is a favourite and excellent food for infants. By the process of preparation much of the indigestible portion of the husk should be removed. Barley in the above form is often successfully used whenever a laxative effect is desired to be produced.

Rice is not extensively used in English dietary, except as a thickening for soups or for making puddings. As an addition to a substantial meal, plain boiled rice, eaten with jam or treacle, is much in favour, and is a good substitute for a pudding composed of flour, suet, &c., without the indigestible properties of the latter, if eaten after a full meal. An excellent and most nourishing rice pudding may be made in the following manner:—Take six ounces of rice. Wash and pick it clean. Cover it with cold water till the grain looks swollen. Pour off the water, and add one pint and a half of milk, two ounces of finely-chopped beef suet, a tablespoonful of moist sugar, a little nutmeg, and a pinch of salt. Work the suet well into the rice before setting the dish in the oven. This pudding should be baked slowly. The above rice pudding is one of the cheapest and most nourishing that can be compounded. If eaten cold, with the addition of a little jam, it may constitute a pleasant and healthy meal in summer time, when the appetite sickens at anything like animal food.

Arrowroot is the least nutritious of the farinaceous articles in general use, and should not be relied on for nourishing properties. Arrowroot is soothing to an irritated state of digestion, but is no "stay by" when lengthy intervals in taking food are observed. Arrowroot made with milk is nourishing, inasmuch as the milk itself constitutes the nutriment; but water arrowroot possesses scarcely any nourishing property.

Fresh eggs are an invaluable article of food. Stale eggs are most pernicious. The best mode of cooking eggs for young children is to coddle them. This may be easily done by filling a basin, containing a pint and a half, with boiling water, and setting the basin aside by the fire, closely covered, for seven or eight minutes. The basin and its cover should be previously heated. At the expiration of the time stated the egg will be found thoroughly set and entirely eatable. The white of boiled eggs is not wholesome for young children, and seldom even agrees with adults. Eggs used in puddings composed of farinaceous substances should be well beaten, and added just before the pudding is sent to table. Any browning of the eggs takes from their nutritious properties.

Fish is an agreeable change of food, but is very inferior in value to beef and mutton. The best kinds for young children are whiting, smelts, and soles. As family fare fish is to be regarded rather as an expensive luxury than profitable food, therefore it is not necessary to dilate in this place on its use. If fish be given to children it requires the greatest nicety in cooking to be wholesome. Melted butter and highly-seasoned sauces should be avoided.

Cooked vegetables of most kinds are a very useful vehicle for conveying animal food in its lightest form to young children. A well-steamed potato, or head of cauliflower, over which gravy from a joint has been poured, is as fine a repast as can be prepared for a child. In the absence of pure meat gravy a well-made cup of beef-tea

may be added, a receipt for making which will be found on another page. The beef need not be wasted; covered afresh with cold water, and left to simmer for a time, it makes an excellent stock for use instead of cold water. One pound of meat to a pint of water is about the proportion generally prescribed for young children and invalids.

The best slices of meat at the family table should be reserved for the little ones. Joints dressed for the children's dinner should be sent up without any made gravy in the dish. The surplus gravy which flows from the joint should be saved for the following day's dinner, when a slice of tender meat put into pure gravy at boiling heat is nearly equal in nourishment to a cut from a freshly cooked joint.

Little folks should be encouraged to feed slowly, and therefore, if possible, a hot-water plate should be supplied to each child. There is no difficulty in supplying this luxury if ordinary soup plates are to be had. A plate of the latter kind filled with boiling water, over which the dinner plate is placed, forms a very good substitute.

The most suitable joints for children are those in which there is little fat. Neither should burnt skin be given them. It is easy to produce a distaste for animal food by acts of oversight, and such acts should be guarded against. Very young children, if once disgusted with fat, seldom recover the habit of eating any, and thereby lose much nourishment. Mild fat of beef or mutton, if very finely minced and mixed with lean meat, is seldom detected, but lumps of fat are almost invariably refused.

In early childhood meat daily is not always considered necessary. In the interval the principal meals should be of a higher class of nourishment than the minor meals consist of. As growth increases, with children reared in towns meat is very desirable for the principal daily meal.

Fats of most kinds are valuable, and children should be accustomed early to partake of such food. Bacon is excellent nourishment, and may be eaten when fresh meat is not served.

The habit of giving children much bread and butter, to the exclusion of other substances, is an error liable to be contracted from the facility of providing the meal. The practice is to be condemned, not only on the score of deficiency of nourishment, but on that of economic value. The butter sold in towns is seldom what it professes to be, and is liable to be composed of inferior fats artfully disguised. Instead of paying a high price for an article of fictitious value, it is far better to make use of substances that are known to be of genuine quality—of such are lard and dripping. The latter is generally plentiful in families, and is far preferable as nourishment to the so-called butter generally sold. As for lard, nothing is easier than for a good housewife to prepare the lard used in her household. In point of price and quality the provisions thus used will be found doubly profitable.

Bakers' bread, which forms a staple article of food with children living in towns, is in experience, and generally speaking, a most unprofitable form of nourishment. If bread cannot be made at home, it is advisable to substitute some article of food which shall prevent craving for a baker's loaf.

A more general use of soup, thickened with any of the farinaceous articles described, would lessen the appetite for bakers' bread. No more nourishing meal, for instance, than a well-compounded basin of pea soup can be imagined. If to the soup be added stock liquor and a certain quantity of clarified beef dripping, most of the constituents of first-class food are present in this simple dish.

Vegetable soups in which slices of bread are put carefully fried in dripping or lard and cut into dice, are very good food, infinitely superior to the meals of bread and butter accompanied by tea or coffee, which too often constitute the nursery breakfast and tea from one year's end to the other.

HOUSEHOLD DECORATIVE ART.

VIII.—MODELLING IN CLAY FOR AMATEURS.

IN the art of sculpture, modelling in clay forms the most important part of the work of the artist. In the formation of a marble statue, the first process consists in making a clay model; from this a cast is taken in plaster of Paris, and an exact copy in marble is carved from the plaster cast. The after labours of casting and carving may be, and are indeed generally, left almost entirely to workmen; but the model, in which the design is shown, and in which all the artistic qualities of the work, such as composition, form, and expression, are evinced, must be the work of the artist himself. Modelling is thus, in the hands of the professed sculptor, considered, and not without sufficient reason, as the highest and most difficult of the arts. *All* modelling, however, is not necessarily high art, does not necessarily demand great artistic powers, and is not necessarily difficult. It is an art of wide application to merely decorative purposes. In the common articles of use in our houses, almost all the *cast* ornamental portions are produced by modelling in clay. The scroll-work and foliage on our fenders and fire-grates, the brass ornaments on our lamps and gas-fittings, even the figures and flowers on our earthenware, when they are raised above the surface, are all reproductions from designs originally made by this process; and these things are the work of persons whom no one would think of calling artists. In fact, the difficulty of modelling, when considered as a part of sculpture, consists in the difficulty of attaining a just knowledge of composition, of the forms and proportions of the human figure, and not in the management of the material. The material itself and the means of manipulating it are of extreme simplicity; and, with a little attention and perseverance, far less than would be necessary to produce anything in the remotest degree satisfactory in drawing or painting, the amateur may arrive at such results in modelling as will afford considerable pleasure.

Apart from the gratification to be derived from the art as an occupation for leisure time—and this is no slight one, for few things are more delightful than to see actual forms growing under our hands—modelling may, in various ways, be made to conduce to the beauty of a home. Vases, brackets, pedestals, and other decorative articles, may be produced and ornamented with original designs, or with animals or foliage copied from nature, as fancy or taste may dictate. Afterwards, as the beginner grows more accustomed to the work, and becomes desirous of higher efforts, he may attempt a medallion or bust of a friend. His work, in the latter case, will probably not be *quite* equal to Chantrey's; but if he copies faithfully the features of his sitter, he will have the satisfaction of preserving in an imperishable manner the actual form of his friend's face, and of giving a likeness which will show him from all points of view, and one which will therefore have a value no photograph can possess. We have already spoken of the simplicity of the means and materials employed; they have another quality which will equally recommend them for amateur use, that is, their extreme cheapness. For a few shillings the beginner may furnish himself with everything requisite. Ladies need not fear to handle the clay on the ground of its being dirty; the clay used for modelling is in its nature clean, and is, indeed, used in domestic life for cleaning purposes, under the name of pipe-clay. It is by no means disagreeable to the touch, and wipes or washes from the hands with the greatest ease, cleansing them as soap does; and in modelling on a small scale there is nothing that may not, by exercising a little care, be done without inconvenience in a drawing-room.

Material.—Various kinds of clay are occasionally used, but for general purposes, and certainly for amateurs, the best is Devonshire pipe-clay. This may be obtained in a state fit for use at any pipe-maker's, at potteries, or at the shops of most plaster-figure moulders. The cost, when bought in small quantities, will not exceed one penny per pound, and in large quantities will be much less; a quarter of a ton may be had at from ten to fifteen shillings. A single shilling's worth will suffice for a beginner. For works on a large scale, sand is sometimes mixed with the clay to make it handle more freely; and where very delicate finish is required, as in the minute figures in silversmiths' work, a certain proportion of grease is occasionally added; but, for ordinary purposes, the clay may be taken as the pipe-maker prepares it for his own use. In consistency it should be rather softer than putty, and more nearly resembling that of butter. It will generally be about right in this respect when procured; should it, however, be too stiff, it may be softened by the addition of a little water—wrapping it in a wet cloth will do it most effectually; if too soft, exposure to the air will soon harden it sufficiently. It is most desirable that it should always be kept at the degree of moisture proper for work. Let the amateur, then, procure a glazed earthen pan with a well-fitting lid, such as he can buy at any earthenware shop for about two shillings. In it the clay should be placed with so much water as will barely cover the bottom. From this there will be no sensible escape of moisture, and the clay will remain in the same state for months. After the clay has been used, it will be necessary, in order to prepare it for employment a second time, to break it into pieces of about the size of walnuts, and then place in a pan with so much water as may be needed to bring it to its original state as regards moisture. When soaked, it must be thoroughly beaten up with an iron bar, and whilst that operation is being performed, all fragments of plaster of Paris, and other foreign substances, which may happen to have become mixed with it, must be carefully picked out. If the beating is not done thoroughly, in such a manner as to reduce the whole to one uniform consistency, some difficulty will be found, when the clay is used, in obtaining an even surface, and the work will have the appearance technically known as "lumpy;" but if the beating up is done properly, the clay will become of better quality with each successive using. The writer remembers some clay being given to him, as of superlative excellence, by a well-known old sculptor, which had been constantly manipulated for more than thirty years.

Tools.—The necessary tools are few and simple. The more important, which are used for pushing, smoothing, and scraping, are generally made of box-wood, but sometimes of bone or ivory, and are usually about six or seven inches long. Half a dozen of these, of useful shapes, will be sufficient. One or two "wire tools" should also be bought. The wire tool consists of a little piece of round wood to serve as a handle, into both ends of which pieces of bent brass wire, flattened and serrated, are inserted. This instrument will be found of value when it is necessary to scrape away the clay more deeply than can conveniently be done with one of wood or bone.

Modelling tools may be bought of any large artists' colourman, and will cost from sixpence to eightpence each; but any person can make the wooden ones for himself with a knife, a file, and a piece of sand-paper. In the cut below are given several of the most useful shapes. The illustration will furnish patterns to the maker, and guide the purchaser; for nothing is more common than for the beginner to select tools from the great variety shown to him which, in his after practice, he will find of no service whatever. It will also be well to have two or three small hog-hair and camel-hair pencils, a pair of compasses, and a piece of sponge of close and regular texture. If he is ambitious of modelling life-size busts, the amateur will also require callipers, for taking exact measurements of the head, and a "banker" or modelling stool. This is simply a strongly-made stool of about three feet six inches high and eighteen inches diameter at the top. The top must be made of double thicknesses of board, and the upper portion so contrived as to turn, by means of a pivot, upon the lower, for the purpose of allowing the bust to

be freely moved in any direction. Sometimes a screw is also introduced which allows the modeller to raise or lower his work at pleasure; but this latter contrivance is not absolutely necessary, and tends to make the stool unsteady. Any carpenter will construct the "banker" for a few shillings; but neither this nor the callipers will be needed by the majority of amateur modellers, and none will require them at the outset.

The First Lesson.—Let us now suppose that our intending amateur has furnished himself with all necessary appliances, and is ready for his initiatory lesson. For his first attempt he will do well not to choose a subject demanding great delicacy of execution or minute finish. In whatever style he may afterwards propose to work, he

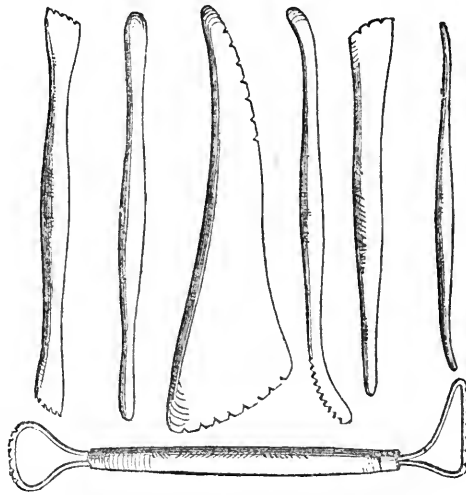

Fig. 1.

cannot do better than begin by making a copy from a plaster cast of a portion of one of the antique statues. Let him take a mask (that is the face only) of, say, the Apollo Belvedere, which will be admirable for the purpose. He can buy it of any plaster-figure moulder for a shilling. It may be well, briefly, to give reasons for selecting this. It is, in the first place, large (somewhat larger than life—what is called "heroic" size), and thus almost every part can be modelled with the thumbs and fingers, without much recourse being had to tools—for learning how to master the clay with the tools of Nature's providing is a great point in the art; the modeller will soon see that wherever they can be brought to bear they are infinitely preferable to any other, and the earlier he learns to use them in his course of study the better. In the second place, in this mask all the surfaces are broad, and the forms clearly defined—there is nothing to perplex or distract the novice. Thirdly, it is a face full of beauty, and the task of copying it, whatever difficulties may arise, cannot be otherwise than a delightful one. Before beginning, a piece of board must be procured some two feet long by eighteen inches broad, and this must be propped on the table in such a manner as to form an inclined plane, sloped at such an angle as is most convenient to the student. Towards one end the plaster cast must be fixed; then, with the sponge, the other half of the board must be slightly wetted for

the purpose of making the clay adhere. This being done, begin roughly to build up the clay upon it, till the general forms of the model correspond with those of the cast. And here it will be well to define the essential differences of procedure in the arts of carving and modelling. The carver cuts *down* through his material till he reaches the required form; the modeller, on the contrary, builds *up* to it. This the beginner will do well to bear in mind; he must not place a great mass of clay on his model and then cut it into shape—that would be carving; but, in roughing out, keep his work somewhat smaller and thinner than he intends it eventually to be, and reach the final form by laying on small portions of clay wherever they are required, and then smoothing them down; continuing the process till the model in every part becomes an exact copy of the plaster cast. This should be done, as far as is practicable, with the thumb and finger, and by preference with the thumb. On the smaller parts, such as the mouth, nostrils, and eyes, he will be obliged to use his tools; but where he can he should use those which most nearly resemble thumbs in shape, and should proceed with them in the manner before recommended, that is by laying on and smoothing down.

Scraping and pushing in the clay will some times be necessary; but they should always be avoided if possible. The form having been attained, it will be necessary to give a good surface to the whole. After long practice this can be done almost entirely by the thumb; but the beginner will require some mechanical aid.

Let him take a small piece of a coarse cotton stocking (which will have a kind of ribbed texture), wet it slightly, wrap it round his thumb, and pass it firmly over the clay; the result will be a generally smooth surface, but marked with ribs from the texture of the stocking. To remove these marks the sponge must be made damp but not wet, and dabbed gently and regularly over the model. The smaller parts, which cannot well be got at in these processes, will only remain to be finished. They will look hard and crude from the tools, and must be softened down with the hog-hair and camel-hair brushes; the mask will then be completed. In the earlier operations it will be well to keep the model almost as moist as the clay before use; later, as the work is nearly finished, it should be allowed to become a *little* harder, but it should never become *very* hard. Whenever necessary, water may be sprinkled on with the sponge; and between the intervals of work the model should be covered with a wet cloth; if it is left for many successive days, it should also be wrapped in a piece of oil-cloth.

Some may imagine that, for a first attempt, the subject we have suggested is too difficult; but years of experience in the practical teaching of modelling have convinced us that this is not the case, the forms, although refined and beautiful, being simple and readily understood.

THE HOUSE.

WATER SUPPLY (*continued*).

THE materials from which water-cisterns are made vary according to the means, requirements, and fancy of those who employ them—from the humble and unpretending barrel of the cottager to the costly iron tank of the manufacturer or theatrical lessee—and there are ample reasons why different materials and forms of construction should be had recourse to. Cisterns may be placed at the top of a building, and so arranged that a large body of water may, in case of accident from fire, be poured rapidly and forcibly downward. In such a case as this it is highly necessary that great strength, combined with comparative lightness and facility of attachment, should be possessed by the arrangement. Galvanised sheet-iron, angled and girdered, is perhaps the best material that could be employed. It not unfrequently happens that a cavity excavated in the earth beneath some back-kitchen floor is made use of as a chamber for the spring-up of water. In such a situation as this, iron would be inapplicable, and it is therefore usual to employ brickwork evenly covered

with Roman cement. It is a very common custom to place cisterns of moderate capacity on the outside of dwelling-houses, where they are mounted on brickwork supports, and protected from the intrusion of foreign substances by a small roof. This is probably the most common form of cistern used in this country; and, without question, the best material for its construction

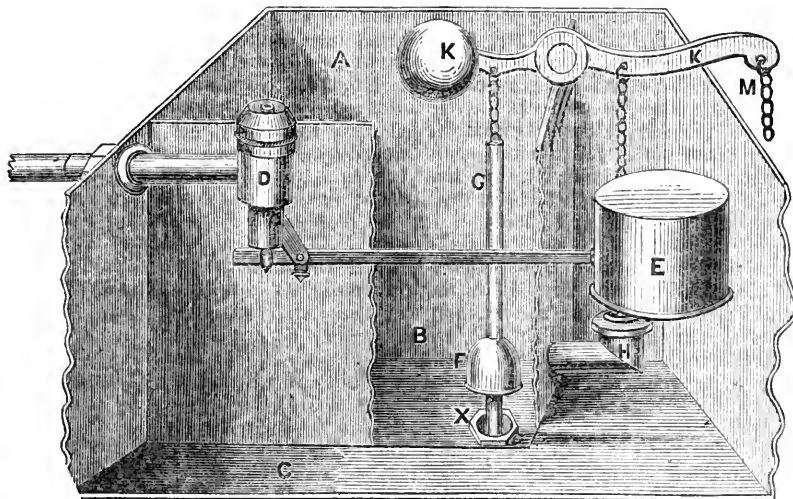

Fig. 1.

is cut and planed slate, as produced at the Delabole and some other of our great slate quarries. So admirably is this stone adapted for use in the arts, that it is worked with the greatest ease with the saw, plane, chisel, and drill. Huge planks—as they may be called—of clean blue slate are first reduced to the required size and thickness by saws and planes driven by engine-power. They are then measured, ruled, grooved at the edges, fitted together with rods, which are nutted and screwed at their ends. These bars pass through holes, drilled for their reception, outside the joining groove or rabbet, thus admitting of the five pieces constituting the cistern (*viz.*, the two sides, two ends, and bottom) being either put together or taken apart by the use of a common nut-spanner. Every cistern of this kind has a match-mark cut on each of its pieces, and the contents in gallons painted on the outside. Lead cisterns we have already referred to as being highly objectionable as reservoirs for the reception of water intended for either drinking or culinary purposes. As a lining for a closet-cistern, or in situations where rain-water is stored up for washing, gardening, or general cleaning-up purposes, lead answers well enough. Do not, however, allow water so collected on any pretence to be either made use of in the kitchen, or given to horses, cattle, poultry, or dogs. When barrels are used to contain water intended for general household use, they should be first well scraped

on the inside, and then be carefully lined with a thick coating of clean, well-melted pitch. An unpleasant taste will be communicated to the water for a short time, but this is greatly decreased by the use of a good-sized cabbage-net full of charcoal. This should have a stone placed in it, in order to make it sink. Fasten a string to its top; let it hang at about the centre of the cask; lay a stick across the top of the barrel, and fasten your string to its middle; your charcoal-net will thus be suspended just at mid-water, where it should remain until all taste and smell of pitch has passed away. No portion of the water-supply arrangements of our cities and towns is so generally—we might even say, almost universally—defective and wasteful as that constructed to regulate the flow of water through closets; and it is because the majority of mechanical arrangements made use of for this purpose are more or less inefficient that householders are compelled, in self-defence, to fasten up the flush-plug, and allow a large quantity of water to be expended, when, by proper mechanical adjustment, enough water to meet sanitary requirements is suffered to run, whilst wasteful expenditure is entirely prevented.

A modification of the improved water-valve and cup-float, described in our last paper, has been lately applied to this purpose by a very well-known provincial firm. This plan is as follows:—A reference to the annexed illustration will show at a glance the manner in which the whole arrangement is carried out. Unlike the majority of contrivances constructed for flushing purposes, the new "Economiser," as it is called, governs expenditure and influx at the same time, by a system of both floating and sinking power. The cistern to which it is attached is constructed in compartments, so that the time (a minute or thereabouts) which is occupied in restoring the balance of the contrivance, after pull on the lever-chain, M, is made, must pass before the flushing ceases. The bulk of the stream thus poured down being regulated by the size of the orifice X is amply sufficient to clear all the pipes and tubes thoroughly without allowing the least waste to take place.

A reference to the annexed illustration and the letters used to indicate the particular parts of the arrangement, will at once serve to explain the mode of construction and operation of this simple and useful arrangement:—A is a cast-iron cistern, divided into two compartments; B the flushing compartment; C the supply: the whole being about 16 inches long, 10 inches wide, and 12 inches deep. In compartment C the "Economiser" valve D and cylinder E are fixed; while in compartment B a flushing-valve, F, through which an air-tube, G, passes, is fixed. From this joint a connection is made with the closet. H is a valve fixed to the partition, and communicates with the flushing compartment B. Each valve is acted upon by means of the weighted lever K. By drawing down this lever at M, the valve F is raised and the valve H closed. The water in compartment B, passing through the aperture X, flushes the closet. On releasing the lever, the opposite action takes place—the valve F closes and the valve H opens, admitting the reserve supply contained in compartment C into the flushing compartment B, while the "Economiser," left to its own free and certain action, supplies the deficiency to the reserve. By this arrangement it is evident that the lever cannot be fixed in such a position as to cause a constant flow of water down the flush-pipe into the closet; before the flush-valve is opened, the valve H is closed, and the supply from the reserve cut off. To obtain a second flushing, the cistern must be allowed to fill in the ordinary manner. Our next paper will treat of the supply of cisterns, &c., so situated as not to be replenished from accumulations of water stored up by public companies and carried through underground tubes and pipes.

DOMESTIC MEDICINE.

APŒPLEXY.

THE word is derived from two Greek words—*Απὸ*, by means of; *πλησσω*, to strike—because those attacked often fall down as if from a blow.

Symptoms.—The ordinary features of the disease are a sudden loss of consciousness, unattended with any convulsion; the breathing is laboured and heavy, and the face generally flushed. The patient falls suddenly down. The loss of consciousness may not be quite complete; and in this case speech may be lost or only impaired. One side will be more or less paralysed.

There are many variations in the way in which the attack comes on. For example, the patient may at first look pale, and the loss of consciousness may be gradual, and not sudden. In this case there is apt to be vomiting. Again, there may be some amount of convulsion, or working of the arm or leg of one side. The important thing for people to know is the difference between apoplexy and drunkenness, and between apoplexy and faintness. It is common in the streets and in police-stations to treat a man with apoplexy as if he were "only drunk." And in a country where, alas! men are too often seen deeply drunk in the streets, it is not so remarkable that this mistake should be made. It is not always easy to distinguish between drunkenness and apoplexy. Drinking tends to produce apoplexy, and then a man may be both drunk and the subject of apoplexy. The guiding points are the smell of drink and the account of persons who know the patient, and the fact that drunken persons are not generally so profoundly asleep as not to allow of being roused. Between apoplexy and faintness the points of distinction are principally these. A faint person is pale; the breathing is quiet, not noisy, as in apoplexy; the pulse can scarcely be felt at the wrist, whereas in apoplexy it is apt to be full. Apoplexy occurs for the most part in elderly persons, and in men; faintness in younger persons, especially women, and when in close places.

Causes of Apoplexy.—The occurrence of apoplexy in a person generally shows that there is something wrong in the walls of the blood-vessels of the head. They have lost their healthy elasticity—become too soft or too hard—and given way instead of expanding when a little extra pressure was put upon them. It is not so much that people have short necks or long ones as that they have unsound blood-vessels. This is worth everybody's knowing; for while people cannot alter the length of their necks, they can—so great is the control of people over their health—do a good deal to keep their blood-vessels sound or to spoil their blood-vessels. Let us give, then, a few hints to people who fear apoplexy; whose father or mother perhaps have had it; or who have lived hard, and have some warnings of it, such as dizziness, slight loss of memory, slight paralytic attacks, and the like. Let nobody think that there is any reason why he should die of apoplexy because his father did. Doubtless it is sometimes hereditary; but a great deal can be done to prevent the development of hereditary diseases. The points to be aimed at to prevent apoplexy are a regular life, free from all excess or intemperance. Excess in eating or drinking is very bad for persons with any tendency to apoplexy. Anything which loads the blood with alcohol or strong animal food tends to produce that condition of the blood-vessels which leads to apoplexy. So, persons with this tendency should drink very little, and claret, or, at most, very weak sherry and water should be their stimulant; and teetotalism, if they are not weak or very much jaded, should be tried. An occasional dinner of fish or fowl will be beneficial. Suppers should be light. Sleep should be regularly taken, and neither too much nor too little. Probably of the two extremes the more

common now-a-days is too little. Exercise in the open air, and healthy, well-ventilated rooms, especially sleeping-rooms, is also important. Care and worry—things very difficult to avoid in this world—should be avoided as much as possible. Attention to these points will greatly tend to preserve the healthy condition of the blood-vessels and other parts of the body, on the integrity of which safety from apoplexy depends. We need not add that nothing tight about the neck should be worn. If what we have said be true, we need not say that much drinking, much eating, indolence, and inactivity, horror of the fresh air, and love of close, warm rooms, are the ways by which apoplexy is to be produced.

Treatment.—This, of course, is a matter for a medical man. But supposing a person to be attacked with apoplexy, his head and shoulders should be raised, his necktie, and any other tight garment, should be unloosed. And nothing more should be done till a doctor arrives.

Prospects of the Case.—Recovery may be quick from this condition, or it may be gradual, or death may result in a few minutes, or hours, or days. Let the nature of the disease be considered, and all this variety of result will be understood. The disease consists in the breaking of a blood-vessel, and the escape from it of blood. If the blood is in great quantity, and in the central parts of the brain, death will probably result; if it is in small quantity, and the escape of more is prevented by quietness, this blood will be absorbed and consciousness will return, and any want of power in the side will gradually be supplied. It will easily be understood that when blood escapes into the brain it tears it up. If there is much of this, even if the blood itself be absorbed, some paralysis is likely to remain. Of course, when an attack has once happened it is not less apt to happen again. In order to prevent this, the same precautions should be taken as we have described for preventing a first attack.

ASTHMA.

Asthma is a disease in which bad breathing comes on in somewhat severe sudden attacks, characterised by a loud wheezing noise. It is a spasmodic disease, that is to say, the muscular fibres surrounding the small bronchial tubes, through which the air passes to the lungs, contract, and so diminish the calibre of the bronchial tubes, often to an excessive fineness, which makes breathing painful, difficult, and very noisy. These attacks of spasmodic breathing are sometimes occasioned by something in the air that irritates the passages. Some substances in the air will excite a fit of asthma in some people—such as ipecacuanha. The writer knows a patient in whom the odour of a linseed poultice often excites asthma. It is not always the clearest air that suits the patient best, for people troubled with asthma have been known to breathe better in the atmosphere of St. Giles's than at Hampstead. On the other hand, people that have scarcely been able to breathe in the more crowded parts of London have got well on Hampstead Heath. Sometimes asthma is brought on by excitement, or emotion of any kind, as fear, love, &c. Sometimes it is brought on by heavy suppers, by indigestible or irritating food. The writer knows a medical man who has cured himself of a liability to asthma in the night by either not taking any supper, or only a very light one. The disease is more common in men than women; it is often hereditary.

Symptoms.—The sight of a person with asthma is very characteristic. There is quite a gasping for breath, the eyes staring, the breathing accompanied by a loud or a fine wheezing noise, and the patient assuming a peculiar position—if standing, probably having his hands resting on the back of a chair; if sitting, leaning slightly forward, with the hands on the knees, the mouth open and greedy of air. The lips will become livid or blue if the breathing is not soon relieved. Attacks often come on in the night.

Treatment.—A medical man should be sent for, but before he arrives a few things may be done calculated to

relieve the patient. Plenty of air should be admitted to the room. If indigestible food has been taken, a stimulating emetic may be given, as half an ounce of mustard in hot water. After the operation of this, or at once, if an emetic is not judged necessary, a cup of strong coffee may be administered. A strong mustard plaster may be applied to the chest. Various substances, smoked or inhaled, have the power frequently of relieving the fit of asthma. Among the most homely of these is the smoke of burnt nitre paper, that is of brown paper dipped in a strong solution of saltpetre (nitrate of potash) and dried. The smoke of this burnt paper often relieves the asthmatic attack. So does a pipe of tobacco, especially in those not accustomed to take it. Medicated cigars, too, are prepared for these attacks, especially cigars of Stramonium and of Datura Tatula. These should only be taken under medical advice, but they are often singularly useful.

All these failing, the asthmatic patient should try change of air. Nobody can tell him what air will suit him best, for the disease is so capricious, that sometimes it is benefited by an air that one would expect to be injurious. But the effect of change of air is often magical, and this remedy often succeeds when all others fail. As a general rule the patient in taking a change of air should go to an atmosphere entirely different from that in which he is living. Anything wrong in the general health should be put right. The asthmatic should live regularly and simply, and, as far as possible, he should live in the atmosphere that suits him the best. (See *Bronchitis*.)

HOUSEHOLD AMUSEMENTS.—X.

THE GAME OF WHIST (*continued*).

Playing out of Turn.—If the third player play before the second, the fourth is entitled also to play before his partner. If the fourth play before the second, the latter may be called on by his adversaries either to win or to lose the trick, as they may deem advisable.

Revoking.—A revoke is committed whenever a player does not follow a suit, although he holds a card of it in his hand. The penalty for every revoke is the loss of three tricks, which the opponents may take either—1, by adding three to their own score; 2, by deducting three from the score of the revoking side; or 3, by taking three tricks from the revoking player and adding them to their own. In the latter case, the penalty may sometimes amount to even more than the loss of three. For instance, if the revoking party have made the odd trick, their opponents, by taking three tricks and adding them to their own six, count three themselves towards game, and make the others lose one, thus making a difference to the score of four in all. This is a point on which misunderstanding prevails, even among practised players; but the law is as we have here stated it. The penalty for a revoke is counted before either tricks or honours. A revoke may be recalled before the revoking player has played to the following trick, but not after; and a player is allowed to ask his partner if he is sure he has not a card of that suit. The tricks played during a hand may be searched, on its completion, to establish evidence of the revoke; but the penalty cannot be claimed after the cards are cut for the next deal.

Here we must end our abstract of the laws, which we believe will be found sufficient for the family circle; but persons requiring further information as to nice points which occasionally arise, and the code by which they are to be met, will find it in the authorities before alluded to.

SINGLE AND DOUBLE DUMMY.

The game of "dummy" is an invention for the benefit of persons who desire to play whist, but cannot make up the requisite party of four persons. Single dummy is played by three, and double dummy by two. The cards in each case are dealt out as in the regular game, and the same

rules are observed; but in single dummy one hand is usually exposed upon the table, the players cutting to decide who shall first take "dummy" as his partner and play his cards; and in double dummy, each of the two players has thus to conduct the game of a supposititious partner as well as his own. The game of "dummy," in either case, is inferior to that of whist in its usual form; but it is considered useful practice, and single dummy especially affords much interest and amusement.

COMICAL COMBINATIONS.

This is a game which can be made a source of considerable merriment and amusement by a party of young people who have some skill, however slight, in drawing. It is not known under any especial name, and it is played in the following way:—Those engaged in it sit round the table, and each is supplied with a piece of writing-paper folded into three parts, and a lead pencil. In the first place each sketches a head and neck—that of a man or woman, or that of some inferior animal, taking care that his neighbour does not see what he has done. Then each re-folds the paper, so as to hide his or her sketch; but leaves indications of where the neck is on the blank part of the paper which is folded over it. The papers then change hands all round, and each proceeds to sketch a body for the head he has not seen. When this has been accomplished, the papers are again re-folded as before; another change takes place; and all proceed to supply legs for the bodies they have not seen, just as before they supplied bodies for the heads they had not seen. When all this has been done, another change of papers takes place, and then each writes the name supposed to belong to the figure thus curiously compounded, after which the papers are unfolded, and the result is usually successive bursts of laughter at the oddness or absurdity of the combinations. For instance, A draws the head (1), B the body (2), C the legs (3); the result of which, when unfolded, may be some such absurdity as is shown in Fig. 1.



Fig. 1.

ACTED CHARADES.

Acted charades, in which syllables and words are represented by short dramatic scenes or tableaux, are a modern invention, and rank among the most attractive of in-door amusements. They require no great art in the performance, and a little practice will enable any family circle to get them up, when they know how to set about it. A word is chosen, of two or more syllables, each of which has a distinct meaning; these syllables are then represented, in their order, by action, either with or without dialogue, and afterwards the entire word is expressed in the same way, the spectators being expected to guess what each scene has represented.

The company should properly be divided into two parties, each side in turn performing a charade, or tasking its penetration to detect the word on which the performance of the other side was founded. But if there be many persons present, the better plan is to select a few from the company to form sides, and each will thus relieve the other in contributing actively to the general

amusement. All persons, old or young, may be brought into the performance of particular scenes, if they are disposed to enter into the pastime.

The first thing necessary is the apartment in which the charades are to be enacted. The ordinary pair of rooms with folding doors, or a pair which may be separated by a screen or curtain, is well adapted to the purpose. The larger should be devoted to the general company or audience; the smaller being the arena in which the performances take place. During the preparation of the charade, and between its different scenes, the doors are closed; and, in order to prevent the spectators feeling the intervals irksome, it is well for some one to volunteer a little performance on the piano, or for ordinary conversation to go on as if nothing were expected.

The performers, retiring, agree among themselves as to the word which shall be the subject of the charade. As a rule, words of two syllables are best; for these, requiring three scenes in all for their expression, are found quite long enough both by the performers and by the spectators who have to guess their meaning. As we have intimated, each syllable of the word chosen should be complete in itself, and capable of complete expression in the little drama or pantomime which has to be represented. Far-fetched puns and distortions of language are generally inadmissible, as not affording a fair chance to the opposite side, or to the company who comprise the audience, to guess the word which the scenes are designed to convey; but the simple doubling of a consonant, as where "in" is expressed by the representation of an "inn," or the occasional addition of a vowel which does not affect the sound, as in "pi(c)lots," is perfectly allowable; and this hint will furnish our readers with a key to the solution of many charades which at first may appear very puzzling.

As examples of words, mostly of two syllables, from which a selection may be made, we will give the following:—

Almshouse	Bridewell	Farewell	Muffin(n)
Altar (all-tar)	Cabbage	Fireworks	Nosegay
Artful	Cand(y)date	Footpad	Outfit
Backgammon	Carmine	Gooseberry	Pancake
Bagpipe	Carpet	Gunpowder	Patchwork
Bandage	Catcall	Hamlet	Patriot
Bandbox	Caterpillar	Hammock	Pilgrim
Bargain	Chairman	Handcuff	Pi(e)lot
Beefeater	Checkmate	Helpmate	Postboy
Bellman	Childhood	Honeymoon	Rest-oration
Birthday	Cornice	Hornpipe	Ringlets
Blacksmith	Cottage	Hostage	Saucebox
Blackstone	Counterpane	Idol	Shamrock
Blockhead	Counterpart	Innkeeper	Snuffbox
Blunderbuss	Courtship	Jew's-harp	Spinster
Boatswain	Coxcomb	Jovial	Sweetheart
Bondage	Crosspatch	Keyhole	Telltale
Bootjack	Cutlass	Luggage	Timepiece
Bracelet	Dewdrop	Madcap	Toi(y)let
Breakfast	Donkey	Magpie	Upshot
Brickbat	Earwig	Messmate	Wardrobe
Bridecake	Eyeglass	Milksop	Watchman
Bridegroom	Falsehood	Mis(s)take	Welcome

HOUSEHOLD DECORATIVE ART.

IX.—FEATHER SCREENS (*continued*).

IN speaking of the kinds of birds best adapted for being manufactured into screens, we can only give the general rule that all birds which have naturally a rapid flight form good subjects, their wing-feathers being strong and stiff, and not liable to get spoilt. The owl, for instance (to take a case of an opposite character), is not so well suited for a screen as a pigeon or a duck, for, though he has a beautiful spread of wing-feathers, and with his large head and eyes will form a noble screen, yet the softness and delicacy of his feathers, so necessary for his silent flight, renders the screen he may be transformed into, very easily soiled by dust (at least in the neighbourhood of London), and spoilt by handling. All the hawk-tribe, on the other hand, are excellent; the large brilliant eye and short hooked beak being very effective (see Fig. 2); and their wing-feathers, being strong, are of a tolerably hard material, though not nearly so hard and durable as those of the wild duck, widgeon, or any of the numberless duck-tribe. So far, indeed, as the shape, strength, and colouring of the *wing* is concerned, the duck-tribe are by far the best subjects for screens that we know of; but when we remember the difficulties

of making their long necks and not always beautiful bills assume a graceful attitude, we return at once to the opinion with which we started, that the race of pigeons (so far as British birds are concerned) bears off the palm of general capability. In London, however, it is very difficult to get pigeons that are worth anything; the tame pigeons at the poulterers' shops being generally (and our readers probably know that they should be always) young birds that have only their first coat on (if they

have got all their feathers); and even if an old bird should be found amongst them, or the wild pigeon should be selected, the chances are that they have been so mangled in the killing or carriage as to be useless for our purpose. Wild ducks, widgeon, pintails, teal, and other kinds of ducks can, however, be readily obtained in

London in perfect condition. Owing, however, to the size of the bill in the larger sorts, we prefer the smaller for making screens, and shall presently give the result of our experience in dealing with a teal, as compared with the directions previously given in the case of the pigeon.

In selecting any bird for making a screen, whether from the poulterer's shop or from the dovecot of a farm-house or elsewhere, the main points are, to see that plumage is good, the quill-feathers of the wing fully developed and perfect in their graduated lengths, and (if the bird is dead) that the feathers of the neck have not been damaged by the dislocation that is usually resorted to. But in selecting a tame pigeon there are other points to be attended to; this is caused by the variety of colouring, which (though it adds to the value of the pigeon-race for making screens) is very often not equally distributed. For instance, one wing may have the three first quill-feathers white on one side, while on the other side four or five may be of this colour, or, perhaps, a single dark one may form the first quill-feather, and then three white ones. These irregularities will much interfere with the beauty of your screen, if not noticed in time, and though they may sometimes be counteracted by painting, this is not often successful. Generally speaking, a pigeon with quite white quill-feathers

should be rejected, as it is seldom that they are so clean as not to show some traces of dirt at the points, and the slate, fawn, or grey coloured pigeons, are generally much more beautifully marked in other respects. From this it will be seen that it by no means follows that the prettiest pigeon that walks about (and picks up the peas you have enticed him down with), will form the handsomest screen. We must here say a word or two as to the time of year when tame pigeons ought to be in

full feather, and we say *ought*, because they often upset all one's calculations by moulting at irregular times, the result, no doubt, of domestication, and the numerous families they rear in the course of each year. Just before, and during the beginning of the breeding season, they will generally be found to have no short

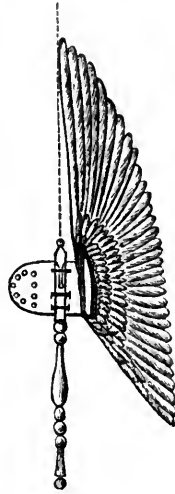

Fig. 1.

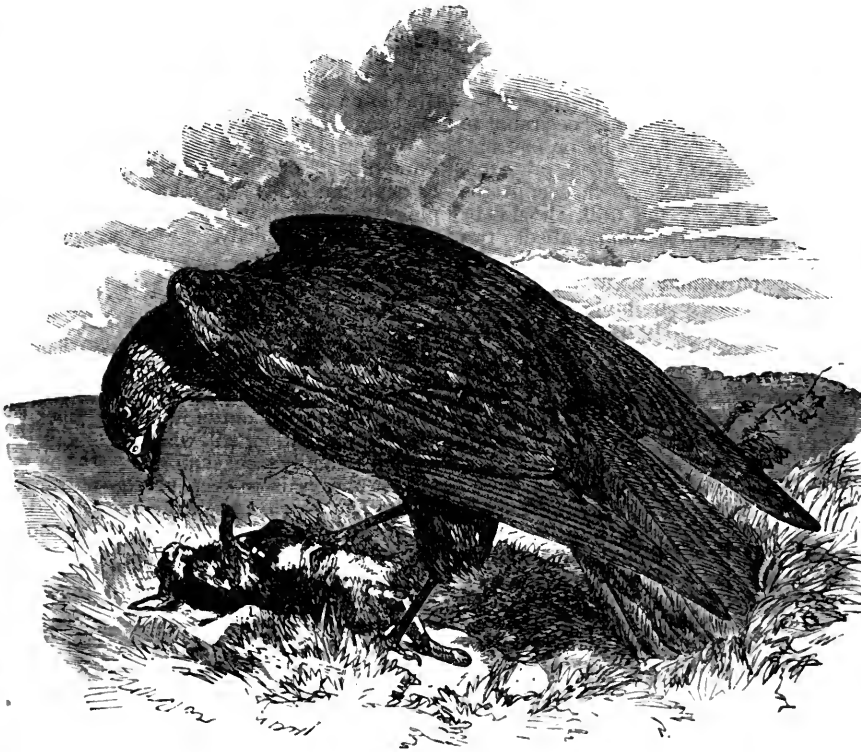

Fig. 2.—THE HAWK.

feathers, and therefore to be most fit for the purpose we have in view; but, of course, breeders do not like supplying you at this season, even if you were hard-hearted enough to kill a pigeon during his honeymoon, or when he had become the head of a young family. Many birds, however, of two years old (and they should not be less) will be found in good feather till August or September, when family considerations will not interfere with your choice. Wild birds are usually in their best plumage late in the shooting season, but as the amateur need not have any voice in the time or manner of their death, I shall say nothing further on this subject.

Of other British birds suitable for screens, there are probably numbers that we do not know, and many others that we might mention, notably, black game; woodcock, curlew, gulls, and sea-birds of numerous sorts. Of wild pigeons, the prettiest screen we have made was from a stock dove (*Columba oenas*), the metallic colouring on the feathers of the neck being particularly effective, and the wings beautifully shaded. A teal in perfect plumage, Fig. 3, is (as probably our readers well know) a most beautiful little bird, and in making a screen of one, we recommend the following variation from the plan of operations already given, when dealing with a pigeon. In skinning the neck it will be found impossible to stretch it sufficiently to let the head come through, and it must therefore be slit or cut throughout its entire length. This cut is most conveniently made in the course of skinning, and should commence from the centre of the back and run up the back of the neck and



Fig. 3.

head sufficiently far to let the head come through without difficulty. I prefer the back of the neck for this cut, because the feathers naturally meet and form a ridge there, which hides the subsequent stitches, but, of course, the intended posture of the bird may render it more desirable to make the cut up one side or in front. When the skull has been prepared, and the feathers redrawn over it, the wire to support the neck should be sharpened, then wrapped round, to within about two inches of its point, with wool, to a size similar to the naked neck of the bird, and then be inserted through the skull, leaving the end projecting, as a handle to assist in bringing the bird to its proper posture when placed on the board. The skin of the neck should be very slightly anointed with the arsenical soap, as it is almost impossible to prevent some of the feathers from getting soiled in some degree, and the cut must then be sewn up. This requires a good deal of patience, as the feathers are constantly getting caught by the thread, and seem to be possessed by a persistent idea that they are wanted to add to the stuffing in the neck. The best stitch for this kind of work is found to be that well known to schoolboys who have covered tennis-balls, and which is sometimes adopted in lacing up walking-boots; *i.e.*, passing in the needle always from the under side of each edge alternately of the parts to be brought together; by this means the skin is not so likely to tear, and the feathers more easily coaxed into their proper places as you proceed.

So much for the head, which in other respects, with the wings, is treated in the same way as before mentioned in the case of a pigeon. But when the screen has to be made up, it will probably be found that, owing to the narrow expanse of the wings, they would appear to be too small for the head, or, at any rate, that much of their beauty would be hidden under the breast-feathers and their effect lost. Instead, therefore, of gluing them close up to the stick, as in the case of the pigeon, it will be found desirable to fix them some distance apart at the base, dispensing, perhaps, altogether with the tie A, mentioned in

a former article (see Fig. 4, page 289), and instead of the appearance there presented when one wing is affixed, it will be as in Fig. 1, page 321. It will be seen that to effect this, the millboard must be made proportionately larger, and so long as it is covered by the breast-feathers, the wider it always is the better. It should also be somewhat stouter than in the case of a bird whose wings are brought close up to the stick, or what is perhaps better, the addition of a piece of millboard, to be glued and tied to the inside of the wings after they are fixed, to correspond with the piece attached to the stick. This arrangement will leave a larger space to cover in the inside of the wings, and for this purpose both the tail and the wing covers may be brought into use. The under side of the tail of this bird especially should be made use of, as it is very pretty.

Should any light-coloured feathers of a bird become soiled with blood, either from the effects of being shot, or unskillful management in skinning, or be stained with dirt, they may be cleaned in the following manner:—Paint the parts affected with a soft brush and warm water, till they are soaked through, without, however, ruffling the feathers, and then sprinkle them thickly over with dry whitening (such as is used for cleaning plate), but powdered finely, and let it thoroughly dry on, then brush it off with a moderately stiff brush, stroking the feathers the right way, and it will be found that most, if not all, the stains will have disappeared, having been soaked up by the whitening with the moisture.

These few hints upon screens will be found useful in dealing with large birds, such as swans, herons, and other birds too large for hand screens, but which may be set up in the manner described, without a handle and affixed to a standard, like the old-fashioned banner screen; but in dealing with such, it will probably be advisable to further strengthen the wings by passing a strong wire up each of the pinion joints, tying it securely to the elbow joints, and to change the millboard for a stout piece of wood.

We wish it, however, to be distinctly understood that the wanton destruction of birds for this purpose is strongly to be deprecated. There may always be found a large supply of dead birds to select from, without having recourse to unnecessary cruelty.

COOKING.

RIVER FISH.

Boiling Fish.—The boiling of fish differs considerably, both in its object and the manner of effecting it, from the boiling of meat. In the latter it is often desired to get all we can out of it, and in cases where that is not the exact intention, still what *is* got out is not necessarily lost to a family's consumption. In the former the object almost always is to keep all the nutriment we can inside the article which is boiled; and what does issue from it in spite of our precautions is, in England at least, wasted and thrown away.

Theoretically, therefore, all boiled fish ought to be plunged into boiling water, to set the albumen and curd in its flesh, and to fix in an insoluble form the particles which would have been dissolved in cold or tepid water. Practically, the rule must be observed with a certain degree of laxity. If a very large and thick-set fish, as an unusually fine salmon or cod—or only the half of one—be plunged in boiling water, as will be seen in the section "Eggs," the heat penetrates its substance but slowly, the outside and the thinner portions will be overdone while the inside near the bone will be still raw. The only means of obviating this is to put the fish into *tepid* water, and give it time to heat through gradually before coming to a boil. When, however, a large fish is scored or "crimped" (whether alive or dead) down to the bone, as cod is often treated, it may be set on the fire in boiling water, as the scoring has

nearly the same effect as if the fish were boiled in slices or moderate-sized pieces, which is often done now that "large joints" are out of fashion, and carving at a side table is in. The difficulties of cooking a very large fish entire *well* (i.e., retaining all its proper qualities) are so great that a little display may be wisely sacrificed to securing a satisfactory amount of firmness and flavour. Flat fish; as turbot and brill, are rarely so thick that they may not be put into boiling water at once. Halibut, if only on account of its size, is mostly cooked in slices. John Dory, which is not a flat fish, although it is flat, may be set on in cold water, whatever its size, as it takes a great deal of boiling, and is none the worse for being robbed of a little of its strong and peculiar flavour.

All fish, while boiling, should be skimmed as carefully as meat. Take it out of the water when it is done enough, and keep it hot, if it has to wait, by leaving it on the fish-bottom, set diagonally across the fish-kettle, so as to receive its steam, and covered with a napkin dipped in the hot boilings.

For boiling carp, pike, tench, and several other river fish (especially those intended to be served whole *cold*), as well as lobsters, crayfish, shrimps, prawns, and other crustaceans, French cooks often used a made-up liquor, which they call *court-bouillon*. We ourselves do not like and therefore do not recommend it. Certainly it covers any muddy flavour by overpowering all natural flavour, but it utterly spoils sweet and delicate fish, and, in our opinion, is ruin for lobsters and shrimps. Nevertheless, if the cook is requested to use it, she may thus make her

Court-bouillon.—The quantity—which must be enough to cover the fish well—will consequently depend upon its size. Take equal parts of vinegar, red wine, and water; add cloves, peppercorns, bay-leaves, thyme, parsley, marjoram, shallots, sliced carrots and onions, and salt. You may also add lemon-juice, and almost any aromatic that suits your fancy. Let these simmer and stew for an hour. The first time of using a *court-bouillon* there is no need to take out the flavouring ingredients; put the fish to them as they are. If it is to be eaten cold, take the kettle off the fire before it is quite done, and let the fish cool in the *court-bouillon*. When you take the fish out strain the liquor. It will serve several times, only it must be diluted with water every time of using, otherwise it would become too strong and concentrated. Oil and vinegar is the only sauce that is customarily eaten with fish boiled in *court-bouillon* and served cold.

The Salmon.—We call the salmon a river fish because it is in rivers that it is most generally caught. The river also is its place of birth. But the sea is its home and its pasture-ground, to which it must return to renew the strength exhausted in its fresh-water revels, or die. In fact, it inhabits fresh and salt waters alternately. It spends its summer inland and its winter in the sea. Moreover, as the swallow returns to the roof or shed that gave it shelter, so does the salmon to the gravelly river's bed where it first saw the light. This instinct involves important consequences. If all the salmon ascending a river are taken, that river will be henceforth salmonless. No stranger salmon, cruising along the coast, will mistake that river's mouth for its own river's mouth. To re-stock the river young salmon must be reared in it, thence to find their way to the sea at the proper age, in the certainty of their coming, like curses and bad shillings, back. This fact has been already taken advantage of with promise of good success. There were no salmon in the Mediterranean; consequently none could ascend the Rhone and other rivers that run into it. But salmon fry, bred at the French piscicultural establishment at Huningue (close to the Swiss frontier, in the neighbourhood of Bâle) have been turned out into the Rhone, and there is reason to hope that, after their descent to the

sea, they have thriven so well on the shoals of sardines as to found a colony of Mediterranean salmon. They may find, however, a formidable opponent in the powerful and gigantic tunny. A still more difficult task appears to have been accomplished, namely, the naturalisation of this noble fish in several Australian rivers. Salmon is abundant, and, moreover, cheap, in Norway and some parts of North America. Here the price is kept up, and made pretty equal all over the country, by the successive discoveries, first of packing it in ice, and secondly of railways. The penny-a-pound times, and the refusals of proud-stomached apprentices and servants to eat salmon more than three times a week, are gone for ever.

In salmon you eat concentrated fish, which, indeed, is true of all fish that are exclusively piscivorous. We do not think the pike can in this respect be for one moment compared with the salmon. But in all questions of this kind tastes vary so widely and so frequently, that it is almost dangerous to express an opinion positively.

Salmon is in season from the beginning of February to the end of August; cheapest in July and August. The fresher from the sea the better it is. A healthy fish has bright silvery scales, small head, plenty of fat at the belly part, and flesh of the pleasing hue emphatically called "salmon colour." On page 324 we give an engraving of the fish in good condition for the table. A shotten fish, that has remained too long in fresh water (sometimes called a "black fish," on account of its dull dark leaden tint) is lank and gaunt, with a large lantern-jawed head, the gills infested with small white worms, the flesh flabby, pale, and unwholesome. The whole aspect of the fish is repulsive, and anything but tempting to eat. We have never seen such exposed for sale (illegal) in England; but on the borders of salmon rivers they are largely poached, and consumed by the poachers, during the close season.

Boiled Salmon is sometimes sent to table with the scales left on it, for show, and to make the fish, or the piece served, look bigger; but we do not recommend the custom, which, in our eyes, has an uncleanly appearance. Moreover, when properly scaled the skin is not only eatable but nutritious. If the fish has roe it may be either served with it, or—which is the more artistic practice—mixed with lobster or anchovy sauce. If a middle-sized fish, or good part of a large one (seven or eight pounds), is to be served entire, the precautions above indicated must be observed. From thirty to forty minutes will not be too long to let it remain in the water after boiling. If its appearing on the table whole is not a condition that is insisted on, it will be better cooked by being cut across into handsome pieces of from two to three pounds each, and so plunged into boiling water, and boiled from twenty to thirty minutes. They can then be served side by side in their natural order and position in the fish. With a garnishing of fresh fennel or parsley they will make quite as presentable a dish as one large piece, and will be much more equally and palatably done. In fact there is considerable economy in avoiding the dilemma of either overdoing the thin parts or underdoing the thick in a large fish served entire. Cooks are mostly caught on the first horn of the dilemma, which causes both waste and disfigurement.

Any of the slices not used, removed from table whole, should be laid at once, and while still warm, in a dish with a cover (as a vegetable or a *paté* dish), and covered with a mixture of half vinegar, if strong, more if weak, and half the boilings of the salmon skimmed. Add a few peppercorns, put on the lid, let it stand in a cool place for twenty-four hours, and you have capital pickled salmon.

Boiled salmon is so excellent, and its natural flavour requires so little foreign aid, that it is quite able to hold its

own and maintain its ground with no other sauce than a boatful of good plain melted butter, the unadorned canvas on which cooks embroider such a multitude and variety of other sauces. As melted butter—not butter melted—is one of the keystones of English cookery, we cannot give the formula at a more appropriate opportunity than the present.

Melted Butter.—Take a lump of butter the size of a hen's egg, cut it into three or four pieces, and work them with a knife into as much as you can get them to take up of a dessert-spoonful of flour. Put them into a saucepan with three-quarters of a pint of cold water, keep stirring in one direction as they gradually melt, and dust in what remains of the flour. When they are well mixed, smooth, and the sauce boils up, it is ready for serving. Or you may simply put the lump of butter in the saucepan with cold water, gradually dusting in the flour as it warms and melts. This rough-and-ready way requires careful management to prevent the flour from gathering into knots. Good melted butter, even if smooth, should not be too thick or pasty. It will acquire that condition by being kept waiting too long at the side of the stove. In that case you can easily thin it by the addition of more butter and a little warm water. Another good accompaniment to salmon is

Mustard Sauce.—When your melted butter is on the

it; let it boil twenty minutes or half-an-hour. Strain off the boilings; let them stand awhile to settle; and with the liquor poured off (instead of with water) make melted butter, being liberal with the butter. When it boils, put in your prepared and picked lobster-flesh, and let it stand on the side of the stove to warm through. If you have any salmon roe, you may at the same time add it (previously cooked and separated into grains). Lobster sauce should be kept delicate in flavour, not high and pungent. The value of Ude's advice, "Never neglect to season your sauce; without seasoning, the best cookery is good for nothing," entirely depends on the meaning of words. For "seasoning" read "flavour," and he is right; for "seasoning" read "spice," and he is wrong.

Any surplus lobster sauce, with the sauce reduced and thereby thickened, will make delicious lobster patties or *bouchées de homard*.

Mock Lobster Sauce.—Take cold turbot, not overdone. If you have no turbot, boil a thick fleshy sole. While hot, remove the meat from the bones, and let it cool. Smear the cold fish on both sides with essence of anchovies, or anchovy paste, or essence of shrimps. Cut it up, not too small, into dice and pieces resembling those which serve for real lobster sauce. Dust with a little very finely powdered sugar. Make your sauce itself

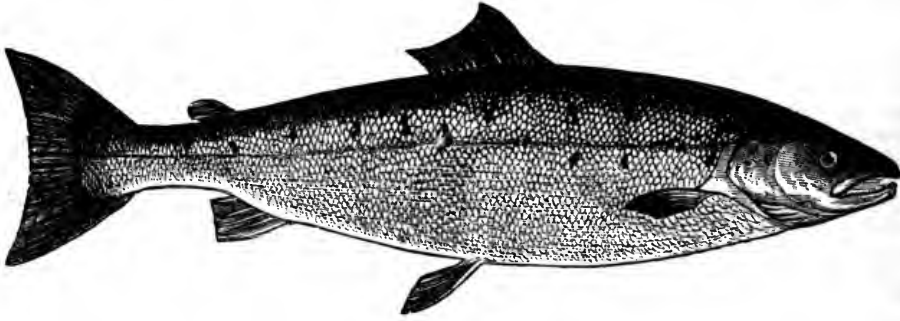

THE SALMON.

point of boiling, incorporate with it a small quantity of *made* mustard (not in powder) mixed with a dessert or tablespoonful of vinegar. The strength of this sauce must depend on the taste of the guests; but it is better to underdo than to overdo the dose. It is best kept in the state of a delicate sauce-piquante, with just enough pungency for the palate to perceive it, without being able to decide to what seasoning to attribute it. Mustard sauce goes exceedingly well with boiled mackerel and with boiled or fried fresh herring.

Anchovy Sauce is also orthodox with salmon. Incorporate with your boiling melted butter a couple of teaspoonfuls of essence of anchovies to make a sauce-boatful. You may make a similar sauce with essence of shrimps; but true shrimp sauce (containing the meat of the shrimps) is not usually served with salmon. The sauce for grand occasions is

Lobster Sauce.—Wash the lobster well before boiling, so as to cleanse it thoroughly from the sand or mud which is apt to adhere to it, especially if it be a hen-lobster with a nest of eggs under her tail. When cold, pick out the flesh of your lobster. If a fine one, you will probably reserve the handsomest pieces for a lobster salad or a Mayonnaise. The pickings and trimmings, the interior of the head and of the small claws, will suffice for your sauce. Separate them into small pieces; dust them with a very little pepper or cayenne; add the juice of a lemon; and set them aside. Take the broken shell of the lobster; again see that it is free from grit; pound or break it up roughly in a mortar; set it on the fire in a little more cold water than will cover

exactly as if there were no deception in the matter. It will help you greatly, if you can add and mix with your ingredients a little lobster-roe previously bruised in a mortar. This, if you have it, can be spared without loss, or even suspicion of loss, from a lobster salad or a Mayonnaise. Moreover, having a lobster, you can boil the shells, as above directed, and use the liquor to make your sauce. Finally, throw in your disguised turbot or sole; heat and serve.

These little economies, like the turbot patties just indicated, cannot be justly sneered at as "leavings;" they are merely the employment of extra supplies which, in any case, *must have* a previous cooking.

Salmon Steaks are cut, about an inch thick, out of the middle or tail-end of the fish. Dry them between the folds of a napkin, dust with flour, fry with care that they do not stick to the pan; or broil over a clear and gentle fire, wrapped in oiled or buttered paper. Serve with mustard sauce, if any; or with a lemon to squeeze over them.

Kipperd Salmon salted, smoked, and dried, is cut into slices, and little more than warmed through, in the oven or before the fire, like red herring. Use mustard sauce, if any, but none is needed.

The Great Lake Trout and Salmon Trout are treated exactly in the same way as salmon. The latter, however, especially, is a more delicate and tender-fleshed fish, and requires less time (for equal weights) to cook, than salmon.

River Trout are still more delicate. Small ones may be fried or broiled. Boil the finer specimens in salt and water, acidulated while still cold with a little vinegar,

thrown in when it is on the point of boiling ; they are soon done (from five to ten minutes), and require careful watching and tender handling.

Potted Trout (Charr) is often merely a proof that the preparer has learnt the art of embalming ; and that the bodies of trout, like those of men, may be kept for indefinite periods, and transported to unlimited distances. What they taste of, besides spice, at their journey's end, we should be sorely puzzled to decide.

ANIMALS KEPT FOR PLEASURE AND PROFIT.—THE HORSE.

ENGLISH HORSES.

HAVING noticed, in our previous article, those breeds from which the English horse appears to be derived, we come next to the consideration of species into which the genus is divided, and to show the great adaptability of the English horse particularly, for the duties which he has to perform. There are many kinds of horses in this country, not only suited to us, but unsuited to others, inasmuch as there is nowhere else exactly the same call for his services. And this adaptation of the animal to peculiar wants and necessities proves the capability of the horse, his dependence upon structure and breeding for his powers, and the care and consideration which have been given to the subject in England.

The Cart-horse.—In the Introduction we hardly mentioned the agricultural horse with the honour which belongs to him, for we ought to have informed the reader, when speaking of indigenous breeds, that one of the earliest known kinds—known before any proper records of the horse exist—is our English cart-horse. He was no beauty ; there was but little external grace to recommend him ; but, like other ill-favoured animals, he had some sterling qualities in his favour. So we crossed him with the Flemish, and even with something in Suffolk which produced what we call the *Suffolk Punch*. An improved sort from the original arose later, and we believe rather repudiates all connection with the drooping quarters and fiddle-case head of the English cart-horse.

The *Lincolnshire* and *Clydesdale* are also two kinds, one of which is known, or was known, to us as the *London Dray Horse*, and the other as the handsome, active, and powerful cart-horse used in the lowlands of Scotland. It does not clearly appear from any writer what are the absolute crosses which go to furnish these remarkably fine specimens of the agricultural horse, but it is always admitted that the Norman blood is the great ingredient which, combining with the Flemish and English, produced the antitype of those magnificent horses for which Suffolk, Lincolnshire, and Yorkshire have made us famous. There is indeed another class, called the *Cleveland*, equally doubtful in origin, which is of a lighter kind, resembling a powerful coach-horse. If this has been crossed, as doubtless it has, with the heavier cart-horse, the result would be a combination of power and activity of considerable value to the farmer.

Lighter Horses, and their Adaptability to our Pursuits.—We have said that the adaptability of the English horse to our various uses was somewhat remarkable. Until lately, the racehorse has been wanted nowhere else but in this

country. Our taste for him has become catching, as contagious as the scarlet fever, and perhaps equally dangerous. When our talents produced him, it was because our necessities called aloud for the propagation of qualities somewhat meet to be combined with our own.

The *Racehorse*, all over the world, is an English horse now, for it is doubtful whether the best Arabs can compete with him ; and France, Germany, America, and Australia have bought and borrowed him from us.

The *High-class Hunter* is bred nowhere but in this country, save by accident, because his qualities, as we shall learn by-and-by, are fitted only for that especial purpose ; while

The *Poor Man's Hunter* would be despised anywhere but in merry England, where he provides health and cheerful and innocent amusement for a very large class of people.

These are mere instances of that care and talent which produce just what we require for our own use. The *Hack*, the *Harness Horse*, the *Charger*, and the *Farmer's Horse*, be they of what class they may, are universal necessities. Every country on which the blessings of civilisation or the dangers of war have alighted requires such horses as these, and it has them ; and, as we advance in this

important subject, we shall generally see that the genius of the people has achieved a victory over difficulties.

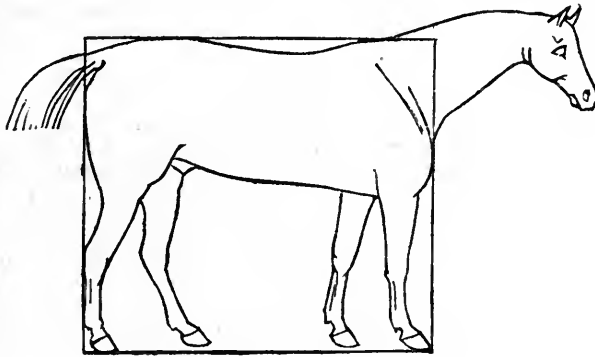

Fig. 1.

STRUCTURE OF THE HORSE.

No man can know much about the horse, or how to buy him, without studying his structure or external form, as distinct from his anatomy. Our present object is to give the reader a general knowledge of the shape of the horse in his best and most conspicuous points. In speaking of him in detail we shall be

able to state those which are the *most essential* for each particular class, and which may be best dispensed with. It is exceedingly difficult to find them all perfect in one subject ; and even then he might not come up to our standard, unless his moral structure, his courage, docility, and freedom from disease coincided with his physical excellence.

His *Head* should be broad in the forehead, but not large between the eyes ; the proportion of one part to another is, however, of most consequence, and the expression of face, which may be easily caught by practice. The eye should be large and prominent, which is characteristic of high breeding and generosity. The nostril should be large, and after exercise expansive, this is usually a sign of fine wind, though not necessarily so, as the internal structure may be equal to the highest exertion without this conformation. The muzzle should be fine, and the jaws open, or wide, as on this depends the way in which he may be taught to carry his head. We leave the teeth for the present.

The *Neck* should be of moderate length, and much longer over the crest than below. At a cursory glance, this will give evidence of a well-placed shoulder. Horses with long thin necks are not generally very good-winded, and frequently require to be steadied by a martingale, or some such device, of which we shall speak later. The mane should be thin and fine : curliness and thickness denote want of breeding.

The *Shoulders* are exceedingly difficult to judge of by sight. High withers—*i.e.*, the upper point of the

shoulders where they meet, are not a requisite. They sometimes are caused by the falling away of the muscles—a common fault in old horses; and they are apt to be galled by the saddle. The shoulders must be oblique, running into the back, and should be well clothed with muscle, which will help to carry the saddle well. Without good shoulders no horse can be a really good goer, and they are less able to recover themselves when they make a mistake. It was said formerly that the late Lord Chesterfield was almost the only infallible judge of good shoulders without mounting. Look well to this point; it is most essential, and requires great practice. When the shoulder is upright instead of oblique, the horse may go high, but he is sure to go short; and he usually puts his foot down on his toe instead of on his heel.

The *Chest and the parts behind it* are also of great importance, for they contain the organs of respiration. It should be round and of fair proportions; if it is not so the horse is seldom of a very good constitution. A very broad chest is, however, an obstacle to great pace, and not therefore desirable in horses sought for very fast work, as the racer or high-class hunter. We shall notice the modification of these rules elsewhere. For the general form of the horse, the eye of the person who wishes to judge should accustom itself to a fair capacity of chest as conducive to health and endurance. This should be looked for chiefly in depth of girth, so that standing sideways the legs shall appear to be short, and the body near the ground.

The *Back* should be short; that is to say, there should be room for a good-sized saddle, and not much more, from the withers to within a couple of inches of the hips. The rule which requires shortness above and length below is here again the correct one. It should flow from behind the shoulders with a graceful curve or segment of a circle, and whatever length there may be along the back should be found in the obliquity of the shoulder-blade and the quarters. The shape of the back depends upon the muscles with which it is clothed; and later we shall endeavour to explain the difference between condition and the want of it, in furnishing the parts of the horse with the roundness the eye so much admires. At present we only desire to give the conformation of a well-shaped horse for general purposes. Although we have given a sketch of the horse having for its basis a perfect square, it will be well to remark that fast horses measure usually a little more in length than they do in height, and that the perfect square is only adapted to the cob-shaped animal.

The *Hind-quarters*, to look at, should be round and muscular; but for work the roundness may be less necessary if the muscularity be well developed. Broad, and what are known as *ragged*, hips denote freedom and strength, especially if there be plenty of length from them to the outside of the upper thighs. The best way to judge of quarters, if they look well generally, is to stand behind the horse, and see that they come close down together some distance below the root of the tail on the inside of the upper thighs. To be slack here, and devoid of substance or muscle, is to be "split up behind," a common enough expression in horse-dealing, describing a fault never to be overlooked. Your horse should also look broad from this point of view on the outside; and the muscles, both of the upper and lower thighs, should stand out like the muscles of a blacksmith's arm when in motion. The tail should be set on high, and should be carried handsomely, though we shall show by-and-by that a drooping quarter is frequently characteristic of weight-carrying and jumping, the hocks being then usually well under the horse.

Fore Legs.—The value must be known to be appreciated. Beginning from the chest they should appear to be placed forward enough to give substantial firmness to

the body when mounted. If they spring from the back part of the shoulder, the horse is liable to fall. The part of the leg called the "elbow" is that which is nearest to the girth; and if that bone be turned inwards so as to leave little or no room between it and the fore-ribs, it will interfere with the action. This may be discovered at first sight by the toes turning out. The opposite conformation of course turns them in. The fore-arm (*i.e.*, from the elbow to the knee) should be long and muscular; the knee large and flat, but not receding—a form which has received the name of "calf-kneed," from its similarity to that of the calf. The bone which descends from the knee to the fetlock, is called the cannon-bone; it should be flat, free from wounds and lumps, and the sinews, the largest of which is called the "suspensory ligament," must be clean and separately sensible to the touch, like strong cat-gut or wire. The fetlock itself should be clean and of moderate size, and the pastern, which extend to the foot, should not be upright, as the action will then want elasticity; whereas, on the other hand, should it be too slanting or oblique, there will be a corresponding liability to weakness. This is rarely the case with half-bred horses.

The *Foot* is of so much importance, that when we come to speak of shoeing we shall have occasion to go further into this than would be consonant with our present cursory view of external form. Almost every writer of note has his views on the subject; and the best authorities are Mr. Mills and Professor Spooner. No amateur can detect disease at sight, unless the case be a very glaring one. When any suspicion exists, we recommend professional assistance for that member (as well as for the eye); it should stand out from the pastern straight, and both feet should appear to the eye equal; in measurement they should be so; it is said the foot should stand at half a right angle with the base, in this case, the sole. The sole of the foot should be slightly concave. The names of the parts most commonly alluded to are the toes; the heels; the quarters, which are the parts between the toe and the heel; the bars, which meet in an angle on the sole, having the heel for their base; and the frog, a ragged and elastic substance between the heels. These have all their uses, which will be explained at the proper place. At present, sufficient has been said for an unprofessional inspection; "No foot, no horse," is the horseman's proverb.

Hind Legs.—What we have to say here is soon said. We have already mentioned the necessity of muscular power in the thighs. They should also have considerable length, which is described in horse-dealer's language as "hocks down to the ground." The hocks themselves are most important, as the propellers of the body. They should be broad to look at sideways, but narrow and clean to stand behind, like a couple of boards. They are the seat of disease and infirmity which will be explained hereafter. The hind cannon-bone is subject to the same remarks as the fore; and is more frequently passed by with less examination, because it is presumed to be less liable to damage. The belly meets the stifle at the bottom of the *back ribs*, which should be long, and tolerably close up to the hips and quarters, especially in horses required to carry weight.

Height, Colour, and Age.—We are now to give you the average height of the horse, which we may put for *general* utility at fifteen hands two inches, equalling sixty-two inches, or five feet two inches. The ordinary height of horses is below this; but they are called small by the dealers, and would not meet the demand for saddle, harness, or hunting, so generally. Most racehorses, as well as hunters, are above it; carriage-horses much in excess of it; and hacks considerably below it. For comfort in the latter capacity commend us to fourteen hands two inches; while for a hunter in such a county as Northamptonshire, where the fences want looking over, we prefer, at

least, an inch or two more. But we like the height to be in the body and not in the legs.

"A good horse," says somebody, "can never be of bad colour." We differ from this gentleman, whoever he may be, and so does our groom. Some colours are proverbially hardy, others soft; and unless a white or light grey be very cleanly in his person he gives a great deal of trouble in the stable.

Bay horses with black legs or points—as they are sometimes called—are generally good, and when bright, very handsome.

A good brown with a tan muzzle is regarded as characteristic of constitution; and a dark rich chestnut is the handsomest of all. A golden chestnut is a good colour, indicative, some say, of pace; but they are frequently hot and skittish; and a pale, washy chestnut is said to show want of stamina. Of greys, the *stea-bitten* and the mottled are the handsomest, and usually considered the best; as they approach white they are apt to stain in the dirt of the stable, and require much soft soap and water and what is commonly known as "elbow grease" to keep them clean. Iron-grey is less common, and we have known one or two hardy horses of that colour; and blacks, excepting as chargers, cavalry horses, or in mourning coaches, are not popular.

Roans are considered to be as a rule very hardy; we have seldom seen a bad one, but they are not usually remarkable for breeding or quality. The texture of the skin is a more valuable test than colour; it should be soft, smooth, silky, and is indicative of health and condition. The swelling of the veins in exercise is another sign of the same thing, and, moreover, furnishes some proof of a ready circulation.

Having given these instructions for an investigation of the general appearance of the horse, we add a sketch on the basis of the square as we proposed doing. (See page 325.)

COTTAGE FARMING.

V.—ARABLE HUSBANDRY (continued).

Farmyard Manure, made under covered homesteads and feeding-boxes, proves to be of more value than that made in open yards and dunghills; and if this is true of large farms, it is still more so in the case of small farms, of from one to twenty acres, where the lesser quantities of manure daily added are more exposed to the wasting influence of the weather. Most cottage farmers have a pit, which keeps the manure together at the sides, but the surface is exposed to sun and rain, like that in the open yards of the large farmers. To gain the full advantage of a covered homestead the cottager's dung-pit should be roofed over. Into this pit the daily cleanings of the stable, cow-house, and piggeries should be well mixed together, and deodorised with dry earth, rough salt, and the ashes from the cottage. The manure-pit in most cases may be so contrived that the liquid from the stable—if there is one—cow-house, or piggery, may flow into it. But the more advisable plan is to use up the liquid with dry earth, and then to spread the wet earth over the pit. We have seen both the solid and liquid droppings of the stable, cowhouse—one horse and two cows—and piggery thus deodorised and removed to the dung-pit at least twice every day; and the advantage of the plan told successfully in the increased produce of hay, corn, forage, and root crops grown by the cottager. The wet earth from the "cottage commode" should also be added to the manure in the pit daily. If there is a liquid-manure tank—as there always should be—the slops from the cottage may flow into it, the pipes being flushed daily with a pailful of water, to keep all clean, and avoid stagnation and sewage gases.

The Liquid Manure Carts and Barrows of the cottage

farmers of the Continent are generally on the old swing-barrel plan, more common in large gardens than on small farms in Britain. But the old wooden barrel, whether swung on two pivots, or placed horizontally between two shafts, with the bung-hole uppermost, is fast being superseded by galvanised iron ones, of vastly-improved construction.

The old practice of applying small doses of farm sewage on the principle of the watering-pan, has also been given up in the case of cultivated crops, as in that of pasture; but the application of 100 tons of water, to wash in artificial manure and supply moisture to the roots of forage plants at the same time and of lesser quantities, applied by water-drills or by hand, are fast coming into general use as improvements; and, therefore, cottage farmers who have not water laid on to their fields by pipes and hydrants, should have each his water-barrow or cart. A pony swing-cart is often used for unlevel land, in which case, by means of a perforated hose, screwed on to the discharge-pipe, and lying on the ground, or by discharging the water into a long shallow or perforated trough, water could be applied at the rate of 100 tons per acre, about 141 gallons per pole of 30½ square yards (see tables); and by screwing on a vulcanised india-rubber hose, terminating in one or two legs, water could be applied to one or two drills, either continuously or on the principle of the drop water-drill. A larger water-cart, supported by three wheels, is sometimes used. It is made for comparatively level work, but can be made suitable for unlevel land.

The following three tables will enable the cottager to calculate the number of plants grown per acre, and the weight and measure of water required to water them:—

TABLE I.
CUBIC MEASURE AND WEIGHT OF WATER.

Cubic Inch.	Ounce.	Pound.	Stone.	Qr.	Cwt.	Ton.
17329	1					
277274	16	1				
3881836	224	14	1			
7763672	448	28	2	1		
31054688	1792	112	8	4	1	
62109376	35840	2240	160	80	20	1

TABLE II.
WEIGHT AND CUBIC CAPACITY OF LIQUID MEASURES.

1 gill	5 oz.	8.6648	cup. in.	
1 pint	1½ lbs.	34.6592	"	
1 quart	2½ "	69.3185	"	
1 gallon	10 "	277.274	"	
6 gal. 1 qt.	62½ "	1728	"	1 cub. ft.
11.2 gal.	1 cwt.	3105.4688	"	1.78 "
168.3 "	15 "	46656	"	27 "
224 "	1 ton	62109.376	"	35.84 "

TABLE III.
NUMBER OF SQUARE AREAS IN AN ACRE OF LAND.

sq. inch.	¼ sq. foot.	1 sq. foot.	1½ sq. ft.	sq. yd.	s. pole.	sq. rd.	acre.
144	4	1					
1296	36	9	4	1			
39204	1089	272¼	121	30½	1		
1568160	43560	10890	4840	1210	40	1	
6272640	174240	435600	19360	48400	160	4	1

The county customs relative to manure, at the expiry and commencement of leases, are very different. In some counties, the incoming tenant gets the manure left by his predecessor, without payment; in other counties, he has to pay for all the manure he receives, and also for the

unexhausted manure in the land. The custom in every place requires to be carefully attended to, both at the commencement and expiry of the lease; the more advisable course being to have the "tenant right," as it is technically termed, expressed in writing.

Liquid Manure Tanks on the old plan were generally circular, resembling a pump. The more recent ones are oblong. Those of the small cottage farmers of the Continent, who farm from one and a half to five acres, and upwards, are mostly oblong, and divided into three or more compartments (generally five) by subdivision walls. This is done purposely to enable the cottager to temper the liquid, by allowing the artificial materials added to undergo fermentation in one compartment while another is being emptied and a third filled, so that by such means he can adapt the supply to the manurial requirements of his different crops. The more advanced plan, however, is to mix the artificial manures required, at the time of application to the land, or else to spread them over the land, and wash them in, so that subdivision tanks are unnecessary; but a much larger percentage of water is now being used than in Flanders and other places of the Continent, so that, unless where there is a command of river, pond, or pump water, or town sewage, larger tanks will be required in which to store rain water for summer use.

The expense of a tank depends much upon the position. It is built and arched over with stone or brick set in cement (technically "steined"), plastered inside and puddled outside the mason-work with tempered clay, when requisite. Those made are quoted to have cost from 10s. to 14s. per cubic yard of liquid, or per contents of 168·3 gallons. A tank 6 feet wide and 30 feet long, by 6 feet deep, would contain 40 cubic yards = 6,730 gallons, and would cost £20 at the former price, and £28 at the latter. One 9 feet wide by 30 feet long and 9 feet deep, would contain 60 yards = 10,098 gallons = 2,799,360 cubic inches, or less than a rainfall of an inch to half an acre when spread evenly over the whole surface. A gallon of water weighs 10 lbs.; a cubic foot (6 gallons 1 quart), 62½ lbs.; a cubic yard, 15 cwt. 7 lbs.; 60 cubic yards, 45 tons and rather more. Many of the tanks in Flanders have a capacity of 200 tons and upwards, on farms not exceeding 5 acres. It is usual to calculate an inch of rainfall at 100 tons per acre, and this weight is necessary to wash in from 3 to 4 cwt. of guano, evenly spread over an acre of Italian rye-grass, in the summer season. Liquid manure and seed drop-drills apply from 200 to 500 gallons per acre, in sowing mangold-wurzel, &c.; watering plants

grown in rows with water-drills, the rows being 27 inches apart, from 1,000 to 2,000 gallons, according to the state of the land; watering newly-planted cabbages, and the like, by hand, requires from a pint to a quart to each plant. The number of plants per acre will be given under the respective crops. At present we are discussing the size of the tank and the quantity of water required per acre, so that it will be sufficient to say that from 6,000 to 50,000 pints or quarts will be required to water an acre of cabbages or Belgian carrots, &c., by hand, and half that quantity for half an acre. Some advocate the keeping of the farm sewage in one tank, on the Flemish plan, and the rain water in another; and the mixing the former with the latter at the time of application; and this plan has several things to commend it, as the water-tank can be filled full in rainy weather, without loss from overflowing; whereas, the sewage tank must never be allowed to

overflow. The urine from a milch cow has been variously estimated by experiment at from two to seven gallons daily, a horse one-third, and a pig one-seventh this quantity. The slops from the cottage can easily be approximated by measurement during a day or two, in a similar way, so as to estimate the size of the tank required to hold the farm sewage of the cottage, when thus collected separately. A portable pump, with a vulcanised india-rubber

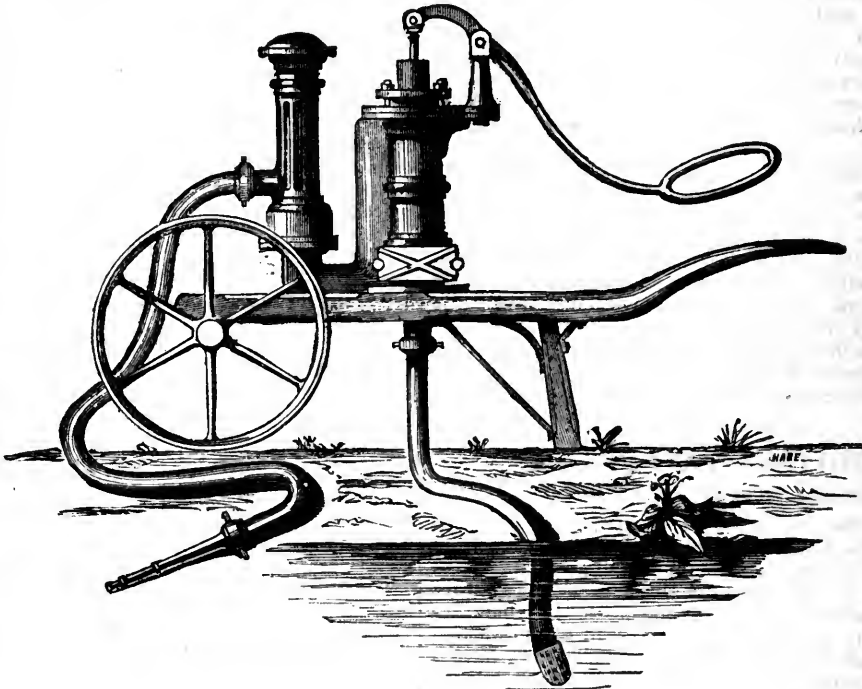

Fig. 1.

hose, as shown at work (Fig. 1), would serve both tanks, and the water and sewage could both be pumped up into a cistern, first the one and then the other, for being sent to the field through pipes by gravitation, in a mixed state; or the water and sewage could be pumped up into a water-barrow or cart, so much of each, when wheeled or carted on the field; or they could be wheeled or carted separately, should crops so require it. Our illustration is from an improved double action force pump, the working parts of which are few and simple, and in the event of accidents can be readily and quickly repaired.

Succession of Crops.—Few subjects have given rise to a greater diversity of opinion than the best mode of cropping land. Some even argue that if land is properly cultivated and manured, it will continue to grow wheat or any other crop, year after year in succession, for an indefinite period; and the argument is supported by actual experiments, extending over a long series of years. Such examples, however, when closely examined, are isolated and exceptional in character, and wanting in many respects to be of general application. They prove much in the progress recently made in the manufacture and use of artificial manures—as will subsequently be shown when we come

to treat of specific manures—but they do not disprove the soundness of the alternate system of cropping. If the cottager is a freeholder or copyholder, he will be at liberty to adopt any system of cropping he may judge best, and to make such changes in the rotation as future improvements may suggest; but if he is a tenant, the mode of cropping is a matter of special agreement with his landlord. A written lease for a term of years, extending over four or five rotations of the farm, renewable one rotation before expiry, is now generally considered advisable both for landlord and tenant, but many tenants prefer yearly tenancy. The common period for farm leases is seven, fourteen, or twenty-one years. Should a lease be allowed to run out, and the tenant remain in occupation from year to year, the conditions of the expired lease as to cropping will (by law) still remain in force. Should a tenant have no lease or written agreement as to crops, he will be considered to be bound by the custom of the district in which the farm is situated. And whether he has or has not an agreement, if, at the expiration of his occupation, the farm is found to be depreciated in value, he will be liable to an action for "dilapidations." In either case, the stipulation for cropping should be liberal, and carefully drawn up, suitable provision being made for change with consent of the landlord, so as to enable the tenant to profit by improvements made during the currency of his lease. And such changes are as necessary for the landlord as the tenant, for unless the productive resources of the land are developed during the currency of the lease, the landowner cannot gain their full benefit at its close. An extension of the four and five course shifts of cropping, according to soil, climate, and crops grown, are those best adapted for cottage farms. The following four examples are given for illustration:—

EXAMPLE I.

Four Course Shift of Cropping.—1. Potatoes, mangolds, and other root crops. 2. White corn crops—as wheat, barley, and oats. 3. Rye-grass and clover, for hay and green forage. 4. White corn crops—as wheat, &c.

EXAMPLE II.

Five Course Shift of Cropping.—1. Turnips, potatoes, and other root crops. 2. White corn crops—as wheat, barley, and oats. 3. Rye-grass and clover, hay. 4. Pasture. 5. White corn—as wheat and oats.

EXAMPLE III.

Six Course Shift of Cropping.—1. Turnip and other root crops. 2. Wheat or barley. 3. Rye-grass and clover, for hay and soiling. 4. Oats. 5. Peas or beans, manured. 6. Wheat.

EXAMPLE IV.

Seven Course Shift of Cropping.—1. Root crops, manured. 2. Barley and wheat. 3. Rye-grass and clover, for hay and soiling. 4. Pasture. 5. Oats. 6. Peas and beans, manured. 7. Wheat.

These may be given as general rules, but they must be varied to suit the nature of the soil. Some particular crops are only adapted to "light," others to "stiff" soils. On extremely "light" land, admirably adapted for the cultivation of turnips and barley, beans cannot be grown to advantage; and on those "stiff" soils, which produce the finest beans and wheat, turnips, mangold, and potatoes do not succeed, and their places have to be supplied by vetches, mustard, and other green crops. On "stiff" land, also, the practice of making naked fallows still prevails in many districts. This, where used, would take the place of the root crop, as given in our rules.

The third example is a modification of the first, and the fourth a modification of the second. A further modification of the five course shift is to allow the land under grass to lie two and three years in pasture, when it is termed the six and seven course ameliorating shifts.

It is easy to extend the four course shift to eight, twelve or sixteen. Thus:—1, Potatoes and mangolds, or swedes, where mangold-wurzel cannot be grown; 2, Barley; 3, Rye-grass and clover; 4, Wheat; 5, Turnips; 6, Oats; 7, Beans; 8, Wheat.

The practice of allowing the land to lie one, two, and three years in pasture (although yet common in some places, under the mistaken notion that any other would exhaust and ultimately ruin the land) is not well adapted for profitable cottage farming, the pasture for the most part being comparatively worthless for milch cows in the summer time, while the other shifts do not produce a sufficient supply of winter food, more especially in the north, where the winters are long. Thus, if the farm consists of seven acres under the above seven course ameliorating shift, three acres would be under pasture, one under hay, one turnips and potatoes, and only two acres under white corn. No doubt the land may "rest" in pasture; but the old proverb must be borne in mind that, "Milch cows eat with two mouths," and that what they consume with their feet adds little to the pail. Practically "rest" means the consolidation of the land with what cow-droppings and refuse vegetable matter it may receive, and as this can be better done by claying, deepening, and manuring, the more advisable course is to improve the land in this way, so as to adapt it for the four course rotation of cropping, sufficiently extended to meet the requirements of both the land and the cottager. For example, according to the four course practice, turnips, barley, grass, and oats, are each grown upon one shift, or plot of land, once in four years, in other words, there are three free years between individual crops; thus, if turnips are grown upon plot 1 this year, then three intervening crops of white corn and grass are grown before turnips are again sown in field 1, and so on for the other crops. Now, under an extended four course shift, there may be seven, eleven, or fifteen years between the crops, the land at the same time being kept in a higher state of fertility.

In situations where there is a command of town sewage or river water for irrigation, Italian rye grass may be profitably grown for two years in succession. The practice, therefore, would rank under a modification of the five course shift. But, as illustrated under Example II., the different crops would follow each other too closely in succession; consequently, the five must be extended to a ten course shift. If for easy calculation we assume the farm to consist of ten acres, in five two-acre fields, then two acres will be in Italian rye grass, one acre being broken up every year and one being laid down. Each of the other four two-acre fields would be divided into two plots of one acre each, so cropped as to keep individual crops sufficiently far asunder so as to prevent degeneracy. And this is one of the most promising modes of cropping for a cottage farm of a few acres of land, as will be shown when we come to treat of the actual quantities of produce now being grown per acre under this system of farming.

In the above hypothetical examples the land has been assumed to be of uniform quality, and this rule generally applies to cottage farms, especially those of the smaller size. There are, however, exceptions, where part of the small farm only is good land, the rest being of inferior quality. If practicable, the bad acres should, in getting the farm into a proper cropping condition, be so improved as to render them as equally productive as the good. But, when this cannot be done, the size of the plots on the inferior land must be inversely as their quality, compared with the others, in order to produce an equal amount of produce for the support of the milch-cows. In other words, the plots of the inferior land must be so much larger than those of the good land, purposely that the former may grow as much produce yearly as the latter, for the use of the cottager and his live stock.

HOME GARDENING.

THE VEGETABLE GARDEN (continued).

The Broad Bean.—The use of this much-esteemed vegetable is well known to every one who has a spot of ground for a garden, and particularly so to cottagers and farmers in most parts of the country, who consider a good dish of beans and bacon a very substantial meal at harvest time. The seeds are the only part used, and very delicious they are when gathered young and from good sorts. There are several varieties of the bean, but the principal now planted in British gardens are the early Mazagan, one of the hardiest and best-flavoured of any of the early kind; Beck's new dwarf green gem, early longpod, early hangdown longpod, early green longpod, Marshall's prolific, broad Spanish, and broad Windsor. This latter variety is greatly esteemed at table, and, as such, no one should fail to put in a row or two of seed. The time of sowing or planting will very much depend upon the time at which the produce is required; for instance, the earliest crop, whether early Mazagan or anything else, should be planted from the beginning of October to the end of

December, provided the weather continues open and mild, on a warm border with a southern exposure. These plant in rows, from two to two and a half feet asunder, making each drill two inches deep, and placing the seed not nearer than three inches to each other in the rows. It is a very good plan to sow a single drill very thickly under a south wall, in order that it may be protected during the winter months, and when spring arrives plant them out in rows. The most successful method is to sow them in a bed of light earth, under a garden frame laid sloping a little to the sun. Plant the beans all over the bed, an inch apart in every direction, and cover them about two inches deep with light earth; and when the plants are well up, and frost shows signs of approaching, cover the frame down with the lights, giving plenty of fresh air whenever the weather will permit with safety. Transplant them in February or March, provided the weather proves fine and mild; but not otherwise, as you had far better defer the work than run the risk of losing them. In taking up the beans, ease the earth about the roots, and take them up with as much soil as will adhere to the roots, taking off the old beans at the bottom, and also the end of the tap root. By this previous protection, the crop will be accelerated about a week or ten days. Although the greatest care may have been taken in the protection, the crop will sometimes be destroyed by very severe frosts. This being the case, we recommend our readers to guard against such a calamity by sowing them thickly in a moderate hot-bed in January or February, or in pots, and placing them in a cucumber-frame, and afterwards hardening them off until they are fit to transplant in the open ground. For full and general crops, begin to sow about the latter end of January, provided the weather is open and mild, such varieties as the longpod and broad Spanish, in some warm quarter of the garden, where the soil is light and mellow, and the exposure open, and continue planting the various sorts until May or even June. The space of time between sowings for successional crops should be carefully considered; that is to say, sow the following or successive crop as soon as the preceding one makes its appearance above ground, but not before. For the main summer crops, the broad Spanish, longpod, and Windsor are considered the most proper. The Windsor is considered the

best flavoured, but not so good a bearer as the others. For late crops, to come in about September, the early kinds are most proper, such, for instance, as the early Mazagan, Beck's new dwarf green gem, early longpod, early hangdown longpod, and early green longpod, as they are constituted to stand late as well as early. For early crops, one pint of seed will be required for every forty feet of row or drill; and for main crops, a quart at least will be needed for every sixty feet; while for late crops, the same quantity as recommended for early ones will be found ample. Plant all the early kinds, both for early and late crops, in rows two feet and a half apart, three or four inches distant from each other in the rows, and two inches deep; and the larger kinds for main crops, three feet from row to row, five or six inches apart in the row, and not less than four inches deep. Perform the work with a dibble, having a thick blunt end, to make a wide aperture for each bean (Fig. 2 shows the dibble, so as to admit each seed down to the bottom, without having any hollow below. As soon as one row is thus planted, move the line for the next, and with a rake fill in the holes, leaving the ground smooth

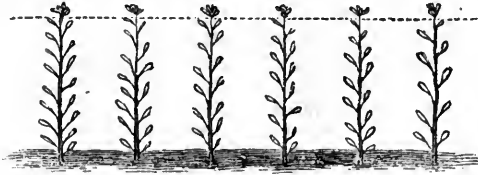

Fig. 1.

and even; and thus proceed until the whole of the space is completed. Dig the ground, and plant it bit by bit, in order to avoid treading upon it, which should always be avoided as much as possible. Some people make it a practice to tread the seed in (as they call it), in order to secure it in the soil; but this, we are convinced, they would never do were they at all acquainted with the use of atmospheric air in promoting germination and vegetation. The beans that are sown in the summer months, and when the ground is dry, may with advantage be soaked in soft water for a few hours previously, as it materially assists their germination; or if sown in drills, as they mostly are, the ground should be well watered, and the beans put in directly, drawing the earth over them while the ground is moist. As soon as the beans are up about three, four, or five inches, they should be earthed up on each side of the row, clearing away all weeds at the same time. The hoeing must be repeated as often as necessary, both to keep down the weeds and loosen the soil about their roots to encourage the growth. In performing this operation, great care must be taken not to cover the plants with earth, as such a

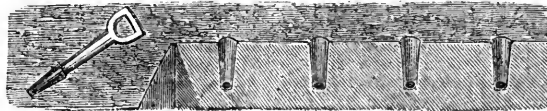

Fig. 2.

course would occasion them to rot or fail. If the ground between the rows were stirred with a three-pronged fork, after the hoeing is finished, it would be of considerable advantage to their growth. As soon as the different crops come into full blossom they should be topped, as it is termed; that is to say, the tops of each should be pinched off at the dotted lines (as shown in the cut, Fig. 1), in order not only to accelerate their fruiting and encourage the pods to become well filled, but to stop the ravages of the black fly, to which they are very subject. The beans should be gathered when about half their full size, as at that time they are much better flavoured than when they are older and become black-eyed. Beans for seed should be gathered when the pods are beginning to turn black; the stalks should be pulled up with the beans upon them, and placed in the sun till quite dry, after which the pods should be taken off the stems, and stored in a dry place for use. Some people take the seed from the pods as soon as dry, a practice we do not approve of, well knowing them to keep much better in the pods than when taken out; the precaution holds good with most other seeds.

Runner Beans.—This plant has a twining stem, and would rise or grow to twelve, fourteen, and even twenty feet high, provided it had sufficient support. This useful vegetable is trained in various ways; for instance, the general method of training resorted to by cottagers, is strings; another, and in our opinion a better method, is to have upright supports, one foot apart, with a cross-rail fixed at the top; and the third, which is the easiest plan of any, is to get some tall brushwood and fix it in the ground in the same manner as you would stick peas, and it will in time cover them, and look exceedingly picturesque.

Another very excellent method is that of employing small poles about six or seven feet long (like hop-poles on a small scale), which are stuck into the ground on either side of the row of beans, so as to cross each other diagonally.

The pods are oblong, seeds kidney-shaped, smooth and shining, and when ripe varying in colour according to the sort—that is to say, either white, black, or mottled. The fruit may be had in the open ground from June till destroyed by frost in the autumn. The unripe pods are the parts in request, and when boiled are very delicious. There are several varieties, as the scarlet runner, the most beautiful and lasting bearer, and consequently the best for a main crop; the white runner, a variety of the scarlet, the seed and blossom white, but the pods very similar to the scarlet kind; and the painted lady, the blossom of which is red and white. Although there are many sub-varieties, these are the only three worth growing. The scarlet runners, like the white and variegated, are tender in their nature, unable to bear the air of our climate before the latter end of April or beginning of May, the seed being liable to rot in the ground if planted sooner, even in a dry soil.

It must be known that sharp cold checks the plants, so that they make but little progress before the weather is settled and warm. The scarlet runner is most esteemed, on account of its greater prolificacy and longer continuance in fruit; the pods are thick and fleshy, and if gathered while young are very good. The white runner is also good for a principal crop. The painted lady is more of an ornament, but the pods are very good eating nevertheless.

The whole family of beans flourishes in a light and very rich soil, and if the land is a little moist, so much the better.

Do not, as a rule, commence planting the beans till the beginning of May, and then only a moderate crop, deferring the principal crop till the first week in June. The scarlet runner is the best for principal crops. Sow in rows about five feet apart, and in drills not more than two inches deep, placing the beans about five inches asunder in the rows; after which cover them up evenly, making the ground quite level. This vegetable may be planted on each side a walk, and so rodded as to form an arched top, making a very pleasant shady walk in the warm days of summer.

THE REARING AND MANAGEMENT OF CHILDREN.

IX.—CHILDREN'S CLOTHING (*continued*).

Nightgowns.—These should be made as simple as possible for little children. Take a plain breadth of calico at eightpence a yard, long enough for the child. Run and fell it together behind, leaving a placket-hole which must be hemmed. Double it in half, and double again to find the shoulders. Take a slope off; cut a straight slip in the side for the sleeves to be put in. The placket-hole should be open enough. Run and fell the

shoulders; scope out the neck a little in front, set it in a band three-quarters high; make the sleeves of straight pieces as long as the rows, and moderately wide; run and fell them together. Run and fell the top into the arm-hole, and set the cuff into a band that will slip over the child's wrist; then run a string round the top band; the bottom having been previously hemmed. The nightgown may be worn this way, or it may be gathered into a band sewn on at the waist in front as far as the arms, and lined with a similar band on the wrong side. The band in front is in one, with a pair of strings, piped and lined, that button or tie behind, but quite loosely, Fig. 17. In winter, a flannel gown is desirable for so young a child, made the same way, of Welsh flannel. If desired, the neck and wrists of the child's gown may be edged with embroidered work; but it is quite unnecessary. A child should have half-a-dozen longcloth nightgowns, and four flannel ones, as they require frequent changes. Some mothers make gowns much longer than the child's height, to wrap the feet in and keep them warm in bed. Fig. 17 shows the gown made to button on one side.

We subjoin a few designs for best frocks. Fig. 18 is a dark blue velvet dress. The body is cut according to our pattern before given, but full two inches larger every way, because the child will grow, and velvet is a costly material. The top of the body is drawn with a ribbon, and at the waist in front two little pleats may be noticed. There are similar ones behind. The skirt is set in the waist with pleats, the front width gored. Behind are a few box pleats. The front of the dress is robed with rich Spanish crochet lace, and the sleeves and berthe ornamented to correspond. Fig. 19 shows how the back is made and adorned. A broad, short pinked sash of dark blue saracenit should be worn, fastened behind.

Fig. 20 is a summer dress. There is first a fine Swiss muslin skirt, with a number of minute tucks edged with a deep embroidery. Over this is a tunic, gathered at the back and plain in front. It is gored and pleatless in front, and edged with a very narrow embroidery. Behind, the tunic is à panier, that is, a single plain breadth much longer than it appears, caught up into pleats in the sides where the seam joins it to the front of the tunic, and gathered in a bunch of gathers at the waist. This not only puffs it out, but gives the edge a scallop look like the front. No sash should be worn with this, but only a narrow plaid waist-ribbon hooked into a bow behind. Plaid ribbons seem to suspend the tunic at the sides. The body and sleeves are plain. The berthe sets out nicely over the sleeves, and is made with three rows of tucks and spaces alternately. It is edged with embroidery and so is the neck. There are plaid satin bows on the shoulders. A frock may also be made from this pattern without a tunic, and the trimming only put on the skirt to imitate one. Then a broad sash may be used, like Fig. 21, which shows the back of the little frock. The sleeves worn with the dress should have bows of plaid ribbon upon them.

Fig. 22 is a pretty design for a muslin frock body for a little girl. It is made with what are called *Sabot* sleeves—very wide frills stiffened up, and fastened down at the lower end to the body. They are exceedingly full and very closely pleated, and edged with lace or embroidery, and goffered when washed. The body is full, back and front, pleated into the neck and into the waistband. A sash and a plain skirt suit this body very well. If made in thick material, the sleeves must be lined with saracenit, and stiffening put between the sleeve and the lining.

Fig. 23 is a frock for a little boy. It is made without pleats in front, of cambric muslin with a deep hem and an embroidered edge. The trimming across the body and skirt is a double-edged muslin insertion, with a blue ribbon run in it. Embroidery edges the neck and sleeves. Either in velvet or muslin this makes a pretty frock; or in merino trimmed with velvet ribbon the same colour,

broad and narrow, and an embroidered edge added on one side of the velvet.

CLOTHING FOR CHILDREN OF SIX YEARS.

The present prices of longcloth and calico are much higher than they were formerly, and the quality is inferior. Longcloth under 8d. or 8½d. is not worth purchasing, because it so soon wears out, and then there is the trouble of making new things, and time occupied that might be otherwise turned to account. 8d. is a good standard price for both ladies' and children's clothing, and *longcloth*, not calico, should be purchased.

For a little boy of six years old, cut a *Shirt* according to Fig. 7 in shape, seventeen inches long and twenty wide (double). It is similar in pattern to the one used at two years old, but larger; the material is double at the top, so as

Drawers for Boys are not only larger, but vary from those used at an earlier age. Each leg is cut separately. The material must be doubled on the straight side of the leg, from A to B (Fig. 3), and here it is eighteen inches long, allowing for a hem and three tucks. But we recommend mothers, as children grow fast, to cut the drawers two inches longer, and dispose of the additional length in a way we shall presently describe. The measure, with the allowance made, is twenty inches from A to B, eleven from C to D, eight and a half from B to E, eleven and a half from F to G, and fifteen and a half from H to D. Run and fell the leg together from E to D. Round the end, from B to E, make an inch wide hem, and above it, three-quarter inch tucks. Cut a slit down the side from A to a. Make a quarter inch wide hem on the front side, and a very narrow one towards the back. Stitch

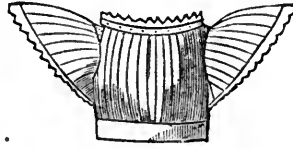

Fig. 22.

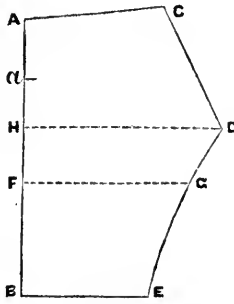

Fig. 3.



Fig. 12.

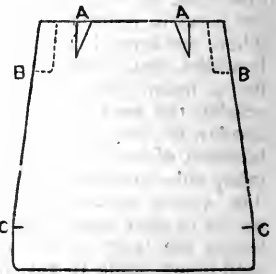

Fig. 7.

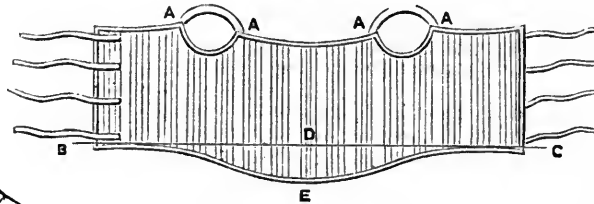

Fig. 10.

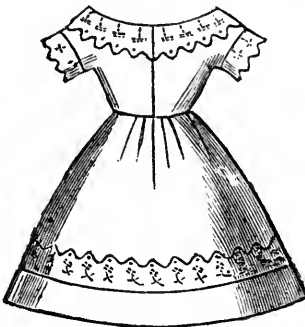

Fig. 19.

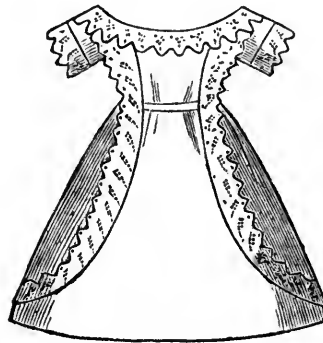

Fig. 18.



Fig. 23.

to form the shoulders. Cut the flaps at the mark at A A, and cut the top of the shoulders straight, in the manner shown there; the three-cornered piece between the shoulder and the flap comes away entirely. The dotted lines at B B show where pieces are applied on the wrong side to strengthen the arm-holes. Two straight bands are cut—each two inches wide and ten inches long—for this purpose, sewn to the edge of the shirt, and then turned down, pinned flat, and neatly hemmed. The flaps must be cut apart at the top, and hemmed round, as well as the edge of the shoulders. The seams should be run and felled before the flaps are hemmed, and left open at the bottom as far as C C. A gusset is inserted at each side at C C, and the open piece hemmed very narrowly. A hem, half an inch deep, round the bottom, completes the shirt.

the wide one across the other. Make the other leg, and then run and fell them together from C to D, going right round the other side from D to C. Lastly, set them in the bands, one for the front and one for the back—the front, thirteen and a half inches long, the half inch to turn in; and the back, fourteen inches, one half inch of which is turned in. Make a button-hole in each side of the front band, and one in the middle (shown in Fig. 4, at A A), but only at the two ends of the back. The drawers are now completed. To shorten them for use, make a tuck near the top of each leg, rather better than half an inch wide, at B B B B, and from C to C, on both sides, rather less than half an inch wide. As the child grows, these can be let down, either entirely, or narrowed to make the drawers longer.

A *Stay Bodice* is the next article required. Measure the

size round of the child, just under the arm-pits, taking the size very loosely and easily; allow three or four inches over. Then measure the depth of the body. Always cut your pattern first in paper, and then try it against the child. If you have any old lining, it is a good plan to put the pattern next to the lining, and fit it. The stay body, like all the other articles of a child's clothing, should be easy. It is wrong ever to girt children in any part of the figure. The stay body should wrap over about four inches, and tie, as shown in Fig. 10, having a good shape cut in jean, and also in linen lining. There are no turnings-in. Tack the jean and lining together flat, by the edges. Run three piping cords across the centre; leave an inch space, and run three more; and so on, till all the body is quilted. These cords are inserted the short way, as Fig. 10 shows. A piece of stay binding is wanted, and should be stitched all round. Cut straps for the shoulders, of jean, line them with linen, bind them all round, and sew them to the body at the four A's in Fig. 10. The strings are sewn in the way illustrated. In cutting the body, there is a slight curve or stomacher in front, and a little sloped out over the hips, which makes the petticoat sit better than if the body were straight, which gives it a bunched look about the waist.

pleat the skirt before sloping, then pin it to the bodice, and try it on the child. It will immediately be seen how much slope is needed.

In another place we shall have a word to say about the washing of children's flannels, which is very important, and yet very little understood.

The White Petticoat is now wanted. Rather stout calico should be used for this. To cut the body, measure the child round easily under the arms, round the waist, and round the shoulders. Write down these measures:—Mark at the top of a square of paper a quarter of the size of the waist, across the paper, like the line A in Fig. 11. Measure the child from under the arm to the waist, and make a dot on the paper at B. Then mark on the paper a quarter of the size round of the child under the arms, which will bring you about to the dot C. You must then draw a line from A to C. Measure loosely round the top of the child's arm. Say it is eight inches (it may be more), but take the half of whatever it is, and pin it on a tape-measure. Suppose it is the eight inches, put a pin at four inches in the tape; lay the tape in a curve like a half circle on your paper, and it will describe the mark from C to D. Take a quarter the measure of the neck, and mark it by a dot

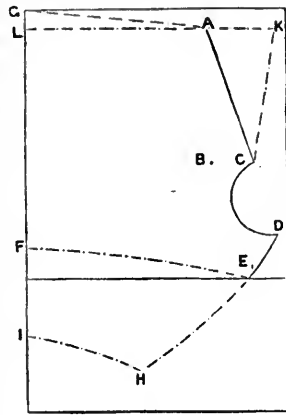

Fig. 11.

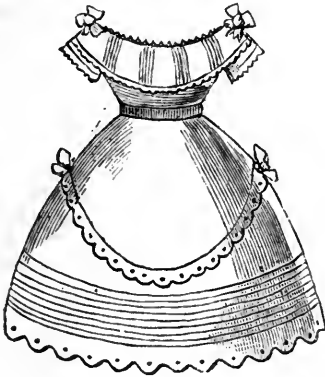

Fig. 20.

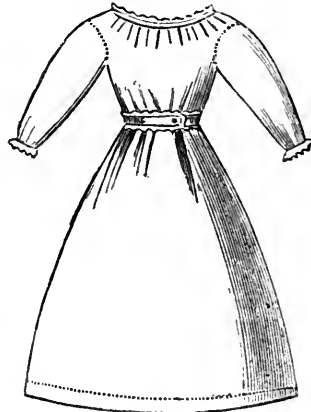

Fig. 17.



Fig. 21.

The neck is also hollowed front and back, but most in front.

Make the *Flannel Petticoat* as before described. Take two widths as long as the child requires, allowing two inches for the hem, and four inches each for two tucks. Herringbone the seams nicely. Make the hem and the tucks an inch apart.

Cut a placket hole in the centre of the back breadth, half way down; herringbone a hem each side. Pleat the flannel at the waist; make a box pleat in front. The front of the flannel requires to be sloped as much as the curve of the body. To do this, place anything across the body, from B to C (Fig. 10), that will make a line exactly straight with the hips. Put a pin where it comes, at D, and measure the distance from D to E. A thin child will bear the flannel sloped equally with this measure; but a stout child has a full stomach, and the slope may be half or three-quarters. It is best to

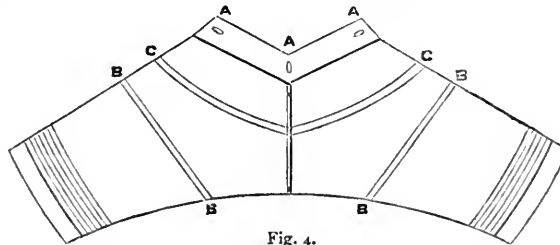

Fig. 4.

at E. Then draw a line from D to E. Make a sloping line from E to F for the neck, and from A to G at the waist. Now cut out the paper; cut a lining from this. First pin the paper on the lining; stick pins in the lining, all round the edge of the paper. Leave the pins in, and cut the lining two inches wider, each way, at the sides. Then

pin it slightly together where the pins are, and try it on. The margin left is to allow for alterations, if the pattern is incorrectly taken. This pattern will serve also for frock bodies. To make a high body, it is only necessary to extend the pattern, by taking the length of the shoulder from D to H, instead of D to E, and measure a quarter of the size of the throat from H to I. This pattern (Fig. 11) must be cut out of double stuff, twofold in the material, coming from G to I, as it represents only half a front, the waist at the top. For the backs, allow an inch for each, to make a hem from G to I, if the stuff is folded

there to cut the backs. Having procured a satisfactory pattern, allow an inch at the sides and shoulders, and half an inch at the neck, waist, and arm-hole, for turnings. Tack the backs and fronts together by the sides and shoulders, an inch in, and slip the bodice on to try it. If too high in the neck, long in the waist, or tight in the arms (making due allowance for turnings-in), slip it with the scissors, as shown by marks in Fig. 12, which represents the three pieces of the bodice before joining. Hem the backs; stitch the sides and shoulders. Run a piping round the neck and waist, turn down, and hem them on the wrong side. Pipe the arm-holes, and put in the sleeve. The skirt of the white petticoat must be a little longer than the flannel, and should be ornamented with a narrow hem, and a number of narrow tucks all of equal width. For every such, allow double the width. Two breadths of longcloth are wanted. Run and fell these; make the hem and tucks. Make a placket-hole; gather the waist, and sew it to the body.

Frocks for girls of this age may be made in a variety of ways. Some like merino, percale, or fancy stuff frocks, according to the season, thick or thin; simply made like the petticoat—a broad hem and one or two tucks in the skirt, and a low body, trimmed. Robe trimmings, covering body and skirt, are pretty; or the body only may have braces, and a row of trimming be placed straight round the head of each tuck. Many frocks are made without tucks, but they are useful, because children grow so fast. When a dress has been made without tucks, and the child grows out of it, the best method of lengthening the skirt is to mitre, that is, regularly scallop the edge, and bind it with braid. If the frock is coloured, lengthen it with black; if black, with a colour. Scallop and bind the piece added, and hem it on above the scallops of the frock, on the wrong side, so that the frock and scallops fall over the new piece. The scallops of the one ought to be uniform with the scallops of the other, and not to be arranged alternately.

DOMESTIC MEDICINE.

BILIOUSNESS AND BILIOUS ATTACKS.

WE will treat first of biliousness. As we have already said, people are very fond of attributing all sorts of symptoms to bile, and are rather pleased than otherwise, when ailing, to be told that their liver is affected. The symptoms generally held to show that people are "bilious" are such as the following:—Want of appetite, foul tongue, constipation, sallow or dingy complexion, flatulence, and other symptoms of indigestion. If any pain about the right shoulder or side is added to these symptoms, then they would be held by "liver" doctors and their patients to be unmistakably bilious. And so they may be; only people should know that really very little is known concerning the symptoms of too much bile, or too little bile, or bad bile. Cases of jaundice are better understood; but the less obvious affections of the liver are yet very obscure; and no great harm and very much good would be done if people talked and thought a little less about their livers. It is probable that in many cases in which the above symptoms are present, the stomach and the intestines are as much at fault, or more, than the liver. Where the complexion gets dingy, the skin greasy and not clear, the countenance rather bloated, where the bowels are costive, where there is a general sluggishness of body and mind, and where digestion goes on slowly and uncomfortably, with much wind; in this case probably the small intestines are as much at fault as the liver. But this is the condition called "biliousness." The state of the bowels is characteristic; the motions are hard, dry, and dark, and the urine is frequently thick.

Causes.—The causes of this condition are various. It is not uncommon in those who have resided for some

time in a climate hotter than their original one. It is almost natural to some people; and in others it is largely brought on by inactivity, by too much food and beer or stimulants, and by want of exercise in the fresh air.

Treatment.—It is in such cases as this that the discipline of a hydropathic establishment, if not its water, does good. But, short of such a costly remedy as this, much may be done by careful diet and simple living to cure this condition of biliousness, which is both depressing and distressing. A mild purgative occasionally in the morning will do good—such as a teaspoonful or two of Epsom salts in cold water. Light food, such as a fish dinner occasionally in place of a heavy dinner, and the use of water, with a glass or two of cheap French wine, in place of the rich beer and hot spirits which are too largely used in daily life in England. Where the light French wines are not liked, nothing stronger than a little weak sherry and water should be used. Bilious people should use brown bread, too, instead of white, and should use water freely for washing purposes all over the body every morning.

Bilious Attacks should be distinguished from "biliousness." Biliousness is a slow habit of dull health. Bilious attacks occur at intervals. They are characterised by severe headache, furred tongue, sickness, perhaps vomiting, and occasionally there is diarrhoea, though there may be constipation. The vomited matters at first consist only of food taken, or of the mucus of the stomach; but if vomiting continues, then the vomit may be yellow or green. Such attacks are accompanied with shiverings and a feeling of illness. They occur frequently in persons subject to them; sometimes they seem to occur almost at regular intervals. Notwithstanding that such attacks are called bilious attacks, it is probable that the stomach is more to blame than the liver. The vomiting of bile proves nothing as to "biliousness," for if vomiting occurs from any cause and goes on long enough, some bile will find its way into the stomach and be vomited up.

Causes.—Such attacks often come on without any very obvious cause. But in other cases it is possible to trace these to one of two causes. A cold east wind, or a long continuance of wet cold weather, especially if it be long continued, will produce such attacks in a large number of people. The complaint is really a sort of "cold" in the stomach—what doctors call gastric "catarrh." Very often it is preceded and followed by symptoms of a cold. At other times this is the only cold experienced; and just as other people would get a cough or cold out of exposure to an east wind, persons subject to bilious attacks will get one of these. Another common cause of the attacks we have been describing is an indiscretion in diet—taking something indigestible. Different people will find different things to disagree with them, and it is impossible to lay down a rule of forbidden food that would apply to all cases. But every person may easily find out for himself what does disagree, and abstain from it. Sometimes such attacks come on not from the bad quality but the bad quantity of food—too much. People indulge in too much food, or too much wine, or spirits or beer.

Treatment.—When such attacks occur they will often yield to domestic measures. The principal points are, rest both of the stomach and the system. The patient should first be quiet; and if very bad, he should lie down, and give his stomach nothing to do for a few hours, more than drinking a little water or a little thin milk-and-water; thereafter he may take a little barley-water, or mutton broth, or beef tea, without fat, and wait till some appetite comes upon him before taking stronger food. If he is cold and shivers, hot bottles may be applied to the feet. In addition to these measures, if the sickness is troublesome, a little mustard plaster may be applied over the stomach, and an effervescent draught may be taken every three or

four hours, consisting of a teaspoonful of the effervescing citro-tartrate of soda of the British Pharmacopœia. Should the sickness continue, or be accompanied with other persisting symptoms, a medical man should be consulted. The great thing for people subject to such attacks is to avoid them. By avoiding exposure to cold and wet, and such articles of food as are likely or known to disagree with them or to irritate the stomach, it will be possible to often prevent such attacks coming on; and prevention is better than cure.

HINTS TO LETTER-WRITERS.—VI.

IN addressing letters to go by post, accuracy is of supreme importance. Myriads of letters find their way to the Dead Letter Office annually, in consequence of insufficient address. There are in the metropolis a great many streets named alike, as North Street, South Street, High Street, Market Street, &c. To prevent miscarriage, therefore, not only should the name of the street follow the name of the person addressed, but it is well to add the parish, and essential to mark the postal district. To lessen the labour of the letter-carriers, the number of the house, as well as the name of the street should be written. The one rule is to specify whatever is required to indicate the district, street, house, and individual. Risk is rather incurred than diminished, however, in ordinary cases, by giving the name of a house. Thus, suppose A. B. resides at a house called Rosemary Lodge, London Road, it is best to omit the mention of "Rosemary Lodge" if the number is known, though it matters little if the number is put upon the envelope. For example, we may either write, "A. B., Esq., Rosemary Lodge, 666, London Road, E.;" or, "A. B., Esq., 666, London Road, E." Usually, the preference should be given to brevity. When the number is unknown, it is very desirable to give the initials or Christian name of the person addressed, because there may be others of the name in the neighbourhood. In writing to country places confusion often arises from the failure to prefix the initials of the person addressed, for in small towns there are several families of one name.

There are many country places, also, which are named alike, as Barton, Burton, Norton, Sutton, Morton, &c. To prevent error, the county should be indicated; and as even this may not be enough if the place wanted is not a post town, it is needful to put in the name of the post town. A letter addressed "George Jones, Esq., Stratford" might be sent either to Stratford-on-Avon in Warwick, or to Stratford in Essex, whereas the mention of the county would prevent mistake. Letters to the smaller towns in Scotland may have N.B. (North Britain) inscribed upon them; letters for North or South Wales may have the initials N.W. or S.W., as the case may be; and letters for Ireland may have that word below the address. To mention all the cases in which similar precautions are advisable would occupy too much space; those which have been given will be sufficient for persons of ordinary prudence.

In writing letters to America several precautions must be observed. To the United States, the address should always end with either U.S.A. or "United States of America." Moreover, the particular State must be indicated, either by the name in full, or by an abbreviation. The Americans are fond of abbreviations, but some of them are little known here: thus, D.C. means the District of Columbia; N.Y. is New York; Pa. is Pennsylvania; Me. is Maine; N.H. is New Hampshire; Vt. is Vermont; Mass. is Massachusetts; R.I. is Rhode Island; N.J. is New Jersey; Ct. is Connecticut; Del. is Delaware; Md. is Maryland; Va. is Virginia; N.C. is North Carolina; S.C. is South Carolina; Geo. or Ga. is Georgia; Ala. is Alabama; Mi. is Mississippi; La. is Louisiana; Ten. is Tennessee; Ky. is Kentucky; O. is Ohio; Ind.

is Indiana; Ill. is Illinois; Mo. is Missouri; Mich. is Michigan; Ark. is Arkansas; Fl. is Florida; Wis. is Wisconsin; Io. is Iowa; Tex. is Texas; and Or. is Oregon. The importance of these names or abbreviations will appear when we state that the American Union is said to contain more than fifty places called Washington. With reference to New York City the name of New York must be written in full.

Similar rules apply to the British territories. The letters U.C. are for Upper Canada; L.C. for Lower Canada; N.S. for Nova Scotia; N.B. for New Brunswick; and N.P. for New Providence. In writing from this country it is undesirable to employ these abbreviations.

Letters for Australia should specify the colony, whether New South Wales, Victoria, South Australia, Queensland, or Western Australia, with such other details as may tend to ensure correct transmission, such as the nearest post town when outlying places are in question. In like manner letters for New Zealand should state what province they are meant for.

It may not be amiss to note that the rate of postage for letters to America and the colonies, and to many foreign countries, varies with the mode of conveyance and the route; therefore it is well to obtain information upon these points, which may be done at any post-office, and may prevent expense and trouble. There are places to which letters are not forwarded at all unless prepaid. Thus, for a letter to Victoria *via* Southampton, 6d. must be prepaid for half an ounce; and for the same colony *via* Marseilles, 10d. must be prepaid. If, in this case, only 6d. is prepaid, the letter will probably be forwarded *via* Southampton or *via* Panama, although the words "*via* Marseilles" are written on the envelope. Where there is only one route and one charge, it is possible the letter will not be sent at all if insufficiently stamped, though it may be opened and returned to the writer if he has put his name and address inside, as he ought to do.

There are many other classes of foreign letters, as those to the continent of Europe, respecting which sundry precautions are needed. Some foreign towns and cities do not bear the same names with us as they do abroad; but this will not cause any difficulty to the sender of letters to such places. To show what we mean, we will give a few examples. Not only is Belgium called Belgique, but Brussels is called Bruxelles, and Liege, Liéttich, while Malines is Mechlin. Aix-la-Chapelle, again, is called Aachen; Mayence is Mentz and Mainz; and Vienna is Wien. In Italy, Leghorn is Livorno; Turin is Torino; Florence is Firenze, and Genoa is Genova. The knowledge of such differences is less important to the sender of letters than to the receiver; and yet it is well to be aware of the fact of their existence. The best rule in writing to foreign places is to employ the spelling adopted by our General Post Office in its official lists. Nor is it necessary to imitate the form of address usual in the country to which a letter is sent. This is optional. Thus, in writing to Paris we might address a letter in the French fashion, and say—

à Monsieur,
M. Jacquet,
Rue de Brétagne, 64,
à Paris.

But it would answer every purpose to write—

M. Jacquet,
64, Rue de Brétagne,
Paris.

There is only one caution which need be given in reference to addressing a French gentleman, and that is, never to write to him as "Mon. Jacquet," or whoever he may be. Either prefix "M.," "Mons.," or "Monsieur;" but never "Mon." which is accounted very vulgar. In the case of letters to the provinces of France, the "department," corresponding to an English county, should be named, unless the town be an important one, when it is optional.

MARKETING.—II.

Mutton (Fig 1).—1. Leg. 2. Shoulder. 3. Breast. 4. Chump end of loin. 5. Best end of loin. 6. Best end of neck. 7. Scrag end of neck. 8. Head. A leg of mutton with a portion of the loin attached forms a haunch of mutton. The loin, not divided along the back, is called a saddle of mutton. In choosing mutton it must be remembered that it is of various kinds as well as qualities. Some sorts run much larger than others, with a corresponding addition of fat and bone, and often a coarser texture. The meat of the black-faced sheep is excellent, when well fed. Welsh mutton is small and highly esteemed. Forest sheep make good meat, and often appear in the London markets. The Dorset mutton is of medium quality. The Ryeland sheep is small, and produces very fine meat. Leicester mutton is large-boned, but when crossed with the Cotswold variety is much improved. South Down mutton is remarkably good; and so is the small Scotch mutton, although it is apt to be lean. As, however, purchasers cannot always ascertain what particular sort is offered, they must usually be guided by size and appearance. Generally speaking, wether mutton is to be preferred: if in good condition, lean will be of a deep red, with a close grain, the fat white and not very hard. Ewe mutton is paler in the lean and closer in the grain. Young mutton is tender and elastic to the touch, but old mutton feels hard, remains wrinkled when pinched, and has fat rather clammy and sticky. The fat of young mutton can easily be separated, while that of old meat is stringy and skinny. The leg of South Down mutton is an economical joint whether for boiling or roasting; but in selecting it or any other leg of mutton, preference should be given to such as is thick in the thigh and short in the shank. The haunch of Welsh mutton is much better than the fore-quarter. Loin of mutton is not usually economical, owing to the quantity of fat, but it is very nice, either roasted or in chops. When the fat of mutton is yellow and watery avoid the meat. A leg of wether mutton is known by a lump of fat on the inside of the thigh. Shoulder of mutton is most economical when roasted and eaten cold. A haunch or leg of mutton for present use is best if it has hung a few days.

Lamb (Fig 2).—1. Leg. 2. Shoulder. 3. Breast. 4. Chump end of loin. 5. Loin. 6. Neck—best end. 7. Neck—scrag end. 8. Head. Lamb is often merely divided into fore-quarters and hind-quarters. A fore-quarter consists of a shoulder with part of neck and breast. A hind-quarter consists of a leg and loin. What is called the target of lamb is the ribs from which the shoulder has been removed. The joints of lamb vary in size like those of mutton, according to the breed and age of the animal. This meat, like veal, is best cooked fresh. Its freshness may be easily ascertained by the colour, feeling, and smell. For a fore-quarter the old test is, that if the vein in the neck is of a fine blue colour, the meat is good, but if greenish or yellow the meat is stale. For a hind-quarter, respect must be had to the kidney and the knuckle: if the kidney emits a faint and unpleasant smell, or if the knuckle joint is flexible, the meat is not good. Lamb is more expensive than mutton, and although highly esteemed is less nutritious. It may be added that the eyes of a recently killed lamb are plump and bright.

Pork.—Of pork there are many varieties. In choosing, as a rule, we should select the meat which is young,

not too large, and not overburdened with fat. Dairy-fed pork has fine white fat, pale and smooth lean, and thin, smooth, and clean rind. It is usually rather small, and a leg ought not to weigh above six or seven pounds. Whenever the joints run large, with coarse-grained lean and fat to match, the meat will be most likely hard and insipid. In all cases the rind must be thin, the lean tender, and the fat of a fine white colour. Old meat is harsh and even hard to the touch, and generally has a thick firm rind, and lean somewhat dark in colour. Fresh pork is cool and smooth to the touch; but stale meat is clammy and apt to look of a greenish tint in places. The first part to turn is the knuckle. What is called mealy pork is diseased meat, and on all accounts to be avoided as very unwholesome. It is commonly sold to the poor, at a low price, by unprincipled dealers. Tainted pork is objectionable and injurious. Pork is often sold salted; and the purchaser must be careful to see that it is in a sound condition. Unsaleable meat is sometimes salted to save it, but it is always an abomination; and so is meat which has been spoiled in the salting, as often occurs in warm weather. The extent to which pork is consumed by the industrial classes at all seasons, renders it important that the rules for ascertaining its quality should be well known.

In selecting *bacon* the purchaser will observe several things. He will not find it economical to buy bacon from huge animals with a great depth of fat and little lean in proportion; nor from large underfed animals with too little fat and too much skin and bone. Smaller sized and well-fed young meat is best. The fat of this will be firm, and have a slight pink tinge, but feel greasy to the touch; the lean will be bright and stick well to the bone, and the rind will be thin. Rusty or reasty bacon will show yellow in the lean, if not in the fat; and will, of course, be ill-flavoured.

Hams are of several kinds. Those from Westphalia are dry, and hard, and covered with spice, not nice to look at, and requiring to be soaked many hours in cold water before cooking. When properly cooked, however, they are very good. Other foreign hams are apt to be coarse and large-boned; but when smaller and well-cured they are often excellent. English hams vary very much. Some are small and dried rapidly after very slight salting. Others are large, thoroughly salted, and slowly dried. The first will not keep so well as the latter, but for present use in small families they are preferable. A ham which is smooth in the rind and short in the hock is most economical and the best eating. Long-legged animals are not to be relied upon either for hams or anything else. After selecting a ham of proper size and shape, its sweetness must be tested. The usual method of doing this is by thrusting a knife under the bone which appears on the fleshy side of the ham. If the knife comes out clean and has a sweet smell, the ham is sound, but if smeared and with an unpleasant flavour it is bad. This operation requires to be performed with some care, otherwise it may be found that the meat is slightly tainted after all.

Venison.—This is chiefly tested by the fat. If the meat is young the fat will be thick, clear or bright, and close; but if old the fat will be tough and coarse. Venison first begins to change at the shoulders and haunches, into which a knife must be thrust. If the meat is good the knife will come out clean and smell sweet; but if bad the knife will be discoloured, and smell rank.

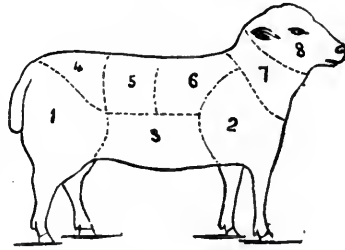

Fig. 1.

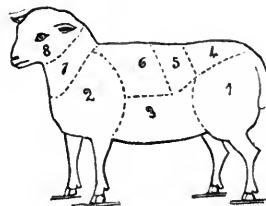

Fig. 2.

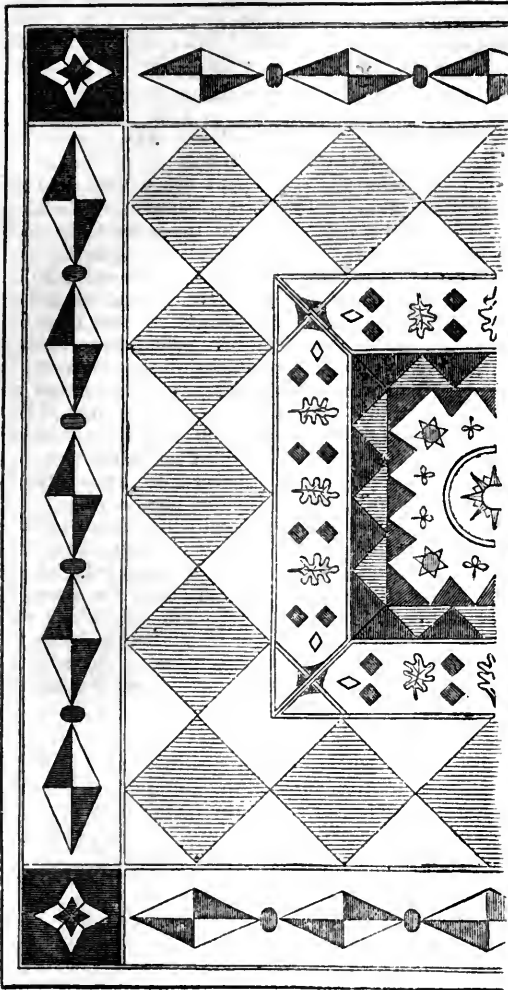

Fig. 1.

PATCHWORK.

INTRODUCTION.

PATCHWORK is looked upon as an old-fashioned thing. But many old-fashioned things are being revived—some of them with benefit. Patchwork is one that should not be despised. Mere cotton patchwork may be made pretty to look at, and useful for the counterpanes for the inferior rooms of a house. Counterpanes are rather expensive articles, if good; and a nicely made patchwork cover looks better than a cheap counterpane. Patchwork quilts may also be given in charity. Patchwork made of pieces of silk and satin is handsome, especially if arranged with taste; and may be used for quilts, sofa and chair covers, cushions, and ottomans. Patchwork counterpanes, if nicely made, look exceedingly well. The pieces can generally be begged, but all good upholstery shops will sell, and even give, cuttings to good customers. Patchwork quilts allow of great exercise of taste. The most common is the diamond, each device kept by alternately light and dark stars, and the chess-board pattern; but there are many others. Some are simply made of squares or diamonds, joined without order. Counter-

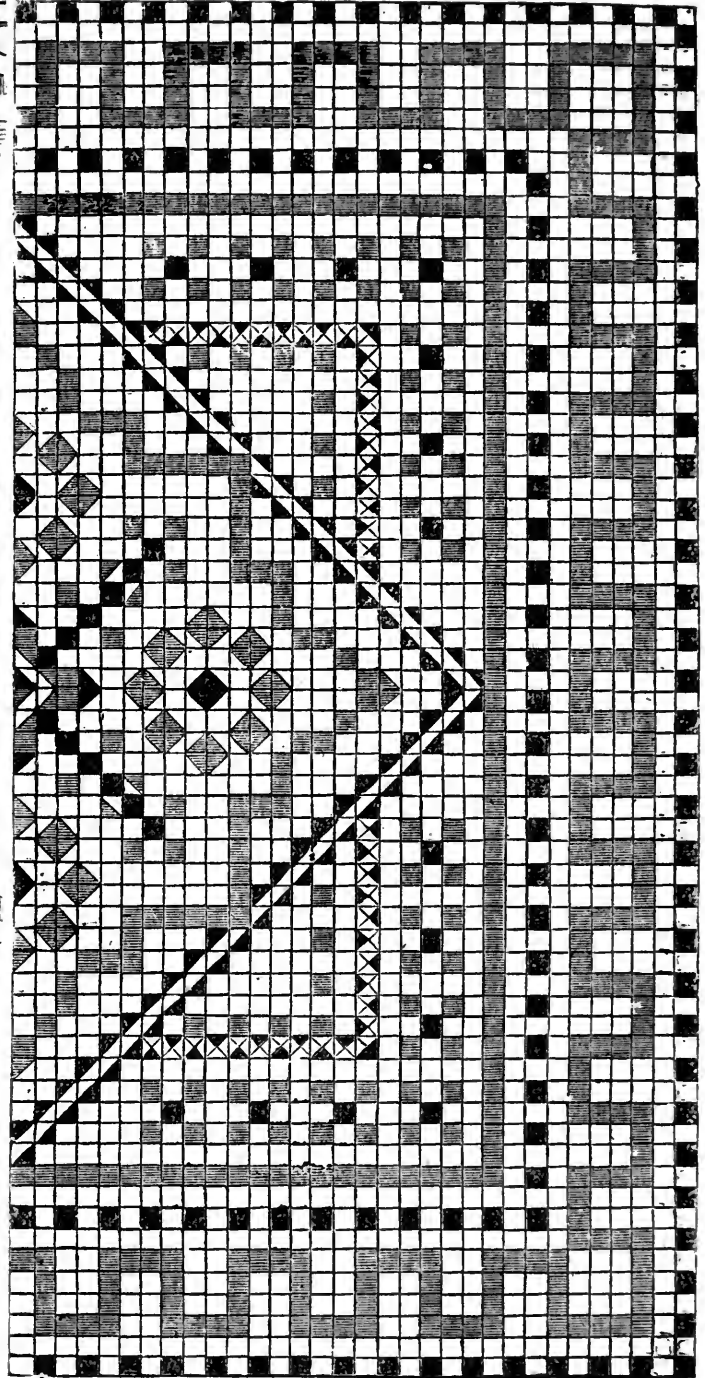

Fig. 2.

panes are often made by mixing a variety of these devices. The centre, perhaps, may be of stars; the intermediate portion and the border chiefly of diamonds, as in Fig. 1, or squares, as in Fig. 2.

ELEMENTARY.

Simple squares are the commonest kind of patchwork. Cut them two inches square each way. They are cut in card. Any common visiting or trade cards will do, and covered with cotton or silk. All pieces are used and

joined by chance and without order; only silk and cotton are not mingled in the same article—it must be of one or the other only.

Counterpanes in Patchwork.—Fig. 2 is a design for a patchwork counterpane or table cover, which may be made of any mixed scraps; keeping the dark parts of the design dark, and the light ones, light. The ground is of light squares.

This would make a beautiful piece of fancy work, in purchased materials of silk or satin. The centre diamond, and the dark squares violet, the light gold colour; the diamond round it, dark patches of bright red, of a crimson shade; the light of azure. The straight lines each way, one violet, one the new intense green, reversed on the opposite side. The four stars, azure for the light, crimson the dark. The zigzag line, bright green. The border of half-squares, which comes next, violet. The alternate light squares at the corners, gold colour; the dark half-squares next them, crimson. The pattern-like clusters of light azure and the black one in centre dark crimson. A straight line round, also of green. Alter, make squares of violet. Greek border of azure. Alternate squares crimson. Ground, a friars' grey (a sort of pale neutral green); a French grey (lavender); azureline (a pale bluish tint); a stone colour, a cream colour or white. Wad, and line with silk. Quilt by running between all the joins. Add a rich upholstery cord all round, and tassels at the corners of gold-coloured silk.

Colours used:—Azure, bright green, violet, gold colour, crimson; and the ground colours to choice.

Another disposal of colours:—All the dark patches a bright crimson red. Greek border, azure, and straight border of a light colour within the Greek one, Metternich green. Light part of the clusters of fine amber. Light-coloured alternate squares round the straight diamond border, Havannah. Zigzag border inside the diamond line, Metternich green. Four stars round light parts, azure. Centre diamond, blue, light parts, amber. Ground of friars' grey. Gold tassels, and lining bright crimson.

Colours used in working:—Bright light crimson, azure blue, Metternich green, golden amber, a very little Havannah, friars' grey.

If these are of satin, and the lining of sarcenet, the quilt will be splendid. Join the lining in breadths. Quilt with friars' grey tailors' twist.

It may be as well to explain that Metternich green is that rich, full, deep-coloured "candlelight green," almost of a verdigris shade, and metallic in hue. Havannah, a light brown, richer than a fawn. The worker can get the light shades at any first-rate Berlin wool depôt, and match them in satin. The green, however, can only be procured in silk, such as filoselle. Greens in wool are all dull.

Fig. 1 is a design for a different kind of patchwork quilt. It is a sort of applique work on stout coarse linen sheeting.

To make this, in the first place a piece of stout white linen, a yard square is taken. On the centre of this a patchwork star (see Fig. 1), is placed. A piece like a ring is cut from dark-coloured chintz and run on round this, leaving a few inches between the star and the ring. A border of three rows of triangular pieces is added. Between the ring and the border eight inches are left, filled in the corners with diamonds, and between with leaves. A border six inches square is covered with dark crosses at the corners and diamonds and leaves between; this is bordered by a piece of light-flowered chintz a foot wide, with dark-coloured diamonds a foot square. The next border is six inches wide, with diamonds and ovals attached to it; the ground light; the diamonds and ovals alternately of two or three colours. A border of striped chintz, with a fringe and cord all round, finishes this counterpane.

We shall return to this subject and give other designs in a forthcoming paper. The size of the patchwork articles we may of course leave to be decided by the require-

ments of the maker. The patterns given in one of our present examples (Fig. 2), may be very readily adjusted for any size by counting the squares and getting the same number into the space of the article the maker has in hand.

HOUSEHOLD CHEMISTRY.

INTRODUCTION.

CHEMICAL operations are performed every hour in the day in every household. From the moment when the housemaid strikes the first match in the morning to the moment when the last candle is extinguished at night the forces of chemistry are at work; and even when all is still, and the gentle breathing of the sleeping inmates is the only perceptible movement in the house, that very breathing involves a beautiful and complex chemical process. And yet how very few people know anything of chemistry! The mistress, when she washes her hands, produces a double decomposition—and does not know it. The housemaid, in striking the lucifer, is—little as she suspects it—promoting oxidation through the influence of friction. And the cook may be shortly defined to be a skilful practical chemist who knows nothing of chemistry.

We hope in this series of articles to illustrate the importance of chemistry in our everyday lives, and the numberless uses to which even a slight knowledge of it may be applied. Systematic instruction in the science would of course be out of place here. The title which we have selected indicates our plan with sufficient distinctness. We only propose to draw attention to those facts in chemistry which have a direct practical bearing upon the welfare of the individual household.

FOOD.

Let us begin with that most interesting, most important, and most extensive subject, food, and endeavour to glean together some few of the many facts which science has made known in regard to its nature, its uses, and the various methods of preparing it which we have at our disposal. It is, indeed, a very wide subject, for not only have we to consider a multitude of different substances, prepared and cooked by a multitude of different methods, but we must also, if we would know anything of the reason of the facts which come before us, endeavour to learn something of the complex changes which go on in the body, and the way in which the food we eat con- duces towards them.

Why is Food required?—The question seems almost absurd, so familiar is the fact; and yet the answer to it involves one of the grandest chapters in the history of science. In its simplest form it may be given in three words—*food is fuel*. We require food frequently for just the same reason that a fire requires coals frequently, and a lamp, oil—because we are burning away. Strange as this may appear, it is a most certain fact. The air that we breathe into our lungs contains oxygen, and this oxygen combines with or burns the muscles and other organs of our bodies just as it does the coals in a fire. The heat produced in a man's body in the course of a day is considerable in quantity, though not very intense in quality. Taking the average, it is enough to raise five and a half gallons of water from freezing point to boiling point, and this is about the heat that would be given off during the burning of a pound of coals. All this heat comes from the slow wasting or burning of the substance of the body, so that it is evident that if we did not make up for this constant loss by eating food, our organs would soon be wasted away and consumed. A moment's thought will show how closely this agrees with well-known facts. Why does an animal become so thin during the slow and painful process of starvation? Clearly because the slow fire in his body is not fed with the fuel of food.

This first simple view of the object of food must, how-

ever, be examined a little more narrowly, and we then find that it requires a slight modification before we can accept it. For after all it is not the food itself, but the substance of the body, which is burnt. We must remember that, even if no food is eaten, the slow burning of the body goes on as long as the life of the animal lasts. It is, therefore, evident that, although it is ultimately burnt, the *immediate* object of the food is to repair the body—to make up for its incessant losses. Let us look for a moment at the changes which the food undergoes when eaten. It first goes to the stomach, and is there subjected to the beautiful cooking process which is called digestion. We shall have more to say about this farther on, and need only remark here, that by it the food is converted into a creamy liquid. This passes on into the intestines, and hence, by a most elaborate and wonderful process, it is absorbed into and becomes a part of the blood. All the food which acts any useful part in the body is first converted into blood. The blood—the mighty river of life, as it has been called—rushes with amazing force and swiftness through every part of the body. And it is from the blood that the constantly-wasting organs of the body, muscles, bones, nerves, and all derive their nutriment; it is by it that their losses are compensated. Finally, to make an end of this part of the wonderful story, it is by the blood that the worn-out, burnt, and now useless materials are removed from the organs and thrown out of the body.

Different functions of Food.—Hitherto we have assumed, for the sake of simplicity, that the whole heat of the body is derived from the combustion of the living organs of the body, and, as a consequence, that all the food, after it is converted into blood, is absorbed by and becomes a part of those organs. But this is not really the case, and we are therefore led to take another step onward in our inquiry. The new step will involve a little additional labour of thought, but it is well worth the effort, for it is absolutely necessary if we wish to attain an accurate and scientific knowledge of the nature of food. It has been found that the heat produced by the burning of the organs of the body, is only a small part of the whole heat of the body. The rest of the heat is produced by the *direct combustion of the blood itself*. So that although all the useful food is converted into blood, only a portion of that blood is employed in repairing the muscles and other organs of the body.

We are thus led to perceive that there are two different uses to which the food which is eaten and converted into blood has to minister. The first is the repair of the organs, and the second the direct production of heat in the blood. And it is a very singular and interesting fact, that side by side with this distinction between the *offices* of food, there is an equally well marked distinction between the *qualities* of different kinds of food. Some of the most important constituents of food are utterly different in composition from the solid organs of the body. They cannot, under any circumstances, be employed in the body for the repairing of those organs. They are only valuable for the heat they produce when they are burnt in the blood; in other words, they are mere fuel. Food of this kind is conveniently described as *heat-producing food*.

On the other hand, there is another great class of food-ingredients, which consists of articles almost identical in composition with the organs which have to be repaired. Let us, for the sake of simplicity, confine our attention to those very important organs, the muscles, which constitute what is generally called the flesh of the animal. A large portion of all food has almost exactly the same chemical composition as flesh. It cannot be doubted that the main purpose of food of this kind is to form flesh, and it is therefore known as *flesh-forming food*. Nevertheless, it is important to remember that this term does not convey the whole truth in regard to this kind of food. For some part of the so-called flesh-forming food

does not become converted into flesh, but is burnt in the blood, like the heat-food. And even that part of it which does become flesh is afterwards, as we before explained, wasted away and burnt, so that although heat-food can never act as flesh-food, flesh-food can, and does act as heat-food. Dr. Savory fed some rats for a considerable time entirely on flesh-forming food, and he found that they remained in good health and retained their ordinary heat; but this experiment, though very interesting as illustrating the double office of flesh-food, must not be understood as proving that heat-food may be dispensed with, for most animals would suffer very seriously upon such a diet, and require a properly-balanced proportion of the two kinds of food.

Work done by the Body.—There is yet another aspect of this subject which must not be left unnoticed. The body is not only a producer of heat—it is a very powerful engine. The muscles of the body are in reality machines for doing work. And the work they do is much greater than most people have any idea of. A strong man can easily do in a day as much work as though he lifted 350 tons a foot high. The heart itself, the most powerful and the most untiring of the muscles, pumps out the blood which passes into it with a force which appears almost incredible. At every beat it throws out five or six ounces of blood, and in twenty-four hours from fourteen to nineteen tons! The force required to do this would lift fourteen sacks of coals to the top of the Monument at London Bridge.

The whole of this enormous daily work is done at the expense of the food consumed, as certainly as the work done by a steam-engine is done at the expense of the coals burnt in the boiler-fire. And it appears probable that the parallel is still closer, for as in the steam engine the work is done, not by the coals, but by the heat produced from the coals, so the work of the animal body is done by means of the heat developed in it, and the whole of this heat, as we have already seen, comes ultimately from the food.

It was, until lately, believed that all the work of the body was done by the burning of the muscles themselves. If this were true, it is evident that flesh-forming food would be the only kind which would be of any use for the doing of work. But this has been clearly shown to be a mistake, and it is now held to be highly probable that both kinds of food, inasmuch as they both produce heat in the body, are alike serviceable for the doing of work. The practical importance of the question will be perceived at once. Men who do hard work eat more than others, and unless they know the right kind of food to eat, it is obviously possible that they may be cramming themselves with large quantities of food which is of little or no real use to them. We shall have more to say on this subject hereafter.

Classification of Food.—We may now attempt to form a classification of the constituents of food, which, without pretending to purely scientific completeness, shall yet be sufficient for the practical purposes which we have in view. It is very difficult to frame a thoroughly satisfactory definition of food. Perhaps the simplest is that which includes under it everything which is assimilated in the body, and which is necessary or useful to it. Taken in this wide sense, the term must be applied to some substances which are not generally reckoned under it. Water for instance, common salt, and, even medicine, must in this view be regarded as food, and, in accordance with it, we will divide the materials of food into the four following heads:—

1. Flesh-formers.
2. Heat-givers.
3. Mineral food.
4. Stimulants, spices, flavours, &c.

The two last of these may be dismissed for the present with very few remarks. We shall have much to say hereafter about water, and something about salt. The

mineral substance called phosphate of lime is an essential ingredient of food, because the bones of animals consist chiefly of it. All the most important articles of food contain it. Our fourth head is of necessity very vague. Under it we include alcohol, tea, coffee, spices, essences, and many other things which are useless, or nearly so, for the actual nourishment of the body, but which in many cases have a high special value of their own. The first two heads require a somewhat closer examination.

Flesh-formers.—The solid part of the flesh of all animals consists chiefly of a substance called *fibrin*. Fibrin stands naturally at the head of the list of flesh-formers, for nothing could be more suitable for the repair of the flesh than flesh itself. *Albumin*, which is found in the juice of flesh, in the white of egg, and in the blood, is another flesh-former, very similar to fibrin in composition and properties. It is equal to fibrin as a flesh-former, and as it is soluble in water in its natural condition, it is more easy of digestion. It has, however, the curious power of becoming insoluble when boiled. White of egg consists almost entirely of albumin, and every one knows how entirely it is altered by a few minutes' exposure to the heat of boiling water. Milk contains a third important flesh-former called *Casein*. It forms the curd of milk and constitutes the greater portion of cheese.

These three substances, almost identical in composition with one another, and with the flesh, are the most important animal flesh-formers. But it has been found that compounds very similar both in composition and properties occur in those vegetables which are used as food. If a little flour be tied up in a small linen bag and squeezed under water with the fingers for some minutes, a fine white powder, called starch, is squeezed out and a sticky mass is left behind, well known as bird-lime. This is called *glutin*. It is a very important and valuable flesh-former. Lastly, peas, beans, and some other vegetable substances contain a compound called *legumin*, which is similar to, some say identical with, casein in composition and properties, and we have therefore in the most important articles of food five distinct, though very similar, flesh-formers.

Heat-producers.—The substances which are exclusively destined for the maintenance of the animal heat, and thereby to the production of work, are more numerous than the flesh-formers, with the exception of gelatin, of which we shall speak presently, and their chemical composition is much better understood. Leaving gelatin out of the question for the present, they may be roughly divided into the three following classes:—

1. Fats and oils.
2. Starches and gums.
3. Sugars.

Fats and oils form a very well-marked and important class. They are found both in animal and vegetable foods, and differ but slightly in composition in all cases. The most important examples among animal food are the fat of butchers' meat, the suet, lard, and dripping which are obtained from it, and butter, which in the form of cream is one of the most valuable ingredients of milk. Most of the staple articles of vegetable food contain a greater or less proportion of fat or oil, and they are, in particular, found in all seeds.

Starches and sugars are mainly derived from the vegetable kingdom, though examples of both occur in the animal body. They all have about the same composition, and although they contribute largely to the heat of the body, they are not as valuable, considered merely as fuel, as the fats and oils, which, we shall hereafter find, give out more heat in their burning than an equal weight of any other article of food.

Another common constituent of food is known as *gelatin*. It occupies a somewhat ambiguous position in

our classification. It can only be obtained from certain animal substances, and does not exist ready-formed even in them. When the tendons, skin, and similar parts of animals are boiled for a length of time in water, they gradually become soluble and then constitute gelatin. Bones behave in a similar manner, but the mineral matter remains behind unchanged. Glue and size are prepared in this way from the hides of animals. They consist of somewhat impure gelatin. Isinglass is nearly pure gelatin, and it is found in a less pure state in calves' feet jelly, and in the substance which is sold under the name of gelatin in the shops.

Gelatin is so like the flesh-formers in composition that we should naturally be inclined to class it among them; and it is almost always considered by persons ignorant of science as a nutritious and valuable food. But it appears to be nearly certain that it has no value whatever as a *flesh-former*, and it must, therefore, be classed amongst the heat-givers. This fact is of greater practical importance than we should at first sight imagine. How often do people judge of the quality of soup or broth by the stiffness of the jelly which it forms on cooling. The test is utterly fallacious, because the stiffness is entirely due to gelatin. It is very easy to make the poorest soup set to a firm jelly by merely adding to it a little isinglass. One pound of gelatin will convert ten gallons of water into jelly, but this jelly has very little value as food, and is utterly useless for the production of flesh.

COOKING.

RIVER FISH.

The Carp, of which we on the next page give an engraving, is a fish retaining its place in general Cookery mainly on the strength of its former reputation. In many parts of the Continent it is still held in more esteem than, in our own opinion, its culinary merits entitle it to. It is, in fact, a fish to keep in ponds, as we keep pretty birds in cages—to look at and not to eat. It becomes very tame; is gifted with considerable cunning; will rarely take a bait; when enclosed in a net, will, if at the bottom, stick its nose into the mud and let the net slip over it; or, if at the surface of the water, will "take back," like a horse wanting to clear a hedge, and then, with a rush, leap over it. There is no knowing how long a carp will live; we have ourselves seen carp which must have been, undoubtedly and with no mistake, not less than eighty or ninety years of age, and yet quite juvenile in appearance. The length of days once accorded to the patriarchs may very possibly be still enjoyed by certain fish, when they once have grown big enough to escape being swallowed by their hungry admirers and friends.

During the last century foolishly high prices were often paid for unusually fine specimens of carp. The real value of the fish (independent of its handsome appearance) lay (in those ante-railway days) in its astonishing tenacity of life, and consequent power of supporting long journeys without injury to its health. Carp were sent to market, or to wealthy customers, on approval, and if not purchased were sometimes returned to their pond.

Carp, like most other permanent freshwater residents, are in season all the year round, except during the interval between their spawning (the first hot days in May) and the flowering of wheat (say the beginning of July). No connoisseur would ever dream of buying a *dead* carp. Scale it, remove the gills, but leave the head; save the blood (to be cooked in the sauce) and the milk or roe. Small or undersized fish do best in a *Matelote* (as on next page); fried, or otherwise, they are, we think, very poor eating. Handsome specimens assert their right to the honours of *Carp, Stewed Whole*, for which you must have a kettle not much larger than will conveniently hold your fish.

After cleaning, marinade or pickle it in wine, salt, and vinegar, with the addition of any spices or aromatics you please. Six or eight hours will not be too long for it to remain there. You may then boil it either in Court-Bouillon (see p. 323), or in wine diluted with broth or water. When the fish is cooked, lay it, without breaking it, in its dish (without a strainer); take enough of the boilings to make your sauce; add to it the blood, some thickening and browning, some seasonings, in which you will be guided by your own discretion, as custom allows you a very broad margin in the preparation of this pretentious dish. Pour the boiling sauce over your carp, and make a prominent display of the milt or roe.

Stewed Carp, under various high-sounding names, may be garnished with the most incongruous and expensive things that a cook's imagination can devise—with ornaments of puff-paste, crawfish, cockscombs, turkey pinions, forcemeat balls, sliced sweetbreads, truffles, dear little dicker-birds, and what not besides. Broiled carp, even with caper-sauce, is not a dish for the gods nor yet for the goddesses. In short, considering the carp's intelligent and familiar disposition; considering that it is a want of the respect due to age to partake of a creature who may be

excellent, make a tasty garnish to lay round *large* dishes of any boiled fish.

Small perch (in company with carp, tench, jack, eels, and whatever else comes to hand) are turned perhaps to the best advantage in

The Mariner's Matelote.—With the matelote of eggs we gave the meaning of the word. Take *live* fish, various and sundry; clean them without washing them; for mariners hold that fish, once out of water, should never go back to it. Cut it in pieces without losing the blood. Put all into a stewpan with a couple of dozen of small white onions, scalded, and almost cooked enough. Season with salt, pepper, bay-leaf, and lemon-peel. Pour in enough claret or red vin ordinaire to cover the fish. Boil over a smart fire, taking care that the wine does not catch fire. Put in a lump of butter as big as a walnut. Arrange your fish on slices of toasted bread, and pour the sauce over them.

Bream and Roach are hardly worth the cooking. You may salt and stew the large ones, and make a fry of the small ones, together with gudgeon, bleak, dace, and any other "such small deer" that can find room in the pan.

Pike, Boiled Whole.—The pike, like carp and most

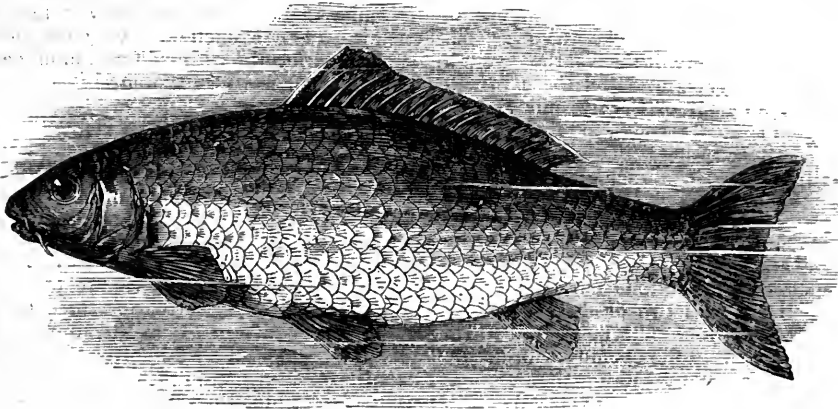

THE CARP.

older than your great-grandfather, should he be alive; and considering that, to eat, he is only a fourth-rate fish, we prefer petting and feeding a carp to feeding on him.

Stewed Tench.—Tench are always bought alive. They spawn later, and therefore continue in season later in spring than the carp. As the skin is invariably eaten, carefully remove *all* the scales, which are small and deep-set. The previous pickling, as with carp, is not necessary, but the fish will be all the better for it. Then treat it in the same way as for stewed carp, omitting the extravagances, and cooking it in the least quantity of liquor possible. As the boilings from tench become, when concentrated, a jelly, stewed tench makes a handsome as well as a palatable dish *cold*, for which purpose it may be a little more highly seasoned. Indeed, we are heretical enough to prefer a fine tench to his much be-praised cousin the carp.

Boiled Tench.—Prepare as above, and boil in salt and water acidulated with vinegar when cold. It may be served with any full-flavoured sauce you prefer.

Perch is an excellent fish, with white, firm, well-flavoured flesh, when taken from waters that are clear and deep. When you buy it dead, see that the eyes are bright and the gills rosy red. It is difficult to scale; plunging it in boiling water a minute will help you; but ask the fish-monger to clean it for you, and beg of him *not to flay it*. Perch boiled in vinegared water, and served with essence of anchovy sauce, is a delicate and dainty dish, light, and easy of digestion. Fried perch, bread-crumbed, also

other fresh-water fish, is in season throughout the cold months of the year, up to the time of its spawning in spring. It then becomes "indisposed" to appearance at table, recovering its health, also with carp, when wheat comes into *flower*. As this event conveys no precise date to most town residents, we would advise them to extend the close season a little longer, and leave pike unmolested till the beginning of August. It is best to buy pike alive, which is frequently possible. Fish that have died in the water, confined and starved in boxes, or forgotten in hoop-nets, are of quite inferior quality. Snared or speared pike are sometimes much injured by the wire or the spear. If killed immediately, the fish is none the worse to eat, and the unsightly scar can be concealed with garnishing. Pike from muddy waters (the same of eels, carp, and tench) are improved by keeping a few days or a week in a tank fed with a current of pure spring water, and giving them a few gudgeons and roach to serve both as companions and prey. The usual advice in selecting fish is to take short plump individuals, and to leave those of longer and slenderer proportions. This, however, must be accepted with a certain reservation. With the pike, as with many other fish, the difference of figure is distinctive of *sex*, the female being short and deep, the male long and slender. The flesh of both, in season, is good; the main question of preference lies between the roe and the milt towards the close of winter. There is a tradition that the pike is an introduced fish,

naturalised in this country at the same time with hops and turkeys; respecting the truth of which we entertain strong doubts. Certainly, live pike may have been brought to England and turned out in some simple-minded gentleman's waters, just as coals may have been carried to Newcastle; but that would be no proof that they did not exist here before. It seems scarcely possible that a fish so widely distributed throughout Great Britain, found in isolated mountain-lakes in Wales and Scotland, in Highland rivers with no other communication than their outlet—the sea (and salt water is fatal to the pike)—can be anything else but a native species. Moreover, in 1586, Camden wrote his dulcet lines—

“Horsea pike,
None like.”

Norfolk must very speedily have attained the reputation for pike in which it is still pre-eminent. The best-sized pike for the table ranges from three to eight pounds. Heavier fish, though handsome on the board, are apt to prove coarse when tested by the eating. Small pike (jack), from one to two pounds, are delicate, and excellent fried whole. For boiling nothing can be better than a six-pound fish. For a large party, two such fish will give greater satisfaction to the palate than one of twelve pounds. Scale your pike, remove the eyes, but leave the fins for show. Empty it; save the liver, if good, together with the roe or milt. Boil these in salt and water a quarter of an hour or twenty minutes, according to their size, and set them aside. Then make

Stuffing for Pike.—After grating enough bread-crumbs to fill your pike's belly two-thirds full, make up the other third with chopped veal or beef-suet, the liver and roe or milt broken up, the rind of half a lemon minced fine, a little fine-chopped parsley, fennel, and chervil, with a fair sprinkling of pepper and salt; during the mushroom season chopped mushrooms or buttons may be added; make this into a stiff paste, with two or three raw eggs broken into it. The belly of your pike being well wiped out, stuff it with this, and sew up the opening with needle and thread. Then tie the head and tail together, passing the tail between the jaws, so as to make an “eternity” fish. Then drop the pike into a large kettle of boiling water, with a small handful of salt in it. A six-pound fish will take *about* half an hour's boiling, but it is illusory to fix the precise number of minutes. A thick female fish, stuffed, will evidently take longer cooking than a slim male fish, unstuffed. If you have any stuffing left, you may make it into cakes, brown them in a Dutch oven, and use as garnishing. Serve your boiled pike on a napkin, garnished with parsley, and accompanied by anchovy sauce, *i.e.*, melted butter with which two or three teaspoonfuls of essence of anchovy have been incorporated in a saucepan over the fire.

Pike, Baked Whole.—For this, take a fish of not less than four, nor more than eight pounds' weight. Stuff and truss it as before, with a more liberal allowance of suet in the stuffing. Put it into a circular dish, not too deep, that will stand the oven. Pour over it enough flour and water, or flour and broth, to make plenty of gravy. You may add thereto a glass of wine, white or red. Lay dabs of butter along the back of your fish, and set it into the oven, where you must be able to *baste it continually* from the moment the butter begins to melt. If you cannot do this, better give up baking your pike. The time will depend on the briskness of the oven. When done, serve the pike on a hot dish. Strain the gravy through a small cullender into a saucepan, stir in a teaspoonful of essence of anchovy, or two table-spoonfuls of catchup, or a glass of red wine, let boil an instant, and send up in a sauceboat. Large pike, of twelve pounds and upwards, are best divided into, say, four portions; the head and shoulders, two middle pieces,

and the tail. The first and the last may be boiled, and served accompanied by anchovy sauce, and garnished with forcemeat baked into cakes or boiled as small dumplings, or both. One middle piece may be stuffed, and roasted with a bottle-jack before the fire. The other may be cut up, *lengthwise*, into squares or oblong pieces, removing the bones, *fried*, and served with anchovy sauce. This is the most expeditious plan (and not the least palatable) when a large pike is sent into the house, and a dish of fish demanded, with little time to prepare it in. The pike being deficient in fat does not lend itself satisfactorily to pickling or potting, or other preparations with vinegar and spice. In trout and salmon countries it is unduly underrated. Pike-fishers there are looked upon as amateur rat-catchers would be in sporting counties, which does not prevent a nice-sized pike from being very acceptable meat now and then.

Eels Stewed with Sorrel, D.B.—Large eels are not required for this dish, middle-sized ones are the best, small ones will do. Buy them *alive*. If you can procure them from brackish water, rivers' mouths, or estuaries, all the better. When skinned, cut them into pieces three or three and a half inches long. Put them into a vessel or bowl, pour boiling water over them, to make them discharge what blood, &c., they may contain. The French kitchen term for this operation, whether performed with cold or boiling water, is *dégorger*, for which our word “disgorge” is rather too strong. Its object is not only to improve colour by rendering provisions whiter and more delicate-looking, but to remove strong and unpleasant flavours. It will thus often render agreeable articles otherwise unpalatable. It is not a cooking, but a mere preliminary to cooking. As soon as the articles are sufficiently cleansed, they are taken out of the water, drained, and the real cooking then begins; therefore, set your cleansed pieces of eel aside to drain. *All* eels, in whatever way they are to be dressed, should be thus treated. Take two or three handfuls of broad-leaved sorrel; if not to be had, any garden variety; in default of which, the wild sorrel of the pastures will do; wash it well, to get rid of sand and dirt. If the leaves are tender, as in spring, put them as they are into a saucepan with the water adhering to them, cover them down close with the lid, stew them, and work them to a mash with a spoon. Later in the season, when the mid rib of the leaf is tough, strip off the green portion, and stew that only to a mash. Thus prepared, with the addition of a little salt, sorrel will keep for some little time, and be ready when wanted. The French, in fact, in whose cookery sorrel is absolutely a necessary ingredient, boil it down in this way during the course of summer, as a provision for their winter requirements. In every small French town, prepared sorrel, fit for immediate use, may be bought by pennyworths, and less. Chop a few onions very fine. Put butter in a stewpan; when it is brown, cook the chopped onions in it. Season with pepper and salt. Throw in your eels, and let them brown in the butter. When they are nearly done enough, add the sorrel prepared as above. When the eels are *quite* done, take them out with a spoon, and lay them on the dish in which they are to be served. Take the saucepan with the sorrel in it off the fire. As soon as it has ceased boiling, stir into it two yolks of egg (or more, according to the quantity of eel), working them together, round and round, until all is smooth and thoroughly incorporated. Then pour the sorrel over the eels, and serve.

Eels are curious and contradictory creatures. They are so tenacious of life as to be hard to kill, and yet can neither stand heat nor cold. A sharp frost, or a temperature a little above 100° Fahr., does for them completely. They were long believed viviparous (not to mention the advocates of their spontaneous generation), but are now ascertained to be produced from roe, like

other bony fishes. The parents prefer brackish water to spawn in. When this is the case, the young perform a migration up-stream, which, on many rivers is called *eel-fare*. We have seen them, a couple of inches long, crawling up sluice-gates, mill-dams, and other obstacles which would seem impossible to be surmounted by such tiny creatures.

THE REARING AND MANAGEMENT OF CHILDREN.

X.—DIETARY OF YOUTH.

THE principal stages of growth may be broadly defined as those of infancy—ranging from birth till the age of two years; childhood—from two to seven years; and youth—from the latter period until maturity is attained. Throughout these respective stages it is of the utmost importance that the food supplied to the growing frame should be of a nature not only adequate to arrest the cravings of hunger, but likewise to ensure the development of the body and mind. The latter is a consideration of fully as much weight as the welfare of the body, for it has been proved by incontestable evidence that under-fed children are apt to be of puny intellect, whilst those who are rationally nourished usually possess the supreme blessing of a sound mind in a sound body.

We have already alluded to the chief articles of food which are suitable to the wants of early childhood; it remains now to consider what changes and additions become necessary to meet the requirements of a more active period of existence. The simple nourishment, consisting chiefly of milk and farinaceous foods, so invaluable at an earlier age, needs, in youth, the reinforcement of stronger elements. More meat is necessary, more fat, more bone-forming substances. A dietary which, from oversight or any other cause, is of too uniform a character, however wholesome in its constituents, fails to fulfil the general utility of food, simply because its powers are confined to one sphere of action. For instance, there are certain foods, as rice, in which the flesh-forming properties are very small; and there are others, as dry peas, in which the same properties are large. Again, in rice, the bone-forming properties are only contained in the proportion of one-third to what is found in dry peas; yet the food of growing boys and girls is liable to consist more largely of rice than of peas, for no reason, possibly, than that the one is more easily prepared—"readier to hand"—than the other. The same illustration may be applied to a variety of foods, which are unwittingly given or withheld, to the benefit or detriment of the growing frame, as pure chance may decide.

The chief point to aim at in feeding young persons is variety. Our range of food is unlimited, and the consumption should not be restricted to a few articles, except in cases of impaired health. The more we limit the tastes of growing children, the more liable is their digestion to suffer later in life. Many parents, from over-anxiety, confine their family fare to what they consider the strictly wholesome, and, by so doing, nauseate the stomachs of their offspring. Others, for the sake of economy, prescribe a certain course of living from one week's end to the other. The intention is to regulate expenses, but it does not answer in the long run. The appetite soon fails; certain dishes on certain days are regularly refused by some members, who prefer to eat dry bread, perchance, to the unwelcome stew or soup. But in advocating variety in the selection and use of food, we must caution our readers against suddenly adopting any very material change in diet, as serious consequences have been known to follow too abrupt a departure from an established system of dietary.

The error of too exclusive a dietary is most apt to be

committed in large schools. Although everything may be wholesome that is set before them, many children loathe some of their meals; and if they have not the means to buy such substitutes as the "tuck shop" supplies, they fare but badly, and are liable to fall into ill health. An instance of the craving of children for the apparently unwholesome, and the beneficial change which freedom to indulge in such coveted treats effects, has recently occurred in one of the largest public schools in England. With a view to counteract some ailments which occasionally broke out in the school, the boys were forbidden to buy any sweets, cakes, or fruit. The shop which had been sanctioned in the play-ground for the sale of such things was closed, and strict watch was kept to prevent any surreptitious articles from being smuggled into the school. Very few weeks had elapsed, however, before the authorities of the school were puzzled by the sudden outbreak of skin-diseases amongst boys of constitutions least subject generally to maladies of the kind. Something wrong in the dietary was suspected. Although perfectly wholesome, it was shrewdly surmised that it might be too exclusive of such things as growing children crave for. The order against "the shop" was rescinded. The boys flocked daily to its stores for sour apples, currant cakes, hardbake, treacle, chocolate, and the innumerable compounds which children delight in. As if by magic, the eruptive complaints began to disappear with a suddenness as remarkable as the outbreak had been.

Undoubtedly, children brought up in homes where the appetite is pampered by sweets and stimulating diet require a totally different treatment. Curtailment then becomes necessary in most cases. But growing boys and girls at school, and youths prematurely confined during long hours in workshops and offices, have few opportunities of similar indulgences. Provided a sufficient interval be placed between meals, and that the food is properly cooked, young people so circumstanced may eat almost anything, and the greater the change of food the better.

The best test of the *quantity* a youth ought to be allowed to consume will be found in his own appetite. When, having vigorously attacked whatever has been set before him, the appetite flags, it is a sign that the meal ought speedily to end, and not to receive stimulating additions. For instance, if a boy, having brought a good appetite to the task, finds it a difficulty to consume the portion of meat allotted to his share, and declares he can eat no more, it is injurious to his health to tempt him to prolong the meal by the offer of puddings, pies, &c. The bait, although irresistible, is injurious and, if often repeated, cannot fail to impair the soundest digestion.

Taking advantage of the well-known preference of children for puddings instead of meat, it is a common practice in some establishments to set the pudding on the table before the joint. Having satisfied the first craving of hunger with the least expensive fare, the meat, from its comparative unpalatableness, is often sent away untasted. Economy of this kind is a great injustice to the constitution of a growing child. Meat, in some form or other, is highly necessary food in our climate daily, especially in the confined atmosphere of town life, combined with excessive activity of mind.

Dr. Lankester writes very forcibly on this subject. Having cited historical instances to the effect that those races who have partaken of animal food have been the most vigorous, the most moral, and the most intellectual races of mankind, he adds that "it is vain for a man to expect to get through intellectual or physical labour without an abundant supply of the material of thought and of physical power." Animal food is the readiest means of securing this supply. As it is with adults so it is with children, with the additional demand in the latter case for extra nourishment consequent on growth. The question, has, however, two sides.

COTTAGE FARMING.

V.—ARABLE HUSBANDRY (*continued.*)

THE course of cropping should, as much as practicable, correspond to the requirements of the cottage farm and the cottager.

1. If he has nothing but his farm or freehold, to depend upon, and keeps two or three milch cows, the extension of the four or five course shift may meet his demands.

2. If, however, his farm is too small to find him in full employment, and if he is consequently either engaged in any handicraft, as shoemaker, tailor, carpenter, or in the service of a large farmer, &c., such will materially affect his position, for then a less extended system, with fewer kinds of crops, may suit him better.

3. If the whole work on the small farm is done by contract, with the exception of the feeding, milking, and attending one or two milch cows, the four or five course shift of cropping may be the best adapted for him—the former, the four course, if he has a small paddock or park in permanent pasture for his cows; and the latter, the five course, if he has not.

4. If a labouring cottager, who has not full employment at home, can undertake the hired work of another small farm—a very common example—then the most extended four or five course shift of cropping may best suit the convenience of both cottagers, as the smaller the plots the less risk will there be in seed-time and harvest.

5. A difference of climate will affect the course of cropping less or more. If, for illustration, we take two extremes—the southern and northern counties of the United Kingdom—then in the former (the southern counties of

England) milch cows may graze on the pasture eight or nine months, so that winter provision has only to be made for three or four months; whereas in the latter—the northern counties of Scotland—milch cows can only graze about five months; consequently, they

are housed for the seven long months of the winter season, and have to be provided for accordingly. And these two extremes are not only wide asunder as to the length of the winter season, when milch cows are housed, and the length of the summer season, during which food for the whole year is provided, but also as to the crops which can be cultivated. Thus, in the south two crops can be taken in one year, or three crops in two years; but in the north bastard spring crops of tares and clover and autumn crops of turnips cannot be grown, so that one crop yearly is all that can be taken off one plot of land. Again, in the south harvest is early, so that stubbles can be autumn fallowed and manured; whereas in the north this can only be done in a few exceptionally early seasons. Throughout the intervening counties, between these two extremes of south and north, the gradation of climate (the altitude as well as the latitude of the land being duly considered) requires to be carefully taken into account in determining the best course of cropping to be adopted. The peculiarly moist and mild atmosphere and soil of Ireland, so favourable to the growth of grass and root crops for dairy husbandry, together with the moister climate of the western seaboard

of Great Britain, as compared with the eastern seaboard, give rise to similar circumstances relative to the best course of cropping to be adopted.

6. The geological character of the soil will also affect the course of cropping. It is the province of art to break down differences under this head to a common equality, and much has been done of late in this direction. Still there remains a wide difference in many examples, where light chalky soils, heavy clays, and ferruginous gravels call for a corresponding difference in the course of cropping and crops best adapted for each. Lucerne, for example, may be grown several years in succession on some chalky and sandy soils, and so may sainfoin.

7. The taste and wealth of the cottager, command of labour, size of farm, and demand for produce of the land, form another series of questions, each of which requires its own solution in determining the course of cropping. The

first—taste and wealth—require no answer. The question of labour will be subsequently considered under a separate paragraph. The size of the farm and demand for its produce will depend upon the family of the cottager. If the produce of the farm exceeds the consumption of the family, the question resolves

itself into whether the excess can best be sold in the form of dairy produce, as milk or butter, veal, pigs and poultry, and so on.

Having determined the course of cropping, the next question for solution is the system of cultivation best suited for carrying it into effect, say on small farms of from two to twenty acres, *i.e.*, whether spade-husbandry, horse-culture (Fig. 1), or steam-culture (Fig. 2), or any combination of them. Until recently the question lay between the former two—the spade and plough; but as

steam has now been proved far more advantageous than either, the conclusion is manifest that a combination of steam-culture with spade-husbandry is the most suited generally, as it promises, under ordinary good management, to yield from sixteen to twenty bushels



Fig. 1.

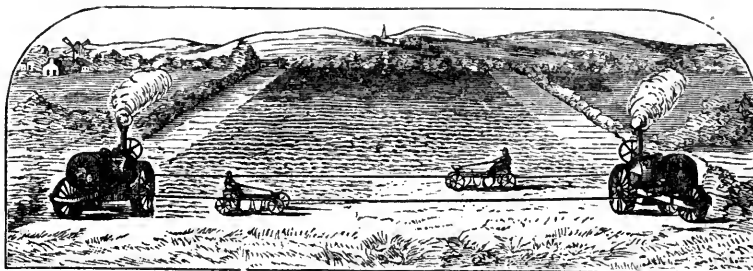

Fig. 2.

more corn per acre, and from twice to three times the weight of root and forage crops, provided the land is laid out for steam as already directed. In digging with the spade or fork an acre of strong clay land twelve inches deep the cottager lifts about twenty-four hundred tons; and, as driving in the spade not unfrequently requires the exertion of more labour than lifting the spit, it follows that the whole bodily toil of the cottager cannot be estimated at less than twice the above, or forty-eight hundred tons. And this heavy toil is not the only drawback to spade-husbandry; for at every spit the cottager lifts his foot and sets it down, thus trampling the land, so that the weight of the spit has to be added to that of his own body in determining the effect produced; and as there will be about 174,240 spits in digging an acre, it is not very easy to estimate the harm done to the land by trampling, especially when the cottager is obliged to dig in bad seasons, as is often the case. Hence the reason why so few have adopted spade-husbandry, preferring to have their land ploughed. But steam promises to obviate the heavy toil of deep digging; for, if properly laid out, three-fourths of the farm, when cultivated on a four course

shift however extended—and three-fifths when cultivated on a five course shift, also however extended—may be deeply ploughed in the autumn, and subsoiled if necessary, the land being left in a far better state for the winter frost and drainage than can be done by the digging-fork or horse-plough. The plots requiring manure may be manured, and the steam contractor will cart out and cover the manure before he leaves the farm. This concludes the heavy work. The subsequent operations of seeding, hoeing, and loosening the land with the digging-fork in the spring can be done by the cottager or a hired servant on piecework, as will subsequently be shown. The heavy labours of clover and rye grass,

DECORATIVE MODELLING.

A Bracket.—Let us say that our student has, in the entrance-hall of his home, wall space on which four brackets can be placed. We shall presently fill them with vases or busts, but will first model the brackets themselves. The ornament upon them shall be taken from nature, and they shall represent the Four Seasons. The first proceeding will be to get two pieces of board, of the size and proportions of our proposed bracket, nailed together at right angles, thus, F. This frame must be laid on the inclined plane, and a solid core or body of clay (which will give the general form of the bracket, and must be similar in all the set) built upon it. (See



THE CORE

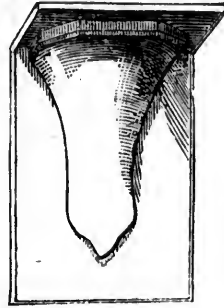

Fig. 1.



Fig. 4.

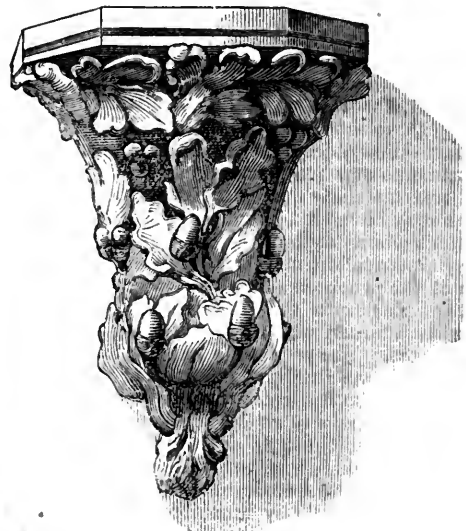

Fig. 3.

hay and corn harvest, can be contracted for by machinery, with or without the labours of the cottager, as the case may be. There are, however, many exceptions to the above, which we shall treat under spade-husbandry.

HOUSEHOLD DECORATIVE ART.

X. — MODELLING IN CLAY FOR AMATEURS (continued).

OUR first lesson has been for practice only, and when the model has been carefully and conscientiously finished, the student cannot do better than break it up and see that the clay is re-prepared for use, as directed in the section on Material; but we shall suppose that by copying the cast, sufficient skill has been attained to fit him for producing something more original in worth preserving.



Fig. 2.—SECTION.

Fig. 1.) On this the ornamental parts will be modelled, but before that is done it should be allowed to remain for a day uncovered, that it may slightly harden and "set." We propose that each bracket shall be ornamented with the appropriate growth of the season it represents. Spring shall have the primrose, anemony, and snowdrop; Summer, oak and briony; Autumn, grapes, corn, and the convolvulus; Winter, holly and ivy. Having placed the natural objects to be copied beside his work, the student may begin to form his composition. And here we may remark that if he possesses some knowledge of drawing, and can make a rough sketch on paper of the general manner in which he proposes to arrange his design, he will save himself some little trouble; but this is not essential; and if he cannot do it he must begin his sketch on the model itself. He can do this by scratching on the clay core with one of the sharp-pointed tools, and sticking on bits of clay

here and there to throw shadow and give something like the proposed effect. When he is tolerably satisfied with the composition, he will proceed to copy the natural forms, by laying on small portions of clay, and then gradually working them up, much as he did when copying the plaster cast, only in the present work he will find himself obliged to use the thumb less and the tools more. In imitating fruit and flowers, he will observe that an infinite number of minute touches are required, which will call for some exercise of patience; but for this he will be amply compensated by the interest and pleasure derived from working direct from Nature. As he goes on he will discover many things in his composition which do not please him, but he will find it easy to detach any leaf or other portion (by cutting it from the background with a thin piece of wire), and move it to the required place, and thus play his foliage about till the eye is satisfied. It will be well to keep all the forms resting somewhat solidly on the background, and not to "undercut" (that is, hollow them from beneath) extravagantly, as, by so doing, he would cause himself considerable difficulty in the after process of casting. Also, as the modelling will be delicate and easily injured by pressure, the wet cloth with which it must be covered should be supported by little wooden pegs, stuck into the background; the holes made by them can be easily filled when the model is finished. In our illustration (Fig. 3) we show the "Summer" bracket completed.

A Vase.—Few objects are more beautiful, either as chimney ornaments or when placed on brackets, than elegantly shaped and tastefully decorated vases; we will now show how one may be made. As it is impossible (except upon the potter's wheel) to form the body or core of a vase perfectly symmetrical in clay, it will be necessary to draw a section of the proposed shape (see Fig. 2), and having cast a block of plaster to the required size, give it, with the drawing, to a turner, who will shape the core accurately in a few minutes. The method of making the block of plaster will be shown in the section on Casting. The core thus made may be decorated with flowers or other natural objects in the same way as the bracket, but more delicate modelling will be required. Before the work is begun it will be necessary that the plaster should be wetted, and the clay will generally adhere to it sufficiently, but it may be made to do so more closely by brushing the core over with a little soft-soap or some similar substance. If handles are desired, pieces of copper wire may be inserted, and bent to the required curve; twine should be wound round them to give a firmer hold to the clay, which may then be worked on. No wet cloth will be needed for this model, as the plaster core, if daily saturated with water, will supply the clay with sufficient moisture; but when handles are added they must be carefully wrapped in wet rag. In Fig. 4 we give a vase in its finished state.

FURNITURE.

THE BEDROOM (*continued*).

Blankets.—To sleep under a heavy weight of bed-clothes is a burden to most people, and whatever be the lightness of the outer quilt, if the blankets be made of coarsely-spun wool of a poor quality, there will be considerable weight in them, and but little warmth. A light, soft, and well-woven blanket will give more warmth than two of coarse and ill make. The best blankets are on both sides nearly, if not quite, alike in the "fluff" of the wool, which, however, is not long, on the contrary, is somewhat short, thick, and very soft. Such blankets are known by the name of "extra supers," and will cost from 35s. to 50s. a pair. The process of raising a pile on the blankets is a most important operation. It is effected by rollers covered with brass pins, and over these one side of the blanket is passed twice, and three times over the other, which is on

that side termed the right side of the blanket; and if the wool with which blankets are spun be of inferior quality, this dressing will vanish in the first time of washing them. Another thing which adds to the cost and also beauty of blankets is, previously to the pile being raised on them, that they are beaten with ponderous wooden hammers, reducing a blanket sometimes to half its original weight; by this process all extraneous matter is beaten out of them. In common blankets the beating is less, and they are consequently less soft.

Blankets are sold by the width and length of so many quarters in size, and should be chosen for their weight, softness of wool, and thickness in pile on both sides—blankets of this quality can seldom be had under 30s. the pair; those of less excellence from any price above 12s. per pair. Common blankets shrink very much in washing them, which is not the failing of the best kind; the different process of manufacture, and the quality of the wool causing the difference.

The Aldershot blankets, made of dark wool, slate-coloured or brown, are useful for servants' blankets, and they are inexpensive—good-sized ones can be purchased for 6s. per pair. They are very soft when washed, and do not shrink so much as common white blankets. When put into a calico casing, two of these make an excellent and warm quilt for winter for servants' beds.

Sheets and Pillow-cases.—Formerly, before the cotton era, linen sheets were highly prized; now these are scarcely to be seen among the poorer classes. Linen sheets seem to belong, by right, to the upper and well-to-do middle classes. It is not alone the difference in the price of the material that has ruled this, but the poorer classes have found out that calico sheets are more comfortable and less likely to give rheumatism, or increase rheumatic tendencies. In former times, and even at the present day, in low, damp situations, among some of the peasantry who cannot afford the luxury of coddling for slight ailments, every effort is made to ward off sickness, and in their homes blankets will be found in place of sheets. Martyrs to rheumatic affections have been cured by constantly sleeping in blankets, and where the skin is too irritable to admit of these, the soft, unbleached cotton sheets, manufactured for use in India and the tropics generally, have been found an excellent substitute. Unbleached cotton is much warmer than the bleached kind. One hundred and fifty years since an Act of Parliament was passed imposing a penalty of £5 upon the wearer, and £20 upon the seller of a piece of calico. This was to encourage the trade in flax, and in articles woven from it. No Act of Parliament, however, could stop the progress of such a universal good as the introduction of cotton. Those who could not indulge in linen garments and sheets on account of the expense, were in a few years, when cotton became cheap, enabled to be clad decently, and have a sufficient change of bed-clothes unattainable heretofore. Previous to the civil war in America, upwards of sixty-five millions were invested in cotton machinery, which employed four hundred and fifty thousand people, who divided among them annually upwards of eleven millions sterling. The domestic trade of England alone realised twenty-four millions sterling. Such is the value of cotton in a financial point of view.

Now, of cotton there are several kinds, mostly resolving themselves into long and short staple; at least, these are the ordinary two kinds which a housekeeper needs to know anything about. Articles made of long staple wear better than when made of short staple, because in the spinning, the joins are not so frequent, and the cotton itself is silkier and softer. During the war much of the worst kind was imported to give employment to the starving operatives, and was woven into calico, its defects being hidden by the quantity of "dress" it contained. These defects are uneven projections in the calico caused

by spinning short staple cotton of inferior quality, and when an undressed calico is held to the light they are easily discernible. A calico of this description will not wear well, simply because it is made of unevenly-spun cotton. In all cotton cloth some defects of the kind are perceivable, but a purchaser should choose that which has the fewest, and of course this will be the most expensive. Sheeting calico should have the thread round and even, both threads, warp and woof, being alike, not a thin thread running the length of the material, and a thick one across it. This calico will "slieve," that is, one thread pull from the other, or it will crack across, without other indications of wear. Calico for sheets is sold in widths suitable for beds of different sizes, and is not dearer in proportion than a number of breadths equal to the width of sheeting would be; but three breadths of three-quarters wide calico seamed together would be stronger than sheeting calico without a seam. The quantity of calico necessary for one sheet the full size for a large bedstead would be three yards and a quarter long by two and a half wide. Whatever be the width of a sheet, it should be three-quarters of a yard longer than it is wide.

For servants' and young schoolboys' sheets, the unbleached brown cotton, free from black specks on both sides, is undoubtedly the best material. The oftener it is washed the softer it becomes, and when not too fine, imparts warmth nearly as much as wool does. It is also the best thing for pillow-cases.

Sheets of linen, to those who have been accustomed to them, cannot be dispensed with—habit is second nature. The same observations apply to choosing the linen for these as to calico: the fabric should be free from coarse threads, that is coarse by comparison with the surrounding threads, and the edges of the material even. The manufacturers have a practice of "dressing" linen so that the threads look sound and even, but are really not so; the quality can only be detected by rubbing soft one end of it. When a great number of coarse threads are prominently visible, the cloth is made of short flax imperfectly spun, and will not wear well.

The practice of rolling a bolster in the sheet is not a comfortable one, nor is it thrifty. The ticking soon gets dirty. A bolster one is always needed, and even if the sheets be of calico, these and the pillow-cases should be of linen. Yard wide cloth is sold for the purpose. A bolster-case should be sixty inches long for a five-foot bedstead, and less or more in proportion to its size. The case may be joined at one end, and your buttons and button-holes on a hem two inches wide will fasten it at the other end, or one end may be set into a circular piece of linen four inches in diameter, and the opposite end drawn up close with a string of tape. Pillow-cases rather more than three-quarters of a yard long are of Irish linen a yard wide, the selvage of one side doubled in half and seamed together; the two raw edges is a felled seam, and the remaining selvage side, turned down, is a hem an inch broad, and for closing this end over the pillow have four small linen buttons and neatly-made button-holes opposite the buttons sewed upon the hem of the seam.

Towelling.—There is a great variety of fabrics sold for towels. First comes the huckaback—originally hucklebock—i.e., having a knotted or bunched surface—and when made up of linen, not fine, is certainly most excellent for absorbing the wet and for rubbing the skin wherewith to create a reaction and glow. Material of this description can be bought for eightpence the yard, and if unbleached is preferable. As all linen articles shrink in washing, huckaback should not be fine, but thick and loose in its texture. Eighteen nails is the proper length for a towel, which should be fringed at the ends, by cutting the selvage on the four sides about an inch in depth, then ravelling so far, and finally sewing over the

towel between the fringe in an *irregular* manner. Thus it never ravel in washing. The reason for fringing the ends is, that when hemmed, the dirt is rarely rinsed out of the hems in washing, then the mangle cannot press in the hems to the detriment of the next towel or article beneath it.

Russian Towelling, termed by drapers "crash," is a strong material of narrow width made in Russia, and imported therefrom. Many persons prefer this make for towels because of its roughness when new, and when old, it is soft, and strong, and convertible to other household purposes. This kind is preferable for runner-towels; three yards is a good length for a runner; and at 5d. a yard it can be bought of an excellent quality.

HOUSEHOLD AMUSEMENTS.—XI.

ACTED CHARADES (*continued.*)

OPINIONS differ as to whether the syllable or word which is represented should be uttered during the scene. Some, in practice, express it only by action; others think it best that it should be mentioned in the course of the dialogue, but so introduced that it is disguised, or withheld from all prominence. This, however, is a matter on which the performers should be left to their own taste or judgment; but there should be an understanding among both themselves and the spectators, as to which rule is to be observed.

The next thing is to represent the syllables agreed upon. Where the company are not generally expert, some one who has had experience in charade-playing should, if possible, be selected as the leader and director of each party, and plan the various parts to be taken by all, giving hints or instructions as to the details of the performance. As much humour as possible should be thrown into it, and clumsiness or blunders should be taken as of no account, the object being simply amusement. An awkward but good-humoured performer is often able to excite as much harmless mirth as any of the rest.

The various characters in the scene to be represented should dress themselves up, according to the means at hand, for their respective parts; but the most "rough and ready" articles of costume are as good for the real purpose as any other. It is enough, for instance, that the principal figure in a scene representing "age" should wear a grey wig, or a slouched hat and spectacles, or hobble along with a stick, doing the pantomime of deafness, &c. Those who have the means as well as the inclination for the adoption of an elaborate costume in the performance of acting charades can, of course, gratify their taste; but this is by no means necessary to the thorough enjoyment of the pastime either by actors or spectators; the resources which any one may find immediately to hand often creating the most amusement.

The following are examples of the "makeshift" expedients which may be resorted to in the performance of various characters in the scenes of a charade.

Baby.—May be either a real one or a dummy; the former preferable when mamma gives consent to its introduction.

Bride.—Wreath made like a boy's kite-tail; antimacassar fastened to the hair to represent the bridal veil; white paper bows pinned to dress; white kid gloves; and bouquet.

Cabman.—Wideawake hat, handkerchief round the neck, two great coats, walking-stick with a string tied to it, tart-dish for a badge.

Child.—Any juvenile, "fractious" or otherwise, will answer the purpose.

Counsel.—Wig made of cotton wool, paper collar with bibs, long dressing-gown, roll of paper in the hand.

Country girl.—Gipsy hat with streamers, dress pinned up at four points, rouge generally requisite.

Countryman.—Hat brushed the wrong way, paper collars with the corners sticking well up, silk neckerchief, and showy waistcoat.

Doctor.—White neck-cloth and black coat, walking-stick with a knob, which is frequently applied to the lips during consultation.

Housemaid.—Short apron, bouquet paper with or without ribbons as cap.

Judge.—Lady's victorine across the head, dressing-gown robes, spectacles, desk, and pen.

Military Officer.—Turn-up collar, cocked hat, sash, moustache, and cane.

Naval Officer.—Buttoned coat, gold paper epaulettes, boy's cap with gilt band.

Old Man.—Hair combed off the forehead, which is marked by a few lines drawn with raw umber; little cotton wool to represent white whiskers, spectacles, and a thick stick.

Policeman.—Coat closely buttoned, collar turned up, and marked in chalk with a number; hair brushed up to the top of the head before putting on the hat.

Prisoner.—Hair short and rough, no shirt-collar or front, spotted

morning costume; Mrs. T. at fancy-work, her spouse looking over the paper.

Mrs. T.—Dear me! How I long to see town again! So many months since we were there; and really one seems to be almost out of the world here, although it is so beautiful in summer. Don't you think so, Charles?

Mr. T.—Well, my love, perhaps it is a little—ah, ahem—secluded; but one can always see what is going on by the papers; and then you know you detest town formalities.

Mrs. T.—True; but, my dear, one can't see the *shops* by the papers, and I should so much like to do so now and then. But there, Julia is coming to-day, and *she* will be able to tell me all the latest styles and the fashions.

Mr. T.—Yes; (*aside*) and to exhibit a few of them in her own person, I'll warrant.

Mrs. T.—Hark, Charles! I'm sure that must be Julia. (*Rising.*) Pray run to receive her. (*Charles yawns, and moves leisurely towards the door.*)

Enter Parlour-maid.—If you please, m'm, Miss Julia Mayfair.

Enter MISS JULIA (in walking costume, but dressed in extravagant



handkerchief round the neck, charcoal beard, and black eye, if required.

Sailor.—Coat tails pinned up behind for jacket, no waistcoat, black neckerchief with ends loose, turn-down collar, yachting hat.

Tax-gatherer.—Buttoned coat, hat over eyebrows, spectacles, book, and pen behind the ear.

Workman.—Square paper cap, shirt sleeves, and white apron.

We will now give an example of the dialogue-charade, founded on a word of two syllables.

FIRST SYLLABLE.

Characters, Mr. and Mrs. Turtledove, Miss Julia Mayfair their cousin, Parlour-maid. **Scene,** the drawing-room of a country cottage; the Turtledoves seated, in easy

imitation of the latest styles, enormous chignon, &c.)—My dearest Louisa! (*embraces her.*) How charmed I am to see you in such rural simplicity! How do, Charles? (*Shakes hands.*) What a pretty cottage! What a delightful retreat! (*Aside*) What an outlandish place! (*Takes a seat.*)

Mrs. T.—You can't think, my love, how I have longed for this visit. You are truly kind to come to see us. But how you have altered! I should scarcely have recognised you!

Miss Julia.—Altered! Pray don't say so. You don't think I am looking any older, I hope! But town life is extremely fatiguing, I must admit, though I should expire without it!

Mrs. T.—Older! Oh dear no! But your complexion, my dear—your (*glances at her chignon*)—in fact, you seem so much fairer than you were.

Miss Julia.—Oh yes, my dear. Quite the rage, I assure you. The Auricomous Fluid. Nobody would be seen without it now—that is (*with emphasis*), nobody who is *in the world*.

Mrs. T.—Ah! and I am quite out of it! But I thought you seemed to *stoop* so much.

Miss Julia.—Stoop! (*laughing.*) What charming rusticity! My dear, that's the Grecian Bend! (*Rising, and walking across the room.*) There, don't you think it extremely graceful?

Mrs. T.—Well, my love, I can't say I appreciate it at present; but, of course, if it's the fashion, that must be *my* want of taste.

Miss Julia.—Quite so, my dear. But you will get used to it in time, and when the fashion comes down into *these* parts, I am sure it will suit you admirably.

Mr. T. (*advancing towards the audience, and speaking aside.*) What! Louisa make herself such an object! Whatever Miss Mayfair may think of herself, I consider her a perfect Guy.

SECOND SYLLABLE.

Scene, supposed to be a ball-room. When the curtain is withdrawn, two ladies are seen seated; two gentlemen advance, and, either in the ordinary way, or by pantomime, invite them to become their partners. They do so, and, some one volunteering on the piano, the four perform a waltz, or a redowa, &c., according to taste.

THE WORD.

Scene, the rooms of Mr. Fitzsquander, in St. Swithin's College. Curtain withdrawn discloses Mr. F. seated at a table, with a letter in his hand and his fingers in his hair.

FITZSQUANDER (*rising*).—Well, I am in a fix! Snapchild and Co. down upon me at last, and Shentpershent says "his friend" can't wait any longer for his money—the old thief. And the governor wrote last time he wouldn't stand it again. I'm up a tree now and no mistake. What's to be done? I must have some advice—don't see my way out of it at all.

Enter TOM TWISTEM.—Mornin', Fitz. How are you, old boy? (*Shakes hands heartily.*) Why, what's the matter? You look scared.

Fitzsquander.—Scared! Well I may be. You're just in the nick of time, Tom—the very man I want. Look here! (*Shows him the letter.*)

Tom (*reading it*).—Whew! That's just like 'em, old fellow. Told you you were not downy enough to have dealings with Snapchild. Wish you had taken my advice.

Fitz.—Well, I want it *now*. What's to be done? You're used to this sort of thing, I know.

Tom.—Done? Why, go to the governor, of course.

Fitz.—No good, Tom. Cut up rusty last time. I know the old boy—you don't.

Tom.—Well, then, go to the Mum—write to the Mamma, and ask her to get round the governor for you.

Fitz.—The Mum! Bravo, Tom! Capital idea. Haven't tried it on for months. She'll do it—she knows how. The governor can't stand her arguments.

Tom.—Yes; and tell her you've been neglecting business affairs to get up for your little-go, and had no time to think of accounts. *That's* how I did it. (*Aside.*) Wish I could do it again; but same game won't do twice.

Fitz.—Thanks, my boy—much. I see my way now, I think. There's nothing like having an experienced guide in these matters, and you are such an old stager. (*Fraternal demonstrations to each other.*)



Fig. 1.

The company now have to guess the word, which is GUIDANCE (Guy-dance).

Before concluding we append some further hints in the shape of an illustrated acted charade (see page 348).

PANTOMIME CHARADES.

Acted charades, as we have already hinted, may be performed entirely in pantomime, and many prefer this method of playing the game, as it is easier than starting impromptu dialogue. All that is necessary is for the characters to dispose themselves in successive groups in which the various syllables of the word are more or less clearly expressed. The meaning should not be too palpable, but afford a little room to the spectators to task their ingenuity in guessing the word represented.

As an example of a pantomime-charade we give the three scenes representing the word POST-AGE. The character of "Meddlesome Matty," it will be observed, is supposed to be personated by a gentleman, who gets himself up for the part—according to the general and the best custom in acting charades—on the spur of the moment.

ODDS AND ENDS.

Indian Jars for Pot Pourri.—Large jars suited to stand in the corners of rooms can, with a little trouble and not much cost, be made to appear as handsome ornaments. They should be a couple of feet high, of common red clay. They may be procured at many large grocers'; but at the potteries, if any one takes the trouble to write, they can be made for a small cost. Any large china vendor can give his customers the address of the potteries. The jar must next be painted some pale colour—a light, delicate sea-green, or pea-green, or friars' grey is a good shade. It must be very pale and delicate. Next beg or buy a number of scraps of chintz. The Cretonne chintz now made, and covered with strange, apocryphal birds and imaginary monsters,



Fig. 2.

is largely used for the purpose. The greater the variety and the brighter the colours the better. When you have a sufficient assortment ready, with strong gum arrange them according to taste all over the jars, being very sure that all the little bits, corners, and stalks, are quite fixed down. An old cambric handkerchief is wanted to dab down the chintz to the jar. When quite dry and perfectly fixed, have the jars varnished, or varnish them at home with gum copal dissolved in turpentine by gentle boiling. Take care not to let the turpentine ignite. Varnish can be bought, but it is difficult to procure it pure, and it is

expensive; but for those unused to handle combustible materials, it is safer to buy than to make it. The varnish is applied with a large brush, going all over the jar with bold strokes, and never touching any part a second time whilst wet. When dry, give another coat. Repeat the coats till the appearance pleases. It should not be too thick, or else it will crack. Whilst varnishing the jars, keep them in an empty room, free from dust. Put roseleaves or pot pourri in the jars, and place ornamental saucers on the top. By obtaining vases of various forms from different sources, and selecting suitable cuttings, very tasteful and useful articles may be made in this way. But the household decorator should remember that he may publish either his or her good or bad taste to all observers according to the selection of patterns which he makes and the mode in which he uses them when cut out. No one who is in the habit of examining attentively the objects of art manufacture exposed in the windows of our "fashionable houses" can have failed to notice the mixed and incongruous character of our modern decorative designs. Variety is, undoubtedly, a most essential principle of decoration, but the variety we speak of does not arise out of the design itself, but results from the mixture of good designs with others decidedly bad, and is by no means desirable. And yet there is scarcely a warehouse window in our most fashionable London streets which does not exhibit, in juxtaposition with good or passable designs, others which indicate the utter absence of artistic taste. As guides for our readers in this question of taste we append two cuts. Fig. 1 is a Greek vase taken from the original in the British Museum, in which the ornaments are very symmetrical and beautiful, and their arrangement such as harmoniously belong to the shapes they decorate. Fig. 2 is an Indian water-goblet, displaying the same evidence of correct taste in ornamentation. Our readers could have no better guides.

The Page.—In our last section of the article "Inmates of the House," we omitted pointing out that a page should not fail to inform his employer of the first indication he perceives of boots wanting repair. If the sole be suffered to wear out till the welt is exposed, it is often not worth the expense to repair a boot. It is a good economy of time and leather for gentlemen to have at least two pairs of boots in wear at a time.

Chintz Window Curtains have the double advantage of being cheap and washing well, while the gay colours are pleasing to the eye, and brighten a little room. Woollen materials have disadvantages, as not only do they fade sooner than chintz, but they catch and retain the dust, and look dirty and old long before it is worth while sending them to the cleaner or dyer.

Stain for Mahogany Colour.—Take one pint of rectified spirits of wine, and put it into a bottle with one ounce of dragon's blood broken to pieces. Put the bottle in a warm place, and shake the mixture from time to time; when the gum is dissolved it will be fit for use. Another method is to put one pound of logwood chips into four quarts of water, with two handfuls of walnut peels. Boil these together, and then take out the chips; after which add one pint of best vinegar, and the preparation will be complete. These stains are for giving a mahogany tinge to lighter coloured woods.

DOMESTIC MEDICINE.

BILIOUSNESS, OR BILIOUS DISORDERS, INCLUDING JAUNDICE.

EVERYBODY thinks himself a physician for this complaint. Of all theories that occur to people to explain little errors of their health, none occurs more commonly than that of Bile—"it's only bile." No organ of the body has more blame laid upon it than the liver. It is the best abused

organ in the body. It is a curious fact, but one that may often be noticed, that ailing people seem to derive great satisfaction from thinking, or being told, that their "liver is affected." What makes this more curious is the fact that though the liver is a large organ, and though it secretes about two pounds or two pounds and a half of bile everyday, of a dark golden brown colour, the wisest people are still very uncertain about the uses of this big organ and all the bile that is formed in it. It is often the case, however, that what learned men *know* least about, ignorant men *talk* most about. It is easy to talk glibly about that of which little is known. Let us try to tell our readers what little is made out as to the uses of the liver, or rather of the bile that flows out of it into the intestine just below the stomach.

First, the bile in some way or other assists digestion. It especially assists the digestion of oily matters.

Then, though it is not necessary to the digestion of meat and eggs, and such like (albuminous) substances, it is necessary to prevent the putrefaction of these in the intestines.

Thirdly, it removes from the blood things that would injure the system if there were no liver to remove them.

Fourthly, it contributes something to the formation of the motions from the bowels, but not so much as used to be thought. A great part of the bile that is formed in the liver and thrown out into the intestines is absorbed again into the system from the intestines—not thrown out of the body with the motions.

Physiologists have tried a curious, but a legitimate experiment with dogs, to find out the uses of bile. The bile flows through ducts, as we have said, into the intestine. They have tied these ducts and made an opening between the gall bladder (which receives the bile when it is first formed before being passed into the intestine) and the outside of the body, so that the bile was not allowed to enter the intestine. Two animals so treated died; one at the end of twenty-seven days; the other at the end of thirty-six. Mark the symptoms which the animals showed. They got steadily and progressively *thin*. This thinning proceeded to such a degree that nearly every trace of fat disappeared from the body. The loss of flesh amounted in one case to more than two-fifths! and in the other to nearly one-half of the entire weight of the animal. There was also a falling off of the hair. There was an unusually disagreeable and putrid odour in the breath and in the discharges from the bowels. Though the animals had a good appetite, they seemed to suffer from wind and putrefaction of the food taken. Notwithstanding all this, the appetite remained good. Digestion went on after a fashion, but after a very windy fashion. None of the food was discharged with the feces, but there was much rumbling and gurgling in the intestines, and abundant discharge of wind. There was no pain, and death took place at last without any violent symptoms, but by a simple and gradual failure of the strength and life of the animals.

It is apparent from these experiments that—though chemists and physiologists have not yet made out exactly the part played by bile—it is necessary to good healthy digestion of food.

Some cases of disease of the liver occur in which no bile is formed in it. The bile is retained in the blood. If this disease is extreme and intense—that is, if no bile is separated from the blood, the chances are that the patient will die heavy and in a deep sleep. For if the urine or the bile, instead of being separated from the blood, are left in it, they act as poisons, and cause either convulsions or coma; that is, insensibility and death.

Let us now try to describe the two common cases of jaundice and the so-called bilious attacks.

Jaundice.—Jaundice is a disease easily recognised by non-medical persons, for its chief sign is a yellowness of the skin and of the white of the eye. There may be any

degree of this discoloration from slight yellow, such as is seen in most babies a few days after birth, to intense green yellowness, such as often shows disease of the liver. The motions are pale and without their usual colour. There is indigestion, flatulence, and dislike for fatty matters, which are not easily digested. There may be pain over the stomach and liver, or there may not be any pain, and, as we have implied, the skin and the eyes get yellow, because what should be separated from the blood by the liver, is not, and gets into all parts of the system. The bowels are generally costive.

Causes.—Now this state of jaundice may arise either because no bile is formed in the liver, or because, after being formed, it does not get into the intestine. This last is the most common case of jaundice. It may be stopped from getting into the intestine by something blocking up the ducts which convey the bile; one of the most common, and really a very common, cause of obstruction to the flow of bile is the formation of little stones in the gall bladder—gall stones—which in passing through the duct that connects the gall bladder with the intestine give rise to severe symptoms, which we shall now describe.

Symptoms of Gall Stones.—Probably after some uneasiness about the right side there sets in, often suddenly, severe pain in the right side or more towards the stomach, so severe as to make the patient writhe. Vomiting soon comes on and is troublesome, though it tends to relieve the pain. The pulse is not much quickened, nor is there much fever. There is often more or less of the yellow tinge of jaundice in the skin or in the eye, and then one may be pretty sure that the case is one of gall stones. In such cases the motions passed after the pain has ceased often contain stones, and should always be carefully examined.

Another common cause of jaundice is when the little ducts we have mentioned become inflamed and their walls get thickened, and the passage of bile along them is hindered.

There is a form of jaundice, occurring in summer or autumn, which we may call painless jaundice, that is not uncommon. It is jaundice and nothing more than that, and the heavy indolent state that accompanies it.

The most unfavourable cases of jaundice are those which occur in older people, and especially in those who have lived very hard, or very anxiously; and in which, notwithstanding the use of means, the jaundice persists.

Treatment.—The reader will not expect us to advise him to treat himself for a complaint which may depend on many different states, and requires very various treatment. But we shall aim at giving a few useful hints to persons affected with gall stones, or having occasional attacks of jaundice. Gall stones occur most frequently in women, and in those who lead a somewhat easy or rather indoor life, especially if they take beer or porter, and have a tendency to become stout. Such persons should live carefully and be chary of beer, and should take exercise in the open air. When an attack of sudden pain from gall stones comes on, a doctor should be sent for. Hot fomentations to the side, drinks of warm water, and hot applications to the feet, should all be used. If the pain is very severe, and a doctor cannot be had, ten drops of laudanum may be given to a grown-up person, and may

even be repeated in an hour or two if relief does not come.

Lastly, let us say a word to hard livers, and all who are conscious that they drink more than is good for them. Whenever they see their eyes or skin getting yellow, let them know that their sin is finding them out, and that it is beginning to affect very vital parts, and that if they do not take thought and mend, they will go steadily from bad to worse. But, in such cases, it is often wonderful how improvement in health follows improvement in habits.

THE HOUSE.

WATER SUPPLY. (continued.)

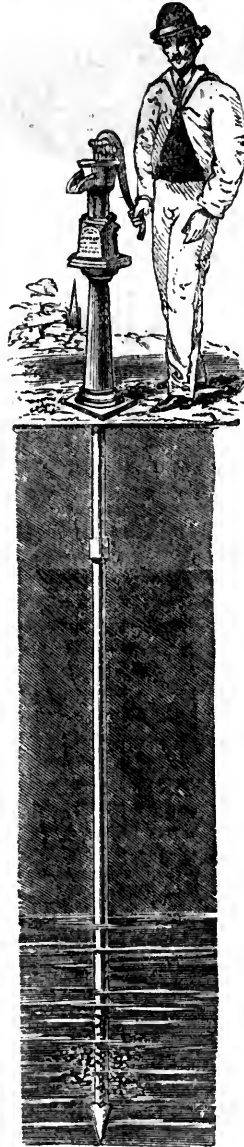

Fig. i.

THE dwellers in cities and large towns are generally so well supplied by public companies with good and wholesome water, that little attention is paid by them to either its obtainment or preservation from contamination. Those who reside in small towns, villages, the rural districts, newly-settled countries, or in camp, must, in self-defence, exercise their ingenuity and powers of resource in the matter of water-collecting and storing for use. There are several sources from which a supply of water may be obtained; some of them so obvious as to need little remark here. Rivers, lakes, and springs, rainfall, and showers link in one system with the waters of the deep sea. The moisture-laden clouds, driven landwards by the gale, meet and are broken by the high rugged peaks of some mountain-chain, or pour out their contents as they sail onwards. It is at all times desirable, when entering a dwelling-place, to make proper provision for the collection of rain water. We have already spoken of the different forms of cisterns and reservoirs in general use. These, to be of value, must be furnished with a carefully arranged set of tubes and water-channels, so placed as to receive the water as it flows from the ridges, and convey it, without loss, to the chamber placed for its reception. It is somewhat curious, notwithstanding the importance to be attached to a well constructed rain-water system as applied to buildings, that so little care is taken in fitting and adjusting the channels and tubes. The latter are too commonly so attached to the outsides of the walls, that at the least interruption to the downward passage of water they overflow, and saturated bricks and mortar are the result. A variety of causes are in force to produce obstruction—dead leaves, broken cement, and the thousand and one nameless waifs and strays which, wind-drifted, at length find a lodgment in the channel, collect, and gather together as they are carried onward, until at length, forming a mass, they either fall into the box head of the wall tube and stop the orifice at its bottom, or form a sort of dam in the channel itself, which, causes the water to flow in a broad stream out, over, and probably ultimately find its way to the ceilings or paper hangings of apartments. A small perforated zinc grating or strainer, placed at intervals of ten or twelve feet in the channels at runways, as shown in Fig. 5, will tend greatly to prevent ponding-up, as no accumulation of small substances can take place—each grate keeps back its own share, and prevents gathering together by onward flow. An occasional cleaning out

will keep the grates in a state of efficiency. The end of autumn, after the leaves have fallen, should be chosen as a time for a general inspection and clearance of the channels. The construction of the box or funnel heads of the main downfall tubes in common use is, as a general rule, very faulty in form. Fig. 2 shows a section of the ordinary tube head, and the manner in which a collection of leaves, straw, sticks, &c., &c. effectually and quickly choke it. Tapering rapidly to the escape-hole at the bottom, the impediment concentrates itself, and becomes impacted by downward pressure of water. Fig. 3 shows a section of a form of funnel or box head rendered free from the chance of being choked—A is a piece of tube the same diameter as the main pipe B; C is a cone of coarse perforated zinc, soldered to the mouth of the upright tube, like the head of a sharp pointed pepper-dredder. All substances entering the box with water will have a tendency to gravitate to the bottom, where they will remain far below the holes in the cone. The point being sharp admits of no lodgment; and as the water sinks in the box, stray floating fragments of matter will fall with it. D shows where two or three holes are made in the tube, in order to keep the bottom of the box dry, by gradual draining through of any matter which may collect below the holes of the cone. Sparrows are most

occasionally thrown into the newly-made well or hole, it was carried to the required depth, to reach the buried supply of water. A bamboo, with a split end, is not unfrequently used to form a small well; thrust continually up and down in a hole made in the surface-soil for its reception, it gathers together, between the split up joints of wood, such gravel, stones, or sand as may oppose its downward progress. When thoroughly filled, it is lifted from the hole and beaten until relieved of its burden.

Wells in sandy regions may be sunk by first building a circular wall of stones. The well sinkers then enter the circle and dig out the sand within, until the wall sinks to the surface level. Another wall is then built on the first, and so on, until by alternate building and digging the required depth is reached. This process, although most ingenious, is extremely tedious. Mr. J. L. Norton, of Belle Sauvage Yard, Ludgate-hill, is the inventor of a most ingenious, simple, and expeditious method of perforating sand, earth, gravel, or clay deposits, for the purpose of reaching the water locked up beneath them. Mr. Norton employs a number of iron tubes, which fit one on the other, much as a fishing-rod is jointed together. The first joint is pointed and perforated. It is placed in the arrangement represented in Fig. 4. B B B are three iron legs, like those of a telescope

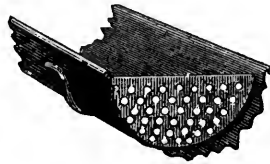

Fig. 5.

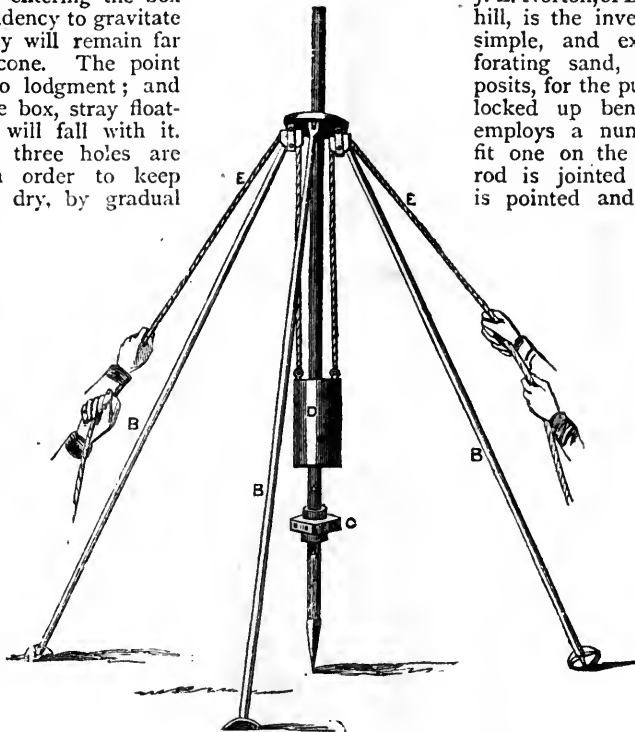

Fig. 4.

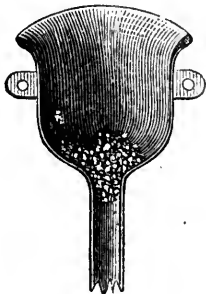

Fig. 2.

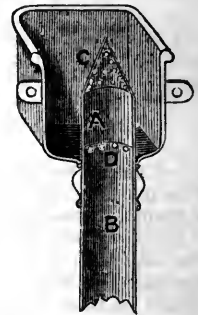

Fig. 3.

industrious collectors of all sorts of odds and ends; and, therefore, care should be taken to stop carefully the line of space between the lower border of the roof and the edge of the water channel, in order to prevent them from gaining an entrance. Pigeons are sad destroyers of rain-water, which is by no means improved by the addition of guano. It will not unfrequently happen, that although no surface water is to be discovered on lands in other respects desirable for occupation, an abundant store exists below overlying deposits; therefore it is that the well-sinker's aid becomes necessary. There are many methods by which a well may be sunk, dependent on the nature of the deposit to be penetrated, and the depth to which the sinkings are to be carried. The simple shaft, sunk in the earth until water is reached, has been had recourse to from the very earliest ages. Then the Chinese, discovering that a small orifice produced water freely, employed a species of shallow pumping borer or bit, which, driven by manual labour applied to a long bamboo lever, kept pecking at the earth, until it was filled through an orifice in the bottom. When charged, it was drawn to the surface, and its contents cast out, and so on, until by the aid of water

being suddenly let go, it falls on a sort of striking stop C, which is removed higher on the tube from time to time, as the tube recedes into the earth. Length after length is added and driven home, until the water is reached, when the arrangement represented in Fig. 1 is had recourse to.

The disintegrating pump is first made use of to clear away all earth, sand, &c., from the perforations of the tube point, when a pump intended for constant use may be attached.

In conclusion we must add that old wells which have failed to yield may be restored to their original value by treating them after the method mentioned, whereby the pointed end of the boring tube descends deep down in the well, which is brought directly up through the perforations to the point above.

There are yet several sources from which a supply of water may be obtained, which we leave unmentioned; the consideration of them must be reserved for our next paper.

HOUSEHOLD DECORATIVE ART.

X.—MODELLING IN CLAY FOR AMATEURS (*continued*).

A Medallion.—We will now turn to another and quite different branch of the art, and show how a medallion portrait may be modelled. Medallions are sometimes

of clay an inch in thickness on board, and, having scraped it to a perfect plane, to use it as a background. This should be prepared a day or two before it is wanted, that time may be allowed for it to set. Then take the compasses and strike out a circle which will be the circumference of the proposed medallion. The size is, of course,



BUST PREPARED FOR CASTING.

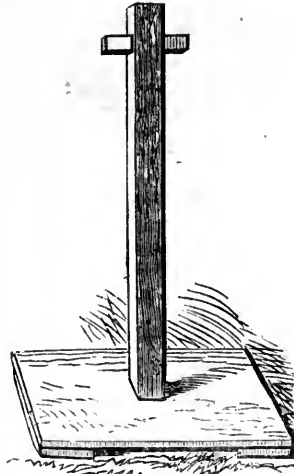

Fig. 1.



BUST.—J. L. TOOLE, ESQ., COMEDIAN.
(Modelled by F. Scarlet Potter.)

made which show the full or three-quarters face, and are occasionally modelled in high relief (that is, are almost detached from the background); but these, to be at all satisfactory, demand great skill and knowledge. The most simple and generally pleasing form is that shown in our engraving, in which the head is modelled in profile, in low relief, on a round or oval background. This is a style of portrait which is by no means difficult, and one which looks well, if carefully modelled and neatly framed, in any room; but some judgment is required in the hanging, for the modelling will not show properly in a wrong light. As a rule, a profile-medallion should be hung with the back of the head turned towards the window.



MEDALLION.—J. S. REYNOLDS, ESQ., HON. SEC., HOME AND COLONIAL SCHOOL SOCIETY.
(Modelled by F. Scarlet Potter.)

The first requisite will be a level substance for the background. A smooth piece of slate or plaster of Paris is sometimes used, and in most respects answers well; but as slate and plaster are different both in colour and texture from the clay, they do not admit of the latter being blended into them at the outline in a soft and artistic manner; and, therefore, if a highly finished work is desired, it is better to spread a slab

a matter of taste, but from seven to ten inches diameter is recommended, within which limits the length of the head should be from four to five inches. Place the "sitter" (the person whose portrait is to be taken) in such a position that his head may be on a level with that of the modeller, and that the light may fall upon the side of the face to be copied, rather from the back. It will be found most easy to work from the *left* side of the face, with the features to the left hand of the spectator, as the face of the queen is shown on the coins of the present reign; and supposing this side to be chosen, the light must fall upon the sitter from the modeller's *right* hand. The light on the model should be as nearly as possible the same. While the work is going forward the sitter should remain steadily in one position, and, when necessary, intervals may be allowed for rest. The first step will be to take one of the sharp-pointed tools, and scratch on the clay an outline of the head and so much of the neck and bust as is intended to be shown. If the slate ground is used this must be done with slate-pencil; if plaster, with charcoal or a soft

blacklead. The form as seen in the sitter must then be built up in clay, in the same manner as when copying the mask, only that in this case constant attention must be paid to the outline, since on that much of the likeness will depend. The hair will probably rather puzzle the beginner. He may, in the first place, get the general effect by using the deeply-serrated ends of the tool shown to the left in the illustration to our first article. Afterwards he must take the fine tool shown to the right, and with that divide into masses as he sees them in his sitter, and then indent them, more especially towards the ends, with curved lines; by the abruptness or easy curvature of which he will be able to show the character of the hair, whether crisp or flowing. This will require some care and delicacy of touch. The relief, or greatest height above the background, should not, in a head of this size, greatly exceed half an inch.

A Bust.—In this lesson we shall give the method of modelling a bust, which shall be one of the size of life; for the greater includes the less, and if the student is able to do this he will find no difficulty in making one of smaller size. The necessary modelling-stool, on which the bust must be worked, has already been described, but a frame will also be required. Its bottom should be of stout board, equal in size with the top of the stool. Into the centre an upright of wood, two inches square and two feet high, should be strongly morticed, and this again should have a cross-arm four or five inches in length near its top. This is shown in Fig. 1, on page 353. Round this the clay must be built into a rude resemblance of a bust, so as to imbed the cross-arm in the centre of the head, and to allow the upright to pass down the middle of the neck. This should be done some three or four days before the first sitting, for a considerable quantity of clay—some half-hundredweight—will be used, and that length of time will be required to allow it to set. Before the work is begun, observe carefully what is the characteristic attitude of the sitter. Most people, when at ease, have some peculiar habit, more or less marked, of holding the head; leaning it forward, throwing it slightly back, or towards the right shoulder or the left. If this trait can be given in the bust, the likeness will be greatly increased. Chantrey, whose busts are second to none, was so convinced of the importance of this, that he made a point of inviting his sitters to breakfast before he began work, that he might study them unobserved. If possible, it will be well to work in front of a tolerably lofty window, and to darken the lower half, that the light may fall somewhat from above on both sitter and bust. Place the bust and sitter side by side facing the light, taking care that the heads of both, as well as that of the modeller, are on the same level, and proceed to build up the forms as in previous instances. It is well to rough out the general proportions of the bust, and to get in the larger masses, before giving details. Give the breadth of the shoulders, the depth of the chest, the thickness of the neck, and the length and width of the head. Measurements may be taken, whenever required, with the callipers, which are merely a large pair of compasses with the points curved inwards. Then begin roughly to plan out the features. At first mere hollows will suffice to show the eyes; and digging in the thumb at the proper places, for the apertures of the ears and corners of the mouth, will indicate those features sufficiently; while a few random strokes with the tool will serve to express the hair. Everything at first should be treated in a large and broad manner; and even in this stage, if the work be done properly, some resemblance will begin to appear. Next make the outline of the profile generally correct, and afterwards put in the features, measuring their dimensions and proper positions with the compasses. For some time it will be necessary to concentrate the chief attention on the face; when that becomes satisfactory, model the neck; and it will then be desirable to devote a sitting to the hair alone. As the masses of hair constantly vary, and are never the same two successive

days, it is well that the whole arrangement of hair on the bust should be modelled at once; mere finish may be given afterwards. Another sitting may be given to the dress. Hitherto the shoulders have been left roughly blocked out to a rude resemblance of the human shape; it is not well to clothe them till the head is far advanced, and the neck, so far as regards form, finished; but they may now be covered, either with the usual dress of the sitter, or with a cloak, mantle, or other piece of conventional drapery thrown loosely round them; this should be copied carefully from the actual material. All that now remains to be done is to bring the whole to a good surface. The face and flesh generally may be treated as directed in the first lesson. The texture of the drapery will be best expressed by leaving upon it the marks of the teeth of the wire-tool, and of the piece of stocking. The hair should be left rough from the tool marks. Whilst modelling a bust, make it an object to put in as much form as possible while the sitter is present; mere smoothing may be done afterwards; remembering that (though in this case absolute stillness is not, as in the medallion, necessary) sitting is tiresome, and that there are limits to human patience. By means of the turn-table on the modelling-stool any side of the bust can be brought forward to be worked upon, without change of position on the part of the modeller; the sitter must, however, be requested to turn as the bust is turned.

It is believed that in the foregoing remarks will be found all the information needful to the amateur, not only for working out the examples chosen, but also, with slight modifications, for enabling him to adapt the art to any other of the numerous purposes for which it is fitted. When some skill has once been acquired, objects on which to employ it, and appropriate methods by which to decorate them, will readily occur to anyone of intelligence and taste. We have now only to treat of one more process—that of Casting; for the clay model, it must be remembered, is not permanent. It is true that such models as have no framework of wood or metal, and are wholly composed of clay, are sometimes preserved by burning, becoming what are known as terra-cottas; but to burn them is a matter of much difficulty, and can only be done with costly appliances; it is, therefore, beyond the reach of the amateur. Usually, if the clay becomes dry it shrinks, cracks, and crumbles to pieces; hence the ordinary method is to keep the model damp till it can be cast in plaster of Paris. How this may be done will be shown in a future article.

THE REARING AND MANAGEMENT OF CHILDREN.

X.—DIETARY OF YOUTH (*continued*).

MUTTON and beef are the highest and most suitable forms of animal food; but compositions in which suet, eggs, milk, and butter enter, come, also, under the head of animal food. In this respect, well-made puddings may represent a meat meal in so far as nourishment is concerned, although the nourishment may not be of the highest possible class. A good homely substitute for a full meal of meat will be found in a pudding composed of batter, made of eggs, milk, and flour, to which has been added morsels of fresh beefsteak, stirred into the batter. This pudding, seasoned with pepper and salt, and carefully baked, constitutes a healthy and palatable meal for a family at comparatively small cost. Again, a well-boiled steak-pudding is excellent fare, and suitable to the strong digestion of growing boys and girls. The crust of the pudding supplies the bulk, combined with nourishment, so important at that age. Prime joints are not absolutely necessary to secure ample nourishment; although, even in point of economy, less quantity of a best cut of meat satisfies hunger more than a larger off-inferior

portions. At the same time, it is an error to supply too concentrated a kind of diet. If, when in health, children are invariably kept nourished at high-pressure mark, there is no resource for them in store, when in sickness further stimulants are needed. Liver, hearts, and soup composed of liquor in which meat has been boiled and thickened with rice, vegetables, and suet dumplings may be advantageously eaten, in turn with prime joints.

Regularity of meals is a matter of almost as much importance as the quality of the food. Of whatever kind the repast may be, a certain time is required for the work of digestion, and a proper amount of rest is needful before the labour recommences. Three meals a day for healthy persons are sufficient, provided the quality of the food be of a nutritious kind. Children that are continually craving for food are either imperfectly nourished or they are in ill-health. From four to six hours is the right interval to observe between meals, according to the age of the individual. In order to render the above period of abstinence endurable, the repast should be of a varied and substantial kind. Breakfast of weak tea and baker's bread and butter, for instance, will not suffice for a growing child till dinner time—five hours afterwards—without a great deal of self-denial. But if good oatmeal porridge, a pint of bread-and milk, or a fair quantity of boiled bacon or eggs, with unlimited bread and butter constitute the meal, the promptings of a craving appetite should be afterwards unheeded. At dinner, meat and vegetables should form the principal fare, followed by pudding; stewed fruit and bread and butter, or bread and jam, in place of pudding. If soup be eaten instead of meat, a good pudding should follow; for although ordinary soup may satisfy hunger for a time, it is not the same "stay-by" as more solid food.

Tea, as a meal, is in many families a delusion. Although the refreshing cup, accompanied by a slice or two of bread and butter or toast, may answer the purpose well enough for adults who have the prospect of a supper before going to bed, neither quality nor quantity is sufficient for young people. Dr. Grosvenor Wilson feelingly remarks: "I have secured to many a child a reasonable evening meal by suggesting to the mother the mere use of the word 'supper' as the name of the third meal." And this is precisely the change that we would wish to see established in every household. It is deplorable to think of the number of hours, craving little stomachs suffer, without food between the time of going to bed, say at seven o'clock, and rising twelve hours afterwards, not partaking of nourishment in the interval, under the impression that suppers are unwholesome.

A proper meal in place of the ordinary "tea" will be found to consist in some of the following additions—cocoa, made with as much milk as the parents can afford; bread and butter, with or without cheese; stewed fruit, hot in the winter, and cold in the summer; a milky rice pudding to which finely-chred beef-suet has been added; plain boiled rice and treacle; or, if possible, some eggs; cold boiled bacon or meat. The additional expense any of the above articles may appear to entail will not be all loss. Less need will be felt for tonics, from the febrile maladies too often occasioned in early life by children being underfed. Another demand may also cease, namely, for cakes and sweetmeats "to put under the pillow."

In addition to the three meals a-day alluded to, growing boys and girls who have lessons to prepare in the evening require a little light nourishment before going to bed. A cup of cocoa and a slice of bread act beneficially on their constitution; for we must ever bear in mind that, although still beneath a parent's roof, children under tuition are actually engaged in the great business of life, and their constitutions require support to meet the wear and tear of mind and body under forced labour and restraint.

Wine and beer are, under ordinary circumstances, not necessary for growing children. Plain water best aids digestion. This beverage should not exceed in quantity half a pint at meals, although an unlimited supply may be permitted afterwards. The only cases where beer or wine are really needed are when a depressed state of constitution requires such stimulants. As much milk as can be afforded, taken hot or cold, may, even in the latter case, successfully replace alcoholic beverages.

HOME GARDENING.

THE VEGETABLE GARDEN (*continued*).

The Dwarf French Bean.—This is an annual, and its constitution and habits are very similar to those of the runner, only it has not a running stem, neither is it so prolific or long-bearing as the former. The young unripe pods are used as in the former case; in addition to which, while these are quite young, and not more than an inch long nor thicker than a straw, they are greatly esteemed for pickling. The varieties generally cultivated are the early yellow dwarf, early red speckled, early black or negro, early white, Battersea white, Canterbury white, black speckled, dun-coloured, and large white dwarf. The dwarfs will bear sowing a little sooner than the larger growing kinds, and will come in somewhat earlier. They are more convenient to cultivate on a large scale, and are also considered by many to be more delicate in flavour. For the first early crop sow the early yellow, early black or negro, or the early red speckled; and for a rather later crop the early white is the best, and is generally considered superior to the others in flavour. The Canterbury and Battersea are decidedly the best for main crops. The dwarf kidney bean does not continue in bearing more than three weeks or a month, so that it is necessary to sow a successional crop or two in order to have a continuance until the runners come in, or for a regular succession throughout the summer. Half a pint will sow a row eighty feet long, the beans being placed from two and a half to three inches apart in the drill. This bean, like the runner, delights in a rich and light soil, and for early crops it should be rather sandy and dry; but for later ones a moist loam is more congenial. You should commence sowing the various kinds of dwarf beans about the first week in April, provided the weather be fine and open. The best situation is a dry south border, although it is not absolutely necessary to their well-doing at all times. Draw drills two feet apart and an inch and a half or two inches deep, for the smaller sized beans, dropping them into the drills rather close together, in order to allow for a failure, which is almost certain to happen at this early season. For main crops, other portions must be sown towards the end of April, and in May and June, in order to have a continual supply. For later crops the drills may be drawn two feet and a half asunder, two inches deep, and the beans be placed from two to two and a half inches apart in the rows. If a late crop is desired, a moderate sowing should be made about the beginning of August. Crops sown late should, as a rule, be favoured with the best situation the garden can afford, otherwise they will not turn out to your satisfaction. It is not worth the trouble to grow very late crops of dwarf beans, as the runners, under proper management, will continue bearing until frost cuts them off; and that will, as a matter of course, be very late in the season. The beans for summer sowing would be greatly accelerated in their germination provided they were soaked in soft water for six or eight hours previous to sowing. As the plants of different crops advance in growth, hoe and stir the surface between the rows, and cut down all weeds as they appear, and draw a little earth to the stems, which will tend very much to encourage the growth of the plants as well as to increase

the crop. The pods should be gathered while young, tender, fleshy, and brittle, as they are then in the greatest perfection. By clean gathering the crop will continue longer in perfection than if a superabundant one were left to grow old; and, independently of this, you will prevent the successive pods from being robbed of a considerable portion of their nourishment or support. A row or two, or more if necessary, should be set apart for seed, taking care not to gather until they are fully ripened; then pull up the haulm, and lay it in the sun until it is thoroughly dry; after which the beans may be cleared out of the pods, and put away till wanted. It frequently happens that a sufficient quantity will be found upon the stalks after a crop is over, and when such is the case dry them and put them away for future use.

Red Beet.—This is a biennial plant, with large, oblong, succulent leaves of a reddish colour; the roots, when at their full size, are from three to four inches in diameter, and from a foot to eighteen inches in length, and of a deep red colour. The flowers are of a greenish colour, and make their appearance in August. The roots are the only eatable portion when boiled and sliced, either by themselves or in salads. They are also used for pickling, and occasionally for garnishing. There are several varieties of beet—namely, Henderson's pine-apple, Nutting's selected, Cattell's dwarf blood-red, and Beck's improved—all of which are good; so that you cannot possibly make a mistake in selecting any one of the four. This plant delights most in a dry, light, and a rather sandy loam, having a good depth, so that there may

be ample room for the root to penetrate at will. It is always raised from seed, which should be sown annually, either the latter end of March or the beginning of April. We never sow earlier ourselves, for this reason, that we have invariably found the early plants run up to stalk, instead of making good root. The ground on which the seed is to be sown should be well manured and trenched the preceding year, in preference to leaving it till the time for sowing arrives, as ground so recently manured invariably causes the roots to canker. The ground should be trenched eighteen inches deep, before sowing for the long-rooted kinds. The seed may either be sown in broad-cast or in drills a foot apart, but we prefer the latter method for two reasons; first, because they can be more easily kept clear of weeds, and, secondly, they can be thinned with greater facility. Draw drills as you would for peas or beans, and drop the seeds, two together, into the same, at about a foot apart, and as soon as the plants are of an age to distinguish the strongest, pull up the weaker, so as to leave one only standing. Presuming that they have been sown broadcast, as soon as the plants are about two inches high, they must be thinned out to about twelve inches apart in every direction, which will allow them full room to grow and swell to a good size by the autumn, at which time they will be fit for use as wanted, and will continue in perfection during the winter and spring following. However, we make it a practice to "provide for a rainy day," if we may use the expression, by pitting them up as we would potatoes. But where, however, you have not a sufficient quantity for such a

purpose, the roots may be then taken up, trimmed of their leaves, and be deposited in sand, in a shed or outhouse; or, if you prefer it, you may take up a portion only and keep them under cover for use, when hard frosts would fasten them in the ground; but the remainder may be still left in the soil, to be taken up as wanted, weather permitting. In February or March the pitted roots may require to be looked at, in order to check the growth, or prevent their running, or they will not keep good till May or June, as they would do if examined periodically, as already observed. Great care must be taken not to break or injure their roots, as they would then bleed much and become pale-coloured. For this reason, on taking off the leaves, an inch of the tops should be left on with the solid root. In order to save seed, a few strong roots should be selected and transplanted to some spot where they will not be in danger, when in flower, of impregnation with any inferior or different variety. A few strong roots may be left standing in the row, which will shoot up the second year, when their flower-stalks should be tied to stakes to prevent their being blown down.

White Beet.—This is a hardy biennial plant, the leaves of which are larger than the red beet, and very thick and succulent. It produces its flowers, which are of a greenish colour, in August and September. The leaves of this plant are the only usable parts, which are boiled like spinach or put into soups. The principal varieties in cultivation are the common small-rooted green-leaved, the common white small-rooted, and the large white, or the Swiss. All the sorts are propa-

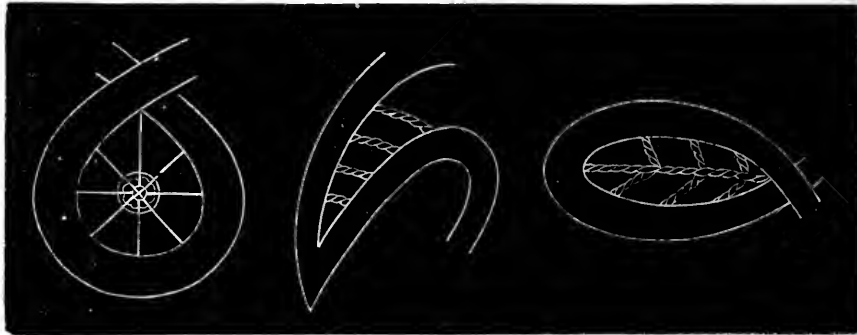

Fig. 1.

Fig. 2.

Fig. 3.

gated by seed, and the soil for these varieties may be considerably stronger and richer than that for the red sorts, but need not be quite so deep. For a bed containing fifty-four square feet, one ounce of seed will be sufficient. The seed should be sown in March, either in drills, six or eight inches apart for the small sorts, and ten or twelve for the larger, or broadcast, and the seeds raked in well. When the plants are up two inches high, they must be thinned out to from eight inches to a foot apart, and afterwards kept clear of weeds. The seed of this sort may be saved in precisely the same manner as that recommended for the red.

POINT LACE WORK.—III.

WE now give, as promised in our last article, the "Spanish Point Loop," forming a companion to the "Trefoil;" and we would advise its being used, alternately, with the trefoil, either for a banner-screen, a bracket, the border of a table-cover, or a "*bordure de cheminée*." If three of these vandykes, viz., one "loop," one "trefoil," and one "loop," or *vice versa*, be traced out on one length of the transparent linen, and tacked down firmly on thick twilled coloured calico, the piece of work, when completed, will be of the right length for trimming a velvet banner-screen, being laid on the velvet, along the lower edge. The two designs will be found to join perfectly, and may be continued alternately to any required length, should a table-cover, a *portière*, or any other long piece of work be

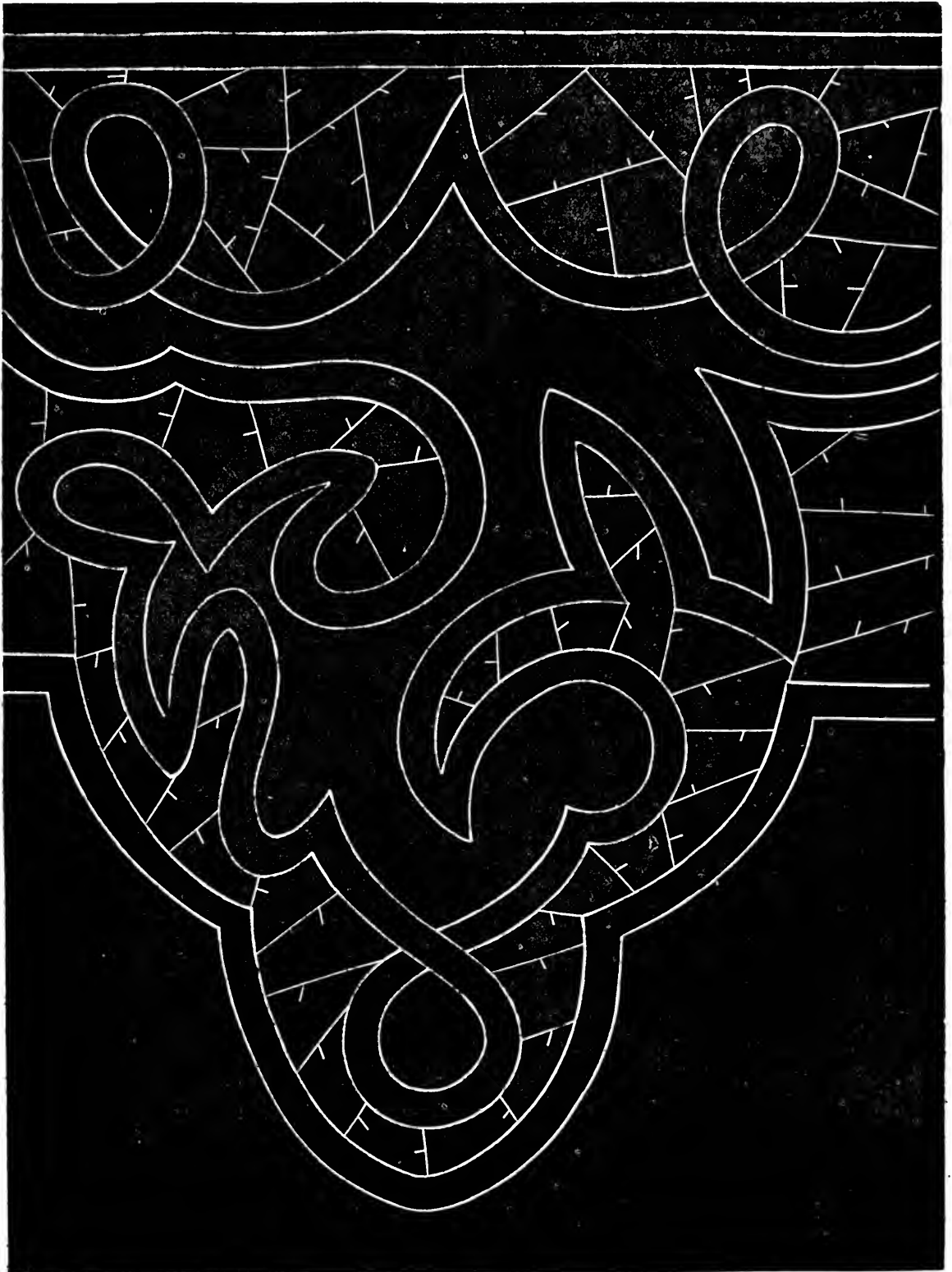

LACE WORK. THE SPANISH POINT LOOP.

required; the open stitches, given in our last, may be used for the present design, and arranged after the worker's own taste.

For the "loop," in the point of the vandyke, in our present number, we should advise that "a wheel" be worked in its open space. For this purpose, threads should be stretched across, as in Fig. 1, by taking the needle from one side of the opening to the other, and then sewing back over the thread, until the starting-point is reached; the needle is now taken on a little way, and another thread is stretched; this is continued until four threads are taken across, each being sewn over before the next one is commenced. After the fourth time, the sewing again goes back as far as the centre, or the point where the lines intersect, and, after taking a stitch of overcast to keep the threads together, the spot is then formed by taking the needle under and over the threads alternately until it be of the required size, when the remaining half of that thread should be sewn over, which will bring the needle to the opposite braid again for fastening. For the wheel, fine thread should be used. In some of the spaces, which are not very wide, the bars shown in Fig. 2 may be employed with much effect, and differ from those given at Fig. 4, p. 282. The thread is taken across and fastened with an overcast to the braid; then sewn back again over the thread, which gives the appearance of a twisted rope. This may be varied by the same style of bar being worked lengthwise, as in Fig. 3, imparting a sort of leaf-like look; and contrasting well with some of the closer patterns of the open-work. With regard to the size of cotton used, it is almost impossible to particularise; indeed, the worker must decide this for herself, and try the effect of different open stitches, until she can suit her own taste as to the cotton. A great variety of braids, for point-lace work, are now made; and we have seen beautiful patterns sent from Nottingham, and, also, samples of cotton. We need hardly say that the "Spanish Point-Lace Cord" is to be continued along the edge of the braid in this "Loop" pattern, as in the "Trefoil." We hope, shortly, to give a design for a border to be laid on the edge of a square-cut open bodice.

ANIMALS KEPT FOR PLEASURE.

V.—THE DOG: DISEASES OF DOGS (continued).

Mange.—This word is used to denote almost every kind of skin disease in the dog. True mange is caused by an insect; but Mr. Mayhew describes four other kinds, and says he believes there are many more.

In real *mange* (which generally arises from contagion) the skin is more or less extensively denuded of hair, dry and scaly, and corrugated (in ridges). The spirits are mostly dejected, with only occasional symptoms of liveliness, and the animal is constantly scratching himself, while the heat of the body is greater than usual, and, as a rule, the animal drinks more than when in health.

Mercurial ointment is commonly prescribed by farriers or illiterate dog-doctors. It doubtless cures the mange, but at the same time it greatly injures the animal. A dog never completely recovers from salivation, therefore the best ointment is one composed of—

Ointment of resin	} at discretion.
Sublimed sulphur	
Oil of juniper	

Add as much of the second ingredient to the first as can possibly be mixed, till the mass is too stiff to add any more, and then thin down with the third till of a convenient consistency for use. Rub well into the skin (smearing the coat merely is ridiculous), and wash off next day. Do this three times, which will last a week. Then rest a

week and repeat the process, which will usually be sufficient; but if the dog begins again to scratch itself suspiciously, the process must be gone through again.

In another kind of skin disease the hair falls off in patches, which, as before, appear hard, scaly, and corrugated, and the itching is intense, but in this kind seems worse in the parts still covered with hair. The treatment begins with tonic medicines for a week or two, such as are given for disemper—omitting quinine when liquor arsenicalis is given, and diluted with water—this being a sure specific. Give a small dog half a drop thrice a day at first, a large one two drops, and so in proportion to the size, each day increasing the doses by half a drop, or a drop, respectively, for the whole day* (not for each dose). At length the dog will have a discharge from the eyes, or they will look bloodshot, or he will loathe his food, or in some other way show the medicine is acting, when it must be stopped for three days, and then commenced again at half a drop less than the last dose, for fear of overdoing it, again increasing till the dog is affected a second time. Some animals require very little before their system is influenced; others will stand an enormous quantity, comparatively, of the poison before they show any sign that the medicine is acting—in fact, require what would kill another dog of equal strength and size. But, whatever be the dose required, the medicine is infallible, and when given cautiously, as described, perfectly innocuous. In one to two months the disease will be cured.

Over-fed or fat dogs are apt to contract another kind of mange, which manifests itself by a most offensive odour and an enormous thickening of the skin. Of course sensation is deadened, and the very hardest pinching only gives the animal pleasure. The back often shows more or less bare places, but not always, and the spirits are dull. The cure consists in withholding all flesh meat, and confining the animal to vegetable diet, giving an emetic of antimonial wine, and then a daily dose for three or four days of a castor-oil mixture (such as is given hereafter), followed by tonics, with a cold bath every morning. Then apply daily some stimulating liniment, such as—

Oil of turpentine... ..	2 parts	} mix.
Nut oil	1 part	
Oil of pitch	2 parts	

After a week make it as follows:—

Oil of turpentine... ..	1 part	} mix.
Nut oil	1 part	
Oil of pitch	1 part	
Turpentine	1 part	

As the turpentine acts in reducing the thickness of the skin it will give acute pain, and the dog will utter piteous cries. The quantities used may then be somewhat lessened: but, in spite of the animal's agony, the process must be continued if a cure be desired, though it is a question whether real humanity would not rather order a merciful execution.

In another kind of mange the hair suddenly falls off in patches. "For this," Mr. Mayhew says, "no application is necessary, if the diet be attended to;" but we think the application of sulphur ointment much facilitates re-growth.

In the last kind of so-called mange—which frequently attacks young pups—the hair nearly all falls off, till the pup is almost naked, the skin being covered with nearly black patches, caused by effusion of blood, and large pustules filled with matter. In grown dogs, as a rule, only the back, neck, and head are affected, and a cure is certain with patience, but is very tedious and expensive. In the case of pups all depends on the strength of the

* As half a drop a day divided in three may puzzle the reader, we may observe that the liquor (ordinary strength) may be diluted with six times its bulk of water. Then an increase of one drop of the mixture to each dose will be equivalent to only half a drop of the liquor during the whole day: and so on.

animal. The treatment consists in opening the pustules freely, and also puncturing the skin to let out the dark blood, then washing the skin with a soft sponge and warm water, and applying the following soothing ointment:—

Camphor, powdered	1 part.
Mercurial ointment	1 part.
Elder ointment	1 part.

The sponging and ointment are to be repeated daily, and liquor arsenicalis given, as already described, and with the same precautions, till a cure be effected.

Canker of the Ear is one of the commonest complaints of dogs, and we believe in every case it is caused by foul, improper, or too high feeding. There are two kinds of canker recognised, and known as internal and external; but internal canker appears to be the only one which can be called a disease, the external canker—a canker of the flap of the ear—being never found unless in conjunction with the internal complaint, and being evidently caused by the creature continually shaking the head, or scratching the ear from the internal irritation, till the continual violence causes a sore, which degenerates into an ulcer of more or less extent. The treatment formerly recommended was almost inoperative, and cruel in the extreme. The diseased parts are still often cut away, without the least effect, as the internal irritation again causes the continual shaking of the ear, which leads to the disorder. For internal canker many practitioners—and even Mr. Youatt—prescribe dressings which make the poor dog howl with agony, and, as this writer confesses, do not seem to have much success.

The first symptom of internal canker is the animal constantly shaking the head or scratching the ear. In worse, or more developed cases, there is a blackish discharge visible within the ear, with a smell which Mr. Mayhew compares to decayed cheese. The remedy is vegetable diet (in nearly every case of canker there has been too much of flesh meat), and a dressing composed of equal parts of extract of lead and water. This is to be carefully applied by two persons, one holding the dog's head in one hand, and having the root of the ear in the hollow between the first finger and thumb of the other. The assistant then pours the dressing (half a teaspoonful to a teaspoonful) into the ear, when the person who holds the dog closes the ear and works it with his fingers, that the liquid may penetrate thoroughly. This dressing is soothing in its character, and gives no pain. As the lead solution makes a mark wherever it touches the clothes, a coarse apron should be worn, and when both ears are done the creature should be suddenly thrown to a distance, that he may not splash any on the operator's garments. The dressing is to be used three times a day.

External canker being different in its nature, and due to mechanical causes, needs different treatment. The first thing is to get a cap of linen or calico, and tie over the creature's head and ears, to prevent further irritation by shaking or scratching; and the only application needed will be the soothing mercurial/camphor ointment prescribed above for one of the varieties of mange.

If the shaking of the ear has produced actual abscesses—as it sometimes will—within the flap, the treatment is the same in principle. The sac must be slit thoroughly open, a small pledget of lint, soaked in the extract of lead solution, kept in it for a day or two, when the wearing of the cap—to prevent further irritation until the *internal* canker be removed and the animal no longer shakes its head—will complete the cure.

The dog is also sometimes subject to malignant cancer in various parts, analogous to the same dreaded human disease. No cure of such cases seems possible, though they may sometimes be so alleviated by a skilled practitioner that the animal's life may be spared. Sometimes excision may be effectual at an early stage.

DOMESTIC MEDICINE.

BRONCHITIS.

THIS disease is one that it behoves to describe carefully, because it is a good deal before the public, and really is one of the most fatal diseases that human nature has to contend with in this climate. The large mortality of our winter weeks is chiefly due to this cause. In very cold winters the mortality will go up to numbers which are more suggestive of plagues than anything else. Medical men have long known that cold was a very deadly thing. Dr. Heberden, at the end of last century, showed that a cold winter was almost twice as fatal as a mild one; and the diseases which the cold causes are of the nature we are about to describe—bronchitis, inflammation of the lungs, &c. The facts of Dr. Heberden's paper, which was published in the "Philosophical Transactions," were very striking and instructive. He compared the number of deaths which took place in London in January, 1795, with the number that occurred in January, 1796. The January, 1795, was a very severe month, and that of 1796 was a very mild month. Now let the reader mark the facts which are thus stated by Sir Thomas Watson, in his Lectures. "Of these two successive winters one was the coldest, and the other the warmest, of which any regular record had been kept in this country. In the month of January, 1795, the thermometer, upon an average, stood at 23° in the morning, and at 29.4° in the afternoon—always, you will observe, below the freezing-point. In the same month, in 1796, it stood at 43.5° in the morning, and at 50° in the afternoon—always much above the freezing-point. The average difference in the two months was more than 20°. In the five weeks, beginning upon January, 1795, there were 2,823 deaths. In the five weeks beginning upon January, 1796, there were only 1,471. The difference (1,352) is enormous. The mortality in the former year was nearly double that in the latter." The mortality to old people was very striking. In the January of 1795 there were in London 717 deaths of persons above sixty years old, while in January, 1796, there were only 153 such deaths, or scarcely more than one-fifth of the former number. Note further—what is to the point for our present purpose—that deaths from diseases of the chest were very fatal in the severe month, and very slightly so in the mild one. The deaths from what they called asthma—which, doubtless, were for the most part deaths from bronchitis, were 249 in January, 1795, and only 29 in January, 1796. The deaths from what they called then consumption—which would include many from bronchitis—were 825 in 1795 and 342 in 1796. But since then there has been a uniform experience of the mortality of cold winters, and yet there is a common notion abroad that cold is a healthy thing. Some people come up to you on a day in which you can scarcely keep warmth in you and say, "What a fine healthy day this is!" And there is a proverb which embodies the same notion, that "A green yule makes a fat churchyard."

There should be no mistake about the deadliness of cold. There may be a great deal of sickness in mild, muggy winters, but there will be less death; and it should be said that cold and cholera are not very unlike each other in their power to kill. It is true that it is chiefly the old and the young and the weakly that die from cold, but these are just the classes that die from anything. The weather that kills them is deadly weather, and should be guarded against. As we have said, one of the great diseases by which the old and the young and the weakly are cut off in winter is

Bronchitis.—We have already described the disease as it affects children; but it is entitled to another notice, as affecting grown-up and old people. A very bad cold in the chest generally means more or less of bronchitis—that is to say, of inflammation of the tubes which go from the

windpipe to the lungs and carry the air to these organs, and he is a very healthy person that is not more or less liable to this complaint in this climate. In most people this only occurs occasionally, and at long intervals. In some people it is almost a *habit*, and all through the winter they cough and wheeze and spit, and breathe very badly. They may go on this way for years or for a lifetime. Winter and spring are their times of danger, and they should look upon these seasons as not friendly, and take corresponding precautions.

Symptoms.—As we have said, the symptoms of bronchitis, roughly speaking, are cough, wheezing, spitting, and short breathing. The cough is generally a severe tearing or choking sort of cough. Perhaps it comes on in fits of coughing, which are apt to be worst at nights. The wheezing noise in breathing, too, is apt to be worst at nights. The expectoration consists, for the most part, of thick yellow phlegm, which is occasionally tinged with blood. There is more or less shortness of breath. This set of symptoms often exists without much inconvenience to the patient. But if there is any fever or heat of skin added to them; if they have come on sharply after a shivering; and if there is much pain in any part of the chest, either sides or front of it; then the attack is severe, and should have every attention, including the advice of a medical man. The case is more serious still, if the patient is advanced in years, for it is found that very little bronchitis, occasionally, is enough to put life in great risk. The common case of bronchitis is one more or less chronic or habitual, not jeopardising life. It is astonishing how many people have every winter a considerable amount of bronchitis, which, with a little care and rest, and perhaps warmth in bed and medical attention, gets better, and lets them go about their duties again. Even the acute cases of bronchitis, generally speaking, occur in those who are more or less accustomed to the chronic form of the disease. In all cases the disease is a weakening one, and even in acute and severe cases there is an early need for support.

* A FEW WORDS ABOUT DYEING.

SOILED or faded articles of dress or household wear may frequently be again rendered serviceable by dyeing; and although the larger ones must, from the trouble and care involved, necessarily be sent to the professed dyer, the smaller ones may often be dyed to advantage at home, and some saving of money and vexatious delay effected, and more especially in the colonies or in the country, where dyers are not easily reached. It appears desirable, therefore, that we should say a few words on the subject of dyeing, and more especially on that branch of it which may be of practical use to our readers.

The art of dyeing is of great antiquity, and a long and interesting essay might be written on its history. For instance, kermes, a dyeing stuff still in use, can be clearly traced backwards through the middle ages to ancient Rome and thence to Greece, where it was employed to colour the scarlet cloaks of the rich Athenians. The poor Athenians, whose average income was fourpence-halfpenny per day, wore undyed cloaks which were washed sometimes, but not too frequently. The Greeks in their turn derived kermes from the Asiatics. Much might be said, if it were to our present purpose, about the famous Tyrian purple; but we shall only remark with regard to it, that it was probably prized by the ancients much more on account of the absence of other good dyes than its own intrinsic merits, as compared with those of our time. The art of preparing it is by no means lost, and the shell-fish which furnished the purple pigment still abounds, but we have better colours, and no one finds it worth the trouble of making.

The superiority of modern to ancient dyeing, is chiefly to be attributed to three causes: to the introduction of alum as a mordant (a term we shall explain by-and-by); to the discovery of America with its valuable dye-stuffs—cochineal, logwood, and many others; and to the researches of modern chemistry, which have brought into use many new substances, and more notably the aniline dyes.

If we avoid entering upon scientific details, the principles on which textile fabrics are made to take up and retain colour, may be explained in a few words. There exists but little affinity between the fibres of which cloth is composed, and the ordinary dyeing matters. Consequently, although the cloth will take up colour, unless some means are used to fix it, it will wash out. The fixing is done by using what is called a mordant. Now, a mordant is some substance which has an affinity for both cloth and colour; the ordinary mordants are alum, oxide of tin, protoxide of lead, infusion of nutgalls, and some others. For instance, the red colour given to cotton by madder could not be fixed unless the cloth were previously steeped in a solution of alum. The cotton cloth has the property of combining with, and retaining a portion of the alum. The red colouring principle of the madder has also an affinity for the alum and combines with it, and thus indirectly the combination of the cloth and colour is effected. Some mordants, more especially alum, have also the property of rendering the colours more brilliant.

It is found that some kinds of material are more easily combined with the colouring matter than others. Silk is most easily dyed, and takes the finest colours. Next in order is wool. The woody fibres of cotton and linen are the most difficult to dye.

But while science improved the art of dyeing, by discovering its principles and adding to its list of materials, it rendered its domestic practice more difficult. While the art was simple, it had been almost as common an accomplishment as spinning; when it had become complex this could no longer be the case. Recently, however, the tendency of science has been in the other direction, and has again made it simple and generally available.

As early as 1826, it was discovered that in the waste formed in the manufacture of coal-gas there existed, among others, a substance which was named aniline. About 1858, it was found that, under different kinds of chemical treatment, this would yield a variety of brilliant colours, which were turned to practical account as dyes. From their beauty some of them soon became fashionable and popular; the best-known of the class are magenta and mauve. Many improvements in the manufacture have since been introduced, and it is found that they have so great an affinity for the cloth, that the use of mordants may be dispensed with.

By the use of these dyes the dirtiness and the difficulty of home-dyeing are done away with. The work may be done with a certainty of success, and without so much as soiling the fingers. The form in which they may most readily be procured is that of "Judson's Simple Dyes for the People," as prepared by Messrs. Judson and Son, Southwark Street, London. Their preparations may be bought at any chemist's, at 6d. a bottle, and give a considerable variety of colours, mostly of great delicacy and brilliancy. The colours sold are: magenta, mauve, violet, puce, purple, canary, cerise, scarlet, orange, blue, pink, green, crimson, brown, black, lavender, slate, and grey; and different shades of these colours may be formed by using a greater or lesser proportion of water. The method of using them is as follows:—

For ordinary small articles, such as ribbons, feathers, &c. Into an earthen basin pour two or four quarts of boiling water. Into this throw the articles to soak for a minute or two, then lift them out with a piece of clean

stick, and pour in a little of the dye. The quantity must depend upon the shade required. The novice will do well rather to put too little than too much, as more can be added afterwards, if needed. The articles must never be allowed to remain in the basin while the fluid is poured in. As soon as the dye is mixed with the water the goods must be put in and stirred briskly with a piece of stick in each hand, that the colour may be equally distributed. For most goods, from five to fifteen minutes' immersion will be sufficient; if a deep shade is required, or if it is desired to utilise the whole of the colouring matter, they may be allowed to remain longer; and so great is the affinity of the dye for the fabric, that the whole will be absorbed and the water rendered colourless. There is, therefore, no reason for using a small quantity of water on the ground of economy of dye. The colour will not be lost in the larger quantity, and the goods should have abundant room to expand. When the goods are of a sufficiently deep shade, remove them from the water with the stick, and hang to dry. Till they are thoroughly dried the full beauty of the colour will not be seen. If desired, a little starch may be added to the dye. Before silk or ribbons are immersed they should be laid on a board and well brushed with soap and water to clean them and take out creases.

The aniline, like other dyes, are found to have a greater affinity for silk than for woollen fabrics, and for woollen than cotton or linen; nevertheless, most of the colours answer well with cotton goods. The magenta is the most powerful as well as the most beautiful. A sixpenny bottle of this (about two tablespoonfuls) is sufficient to dye twenty yards of bonnet ribbon, or a much larger quantity, to the fainter shade, rose pink. Hitherto the least satisfactory has been the black, which has not been considered equal to the ordinary black dyes; but within the last few weeks improvements have been made which render it available for silk. In woollen or cotton it is still imperfect. For dyeing black a longer immersion is necessary than for bright colours, and it is even well to boil the goods in the dye.

There is nothing disagreeable in the use of these dyes: the process is, on the contrary, a pretty and interesting one.

ODDS AND ENDS.

Mantel-shelves.—A good mantel-shelf is improved by a velvet hanging, and a bad one is rendered endurable. For this purpose measure the shelf, and get a shelf-board, or plank of wood, two feet longer than your mantel-shelf, and half as wide again. It is cheapest to make two together if you wish to cover them with velvet, because one length of velvet splits down and covers two. Cloth makes an excellent cover, and keeps its colour longer than cotton velvet. Cotton velvet costs 1s. 6d. or 2s. a yard; Utrecht velvet about 7s. or 8s.; cloth 7s., but it is so wide that a quarter of a yard generally covers a shelf. Cotton velvet is only three-quarters of a yard wide, and must be bought the whole length. Strain it over the plank of wood, and fasten down with tacks; then add a valance notched out all round to back the fringe you intend to use. Or a piece of double tammie may be used where Utrecht velvet or expensive cloth is adopted. Over this arrange the fringe, which costs from 11d. a yard, with star-headed gilt nails at 7d. a dozen. A handsome hanging may be edged with a fine worsted fringe of the same colour as the velvet, over which a tassel fringe of yellow silk is laid. The mantel-hanging always matches the window-curtains, and the carpet and other appointments of the room should, if possible, correspond. A brass double-eyed crank is nailed to the board first by one hole, and afterwards by another hole serves to fix it to the wall. Any ironmonger will furnish this, and anybody can put up the board so furnished. Fig. 1 represents a plain mantle-board; Fig. 2 a curved one with an ornamental fringe.

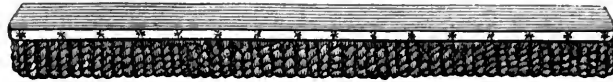

Fig. 1.

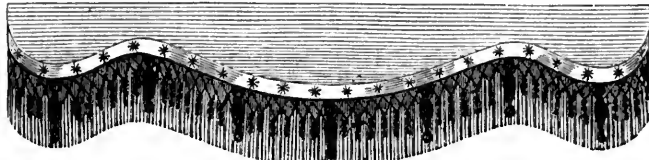

Fig. 2.

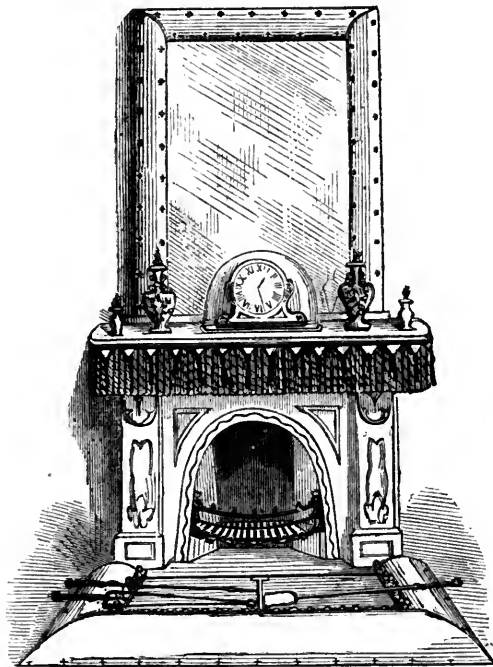

Fig. 3.

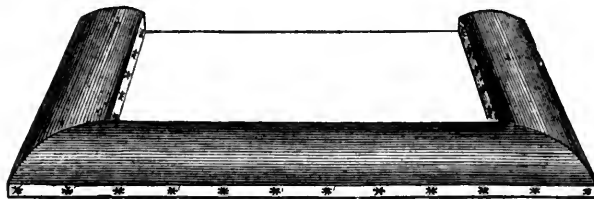

Fig. 4.

to the room, the merit of costing little, giving no labour to keep clean, and not spoiling. The grates of the drawing-room were very handsome. The hearthstone was as dazzling as whitening or pipe-clay, instead of hearthstone, could make it. The fender left the whole of this beautifully white stone clear: the inner edge of the fender just bordered over the hearthstone. This was

yard generally covers a shelf. Cotton velvet is only three-quarters of a yard wide, and must be bought the whole length. Strain it over the plank of wood, and fasten down with tacks; then add a valance notched out all round to back the fringe you intend to use. Or a piece of double tammie may be used where Utrecht velvet or expensive cloth is adopted. Over this arrange the fringe, which costs from 11d. a yard, with star-headed gilt nails at 7d. a dozen. A handsome hanging may be edged with a fine worsted fringe of the same colour as the velvet, over which a tassel fringe of yellow silk is laid. The mantel-hanging always matches the window-curtains, and the carpet and other appointments of the room should, if possible, correspond. A brass double-eyed crank is nailed to the board first by one hole, and afterwards by another hole serves to fix it to the wall. Any ironmonger will furnish this, and anybody can put up the board so furnished. Fig. 1 represents a plain mantle-board; Fig. 2 a curved one with an ornamental fringe.

Fenders.—We have seen some fenders constructed of velvet that were very elegant indeed. They were made by the master of the house, and had, besides giving a superior air

partly the reason of its stylish appearance, and was obviously designed to prevent any burning coal alighting on the velvet. A frame of wood was first made to set flat round three sides of the hearth; it was about eight inches or a foot wide; over this, arches of wood were placed at close intervals, a lath from end to end supporting the arches. A canvas was then fastened over this by tacks; on the top was a little padding of flock or wadding, then a second canvas. Lastly, the velvet was stretched across, the side pieces first and the front pieces after them, the oblique join at the corner neatly and imperceptibly folded in. The velvet was well secured down by tacks. Round both edges were placed handsome gilt star-headed nails. (See Figs. 3 and 4.)

Curtains.—There are some things in which it is well to economise, and some things in which a little expenditure is wiser. Curtains are well worth all they cost. It is a good plan to buy curtains at sales. All kinds of damask, moreen, and rep will, for wear and effect, be preferable to chintz. Chintz in London soon gathers dirt, and often needs cleaning. A damask is the most serviceable of all things of this kind. Poor materials, half cotton and pervious to light and draught, are by no means comfortable, and may be described as merely "better than nothing." Good green damask cannot be purchased under 3s. or 3s. 6d. per yard; red is dearer. But an excellent stout kind of curtain, very general in Paris, has lately been introduced, at about 2s. a yard. It wears well, looks well, and needs no trimming. It is striped horizontally in white, scarlet, black, and yellow, on a green, red, or blue ground. The name is Timbuctoo. The width double. A friend of ours—her means being small—purchased some old curtains second-hand. Hopeless enough they looked, so grimed with the smoky dust of central London that the black came off on the fingers that touched them. Nevertheless, she felt that they were still rich in substance, as the thickness and closeness of the worsted—they were damask—showed her. They were therefore bought cheap, unpicked, and cleaned, and soon after came home as handsome and fine as new ones. Every bedroom window ought to have a good pair of thick curtains, which can be readily drawn in windy and cold weather. And, if possible, in winter the same indulgence should be extended across all folding-doors. If the curtains are shabby-looking, place them on the wrong side of the partition; but better shabby curtains than none at all. An iron rod can be procured at threepence per foot, and it may be fastened to the wall by large hooked nails, sold at a penny each. Ordinary curtain rings furnish the rod, and hooks may be sewn to the curtains, or the curtains sewn to the rings. Where a better appearance is desired, and can be afforded, mahogany poles can be purchased for a small cost; but the purchaser should ascertain that the rings run easily on the cornice, as many of the cheap ones seem designed rather for sale than use. Any lady can easily fix up cornice brackets, which can be purchased separately at the ironmonger's; but the large hooked nails for holding iron rods require more strength to hammer into a wall than a woman usually possesses.

Stays.—If the fair reader of these pages for the household complains of a sense of heat and pain after meals, the pain being acute and darting through the bowels, and occasionally up to her chest; if she suffers from occasional palpitations and difficulty of breathing; if a headache often troubles her, usually settling in one temple, and she finds herself worse after any unusual exertion; if a little walking makes her limbs ache, and induces a feeling of weariness; if her feet often get numbed, or what is commonly called "asleep;" if fits of melancholy are frequent and unaccountable, and she bursts into tears without knowing why; if the spine is sore and tender to the touch, and the whole frame appears enervated, let her

remember that such symptoms are commonly traceable to the prevalent system of tight-lacing.

Hints for the Household Uses of Lead.—Lead plays so common a part as a covering for roofs, &c., that a few hints on the subject will not be out of place in the HOUSEHOLD GUIDE. M. Detain has recently pointed out, in a foreign contemporary, that when lead comes in contact with damp plaster—as pipes often do—it is rapidly deteriorated in consequence of the formation of sulphate of lead, a most energetic oxidising agent. Again, in damp cellars saltpetre is often to be found, which also attacks lead very powerfully. The prolonged contact of lead with another metal leads to its destruction by the electrical action which is set up. M. Detain quotes a case which came under his personal inspection. The roof of a bathing establishment was covered with copper, but at one point lead was used in contact with the former metal. After a time the roof began to leak, and a workman being called in, the roof was found completely oxidised; it had kept its form, but on being touched it crumbled into powder. The lead was likewise in contact with an oak plank, and its destruction was due to three causes: contact with the damp wood, the action of the vapour of water, and electrical action. New lead is, moreover, subject to the attacks of certain insects, which gnaw very minute orifices in it; but old lead is, it seems, not liable to their attacks.

Brokers' Furniture.—Never buy furniture at a broker's, unless you are judge enough to understand thoroughly what constitutes good workmanship, in which case you are of course right to get the best bargain you can; but if you have not this knowledge, and have no friend whose advice you can take, go to a respectable dealer, and by paying ready money you will get a good article at as reasonable a rate as the material, workman's labour, and just profit will allow.

Cleaning Plate.—Plate that is to be laid aside any time after use should be rubbed with a little spirits of ammonia and water, afterwards rinsed in plain water, to destroy the corroding effects of any salt that may be left on the surface. Silver salt-cellars, cruet-frames, and mustard-pots require especial care in this respect.

Feather Mats.—Exceedingly handsome mats for drawing-room doors, under a piano, for drawing-room windows, or as hearthrugs, can be made of game and poultry feathers. These should be sewn on unbleached or grey linen, of good quality, as close as possible, in layers. The mat must either be entirely of the feathers of corresponding colour, or of one colour bordered by another, or in patterns. Thus a white and drake's-neck green medallion, in a device of the two colours, may be mounted on a ground of partridge-feathers, and have a border of white duck-and-drake's-neck green blended in a pattern.

CHOOSING A TRADE.

WATCHMAKING (*continued*).

THE earliest kinds of clocks, which were certainly made as far back as the eleventh or twelfth century, consisted of a small, toothed wheel, or "pinion," fastened to an axle with square end, so that a key could be fitted on it with which to turn it. The teeth of this "pinion" operated on another and larger toothed wheel fastened to a barrel, or roller, round which a string or chain, with a weight at the end, could be wound by the action of the key on the spindle of the first wheel. In order to prevent the cord or chain from unwinding as fast as it was wound, because of the weight at the end, a third wheel with cogs, called a "ratchet," acted, by means of a click or movable lever, on a still larger wheel at the other end of the barrel. When the weight was wound up, however, it began at once to drag the barrel round as it descended, and so turned both

the large wheels as well as another, which moved the hands of the clock on the dial-plate. The question was therefore, first, how to prevent its going down all at once with a run, and secondly, how to make it go down not only slowly, but at about the same pace, so as to measure off the time of its unwinding into degrees representing portions of a day or an hour. For this purpose another wheel was added, also with teeth, but instead of being a flat wheel, it was a strip of metal bent into a broad hoop and having teeth at one of its edges—in fact, a saw-blade bent into a wheel. This wheel was also set in motion by the barrel turned by the weight, but close to it was placed an upright spindle fitted with two projecting blades or pieces of metal, called “pallets,” each of which fitted in between two of the teeth of the saw-like wheel. Every time the wheel caught one of these pallets its motion was retarded, and though by the turning of the spindle it threw off the obstacle, that same motion also turned a heavy balance fitted to the top of the spindle, which had the effect of bringing the second pallet round to catch the next tooth of the saw. So the wheel went jogging round at a slow and even pace, and at every jog the balance went regularly backward and forward, just as the pendulum of a modern clock, and the balance-wheel of a watch now goes tick-ticking till the cord or the chain has run out its length. Of course, both clocks and watches have now attained such an exact regularity of movement, that there is no comparison between the clock mentioned by Chaucer and that in the great tower at Westminster, any more than there is much resemblance between the Nuremberg watches, that were, from their shape, called “eggs,” and used to hang like weights to a chain round the necks of their wearers; but the principle of motion is the same. A watch differs from a clock in its having a vibrating wheel instead of a vibrating pendulum; and, as in a clock, gravity is always pulling the pendulum down to the bottom of its arc, which is its natural place of rest, but does not fix it there, because the momentum acquired during its fall from one side, carries it up to an equal height on the other—so in a watch, a spring surrounding the axis of the balance-wheel is always pulling this towards a middle position of rest, but does not fix it there, because the momentum acquired during its approach to the middle position from either side, carries it just as far past on the other side, and the spring has to begin its work again. The balance-wheel at each vibration allows one tooth of the adjoining wheel to pass as the pendulum does in a clock, and the record of the beats is preserved by the wheel which follows. A mainspring is used to keep up the motion of a watch instead of the weight used in a clock; and as a spring acts equally well, whatever be its position, a watch keeps time, though carried in a pocket or in a moving ship. In winding-up a watch, one turn of the axle on which we fix the key is so multiplied by the train of wheels, as to make it equal to about 400 turns or beats of the balance-wheel, and thus only a few turns of the key gives motion for about twenty-four or thirty hours.

In watches, as well as in clocks, the wheel which retards the running down of the mechanism is called the “escapement” wheel, and it is by various improvements in that portion of watches called the “escapement,” that the mechanism has been brought to its present perfection. The object has, of course, been to remove the friction of the wheel in working, and to adjust the various parts that the escapement may move with perfect ease, regularity, and freedom. The spiral springs for escapements are of two kinds—the ordinary one being in one place, while another kind, used principally for chronometers, resembling a wire wrapped round a cylinder. Just as in a clock, the rate of going is regulated by the pendulum, so in the watch it is regulated by the spring, by altering the point at which it begins to bend. Almost all watches are

now “jewelled”—that is, in order to remove friction, and render the working as easy and smooth as possible, the pivots and turning points of the wheels, &c., are formed of small, hard, and almost indestructible precious stones, while in the best watches the pallets of the “escapement” are also made of jewels. The tools used by the watchmaker require great care in handling, because of the fineness of the work, and they consist principally of a metal turning-lathe, a hand-vice, pliers, several fine files, drills, broaches, “sliding-tools,” for adjusting the works, screw-drivers, nippers, tweezers, callipers for measurement, and some other more common implements.

Our next paper under this head will be on Working in Metals.

INMATES OF THE HOUSE.—DOMESTIC.

VI.—THE LADY'S-MAID.

THE duties of a lady's-maid towards her mistress being of a purely personal nature, propriety of demeanour and a well-informed mind are requisite qualities. The strictly technical knowledge required in the situation may be learnt in various ways; but no teaching will convey the delicate tact which proceeds from a pure mind, and the high sense of integrity which should characterise the slightest action where the interests and feelings of an employer are concerned.

Gentlewomen of refined education appreciate the latter qualities in a personal attendant far beyond consummate knowledge of certain arts and adornments. They are sensible that a first-rate milliner or hairdresser can supply some deficiencies on the part of their maids, but they feel that no amount of lessons can teach a confidential servant when to speak and when to be silent, when to expose the faults of fellow-servants or to make excuses. Unfortunately, some ladies'-maids consider that they display zeal for their mistresses' welfare by detecting and commenting on the shortcomings of other domestics. By so doing they create a great deal of preventable unhappiness. If faults exist—and provided it is not the lady's-maid's duty to report them to her mistress—the discreet plan is to wait till an opinion is asked for. If a lady has confidence in the sense and honesty of her maid, she will not fail to appeal to her judgment whenever household difficulties occur. On such occasions plain speaking is an imperative duty, at whatever cost of the opinion of fellow-servants.

Another temptation to steer clear of is the offer of gratuities and presents on the part of tradesmen who deal in articles of doubtful excellence.

It is very important that a lady's-maid should know something of the nature of the *cosmetiques* and contrivances which fashion is ceaselessly thrusting upon public notice. Many articles in vogue may be perfectly harmless, whilst others, although effective in their operation for awhile, may ultimately destroy the organ they may have been applied to. Here our Toilette articles will prove serviceable.

In large establishments the position of a lady's-maid is considered to be sometimes exposed to annoyances from the unwelcome attentions of men-servants. In well-regulated households these intrusions do not take place, unless with the lady's-maid's consent. Except at meals, she seldom has occasion to leave the apartments assigned to her own and her mistress's use. In modesty of behaviour, and in cordiality of manner towards every one in the servants' hall, she will find her chief safeguards against any approach to undue familiarity.

Visiting with her mistress at other people's houses is liable to cause inconvenience, without a lady's-maid makes up her mind to regard herself somewhat in the light of a guest. Most persons find something they do not like

when staying in even the most hospitable mansions. But well-bred people cheerfully conform to the rules of the household where they are visiting, and it is very annoying to employers when their servants cannot do the same. Whenever real grounds for complaint exist, it is better for the lady's-maid to speak to her mistress on the subject, who, on her part, will refer the matter to the lady of the house.

Honesty is of course an indispensable quality in one who has the charge of articles of value. A lady's-maid's fidelity in this respect should be beyond suspicion. She had better be scrupulously saving of things not likely to be asked for, than to make away with them because they are worthless. When old dresses and odds and ends of all kinds have inconveniently accumulated—as they sometimes do from oversight—the lady's-maid should ask her mistress what her wishes are with regard to the disposal of them. Even when ladies agree to give their maids cast-off dresses as perquisites, this understanding is expected to be in force.

With regard to the disposal of such articles, the best plan is for the lady's-maid to sell them to friends of her own acquaintance, or to part with them by some other private means. By this mode she is likely to get a better price, and to be less exposed to temptation from offers for things of, perchance, a more costly nature than would fairly come into her possession. As a general rule, ladies do not like to see their maids dressed in the clothes they themselves have worn—except in wearing a black or a dark-coloured silk—the difference in the social scale of mistress and maid renders this displeasing.

The dress of a lady's-maid should be studiously neat, although tasteful. She should wear nothing likely to spoil or impede her in her various duties—above all things she should cultivate personal cleanliness as her chief charm and adornment.

The duties of a lady's-maid are so numerous that it is difficult, in a limited space, to particularise them. Some knowledge of dress-making is generally considered indispensable, also of millinery and hair-dressing. Novelty in these arts may be learnt by taking lessons from time to time of persons who make the giving instruction of the kind their means of livelihood. When taking such lessons the lady's-maid should learn from her teacher the best style to suit her mistress, in the view of being successful in her work—the same head-dress, for instance, will not become all persons equally well; and it makes a great difference if a lady be short and stout, or tall and thin, whether one style of costume or another is suitable. As far as her means extend, a lady's-maid should discover what style of dress ladies of high birth, reputed to have good taste in dress, are wearing at a season when her mistress is choosing her attire. The several ladies of the royal family of England are an instance of the excellent tact sensible people display in avoiding all unbecoming exaggerations of fashion, whilst they adhere sufficiently to the prevailing mode to avoid the opposite error of being eccentric.

The arrangement of her mistress's room devolves on the lady's-maid, but in very few cases is she required to do more than dust the room. She is, however, responsible for the manner in which the housemaid does the work of cleaning, &c.

Order in putting things aside is indispensable. Whatever articles are likely to be wanted for dressing, or any other purpose, should be at hand at a moment's notice.

Although the lady's-maid's duties do not usually require her to be a very early riser, it is desirable that she should be up some time before her mistress is likely to want her, in order to get any work done likely to soil her hands or dress. The washing of fine things, laces, &c., generally falls to the lady's-maid share of work, and the earlier this is done in the day the better. The numberless works of

cleaning, scouring, and dyeing, that an experienced maid has to perform, should all be undertaken before her mistress has risen. By this means interruptions are obviated, and good temper preserved. Any time that is thus spared could be devoted, in leisure hours, to reading and improvement of the mind.

The economy of her mistress's wardrobe is a great test of a lady's-maid's skill. Whether she has the perquisite of cast-off dresses or not, it is her duty to suggest any saving that may be made by "turning" or "altering" gowns, &c. A servant that is apt at these suggestions deserves better wages than one who is not so skilled, and may reasonably expect the fullest remuneration for her services.

The preservation of clothes is a matter that a lady's-maid should understand, as well as their restoration—for instance, the elaborate dresses of the present day cannot be folded up and laid in drawers without detriment to their beauty. Dresses in wear should be hung up separately in a clothes-closet, or wardrobe, each dress in a separate bag made of brown holland. The bag should be, at the very least, half a yard longer than the dress, to prevent dust from penetrating through the opening. Any loose trimmings that may be laid aside flat should be removed.

White satin shoes and boots should be put aside in separate bags, having been previously folded in blue paper.

Furs should be well dried before a fire, and thoroughly shaken before they are put away. The box containing them should also be previously dried and brushed out. A celebrated furrier says that, "Furs, when put away after winter use, should be closely packed in linen or brown paper to preserve them from moth, having been previously well beaten with a small cane and carefully combed through; this process should be repeated at least once a month, and may be relied on as effectual." Strong aromatic odours are useful for preventing the attack of moths; but without the above precautions their use may prove ineffectual.

Laces not in wear should be thoroughly cleansed in several waters from all traces of starch. They should then be dried in the sun if possible, and afterwards put away in bags made of blue paper.

Unpicked dresses should not be folded, but each width of the material should be separately wound on a roller. Skirts that are not likely to be worn for a time should be taken out of the band and laid flat. In folding all plain skirts begin at the bottom, and divide the skirt into four equal folds commencing at the middle of the back width; then divide the skirt in cross folds, according to the size desired, taking care to pass the hand between each division to avoid "corner creases." Some hours before dresses that have been laid aside are worn, they should be shaken well out, and hung before a fire.

Woollen materials require much the same treatment as furs to prevent the ravages of moth and mould.

Linen and calico garments should be rough dried before they are laid aside. It is also essential that they be thoroughly free from damp.

All materials of clothing not in constant use require to be periodically aired. A dry sunny day is best for this purpose.

COOKING.

RIVER FISH (*continued*).

Eel Roasted in the Ashes.—This can only be done where wood is burnt upon the hearth. Take a fine eel, flay and empty it, cut off the head, and throw it into salt and water for an hour. Take it out, wipe it dry; roll it flat into a spiral with the big end in the middle. You can keep it in that shape by running a long thin skewer, of

wood or iron, through it. Dust it on both sides with pepper and salt. Lay it in the middle of a large sheet of white paper, buttered or oiled. Sprinkle over it a little chopped parsley, with a small admixture of chervil or fennel, if not objected to. Fold it neatly and closely in the paper, and then fold the parcel so made in another sheet of buttered paper. Sweep clean from ashes a portion of the hearthstone where it is hot. Lay your wrapped-up eel there, and shovel hot ashes over it till it is completely covered. It will take about half an hour to do, but the time will be regulated by the heat of the ashes. When done, remove the outside paper, and dish it, still wrapped in the inner one, and accompanied by piquant sauce, Tartar sauce, or Robert sauce, which we give.

Tartar Sauce.—Into a large bowl put a small quantity each of parsley, chervil, tarragon, and chives or green onions, all chopped very fine; also a little mustard, a few chopped capers, pepper, salt, and cayenne, with two raw yolks of egg, or the same quantity of stiff calf's-foot jelly melted. Add a good tablespoonful of tarragon vinegar, and mix all well together. Then comes the process which tests your skill; namely, to add, drop by drop, olive oil with one hand while you keep continuously stirring and mixing with the other, until the result is a thick, yellow, creamy sauce, sharp and pungent, although smooth, with the chopped herbs and pickles equally distributed throughout its substance. Gherkins or nasturtium-buds may be substituted for capers. This sauce is best not made until immediately before it is wanted.

Sauce Robert.—Chop onions, and brown them in butter; add a little flour; fry a minute or two longer; dilute with broth and a decided dash of vinegar. Let it reduce, by simmering, to the proper thickness; season with pepper, salt, and a little mustard. This sauce, which is one of the most ancient in contemporary cookery, should be passed through a strainer for grand occasions. It is an excellent accompaniment to boiled meats in general, as well as for warming up slices of any cold meat next day.

Tartar Eels, or à la Tartare.—Skin and empty your eels; cut them into two-inch lengths; let them lie half-an-hour in salt and water. Boil them enough, but not too much, in broth with a glass of red wine in it. So prepared, they may be set aside in store. When wanted, dip each piece separately into oiled butter or beat-up egg; roll them in bread crumbs or grated biscuit. Broil over a clear fire till they are nicely browned outside and heated through. Spread a layer of the above Tartar sauce in the middle of a cold dish, and serve the broiled eel upon the sauce.

Mayonnaise of Eel.—Take a fine eel, weighing two or three pounds at least. Skin and empty it; cut it into two-inch lengths; let it lie half-an-hour in salt and water, to cleanse; rinse the pieces, and let them drain. Then pot them in vinegar and water with spice, in a paté dish, as directed in another paper. Their liquor, when cold, ought to form a jelly around them. To make it stiffer, you may dissolve some isinglass or stiff calf's-foot jelly in the water to be mixed with the vinegar before pouring it over the eel in the paté-dish. In the middle of a dish comparatively small (this is a kitchen gem, not a substantial joint) pack together, as closely as you can, as many pieces of cold potted eel as you expect guests, with two or three pieces over, in case of love at first taste. Pour over these (*mask* them, is the kitchen phrase) as much Mayonnaise sauce as will completely hide them. Over the sauce lay a net-work of strips of anchovy or uncooked red-herring, exactly as you would decorate an open lay-tart with strips of paste. Into each mesh of the net-work put a single caper, and surround the bottom of the heap with a necklace of capers. You may further garnish with a few olives peeled from their kernels, gherkins, picked shrimps, or any thing else that is savoury, pretty, and picturesque. It is entirely a work of imagi-

nation and taste. Surround the pile with the hearts of cabbage-lettuces cut in quarters, and leaning against it, like buttresses supporting an edifice. Outside the whole, at the foot of the lettuces, lay six or eight spoonful-lumps of the savoury jelly from the potted eel.

Approved Mayonnaises are also made, with little variation, with cold salmon, turbot, lobster, roast fowl, &c., for their basis.

Mayonnaise Sauce.—Take one or more raw yolks of egg, according to the quantity of sauce required. With a wooden spoon mix in, in small quantity, one-third tarragon vinegar and two-thirds common vinegar, salt, pepper, and a little made mustard. When those are well combined, add, little by little, almost drop by drop, with one hand, good eating oil, and, with the other hand, keep incessantly stirring round and round. In this case, there is no escaping the oil; substitutes are unavailing. No oil, no Mayonnaise sauce worthy of the name. By stirring and dropping in oil, it will be worked up to the proper thickness, which should be somewhat more than that of very good cream. If it oils, add a little vinegar, stir away, and it will come right again. Taste, to be sure that it is neither too pungent nor too insipid. If too thick, dilute with a little water, still stirring till all is smooth. For the composition of a Mayonnaise, if the preceding directions are not sufficiently clear, see and eat one. Having pulled one to pieces, you will, without difficulty, put another together. There is great room for whim and fancy. Nicely done, it is an elegant dish, well worth the trouble it gives.

Grey Mullet, a summer fish, caught at the mouths of rivers and some way up them, has its friends and its enemies. We ourselves belong to the former, and should never think of shutting our door in the face of a fresh and fine specimen. It may be cooked, if middle-sized, in any of the ways directed for mackerel; and, like that fish, calls for sauce relieved by a moderate dose of acid. A large grey mullet (from four to five pounds and upwards) is excellent boiled in water, vinegar, and salt, and accompanied by

Shrimp Sauce.—Boil the shrimps in plain salt and water, without bay-leaf, spice, or other condiment. Set before you a bowl of fresh-boiled shrimps, and two small empty bowls between it and you. As you pick the shrimps, put the heads and the shells into one of these, and the flesh of the shrimps into the other. When you have enough picked shrimp-meat, boil the heads and shells in a sufficient quantity of water, until their flavour and essence is all extracted. A quarter of an hour or twenty minutes will do this. Strain through a common cullender; let it stand and settle, and then pour off the clear liquor. Use the decoction of shrimp-shells, instead of water, to make enough melted butter to fill your sauce-boat more than half full. Throw your picked shrimps into that melted butter; let it stand on one side until they are well warmed through, and then serve in a heated sauce-boat. Whether prawns, pink shrimps, or brown shrimps are used, the sauce will have a natural tint that will please the eye, without the addition of artificial colouring, as anchovy; and if the shrimps have been properly boiled, not a grain of salt will be needed.

Whitebait.—This (see illustration, p. 366), the smallest of the herring genus, is a sea fish, though caught in rivers. Mr. Garrell demonstrated that it was not the young of any *Clupea*, but an independent species. It had been referred, amongst others, for its parentage, to the shad, one of the poorest fishes that swim in the sea; but now takes rank by its own style and title. Whitebait is one of the fishes which a cook has to dress either very often during the season (from April to September) or very seldom—which is not surprising, if—which is disputed—it has not hitherto been observed elsewhere than in the Thames, and will only bear transport packed

in ice. In the former case, the cook will be set up with every needful appliance; plenty of frying-fat, deep frying pans, and wire baskets or wire-work ladders, for plunging the fish in the hot fat and taking them out. Do not handle the fish; but, after draining, toss and shake them in a napkin with plenty of flour, to make as much of it as possible adhere to them. Then plunge



WHITEBAIT.

them in fat of the proper temperature, tested by putting in bits of crumb of bread. In from one to two minutes the fish will be fried. Let them drain a moment in the basket or fish-ladle; then pile them on a dish covered with a napkin. Serve scalding hot, accompanied by brown bread and butter and a lemon to squeeze over them.

The fry of several species of fish are treated as white-bait; and, if not too large, are very passable.

THE TOILETTE.

III.—DISORDERS OF THE HAIR, AND THEIR TREATMENT.

Hair Washes.—We would again say that all strong spirit applications in the end do harm, by disordering the cuticle of the scalp, and by removing to some extent the natural fatty matter which is necessary to the protection of the head. We give the forms for the making of a few harmless washes, which may be used by those who prefer them to pomades and oils.

Rosemary Wash.

Take two ounces of rosemary tips, add boiling water a pint, and let the former infuse awhile. When cold, add an ounce or two of best Jamaica rum, and the liquid is fit for use.

Cooling Wash.

Dilute acetic acid	½ ounce.
Spirits of rosemary	1 ounce.
Glycerine	1 drachm.
Eau-de-Cologne	2 ounces.
Rose water	4 ounces.
			Mix.	

Ammonia Wash.

Strong solution of ammonia	60 drops.
Rose water	6 ounces.
			Mix.	

Detergent Lotion.

Honey	2 ounces.
Borax	1 ounce.
Camphor	60 grains.
Spirits of wine	1 ounce.
Soft water	15 ounces.
Oil of rosemary	15 drops.
			Mix, for use.	

We now proceed to treat of topics in which an especial interest will be felt by the gentler sex. The way in which we should behave towards the hair, so as to keep it in a state of health and to prevent its becoming deranged in structure and vigour, has been noticed. It now remains for us to sketch the principal diseases to which it is liable, the causes of those derangements from a healthy standard, and the means to be adopted to rectify them. The commonest alterations noticed in the hair have reference to the presence of hair in places from which it should be absent; to changes in the amount of hair, in its colour, in its rate

of growth, and in its structure and appearance, and to diseases by which it is rendered more brittle or dryer than usual.

Hair in Unusual Situations, or Superfluous Hair.—Cases are on record in which the hair is found on a large extent of surface not usually so ornamented; and this condition of things may be congenital, or it may come on as the result of disease; but the latter occurrence is very rare. A curious case is recorded by Ollivier, in which a young lady, with a remarkably white skin and a magnificent head of jet black hair, while recovering from an attack of severe illness, became covered over with a short hairy coat. This growth of hair began as a kind of goose-skin; the whole of the follicles of the skin became prominent, and raised into little pimples; in a few days little black points protruded from them, and at the end of a month every part of the body, except the palms of the hands and the soles of the feet, was covered over with hairs, which grew eventually to the length of an inch or so. Now we might multiply instances, but it would serve no useful purpose. In all cases where hair makes its appearance in large quantities over a considerable area, little can be done to remedy the defect. We must confine our attention to those instances in which the appearance of hair in an unusual situation is confined to a very limited spot. Such abnormal formations are found in what are known as hairy warts or moles, in the development of hairy patches after blisters, or the application of irritants to the skin, and on the upper lips and chins of women of advanced periods of life, or in young women even who are out of health. There are several ways of getting rid of these disagreeables, chiefly, however, by the use of depilatories. These remedies, however, require to be used with the greatest caution, lest they injure the healthy skin, as well as destroy the hair, in virtue of their caustic properties. Moles and hairy skin may be cut out by the surgeon, or be destroyed by the application of strong acids; for by these means the deep parts of the skin, where the roots of the hairs are situated, are destroyed. Depilatories do not annihilate the roots of the hairs unless severely applied, but eat away the hair; hence they do, as the rule, no more than the razor, which is the best thing to trust to, with the subsequent application of a suitable cosmetic, in the majority of cases. It is of no use to pluck out the hairs, so far as a permanent removal of the offenders is concerned, because the hairs will certainly reappear. But, however, we will name one or two of the more common depilatories in use for the purpose of getting rid of superfluous hairs. For centuries lime and orpiment (sulphuret of arsenic) have entered into the composition of some depilatories. In other of the depilatories arsenic and quick-lime are intermixed. We do not think it advisable to give our readers the recipe for any one of the arsenical depilatories, but will mention here some containing lime, and those which are least dangerous to use.

Bouclé's Depilatory.

Crystallised hydro-sulphate of soda	3 parts.
Quick-lime	10 parts.
		Mix.	

When applied, this is to be mixed with a little water, and applied to the skin. After it has remained on for a few minutes—about three is enough—it should be scraped off with a wooden knife or spatula.

Chinese Depilatory.

Quick-lime	8 ounces.
Pearlash	1 ounce.
Flowers of sulphur	1 ounce.

All to be rubbed together into a fine powder, and to be kept in a well-stoppered bottle. When applied, mix with a little water, and wash off when it has dried on.

Spelasco's Depilatory.

Freshly-prepared sulphuret of calcium 1 ounce.
 Quick-lime 1 ounce.
 Mix, and apply as the Chinese Depilatory.

Cazenave's Depilatory, or the Pomade Épilatoire of the French.

Quick-lime 1 part.
 Carbonate of soda 2 parts.
 Lard 8 parts.
 Mix.

This preparation is applied in the form of an ointment, several times if necessary.

In addition to the above, there is a remedy for superfluous hairs that is regarded as perhaps the best, and certainly the most harmless of all yet mentioned. It is Redwood's depilatory, and is made by mixing powdered starch with a strong solution of sulphuret of barium. But the depilatory is to be applied directly it is prepared. After being left on for a few minutes, it is to be scraped off with the back of a knife.

Now these depilatories which we have mentioned, and others in use by barbers and hair-doctors, are scarcely fit to be employed against "moustaches." We commend, as we said before, the razor and some cosmetic for those cases, if the presence of hair is offensive. But these depilatories are available for the destruction of hairy moles and the growth of hair on the surface of the body generally in small amounts. Let us repeat that they should be used with caution, and be applied to the hair which it is desirable to remove, and not smeared too freely over the skin so as to damage it.

Before leaving this subject, we may refer to a very erroneous idea, that it is possible to restrain the encroachment of the hair over the forehead of the young, by dragging back the hair over the head from the front. This is quite erroneous. The disposition of the hair has no influence whatever upon the springing up of new hair. Whilst it is quite right to keep the hair from hanging down over a child's head, mothers should not, from a belief that it will prevent new hair springing up on the forehead, drag the front hair of their children too markedly backward, because the strain upon the hair will tend to injure its connection with the skin on the hair follicles.

Changes in the Colour of the Hair, including Blanching and Greyness.—These changes in the colour of the hair may arise from many different causes, and be of varied nature themselves. We shall only deal with the more common alterations, especially the tendency often exhibited to premature greyness, which so frequently wounds the personal vanity of men and women. The colour of the hair is due to the scattering amongst its fibres of a fine deposit of pigment in minute granules, and also to difference in the chemical constitution of the hair itself. Something also is due to the amount of air contained in the shaft of the hair. Now it can be readily understood that the production of pigment is greatly influenced by the state of the general health; it may be very deficient where the powers are exhausted, and we find after severe illnesses and in old age that the hair loses its colour. Deficiency of colouring matter may likewise be congenital, as in the albino, and this deficiency of colouring matter may be exhibited likewise not only over the whole hairy parts of the body, but also in certain localised spots, and we may then have a white tuft in amongst a black head of hair. These more uncommon cases we do not intend to deal with, but we shall speak of the instances of everyday occurrence in which there is a loss of colour. Let us get rid of cases of whitening after severe disease, by observing that these should be at once placed in the hands of the physician, for strong internal tonics are greatly needed to bring back the vital powers to their proper

status, when the colour of the hair will return. These cases are not uncommon. The instances in which the reader will be most interested are those in which the hair is naturally of a good, and it may be beautiful black hue, but in which it gradually assumes a greyish tint. Now, the loss of colour may be absolute, then we have blanching; or it may be relative, and then we have premature greyness. People affected by this latter form, say they are getting bald before their time. Now, in regard to the whiteness of old age, we have nothing to say in the way of advice as to the means to be taken to restore the lost colour. The change can only be concealed by dyes, and of these we shall speak presently. There remains for notice, then, the large class of cases in which the hair gets prematurely grey, and it is here that the results of emotional nervous debility in altering the supply of pigment, in changing the chemical composition of the colouring matter, and in leading to the generation of air in the hair shaft, which is probably the cause of sudden whitening or blanching, are most visible. In order to show how worry, mental distress, and anxiety, may lead to change in the colour of the hair, we might relate many anecdotes—those relating to Marie Antoinette, Sir Thomas More, Mary Queen of Scots, and others, are well known. Let us premise that the sudden blanching of the hair, and the gradual occurrence of greyness are, after all, only differences of degree rather than of kind, only that in one case the change is immediate and in the other gradual. Byron illustrated great truths in the "Prisoner of Chillon," when he wrote—

"My hair is grey, but not with years,
 Nor grew it white
 In a single night,
 As men's have grown from sudden fears."

He distinguished the gradual greyish from slow and protracted nervous exhaustion, or excitement which is always followed by exhaustion; and secondly, the effect of a violent and sudden shock upon the nervous system, producing in a few hours what it takes years to induce under other circumstances.

Moreau, a distinguished French physician, writes, "I once knew an aged man for whom snow-white hair and a countenance deeply marked by the furrows of care, inspired the respect which we owe to age and misfortune." "My hair," said he, "was as thou seest it now long before the latter season of my life. More energetic in their effects than assiduous toil and lingering years, grief and despair at the loss of a wife most tenderly loved, whitened my locks in a single night. I was not thirty years of age. Judge then the force of my sufferings. I still bear them in frightful remembrance." One more illustration shall suffice on this point. The sexton of St. Joseph's Cathedral, Vienna, being a man of extraordinary nerve and boldness, was accustomed to stand on the pinnacle of the tower, whenever the emperor made a grand entry to the city, and wave a flag as the pageant passed by. When, however, Leopold, who had just been chosen emperor at Frankfort, was about to enter the city, the loyal sexton, still anxious to be true to the old custom, but finding that years had told against his nerve, declared that any one who would take his place successfully should win his daughter. Gabriel Petersheim, who was disliked by the sexton, but beloved of his daughter, at once accepted the offer, to the disgust of the sexton, who then arranged with two villains to close the trap-door of the upper stairway while Gabriel was above, thinking that as the emperor was to enter towards evening, no one need be the wiser, and the lad must certainly fall before morning. The two accomplices did their foul work, and their intended victim, finding his way down again barred, was confronted with the alternative of clinging to the slender spire, through a cold wintry night, with his feet resting on a surface hardly ten inches in circumference, or of precipitating himself to the pavement at

once, and thus ending the matter. Gabriel was a youth of firm will and hardy constitution; he clung to the cold column till morning. But the story goes that his rescuers were amazed to observe that his curling locks were white as snow; his wonted rosy cheeks were yellow and wrinkled; and his eyes, before so bright, were now sunken and dim. One night of horror had placed him forty years nearer his grave. These anecdotes may illustrate, as before observed, on a large scale what is generally going on in men and women as the result of anxiety and mental distress and tension. The writer has seen many instances in which persons have become more grey than at others, particularly when over-worked, or harassed by business, or after illness connected with nervous debility.

The proper treatment of the more common instances of greyness, the result of nervous debility, is the administration of internal tonics. Nothing is better than a course of arsenic or steel, but these must be taken under the advice of a medical man. In our next article on this subject we shall do all that we can undertake to do here—namely, to give a sketch of the various dyes of the least harmful nature, which our readers may try, if they will, for the concealment of advancing greyness.

MAKING SEALING-WAX.

1. *Common Hard Red Sealing-wax.*—Take of rosin six ounces, and powder it; add four ounces of red lead; two ounces of vermilion, or less, if expense is objected to; and the same of shellac reduced to powder. Mix all these carefully, and melt them over a slow fire. When thoroughly incorporated, and while fused, work it

into sticks of any size required. The vermilion is sometimes left out altogether, and, for very common wax, the shellac also.

2. *Common Hard Black Sealing-wax.*—This is made in exactly the same way, only ivory-black is used instead of red lead and vermilion.

3. *Hard Green Sealing-wax.*—The process is the same as before, only for the colouring matter finely-powdered verdigris is used.

4. *Hard Blue Sealing-wax.*—This is made as above, only the colouring ingredient is verditer, or smalt, or a mixture of the two, according to the shade wished for.

5. *Hard Yellow Sealing-wax.*—The process is the one already described. The colour may be given by means of massicot, or other yellow pigment, as chrome.

6. *Hard Purple Sealing-wax.*—This is made in the same way, but the purple is produced by a mixture of vermilion and smalt, in any proportions desired.

In all cases the incorporation of the materials must be effected with caution in an open copper pan. After cooling a little, the wax should be formed into sticks by rolling the pieces with a piece of polished wood upon a warm slab of marble. It may, however, be poured out, and cast in moulds prepared for the purpose.

Variogated sealing-wax is made by melting several kinds separately, and mixing them when partially cooled.

Sealing-wax with gold speckles is made with an addition of gold-coloured mica spangles, talc, or other matters, after taking it from the fire.

Sealing-wax is scented in different ways, one being to stir in $\frac{1}{100}$ th part of balsam of Peru.

Sealing-wax is better made with Venice turpentine than with rosin.

WAGES AND INCOME TABLE.

Per Day.			Working Day (six to week).			Week.			Lunar Month.			Calendar Month.			Year of 52 weeks.			Year.					
ℓ	s.	d.	ℓ	s.	d.	ℓ	s.	d.	ℓ	s.	d.	ℓ	s.	d.	ℓ	s.	d.	ℓ	s.	d.	ℓ	s.	d.
0	0	0	0	0	0	0	0	0	0	0	0	0	0	0	0	0	0	0	0	0	0	0	
0	0	6	0	0	7	0	3	10	0	15	4	0	16	8	0	19	5	12	0	0	0	0	
0	0	0	0	0	9	0	4	7	0	18	4	1	19	4	11	19	4	12	0	0	0	0	
0	0	0	0	0	9	0	4	9	0	19	2	1	0	10	12	9	3	12	0	0	0	0	
0	0	0	0	0	8	0	5	0	1	1	8	13	0	0	13	0	0	8	1	0	0	0	
0	0	0	0	0	9	0	5	9	1	3	0	1	5	0	14	19	2	15	0	0	0	0	
0	0	0	0	1	0	0	6	0	1	4	0	1	6	0	15	12	0	15	12	10	1	0	
0	0	0	0	1	1	0	6	10	1	7	7	1	10	0	17	19	0	18	0	0	0	0	
0	0	0	0	1	2	0	7	0	1	8	0	1	10	5	18	4	0	18	5	0	0	0	
0	0	0	0	1	3	0	7	6	1	10	0	1	12	7	19	10	0	19	11	0	0	0	
0	0	0	0	1	3	0	7	8	1	10	8	1	13	4	19	18	11	20	0	0	0	0	
0	0	0	0	1	4	0	8	0	1	12	0	1	14	9	20	16	0	20	17	1	0	0	
0	0	0	0	1	3	0	9	0	1	16	0	1	19	14	23	8	0	23	9	3	0	0	
0	0	0	0	1	7	0	9	7	1	18	4	2	1	8	24	18	7	25	0	0	0	0	
0	0	0	0	1	4	0	10	0	2	0	0	2	3	5	26	0	0	26	1	5	0	0	
0	0	0	0	1	6	0	10	0	2	4	0	2	7	9	28	12	0	28	13	6	0	0	
0	0	0	0	1	7	0	11	6	2	6	0	2	10	0	29	18	4	30	0	0	0	0	
0	0	0	0	1	8	0	12	0	2	12	0	2	12	1	31	4	0	31	5	8	0	0	
0	0	0	0	1	9	0	12	6	2	10	0	2	14	1	32	10	0	32	11	9	0	0	
0	0	0	0	1	10	0	13	0	2	18	5	2	16	5	33	16	10	33	17	10	0	0	
0	0	0	0	1	11	0	13	5	2	13	8	2	18	4	34	18	1	35	0	0	0	0	
0	0	0	0	2	0	0	14	0	3	0	10	3	0	10	36	8	0	36	10	0	0	0	
0	0	0	0	2	1	0	15	0	3	5	0	3	5	0	39	0	0	39	2	1	0	0	
0	0	0	0	2	2	0	16	0	3	6	8	3	6	8	39	17	9	40	0	0	0	0	
0	0	0	0	2	3	0	16	3	3	4	0	3	9	6	41	12	0	41	14	3	0	0	
0	0	0	0	2	4	0	17	0	3	8	0	3	13	10	44	4	0	44	6	5	0	0	
0	0	0	0	2	5	0	17	3	3	9	3	3	15	0	44	17	6	45	0	0	0	0	
0	0	0	0	2	6	0	17	6	3	10	0	3	16	0	45	10	0	45	12	6	0	0	
0	0	0	0	2	8	0	18	0	3	12	0	3	18	2	46	16	0	46	18	6	0	0	
0	0	0	0	2	8	0	19	0	3	16	0	4	2	6	49	8	0	49	10	8	0	0	
0	0	0	0	2	8	0	19	2	3	16	8	4	3	4	49	17	3	50	0	0	0	0	
0	0	0	0	2	10	0	3	4	0	4	6	10	4	11	52	0	0	52	2	10	0	0	
0	0	0	0	3	0	0	1	1	0	4	4	4	11	3	54	12	0	54	15	0	0	0	
0	0	0	0	3	0	0	1	1	4	4	4	4	11	3	54	17	0	55	0	0	0	0	
0	0	0	0	3	1	0	1	2	0	4	8	0	4	5	7	4	0	57	7	1	0	0	
0	0	0	0	3	3	0	1	3	0	4	12	0	4	19	11	0	0	59	19	3	0	0	
0	0	0	0	3	3	0	1	3	0	4	12	0	5	16	8	0	0	60	9	0	0	0	
0	0	0	0	3	5	0	1	4	0	4	16	0	5	4	7	0	0	62	11	5	0	0	
0	0	0	0	3	6	0	1	5	0	5	0	5	8	7	65	0	0	65	3	6	0	0	
0	0	0	0	3	8	0	1	6	0	5	4	0	5	12	11	3	0	67	15	8	0	0	
0	0	0	0	3	10	0	1	6	10	5	7	0	5	16	8	0	0	69	16	2	0	0	
0	0	0	0	3	10	0	1	7	0	5	8	0	5	17	3	0	0	70	4	0	0	0	

THE REARING AND MANAGEMENT OF CHILDREN.

XI.—CLOTHING FOR CHILDREN OF SIX YEARS (*continued*).

In winter weather, *Garibaldi Suits* for girls are very comfortable. Black alpaca looks neat and wears well, and is pretty when trimmed with bright green worsted braid. To cut a Garibaldi bodice, take the pattern like Fig. 11 (page 333), cutting it high, but instead of sloping from A to C,

together a little way in on the *right side*. Then reverse them, fold them, and run them again a little way in, so that no raw edges show either side. Pipe the neck, and instead of hemming it down run on a ribbon and run it down, because alpaca is rough and chafes the neck. Pipe the armholes.

For the Sleeves, measure the full length of the child's arm; allow a good inch over. A fair width for a bishop sleeve is about thirteen inches and a half for turnings. Unite this with a mantua-maker's seam. Slope the top by

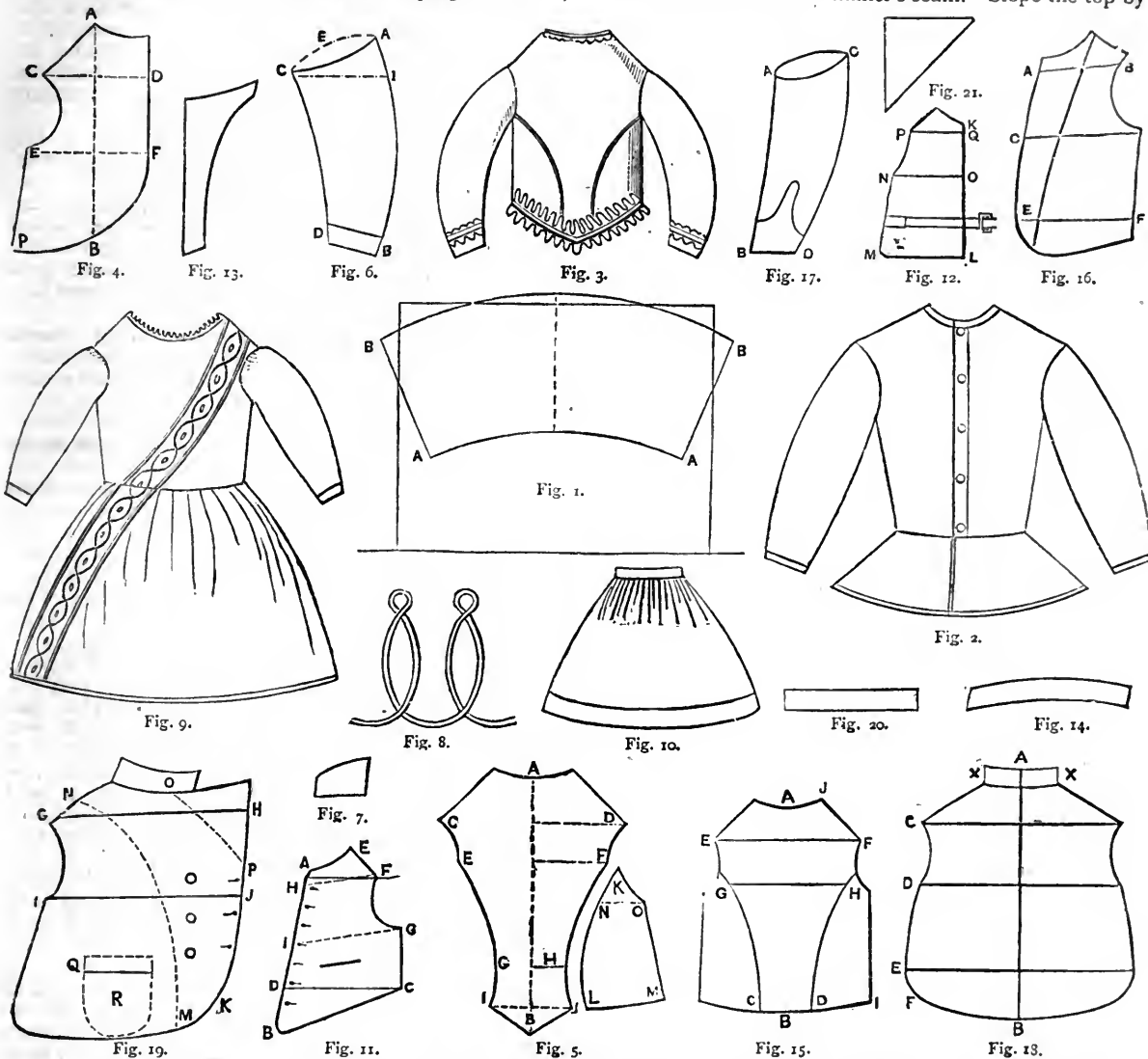

keep it as wide at the waist as at the arms, by the dotted line K, and also level from K to L. Take the pattern thus in paper. The two fronts of the Garibaldi are not cut together. Take a width of the alpaca as long as the body pattern; fold a hem for the front, and tack it. Tack as many tucks as you wish, down from I to G and H to A. Then lay the pattern upon it, pin it down, and cut it. Both fronts are cut alike. The backs are in one, and the tucks must also be tacked in them first. Be sure that one of the tucks comes exactly in the centre of the back. Run stripes of coloured braid between the tucks. Make button-holes up the front, and sew on buttons. Make mantua-makers' seams at the sides and shoulders.

Mantua-makers' Seams are done by running the pieces

rounding it in the way shown in the illustrations of the paletôts which appear on this page. Slope the wrist away slightly towards the inside of the wrist about an inch, with a straight cut. There is rather a large armhole to a Garibaldi. Put in the sleeve plain with a mantua-maker's seam. Pleat the wrist into a band to button, using small pleats turned one way—from the wearer. Gather or pleat the waist of the body into a band that buttons easily. To this band sew the pleats of the skirt, which may be trimmed with plain rows of green worsted braid.

When children wear frocks with high bodies, or Garibaldis, a high petticoat body should be worn. The piece calico will come in excellently for this. It may be cut and made precisely like the Garibaldi already described, or it

may be sloped under the arms from A to C, Fig. 11 (p. 333), as a regular body. The mantua-makers' seams are the best. Pipe the waist and hem it down. Then cut a *basque*, like Fig. 1. The pattern need only be half the size of the dotted line. From A to A it must measure half the circumference of the waist, and it is curved. It slopes out from A to B, so as to sit well over the hip. Fig. 1 shows the entire piece for the back. Two half pieces for the fronts must be joined to those from A to B by stitching. Hem all round except the waist. Stitch that to the waist of the body along the piping. Add long sleeves, a small bishop shape, and set in cuffs to slip over the hand. Fig. 2 shows this body completed. If a high washing-body like this is not worn under a high body, the dye of the body stains the child's skin, and the dress itself is damaged with perspiration.

Out-door Jacket for a Child Six Years old (in white piqué), Fig. 3.—The fronts are cut out in separate pieces, like Fig. 4, measuring thirteen inches from A to B, seven and a-half from C to D, six and a-half from E to F. The centre piece of the back is cut like Fig. 5, fourteen inches from A to B, ten and a-half from C to D, nine from E to F, two inches from G to H, and two and a-half from I to J. There are two side-pieces joined to the back, K to F, and L to J, stitched together on the wrong side. The side-piece is tacked to the centre-piece and stitched, holding it uppermost, from K to L. The side-pieces measure five and a-half from L to M, and two and a-half from N to O; seven long from O to M, ten long from K to L. When the side-pieces are stitched on, one each side, the back is complete. Join each front by stitching it from down the side under the arm from E to P, (Fig. 4), and the back from O to M (Fig. 5), holding the front uppermost. Stitch the shoulders together, keeping the front uppermost. In the measurement of this jacket, no allowance is made for turnings in, which are only a quarter of an inch wide. A muslin piping is tacked on all round the edge, but not hemmed down at all. The embroidered edge is then tacked to the piping easily, and the whole stitched all round. The hem is not turned down at all, but overcast and left. It is only a half-quarter of an inch wide. The neck is piped and trimmed the same way, the embroidery turned down on it like a narrow collar. The coat-sleeve (Fig. 6) measures sixteen inches on the curve from A to B, eleven from C to D, four inches from D to B, and six from C to A. The two pieces are cut alike, except at the top, where the front of the sleeve is rounded, according to the dotted line from C to A. The sleeves are stitched together and stitched into the armholes. The seam at the top of the sleeve is half an inch further back than the shoulder seam and the rounded part of the top of the sleeve, E in Fig. 6, to the front of the jacket. Cut a half-cuff, like Fig. 7, by the lower end of the sleeve, pipe and trim the top with embroidery, stitch it to the edge of the sleeve, turn it over, tack it down, before the two pieces of the sleeve are joined together. It is laid on that side of the sleeve which has the rounded top. It is a pretty addition to braid the jacket and cuff, like Fig. 8, with white cotton braid. The same pattern is suitable for cloth, bound round the edge with military braid, and with a row of the braid laid on straight round it.

To get the pattern, first draw it on paper, and measure it to the right number of inches, thus: Take the length of the back 14 inches, measure this on paper, make a dot at each end, and draw a line between. Then take the width across the shoulders 10½ inches. Only half the pattern of the back is wanted, therefore measure 5½ inches from the one side of the first line, 2½ inches down it. Four inches down it, measure 4½ inches the same way, making a dot. These are the dotted lines shown in Fig. 5 at D and F. Three inches from the bottom, it measures one inch at H. It will now be easy to draw a line for the shape of the jacket from dot to dot marked on the paper.

The stay-bodies, flannels, and white petticoats for boys

and girls at this early age are cut alike, therefore the directions we have already given will suffice for both. The shirt for a boy has been described. The girl's chemise is but similar to those worn by children of four years old, and already illustrated, but of course rather larger. The white piqué jacket we have described can be worn either by a boy or girl, and also can be made in silk, velveteen, cloth, velvet, or of any fancy material *en suite* with the frock. The patterns for the low frock body and the high body are equally useful for boys who wear frocks at that age; but their bodies are not sloped in the side seams. Garibaldi bodies are not suitable for boys. Boys' bodies are always cut straight at the waist, and not sloped. They may have a single tuck in the skirt to let down, but are not made with fancy tucks. Neither are the skirts or bodies trimmed in any way unless with a welt straight down the front and large buttons in it, or a slanting trimming brought from the left shoulder in an oblique line to the edge of the skirt on the right side. This may be a mitred welt with buttons, a braid trimming, or an embroidered muslin (Fig. 9). Coat sleeves, such as are made for the paletôt, suit boys best. Their high bodies are piped with the same material, and square and loose at the waist. The cuffs of the sleeves do not button, but slip over the hand. The skirts are shorter than girls, but quite as full. At the waist they are set into a number of fine, regular, equal box pleats, turning one way all round the waist. Our next description will be of a knickerbocker suit for a boy.

Tunic for a Little Boy of Six, with or without Knickerbockers.—We will suppose this made in speckled brown tweed, but plaid or any fancy material may be used. The skirt takes two widths, seventeen inches long. Stitch these together. Take six inches off one of the breadths, before joining, to bring the front seam a little on one side. At the back, do not run the seam all the way up, but leave six and a-half inches open. Hem one side quite narrow, and the other half an inch wide. Pass the wide seam over the narrow, and stitch it across the skirt, where the division commences. Make a hem at the bottom, two and a quarter inches wide. Over this put a row of brown military braid, half an inch deep. Lay half the skirt on the table, and the braid with it; slightly turn the braid down, then tack it. Tack the other half also, and lastly hem it neatly at both edges. It must be put on quite easily, neither full nor dragged. To form the band, cut down the stuff, not across, twenty-five inches long, and either four wide, or in two pieces, each two and a-half, and joined. The skirt is set at the waist in a number of inch and a-half deep pleats, all turning one way, and overlapping one another rather better than half an inch. They go the same way all round. One edge of the band is set on to this; it is then turned over, doubled, hemmed down, the ends sewn, and a couple of hooks and eyes set on. (See Fig. 10.)

With this a *Waistcoat* is worn, of the same material. From A to B, in Fig. 11, is twelve inches; the neck, five and a-half in the curve; the line above the armhole, H to F, six and a-half; below the armhole, I to G, seven and a-half; at the waist, D to C, seven and a-half; E to F, three; and G to C, six inches. The back can be made of double grey lining, or lining lined with flannel, or of jean. The back (Fig. 12) measures twelve inches from K to L; from L to M, six inches; at the line under the arms, N to O, six inches; at the line between the shoulders, P to Q, five. Two pieces of tweed are cut like Figs. 13 and 14. Take these to line the front of the jacket, turning the edge down over the right side. Join fronts and backs of the waistcoat. With jean or lining line the rest of the front, putting the edge of the jean over the tweed. Hem it on, the seams having been run first, and the seams turned inside. The back is also lined. Double-stitch the cloth fronts all round the edge and neck the eighth of

an inch from the edge. Place at the extreme edge, but not beyond, a military braid like that on the skirt. Make six button-holes one side, and put buttons on the other. At the back, two broad straps and a buckle are put on. The strap is sewn to the back before the sides are seamed, to give it strength. It is also stitched all round. (See Fig. 12.) This is used to draw the waistcoat to the figure. It is made of double jean.

Over the waistcoat a *Jacket* is worn. From A to B (Fig. 15), is $14\frac{1}{2}$ inches; the line above the shoulders, E to F, 12 inches; the line below the shoulders, G to H, 11 inches; and from C to D $6\frac{1}{2}$ inches. It may be seen that the back is in three pieces. The sides measure 8 inches under the arms, H to I, and 3 inches wide, from D to I, being, with the exception of the curve at top, straight. The shoulders, J to F, measure $5\frac{1}{2}$ inches. Fig. 16 represents the front. The front measures above the arm, A to B, $8\frac{1}{2}$ inches; below the arm, C to D, $8\frac{1}{2}$ inches; and where the pocket is, E to F, $7\frac{1}{2}$ inches. The pocket is sewn in before the jacket is lined. The jacket is faced down each side of the front with tweed 3 inches wide, put on as the waistcoat is faced, only that was not quite 2 inches wide. Shape it like Fig. 16. The dotted line in Fig. 16 shows how it is used. Cut it by the jacket pattern first in paper. Stitch the seams of the coat together before lining it. Stitch the lining, which is of a thin jean, together, and lay it on and line it as described for the girls' paletôts. The pocket comes between the jacket and the lining.

The inner side of the *Sleeve* is a straight piece (Fig. 17), and measures 12 inches long, from A to B; the curve at the back, from C to D, 15 inches. Both pieces are alike, except in the curve at the top, from A to C. Line, and put them in like the paletôt sleeves. Run a military braid all round the extreme edge of the jacket and pocket, and neck. Trim the sleeve like it. The pocket of this jacket, be it noticed, is inserted between the tweed and lining.

Over this a *Coat* is worn, in tweed, like Fig. 18. For the back, A to B, 16 inches. The line at C is 12 inches right across; at D, 15 inches; at E, 18 inches. A little bit is sloped off at each side below E, from E to F, and left open at the seam. The shoulder, X to C, 5 inches, and D to F, 9 inches. For the front (Fig. 19) measure $9\frac{1}{2}$ inches, G to H; 11 inches from I to J, and H to K 15 inches. Round the entire neck $12\frac{1}{2}$ inches. Round off the corner, K, to match the back (Fig. 19).

The sleeves are the same shape as the jacket sleeves, 16 inches in the curve, C to D; 11 inches on the straight side, A to B; $4\frac{1}{2}$ inches across the wrist, B to D; 6 at the top, A to C. A false piece of the tweed is tacked on the coat from N to M, covering the point (at H) and all (Fig. 19). It is laid on with a raw edge on the right side, and stitched; neatly turned in and hemmed on the wrong side at the inner edge. Cord the fronts at the shoulders and side seams, and then stitch them to the back. Cut two pieces for the collar, 12 inches long and $2\frac{1}{2}$ inches wide (see Fig. 20). Join one to the neck, and then join both, the seams inwards, at the neck. Turn them, to meet upright, like X X in Fig. 18 and O in Fig. 19; tack them together, leaving the raw edges. Turn up the edge of the jacket all round, on the right side, and tack it. The seams are left open a little way at the bottom. Put a braid all round up the open part of the seams, covering the raw edges turned over, and run a braid round the collar and the inside of the pointed piece which turns over at the dotted lines from O to P (Fig. 19). The pocket is made of one piece of tweed and one of lining, run together, turned the other side over, and stitched, the tweed outside and a little larger than the lining, so that after both are joined with raw edges on the right side of the coat the pocket can be stitched by the tweed side a little above the hole, shown by the dotted lines at Q (Fig. 19); a sort of fold is made in the tweed of the pocket

to do this. The dotted line shows the shape of the pocket. Braid laid round the pocket-hole covers the raw edges. The armhole is corded round, and the sleeve inserted in the usual manner, the seam an inch behind the shoulder seam. Braid straight round the cuff, three inches up it. There are three wooden buttons and three button-holes, seen in Fig. 19, on both sides. Put on the braid strongly on both edges, inside and out, from O to K, including the point. The cord is run with the tweed itself turned over it, not a piping. X X, in Fig. 18, and O, in Fig. 19, show the collar, which is afterwards put on as above directed. The point O to P in Fig. 19 is double. A piece of tweed the shape of Fig. 21 is cut for the lining, bound in at the edges, but left loose from O to P (Fig. 19).

THE DRESSING OF DINNER-TABLES, &c.

THREE modes of laying out a dinner-table are practised in the United Kingdom. The old English way, in which the tablecloth is removed after the cheese and the dessert are set on the bare mahogany; the French way, in which the table-cloth remains to the last; and the Russian way, in which the dessert is set on the table at the time of laying it out, and remains permanently there throughout the meal. This last arrangement, the *Diner à la Russe*, is growing in favour, in consequence of its elegance and its economy both of expense and trouble. An objection to it is that it cannot always be carried out on a very small table and in a small dining-room. It is admirably adapted for large dinner-parties, official banquets, public festive meetings, and *tables d'hôte*; but is not always suited for a snug party dining together, either in public or private, at a table of modest dimensions, around and outside which elbow-room is scanty.

One fault of the old English dinner was the immense multiplicity of dishes which every dinner-giver was obliged to produce. In the olden time, the table, at each successive course, had to be covered with a set number of dishes, which served for ornament rather than for use, as it was impossible to taste one-third of them. It was hard work for a family to have to eat their way out of the leavings of a dinner-party. The mistake of overloading the bill of fare is much easier to avoid now than it was forty or fifty years ago. English dinners, since that time, have passed through a series of radical reforms. The leader of the movement may be assumed to be the late police magistrate, Walker, who, in his "Original," strongly urged that it was possible to dine well off a very few dishes. The book, which contains both instruction and amusement, is still well worth referring to. The modern fashions—of substituting the white table-cloth for the brown mahogany at dessert; of decorating the table with the dessert and with flowers from the beginning; and of carving joints at side-tables and handing the dishes round—greatly relieve the dinner-giver of the temptation to display ostentatious masses of fish or meat.

Another fault was the break and the disturbance caused by the removal of the cloth after cheese and the setting on the dessert. Conversation was interrupted; and the thread of pleasant discourse, once broken, is hard to be mended smoothly and neatly. The host and hostess were on thorns lest each dish of fruit should miss its place or fail to find its appointed partner opposite. Much of the interruption caused by such changes is avoided by the French and Russian plans.

With the white cloth, before the dessert is attacked, a sweep round with the crumb-brush is rapidly performed. The cloth will be kept still more spotless for dessert, if the portion of it occupied by the *plates only* is covered with napkins, to be removed at the close of dinner, leaving the under-cloth itself unsullied white. Of course, none of the

standing dishes of the dessert must set foot upon these temporary napkins.

According to either mode, the plate of each guest is flanked with at least three glasses; a tumbler, beaker, or beer-glass, for malt liquor or wine and water; a large or claret wine-glass; and a smaller or port and sherry glass. All these are now made of luxurious forms and materials. A champagne-glass, when that wine is given, completes the goodly quaternion. The dinner-service, porcelain or China, will depend on taste and means. A *plated* dinner-service, though costly at the outset, has the advantage of never being broken. We once knew a plated dinner-service which was calculated, after a course of years, to have more than paid for itself by avoiding breakage. On each guest's plate, or beside it, there is, of course, a dinner-napkin. In a modest French establishment, a table laid without a napkin for each person would be considered as incomplete as a bed without sheets would be here. Napkins are things to be taken for granted, about the presence of which there is no question. They may be folded according to fancy, placed on the plate with a roll of bread inside, or stuck in a fan-shape into the beer-glass; but some prefer them laid on the plate, or table, with no manipulation.

As we shall devote a separate article to this portion of our subject, we refrain from entering into it more fully in our present paper.

At dessert, a coloured finger-glass to each guest, purple, green, pink, or blue—by alternating colours you get a pleasing effect on the white cloth—is a good old custom. These glasses are not merely a pretty ornamental addition, but they are really useful. However neatly a person may eat, sugary sweets and juicy fruits will leave a trace on the fingertips: not to mention asparagus, smelts, peach or apple fritters, or gingerbread cakes, if handled when eaten, which is perfectly orthodox. Shrimps and other crustaceans, which also are allowed to come in contact with the finger and thumb, betray the presence of saline elements. Now, it is uncomfortable, to say the least, for a young lady to draw on kid gloves, or sit down to the piano with clammy fingers. A finger-glass remedies the inconvenience. The hand may be dipped, the napkin slightly wetted and applied to the lips; and that is all, according to *our* code of etiquette. A refinement is to supply the finger-glasses with tepid water, mixed with eau-de-Cologne.

One marked feature in the English and foreign styles of dining is the place respectively occupied by cheese. With us, it is the bouquet, or finishing-touch of the *dinner*—Continental make it the pearl of the dessert. The fourteenth of Brillat-Savarin's twenty aphorisms is, "*Un dessert sans fromage est une belle à qu'il manque un œil*"—"A dessert without cheese is a beautiful woman who has lost an eye." Cheese appears, at dessert, not entire, like our Stiltons and Cottenhams, wrapped in their snow-white napkin, but in slices, or portions, covered by bell-glasses; because some of them, as Rochfort, Brie, and Marolles cheeses smell so strong as scarcely to be pleasant to impressionable noses.

In the Russian mode, almost all the carving is done at a side-table. A dish is placed on the table for a few moments to be looked at while its predecessor is being eaten, and then removed, to be dissected and distributed. Nevertheless, at private dinners an amiable hostess will take the opportunity of serving the soup herself to each guest by way of welcome. And when the carving is done at side-tables, and the viands sent round, the lord or lady of the feast should distribute at least some one dish with their own hands (which was Talleyrand's constant practice) as a graceful proof of their hospitable intentions, and to save their dinner from bearing too great a resemblance to a *table d'hôte*. As only one dish is brought forward at a time, each guest is furnished with a bill of fare, to take, or wait for, what he likes best. The *hors d'œuvres*

—radishes, pickles, olives, shrimps, sardines, anchovies, sliced ham, tongue, or sausage, &c. &c.—are disposed up and down the table, adding to its ornamentation, to be taken at will in the intervals of serving. A waiter is ready at hand with salad, for those who choose to eat it with their roast.

A French dinner may be served either in courses; or *all* set on the table at once, the hot things on chafing-dishes; or in successive dishes, as just described. The last is the most common modern practice, especially for small friendly entertainments. The cook, not being distracted by having to send up a multiplicity of things at once, is able to give her undivided attention to the finishing off of every individual dish. Nevertheless, the simultaneous plan of serving has a simplicity of grace and welcome, especially in summer, when things do not speedily get cold. As a sample, we give the following bill of fare for a family dinner, the dessert being on the table from the commencement:—

Dessert à la Russe. Strawberries and Cream. Cherries.

Biscuits. Cheese. Mixed Sweets, &c.

COURSES.

Vermicelli Soup. Madeira.

Fowl Stewed in Rice. St. Emilion Claret.

Braised Leg of Mutton. Samphire Sauce. Burgundy.

Sweetbreads (White). Dutch Sauce. Green Peas. Sauterne.

Roast Loin of Beef. Salad. St. Estèphe Claret.

Little Custards in Pots, flavoured with Curaçoa.

Dessert. Bagnolles. Champagne.

Coffee. Liqueurs.

Peaches, apricots, apples, pears, and other choice fruits of like dimensions, look well, laid each on a vine-leaf with its side upraised, so as to form a sort of partition between each fruit. If you have flowers upon the table, take care that they be in vessels of a shape not liable to be upset.

THE HOUSEHOLD MECHANIC.

GARDEN FURNITURE AND DECORATIONS.

Garden Chairs, Seats, and Tables.—It is our intention in these articles to show how garden furniture may be constructed with some degree of taste, and be made to harmonise with the general surroundings of the place wherein it may be situated. We shall treat of rustic chairs, garden seats, and tables, and shall commence by showing how the ordinary square furniture commonly in use may be rendered more suitable in appearance and effect, without entire reconstruction.

In the first place, some few tools will be required. These are mostly such as we have described in other articles belonging to this section of our work, and are usually to be found in every household. In their absence however, the amateur would do well to provide himself with a cheap set of good tools, such as the Messrs. Moseley, of Broad Street, Bloomsbury, sell under the name of the Household Tool-box. The first tool required is a short, stout-bladed hand-saw, such as is ordinarily used for rougher work. This should be kept very sharp, and be "set" wide—that is to say, so that the cut made by its means is very much wider than the thickness of the blade itself. This is important; because, unless this be attended to, in cutting wet wood, such as the branches of trees, the grain closes up very quickly, and will speedily fix the saw, and occasion its breakage. A hammer of medium size, and a wooden mallet, will also be necessary. Besides these, a couple of strong chisels should be provided—one of an inch and a half in width, and one of an inch. Gimlets and bradawls, of various sizes, and a few wrought-

iron nails, will nearly complete the number of appliances absolutely in requisition. If, however, extended operations be contemplated, a few more articles may be needed, of which the most useful will be a "stock" or "brace," and a few "centre-bits," of various sizes, from one inch to one and a half inch in width. Some wrought brads, of about one inch in length (or, better still, if for outdoor unpainted work, some copper ones) will be found exceedingly useful for securing the more delicate parts of the work.

The above-mentioned tools having been provided, it will be well for the amateur to select an old kitchen chair upon which to commence operations, as it will be much easier for him to decorate a frame already put together than to construct the frame itself. A good square, old-fashioned chair will be the best to begin with—one similar to that, part of which is shown in Fig. 1, will do capitally.

Now collect a quantity of small branches of trees, of about one inch in diameter. These may be of various sorts, or altogether of one kind, according to taste. If the colour and texture of the bark is varied, many very pretty effects may be produced by working them into patterns; but, perhaps, it will be best for the beginner to limit himself to one, until he has acquired some little skill in the use of the tools. The next operation is to cut off the selected branches into lengths of about eight inches. If the bark of the wood selected be thin, and tolerably smooth, this may be done with a sharp hatchet or large knife; but a saw is always the safest. When a good quantity is thus provided, of suitable length and thickness, these will require splitting longitudinally, in the manner shown in the sketch (Fig. 2, B); or, if the wood be of larger diameter than one inch, it may be split into several portions, as at A. A good sharp, heavy knife will be found the most useful implement for this purpose. If the wood be freshly cut from the tree, it will work very easily; but if not, it should be well soaked in water over night. The next thing will be to trim up all the best pieces cut with a sharp knife, taking especial care to remove all the sharp knots formed where the smaller shoots have grown from the branch, as these would be very liable to tear the dress of the person using the chair when finished.

All the material being thus provided, the actual decoration may now be proceeded with. The lower rail of the chair, marked A in Fig. 1, will be a convenient starting-point; and having determined whether the branches shall be placed in right lines or obliquely (as shown in the diagram), the wood may be cut off to the required length, and bradded on to the frame as shown in Fig. 3.

Some little care will be required in fitting the branches together so as to leave no intervening spaces through which the frame may be seen; but if the wood be green,

or wet, it can easily be forced up quite close enough for the purpose; and any little projecting portions preventing this may be removed with the knife, taking care not to remove the bark where it would be seen. Each piece of wood should be carefully bored with the bradawl, and secured at both ends. If it be desired to disguise the original lines and shape of the chair, the ends of the split branches may be allowed to remain below the rail, as shown in the dotted lines of Fig. 1, and cut to the required shape, after they are fixed, by means of a narrow saw, called a turning-saw.

When the rails are covered as above described, the legs of the chair may be operated upon in like manner, except that the wood will require cutting to a somewhat different form, in order to meet at the external edges. The form of joint at these points will be that technically known as "mitreing." Each piece is cut to an angle of forty-five degrees, as shown at

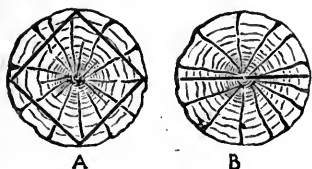

Fig. 2.

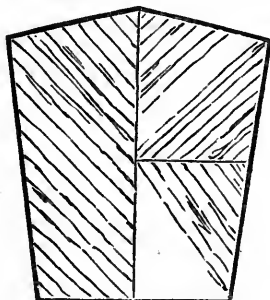

Fig. 5.

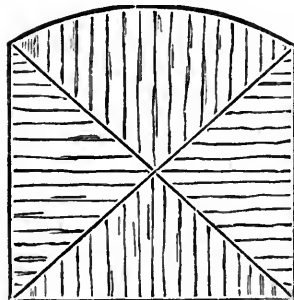

Fig. 6.

Fig. 4; and the ends thus cut, being brought together, form an unbroken line. In work such as that we are describing, no very great accuracy of fitting is necessary, and the mitres may easily be cut with a knife or chisel. The best plan will be to cut one piece to a rough

approximation of the required angle, and secure it temporarily with a brad, while the other parts are fitted thereto; when all may be secured.

The legs being finished, the seat and back of the chair may be proceeded with. These may be covered with strips of wood in one length, if required; but a much more pretty effect will be produced if they are worked as shown in Figs.

5 and 6. For the seat, the best plan will be to round the ends off, as shown in Fig. 7; but for the back, it will look better to mitre the ends into the pieces used for covering the edges.

When the whole of the chair is covered, the work may be varnished with one or two coats of the best "oak varnish." But before this is done, the wood should be allowed to become thoroughly dry; and this operation, it should be borne in mind, is only suitable for work executed with smooth-barked woods, which have some natural colour and gloss.

A very pleasing use may be made of what are called oak *bangles*, that is, the smaller branches of the oak. They are procured without bark, which has been removed for the purposes of the tanners. They are grotesque in form, and when varnished make very pretty rustic work; but their shapes are too eccentric to permit them to be used in geometrical or any intricate patterns; nor can they be split, the wood being too hard and knotted. They are best adapted for ornamental fences, arches, or trellis-work, to be covered with creepers, or the backs, legs, and arms of the more rustic of rustic chairs. When this first work is finished, the tyro may safely proceed to larger and more intricate work.

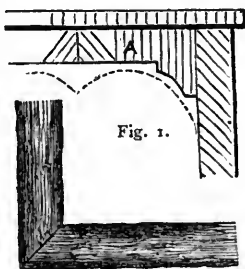

Fig. 1.

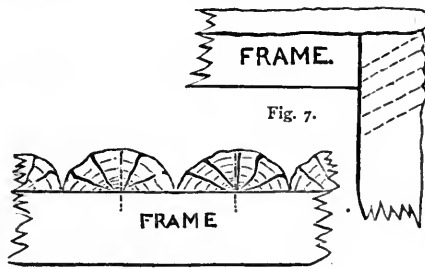

Fig. 3.

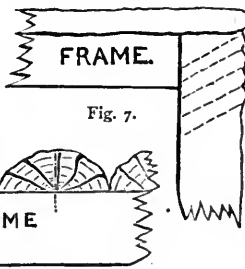

Fig. 7.

ANIMALS KEPT FOR PLEASURE AND PROFIT.—THE HORSE.

BREEDING AND BREAKING.

Sire and Dam.—In commencing this part of our subject, it will be well to state at starting that, with two exceptions, breeding is not a paying concern. The two exceptions are those whose limits do not extend beyond two certain classes of persons—the racing man and the farmer. Breeding racehorses may pay, and under some modifications it has paid very largely of late years. There is now some stagnation in the market, which arises from causes into which we need not go yet. The other is the agricultural or cart-horse, which pays because he is cheap to rear, and earns his own living at an early period of his existence. In this respect he is like the racehorse, which begins to work at two years old, though up to that point he is a very costly and uncertain luxury. Our present business is not with either of these in particular, but with those general principles of breeding and rearing which pertain to the more ordinary kinds of horses. These principles will be found generally applicable, with differences which may be pointed out as we proceed. We begin, then, with the choice of sire and dam, although we might go back one generation, if it were practicable, because the qualities of horses sometimes lie dormant for one generation, and as assuredly come out in the next. It is something like gut in the human species, which is subject to the same intermission. But this is not often practicable. It is not always in private stables, except in the case of thoroughbred stock, that the breeder knows the pedigree of his mare, or the qualities of her sire and dam. In fact, it is very seldom that he does so.

Hereditary Ailments.—Never breed from a sire or dam which you know to be unsound or of bad constitution. If you do so with your eyes open, you know the risk you run. There is scarcely an infirmity to which horses are liable which is not hereditary. Curbs, spavin, bad feet, broken wind, roaring, blindness—all these ills and many more will descend from parents to progeny, as well as conformation and general weakness of constitution. Where even, as in the case of roaring, the disease is the immediate result of bronchitis or influenza, or bad management, beware lest the offspring inherit a tendency to the infirmity which has previously existed in the parents. Some have even gone the length of saying that the results of accidents and hard work may be transmitted. We are writing from experience, and nothing that we have ever seen justifies that statement. Horse-breeding is so interesting an occupation, that many men enter upon it only because they have a paddock and a horse and, above all things, a favourite old mare. Now it is this love for the old mare that spoils it all. The stallions are usually selected for this service with reference to their constitutional and formal excellence, but there is not a corresponding care in the selection of the mare. The one is of quite as much consequence as the other. There is a great falling-off in hacks, hunters, and harness horses, in comparing supply with demand, and some of the fault consists in the defects of the half-bred mares.

Of the sire, we should regard above all things his compactness of form, his combination of power with quality, his obliquity of shoulder, and depth of "barrel." The external form is most frequently transmitted from him. There is no necessity for great size; indeed, for general purposes of saddle or harness, it should be avoided. The modern system of racing has sent more indifferent horses into the provinces than formerly, and therefore some knowledge of their performances on the turf, and of their antecedents as to pedigree, constitution, and soundness is necessary, and some judgment must be exercised *when you know what you wish to breed*. The selection of the mare is even more difficult. She should be long in carcase, with

roomy back ribs, and yet low on the leg. She is apt to transmit her moral qualities, so that weakness of constitution, irritability, and tendency to vice should be avoided. The foal will also inherit probably her paces, her endurance, and courage, all which should be looked to. An endeavour, too, should be made to counteract defects in the one by virtues in the other; but we do not advise *violent contrasts*, which are sure to spoil the virtues of both. To give decided advice on this point is impossible, and argues an impertinent superiority to natural claims. The fact is that the foal inherits from both parents form, constitution, disease, and moral qualities. It is impossible to separate them entirely, or to assign them universally, and there are hundreds of contradictory proofs which our own experience supplies.

Of Age.—The *old* mare, again, is a source of much mischief. It is no great advantage that horse or mare should have seen their best days, though unfortunately it is too often the case. Hence many disappointments. The produce will be better than that of those that never were good, but not half so good as they might have been, had they been begotten a few years earlier. There are plenty of proofs of this among racehorses which have been run off their legs early in life; the offspring frequently inherits the weakness of a decaying constitution. A mare *can* be bred from at three or four years old, but it is far better to postpone it. It should not be tried later than her fourteenth or fifteenth year, though there are plenty of instances to the contrary, especially among the slower breeds of horses. The sire is at his best from eight to twelve.

Management of mare and foal goes a great way towards the success of this undertaking. If the mare be sent to the horse about May, she will throw her foal in the April following—an excellent time for reaping the benefit of the succulent young grasses. It is far better for her that she should be worked regularly and well fed; and this in a moderate degree may be continued up to the very time of foaling. We ourselves inadvertently rode a mare with the Pytchley to within a month of her time without any misadventure, though we do not, of course, recommend such violent exertion. Too much cannot be said in favour of good nourishment, which is a preventive to many possible ills, especially to that of slipping or slinking the foal. This may happen about the fifth month of gestation, and when it has once happened it is very likely to happen again. After foaling, she should be provided with good pasture in a well-warmed spot, with every accommodation in the way of shelter. She should be fed with corn night and morning, exclusively of her grass. Economy at this time is a fatal error. You may wean the foal when he is five or six months old, and he cannot be too well fed, if you expect him to be of any use. Whether he will pay for feeding is a question: there is none about his paying for starving.

At this time, if he be a colt foal, the operation which converts him into a gelding should take place. It must be ranked under those operations which are always entrusted to professional hands. There have been two or three methods of performing this, and it need not here be further enlarged upon. If the colt be small and mean in his crest or fore hand generally, it may be postponed with advantage a month or two longer, but usually this will be found to be the proper period for its performance.

Handling the foal should commence at a very early period. The more he is accustomed to the voice and hand of man, the less will be the difficulty of actual breaking. For this purpose a headstall should be put upon him, which may be well done at the time of weaning. Take care that it be not too loose, as, in the scratching of his ear with his hind foot, or any one of the numerous tricks he plays in rolling or lying down, he will possibly get his

foot inside it, and seriously injure himself. Everything that is done to him now should be done with the greatest kindness, and the more gradual approaches are made to him the better. He should never be entrusted to a man of bad temper; permanent ill may be wrought in a moment, for a horse's memory in such matters is very tenacious. Colts are by nature exceedingly mischievous, and play should be avoided, as it is liable to result in tricks which may give great trouble to cure.

Feeding.—After separation from the dam, the foal should in a short time be turned again into a paddock, and at six months old his teeth will be strong enough to nip the short grass. As there may be not a sufficiency of this, let him have bruised oats twice a day, and boiled bran and carrots. Up to the age of two years, it is difficult to overfeed on dry food; after that, unless the exercise and food go hand in hand, inflammation is likely to go to

in those large establishments which we do not here contemplate. The principles and method we shall give will be therefore the plainest, and such as will enable the owner to overlook the process rather than personally to interfere in it.

The first point is a good mouth; and, supposing the horse to have been constantly handled, accustomed to the headstall, and to have been led about, it will not be difficult to *bit* him. The bit used should be perfectly plain and smooth—not too large—and incapable of hurting the mouth. It is usual to attach to it some keys or rings for the colt to play with. We prefer ourselves that this smooth bit should be curved, forming a segment, and not straight, as has been hitherto frequently adopted. The main object is that the mouth should not be hurt, and that the bearing, when reins are attached, should be equal on both sides of the mouth. The surcingle and crupper

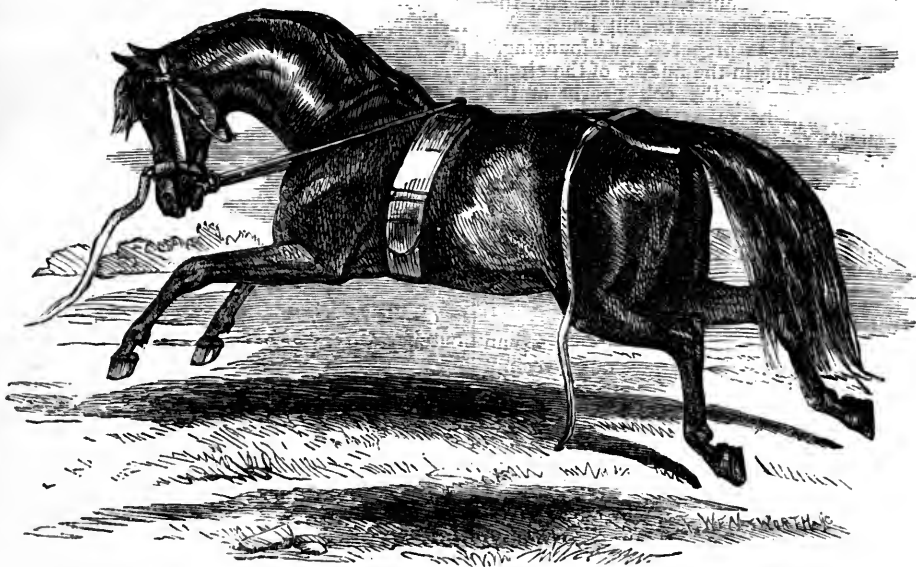

COLT PREPARED FOR "LOUNGING."

the eyes or to the feet. Wherever the foal is turned out, care should be taken that it can have shelter as well as food; the fences surrounding the paddock, of what kind soever, should be free from rough nails, splinters, or such things as can tear or lacerate the foal, which is sure to gallop about. For the same reason, there should be no holes in the ground. That the paddock should be level is not so desirable, as the young things learn to use their legs and muscles with greater freedom on inequalities. Horses will go out of their sheds in all weathers; but, when you can do so, prevent them from cold, and especially from cold rain. Warmth is a great assistance to food in obtaining symmetry and size.

Breaking to Saddle.—This process, having been begun by early handling, will be exceedingly gradual—the more so the better. The actual lessons to be taught should begin when the colt is from eighteen months to two years old; there is no greater mistake than postponing this. He gets strength and docility at the same time. For a person utterly inexperienced in these matters, it will be necessary to apply to a professional breaker, as few grooms can be trusted to go through the whole process, excepting

should be put on. After two or three days, the reins may be fastened loosely to the surcingle or girth; they should be tightened daily very gradually, so that the colt, in endeavouring to shirk the bit, will bend his neck. This is an essential in all horses, and none are pleasant to ride or drive, and not often safe, which have not been taught to bend to the rein. After he has been led about, and has become accustomed to this, portions of harness, and the dumb-jockey—*i.e.*, the two pieces of crossed wood which represent the rider—should be placed upon his back. Some have tried bags weighted with sand, and tied down so as to represent the legs of the horseman, to which he soon becomes habituated. After this he will not fear the saddle, but will allow it to be put upon his back and the stirrups to dangle below. The weight that will be brought to bear upon him at first mounting must be very gradual indeed; and, although a fight usually takes place—not immediately, but soon afterwards—if the horse's head be not let go, and no violence or punishment be used, in a few days he submits. It cannot be too strongly urged that neither punishment nor *harshness of language* should be permitted in these early trials. Every master's eyes and

ears should be open to check this in a servant at once. Firmness is quite compatible with gentleness.

When the rough edge has thus been taken off, lessons in the road must begin. The colt should be early accustomed to the objects he is likely to meet with. At first he is sure to be shy of things he has not seen before, especially when accompanied by the rattling of wheels. If he be now hurried past them, or punished in any way, his fears increase. See that your groom endeavours to give him confidence by talking to him and patting him; or, if able, do it yourself. Let the colt look at the offending object, pass and re-pass the same thing, listen daily to the same noises. Never let him be punished for anything but vice or obstinacy, and then only when he quite understands what it is for. Before I speak of "lounging" the colt, as a necessary part of his education, let me give one precept which it will be easy to remember and to follow: *Do not give a breaker £2 2s. to perform in one fortnight what ought, if properly done, to take at least twice the time.*

Lounging a young horse is an important part of horse-breaking. It is a means of exercising him without a rider, and of making his paces to a certain extent. Its great use is for teaching the canter, the walk and the trot being best taught by exercise in straight lines. We append a sketch of the colt as prepared for "lounging," p. 375. The breaker, standing in the middle of the circle, directs the movements, keeping the colt nearly at the length of his cord. It will be seen that a pressure is exercised on his mouth, and by this means he learns to go evenly and within himself. "Lounging" should be slow and steady—never hurried—and when the colt has reached this stage good hands and patience may do all the rest for him. Every horse-master should look after these things himself, although many men are precluded from doing so by their occupations. Our space here prevents us from going further into the details.

Breaking to Harness may be done in more ways than one, and each has its advocates. We have ourselves not unfrequently, with good-tempered horses, put them at once into single harness, and found them proficient after a drive of an hour or two. Such is, however, not always the case, and, as a general rule, it is safer to begin with double harness and the proper appliances. Let your horse stand for an hour in the harness. You must have a break—*i.e.*, a long carriage, with a high box, adapted for this kind of work—and a very steady old horse as a companion and guide to the young one. The old horse must be put in on the near side, and be sure that the harness is strong. A breakage at starting has been the ruin of more than one promising young horse. He must have a halter on his head, and a man whose sole business is to attend to him. Quiet is again the great desideratum, and he should be almost imperceptibly attached to the pole by the pole-strap. The reader must excuse a conventionality or two, as these expressions will be explained when we come to speak of harness and its parts. The inner trace should then be fastened, and afterwards the outer. The horse is now "to." When the reins are crossed and buckled, let him stand. Then draw up the pole-strap to its right length, taking care that the reins are buckled at the cheek—*i.e.*, at the top ring—and let the trap be started at a foot's pace by the break horse. The slower and shorter the first lesson the better, and the chances are much in favour of your success. Let the turning be done by the break horse, with the assistance of the man at the colt's head. In four or five lessons, if nothing untoward occurs, he will be tolerably safe.

There are certain vices connected with harness, as jibbing, kicking, and bolting. They and their remedies must be left till we come to speak of the vices of the horse in its proper order; at present we have said enough

on the general principles of breaking, which was all we proposed at this time to do.

If it be decided to put the horse at once into single harness, it should be done with considerably more caution, as the horse will have to start himself—always the great difficulty with young horses. They have a way of jumping forward, and, finding themselves suddenly checked, become irritable and impatient. The gig or single break should be high, the harness strong as before, with the addition of the kicking-strap. The shafts should be let down very gently into the tugs, which should be open on the upper side, and, if there is any disposition to jibbing—*i.e.*, hanging back—the gig should be pushed forward very cautiously, so as to relieve the shoulders without touching his hocks. You will then proceed as before, slowly and cautiously. If he takes to lying down, it will be your duty to sit still till he gets up again, according to orthodox authorities. It is easier in double harness than in single, but we scarcely think it worth the trouble. *Le jeu ne vaut pas la chandelle.*

The other method by which a horse may be made to bear harness quietly, is to put him into a team between two others, in a light harrow, wagon, or plough. We think the latter too heavy. If he tries to pull, he finds the resistance too great; if he leaves it all to the others, he gets no lesson in draught.

The one thing the above plan will do will be to accustom him to chains and rough harness dangling about him, and if the lesson be upon grass he will not be frightened by the noise of the wheels behind him. However, as a rule, there is nothing that answers better than beginning with double harness.

COOKING.

CALF'S HEAD.

Calf's Head, Plain Boiled.—Calves' heads are sold by butchers in two very different conditions—*viz.*, skinned and unskinned, with the hair completely removed by scalding. The latter state is indispensable for making mock-turtle soup; calf's head *à la tortue*; hashed, or rather stewed calf's head, and other ways of serving it at company dinners, and is well worth the extra cost. A scalded head, with the skin on, has generally to be ordered of the butcher beforehand, especially as half a fine head is sufficient for a small family, and he has to find a customer for the other half. True, the two halves can be cooked in different ways—one boiled, &c., the other made into mock turtle. But many people do not care to have too much, even of a good thing. Whether the whole is taken or not, the head is halved, the tongue being equally divided between the two portions, as also the brain. On a scalded head the ear is left in its natural position, erect; the eye also remains entire beneath the lid. From a skinned head we always have the eye-ball removed, simply for the sake of rendering it more sightly. The iris and crystalline lens are not the eatable parts, and, whether cooked or uncooked, are no ornament after death. The edible portion, one of the epicure's tit-bits, lies deep in the socket of the eye, and is not injured by the removal of the poor calf's ogling apparatus. On receiving a calf's head, half or whole, take out the brain; throw it into cold water for an hour; after draining, throw it into boiling salt and water, and let it boil galloping a quarter of an hour. Then set it aside. You will have asked the butcher to remove the internal cartilage of the nose; the other bones remain, to keep the head in shape; the halved tongue is also left in its place. In all weathers, calf's head is best cooked as fresh as convenient; in summer especially, delays are dangerous; during hard weather, take precautions to prevent its getting frozen. After the above preparation

and trimming, put the head into a pail of cold water; wash it well by hand, inserting the fingers into the cavities of the interior. Then put it into fresh cold water, and leave it there to draw out any blood and mucilage that may remain adhering to it. When you want to cook it, put it first into a large boiler three-quarters full of warm (not scalding) water, with a handful of salt in it. Skim carefully. When no more scum rises, and the water has boiled for five or ten minutes, take out the head, lay it on a dish, throw away this first water, rinse and wipe out the boiler, and set the head again in it on the fire in water which, this time, may be hot. Should more scum appear, remove it as it rises. After one good boil up, let the head simmer gently until enough. This will take from an hour and a half to three hours, according to size, &c. It is clear that a small skinned head will take much less time to boil than a large one with the skin on; the latter addition requires both more time and more gentle simmering, to cook it well. A calf's head should be thoroughly done, without being overdone: you ought to be able to help it in slices; it should not fall to pieces. When done, lift it carefully out of the boiler and lay it, cheek upwards, on the dish, without making a mess of it; in which you will be assisted by previously binding it with broad tape. You can either serve it in that way, quite plain, or you may smear its surface with beat-up egg, dust over it bread-crumbs or biscuit-raspings, and brown them nicely under a hot salamander. This will not take more than two or three minutes to do, and will greatly add to the style of its appearance. In any case, it will be accompanied by

Brain Sauce.—You have already set aside the brains to cool, after a thorough boiling. Chop them up, but not too small, with a little of the calf's-head boilings. Make a very small quantity of melted butter. Heat up the brains in this, with pepper, salt, and sage-leaves minced very fine. Chopped parsley or chervil may be added, together with a dessert-spoonful of vinegar or lemon-juice; or with a portion of the brains, you may make

Brain Cakes.—Mix the chopped brains into a paste, with flour, pepper, salt, butter, and minced sage-leaves. Make these into little cakes, half an inch thick, and the size of a florin. Dust them outside with flour, and either fry them or brown them before the fire in an American oven. With these you may garnish your boiled calf's head; they are even more appropriate with calf's head *à la tortue* and hashed calf's head.

Fine Herb Sauce.—On the Continent, this is the most common accompaniment for boiled calf's head. Chop together very finely parsley, chervil, and chives, or spring or small seedling onions, allowing the parsley to predominate. These are the regular and orthodox herbs; you may also add to them (and we think it is an improvement) some aromatics, as common thyme, lemon thyme, sage, knotted marjoram, or sweet basil, if you can procure it. Put these into your sauce-boat, and pour over them enough vinegar to fill it a little more than half full, at least an hour before the sauce is wanted, in order to extract the flavour of the herbs. With cold calf's head (and sometimes also with hot), oil is eaten in conjunction with this fine herb sauce, which will be seen to be a modification of our mint sauce, with the sugar omitted.

Calf's Head à la Tortue (Turtle-wise).—This very pretentious and apparently elaborate dish is by no means difficult to prepare so as to be good to the palate—and it really is good.

The subject of decorations, by which it appeals to the eye, is a matter which will depend upon your own taste, and the materials which you have at hand. In these you are allowed a tolerably wide margin, and it will be strange if you cannot master some of them.

Procure a *large* calf's head; scald with the skin on;

prepare it as directed for calf's head plain boiled; make brain cakes with the brains. Boil it, as above directed, till it is tender enough to allow you to take all the flesh entire away from the bones. Keep the flesh so removed in handsome shape, retaining the tongue in its place beneath, to help to plump it up. Set it aside. For convenience it may be brought to this stage of forwardness the day before. Take a stewpan, large enough to hold your boned calf's head. In it brown some flour in butter. Dilute it with just enough of the boilings to warm up the meat in it. Season with salt, pepper, grated nutmeg, a little cayenne, and a bumping wingglass of Madeira, Bronté, or Marsala wine. Mix together, and put the calf's head in, basting with the sauce while it is warming up.

The meat when dished hot, and covered with this sauce (to which a little tomato sauce is a correct addition), would be calf's head *à la tortue*, in its simplest form. But no cook would think of serving it without sundry and miscellaneous trimmings, some of which are to be heated up in the sauce at the same time with it, and some not; the latter being merely laid upon and about it as garnish. With the sauce you may heat up and serve button mushrooms; olives, peeled from off their kernels; brain cakes; gherkins; forcemeat-balls, composed of anything you choose; hard egg-yolks; cocks'-combs, real or artificial; cocks' kidneys, idem; nouilles; sliced truffles; sweet-bread; dice, &c. On and about the head you may place fried eggs, one for each guest; slices of fried bread, idem; fresh-water cray-fish in their shells, idem (these, in case of need, might be replaced by prawns); little stars, half-moons, and buttons, made of puff-paste, varying in size from that of a sixpence to a shilling, &c.

ODDS AND ENDS.

Chairs.—If these are cane-bottomed, make cushions as described for the box; cover with velvet and edge with fringe. If cushioned, it is merely needful to re-cover the cushions. If the backs are shabby also, merely add canvas covers comfortably stuffed with flock, if there are no cushions, and tie as well as tack them on. Make entire covers of brown holland, like frocks, for the chairs, and bind with scarlet worsted braid. In this way a parlour, a boudoir, or a bedroom can be made to appear elegant, especially if the latter has a silk patchwork quilt the prevailing colour to correspond, a monogram in the centre, and a deep velvet border like the hangings, edged with fringe. Crimson, antique blue, or green is the colour to select. Crimson looks best of all, and next to that the blue.

Looking-glass.—If the looking-glass frame has become very shabby, take out the glass and the board at the back; tack a strip of canvas to each of the four sides, beginning with the two upright sides. Fill all the irregularities, just enough to level them, with flock. Strain the canvas over, tack it down; next do the top, and lastly the base. Afterwards cover it with velvet, and set a row of gilt-headed star nails around both the outer and inner edges. Replace the glass and back. Great care must be taken not to touch any part of the back of the looking-glass with the fingers, or the quicksilver will be removed. Another way is to have a wooden frame made as for the fender (page 361), and then at a wholesale glass manufactory purchase a sheet of plate-glass. Take your frame there in a cab and get the glass secured in. Furniture-pictures look very well furnished in the same manner.

Side Tables.—The plan recommended on page 361 may also be applied to the covering of small round tables which are common, or have become shabby with long use. The tops of these may be of deal, covered with the cotton velvet or cloth in the way there described, with fringe and star-headed gilt nails, &c., as shown

in our engraving, Fig. 1. If the legs are very shabby, these also may be covered with velvet; but the tacks may here be of the common ordinary kind, as they will, of course, be placed inside and out of sight. Cheap deal boxes may in the same way be converted into quite ornamental and very useful pieces of furniture. Fig. 2.

Ottomans.—A pair of ottomans may very well be placed one each side of the fireplace, or one under the window. Boxes of any kind come in use for the construction of ottomans. First cover the lower part of the box all over with velvet, cutting out the place over the key-hole, and nailing it well down. Nail the velvet securely under the box, then cover the lid entirely. Fix a worsted fringe, price 11d. or 5d., according to depth, all round the edge of the lid by means of star nails. The fringe covers the space left for the lock. Another way is to cover the box as already named, turning the edge of the velvet over inside and underneath, and nailing some good white calico on the bottom, with the edge turned in, and also lining the box with calico. Make a cushion, the size of the lid, of canvas. Cut the lower part the size of the lid, and the upper larger, to admit of raising it. Full it a little to the lower in running them together. Stuff well with flock till quite hard. Then fix it to the box by tacks. Cover afterwards with velvet and fringe, as before described. The box with a thick canvas cover will travel well, and be a great comfort to the owner in strange places. To preserve it better, put first a calico and then a canvas, or American-cloth, cover.

Whitewashing Walls.—Sulphate of baryta has been strongly recommended as a substitute for lime in white-washing walls. Its advantages are said to be numerous. The mode of using it is as follows:—Four ounces of glue are soaked for twelve hours in tepid water, and then placed, until boiling, in a tin vessel with a quart of water. The vessel being placed in water, as in the usual process of boiling glue, the whole is then stirred until dissolved. Six or eight pounds of sulphate of baryta, reduced to an impalpable powder, are put into another vessel; hot water is added, and the whole stirred until it has the appearance of milk of lime. The sizing is then added, and the whole stirred well together, and applied in the ordinary way whilst still warm.

Oxidised Silver.—Silver ornaments may be oxidised of a brownish tint by the application of a solution of sal ammoniac. Equal parts of sulphate of copper and sal ammoniac, dissolved in vinegar, form a better mixture than sal ammoniac alone. A slightly warm solution of sulphate of potassium gives to silver a fine black tint.

HOME GARDENING.

THE VEGETABLE GARDEN (continued).

Borecole or Kale.—This is a plant of the *Brassica oleracea* tribe. There are several sub-varieties, all of which have large open heads, with curled, wrinkled leaves, and are of a more hardy constitution than most of the other kinds of this genus, which enables them to stand the winter better, and remain fresh and green during the season. This we shall be rather particular in describing, as it is a somewhat difficult family to understand thoroughly.

The Green Borecole, or Scotch Kale.—The leaves are of a bright light-green colour, deeply lobed but not very wide. The margins of the leaves are so closely curled, or plaited, as to widen the margin of the leaf three or four times as much as it would measure if a quarter of an inch of plaiting were taken away all round the edge. The part used is the crown or centre of the plant, cut off so as to include the leaves, which do not exceed nine inches in length. It boils very tender, and is very sweet and delicate, provided it has been duly exposed to frost.

Purple Borecole, or Brown Kale.—This differs from the other in being of a deep purple colour, becoming greener as the leaves enlarge. Yet the veins and ribs still remain purple. It is more hardy, but less delicate in flavour, than the former; and when boiled the purple colour disappears.

German Kale, or Brown Kale.—This is a variety of the green kale, but differs in its leaves being more pointed and longer than the others, but their margins not so plaited; yet they are considerably so, which gives the plants a fringed appearance, but not so rich and beautiful as the true Scotch kale. The chief difference is that this affords a greater abundance of sprouts than the other, after the crown has been cut. It is disposed to grow tall, consequently ought to be planted earlier than the others, as the produce is in proportion to its length in stem. It is somewhat hardier than the Scotch kale, possessing nearly the same taste when mellowed by frost; otherwise it is rather better.

The Hundred-headed Cabbage.—This grows three feet or more, and branches out from the stem like a fan, tongued-shaped and entire, being narrower than any of the other kinds. This is best known to the agriculturists, as being grown chiefly for cattle. It is more hardy than any of the former, but its flavour is much inferior.

The Egyptian Kale.—This greatly resembles the Swede turnip when it has run up to head, it having a very thick stalk and rising about a foot above the ground. The leaves are narrow, generally having, at the lower part, one strong indentation on each side. They are of a dark green, like those of the Swede turnip, and much resemble them in flavour.

Ragged Jack.—This grows close to the ground, and in spring grows up strong from the sides and crown. The leaves are very much cut or divided on the edges, which are marked with small obtuse serratures. This is seldom grown anywhere but in farmers' and cottage gardens.

The Jerusalem Kale very much resembles the preceding, both in habit and growth. The leaves are long, with several indentations, and the edges are serrated, but not deeply; the upper surface being of a purplish colour, the under one a pale green, and the veins inclined to a pink colour. It is very hardy, and when growing appears of a dingy purple. This is not considered fit for use until spring, when other greens have ceased to be good, and hence it is a kind that should be cultivated in every garden, if only to a limited extent.

The Manchester Kale, like the preceding, grows low, but more close and compact, with leaves somewhat like the German kale, having the same sort of fringe on its margin. The whole plant appears purple before it begins to shoot in spring. It is, in our opinion, as valuable as

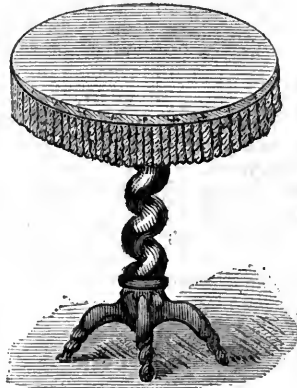

Fig. 1.

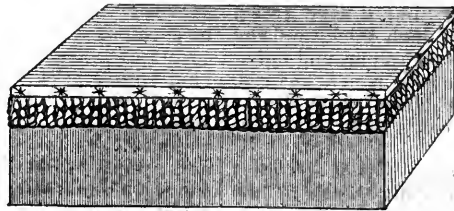

Fig. 2.

any of the borecoles, being very hardy; and remaining, as it does, late in the spring before it comes into flower, it eats very sweet.

Melville's improved variegated Borecole or Kale.—This is the most beautiful of the whole family, the colours almost defying description, ranging as they do from almost a black purple to the palest pink, from the deepest orange to the most delicate straw colour, from the darkest bronze green to the palest imaginable green, and almost every mentionable hue. It is an annual of dwarf habit, and hardy, and when grown in collection would beat many a bed of choice flowers. Therefore it has the double advantage of being handsome as a garden ornament, and delicious as an edible, after you have feasted your eyes, as it in reality is. All the sorts are propagated by seed, which may be sown at any time from the first of February to the end of May, with the exception of the Manchester kale, which should be sown the first week in August, and transplanted in September for the latest spring crop. The future culture of these plants generally should be carried out or managed as follows:—When the seedlings are an inch and a half high, the strongest plants should be drawn out of the seed-bed, and pricked out into other beds five or six inches apart, well watered, and there remain for four or five weeks, when they will be sufficiently strong for final transplanting in May and up to August. In transplanting always be guided by the weather rather than the season, taking advantage of showers, if possible. These should be planted in open compartments in rows, two and a half feet asunder, for the first summer planting, and the later crops two feet, and so on; setting the rows nearer each other as the season advances. They must be watered immediately after planting, to settle the soil to the roots, and this watering must be continued in dry weather. In order to employ land to the best advantage—and this should be the first consideration of every landed proprietor, whether his means be large or small—plant between the rows of early beans and potatoes, which will be ready to be cleared from the ground by the time these plants will require hoeing. In this case, as soon as the potatoes and beans are ripe, have the crop gathered, and dig over the spaces between the plants, that is, where the former crop stood, and place the soil round and about the stems as much as possible. We have always found this practice to answer well, inasmuch as by this means an extra crop is obtained. The ground between the rows should be hoed over once or twice a week in order to destroy weeds, as well as to draw earth to their stems, which will be found to encourage their growth in the production of large full heads in the autumn and winter months. In October it is a very good plan to take the plants up with as much soil round about their roots as possible, removing all the lower leaves, and immediately replant them in a sloping direction, about eighteen inches apart, covering their stems quite close up to the leaves. By doing so the crowns of the plants will be close to the ground, and when snow falls they will be all the sooner covered from the severity of the frost, and thus be preserved over the winter until spring. When all danger of frost is over, set them erect again, by taking hold of their heads and drawing them up straight, pressing them down with the foot at the same time to keep them in that position; they will then sprout out from the top to the bottom of the stem. These will be fit to gather as soon as they have been frozen, and the heart is the part to be gathered for table, although every sprout is eatable. Those contemplating saving seed will do well to attend to the following hints. The seed of more than one sort seldom can be saved the same year in the same garden, on account of accidental impregnation, by bees, the wind, and other causes, no plant being more addicted to sport than this. The seed when once saved true, will keep good for several years. therefore, if the garden be large, one or two sorts may be saved every year in rotation, but in a small garden it would

be folly to attempt to do so. If, as we have said, you have room to save a little seed, you must in the autumn or spring, select some of the best and truest plants, and plant them as far distant as the garden and other circumstances will allow. All loose and ragged leaves should be cleared away, and the plant inserted to the head, and at about double the distance they stood before in the plantation. The seed will be ripe in August, when it may be gathered, dried, and threshed out, and after being exposed to the air a few days may be put up in bags for use. We do not advise any small grower to save his own seed, unless for novelty's sake, as good seed is now to be had so reasonable that it is not worth the trouble.

THE TOILETTE.

III.—DISORDERS OF THE HAIR AND THEIR TREATMENT (continued).

Hair Dyes.—Those used for the production of a black colour contain, as a rule, either a preparation of silver or lead. When lead compounds are used there is danger lest their continued application cause serious symptoms. The lead may become absorbed, and induce paralytic symptoms, such as are noticed in what is known as "wrist-drop." The silver compounds act in virtue of the property they possess of being turned black by the action of the air. Certain vegetable juices, such as those of the walnut, the lye of vine branches, pyrogallic acid got from nut-galls, are likewise employed. These black hair dyes are used in the liquid state, and when they rapidly change the hair, they are called "Instantaneous Hair Dyes;" or when more slow in action, "Atmospheric Hair Dyes." Now all the dyes that contain nitrate of silver or caustic, stain the skin as well as the hair, if they come in contact with it; hence care must be taken to use them only to the hair. Those who dye hair are therefore careful to avoid touching the skin of the head, or apply pomatum to the scalp, so as to protect it from the dye. It is first necessary to wash the hair very thoroughly with soap and water, and dry it before applying the dye, which latter must be kept from touching the skin. We will describe in a moment how this is to be actually carried out. Most people now prefer lead-dyes, because of the disagreeableness of staining the skin. With these preliminary observations we will give the recipes for several black dyes.

Instantaneous Hair Dye.—The hair is to be moistened, after being cleansed and perfectly dried, by a solution of nitrate of silver in water, in the proportion of 1 part to 8, and then after a few minutes it is to be brushed over with a weak solution of hydrosulphuret of ammonia.

Eau d'Afrique.—Two solutions are used here. The first is made by dissolving 90 grains of crystallised nitrate of silver in two ounces of water; the second by mixing 3 drachms of liquor of potash, 7 drachms of hydrosulphuret of ammonia, and 1 ounce of water. To dye the hair, brush it over with No. 1 solution by means of a tooth-brush, but do not touch the skin. Then in ten minutes dilute No. 2 solution with 5 ounces of water, and brush that over the hair. If the skin is wetted wipe it dry with a piece of rag. Arrange the hair after washing it gently over with warm water, and leave it for a few hours untouched.

The above details we give for those who are determined to experiment upon themselves, but we strongly advise our readers to use, if they wish to dye their hair, a preparation devoid of silver, and the following may be used without danger. It consists of two solutions as in the above silver dyes:—

No. 1 is made by mixing together eight grains of bichloride of mercury, two drachms of spirits of wine, and ten ounces of water. This solution should be brushed through

the hair (after the latter has been cleansed) for several days, and then No. 2 should be applied.

No. 2 is made by dissolving half an ounce of hyposulphite of soda in four ounces of water.

N.B.—The amount of mercury is too small to do any harm, in addition to which the compound used is altered by the No. 2 solution.

The formulæ we have given are those available when the whole hair needs a thorough dyeing. We now append the composition of a pomade which can be used so as to produce a more gradual change to a black colour.

Nitrate of silver...	1 part.
Dilute nitric acid	2 parts.
Iron filings	2 parts.

Mix, and let them remain for four or five hours; then add them to 2 parts of oatmeal, and stir in 3 parts of lard and then scent it.

If in consequence of the liability to staining of the skin by the silver dyes, they are found to be difficult of use, one of the less active lead dyes may be had recourse to. The chief ingredients in the more generally used and more largely advertised black dyes are lead and sulphur. The following is a liquid dye containing these two elements:—

Acetate (or sugar) of lead	60 grains.
Flowers of sulphur	60 grains.
Glycerine	1½ ounce.
Rose water	6 ounces.

This lotion is one which used to the hair daily for a week or two will take away all greyness, and turn the hair to a jet black. It must not be applied to the skin but only the hair, lest the lead be absorbed and do mischief.

Some writers advise a pomade made with bismuth, but this does not act well. If persons will dye from greyness they had better chance the use of the last given recipe.

A *dark-brown* colour is given by using a solution of prussiate of potash with a mordant of sulphate of copper; and light hair is dyed *golden* brown by the employment of the following solution:—

Gold Dye.

Solution of perchloride of gold	2 drachms.
Water...	1½ ounce.

This is to be brushed through the hair.

Thinning and Loss of Hair.—We now come to consider the important question of loss of hair, the causes that lead thereto, and the remedies to be used in order both to prevent the evil, and to promote the re-growth of hair in place of that which is lost. Now, loss of hair, varying in degree, may be a congenital peculiarity—with that we shall have nothing to say. It may likewise be the natural consequence of advancing age. This is, of course, a matter of every-day experience; but the instances in which the reader is most interested, are those in which the hair thins, or is lost absolutely, over a greater or less extent of surface prematurely, and as the result of disease or disturbance of the proper nutrition of the body. It may be asserted, without fear of contradiction, that the growth of the hair is retarded by any cause which leads to debility, and promoted by anything that tends to give tone to the system. This is the rule—indeed, it must be within the experience of most persons that the assertion is true, and individual peculiarities are but exceptions proving the rule. We shall speak of thinning of the hair, first of all; then, of complete loss of hair over a certain limited extent of surface; and, lastly, complete loss of the hair of the body or of different regions, such as the whole scalp.

HOW TO MAKE TEA.

THE Scotch do not say “to make tea,” but “to *infuse* the tea,” which is more correct in every respect. Good tea is an infusion, not a decoction. By *boiling* the tea-leaves, you get from them a bitter principle, and you drive off the delicate perfume of the tea. For this reason, the teapot should never be kept hot by letting it stand on the top of a cooking-stove, over a lamp, or where it is likely to be made to boil. Excessively bad tea is made in some parts of the Continent by people who do not know better, by putting a small pinch of tea into a large kettle of water, and letting it boil till they have extracted all its *colouring* matter, in which they think the goodness of tea consists. A metal teapot is better than an earthen one, and the brighter it is kept the better is the tea. Rinse the teapot with boiling water. Put in a bumping spoonful of tea for each person, and one for the pot. Pour over it just enough boiling water to soak the tea. Let it stand a few minutes, and then fill up the pot with boiling water. Do not put in carbonate of soda to soften the water and make the tea draw better; *i.e.*, to make a wretched saving of tea, unless you are in absolute poverty. The water, in fact, is softened by boiling, which causes it to deposit some of the matters it held in solution; witness the “fur” in long-used tea-kettles, and the lime which settles at the bottom of many waters after boiling.

A cup of tea is an excellent thing after any fatigue. Its refreshing effects may then be followed up by more substantial nutriment. A proof amongst others (such as steam, railways, electric telegraphs, &c.) that the world is still in its infancy, is that it is scarcely two hundred years since tea came into general use. Pegys mentions having tasted tea for the first time in September, 1660:—“Tea—a Chinese drink, of which I never drank before.” Sir Kenelm Digby records, as important, the Jesuits’ mode of preparing tea:—“The priest that came from China told Mr. Waller (the poet) that to a pint of tea they frequently take the yolks of two new-laid eggs, and beat them up with as much fine sugar as is sufficient for the tea, and stir all well together. The water must remain upon the tea no longer than while you can say the *Miserere* Psalm very leisurely; you have then only the spiritual part of the tea, the proportion of which to the water must be about a drachm to a pint.”

In 1688, the Court of Directors of the East India Company, writing to their agents at Bantam, in Java, ordered them to send home one hundred pounds weight of the best tea they could get; and the next year there arrived their first consignment of tea, in two canisters of one hundred and forty-three pounds and a half each. Before that date, namely in 1671, tea had already found a doughty champion in Cornelius Boutekoe, a Leyden doctor, who vaunted tea as a panacea against all the ills that flesh is heir to. He pronounced it an infallible cause of health, and thought two hundred cups daily not too much even for a moderate drinker. The Dutch East India Company is said to have made it worth his while to uphold that opinion. There are sundry and divers “teas” made from sage, camomile, ground ivy, hawthorn, black-currant, sloe, and other leaves. They are ptisanes, or herb-drinks, and may be taken in obedience to medical advice, or drunk by hypochondriacs, who must be always dosing themselves with something; but they are not, and never will be tea—“the cups that cheer, but not inebriate.” The Russians (who certainly drink the best tea in Europe, obtained overland from China) as a rule prefer their tea with something which *does* inebriate in it.

ANALYTICAL INDEX.

A.

Abscess, Description of, 303.
 Abscesses (Chronic or Cold), Milk Abscess, Particulars of, and Treatment, 252, 253; Figure, 253.
 Administration, 91.
 Ague, Particulars, Symptoms, and Treatment, 303.
 Aitch-bone of Beef, *see* Beef.
 Alabaster, How to Clean, 255.
 Albums and Scrap-books, Making of, 130; Figures, 129.
 Alum-baskets and other Ornaments, Making of, 263.
 AMUSEMENTS, HOUSEHOLD.—The Ball of Wool, Shadows, The Messenger, Magic Music, 127, 128; Prussian Exercises, The Courtiers, The Dumb Orator, Speaking Buff, The Shopkeepers, Twirling the Trencher, Proverbs, 159, 160; Forfeits, 163, 164; Novelties in Toys and Tricks—The Siamese Link, The Chameleon Top, The Obedient Ball, The Magic Bottles, 191, 192; Forfeits (*continued*), 202, 203; The Newspaper, The Picnic, The Coach, The Traveller, 238, 239; Impromptu Romance, 251; Card Games, 261—263; The Game of Whist, 278, 279; The Game of Whist (*continued*), Comical Combinations, Acted Charades, 319, 320; Acted Charades (*continued*), Pantomime Charades, 347—349.
 Anacharis alinastrum, 63; Figure of, *ib.*
 Anagallis, 82.
 Anchovy Sauce, Making of, 324.
 Anemone, 82, 132.
 —, Single Garden, Growing of, 81.
 Anemones, 60, 162.
 ANIMALS KEPT FOR PLEASURE.—THE DOG, 11—13, 60—62, 76, 77, 106—109, 204, 205, 266, 267, 308.
 ANIMALS KEPT FOR PLEASURE AND PROFIT.—THE HORSE, 295—299, 325—327, 374—376.
 ANIMALS KEPT FOR PROFIT.—POULTRY, 30—32; The Feeding and General Management of Adult Fowls, 46—48; Incubation of Poultry, 95, 96; Poultry, 121, 122; The Rearing and Fattening of Chickens, 145—147, 168, 169; Ducks and Geese, 169, 170; Cattle, 188, 189; Poultry, 217—219; Cattle, 228—230, 309, 310.
 Animals, Fresh Water, Selection of, for the Aquarium, 64.
 Annuals, Autumn-sown, 65.
 —, Description of, 82; Treatment of, *ib.*
 Apoplexy, Symptoms, Causes, Treatment, and Prospects, 318, 319.

Apple Dumplings; *see* Dumplings.
 — Fritters, Particulars of, 67.
 — Jam, Directions for Making, 220.
 — Jelly, Directions for Making, 220; *see* Orange Apple Jelly.
 — Pudding, Baked, Making of, 28.
 — Rolls, How to Make them, 55.
 Apples, Baked, for Children, 219.
 —, Baked (two recipes), Preparing and Serving of, 219.
 —, Dried, Directions, 220.
 —, Stewed, Particulars and Serving of, 219, 220.
 Apricot, 109.
 — Jam, Directions for Making, 221.
 AQUARIUM, THE, 17; (For the Window) Figure of, *ib.*; Bell-glass, *ib.*; Figure of, 18; Tanks for Fitting on the Outside of Window-sills, 17; Figure of, *ib.*; Hexagonal Shape, 18; Figure of, *ib.*; Situation, Temperature, &c., for, *ib.*; Preparation of, *ib.*; Fresh-water Vegetation, 63, 64; Suitable Plants, *ib.*; Modes of Arrangement, 64; (with Rockwork and Fern) Figure of, *ib.*; Selection of Fresh-water Animals, 64, 69; How to Stock, 69; Names of Fish, *ib.*; Food for, *ib.*; How to Manage, *ib.*
 —, Marine, 105, 106, 132—134; Light and Temperature, 105; Choice of Vessel, *ib.*; Water, *ib.*; Means of Procuring, *ib.*; Analysis of Water of the Channel, *ib.*; Gathering of Objects, *ib.*; Figure of Tin Can, *ib.*; Figure of Net, *ib.*; Figure of Rockpool, with Seaweed and Anemones, *ib.*; Figure of Shrimp, *ib.*; Figure of *Æsop* Prawn, *ib.*; Sea Anemones, *ib.*; Stocking of, 161, 162; Figure of, 161.
 Arable Husbandry, 301, 302, 344, 345; Figures, 344; Farm-yard Manure, Liquid Manure Carts and Barrows, Tables of Cubic Measure and Weight of Water, Table of Weight and Cubic Capacity of Liquid Measures, Table of the Number of Square Areas in an Acre of Land, Liquid Manure Tanks, Succession of Crops, Particulars of the Four, Five, Six, and Seven Course Shift of Cropping, 327—329.
 Arrowroot, with Milk, Making of, 235.
 Arteries, 9.
 Artichokes, Globe, 138; (December), 271; Particulars and Cultivation of, 272.
 —, Jerusalem, 272.
 Ash, Particulars and Uses of, 77, 78.
 Asparagus, 65; The Growing, Dressing, Forcing of, &c., with Illustrations, 287, 288.
 Assessed Taxes, *see* Queen's Taxes.
 Assurance, Fire and Life, 2, 3.

Assurance Policies; *see* Insurance Policies.
 Asthma, Description, Symptoms, and Treatment, 319.
 Auriculas, 66.
 Arum (*Calla palustris*), 63.
 Augers, 16; Figure of, 23; *see* Gimlets.
 Axe, Particulars and Uses of, 137.

B.

Babies.—First Attentions, 10; First Feeding, *ib.*; Evil effects of Laudanum, *ib.*; Remedy for Pain in the Stomach, *ib.*; Sleeping with the Mother, *ib.*; Cradle—its Position, and Comforts for, 10, 11; Feeding of, 11; Washing of, *ib.*; Use of Violet-powder, *ib.*; Water for, *ib.*; *see* Children.
 —, Rickety; *see* Children, Rickety.
 Babies' Long Frocks and Petticoats, Directions for Making, with Figures, 116—119; Materials for, 116, 118.
 Baby-linen, 11.
 Baby's Bib, 119; Figures of, 117.
 — Chemises, Making of, 34; Figures, 33; Directions for Making, accompanied by Figures, 88.
 — Cloak, Directions for Making, accompanied by Figures, 88—90.
 — House Cloak or Flannel Wrapper, Directions for Making, accompanied by Figures, 88.
 — Flannels, Making of, 34; Figures of, 33.
 — Day Flannels, Making of, 34; Figure of, 33.
 — Handsome Day Flannel, 35; Figure of, 33.
 — Rich First Frock, Making of, 35; Figure of, 33.
 — Frock, 90; Figure, 89.
 — First Gowns, Making of, 34; Figures, 33.
 — Robe, Making of, 118, 119; Figures, 117.
 Bacon, Carving of, 198.
 —, Particulars for Marketing, 336.
 Back Windows: How to Shut out a Disagreeable View, 299.
 Baking Powders, Making of, 263.
 Ball of Wool (a game), 127.
 Balsam, 82.
 Balsams, 114.
 Bandages, 9; Figure of, 8; Application of, 9; Figures of, 8, 9.
 Bandaging for Arterial Bleeding, 9; Figure of, 8.
 Barley-water, Making of, 234, 284.
 Barrow, Hand, Uses of, 137, 138; Figure of, 137.

- Baskets, Garden, Uses of, 149; Figure of, *ib.*
- Bathing Recommended, 46; Cold Douche, *ib.*; Hot Baths, *ib.*; Turkish Baths, *ib.*; Flesh Gloves and Brushes, *ib.*; Bathing when the Body is slightly heated by Exercise recommended, *ib.*; Signs of Bathing doing Good or Harm, *ib.*; Rules for Bathing, *ib.*
- of Children, 46.
- Baths, *see* Bathing.
- Batter, Making of, 37.
- Pudding, Plain Boiled, *see* Pudding.
- Pudding, Baked, with Apples, *see* Pudding.
- Pudding, Baked, with Sausages or Bacon, 37.
- Beads, 42.
- Bean, The Dwarf French, Cultivation of, 355.
- Beans, 174; Cooking of, 182; Early, 109.
- Dwarf Kidney, 139.
- , Pickled French, Pickling, &c., of, 196.
- , Runner, 138, *see* Runner Beans.
- , Scarlet Runners, 139; Sticking of, *ib.*
- , *see* Broad Beans.
- Bedroom, The.—Blankets, Sheets, and Pillow-cases, Towelling, Russian Towelling, 346, 347.
- Bedroom Furniture, Particulars of, 155—157; Mattresses, Quilts and Counterpanes, Feather Beds, 285, 286.
- Bedsteads, 156.
- , *see* Furniture.
- , Arabian, 183, 184; Figures of, 184.
- Beech, Particulars and Uses of, 78.
- Beech, *see* Copper Beech.
- Beef; how the Beast is divided, with Illustration, 261; Quality of, *ib.*
- , *see* Roast Beef.
- , Aitch-bone: How to Carve, 256.
- Pudding, *see* Pudding.
- , Ribs of, Carving of, 7, 256.
- , Ribs or Breast, Stewed with Vegetables, 140.
- , Round: How to Carve, 256.
- , Shin of, Soup, *see* Soup.
- , Sirloin of, 7; Serving of, *ib.*; Carving of, *ib.*
- Tea, 258; Dr. Dobell's, *ib.*
- Beet, 139, 272.
- , Red, Cultivation of, 356.
- , White, Cultivation of, 356.
- Beet-root, Pickled, *see* Pickled.
- Beet-roots, 174, 175.
- Beets, 191.
- Beetles, 69.
- Bell-glasses, 113.
- Bell-hanging, Particulars and Description of, with Figures, 180, 181.
- Bernays, Dr., 162, 163.
- Bevel, Mitre, Description of, 50; Figure of, 49.
- Bilious Attacks, Causes and Treatment, 334—335.
- Biliousness, Causes and Treatment, 334.
- , or Bilious Disorders, including Jaundice, 350, 351.
- Birch, *see* Silver Birch.
- Birds, *see* Cage-birds.
- Biscuits, Orange, Making of, 234.
- Bits, 16; *see* Centre-bit, Pin-bit, Counter-sink-bit.
- Blackberry Jam, Making of, 220.
- Black-cap Pudding, *see* Pudding.
- Currant Jam, Directions for Making, 220, 221.
- Black Pudding, 104.
- Thorn, *see* Red.
- Blacking, How to Make, 313.
- Blankets, 346.
- , Washing of, 299.
- Bleeding Piles, Causes and Treatment, 30.
- Blinds, 19; Fixing and Making of, *ib.*
- , Venetian, 19.
- , Spring Blinds, Venetian Blinds, Descriptions, with Particulars of the Working and Fixing, 175, 176; Figures of, 176.
- Blowing the Feather, 127.
- Boar's Head, 150.
- Body, Unusual Heat of the, 41, 42.
- Boiling of Meat, 171.
- Boils (at Short Notice), 167.
- Boils, Particulars and Treatment, 253.
- Boot-cleaning, 305, 306; Figure, 305.
- Boots, *see* India-rubber Varnish.
- , *see* Shoes.
- Borecole or Kale, Particulars of the Many Sorts, 378, 379.
- Border, The, Culinary Art in, 5.
- Bow Legs, Cause and Treatment of, 202.
- Bowel, Lower, 8.
- Brace, Figure and Description of, 16.
- Bracket, Modelling of, 345; Figures, *ib.*
- Brad-awls, Description of, 16.
- Brain Cakes, Making of, 377.
- Sauce, Making of, 377.
- Brass and Copper, Cleaning of, 222.
- Brawn, 150.
- Bread, Use of, 5; Making of, 5, 6; Cutting of, 7.
- and Flour, Weights of, 284.
- without Yeast, Making of, 6.
- , *see* Corn Bread.
- , Barley, Making of, 6.
- , Oaten, Making of, 6.
- , Rye, Making of, 6.
- and Butter Pudding, without Butter, *see* Pudding.
- Pudding, Broken, Baked, *see* Pudding.
- Breakfast, 4.
- Bream and Roach, 341.
- Breathing Apparatus, *see* Bronchitis.
- Brill; How to Carve, 256.
- Broaches, *see* Rymers.
- Broad Bean, The, Particulars and Growing of, with Figures, 330.
- Beans, 138, 139, 149.
- Broadstairs, 132, 133, 134.
- Broccoli, 138, 139, 149, 174, 175, 190, (December) 271, 272.
- , *see* Cauliflowers.
- , Cape, 190.
- Broiling, 171, 172.
- Bronchitis and Croup, and Nervous Croup, 83.
- and Diseases of the Breathing Apparatus, Particulars and Treatment of, 115.
- , Particulars, Symptoms, &c., 359, 360.
- Broth, Chicken, 255, 258.
- , Hasty, Making of, 283.
- , Mutton, 258; Another Recipe, *ib.*
- , Pea, 311.
- , White Veal, 258.
- , Brown Veal, 258.
- from Essences and Extracts of Meat, Particulars, 311.
- Broths, Generally, 253, 254; Pot-au-Feu, 254; Ratatouille, *ib.*
- and Soups, 258—260; Fish Soups, 260, 261.
- Broths and Beverages, Invalid — Hasty Broth, Porridge, Gruel, Barley-water, 283, 284.
- Brown Sauce, *see* Sauce.
- Bruises and Contusions, Treatment of, 52, 53.
- Brussels Carpets, Testing of Quality, 126.
- Sprouts, 174.
- Budding-knife, Description of, 149; Figure of, *ib.*
- Buhl Work, Description of, 223.
- Saw: its Uses, 49; Figure of, *ib.*
- Bulbs, 60, 66, 82, 109.
- Bull-terrier, *see* Dogs.
- Bullace Cheese, *see* Damson.
- Bullock's Heart à la Mode, Preparing and Dressing of, 120.
- Kidney, Dressing of, 120.
- Bunions, Causes and Treatment of, 201.
- Buns, Saffron, *see* Cakes.
- Burns and Scalds, Particulars and Treatment of, How to Guard against, &c., 73, 74.
- Bustard, 150.
- Busts, 354.
- Butter, 160.

C.

- Cabbage, Hundred-headed, 378.
- , *see* Red Cabbage.
- Plant, 272.
- Plants, 175, 190.
- Soup, *see* Soup.
- Cabbages, 65.
- CAGE-BIRDS: THEIR HOMES AND TREATMENT IN WINTER.—Keeping and Feeding of, 175.
- Cake, American White, Recipe for, 234.
- , Cheap, Making of, 27, 28.
- , Good Common, Making of, 66.
- , Egg Powder, Making of, 27.
- , Johnny, or Journey (American), Making and Baking of, 28.
- , Fried Bread (American), Making and Frying of, 28.
- Cakes, Little, Making of, 234.
- , Raised Buckwheat (American), Making and Baking of, 28.
- or Buns, Saffron, Particulars of, 66.
- , Sally Lunn, Making of, 28.
- Calandrinia, 82.
- Calceolaria, 82, 114.
- Calf's Cheek, Particulars and Dressing of, 139.
- Head, Plain Boiled, Particulars, Preparing and Boiling of, 376, 377; Brain Sauce, 377; Brain Cakes, *ib.*; Fine Herb Sauce, *ib.*
- Head à la Tortue (Turtle-wise), Preparing and Decorations of, 377; Sauce, *ib.*; How to Carve, 79, 80; Figure, 80.
- or Sheep's Liver, Sliced, Fried, Dressing and Serving of, 120.
- Liver, Stewed, How to Dress, Particulars of, &c., 119.
- Liver Cheese, Dressing of, 120.
- Camel, Wild, 12.
- , Young, 12.
- Camellias, Culture and Propagation of, 81.
- CAMEOS, A WORD OR TWO ABOUT.—Particulars and Values of Different Kinds, 123.
- Canariensis, 113.
- Candied Horehound, Recipe for Making, 291.
- Cape Broccoli, *see* Broccoli.
- Capons, 150.

- Carbuncles, Particulars, 253.
 Card Games, 261, 262, *see* Whist.
 Carnation, *see* Tree Carnation.
 Caroline, Queen of George II., 8.
 Carp, The, 340; Figure, 341.
 —, Stewed Whole, 340, 341.
 —, Golden, 69.
 —, Common, 69.
 —, Prussian, 69.
 Carpenter's Bench, Construction of, 101; Figures, *ib.*
 Carpenters' Joints, *see* Joints.
 Carpentry, *see* Woods, Tools, Mechanic (the Household), &c.
 Carpets, How to Remove Grease from, 313.
 Carrot Pudding, *see* Pudding.
 Carrots, 4, 149, 174, 175, 191, 272.
 —, Sowing of, 138; Thinning of, 139.
 —, Early Horn and Long Surrey, Sowing of, 138.
CARVING, HINTS ON.—Particulars, Leg of Mutton, Sirlon of Beef, Ribs of Beef, 6, 7; History of, Roast Fowls, Salmon, 55, 56; Hare, Rabbit, Turkey, Calf's Head, Shoulder of Mutton, 79, 80; Ham, Neck of Mutton, Loin of Mutton, Neck of Veal, Loin of Veal, Pheasant, Partridges, 143, 144; Goose, Sucking-pig, Saddle of Mutton, Fore-quarter of Lamb, Leg of Pork, Tongue, Bacon, 197, 198; Whiting, Pike, Cod, Flat Fish, Pigeons, Mackerel, Pilchards, &c., Loin of Pork, Aitch-bone of Beef, Round of Beef, Ribs of Beef rolled, 256.
CATTLE, THE VARIETIES AND BREEDING OF.—The Shorthorn, The Ayrshire, The Alderney, The Brittany, The Suffolk, Welsh Breed of Black Cattle, The Kerry, 188, 189; Flesh-producing Breeds: The Shorthorn, The Hereford (Figure of, 228), The Devon, The Sussex, The West Highland or Kyloe (Figure of, 229), The Galloway, The Angus, Peculiarities of a Good Milking Cow, Rules for Breeding for the Growth of Beef, Ditto for Milking Stock, 228—230; The Housing, Feeding, and Management of Dairy Cows, 309, 310; Figure, 309.
 Cauliflowers, 65, 138, 139, 149.
 — and Broccoli, Season and Dressing of, 183.
 — and Cheese, Dressing of, 183.
 Ceilings, 19.
 Celery, 139, 149, 183; (November), 190, 191; (December), 272.
 —, Planting of, 174; Earthing of, 175.
 —, Stewed Brown, 183.
 —, Stewed White, 183.
 Cement, *see* Liquid Glue.
 — for Mending Broken Vessels, How to Make, 190.
 —, Cheese, How to Make, 255.
 —, Cheese (for Mending China), How to Make, 284.
 Centre-bit, Figure and Description of, 16.
 Cesspools, 247.
 Chafings of Infants, 71.
 Chairs, Particulars of, 126.
 —, How to Make Cushions, Coverings, &c., for, 377.
 Chameleon Top, 191, 192.
 Chapped Hands and Lips, Cures for, 124.
 "Characters," Giving, 14.
 Charades, Acted, Particulars of, with a List of Words, 320.
 Charades, Words, with Acting and Illustrations, 347—349.
 —, Pantomime, 349.
 Cheese, 160.
 Cheesecakes, Orange, How to Make, 234.
 Chemicals, Injuries from, Particulars and Treatment of, 154.
CHEMISTRY, HOUSEHOLD.—Introduction, 338; Food: Why is Food Required? Different Functions of Food, Work done by the Body, Classification of Food, Flesh-formers, Heat-producers, Gelatin, 338—340.
 Cherry Trees, 109.
 Chicken Broths, *see* Broths.
 Chicken-pox, Particulars and Treatment of, 271.
 Chickens, Directions for Hatching, 95, 96; Rearing and Fattening of, 145—147; Figures of Coops and Shed for, 145; Fattening of, 168; Killing of, *ib.*; Plucking of, *ib.*
 Chiffonier, Full Particulars of, 126.
 Chilblains, Cause, Particulars, and Treatment of, 123.
 Child, *see* Parent and Child.
 Children, Diet for, 4; Mastication of Food, *ib.*
 —, Dietary in Early Childhood, 314, 315.
 —, Diseases Incidental to, 83, 84.
 —, Diarrhoea of, 83, 84.
 —, Duties to Parents, 36.
 —, Exercise for, 242, 243.
 —, Feeding, Clothing, and Training (*Introduction*), 2.
CHILDREN, THE REARING AND MANAGEMENT OF.—The Mother and Baby, 10, 11; Clothing for Infants, 33—35, 88—90; The Nursery, 110, 111; Children's Clothing, 116—119; Sleep, 142, 143; Children's Clothing (*continued*), 177—179, 236—238; Exercise, 242, 243; Food in Infancy, 270, 271; Children's Clothing (*continued*), 291—294; Dietary in Early Childhood, 314, 315; Children's Clothing (*continued*), 331—334; Dietary of Youth, 343, 354, 355; Clothing for Children of Six Years, 369—371.
 Children, Rickety, Recipe for, 11.
 Children's Clothing, 116—119 (*see* Baby's, Babies'); Short-coating the Baby, Particulars of Young Children's Clothing, with Figures, 177—179; Chemises, Short-coat Stay, Little Boy's Shirt, Stay-body, Drawers, Flannel Petticoat, White Petticoats, with Full Particulars of the Proper Materials, How to Cut Out, Make, &c., and exemplified by Figures, 236—238; Pelisse and Cape, To Cut a Cape, 291, 292; The Pelisse, 292, 293; To Make up the Pelisse, 293; Lining of the Cape, *ib.*; Trimmings, *ib.*; Material for, 294; Figures, 292, 293; Jackets, 294; Pinafores, *ib.*; Day Frocks, *ib.*; Materials, *ib.*; Night-gowns, Frocks, 331.—Clothing for Children of Six Years: Shirt, Drawers (for Boys), Stay Bodice, Flannel Petticoat, White Petticoat, Frocks (for Girls), with Illustrations, 332—334; Garibaldi Suits (for Girls), Mantua-makers' Seams, For the Sleeve, Out-door Jacket, Tunics, Waistcoat, Jacket, Sleeve, Coat, with Illustrations, 369—371.
 Chimney-glass, Particulars of, 126.
 China, To Mend, 190.
 — Roses, Culture of, 81.
 Chinese Primrose, Propagation of, 81.
 Chintz Window-curtains, 350.
 Chisels, 16; Sharpening of, *ib.*
 —, Common, Figure and Description, 16.
 —, Mortice, Figure and Description of, 16.
 — Paring, Description of, 16.
 Chops and Steaks, 4; Cooking of, 5.
 Christening Robe, Making of, 119; Figure of, 117.
 Christmas Decorations of the Home, Materials to be used, and how to use them, with Figures of Designs, 97, 98.
 — Dinner (Ancient), 151.
 — Fare, History and Particulars of, 150, 151.
 — Boxes, History of, 151.
 — Tree, History of, 151.
 Chrysanthemums, 60; *see* Pompon Chrysanthemums.
 Cinder-sifting, 305.
 Cisterns, 163.
 Citizenship, Rights of.—Electoral Rights: Franchise, Distribution of Seats, Supplementary Provisions, Freedom of Conscience, Freedom of Speech, 230, 231.
 Clams, Various Modes of Dressing, 182.
 Clerks, Governesses, or others, holding posts not menial, Term of Notice, &c., 13.
 Clothes-brushing, 306.
 Clothing, &c., 23, 38; *see* Children's Clothing.
 — for Children; *see* Children.
 Coals, 160.
 Cochon China Fowls, *see* Fowls.
 Cockles, 134.
 Cockscomb, 82.
 Cod, How to Carve, 256; Figure, *ib.*
 Cod-fish, Sauce for, 68.
 Cod's Head and Shoulders (Coloured Plate), 193.
 — Heads, Particulars of, 68; Sauces for, 68.
COFFEE MAKING, 294, 295.
 Colds, Precautions against, 284.
 Colour, Loss of, 42.
 Comforts, *see* Home Comforts.
 Comical Combinations (a Game), 320; Figure, *ib.*
 Compass-saw, its Uses, 49.
 Conger-eels, Serving of, 256.
 Conger; *see* Eels.
 Conifers, 109.
 Concussion of the Brain, Treatment of, 53.
 Contusions, *see* Bruises.
 Convolvulus, 82.
 — Major, 113.
 Convulsions, 83; Diagnosis, *ib.*; Causes, *ib.*; Treatment, *ib.*
 Cook, her Position and Duties, 170; Judicious Engagement of, *ib.*; Kitchen Fire, *ib.*; Roasting, 170, 171; Gravies, 171; Poultry, *ib.*; Boiling, *ib.*; Boiling of Fish, *ib.*; Frying of Fish, *ib.*; Broiling, *ib.*; Making of Pastry, Sauces, Gravies, and Soups, 171, 172.
COOKING (*Introduction*), 2, 19, Plain, 172.
 —, Plain Cookery—General Remarks, How to Cook, &c., 4, 5; Simple Recipes, 5, 6, 27, 28, 30, 37, 53—55; Puddings, Cakes, Fritters, Fish, 66—68; Fish, 86, 87; Soups and Meat Dishes at moderate cost, 103, 104; Meat Dishes at moderate cost—Sheep's Trotters, Sheep's Feet Pâté (French), Pigs' Feet, Calf's Liver (Stewed), Sliced Calf's or Sheep's Liver (Fried), Calf's Liver

- Cheese, Bullock's Heart à la Mode, Bullock's Kidney, Tripe (Normandy fashion), Stewed Tripe, Tripe à la Lyonnaise, Neat's Foot or Cow Heel, Neat's Foot with Parsley Sauce, Breast of Pork with Rice, 119, 120; Calf's Check, Sheep's Head, Fried Fowl, Boiled Fowl, Fowl Stewed with Rice, Ends of the Ribs or Breast of Beef Stewed with Vegetables, 139, 140; The Cheaper Shell-fish—The Common Limpet, Periwinkles, Whelks, Mussels and Rice, Husted Mussels (Plain), Pickled Mussels, 140; Christmas Fare, 166, 167; Hot Dishes easily served at short notice, 167; Shell-fish, 181, 182; Vegetables, 182, 183; Mushrooms and Pickles, 195, 196; Pickles (*continued*), 219; Preserves, 219—221; Kitchen Requisites, Miscellaneous Recipes, 232—235; Broths, 253—255; Broths and Soups, 258—261; Fish Soups (*continued*), Miscellaneous Soups, Invalid Broths and Beverages, 282—284; Soups and Purées, 304; Soups (*continued*), 310, 311; River Fish, 322—325; 340—343; 364—366; Calf's Head, 376, 377.
- Coopers' Awls, 16.
Copper Beech, 109.
Coral-stitch, 118; Figure of, 117.
Corn Bread, American, Recipe for, 190.
Corns (Soft and Hard), Causes of, Remedies and Cures for, 124.
Cornwall, Coast of, 134.
CORRESPONDENCE, *see* Ways and Means.
Cosmetics, *see* Skin Cosmetics.
Cottage Farm (*Introduction*), 2.
— Buildings, 301, 302.
COTTAGE FARMING (*Introduction*), 2; *see* Farming.
Couches, 127.
Counterpanes, *see* Patchwork.
—, *see* Quilts.
Countersink-bit, Figure, and Description of, 16.
Court-bouillon, 323, 341.
Courtiers, The, (a game,) Particulars of, 159.
Cows, *see* Cattle.
Crab, Figure of, 133.
Crabs, 133, 134, 161.
Cranes, 150.
Crocuses, Cultivation of, 81.
Cropping, Four, Five, Six, and Seven Course Shift of, 329.
Crops, Succession of, 328.
Cross-cut Saw, 43; Figure of, *ib.*
Croup and Nervous Croup, Diagnosis and Treatment of, 115.
—, False or Nervous (Child-croup), Diagnosis and Treatment of, 115.
—, *see* Bronchitis.
Crumpets, Making of, &c., 28.
Cucumber Frames, 15.
Cucumbers, Pickled, *see* Pickled.
Culinary Utensils, Necessary, 5
— Vessels, 5.
Currants, 65.
Currant Trees, 109.
— Jelly, Directions for Making, 221.
Curry, Ratatouille, 255.
Curtain Poles, 15.
Curtains, Particulars of, 208; Figure of Rod and Fixings, *ib.*; Particulars and Uses of, 362.
Cuttings, 114.
Cuts, 9 (*see* also Wounds); in the Ball of the Thumb, *ib.*; Mode of Bandaging, 9, 10; Cuts about the Face, Use of Collodion, Court-plaster, Stitches of Silk, &c., 29.
Cypress, 109.
- D.
- Damson or Bullace Cheese, Directions for Making, 221.
Damson Drops, Recipe for Making, 291.
Dandriff or Scurfiness, Particulars of, and Cures for, 70.
Daphne, Cultivation of, 81.
Deal, Yellow, Particulars and Uses of, 78.
DECORATIVE ART, HOUSEHOLD.—Leather Work, 39—41, 57, 58; Diaphanie, 92, 93; Christmas Decorations of the Home, 97, 98; Recreations for Long Evenings, 129, 130; to Imitate Busts and Statuettes in Marble, by means of Wax, 164, 165; Coloured Transparencies, 165; Paper Flower Making, 193—195, 264—266; Feather Screens, 289—291; Modelling in Clay for Amateurs, 315—317; Feather Screens (*continued*), 321, 322; Modelling in Clay for Amateurs (*continued*), 345, 346, 353, 354.
Dentition, 83.
Deodar, 109.
Depilatories, Recipes for Making, 366, 367.
Dessert, Setting of the Table; *see* Dinner Tables.
Devonshire, Coast of, 134.
Diaphanie, Full Description of, and Rules for, accompanied by Figures, 92, 93.
Diarrhoea, 83.
— of very Young Children, Particulars and Treatment of, 83, 84.
— of Teething Children, Directions, and Treatment of, 84.
—, Inflammatory, Description of, 84.
Dibbler or Dibble (two kinds), Uses of, 149; Figures of, *ib.*
Dietary of Youth, *see* Youth.
Dinners, French, Serving of, 372.
— Courses, 372.
DINNER-TABLE, HINTS ON ARRANGING, 114.
DINNER-TABLES, THE DRESSING OF, &c., 371, 372.
— in the Russian Mode, 372.
Diseases, Common, Alphabetical List of Diseases for Treating of in the HOUSEHOLD GUIDE, 303.
Dish-covers, 19, 20.
Dishes, Hot, Easily Served at Short Notice, 167.
Dislocations, Particulars of, 73; Figure, *ib.*
DOG, THE, Origin and Principal Varieties, 11—13; Rearing and Feeding of, 12.
—, Arctic, 11.
—, Esquimaux, 11.
—, Terriers, 12, 13.
—, Bull-terrier, 12, 13; Figure of, 12.
—, English Terrier, 12.
—, Black-and-tan Smooth Terrier, 12.
—, Scotch or Rough Terrier, 12; Figure of, *ib.*
—, Broken-haired Terrier, 12.
—, Skye, 12.
—, "Dandie Dinmont," 12.
—, Poodle, "Clever Dog," 13.
—, Poodle, French, 13.
—, Principal Varieties (*continued*), 60—62.
—, English Mastiff, Particulars of, 60; Figure of, 61.
—, Bull-dog, Origin and Particulars of, 60, 61.
- Dog, Bloodhound, Description of, 61.
—, St. Bernard, Description of, 61.
—, Newfoundland, Particulars of, 61, 62; Figure of, 61.
—, Labrador, the, Description of, 62.
—, Spaniels and Retrievers, 62.
—, Principal Varieties (*continued*), 76, 77.
—, Water Spaniel, Description of, 76.
—, Setter, Particulars of, 76.
—, King Charles and Blenheim Spaniels, 76.
—, Retriever, Particulars of, 76.
—, Pointer, Particulars of, 76; Figure, *ib.*
—, Greyhound, History and Particulars of, 76, 77; Figure of, 76.
—, Hounds, History and Particulars of, 77.
—, Sheep-dogs, Description of, 77.
—, Dalmatian or Carriage Dog, The, 77.
—, Training of, 106—109.
—, Newfoundland, Training of, 106.
—, Sheep-dog, Training of, 106, 107.
—, Pointers, Training of, 107, 108.
—, Setter, Training of, 108.
—, Retriever, Training of, 108.
—, Spaniels, Training of, 108.
—, Sporting Dogs, Training of, 108, 109.
—, Scotch Collie, Figure of, 108.
—, Greyhounds, Training for Coursing, 109.
—, Training for Performance, 109.
—, Feeding and General Management—Lodging, 204; Figure of a Kennel, 205; Feeding, 204, 205; Washing and General Treatment, 205.
—, Diseases of, 266, 267; Rearing of Pups, 266.
—, Diseases of (*continued*)—Affections of the Eyes, Fits, Rabies or Hydrophobia, their Causes and Treatment, 308.
—, Diseases of (*continued*)—Mange, Canker of the Ear, &c., 358, 359.
Dog's Licence, 131.
Domestic Comfort (*Introduction*), 1.
DOMESTIC MEDICINE, *see* MEDICINE.
Domestic Servants and their Duties, 102, 103; Causes of Vexations and Disappointments, 102; Education as a Corrective, *ib.*; High Wages as a Means to Procure Efficient Service, Fallacy of, *ib.*; Extras, *ib.*; Beer Money, *ib.*; Perquisites, *ib.*; Remnants of Food and Clothes, Disposal of, *ib.*; Followers, *ib.*; Holidays, Going to Church, 103; Dress, *ib.*; Caps and White Aprons, *ib.*
DOMESTIC SURGERY, *see* SURGERY.
Door-locks, 15.
Doors, Particulars of Making, with Figures, 128.
Dorset, Coast of, 134.
Dove-tailing, 85, 86; Dove-tail Joint, Figure of, 85.
Drainage—Construction of House Drains, Size of Drains, Fall, Traps, Ventilation of Drains, Inspection of Drains, Three Conditions with regard to, (with Illustrations), 247—250.
— of Grass Land, *see* Grass Land.
— of Roads, 93.
Drains, 109.
—, *see* Drainage.
Draughts, Stopping of, 312.
Drawers, Chests of, 157.
Drills, 16.
Drooping Plants, 113.
Drowning, Treatment of, 111; Figures, 112.
Ducks, Keeping of, 169; Breeds, *ib.*
Dumpling, *see* Sausage Dumpling.
Dumplings, Light, Steamed, 27.

Dumplings, Light, Boiled, 27.
 —, Light, Sauce for, *see* Matrimony Sauce.
 —, Hard or Suffolk, 27.
 —, Drop, Making of, 27.
 —, Suet (highly recommended), the Making of, 53, 54.
 —, Plum, How to Make, 54.
 —, Apple, the Making of, 55.
 Dusting, 222.
 DYEING, A FEW WORDS ABOUT, 360, 361.

E.

Easy Chairs, Particulars and Prices of, 126;
 Figure of, *ib.*
 Economy in the Household—Domestic and Social, 1.
 Eel, Mayonnaise of, How to Make, 365.
 — Pie (Conger), 67.
 — Roasted in the Ashes, 364, 365.
 Eels, Cooking of, 67.
 —, Potted, 67.
 —, Collared, 67.
 —, Large Conger, Roasted, 68.
 —, Serving of, 256.
 —, 342, 343.
 —, Stewed with Sorrel, 342.
 —, Tartar, Dressing, 365.
 Egg Balls, Making of, 304.
 Eggs, 122.
 Electoral Rights, 230, 231.
 Employers, Duties of, to Servants, 13, 14;
see Characters.
 Endive, 65, 149, 191.
 Epping Sausages, *see* Sausages.
 Eruptions, Diagnosis and Treatment of, 70, 71.
 — of the Soles of the Feet, 71.
 —, Discharging, Treatment of, 123.
 Evening Recreations—Screen-making, Albums, 129, 130.
 Evergreens, 60.
 —, Dwarf Potted, 60.
 Everton Toffy, How to Make, 234.
 Executors, 91.
 Expenditure, *see* Income.
 Eye, Dust in the, Treatment of, 154, 155.
 —, Cold in the, &c., Causes and Treatment, 252.
 —, Sty in the, Causes and Treatment, 252.

F.

Fainting, Treatment of, 111.
 False or Nervous Croup, *see* Croup.
 — Teeth, *see* Teeth.
 Farm, Cottage (*Introduction*), 2.
 FARMING, COTTAGE (*Introduction*), 2;
 Drainage, 25—27 (*see* Grass Land);
 Drainage, Levelling, Claying Peaty,
 Open, Porous, Gravelly, and Sandy
 Lands, Chalking and Marling, Liming,
 Fencing, Liquid Manure, Irrigation,
 Warping, 93, 94; Manuring of Grass
 Lands, Liquid Manure Cart, 152; on
 the Grasses best adapted for Meadow
 and Pasturage, 153, 154; Grasses
 adapted for a Cottage Farm, 209;
 Manures, 209—211; Housing Hay,
 Fencing, 276, 277; Fencing (*continued*),
 300, 301; Arable Husbandry,
 Cottage Farm Buildings, 301; Arable
 Husbandry (*continued*), 327, 329, 344,
 345.
 Feather Beds, 156; Particulars and Prices,
 286.
 — Mats, How to Make, 362.

Feather Screens, Particulars of Making,
 with Illustrations, 289—291, 321, 322.
 Feeding-bottles, 11.
 Fencing—Stubbing out of Old or Super-
 fluous Hedges, 276, 277; Planting of
 Thorn or Quick Hedges, with Figures,
 277; Young Hedges, Beech and Horn-
 beam Hedges, Thorn Hedges (renewing
 or renovating of), Subdivision Fences,
 300, 301; Figure, 301.
 Fenders, 126.
 —, Velvet, Making of, 361; Figure, *ib.*
 Ferns—Maidenhair, Hart's-tongue, Spleen-
 wort, Lady Fern, 113.
 Fever, Symptoms of, 41.
 —, Scarlet, Vomiting a Symptom of, 42.
 Fevers, Eruptive, 83, 215.
 —, Eruptive, Scarlet Fever or Scarlatina,
 Measles, Vaccination, and Small-pox,
 186, 187.
 —, Relapsing, Diagnosis, Symptoms and
 Treatment, 226.
 —, Typhoid, and Typhus, and Infantile
 Intermittent, 215, 216.
 Files and Rasps, Description of, 23.
 Fillisters, 42.
 Fine-herb Sauce, How to Make, 377.
 Finger Plates, 126.
 Fire-irons, 126.
 Fish, 67, 68.
 —, Cooking of, 86, 87.
 —, Seasonable (December), 111.
 —, Seasonable (January), 148.
 —, Boiled, 167.
 —, Fried, 167.
 —, Broiled, 167.
 —, Boiling and Frying of, 171.
 —, Seasonable (February), 235.
 —, Carving of, 256; Figures, *ib.*
 —, Seasonable (March), 284.
 —, River—The Carp, Figure, 341; Carp
 Stewed whole, Stewed Tench, Boiled
 Tench, Perch, the Mariner's Matelote,
 Bream and Roach, Pike Boiled whole,
 Stuffing for Pike, Pike Baked whole,
 Eel Stewed with Sorrel, D.B., 340—
 343; Eel Roasted in the Ashes, Tartar
 Sauce, Sauce Robert, Tartar Eels or
à la Tartare, Mayonnaise of Eel,
 Mayonnaise Sauce, Grey Mullet, Shrimp
 Sauce, Whitebait, Figure of, 365, 366.
 —, River, Boiling of, 322, 323.
 —, Sauce, *see* Sauce.
 —, Soups, *see* Soups.
 Flat Foot, Causes and Treatment, 201;
 Figure of, *ib.*
 Flesh, Loss of, 42.
 Flour, *see* Bread.
 — Pudding (Dr. Dobell's), *see* Pudding.
 Flower-garden, 109.
 Flowering Plants, 65.
 Food, its Functions, &c., *see* Chemistry,
 Household.
 FOOD, SEASONABLE (December), 111;
 (January), 148; (February), 235;
 (March), 284.
 Forecmeat Balls, Making of, 304.
 Forfeits, Game of, 163, 164; List of, for
 a Gentleman, 202, 203; List of, for a
 Lady, 203.
 Forget-me-not, 82.
 Foreign Bodies introduced into Various
 Parts of the Body, 154.
 — introduced into the Nose or Ear,
 Treatment, 155.
 — in the Wind-pipe, Particulars and
 Treatment, 155.
 — in the Gullet, Particulars and Treat-
 ment, 155.

Foreign Bodies introduced (as Coins, Pins,
 Needles, &c.) into the Stomach, Treat-
 ment, 155.
 Fork, Digging, Uses of, 137; Figure of, 136.
 —, Small Weeding, Uses of, 137; Figure,
 136.
 Fowl, Boiled, and Rice, 255.
 —, Fried, Dressing and Serving of, 139,
 140.
 —, Boiled, Dressing and Serving of, 140.
 —, Stewed with Rice, Dressing and Serv-
 ing of, 140.
 Fowl-houses, 15, 30—32; Construction of,
 31; Figure of, 32.
 — Run, 31, 32.
 Fowls, Keeping of, 30—32.
 —, Cochins or Brahmas, 32.
 —, Adult, Feeding and General Manage-
 ment of, 46—48; Figure of a Feeding-
 dish, 47; Figure of Cover to ditto, 48;
 Figure of Drinking-fountain, 48.
 —, 95, 96.
 —, Cochins, 95.
 —, Brahmas, 95.
 —, Dorkings, 95; Figure of, 96.
 —, Game, 95, 96.
 —, Hatching Nest, 121; Attention to
 Eggs and Hens Sitting, *ib.*; Figure,
 122; Number of Eggs to Set, 121;
 Time of Hatching, 122; Cleanliness,
ib.; Eggs, *ib.*; Profit, *ib.*; Feeding of,
ib.; Cost, *ib.*
 —, Cochin China, White, Figure, 121.
 —, Loss of Feathers, Causes of, 218.
 —, Roup, Causes and Treatment of, 218.
 —, Diarrhoea, Causes and Treatment of,
 218.
 —, Soft Eggs, Causes of, 218.
 —, Insect Vermin, Causes and Cure of,
 218.
 —, Cure for Disease, 219.
 Fractures, Particulars of, 71, 72.
 Frames, 65, 66.
 Frame (One Light), 66; Figure, 65.
 France, Culinary Art in, 5.
 Franchise, 230.
 Frankland, Professor, 163.
 Freckles, *see* Skin, Discoloration of the.
 Freedom of Conscience, 231
 — of Speech, 231.
 French Bean, *see* Bean.
 — Revolution, 130.
 — Rolls, Making of, 234.
 — Use of Bread, 5.
 Fritters, 167.
 —, *see* Apple, Parsnip, Peach, and Turnip
 Fritters.
 Frog, Development of the, Figures, 69.
 Frog-bit (*Hydrocharis morsus-ranæ*), 63;
 Figure of, *ib.*
 Frost-bite, Particulars and Treatment of,
 154.
 Fruit Trees, Aged, Dressing of, 109.
 Fruits, Seasonable (December), 111.
 —, Seasonable (January), 148.
 —, Seasonable (February), 235.
 —, Seasonable (March), 284.
 Frumenty, 150.
 —, How to Make, 235.
 Frying, 171.
 Fuchsia, 82; Propagation, Culture, and
 Training of, *ib.*; Figure of, 81.
 Fuchsias, 66, 109, 114.
 Fuel, 5.
 Furmenty, *see* Frumenty
 FURNITURE (*Introduction*), 1; General
 Remarks, 18.
 —, The General Furniture of the House,
 125—127.

Furniture, Bedroom Furniture, 155—157.
 —, General Particulars of, 183—185; Figures of, 184, 185.
 —, Bedroom Furniture, Full Description of Bedsteads, Four-post Bedsteads, and other Bedroom Furniture, with Illustrations, 243—246.
 —, Bedroom Furniture, 285, 286.
 —, The Bedroom, 346, 347.
 —, Hiring of, 312, 313.
 —, Brokers', 362.
 —, Polish for, Making of, 230.

G.

Gall-stones, Symptoms, Treatment, &c., 351.
 Game, Seasonable (December), 111.
 — (January), 148.
 — (February), 235.
 — (March), 284.
 Games—Impromptu Romance, 251.
 Garden, The (Introduction), 2.
 —, Advantages of, 4.
 —, Small Suburban, 58—60; Primary Operations, 58; Laying out of, 58, 59; Figures of Designs for, 59; Formation of Garden Paths, 59; Borders or Edging, 59, 60.
 Gardens, Small, the Cultivation of, 65, 66.
 —, Small, Laying out of, 65; Figure, *ib.*
 —, Laying out of, 109; Figure, *ib.*
 Garden, Small, Rotation Cropping of, 138, 139.
 — Operations for January, 138.
 — for February, 138.
 — for March, 138.
 — for April, 138.
 — for May, 138, 139.
 — for June, 139.
 — for July, 149.
 — for August, 174.
 — for September, 174.
 — for October, 174, 175.
 — for November, 190.
 — for December, 65, 66; Calendar for December, 109, 110.
 —, *see* Vegetable Garden.
 —, Profit on [Correspondent], 106.

GARDENING, HOME, 20; TOWN—Conditions of, *ib.*; Selection of Plants, *ib.*; Cleanliness, *ib.*; The Soil, and How to Improve it, 20, 21; Aspect of the Ground, 21; Walls and Fences, *ib.*; Laying out the Garden, *ib.*; Succession of Plants, *ib.*; The Small Suburban Garden—Formation of Garden Paths, Gardening Operations for November, 58—60; The Cultivation of Small Gardens, Gardening Operations for December, 65, 66; Gardening Calendar for December, 109, 110; The Tool-house, Rotation Cropping of a Small Garden, 136—139; The Tool-house (*continued*), 148, 149; Rotation Cropping of a Small Garden (*continued*), 149, 174, 175, 190, 191; The Vegetable Garden, 223, 224, 239, 240, 246, 247; Rotation Cropping (*continued*)—Operations for December, 271; The Vegetable Garden, 377, 379, 287, 288, 330, 331, 355, 356.
 —, WINDOW (*Introduction*), 2; The Window Garden, 43—45; Pots, Zinc Boxes, Drainage of Boxes and Pots, Soil, &c., 44; Seedlings, 44, 45; Hanging-baskets, 45; Figures of, 44;

The Window Garden, 81, 82, 113, 114; Figure of Small Green-house, without Heating Apparatus, 113; Figure of ditto, with Heating Apparatus, *ib.*; Ferns, *ib.*; Drooping Plants, *ib.*; Bell-glasses, &c., *ib.*
 Garden Frame, 114.
 — Furniture and Decorations—Garden Chairs, Seats, and Tables, Tools for Constructing and the Construction of, Varnishing, &c., with Illustrations, 372, 373.
 Gas, General Remarks, 250; the Iron Service-pipes, Horizontal Pipes, Pendants, Brackets, Chandelier—its Water-chamber, &c., Ventilation, Burners, Regulators, &c., with Illustrations, 273, 274; for Heating Purposes, 299, 300.
 — Explosions, 15.
 Gas-meters, 300.
 Gases, Foul, Suspended Animation from, Treatment of, 112.
 Gâteau (French Country Cake), Making and Use of, 37.
 Gauge, Common Marking, Description and Use of, 24; Figure of, 23.
 —, Cutting, 24.
 —, Mortice, Description and Figure of, 24.
 Geese, Breeds of, 169, 170; Setting of, 170, Goslings, *ib.*; Feeding of, *ib.*; Fattening of, *ib.*
 George III., a Statute of, 14.
 Geraniums, Scarlet, 81, 82.
 —, 82, Propagation and Culture of, *ib.*
 —, Fancy or Dwarf, Culture of, 82.
 Germany, North, 6.
 Gherkins, Pickled, *see* Pickled.
 Gimlets and Augers, Description and Figures of, 23.
 Gingerbread, Making and Baking of, 27.
 —, Mrs. Smith's, Making of, 27.
 Ginger Drops, Recipe for Making, 291.
 Glass, Washing of, 222, 306.
 Glue, *see* Liquid Glue.
 Godfrey's Cordial, Particulars of, 284.
 Gold, Cleansing of, 284.
 GOLD AND SILVER MARKS (generally), 180; Hall Mark, *ib.*; Duty Mark, *ib.*; Standard Mark, *ib.*; Maker's Mark, *ib.*; Date Mark, *ib.*
 —, THE QUALITIES AND VALUES OF. With Tables, 279, 280.
 Golden Carp, *see* Carp.
 Goose, 150.
 —, Roast, Coloured Plate, 193.
 —, Carving of, 197; Figure of, *ib.*
 Gooseberries, 65.
 Gooseberry Jam (Ripe), Directions for Making, 220.
 — Trees, 109.
 Goslings, *see* Geese.
 Governesses, *see* Clerks.
 Gouges, 16; Sharpening of, *ib.*
 Grasses best Adapted for Meadow and Pasture, 153, 154; Figures of, 152, 153.
 — Adapted for a Cottage Farm, 209.
 Grass Land, 25, 26; Drainage of, 25—27; Figures of the Four Ways of Draining, *ib.*; Drainage Pipes, 26, 27; (Figures of, 25); Tapping, 26; Draining Springs, *ib.*
 —, General Management of, 152.
 —, Renovating of, 211.
 Grates, Cleaning of, 222.
 Gravies, 171.
 Grease, to Erase Stains of, 190.
 —, *see* Carpets.
 Greengage and Plum Jam, Directions for Making, 221.

Greenhouses, 15.
 —, Miniature, Figures of, 113, 114.
 Greens, Winter, 272.
 Gregory's Powder, Making of, 230.
 Grey Mullet, *see* Mullet.
 Greyness, Treatment, &c., of, 367, 368.
 Gridiron, Figure of, 4, 5.
 Gruel, Making of, 284.
 Gudgeon, The, 69.
 Guinea-fowl, Directions for Keeping and Rearing, 218.
 Gums, Lancing of, 172; Figure of, 173; Figure of Lancet, 173.
 — and Teeth, Particulars of, 172; Figure of, 173.
 Gunpowder Accidents, Particulars and Treatment of, 154.
 Gun-shot Injuries, Particulars and Treatment of, 154.
 GUTTA-PERCHA FOR MENDING SHOES, 214.

H.

Hæmorrhage, 9, 10.
 Hair, The, and its Management, with Figures, 241, 242, 274, 275; Washing, 275; Brushing, *ib.*; Cutting, *ib.*; Curling, *ib.*; Pomades, 275, 276; Recipes for Making, 276; Disorders of, and their Treatment; Hair-washes (Recipes, how to make); Hair in Unusual Situations, or Superfluous Hair (Depilatories, how to make); Changes in the Colour of the Hair, including Blanching and Greyness, 366—368; Disorders of, and their Treatment (*continued*), 379, 380; Thinning and Loss of, 380.
 Hair-dyes, 379, 380.
 Hair-washes, Recipes for Making, 366.
 Half-rip-saw, 43.
 Hall or Passage Furniture, &c., 125.
 Ham, Carving of, 143; Figure of, 144; Coloured Plate, 193; Particulars for Marketing, 336.
 Hammer, Ordinary Claw, Figure of, 24.
 —, Tang, Figure of, 24.
 —, Smith's Chipping, Figure of, 24.
 — for the Garden, Description of, 137.
 Hammers and Mallets, 24.
 Hand-saws, Plain, 43.
 Hanging, Treatment of, 112.
 Hanging-basket, 113; Plants for, *ib.*
 Hare, How to Carve, 79; Figure, 80.
 Haricot Mutton, Directions, 104.
 Hay-barn, 211.
 Hay Harvest, Particulars, 211.
 —, Housing of; Stack Stands; Dutch Hay Barns (Figure of, 277), The Modern English Hay-barn, 276.
 — Stack and Rick-cloth, Figure of, 209.
 Hayes' "Arctic Boat Journey," 11.
 Health, Board of, 163.
 Heat, Artificial, for Plants, *see* Plants.
 Heaths, Culture of, 81.
 Hedges, *see* Fencing.
 Heliotropes, 113.
 Hens, *see* Fowls.
 Hermit, 133.
 Hernia, *see* Rupture.
 Herrings, Fresh, Broiled, Directions, 87.
 —, Siamese, Broiled as Twins, Directions, 87.
 —, Red, Directions for Dressing, 87.
 —, Pickled (French way), Directions, 86, 87.
 —, Serving of, 256.
 Hindoos, 5.

Hip Disease, Particulars of, 202.
 Hoe, 137; Figures of, 136.
 —, Dutch, Uses of, 148; Figure of, 149.
 —, Drill, Uses of, 148; Figure of, 149.
 Hollows, 42.
 HOME COMFORTS, SOME CHEAP.—Stopping Draughts, Mats, 312.
 Honeysuckle, 113.
 Hooping-cough, its Symptoms, various Forms, Complications, Effects, and Treatment; 226, 227.
 HORSE, THE.—Introduction, 295; Of the Different Breeds of Horses, *ib.*; The Horse in Scripture, *ib.*; Of Eastern Breeds—The Arabian, 295, 296; The Persian Horse, 296; the Turkoman, *ib.*; India—Native Breeds, *ib.*; Portrait of "Varna," a high-bred Arab, *ib.*; Portrait of the Head and Neck of the Godolphin Arabian, 297; Western Breeds (The Barb)—Egyptian Horses, 296; South and North American Horses, 297; European Horses—The Flemish, 297, 298; The Norman Horse, 298; The Hanoverian Horses, *ib.*; The Spanish Jennet, *ib.*; The British Horse, *ib.*; The Scotch Galloway, *ib.*; The Shetland, or Sheltie, *ib.*; The New Forest Pony, and the Exmoor or Devonshire Pony, *ib.*; The Welshman, 298, 299; English Horses—The Cart Horse, Lincolnshire and Clydesdale (London Dray Horse); Lighter Horses and their Adaptability to our Pursuits—Race-horse, High-class Hunter, Poor Man's Hunter, Hack, Harness Horse, Charger, Farmer's Horse, 325; Structure of the Horse—Head, Neck, Shoulders, Chest, &c., Back, Hind-quarters, Fore Legs, Foot, Hind Legs, Height, Colour, and Age, 325—327; Breeding and Breaking—Sire and Dam, Hereditary Ailments, Of Age, Management, Handling, Feeding, Breaking to Saddle, Lounging (Figure of Colt prepared for), Breaking to Harness, 374—376.
 Horse-radish, 109.
 HOUSE, THE, as a Building, a Possession, and a Home (*Introduction*), 1; Building or Improvement of, *ib.*
 —, Ways and Means, 2; As Determining the Respectability, Class, Credit, or Means of the Occupier, *ib.*; Ways and Means (*continued*), 38, 39; Life Assurance, 134—136; Water Supply, 162, 163; Life Assurance (*continued*), 179, 180, 198—200; Drainage, 247—250; Water Supply (*continued*), 257, 258, 317, 318, 351, 352.
 HOUSE, INMATES OF THE.—Law of Master (or Mistress) and Servant, 13, 14.
 —, —, LEGAL (*Introduction*), 2; Parent and Child, 35, 36; Law of Will-making, 90, 91; Rates and Taxes, 130—132, 206, 207; Rights of Citizenship, 230, 231.
 —, —, DOMESTIC (*Introduction*), 2; Domestic Servants and their Duties, 102, 103; the General Servant, 147, 148; the Cook, 170—172; the Housemaid, 221—223; the Parlourmaid, 268, 269; the Page, or Occasional Boy, 305, 306; the Lady's-maid, 363, 364.
 Household, as an Institution (*Introduction*), 1; Economy in, *ib.*; Management in the, *ib.*; Expenditure in, 2.

Household, Out-of-door Departments of, *Introduction*, 2.
 HOUSEHOLD GUIDE, The, *Introduction*, 1.
 Householders, Compound, Particulars of, *Résumé* of Act 32 & 33 Vict., cap. 41, 206, 207.
 House-hunting, Directions for Judicious Selection of a House, 99—101.
 Housekeeping, &c., 2, 3, 38.
 Housemaid, The, General Particulars and Duties of, Sweeping and Dusting, Dusting, Scrubbing, Cleaning of Grates, Brass and Copper, Ormolu, Lacquered Work, Marble, Washing of Glass, cleaning of Oil-cloth, Paint, Paper-hangings, Stone Staircases, 221—223.
 Housemaid's Knee, Description and Treatment of, 202; Figure of, 201.
 House-tax, or Duty; Particulars of, 130, 131; Table showing, 132.
 Hyacinths, 60; Cultivation of, 81, 82; Figure of Ornamental Box, *ib.*; Cultivation of, 191; Potting of, *ib.*; in Glasses, *ib.*
 Hyposulphite of Soda, a Hint for the Laundry, 299.

I.

Income of £1 per week [*Correspondent*], Table of Expenditure, 106.
 —, £150 per annum, Expenditure of, 38, 39; Tables, Yearly and Weekly, 38.
 — (*Introduction*), 1; Surplus, *ib.*
 — Tables * for Expenditure, Yearly, Weekly, Daily, and Monthly—£100 per Annum, 3.
 —, £200 per Annum, 3.
 —, £300 per Annum, 3.
 —, £400 per Annum, 3.
 —, £500 per Annum, 3.
 —, £150 per Annum (*Future Article*), 3.
 INCOME TABLE, *see* WAGES AND INCOME TABLE.
 — Tax, 130; Particulars of, 131.
 Indian Pink, 82.
 India-rubber Varnish for Boots, Making of, 230.
 Infancy, Food in, 270, 271; the Period of Weaning, *ib.*; Feeding-bottles, *ib.*
 Infants, *see* Babies.
 Infants, Clothing for, 33—35, 88—90; *see* Baby's; Exercise not Desirable for, 242; Red Gum, Red Gown or Tooth Rash, Particulars of and Remedies for, 70; Sleeping of, 142, 143; Bedding, and Arrangement of the Bed, 143.
 Inflammation, Symptoms of, 41.
 Ink, to Erase Stains of, 190.
 —, Red, Making of, 230.
 —, Violet, Making of, 230.
 —, Black, Making of, 230.
 —, Solid, Recipe for, 284.
 Inlaying, 223.
 Insurance, Life and Fire, Advantages of, &c., 39.
 —, *see* Assurance.
 — Policies, Table of Duties Chargeable upon, 207.
 Intestacy, Administration, 91.
 Intoxication, Treatment of, 112.
 Iron Pipes, How to Preserve, 255.
 Itch, The, Diagnosis and Treatment, &c., 158; Figure of the Itch Insect, *ib.*

J.

Jam, Making of, *see* under the respective heads of Sorts.

Jaundice, Particulars, Causes, and Treatment, 350, 351.
 Jelly, *see* Apple Jelly, Currant Jelly, Orange Apple Jelly.
 John Dory, How to Carve, 256.
 Johnson, Dr., 130.
 Joints, 78; Figure of a Cross-joint, 77, 84—86; Figures, 85; *see* Dovetailing.
 Jonquils, Cultivation of, 81.

K.

Kale, Particulars of the Many Sorts, 378, 379.
 Keyhole-saw, 43.
 Kidderminster Carpets, 126.
 Kidney Beans, 149, 174.
 Kitchen Garden, *see* Vegetable Garden.
 — Range, 5; Figure of, 4.
 — Requisites, 19, 232—234; Figures of, 232, 233.
 — Ranges, 19, 20.
 — Cupboards, 19.
 — Furniture, 20.
 Knife-cleaning, 306; Figures, 305, 306.
 Knock Knees, Treatment, &c., of, 202.

L.

Lace, *see* Point Lace.
 Lacquered Work, Cleaning of, 222.
 Ladder, Uses of, 137; Figure of, 4.
 Lady's-maid, The, Duties of, &c., 363, 364.
 Lamb, Particulars for Marketing, 336; Figure, *ib.*
 —, Fore-quarter of, Coloured Plate, 193; Carving of, 198; Figure of, 197.
 Lamp-trimming, 306.
 Larch, Description and Uses of, 78.
 Laundry, a Hint for the, 299.
 Lawn, 109.
 Lead, Hints for the Household Uses of, 362.
 Leather Work, 39—41; Its Introduction into England, 39; Materials and Instruments for, *ib.*; Figure of a Veiner, 40; the Making of Leaves, 39, 40; the Making of Stems, 40; the Making of Berries, Grapes, Acorns, Filberts, &c., 40, 41; Branches, 41; Patterns for the Ivy and a Fern Frond, 41; Figures, 40; Oak Leaf, Figure of, 41; Stains and Varnishes, Mode of Using, &c., 41; Recipe for Preserving Leaves, 41; Making of Flowers or Fruit, 57; Camellias, *ib.*; Figures of, *ib.*; Dahlias, *ib.*; Figure of, *ib.*; White Lilies, *ib.*; Figure, *ib.*; Hops, *ib.*; Figure, *ib.*; in Constructing Fruit, 57, 58; How to Construct a Peach, *ib.*; Cherries, 58; Walnuts, *ib.*; Filberts, *ib.*; Figure, 57; Currants, 58; Strawberries, *ib.*; Raspberries and Mulberries, *ib.*; Wheat, *ib.*; How to Make Leather Figures, *ib.*; How to Make Beehives, *ib.*; Frames for Pictures and Mirrors, Brackets, Book-stands, &c., *ib.*
 Legacy and Succession Duty, Table, 207.
 Lemon Drops, Recipe for Making, 291.
 LETTER-WRITERS, HINTS TO, 79; How to Address, &c., 101, 207, 208; The Title of "Esquire," Heading and Concluding of Letters, 235; The General Principle for Addressing Persons of Distinction, bearing Academical Honours, &c., 267, 268; The Directing

or Addressing of Letters, British, Colonial, or Foreign, 335.
 Lettuces, 65, 109, 139, 149, 191, 272.
 Levels, 50; *see* Spirit-level.
 Lice, or Pediculi, Treatment of, 158, 159.
 Life Assurance, Full Particulars of, 74, 75; Principle of, 74; Credit of, *ib.*; Selection of an Office, 75; Bonuses, *ib.*; Loans, *ib.*; Particulars of, 134—136; Bonuses, 135, 136; Generally, 179; Publication of Accounts, *ib.*; Expenditure, 180; Amalgamations, *ib.*; Caution in the Acceptance of Risks, *ib.*; Safe Investment, *ib.*; Careful Management, *ib.*; Special Uses and Appliances of, 198, 199; Endowments to Children and Life Annuities, 199; Government Annuities, *ib.*; Bequeathing of Policies, *ib.*; Mortgaging of Policies, 200.
 Lily of the Valley, 82.
 Lime-wash, Making of, 223.
 Limpet, 132.
 — Shell, Acorn Barnacles on, Figure, 133.
 Limpets, Dressing of, 140.
 Liquids, How to Keep Warm, 299.
 Liquid Glee and Cement, How to Make 203, 223.
 Liquid Manure, *see* Manure.
 Liver, Complaints of the, *see* Biliousness
 Liver and Bacon, Fried, 119, 120.
 Liver, *see* Calfs, Sheeps.
 Liver Sauce, *see* Sauce.
 Loach, The, recommended, 69; Figure of, *ib.*
 Loaf, *see* Bread.
 Lobelia, 82, 113, 114.
 Lobster Sauce, 324.
 Locks and Door Fittings, Particulars of, 213, 214; Figures, 213.
 LODGERS, ADVICE TO, 211—213.
 Loin of Pork, *see* Pork.
 Looking-glass, Re-decorating of the Frame, 377.

M.

Macaroni Pudding, Directions for Making, 234.
 Mackerel, Plain Boiled, with Fennel Sauce, 68.
 —, Plain Broiled, How to Dress, 86.
 —, Potted, Directions, 86.
 —, Coloured Plate, 193.
 —, How to Carve, 256.
 Magic Bottles, The, 192.
 — Music (a game), 127.
 Mahogany, Particulars and Uses of, 78
 Mallets, *see* Hammers.
 Management, (*Introduction*), 1.
 Mantel-shelves, Making of Velvet Hangings for, &c., with Illustrations, 361.
 Manure, 109, 246, 247.
 —, Farm-yard, 327.
 —, Liquid, Carts and Barrows, 152, 327.
 —, Liquid, Tanks, 328; Figure of a Portable Pump, *ib.*
 —, Composts, Farm-yard Manure, Farm Sewage, Manure Pits, Dry-earth Compost and Sewage Tank combined, Top-dressings, Liquid Manuring, 209—211.
 Manuring, 138, 174.
 Marble, Cleaning of, 222.
 —, Polish for, Making of, 230.
 Mariner's Matelote, The, 341.
 MARKETING, 261; Mutton, Lamb, Pork, Bacon, Ham, Venison, 336.

Marquetry, Particulars, 223.
 Marrow, 103.
 Master (or Mistress) and Servant, 13, 14; *see* Employers; Characters, Responsibility and Non-responsibility for Acts of Servants, 14.
 Mats, 312; Figures, *ib.*
 —, *see* Feather Mats.
 Matelote, *see* Mariner's Matelote.
 Matrimony Sauce, 27.
 Mattresses, Stuffing of, 263; Particulars and Figure, 285.
 Mayonnaise Sauce, How to Make, 365.
 — of Eel, *see* Eel.
 Meadow, Grasses best Adapted for, 153, 154.
 Meadows, 209; Top-dressings, 210; Liquid Manuring, 210, 211.
 Measles, Diagnosis, 186, 187; Treatment, 187.
 Measures, Tables of, 160.
 Meat, 171.
 —, *see* Boiling of Meat.
 —, Seasonable (December), 111.
 —, Seasonable (January), 148.
 —, Seasonable (February), 235.
 —, Seasonable (March), 284.
 MECHANIC, THE HOUSEHOLD. — Introduction, The Tool-chest, 14—16; The Tool-chest, 23, 24, 42, 43, 49—51; Woods used in Household Carpentry, 77, 78; Joints, 84—86; The Carpenter's Bench, 101; Doors, 128; Windows, 140—142; Blinds, 175, 176; Bell-hanging, 180, 181; Curtains, 208; Locks and Door Fittings, 213, 214; Gas, 250, 273, 299, 300; Garden Furniture and Decorations, 372, 373.
 Medallions, 353, 354.
 Medical Men, 7.
 MEDICINE, DOMESTIC (*Introduction*), 2; General Remarks, 7, 8, 41, 42; Symptoms Justifying to Send for the Doctor, 41; Diseases Incidental to Children—Convulsions, Diarrhoea, 83, 84; Teething, Bronchitis and Diseases of the Breathing Apparatus, Croup and Nervous Croup, False or Nervous Croup (Child-crowling), 114, 115; Eruptive Fevers, 186, 187, 215; Typhoid and Typhus, and Infantile Intermittent Fevers, 215, 216; Relapsing Fever, Hooping Cough, Mumps, 226, 227; Chicken Pox, 271; Worms, Abscess, Ague, 302, 303; Apoplexy, Asthma, 318, 319; Biliousness and Bilious Attacks, 334, 335; Biliousness or Bilious Disorders, Including Jaundice, 350, 351; Bronchitis, 359, 360.
 Melted Butter, Making of, 324.
 Mesembryanthemum, 82.
 —, Trailing, 113.
 Messenger, The (a game), 127.
 Mignonette, Directions for Culture, 81, 82, 114.
 Mince Meat, for Mince Pies, Making of, 166.
 —, Old-fashioned, Making of, 167.
 —, or Bacon Pudding, Making of, 28.
 — Roll, 28.
 Mince Pies, Particulars of, 151.
 —, Making of, 167, *see* Mince Meat.
 —, Lemon, Making of, 234.
 —, Egg, Making of, 234.
 Minnow, Highly Recommended, Particulars of, 69.
 —, Disease of, 69.
 Mimulus, 82, 113.
 Mock Lobster Sauce, 324.

Mock Turtle Soup, *see* Soup.
 Modelling in Clay for Amateurs—General Remarks, Material, Tools, the First Lesson (with Figures), 315—317; Decorative Modelling: a Bracket, a Vase (with Illustrations), 345, 346; a Medallion (Illustration), a Bust (Illustrations), 353, 354.
 Moles and Mothers' Marks, Particulars and Treatment of, 124.
 Moss, 82.
 Mother and Baby, 10; when about to become a Mother, *ib.*; Nursing, *ib.*; Early Rising from Childbed, *ib.*; Diet, *ib.*
 — and Child, 36.
 Mothers' Marks, *see* Moles.
 Moths, 190.
 Moulding, Paste for Making of, 230.
 Mouldings, 42.
 Muffins, Making of, &c., 28.
 Mullet, Grey, Particulars and Dressing of, 365.
 Mumps, Particulars of and Treatment, 227.
 Mushroom, Broiled, Dressing of, 195.
 —, Stewed, Dressing and Serving of, 195.
 — Catchup, Making of, 195.
 — Toast, Making of, 195.
 —, Pickled, Making and Keeping of, 195.
 Mushrooms and Pickles, 195, 196.
 Musk, Directions for Culture, 81, 82.
 Mussels, 134.
 — and Rice (an Algerian Recipe), Dressing and Serving of, 140.
 —, Husted, Dressing and Serving of, 140.
 —, Pickled, Pickling of, &c., 140.
 —, Various Modes of Dressing, 181.
 Mustard Sauce, Making of, 324.
 Mutton, Leg of, 7; Carving of, *ib.*; Figures of, *ib.*
 —, Cold, Serving of, 7.
 —, Particulars for Marketing, 336; Figure, *ib.*
 —, Haricot, *see* Haricot.
 —, Neck of, Carving of, 143; Figure, 144.
 —, Loin of, Carving of, 143.
 —, Saddle of, Coloured Plate, 193.
 —, Carving of, 198; Figure of, 197.
 Myrtle, Culture of, 81.

N.

Nails, Common forms of, with Names, 51; Figures of, *ib.*
 Narcissus, Cultivation of, 81.
 Nasturtium, 113.
 —, Pickled, *see* Pickled.
 Navel, Started, Treatment, 286, 287.
 Neat's Foot or Cow Heel, Uses of, 120.
 —, with Parsley Sauce, Cooking and Serving of, 120.
 Nectarine, 109.
 Nemophila, 60, 82, 113.
 Nervous Croup, *see* False Croup.
 Nettle-rash, Diagnosis and Treatment, 158.
 Newt, the Common, Figure of, 69.
 Nipples, Sore or Chapped, Causes and Treatment, 157, 158, 253
 Nitrates, 163.
 Nose, Bleeding from the, Treatment of, 52.
 Nursery, Aspect of, 110; Part of the House, *ib.*; Furniture, *ib.*; Walls, *ib.*; Bedding, *ib.*; Fittings, *ib.*; Pictures, *ib.*; Carpet, *ib.*; Stove, *ib.*; Fenders, 110; Ventilation, 111.
 Nurses, 10.

O.

Oak, Particulars and Uses of, 78.
 Oatmeal Porridge, Making of, 234.
 Obedient Ball, The, 192.
 Oil-cloth, 125; Cleaning of, 222.
 Old Woman's Tooth (for cutting out grooves across the grain), Figure of, 42.
 Omelettes, Sweet, 167.
 Onions, 4, 65, 138; Thinning of, 139, 174.
 —, Pickled, Pickling of, 196.
 —, Stewed, 182.
 Opodeldoc, Recipe, 230.
 Orange Apple Jelly, Making, 220.
 Ormolu, Cleaning of, 222.
 Ornaments, Table and Other, How to Make, with Illustrations, 313.
 Ottomans, How to Construct, Cover, &c., 378; Figure, *ib.*
 Ox-tail Soup, *see* Soup.
 Oxidised Silver, *see* Silver.
 Oysters, Stewed, Dressing of, 182.

P.

Page, The, or Occasional Boy, His Duties, Dress, Cinder-sifting, Boot-cleaning (Figure), Knife-cleaning (Figures), Plate-cleaning, Window-cleaning, Trimming Lamps, Washing Glass, Brushing Clothes, 305, 306, 350.
 Pagurus Bernhardus, 133.
 Paint, Cleaning of, 222, 223.
 —, French, Recipe for, 284.
 — for Out-door Work, 284.
 Pancakes, Particulars of, 66, 67, 167.
 —, Apple, Making of, 67.
 Panel-saw, 43.
 Pansies, 109.
 Paper Flower Making (generally), 193, 194; To Make the Cement, 194; To Make a Cabbage Rose, &c., 194, 195; Making the Stamens and Pistils, Calyxes, The Azalea and Rhododendron, A Half-blown Rosebud, Carnation, Primrose, with Illustrations, 264—266.
 Paper-hangings, Cleaning of, 223.
 Parent and Child, Relations between, 35; Legal Duties of Parents, *ib.*; Education of Children, 35, 36; Power of Parents over Children, 36.
 Parishes, Persons Chargeable to, 206.
 Parlour-maid, The, her Duties, Directions Regarding Answering the Door, Waiting at Table, the Serving of Meals, Wine, &c., 268, 269.
 Parochial Rates, Particulars of, 131.
 Parquetry, Description, 223.
 Parsley Sauce, *see* Sauce.
 Parsnips, Sowing of, 138; Thinning of, 138, 174, 175, 191.
 Parsnip Fritters, American, How to Make, 67.
 Partridges, Carving of, 144; Figure, *ib.*
 Pasturage, Grasses best Adapted for, 153, 154.
 Pastures, 209.
 PATCHWORK.—*Introduction*, with Illustrations, 337; Elementary—Counterpanes in Patchwork, 337, 338.
 Peach, 109.
 — Fritters, 67.
 Peacocks, 150.
 Pear-trees, 109.
 Pearl White, 299.

Peas, Early, 109; Sowing of, 138; Sticking of, 138, 149; Cooking of, 182, 272.
 Pea-soup, *see* Soup.
 Pediculi, *see* Lice.
 Pelargoniums, *see* Geraniums.
 Peppermint Drops, Recipe for Making, 291.
 Perch, How to Cook, 67; Boiled, Fried, &c., 341.
 Perennials, 82.
 Periwinkle, 132.
 Periwinkles, Dressing and Serving of, 140.
 Perpetual Paste, Making of, 203.
 Petunias, 113.
 Pheasant, Carving of, 144; Figure of, *ib.*
 Pick-axe, Uses of, 137; Figure of, 136.
 Pickled Beet-root, *see* Pickled Cucumbers.
 — Cucumbers, Tomatoes, and Beet-root, Preparation, Pickling, and Keeping of, 219.
 — Gherkins, Particulars of Pickling, &c., 219.
 — Nasturtium Buds and Seeds, Description and Pickling of, 219.
 — Onions, Walnuts, &c., *see* under their Respective Names.
 — Samphire, Particulars and Pickling of, 219.
 — Tomatoes, *see* Pickled Cucumbers.
 Pickle-jars and Bottles, Wax for Sealing, 195, 196.
 Pickles, 219.
 —, *see* Mushrooms.
 Pigeons, How to Carve, 256.
 Pie-crust, Good Common, Making of, 54, 55.
 Pigs, Keeping of, Profit on, &c. [Correspondent], 106.
 Pigs' Feet, Dressing of, 119.
 — Fry, Directions for Dressing, 104.
 — Liver, Directions for Dressing, 104.
 — Head, Boiled with Vegetables, Directions, 104.
 Pike, Small, How to Cook, 67.
 —, Boiled Whole, 341.
 —, Stuffing for, 342.
 —, Baked Whole, 342.
 —, Serving of, 256.
 Pilchards, Serving of, 256.
 Piles, Treatment of, 287.
 —, *see* Bleeding Piles.
 Pillow-cases, 346.
 Pimples and Rashes of the Face, Particulars of, and Cures for, 70.
 Pin-bit, Figure and Description of, 16.
 Pin-vices, 51; Figure of, *ib.*; Prices of, *ib.*
 Pincers, Ordinary, Figure of, 24.
 — and Pliers, 24.
 Pine, Particulars and Uses of, 78.
 Pines, 109.
 Pinks, 109.
 Pippins, Dried Normandy, Directions and Serving of, 220.
 Pitchfork, Uses of, 149; Figure of, *ib.*
 Pit-saw, 43.
 Pits, 65, 66.
 Plaice, How to Carve, 256.
 Plane, Ordinary (or Jack), Construction of, 24; Figure of a Section, *ib.*; Figure of Double Iron, *ib.*
 —, Smoothing, 24.
 —, Trying, 24.
 —, Tooothing (for Mahogany), 42.
 —, Beading, 42.
 —, Rebating, *see* Fillisters.
 —, Match, 42.
 —, Compass, 42.
 —, *see* Spokeshave.

Plane, Principle in, 42.
 Plane-irons, Sharpening of, 24.
 Plants, Artificial Heat for, 114.
 —, Young, Training House for, 114.
 Plate-cleaning, 306, 362.
 Pliers, Common, Figure of, 24.
 — Culling, Figure of, 24.
 Plum Dumpling, *see* Dumpling.
 — Jam, *see* Greengage.
 — Pudding (Economical and Excellent), Making and Boiling of, 28.
 —, Sauce for, 28.
 —, History of, 151.
 —, Making, Boiling, and Serving of, 166.
 —, without Eggs, Making and Boiling of, 166.
 — (Economical), Making, Boiling, and Serving of, 166.
 —, Smaller (Reasonable), Making of, 166.
 —, Family, (very Palatable), Making, Serving, and Keeping of, 166.
 —, with Apples, Making of, 166.
 —, Sauce for, 166.
 Plum Trees, 109.
 POINT LACE WORK.—Tracing Linen, Braid, &c., with Illustrations, 225, 226; Spanish Point Trefoil, 280—282; Spanish Point Loop, with Illustrations, 356—358.
 Poisoning, Treatment of, 112.
 Polishing Paste, How to Make, 190.
 Polyanthus, 81.
 Pomades—Castor Oil, Crystallised, Marrow, Macassar, East India, Macassar Oil, Marrow Oil, Recipes for Making, 276.
 Pomatum, Ordinary Scented, Recipe for Making, 276.
 Pompon Chrysanthemums, Suitable for Window Decoration, 81.
 Poor Rate, The, History and Particulars of, 131, 132.
 Pork, Particulars for Marketing, 336.
 —, Roast, and Potatoes Fried Whole, Directions, 104.
 —, Breast of, with Rice, Preparing and Serving of, 120.
 —, Leg of, Carving of, 198; Figure of, 197.
 —, Loin of, How to Carve, 256.
 Porridge, Making of, 284.
 —, *see* Oatmeal Porridge.
 Portulaca, 82.
 Pot Pourri, Indian Jars for, with Illustrations, 349, 350.
 Potage à la Tortue, Recipe for, 304.
 Potato Bread, Making of, 27.
 — Cake, ditto, *ib.*
 — Dumpling, Making of, 6.
 — Pie, 6; Figures of Dish and Pie, *ib.*
 Potatoes, 138, 139, 160; How to Cook, 182; Mashed, 182.
 Potting of Plants, 65; Rearing of Delicate Plants from Seed in Pots, 114; How to Sow, *ib.*; How to Water, *ib.*
 Poultry (*Introduction*), 2.
 —, Incubation of, 95, 96.
 —, Roasting of, 171.
 —, Seasonable (December), 111; (January), 148; (February), 235; (March), 284.
 POULTRY—Turkeys and Guinea-fowl, 217, 218; Diseases of Poultry, 218, 219.
 — Houses and Runs, 30—32.
 — Keeping, 30—32.
 — Yard, 32; Plan (Figure of), 32.
 Preserves, 219—221.

Primrose, *see* Chinese Primrose.
 Primroses, 82.
 Prolapse (of the Bowel), Particulars, 287.
 Property-tax, 130; Particulars of, 131.
 Proven, 11.
 Proverbs (a game), Particulars of, 160.
 Pruning-knife, Uses of, 149; Figure of, *ib.*
 Scissors, Particulars of, 148.
 Prussian Exercises (a game), Particulars of, 159.
 Pudding, Tapioca, Baked, Making of, 36.
 —, Rice, Baked, Making of, 36.
 —, Bread, Broken, Baked, Making of, 36.
 —, Bread and Butter, without Butter, Making of, 36.
 —, Batter, Plain, Boiled, Making and Boiling of, 37.
 —, Black Cap, Making, 37.
 —, Batter, Baked, with Apples, Making of, 37.
 —, Batter, Baked, with Sausages or Bacon, 37.
 —, *see* Toad-in-the-hole.
 —, Batter, Baked under Meat, Making and Serving of, 37.
 —, Yorkshire, Making and Cooking of, 37.
 —, Carrot, Making and Boiling, 37.
 —, Saratoga (American), Making and Baking, 37.
 —, Flour, Dr. Dobell's, 37.
 —, Suet, How to Make, 54.
 —, Treacle, the Making of, 55.
 —, Beef, How to Make, 66.
 Puddings, *see* Apple Pudding, Mince-meat or Bacon Pudding, Plum Pudding, &c.
 Pumpkin and Rice Soup, *see* Soup.
 Purée of Green Peas, *see* Soup.
 Putty and Paint, How to Soften, 255.

Q.

Queen Cakes, Making of, 234.
 Queen's Taxes, 130, 131.
 Quilts and Counterpanes, Particulars and Prices of, 285, 286.
 Quince Marmalade, Making, &c., of, 221.

R.

Rabbit, How to Carve, 79.
 Radishes, 65, 109, 138.
 Radish Pods, Pickled, Pickling of, 196.
 Rake, Uses of, 137; Figure of, 136.
 —, Daisy, 137; Figure, 136.
 Ranunculus, 82.
 Raspberries, 65, 138, 149, 174; Dressing (November), 190; (December), 271.
 Raspberry Drops, Recipe for Making, 291.
 —, Jam, Directions for Making, 220.
 Rasps, *see* Files.
 Ratatouille, 254, 255.
 Ratchet Braces, 16.
 Rates and Taxes, 130—132; Unions, Persons Chargeable to Parishes, Compound Household-ers, Table of Duties Chargeable upon Insurance Policies and Legacies, 206, 207.
 Razor-fish or Solen, Dressing of, 182.
 Recipes, Simple, 5.
 Recreation, and Migrations into Purer Atmosphere, as Necessary to Health (*Introduction*), 1.
 Red Blushes, 71.
 —, or Black Thorn, 109.
 —, Cabbage, Pickled, Pickling of, 196.
 Reeds and Rushes, 64.

Reform Act, 1867, 206.
 Rent, Taxes, &c., 2, 3, 38.
 Rhubarb, 65, 109, 138, 149; Forcing of, 271.
 Ribs of Beef, *see* Beef.
 Rice Milk, Savoury, Making of, 36
 —, Sweet, Making of, 36.
 —, Pudding, Baked, *see* Pudding
 Ringworm of the Body, Diagnosis and Treatment, 158.
 Rip-saw, 43; Figure of, *ib.*
 River Fish—Boiling of, Court-bouillon, The Salmon (Figure, 324), Boiled Salmon, Melted Butter, Mustard Sauce, Anchovy Sauce, Lobster Sauce, Mock Lobster Sauce, Salmon Steaks, Kipperd Salmon, The Great Lake Trout and Salmon Trout, River Trout, Potted Trout (Charr), 322—325.
 Rivers, Dr. Edward, 163.
 Roach, The, 69.
 —, *see* Bream, 341.
 Roast Beef, Christmas Fare, 150; Roasting of, 166.
 —, Fowls, How to Carve, 56; Figure of, *ib.*
 —, Turkey, Dressing and Serving of, 166.
 Roasting, 170, 171.
 Roasting-jack, 5.
 Roasts, at Short Notice, 167.
 Robes, Infants', 88.
 Roller, Particulars of, 137.
 Roly-poly, Sugar, Making of, 55; Sauce for, *ib.*
 —, Apple, the Making of, 55.
 —, Fruit, Jam, or Marmalade, 55.
 Room Furniture, Particulars of, 126.
 Round of Beef, *see* Beef.
 Round Worm, The, Particulars of, 302; Treatment for, *ib.*
 Rounds, 42.
 Runner Beans, Particulars and Growing of, 331; *see* Beans.
 Rupture or Hernia, Particulars, 286.
 Ruptures, 8.
 Rymers, or Broaches, 16.

S.

Saffron Cakes or Buns, *see* Cakes.
 Salading, Small, 110.
 Salmon, Carving of, 56; Figure of, *ib.*; Figure of Fish-slice, *ib.*
 —, 150; Full Particulars of, 323; Figure of, 324.
 —, Boiled, 323, 324.
 —, Sauces for, 324.
 —, Steaks, 324.
 —, Kipperd, 324.
 —, Trout, Cooking of, 324.
 Salvia, 82; Management of, *ib.*
 Samphire, Pickled, *see* Pickled.
 Saratoga Pudding, American, *see* Pudding.
 Sauce, *see* Brain Sauce.
 —, *see* Fine Herb Sauce.
 —, *see* Tartar Sauce.
 —, *see* Mayonnaise Sauce.
 —, Fish, *see* Melted Butter, Mustard, Anchovy, Lobster, Mock Lobster.
 —, Liver, How to Make, 68.
 —, Fennel, 68.
 —, for Codfish, 68.
 —, Sharp, 68.
 —, for any Boiled Fish, 68.
 —, Brown, 68.
 —, Parsley, Making of, 140.
 —, for Plum Pudding, *see* Plum Pudding.
 —, Robert, Making of, 365.

Sauces, at Short Notice, 167.
 Sausage Dumpling, Making of, 28.
 —, Rolls, Making of, 66.
 Sausages and Cabbage, Directions, 103, 104.
 —, Epping, Directions, 104.
 Savoy's, 174.
 Saw, Common Metal, Use of, 49; Figure of, *ib.*
 —, Hand, Uses of, 148.
 —, Tenon, Uses of, 148.
 Saws, Particulars of, 42, 43.
 —, *see* Pit-saw, Rip-saw, Half-rip-saw, Panel-saw, Hand-saws, Tenon-saw, Keyhole-saw, Crosscut-saw, Compass-saw, Turning-saw.
 Sawdust for Forcing Purposes, 113.
 Saw-set, 43; Figure of, *ib.*
 Scalds, *see* Burns.
 Scallops, Dressing of, 181, 182.
 Scarlet Fever, Diagnosis, 186, 187; Treatment, 186; Dropsy, *ib.*; To Prevent the Spread of the Disease, *ib.*; *see* Fever.
 Scarlet Runners, *see* Beans.
 Scillas, Cultivation of, 81.
 Scotch Terrier, *see* Dogs.
 Scotland, Culinary Art in, 5
 Scott, Sir Walter, 12.
 Scrap-books, *see* Albums.
 Screen Making, with Figures, 129, 130.
 Screw-drivers, 16, 50; Figure of, 49.
 Screw Hammer, 51; Figure of, *ib.*
 Scrubbing, 222.
 Scurfiness, *see* Dandriff.
 Scythe-stone, or Rubber, Particulars of, 148.
 Sea-bathing, Rules for, 62
 Sea-kale, Forcing of, 27, 65, 109, 138, 139, 149, 174, 175, 190.
 Seaweeds, 132.
 SEALING - WAX, MAKING. — (Various Colours), 368.
 Seats, Distribution of, 230, 231.
 "Sedan Chair" for Carrying the Wounded, 72; Figure of, 73
 Seedlings, 113.
 Seeds, Rearing of, 114; Soils for, *ib.*; In Pots, *ib.*; Thinning of, *ib.*; Watering of, *ib.*
 Sempula, 134, 162; Figure of, 133.
 Servant, General, The, Particulars of, Including Wages, Duties, Time for Dressing, Arrangement of Work, &c., 147, 148.
 Servants, Domestic, 13, 14; Certain Duties of, 13; Duration of the Service, *ib.*; Notice or Warning, *ib.*; Summary Dismissal, *ib.*; Diet, &c., *ib.*; Ill-treatment of, *ib.*; *see* Characters.
 Settees, Conversion of Superfluous Boxes into, 313.
 Shadows, or Shadow Buff, 127.
 Sharp Sauce, *see* Sauce.
 Shears, Uses of, 148; Figure of, 149.
 Sheep's Feet Pâté, Dressing of, 119.
 —, Heads, Dressing and Serving of, 139.
 —, Liver, *see* Calf's.
 —, Trotters, How to Dress, 119; Sauce for, *ib.*
 Sheets, 346.
 Shell-fish, The Cheaper — Limpets, Periwinkles, Whelks, Mussels, Dressing of, 140; Mussels with Sharp Sauce, Scalloped Mussels, Fried Mussels, Scallops, Stewed Oysters, the Razor Fish or Solen, Clams, Stewed Clams, Hashed Clams, 181, 182.
 Shells, 132—134.

Shingles, The, Diagnosis and Treatment, 157.
 Shiverings, 42.
 Shoes, Gutta-percha Soles, 190.
 — and Boots, Soleing with Gutta-percha, 214.
 Shopkeepers, The (a Game), Particulars of, 159.
 Short Cake, How to Make and When to Eat, 54.
 Shoulder of Mutton, the Carving of, 80; (Figures), *ib.*
 Shrubby, 109.
 Shrubs, Removal of, 60, 65, 66; Protections for, *ib.*; (Figures), 65.
 Shutters, 15.
 Siamese Link (a game), 191.
 Sickness, 42.
 Side Tables, Covering, &c., of, 377, 378; Figure, 378.
 Silver, *see* Gold.
 —, Oxidised, How to Oxidise, 378.
 — Birch, 109.
 Skate, Particulars of, 68.
 Skin, Management of the, 22, 23; Its Structure and Functions, 22; How to Keep the Skin in Health, 22, 23, 45, 46; Warmth, 45; Exercise, 45; Cleanliness, 45, 46; Sea-bathing, 62; Disorders of the Skin—Dry Skin, Moist Skin, 62, 63; Pimples and Rashes of the Face, Skin Cosmetics, Dandruff or Scurfiness, Eruptions, Red Blushes, 70, 71; Discharging Eruptions, Chilblains, Warts, Corns, Moles and Mothers' Marks, Discolorations of the Skin, Chapped Hands and Lips, 123, 124; The Shingles, Sore Nipples, Nettle-rash, The Itch, Ringworm of the Body, Lice or Pediculi, 157—159.
 —, Discolorations of the, Particulars of and Remedies for, 124.
 — Diseases, 83.
 — Cosmetics, Particulars of, 70.
 Small-pox, Diagnosis, 215; Treatment, *ib.*; How to Prevent the Disease Spreading, *ib.*
 —, *see* Vaccination.
 Smelts, Serving of, 256.
 Smith, Rev. Sydney, 2.
 Snails, 69.
 Snowdrops, Cultivation of, 81.
 Soap Liniment, *see* Opodeldoc.
 Sofas, 126, 127.
 Soil for Potting, 114.
 Soiling, 211.
 Solen, *see* Razor-fish.
 Soup, Recipes for: Cabbage, 87.
 —, Meagre Cabbage, 87.
 —, Pea, 103.
 —, Vegetable, 103.
 —, Shin of Beef, 103.
 —, Pumpkin and Rice, 104.
 —, Van Abbot's Invalid's, 259.
 —, Meagre (Soupe Maigre), 259.
 —, Sorrel and Potato, 259.
 —, Small White Onion, 259.
 —, Leek and Potato (Meagre), 259.
 —, Turnip and Potato (Meagre), 259.
 —, Carrot, 259.
 —, Onion, 259.
 —, Rice and Onion, Brown, 259.
 —, Rice and Onion, White, 259.
 —, Green Pea, (French Way), 259.
 —, Pumpkin, 259.
 —, Cauliflower, 259.
 —, Provençal, 259.
 —, à Garbure, 259.
 —, Garbure à la Béarnaise, 259, 260.

Soup, Tomato, 260.
 —, Gravy, 260.
 —, Cheese, (Meagre,) 260.
 —, Tapioca, 283.
 —, Vermicelli, 283.
 —, Macaroni, 283.
 —, Julienne, 283.
 —, White, 283.
 —, Mock Turtle, 304; *see* Force-meat Balls.
 —, Ox-tail, 304.
 —, Cherry, German Recipe for, 304.
 —, Mulligatawny, How to Make, 310.
 —, All the Year Round's Mulligatawny, 310.
 —, Giblet, Making of, 310.
 —, Cabbage, Making of, 310.
 —, Purée of Green Peas, Making of, 310.
 —, Hare, Making of, 311.
 —, Pea, Purée of Dried Peas, Making of, 311.
 —, Hasty, 311.
 —, Green Pea, 311.
 —, Cabbage, (Maigre,) Making of, 311.
 —, Small Onion, Making of, 311.
 —, From Essences and Extracts of Meat, *see* Broth.
 —, Fish, Recipes for, a Soup of Plaice, Small Conger Eels, and Whiting, 260.
 —, Shrimp-tail and Tomato, 260.
 —, Oyster, 260.
 —, Mussel or other Shell-fish, 260.
 —, Clam, 260, 261.
 —, Eel, 261.
 —, White Eel, 282, 283.
 —, Brown Eel, 283.
 —, Similar Soups, with Firm-fleshed Middle-sized Fish, as Small Conger, Soles, &c., 283.
 —, Salmon, 283.
 —, Bouille-à-baisse, 283.
 Soups and Purées—Mock-turtle, Force-meat Balls, Egg Balls, Potage à la Tortue, Ox-tail Soup, Cherry Soup (German Recipe), 304.
 Soups, Plain, Directions for Making, 87, 103; (at short notice), 167.
 South Americans, 5.
 Spade, Particulars of, 137; Figures of, 136.
 Spanner, 51.
 Speaking Buff (a game), Particulars of, 159.
 Spermoceti Ointment, Recipes for, 284.
 Spinach, 65; Round-leaved (sowing of), 138.
 Spirit-level, 50; Figure of, *ib.*
 Spokeshave (lowest form of Plane), 42.
 Sponge Cake, How to Make, 234.
 Sprained Ankle, 53; Strapping or Bandaging, *ib.*; Figure of, *ib.*
 —, Method of Carrying (Figures), 72.
 —, Knee, 53; Strapping or Bandaging, *ib.*; Figure of, *ib.*
 Sprains, Treatment of, 53.
 Sprats, Serving of, 256.
 Spring-blinds, *see* Blinds.
 — Mattresses, 156.
 Springs, 15.
 Squares, Uses of, 50; Figures of, 49.
 —, Used by Masons, 50; Figure of, 49.
 Stain for Mahogany Colour, 350.
 Stair Carpets, 125.
 Stairs, 125.
 Stays, 362.
 Steaks, *see* Chops.
 Steps, Garden, Uses of, 137; Figure of, *ib.*

Stereoscopic Company, The London—Christmas Novelties—The "Scientific Mystery," &c., 192.
 Stocks, 60.
 Stone Staircases, cleaning of, 223.
 Stone-wort (*Chara vulgaris*), 63; Figure of, *ib.*
 Stools for Children, 299.
 Stoppers, Glass, to Loosen, 203.
 Stove (Oven, or Oven and Boiler), 5; Figure of, 4.
 Strawberries, 138, 139; Watering, 138; Propagation of, 149; Dressing for August, 174; November, 190; December, 271.
 Strawberry Beds, 109.
 — Jam, Full Particulars for Making and Keeping, 220.
 Strength, Loss of, 42.
 Stretchers, and their Substitutes, 71, 72; Figure of, 72.
 Striking-knife, 50; Figure of, *ib.*
 Sucking Pig, Carving of, 198; Figures of, 197.
 Suet Dumpling, *see* Dumpling.
 Suet Pudding, *see* Pudding.
 Sun Star, Figure of, 133.
 Sunstroke, Treatment of, 112.
 Supper, 4.
 SURGERY, DOMESTIC (*Introduction*), 2; General Remarks, 7—10; *see* Bandaging; Hæmorrhage, 29, 30; *see* Cuts, Wounds; Wounds, Bruises, and Sprains, 51—53; Fractures, Dislocations, Burns, and Scalds, 71—74; Suspended Animation, Fainting, Drowning, Hanging, Foul Gases, Sunstroke, Intoxication or Poisoning, 111, 112; Frost Bite, Gunpowder Accidents, Gunshot Injuries, Injuries from Chemicals, Foreign Bodies in the Nose or Ear, in the Windpipe, Gullet, or Stomach, Dust in the Eye, &c., 154, 155; Teething, 172, 173; Bunions, and Affections of the Feet and Legs, 201, 202; Various Local Ailments, 252, 253, 286, 287.
 Swans, 150.
 Sweeping and Dusting, 222.
 SWEETMEATS, MAKING OF.—Candied Horehound, Peppermint Drops, Ginger Drops, Lemon Drops, Damson Drops, Raspberry Drops, 291.

T.

Tables, Dressing, Setting (or Laying) of, *see* Dinner-tables.
 —, *see* Side Tables.
 Table-vices, 50, 51; Figure of, 51; Prices of, *ib.*
 Tadpoles, 69; Figure of, *ib.*
 Tail-vices, 50; Figure of, *ib.*; Prices of, 51.
 Tape-worm, The, Particulars of, 302; Treatment for, *ib.*
 Tapestry Carpeting, Particulars of, 126; How to Distinguish from Brussels, *ib.*
 Tapioca Pudding, *see* Pudding.
 Tarragon Vinegar, Making of, 223.
 Tartar Eels, *see* Eels.
 Tartar Sauce, Making of, 365.
 Tax on Armorial Bearings, on Servants, Horses, and Carriages, 130; Table Showing Rates, 132.
 Taxes upon Household Servants, Carriages, Horses, &c., 131.
 —, Means of Recovering, 131.
 —, 130, 131; *see* Queen's Taxes, Rates, Parochial Rates, Poor Rate.

TEA, HOW TO MAKE, 380.
 Tea Roses, 66.
 Teeth, Care of the, 172, 173; *see* Gums and Teeth.
 —, False, Particulars, 173.
 Teething, Description of, 114, 115; Care and Diet, 115; Gums and Teeth, Lancing the Gums, Care of the Teeth, Toothache, False Teeth, Inflammation of the Tonsils, Enlarged Tonsils, 172, 173.
 Tench, the, 69.
 —, Stewed, 341.
 —, Boiled, 341.
 Tenon-saw, 43.
 Terriers, *see* Dogs.
 Thread-worm, The Small, Particulars of, 302; Treatment for, *ib.*
 Thrush, Treatment of, 71.
 Toad-in-the-hole, Making and Serving of, 37.
 Toast, Hot Buttered, How to Make, 313.
 Toe-nail, Ingrowing, Causes and Treatment of, 201; Figure of, *ib.*
 Toffey, *see* Treacle Toffey.
 Toilette, The (*Introduction*), 2.
 TOILETTE, THE.—Management of the Skin—Structure and Functions, to Keep the Skin in Health, 21—23; Warmth, Exercise, Cleanliness, the Bath, and Bathing in general, 45, 46; Management of the Skin, Sea-bathing, Disorders of the Skin, Dry Skin, Moist Skin, 62, 63; Pimples and Rashes of the Face, Dandruff or Scurfiness, Eruptions, Red Blushes, 70, 71; Discharging Eruptions, Chilblains, Warts, Corns, Moles and Mothers' Marks, Discolorations of the Skin, Chapped Hands and Lips, 123, 124; the Shingles, Sore Nipples, Nettle-rash, the Itch, Ringworm of the Body, 157—159; the Hair and its Management, 241, 242, 274—276; Disorders of the Hair and their Treatment, 366—368, 379, 380.
 Tomatoes, 109.
 —, Pickled, *see* Pickled.
 Tongue, Coloured Plate, 193; Carving of, 198; Figure of, 197.
 Tonsils, Inflammation of the, Particulars, 173.
 —, Enlarged, Particulars, 173.
 Tool-box, Household, Where to Purchase, 372.
 Tool-chest, the Domestic, (*Introduction*), 2, 15, 16, 23, 24, 42, 43, 49—51; Engraving of, 15; Description of, 15, 16.
 Tool-house, 136—138.
 —, Particulars of Certain Tools, 148, 149.
 Tools, 14, 15; Lists of, with Approximate Prices, 15, 16.
 —, List of Garden Tools, with their Prices, 138.
 Toothache, 173.
 Towelling, 347.
 Toys and Tricks, Novelties in—The Siamese Link, The Chameleon Top, (Figure of), 192; The Obedient Ball, The Magic Bottle, The Invisible Gift, and the Vanishing Coin, 191, 192.
 TRADE, CHOOSING A.—General Remarks, Watchmaking, 307, 308, 362, 363.
 Transparencies, Coloured, 165; Design for a Transparency, *ib.*
 Treacle Pudding, *see* Pudding.
 — Toffey, Making of, 223.
 Tree Carnation, Propagating and Training of, 81.

Trees, Removal of, 60.
 —, Ornamental, 109.
 Trenching, 60.
 Tricks, *see* Toys.
 Tripe, Normandy Fashion, Dressing of, 120.
 —, Stewed, Dressing of, 120.
 — à la Lyonnaise, Dressing of, 120.
 —, Broiled, with Sauces, 120.
 —, Provençal Way, 120.
 —, Milanese Way, 120.
 —, Italian Way, 120.
 Triton, The, Figure of, 69.
 Tropeolum, 113.
 Trout, Great Lake, 324.
 —, Salmon, 324.
 —, River, Cooking of, 324.
 —, Potted, 325.
 Trowel, Uses of, 149; Figure of, *ib.*
 Trustees, 91.
 Tulips, 60; Cultivation of, 81, 109.
 Turbot, How to Carve, 256; Figure, *ib.*
 Turf-cutter, Uses of, 137; Figure, 136.
 Turkey, Carving of, 79; Figure, 80; Figure of the Leg, *ib.*
 Turkeys, Directions for Keeping and Rearing, 217, 218; Figure of Variegated Cambridge Turkeys, 217.
 Turkish Bath, *see* Bathing.
 Turning-saw, its Uses, 49; Figure of, *ib.*
 Turnip Fritters, 67.
 Turnip-tops, Dressing of, 183.
 Turnips, Sowing of, 138, 139, 149, 191.
 —, Stewed, 182, 183.
 Twirling the Trencher (a game), Particulars of, 159.
 Typhoid Fever, Diagnosis, 215, 216; Causes, 216; Treatment, *ib.*
 Typhus Fever, Diagnosis and Particulars of, 216; Treatment, *ib.*

U.

Unions, Particulars of, 206.
 Urine, Incontinence of, in Sleep, 287.

V.

Vaccination and Small-pox, Particulars of Vaccination, its Protective Power, &c., 187.
 Valisneria, Spiral, 63; Figure of, *ib.*
 Varicose Vein, Burst, Treatment and Bandaging of, 29, 30.
 Vase, Modelling of, 346; Figures, 345.
 Veal, How the Beast is Divided, with Illustrations, 261; Qualities of, *ib.*
 —, How to Pot, 235.
 —, Fillet of, Coloured Plate, 193.
 —, Neck of, Carving of, 143; Figure, 144.
 —, Loin of, Carving of, 143, 144; Figure, 144.
 — Sausages, 235.
 Vegetable Garden, The—Formation of, 224; Situation, *ib.*; Exposure, *ib.*; Aspect, *ib.*; Extent, *ib.*; Soil, *ib.*; Water, *ib.*; Form, *ib.*; Walls, *ib.*; Trenching, Ridging, Manuring, Illustrated by Figures, 239, 240; Rotation of Crops, Manure, &c., 246, 247; Asparagus, 287, 288; The Broad Bean, Runner Beans, 330, 331; The Dwarf French Bean, Red Beet, White Beet, 355, 356; Borecole, or Kale—The Green Borecole or Scotch Kale, Purple Borecole or Brown Kale, German Kale

or Brown Kale, The Hundred-headed Cabbage, The Egyptian Kale, Ragged Jack, the Jerusalem Kale, The Manchester Kale, Melville's Improved Borecole or Kale, 378, 379. *See* GARDEN and GARDENING.
 Vegetables, 109, 110; Seasonable (December), 111; (January), 148; (February), 235; (March), 284; at Short Notice, 107; Cooking of, 182, 183.
 —, the Culture of, 272.
 — Soup, *see* Soup.
 Velvet-pile Carpets, Testing of Quality, 126.
 Veneering, Particulars, 223.
 Venetian Blinds, *see* Blinds.
 Venison, Particulars for Marketing, 336.
 Verbenas, 60, 113, 114.
 Vices, Tail-vices, Pin-vices, Table-vices, Various Kinds of, 50.
 Vine, 109.
 Violets, 82.
 —, Neapolitan and Russian, Growing of, 81.

W.

Wages, 2, 3.
 WAGES AND INCOME TABLE, 368.
 Wall-flowers, Culture of, 81.
 Wall-papers, 18, 19.
 Walls, Ground Colour for, before Painting, 284.
 —, Blue Wash for, Making of, 204.
 —, Whitewashing of, 378.
 Walnut, Description and Uses of, 78.
 Walnuts, Pickled, Pickling, and Particulars of, 196.
 Wardrobes, 156, 157.
 Warning, 13.
 Warm-plate, Description of, 19.
 Warts, Causes and Treatment of, 124.
 Washing, 38.
 Wat Tyler's Rebellion, 130.
 Watchmaking, Particulars, 307, 308, 362, 363.
 Water, Overflows of, 15.
 —, Filtered, 162.
 —, Boiled, 162.
 —, Rain, 162.
 —, Impurities in, 162, 163.
 —, A Few Facts About, 223.
 — Courses, 109.
 Watering of Plants, 327.
 Watering-pot, Uses of, 137; Figure of, *ib.*
 Water-lilies, 63, 64.
 Water-milfoil, Spiked (*Myriophyllum spicatum*), 63.
 Waterproof Boots, 190.
 Water-soldier (*Stratiotes alvodes*), 63.
 Water Supply, 162, 163; Particulars of, with Illustrations, 257, 258; Particulars Regarding Cisterns, &c., with Illustration, 317, 318; Particulars of Apparatus, &c., especially by Mr. J. L. Norton, of Belle Sauvage Yard, Ludgate Hill, with Illustrations, 351, 352.
 Wax for Modelling, Preparation of, 255.
 Wax-work Busts and Statuettes, Making of, 164, 165.
 Ways and Means [Correspondence], Concerning Small Incomes, 106.
 Weak Ankles, Treatment of, 202.
 Wealth (*Introduction*), 1.
 WEIGHTS AND MEASURES, Tables of, 160.
 Wet and Colds, Precautions Against, 284.
 Wheel of Fortune for a Raffie, How to Make, 312; Figure of, *ib.*

Wheelbarrow, 15.
 Whelk, 132.
 Whelks, &c., Dressing, of, 140.
 Whist, The Game of, Directions for Playing, 262, 263; First Player, Second Player, Third Player, Fourth Player, General Rules, Inferences; Laws of the Game—Dealing, the Last or Trump Card, Exposed Cards, 278, 279; Playing Out of Turn, Revoking, 319; Single and Double Dummy, 319, 320; *see* Card Games.
 Whitebait, Serving of, 256; Particulars and Dressing, of, 365, 366; Figure of, 366.
 Whitewash, How to Make, 255.
 Whitewashing Walls, *see* Walls.
 Whiting, Serving of, 256.
 Whitlow, Description and Treatment, 252.
 Whooping-cough, 83.
 Will-making, Law of, 90, 91.
 Wills, Full Particulars Concerning, 90, 91.

Window-blinds, 15.
 — Cleaning, 306.
 — Garden, *see* Gardening.
 — Gardening, *see* Gardening.
 Windows, Particulars of, 140, 142; Figures, 141; Repairing of Sash-lines, 141; Glazing, 141, 142; Knife for, 141; Figures of, *ib.*; Thickness of Glass, and Price, *ib.*
 Wolf, The, with Relation to Dogs, 11.
 Woods used in Household Carpentry, 77, 78; Seasoning of, 77; Result of Green Wood Left to Take Care of Itself (Figure), *ib.*
 —, Technical Terms Applied to the Sizes into which Pine and other Woods are Cut, 78.
 Wool, 160.
 Worms, 83; the Small Thread-worm; the Round-worm, the Tape-worm, 302; Causes of Worm Disease, *ib.*; Treatment and Remedies, *ib.*

Wounds in the Palm of the Hand, 10;
 — Bandaging for, *ib.*; Figure of, 9.
 —, Bandaging and Treatment of, 30.
 — about the Head, Treatment of, 29.
 —, Poisoned, Treatment of, 51, 52.
 —, Penetrating, Treatment of, 52.
 Wrenches, 51, *see* Screw Hammer.

Y.

Yeast, Making of, 234.
 Yorkshire Pudding, *see* Pudding.
 Youth, Dietary of, 343.
 —, Dietary of, Dr. Lankester on, 343;
 Mutton and Beef, Regularity of Meals, Tea (as a Meal), Wine and Beer, 354
 355.

Z.

Zoophytes, 134.

LIST OF ILLUSTRATIONS.

	PAGE
Kitchen Range, Stove, and Grid-iron	4
Potato Pie, Dish and Lid	6
Joints (marked how to carve)	7
Bandages and How to Bandage (Eight Figures)	8, 9
Dogs—Bull Terrier and Scotch Terrier	12
Tool-chest	15
Brace and Bits (Four Figures), Chisels (Two Figures)	16
Aquarium for the Window	17
Aquarium-glass and Tanks (Three Figures)	18
Gimlets (Two Figures), Auger, and Marking-gauge	23
Mortice-gauge, Heads of Hammers (Three Figures), Pair of Pincers, Common Pliers, Cutting Pliers, Plane, Double Iron of Planes	24
Drainage and Drain-pipes (Seven Figures)	25
Bandaging (Four Figures)	29
Fowl-house, Plan, &c.	31, 32
Infants' Clothing (Twelve Figures)	33
Veiner for Leather-work, and Three Leaves	40
Ivy-leaf	41
Old Woman's Tooth	42
Saw-set and Four Saws	43
Hanging-baskets for Flowers (Two Figures)	44
Fowl-dish	47
Fowl-dishes (Two Figures)	48
Carpenters' Tools (Ten Figures)	49, 50

	PAGE
Carpenters' Tools (Three Figures), Samples of Nails	51
Bandages for Sprains (Two Figures)	53
Roast Fowls and Salmon (marked how to carve), and Figure of Silver Fish-slice, or Knife	56
Flowers, &c., for Leather-work (Six Figures)	57
Plans for Garden-paths	59
Dogs—English Mastiff, Newfoundland	61
Plants for the Aquarium (Four Figures)	63
Aquarium, with Rockwork and Fern Frames, Pits, and Shelters for Plants (Five Figures)	65
Aquarium—Development of the Frog; the Loach, the Triton, the Common Newt	69
Stretcher—Modes of Carrying in Cases of Sprained Ankle, replacing Dislocated Shoulder, &c. (Four Figures)	72
"Sedan-chair" of Schoolboys for Carrying, in cases of Sprained Ankle, &c., replacing Dislocated Shoulder	73
Dogs—the Pointer, the Greyhound	76
Diagram Showing the Drying of Wood, Carpenter's Joint	77
Hare, Turkey, Calf's Head, Shoulder of Mutton (Two Figures), showing how to carve	80
Fuchsia in Pot, Box of Hyacinths and Spring Flowers for the Window	81

	PAGE
Joints, Dovetailing, &c. (Six Figures)	85
The Lap Dovetail	86
Infants' Clothing (Eighteen Figures)	88, 89
Diaphanie (Four Figures)	92
Drains	94
Fowls—Dorking Cock and Hen, Wooden Box for Nest	96
Christmas Decorations (Four Figures)	97
Carpenter's Bench (Two Figures)	101
Aquarium—Tin Can, Net, Rock-pool with Seaweeds and Anemones, Shrimp, Æsop Prawn	105
Dogs—Scotch Collie	108
Garden-plot, Showing How to Lay out	109
Treatment of Drowning (Two Figures)	112
Small Greenhouse, without Heating Apparatus; ditto, with Heating Apparatus	113
Children's Clothing (Twenty-one Figures)	116, 117
Fowls—White Cochin China Cock and Hen	121
Easy Chair	126
Doors, &c. (Five Figures)	128
Designs, &c., for Screens and Albums (Eight Figures)	129
Marine Aquarium—Sun-star, Serpula, Crab, Acorn Barnacles on a Limpet-shell	133
Garden Tools (Fifteen Figures)	136, 137
Windows—Plan of, Frame and Sash, &c., Knives (Five Figures)	141
Joints (Four Figures), Pheasant (Two Figures), showing how to carve	144

	PAGE		PAGE		PAGE
Chicken Coops (Three Figures)	145	Children's Clothing (Seventeen Figures)	236, 237	Boot-cleaning, Knife-cleaner	305
Garden Tools (Ten Figures)	149	Trenching and Ridging (Two Figures)	240	Knife-cleaner	306
Grasses (Eight Figures)	152, 153	Skin and Hair (Two Figures)	241	Cow-stall	309
The Itch	158	Bedstead and Bedroom Furniture (Four Figures)	244	Matting (Two Figures), Wheel of Fortune	312
A Marine Aquarium	161	Bedroom Furniture (Two Figures)	245	Table and other Ornaments (Six Figures)	313
Design for a Transparency	165	Plans of Drains (Four Figures)	248, 249	Clay Models and Tools (Group)	316
Ducks	168	Milk Abscess—Female Figure	253	Water Supply—Apparatus	317
Teeth in the Jaws of a Child, Lancing the Gums, Lancet	173	Pigeons and Fish (Three Figures), showing how to carve	256	Comical Combinations	320
Blinds, Fittings, &c. (Seven Figures)	176	Water Supply—Four Figures of Apparatus	257	Feather Screens—The Hawk, &c., Figure of a Bird	321, 322
Children's Clothing (Eleven Figures)	177	Marketing—Figures of Calf and Ox, showing how the Animals are cut up	261	Salmon	324
Bell-hanging and Bell-pull	181	Paper Flower Making (Seventeen Figures)	264, 265	Horse (Structure of)	325
Bedsteads (Three Figures)	184	Linen Press, or Mangle (Two Figures)	269	Portable Pump	328
Bedroom Furniture (Four Figures)	185	Gas-fittings (Seven Figures)	273	Windsor Beans (Two Figures)	330
Cows—Shorthorn, Ayrshire	188, 189	Dutch Hay-baru, and Two Figures of Thorn or Quick-hedge	277	Children's Clothing (Thirteen Figures)	332, 333
Chameleon Top	192	Lace-work—Pattern in Spanish Point Trefoil (Six Figures)	281, 282	Marketing—Sheep and Lamb, how cut up	336
Parts of Paper Flowers and Tools (Eleven Figures)	193	Spring-mattress	285	Patchwork (Two Figures)	337
Poultry and Joints (Seven Figures), showing how to carve	197	Asparagus, Asparagus-beds, and Knife (Four Figures)	288	Carp, The	341
Ingrowing Toe-nail, Flat Foot, Housemaid's Knee	201	Feather Screens (Four Figures)	289	Plough and Farm Machines	344
Dog's-house	205	Children's Clothing (Seventeen Figures)	292, 293	Models in Clay (Five Figures)	345
Rod and Fittings for Window-curtains	208	"Varna," a High-bred Arab (Horse)	296	Charades (Three Figures)	348
Haystack and Rick-cloth	209	Head and Neck of the Godolphin Arabian (Horse)	297	Indian Jars for Pot Pourri	349
Locks and Door Fittings (Five Figures)	213	The Shetland Pony	297	Water Supply (Five Figures)	351, 352
Variiegated Cambridge Turkeys (Cock and Hen)	217	Crystals for Windows (Three Figures)	299	Models in Clay (Four Figures)	353
Point Lace Work (Four Figures)	225	Jet of Gas	300	Point Lace Work	356
Hereford Cow	228	Iron Fencing	301	The Spanish Point Loop	357
West Highland Cow	229			Mantel-shelves and Fenders (Four Figures)	361
French Cuisinière and Kitchen Requisites	232			Whitebait	366
Stoves, Dutch Oven, &c. (Five Figures)	233			Children's Clothing (Nineteen Figures)	369
				Garden Furniture, Parts (Seven Figures)	373
				Colt Prepared for "Lounging"	375
				Table and Ottoman	378

COLOURED PLATES.

FRONTISPIECE, showing the method of Serving Sirloin of Beef, Roast Turkey, Boiled Salmon, Calf's Head, Leg of Mutton, Roast Ducks, Boiled Turbot, and Roast Hare.

PLATE II., showing the method of Serving Cod's Head and Shoulders, Saddle of Mutton, Ham, Fore-quarter of Lamb, Mackerel, Goose, Tongue, and Fillet of Veal *To face page 198.*



LIST OF WORKS

PUBLISHED BY

MESSRS. CASSELL, PETTER, AND GALPIN.

Bibles and Religious Literature.

Bible, Cassell's Illustrated Family. Complete in One Volume, royal 4to, in cloth, gilt edges, 1,710 pp., 960 Illustrations, and Family Register, £1 11s. 6d.; calf, £2 10s.; morocco antique, £3 10s.

* * Cassell's "Illustrated Family Bible" has attained a circulation of nearly *Half a Million*.

Bible, Cassell's Illustrated Family. Toned Paper Edition. Half morocco, gilt edges, £2 10s.; full morocco antique, £3 10s.; best full morocco elegant, £3 15s.

Bible, Cassell's Illustrated Family. Large Paper Edition. 1,494 pp., and Family Register. Cloth gilt, £2 10s.; flexible morocco antique, £4; full gilt morocco elegant, £5.

Bible, The Child's. 830 pp.; 220 Illustrations. Demy 4to. Being a Selection from the Holy Bible, in the words of the Authorised Version. Cloth elegant, gilt edges, £1 1s.; flexible leather binding, hand tooled, gilt edges, £1 10s.; best morocco elegant or antique, £2 2s.

* * Nearly 60,000 copies of "The Child's Bible" have been already sold.

Bible, The Doré. Illustrated by GUSTAVE DORÉ. Complete in Two very handsome Volumes. Bound in cloth gilt, £8; morocco, gilt edges, £12; best polished morocco antique extra, £15.

Bible Dictionary, Cassell's. Complete in One or Two Vols., strongly bound in cloth, 21s.; in One Vol., strongly bound in russia or morocco, 40s. 1,159 pp., and nearly 600 Illustrations. Imp. 8vo.

Commentary, Matthew Henry's. Complete in Three Volumes. Cloth, lettered, £2 12s. 6d. Demy 4to, 3,308 pp.; numerous Illustrations and Maps.

Family Prayer Book, Cassell's. Cloth, 7s. 6d.; with gilt edges, 9s.; morocco antique, 21s. 398 pp., demy 4to.

Mission Life. A Record of Mission Work in all Parts of the Globe. Volume for 1870, containing about 800 pages letterpress, and numerous Engravings. Cloth, 5s.

Quiver, The. Volume for 1870. 840 pages letterpress, and numerous Engravings. Cloth, lettered, 7s. 6d.; gilt edges, 8s. 6d.

Children's Books.

Shilling Story Books. 96 pp., fcap. 8vo, cloth, lettered. Two Illustrations in each Volume.

Lottie's White Frock, and other Stories.

Helpful Nellie, and other Stories.

Only Just Once, and other Stories.

The Boot on the Wrong Foot, and other Stories.

Little Content, and other Stories. By EDITH WALFORD.

Little Lizzie. By MARY GILLIES. And other Tales.

Luke Barnicot. By WILLIAM HOWITT. And other Tales.

My First Cruise. By W. H. KINGSTON. And other Tales.

The Boat Club. By OLIVER OPTIC. And other Tales.

The Delit Jug. By SILVERPEN. And other Tales.

The Elchester College Boys. By Mrs. HENRY WOOD. And other Tales.

The Little Peacemaker. By MARY HOWITT. And other Tales.

Jonas on a Farm. By JACOB ABBOTT. And other Tales.

Shilling Toy Books. In demy 4to, stiff covers. With full-page Illustrations printed in Colours by KRONHEIM.

1. **How Cock Sparrow Spent his Christmas.**

2. **The Adventures of Robinson Crusoe.**

3. **Queer Creatures.** Drawn by One of Themselves.

4. **Æsop's Fables.** (21 Plates.)

Shilling Reading Books.

Evenings at Home. In Words of One Syllable.

Cloth, limp, 1s.

Æsop's Fables. In Words of One Syllable.

Cloth, limp, 1s.

Eighteenpenny Series of New and Original Works. Bound in best cloth, gilt edges, with Four Coloured Plates by KRONHEIM in each Book. 128 pp., fcap. 8vo.

Little Blackcap. And other Stories.

Tommy and his Broom. And other Stories.

Little Red Shoes. And other Stories.

Charlie's Lessons about Animals.

The Broken Promise. And other Stories. By the Hon. Mrs. GREENE.

The Holidays at Llandudno.

The Hop Garden: A Story of Town and Country Life.

Algy's Lesson. By S. E. DE MORGAN.

Hid in a Cave; or, The Lost Child.

Ashfield Farm; or, Ellen and Robert's First Journey from Home.

Grandmamma's Spectacles. By the Author of "A Trap to Catch a Sunbeam."

Little Fables for Little Folks.

Flora Selwyn: A Story for Girls.

Two Shilling Series of New and Original Works. Bound in cloth gilt, gilt edges, with Illustrations printed in Colours, 160 pp., fcap. 8vo.

Dr. Savory's Tongs. By TWO SISTERS.

The Golden Gate. By H. G. B. HUNT.

Love and Duty. By ANNA J. BUCKLAND.

Brave Lisette. And other Stories. By Miss CARLESS.

Beatrice Langton; or, The Spirit of Obedience.

Owen Carstone: A Story of School Life.

The Boy who Wondered.

New Stories and Old Legends. By Mrs. T. K. HERVEY.

The Little Orphan.

The Story of Arthur Hunter and his First Shilling.

The Story of the Hamiltons.

The Hillside Farm.

Children's Books—continued.

Half-Crown Library. 160 pp., extra fcap. 8vo, handsomely bound in cloth gilt, with Illustrations and Ornamental Chapter Heads.

- Labour Stands on Golden Feet.** A Holiday Story for the Industrial Classes. Translated from the German of HEINRICH ZSCHOKKE, by Dr. JOHN YEATS.
- Stories of the Olden Time.** Selected and arranged by M. JONES, Author of "The Story of Captain Cook," &c.
- One Trip More.** And other Stories. By the Author of "Mary Powell."
- Truly Noble: A Story.** By MADAME DE CHATELAIN.
- Autobiographies of a Lump of Coal and a Grain of Salt, &c.** By ANNIE CAREY.
- Love and Life in Norway.** By BJORNSTJERNE BJORNSEN. Translated from the Norwegian by the Hon. AUGUSTA BETHELL and A. PLESNER.
- The Fishing Girl.** By BJORNSTJERNE BJORNSEN. Translated from the Norwegian by F. RICHARDSON and A. PLESNER.

The Children's Library. A Series of Volumes specially prepared for Children. Beautifully Illustrated, and handsomely bound in cloth gilt, uniform in size and price.

- The Children's Sunday Album.** By the Author of "A Trap to Catch a Sunbeam." With upwards of 100 Engravings. A companion volume to "The Children's Album," by UNCLE JOHN. Cloth gilt, 3s. 6d.
- The Story of Robin Hood.** Illustrated with Eight Plates printed in Colours. Cloth, 3s. 6d.
- The True Robinson Crusoes.** A Series of Stirring Adventures. Edited by CHAS. RUSSELL. Cloth gilt, 3s. 6d.
- The Merrie Heart.** A Collection of Nursery Rhymes and Short Tales. Illustrated with Eight Coloured Plates from Designs by WALTER CRANE, and numerous smaller Engravings by J. SWAIN, from Drawings by ERNEST GRISET, F. BARNARD, and others. Cloth gilt, 3s. 6d.
- Off to Sea.** By W. H. G. KINGSTON. With Eight Coloured Plates by KRONHEIM. Cloth gilt, 3s. 6d.
- The Children's Album.** Containing Coloured Frontispiece and nearly 200 Engravings, with Short Stories, by UNCLE JOHN. With several Pieces of Music. Twenty-sixth Thousand. 3s. 6d.
- Old Burchell's Pocket: A Book for the Young Folks.** By ELIHU BURRITT. 3s. 6d.
- Peggy, and other Tales; including the HISTORY of a THREEPENNY BIT, and THE STORY of a SOVEREIGN.** 3s. 6d.
- Mince-Pie Island: A Christmas Story for Young Readers.** By R. ST. JOHN CORBET. 3s. 6d.
- Cloudland and Shadowland; or, Rambles into Fairy Land with Uncle White Cloud.** 3s. 6d.
- The Queen of the Tournament, and Butterfly Ball at Maperley Hall.** By the Author of "Mince-Pie Island." 3s. 6d.
- Lily and Nannie at School: A Story for Girls.** By the Author of "The Little Warringtons." 3s. 6d.
- The Magic of Kindness; or, The Wondrous Story of the Good Huan.** By the Brothers MAYHEW. With Eight Plates by WALTER CRANE. Cloth gilt, 3s. 6d.
- On a Coral Reef: A Sea Story for Boys.** By ARTHUR LOCKER. Cloth gilt, 3s. 6d.
- King Gab's Story Bag; and the Wondrous Tales it contained.** By HERACLITUS GREY. With Eight Plates by WALTER CRANE. 3s. 6d.
- Crocker the Clown: A Tale for Boys.** By B. CLARKE, Editor of "Kind Words." 3s. 6d.
- Hours of Sunshine: A Series of Poems for Children.** By MATTHIAS BARR, Author of "Little Willie," &c. With Sixteen Coloured Plates from Designs by OSCAR PLETSCH. 3s. 6d.
- Playing Trades.** By HERACLITUS GREY, Author of "King Gab," &c. With Sixteen Coloured Plates from Designs by J. BARFOOT. 3s. 6d.
- The Happy Nursery.** By ELLIS A. DAVIDSON. Containing Designs for Toys, New Games, &c. Cloth gilt, 3s. 6d.
- The Angel of the Iceberg.** And other Stories. By JOHN TODD, D.D. (New Edition.) 3s. 6d.
- Drawing-Room Plays.** Gilt edges, 3s. 6d.
- Famous Regiments of the British Army.** By WILLIAM H. DAVENPORT ADAMS. 320 pp. Four Illustrations and Coloured Frontispiece. 3s. 6d.

The Children's Library—continued.

- Will Adams: The Adventures of the First Englishman in Japan.** By WILLIAM DALTON. 3s. 6d.
- Working Women of this Century: The Lesson of their Lives.** By CLARA LUCAS BALFOUR. 436 pp. 3s. 6d.

ONE SYLLABLE SERIES.

Uniform with the Children's Library.

- Æsop's Fables,** in Words of One Syllable. With Eight Illustrations printed in Colours by KRONHEIM. 3s. 6d.
- Sandford and Merton,** in Words of One Syllable. With Eight Illustrations printed in Colours by KRONHEIM. 3s. 6d.
- Reynard the Fox; the Rare Romance of, and the Shifts of his Son Reynardine.** In Words of One Syllable. By SAMUEL PHILLIPS DAY. With Eight Coloured Illustrations by KRONHEIM, from Designs by ERNEST GRISET. 3s. 6d.
- The Pilgrim's Progress.** Written in Words of One Syllable by S. PHILLIPS DAY. With Eight Coloured Illustrations by KRONHEIM. 3s. 6d.
- The Swiss Family Robinson,** in Words of One Syllable. By the Author of "The Boy's First Reader." Eight Coloured Illustrations from Designs by GRISET, CRANE, &c. 3s. 6d.
- Evenings at Home,** in Words of One Syllable. By the Author of "The Children's Album." Eight Coloured Illustrations from the Designs of DOWNARD, BAYES, &c. 3s. 6d.

Five Shilling Books.

- Home Chat with Our Young Folks.** By CLARA MATEAUX, Author of "The Story of Don Quixote," &c. &c. With 200 Illustrations.
- The Story of Don Quixote.** By CLARA MATEAUX. Re-narrated in a familiar manner, especially adapted for Young Readers, and illustrated with numerous Engravings. Crown 8vo.
- Robinson Crusoe, Life and Adventures of.** New Edition. Cloth plain, 5s.; full gilt, 6s. 6d.
- Swiss Family Robinson.** New Edition, complete. Cloth plain, 5s.; full gilt, 6s. 6d.
- A Voyage to the South Pole.** A New Story. By W. H. G. KINGSTON. Profusely Illustrated.
- Scraps of Knowledge for the Little Ones.** By JANET BYRNE, Author of "Picture Teaching."
- Picture Teaching for Young and Old.** A Series of Object Lessons Progressively Arranged, so as to teach the meaning of every term employed. With more than 200 Illustrations.
- Picture Natural History.** A Series of Plates numbering upwards of 600, in which the Animal, Vegetable, and Mineral Kingdoms are classified in Families. With Descriptive Letterpress. Edited by the Rev. C. BOUTELL, M.A.
- Old Friends and New Faces.** Demy 4to. Twenty-four Coloured Plates by KRONHEIM. 1s.

Six Shilling Books.

- Esther West.** By ISA CRAIG-KNOX. With Twenty-four full-page Illustrations.
- Peoples of the World.** By BESSIE PARKES-BELLOC. With about Fifty Engravings. Cloth gilt.
- Little Songs for Me to Sing.** Illustrated by J. E. MILLAIS, R.A.; with Music composed expressly for the work by HENRY LESLIE. Dedicated to Her Royal Highness the PRINCESS OF WALES, by Special Permission.
- The Story of Captain Cook.** By M. JONES. With about Fifty Engravings. Cloth gilt.

Seven and Sixpenny Books.

- Bright Thoughts for the Little Ones.** Twenty-seven Original Drawings by PROCTER. With Prose and Verse by GRANDMAMMA. Cloth gilt, gilt edges, 7s. 6d.
- The Child's Garland of Little Poems: Rhymes for Little People.** With exquisite Illustrative Borders by GIACOMELLI. Cloth gilt, 100 pp. fcap. 4to, 7s. 6d.
- Favourite Poems by Gifted Bards.** Illustrated, cloth gilt, 7s. 6d.
- Beauties of Poetry and Gems of Art.** With 32 Illustrations, cloth gilt, 7s. 6d.
- Jewels Gathered from Painter and Poet.** Cloth gilt, gilt edges, 7s. 6d.

Dictionaries.

Bible Dictionary, Cassell's. With 600 illustrations. One or Two Volumes, 21s.; bound in morocco, 40s.

Biographical Dictionary, Cassell's. 1,160 pages, imp. 8vo. Illustrated with Portraits. Cloth, 21s.; half morocco or calf, 35s.

Brewer's Dictionary of Phrase and Fable; giving the Derivation, Source, or Origin of Common Phrases, Allusions, and Words that have a Tale to Tell. By the Rev. Dr. BREWER. Demy 8vo., 1,000 pp., cloth, 10s. 6d.

Dictionary of the English Language, A. 16th Edition. 3s. 6d.

French and English Pronouncing Dictionary. Crown 8vo, 956 pp., cloth, 3s. 6d.

German-English and English-German Pronouncing Dictionary. Crown 8vo, cloth, 864 pp., 3s. 6d.)

Latin-English and English-Latin Dictionary. By J. R. BEARD, D.D., and C. BEARD, B.A. Cloth, 914 pp., 3s. 6d.

Illustrated National Dictionary, The, on the basis of Webster. With 250 Engravings. Crown 16mo, 1s.

Webster's Etymological Dictionary. 3s. 6d.

Dictionary of Derivations, The. By Professor SULLIVAN, LL.D. 11th Edition. 2s.

Educational Works.

Algebra, Elements of. Paper covers, 1s.; cloth, 1s. 6d.

Anatomical Atlas, The. Designed and Printed in Colours from Nature. Royal folio, with Index, 10s. 6d.

Arithmetic.

Hudson's Arithmetic for School and College Use. With a copious Collection of Exercises, and Key. 1s. 6d.

Wallace's Arithmetic. Cloth, 1s. 6d.

Arithmetic for the Young. Cloth, 1s.

Elementary Arithmetic. Simple Rules. 4d. Key to Ditto, 3d.

Elementary Arithmetic. Compound Rules. 6d. Key to Ditto, 3d.

Book-Keeping, by Single and Double Entry. 1s. Ruled Account Books to Ditto, extra, 1s. 6d. each Set.

Book-Keeping for the Million. By THEODORE JONES. Cloth, 3s.

Book-Keeping for Schools. The English System. By THEODORE JONES. 2s.; cloth, 3s.

Book-Keeping for Schools, The Key to. 2s.; cloth, 3s.

Books for Jones's System, Ruled Sets of. 2s.

Brewer's Series of First Books. Price 6d. each.

Reading and Spelling.
Bible History.
History of England.
Geography.
Science.
Common Things.

French History.
Astronomy.
Chemistry.
Facts and Discoveries.
Grecian History.
The History of Rome.

Brewer's, The Young Tutor. First Series. Being the First Six Books in this Series, bound in One Volume. Cloth, 3s. 6d.

Brewer's, The Young Tutor. Second Series. Being the latter Six Books in this Series, bound in One Volume. Cloth, 3s. 6d.

Brewer's Guide to Every-Day Knowledge. 284 pp., 2s. 6d.

Cassell's Drawing Books, for Joiners, Carpenters, Machinists, Builders, Cabinet Makers, Stonemasons, Tin-plate Workers, Plumbers, and Artisans generally.

Linear Drawing. By E. A. DAVIDSON. With 150 Illustrations. 128 pp., extra fcap. 8vo, cloth limp, 2s.

Orthographic and Isometrical Projection. By the same Author. With 40 whole-page Diagrams. 128 pp., extra fcap. 8vo, cloth limp, 2s.

Linear Drawing and Projection. The Two Volumes in One. Cloth, lettered, 3s. 6d.

Building Construction, the Elements of, and Architectural Drawing. By ELLIS A. DAVIDSON. With 130 Illustrations. Extra fcap. 8vo, 128 pp., cloth limp, 2s.

Systematic Drawing and Shading. By CHARLES RYAN, Head Master, Leamington School of Art. With numerous Illustrations and Drawing Copies. 120 pp., extra fcap. 8vo, cloth limp, 2s.

Drawing for Carpenters and Joiners. By ELLIS A. DAVIDSON. With 253 Illustrations and Drawing Copies. 104 pp., extra fcap. 8vo, cloth, 3s. 6d.

Practical Perspective. By ELLIS A. DAVIDSON. With 36 double-page Illustrations. 90 pp., cloth, 3s.

Drawing for Machinists. By ELLIS A. DAVIDSON. With nearly 200 Illustrations and Diagrams. Extra fcap. 8vo, cloth, 4s. 6d.

Cassell's Elementary Atlas. 16 Coloured Maps. Fcap. 4to, 6d.

Cassell's Preparatory Atlas. 16 Coloured Maps. Crown 4to, 6d.

Cassell's First School Atlas. Coloured Maps. Crown 4to, 1s.

Cassell's Handy Atlas. 24 Coloured Maps, and Index. Crown 8vo, cloth, 2s. 6d.

Cassell's Beginner's Atlas. 24 Coloured Maps, and Index. Crown 4to, cloth, 2s. 6d.

Cassell's Introductory Atlas. 18 Coloured Maps, and Index. Cloth, 3s. 6d.

Cassell's Select Atlas. 23 Coloured Maps, and Index. Imperial 8vo, cloth, 5s.

Cassell's Comprehensive Atlas. 42 Coloured Maps, and Index. 10s. 6d.

Chemistry. Specially adapted for the use of Self-Students. Cloth, 1s.

Educational Works—continued.

Chemistry, Elementary. By the Rev. H. MARTYN HART. 290 pp., crown 8vo, cloth, 3s. 6d.

Copy-Books for Schools, Cassell's. With Set Copies on every page. 14 sorts. Price 2d each.

- | | |
|------------------------------|-----------------------------------|
| 1. Initiatory Exercises. | 9. Small Hand. |
| 2. Letters and Combinations. | 10. Text, Round, and Small Hands. |
| 3. Short Words. | 11. Introduction to Ladies' Hand. |
| 4. Capitals. | 12. Ladies Hand. |
| 5. Text Hand. | 13. Commercial Sentences. |
| 6. Text and Round. | 14. Figures. |
| 7. Round Hand. | |
| 8. Round and Small Hands. | |

** These Books are now very largely used in Schools, and have been described as the *cheapest* and *best* ever published.

Drawing Copies, Cassell's Popular.

- Series A. **Floral and Vegetable Forms.** Twelve Parts, 6d. each. Twelve Packets, on Cardboard, 1s. each.
- Series B. **Model Drawing.** Twelve Parts, 6d. each. Twelve Packets, on Cardboard, 1s. each.
- Series C. **Landscape Drawing.** Twelve Parts, 6d. each. Twelve Packets, on Cardboard, 1s. each.
- Series D. **Figure Drawing.** Twelve Parts, 6d. each. Twelve Packets, on Cardboard, 1s. each.
- Series E. **Animal Drawing.** Twelve Parts, 6d. each. Twelve Packets, on Cardboard, 1s. each.

The Drawing Copies, in 6d. Parts, and 1s. Packets on Cardboard, may be had in separate Parts or Packets.

Drawing Copies.

- Gregory's First Grade Self-teaching Free-hand Outline Drawing Examples.** By CHARLES GREGORY, Wolverhampton (Master of the Art Classes at the Willenhall Literary Institute, &c. &c.). In Two Packets, each containing Twenty-four Examples, on Card, price 1s. per Packet. Enlarged for black-board, 2s. 6d. per Packet.
- Gregory's Outlines from Models used in Schools,** on Twelve Cards, 1s.; and enlarged for black-board, 2s.
- Gregory's Outlines from Flowers.** Twelve large Cards, in Packet, 1s. 6d.
- Gregory's Easy Drawing Examples.** Twenty-four Cards, in Packet, 1s.; enlarged for black-board, 2s. 6d.
- First Examples in Freehand Drawing.** By WALTER SMITH. Price 2s.
- The School of Art Model and Object Drawing Book.** By WALTER SMITH, Head Master of the Leeds School of Art and Science. Price 3s.

English Grammar. By Professor SULLIVAN, LL.D. 85th Edition. 1s.

Etymology, a Manual of. By Professor SULLIVAN, LL.D. 3rd Edition. 10d.

English Spelling and Reading Book. With upwards of Fifty Illustrations, cloth, 1s.

Euclid, Cassell's. Edited by Professor WALLACE, A.M., of the Glasgow University. 1s.; cloth, 1s. 6d. Key to Ditto, 4d.

French, Cassell's Lessons in. By Professor FASQUELLE. New Edition, Revised and Improved. By Professor DE LOLME. Parts I. and II. in paper, 2s.; cloth, each 2s. 6d. Complete in One Volume, 188 pp., 4s. 6d.

French, Key to the Exercises in Cassell's Lessons in. 1s.; cloth, 1s. 6d.

French, Shilling Lessons in. By Professor DE LOLME. 1s.; cloth, 1s. 6d.

French, Sixpenny Lessons in. 6d.

French Manual. By Professor DE LOLME. Cloth, 3s.

French and English Correspondence for Boys. 2s. 6d.

French and English Correspondence for Young Ladies. 2s. 6d.

French and English Commercial Correspondence. 2s. 6d.

French Reader, The. New Edition. By Professor DE LOLME. Paper, 2s.; cloth, 2s. 6d.

Galbraith and Haughton's Scientific Manuals. Cloth, red edges.

- Arithmetic. Cloth, 3s. 6d.
- Plane Trigonometry, 2s. 6d.
- Euclid. Elements I., II., III. 2s. 6d.
- Euclid. Books IV., V., VI. 2s. 6d.
- Mathematical Tables. 3s. 6d.
- Mechanics. Cloth, lettered. 3s. 6d.
- Optics. 2s. 6d.
- Hydrostatics. 3s. 6d.
- Astronomy. 5s.
- Steam Engine. 3s. 6d.
- Algebra. Third Edition. Part I., 2s. 6d.; complete, 7s. 6d.
- Tides and Tidal Currents. New Edition, with Tidal Cards. 3s.
- Natural Philosophy. With 160 Illustrations. 3s. 6d.
- The Three Kingdoms of Nature. With 230 Illustrations. 5s.

Geography, Ancient, Modern, and Sacred. By Professor SULLIVAN, LL.D. 1s.

Geography Generalised; with Maps and Illustrations. By Professor SULLIVAN, LL.D. 2s.

German Reader, The International, for the Use of Colleges and Schools. By EDWARD A. OPPEN, of Haileybury College. 4s. 6d.

German, Lessons in. By W. H. WOODBURY. Parts I. and II., 2s.; cloth, each 2s. 6d. Complete in One Volume, cloth, 4s. 6d.

German, Key to Lessons in. 1s.; cloth, 1s. 6d.

German, Sixpenny Lessons in. By E. A. OPPEN, of Haileybury College. 6d.

Latin Reader, The. Adapted to "Cassell's Latin Grammar." Cloth, 1s. 6d.

The Literary Class Book. By Professor SULLIVAN, LL.D. 11th Edition. 2s. 6d.

Natural History of Commerce, The. By J. YEATS, LL.D. Intended for the study of Young Merchants, Manufacturers, and Business Men. 452 pp., crown 8vo, cloth, 5s.

Natural Philosophy, the Elements of. For the use of Schools. By the Rev. SAMUEL HAUGHTON, M.D., F.R.S., Fellow of Trinity College, Dublin. With 160 Illustrations. Cloth, 3s. 6d.

Natural Philosophy, in Easy Lessons. By Professor TYNDALL, F.R.S. Illustrated. New Edition, 2s. 6d.

Natural Philosophy, Hand-book of. Cloth, 1s.

Educational Works—continued.**Popular Education and School-keeping.**

By Professor SULLIVAN, LL.D. Second Edition. 2s.

Popular Educator, Cassell's New. Revised to the Present Date, with numerous Additions. Vols. I., II., III., IV., V., and VI. now ready, best cloth gilt, 6s. each; complete in Three Vols., half-calf, £2 10s.

Primary Series. An entirely new and original Series of Volumes, specially prepared for the use of Elementary, National, and other Schools, by first-class practical men.

Elementary Arithmetic: Simple Rules. 4d.
Key to ditto, 3d.

Elementary Arithmetic: Compound Rules. 6d.
Key to ditto, 3d.

Elementary British History. 6d.

Elementary Geography. 4d.

England at Home: An Elementary Text-Book of Geography, Manufacture, Trade, and Commerce. 1s.

Our Bodies: An Elementary Text-Book of Human Physiology. 1s.

Our Houses, and what they are Made of. 1s.

Our Food. 1s.

Our First Grammar: an Elementary Text-Book. 1s.

The Uses of Plants in Food, Arts, and Commerce. With Illustrations. 1s.

Vegetable Physiology, in Easy Lessons, with numerous Illustrations. 1s. 6d.

The Animal Kingdom. With abundant Illustrations. Double Vol., cloth, lettered, 200 pp. 2s.

Primary Series—continued.

Right Lines in their Right Places; or, Geometry without Instruments. With Drawings on Wood by the Author. 1s.

CASSELL'S STANDARD READERS.

The Boy's First Reader. Standard I. With easy Spelling Exercises. Illustrated. 4d.

The Boy's Reader. Standard II. Containing Lessons in Reading and Spelling. With many Illustrations. 4d.

The Girl's First Reader. Standard I. With easy Spelling Exercises. Illustrated. 4d.

The Girl's Reader. Standard II. Containing Lessons in Reading and Spelling. Illustrated. 4d.

The Boy's and Girl's Reader. Standard III. Adapted to the Requirements of the Revised Code. Cloth, 7d.

The Boy's and Girl's Reader. Standard IV. 9d.

The Poetical Reader. Standard V. 208 pp., fcap 8vo., cloth. 1s.

The Explanatory Reader. Standard VI. Cloth, 1s.

Science Popularly Explained. Cloth, 3s. 6d.

The Spelling-Book Superseded. By Professor SULLIVAN, LL.D. 1s. 4d.

Upwards of Four Hundred Words, Spelled in Two or More Ways by different Authors; with an Attempt to Settle their Orthography. By Professor SULLIVAN, LL.D. 10d.

Fine Art Volumes.

Æsop's Fables. With numerous Illustrations from Original Designs by ERNEST GRISET. Imperial 8vo, 236 pp., cloth gilt, gilt edges, 21s.

After Ophir. By Captain A. F. LINDLEY. Illustrated with about Sixty Engravings. Cloth gilt, 7s. 6d.

Arms and Armour. By CHARLES BOUTELL, M.A., Author of "English Heraldry." With numerous Engravings. 7s. 6d.

Beauties of Poetry and Gems of Art. With Thirty-two Illustrations by J. C. HORSLEY, R.A., J. TENNIEL, C. W. COPE, R.A., PICKERSGILL, &c. With Ornamental Borders, &c. 7s. 6d.

Book of Historical Costumes, The. With 96 full-page Coloured Engravings. 50s.

British Army, The History of the. By Sir SIBBALD DAVID SCOTT, Bart. Dedicated, by special permission, to the Queen. Two Vols., 1,178 pp., demy 8vo, cloth, £2 2s.

Bunyan. The Pilgrim's Progress. Cloth, 7s. 6d.; gilt edges, 10s. 6d.; morocco antique, 21s.

Bunyan. The Holy War. Uniform with above, and same price.

Chefs-d'œuvre of the Industrial Arts. With 200 Illustrations. By PHILIPPE BURTY. Edited by W. CHAFFERS, F.S.A. Cloth, 16s.; extra cloth gilt, 21s.

Crusoe, Life and Adventures of. With 100 Illustrations by MATT MORGAN, HARRISON WEIR, R. P. LEITCH, &c. Cloth, 7s. 6d.; full gilt, 10s. 6d.; morocco, 21s.

Doré Gallery, The. Containing 250 of the finest Drawings of GUSTAVE DORÉ. Letterpress and Memoir by EDMUND OLLIER. Cloth gilt, £5 5s.; full morocco elegant, £10.

Doré Bible (see Biblical Literature).

Doré's Milton's Paradise Lost. Illustrated with full-page Drawings by GUSTAVE DORÉ. Cloth, £5; best polished morocco, gilt extra, £10.

Doré's Dante's Inferno. Cloth £2 10s.; morocco antique, with gilt edges, £4 4s.; full morocco, £6 6s.

Doré's Dante's Purgatory and Paradise. Uniform with the INFERNO, and same price.

Doré's Don Quixote. With 400 Illustrations. Cloth, £1 10s.; half morocco, £2 5s.; full morocco antique, £3 10s.

Doré's Atala. By CHATEAUBRIAND. Cloth, £2 2s.; morocco gilt, £4 4s.

Doré's La Fontaine's Fables. With 86 full-page and many other Engravings. Cloth, £1 10s.; half morocco, £2 5s.; full morocco antique, £3 10s.

Doré's, The History of Croquemitaine, and the Times of Charlemagne. With nearly 200 Engravings. Cloth, £1 1s.

Doré's Fairy Realm. Illustrated with 25 full-page Engravings by GUSTAVE DORÉ. Cloth gilt, gilt edges, £1 1s.

Doré's, The Adventures of Munchausen. With 31 full-page Engravings. Cloth, 10s. 6d.

Fine Art Volumes—continued.

- Doré's, The Legend of the Wandering Jew.** Folio, 15s.; extra gilt, 21s.
- English Heraldry.** By CHARLES BOUTELL, M.A., Author of "Arms and Armour," &c. With 460 Engravings. Cloth, gilt top, 7s. 6d.
- Favourite Poems by Gifted Bards.** Illustrated with 24 Engravings, by CORBOULD, THOMAS, SELOUS, and other eminent Artists. Cloth, gilt edges, 7s. 6d.
- Foxe's Book of Martyrs.** Illustrated with 181 Engravings. Plain cloth, 12s.; full gilt cloth, gilt edges, 15s.
- Goethe Gallery.** A Series of beautiful Photographs from KAULBACH'S Drawings of the Heroines of Goethe. Handsomely bound in morocco, 42s.
- Goethe's Heroines.** A Series of 21 exquisite Engravings on Steel. Cloth, lettered, £7 7s.
- Greece, The Scenery of.** By W. LINTON. Fifty exquisitely beautiful full-page Steel Engravings. Cloth, lettered, gilt edges, 42s.
- Gulliver's Travels.** By DEAN SWIFT. Illustrated with 88 Engravings by MORTEN. With an Introduction, Annotations, and a LIFE OF SWIFT, by J. F. WALLER, LL.D., M.R.I.A. Imperial 8vo, 400 pp., plain cloth, 7s. 6d.; full gilt cloth, gilt edges, 10s. 6d.; full morocco antique, 21s.
- Illustrated Readings.** Vol. I., cloth gilt, 7s. 6d.; full gilt, gilt edges, 10s. 6d. Vol. II., cloth, 7s. 6d.; full gilt, gilt edges, 10s. 6d. Or the Two Vols. in One, cloth, 12s. 6d.; half morocco, 15s.
- Illustrated Travels:** a Record of Discovery, Geography, and Adventure. Edited by H. W. BATES, Assistant-Secretary of the Royal Geographical Society. Vols. I. and II., each, cloth, 15s.; cloth, extra gilt, gilt edges, 18s. Or, the Two Vols. in One, cloth, 25s.; best cloth, gilt edges, 31s. 6d.; Roxburgh binding, 35s.
- Illustrations, Millais'.** A Collection of 80 Drawings on Wood by JOHN EVERETT MILLAIS, R.A. Cloth, gilt edges, 16s.
- Insect World, The.** From the French of LOUIS FIGUIER. With 570 Illustrations. Edited by E. W. JANSEN, Lib. E.S. Cloth, lettered, 16s.; extra cloth gilt, 21s.
- Jewels Gathered from Painter and Poet.** Cloth, gilt edges, 7s. 6d.
- Log of the Fortuna, The.** By Captain A. F. LINDLEY. Fcap. 4to, 256 pp., cloth gilt, 7s. 6d.
- Ocean World, The.** From the French of LOUIS FIGUIER. Edited by C. O. G. NAPIER, F.G.S. Cloth, lettered, 16s.; extra cloth gilt, 21s.
- Old Friends with New Faces.** With 24 full-page Illustrations, beautifully printed in Colours by KRONHEIM. 5s.
- Pictures from English Literature.** With 20 full-page Illustrations by J. C. HORSLEY, R.A., W. F. YEAMES, A.R.A., MARCUS STONE, J. GILBERT, H. K. BROWNE, W. CAVE THOMAS, LAWSON, HUGHES, BARNARD, FILDES, &c. &c. The Text by Dr. WALLER. Crown 4to, cl. gilt, 21s.
- Poems and Pictures.** Very handsomely bound in extra cloth gilt, 21s.
- Reptiles and Birds.** From the French of LOUIS FIGUIER. Edited by PARKER GILMORE, Esq. 18s.; extra cloth gilt, 23s.
- Sacred Poems, The Book of.** Edited by the Rev. R. H. BAYNES, M.A. Cl., plain, 7s. 6d.; cl., extra gilt, gilt edges, 10s. 6d.; morocco antique, 21s.
- Schiller Gallery, The.** A Series of Choice Photographs from KAULBACH'S Paintings of Scenery from SCHILLER. £5 5s.
- Selection of One Hundred of the Finest Engravings by the late G. H. Thomas.** Cloth, gilt, 21s.
- Thorwaldsen's Triumphal Entry of Alexander the Great into Babylon.** Twenty-Two Plates, folio. 42s.
- Vegetable World, The.** With 471 Illustrations. From the French of LOUIS FIGUIER. Edited by C. O. G. NAPIER, F.G.S. Cloth, lettered, 16s.; extra cloth gilt, 21s.
- Vicar of Wakefield, The, and POEMS.** Beautifully printed on Toned Paper, and Illustrated with 108 Engravings. In one handsome imperial 8vo Volume, 378 pp., bound in cloth, 7s. 6d.; full gilt cl., with gilt edges, 10s. 6d.; full morocco antique, 21s.
- World before the Deluge, The.** With 233 Illustrations. From the French of LOUIS FIGUIER. Edited by H. W. BRISTOW, F.R.S. Cloth, lettered, 16s.; extra cloth gilt, 21s.
- World of the Sea.** With 18 Coloured Plates, and numerous Wood Engravings. Cl., lettered, 21s.

Hand-Books and Guides.

- Bacon's Guide to America and the Colonies.** With Maps, &c. Cloth, 2s. 6d.
- Civil Service, Guide to Employment in the.** Revised to the Present Time. Cloth, 2s. 6d.
- Civil Service, Guide to the Indian.** By A. C. EWALD, F.S.A. Cloth, 4s. 6d.
- Guide to America for the Capitalist, Tourist, or Emigrant.** By G. W. BACON, F.R.S. With Coloured Map, 1s.
- Hand-Books, Cassell's Popular.** Cloth, 1s. each; free by post for 13 stamps.
- | | |
|--|--|
| <p>Art of Conversation.</p> <p>Book - Keeping, by Single and Double Entry.</p> | <p>Ruled Account Books to do., extra, 1s. 6d. each set.</p> <p>Business.</p> |
|--|--|
- Chemistry.**
- Chess and Draughts.**
- Domestic Pets.**
- Domestic Recipes.**
- Drawing - Room Magic.**
- Elocution and Oratory.**
- Emergencies.**
- Etiquette for Ladies and Gentlemen.**
- Gardening.**
- Health & Physiology.**
- How to Colour a Photograph in Oil or Water.**
- Investments.**
- Letter-Writing.**
- Natural Philosophy.**
- Photography.**
- Railway Situations.**
- Household Guide, The—**
- Vol. I., with Two Coloured Plates, and 150 Illustrations. Cloth gilt, 6s.
- Vol. II., with Two Coloured Plates, and numerous Illustrations. Cloth gilt, 6s.
- Thames and Tweed—New Work on Fishing.** By GEORGE ROOPER, Author of "Flood, Field, and Forest." 2s. 6d.

History.

England, Illustrated History of. Complete in Eight Volumes, bound in cloth, 6s. and 7s. 6d. each. Ditto, Four Volumes, strongly bound in half-calf, with full gilt backs and cloth sides, £4. The TONED PAPER EDITION, Volumes I., II., III., IV., and V. Cloth, each 9s.

England, History of, from the First Invasion by the Romans to the Accession of William and Mary in 1688. By JOHN LINGARD, D.D. In Ten Volumes. Cloth lettered, 35s.

History of the British Army. By Sir S. D. SCOTT, Bart. Two Vols. 100 Plates. 42s.

Miscellaneous.

A Poet-Hero. By COUNTESS VON BOTHMER. Being a Biography of the German War-Poet, Theodore Körner. Cloth, 10s. 6d.

Appropriation of the Railways by the State. By ARTHUR JOHN WILLIAMS, Barrister at Law. The People's Edition. Crown 8vo, 1s.

Arms and Armour, in Antiquity and the Middle Ages; also a Descriptive Notice of Modern Weapons. Translated from the French of M. P. LACOMBE, by CHARLES BOUTELL, M.A., Author of "English Heraldry." With Seventy-one Illustrations. Cloth, gilt top, 7s. 6d.

Belle Sauvage Library, The. Price 3s. 6d. per Vol., cloth, fcap. 8vo.

1. Pulpit Table Talk. By DEAN RAMSEY, M.A.
2. The Search for the Grail. By JULIA GODDARD.
3. Sermons for Boys. By the Rev. ALFRED BARRY, D.D., Principal of King's College.
4. The Life of Bernard Palissy, of Saintes. By HENRY MORLEY.
5. The Young Man in the Battle of Lifo. By Dr. LANDELS.

Burritt, Elihu. Thoughts and Notes at Home and Abroad. Cloth, 6s.

Cassell's Magazine. Vol. I., New Series, containing "Man and Wife," by WILKIE COLLINS. 600 pp. of Letterpress and Engravings. Cloth, gilt lettered, 6s. 6d.

Daybreak in Spain. By the Rev. Dr. WYLIE. Being the first account that has yet appeared of the extraordinary reformation now going on in Spain, written with all the power and truthfulness of an eye-witness. Crown 8vo, 424 pp., with Twelve Illustrations. 6s.

History of the Pianoforte. By EDGAR BRINSMEAD. Illustrated. Cloth, 3s.

Natural

Cassell's Brehm's Book of Birds. Translated from the Text of Dr. BREHM by T. RYMER JONES, F.R.S. Monthly Parts, 7d., and Volumes, crown 4to, cloth plain, 7s. 6d.; extra cloth gilt, 10s. 6d. each. Vol. I. contains Ten Coloured Plates and 384 pp. letterpress, with numerous Illustrations.

Figuer Series, The.

The World before the Deluge. With 233 Illustrations. Cloth, lettered, 16s.; extra cloth gilt, £1 1s.

The Vegetable World. With 471 Illustrations. Cloth, lettered, 16s.; extra cloth gilt, £1 1s.

The Ocean World. With 427 Illustrations. Cloth, lettered, 16s.; extra cloth gilt, £1 1s.

The Insect World. With 576 Illustrations. Cloth, lettered, 16s.; extra cloth gilt, £1 1s.

Birds and Reptiles. With 307 Illustrations. Cloth, lettered, 18s.; extra cloth gilt, £1 3s.

Hood's Works. Vols. I., II., III., and IV., each containing 464 pp., and numerous Illustrations. Cloth, 5s. each.

Little Gem Series, The. Bound in cloth, 6d. each; red edges, 9d. each.

Shall we Know One Another? By the Rev. J. C. RYLE.

The Voice of Time. By J. STROUD.

Home Religion. By the Rev. W. B. MACKENZIE, M.A.

Penny Library of Popular Authors.

1. Foxe's Book of Martyrs. Price 1d.
2. Bunyan's Pilgrim's Progress. Price 1d.

Practical Poultry Keeper, The. By L. WRIGHT. Fourth Edition. With 36 Plain Illustrations. Cloth, 5s.; with 12 Coloured ditto, ditto, crown 8vo, 6s. 6d.

Quiz, Sketches by. Illustrated by "PHIZ." Cloth, 3s. 6d.

San Juan Water Boundary Question. By VISCOUNT MILTON, M.P. Cl., lettered, 10s. 6d.

The Stock Feeder's Manual. By Dr. CAMERON. Cloth, 5s.

Woman: Her Position and Power. By W. LANDELS, D.D. Being Essays on the social and moral position of Woman, her influence, duties, &c. Cloth, lettered, 5s.

Wonders, Library of. Fully Illustrated. A Series of Gift Books and School Rewards. Cloth gilt, gilt edges, each 5s.

Wonders of Animal Instinct.

Wonders of Bodily Strength and Skill.

Wonders in Acoustics.

Wonderful Balloon Ascents.

Wonderful Escapes.

Wonders of Architecture.

World of Wonders, The. With 130 Illustrations. Cloth, 7s. 6d.; full gilt, 10s. 6d.

History.

The Transformations of Insects. (*Insecta, Myriapoda, Arachnida, and Crustacea.*) By P. MARTIN DUNCAN, F.R.S., Secretary of the Geological Society, and Professor of Geology, King's College, London. Being an Adaptation, for English readers, of M. EMILE BLANCHARD'S "Metamorphoses, Mœurs et Instincts des Insectes;" and a compilation from the works of NEWPORT, CHARLES DARWIN, SPENCE BATE, FRITZ MULLER, PACKARD, and others. Illustrated with 50 full-page, and numerous other highly-finished Engravings. Royal 8vo, 500 pp., handsomely bound in cloth gilt, 16s.

World of the Sea. Translated from the French of MOQUIN TANDON, by the Rev. H. M. HART. With 18 Coloured and Tinted Plates, and numerous Wood Engravings. Best cloth, lettered, 21s.

Natural History—*continued.*

Natural History, Picture. Edited by the Rev. C. BOUTELL, M.A. With 600 Illustrations. Cloth, lettered, 7s. 6d.

Natural History, Cassell's Popular. Complete in Two Volumes, cloth, 30s. Do., Two Volumes, half-calf, full-gilt back, 45s. Do., Two Volumes, half-morocco, full-gilt, 50s. Do., with Coloured Illustrations, Four Volumes, cloth, 42s.

Poetry and the Drama.

Barr's Poems. New and Revised Edition. Cloth, 5s.

Book of Sacred Poems. With about 200 Illustrations. Edited by the Rev. R. H. BAYNES, M.A. Cloth, 7s. 6d.; full gilt, 10s. 6d.; morocco, 21s.

Bright Thoughts for the Little Ones. With Twenty-seven Original Drawings by PROCTER. Cloth, lettered, gilt edges, 7s. 6d.

Child's Garland of Little Poems, The. With exquisite Illustrative Borders by GIACOMELLI. Cloth gilt, 7s. 6d.

Favourite Poems by Gifted Bards. With Twenty-four Illustrations. Cloth, gilt edges, 7s. 6d.

Golden Leisures. By W. GORDON SMYTHIES. 1s.

Hours of Sunshine. By MATTHIAS BARR, Author of "Little Willie," &c. With Sixteen Coloured Plates. Cloth gilt, 3s. 6d.

Jewels Gathered from Painter and Poet. Cloth, gilt edges, 7s. 6d.

Poets, Cassell's Three-and-Sixpenny

Editions of the. In fcap. 8vo, printed on Toned Paper, elegantly bound in cloth, extra gold and colours, 3s. 6d. each; best morocco, inlaid with enamel letter-piece, 6s. 6d. each. LONGFELLOW; SCOTT; BYRON; MOORE; WORDSWORTH; COWPER; MILTON; POPE; BURNS; THE CASSET OF GEMS; BOOK OF HUMOROUS POETRY; BALLADS, SCOTTISH AND ENGLISH; LIVES OF THE BRITISH POETS.

Poems and Pictures. With 100 Illustrations. Cloth gilt, gilt edges, 21s.

Shakespeare, Cassell's Illustrated. With 500 Illustrations. Imperial 8vo. Edited by CHARLES and MARY COWDEN CLARKE. Vol. I. (COMEDIES), 12s.; Vol. II. (HISTORICAL PLAYS), 10s. 6d.; Vol. III. (TRAGEDIES), 12s. 6d. The Complete Work, in Three Volumes, cloth lettered, uniform, £1 15s. Half morocco, £2 10s. The Separate Plays may be had, price 1s. each.

Travel and Adventure.

Illustrated Travels: a Record of Discovery, Geography, and Adventure. Edited by H. W. BATES, Assistant-Secretary of the Royal Geographical Society. Vols. I. and II., each, cloth, 15s.; cloth, extra gilt, gilt edges, 18s. Or, the Two Vols. in One, cloth, lettered, 25s.; best cloth gilt., 31s. 6d.; bound in Roxburgh, 35s.

North-West Passage by Land, The.

By Viscount MILTON, M.P., &c., and W. B. CHEADLE, M.A., M.D. Cantab., F.R.G.S. 21s. Ditto, ditto, smaller edition, complete, 6s.

Thoughts and Notes at Home and Abroad. By ELIHU BURRITT. Crown 8vo, 320 pp., cloth, 6s.

Serial Publications.

BOOK OF BIRDS. Monthly, 7d.

CASSELL'S MAGAZINE. Monthly, 6d.; Weekly, 1d.

BRITISH POETS. Monthly, 6d.

FAMILY BIBLE. Monthly, 7d.; Weekly, 1½d.

POPULAR EDUCATOR. Monthly, 7d.; Weekly, 1½d.

TECHNICAL EDUCATOR. Monthly, 7d.; Weekly, 1½d.

DORE DON QUIXOTE. Monthly, 7d.; Weekly, 1½d.

HOUSEHOLD GUIDE. Monthly, 7d.; Weekly, 1½d.

THE QUIVER. Monthly, 6d.; Weekly, 1d.

CHILD'S BOOK OF SONG AND PRAISE. Monthly, 6d.; Weekly, 1d.

MATTHEW HENRY'S COMMENTARY. Monthly, 7d.; Weekly, 1½d.

DORE BIBLE. Monthly, 2s. 6d.

ILLUSTRATED TRAVELS. Monthly, 1s.

HISTORY OF ENGLAND. Monthly, 7d.; Weekly, 1½d.

RAILWAY TIME TABLES AND TRADES DIRECTORY. Monthly, 2d.

Annuals, Almanacks, &c.

HENRY LESLIE'S MUSICAL ANNUAL for 1871. 5s.

THE HOUSEHOLD RECORD for 1871. Paper, 1s.; cloth, 1s. 6d.

MORTON'S FARMER'S ALMANACK for 1871. 1s.

CASSELL'S ILLUSTRATED ALMANACK for 1871. 6d.

THE SILVER BOW: Being THE QUIVER Christmas Annual for 1870. 6d.

Now Ready, price 2s. 6d.

Cassell, Petter, & Galpin's New Illustrated Catalogue for 1870:

Containing nearly ONE HUNDRED SELECTED ENGRAVINGS, from Designs by DORÉ, GRISSET, T. MORTEN, W. CAVE THOMAS, MISS EDWARDS, G. H. THOMAS, F. BARNARD, &c. Printed on Fine Paper. Folio, with Coloured Frontispiece.

* * For detailed particulars of all the Works inserted in the foregoing List, consult CASSELL, PETTER, and GALPIN'S DESCRIPTIVE CATALOGUE, supplied by all Booksellers, and forwarded post free by the Publishers.

BELLE SAUVAGE YARD, LONDON; & 596, BROADWAY, NEW YORK. 136



**PLEASE DO NOT REMOVE
CARDS OR SLIPS FROM THIS POCKET**

UNIVERSITY OF TORONTO LIBRARY

BioMed

