

REINFORCED CONCRETE CONSTRUCTION

VOLUME III

BRIDGES AND CULVERTS

**REINFORCED
CONCRETE CONSTRUCTION**

IN THREE VOLUMES

BY

GEORGE A. HOOL, S. B.

**ASSOCIATE PROFESSOR OF STRUCTURAL ENGINEERING
THE UNIVERSITY OF WISCONSIN**

-
- VOL. I. —FUNDAMENTAL PRINCIPLES**
254 *pages*, 6×9, 88 *illustrations*..... \$2.50
- VOL. II. —RETAINING WALLS AND BUILDINGS**
675 *pages*, 6×9, 412 *illustrations*, 34 *plates* \$5.00
- VOL. III.—BRIDGES AND CULVERTS**
688 *pages*, 6×9, *over 600 illustrations*, 41
plates..... \$5.00

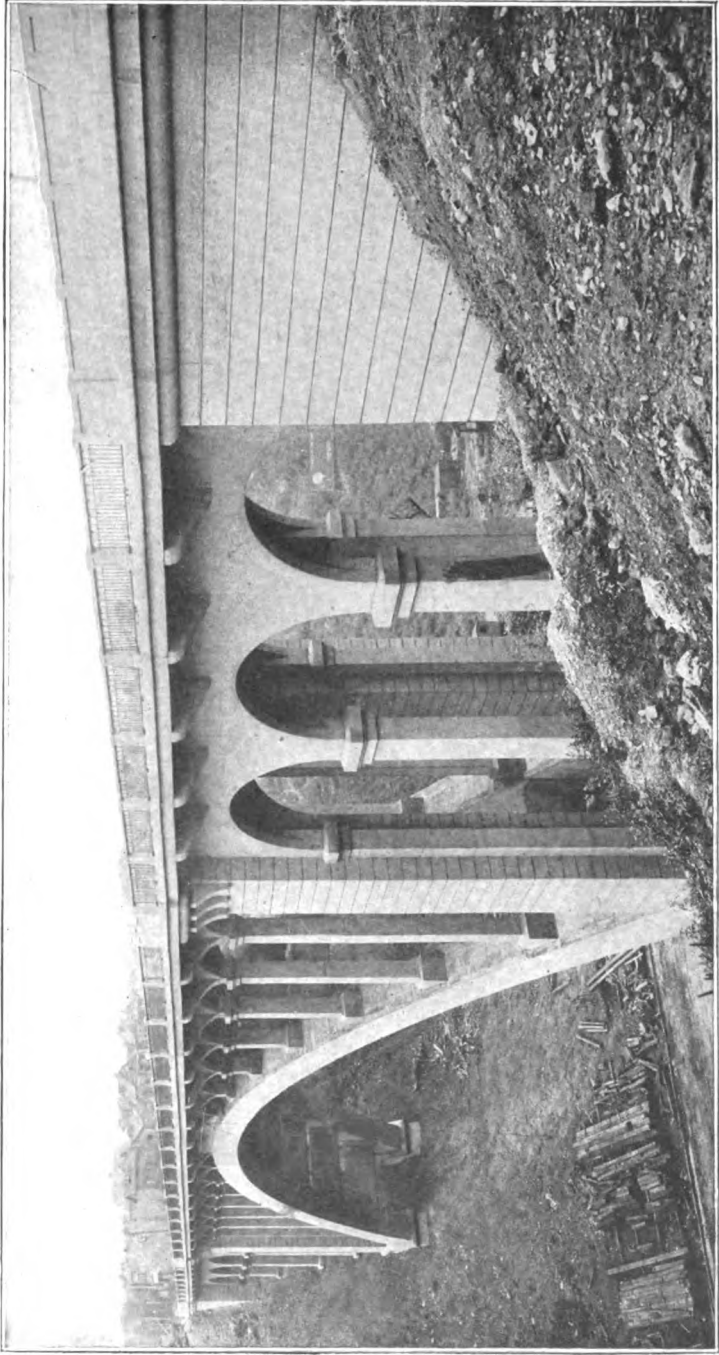

Courtesy of Mr. A. M. Wolf, Prin. Asst. Eng'r., Condron Co., Chicago...
Larimer Avenue bridge, Pittsburgh, Pa.

Frontispiece

ENGINEERING EDUCATION SERIES

REINFORCED CONCRETE CONSTRUCTION

VOLUME III. BRIDGES AND CULVERTS

PREPARED IN THE
EXTENSION DIVISION OF
THE UNIVERSITY OF WISCONSIN

BY
GEORGE A. HOOL, S. B.
ASSOCIATE PROFESSOR OF STRUCTURAL ENGINEERING
THE UNIVERSITY OF WISCONSIN

ASSISTED BY
FRANK C. THIESSEN, B. S.
INSTRUCTOR IN STRUCTURAL ENGINEERING
THE UNIVERSITY OF WISCONSIN

WITH CHAPTERS BY
A. W. RANSOME, LESLIE H. ALLEN,
W. M. J. TITUS, ALBERT M. WOLF,
PHILIP AYLETT AND P. J. MARKMANN

AND ARTICLES BY
A. C. JANNI AND S. W. BOWEN

FIRST EDITION

McGRAW-HILL BOOK COMPANY, Inc.
239 WEST 39TH STREET, NEW YORK
6 BOUVERIE STREET, LONDON, E. C.
1916

THE NEW YORK
PUBLIC LIBRARY
731029
ASTOR, LENOX AND
TILDEN FOUNDATIONS
R 1916 L

COPYRIGHT, 1916, BY THE
MCGRAW-HILL BOOK COMPANY, INC.

NOV 20 1916
MCGRAW-HILL
NEW YORK

THE MAPLE PRESS YORK PA

PREFACE

This volume on reinforced concrete construction was originally planned to treat of practically all the various types of reinforced-concrete structures not receiving consideration in Volumes I and II. The number of requests, however, for a comprehensive text on the analysis and design of arch bridges has made it desirable to devote an entire volume to bridges and culverts alone, and to leave the treatment of the remaining structures to a fourth volume to appear at some future time.

The students enrolled in the correspondence-study courses in reinforced concrete in the Extension Division of The University of Wisconsin are, for the greater part, engineers in active practice throughout the country, and most of the requests above mentioned have come directly from these students who all appear to desire a text-book, treating of arch bridges, which will be neither too complex nor too much abbreviated for the average engineer to readily understand the methods set forth, and, on the other hand, will be sufficiently comprehensive to enable the reader to properly analyze and design any form of reinforced-concrete arch. The present volume is an attempt to meet the needs of the students by omitting intricate mathematical analyses involving the calculus; by avoiding mathematical sign language wherever it is found possible; and by including complete methods of design of both symmetrical and unsymmetrical arches, not only of single span, but of multiple spans with elastic piers. Two entirely different methods of arch analysis are presented in order that a check may be had on all arch computations. As in the previous volumes, an effort has been made to gain clearness by careful arrangement of the subject matter and by numerous drawings and photographs. This volume when used for correspondence-study instruction is intended to be supplemented with such material as is suited to the special needs of the individual student. If used in residence classes, the attention of the students should be frequently called to the typical designs of arch bridges in Chapter XIII.

Problems to be solved by the student are not included in this text, as in the two volumes preceding. This omission may seem somewhat inconsistent, but it is due to the fact that many of

the problems on arch bridges used at the present time in the Extension courses of this University have not been tried out a sufficient length of time to be sure that no further changes are necessary to put them in the best form for teaching purposes.

The author is greatly indebted to Messrs. A. W. Ransome, Leslie H. Allen, Wm. J. Titus, Albert M. Wolf, Philip Aylett, and P. J. Markmann for the chapters in Parts IV, V, VI, VII, and VIII, respectively. These chapters were included to give the student valuable reading matter not otherwise available, and incidentally to put the finishing touches to the chapters prepared by the writer. In a few matters, varying opinions are expressed because the book is the work of several authors, but such differences are not serious and should serve to broaden the student's viewpoint.

The author is under obligation to Mr. Frank C. Thiessen for many helpful suggestions and for his excellent work in the making of all drawings for illustrations. The author is also under obligation to Mr. Wm. J. Fuller for the checking of a number of the Designing Sheets and for the computations and plotting of curves connected with the preparation of the diagrams in Chapter V.

Many thanks are due to a large number of engineers who have supplied data for this book and have generously given their views in regard to both theory and practice. Special thanks are here given to Mr. A. C. Janni for his help in the preparation of Chapter VIII. The author also desires to acknowledge the kindness of Mr. S. W. Bowen for his contribution to Chapter XI.

In the preparation of certain chapters of this volume valuable help has been obtained from the engineering journals and from various other sources. Due acknowledgment for this help is given in the proper chapters, but the writer wishes in particular to declare his indebtedness to "Principles of Reinforced Concrete Construction" by Turneaure and Maurer (Copyright 1907, 1909, by F. E. Turneaure and E. R. Maurer); "Design of an Arch System by the Method of the Ellipses of Elasticity," by A. C. Janni (Journal of the Western Society of Engineers, May, 1913); "The Determination of Internal Temperature Range in Concrete Arch Bridges," by C. S. Nichols and C. B. McCullough (Bulletin No. 30, Engineering Experiment Station, Iowa State College of Agriculture and Mechanic Arts); "The Theory of Loads on Pipes in Ditches," by Professor A. Marston and A. O. Anderson (Bulletin No. 31, Engineering Experiment Station, Iowa State

College of Agriculture and Mechanic Arts); and "Tests on Reinforced-concrete Culvert Pipe" by Professor Arthur N. Talbot (Bulletin No. 22, Engineering Experiment Station, University of Illinois).

Due recognition is here given to the following engineers and engineering companies for the use of plans and photographs (acknowledgments for the use of material in Parts VII and VIII are given in detail in each of these sections): Aberthaw Construction Co., A. N. Johnson, A. P. Linton, Assoc. Portland Cement Mfgs., Blaw Steel Construction Co., Brenneke and Fay, C. A. P. Turner, C. B. McCullough, Charles A. Byers, Chas. W. Cole, Chester and Fleming, C. H. Purcell, Daniel B. Luten, E. A. Gast, E. C. L. Wagner, Eugene M. Webster, E. W. Robinson, Frank L. Raschig, Frank W. Buffum, Greiner and Whitman, H. C. Lothholz, Hedrick and Cochrane, Horton Concrete Construction Co., Hugo Eichler, J. A. Ferguson, J. J. Yates, John F. Skinner, J. R. Worcester, Koehring Machine Co., Lehigh Portland Cement Co., Link Belt Co., Louis P. Wolff, Maro Johnson, Marquette Cement Mfg. Co., McKenzie Construction Co., Morton Macartney, M. W. Torkelson, N. S. Sprague, O. F. Lackey, R. A. Rutledge, Raymond Concrete Pile Co., Robert A. Cummings, Sandusky Portland Cement Co., Strauss Bascul Bridge Co., T. E. Rust, T. L. Smith Co., Universal Portland Cement Co., Waddell and Harrington, Walter Braun, W. C. Giffels, Wilbur J. Watson, William Hunter, Wm. E. Beilharz, and Wm. M. Thomas.

G. A. H.

THE UNIVERSITY OF WISCONSIN,
MADISON, WISCONSIN,
September 1, 1915.

GENERAL NOTATION
USED IN PART I OF THIS VOLUME
IS ALSO LISTED IN THE APPENDIX



TABLE OF CONTENTS

PART I ARCH BRIDGE

CHAPTER I

GENERAL DATA

ART.	PAGE
1. Definitions	2
2. Curve of the intrados	3
Three-centered curve	4
Semi-ellipse	5
Parabola	6
3. Arrangement of spandrels	6
4. Selection of the most suitable intrados	9
5. Piers and abutments	10
6. Depth of filling at crown	14
7. Loads	14
8. Empirical rules for thickness of arch ring	18
9. Classification of arch rings	19

CHAPTER II

DEFLECTION OF CURVED BEAMS

10. Angular change	20
11. Components of deflection	22

CHAPTER III

ANALYSIS OF THE SYMMETRICAL ARCH BY THE ELASTIC THEORY

12. General discussion	25
13. Notation	27
14. Formulas for thrust, shear, and moment	28
15. Division of arch ring for constant $\frac{s}{I}$	32
16. Loadings to use in computations	34
17. Internal temperature investigations	34
Internal range in temperature	35
Heat generated in setting	35
Temperature variation	36
Effect of atmospheric temperature	37
Lag	37

Art.		Page
	Agreement with theory	38
	Conclusions as to necessary provision for temperature changes	38
18.	Shrinkage stresses due to setting	38
19.	Deflection at any point	41
20.	Reliability of the elastic theory	42
21.	Method of procedure in arch-ring design	42
22.	Skew arches.	43

CHAPTER IV

DESIGN OF AN EARTH-FILLED ARCH BRIDGE

23.	Data	44
24.	Selection of the trial arch	45
25.	Dead loads and their action lines	45
26.	Approximate method of testing trial arch	46
27.	Division of arch ring for constant $\frac{s}{l}$	48
28.	Moments and thrusts	48
29.	Combining of moments and thrusts	52
30.	Maximum stresses	53
31.	Design of abutments	54
32.	Design of spandrel walls	57

CHAPTER V

USE OF INFLUENCE LINES IN ARCH ANALYSIS

33.	Advantage of using influence lines	67
34.	Analysis of an arch ring in open-spandrel construction	67

CHAPTER VI

UNSYMMETRICAL ARCHES

35.	Method of analysis	86
36.	Examples of computations in unsymmetrical arch analysis	88

CHAPTER VII

ARCHES WITH ELASTIC PIERS

37.	Method of analysis	97
38.	Analysis of a two-span arch bridge with pier elastic	104

CHAPTER VIII

ARCH ANALYSIS BY THE METHOD OF THE ELLIPSE OF ELASTICITY

39.	Preliminary considerations pertaining to the method of treating the symmetrical arch	107
-----	---	-----

TABLE OF CONTENTS

xv

ART.	PAGE
40. Properties of the ellipse	114
41. Properties of the center of gravity of static moments	117
42. Determination of the ellipse of elasticity	118
43. Graphical constructions for finding moments and products of inertia of the elastic weights	121
44. Method of analyzing <i>symmetrical</i> arches for loading only	124
45. Method of analyzing <i>unsymmetrical</i> arches for loading only	129
46. Temperature and rib-shortening	131
47. Analysis of a symmetrical arch—by A. C. Janni, C. E.	134
48. Method of analyzing a series of arches with deformable supports	148

CHAPTER IX

DETAILS OF ARCH BRIDGES

49. Spandrel details in earth-filled bridges	157
50. Spandrel details in open-spandrel bridges	176
51. Piers and abutments	178
52. Railing and ornamental details	178

CHAPTER X

CONSTRUCTION OF ARCH BRIDGES

53. Arch-ring construction	182
54. Centering	196
Timber centers	198
Steel centers	218
Suspended systems	224
55. Forms	228

CHAPTER XI

THREE-HINGED ARCHES

56. General discussion	245
57. Methods of analysis	245
Common method	246
Influence-line method	250
58. Types of hinges	250
59. Methods of construction	252
60. Details of design	254
61. Design of a three-hinged arch—by S. W. Bowen, C. E.	260

CHAPTER XII

PATENTS

62. Patents in general	269
63. Patents pertaining to arch bridges	271
64. Patent litigation	281

CHAPTER XIII

TYPICAL DESIGNS OF THE VARIOUS TYPES OF ARCH BRIDGES
(Pages 285 to 355 inclusive)

PART II

SLAB AND GIRDER BRIDGES

CHAPTER XIV

SLAB BRIDGES

ART.		PAGE
65.	Slabs under concentrated loading	358
66.	Slab bridges of single span	364
67.	Slab bridges of multiple spans.	370
	Concrete pile trestles	370
	Pier trestles	374
	Trestles with framed bents.	377
	Cantilever flat-slab construction	377

CHAPTER XV

SIMPLE GIRDER BRIDGES

68.	Deck girders	380
69.	Through girders	390

CHAPTER XVI

CONTINUOUS GIRDER BRIDGES

70.	Durability of monolithic construction.	394
71.	Details of design.	394
72.	Examples of typical bridges of the continuous girder type.	395

CHAPTER XVII

CANTILEVER BRIDGES

73.	Theory of design.	403
74.	Examples of cantilever bridges.	404

CHAPTER XVIII

REINFORCED CONCRETE IN STEEL BRIDGE CONSTRUCTION

75.	Concrete floors on steel bridges	410
76.	Reinforced-concrete abutments for steel bridges	414

PART III

CULVERTS

CHAPTER XIX

FACTORS IN CULVERT DESIGN

ART.	PAGE
77. Culvert efficiency	417
78. Waterway required.	418
79. Length of culverts	419
80. Design of ends.	419

CHAPTER XX

PIPE CULVERTS

81. Pressure in trenches	422
82. Strength of pipe	430
83. Circular culverts cast in place	436

CHAPTER XXI

BOX CULVERTS

84. Forms of box culverts	438
85. Loading.	439
86. Design of cross-section	440
87. Construction	446

CHAPTER XXII

ARCH CULVERTS

88. Design of cross-section	449
89. Forms	452

PART IV

NOTES ON CONSTRUCTION PLANT

BY A. W. RANSOME

CHAPTER XXIII

HANDLING MATERIALS

90. Aggregates	453
91. Cement.	457
92. Water	459

CHAPTER XXIV

MIXING

ART.	PAGE
93. Hand mixing	462
94. Machine mixing	464

CHAPTER XXV

TRANSPORTING OF CONCRETE

95. The use of barrows or carts	470
96. Spouting plants	471
97. Hoists	476

PART V

NOTES ON ESTIMATING

BY LESLIE H. ALLEN

CHAPTER XXVI

ESTIMATING BRIDGES

98. General considerations	479
99. Examples of typical estimates	481
Arch bridge estimate	481
Beam-and-girder bridge estimate	485

CHAPTER XXVII

ESTIMATING CULVERTS

100. Typical estimate	490
---------------------------------	-----

PART VI

THE ARTISTIC DESIGN OF CONCRETE BRIDGES

BY WM. J. TITUS

CHAPTER XXVIII

PRESENT STATUS OF THE ART

101. City bridges	493
102. Bridges in country districts	494
103. Influences affecting design	494

TABLE OF CONTENTS

xix

CHAPTER XXIX

MAIN FEATURES IN DESIGN

Art.	Page
104. Principles of design.	496
105. The proper use of material	496
106. Symmetry	497
107. Style.	498
108. Harmony.	499
109. Harmony of material.	499
110. Harmony of form	500
111. Harmony of dimension	505

CHAPTER XXX

ORNAMENTATION

112. The purpose of ornamentation.	508
113. The piers	508
114. The abutments	509
115. The arch-ring and spandrel walls.	509
116. The pilasters	513
117. The retaining walls.	515
118. The spandrel coping	515
119. The railing	517
120. Parts of the railing.	519
121. Pedestals over piers and abutments	524
122. Special features	525

PART VII

THE CONSTRUCTION IN DETAIL OF SEVERAL TYPES OF CONCRETE BRIDGES

by ALBERT M. WOLF

CHAPTER XXXI

CONSTRUCTION OF THE YARDLEY BRIDGE

123. General plant layout	529
124. Construction methods	531
125. Excavation for piers	531
126. Pier forms	533
127. Concreting piers.	536
128. Abutment construction.	538
129. Cableway.	538
130. Umbrella sections	538
131. Umbrella forms	539
132. Arch centers.	540

TABLE OF CONTENTS

ART.	PAGE
133. Concreting arches	543
134. Spandrel forms	545
135. Expansion joints in spandrels	545
136. Concreting spandrels	545
137. Surface treatment	546
138. Waterproofing	546

CHAPTER XXXII

CONSTRUCTION OF THE TUNKHANNOCK CREEK VIADUCT

139. General design	548
140. Construction methods	551
141. General excavation	553
142. Cofferdam excavation	554
143. Special methods of pier excavation	558
144. Concrete plant	559
145. Derricks and cableway	559
146. Pier construction	560
147. Details of arch rib centers	565
148. Erection of centering	568
149. Constructing arch ribs	570
150. Special methods used in constructing arch No. 6	571
151. Spandrel construction	572

CHAPTER XXXIII

CONSTRUCTION OF UNIT-BUILT CONCRETE PILE TRESTLES

152. Details of design	575
153. Casting piles	577
154. Fabrication of pile reinforcement	577
155. Concrete plant	578
156. Handling piles	579
157. Driving piles	579
158. Capping pile bents	583
159. Casting slabs	583
160. Handling and placing slabs	583

CHAPTER XXXIV

CONSTRUCTION OF CONCRETE SLAB BRIDGES FOR TRACK-ELEVATION
SUBWAYS

161. General design	585
162. Construction of abutments and piers	586
163. Construction of slabs	587
164. Concrete plant	588
165. Drainage and waterproofing	590

TABLE OF CONTENTS

xxi

CHAPTER XXXV

CONSTRUCTION OF THE NORTH SAMUELS AVENUE VIADUCT, FORT WORTH, TEXAS

ART.	PAGE
166. Excavation	593
167. Piling	593
168. Forms for piers and abutments	594
169. Concrete work on piers and abutments	597
170. Forms and centering for superstructure.	598
171. Placing reinforcement	602
172. Methods of concreting superstructure.	602
173. Progress chart.	603
174. Surface finish	604
175. Expansion joints.	604
176. Concrete railings or parapets	605

PART VIII

EUROPEAN CONCRETE BRIDGES

BY PHILIP AYLETT AND P. J. MARKMANN

CHAPTER XXXVI

EUROPEAN VS. AMERICAN PRACTICE

177. General discussion	608
178. The scientific element	610
Theory	611
Hinge construction.	611
"Free-ring" construction	614
Cellular construction.	616
"Unit" or subdivided erection.	618
Bow-string and open-web (cored) girders	619
Special construction features	622
Rigidity and connections of reinforcement.	622
Temperature influence and expansion devices.	622
Drainage and waterproofing	626
Bearings.	629
Special falsework and erection features	632
Tests	633
179. The esthetic element.	636
Selection of design	639
Architectural form	648
Emphasis or accentuation	650
Combinations of concrete with stone, brick, and concrete blocks	654
European methods of surface finish and texture.	657

ART.	PAGE
Ornamental detail	669
180. The economic element	659

CHAPTER XXXVII

HINGES OF ARCHED CONCRETE BRIDGES

181. Stone and concrete hinges.	663
Examples	667
182. Hinges of lead and asphalt-felt plates.	668
183. Hinges of iron	671
Pin bearings as hinges.	674
Flexural hinges.	676

REINFORCED CONCRETE CONSTRUCTION

PART I

ARCH BRIDGES

INTRODUCTION

A concrete arch as ordinarily constructed—that is, with fixed ends—is statically indeterminate, but it can be analyzed by taking into account the elasticity of the material. The arch ring is nothing more than a curved beam and is so considered.

In arches of stone, it is essential (if we disregard, as we should, the adhesion between the mortar and the stone) that the line of pressure for any possible loading should pass within the middle third of each joint of the arch ring, in order to avoid a tendency for any joint to open. In arches of concrete, however, the structure considered may be made monolithic and thus capable of withstanding tension, which means that the line of pressure may pass outside of the middle third without endangering the structure. As regards a plain-concrete arch, no variation of the line of pressure from the middle third should properly be allowed in practice, due, of course, to the low strength of concrete in tension but, on the other hand, where concrete is reinforced with steel, a considerable variation of this line may be permitted.

It would seem from purely theoretical considerations that but little could be gained by the use of reinforcement in a concrete arch since the direct compression usually controls to such an extent that the allowable stress in the concrete permits of but a small unit tensile stress in the steel. From a broader viewpoint, however, it is clear that the steel adds greatly to the reliability of the construction and makes possible a higher working stress in the concrete than could properly be employed in the design of plain-concrete structures. Higher working stress produces a

thinner arch ring, and consequently less dead load and lighter abutments. Undoubtedly, a large saving may result from this cause in the case of long-span arches.

A considerable portion of an arch ring is subject to both positive and negative moments, and for this reason the reinforcement should be placed, for some distance at least, near both upper and lower surfaces. The general practice is to carry both rows of steel throughout the entire span thereby eliminating any possibility of failure due to an inadequate provision for tensile stresses. On account of the heavy compressive stress in arch rings, the upper and lower reinforcement should be tied together to prevent buckling.

Before the elastic theory can be applied to arch design, either the dimensions of the arch ring must be assumed outright or the thickness at the crown made to conform to some empirical formula. With the arch thus approximately designed, the stresses may then be computed by the elastic theory. If the computed stresses are found to be greater than is considered safe, the dimensions must be altered and the arch tested again.

The percentage of longitudinal steel in arch rings is to a certain extent arbitrary. An amount of steel between $\frac{1}{2}$ and $1\frac{1}{2}$ per cent of the ring at the crown seems to be good practice in the ordinary full-barrel arch ring design although the exact amount depends upon the loading and the form of arch selected, and must be finally tested by computation. Transverse rods at right angles to the longitudinal are generally used to prevent cracks in the concrete and to distribute the loads laterally. Web reinforcement is not required in ordinary construction.

Three-hinged arch construction is being looked upon with some favor at the present time. This type of arch will be treated in Chapter XI.

CHAPTER I

GENERAL DATA

1. Definitions.—The following are some of the common technical terms applied to the various parts of an arch. (See Figs. 1A and 1B.)

Soffit.—The under or concave surface of an arch.

Back.—The upper or convex surface of an arch.

Skewback.—The surface upon which the end of the arch rests.

This definition applies particularly to the stone or brick arch since the surface mentioned is purely imaginary in the case of the concrete arch. The term, however, is useful in concrete-arch analysis.

Springing Line.—The line in which the soffit meets pier or abutment—that is, the inner edge of the skewback.

Span.—The horizontal distance between springing lines measured parallel to the center line of roadway.

Intrados.—The line of intersection of the *soffit* with a vertical plane taken parallel to the center line of roadway.

Extrados.—The line of intersection of the *back* with a vertical plane taken parallel to the center line of roadway.

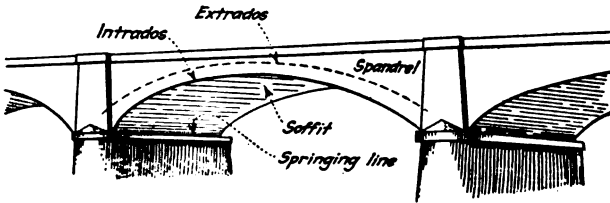

FIG. 1A.

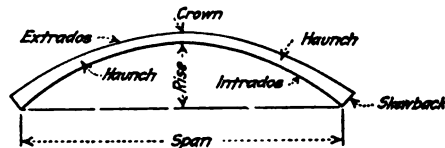

FIG. 1B.

Crown.—The highest part of the arch ring.

Rise.—The height of intrados at crown above level of springing lines.

Haunch.—The portion of the arch ring about midway between the springing line and crown.

Spandrel.—The space between the back of arch and the roadway.

Arches are divided into *right* arches and *skew* arches, depending upon the angle made by the springing lines with the center line of roadway. A *right* arch is one that makes this angle exactly 90° .

2. Curve of the Intrados.—The form or general outline of an arch is the first consideration in its design. According to the curve of the intrados, arches are usually divided into circular,

multi-centered, elliptical, and parabolic. If the intrados is a semicircle, the arch is a semicircular arch; and, if the intrados is less than a semicircle, it is a segmental arch. A multi-centered arch is one in which the intrados is composed of several arcs of circles tangent to each other. Semicircular and semi-elliptical arches are full centered—that is, they spring from horizontal beds—while segmental and parabolic arches spring from inclined beds called skewbacks. (See Fig. 1B.) Multi-centered arches may have beds either inclined or horizontal. The parabola may be modified for the sake of appearance by short circular curves at its ends, made tangent to the parabola and to the vertical side of the pier or abutment. Minor curves joining the arch soffit to the pier are not effective, however, and should not be considered as part of the arch rise.

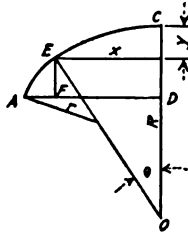

FIG. 2.

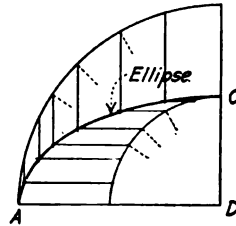

FIG. 3.

Three-centered Curve.—A segmental arch cannot often be used to advantage, for it seldom can be made to fit the line of pressure. The three-centered arch is perhaps the most common for solid-spandrel construction and gives a pleasing and generally an economical design. The formula for the radius of a circular segment when the chord distance (span) and mid-ordinate (rise) of the segment are known, is as follows:

$$\text{Radius} = \frac{(\frac{1}{2} \text{ chord})^2 + (\text{mid-ordinate})^2}{2 \times \text{mid-ordinate}}$$

Following are the formulas for the radii of a three-centered curve. See Fig. 2.)

$$R = \frac{x^2 + y^2}{2y}$$

$$r = \frac{1}{2} \frac{\overline{AF}^2 + \overline{FE}^2}{FE \cos \theta - AF \sin \theta}$$

Semi-ellipse.—The multi-centered curve can be made to approximate an ellipse. Entirely graphical methods of obtaining the semi-ellipse and corresponding approximate multi-centered curves are as follows:

Let AD and CD (Fig. 3) be the semi-major and semi-minor axes, respectively, of the ellipse. With D as a center, draw circular arcs with radii AD and CD . From points where a common radius intersects the two circular arcs, draw vertical and horizontal ordinates. The intersection of these ordinates gives one point on the ellipse. Other points may be found in a similar manner.

Suppose now that a three-centered intrados is required which

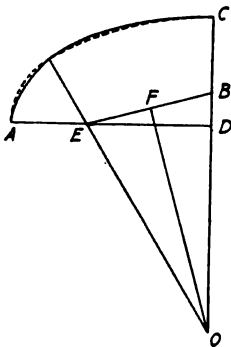

FIG. 4.

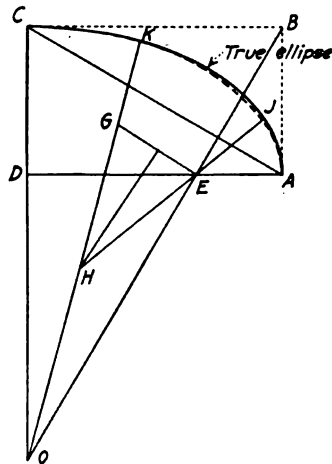

FIG. 5.

approximates a true ellipse. The form of the true ellipse is first drawn by the method given above and is shown in Fig. 4 by the full line. The approximate form, shown dotted, is what is required. Assume any two equal distances CB and AE more than one-half of the semi-minor axis. Join BE and bisect the line BE at F . Through F draw a perpendicular to BE , intersecting the line CD at O . The two points O and E will be centers of two circular arcs which will form an approximate ellipse. By first selecting the position of the point E so that the circular arc described from E as center will conform as closely as possible with the true ellipse, satisfactory curves will easily be found.

The method of drawing an approximate ellipse using a five-

centered curve will now be explained. In order to have a check on the work, it is advisable to first draw the form of the true ellipse by the method given above. Let AD and CD (Fig. 5) be the given semi-axes. Join A and C , and through B draw a perpendicular to AC , determining E and O , two of the centers. From O , with OC as radius, draw an arc CK as long as thought suitable, and join K with O . Make KG equal to AE . Join E and G . At the center of EG draw a perpendicular to EG , and note its intersection H with KO . From H , with radius HK , draw an arc to HE (extended); and from E , with EA as radius, complete the curve.

Parabola.—The equation of the parabola, Fig. 6, is as follows:

$$y = \frac{x^2b}{a^2}$$

Divide the line OR into any number of convenient equal parts, and number the points of division 1, 2, 3, etc., beginning at the

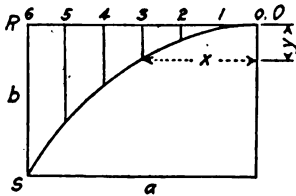

FIG. 6.

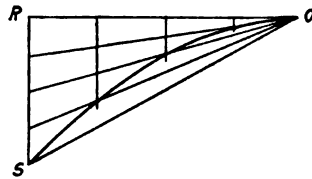

FIG. 7.

point nearest O . Then to find the values of y , for the various abscissas x , the numbers 1, 2, 3, etc., should be inserted in the above equation for values of x , and the total number, which in the illustration is 6, should be inserted for the value of a .

A very simple graphical method of drawing the parabola is to lay off on the vertical line RS , Fig. 7, the same number of equal divisions as are made on the horizontal axis OR , and from O draw radiating lines to the various division points on the vertical axis RS . From the various points on the horizontal line OR draw vertical lines intersecting the radiating lines from O . The points of intersection of these vertical lines with corresponding radiating lines are points on the required parabolic curve.

3. Arrangement of Spandrels.—Arch spandrels may be entirely filled with earth (Figs. 8A, 8B, and 8C), or they may be left more or less open and the roadway supported on a series

of transverse walls (Figs. 9A, 9B, and 9C), or on a complete superstructure of columns, girders, beams, and slabs (Figs. 10A, 10B, and 10C). If, as is rarely the case, a heavy or massive appearance is desired in open-spandrel construction, then side curtain walls may be used and all spandrel openings closed (Fig. 10D). In the open-spandrel type, the arch ring may be either solid or composed of two or more longitudinal ribs. Other features of open-spandrel construction are shown in Figs. 10E and 10F.

With filled spandrels, the filling material is held in place laterally by retaining walls which rest upon the arch ring. These



Courtesy of Universal Portland Cement Co.

FIG. 8A.—Highway bridge at Ellerton, Ohio.

retaining walls may be of either the gravity or the reinforced type, or they may consist of thin vertical slabs tied together by reinforced-concrete cross walls. Solid fillings increase the weight of the superstructure and make necessary thicker arch rings and larger foundations. Open-spandrel construction, on the other hand, requires a relatively larger amount of form work. At the present cost of labor and materials in this country, the filled type of arch spandrel is preferable from the standpoint of economy for all arches of moderate rise with spans less than about 100 ft. and also for flat arches of greater span where the ratio of rise to span is not more than one-tenth. Fortunately, a proper artistic appearance is usually obtained in satisfying these economical requirements.



Courtesy of Mr. Daniel B. Luten, Consulting Engineer, Indianapolis.

FIG. 8B.—Georgetown bridge over Wabash River, Georgetown, Indiana.



Courtesy of Universal Portland Cement Co.

FIG. 8C.—Earth-filled arch bridge at South Bend, Indiana.

4. Selection of the Most Suitable Intrados.—The length of span and curve of an arch are often determined by physical conditions. Ample waterway must be provided for over streams and, if possible, piers and abutments should be located where the cost of foundations is a minimum. Sufficient clearances, also, must be allowed over roadways. These and other conditions

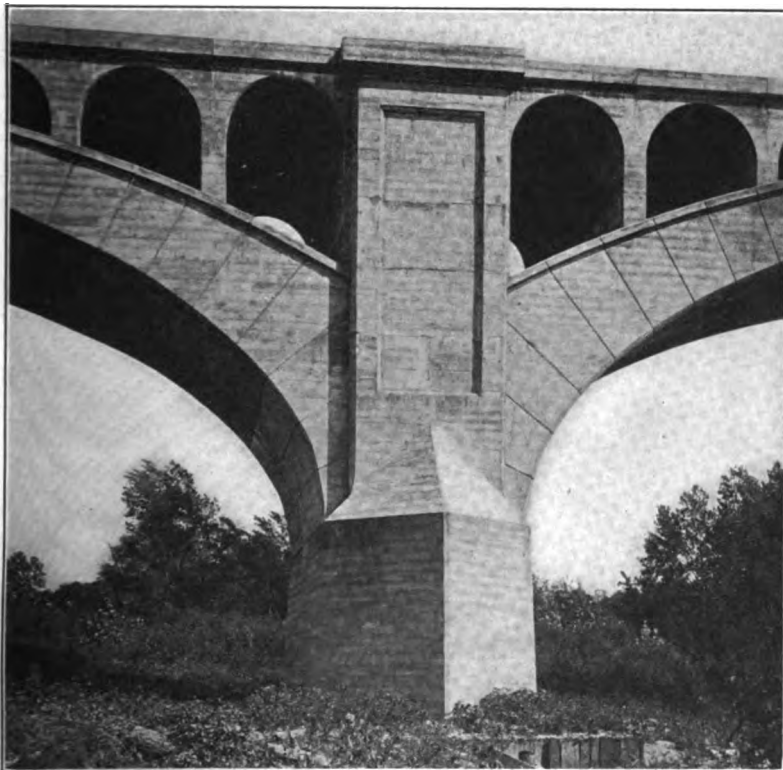

Courtesy of Assoc. American Portland Cement Mfrs.

FIG. 9A.—Detailed view of spandrel arches in railroad construction.

may compel the selection of an arch curve which will not be the best from the standpoint of economy.

If outside considerations are not taken into account, a parabolic form of intrados should be used for a uniform load on the horizontal projection, which is closely the case for an arch having spandrel columns or spandrel arches. For earth-filled arches having a ratio of rise to span *greater* than one-fourth, an ellipse should be used. For earth-filled arches having a ratio of rise to

span of *less* than one-fourth, the most economical curve lies between a circular segment and an ellipse and may be approximated by a three-centered intrados.

5. Piers and Abutments.—The springing lines, or springs of an arch, should be located as near the foundation as conditions will permit. This will often make possible a less expensive design for the abutments and, where piers are employed, will reduce the overturning effect on the piers to a minimum.

In the case of long bridges with a series of arches, what are

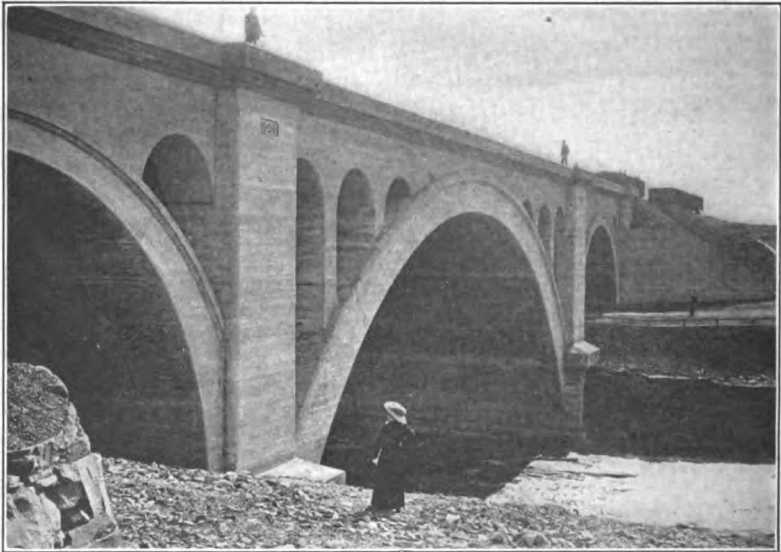

Courtesy of Sandusky Portland Cement Co.

FIG. 9B.—Bridge on Lake Shore & Michigan Southern R. R. at Berea, Ohio.

called abutment piers should be placed at frequent intervals (usually every 5 or 6 spans) so as to act as an abutment in case of failure of one or more of the arches. This type of pier is made of sufficient thickness to resist the pressure for either arch standing and the other arch removed, and for both arches standing. The ordinary arch pier should be analyzed for one adjacent arch without live load and the other adjacent arch with live load over the whole span.

Arch bridges of four and six spans do not present a desirable appearance. For esthetic effect, an odd number of spans should

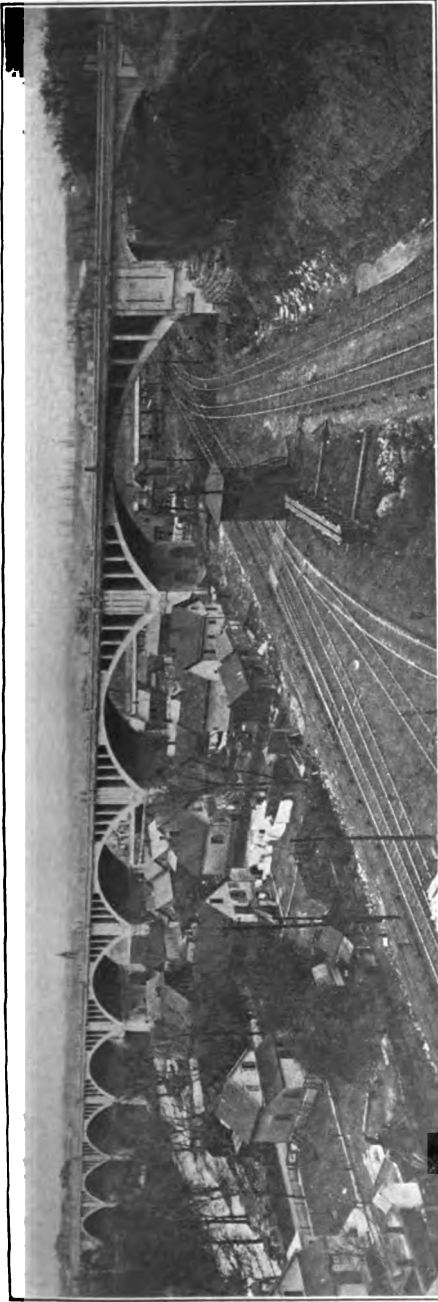

Courtesy of Marquette Cement Mfg. Co.

FIG. 9C.—Grand Avenue viaduct, Milwaukee, Wis.

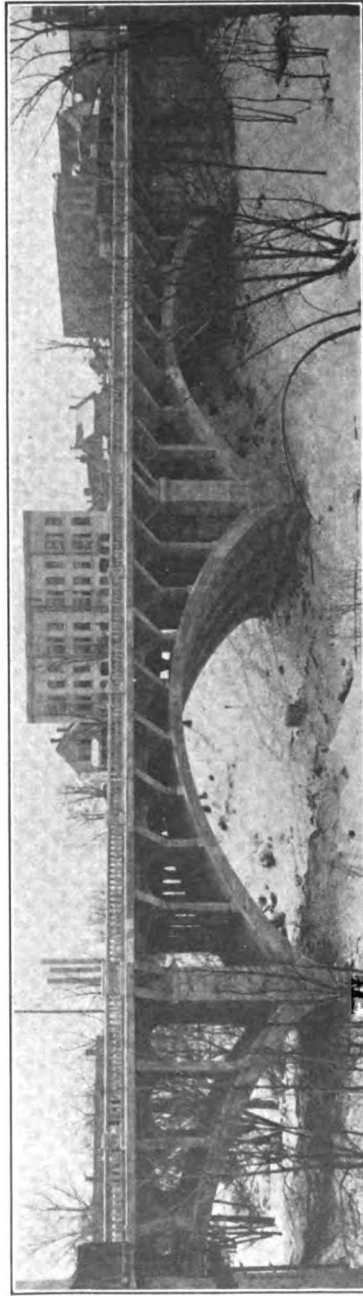

Courtesy of Marquette Cement Mfg. Co.

FIG. 10A.—Ribbed-arch bridge at Waukegan, Ill.



Courtesy of Mr. N. S. Sprague, Superintendent, Board of Public Works, Pittsburgh.

FIG. 10B.—Murray Avenue bridge, Pittsburgh, Pa.



Courtesy of Mr. N. S. Sprague, Superintendent, Board of Public Works, Pittsburgh.

FIG. 10C.—Meadow Street bridge, Pittsburgh, Pa.



FIG. 10D.—Ludlow Avenue bridge, Cincinnati, Ohio.

be selected and the span lengths should decrease each way from the center of bridge.



FIG. 10E.—Wealthy Street bridge, Grand Rapids, Mich. Note thin slab between arch ribs at extrados.

The depth of arch foundations and the shape of abutments and piers is dependent upon local conditions, and in some difficult

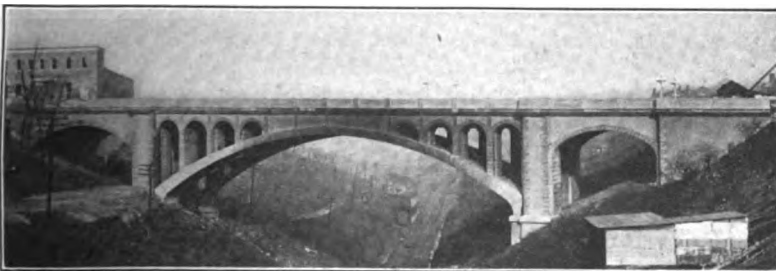

Courtesy of Mr. N. S. Sprague, Superintendent, Board of Public Works, Pittsburgh.
FIG. 10F.—Atherton Avenue bridge over P. J. R. R., Pittsburgh, Pa.
Note fake joints in ribs, posts, and quoins.

cases have to be chosen after thorough study. A certain shape of abutment or pier is first assumed; and this is then reviewed to see that the load upon the ground does not exceed the allowable,

and that it is well distributed. Great saving is effected in some cases by the use of hollow, or ribbed, abutments and piers.

6. Depth of Filling at Crown.—In making a preliminary design for an earth-filled arch bridge, it is necessary to know approximately the required crown thickness of the arch ring and also the amount of earth filling over the crown. This must be known in order to determine the remaining distance from the crown to the springing line—that is, the available rise for the arch. For highway bridges, a depth of filling including the pavement, of from 1 to 2 ft. will be sufficient; but for railroad structures a minimum depth of from 2 to 3 ft. below the ties will be needed in order to form a cushion for the ties, to distribute the load, and to absorb the shock from passing trains.

7. Loads.—The dead weight of the arch ring itself and of the superimposed material, constitute usually the principal loads on an arch ring. With open-spandrel construction, the dead loads act vertically upon the arch ring or arch rib through the transverse walls or columns, and are hence definitely known. With filled spandrels, the pressure produced on the arch ring by the earth filling is really inclined and the dead load cannot be so accurately determined.

On flat earth-filled arches, it is better to consider only vertical loads as acting on the arch ring, for the conjugate horizontal forces are small and may be neglected. On earth-filled arches with large rise, the horizontal thrusts become great, especially close to the springing lines, and it may be advisable in some cases to take these horizontal components into account. The omission of these horizontal thrusts, however, is always on the side of safety.

A common assumption for weight of earth fill where the actual value is unknown is 100 lb. per cubic foot. When sand is used, its weight should be taken at 120 lb. Pavement is usually assumed as 12 in. thick and as weighing 150 lb. per cubic foot.

The live load to be used in the investigation of an arch bridge should be the greatest that comes or is liable to come upon the roadway. Each location should be studied and the live load chosen to fit the requirements. For ordinary conditions a standard loading is commonly employed. Wind pressure is considered only on light or exceptionally high structures.

In earth-filled bridges where there is sufficient thickness of filling to distribute the concentrated loads over a considerable

area of arch ring, uniform live loads are used in the arch-ring design. City highway bridges are generally designed for 50-ton electric cars and for such bridges, with spans of 200 ft. or more, a uniform load of 1200 lb. per linear foot is usually taken on each railway track together with a uniform load of 80 lb. per square foot over the remaining area of roadway and sidewalks. For spans less than 100 ft., the values corresponding are 1800 lb. per linear foot of each track, and 100 lb. per square foot of remaining area. For spans between 100 and 200 ft., the loads are taken proportionally. The loads specified above for city bridges may be reduced by about 20 per cent to apply to the arch rings of light country bridges. The load on each street railway track is generally assumed to cover a width of 9 ft.

In addition to the above loads, city bridges and bridges on thoroughfares likely to be used for heavy hauling should be designed to carry 20-ton trucks, with axles about 10 ft. c. to c., 14 tons on rear axle and 6 tons on front axle; wheels about 5 ft. c. to c.

Because of the permanent character of concrete bridges it may be wise to provide a larger margin for increase of loading than is above suggested, or than is usually allowed in steel bridge design. Fortunately, in the case of concrete arch bridges a large increase can be provided for with only a slight increase of expense due, of course, to the controlling influence of the dead load.

Following is an extract from the report of a Committee on Reinforced Concrete Highway Bridges and Culverts, American Concrete Institute, presented at the Annual Convention at Chicago, Feb. 17, 1914:

“Class ‘A’ Bridges—main thoroughfares leading from large towns.— In view of the extensive introduction of the heavy motor trucks and traction engines, and the probable general use of such vehicles in the future, it is recommended that bridges on main thoroughfares and other roads which are likely to be used for heavy hauling, be designed to carry 20-ton trucks, with axles about 10 ft. c. to c., 14 tons on rear axle and 6 tons on fore axle; wheels about 5 ft. c. to c. Outside of the large cities it is recommended that only one such vehicle be assumed to be on the bridge at any one time; the likelihood of more than one being on the bridge, in a position to produce maximum stresses at the same time, is so remote that this assumption is considered safe. It is advised that such very heavy loads be considered as occupying only the ordinary width of the road, about 8 ft. in width and about 35 ft. in length. Congested traffic of heavily-loaded wagons or motor trucks will rarely

impose a load of more than 100 lb. per square foot over a considerable area. The above-mentioned 20-ton truck gives a load of about 140 lb. per square foot, on the area actually occupied, but it is considered extravagant to assume that a large bridge is covered with such heavy loads. One hundred pounds per square foot is thought ample to assume for the loading of spans more than 60 ft. long in designing the trusses or main girders. It is thought to be safe to reduce this assumed load in the case of longer spans, to the following amounts:

Length of span, ft.	Assumed load, lb. per sq. ft.
80	90
100	80
125	75
200 and over	70

with all intermediate spans in proportion.

“The greatest load that is liable to be imposed on a bridge sidewalk occurs when there is some excitement in the neighborhood which attracts a large crowd, and for which the bridge affords an especially good point of view. In that case the crowd forms a compact mass against the railing, not more than 4 ft. deep, making a load seldom exceeding 100 lb. per square foot over a very considerable space. The remaining portion of the sidewalk may be covered by a moving crowd which can scarcely weigh more than 40 lb. per square foot. It may be advisable, sometimes, to so design sidewalk slabs, that if a street car or motor truck accidentally gets upon the sidewalk, it will not go through. Such accidents are so rare, that it is thought safe to allow materials to be stressed somewhat beyond the elastic limit in such cases.

“Class ‘B’ Bridges.—Although it is impossible to determine beforehand, especially in the newer parts of the country, whether any given road is to be used for heavy traffic, it seems extravagant, at least in the cases of larger spans, to design bridges to carry much heavier loads than can be expected to come upon them. It is recommended that bridges of this class be designed to carry 15-ton trucks, with axles 10 ft. apart, 5 tons on the front and 10 tons on the rear axle. This will allow for a considerable overloading of existing motor trucks. It is further recommended that only one truck be assumed to be on the bridge at one time, in designing the floor system, that it be assumed to cover a width of 8 ft. and a length of 35 ft. and that the remainder of the bridge be covered with a load of about 90 lb. per square foot, for spans up to 60 ft.

“For longer spans, the trusses and main girders should be designed for the following loads:

Length of span, ft.	Assumed load, lb. per sq. ft.
80.....	80
100.....	70
125.....	65
150.....	60
200 and over.....	55

with intermediate spans in proportion.

“Sidewalks should be designed to carry the same loads as in the case of Class ‘A’ bridges.

“Special Bridges.—City bridges and bridges carrying traffic connected with mines, quarries, lumber regions, mills, manufactories, etc., require special consideration and should, of course, be designed to carry any load which can reasonably be expected to pass over them, bearing in mind the likelihood of heavy traction engines and motor trucks coming into extensive use in the not distant future.

“Bridges Carrying Electric Cars.—Electric traction is still in its infancy and nobody is able to forecast its future development. It seems probable, however, that it will not be profitable to run cars weighing more than 50 tons each, at a speed that would be permitted on any public road. If very high speeds are desired, the traction company will doubtless be required to operate over its own right-of-way. It is recommended that bridges carrying either urban or interurban electric cars be designed to carry 50-ton cars on two trucks, spaced 30 ft. c. to c., each truck having two axles spaced 7 ft. c. to c. The Committee sees no reason for changing the customary practice of assuming that an axle load is distributed over three ties.”

For railroad bridges, Cooper’s Standard Loadings are generally specified, the particular loading to be used depending upon the location of the line and the future traffic that may be expected. As regards the arch ring in earth-filled arches, where the thickness of filling is sufficient to distribute the concentrated loads over a considerable area, an equivalent uniform loading per linear foot per track is generally substituted. A load of 700 lb. per square foot is common for railroad traffic on spans, say, over 80 ft. in length. A uniform load of 1000 lb. per square foot is frequently adopted for shorter spans. The impact of live loads is not usually considered except, of course, for the floors in all arches of open-spandrel construction. Braking or tractive stresses are important only for bridges on heavy grades.

A concentrated load is usually assumed to be distributed downward through the fill on a 45° slope starting from the ends of

the ties. An axle load is assumed as distributed over three ties in the direction of the track.

8. Empirical Rules for Thickness of Arch Ring.—With the trial curvature of the intrados decided upon, the next step in the design of a concrete arch is to choose a trial thickness of the ring at the crown and at the springing. Since the crown thickness depends not only on the thrust, but also upon the location of the line of pressure, it is obvious that it is impossible to devise a formula for its determination. Various empirical formulas, however, have been developed for this trial thickness at the crown and are an aid to the judgment.

Mr. F. F. Weld¹ gives the following formula:

$$h = \sqrt{l + \frac{l}{10} + \frac{w}{200} + \frac{w'}{400}}$$

where

h = crown thickness in inches.

l = clear span in feet.

w = live load in pounds per square foot, uniformly distributed.

w' = weight of dead load above the crown of the arch in pounds per square foot.

Mr. W. J. Douglas gives the following tabulated formulas² for different highway spans, the values of h being given in feet:

Under 20 ft. $h = 0.03 (6 + l)^*$

20 to 50 ft. $h = 0.015 (30 + l)^*$

50 to 150 ft. $h = 0.00010 (11,000 + l^2)^\dagger$

Over 150 ft. $h = 0.016 (75 + l)^\ddagger$

* For railroad arches, add 25 per cent.

† For railroad arches, add 20 per cent.

‡ For railroad arches, add 15 per cent.

Mr. D. B. Luten gives the following formula for solid-spandrel arches:

$$h = 4 + \frac{3l^2(r + 3F)}{4000r - l^2} + \left[\frac{(w)l^2}{30,000r} \text{ or } \frac{w_c(l + 5r)}{150r} \right]$$

where h = crown thickness in inches.

l = clear span in feet.

r = the rise from springing line to intrados in feet.

¹ Engineering Record, Nov. 4, 1905, page 529.

² Taken by permission from the American Civil Engineers' Pocket Book.

- F = the fill over the crown of the extrados in feet.
 w = uniform live loads in pounds per square foot.
 w_c = concentrated loading consisting of maximum live loading on single track over half-span in tons.

The thickness of an arch should increase from the crown to the springing (except for a hinged arch which is not considered here). The radial thickness of the ring at any section is frequently made equal to the thickness at the crown multiplied by the secant of the angle which the radial section makes with the vertical. For segmental and three-centered curves the radial thickness at the springing ($a-a$, Fig. 11) should be taken from two to three times the crown thickness.

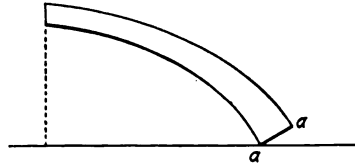

FIG. 11.

The empirical rules given above, it must be remembered, should be used only for trial. The exact shape of the arch ring and the thickness at different sections must be determined by analysis as subsequently explained.

9. Classification of Arch Rings.—Arches may be classified as hinged or hingeless. A hingeless arch is one having fixed ends, while a hinged arch may have a hinge at the crown, a hinge at each end, or a hinge at each end and one at the crown. Arches of one and two hinges are not used to any extent in masonry construction since the three-hinged arch offers the advantage of more definitely fixing the line of pressure throughout the ring and thus makes possible a saving of material. Hinges are, however, often an expensive detail and the three-hinged arch is by no means so common as the concrete arch having fixed ends. Friction on hinges is also an important consideration.

Concrete arches without hinges will be treated in the chapters immediately following and later on will be considered the modifications necessary for three-hinged arches.

CHAPTER II

DEFLECTION OF CURVED BEAMS

Deflection formulas for curved beams (in which the radius of curvature is large as compared with the depth) are employed in the development of arch theory. Hence, it is important for the student to appreciate the meaning of these deflection formulas before taking up the theory of arches, and this appreciation of the formulas can come only by following through their derivation. A proof for these formulas will now be attempted.

Let AB , Fig. 12, be any portion of a curved beam in its *unstrained* form and $A'B$ the same portion in its *strained* form, assuming the beam rigidly fixed at B . Let $X - X$ and $Y - Y$ be rectangular axes with origin at A , and denote the components of A' as Δx and Δy . AO , tangent to the arch axis at A , moves through the angle k . It is desired to derive formulas for the following values: (1) angular change of AO , (2) component Δx of A' , (3) component Δy of A' . Only the effects of dead and live loading will be treated in this chapter leaving the effects of temperature change and direct stress for consideration in the chapter on Arch Analysis.

10. Angular Change.—Consider $abcd$ as any small portion of the beam included between two consecutive cross-sections at right angles to the axis. Assume the curvature of the beam as large in proportion to the depth so that the length of all fibers may be assumed equal. Now assume the end ad as fixed, and let the change in angle between end faces or end tangents of this element (of length s) due to bending be denoted by k' . (See Figs. 12 and 13.) The change in length of a fiber at a distance r from the neutral axis will be equal to rk' (the angle k' being expressed in circular measure) and the deformation per unit length of beam will be equal to $\frac{rk'}{s}$. Now, $E = \frac{\text{unit stress}}{\text{unit deformation}}$ (by definition of modulus of elasticity), or, stress per unit area at distance r from the neutral axis = $(E) \times (\text{deformation}) = E \cdot \frac{rk'}{s}$.

Let a (Fig. 14) be the area of a small element of the cross-section at a distance r from the neutral axis. Then the stress on this area equals $E \cdot \frac{rk'}{s} \cdot a$, and the moment of this stress about the neutral axis equals $E \cdot ar^2 \cdot \frac{k'}{s}$. The total moment of resistance of the cross-section is the sum of all the moments of resistance for

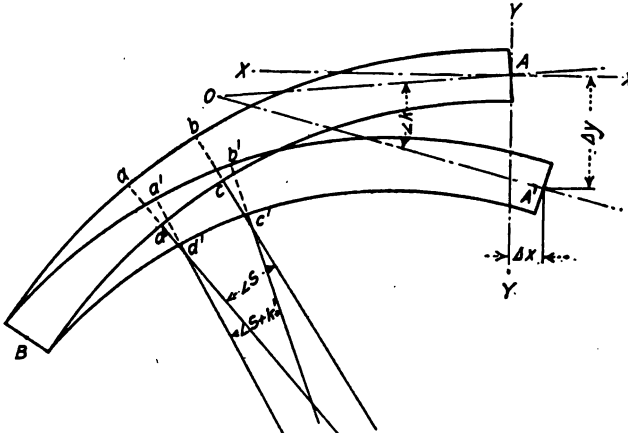

FIG. 12.

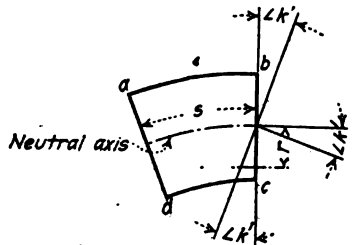

FIG. 13.

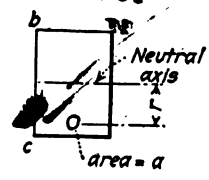

FIG. 14.

the separate elements, which resolves itself into finding the sum of the expressions (ar^2) .

The term *moment of inertia*, I , may be defined as follows: The moment of inertia of a plane surface with respect to an axis is the sum of the products obtained by multiplying each elementary area by the square of its distance from that axis. If Σ is taken to mean *the sum of*, then it is evident that Σar^2 between the limits of the section represents the moment of inertia of the section.

Hence,

$$M = EI \frac{k'}{s}, \text{ or } k' = \frac{Ms}{EI}$$

(This expression might have been obtained more directly by employing the formula derived from the common theory of flexure.) But an expression for the angle k is desired, and this must be obtained by a summation of all the angles k' for the elements of the curved beam from A to B . Denote this summation by $\sum_A^B k'$, then

$$k = \sum_A^B \frac{Ms}{EI}$$

In deriving the foregoing equation, a material with constant E has been assumed. For beam of reinforced concrete

$$\begin{aligned} M &= E_c I_c \frac{k'}{s} + E_s I_s \frac{k'}{s} \\ &= (E_c I_c + n E_s I_s) \frac{k'}{s} \\ &= E_c (I_c + n I_s) \frac{k'}{s} \\ &= E_c I \frac{k'}{s} \end{aligned}$$

or

$$k' = \frac{Ms}{E_c I} \quad (a)$$

and

$$k = \sum_A^B \frac{Ms}{E_c I} \quad (1)$$

The smaller the elementary lengths of beam considered, the more accurately will Formula (1) apply. The values of M and I have been regarded as constant quantities for each particular elementary length considered. Since this is not true in practice on account of each element having appreciable length, a close approximation to the actual M and I for a given element may be obtained by taking the values of the bending moment and moment of inertia at the mid-point of s .

11. Components of Deflection.—Consider $BCDEFA$, Fig. 15A, to represent the axis of the unstrained form of the beam of Fig. 12 and let the beam pass into its strained form by the bending of each elementary length s in consecutive order. Bending the

element BC through the angle k' causes the portion AC to turn through this same angle about C as a center, the point A moving to A_c (with radius u) through a small distance that we will call dv , having the components dx and dy . Fig. 15B shows clearly the method of bending. Bending the element BC through the angle k' , if AC is kept stationary, would cause B to move to the point B' . Now revolving the bent beam about C as a pivot until B' is brought back to B , it should be noticed that A moves

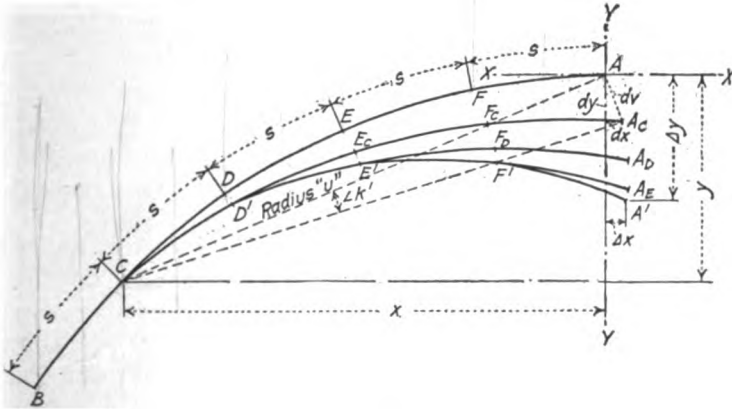

FIG. 15A.

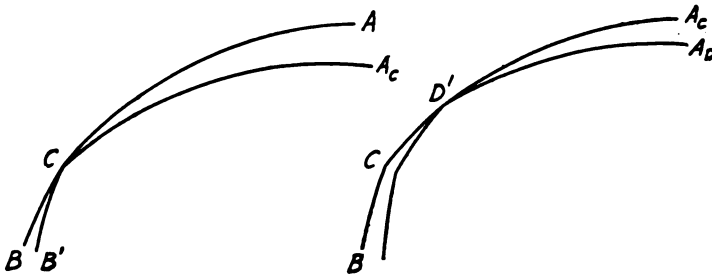

FIG. 15B.

FIG. 15C.

to A_c . Fig. 15C shows the bending of the element CD . Thus from the bending of CD' the point A_c moves to A_d , etc.

If x and y are the coördinates of any point C , origin at A , we have, by similar triangles (triangles are similar since the side dv is practically at right angles to the radius u , the movement being very small)

$$\frac{dy}{dv} = \frac{x}{u}, \text{ and } \frac{dx}{dv} = \frac{y}{u}$$

Solving for dy and dx and substituting for dv the value uk' , we have

$$dy = xk' \quad dx = yk'$$

Substituting the value of k' from Equation (a), we have

$$dy = x \frac{Ms}{E_c I}, \text{ and } dx = y \frac{Ms}{E_c I}$$

Summing up the value of the components for each change of k' in angle, the total change of angle made is k , and dy and dx become Δy and Δx , respectively. Then

$$\Delta y = - \sum_A^B \frac{Mxs}{E_c I} \quad (2)$$

and

$$\Delta x = \sum_A^B \frac{My s}{E_c I} \quad (3)$$

(As in simple beams, M is considered positive when it tends to increase the compression on the back of the arch. The minus sign is used in Formula (2) because the effect of a positive value of M in any element causes an upward deflection—that is, a minus value of Δy , considering only the effect of bending in the element in question.)

Formulas (1), (2), and (3) are the fundamental formulas employed in the analysis of masonry arch rings by the elastic theory.

CHAPTER III

ANALYSIS OF THE SYMMETRICAL ARCH BY THE ELASTIC THEORY¹

12. General Discussion.—A concrete arch with fixed ends is statically indeterminate. There are, in all, six unknown quantities—three at each support (the vertical and horizontal components of the reaction, and the bending moment; or, what is the same thing, the magnitude, direction, and point of application of the reaction)—and it is possible to determine only three unknowns by the principles of statics. The three additional equations may be found from the following conditions:

The change in span of the arch $= \Delta x = 0$

The vertical deflection at one end (the origin of coördinates) $= \Delta y = 0$

The change in direction of the tangent to the arch axis at the origin of coördinates $= \angle k = 0$

These three conditions must be true since the arch is fixed at the abutments.

Instead of actually finding the components of the reactions and the moments at the supports as outlined above, it is simpler for symmetrical arches to take the origin of coördinates at the crown and find the thrust, shear, and moment at that point. The method of doing this will be explained later, but it should be clear that, with these three unknowns determined, each half of arch may then be treated as statically determinate.

The analysis of an arch consists in finding the thrust, shear, and bending moment at the crown and at intermediate sections in the arch ring or arch rib, and then finding the stresses resulting therefrom. A longitudinal slice of the arch is considered, having a thickness of 1 ft. The thrust is here taken to be the normal component of the resultant force on the section, and the shear is the component at right angles to the normal. The

¹ Method of analysis is taken by permission from Turneaure and Maurer's "Principles of Reinforced-concrete Construction," 2d edition, pages 335 to 344. Copyright 1907, 1909 by F. E. Turneaure and E. R. Maurer.

bending moment will be considered positive when it tends to increase the compression on the back of the arch, this being the same convention as for beams.

A horizontal thrust is produced at the crown when the arch is loaded symmetrically. For non-symmetrical loading, an inclined pressure acts at the crown, but its horizontal component is called the horizontal thrust for that loading. Its vertical component is the shear at the crown. Let us assume the arch as cut at the crown and consider each half to act as a cantilever sustaining exactly the same forces as exist in the arch itself. The external forces holding a semi-arch in equilibrium (Fig. 16)

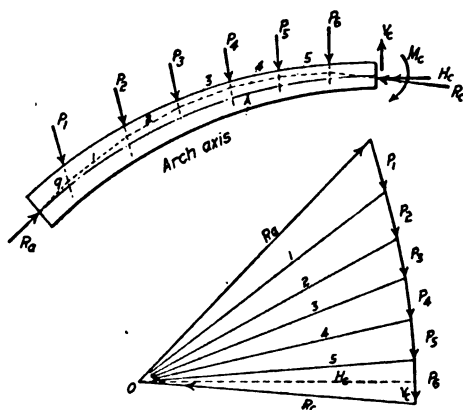

FIG. 16.

are the loads P_1, P_2 , etc., the horizontal thrust H_c , the vertical shear V_c , and the reaction at the skewback R_a .

After H_c, V_c , and M_c have been computed, the line of pressure (accurately enough represented by the equilibrium polygon) can be constructed by help of the force polygon, Fig. 16. The value of M_c definitely determines the point of application of H_c and makes the construction of the exact line of pressure possible. (For a positive value of M_c , the thrust H_c acts above the arch axis.) From this line of pressure and the accompanying force polygon may be obtained the thrusts, shears, and bending moments at intermediate points of the arch. The force polygon gives directly the thrusts and shears, while the line of pressure makes possible the determination of the bending moment at any section, the bending moment being equal to the resultant

pressure at the given point multiplied by the perpendicular distance from the arch axis to the line of pressure. Usually the line of pressure is drawn to serve only as a check on the computations, and the bending moments at the various points are determined algebraically. This algebraic method for finding moment will be employed in the designing work to follow.

The line of pressure of an arch is a continuous curve, but differs very little from an equilibrium polygon for the given loads (Fig. 16). In fact this curve becomes tangent to the equilibrium polygon between the angle points. The greater the number of loads, the nearer the polygon approaches the line of pressure.

With H_c , V_c , and M_c determined, all external forces are known except the reaction at the skewback, and this is determined by the closing line of the force polygon. An equilibrium polygon may then be constructed as already mentioned, the first side being in the line of R_c produced, the second parallel to the ray 5, and so on until the last side through q gives the position of R_a .

13. Notation.—The following notation will be employed in arch analysis:

Let

- s = length of a division of the arch ring measured along the arch axis.
- n_h = number of divisions in one-half the arch.
- l = span of arch axis.
- c_a = average unit compression in concrete of arch ring due to thrust.
- t_c = coefficient of linear temperature expansion.
- t_D = number of degrees rise or fall in temperature.
- E_c = modulus of elasticity of concrete.

At the crown, let

- H_c = horizontal thrust.
- V_c = vertical shear.
- R_c = resultant of H_c and V_c .
- M_c = bending moment.

At any point on the arch axis, with coördinates x and y referred to the crown as origin, let

- N = thrust (normal) on radial section.
- S = shear on radial section.
- R = resultant force on radial section, resultant of N and S .

x_0 = eccentricity of thrust on section, or distance of N from the arch axis.

t = depth of section.

I = moment of inertia of section including steel = $I_c + nI_s$.

A = area of section including steel = $a_c + na_s$.

p_o = steel ratio for total steel at section.

d' = embedment of steel from either upper or lower surface.

M = moment = Nx_0 .

m_L = moment at any point on left half of arch axis of all external loads (P_1, P_2 , etc.) between the point and the crown.

m_R = moment at any point on right half of arch axis of all external loads between the point and the crown.

m = moment at any point on either half of arch axis of all external loads (P_1, P_2 , etc.) between the point and the crown.

14. Formulas for Thrust, Shear, and Moment.¹—Let Fig. 17 represent a symmetrical arch loaded in any manner and cut at

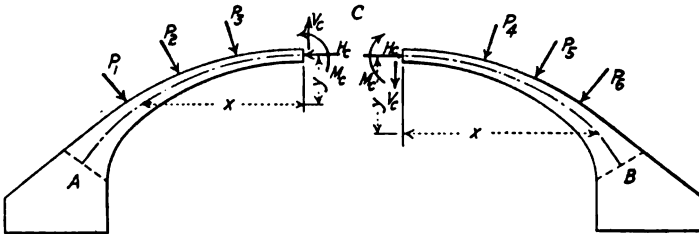

FIG. 17.

the crown, the halves being separated in order to show the forces acting at the section cut.

Formulas for thrust, shear, and moment at the crown will first be developed and then will follow a formula for moment at any section. Thrust and shear at any section may easily be determined graphically.

The horizontal motion of C as regards the left cantilever, due to bending of the elements between A and C , is the same in

¹ Taken by permission from Turneure and Maurer's "Principles of Reinforced-concrete Construction," 2d edition, pages 338, 339, 343, and 344. Copyright 1907, 1909 by F. E. Turneure and E. R. Maurer.

amount as the horizontal motion of C as regards the right cantilever, due to bending of the elements between B and C . It should be noticed that a positive bending moment for an element on the left will tend to move C in the opposite direction from a positive bending moment for an element on the right. Then, from Chapter II on "Deflection of Curved Beams," we have

$$\sum_C^A My \frac{s}{E_c I} = - \sum_C^B My \frac{s}{E_c I}$$

(The coordinates x and y refer to the center of each short length of arch ring of length s , when M is also taken at the center.) The vertical motions are equal but in the same direction, hence

$$\sum_C^A Mx \frac{s}{E_c I} = \sum_C^B Mx \frac{s}{E_c I}$$

Also the changes in direction of the tangent to the axis at C are equal but opposite in direction, hence

$$\sum_C^A M \frac{s}{E_c I} = - \sum_C^B M \frac{s}{E_c I}$$

The arch ring will be so divided into sections that $\frac{s}{I}$ will be made a constant. Then E_c also being a constant, the quantity $\frac{s}{E_c I}$ may be placed outside the summation sign. Thus, denoting $\sum_C^A M$ by $\sum M_L$ and $\sum_C^B M$ by $\sum M_R$, we have

$$\sum M_L y = - \sum M_R y \tag{b}$$

$$\sum M_L x = \sum M_R x \tag{c}$$

$$\sum M_L = - \sum M_R \tag{d}$$

The bending moment at any point may be expressed as follows:

$$M_L = M_c + H_c y + V_c x - m_L$$

$$M_R = M_c + H_c y - V_c x - m_R$$

where M_L and M_R are the moments at the center of any division to the left and right of the crown respectively. Substituting these equations in (b), (c), and (d), combining terms, and noting that $\sum M_c$ for one-half the arch is equal to $n_A M_c$, we have

$$2M_c \sum y + 2H_c \sum y^2 - \sum m_L y - \sum m_R y = 0 \tag{e}$$

$$2V_c \sum x^2 - \sum m_L x + \sum m_R x = 0 \tag{f}$$

$$2n_A M_c + 2H_c \sum y - \sum m_L - \sum m_R = 0 \tag{g}$$

Combining (e) and (g)

$$H_c = \frac{n_h \Sigma(m_L + m_R)y - \Sigma(m_L + m_R) \Sigma y}{2[n_h \Sigma y^2 - (\Sigma y)^2]} \quad (4)$$

From (f)

$$V_c = \frac{\Sigma(m_L - m_R)x}{2 \Sigma x^2} \quad (5)$$

From (g)

$$M_c = \frac{\Sigma(m_L + m_R) - 2H_c \Sigma y}{2n_h} \quad (6)$$

These are the fundamental equations in the analysis of arch rings. All summations refer to one-half the arch axis, and the signs of m_L , m_R , x , and y being taken into account in the derivation of the formulas, their numerical values should be taken as positive when substituting to obtain the corresponding values of H_c , V_c , and M_c . A positive value of V_c indicates that the line of pressure at the crown slopes upward toward the left; a negative value, downward toward the left.

The values of the thrust, shear, and moment being found from the above equations, the moment of any section of the left cantilever is

$$M = M_c + H_c y + V_c x - m_L \quad (7)$$

and, at any section of the right cantilever,

$$M = M_c + H_c y - V_c x - m_R \quad (8)$$

To the thrusts, shears, and moments in an arch due to loads must be algebraically added the thrusts, shears, and moments due to a change of temperature. For a rise (or fall) of temperature of the arch ring of t_D degrees, the span of arch axis l would *tend* to increase (or decrease) in length an amount expressed by $t_D l$, t_c being the coefficient of linear expansion. The arch being restrained at the abutments, thrust, shear, and moment would be caused at the different sections of the arch ring.

The method of procedure for determining formulas for H_c and M_c due to temperature is similar to that employed in determining the corresponding formulas due to loads. The value Δx of Formula (3) is equal to the amount of the tendency of the half-span to change in length, or $\frac{t_c t_D l}{2}$; and k of Formula (1) is

zero since the crown section rises and falls in a vertical line as the material of the arch expands and contracts. Thus, we have, considering either half of the arch,

$$\Sigma My \frac{s}{E_c I} - \frac{t_c t_D l}{2} = 0$$

$$\Sigma M \frac{s}{E_c I} = 0$$

Since there are no external loads to be considered in the matter of temperature and since the arch is symmetrical, $V_c = 0$, and

$$M = M_c + H_c y$$

Substituting this value of M in the above equations and remembering that $\frac{s}{E_c I}$ is to be made a constant, we have

$$M_c \Sigma y + H_c \Sigma y^2 = \frac{t_c t_D l}{2} \cdot \frac{E_c I}{s}$$

$$n_h M_c + H_c \Sigma y = 0$$

From which

$$H_c = \frac{I}{s} \cdot \frac{t_c t_D l n_h E_c}{2[n_h \Sigma y^2 - (\Sigma y)^2]} \quad (9)$$

and

$$M_c = - \frac{H_c \Sigma y}{n_h} \quad (10)$$

The bending moment at any point is

$$M = M_c + H_c y \quad (11)$$

In Formula (9) the value t_D should be inserted as positive for a rise in temperature and negative for a drop in temperature. The value of t_c may be taken at 0.000006 per degree Fahrenheit (see Art. 13, Volume I) and the value of E_c at 2,000,000 lb. per square inch. Moments are usually expressed in foot-pounds and the distance y in feet, in which case the value of E_c should be substituted in Formula (9) in pounds per square foot and the value of l in feet. Since there are no outer loads to consider, the thrust and shear at any point in the arch may be found by resolving H_c normal and parallel to the arch section at that point.

It should be noted in Formula (9) that, for a given span, the horizontal thrust due to temperature varies inversely as $[n_h \Sigma y^2 - (\Sigma y)^2]$, which means that a slight decrease in rise of the arch will produce considerable increase in ring stress.

If the span and rise are kept constant, H_c and likewise M_c vary directly with I , or, in other words, with the cube of the depth of section. On the other hand, fiber stresses for a given moment are known to vary inversely only as the square of the depth of section. Thus in light highway bridges, where temperature moment constitutes a large proportion of the total moment, the resulting fiber stresses may actually be increased by an increase of section.

The thrust acting throughout the arch tends to cause a shortening of the span. Denote c_a as the average unit compression in concrete of arch ring due to thrust. Then the arch span will tend to shorten the amount $\frac{c_a l}{E_c}$. This action tends to produce the same result as a lowering of temperature and the value of the resulting crown thrust may be found by substituting $\frac{c_a l}{E_c}$ for t_{Dl} of Formula (9). Hence,

$$H_c = -\frac{I}{s} \cdot \frac{c_a l n_h}{2[n_h \Sigma y^2 - (\Sigma y)^2]} \quad (12)$$

and, as for temperature stresses,

$$M_c = -\frac{H_c \Sigma y}{n_h} \quad (13)$$

$$M = M_c + H_c y \quad (14)$$

Thrusts and moments due to rib shortening are usually small except in flat arches, where they may become fairly large.

15. Division of Arch Ring for Constant $\frac{s}{I}$.—Since the depth of the arch ring generally increases from the crown to the springing, the moment of inertia I likewise increases, but much more rapidly; in fact, it increases approximately as the cube of the depth. To maintain a constant $\frac{s}{I}$, the divisions should be made to increase in length as the arch ring deepens, and some preliminary computations are necessary to do this.

The greater the number of divisions selected, the more accurate the results; but for an arch of ordinary span, the number need not be greater than twenty—sixteen or twenty being the common

rule. Of course, since each half of arch is considered separately, the number of divisions should be even.

To obtain the value of $\frac{s}{I}$ (the constant), determine first the length of the arch axis. Next, calculate several values of $\frac{1}{I}$ at equal intervals along the arch and determine its mean value. Then

$$\frac{s}{I} = \frac{l'}{n_h} \cdot \frac{1}{I}$$

where l' is one-half the length of arch axis, n_h the desired number of divisions in one-half the arch, and $\frac{1}{I}$ the mean value found as previously explained. In determining this value the steel should be considered.

~~After~~ once the value of $\frac{s}{I}$ is known, the lengths of the divisions can be readily determined. Assume a length of the first division to one side of the abutment. Determine the value of I at the center of the assumed division. Then divide the length assumed by the value of I determined for the center. If the length of the division was assumed correctly, the result should equal the value of $\frac{s}{I}$ computed above. If not, the necessary adjustment should be made, and so on for each division until the crown is reached. The lengths of the assumed number of divisions should agree with the length of one-half of the arch axis. If an error exists which is not large, it should be divided proportionately among the divisions.

If desired, a graphical means may be employed by which to divide the arch axis into divisions having a constant $\frac{s}{I}$. The method to be given will be used in the arch design which follows.

Fig. 18 illustrates the method in detail. AB is drawn to any convenient scale equal in length to one-half the arch axis. The curve EF is then drawn through points whose ordinates are the values I and whose abscissas are the corresponding distances along the arch axis from the skewback. (In order to make the drawing clear, the ordinates and corresponding abscissas which

determine the curve EF are not shown.) A length AH is then assumed, a perpendicular LC erected at its center, and the lines AC and CH determined. Starting from point H , lines are drawn parallel alternately to AC and CH , as shown in Fig. 18. Only three or four trials will usually be required to divide the line AB into the desired number of divisions. The base of each triangle thus formed corresponds to s and its altitude to I . Since all the triangles are similar by construction, the term $\frac{s}{I}$ is constant throughout.

A convenient modification of the above method is to draw a second curve $E'F'$ below AB , using the same ordinates as for EF . AH is then assumed as before and the perpendicular CC' erected at its center. Starting with C' , diagonals and verticals are drawn alternately making the diagonals parallel to AC . This method

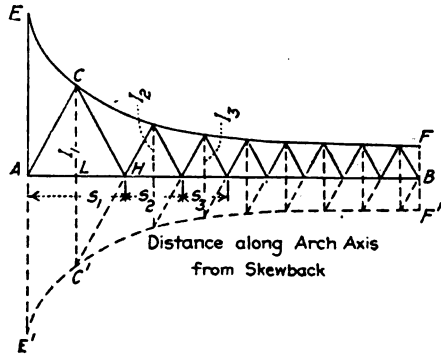

FIG. 18.

offers the advantage of drawing all the diagonals parallel to the same line.

16. Loadings to Use in Computations.—Small earth-filled arches should be designed at least for uniform live load over the whole span and the half-span. Large earth-filled arches and arches having the roadway supported on spandrel arches or spandrel columns should be designed for live load over one-third of the span, one-half of the span, two-thirds of the span, the whole span, the middle third of the span, and the end thirds of the span. These uniform loadings are only approximations to the true loadings which produce the maximum stresses. The exact loadings to cause maximum conditions may be found by the use of influence lines, as will be explained in Chapter V.

17. Internal Temperature Investigations.—Comparatively few experiments have been made which furnish data on the internal

temperature range in concrete structures. Undoubtedly the most important are those which have recently been completed under the direction of the Engineering Experiment Station at Ames, Iowa, on two highway arch bridges of the earth-filled type. These experiments¹ are described in detail in Bulletin No. 30 of the Iowa State College of Agriculture and Mechanic Arts where a summary is also given of the other tests that have been made on internal temperature variation.

In the Iowa experiments, thermometers were embedded in different parts of the arch ring in such a manner that the thermometers were in direct contact with the concrete at the depth of penetration. Both mercurial soil and electrical resistance thermometers were employed.

The tests of the Squaw Creek arch at Ames, extended over the greater part of the school years 1909 to 1912. The west arch of this bridge was the one tested, it being easy of access. The arch is unsymmetrical with a span of 45 ft. and a total rise of 11 ft. 3 in. at the center of span.

The tests on the Walnut Street bridge at Des Moines were made in 1911 and 1912—daily readings being taken covering a period of 1 year. This bridge is composed of six 68-ft. spans with a rise of 11 ft. 6 in. The east arch was selected upon which to make the experiments.

Internal Range in Temperature.—The results on the two bridges mentioned were obtained during years in which the extreme atmospheric temperatures, both high and low, were the greatest recorded for many years. With this in mind, the results show that about 75 per cent of the mean atmospheric variation would be effective temperature range in a mass of concrete of less than 5 or 6 ft. in thickness. The atmospheric mean variation at Des Moines was 102°F., 75 per cent of which is 76.5°F. This is only 2.7° less than the average obtained on the Walnut Street bridge during the period January to August, 1912, and but 2.6° less than the average obtained on the Squaw Creek bridge for the same year.

Heat Generated in Setting.—The results obtained in the Walnut Street arch tests show a rise to an average maximum temperature of 94.5°F. in an average time of 33 hours after pouring, while other

¹ By Messrs. C. S. Nichols and C. B. McCullough.

results quoted in the bulletin show maximum high temperatures in setting varying from 100° to 130°F. attained in time intervals of from 18 hours to 8 days after placing. All considered, the value of 100° may be taken as a safe average of the final temperature attained by concrete in setting in structures typical of the Walnut Street arch.

The following is quoted from the bulletin above mentioned:

Temperature Variation.—"The main point of interest in connection with the temperature rise, due to the setting action, is not so much in the amount of this maximum itself, as in the fact that apparently all the subsequent temperature change is a drop, the stress-producing variation thus becoming more nearly equal to the entire temperature range than to one-half of it. This seems to be the conclusion drawn by Mr. Merriman (from his experiments on the Boonton dam), who says: 'If the maximum temperature attained is 100°F., then the stress-producing range is the difference between 100°F. and the lowest temperature subsequently attained.'

"While at first thought the above conclusion would seem to apply also to concrete arch structures typical of the ones herein described, yet the following facts demand our consideration. The sheer drop in temperature during the first season might induce stresses in the steel of the arch ring exceeding the elastic limit, thus producing a permanent set in the steel. This would operate to raise the elastic limit of the material in the direction of the stress (tension) to about the point of greatest stress, and produce in the arch ring a permanent deformation. The temperature of zero stress would then be, not the initial temperature, but the temperature which originally produced an elongation or distortion in the steel equal to the permanent set. During the subsequent seasonal variations, the variation of temperature would be each way from this new mean. Thus the temperature variation would be reduced to a value more nearly equal to one-half of the temperature range than to the whole range. On the other hand, the elongation of the steel might be so localized at the point of greatest bending as to cause an unsightly crack in the concrete.

"In the Walnut Street arch a temperature drop of the entire range, 87.6°F. plus the entire dead load and rib shortening cause a stress in the steel less than the elastic limit of the material. As a result, there are as yet no cracks in the structure, although it

has passed through a season of maximum external temperature variation.

"In the Squaw Creek bridge at Ames, a temperature drop of 80° or even 60° will stress the steel at the spring-line above the elastic limit, with the result that at three of the four corners of the structure there are unsightly cracks at the exact point of computed maximum stress. If this cracking is due to a permanent set in the steel, the effective stress-producing variation is now probably each way from a mean corresponding to the amount of the set produced, and the stresses consequently much lower than during the first year.

"In the Locust Street bridge at Des Moines, the steel is also stressed above the elastic limit with a sheer temperature drop equal to the range, and in proof of the theory above advanced, there are cracks at the crown of both the shore spans at the points where a theoretical elongation in the steel corresponds to a temperature drop.

"In spandrel-filled arches it is doubtful if at the coldest period much of the dead load, aside from that of the concrete itself, comes upon the structure by reason of the arching action of the partially frozen fill. However the amount of the arching action is problematical. This might tend to reduce the mathematical stresses produced by the application of all forces.

Effect of Atmospheric Temperature.—"It will be noted that the range during the first seasonal variations, which include the high temperatures of setting, exceeded the subsequent seasonal range by about 10 per cent of the former. It is obvious that had the concrete been placed at any other than the extreme high temperature of summer, the heat of setting would have been dissipated to a greater extent, and the range would have been less. This is illustrated by a comparison of the setting temperatures attained in different latitudes. The experiments in the tropical Panama climate showed a rise exceeding those of this country by from 10° to 30°. Other conditions being equal, a temperature more nearly normal would seem to be better for the concreting of arch structures typical of the ones herein described.

Lag.—"The data on the lag seem to show that in structures of this type the minimum temperatures are attained in time intervals anywhere from less than 1 day to 4 days after the atmospheric minimum. This interval depends upon the posi-

tion of the portion of the structure considered, and is roughly proportional to the distance from the nearest exposed face."

Agreement with Theory.—Levels were taken over the arch rings of both bridges from time to time to determine the rise and fall of the arch ring with variations in temperature. It was found that when uninfluenced by other factors than atmospheric variation, the rise and fall agreed quite closely with theory.

Conclusions as to Necessary Provision for Temperature Changes.—The writers of the bulletin concluded from the foregoing results and considerations that "to render an arch structurally safe, provision should be made (in the latitude where the bridge tests were conducted) for stresses induced by a temperature variation of *at least* 40°F. each way from an assumed temperature of no stress. Particular circumstances may demand that a greater variation be used for drop in temperature to prevent the appearance of cracks. This will always remain largely a matter of judgment with the designing engineer."

18. Shrinkage Stresses Due to Setting.¹—In arches constructed in longitudinal ribs, shrinkage in the concrete due to setting tends to deform the arch ring in a manner similar to that resulting from a temperature drop. A lowering of the temperature, however, causes contraction of both steel and concrete, while with shrinkage the concrete alone is contracted. As the concrete contracts, the steel is compressed until an equilibrium is established between the compression in the steel and the tension in the concrete which entirely restrains further shrinkage of the mass.

The contraction which results from shrinkage causes a downward deflection of the arch ring, which induces bending stresses. One side of the arch ring is thrown into tension and the other side into compression. On the one side the tension in the steel is offset by the compression due directly to shrinkage. On the other side the compressive effects in the steel are additive, tending to throw quite heavy compressive stresses in the reinforcement.

The primary effect of shrinkage and the bending effect due to the same cause must be considered in the concrete as well. The primary effect is tension, but the bending stresses which result must be taken into account and added algebraically to the direct shrinkage stresses.

¹ The greater portion of this article is taken almost verbatim from Bulletin No. 30 of the Iowa Engineering Experiment Station, by Messrs. C. S. Nichols and C. B. McCullough.

In connection with the temperature range experiments on the Walnut Street bridge described in the preceding article, observations were made on a block of concrete 36 in. long, 10 in. wide, and 6 in. deep, cast at the same time as the arch ring on the east arch. The object of these measurements was to determine the change in dimensions of the concrete during the period of setting. The block was of a 1:2:4 mixture, cast wet, and unreinforced. The measurements, made at a constantly-maintained room temperature of 72° for 100 days, showed a shrinkage of 0.04 per cent. This is somewhat less than the results of Mr. A. T. Goldbeck (see Concrete Age, August, 1911), who arrived at a coefficient of shrinkage of about 0.0005.

It is possible theoretically to determine the stresses in steel and concrete due directly to shrinkage. If we let c denote the coefficient of contraction of the concrete, the contraction per unit length of the reinforced section may be expressed as follows:

$$c_r = c - \frac{f_c}{E_c} = \frac{f'_s}{E_s}$$

Now, for equilibrium,

$$f_c = pf'_s$$

From these equations we get

$$f_c = cE_c \frac{np}{1 + np}$$

$$f'_s = \frac{f_c}{p}$$

The contraction of the reinforced section may be found by the formula

$$c_r = \frac{f'_s}{E_s}, \text{ or } c_r = \frac{c}{1 + np}$$

which is, of course, somewhat less than that of an unreinforced section. It is this contraction which causes the downward deflection of the arch ring and causes bending stresses throughout. Formulas may be determined for thrust, shear, and moment due to this bending, in the same manner as described for temperature in Art. 13.

The following tables have been taken from Bulletin No. 30 of the Iowa Engineering Experiment Station. They give the shrinkage stresses in the Walnut Street arch based upon the

above theory. A value of 0.0004 was taken for c which gave an average value of $c_r = 0.0003\frac{1}{2}$.

STRESSES AT CROWN

Condition of loading	Stress in steel		Stress in concrete	
	Maximum tension	Maximum compression	Maximum tension	Maximum compression
Dead load and shrinkage.....	7,400	6,400	None	513
Dead load only.....	-2,000	3,130	-136	213
Effect of shrinkage bending....	9,400	3,270	136	318
Primary effect of shrinkage....	-10,000	10,000	130	-130
Net maximum stress induced by shrinkage.....	None	13,270	130	188

- Indicates stress of opposite kind.

STRESSES AT SPRINGING LINE

Condition of loading	Stress in steel		Stress in concrete	
	Maximum tension	Maximum compression	Maximum tension	Maximum compression
Dead load and shrinkage.....	4,200	2,950	None	218
Dead load only.....	None	1,500	None	110
Effect of shrinkage bending....	4,200	1,450	None	108
Primary effect of shrinkage....	-10,250	10,250	121	-121
Net maximum stresses induced by shrinkage.....	None	11,700	121	None

- Indicates stress of opposite kind.

From the tables the most serious results seem to be the high compressive stresses induced in the steel reinforcement. The ordinary compressive stresses in the steel of arch rings, however, due to dead and live load, temperature, and rib shortening are usually low and, unless these stresses approach the allowable value, the effect of shrinkage need not be considered. The Walnut Street arch has a high percentage of steel and the tables

seem to show that in arches lightly reinforced the compressive stresses in the concrete may need to be investigated.

The above discussion is instructive but should not be taken too seriously. For example, it is doubtful if such large initial stresses occur in concrete (restrained by reinforcing material only) as is represented by a value of $c_r = 0.0003\frac{1}{2}$. Considère in his experiments observed a contraction in 1:3 mortar reinforced with 5½ per cent of steel to be only 0.01 per cent, or one-fifth the amount his tests showed on plain mortar. By the preceding formulas a contraction of about 0.03 per cent could be expected. It is reasonable, then, to conclude that a gradual adjustment takes place in the concrete during the process of hardening which results in less internal stress than theory would indicate. It is also unlikely that the shrinkage in any actual structure would be as great as that found on the laboratory specimen. Investigations of the actual shrinkage in concrete arch bridges will be needed before any very exact computations can be made for shrinkage stresses.

19. Deflection at Any Point.—The deflection at any point in an arch may be found by Formula (2), Art. 11, or

$$\Delta y = -\frac{s}{E_c I} \Sigma Mx$$

The arch should be assumed as cut at the point in question, and either portion of the arch may be considered. The cantilever selected should be subjected to exactly the same forces as exist in the arch itself.

If the deflection of the crown of a symmetrical arch is desired, the value of M due to loading for any section of the left cantilever may be found from Formula (7), Art. 14; or, substituting this value in the above equation, we have

$$\Delta y = -\frac{s}{E_c I} (M_c \Sigma x + H_c \Sigma xy + V_c \Sigma x^2 - \Sigma m_L x)$$

For temperature changes, Formula (11) of Art. 14 may be substituted in place of Formula (7), or

$$\begin{aligned} \Delta y &= -\frac{s}{E_c I} (M_c \Sigma x + H_c \Sigma xy) \\ &= -\frac{t \Delta D l (n_h \Sigma xy - \Sigma x \Sigma y)}{2[n_h \Sigma y^2 - (\Sigma y)^2]} \end{aligned}$$

20. Reliability of the Elastic Theory.—Formulas based on the elastic theory and actual experiments on arches have been found to give results which agree within practical limits. Whatever error occurs in applying the formulas is due chiefly to the inaccurate assumption that the entire cross-section of the concrete of each section of the arch ring is effective and that the location of the neutral axis, due to bending only, does not change throughout the arch. The neutral axis without any doubt shifts about under the action of different loads (see Art. 39, Volume I) and, as the elastic theory assumes the bending to take place about the neutral axis of each element (see Fig. 13), the values of x and y should properly be measured to some kind of an undulating curve. This curve, however, cannot be determined conveniently, so that the assumption is made in arch analysis that the arch axis passes through the neutral axis of each section. This is undoubtedly far from the truth where tension occurs and the steel takes all the tensile stress. Such a condition of stress is limited, however, to small isolated portions of the span and the error in the total result is undoubtedly small.

A comparison of some theoretical and experimental results on arches is given in the *Railroad Age Gazette*, March 26, 1909, in an article by Malverd A. Howe entitled "Experimental Verification of Arch Formulas."

Attention should be called to the uncertainty as to the fixedness of the ends of the arch. This uncertainty can be reduced or entirely eliminated by taking the skewback for purposes of analysis at a plane where the ends of the arch are virtually fixed. Whenever the abutments are of such a form that there is no pronounced change of section at the springing lines, then the analysis should include the whole structure down to the point where the distortion due to the live load on the arch will be inappreciable. In some cases this may be the very bottom of the abutment.

21. Method of Procedure in Arch-ring Design.—The main steps that need to be taken in the design of an arch ring may be enumerated as follows:

1. Assume a thickness for the arch ring at the crown and at the springing, using empirical formulas, if desired, as an aid to the judgment.

2. Lay out the curve assumed for the intrados.

3. Lay out a curve for the extrados to give as nearly as possible the assumed ring thickness at the springing.

4. Draw the arch axis between the extrados and intrados.

5. Divide the arch axis into an even number of divisions such that the ratio $\frac{s}{l}$ is constant for all.

6. Compute the dead and live loads, and indicate these loads properly on the drawing.

7. Compute H_c , V_c , and M_c at the crown for the different conditions of loading.

8. Draw the force polygons for the different conditions of loading and the corresponding equilibrium polygons, or lines of pressure.

9. Determine the thrusts, shears, bending moments, and eccentric distances at the centers of the $\frac{s}{l}$ divisions of the arch ring for the different conditions of loading.

10. Compute the thrust and moment at the crown due to variation in temperature; also the moments on the various sections, and the corresponding thrusts and shears by resolving the crown thrust into tangential and radial components.

11. Where necessary, compute the thrust and moment at the crown, and the thrust, shear, and moment at various sections due to rib shortening.

12. Combine the thrusts, shears, and moments due to the different conditions of loading with the thrusts, shears, and moments due to temperature and rib shortening. (The results usually show that the shearing unit stresses are very small and need not be considered.)

13. Compute the maximum stresses—compression in the concrete and tension in the steel—due to the thrusts and moments. If the stresses are either too small or too large, the dimensions or even the shape of the arch ring must be changed and the computations repeated.

Note.—A book of multiplication tables such as Dr. A. L. Crelle's "Rechentafeln" is convenient when making computations in arch analysis. The student is advised to procure a book of this nature.

22. Skew Arches.—Skew arches may be treated exactly as right arches, the span being taken parallel to the center line of roadway and not at right angles to the springing lines of the arch.

CHAPTER IV

DESIGN OF AN EARTH-FILLED ARCH BRIDGE

23. Data.—It is proposed to design an electric-railway arch bridge in accordance with the following data:

Rise, 9 ft. 0 in.

Span, 48 ft. 0 in.

Depth of earth filling over crown, 12 in.

Depth of ballast above earth filling (at crown) to base of rail, 16 in.

Dead load:

Earth filling, 120 lb. per cubic foot.

Concrete, including reinforcement, 150 lb. per cubic foot.

Ballast, ties, and rails, 150 lb. per square foot of roadway.

Live load:

A uniform load equivalent to 50-ton electric cars in train. In view of the considerations presented in Art. 7, it will be sufficiently accurate and on the safe side to consider a uniform load of 200 lb. per square foot extending over a 12-ft. width of arch at the crown. Live load will be applied over only the whole span and half-span. No allowance will be made for impact.

Latitude of Ames, Iowa.

Conditions of calculations:

$f_c = 600$ lb. per square inch in arch ring for a 1:2:4 concrete—temperature variation of 40°F. each way from an assumed temperature of no stress.

$f_s = 16,000$ lb. per square inch—temperature variation of 40°F. each way from an assumed temperature of no stress.

$E_s = 30,000,000$ lb. per square inch.

$E_c = 2,000,000$ lb. per square inch.

$n = 15$.

Allowable pressure on foundations shall not exceed 5 tons per square foot.

Steel in the arch ring will be placed in two layers—one layer near the intrados and the other a corresponding distance from the extrados. The writer can give no assurance that the steel arrangement to be used in this design does not infringe one or more of the existing patents on concrete bridges. Assurance of this nature would be unwise since engineers well versed in patent law claim that an efficient, safe, and economical concrete arch bridge cannot be designed at the present time without patent infringement. In this connection the reader is urged to study carefully Chapter XII of this volume.

24. Selection of the Trial Arch.—A trial depth of 9 in. will be taken at the crown with a radial depth of 21 in. at the springing. The arch assumed is shown on Designing Sheet No. 1. As explained in Art. 4, the intrados for an earth-filled arch with a ratio of rise to span of less than one-fourth will lie between an ellipse and a segment of a circle, and the trial shape of arch ring must be chosen according to judgment.

25. Dead Loads and Their Action Lines.—Now that the trial arch ring has been assumed, the dead loads may be determined.

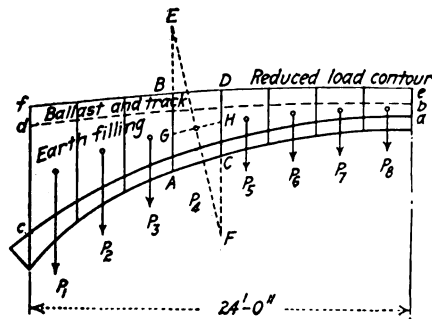

FIG. 19.

The earth filling and ballast, ties, and rails should first be reduced to an equivalent height of masonry, as shown in Fig. 19. For example, since the earth filling reaches 1 ft. above the extrados at the crown, the vertical distance ab should be laid off equal to $\frac{120}{150} = 0.8$ ft. In a similar manner the distance bc should be laid off equal to $\frac{150}{150} = 1$ ft. Points d and f should be determined for the loading at c , and similar points should also be found for other places along the arch ring, a sufficient number

being taken to fully determine the curved line fe . This line is called the *reduced-load contour*.

The arch with its load should now be divided by vertical lines into trapezoids, or what are nearly so. For testing the trial arch by the approximate method (to be presented in the following article), the horizontal distance between springing lines may be conveniently divided into divisions of equal horizontal length and, for the trial arch at hand, the number will be made sixteen, that is, eight divisions on each side of the crown.

The next step is to determine the area and center of gravity of each trapezoid. With the area known, the load corresponding to each trapezoid is found by multiplying by the weight of a cubic foot of concrete. (The student must carefully bear in mind that the arch considered is included between two longitudinal vertical planes 1 ft. apart.) The center of gravity for each of the trapezoids may be found as follows: Extend AB (Fig. 19) so that $BE = CD$, and in the opposite direction extend CD so that $CF = AB$. The intersection of EF and the median GH is the center of gravity sought.

26. Approximate Method of Testing Trial Arch.—Since the dead load of earth-filled arches usually controls the shape of the arch ring, the next step will be the testing of the trial arch for this loading, employing an approximate graphical method. In the method referred to, that form of arch in which the line of pressure and the arch axis most closely approach each other is considered to be the best that can be designed. A few words of explanation are needed for the student to understand the limits of this method.

There are two classes of theories of the stability of the masonry arch—the line-of-thrust theories and the elastic theories. The line-of-thrust theories do not consider the elastic properties of the material and are usually employed for arches made up of wedge-shaped stones, called *voussoirs*. For instance, stone arches are generally calculated by these theories and the stability of the arch ring is considered as depending upon the friction and the reaction between the several arch stones. Various assumptions are made in arriving at these different line-of-thrust theories, and the results derived from them are not so accurate as where the elastic properties of the material are employed. They may be made use of, however, in determining the proper shape of the arch ring before applying the elastic theory to monolithic arches;

or even before applying the elastic theory to voussoir arches, since any voussoir arch, whether of stone or brick, will act as an elastic arch as long as the line of resistance remains within the middle third.

A line-of-thrust theory by Winkler may be stated in a general way as follows: "The true line of pressure is the one lying nearest to the center line of the arch ring." The proof of this theorem depends on the assumption that the load is vertical, that the equilibrium polygon coincides with the line of pressure, and that the arch ring has a constant cross-section. This theorem for an earth-filled arch will evidently be more reliable the flatter the arch, since for such a type of arch the less are the conjugate horizontal forces produced on the arch ring by the earth filling. The matter of regarding the equilibrium polygon as coinciding with the line of pressure is assumed in all theories, but a constant cross-section of the arch ring is not usually the case in practice and generally increases, as it should, toward the springing as the thrust increases.

Now if an equilibrium polygon be passed through the centers of the arch ring at the crown and springing, this line will be very near the true line of pressure. In the trial arch mentioned above, if the equilibrium polygon and the arch axis do not closely approach each other there will surely be another shape of arch ring which will fulfill this condition, and hence have probably lower maximum stresses resulting from the live and dead loads. Thus, the method of obtaining the best form of arch is to find for what form the line of pressure for the dead load and the arch axis most nearly coincide. It should be clear that this method will aid us in getting pretty near, at any rate, to the proper form for the arch before applying the elastic theory.

In order to pass an equilibrium polygon through the centers of the arch ring at the crown and springing, the load line should first be laid off as shown on Designing Sheet No. 1 and then any convenient pole O' selected in the horizontal through the point k in the load line, this point representing the end of the load nearest the crown. The next step is to draw the rays to the force polygon and then construct the corresponding equilibrium polygon beginning at the center of the arch ring at the skewback (point A). If now the first and last strings are prolonged to an intersection at B , a vertical line is determined which contains the resultant of the loads occurring over the left half of span.

The equilibrium polygon which we have constructed does not pass through the center of the arch ring at the crown and is not the one required. We do know, however, that the first string which passes through A must intersect the last string in the vertical through B and that the last string must be horizontal due to symmetrical loading. Drawing a horizontal line through the center of the arch ring at the crown determines the point C which is the intersection of the first and last strings of the equilibrium polygon required. A line drawn through m of the force diagram parallel to CA determines the true pole O on the horizontal through k . If the force diagram is now completed for this pole, the required equilibrium polygon may be easily drawn. The line of pressure is seen to follow the arch axis very closely and the trial arch will be accepted for analysis.

In both preliminary and final analysis the arch ring should be laid out to a scale of 1 in. = 3 ft., and care should be used in the drafting work so as to have the dimensions exact and the lines sharp.

27. Division of Arch Ring for Constant $\frac{s}{l}$.—The method of dividing the arch ring into divisions having constant $\frac{s}{l}$ is given on Designing Sheet No. 2, and the divisions themselves are shown on Designing Sheet No. 4. The procedure should be clear from a study of Art. 15.

28. Moments and Thrusts.—A complete set of formulas, as shown on Designing Sheet No. 3, should be at hand before starting the arch analysis. The notes on this sheet are given for convenience and may aid in preventing errors due to the use of wrong algebraic signs. The formulas show, first of all, that the cantilever bending moments are required at the centers of the $\frac{s}{l}$ divisions caused by the given external loads (considering the arch as two cantilevers). These moments are found on Designing Sheets Nos. 5 and 5A by both algebraic and graphical methods. The algebraic method should be clear, but the graphical or equilibrium polygon method of finding these moments may need explanation.

ACB represents the arch axis and the load line is acb . O is any convenient pole on a horizontal line through the point c —a point on the load line at the junction of the crown loads P_s .

The equilibrium polygon corresponding is mno and, since $Oc = H$ is horizontal, the segment no is horizontal, and the desired bending moment at any point such as 5 is equal to the intercept on the vertical through this point (included between the equilibrium polygon and the horizontal line no produced) multiplied by the pole distance H , or $m = Hk_5$.

If desired, the cantilever moments due to live loading may be found somewhat more accurately than indicated in Designing Sheet No. 5. This may be done either by drawing the parabolic curve for moment due to uniform loading or by computing the value of the live moment at the center of each $\frac{s}{I}$ division in the same manner as for any point in a simple cantilever beam.

Designing Sheet No. 4 shows that the dead load is divided into separate forces in a different manner than in the preliminary analysis of the arch. This second division of the dead-load forces is not common in practice since, theoretically, there is no relation between the divisions of the arch ring and the points of application of the loads, the only requirement being to have such a small subdivision of the arch ring and of the load that the errors of approximation may be neglected. It seems to the writer, however, that taking the separating load-planes through the centers of the $\frac{s}{I}$ divisions results in more accurate values of the bending moments, which actually bend the separate elements of the arch ring, than are obtained by the common method of load subdivision. Besides, the usual division of the arch requires the perpendicular distance from the arch axis to the line of pressure at a division point to be measured *at* or *near* the load, and this is a most unfortunate selection if the eccentric distances at the sections are to be checked graphically. The load arrangement here proposed eliminates any error in scaling these distances, since between load points the equilibrium polygon and line of pressure coincide.

The live and dead loads near the crown act practically in the same vertical line and hence no sensible error results from assuming them to do so. Near the springing, however, where the horizontal distance between division points is considerable, the live and dead loads may need to be considered separately. In the arch in question a separation of dead and live load is made between division points 1 and 2.

Moments and thrusts for the different conditions of loading and for temperature and rib shortening are given on Designing Sheet No. 6. The writer has tried to arrange the results on this sheet in such a form that the operations involved will be clear and will need but little explanation. The values of x and y were scaled, and the values of m for dead load and for live plus dead load were carried forward from Designing Sheet No. 5. The magnitudes of the thrusts, N , were scaled from the force polygons on Designing Sheet No. 4, and the computed eccentricities x_e used simply as a check on the resultant line of pressure determined from the computations. The values of M and N for rib shortening were obtained directly from the moments and thrusts due to a fall of temperature by multiplying by the decimal 0.337.

In finding the average unit compression in the concrete due to thrust, only the total thrusts caused by dead load plus live load on right half of span have been considered, and these only at five sections of the arch ring. For light arches, such as the one we are designing, this method is sufficiently accurate for all practical purposes. For heavy arches, however, the effect of temperature (rise and fall) and rib shortening may need to be taken into account. There are two cases to be considered in such arches: (A) That due to dead load, live load, fall of temperature, and rib shortening; and (B) that due to dead load, live load, rise of temperature, and rib shortening. The method of finding the average unit compression in this more accurate manner will be shown by making the computations for the arch in question, adopting the same position of the live load as previously mentioned.

Case A. Assume $c_a = 155$ lb. per square inch.

$$H_c = \frac{-(0.016)(155)(144)(49.2)(8)}{490.8} = -287 \text{ lb.}$$

$$c_a \text{ (at crown)} = \frac{22,400 - 890 - 287}{(1)(0.75) + 0.092} = 25,250 \text{ lb. per square foot.}$$

$$c_a \text{ (at point 3)} = \frac{\frac{1}{2}(23,600 + 23,900) - 850 - \frac{850}{890}(287)}{(1)(0.80) + 0.092} = 25,400 \text{ lb. per square foot.}$$

$$c_a \text{ (at springing)} = \frac{\frac{1}{2}(29,200 + 31,600) - 620 - \frac{620}{890}(287)}{(1)(1.75) + 0.092} = 16,050 \text{ lb. per square foot.}$$

$$c_a \text{ (for arch)} = \frac{25,250 + 25,400 + 16,050}{3} = 22,200 \text{ lb. per square foot.}$$

(155) (144) = 22,300 lb., assumed value of c_a is satisfactory.

$$M_c = - \frac{(-287)(14.65)}{8} = + 526 \text{ ft.-lb.}$$

Case B. Assume $c_a = 160$ lb. per square inch.

$$H_c = (-287) \left(\frac{160}{155} \right) = 296 \text{ lb.}$$

$$c_a \text{ (at crown)} = \frac{22,400 + 890 - 296}{0.842} = 27,300 \text{ lb. per square foot.}$$

$$c_a \text{ (at point 3)} = \frac{\frac{1}{2}(23,600 + 23,900) + 850 - \frac{850}{890}(296)}{0.892} = 24,300 \text{ lb. per square foot.}$$

$$c_a \text{ (at springing)} = \frac{\frac{1}{2}(29,200 + 31,600) + 620 - \frac{620}{890}(296)}{1.842} = 16,700 \text{ lb. per square foot.}$$

$$c_a \text{ (for arch)} = \frac{27,300 + 24,300 + 16,700}{3} = 22,700 \text{ lb. per square foot.}$$

(160) (144) = 23,000 lb., assumed value of c_a is satisfactory.

$$M_c = - \frac{(-296)(14.65)}{8} = + 542 \text{ ft.-lb.}$$

TABLE OF SHEARS

Pt.	Live load on right half of span		Live load on whole span	Temperature (fall of 40°, rise of 40°, shears of opposite sign)	Rib shortening	Max. shear	Cross-section (sq. in.)	Max. shear (lb. per sq. in.)
	Left half	Right half						
Cr.	- 820	- 820	0	0	0	- 820	108	8
Spg.	+3200	+1000	+1300	-640	-220	+3620	252	14
1	+1900	- 200	+1100	-535	-180	+2255	161	14
2	- 200	-1600	- 600	-360	-120	-2080	117	18
3	+ 100	- 900	- 300	-280	- 95	-1275	115	11
4	+ 100	- 300	- 100	-230	- 80	- 610	114	5
5	+ 50	+ 100	-175	- 60	+ 215	111	2
6	- 150	+ 400	-120	- 40	+ 480	109	4
7	- 400	+ 600	- 75	- 25	+ 650	108	6
8	- 700	+ 800	- 25	- 10	+ 815	108	8

It is not customary to determine the shears at the centers of the $\frac{s}{l}$ divisions. The shears for the arch here analyzed are given above in order to show the student that the values obtained are actually very small.

29. Combining of Moments and Thrusts.—The method used in combining moments and thrusts for maximum stresses will be explained by giving all the computations needed in finding the maximum stresses at point 1. Reference should be made to Designing Sheets Nos. 6 and 7. Moments and thrusts due to a *fall* of temperature will usually combine with the moments and thrusts on right half of span (live load on right half of span) to give one set of maximum conditions. Moments and thrusts due to a *rise* of temperature will usually combine with the moments and thrusts on left half of span (live load on right half of span) to give a second set of maximum conditions. A third set due to live load on the whole span will need consideration at the crown and at sections near the quarter points. It is convenient to combine rib-shortening moments and thrusts with those for temperature as a preliminary operation. If the values of M , N , and x_0 (or $\frac{x_0}{l}$) of any given set are lower than corresponding values in some other set for the same section, then the first-mentioned set of values need receive no further consideration. Thrusts are likely to control at the crown and moments near the springing.

The necessary computations in combining moments and thrusts at section 1 are as follows:

<i>Fall of Temperature:</i>		<i>M</i>	<i>N</i>
	Temp.	- 3900	- 710
	R. short.	- 1300	- 240
		<hr style="width: 50%; margin: 0 auto;"/> - 5200	<hr style="width: 50%; margin: 0 auto;"/> - 950
<i>M</i>	<i>N</i>	<i>M</i>	<i>N</i>
- 5200	- 950	- 5200	- 950
<hr style="width: 50%; margin: 0 auto;"/> - 5200	28,000	<hr style="width: 50%; margin: 0 auto;"/> + 900	<hr style="width: 50%; margin: 0 auto;"/> 31,650
- 10,400	27,050	- 4300	30,700
<i>Rise of Temperature:</i>		<i>M</i>	<i>N</i>
	Temp.	+ 3900	+ 710
	R. short.	- 1300	- 240
		<hr style="width: 50%; margin: 0 auto;"/> + 2600	<hr style="width: 50%; margin: 0 auto;"/> + 470

<i>M</i>	<i>N</i>	<i>M</i>	<i>N</i>
+2600	+ 470	+2600	+ 470
+5500	26,500	+ 900	31,650
+8100	26,970	+3500	32,120

It is quite evident that the other possible combinations could not give maximum conditions. In fact, an experienced designer of arches would recognize immediately that the first set, only, needs consideration. The set having a value of $M = +8100$ ft.-lb. should be eliminated at once since the values of M , N , and x_0 of this set are lower than the corresponding values of the first set.

To comply with some types of specifications it is also necessary to find the maximum moments and thrusts with those due to temperature variation excluded, the idea being not to allow the line of pressure to depart from the middle third for such conditions. The method of doing this should be clear from the above example in which the moments and thrusts due to temperature are taken into account.

30. Maximum Stresses.—Maximum stresses at each section should be found for the entire arch, using Diagrams 13, 14, and 15 of Volume I, which are based on an embedment of the rods from each surface equal to one-tenth the depth. (Diagrams for other depths of embedment will be given in Chapter V, but these will not be considered here.) In light arches the embedment near the crown will be proportionately much greater than assumed and the stresses as determined by the diagrams of Volume I will be lower than the actual. Those sections where maximum stress is likely to result should then be again considered and the stresses computed accurately by using the formulas on Designing Sheet No. 7 which are reproduced from Volume I for convenience. The determination of k must be by trial.

The method of finding the *exact* compressive stress at any section when tension exists over part of section (Case II) will be explained by giving the computations for finding the stress at section 1. Since $k = 0.620$ for one-tenth embedment of the rods, a good value to use for a trial would be 0.600. Substituting in the formula for k , this value, however, does not satisfy the equation. A value of $k = 0.596$ is then readily determined. Substituting in the formula for L gives a value for this term of 0.1066. Then

$$f_o = \frac{(10,400)(12)}{(0.1066)(12)(1.12)^2(144)} = 540 \text{ lb.}$$

The steel stresses are evidently very small and need be computed in but few cases. The concrete stress at sections 3, 7, and 8 will evidently be lower than that in adjoining sections having approximately the same value of t . The arch assumed we will consider as satisfactory.

When the stresses in an arch are found to be altogether too small or too large, the dimensions or even the shape of the arch ring should be changed and the computations repeated. Small changes, however, may be made without refiguring the whole arch. For example, the thickness of the arch ring may be decreased throughout by changing the moment of inertia of all sections in the same ratio—that is, by keeping $\frac{s}{I}$ constant. This may be done since the dead- and live-load stresses will remain sensibly unchanged, and the temperature and rib-shortening stresses will be but slightly modified. The point in the arch where the unit stress is the greatest should be selected, and the depth t determined by trial which will give the required allowable stress. Of course, this depth should be determined by considering M , N , and x_0 the same as for the unchanged section. The depth at every other section, then, must be changed by such an amount that the percentage change in the moment of inertia will be a constant throughout the arch.

If desired, the modified arch ring may be again tested for maximum stresses. This may be accomplished by finding the new moments due to temperature and rib shortening and combining these with the moments due to loading which can be considered to remain unchanged. The values of the moments and thrusts for temperature change will be increased or decreased in the same ratio as the value of I . The values of the moments and thrusts for rib shortening will increase or decrease inversely as I , but obviously not in the same ratio, and will need to be determined in the same manner as in the previous computations.

31. Design of Abutments.—The shape of abutment must be such that the load on the foundation will not exceed the allowable and will be well distributed. The shape that will be assumed is shown on Designing Sheet No. 8, the top of the abutment being drawn somewhat above a tangent to the extrados at the skewback.

In general, the so-called lines of pressure through the abutment should be drawn for the following conditions:

1. Dead load and live load on the half span opposite to the abutment.
2. Dead load and live load on the half span adjacent to the abutment, with live load *on* the abutment.
3. Dead load and live load over the whole span, with live load *on* the abutment.
4. In some cases, depending upon the method of procedure adopted in arch construction, an analysis should also be made for dead load only of the arch ring, without earth fill either above or back of the abutment.

The lines of pressure for all cases should be as near to the center of the base as possible in order to obtain a nearly uniform distribution of load over the entire foundation. The analysis and design of the abutment is given on Designing Sheet No. 8, with the exception that for clearness the combination of forces for condition (4) is not shown.

The forces that may act on the foundation consist of (1) the reaction of the arch; (2) the weight of the abutment; (3) the weight of the earth, ballast, and live load directly above the abutment; and (4) the lateral earth pressure. To find the maximum lateral earth pressure, the live-load surcharge should be determined, also the surcharge due to ballast, ties, and rails. The height of the live-load surcharge may be found by dividing the live load per square foot by the weight of a cubic foot of earth. The surcharge due to ballast, ties, and rails may be found in a similar manner. The horizontal pressure on AC' when the live load is acting is thus equal to the difference between the pressures on AG and $C'G$, and may be determined by the method explained in Art. 3 of Volume II. If we assume an equivalent fluid weight of 25 lb. per cubic foot, then this horizontal pressure

$$P = 2\frac{1}{2}(5)(19.23^2 - 12.33^2) = 2720 \text{ lb.}$$

and acts at a distance of

$$\frac{6.90^2 + (3)(6.90)(12.33)}{3(6.90 + 2 \times 12.33)} = 3.19 \text{ ft.}$$

above the base. Without the live load, $P = 2470$ lb. and acts at practically the same distance above the base as when the live load is included. In this design a lateral pressure of 2700 lb. may be considered with sufficient accuracy for all cases.

The weight of the prism of earth whose cross-section is *BGHC* and thickness 1 ft. is

$$\frac{(12.33 + 6.90 - 1.00) + 12.33}{2} \times 9.50 \times 120 = 17,500 \text{ lb.}$$

The weight of the prism represented by *BKLC* = 17,500 - (9.50)(1.67)(120) = 15,600 lb. The center of gravity of these prisms may be found by the method outlined in Art. 25. The forces representing the weights of the prisms act practically in the same vertical line, and for simplicity we shall use a force of 17,500 lb. for both cases acting 4.45 ft. from the inner edge of abutment.

The weight of the masonry is readily found by dividing the outline of the abutment into a number of triangles and placing the weight represented by a given triangle at its center of gravity. (The center of gravity of a triangle is at the intersection of the medians.) The resultant of all the vertical forces acting (including the weight of the prism of earth) may then be determined by the principle of moments which is explained fully in Art. 2 of Volume II. The resultant is found to have a magnitude of 25,000 lb. and acts 4.94 ft. from the back edge of the abutment.

Designing Sheet No. 8 shows the method of combining forces to find the thrusts on the foundation for the three conditions of loading. The maximum and minimum pressures for any loading may be obtained by using the formulas of Art. 9, Volume II. The true maximum equals

$$p_1 = \frac{15,200}{7.50} \left(1 + \frac{6 \times 0.65}{7.50} \right) = 10,400 \text{ lb. per square foot}$$

The method of design described above is considerably on the safe side. The student should note that in using the reactions from the arch ring the assumption is made that the live load of 200 lb. per square foot extends over the entire 16 ft. width of bridge, when, in fact, a load of this intensity covers approximately only 12 ft. at the crown, spreading out at other points so that the unit live load on the back of the arch ring near the abutment is very much less than the maximum. In other words, a much more accurate set of reactions could be obtained with which to analyze the arch abutment by assuming a live load of 200 lb. per square foot at the crown and decreasing this load as the

abutment is approached. Some allowance for this condition of loading is sometimes made in the abutment design, but since the elastic theory fails if the foundation is not unyielding, the added factor of safety is not usually considered.

Many engineers believe (the writer included) that in many, if not the majority of cases, the dead and live load per linear foot of arch on a strip 1 ft. wide may be determined for purposes of analysis as equal to the total dead load plus total live load divided by the total width of arch. This loading is adopted on the assumption that a 1-ft. strip will not fail separately but will be assisted by the adjoining strips so as to produce average conditions.

32. Design of Spandrel Walls.—The details of the spandrel walls are shown on Plate I which also gives the complete design of bridge. Since cantilever retaining walls would bring indeterminate stresses in the arch near the edges of the ring, which would not be at all desirable in such a thin arch, the curtain-wall type of construction with cross walls was adopted. The method of design is the same as for counterforted retaining walls which is explained in Art. 12 of Volume II.

Expansion joints in the spandrel walls are made at the springing lines (in larger arches additional joints should be made throughout the span) and may be made mere planes of weakness or as actual joints filled with one or more layers of felt or some other partially elastic material. Such expansion joints are desirable to prevent unsightly cracks due to rise and fall of the arch caused by temperature changes. If the arch centers are not struck until after the spandrel walls are constructed, then expansion joints are also necessary to prevent cracking due to settlement of the crown of the arch when the centers are lowered.

Since an arch bridge with a level coping will always appear to sag in the middle, a camber of 4 in. is provided. This slight camber, of course, was not considered in the previous loading calculations.

A batter is given to the back of the cantilever retaining walls resting on the abutments so as to give a low compressive stress per square inch on the abutment concrete, this concrete being only a 1:3:6 mixture. The back of the arch and the lower parts of the spandrel and cross walls should be waterproofed in order to prevent seepage of water through the arch ring and to facilitate drainage.

Designing Sheet 1

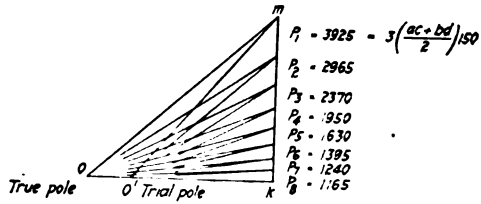
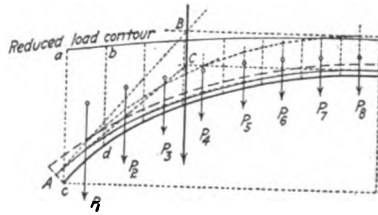
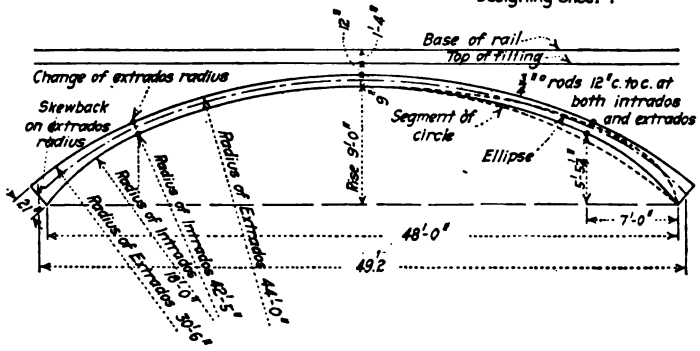

Designing Sheet 2.

Division of Arch Ring for Constant $\frac{I}{S}$

Measured length of $\frac{1}{2}$ arch axis = 26.82
 Rads. $\frac{3}{4}^\circ$, $12\frac{1}{2}''$ c to c.
 Steel area = $0.44 \times 2 = 0.88$ sq. in

$$P_c = \frac{0.88}{(12 \times 9)} = 0.00815 \text{ (at crown)}$$

$$a_s = \frac{0.88}{144} = 0.00611 \text{ sq. ft}$$

$$15a_s = 0.092$$

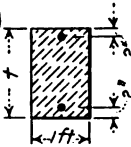

Distance along the axis from skewbk	t (ft.)	$I_c = \frac{t^3}{12}$	$\frac{t}{2}$	$\frac{t}{2} - d'$	$15a_s(\frac{t}{2} - d')^2 = 15I_s$	$I = I_c + 15I_s$	Division	Lengths of divisions to make $\frac{I}{S}$ constant (by diagram)
3.00	1.23	.155	.615	.448	.019	.174	1	8.00
4.50	1.07	.102	.535	.368	.012	.114	2	3.23
6.00	.92	.065	.460	.293	.008	.073	3	2.91
7.50	.86	.053	.430	.263	.006	.059	4	2.74
9.00	.83	.048	.415	.248	.006	.054	5	2.60
10.50	.82	.046	.410	.243	.005	.051	6	2.52
12.00	.80	.043	.400	.233	.005	.048	7	2.44
15.00	.78	.040	.390	.223	.005	.045	8	2.38
18.00	.77	.038	.385	.218	.004	.042	$\frac{I}{S} = 0.016$ (from diagram)	
21.00	.76	.037	.380	.213	.004	.041		
24.00	.75	.035	.375	.208	.004	.039		
26.82	.75	.035	.375	.208	.004	.039		

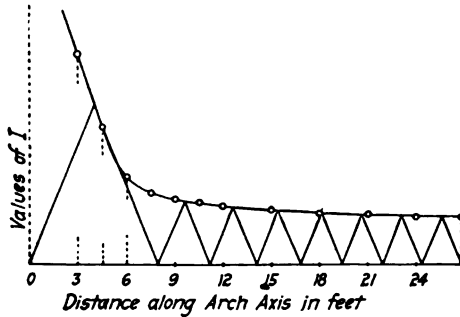

Designing Sheet 3.

Formulas Required

Loading:

$$H_c = \frac{n_h \sum (m_L + m_R)y - \sum (m_L + m_R)\sum Y}{2[n_h \sum Y^2 - (\sum Y)^2]} \quad (4)$$

$$V_c = \frac{\sum (m_L - m_R)x}{2\sum x^2} \quad (5)$$

$$M_c = \frac{\sum (m_L + m_R) - 2H_c \sum Y}{2n_h} \quad (6)$$

$$M = M_c + H_c y + V_c x - m_L \quad (7)$$

$$M = M_c + H_c y - V_c x - m_R \quad (8)$$

All values of m_L , m_R , x , and y should be substituted as positive. All summations refer to one-half of the arch axis. Positive value of V_c indicates that the line of pressure slopes upward towards the left; a negative value, downward towards the left. Positive value of M_c indicates that the thrust H_c acts above the arch axis. Signs preceding terms M_c and $V_c x$ in formulas (7) and (8) depend upon the results of (5) and (6).

Temperature:

$$H_c = \frac{I}{s} \cdot \frac{\epsilon t_D \ell n_h E_c}{2[n_h \sum Y^2 - (\sum Y)^2]} \left\{ \begin{array}{l} t_D \text{ should be} \\ \text{inserted as +} \\ \text{for a rise;} \\ \text{- for a drop.} \end{array} \right\} \quad (9)$$

$$M_c = -\frac{H_c \sum Y}{n_h} \quad (10)$$

$$M = M_c + H_c y \quad (11)$$

The value of t_D should be inserted as plus for a rise of temperature; minus (-) for a drop. Signs preceding H_c in formulas (10) and (11) depend upon the result of formula (9). Sign preceding M_c in formula (11) depends upon the result of formula (10). Thus for fall of temperature, thrust and moment are of opposite sign from those for a rise. ℓ = span of arch axis.

Rib Shortening:

$$H_c = -\frac{I}{s} \cdot \frac{\epsilon_a \ell n_h}{2[n_h \sum Y^2 - (\sum Y)^2]} \quad (12)$$

$$M_c = -\frac{H_c \sum Y}{n_h} \quad (13)$$

$$M = M_c + H_c y \quad (14)$$

Values of moments and thrusts for rib shortening are of same sign as for temperature fall. ℓ = span of arch axis.

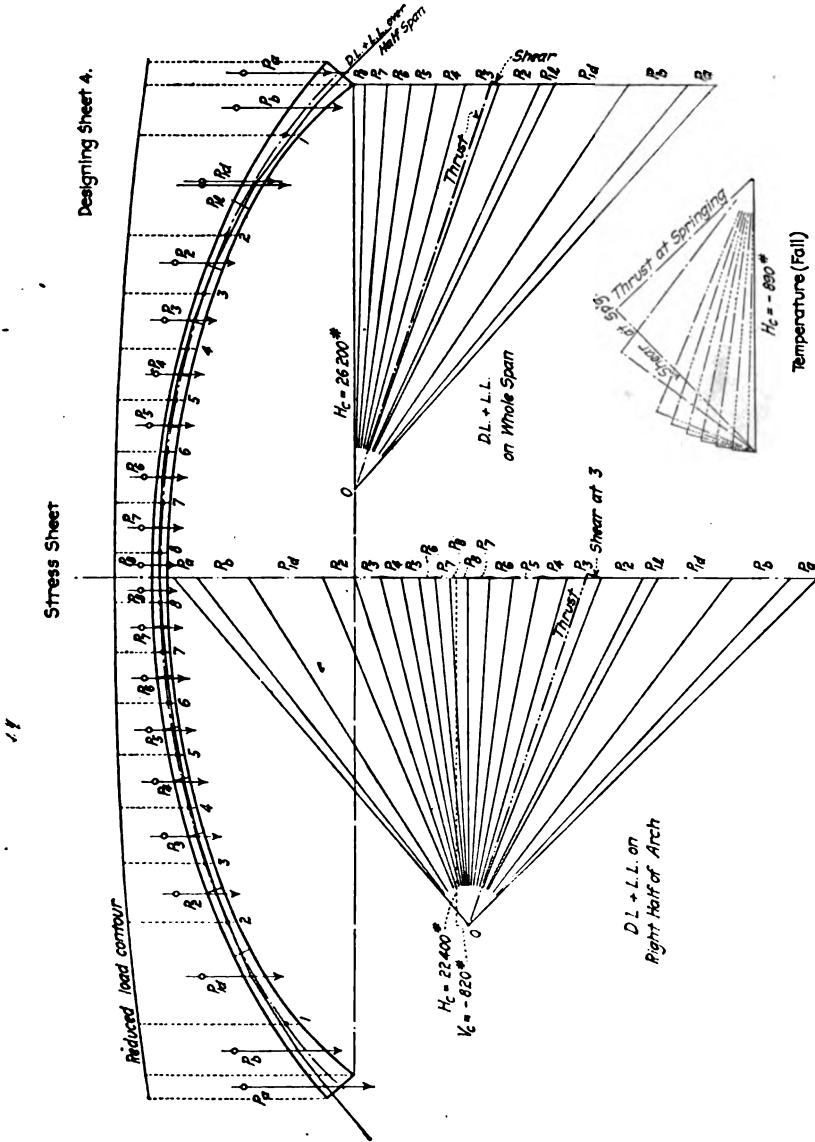

Cantilever Moments
(Algebraic Method)

Designing Sheet 5-

Point	Hor. dist. from crown	Hor. distance between points	Dead Load				Dead Load plus Live Load				
			Dead Loads	Summation of Dead Loads	Increment of Moment (Dead)	Moments (Dead)	Live Loads	Sum. of Live Loads	Increment of moment	Moments	
									Live Load	LL+DL	
P_7	.61		460	460			240	240			
8	1.19	.58			270	270		140	140	410	
P_7	2.41	1.22	940	1400	560	830	480	720	290	430	
7	3.60	1.18			1670	2500			860	1290	3730
P_6	4.87	1.27	1020	2420	1780	4280	490	1210	910	2200	
6	6.07	1.20			2900	7180			1450	3650	10830
P_5	7.37	1.30	1140	3560	3150	10330	590	1710	1570	5220	
5	8.57	1.20			4270	14600			2050	7270	21870
P_4	9.89	1.32	1320	4880	4700	19300	510	2220	2260	9530	
4	11.12	1.23			6000	25300			2730	12260	37560
P_3	12.51	1.39	1640	6520	6780	32080	540	2760	3090	15350	
3	13.82	1.31			8540	40620			3620	18970	59590
P_2	15.28	1.46	2060	8580	9520	50140	570	3330	4030	23000	
2	16.66	1.38			11840	61980			4600	27600	89580
P_{1d}	19.26	2.60	4770	13350	22310	84290					
P_{1e}	19.09	2.43					P_2 970	4300	8090	35290	
1	21.53	P_1 2.27 P_2 2.44			30300	114590			10490	46180	160770
P_D	22.86	1.33	3280	16630	17760	132350	490	4790	5720	51900	
P_{1a}	24.55	1.69	1560	18190	28100	160450	220	5010	8100	60000	220450
			24.55	18190	160450	5010	60000				
						(25.05)(200) = 5010					

Camblever Moments
(Graphical Method)

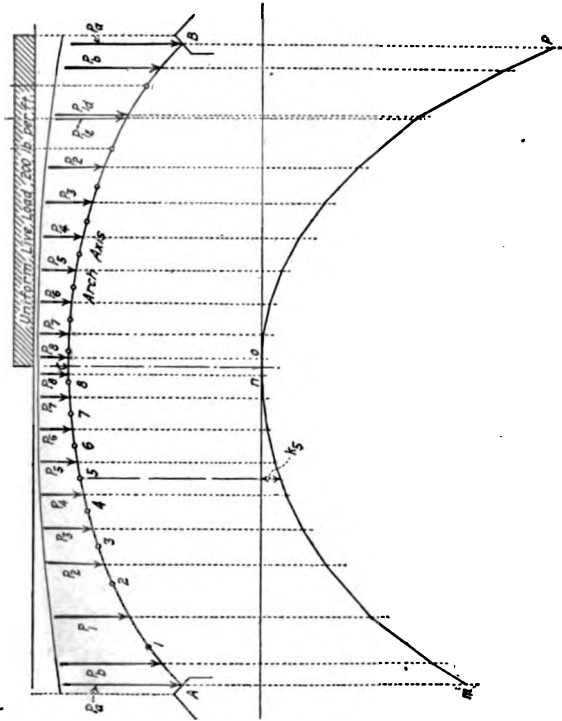

Designing Sheet 5 (A)

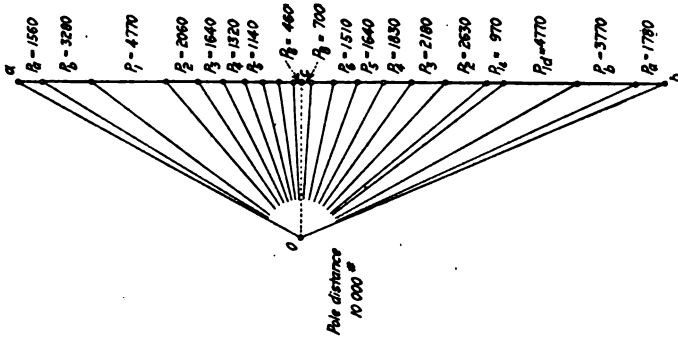

Abut distance
10 000 ft

MOMENTS AND THRUSTS

Designing Sheet 6.

Pt.	x	y	x ²	y ²	Dead Load		Live plus Dead Load		Dead Load plus Live Load on Right Half of Span			D.L. plus L.L. on Whole Span			Temperature			Rib Shortening 1/2 (L ₁ + L ₂) M _c = 850			
					m	mx	my	m	mx	my	H _c	V _c	M	N	H _c	M	N		H _c	M	N
C ₁																					
5	24.55	8.82	603.7	77.79	160.450	3339.000	1415.200	220.450	5412.000	1944.400	187.600	-20.000	+57.000	+28.200	-50	-28.200	-682	+1630	-880	1650	300
1	21.53	6.17	463.5	39.07	114.590	2467.100	707.000	160.770	3461.400	992.000	139.200	+5.000	+27.500	+161.700	+900	+31.650	+03	-3500	-3900	-710	200
2	16.66	3.35	277.6	11.22	61.980	1032.600	207.600	89.580	1492.400	300.100	75.000	-13.700	-1.000	+24.900	+800	+28.800	-06	-3000	-1400	-820	200
3	13.82	2.28	191.0	5.20	40.620	561.400	92.600	59.590	823.500	135.900	51.100	-11.300	-1.000	+20.800	+100	+27.800	+04	-2000	-1400	-820	200
4	11.12	1.45	123.7	2.10	25.300	281.300	36.700	37.560	417.700	54.500	32.500	-9.100	-2.900	+10.470	+300	+30.000	+05	-1500	-800	-660	100
5	8.57	.86	73.4	.74	14.600	125.100	12.600	21.870	187.400	18.800	19.300	-7.000	-2.700	+22.650	+18	+22.500	+60	-800	-600	-870	200
6	6.07	.40	36.8	.16	7.180	43.600	2.900	10.850	63.800	4.300	9.000	-5.000	-3.600	+22.650	+16	+10.500	+400	-400	-28.500	-05	400
7	3.60	.12	13.0	.01	2.500	9.000	300	3.790	13.600	500	2.700	-3.000	-3.800	+22.650	+14	+3.100	+700	-100	+1200	-680	400
8	1.19	.02	1.4	.00	.270	300	—	.410	500	—	.400	-1.000	-1.200	+22.400	+05	+500	0	-100	+1600	-680	500
Σ	14.65	1180.4	57.50	287.040	4520.400	1039.700	383.400	6462.300	1506.100	—	—	—	—	—	—	—	—	—	—	—	—

Live Load on Right Half of Span:

$$H_c = \frac{8(1,039,700 + 1,508,100) - 667,040 + 383,400(14.65)}{2[8(57.50) - (14.65)^2]}$$

$$= \frac{10,997,500 - 22,400 \text{ lb.}}{490.8}$$

$$= \frac{4,520,400 - 6,462,300}{2(1180.4)} = -820 \text{ lb.}$$

Live Load on Whole Span:

$$H_c = \frac{0(12,150,800) - 2(383,400)(14.65)}{490.8}$$

$$= \frac{-12,864,000}{490.8} = -26,200 \text{ lb.}$$

$$V_c = 0$$

$$M_c = \frac{2(383,400) - 2(26,200)(14.65)}{16}$$

$$= \frac{-860}{16} = -50 \text{ ft. lb.}$$

Temperature (fall):

$$H_c = \frac{-(0.00008)(60)(2)(10)(26,200)(14.65)}{490.8}$$

$$= -880 \text{ lb.}$$

$$V_c = 0$$

$$M_c = \frac{(880)(14.65)}{8} = +1650 \text{ ft. lb.}$$

Temperature (rise load on one-half span):

$$H_c = \frac{-(0.00008)(60)(2)(10)(26,200)}{490.8} = -300$$

$$C_c \text{ (at crown)} = \frac{22,400}{(1175) \times .982} = 26.600$$

$$C_c \text{ (at point 3)} = \frac{1}{2} \frac{23,600 \times 23,900}{(11,800) \times .982} = 16.600$$

$$C_c \text{ (at springing)} = \frac{1}{2} \frac{29,200 \times 31600}{(10,175) \times .982} = 16.800$$

$$C_c \text{ (at springing)} = \frac{1}{2} \frac{31,600 \times 33,700}{(11,715) \times .982} = 16.800$$

$$\text{Ratio of } \frac{H_c \text{ for rib shortening}}{H_c \text{ for temperature}} = \frac{300}{890} = .337$$

Designing Sheet 7.

Maximum Stresses

Point	t	P ₀	Combination of Moments and Thrusts and Resulting Stresses				
			M	N	$\frac{M}{I}$	ϵ_c	ϵ_t
Crown	0.75	.00815	^a + 2130	25 010	.113 (f)	^a 335	
Springing	1.75	.0035	+20800	29 610	.401 (r)	472	6100
			^a +14700	35 310	.238 (r)	^a 324	(Exact 540)
1	1.12	.0054	-10 400	27 050	.343 (f)	516	7800
2	0.81	.0075	^a - 3700	27 700	.165 (f)	^a 408	
3	0.80	.0076	+ 2700	24 460	.138 (r)		
4	0.79	.0077	+ 4100	22 150	.235 (f)	406	(Exact 572)
5	0.77	.0079	+ 5200	21 640	.312 (f)	508	
			- 3200	23 430	.177 (r)	371	
6	0.76	.0080	- 4400	23 230	.249 (r)	458	
7	0.75	.0081	- 4200	23 030	.243 (r)		
8	0.75	.00815	- 3300	22 980	.192 (r)		
			^a + 2100	25 010	.112 (f)		

^a means due to live load on whole span

Formulas for Bending and Direct Stress

$$\left\{ \begin{array}{l} \text{Compression over entire section} \\ \text{Tension over part of section} \end{array} \right. \left\{ \begin{array}{l} \epsilon_c = \frac{N}{bt} \left(\frac{1}{1 + \eta \rho_c} + \frac{6k_t}{t^2 + 12 \eta \rho_c r^2} \right) = \frac{N}{bt} (K) \\ k^2 - 3 \left(\frac{1}{2} - \frac{k}{t} \right) k^2 + \eta \rho_c k \frac{k}{t} \pm 3 \eta \rho_c \left(\frac{k}{t} + 2 \frac{r^2}{t^2} \right) \\ L = \left[\frac{\eta \rho_c r^2}{k t^2} + \frac{k}{12} (3 - 2k) \right] \\ \epsilon_t = \frac{M}{L b t^2} \\ \epsilon_s = \eta \epsilon_c \left(\frac{d}{k t} - 1 \right) \end{array} \right.$$

Analysis of Abutment

Designing Sheet 8.

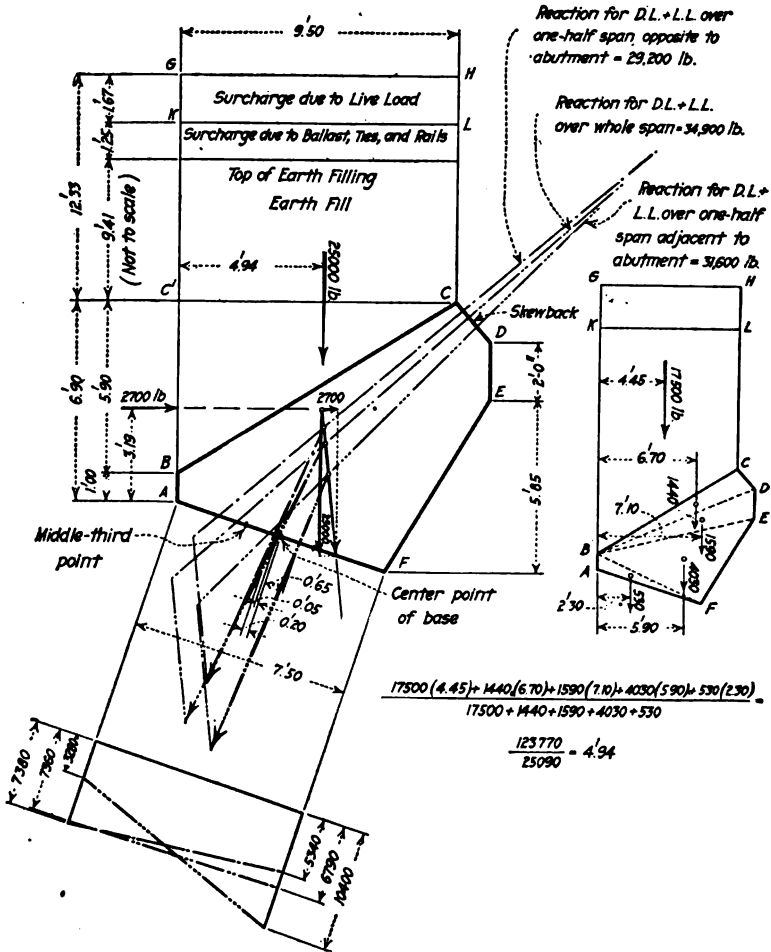
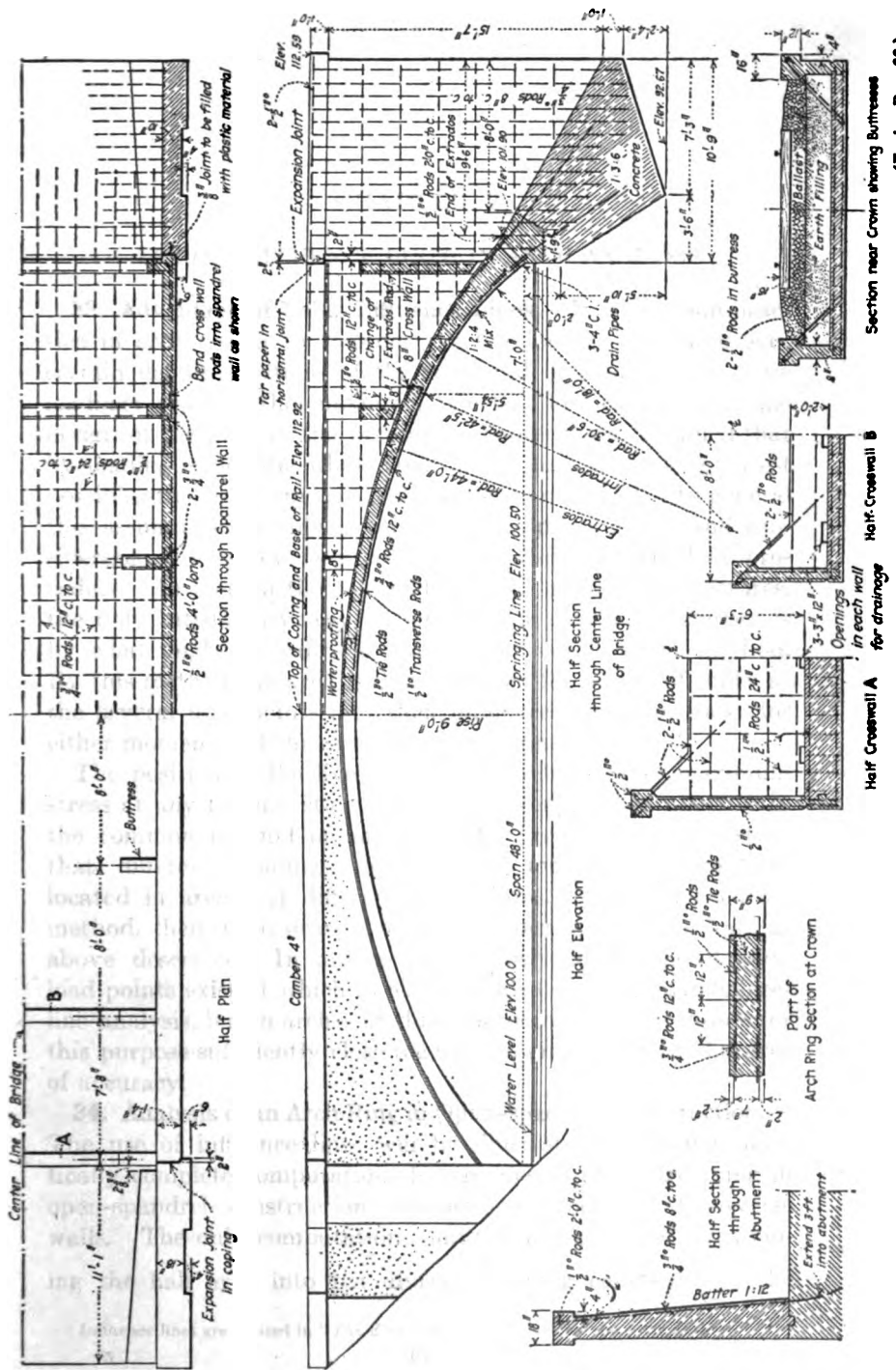

PLATE I



(Facing Page 66.)



100

CHAPTER V

USE OF INFLUENCE LINES IN ARCH ANALYSIS

33. Advantage of Using Influence Lines.—It is common practice in arch design to consider the live load as extending over certain definite portions of the span and to assume that these loadings produce the maximum effects. For example, in the design of the arch in the preceding chapter it was assumed that by loading either the whole span or the half span the greatest possible stresses at any given section were obtained. In general this assumption is only a very rough approximation, and considerable inaccuracy may result from such a method of procedure. In fact, in the case of large and important structures, the only satisfactory way to analyze for maximum stresses is by what might be called a *unit-load* or *influence-line* method. By this method the arch is first analyzed for a load of unity at the several load points and then influence lines¹ are drawn for either moment and thrust or for fiber stress.

The position of the live load on an arch to cause maximum stress at any given section cannot be determined in advance in the common method of analysis. An investigation will show that different loadings are required for sections similarly located in arches of different proportions. The only accurate method, then, is to draw a proper number of influence lines as above described. In arches continuously loaded no definite load points exist at which to place the load of unity in influence-line analysis, but in arches of this class points may be chosen for this purpose sufficiently close together to give any desired degree of accuracy.

34. Analysis of an Arch Ring in Open-spandrel Construction.—The use of influence lines will be illustrated by giving practically complete computations for the design of an arch ring in open-spandrel construction supporting a series of transverse walls. The only computations omitted will be those for dividing the half arch into ten divisions having constant $\frac{s}{l}$. The

¹ Influence lines are treated in "The Elements of Structures," by the same author.

arch to be analyzed is shown in Fig. 20. Loads apply to a longitudinal strip of arch ring 12 in. in width. The notation that will be used is given in Art. 13.

Designing Sheet No. 9 gives the computations needed in determining the moments and thrusts at the crown for a load of unity placed successively at the load points $L_1, L_2, L_3,$ and L_4 . In a symmetrical arch such as the one under analysis, load points need be taken only to one side of the center of span. The quantity m (cantilever moment) at a given section for a load of unity at a given load point is equal to the value of x for the section in question minus the value of x for the given load point. For example, the value of m for section 1 with a unit load at L_1

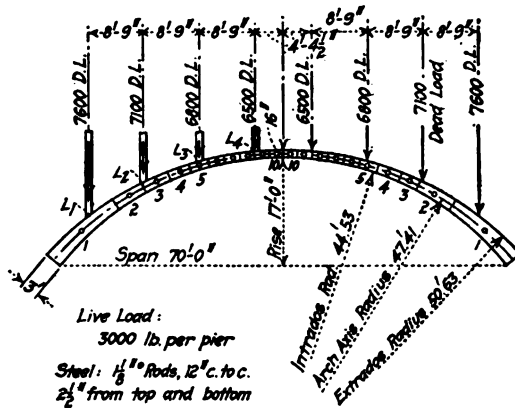

FIG. 20.

equals $31.70 - 30.62 = 1.08$ ft.-lb. Also the value of m for section 1 with a unit load at L_4 equals $31.70 - 4.37 = 27.33$ ft.-lb. The values of the moments and thrusts at the crown were determined by the formulas given on Designing Sheet No. 3.

Designing Sheets Nos. 10 and 10A give the computations and graphical work required in determining the moments and thrusts at the various sections due to the above loadings. The moments and thrusts could all be determined algebraically, but the graphical method is much the simpler. The method of procedure in constructing Designing Sheet No. 10A will be explained by considering a unit load at L_4 .

The values of H_c , V_c , and x_o (at crown) for this loading are known, having been computed on Designing Sheet No. 9. These

values determine the magnitude, direction, and point of application of the reaction at the crown. The point of application, designated as a on Designing Sheet No. 10A, is 1.06 ft. from the arch axis and should be laid off above the same, since the sign is plus. The value of V_c is positive and indicates that the line of pressure slopes upward toward the left. The force polygon for the unit load at L_4 is designated as AOC . The side OA is determined by laying off AB on the vertical side AC equal to V_c , and making the horizontal distance BO equal to H_c . With AC as one side of the force polygon made equal to the load of unity, and with OA equal to the reaction on the right of the arch, the reaction to the left of the point L_4 must equal OC , or the closing side of the polygon. In order for the forces acting on the arch to be in equilibrium, the forces must act in order around the triangle. This fact shows that OC acts upward toward the right, as was to be expected.

The equilibrium polygon may thus be determined by drawing a line through the point a parallel to OA , and then drawing a line on the left portion of the arch parallel to OC , both lines intersecting in the load vertical at b . The bending moment at any section, due to the unit load at L_4 , is therefore equal to the vertical ordinate measured from the arch axis to the equilibrium polygon, multiplied by the force H_c . If the vertical ordinates be designated in general as v_d , then, at any section, $M = H_c v_d$. The thrusts and shears at any section may be found by resolving the proper reaction into components perpendicular and parallel respectively to the section in question. The values of the moments and thrusts are given in the proper columns on Designing Sheet No. 10. Moments and thrusts for other loadings may be determined in a similar manner.

Influence lines could now be drawn for moment and thrust, but maximum fiber stress does not occur in general for either maximum moment or maximum thrust. Obviously, the true maximum stress occurs for the loading that makes the algebraic sum of the stresses due to moment and thrust a maximum. Influence lines, therefore, should often be drawn directly for outer fiber stress, as such procedure eliminates any necessity for trial loadings.

Before influence lines are plotted, there is no way of telling, for a given maximum condition of loading, whether the stress analysis of a given section will fall under Case I or under Case II

(see Arts. 75 and 76, Volume I)—that is, whether compression will be produced over the entire section or whether a tension will exist over part of the section greater than the allowable tensile strength of the concrete. If the latter condition (Case II) should result, an influence line for fiber stress cannot be employed to determine the corresponding maximum stress, due to the fact that it is impossible, when computing values of the fiber stress for a load of unity at separate load points, to take properly into consideration the exact amount of tensile stress in the concrete that would be neglected if the analysis should be made for the maximum loading using total moment and total thrust. This is not serious, however, since no matter whether maximum stress is desired at an upper or lower fiber, the loading that will produce a maximum value, assuming a Case I distribu-

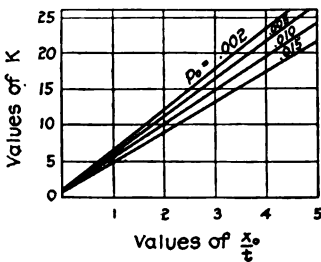

DIAGRAM 1.

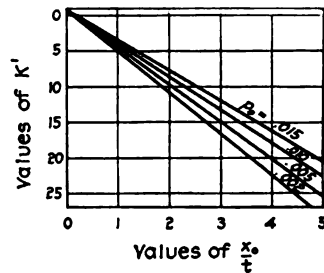

DIAGRAM 2.

tion of stress, will always be the same loading that will cause maximum stress for Case II distribution. Consequently, the influence lines should all be drawn assuming Case I distribution, and, if tension is found greater than the allowable tensile strength of the concrete, the Case II conditions should be separately considered by drawing influence lines for moment and thrust and finding the values of the moments and thrusts that correspond to the Case I loadings for maximum stress.

(If no tension greater than the tensile strength of the concrete is likely to result at any section of the arch, then Designing Sheet No. 10 may be omitted. The values of x_0 and N may be scaled and used directly in Designing Sheets Nos. 11 and 11A. In fact, even with considerable tension at some sections, not all of Designing Sheet No. 10 will be needed and only those values should be determined as are later found necessary. The de-

signing sheet is given in full here, however, for convenience and for instructive purposes.)

The following formulas refer to Case I:

$$f_o = \frac{NK}{bt}$$

$$f'_o = \frac{NK'}{bt}$$

in which, for reinforcement symmetrical about the center of section,

$$\frac{(K)}{(K')} = \left[\frac{1}{1 + np_o} \frac{(+)}{(-)} \frac{6x_o t}{t^2 + 12np_o r^2} \right]$$

For an embedment of rods equal to one-tenth the depth, and $n = 15$,

$$\frac{(K)}{(K')} = \left[\frac{1}{1 + 15p_o} \frac{(+)}{(-)} \frac{x_o}{t} \cdot \frac{6}{1 + 28.8p_o} \right]$$

Diagrams 1 and 2 give values of K and K' for various values of p_o and $\frac{x_o}{t}$, and for one-tenth embedment. These diagrams as

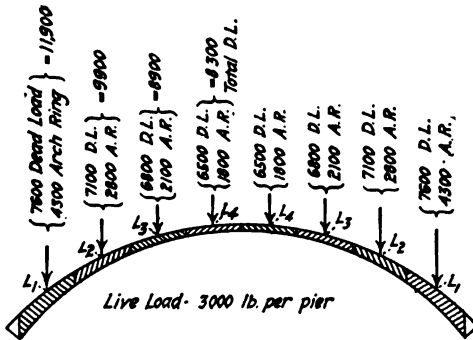

FIG. 21.

presented here are too small for actual use, but illustrate the construction of diagrams which should be drawn to a large scale in practice for at least three depths of embedment—that is, for d' equal to $0.05t$, $0.10t$, and $0.15t$. The size of the diagrams should be approximately 30 in. square to obtain a reasonable degree of accuracy. The few values above $\frac{x_o}{t} = 5.0$ may easily be computed directly from the formulas.

Since the denominators in the formulas for maximum and minimum fiber stress (Case I) remain constant for any given section, influence lines drawn for the quantities NK and NK' will serve as influence lines for fiber stress. (See Art. 44 for another method of determining fiber stresses.) The values of K and K' on Designing Sheets Nos. 11 and 11A have been determined directly from the diagrams, making the assumption, for simplicity, that $d' = 0.10t$ at all sections. The influence lines resulting from multiplying these values by the thrusts are shown on Designing Sheet No. 12, making no attempt to obtain smooth curves. The full lines are for upper fiber stress and the dot-and-dash lines for lower fiber stress. Ordinates above the base line indicate compression for both upper and lower fibers.

The maximum fiber stresses (assuming Case I to apply at all sections) are given on Designing Sheet No. 13, considering the weight of the arch ring as applied at the centers of the supported piers (Fig. 21). The computations are given on this sheet for the maximum stresses at the crown and springing. Notice that tension exists at the springing for loading No. 1—that is, the loading for maximum compression in upper fiber—and influence lines for moment and thrust should be drawn if the stresses due to loading only are to be determined.

The student should note that where all the loads on an arch act at load points, the actual influence lines need not be drawn. In such a case a table as on Designing Sheet No. 14 may be convenient, the values being taken directly from Designing Sheets Nos. 11 and 11A.

The stresses given on Designing Sheet No. 13 are for loading only, assuming Case I. When stresses are required including temperature and rib shortening, these stresses due to loading should be combined with those for temperature and rib shortening, and the resulting stresses computed. When tension exists at any section, due to Case I loading combined with temperature and rib shortening, then influence lines for moment and thrust should be drawn, whether or not such lines are required for loading alone.

Designing Sheet No. 15 gives the total maximum stresses for the four conditions of loading shown, assuming Case I to apply at all sections. The last column gives the sections and loadings that need to be considered for a Case II distribution of stress. Although the depth of section gradually decreases toward the crown, it is obvious that, for Case II conditions, the stresses on

Determination of Moments and Thrusts at Crown
(Unit Load at Definite Points)

Designing Sheet 9.

Pt.	x	y	x ²	y ²	Unit Load at L ₁		Unit Load at L ₂		Unit Load at L ₃		Unit Load at L ₄				
					m	my	m	my	m	my	m	my			
L ₁	30.82														
L ₂	21.87														
L ₃	13.12														
L ₄	4.37														
1	31.70	12.16	1004.9	147.87	1.08	34.2	13.13	9.83	311.6	119.53	18.58	588.0	27.33	866.4	332.33
2	24.18	6.83	584.7	43.96				11.06	267.4	73.33	15.81	479.0	131.34		
3	19.61	4.25	384.6	18.06				6.49	127.3	27.58	15.24	286.9	64.77		
4	16.08	2.80	258.6	7.84				2.96	47.6	8.29	11.71	188.3	32.79		
5	13.06	1.85	170.6	3.42							5.96	61.6	6.73		
6	10.33	1.13	106.7	1.28							3.43	26.7	2.20		
7	7.80	.64	60.8	.41							1.06	5.8	.32		
8	5.43	.30	29.5	.09											
9	3.18	.12	10.1	.01											
10	1.05	.02	1.1	.00											
Σ	29.90	12.16	2511.6	222.94	1.08	34.2	13.13	12.14	367.5	134.85	39.09	1031.3	335.13	93.23	2042.586.56

Unit Load at L₁

$$H_c = \frac{10(13.13) - (1.08)(29.90)}{2[10(222.94) - (29.90)^2]}$$

$$\frac{99.0}{2670.8} = 0.037$$

$$V_c = \frac{34.2}{2(2611.6)} = \frac{34.2}{5223.2} = 0.007$$

$$M_c = \frac{(1.08) - 2(0.037)(29.90)}{(2)(10)} = -0.057$$

$$x_0 \text{ (at crown)} = \frac{-0.057}{0.037} = -1.54$$

Unit Load at L₂

$$H_c = \frac{10(134.85) - (12.14)(29.90)}{2670.8}$$

$$\frac{985.5}{2670.8} = 0.369$$

$$V_c = \frac{367.5}{5223.2} = 0.070$$

$$M_c = \frac{12.14 - 2(0.369)(29.90)}{20} = -0.496$$

$$x_0 \text{ (at crown)} = \frac{-0.496}{0.369} = -1.35$$

Unit Load at L₃

$$H_c = \frac{10(335.13) - (39.09)(29.90)}{2670.8}$$

$$\frac{2182.5}{2670.8} = 0.818$$

$$V_c = \frac{1031.3}{5223.2} = 0.197$$

$$M_c = \frac{(39.09) - 2(0.197)(29.90)}{20} = -0.491$$

$$x_0 \text{ (at crown)} = \frac{-0.491}{0.197} = -0.60$$

Unit Load at L₄

$$H_c = \frac{10(586.56) - (93.23)(29.90)}{2670.8}$$

$$\frac{3078.0}{2670.8} = 1.151$$

$$V_c = \frac{2040.2}{5223.2} = 0.391$$

$$M_c = \frac{93.23 - 2(1.151)(29.90)}{20} = +1.22$$

$$x_0 \text{ (at crown)} = \frac{+1.22}{1.151} = +1.06$$

Moments and Thrusts at the Various Sections
(Unit Load at Definite Points)
Designing Sheet 10

Pt.	Unit Load at L ₁						Unit Load at L ₂						Unit Load at L ₃						Unit Load at L ₄																	
	H _c = 0.037			V _c = 0.07			M _c = -0.057			H _c = 0.369			V _c = 0.070			M _c = -0.496			H _c = 0.918			V _c = 0.197			M _c = -0.491			H _c = 1.151			V _c = 0.391			M _c = +1.22		
	Left Half	M+H _c V _d	N	H _c V _d	Right Half	V _d	Left Half	M+H _c V _d	N	H _c V _d	Right Half	V _d	Left Half	M+H _c V _d	N	H _c V _d	Right Half	V _d	Left Half	M+H _c V _d	N	H _c V _d	Right Half	V _d	Left Half	M+H _c V _d	N	H _c V _d	Right Half	V _d						
Cc.	-1.54	+0.57	0.07				-1.35	-0.496	0.69				-1.35	-0.496	0.69				-1.35	-0.496	0.69				-1.35	-0.496	0.69									
1	-125.60	-4.647	783	+8.62	+319	0.030	-16.27	-6.004	4.44	+6.46	+3.122	2.93	-32.1	-2.628	1.42	+7.32	+5.988	0.60	+2.45	+2.820	1.211	+5.50	+6.331	1.044	+2.45	+2.820	1.211	+5.50	+6.331	1.044						
2	+9.39	+3.47	0.29	+0.70	+0.26	0.35	-9.74	-3.594	0.97	+4.75	+1.753	3.21	-3.42	-2.798	1.45	+3.05	+3.149	0.71	+0.26	+0.299	1.263	+2.40	+2.762	1.119	+0.26	+0.299	1.263	+2.40	+2.762	1.119						
3	+6.23	+2.31	0.90	-0.84	-0.31	0.38	+3.58	+1.321	7.95	+0.67	+2.47	3.53	-1.62	-1.325	1.14	+0.15	+1.23	0.04	-1.30	-1.496	1.301	-0.55	-0.633	1.188	-1.23	-1.415	1.298	-1.37	-1.577	1.207						
4	+4.14	+1.53	0.32	-1.63	-0.60	0.38	+6.62	+2.443	3.09	-0.82	-3.03	3.65	+0.45	+3.68	0.77	-1.11	-0.908	0.26	-0.80	-0.92	1.288	-1.60	-1.842	1.215	-0.80	-0.92	1.288	-1.60	-1.842	1.215						
5	+2.63	+0.97	0.94	-2.07	-0.77	0.38	+2.95	+1.089	3.37	-2.01	-7.42	3.74	+2.49	+2.037	0.43	-1.70	-1.595	0.41	-0.20	-0.230	1.274	-1.55	-1.784	1.214	-0.20	-0.230	1.274	-1.55	-1.784	1.214						
6	+1.45	+0.54	0.25	-2.25	-0.83	0.38	+1.77	+0.653	3.45	-2.18	-8.04	3.75	+3.05	+2.495	0.75	-1.97	-1.611	0.40	+0.58	+0.645	1.255	-1.30	-1.496	1.207	+0.58	+0.645	1.255	-1.30	-1.496	1.207						
7	+0.49	+0.18	0.96	-2.30	-0.85	0.38	+0.78	+0.288	3.53	-2.19	-8.08	3.76	+1.83	+1.497	0.76	-1.83	-1.487	0.39	+1.42	+1.634	1.237	-0.92	-1.059	1.200	+1.42	+1.634	1.237	-0.92	-1.059	1.200						
8	-0.25	-0.09	0.97	-2.20	-0.81	0.37	0.00	0.000	3.59	-2.06	-7.60	3.75	+1.05	+0.859	0.79	-1.60	-1.309	0.36	+2.35	+2.705	1.213	-0.45	-0.518	1.187	+2.35	+2.705	1.213	-0.45	-0.518	1.187						
9	-0.83	-0.31	0.97	-2.01	-0.74	0.37	-0.60	-0.221	3.63	-1.82	-6.72	3.73	+0.34	+0.278	0.84	-1.24	-1.014	0.30	+2.30	+2.647	1.222	+0.12	+0.138	1.174	+2.30	+2.647	1.222	+0.12	+0.138	1.174						
10	-1.37	-0.81	0.97	-1.72	-0.64	0.37	-1.15	-0.424	3.60	-1.54	-5.68	3.70	-0.35	-0.286	0.81	-0.83	-0.679	0.24	+1.40	+1.611	1.142	+0.72	+0.829	1.159	+1.40	+1.611	1.142	+0.72	+0.829	1.159						

Graphical work on Designing Sheet 10A.

Designing Sheet 10 A.

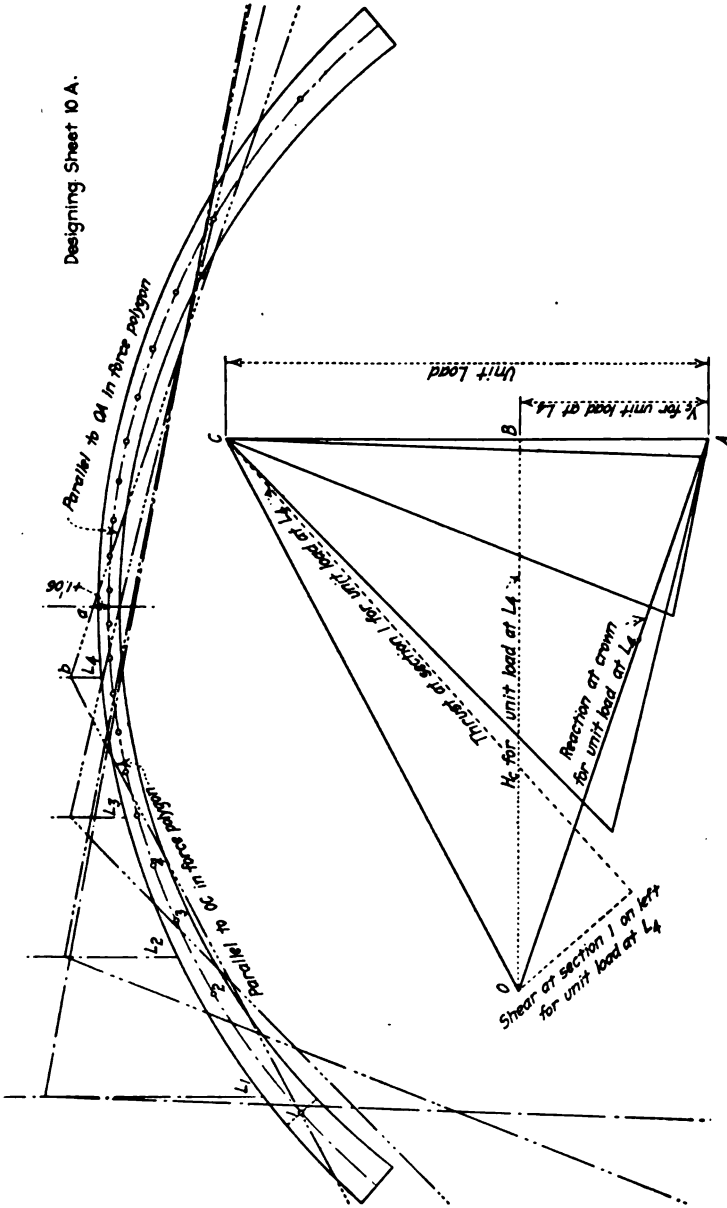

Designing Sheet II:

Data for Influence Lines
 Values of NK and NK' in formulas $f_c = \frac{NK}{\Delta L}$ and $f_c' = \frac{NK'}{\Delta L}$ respectively
 (Unit Load at Definite Points)

Point +	P _o	Unit Load at L ₁						Unit Load at L ₂														
		Left Half			Right Half			Left Half			Right Half											
		$\frac{M}{L}$	K	NK	K'	NK'	$\frac{M}{L}$	K	NK	K'	NK'	$\frac{M}{L}$	K	NK	K'	NK'						
Cc.	1.33	0.04	-1.16	6.23	-2.31	4.49	+1.66															
Spg	3.00	0.046	-1.98	11.42	-8.942	9.54	+7.470	+3.55	19.74	+592	17.86	-536										
1	2.50	0.035	-0.26	2.27	-1.571	0.43	+2.98	+2.06	11.61	+446	9.77	-342	-1.60	9.22	-8.270	7.30	+6.620	+2.18	12.20	+3.916	10.38	-3.332
2	1.97	0.070	+6.29	32.27	+9.04	30.45	-853	+0.37	2.76	+0.99	0.94	-0.34	+0.84	5.10	+4.055	3.20	-2.600	+0.36	2.70	+0.953	0.80	-0.311
3	1.74	0.079	+4.42	22.45	+6.74	20.77	-623	-0.47	3.14	-1.19	1.46	+0.55	+4.56	23.14	+7.127	21.46	-6.610	-0.48	3.19	-1.164	1.51	+0.551
4	1.56	0.089	+3.06	15.51	+4.96	13.75	-440	-1.01	5.71	-2.17	3.95	+1.50	+3.30	16.80	+5.443	15.04	-4.873	-1.02	5.76	-2.137	4.04	+1.499
5	1.47	0.094	+1.94	10.04	+3.41	8.28	-282	-1.38	7.39	-2.81	5.63	+2.14	+2.20	11.26	+3.795	9.50	-3.202	-1.35	7.25	-2.712	5.49	+2.053
6	1.42	0.097	+1.09	5.98	+2.09	4.24	-148	-1.54	8.09	-3.07	6.35	+2.41	+1.33	7.11	+2.453	5.37	-1.853	-1.51	7.95	-2.981	6.21	+2.329
7	1.37	0.101	+0.57	2.59	+0.93	0.85	-031	-1.63	8.45	-3.21	6.71	+2.53	+0.60	3.66	+1.341	1.92	-0.730	-1.57	8.17	-3.105	6.43	+2.443
8	1.35	0.102	-0.18	1.70	-0.63	0.04	+0.01	-1.62	8.37	-3.10	6.63	+2.45	0.00	0.87	+0.311	0.87	-0.311	-1.50	7.81	-2.929	6.07	+2.276
9	1.33	0.104	-0.63	3.78	-1.40	2.04	+0.75	-1.50	7.80	-2.89	6.06	+2.44	-0.46	3.00	-1.049	1.26	+4.57	-1.35	7.11	-2.652	5.37	+2.003
10	1.33	0.104	-1.04	5.66	-2.09	3.94	+146	-1.30	6.87	-2.54	5.15	+1.91	-0.87	4.88	-1.796	3.16	+1.163	-1.15	6.17	-2.293	4.45	+1.647

+ Indicates upper fiber

- Indicates lower fiber

* Indicates tension except as noted.

Designing Sheet 11A

Data for Influence Lines
Values of NK and NK' in formulas $\xi_c \cdot \frac{NK}{BT}$ and $\xi_c \cdot \frac{NK'}{BT}$ respectively

Pt. +	P _o	Unit Load at L ₃												Unit Load at L ₄											
		Left Half						Right Half						Left Half						Right Half					
		$\frac{3}{4} \cdot \frac{M}{BT}$	K	NK	K'	NK'	$\frac{3}{4} \cdot \frac{M}{BT}$	K	NK	K'	NK'	$\frac{3}{4} \cdot \frac{M}{BT}$	K	NK	K'	NK'	$\frac{3}{4} \cdot \frac{M}{BT}$	K	NK	K'	NK'				
Cr.	1.33	0.104	-0.45	2.95	-2.413	1.21	+0.990																		
Sps	3.00	0.046	-0.77	5.01	-5.721	3.14	+3.586	2.94	16.51	+11.227	14.63	-9.948	+0.80	4.56	+5.849	2.82	-3.246								
1	2.50	0.055	-0.98	6.00	-6.870	4.16	+4.763	+1.70	9.74	+7.217	7.90	-5.854	+0.09	1.59	+1.756	0.46	(comp)	+0.919	6.05	+6.770	4.21	-4.711			
2	1.97	0.070	-0.60	3.90	-4.345	2.08	+2.317	+0.08	1.31	+1.053	0.51	comp.	-0.58	3.80	-4.944	1.98	+2.576	-0.271	2.26	-2.685	0.44	+5.223			
3	1.74	0.079	+0.20	1.82	+1.960	0.14	-1.51	-0.63	3.92	-3.238	2.24	+1.850	-0.63	3.92	-5.008	2.24	+2.908	-0.75	4.51	-5.444	2.83	+3.416			
4	1.56	0.089	+1.25	6.86	+7.155	5.10	-5.319	-1.07	6.00	-5.016	4.24	+3.545	-0.46	3.08	-3.967	1.32	+1.700	-0.971	5.47	-6.646	3.71	+4.508			
5	1.47	0.094	+3.36	16.74	+12.237	14.98	-10.950	-1.29	6.97	-5.862	5.21	+4.382	-0.12	1.45	-1.847	0.31	comp.	-1.00	5.60	-6.738	3.84	+4.662			
6	1.42	0.097	+2.32	11.75	+8.871	10.01	-7.558	-1.35	7.20	-6.048	5.46	+4.586	+0.36	2.56	+3.213	0.82	-1.029	-0.871	4.95	-5.975	3.21	+2.580			
7	1.37	0.101	+1.41	7.43	+5.766	5.69	-4.415	-1.30	6.91	-5.797	5.17	+4.338	+0.97	5.38	+6.655	3.64	-4.503	-0.65	3.89	-4.668	2.15	+3.874			
8	1.35	0.102	+0.81	4.62	+3.654	2.88	-2.278	-1.16	6.24	-5.217	4.50	+3.762	+1.65	8.51	+10.323	6.77	-8.212	-0.32	2.35	-2.789	0.61	+1.784			
9	1.33	0.104	+0.26	2.07	+1.664	0.33	-2.65	-0.92	5.12	-4.250	3.38	+2.805	+1.77	9.05	+10.154	7.31	-8.202	+0.09	1.29	+1.514	0.45	+3.528			
10	1.33	0.104	-0.26	2.06	-1.679	0.34	+2.77	-0.62	3.72	-3.065	2.00	+1.648	+1.06	5.76	+10.578	4.04	-4.614	+0.54	3.35	+3.883	1.63	+1.889			

+ Indicates upper fiber

- Indicates lower fiber

* Indicates tension except as noted

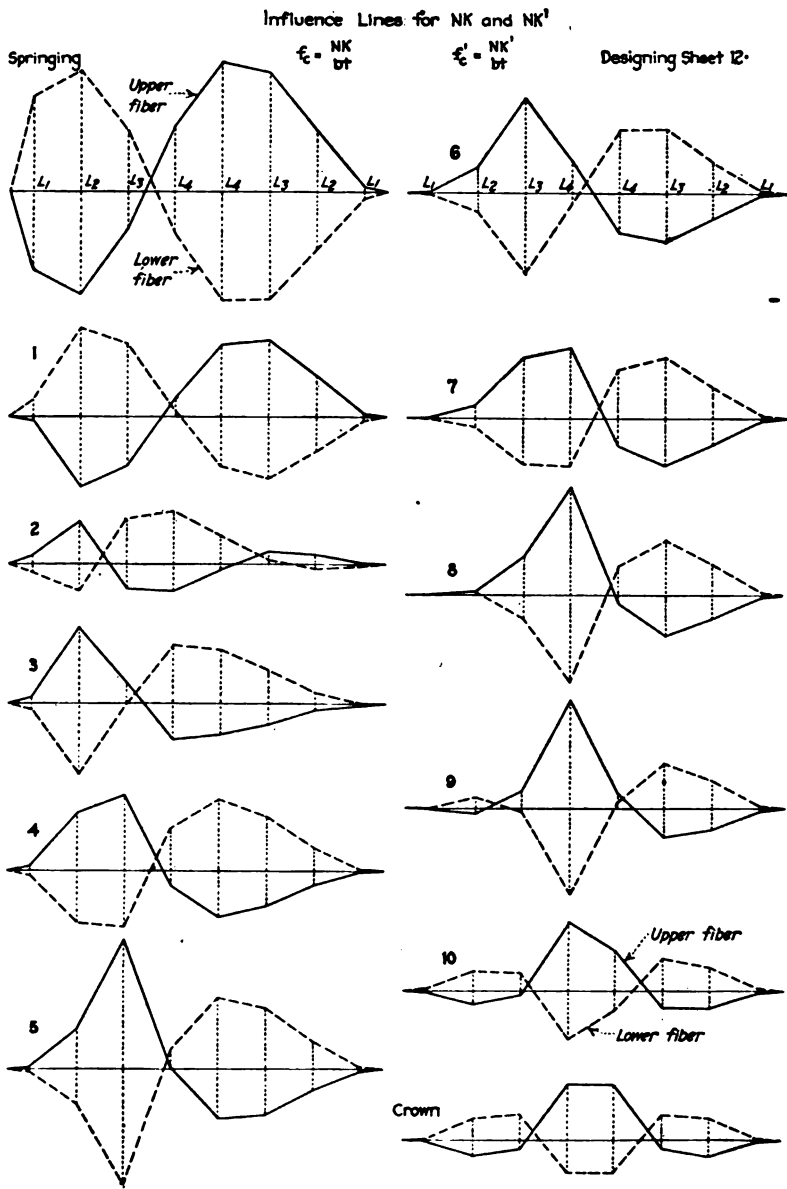

Maximum Stresses Due to Loading: Assuming Case 1 to Apply at All Sections.

Designing Sheet B.

Maximum Stresses (Loading)

Point	No. 1 Loading Max. Comp. in Water Pier		No. 2 Loading Max. Comp. in Air Pier	
	Upper	Lower	Upper	Lower
Ct.	362	81	118	329
Spgr.	477	-239	84	199
1	354	-5	104	253
2	161	198	40	364
3	200	131	-22	400
4	281	106	-47	488
5	489	-76	97	351
6	360	44	2	424
7	376	59	20	417
8	510	-65	187	270
9	521	-52	248	214
10	362	77	118	324

Crown: Springing: No. 1 Loading

Upper: $-2(1.66)(11,900) - 2(1.399)(12,900) - 2(1.990)(14,900) + 2(5.249)(11,300) = 2(34,700)$
 $f_c = \frac{2(34,700)}{(1.33)(144)} = 362$

Lower: $2(2.23)(11,900) + 2(2.077)(9,900) + 2(2.413)(8,900) - 2(3.846)(11,300) = 2(7,700)$
 $f_c = \frac{2(7,700)}{(1.33)(144)} = 81$

Upper: $-2(1.66)(14,900) - 2(1.399)(12,900) - 2(1.990)(11,900) + 2(5.249)(9,300) = 2(11,300) = 2(166 + 1.399 + 990 + 5.249)(3000)$
 $f_c = \frac{2(11,300)}{(1.33)(144)} = 118$

Lower: $2(2.23)(14,900) + 2(2.077)(12,900) + 2(2.413)(11,900) - 2(3.846)(8,300) = 2(31,500) = 2(7700) + 2(231) + 2(237) + 2(413) + 3(245)(3000)$
 $f_c = \frac{2(31,500)}{(1.33)(144)} = 329$

Upper: $-(7.470)(11,900) + (7.592)(14,900) - (9.689)(9,900) + (5.782)(12,900) - (3.586)(8,900) = (11.827)(11,900) + (18,199)(11,300) = 2706,100$
 $f_c = \frac{206,100}{(3.00)(144)} = 477$

Lower: $(8.942)(11,900) - (5.96)(14,900) + (1.471)(9,900) - (5.242)(12,900) + (5.72)(8,900) - (9.048)(11,900) + (14.032)(11,300) = -81,700$
 $f_c = \frac{-81,700}{(3.00)(144)} = 239 \text{ lb. tension}$

etc.

No 1 Loading

Designing Sheet 14

(For method of computing No 2 Loading see Designing Sheet 13)

Fibrit	Fiber	L ₁				L ₂				L ₃				L ₄			
		DL=11,900		DL+LL=14,900		DL=9,900		DL+LL=12,900		DL=8,900		DL+LL=11,900		DL=8,300		DL+LL=11,300	
		Comp	Ten.	Comp	Ten.	Comp	Ten.	Comp	Ten.	Comp	Ten.	Comp	Ten.	Comp	Ten.	Comp	Ten.
Crown	Upper		2(.166)				2(.139)				2(.990)					2(.524)	
	Lower	2(.231)				2(.203)				2(.243)							2(.326)
Spgs	Upper	7.470	.592			9.689	5.793			3.586	11.227					16.067	12.131
	Lower	8.942		.536	11.471			5.242	5.721			9.948				3.863	10.169
1	Upper		.298	.406			6.620	3.916			4.763	7.217				11.756	8.770
	Lower	1.871			.342	8.270			3.332	6.870			5.854			.581	4.711
2	Upper			.904	.099			4.055	.953		2.317	1.053				12.576	1.523
	Lower				.853	.034			12.808	1.311	4.345	.410			4.944	12.685	
3	Upper		.055	.674			.551	7.127			1,850	1,960				12.908	3.418
	Lower	.119			.623	1.164			6.610	3.238		.151			15088	5.444	
4	Upper		.150	.496			1,499	5,443			3,545	7,155				11,700	4,508
	Lower	.217			.440	2,137			4,873	5,016		5,319	3,967	16,646			
5	Upper		.214	.341			2,053	3,795			4,382	12,237				4,662	.395
	Lower	.281			.282	2,712			3,202	5,862		10,950	6,798			1,847	
6	Upper		.241	.209			2,329	2,453			4,586	8,871				3,874	3,213
	Lower	.307			.148	2,981			1,853	6,048		7,558	5,975				1,029
7	Upper		.255	.093			2,443	1,341			4,338	5,766				2,580	6,655
	Lower	.321			.031	3,105			.730	5,797		4,415	4,668				4,503
8	Upper		.245	.001			2,276	.311			3,762	3,654				724	10,323
	Lower	.310			.063	2,929				.311	5,217		2,278	2,789			8,212
9	Upper		.075	.224				4,57	2,003			2,805	1,664				10,154
	Lower	.140	.289			1,089	12,652				4,250		2,65				1,814
10	Upper		.146	.191				1,163	1,647			1,277	1,648				6,578
	Lower	.209	.254			1,796	12,283				1,679	3,065					3,883
																	4,614
																	1,883

the sections shown on Designing Sheet No. 16 will control. In fact, section 5 might well be omitted, but is given here with the others to show the influence of the depth of section upon the resulting fiber stresses. Notice that although the maximum stress at the springing, given for loading (b) on Designing Sheet No. 15, is very much less than at section 9 for loading (a), the effect of neglecting the tension is much greater for the deeper section, and the actual springing stress is not far from the maximum for the entire arch.

The formulas for fiber stress for Case II are as follows:

$$f_c = \frac{M}{Lbt^2}$$

$$f_s = nf_c \left(\frac{d}{kt} - 1 \right)$$

The value of L may be determined by means of Diagrams 3 to 6 inclusive. These diagrams are similar to Diagrams 14 and 15

Designing Sheet 15.

Total Maximum Stresses Assuming Case I to Apply at All Sections

Point	y	t	P ₀	Temperature				Fall of Temperature and Rib Shortening					Rib Shortening			Stress in		Total Maximum Stresses (Case I)						Sections and Loadings for which Case I does not apply				
				Fall of 20° Moments and thrusts for rise of 20° of opposite sign.		Rib Shortening		M	N	K	K'	Upper Fiber	Lower Fiber	Upper	Lower	Upper	Lower	Upper	Lower	Upper	Lower							
				M _C = -1150	M _C = +3440	M	N															Upper Fiber	Lower Fiber		σ(a)	σ(b)	σ(c)	σ(d)
Cc	1.35	0.04		+3,400	-1150	+2,700	-910	9.43	+13	-120	+6,100	-2,060	-2.23	11.17	9.43	+13	-120	475	-39	350	94	231	209	106	342	{ (a) }		
Sppt	16.75	3.00	0046	-19,270	-15,800	-750	-16,600	36.04	-19	+13	-28,400	-1,350	+7.01	38.04	36.04	-19	+13	359	-126	490	-251	-35	312	97	187	{ (a) }		
1	12.16	2.50	0055	-13,980	-10,500	-860	-8,400	26.37	-13	+105	-18,900	-1,540	+4.91	26.37	24.53	-13	+105	241	100	366	-17	-9	358	116	241	{ (b) }		
2	6.63	1.97	0070	-3,620	-4,200	-990	-3,300	11.59	7.7	+61	-7,500	-1,780	+2.14	11.59	9.77	+73	+61	86	259	169	191	-33	425	48	357	{ (c) }		
3	4.25	1.74	0079	-4,890	-1,400	-1,050	-1,100	4.66	2.88	+22	-2,500	-1,890	+0.76	4.66	2.88	+34	+22	166	153	204	129	-56	422	-18	398	{ (c) }		
4	2.80	1.66	0089	-3,220	+200	-1,090	+160	-870	+400	-1,960	-0.13	1.50	-0.26	1.50	-0.26	-2	-13	0	1	279	93	281	107	-48	475	-47	468	{ (a) }
5	1.85	1.47	0094	-2,130	+1,300	-1,110	+1,000	-840	+2,310	-1,990	-0.79	4.61	2.85	2.7	-43	-3	+5	516	-119	486	-71	124	308	94	356	{ (b) }		
6	1.13	1.42	0097	-1,300	+2,100	-1,130	+1,700	-900	+3,800	-2,030	-1.32	7.06	5.32	+53	-70	-6	+8	433	-26	374	52	55	364	-4	432	{ (a) }		
7	.64	1.37	0101	-740	+2,700	-1,140	+2,200	-910	+4,900	-2,050	-1.75	9.01	7.27	+76	-94	-8	+0	452	-35	368	69	96	323	12	427	{ (a) }		
8	.30	1.35	0102	-350	+3,100	-1,140	+2,500	-910	+5,600	-2,050	-2.02	10.22	8.48	+90	-108	-10	+12	600	-173	500	-53	277	162	177	282	{ (a) }		
9	.12	1.33	0104	-140	+3,500	-1,140	+2,600	-910	+5,900	-2,050	-2.16	10.85	9.11	+96	-116	-11	+13	619	-168	510	-59	346	98	237	227	{ (a) }		
10	.02	1.35	0104	-20	+3,400	-1,150	+2,700	-910	+6,100	-2,060	-2.23	11.16	9.44	+101	-120	-11	+13	663	-43	351	90	219	204	107	337	{ (a) }		

* Loading (a) - No. 1 Loading, fall of temperature, and rib shortening
 (b) - " " " " rise " " " "
 (c) - No. 2 loading, fall of temperature, and rib shortening
 (d) - " " " " rise " " " "

Temperature fall: $H_C = \frac{-1,028,000(26,800) + (1,045,856)(20,800) + (1,151,800)(1,300)}{2(10)(222,94)} = -1150$ lb.
 $H_C = \frac{-1,028,000(26,800) + (1,045,856)(20,800) + (1,151,800)(1,300)}{2(10)(222,94)} = -1150$ lb.

Rib Shortening for live load on one-half span, using Designing Sheet 10:
 c_s (at crown) = $\frac{.037(11,900+14,900) + .369(9,900+12,900) + 1(11,333) + 15(\frac{288}{144})}{1(1.33) + 15(\frac{288}{144})} = 91$
 c_s (at pier top) = $\frac{.1(1,028,000)(26,800) + (324,371)(22,800) + (1,045,856)(20,800) + 1(204,215)(19,600)}{1(1.56) + 2(7)} = 30,000$
 c_s (at springing) = $\frac{.1(783,030)(26,800) + (461,230)(22,800) + (1,028,000)(20,800) + (210,104)(19,600)}{1(1.50) + 2(7)} = 20,600$
 $H_C = \frac{-1,028,000(26,800) + (324,371)(22,800) + (1,045,856)(20,800) + (210,104)(19,600)}{2(10)(222,94)} = -1150$ lb.
 Ratio of H_C for rib shortening = $\frac{914}{1150} = 0.795$

Total Maximum Stresses
 1150 lb.
 1150 lb.
 20,600 lb.
 30,000 lb.
 27,300 lb.
 per sq ft.

Total Maximum Stresses for Case II Conditions

Designing Sheet 16-

Point	+	R _b	Type of Loading	Moments and Thrusts								Total Maximum Stresses (Case II)								
				Loading				Fall of Temperature and Rib Shortening		Rise of Temperature and Rib Shortening							Totals			
				No. 1 Loading		No. 2 Loading		M	N	M	N	M	N	M	N	S	k	L	f _c	%
				M	N	M	N	M	N	M	N	M	N	M	N					
Spq.	3.00	.0048	(b)	+81,600	76,870					+3,200	+150	+84,800	76,820	.568	.57	.100	606	3,300		
5	1.47	.0084	(a)	+18,600	48,700			+2,300	-1,980			+20,900	47,710	.299	.74	.124	540	1,800		
8	1.35	.0102	(a)	+16,800	48,700			+5,600	-2,050			+21,400	47,650	.319	.68	.129	644	3,100		
9	1.33	.0104	(a)	+18,700	51,070			+8,900	-2,080			+21,600	48,990	.331	.68	.129	648	2,900		

of Volume I, but are plotted in such a manner as to give greater accuracy.

Designing Sheet No. 17 gives the influence lines for moment and thrust for all sections. Although these lines are not actually needed in the problem under consideration, they are presented for instructive purposes. In order to show smooth curves, additional load points have been taken intermediate between the first set, and values of moment and thrust have been computed and plotted at these points.

If the dead weight of the arch ring had been considered as concentrated at seventeen load points (Fig. 21A) instead of eight as in the preceding analysis, a maximum fiber stress at section 9 of 640 lb. per square inch would have been the result. This gives some idea of the increased accuracy that may be obtained by doubling the number of load points. A greater number of such points, however, than just sufficient to determine accurately smooth curves for the influence lines are entirely unnecessary. This is due to the fact that, with influence lines properly drawn, loads may be placed at any point and the values scaled with a reasonable degree of accuracy. Thus for continuous loadings, such as occur in earth-filled arches, four to eight load points on each half of the arch may be sufficient to determine properly the curves of the influence lines, but the continuous loading should be broken up into a greater number of loads than represented by the number of load points in order to obtain accurate values of the maximum fiber stresses at the various sections.

A general discussion in regard to the use of influence lines for moment and thrust may serve to make this part of the subject more clear. Consider influence lines as shown in Fig. 22 and assume uniform live loading. A load placed anywhere on the structure is seen to cause a positive thrust at the given section. For this reason it might seem on first thought that

Influence Lines for Moment and Thrust.

Designing Sheet 17.

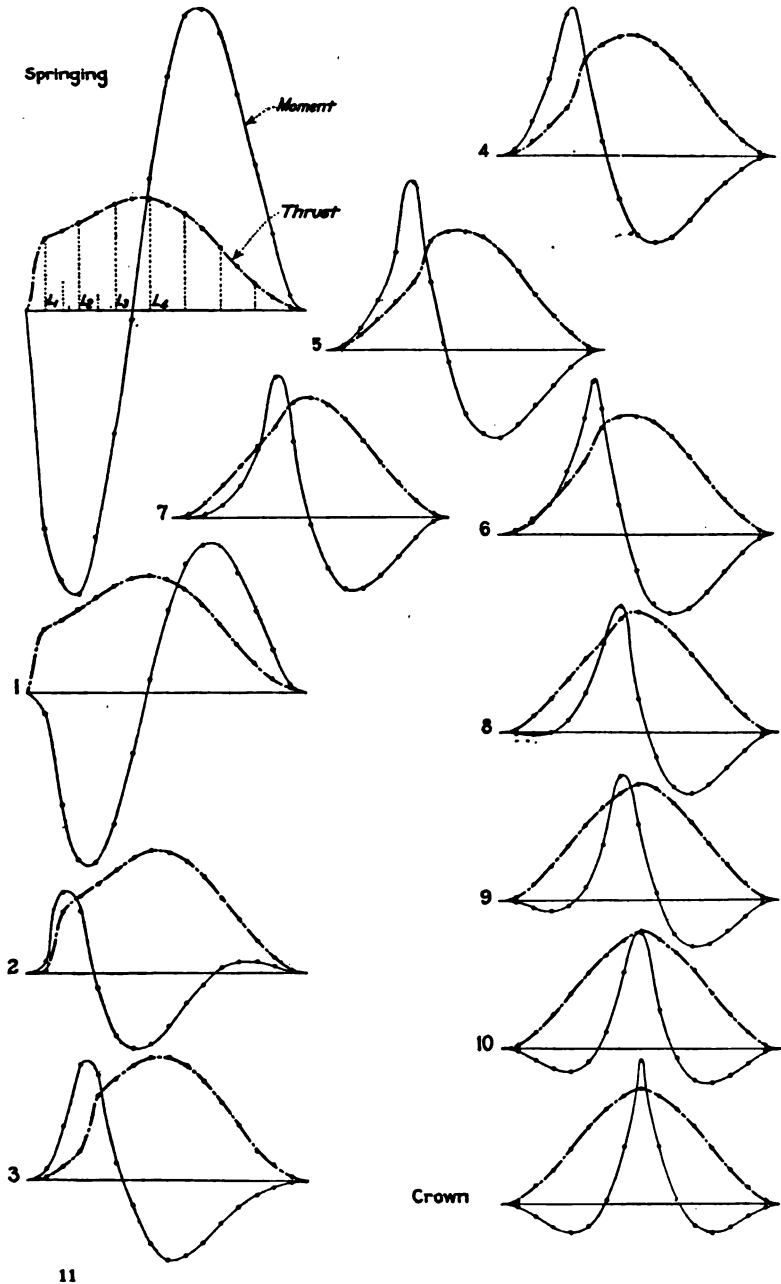

maximum compression on the *upper* fiber will be obtained if the live load extends from *C* to *F*. Loads to the left of *C* and to the right of *F*, however, will also be found to give compression in the upper fiber, although the resultant moment for such loads is

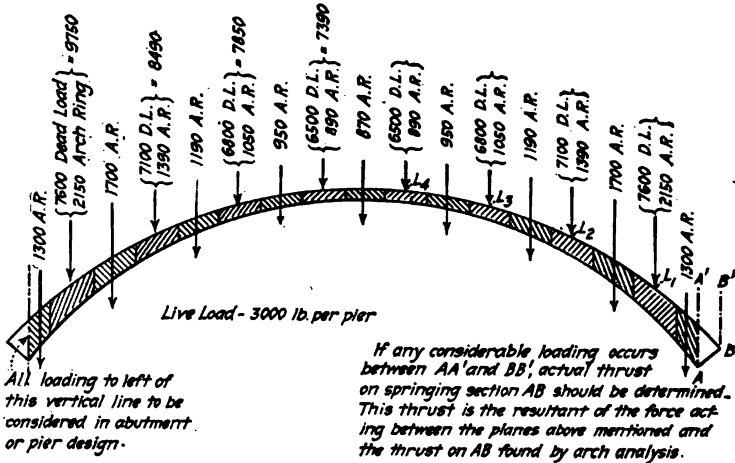

FIG. 21A.

negative. The live load, for example, should extend to points such as *B* and *G* where a load placed at such points will be found to give a zero stress at the upper fiber. Likewise, for maximum compression in the *lower* fiber, the live loading should extend from *A* to *D* and from *E* to *H*. Thus, the termination of the proper

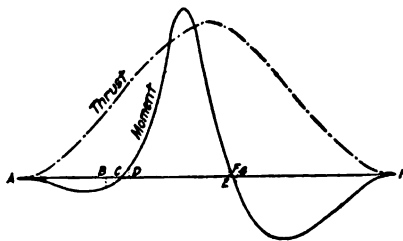
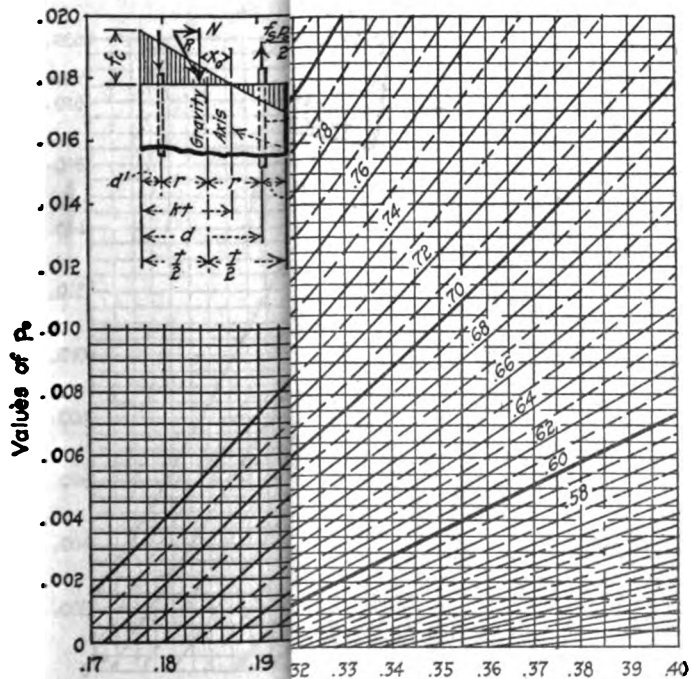
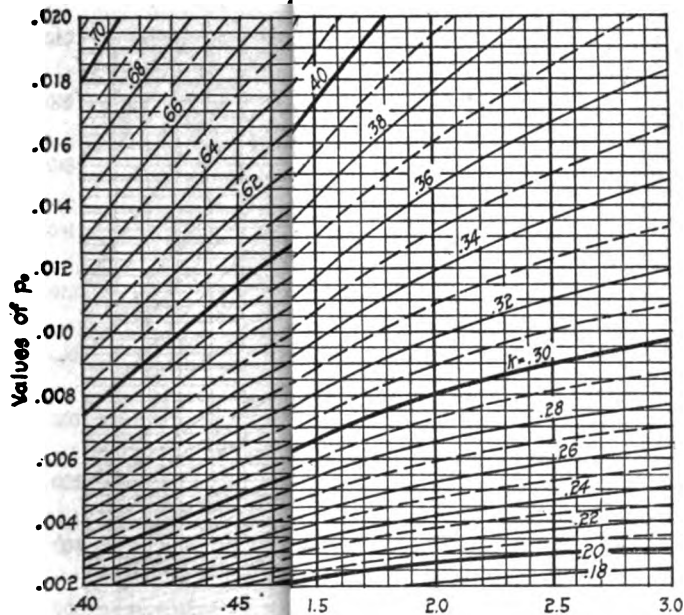

FIG. 22.

steel percentage curve in Diagram 13 of Volume I will give the value of $\frac{M}{Nt} = \frac{x_o}{t}$ for which there is no tension or compression at the outer fiber, and points *B*, *D*, *E*, and *G* may be determined by trial when influence lines are not drawn directly for fiber



(Facing Page 84.)

of section.

THE NEW YORK
PUBLIC LIBRARY
ASTEN LENOX
TILDEN FOUNDATIONS

stress. With load points widely separated, as in the preceding analysis, it is not often that load points enter the spaces corresponding to BD and EG , but this sometimes occurs, as at sections 1, 2, 5, 8, and 9 on Designing Sheets Nos. 11 and 11A. For the section represented in Fig. 22, maximum tensile stress in the lower steel would occur for the live load extending from D to E , and for the upper steel from A to B and G to H . This is obvious when it is considered that a load anywhere between A and D and between E and H will cause compression in the *lower* steel, while a load anywhere between D and E will cause compression in the *upper* steel.

Referring to Designing Sheet No. 16, it should now be clear that the steel stresses there given are not necessarily the maximum stresses. For example, a greater steel stress than 2900 lb. per square inch may be obtained at section 9 if only the dead load is placed at point L_4 on the right half of the arch. Removing the live load at this point causes a stress of 640 lb. per square inch in the concrete and a tensile stress of 3300 lb. in the steel. Thus the live load just removed is seen to cause a greater stress in the concrete at the upper fiber, but decreases the tensile stress in the lower steel. In some analyses, where the steel stress has its greatest value under such conditions, it may be necessary to consider the exact loading which will give the maximum stress.

Maximum and minimum pressures on abutment foundations are not necessarily obtained for any of the positions of the live load which give maximum stresses at the various sections in the arch. For abutment design, consideration of live load over the half span and the whole span will usually suffice.

CHAPTER VI

UNSYMMETRICAL ARCHES

Unsymmetrical arches are sometimes desirable in the end spans of a series of two or more arches in order to reduce material in abutments and, at the same time, to provide ample waterway area over streams. Also, arches of this type are often necessary under other conditions, as, for example, when a river in a deep ravine is bordered by a railway requiring maximum clearance near the abutments.

35. Method of Analysis.—In the analysis of unsymmetrical arches, the entire arch ring should be divided into a sufficient number of $\frac{s}{I}$ divisions to obtain the desired degree of accuracy. The origin of coördinates may then be taken at the center of any

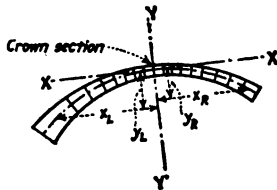

FIG. 23.

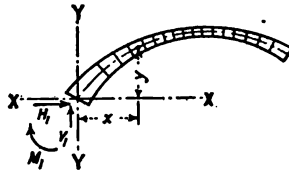

FIG. 24.

one of the sections occurring between the divisional lengths, but, for convenience in scaling the values of x and y , this origin should be placed at one of the sections near the crown—which we shall call the crown section. The X and Y axes should be drawn perpendicular and parallel respectively to this section so as to permit the crown thrust to be determined directly without composition and resolution of forces. Fig. 23 shows how these axes should be drawn.

The flexure formulas for H_c , V_c , and M_c for unsymmetrical arches, considering the origin of coördinates near the crown, are exceedingly complex and inconvenient for use in practice. The best plan is to use formulas similar to those designated as (e), (f), and (g), Art. 14, and to solve simultaneously for the above

values after the numerical values of the coefficients are substituted. Following are the formulas to be solved in this way (see also Designing Sheet No. 18):

$$\begin{aligned}
 H_c \Sigma y^2 + V_c(\Sigma x_L y_L - \Sigma x_R y_R) + M_c \Sigma y - \Sigma m y &= 0 \\
 H_c(\Sigma x_L y_L - \Sigma x_R y_R) + V_c \Sigma x^2 + M_c(\Sigma x_L - \Sigma x_R) & \\
 - \Sigma m_L x_L + \Sigma m_R x_R &= 0 \\
 H_c \Sigma y + V_c(\Sigma x_L - \Sigma x_R) + n M_c - \Sigma m &= 0
 \end{aligned}$$

The subscripts *L* and *R* in these formulas refer to summations to the left and right of the crown section respectively. No subscript indicates that the summation is to be taken for the entire arch.

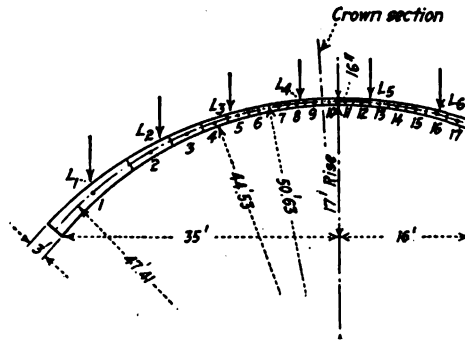

FIG. 25.

The three corresponding equations for temperature are as follows:

$$\begin{aligned}
 H_c \Sigma y^2 + V_c(\Sigma x_L y_L - \Sigma x_R y_R) + M_c \Sigma y - \frac{I}{s} \cdot t_c t_D E_c &= 0 \\
 H_c(\Sigma x_L y_L - \Sigma x_R y_R) + V_c \Sigma x^2 + M_c(\Sigma x_L - \Sigma x_R) &= 0 \\
 H_c \Sigma y + V_c(\Sigma x_L - \Sigma x_R) + n M_c &= 0
 \end{aligned}$$

The value of t_D should be inserted as plus (+) for a rise of temperature; minus (-) for a drop.

Rib shortening causes the same effect as a lowering of the temperature. By referring to Art. 14, it should be clear that the following formula may be employed to solve for the equivalent temperature drop:

$$\frac{c_a l}{E_c} = t_c t_D l, \text{ or } t_D = \frac{c_a}{E_c t_c}$$

The writer believes that for unsymmetrical arches it is convenient to assume the origin of coordinates at the center of the section through the springing. Fig. 24 shows how the coördi-

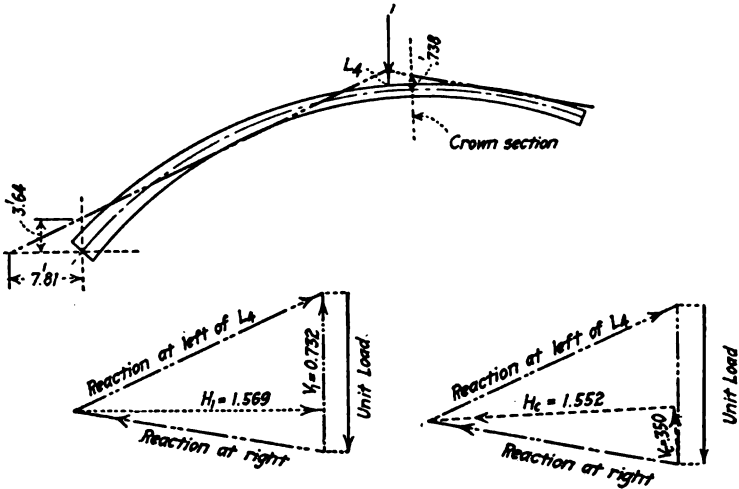

FIG. 26.

nates x and y should be measured. The directions of H_1 , V_1 , and M_1 are shown for values considered as positive in the formulas given on Designing Sheet No. 19. Special note should be made of

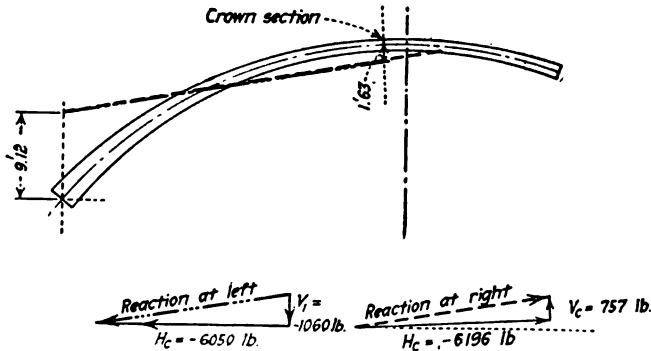

FIG. 27

the fact that values of y measured below the axis $X - X$ should always be considered as negative.

36. Examples of Computations in Unsymmetrical Arch Analysis.—In order to show the method of analyzing unsym-

metrical arches, the computations are given on Designing Sheet No. 20 for finding the thrust, shear, and moment at the crown section of the arch shown in Fig. 25 due to a unit load at L_4 . (This unsymmetrical arch was obtained by simply shortening the arch of Fig. 20.) Similar computations are given on Designing Sheet No. 21 for finding H_1 , V_1 , and M_1 at the springing due to the same loading. Fig. 26 shows the agreement between the two methods, the equilibrium polygon being drawn for the unit load at L_4 .

Designing Sheets Nos. 20A and 21A show the temperature computations by the two methods for the arch in question, assuming a drop of temperature of 40°F . The equilibrium polygon for temperature is a straight line, and Fig. 27 shows the method of determining this line by the two methods.

Formulas Required for Unsymmetrical Arches
Origin of Coordinates near Crown

Loading:

$$\begin{aligned}
 H_c \Sigma y^2 + V_c (\Sigma x_L y_L - \Sigma x_R y_R) + M_c \Sigma y - \Sigma m y &= 0 \\
 H_c (\Sigma x_L y_L - \Sigma x_R y_R) + V_c \Sigma x^2 + M_c (\Sigma x_L - \Sigma x_R) - \Sigma m_L x_L + \Sigma m_R x_R &= 0 \\
 H_c \Sigma y + V_c (\Sigma x_L - \Sigma x_R) + n M_c - \Sigma m &= 0 \\
 M_L = M_c + H_c y_L + V_c x_L - m_L \\
 M_R = M_c + H_c y_R - V_c x_R - m_R
 \end{aligned}$$

All values of m_L , m_R , x_L , x_R , y_L , and y_R should be substituted as positive. The subscripts L and R refer to summations to left and right of the crown section respectively. No subscript indicates that summation is for entire arch. Positive value of M_c indicates that the thrust H_c acts above the arch axis. Considering the crown section as vertical, a positive value of V_c indicates that the line of pressure slopes upward towards the left; a negative value, downward towards the left. Signs preceding terms M_c , $V_c x_L$, and $V_c x_R$ in the last two formulas depend upon the signs of M_c and V_c resulting from the three simultaneous equations.

Temperature.

$$\begin{aligned}
 H_c \Sigma y^2 + V_c (\Sigma x_L y_L - \Sigma x_R y_R) + M_c \Sigma y - \int \cdot \epsilon \cdot t_D \cdot l \cdot E_c &= 0 \\
 H_c (\Sigma x_L y_L - \Sigma x_R y_R) + V_c \Sigma x^2 + M_c (\Sigma x_L - \Sigma x_R) &= 0 \\
 H_c \Sigma y + V_c (\Sigma x_L - \Sigma x_R) + n M_c &= 0 \\
 M_L = M_c + H_c y_L + V_c x_L \\
 M_R = M_c + H_c y_R - V_c x_R
 \end{aligned}$$

The value of t_D should be inserted as plus (+) for a rise of temperature; minus (-) for a drop. Signs preceding terms M_c , $H_c y_L$, $H_c y_R$, $V_c x_L$, and $V_c x_R$ in the last two formulas depend upon the signs of M_c , H_c , and V_c resulting from the three simultaneous equations. l = span of arch axis measured parallel to X axis.

Rib Shortening:

$$t_D = \frac{C_R}{E_c \gamma_c}$$

Rib shortening causes the same effect as a lowering of the temperature. Solving for t_D gives equivalent temperature drop.

Formulas Required for Unsymmetrical Arches

Origin of Coordinates at Left Springing

Loading:

$$H_1 Z y^2 - V_1 \Sigma x y - M_1 Z y + \Sigma m y = 0$$

$$H_1 \Sigma x y - V_1 \Sigma x^2 - M_1 \Sigma x + \Sigma m x = 0$$

$$H_1 \Sigma y - V_1 \Sigma x - n M_1 + \Sigma m = 0$$

$$H_1 = \frac{ab - cd}{ae - cf} \qquad \text{or} \qquad V_1 = \frac{d - H_1 f}{a} \qquad M_1 = \frac{H_1 Z y - V_1 \Sigma x + \Sigma m}{n}$$

in which

$$a = \Sigma x \Sigma y - n \Sigma x y$$

$$b = \Sigma m x \Sigma y - \Sigma x \Sigma m y$$

$$c = \Sigma x^2 \Sigma y - \Sigma x \Sigma x y$$

$$d = \Sigma m \Sigma y - n \Sigma m y$$

$$e = \Sigma x \Sigma y^2 - \Sigma x y \Sigma y$$

$$f = n \Sigma y^2 - (\Sigma y)^2$$

$$\text{Then } M = M_1 + V_1 x - H_1 y - m$$

All values of m and x should be substituted as positive. Values of y below the $x - x$ axis should be negative. The summations refer to entire arch. Positive value of M_1 indicates that the reaction acts to the left of the arch axis at the springing. Positive values of H_1 and V_1 indicate that the reaction acts upward to the right. Signs preceding terms M_1 , $V_1 x$, and $H_1 y$ in the last formula depend upon the signs of M_1 , V_1 , and H_1 resulting from the preceding equations.

Temperature:

$$H_1 Z y^2 - V_1 \Sigma x y - M_1 Z y = \frac{1}{2} \cdot t_D \cdot l \cdot E_c$$

$$H_1 \Sigma x y - V_1 \Sigma x^2 - M_1 \Sigma x = 0$$

$$H_1 \Sigma y - V_1 \Sigma x - n M_1 = 0$$

$$H_1 = \frac{a \Sigma x - n c}{a e - c f} (k) \qquad \text{or} \qquad V_1 = \frac{k \Sigma x - H_1 e}{c} \qquad M_1 = \frac{H_1 Z y - V_1 \Sigma x}{n}$$

in which

$$k = \frac{1}{2} \cdot t_D \cdot l \cdot E_c$$

Then

$$M = M_1 + V_1 x - H_1 y$$

The value of t_D should be inserted as plus (+) for a rise of temperature; minus (-) for a drop. Signs preceding terms M_1 , V_1 , and H_1 in the last formula depend upon the signs of M_1 , V_1 , and H_1 resulting from the preceding equations. l = span of arch axis measured horizontally; that is, parallel to X axis.

Rib Shortening:

$$t_D = \frac{e_c}{E_c \xi}$$

Rib shortening causes the same effect as a lowering of the temperature. Solving for t_D gives equivalent temperature drop.

Determination of Moments and Thrusts at Crown Section - Unsymmetrical Arch
(Unit Load at Definite Points)

Designing Sheet 20

$$H_c \Sigma y^2 + \frac{1}{2} (\Sigma x_1 y_1 - \Sigma x_2 y_2) + M_c \Sigma y - \Sigma m y = 0$$

$$H_c (\Sigma x_1 y_1 - \Sigma x_2 y_2) + \frac{1}{2} \Sigma x^2 + M_c (\Sigma x_1 - \Sigma x_2) - \Sigma m_1 x_1 + \Sigma m_2 x_2 = 0$$

$$H_c \Sigma y + \frac{1}{2} (\Sigma x_1 - \Sigma x_2) + n M_c - \Sigma m = 0$$

$$100.36 H_c + 431.73 \frac{1}{2} + 33.01 M_c - 468.81 = 0 \quad (a)$$

$$431.73 H_c + 2950.6 \frac{1}{2} + 43.60 M_c - 1782.3 = 0 \quad (b)$$

$$33.01 H_c + 43.60 \frac{1}{2} + 17 M_c - 85.96 = 0 \quad (c)$$

Multiplying (a) by 17 and (c) by 33.01

$$3065.12 H_c + 7339.41 \frac{1}{2} + (531.01) M_c - 7963.77 = 0$$

$$1089.66 H_c + 1439.24 \frac{1}{2} + (53.01)(17) M_c - 2937.54 = 0$$

$$1976.46 H_c + 5900.17 \frac{1}{2} - 5132.23 = 0 \quad (d)$$

Multiplying (d) by 17 and (c) by 43.60

$$7339.41 H_c + 50160.2 \frac{1}{2} + (43.60)(17) M_c - 29789.1 = 0$$

$$1439.24 H_c + 1900.96 \frac{1}{2} + (43.60)(17) M_c - 3747.9 = 0$$

$$5900.17 H_c + 48259.24 \frac{1}{2} - 26,041.2 = 0 \quad (e)$$

Multiplying (d) by 48,259.24 and (e) by 5900.17

$$93,382,457 H_c + (48,259.24)(5900.17) \frac{1}{2} - 247,677,519 = 0$$

$$34,812,006 H_c + (48,259.24)(5900.17) \frac{1}{2} - 153,647,507 = 0$$

$$60,570,451 H_c = 94,030,012$$

$$H_c = 1.552 \text{ lb.}$$

Substituting value of H_c in (d)

$$3067.47 + 5900.17 \frac{1}{2} - 5132.23 = 0$$

$$\frac{1}{2} = \frac{2064.76}{5900.17} = .350 \text{ lb.}$$

Substituting values of H_c and $\frac{1}{2}$ in (c)

$$5123 + 15.26 + 17 M_c - 85.96 = 0$$

$$M_c = \frac{19.47}{17} = 1.145 \text{ ft. lb.}$$

$$x_c = \frac{1.145}{1.552} = .736 \text{ ft.}$$

Point	x	y	xy	x ²	y ²	Unit Load at L ₄		
						m	mx	my
1	29.94	10.62	317.96	896.4	112.70	26.30	767.4	279.31
2	22.26	5.52	122.86	495.5	30.47	18.85	419.6	104.05
3	17.59	3.37	59.28	309.4	11.36	14.30	251.5	49.19
4	14.00	2.10	29.40	196.0	4.41	10.79	151.1	22.66
5	10.95	1.29	14.02	119.9	1.64	7.77	85.1	9.98
6	8.22	0.72	5.92	67.6	.52	5.09	41.8	3.66
7	5.74	0.37	2.12	32.9	.14	2.60	14.9	.96
8	3.36	0.12	.40	11.3	.01	0.26	0.9	.05
9	1.12	0.00	.00	1.3	.00	0.00	0.0	.00
Σ Left	121.8	24.10	551.98	2130.3	161.33	85.96	1752.3	466.81
10	1.06	0.00	.00	1.1	.00			
11	3.18	0.12	.38	10.1	.01			
12	5.24	0.29	1.52	27.5	.08			
13	7.32	0.56	4.10	53.6	.31			
14	9.52	0.96	9.14	90.6	.92			
15	11.87	1.51	17.92	140.9	2.28			
16	14.32	2.25	30.22	205.1	5.06			
17	17.07	3.22	54.97	291.4	10.37			
Σ Right	68.54	8.91	120.25	820.3	19.03	0.00	0.0	0.00
Σ Totals		33.01		2950.6	180.36	85.96		466.81

Determination of Moment and Thrust at Crown Section- Unsymmetrical Arch
(Temperature Fall of 40°F.)

Designing Sheet 20A.

$$H_c \Sigma y^2 + V_c(\Sigma x_L y_L - \Sigma x_R y_R) + M_c \Sigma y - \frac{1}{2} \cdot t_c \cdot D \cdot \Delta E_c = 0$$

$$H_c(\Sigma x_L y_L - \Sigma x_R y_R) + V_c \Sigma x^2 + M_c(\Sigma x_L - \Sigma x_R) = 0$$

$$H_c \Sigma y + V_c(\Sigma x_L - \Sigma x_R) + \pi M_c = 0$$

$$180.36 H_c + 431.73 V_c + 33.01 M_c + (.125)(.000006)(40)(52.95)(2,000,000)(144) = 0 \quad (a)$$

$$431.73 H_c + 2950.6 V_c + 43.60 M_c = 0 \quad (b)$$

$$33.01 H_c + 43.60 V_c + 17 M_c = 0 \quad (c)$$

Multiplying (a) by 17 and (c) by 33.01

$$3066.12 H_c + 7339.41 V_c + (33.01)(17) M_c + 7,777,296 = 0$$

$$1089.66 H_c + 1439.24 V_c + (33.01)(17) M_c = 0$$

$$\hline 1976.46 H_c + 5900.17 V_c + 7,777,296 = 0 \quad (d)$$

Multiplying (b) by 17 and (c) by 43.60

$$7339.41 H_c + 50,160.2 V_c + (43.60)(17) M_c = 0$$

$$1439.24 H_c + 1900.96 V_c + (43.60)(17) M_c = 0$$

$$\hline 5900.17 H_c + 48,259.24 V_c = 0 \quad (e)$$

Multiplying (d) by 48,259.24 and (e) by 5900.17

$$95,382,457.49 H_c + (48,259.24)(5900.17) V_c + 375,326,394,215 = 0$$

$$34,812,006.03 H_c + (48,259.24)(5900.17) V_c = 0$$

$$\hline 60,570,451 H_c = -375,326,394,215$$

$$H_c = -6,196 \text{ lb.}$$

Substituting value of H_c in (d)

$$-12,246,146 + 5900.17 V_c + 7,777,296 = 0$$

$$V_c = \frac{4,468,850}{5900.17} = 757 \text{ lb.}$$

Substituting values of H_c and V_c in (c)

$$-204,530 + 33,005 + 17 M_c = 0$$

$$M_c = \frac{171,525}{17} = 10,090 \text{ ft. lb.}$$

$$x_0 = -\frac{10,090}{6196} = -1.63 \text{ ft.}$$

Determination of Moments and Thrusts at Springing - Unsymmetrical Arch
(Unit Load at Define Points)

Pt.	x		y	xy	x ²	y ²	Unit Load at L ₄		
	m	mx					my		
1	4.33	4.50	19.49	18.7	20.25				
2	11.78	10.00	117.80	138.0	100.00				
3	16.33	12.40	202.49	266.7	153.76				
4	19.84	13.82	274.19	393.6	190.99				
5	22.86	14.83	339.01	522.6	219.93				
6	25.54	15.53	396.64	652.3	241.18				
7	28.03	16.02	449.04	785.7	256.64				
8	30.37	16.39	497.76	922.3	268.63				
9	32.59	16.59	540.67	1062.1	275.23	1.96	63.9	32.52	
10	34.78	16.72	581.52	1209.6	279.50	4.15	144.3	69.39	
11	36.90	16.73	617.34	1361.7	279.89	6.27	231.4	104.89	
12	38.96	16.67	649.46	1517.9	277.89	8.33	324.5	138.86	
13	41.07	16.50	677.66	1686.7	272.25	10.44	428.8	172.26	
14	43.28	16.21	701.57	1873.2	262.76	12.65	547.5	205.06	
15	45.65	15.79	720.81	2083.9	249.32	15.02	685.7	237.17	
16	48.15	15.19	731.40	2318.4	230.74	17.52	843.6	266.13	
17	50.82	14.35	731.21	2592.8	206.21	20.29	1033.2	291.36	
Σ	531.88	548.26	6248.08	18407.0	3765.23	96.63	4302.9	1517.64	

Designing Sheet 21.

$$\begin{aligned}
 a &= 2x_1y_1 - n^2x_1y_1 \\
 b &= 2mx_1y_1 - 2x_1x_1my \\
 c &= 2x_1^2y_1 - 2x_1x_1y_1 \\
 d &= 2m_1y_1 - n^2x_1my \\
 e &= 2x_1x_1y_1^2 - 2x_1y_1y_1 \\
 f &= n^2x_1y_1^2 - (x_1y_1)^2
 \end{aligned}$$

$$\begin{aligned}
 H_1 &= \frac{ab - cd}{ae - cf} \\
 V_1 &= \frac{d - H_1f}{a} \\
 M_1 &= \frac{H_1x_1y_1 - V_1x_1x_1 + 2m}{n}
 \end{aligned}$$

$$\begin{aligned}
 a &= (531.38)(248.25) - (17)(8248.06) = -8301.93 \\
 b &= (4302.9)(248.25) - (531.38)(1517.64) = 261,751.39 \\
 c &= (19,407.0)(248.25) - (531.38)(8248.06) = 434,933.63 \\
 d &= (96.63)(248.25) - (17)(1517.64) = -1,811.48 \\
 e &= (331.39)(3785.23) - (6248.06)(248.25) = -36185.38 \\
 f &= (17)(3785.23) - (248.25)^2 = 2720.85
 \end{aligned}$$

$$\begin{aligned}
 H_1 &= \frac{(-8,301.93)(261,751.39) - (434,933.63)(-1,811.48)}{(-8,301.93)(-36,185.38) - (434,933.63)(2,720.85)} \\
 &= \frac{-1,365,168,145}{-802,980,675} = 1.699 \text{ lb.} \\
 V_1 &= \frac{(-1,811.48) - (1.699)(2,720.85)}{-8,301.93} = \frac{-6,080.49}{-8,301.93} = 0.732 \text{ lb.}
 \end{aligned}$$

$$\begin{aligned}
 M_1 &= \frac{(1.699)(248.25) - (0.732)(531.38) + 96.63}{17} = \frac{97.16}{17} = 5.715 \text{ ft. lb.} \\
 x_1 &= \frac{5.715}{0.732} = 7.81 \text{ ft.} \\
 x_2 &= \frac{5.715}{1.699} = 3.64 \text{ ft.}
 \end{aligned}$$

Determination of Moment and Thrust at Springing - Unsymmetrical Arch
 (Temperature fall of 40°F.)

Designing Sheet 21A.

$$H_1 = \frac{\alpha \Sigma X - \frac{176}{c} \cdot (k)}{\alpha e - c f} \cdot (k)$$

$$k = \frac{1}{3} \cdot \epsilon \cdot \tau_D \cdot \ell E_c$$

$$V_1 = \frac{k \Sigma X - H_1 e}{c}$$

$$= (.125 \times .000006) \times (-40) \times 52.4 \times 2,000,000 \times (.44)$$

$$= -452,736$$

$$M_1 = \frac{H_1 \Sigma y - V_1 \Sigma x}{17}$$

$$H_1 = \frac{(-8301.93 \times 531.38) - (17 \times 434,933.63)}{-882,980,675} \cdot (-452,736) = -6050 \text{ lb.}$$

$$V_1 = \frac{(-452,736 \times 531.38) - (6050 \times 36,185.38)}{434,933.63} = -1060 \text{ lb.}$$

$$M_1 = \frac{(-6050 \times 240.25) - (-1060 \times 531.38)}{17} = -55,215 \text{ ft. lb.}$$

$$x_0 \text{ (vertically)} = \frac{-55,215}{-6050} = 9.12 \text{ ft.}$$



CHAPTER VII

ARCHES WITH ELASTIC PIERS

The necessity for considering relatively thin piers elastic was probably brought to public attention by Mr. Daniel B. Luten of Indianapolis, as early as the year 1904. Undoubtedly the idea came from his experience with the design of the arch bridge across the Wabash River at Peru, Ind., in which the conditions for a satisfactory design required the balancing of thrusts of unequal spans by introducing a moment in the piers.¹ Whether or not the idea was brought forward in this way, it is a fact that Mr. Luten since the Peru bridge experience has built many arch bridges with unusually thin piers, two of the more pronounced



Courtesy of Mr. Daniel B. Luten, Consulting Engineer, Indianapolis.

FIG. 28.—Venore bridge over Tellico River, Venore, Tenn.
(Twin spans of 65 ft. each.)

structures of this class being shown in Figs. 28 and 29. Mr. A. C. Janni has also made use of the elastic-pier principle in the Kings-highway viaduct, recently constructed at St. Louis, in which the arches and piers were analyzed as a continuous elastic body.

Arches with elastic piers are undoubtedly somewhat more difficult to analyze than single arches extending only from springing to springing, but this does not change the fact that a great number of arch bridges of multiple spans have piers which should be considered as elastic if a thorough analysis is to be made. In any given structure, good judgment should be exercised in determining whether or not the piers are of such slender pro-

¹*Engineering News*, Mar. 29, 1906.

portions that the bending due to unequal arch thrusts should be considered.

Thin piers not only save concrete in most cases but increase the area of waterway and, on this account, it is quite likely that elastic piers will be much used in the future where architectural appearance is satisfied with this type of construction. In some cases, however, increased thickness of arch rings in elastic-pier construction will offset any advantage gained from diminishing the cross-sectional area of the piers.

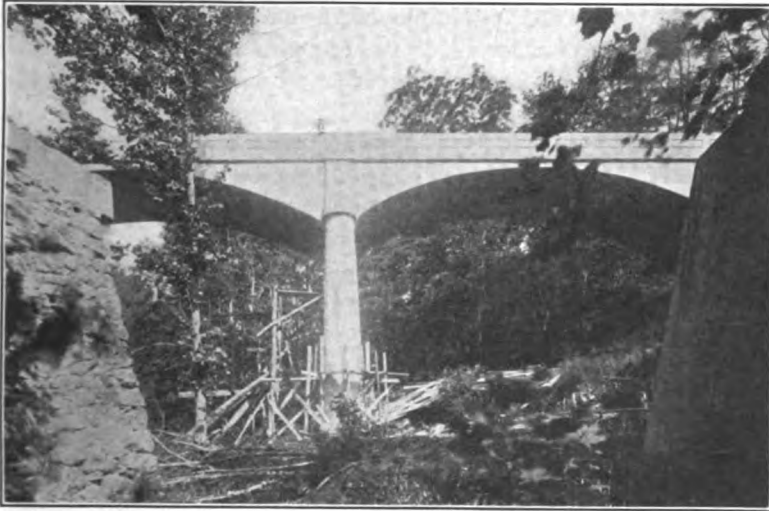

Courtesy of Mr. Daniel B. Luten, Consulting Engineer, Indianapolis.

FIG. 29.—Paint Branch bridge near Washington, D. C.
(Three spans of 60 ft. each.)

37. Method of Analysis.—Very few American engineers have made any attempt to analyze arches having elastic piers, due undoubtedly to a lack of textbook material on the subject. Up to the present time,¹ the method outlined by Mr. A. C. Janni in the *Journal of the Western Society of Engineers*, May, 1913, and described in the next chapter, is, as far as the writer knows, the only published treatment of arch analysis in this country giving some attention to elastic-pier construction. In the paper referred to, Mr. Janni presents a new and complete graphical treatment for the analysis of arches for any and all conditions based on the theory of the ellipse of elasticity. The

¹ January 1, 1915.

method to be proposed in this article, however, will not differ in principle from the analysis previously presented in this text for single symmetrical and unsymmetrical arches.

Consider first the two-span arch structure represented in Fig. 30. The points indicated as fixed may be the bottoms of the pier and abutments, or they may be at intermediate sections, depending upon where the designer considers the structure fixed. The method proposed is to take a horizontal section $A - A$ where arches and pier join and study the movement at that section.

In Art. 14 the method employed in deriving formulas for the thrust, shear, and moment at the crown of a symmetrical arch was to cut the arch at the crown and study the horizontal,

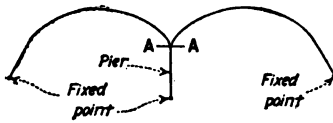

FIG. 30.

vertical, and angular moments of the cantilever on the left with respect to similar movements of the cantilever on the right. From the formulas for deflection of curved beams, three independent equa-

tions were possible and expressions for the three unknowns (H_c , V_c , and M_c) were then derived.

A similar method may be followed in finding expressions for the forces acting at the horizontal section $A - A$ in Fig. 30. The thrust from the left arch and the thrust from the right arch combine to produce a resultant thrust on the pier. There are three unknowns with respect to each arch—that is, six unknowns in all, since there is a known relation between the thrust on the pier and the thrusts from the arches. Three independent equations may be written by placing the vertical, horizontal, and angular movements of the pier end of the left arch algebraically equal to similar movements respectively of the pier end of the right arch. The other three independent equations required may be written by placing the vertical, horizontal, and angular movements of the pier end of either arch algebraically equal to similar movements respectively of the top of the pier. These independent equations may be simplified and changed somewhat by placing the vertical movement of the section $A - A$ (due to loading) equal to zero, since this may be done without any appreciable error.

In Fig. 31 the top of the pier is shown in detail. The horizontal section $A - A$ may be regarded as common to the pier and the

arches. What may be called the skewbacks of the arches are shown. The weight of the material between the skewbacks and the section $A - A$ need be considered only in finding the resultant thrusts on the pier sections. The origin of coördinates x and y for each arch may be taken at the middle point C of the section $A - A$ instead of at the center of the skewbacks. This should be obvious from a study of the derivation of the deflection formulas of Chapter II.

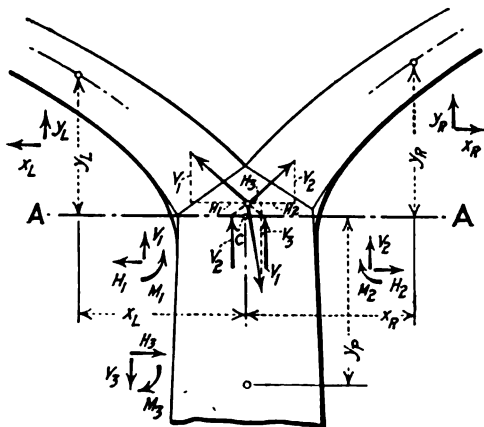

FIG. 31.

The following notation will be employed:

Let

x_L, y_L = coördinates of any point on the axis of the left arch referred to the center of the section $A - A$ as origin. Values of y_L should be considered plus when measured above the axis $X - X$, and as negative when measured below that axis.

x_R, y_R = coördinates of any point on the axis of the right arch referred to the center of the section $A - A$ as origin. Values of y_R should be considered plus when measured above the axis $X - X$, and as negative when measured below that axis.

y_P = depth of any point on the vertical axis of the pier below the section $A - A$.

m_L, m_R = moment at any point on axis of left arch and right arch respectively of all external loads between the point in question and the top of the pier.

M_L, M_R, M_P = moment at any point on axis of left arch, right arch, and pier respectively.

n_L, n_R, n_P = number of $\frac{s}{l}$ divisions in the left arch, right arch, and pier respectively.

c_L, c_R, c_P = values of $\frac{s}{l}$ for left arch, right arch, and pier respectively.

H_1, V_1 = horizontal and vertical components of the thrust from the left arch at the top of pier.

M_1 = moment at section $A - A$ due to thrust from left arch = vertical component of thrust from left arch multiplied by the distance from the point C (the center of the section) to where this thrust produced cuts the section $A - A$.

H_2, V_2 = horizontal and vertical components of the thrust from the right arch at the top of pier.

M_2 = moment at section $A - A$ due to thrust from right arch.

H_3 = resultant shear on section $A - A = H_1 - H_2$.

V_3 = resultant thrust (normal) on section $A - A = V_1 + V_2$.

M_3 = resultant moment on section $A - A = M_1 - M_2$.

Other notation that will be used is given in Art. 13. The arrows in Fig. 31 indicate what will be considered positive values of the quantities.

Referring to Chapter II on "Deflection of Curved Beams," we have

$$c_L \Sigma M_{LYL} = - c_R \Sigma M_{RYR}$$

$$c_L \Sigma M_{LXL} = 0$$

$$c_R \Sigma M_{RXR} = 0$$

$$c_L \Sigma M_L = - c_R \Sigma M_R$$

$$c_P \Sigma M_{PYP} = c_L \Sigma M_{LYL}$$

$$c_P \Sigma M_P = - c_L \Sigma M_L$$

Designing Sheet 22.

Formulas Required - Arches with Elastic Piers

Loading:

$$C_L (M_1 \Sigma y_L - H_1 \Sigma y_L^2 + V_1 \Sigma x_L y_L - \Sigma m_L y_L) - C_R (M_2 \Sigma y_R - H_2 \Sigma y_R^2 + V_2 \Sigma x_R y_R - \Sigma m_R y_R)$$

$$M_1 \Sigma x_L - H_1 \Sigma x_L y_L + V_1 \Sigma x_L^2 - \Sigma m_L x_L = 0$$

$$M_2 \Sigma x_R - H_2 \Sigma x_R y_R + V_2 \Sigma x_R^2 - \Sigma m_R x_R = 0$$

$$C_L (\pi_L M_1 - H_1 \Sigma y_L + V_1 \Sigma x_L - \Sigma m_L) - C_R (\pi_R M_2 - H_2 \Sigma y_R + V_2 \Sigma x_R - \Sigma m_R)$$

$$C_P [(M_1 - M_2) \Sigma y_P + (H_1 - H_2) \Sigma y_P^2] = C_L [M_1 \Sigma y_L - H_1 \Sigma y_L^2 + V_1 \Sigma x_L y_L - \Sigma m_L y_L]$$

$$C_P [\pi_P (M_1 - M_2) + (H_1 - H_2) \Sigma y_P] = -C_L [\pi_L M_1 - H_1 \Sigma y_L + V_1 \Sigma x_L - \Sigma m_L]$$

Bending Moment at any point:

$$M_L = M_1 - H_1 y_L + V_1 x_L - m_L$$

$$M_R = M_2 - H_2 y_R + V_2 x_R - m_R$$

$$M_P = (M_1 - M_2) + (H_1 - H_2) y_P$$

Values of y_L and y_R should be considered plus when measured above the axis $X-X$, and as negative when measured below that axis. The values of H_3 , V_3 , and M_3 may be obtained from the following relations:

$$H_3 = H_1 - H_2$$

$$V_3 = V_1 + V_2$$

$$M_3 = M_1 - M_2$$

The bending moment at any point may be expressed as follows:

$$\begin{aligned}M_L &= M_1 - H_1y_L + V_1x_L - m_L \\M_R &= M_2 - H_2y_R + V_2x_R - m_R \\M_P &= M_3 + H_3y_P = (M_1 - M_2) + (H_1 - H_2)y_P\end{aligned}$$

Substituting these expressions in the preceding equations and combining terms, we have the six simultaneous equations given on Designing Sheet No. 22. These six equations may now be solved simultaneously for the values of H_1 , V_1 , M_1 , H_2 , V_2 , and M_2 . The values of H_3 , V_3 , and M_3 may then be obtained from the following relations:

$$\begin{aligned}H_3 &= H_1 - H_2 \\V_3 &= V_1 + V_2 \\M_3 &= M_1 - M_2\end{aligned}$$

For arch bridges symmetrical about the center line of pier, the labor involved in solving the simultaneous equations mentioned above will be greatly reduced.

All the simultaneous equations given above pertain to the unknown forces acting at the section $A - A$. With these completely determined, however, the moment and thrust at any section may be found in the manner described for the single symmetrical arch. Each of the three members, of course, must be considered separately and each subjected to exactly the same force that is found to act upon it at the top of pier in the monolithic structure.

Consider now the case of a three-span arch bridge, as represented in Fig. 32. The portion of the structure shown by a solid line should be treated first, solving for the unknowns at section A . The dotted portion should next be considered, solving for the unknowns at section B but placing at A the thrust coming from (or acting upon) the left arch for the given loading. The process may now be repeated by considering the solid portion again and solving for the unknowns at A , but placing at B the thrust coming from (or acting upon) the right arch for the given loading. Likewise in treating the dotted portion the second time, more accurate values of the unknowns at B may be determined by placing at A the second value obtained for the thrust coming

from (or acting upon) the left arch. It will be only in exceptional cases that the unknowns at sections *A* and *B* will need to be solved more than once in order to obtain sufficient accuracy. In fact, solving for the unknowns at *A* twice and at *B* once is usually all that is desired.

Fig. 33 shows how the method may be applied to four spans and Fig. 34 represents its use in five, or any greater number of spans. It is very seldom that arch bridges of more than six or seven spans are constructed without an intermediate abutment

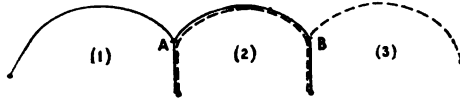

FIG. 32.

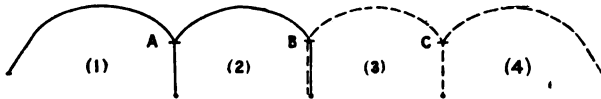

FIG. 33.

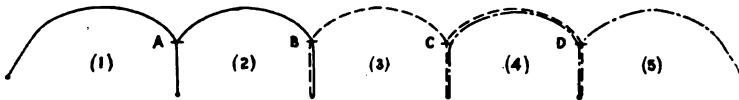

FIG. 34.

pier. The method for a large number of arches may be simplified by the fact that the effect of a load on any one span extends principally over the span itself and the two spans immediately adjacent.

In a series of arches with elastic piers, there is seldom, if ever, any radical change in span lengths between successive arches. On this account the unbalanced thrust acting on any pier due to a maximum change in temperature will be relatively small, and each arch of a series when analyzed for temperature stresses may be considered in nearly all cases as having immovable or fixed supports. Of course, if the arch spans are all equal, then

this method of analysis will give exact results since the piers are not acted upon by any unbalanced thrusts.

Rib shortening causes the same effect as a lowering of the temperature. By referring to Arts. 14 and 34, it should be clear that the following formula may be employed to solve for the equivalent temperature drop:

$$t_D = \frac{c_a}{E_c t_c}$$

38. Analysis of a Two-span Arch Bridge with Pier Elastic.—

The earth-filled bridge shown in Designing Sheet No. 23 will be partially analyzed for loading only, assuming a live load of 150 lb. per linear foot over the entire right arch—that is, considering a strip of bridge 1 ft. in width—and dead load only on the left arch. This loading causes the greatest stresses in the pier and also causes the resultant thrust on the base of pier to act at the maximum distance from the center line.

The structure represented is symmetrical about the center line of pier and $x_L = x_R$, $y_L = y_R$. The following values may then be determined in the manner described in previous chapters:

$$\begin{array}{lll} \Sigma x & = & 403.85 \quad \Sigma m_L & = & 3,908,000 \quad c_L = c_R = 9.40 \\ \Sigma y & = & 100.00 \quad \Sigma m_L x & = & 128,241,600 \quad c_P = 0.41 \\ \Sigma xy & = & 2258.74 \quad \Sigma m_L y & = & 19,918,500 \quad n_L = n_R = 17 \\ \Sigma x^2 & = & 11,986.6 \quad \Sigma m_R & = & 4,752,100 \quad n_P = 7 \\ \Sigma y^2 & = & 671.65 \quad \Sigma m_R x & = & 156,842,600 \\ \Sigma y_P & = & 64.99 \quad \Sigma m_R y & = & 24,056,500 \\ \Sigma y_P^2 & = & 867.13 \end{array}$$

Substituting these values in the six simultaneous equations of Designing Sheet No. 22 and solving, we have

$$\begin{array}{ll} H_1 = 18,400 \text{ lb.} & H_2 = 21,400 \text{ lb.} \\ V_1 = 13,850 \text{ lb.} & V_2 = 17,400 \text{ lb.} \\ M_1 = 9250 \text{ ft.-lb.} & M_2 = -7500 \text{ ft.-lb.} \end{array}$$

Thus both arch thrusts act to the right of the center of the section *A - A* (Fig. 35). The thrust from the left arch acts through a point $\frac{9250}{13,850} = 0.67$ ft. from *C* and the thrust from the right arch acts through a point $\frac{7500}{17,400} = 0.43$ ft. from the same point, both distances measured to the right.

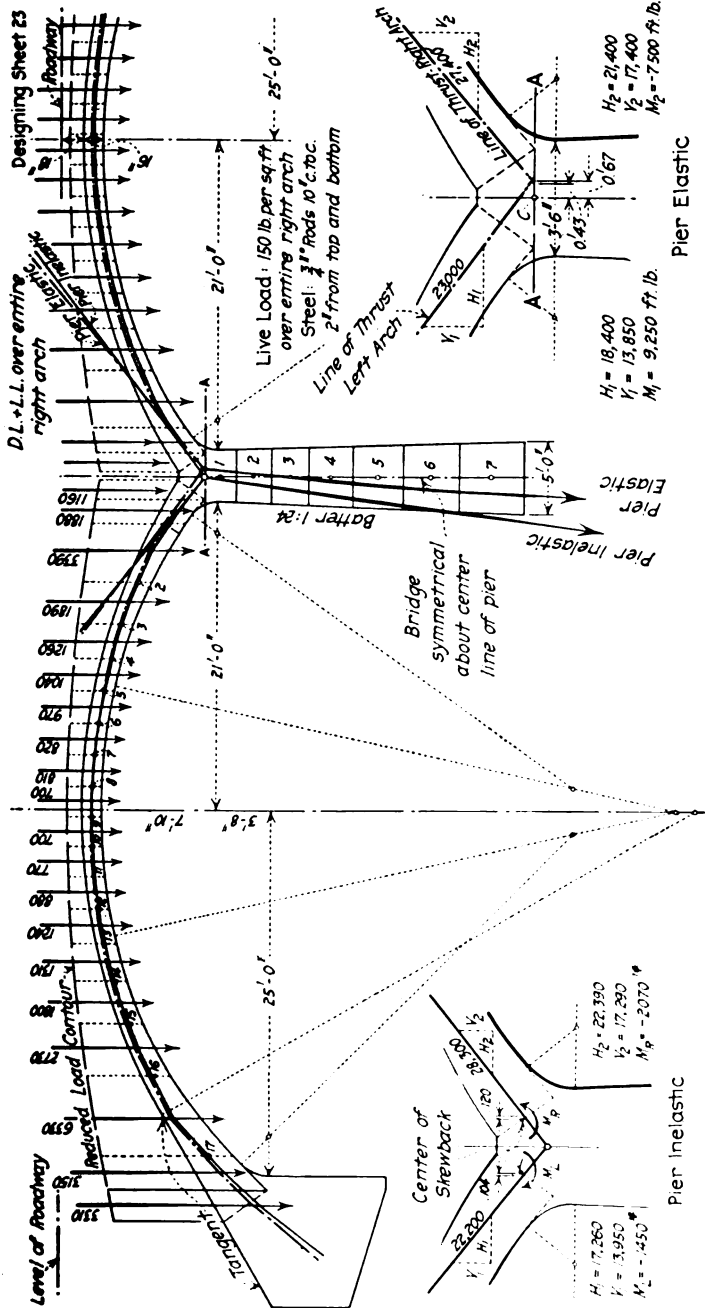

Designing Sheet No. 23 shows the lines of pressure in the arches and the pier. The resultant thrust on the base of pier is seen to act outside the middle-third point. This should not be allowed in good construction and the pier should either be increased in width, or a reinforced-concrete footing should be added to make a more nearly uniform distribution of pressure over the pier base. If the structure should be analyzed assuming the arches to have fixed ends, the resultant thrust would fall even farther from the middle third point, as shown, indicating that the elastic properties of the pier tend to prevent failure in so far as that is possible. It should be noted that if the pier should tip due to unequal intensity of pressure on its foundation, the thrust from the right arch would be somewhat reduced and the thrust from the left arch increased. This would cause a certain righting moment at the top of pier and would tend to prevent failure. Relying on such a possible factor of safety, however, would not be acting according to good practice as unknown stresses might be set up in the arch rings which would otherwise endanger the structure. Of course, it is possible to determine these stresses for any predetermined amount of unequal settling.

If desired, each arch in the above design may be considered as fixed for dead load only. The live-load stresses should then be combined with those due to dead load in order to give the correct maximum stresses. If the arches had been taken unequal, the resultant for dead load should be made to pass through the middle third of the pier base if the arches are to be considered as fixed for this loading. This may be done by overloading the arch having the shorter span.

CHAPTER VIII

ARCH ANALYSIS BY THE METHOD OF THE ELLIPSE OF ELASTICITY¹

The ellipse-of-elasticity method of arch analysis is almost entirely graphical and is unique in the fact that by its use influence lines may be readily constructed for finding the stresses at any section. Even arches with elastic piers may be rigorously analyzed by this method without any great difficulty. The method is rapid and easily applied, and is likely to be in great favor with American engineers as soon as it becomes well known. A number of underlying principles must be explained before this method can be completely understood.

39. Preliminary Considerations Pertaining to the Method of Treating the Symmetrical Arch.—Let Figs. 13 and 14 in Chapter II represent any given element of an arch, and let k' represent the angle of rotation of the face bc with respect to the face ad which would be caused by a bending moment M . From Art. 10 we know that

$$k' = \frac{Ms}{E_c I} \quad (1)$$

Now if we consider the symmetrical arch shown in Fig. 35A as fixed at the right end and free at the left end, each element will cause a rotation of the left skewback equal to $\frac{Ms}{E_c I}$, where M is the moment acting upon a given element, s its length, and I the moment of inertia of its average cross-section. If the element considered is $abcd$, then s is the distance between the intersections of the neutral axis of the arch with the faces ad and bc , and I is the moment of inertia of the cross-section at the center of gravity of the element. Since the quantity $\frac{s}{E_c I}$ is a characteristic of the given element and shows the amount of its

¹ Method taken by permission from a paper presented before the Western Society of Engineers, January 13, 1913, by Mr. A. C. Janni, C. E. Printed in the Journal of the Western Society of Engineers, May, 1913. Most of the data in this chapter other than that included in above paper have been supplied directly by Mr. Janni.

ability to cause rotation if acted upon by a moment, we may treat this quantity as a force acting at the center of gravity of the area *abcd*. We shall call this quantity the *elastic weight* of the element.

Suppose the bending moment acting on the element *abcd* is due to a force *P* having a leverage of *x'* about the center of gravity of the element. Then the rotation of the left skewback due only

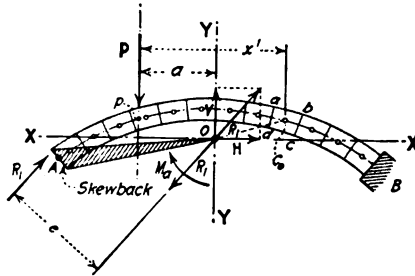
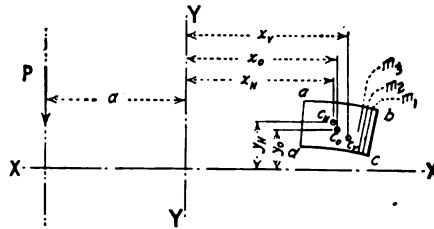

FIG. 35A.



G₀ = center of gravity of the element *abcd*, which is also the center of gravity of the $\frac{s}{E_c I}$ forces corresponding to the small elements *m₁*, *m₂*, *m₃*, etc.

$\left. \begin{matrix} c_y \\ c_x \end{matrix} \right\}$ = center of gravity of the moments of the small $\frac{s}{E_c I}$ forces about the axis $\begin{matrix} Y-Y \\ X-X \end{matrix}$

FIG. 35B.

to the bending of this element will be $Px' \cdot \frac{s}{E_c I}$. Considering $\frac{s}{E_c I}$ (the elastic weight of *abcd*) as a force, this angle of rotation may also be determined by multiplying the force *P* by the moment of the elastic weight of *abcd* about an axis through the line of action of *P*, or

$$k' = P \cdot \frac{s}{E_c I} x'$$

Designating the elastic weight by the letter G , we have

$$k' = P(Gx') \quad (2)$$

The total angle of rotation of the left skewback due to the force P will equal the sum of all the moments of the elastic weights to the right of the line of action of the force P with respect to this line of action, or

$$k = P \sum_p^B Gx' \quad (3)$$

In Art. 10 the moment of inertia has been defined as follows: "The moment of inertia of a plane surface with respect to an axis is the sum of the products obtained by multiplying each elementary area by the square of its distance from that axis." If each elementary area is considered a force, then the moment of inertia becomes the sum of the products obtained by multiplying each force by the square of its distance from the given axis. From this interpretation of the definition we may consider the same term to apply in the case of the elastic weights of the arch elements. In other words, whenever we obtain the sum of the products mentioned above for a system of elastic weights with respect to a given axis, we shall designate such sum as the moment of inertia of these weights about the axis in question. Thus if each product Gx' in the expression $\sum_p^B Gx'$ in the above formula should be multiplied again by x' the result of the expression would be the moment of inertia of all the elastic weights to the right of the line of action of P with respect to this line of action. If any given horizontal axis is also considered, the expression $\sum Gx'y$, or in general $\sum Gxy$, will be called the *product of inertia*. If two vertical axes are considered, the expression for the product of inertia takes the form $\sum Gxx'$. It should be clear that "moment of inertia" is found with respect to one axis only, while "product of inertia" is found with respect to two axes at any inclination whatever and making any angle with each other.

In Art. 11 it is shown that the vertical and horizontal displacements (Fig. 15) of the free end of the arch due to the moment M acting upon a given element may be expressed respectively by the formulas

$$dy = x \frac{Ms}{E_c I} \quad \text{and} \quad dx = y \frac{Ms}{E_c I} \quad (4)$$

where x and y refer to coördinate axes with the origin at the free end. These formulas if applied to the element $abcd$ of Fig. 35A may be put in the form

$$dy = x \cdot Px' \cdot G \quad \text{and} \quad dx = y \cdot Px' \cdot G$$

Suppose now that a certain point O is assumed to be rigidly connected with the cross-section of the left skewback and let it be desired to find the displacements of this point O due only to the rotation of the element $abcd$, this rotation being caused by the bending moment Px' .

First of all it should be noted that the angle of rotation of the free end (A) of the arch which is determined above by the formula $k' = P(Gx')$ refers to the angle of rotation at any point to the left of the element $abcd$, and also to the point O since this point is in rigid connection with A . If we consider C_o , the center of gravity of the element $abcd$, as the center of rotation (considered so simply for illustration as the student will find later that the center of rotation is not at C_o), then the preceding statement means that the line C_oO turns through the same angle as a line connecting C_o and A . Thus the above formulas for vertical and horizontal displacements can be applied with respect to axes through the point O as well as through A or any other point which is rigidly connected with the arch and is to the left of the given element. We have then the formulas

$$dy = P \cdot Gx' \cdot x \quad \text{and} \quad dx = P \cdot Gx' \cdot y \quad (5)$$

which give the displacements at point O provided x and y are measured with respect to the axes $X - X$ and $Y - Y$.

The total vertical and horizontal displacements of O due to the force P causing bending in all elements to the right of its line of action are

$$\Delta y = -P \sum_p^B Gx \cdot x' \quad \text{and} \quad \Delta x = P \sum_p^B Gy \cdot x' \quad (6)$$

considering positive values of y above the axis $X - X$ and positive values of x to the right of $Y - Y$. The expression $\sum_p^B Gy \cdot x'$ represents the product of inertia of the elastic weights at the right of P with respect to the axis $X - X$ and to the axis through the line of action of P . The expression $\sum_p^B Gx \cdot x'$ represents the

product of inertia of the same elastic weights above mentioned with respect to the axis $Y - Y$ and to the axis through the line of action of P .

Suppose now that a force or reaction R_1 acts upon the structure so as to cause equilibrium, and suppose this same reaction R_1 is applied twice at the point O (rigidly connected with left skewback), but acting in opposite directions as shown. It will be possible to resolve one of these two forces at O into two components V and H , and then the opposite force R_1 can be combined with the actual skewback reaction so as to form a couple R_1e . Thus at the point O we have the three unknowns V , H , and $M_a = R_1e$.

The angle of rotation at the point O due to the moment $M_a = R_1e$ is given by the formula

$$k' = M_a \sum_A^B G \tag{7}$$

where $\sum_A^B G$ represents the sum of all the elastic weights from A to B . This expression comes directly from Formula (1), taking into consideration the fact that the moment R_1e acts upon the entire arch. Therefore

$$M_a \sum_A^B G = P \sum_p^B Gx' \tag{8}$$

since the angles of rotation at O due to the force P and to the reaction moment $M_a = R_1e$ must be the same.

It will be convenient to take the point O at the center of gravity of all the elastic weights. By center of gravity is meant the point through which the resultant elastic weight will always pass no matter in what parallel direction the weights are supposed to act. This point may be readily determined by finding the lines of action of the vertical and horizontal resultants. The intersection of these two resultants is the center of gravity of the system.

With the point O located as above mentioned, the vertical displacement of this point due to the vertical reaction V is, by Formula (6),

$$\Delta y = V \sum_A^B Gx^2 \tag{9}$$

This means that the vertical displacement of O from this cause is equal to the product obtained by multiplying the force V by the

moment of inertia of the whole elastic system with respect to the vertical axis through O . This displacement must be equal to that previously found due to the load P , or

$$V \sum_A^B Gx^2 = P \sum_p^B Gx \cdot x' \quad (10)$$

The horizontal reaction H does not cause any vertical displacement at the point O since it acts at right angles to V and through the center of gravity of the system of elastic weights. The expression for the vertical displacement of point O due to force H is as follows: $H \sum_A^B Gxy$. The arch, however, is symmetrical, so that $\sum_A^B Gxy$ reduces to zero and no vertical displacement results.

The horizontal displacement of O due to the horizontal reaction H is, by Formula (6),

$$\Delta x = H \sum_A^B Gy^2 \quad (11)$$

that is, the horizontal displacement of O is equal to the product obtained by multiplying the force H by the moment of inertia of the elastic weights of the whole elastic system with respect to the horizontal axis through O . Placing this equal to the horizontal displacement previously found, we have

$$H \sum_A^B Gy^2 = -P \sum_p^B Gy \cdot x' \quad (12)$$

With a known force P (which should be considered as unity in order to plot influence lines), Formulas (8), (10), and (12) may be employed to determine the values of $M_a = R_1e$, V , and H . The moments and products of inertia of the elastic weights may be found readily by graphical methods. The magnitude of the reaction R_1 is equal to the resultant of V and H , and its actual position may be determined by drawing a tangent parallel to this resultant at a distance

$$e = \frac{M_a}{R_1}$$

from the point O . The reaction at the right of the structure may be obtained in the manner shown on Designing Sheet No. 10A.

If the lengths of the semi-major and semi-minor axes of an ellipse are known, the antipole of any line or axis can be determined by a simple graphical construction. For example, in Fig. 38 the antipole (C_{MN}) of MN may be found in the following manner:

Lay off $C_oB' = C_oB$, and $C_oD' = C_oD$.

Connect B' with F , and D' with G .

Draw $B'B''$ perpendicular to $B'F$, and $D'D''$ perpendicular to $D'G$.

From B'' draw a line parallel to C_oD , and from D'' draw a line parallel to AB .

The intersection of these lines is the antipole C_{MN} .

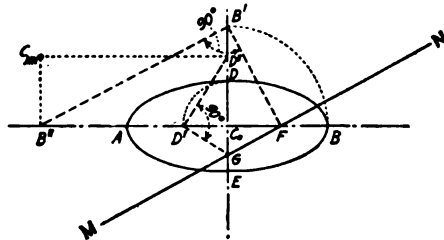

FIG. 38.

41. Properties of the Center of Gravity of Static Moments.—

Let C_o of Fig. 39 be the center of gravity of the given element, which is the center of gravity of all the small elastic weights. Also let C_{RS} be the center (see Art. 39) relative to the axis RS , and C_{MN} the center relative to the axis MN . Then the product of inertia of all the small elastic weights of the given element about RS and MN is

$$Gx_o y_{RS} = Gy x_o MN$$

This equation shows that if y_{RS} should be zero, then also x_{MN} would be equal to zero. Thus it follows that if the center relative to an axis falls upon another axis, the center relative to the latter will fall upon the first. (It should be noted that this is the same relation which exists between the poles and polars, or antipoles and polars, of an ellipse, Fig. 37.) Also any axis passing through the center relative to another axis will have its center somewhere on that other axis. For such axes, which are conjugate axes, the product of inertia of the small elastic weights is zero.

The moment of inertia of the weights about the axis RS may be expressed as follows:

$$I_{RS} = Gx_0x_{RS}$$

or

$$x_{RS} = \frac{I_{RS}}{Gx_0}$$

If the axis RS should pass through the center of gravity C_0 , then x_0 would equal zero and x_{RS} would equal infinity, which is the same relation which exists between the poles and diameters, or antipoles and diameters, of an ellipse (Fig. 37B).

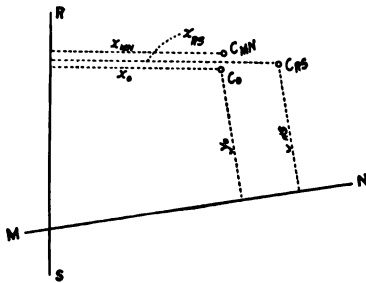

FIG. 39.

It should now be clear that the centers C_V and C_H for the given element with respect to given axes must be either the poles or antipoles of some ellipse which has its center at the center of gravity of the element and one axis lying in the geometrical axis of the arch. The lengths of

the major and minor axes of this ellipse, however, we have not yet determined.

42. Determination of the Ellipse of Elasticity.—Points C_V and C_H in Fig. 35B are termed *centers* in Art. 39. They are in reality centers of rotation of the element $abcd$ if forces are considered to act on the element along the axes $Y - Y$ and $X - X$ respectively. For example, a force along $Y - Y$ causes a bending moment in each of the small elements m_1, m_2, m_3 , etc., and the center of gravity of all these bending moments considered as forces will be the instantaneous center of rotation of the element $abcd$ —that is, the point C_V .

In order to show conclusively that this is true, consider the very small elements m_1 and m_2 of $abcd$ (Fig. 40), with centers of gravity C_1 and C_2 respectively, and assume that bending is caused in these elements by a force acting along an axis $Y - Y$. The vertical displacement of some point A to the left of $abcd$ due to the force acting on the small element $m_1 = M_1x_1g$ (see Formula 4, Art. 39), where M_1 is the moment acting on this given element. Likewise, the vertical displacement of A due to the force acting on the small element $m_2 = M_2x_2g$. Thus the total vertical displacement of A due to the force acting on both m_1 and $m_2 = M_1x_1g + M_2x_2g = g(M_1x_1 + M_2x_2)$. In like manner it may be shown that the total horizontal displacement of A due to the bending in the elements m_1 and $m_2 = g(M_1y_1 + M_2y_2)$.

Suppose we select a point C_{1-2} on the straight line joining C_1 and C_2 , such that $\frac{C_1 C_{1-2}}{C_{1-2} C_2} = \frac{M_2}{M_1}$. In other words, we will choose a point C_{1-2} which is the center of gravity of forces equal to M_1 and M_2 applied at C_1 and C_2 , respectively. If the point A should rotate about this point due to the force acting on the elements m_1 and m_2 , the vertical displacement of A would be

$$M_1 x_{1-2} g + M_2 x_{1-2} g = (M_1 + M_2) x_{1-2} g$$

Since $x_{1-2} = x_2 + \frac{M_1}{M_1 + M_2} (x_1 - x_2)$, we have

$$(M_1 + M_2) x_{1-2} g = g(M_1 x_1 + M_2 x_2)$$

In a similar manner, the horizontal displacement of A under the same conditions would be

$$(M_1 + M_2) y_{1-2} g = g(M_1 y_1 + M_2 y_2)$$

But these values are identical with those found above for the sums of the components of the two displacements. Thus the rotation caused by the force along $Y - Y$ acting on the elements m_1 and m_2 is about a point C_{1-2} which is the center of gravity of the moments M_1 and M_2 , when these

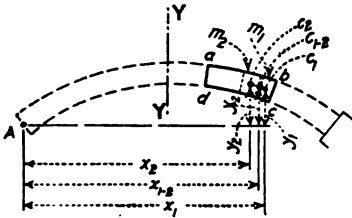

FIG. 40.

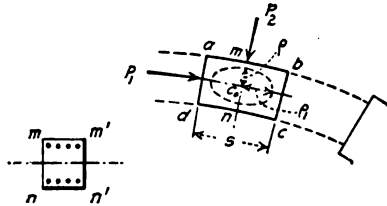

FIG. 41.

moments are considered as forces and applied at the centers of gravity of their respective elements. It should be evident that this same proof will hold with respect to any number of small elements and we have then the rule that the center of gravity of the bending moments of the small elements, when these moments are considered as forces, is the center of rotation of the large element $abcd$.

Now in Art. 41 it is shown that instantaneous centers C_Y or C_H , Fig. 35B, are either poles or antipoles of some ellipse with respect, of course, to the lines $X - X$ and $Y - Y$. If the centers were the poles of $X - X$ and $Y - Y$, there would be positions of each axis (polar) for which its corresponding center (pole) would lie on itself. (A polar is tangent to an ellipse at its pole, Art. 40.) This, however, cannot happen since a center of rotation can never lie on the line of action of a force. The centers, therefore, are the antipoles of the ellipse for the given element with respect to the axes in question.

In order to determine the lengths of the major and minor axes of the ellipse, consider a force P_1 lying in the arch axis and acting on the section ad of the element $abcd$, Fig. 41. Since P_1 acts through the center of gravity C_e of the element, the shortening due to this force will be

$$\Delta s = \frac{P_1 s}{E_c A} = P_1 \cdot \frac{s}{E_c I} \cdot \frac{I}{A} = P_1 \cdot G \cdot \frac{I}{A}$$

where A (representing the cross-sectional area) $= a_c + na_s$, and $I = I_c + nI_s$. From Art. 39, we also know that the displacement of the face ad is equal to the product of the force by the moment of inertia of the elastic weight G with respect to the line of action of the force P_1 . If ρ is the semi-minor axis (radius of gyration) of the ellipse of elasticity in question, then $G\rho^2$ will be the moment of inertia we desire, and $P_1 G\rho^2$ will be the displacement of the section ad with respect to the section bc , so that

$$\Delta s = P_1 \cdot G \cdot \rho^2$$

It should be clear that this displacement, computed by two different methods, must be the same. Hence

$$P_1 \cdot G \cdot \frac{I}{A} = P_1 \cdot G \cdot \rho^2$$

or

$$\rho = \sqrt{\frac{I(\text{of } mm'n'n)}{A(\text{of } mm'n'n)}}$$

which is the semi-axis of the ellipse of elasticity normal to the geometrical axis of the arch, and which also turns out to be the radius of gyration of the central cross-section of the element $abcd$. In a somewhat similar manner, using force P_2 rigidly connected with face ad , the semi-axis of the ellipse lying on the arch axis may be shown to be

$$\rho_1 = \sqrt{\frac{I(\text{of } abcd)}{A(\text{of } abcd)}} = s \sqrt{\frac{1}{12}} = 0.289s$$

The graphical construction in Fig. 38 (Art. 39) may now be employed to determine centers or antipoles relative to any given axis.

It should be clear from the above that we may treat the elastic weights of the elements (as $abcd$) for the whole arch in the same manner as we have the small elastic weights of each element.

Then it follows that an ellipse with its center at O , Fig. 35A (major and minor axes horizontal and vertical respectively for a symmetrical arch) may be employed to find the "centers" of the *entire* system of elastic weights with respect to given axes—that is, the antipole of such an ellipse, with respect to an axis through the line of action of a given force, will be the center of rotation of the free end of the arch (A , Fig. 35A) due to this given force. The length of the semi-minor axis would be equal to

$$\sqrt{\frac{I}{\sum_A^B G}}$$

where I represents the moment of inertia of all the elastic weights about the axis $X - X$, and $\sum_A^B G$ represents the *sum* of all these weights. The length of the semi-major axis may be found by the same general expression, but I would be taken about the axis $Y - Y$. Of course, the ellipse for an unsymmetrical arch would not have vertical and horizontal axes as above described. The method of determining the position of the ellipse for such arches will be given in Arts. 45 and 46.

For a symmetrical arch (Fig. 35A), it is shown in Art. 39 that any vertical force V acting through the point O would cause only vertical displacement of this point. This same conclusion is reached from the theory of the ellipse of elasticity. For example, the force V acts along the minor axis of the ellipse and the antipole, or instantaneous center of rotation, falls upon the major axis at infinity (Art. 40); which means that this force causes a rotation about a point at infinity—that is, a displacement in a straight line perpendicular to the major axis.

43. Graphical Constructions for Finding Moments and Products of Inertia of the Elastic Weights.—In Art. 39 the following formulas are derived:

$$\begin{aligned} M_o \sum_A^B G &= P \sum_p^B Gx' \\ V \sum_A^B Gx^2 &= P \sum_p^B Gx \cdot x' \\ H \sum_A^B Gy^2 &= - P \sum_p^B Gy \cdot x' \end{aligned}$$

by which it is possible to determine the moment and the horizontal and vertical components of the reaction acting at the point

O, Fig. 35A. In order to find M_a , V , and H , it is first necessary to determine the values of the following expressions:

$$\begin{array}{r} \sum_A^B G \\ \sum_A^B Gx^2 \\ \sum_A^B Gy^2 \end{array} \quad \begin{array}{r} \sum_p^B Gx' \\ \sum_p^B Gx \cdot x' \\ \sum_p^B Gy \cdot x' \end{array}$$

This may be done graphically. In fact it will be shown later that the graphical constructions for finding moments and products of inertia of the elastic weights will give directly the values of M_a , V , and H , if the constructions are made with this result in view.

For the present it will suffice to show the general method to be followed in finding the above expressions graphically. In order to gain clearness in the explanation of this method, the weights assumed—namely: G_1 , G_2 , G_3 , G_4 , and G_5 (Fig. 42)—will be considered as the weights of heavy particles concentrated at the points 1, 2, 3, 4, and 5 respectively. In other words, five concentrated weights will be assumed and these will be applied at any five selected points, thus eliminating any consideration of “centers” or antipoles in this preliminary discussion. The method will be shown as perfectly general by choosing coordinate axes oblique to each other.

The first consideration is to find the center of gravity O of the system and this may be accomplished by means of equilibrium polygons f_a and f_b .¹ For example, to determine the axis $X - X$ (the inclination of which is previously decided upon), the weights are assumed to act parallel to this axis, next the force polygon F_a is constructed, and then the corresponding equilibrium polygon f_a . The line $X - X$ through the intersection p' of the first and last sides of the equilibrium polygon f_a will contain the center of gravity of the system. Also, the sides of the polygon f_a will determine, on this line, segments proportional to the moments of the corresponding weights with respect to this same axis through the center of the system. The axis $Y - Y$ may be determined in a like manner employing the force polygon F_b and the equilibrium polygon f_b . The intersection of the axes $X - X$ and $Y - Y$ determines the center of gravity O of the system.

¹ See “Elements of Structures,” by the same author.

If verticals are drawn through the points of application of the weights, the segments cut off on any given vertical by the

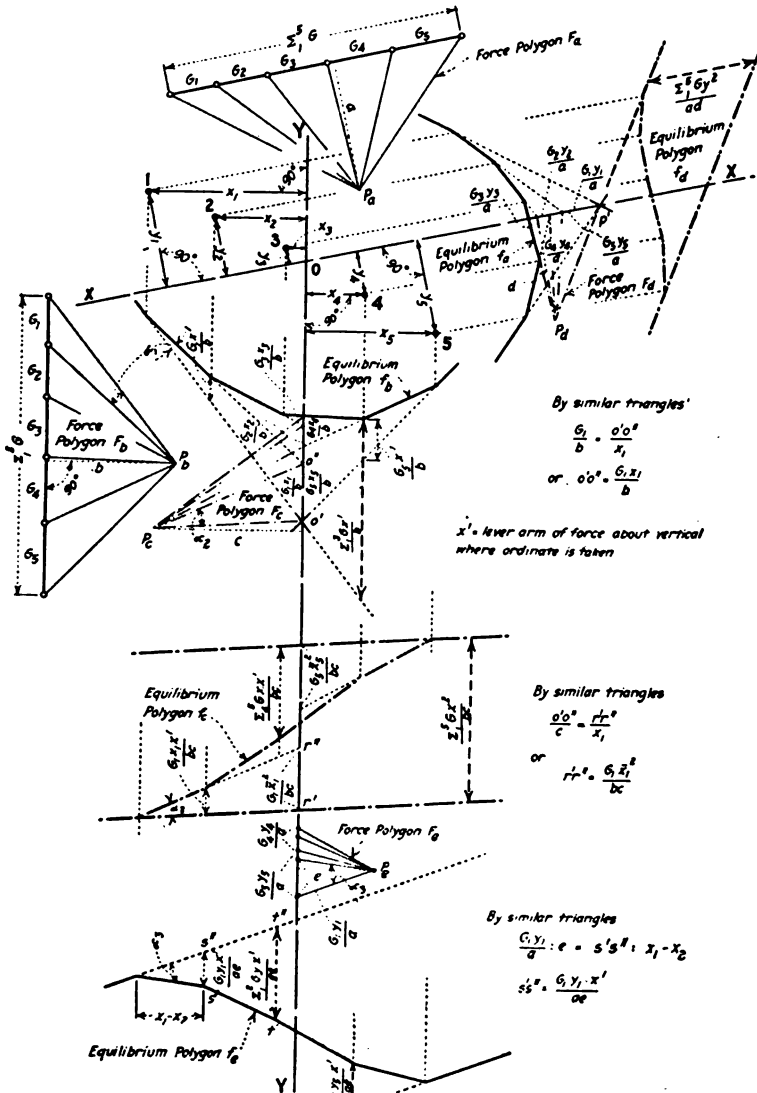

FIG. 42.

equilibrium polygon f_b will be proportional to the moment of all the weights to one side of the vertical with respect to this vertical.

Fig. 42 shows what intercepts should be considered to give desired moments.

As stated above for polygon f_a , the sides of the equilibrium polygon f_a intercept, on the axis $Y - Y$, segments proportional to the moments of the weights with respect to this axis. If these segments are treated as vertical forces applied at the points of application of the original weights, the equilibrium polygon f_c (constructed by means of the force polygon F_c) will intercept, on the axis $Y - Y$, a segment which will be proportional to the moment of inertia of the weights with respect to this axis. This segment is determined by the first and last sides of the polygon f_c . As shown in Fig. 42 the intercepts on verticals through the points of application of the weights correspond to the general expression $\Sigma Gx \cdot x'$. If equilibrium polygon f_d is constructed in a similar manner to polygon f_c (only with respect to the axis $X - X$ instead of $Y - Y$), then the segment cut off on the axis $X - X$, between the first and last sides of the polygon f_d , is the moment of inertia of the weights about this coordinate axis.

The equilibrium polygon f_a determines the moments of the weights with respect to the axis $X - X$. If these moments are considered as forces and applied at the points of application of the original weights, but this time acting vertically, the equilibrium polygon f_e (corresponding to force polygon F_e) will intercept on a vertical through any weight, a segment proportional to the product of inertia of the weights to one side of the given vertical with respect to this vertical and the $X - X$ axis. Fig. 42 shows what intercepts to consider for moments of the weights to the right and those for moments of the weights to the left of any given vertical.

44. Method of Analyzing Symmetrical Arches for Loading Only.—The graphical constructions in Fig. 43 are similar to those given in Fig. 42 except that G_1, G_2 , etc., apply to the elastic weights of arch elements (made of equal lengths for convenience) instead of to the weights of concentrated loads. Each part of a given element has an elastic weight of its own (Art. 39), consequently the *centers* of each element with respect to axes $X - X$ and $Y - Y$ must be determined. These may be found by means of the ellipse of elasticity, as explained in Art. 40. Since the arch is symmetrical about a center line, only one-half of the structure need be considered. The arch is divided into a small number of

elements in order to show the method without any considerable duplication of work.

In finding the moment of inertia of the elastic weights about

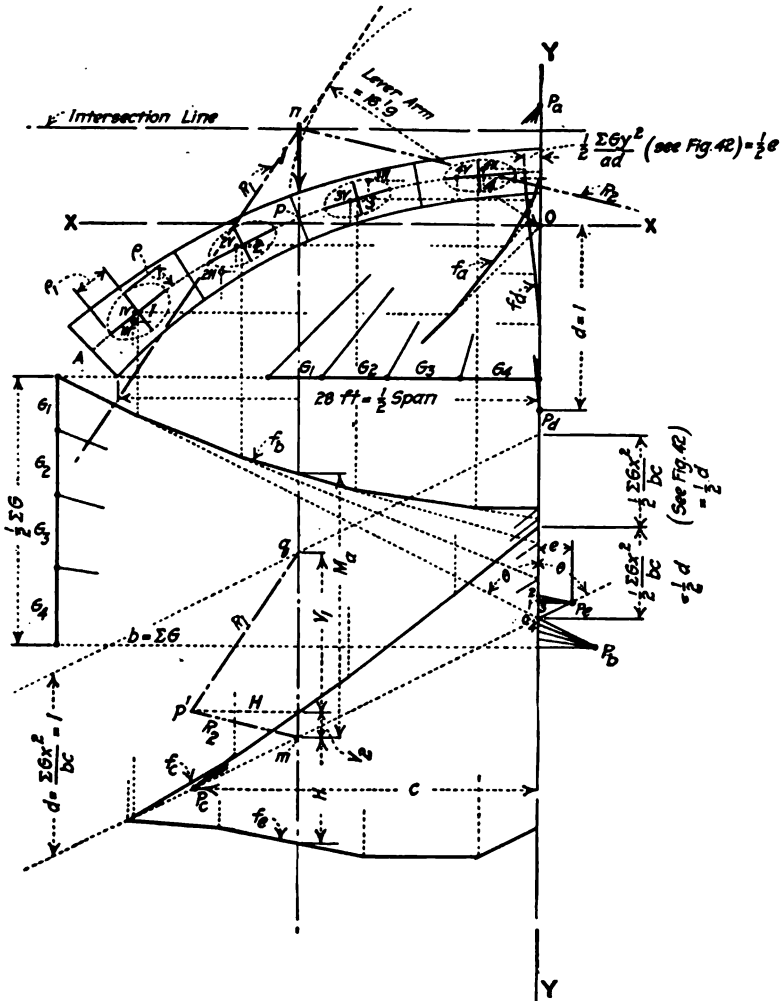

FIG. 43.

the axis $Y - Y$, by means of the equilibrium polygon f_c , the moments of the elastic weights determined by equilibrium polygon f_b should be considered as vertical forces acting at the centers of the arch elements with respect to the axis $Y - Y$

(1V, 2V, etc.). Similarly, the moment of inertia of the elastic weights about the axis $X - X$ (see equilibrium polygon f_a) should be determined by assuming the moments of the elastic weights, given by equilibrium polygon f_a , to act as horizontal forces applied at the *centers* of the arch elements relative to the axis $X - X$. The equilibrium polygon f_e should be drawn by assuming the forces corresponding to the moments with respect to the axis $X - X$ to be placed at the *centers* relative to the same axis, but acting vertically. (The results from equilibrium polygons f_a and f_d should be checked analytically in many cases as the intersections are not advantageous and may lead to cumulative errors. The force polygon with P_e as pole may be drawn to a larger scale for convenience in drawing the corresponding equilibrium polygon f_e .)

It should be noted in Fig. 43 that the pole distance b is taken equal to ΣG ; that d is made equal to $\frac{\Sigma Gx^2}{bc}$ and considered as unity in scaling; that e is given a value equal to $\frac{\Sigma Gy^2}{ad}$; and that the pole P_e is taken on the end string of the equilibrium polygon f_b which occurs at the right of the entire arch, this string being produced backward to the left side of the axis $Y - Y$. By so doing the values of the reactions and the moment M_a for a load unity at any given point may be scaled directly.

The truth of the preceding statement may be proved as follows: From the preceding article we know that

$$M_a = \frac{P \sum_P^B Gx'}{\sum_A^B G}$$

With $P = 1$ and $b = \Sigma G$, we have

$$M_a = \frac{\sum_P^B Gx'}{b}$$

which may be scaled from Fig. 43 in the manner shown for a load unity at p . (See also Fig. 42.) Likewise

$$V_1 = \frac{P \sum_P^B Gx \cdot x'}{\sum_A^B Gx^2} = \frac{\sum_P^B Gx \cdot x'}{bc} \times \frac{bc}{\sum_A^B Gx^2} = \frac{\sum_P^B Gx \cdot x'}{bc}$$

$$\begin{aligned}
 H &= \frac{P \sum_P^B Gy \cdot x'}{\sum_A^B Gy^2} = \frac{\sum_P^B Gy \cdot x'}{ae} \times \frac{ae}{\sum_A^B Gy^2} \\
 &= \frac{\sum_P^B Gy \cdot x'}{ae} \quad (\text{since } \frac{\sum_A^B Gy^2}{ad} = e, \text{ or } \sum_A^B Gy^2 = ae)
 \end{aligned}$$

The student should note that the first and last sides of the equilibrium polygon f_e in Fig. 43 would coincide if the right-hand half of the polygon were completed. This occurrence is due to the fact that the directions of the coördinate axes are conjugated and the product of inertia of all the elastic weights with respect to these axes must be zero (Art. 41). Thus the values of M_a , V_1 , V_2 , and H due to a load unity at any given point p may be determined by drawing a vertical line through the point in question and, in the manner shown in Fig. 43, scaling the intercepts which are cut off on this line by the sides of the equilibrium polygons f_b , f_c , and f_e . By laying off H horizontally as in the drawing and joining the point p' to the ends of V_1 and V_2 , the magnitude and directions of the reactions may be determined. The actual position of R_1 may be found by drawing a tangent parallel to $p'q$ at a distance $\frac{M_a}{R_1}$ from the point O . The right reaction R_2 may then be drawn from the intersection of R_1 with the vertical through p parallel to $p'm$.

Considering d equal to 1 lb. in scaling, we have, for a 1-lb. load at p in Fig. 43, $R_1 = 1.05$ lb. and $M = 17.7$ ft.-lb. The lever arm of R_1 about $O = \frac{17.7}{1.05} = 16.9$ ft. In a similar manner the reactions may be found for a 1-lb. load at other points on the arch. The intersection line shown passing through n (Fig. 43) is intended to represent the line of intersection of all reactions with their corresponding loads. It is shown as horizontal in this case in order to save the labor of determining its exact location.

Influence lines may now be drawn in the manner described in Art. 34 and the maximum stresses computed. Another and more graphical method, however, of determining values of ordinates to influence lines to represent maximum stress is shown in Fig. 44 with reference to a given section designated as S . It is convenient in this method to determine the envelopes of the reactions and the

influence line for horizontal thrust (H) which, of course, may be plotted directly from the data given in Fig. 43. Seven positions of the unit load are shown.

Assuming no tension at a given section greater than the tensile strength of the concrete, we have, from Art. 74, Volume I, that the stress on the extreme fiber

$$f_c = \frac{N}{A} \pm \frac{Nx_0x_1}{I}$$

where N is the thrust normal to the section, and x_0 and x_1 are the distances from the gravity axis to the point of application of the

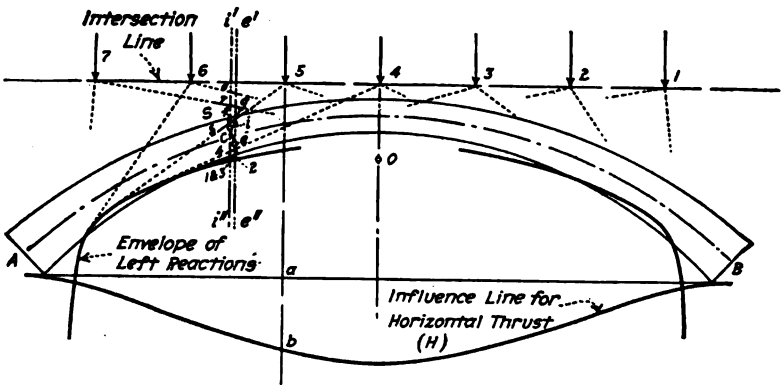

FIG. 44.

thrust and to the extreme fiber respectively. Let ρ be the letter used for the radius of gyration of the section, then

$$f_c = \frac{N\left(\frac{\rho^2}{x_1} \pm x_0\right)x_1}{A\rho^2} = \frac{N\left(\frac{\rho^2}{x_1} \pm x_0\right)}{A \cdot \frac{\rho^2}{x_1}}$$

If the stress in the upper fiber is desired, the numerator in the above expression represents the moment about a point a distance $\frac{\rho^2}{x_1}$ below the gravity axis of the section, where x_1 is the distance from the gravity axis to the upper fiber. Similarly the moment for the lower fiber would be taken about a point a distance $\frac{\rho^2}{x_1}$ above the gravity axis where x_1 is the distance from the gravity axis to the lower fiber. If we denote these moments by M ,

and M_e , and the maximum fiber stresses by f_e and f_i , respectively, then

$$f_e = \frac{M_e}{A \cdot \frac{\rho^2}{x_1}} = \frac{M_e}{A(ce)} \quad (\text{See Fig. 45})$$

$$f_i = \frac{M_i}{A \cdot \frac{\rho^2}{x_1}} = \frac{M_i}{A(ci)} \quad (\text{See Fig. 45})$$

M_e and M_i are given graphically in Fig. 45 as the products $R(ae)$ and $R(bc)$ respectively. It will be more convenient, however, to draw vertical lines through the points e and i , and to determine the products $H(ge)$ and $H(fi)$.

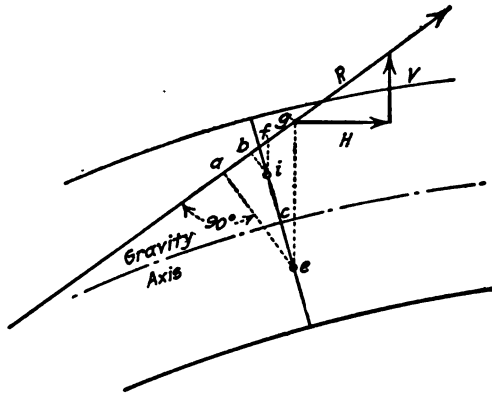

FIG. 45.

With the above discussion in mind, let us consider the influence on section S , Fig. 44, of a 1-lb. load at point 5. A vertical through this point shows the horizontal thrust to have a value $ab = 0.98$ lb., and a line drawn from the same point on the intersection line, tangent to the envelope of the left reaction, cuts off the distances ge and fi on the verticals through points e and i of the given section S . $ge = 2.00$ ft. $fi = 0.35$ ft. Therefore $M_e = 1.96$ ft.-lb. and $M_i = 0.34$ ft.-lb., and these moments may be plotted as the influence lines for fiber stress since the denominators in the preceding equations are constants.

45. Method of Analyzing Unsymmetrical Arches for Loading Only.—In deriving equations (8), (10), and (12) of Art. 39, the assumption was made that $\sum_A^B Gx = 0$, $\sum_A^B Gy = 0$, and $\sum_A^B Gxy$

= 0. The first two assumptions express the condition that the origin of coördinates is taken at the center of gravity of the elastic weights, while the third assumption is satisfied when the product of inertia of these weights referred to the two coördinate axes is zero. In Arts. 41 and 42 it is shown that the latter is the case when the two axes are conjugate diameters with reference to an ellipse for the entire arch with its center at the center of gravity

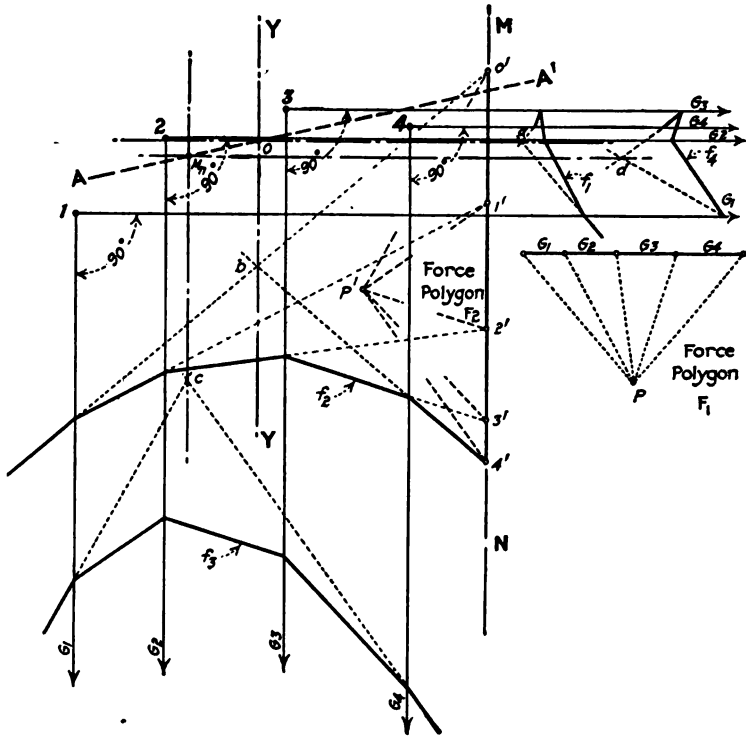

FIG. 46.

of the elastic weights. It will be convenient to assume a vertical direction for one of the coördinate axes. In a symmetrical arch it is then recognized at once that the horizontal axis is conjugate to the vertical, but this is not so for an arch that is unsymmetrical. For such an arch the additional problem is presented of finding a coördinate axis which will be conjugate to the assumed vertical axis. This may readily be accomplished graphically.

In Fig. 46 let points 1, 2, 3, and 4 be the centers of gravity

of elements with elastic weights $G_1, G_2, G_3,$ and $G_4,$ respectively. O is the center of gravity of all the elastic weights and may be found as usual by assuming the elastic weights to act, first horizontally, and then vertically, and finding the line of action of the resultant in each case. The intersection of these two lines locates the center of gravity of all the weights. The construction to find O is all shown by means of force polygon F_1 and equilibrium polygons f_1 and f_2 .

Now in order to find a conjugate diameter AA' to a vertical through O , take any vertical axis MN and extend all sides of the equilibrium polygon f_2 to intersect this axis at $0', 1', 2', 3',$ and $4'$. The segments, as we know, will be proportional to the moments of the elastic weights with respect to MN . Consider these segments $0'1', 1'2', 2'3',$ and $3'4'$ as forces and find their center of gravity M_n , assuming that they are applied at the same points 1, 2, 3, and 4. The construction is the same as for finding O except that the acting forces are $0'1', 1'2',$ etc., instead of $G_1, G_2,$ etc. The force polygon F_2 and the equilibrium polygons f_2 and f_4 furnish the solution. The vertical passing through the intersection c of the first and last sides of f_2 will contain the point M_n . Rotating by 90° the forces $0'1', 1'2',$ etc., about points 1, 2, 3, and 4, the horizontal through the intersection d of the first and last side of f_4 will also contain M_n . Thus the meeting point of the vertical through c and the horizontal through d will definitely determine the point M_n , which is the antipole of the ellipse of the entire arch with respect to the vertical axis MN . As shown in Fig. 37A, a line through this point M_n and the center O of the ellipse is a conjugate diameter to the line MN or to a parallel or vertical line through O . Thus AA' is conjugate to a vertical through the center of gravity of the elastic weights—that is, AA' is the proper coördinate axis $X - X$ corresponding to a vertical axis $Y - Y$.

Once the conjugate axes for an unsymmetrical arch have been determined, the remainder of the arch analysis is similar in every way to the analysis of a symmetrical arch described in the preceding article with the exception, of course, that the entire arch must be considered. The method of analysis should be clear from a study of Figs. 42, 43, and 44.

46. Temperature and Rib Shortening.—If the left end of the unsymmetrical arch AB , Fig. 47, is assumed as free, a variation of t_D degrees in temperature will change any unit linear dimension

to a length $1 + t_c t_D$, t_c being the coefficient of linear temperature expansion. The length of arch chord, l' , will become $l'(1 + t_c t_D)$ and this will be accomplished without any rotation. The reaction at the free end of the arch to return the arch axis to its original position must be such that no rotation is produced, which means that the line of action of such reaction due to temperature must pass through the elastic center O , and lie in the diameter conjugate to the normal to the chord of the arch (see Arts. 40 and 41). The method of finding a conjugate axis to the normal is the same in principle as the method explained in the preceding article for finding a conjugate axis to the vertical. By

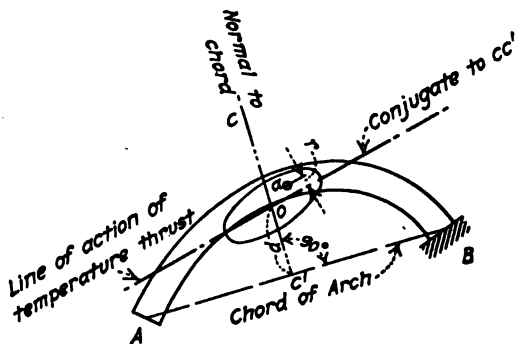

FIG. 47.

formula (6) Art. 39, the displacement of O (rigidly fastened to A) is as follows:

$$H \sum_A^B Gy \cdot x' = l' t_c t_D$$

in which H is the reaction and $\sum_A^B Gy \cdot x'$ is the product of inertia of the entire elastic system with respect to the line of action of the force H and to the arch chord. If a , Fig. 47, is the antipole of the ellipse with respect to the chord AB , then the displacement along AB is equal to $H(OC')(r) \sum_A^B G$, or

$$H \cdot d \cdot r \sum G = l' t_c t_D$$

$$H = \frac{l' t_c t_D}{d \cdot r \cdot \sum G}$$

In order to determine the antipole a of the ellipse with respect to the chord AB using the graphical construction of Fig. 38, the location and lengths of the principal axes of the ellipse need to be found. The quantities already determined by the graphical constructions for loading, admit drawing tan-

gents to the ellipse of elasticity of the system parallel to the conjugate axes X and Y . For example, in Fig. 48 the normal distance to axis $X - X$ is

$$ab = \sqrt{\frac{I_x}{\sum_A^B G}}$$

where I_x represents the moment of inertia of all the elastic weights about the axis $X - X$ and $\sum_A^B G$ represents the sum of all these weights (see Art. 42). Likewise

$$cd = \sqrt{\frac{I_y}{\sum_A^B G}}$$

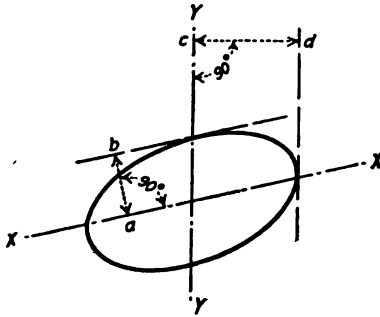

FIG. 48.

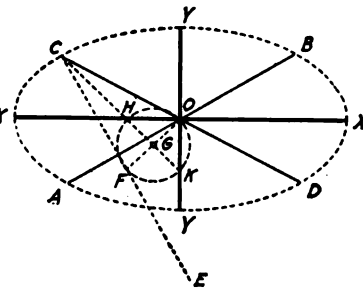

FIG. 49.

The lengths of the conjugate diameters being determined in the above manner, the graphical construction shown in Fig. 49 may be employed to determine the directions and lengths of the principal axes.

Let AB and CD be two conjugate diameters of an ellipse. From C draw CE normal to AB and upon it, starting from C , lay off $CF = OA$. Join F with O and on FO , as diameter, describe the circle G . Join C with the center G obtaining the two intersections H and K . Then OK and OH will determine the direction of the principal axes. CH will be the length of OY , and CK that of OX . (In order to obtain sufficient accuracy it will be necessary in many cases to assume an ellipse with the lengths of its conjugate diameters some suitable multiple of the lengths of the conjugate diameters of the true ellipse.)

If the arch is symmetrical, then the force H acts along the horizontal or major axis of the ellipse of elasticity and

$$H \sum_A^B Gy^2 = ll_c t_D$$

or

$$H = \frac{ll_c t_D}{\sum_A^B Gy^2}$$

The value of $\sum_A^B Gy^2$ is easily found from the graphical construction of Fig. 43—that is, from the equilibrium polygon f_d . (If E_c has been considered as unity in calculating the elastic weights for Fig. 43, then the above value of H should be multiplied by the actual value of E_c . It is permissible to assume E_c as unity in analyzing for loading since equations 8, 10, and 12, Art. 39, contain the value of E_c on each side of the equality sign.)

Rib shortening causes the same effect as a lowering of the temperature. By referring to Arts. 14 and 34, it should be clear that the following formula may be employed to solve for the equivalent temperature drop:

$$t_D = \frac{c_a}{E_c t_c}$$

where c_a is the average unit compression in concrete of arch ring due to thrust.

47. Analysis of a Symmetrical Arch—By A. C. JANNI, Consulting Engineer, New York City, Designer of the Carondelet Park Bridge, St. Louis, Mo.—The arch of the Carondelet Park bridge (see Plates XII, XIII, and XIV of Chapter XIII) is a reinforced-concrete hingeless arch of the solid barrel type, with segmental intrados and extrados. Its principal dimensions are as follows:

Span.....	95.00 ft.
Rise.....	7.50 ft.
Thickness at key.....	1.50 ft.
Thickness at springing.....	2.50 ft.
Intrados radius.....	154.00 ft.
Extrados radius.....	179.00 ft.

A longitudinal section of the barrel of the arch 1 ft. in width was considered, and the graphical constructions were confined to one-half the arch on account of its symmetry.

Since the length of the geometrical axis of one-half the arch was found to be 48.80 ft., the dividing of the arch into eight equal parts (made equal for convenience) gave each element a length of 6.10 ft., and the semi-axes of all the ellipses of elasticity of the various elements lying in the arch axis had the same value, namely:

$$\rho_1 = 6.10 \times \sqrt{\frac{1}{12}} = 6.10 \times 0.289 = 1.76 \text{ ft.}$$

Taking into account the steel reinforcement in the various cross-sections of the elements, the area, A , and moments of inertia, I , were found to be as follows:

	A	I
1.....	2.48 sq. ft.	0.46
2.....	2.48 sq. ft.	0.46
3.....	1.93 sq. ft.	0.46
4.....	2.03 sq. ft.	0.55
5.....	2.13 sq. ft.	0.64
6.....	2.33 sq. ft.	0.87
7.....	3.18 sq. ft.	1.48
8.....	3.38 sq. ft.	1.92

The elastic weights of the elements $\left(\frac{\Delta s}{E_c I} = G\right)$, assuming $E_c = 1$ for the sake of simplicity, were found to have the following values:

	G		G
1.....	13.26	5.....	9.53
2.....	13.26	6.....	7.01
3.....	13.26	7.....	4.12
4.....	11.09	8.....	3.18

The semi-axes of the ellipses of elasticity $\left(\sqrt{\frac{I}{A}}\right)$, normal to the axis of the arch, were as follows:

1.....	0.43 ft.	5.....	0.55 ft.
2.....	0.43 ft.	6.....	0.61 ft.
3.....	0.49 ft.	7.....	0.68 ft.
4.....	0.52 ft.	8.....	0.75 ft.

The graphical constructions on Designing Sheet No. 24 were made in the following manner:

Polygon p_1 .—The elastic weights given above were considered as vertical forces applied at the corresponding centers of gravity of the elements. The static moments of these forces with respect to center line Y were then found by means of the force polygon with the pole distance ΣG , and the corresponding equilibrium polygon p_1 . The sides of P_1 , produced, cut on the vertical through O the static moments required.

Polygon p_2 .—The same elastic weights given above were next assumed as applied *horizontally* at the centers of the elements, and the polygon p_2 was constructed to find the position of the center of gravity O of the elastic weights, as well as the static moments of these weights with respect to the horizontal passing through O .

Polygon p_3 .—Knowing the semi-axes of the ellipses of elasticity of the various elements of the arch, the next step was to locate the antipoles $O'_1 . . . O'_8$ of the vertical through O with respect to each one of these ellipses. The static moments obtained by polygon p_1 were then regarded as vertical forces applied at the corresponding antipoles of the elements, and the equilibrium polygon p_3 constructed. It should be clear that this polygon gave the moment of inertia of the whole arch with respect to the vertical Y . (The pole P_3 was chosen arbitrarily.)

Polygon p_4 .—The antipoles of the horizontal OX were next located with respect to the various ellipses, and these points designated as $O''_1 . . . O''_8$. The static moments, obtained by polygon p_2 , were regarded as horizontal forces applied respectively at the points $O''_1 . . . O''_8$. (The pole or center P_4 was selected at a distance below OX equal to the vertical distance between the first and the last sides of the polygon p_2 .) The corresponding equilibrium polygon p_4 gave the moment of inertia of the elastic system with respect to OX .

Polygon p_5 .—The polygon p_5 was constructed by considering the same static moments as were used in determining the polygon p_4 , assuming also these moments to act as forces at the same points $O''_1 . . . O''_8$, but this time in a vertical direction. (The pole distance of the force polygon P_5 was made equal to e . In Designing Sheet No. 24 this distance is shown as $2e$, but this is because the entire force polygon was made twice the usual size for convenience in drawing the corresponding equilibrium polygon p_5 .)

Polygons p_1 , p_3 , and p_5 are the only polygons necessary for the study of the arch. They are, so to speak, characteristics peculiar to the arch, by means of which moments, vertical reactions, and horizontal thrusts can be determined immediately for any hypothesis of loading.

Dead Load.—For 1-ft. width the following loads were computed:

	Weight of elements	Weight of fill over elements
1.....	0.686 ton.....	0.457 ton
2.....	0.686 ton.....	0.457 ton
3.....	0.732 ton.....	0.518 ton
4.....	0.778 ton.....	0.670 ton
5.....	0.823 ton.....	0.854 ton
6.....	0.915 ton.....	1.110 tons
7.....	1.006 tons.....	1.386 tons
8.....	1.098 tons.....	1.590 tons

The verticals of these loads, applied at the respective centers of gravity, cut the polygons p_1 , p_3 , and p_5 . The intercepts on these verticals with polygon p_1 , measured to the scale of the drawing and multiplied each by its corresponding load, gave in each instance the amount of the moment at the point O for the load in question. Adding together all these partial moments, the total moment at O was obtained due to the dead load of the entire arch.

Similarly, the intercepts on these verticals with polygon p_3 (measured on a scale having as a unit the vertical distance between the first and last side of polygon p_3) multiplied each by its corresponding load, gave in each instance the amount of horizontal thrust due to the load under consideration. Adding together all these partial horizontal thrusts, the total horizontal thrust was obtained.

The results were as follows:

$$\Sigma M = 442.816 \text{ ft.-tons}$$

$$\Sigma H = 33.458 \text{ tons}$$

Knowing the total dead load of the arch = 13.766 tons, the points where the resultant reaction crossed the axes X and Y were found in the following manner, the values of x and y being given with respect to the center O :

$$x = \frac{442.816}{13.766} = 32.16 \text{ ft.} \quad y = \frac{442.816}{33.458} = 13.20 \text{ ft.}$$

The exact position of the polygon of pressure, therefore, was located, and the maximum stresses (tons per square foot) in the four sections S_1 , S_2 , S_3 , and S_4 due to dead load were found to be as follows:

Section	Intrados	Extrados
S_1	11.354	17.034
S_2	8.663	26.447
S_3	11.686	19.481
S_4	33.400	-105.000 (steel)

A short graphical method of analyzing an arch for dead load (including temperature and rib shortening) is shown in Designing Sheet No. 25. Since dead load usually controls in the shape of an arch ring, this method should be used for making preliminary investigations with a view to determine the probable adequacy of the arch dimensions assumed. Proof of the correctness of the graphical construction may be found in the Journal of the Western Society of Engineers, issue of May, 1913. The method in detail is as follows: Construct equilibrium polygons p_2 and p_4 as in Designing Sheet No. 24. On an arbitrary vertical ab lay off the dead loads and assume the pole P_0 on the horizontal through a . Draw the corresponding equilibrium polygon p_0 intersecting with the verticals through the points of application of the loads. Now load the polygon p_0 horizontally with the same elastic weights as determined for the arch, at the points where the verticals through the centers of gravity of the elements meet the polygon p_0 . Then intersecting these horizontals with an equilibrium polygon p'_2 , corresponding to the force polygon P_2 , the center of gravity O' of this new elastic system is determined. Again load the polygon p_0 with the static moments found for the construction of polygon p_4 , but this time assume them applied at the meeting point of the verticals through the antipoles with the sides of the polygon p_0 . The equilibrium polygon p'_4 , corresponding to the force polygon P_4 , determines a distance $\frac{1}{2}e'$ between its first and last sides. This distance is proportional to the moment of inertia of the elastic weights acting on this new elastic system, in the same manner that $\frac{1}{2}e$ is proportional to the moment of inertia of the system of elastic weights with respect to the horizontal passing through O .

Between the polygon p_0 and the true pressure polygon p there is a geometrical relation. For example, the distance of any point on the true pressure polygon p from the horizontal through O can be obtained by multiplying by the ratio $\frac{e}{e'}$ the distance from the horizontal through O' to the point of the polygon p_0 on the same vertical with the point in question. Thus any distance as kk equals $k'k'$ multiplied by $\frac{e}{e'}$. The horizontal thrust aP , likewise, may be found by multiplying the assumed thrust aP_0 by the inverse of the ratio, or $\frac{e'}{e}$.

In the arch in question $\frac{e'}{e} = \frac{0.59}{0.44} = 1.34$ and the assumed horizontal thrust = 25 tons. The true thrust, therefore, was $1.34 \times 25 = 33.5$ tons. The ratio $\frac{e}{e'} = \frac{0.44}{0.59} = 0.745$, and the vertical distance between O' and the polygon $p_0 = 0.70$. Then $0.745 \times 0.70 = 0.52$ determined the exact point where the true horizontal thrust intersected the key of the arch.

Note that the coördinates of the resultant obtained by the method of Designing Sheet No. 24 checked exactly with those obtained by this method. The horizontal thrust also checked by the two methods.

Temperature.—The horizontal thrust, due to temperature changes, passed through O and its intensity was given by the formula:

$$H = \frac{t_e E_c}{\Sigma Gy^2}$$

where

t_e = coefficient of expansion = 0.0000066.

l = span of the geometrical axis = 95.7 ft.

E_c = modulus of elasticity of concrete = 144,000.

ΣGy^2 = moment of inertia of the arch with respect to the horizontal passing through $O = e \times 14.16 \times 11.76 = 2.64 \times 14.16 \times 11.76 = 439.61$.

(e was measured to the same scale as the elastic weights—that is, 1 in. = 6 units. The polar distances were measured to the same scale as the drawing, namely: 1 in. = 3 ft.)

Substituting these values

$$H = \frac{0.0000066 \times 95.7 \times 144,000}{439.61} = 0.20$$

for 1° change of temperature. For a change of 30°F.

$$H = 6.00 \text{ tons.}$$

For a drop of temperature of 30°, which was the only case needing consideration, the following stresses were obtained in tons per square foot:

	Intrados	Extrados
At spring (section S_1).....	8.90 (concrete)	279.60 (steel)
At key (section S_4).....	45.00 (steel)	6.10 (concrete)

Shortening of Arch Due to Dead Load and Shrinkage.—The shortening of the geometrical axis of the arch due to dead load, at the time when the arch is allowed to bear upon its supports, may be considered as a shortening due to a drop in temperature.

Knowing, by means of the pressure polygon, the amount of compression on each cross-section, and knowing also the modulus E_c , the shortening of the arch was calculated and found to correspond to a drop in temperature of 23.4°F.

The arch was concreted by the alternate block method (see Art. 53) and the shrinkage of the arch was confined to the shrinkage of its keys only. The total key space was 6 ft., and $\frac{1}{2000}$ was considered the ratio of shrinkage in a 1:2:4 concrete. The shortening of the arch axis, using these values, was found to correspond to a drop of 4.6°F. in the arch.

The total drop of temperature due to the above two causes was assumed at 28°F. The corresponding horizontal thrust which, of course, passed through O , induced the following stresses (tons per square foot) in sections S_1 and S_4 of the arch.

	Intrados	Extrados
At spring (section S_1).	8.30 (concrete)	-315.00 (steel)
At key (section S_4).	-42.00 (steel)	5.80 (concrete)

It might be interesting to note that had the arch been concreted by longitudinal sections from springing to springing in one operation, the shrinkage in the concrete would have induced in the arch, stresses equivalent to a drop of temperature of 75°F.

Stresses Due to Live Load.—From Designing Sheet No. 24 it should be clear how the envelope lines and the intersection line can be constructed, the construction being fully indicated for position 4 of the load.

In Designing Sheet No. 26, which represents the whole arch, the envelope lines, the intersection line, and the polygon p_6 have been redrawn.

By means of the above lines, the various reactions corresponding to the several positions of the unit live load, together with the corresponding horizontal thrust in each case, have been determined. Moments have been determined, likewise, for the kern points i and e of each section and the results obtained are given in the following table:

Influence lines for kern moments have been plotted in Design-

Positions	S ₁					S ₂					S ₃						
	ci	ce	M _i	M _e	H	ci	ce	M _i	M _e	ci	ce	M _i	M _e	ci	ce	M _i	M _e
1	2.08	3.05	0.18	0.27	0.09	-0.52	0.25	-0.05	0.02	-1.96	-1.30	-0.17	-0.12	-1.60	-1.10	-0.14	-0.10
2	2.02	3.00	1.01	1.50	0.50	-0.53	0.25	-0.26	0.12	-1.90	-1.25	-0.95	-0.62	-1.43	-0.93	-0.71	-0.47
3	1.90	2.86	2.09	3.15	1.10	-0.55	0.22	-0.60	0.24	-1.80	-1.20	-1.98	-1.32	-1.27	-0.77	-1.39	-0.85
4	1.65	2.62	3.10	4.92	1.88	-0.60	0.18	-1.13	0.34	-1.60	-1.00	-3.00	-1.88	-0.90	-0.40	-1.69	-0.75
5	1.40	2.38	3.71	6.31	2.65	-0.66	0.12	-1.70	0.32	-1.40	-0.78	-3.71	-2.07	-0.48	0.02	-1.27	0.05
6	1.02	2.00	3.22	6.32	3.16	-0.73	0.08	-2.31	0.25	-1.10	-0.45	-3.47	-1.42	0.13	0.63	0.41	1.99
7	0.50	1.50	1.65	4.95	3.30	-0.82	-0.05	-2.70	-0.16	-0.70	0.0	-2.31	0.0	1.04	1.54	4.51	5.08
8	-0.35	0.68	-1.11	2.15	3.16	-0.98	-0.19	-3.09	-0.60	0.02	0.68	0.06	2.15
9	-1.70	-0.62	-4.50	-1.64	2.65	-1.15	-0.30	-3.05	-0.79	1.32	2.00	3.49	5.30
10	2.53	1.65	4.17
11	2.54	2.30	5.84
12	1.88	-4.10	-3.00	-7.71	-5.64	-1.17	-0.29	-2.20	-0.54
13	1.10	-8.50	-7.30	-9.35	-8.03	0.0	0.91	0.0	1.00
.....	0.63	4.30	2.71
.....	0.65	5.05	3.28
.....	0.50	-17.45	-15.90	-8.72	-7.95	4.20	4.93	2.10	2.47
.....	0.09	-46.85	-42.90	-4.22	-3.86	4.02	4.75	0.36	0.43

ing Sheet No. 26. These influence lines have no direct importance in a design of a reinforced-concrete arch section where the tension in concrete is omitted, and the intention in showing them in this case is to demonstrate how careful a designer should be in applying certain empirical rules of loading in order, as he thinks, to find the maximum stresses in the arch. These lines show clearly that the maximum stresses at intrados and extrados for the same section do not happen with the same hypothesis of loading.

The stresses at section S_1 due to the live load of 100 lb. per square foot were found to be as follows in tons per square foot:

Intrados	Extrados
10.60 (concrete)	-243.0 (steel)

Total stresses in section S_1 of the arch were finally determined and found to be:

$$f_s = 12,750 \text{ lb. per square inch (steel)}$$

$$f_i = 850 \text{ lb. per square inch (concrete)}$$

The computations of the stresses in the sections S_2 , S_3 , and S_4 have been omitted, as they would have shown smaller stresses than those found above for section S_1 .

Design of Abutment.—The resultant due to the dead load of the arch was found to be 36.2 tons (per 1-ft. length of abutment) and the vertical dead load on the abutment itself, 45.00 tons. The resultant of these two forces was 67.500 tons, and its vertical component 58.7 tons. (See Designing Sheet No. 27.) The resultant dead load intersected the base at point E which is not the center of the base. Using formulas for bending and direct stress for compression over the whole section, there resulted a pressure of 2.5 tons per square foot at C and a pressure of 0.38 ton per square foot at D .

K_2 and K_1 are shown as the middle third points of the rectangular base $CD \times 1$ ft. If from K_1 we draw the tangent K_1B to the left envelope line, all positions of the live load to the right of B will cause compression at C . Also if we draw from K_1 the vertical K_1F , and from C the vertical CG , all positions of the live load between G and F will affect the point C in the same manner, so that the most prejudicial hypothesis of loading, as far as pressure at C is concerned, is when it is assumed that all arch and abutment is loaded except the space FB .

Assuming, as for the arch, a live load of 100 lb. per square foot,

the maximum compression at *C* was found to be 0.50 ton per square foot.

On account of a rise in temperature, an additional pressure at *C* was taken into account. Assuming that there would be a rise of 30°F., which corresponds to a horizontal thrust of 6.0 tons, the corresponding pressure at *C* was found to be 0.48 ton per square foot.

The total maximum pressure at *C* was found to be as follows:

$$2.50 + 0.50 + 0.48 = 3.48 \text{ tons per square foot}$$

The part *PD* of the footing slab was designed as a slab supported on two sides (counterforts) and loaded as shown by the pressure diagram.

The part *CP* was reinforced to stand a deflection indicated by the arrow.

For shear, it was necessary only to ascertain the intensity at *P*, where it was 22.5 tons per 1-ft. depth of slab, safely absorbed by the sections of concrete, longitudinal upper reinforcement, and stirrups.

Of course the shear (likewise the moment) increased going from *P* to *E*, where it reached the maximum; but it is not necessary to go into details for the sections on the right of the section *PQ*, since the shape and area of these sections preclude any possibility of maximum conditions. The maximum compression at *Q* was found to be 601 lb. per square inch.

The front wall of the pier (2 ft. thick) was found to safely support the vertical component of the total reaction, or 13.76 tons + 4.70 tons.

Concerning now the horizontal component of the above reaction, two sections were considered for shear—namely: sections *HL* and *MN*. The maximum shear in concrete at section *HL* was found to be 52 lb. per square inch (considering the steel reinforcement to be 12.5 sq. in. per linear foot depth), and at section *MN*, 64 lb. per square inch. Considering that a good vertical compression acted on these two sections, it will be seen that the above stresses were quite legitimate.

Finally, the counterforts were designed as solids under combined action of direct compression and bending with regard to the thrust of the arch. Fig. 50 on Designing Sheet No. 27 gives an idea of how the problem was solved by means of the formula for bending and direct stress. *F* is the resultant acting upon the counter-

Designing Sheet 24

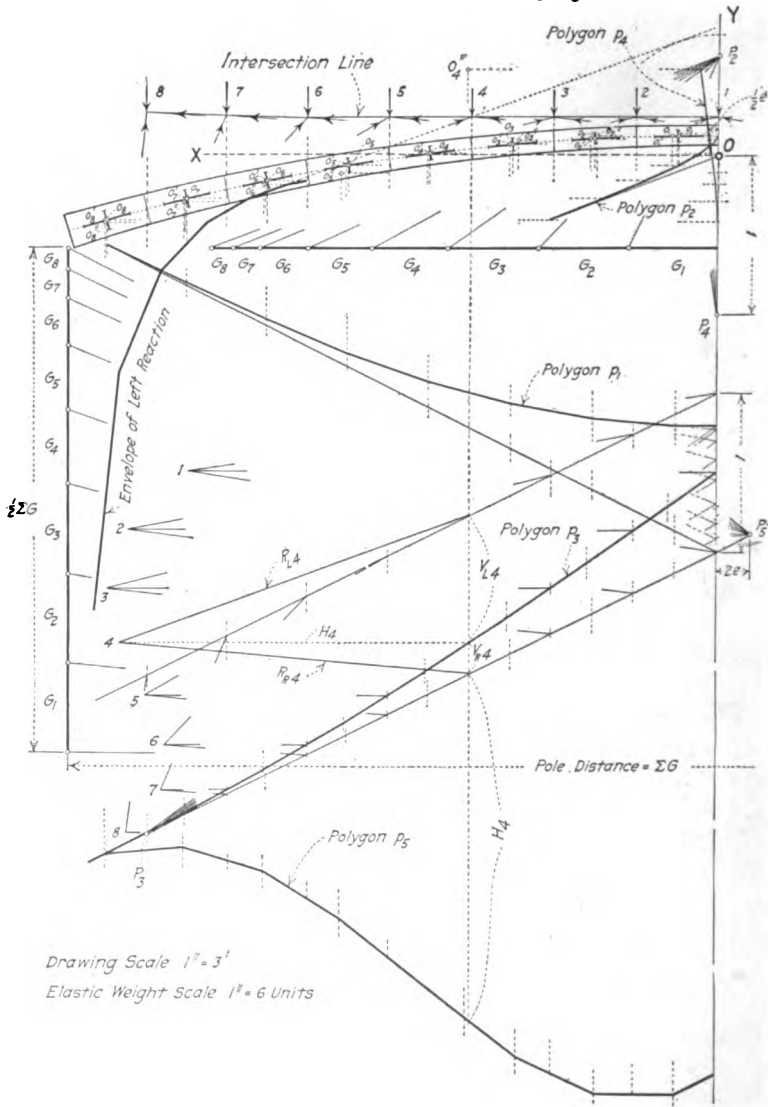

Designing Sheet 25.

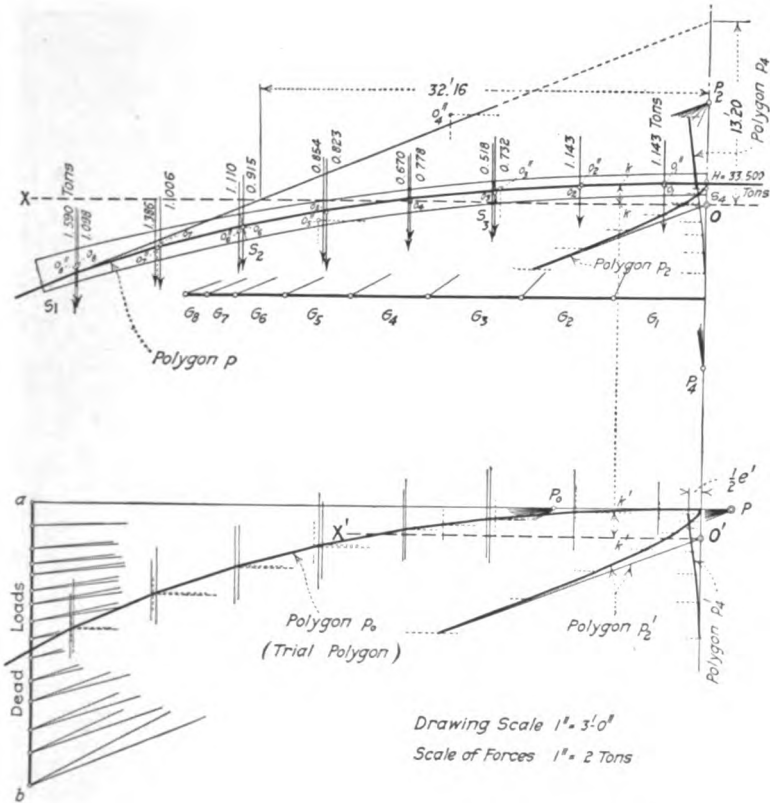

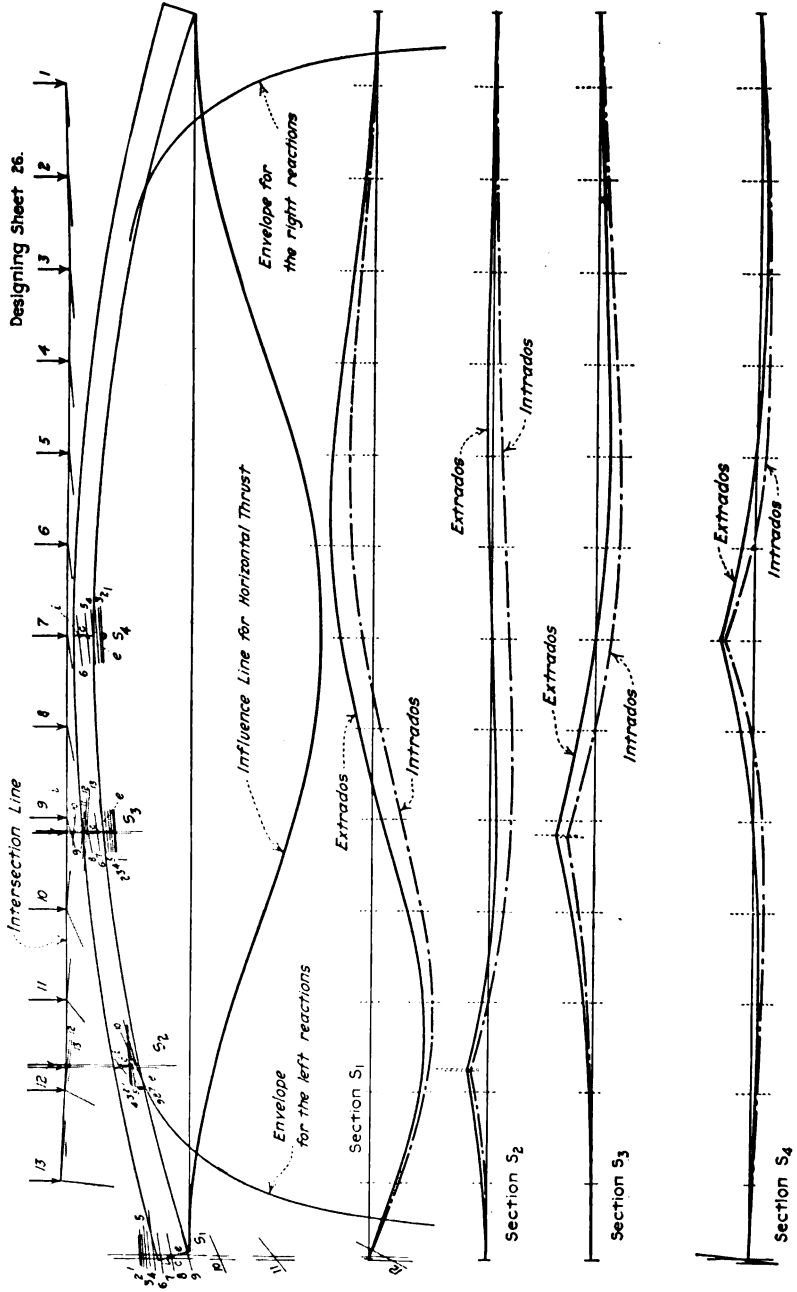

fort, and AB is a section taken normally to MN . F' is the compressive force on the section and F'' the shear. O is the center of gravity of the cross-section AB .

48. Method of Analyzing a Series of Arches with Deformable Supports.—Consider first a three-span symmetrical arch structure as shown in Fig. 51, whose piers P_1 and P_2 are of such dimensions that they can be regarded as deformable. If the arches A_1 , A_2 , and A_3 were equal, then, as far as the dead load is concerned, each of them could be regarded as a fixed arch. If they are unequal as shown, then, with the overloading of the short spans, it is usually possible to drive the resultant to the center or near the center of the base of the pier. This result being accomplished, it is then permissible to consider each arch as fixed.

The live load, in every case, requires a totally different treat-

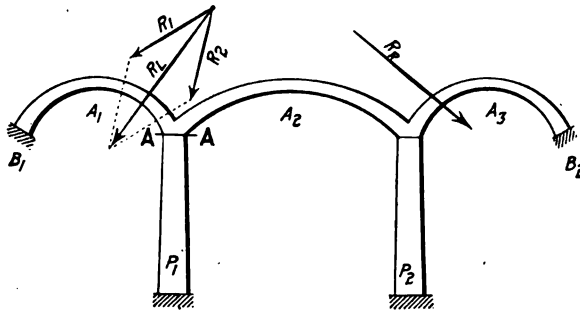

FIG. 51.

ment from that mentioned above. It is evident that the middle arch A_2 is supported by two elastic systems— A_1P_1 on the left and A_3P_2 on the right. The method is to construct the ellipse of elasticity for the arch A_1 and for the pier P_1 (Fig. 52)—that is to say, to construct the ellipse O_a (ellipse of elasticity of the arch with respect to its terminal section $A - A$) and the ellipse O_p (ellipse of elasticity of the pier with respect to its terminal section $A - A$)—and then to construct the ellipse of elasticity with respect to the same section $A - A$ when this section is regarded as a section of the entire system A_1P_1 .

A horizontal displacement without rotation of section $A - A$, regarded as the terminal section of P_1 , cannot happen but for the action of a horizontal force F_p passing through O_p , and

if ΣG_p is the elastic weight of the pier P_1 , this displacement of $A - A$ will be given by (see Art. 42)

$$F_p \cdot \Sigma G_p \cdot \rho_p^2$$

This same displacement of $A - A$, when $A - A$ is regarded as a terminal section of A_1 , is given by (see Fig. 52)

$$F_a \cdot \Sigma G_a \cdot \rho_a^2$$

where ΣG_a is the elastic weight of the arch A_1 .

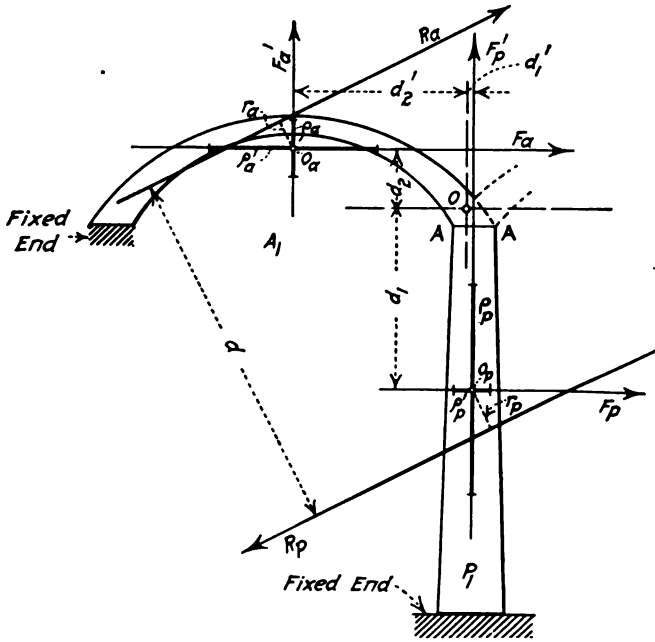

FIG. 52.

We have, therefore:

$$F_p \cdot \Sigma G_p \cdot \rho_p^2 = F_a \cdot \Sigma G_a \cdot \rho_a^2$$

or

$$\frac{F_a}{F_p} = \frac{\Sigma G_p \cdot \rho_p^2}{\Sigma G_a \cdot \rho_a^2} \tag{1}$$

which gives the position of the horizontal passing through the center O . In fact, if we regard $A - A$ as a section of the elastic system A_1P_1 , its horizontal displacement must be caused by a horizontal force $F_a + F_p$ passing through O . If we designate

d_1 and d_2 as the perpendicular distances from O to F_p and F_a respectively, then

$$\frac{d_1}{d_2} = \frac{\Sigma G_p \cdot \rho_p^2}{\Sigma G_a \cdot \rho_a^2}$$

or

$$d_1 = \frac{d_1 + d_2}{1 + \frac{\Sigma G_a \cdot \rho_a^2}{\Sigma G_p \cdot \rho_p^2}} \quad (2)$$

In exactly the same way, we obtain

$$\frac{F'_a}{F'_p} = \frac{\Sigma G_p \cdot (\rho'_p)^2}{\Sigma G_a \cdot (\rho'_a)^2} = \frac{d'_1}{d'_2}$$

or

$$d'_1 = \frac{d'_1 + d'_2}{1 + \frac{\Sigma G_a \cdot (\rho'_a)^2}{\Sigma G_p \cdot (\rho'_p)^2}} \quad (3)$$

This expression gives the position of the vertical through O .

The point O being located, the elastic weight of the combined arch and pier must now be determined. Since O is the center of the ellipse, any rotation of section $A - A$ (as belonging to A_1P_1) about O cannot be caused but by a couple. (A force of which O is the antipole must lie at infinity—that is, will act along the antipolar of O —which is the same thing as saying that the rotation is caused by that of a couple.) On the other hand, the same rotation of $A - A$, regarded as terminal section of A_1 , is caused by a force R_a acting along the antipolar of O with respect to the ellipse O_a ; also the same rotation of $A - A$, regarded as terminal of P_1 , is caused by a force R_p acting along the antipolar of O with respect to the ellipse O_p . Hence the forces R_a and R_p will constitute a couple, or $R_a = R_p = R$. The angle of rotation is given by the formula (Art. 39)

$$k = M \Sigma G = R d \Sigma G$$

and considering the section $A - A$ as belonging first to A_1 and then to P_1 , we have

$$k = R r_a \Sigma G_a = R r_p \Sigma G_p$$

or

$$\Sigma G = \frac{r_a \Sigma G_a}{d} = \frac{r_p \Sigma G_p}{d} \quad (4)$$

which determines the total elastic weight of arch and pier.

The horizontal displacement of $A - A$ as belonging to A_1P_1 is

$$(F_a + F_p) \Sigma G \cdot \rho^2$$

This displacement must be the same as that due to the force F_p , or

$$(F_a + F_p) \Sigma G \cdot \rho^2 = F_p \cdot \Sigma G_p \cdot \rho_p^2$$

$$\rho^2 = \frac{\Sigma G_p \cdot \rho_p^2}{\Sigma G \left(1 + \frac{F_a}{F_p}\right)}$$

Substituting the value of $\frac{F_a}{F_p}$ from Equation (1)

$$\rho^2 = \frac{\Sigma G_p \cdot \rho_p^2}{\Sigma G \left(1 + \frac{\Sigma G_p \cdot \rho_p^2}{\Sigma G_a \cdot \rho_a^2}\right)}$$

or

$$\rho^2 = \frac{\Sigma G_p \cdot \rho_p^2}{\Sigma G \left(1 + \frac{d_1}{d_2}\right)} \quad (5)$$

Similarly

$$(\rho')^2 = \frac{\Sigma G_p (\rho'_p)^2}{\Sigma G \left(1 + \frac{d'_1}{d'_2}\right)} \quad (6)$$

Equations (5) and (6) determine the lengths of the semi-minor and semi-major axes of the ellipse at O .

The ellipse of elasticity for the system A_1P_1 (Fig. 51) is now fully determined. In a like manner the ellipse may be drawn for the system $A_1P_1A_2$ by combining the ellipse for A_1P_1 with the ellipse for A_2 , and so on. The same operation can be carried out starting from the right abutment.

Suppose the effect of loads on the arch A_2 is to be determined. The method of doing this is to find the ellipse of elasticity for the system A_1P_1 and for the system A_2P_2 . (If the entire arch system is symmetrical about the center line between piers P_1 and P_2 , there is a great deal of work saved.) The arch A_2 is then studied in the usual way, with the only variation that it is assumed that the arch is constituted by its elements plus two *ideal* elements, one on each side of the arch A_2 (Fig. 53), each having the ellipse of elasticity as above determined. These ellipses of the ideal elements are considered as any other of the ellipses of the arch elements.

Having found by the above method the reactions R_L and R_R due to the actions of the elastic systems A_1P_1 and P_2A_2 , respectively against the arch A_2 , it becomes necessary to determine which com-

ponent of R_L belongs to the arch A_1 and which belongs to the pier P_1 . (In Fig. 51 consider R_1 the component acting upon A_1 , and R_2 the component acting upon the pier.) This is most easily accomplished by means of the three ellipses O_a , O_p , and O , already found (Fig. 52). Consider the section $A - A$ as a section of the system A_1P_1 under the action of the force R_L . A rotation of this section will be performed about a certain point D (not shown), which is the antipole of R_L with respect to the ellipse O . The same rotation of $A - A$, if we regard $A - A$ as the terminal section of P_1 , will be caused by a force R_2 acting along the antipolar line of the same point D with respect to the ellipse O_p . Similarly, if $A - A$ is regarded as the terminal section of A_1 , then the same rotation of this section will be caused by a force R_1 acting along the antipolar of D with respect to O_a . With the usual construction for finding polar and antipole, or, what is the same thing, for finding antipolar and pole, the lines of action of R_1 and R_2 can be located. Of course, as a check, the two components as found above must meet on R_L . A similar method of finding components can be applied to the system P_2A_3 for finding the forces acting on P_2 and A_3 .

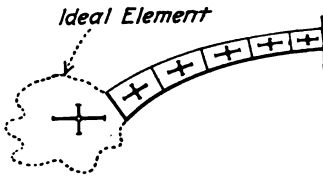

FIG. 53.

In the case of a bridge of two spans, each arch could be regarded as fixed at one end and supported at the other end by the elastic system, including arch and pier. The end arch of a three-span structure could be regarded in a similar manner except that the elastic system would consist of two arches and two piers.

It can be readily appreciated that the analysis of a large series of arches in the manner above suggested would be exceedingly laborious on account of the large number of ellipses of elasticity which would need to be determined and the consequent resolving of reactions into components. The method may be greatly simplified by the fact that the effect of a load on any one span extends principally over the span itself and the two spans immediately adjacent. For example, if A_2 in Fig. 51 is assumed as an arch of a large series of arches, it is permissible for all practical purposes to consider the arches A_1 and A_3 as fixed at B_1 and B_2 and to analyze arch A_2 with its supports A_1P_1 and A_3P_2 without regard to any of the remaining arches of the system. If the arches are

all equal, then the same calculations will serve for any three arches of the series.

It is possible to take into account the stresses in an arch resulting from the yielding of the soil beneath the piers due to an eccentricity of the resultant thrust on the base. Knowing E of the ground, which is the same thing as knowing the load necessary to have the soil yield 1 in., and neglecting the even or horizontal displacements of the soil, an ellipse of elasticity may be deter-

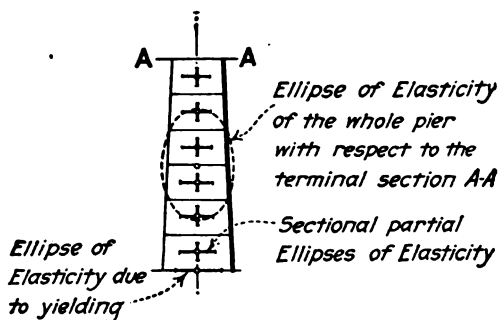

FIG. 54.

mined due to yielding. If we call I the moment of inertia of the supporting surface in contact with the footing of the pier, and g_y the amount of yielding found as above, then the expression

$$G_y = \frac{1}{g_y I}$$

will be the elastic weight to be applied at the center of gravity of that section. The ellipse of elasticity of this point (Fig. 54) will have only the horizontal axis, since the vertical one will be zero on account of the assumption that the horizontal displacements may be neglected.

The method of analyzing a series of unsymmetrical arches with elastic piers is the same in principle as the method already explained for symmetrical arches. A graphical construction is convenient, however, to find the lengths and directions of the principal axes of an ellipse when two pairs of conjugate axes are known.

These principal axes are required in order to use the construction of Fig. 38 to find antipoles from polars or antipolars from poles. A brief description of the method of combining ellipses for unsymmetrical arches will be given.

Referring to Fig. 55, consider first the arch *AB*, and let us determine a force F_a which will cause the point *A* to undergo a horizontal displacement, without rotation. The line of action of this force F_a will be along the conjugate diameter of the vertical

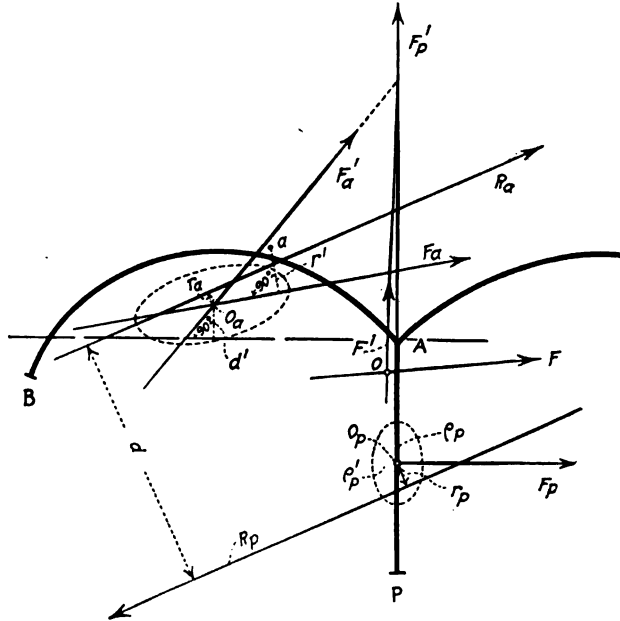

FIG. 55.

through the center of the ellipse O_a . The horizontal displacement is equal to

$$F_a \cdot \Sigma G_a \cdot r' \cdot d'$$

considering a the antipole of the horizontal through the point *A*. (See Art. 46.) The horizontal displacement of the point *A* due to force F_p is, as before,

$$F_p \cdot \Sigma G_p \cdot \rho_p^2$$

Then

$$F_p \cdot \Sigma G_p \cdot \rho_p^2 = F_a \cdot \Sigma G_a \cdot r' \cdot d'$$

or

$$\frac{F_a}{F_p} = \frac{\Sigma G_p \cdot \rho_p^2}{\Sigma G_a \cdot r' \cdot d'}$$

If F_a and F_p are prolonged until they intersect, then the resultant F of these two forces, the direction of which may be determined by means of the above equation, will cause A of the system BAP to move, without rotation, through the same horizontal distance as the force F_a acting on the system AB or the force F_p acting on the system AP .

Considering the vertical displacement of A , we obtain a similar equation to the above. The resultant F' of the forces F'_a and F'_p will cause point A of the system BAP to move through the same vertical displacement without rotation.

The two forces F and F' will cause point A to be displaced along a line passing through the center of the ellipse of elasticity of the system. Consequently the center of the ellipse is at the inter-

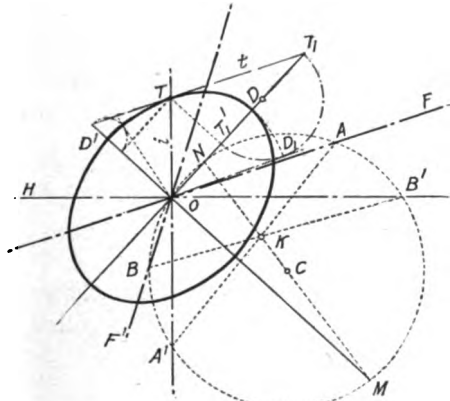

FIG. 55A.

section of the forces. The elastic weight ΣG of the system BAP may be found in the identical manner previously explained for the symmetrical arch and pier.

The graphical construction of Fig. 55¹ serves to determine the principal axes of the ellipse O . Considering ellipse O , the line of action of the force F and a vertical (V) through O on the one hand, and the line of action of the force F' and a horizontal (H) through O on the other hand, constitute two pairs of conjugate elements of the ellipse by means of which the principal axes may be determined.

To find the major and minor axes, describe an arbitrary circle

¹ Taken from an article by Prof. H. Lossier of the University of Lausanne in the "Genie Civil," volume of 1903. Translation by Mr. Samuel Moreell, Jr., Bridge Designing Engineer for City of Chicago.

(with center C) passing through O . This circle will intersect the straight lines F , V , F' , and H in the points A , A' , B , and B' respectively. The point of intersection K of the straight lines AA' and BB' will be the center of the figure $AA'BB'$. Connect points C and K and prolong to intersections M and N on the circumference of the circle. The two conjugate diameters OM and ON will be perpendicular and determine the direction of the principal axes of the ellipse. The length of the axes required may be found by drawing the tangent t to the ellipse O , parallel to F . The point of contact T of t lies on the vertical V at a distance OT from O

equal to $i = \sqrt{\frac{1}{\Sigma G \cdot H_0}}$, where H_0 is the horizontal projection of the force F which causes a horizontal displacement of the point O equal to unity without rotation. Let T_1 be the point of intersection of the tangent t with the axis ON and let T'_1 be the projection of T on this axis. Then the length of the semi-axis is

$$OD = \sqrt{(OT'_1)(OT_1)}$$

that is, OD may be measured by the length OD_1 of the tangent passing through O to the circle described on $T_1T'_1$ as a diameter. The length of the other principal axis may be found in a like manner.

The statements made in the preceding chapter in regard to temperature and rib shortening in a series of arches with elastic piers should be noted.

CHAPTER IX

DETAILS OF ARCH BRIDGES

49. Spandrel Details in Earth-filled Bridges.—As stated in Art. 3, the filling material in solid-spandrel bridges is held in place laterally by retaining walls which rest upon the arch ring. These retaining walls may be of either the gravity or the reinforced type, or they may consist of thin vertical slabs tied together by reinforced-concrete cross walls as employed in the design of the arch bridge of Chapter IV. In the usual type of solid-spandrel construction the sidewalk rests upon the earth filling, which is the type shown in Fig. 56. Where the counterforted type of spandrel wall is employed, sidewalks are sometimes cantilevered beyond the faces of the arch ring, as illustrated in Figs. 57, 58,

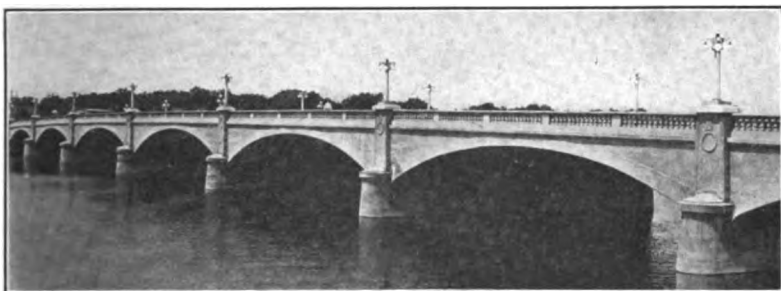

FIG. 56.—Leonard Street bridge over Grand River, Grand Rapids, Michigan.

and 59. The faces of spandrel walls may be entirely plain (Fig. 57), or panels of approximately a triangular shape may be formed either by indenting the portion above the arch ring or by nailing beveled strips to the form work with the result shown in Fig. 60. Brick and stone are used in some cases as a facing for arch rings and spandrel walls.

Figs. 61A and 61B show a portion of a flat arch bridge designed for the city of Lima, Ohio. The spandrel walls are of the reinforced cantilever type. Other examples of this form of spandrel wall and sidewalk construction may be found in Chapter XIII.

A bridge with gravity spandrel walls is shown in Fig. 62. The

brick facing for the arch ring and the cast concrete and brick belt courses should be noted. The spandrel walls rest partly on the brick facing and partly on the concrete portion of the arch,

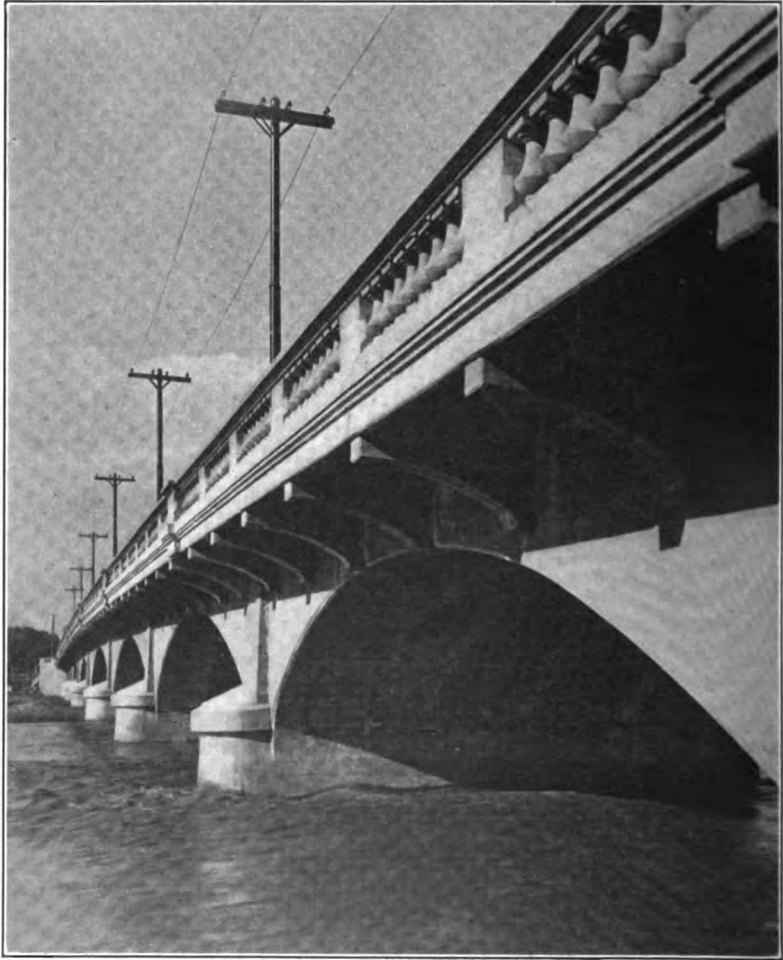

Courtesy of Mr. Daniel B. Luten, Consulting Engineer, Indianapolis.

FIG. 57.—Bridge at La Junta, Colorado.

and are keyed into the concrete portion by means of a projection which fits into a 6 in. by 12-in. groove in the arch.

Engineering and Contracting, issue of Oct. 7, 1914, describes the character of the cast concrete and brick masonry as follows:

"The cast concrete blocks for the belt courses and copings are composed of 1 part cement and 3 parts crushed stone chips, the chips being of

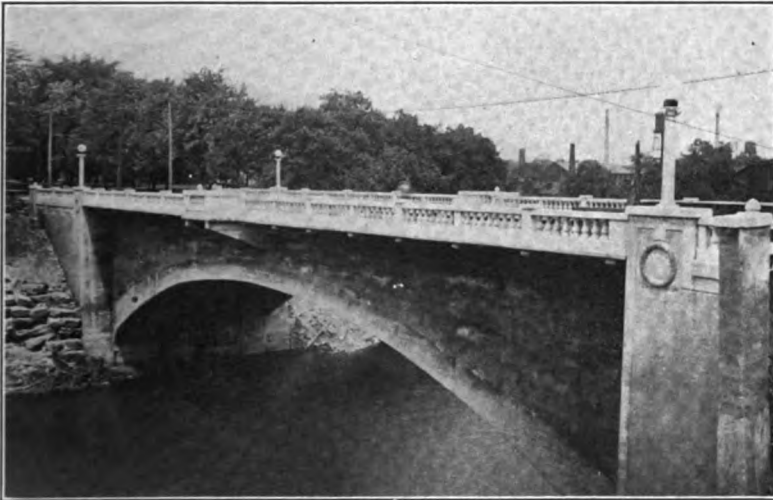

Courtesy of Mr. Daniel B. Lutten, Consulting Engineer, Indianapolis.

FIG. 58.—Washington Avenue bridge, Elyria, Ohio.

such sizes as to pass through a $\frac{3}{4}$ -in. mesh screen. Waterproofing material is incorporated in the concrete of the cast stone. After being

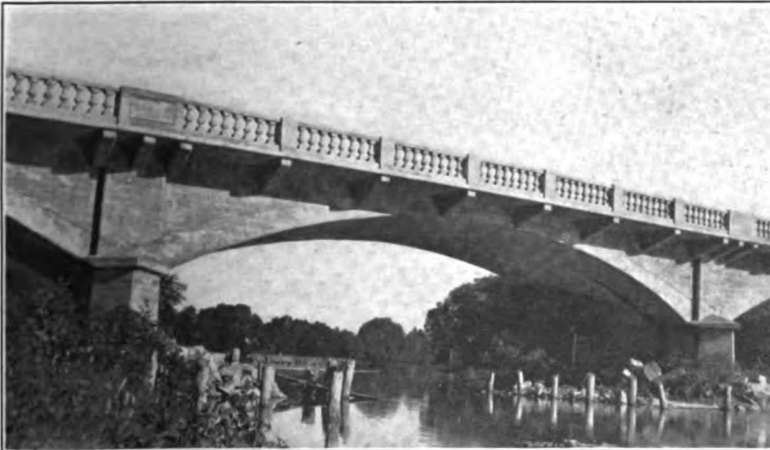
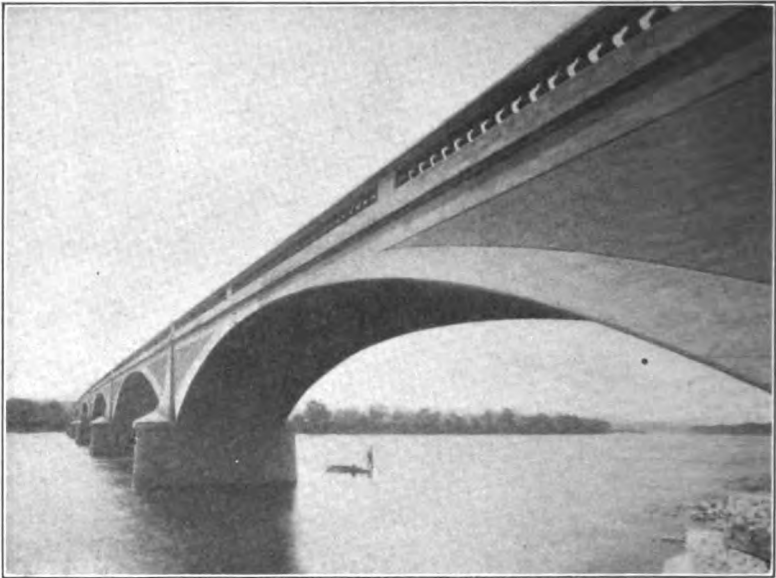

FIG. 59.—Adams Street bridge, Troy, Ohio.

cast from 40 to 60 days, all exposed surfaces of the stones were dressed with six-cut bush hammers. The cast concrete blocks are laid in 1:2



Courtesy of Mr. Daniel B. Luten, Consulting Engineer, Indianapolis.
FIG. 60.—Georgetown bridge over Wabash River, Georgetown, Indiana.

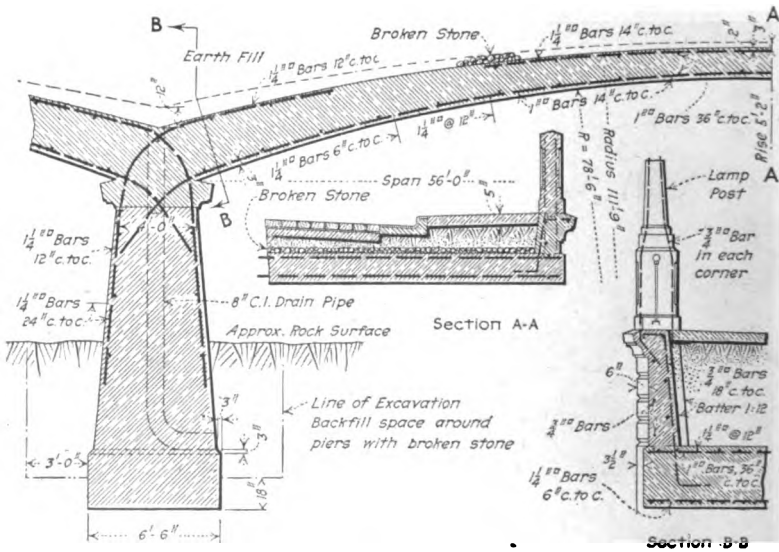
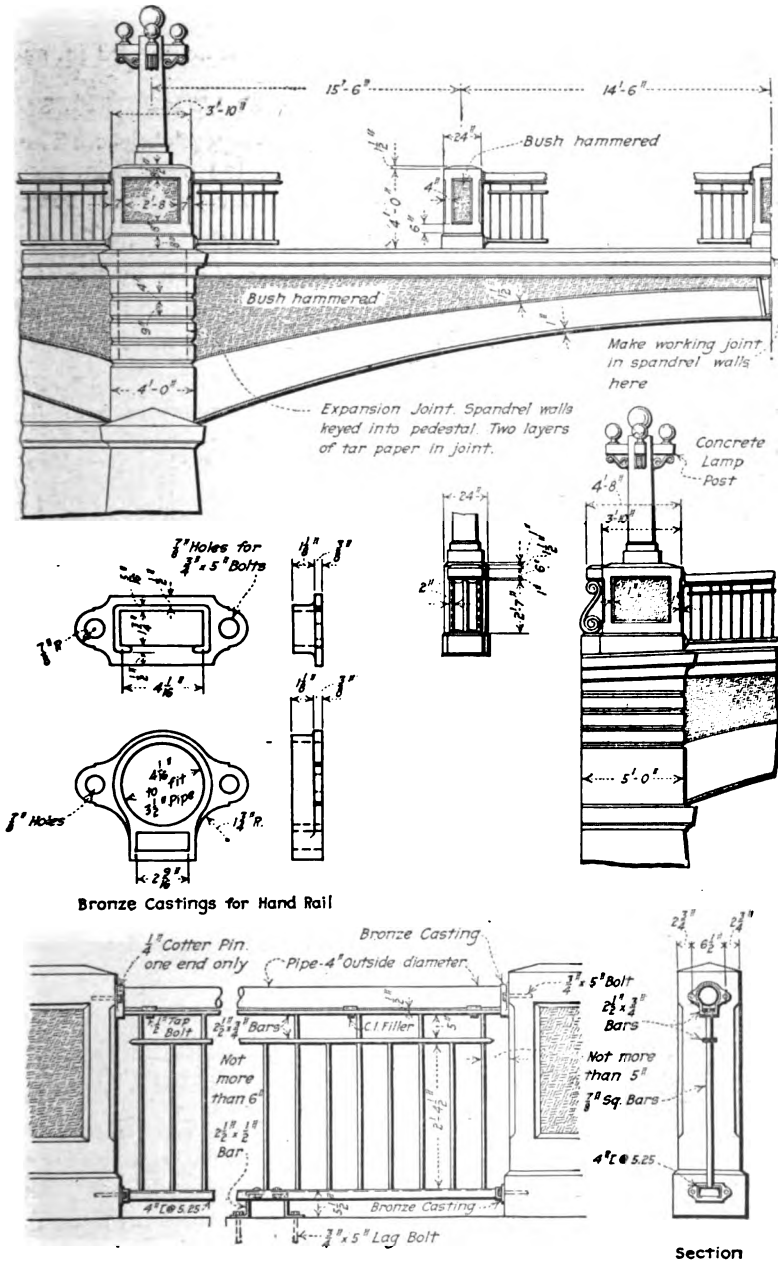

FIG. 61A.—Details of Pine Street bridge, Lima, Ohio.



Details of Railing

FIG. 61B.—Details of Pine Street bridge, Lima, Ohio.

Portland cement mortar, with joints of not more than $\frac{1}{4}$ in. Before the mortar had set the joints were raked out for a depth of 3 in. and pointed with 1:1 Portland cement mortar.

“The bricks used for facing the arch rings and for the ornamental courses are up-and-down, hard-burned, dark, water-struck bricks. They are laid in 1:3 Portland cement mortar, except the outer 4-in. faces where “Puzzolan” cement is used. One pail of lime putty was allowed to be added for each barrel of cement.”

A counterforted type of spandrel wall is shown in Fig. 63. These walls are 12 in. thick and are reinforced on both faces with a double system of rods. The counterforts occur at about 9-ft.

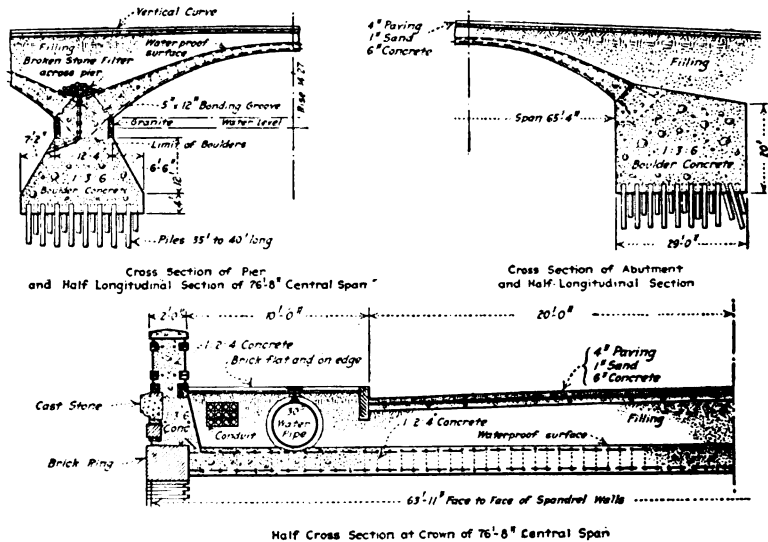
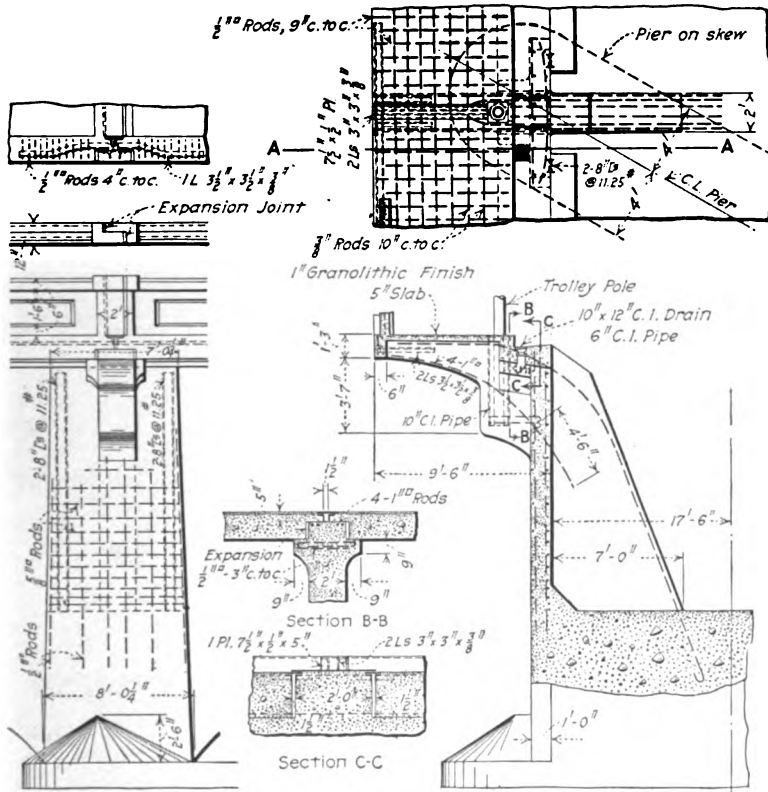

FIG. 62.—Details of Larz Anderson bridge over the Charles River, Cambridge and Boston, Mass.

intervals, and cantilever brackets are placed at these counterforts to support the sidewalks. The following description is taken from Engineering Record, issue of February 22, 1913.

“The entire width of the arch ring between outside faces of spandrel walls is 35 ft., and the roadway above is 39 ft. wide, thus giving an overhang of 2 ft. on each side of the bridge between the curb lines. This 2-ft. overhang constitutes the concrete gutter of the roadway and, as such, will be subject to heavy concentrated wheel loads coming upon the cantilever section. It was, therefore, built as a heavily-reinforced concrete beam. This beam is 2 ft. 9 in. wide, having a depth of 15 in.

at the spandrel wall and 10 in. at the curb, and is reinforced with fourteen $\frac{3}{4}$ -in. rods, with additional reinforcement at the brackets.



Side Elevation
Section A-A
FIG. 63.—Counterforted spandrel wall, highway bridge at Ansonia, Conn.

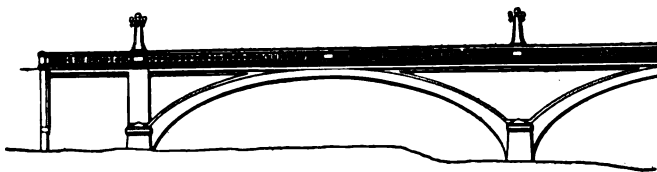

Elevation
FIG. 64A.—Elevation of west end of Olentangy River bridge on King Avenue, Columbus, Ohio.

“The bridge is designed for trolley traffic, and provision is made for the trolley poles by anchoring sections of 10-in. cast-iron waterpipe in the

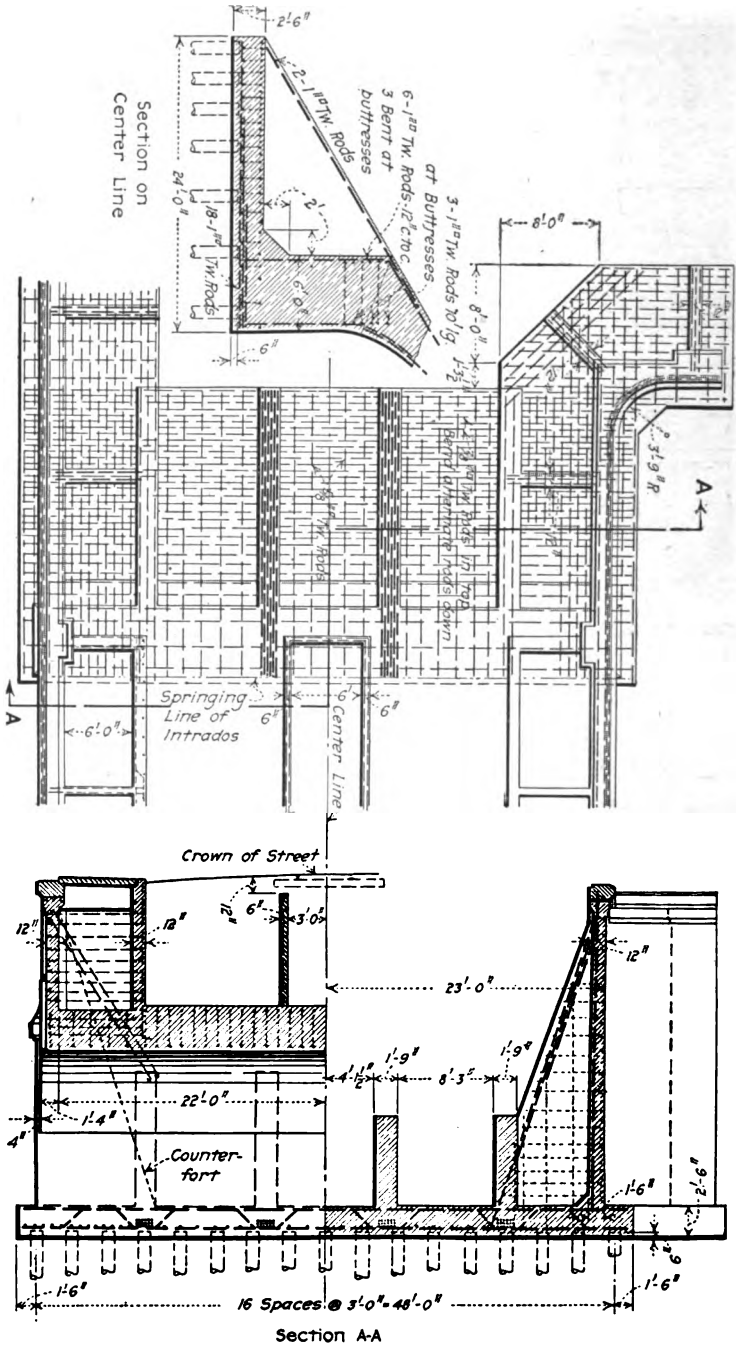

FIG. 64B.—Details of west abutment, Olentangy River bridge on King Avenue, Columbus, Ohio.

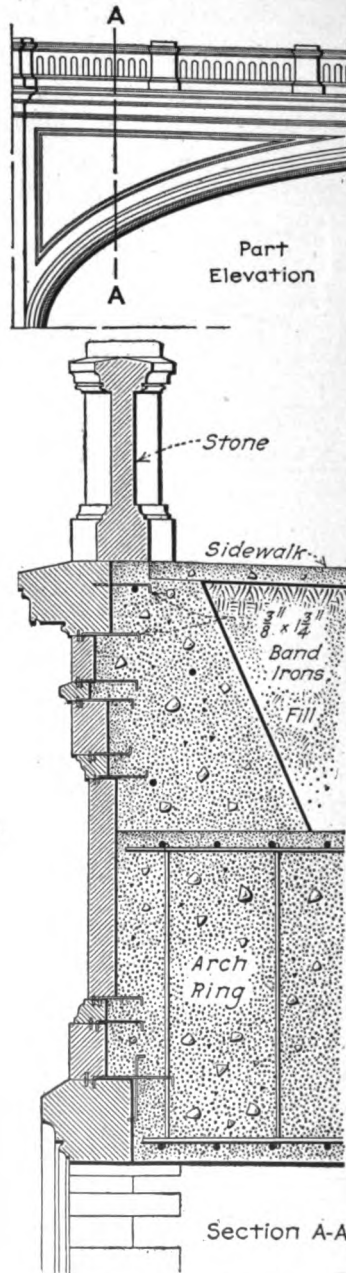

FIG. 65.—Details of stone facing of Michigan Street bridge over St. Joseph River, South Bend, Ind.

brackets of the piers and abutments. Drainage is provided by means of 6-in. cast-iron drains in the gutters over the piers."

Details of the arch bridge over the Olentangy River on King Avenue, Columbus, Ohio, is shown in Figs. 64A, 64B, and 64C. The type of spandrel walls without pilasters over piers should be noted. Since the space beneath each sidewalk is hollow, the inner wall was designed as a slab with the principal steel placed horizontally between cross walls. The longitudinal walls under

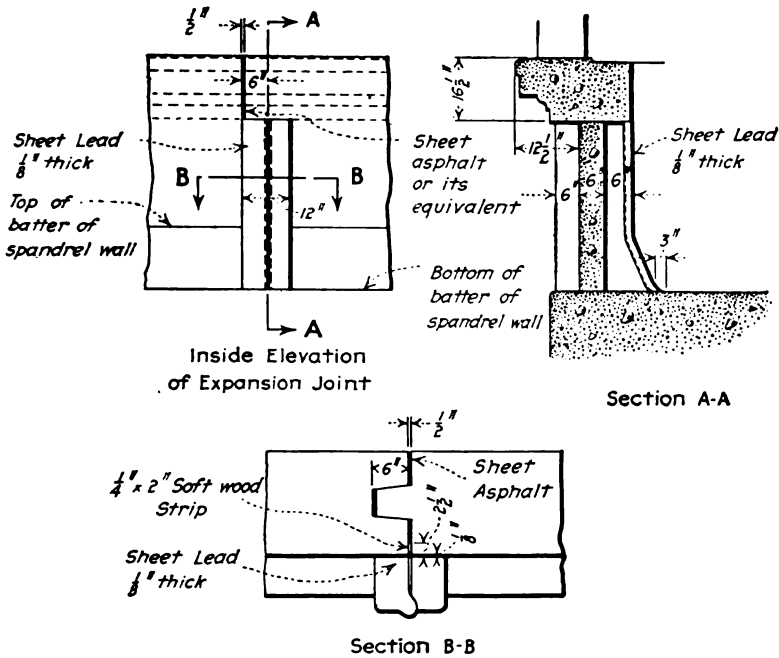
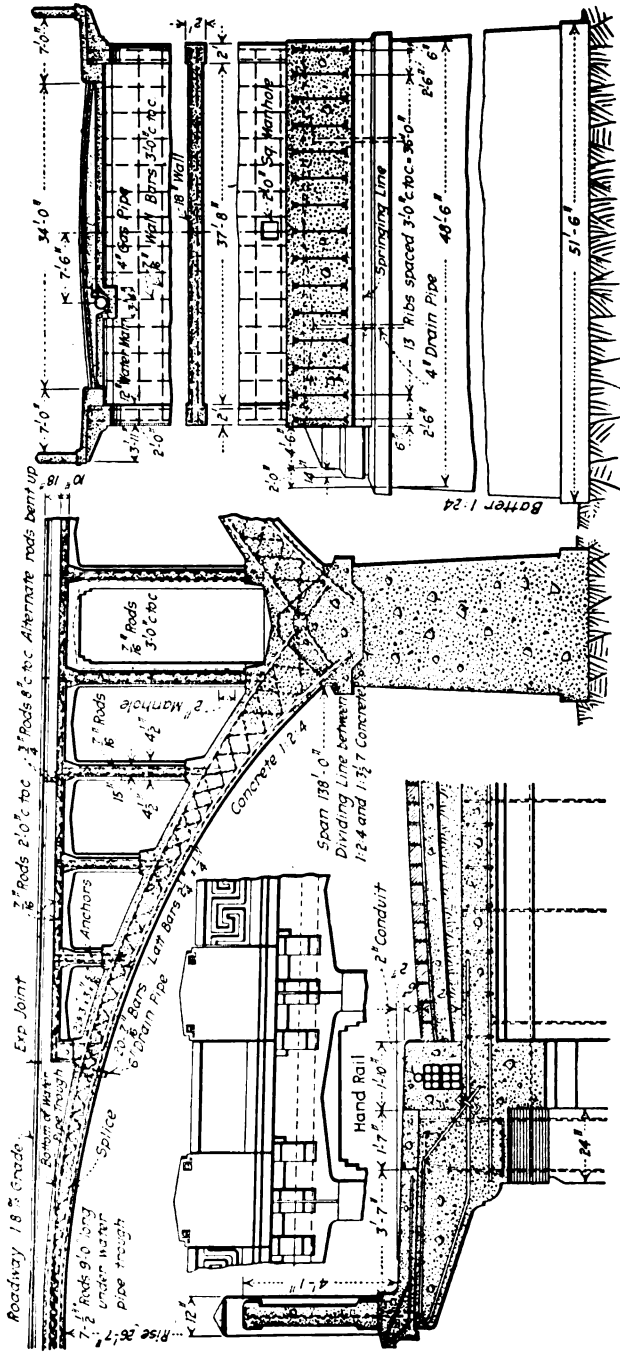

FIG. 66.—Details of expansion joint in highway arch bridge over Chattahoochee River at Columbus, Georgia.

the car track were employed to prevent the usual settlement of the track when laid on a new fill. The ties were laid directly on top of these walls and earth filling was dumped both sides of, and also between, the longitudinal walls.

An earth-filled arch faced entirely with stone is shown in Fig. 65. The bonding irons should be noted.

Drains should be placed on each side of the roadway of a concrete bridge at intervals of 30 to 40 ft. when the roadway is level and about every 100 ft. when on a grade. These drains should



Detail of Sidewalk

Section of Bridge at Pier
 Section of Bridge at Pier
 Fig. 67.—Details of Broadway bridge across the Oswego River at Fulton, N. Y.

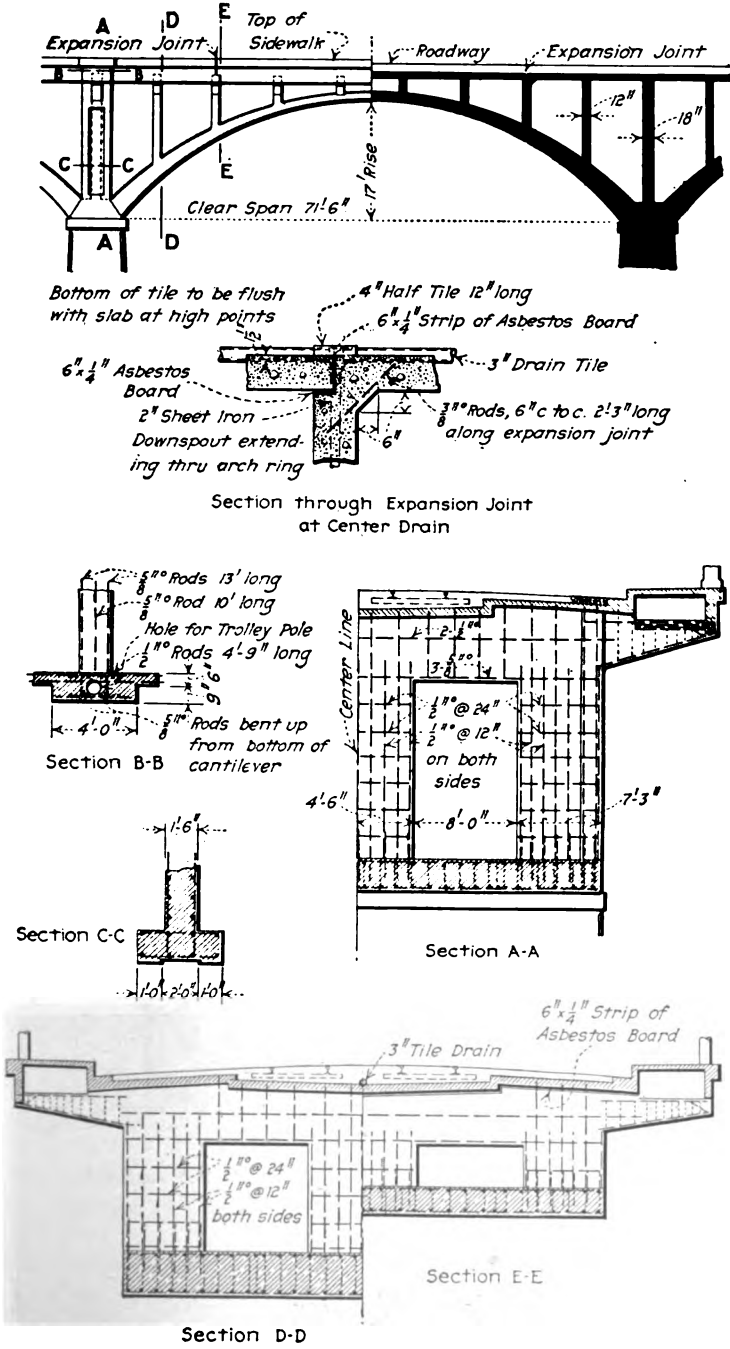

FIG. 68A.—Details of the Dallas-Oak Cliff viaduct, Dallas, Texas.

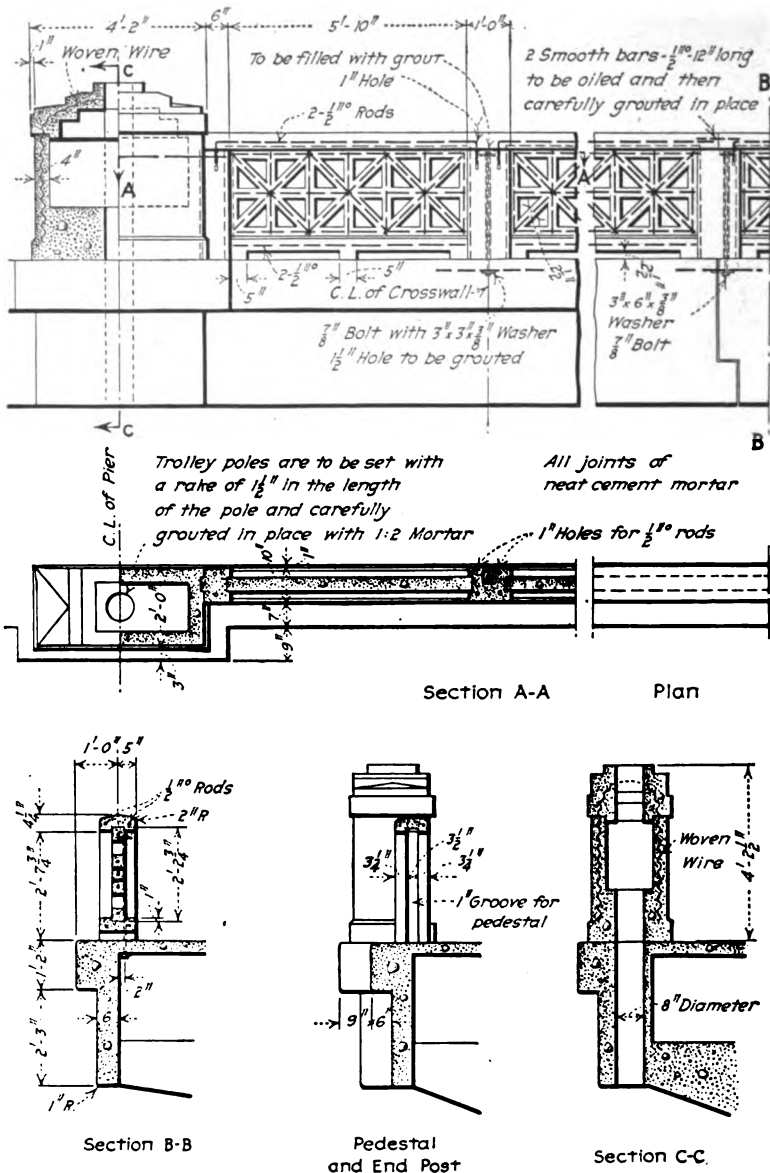
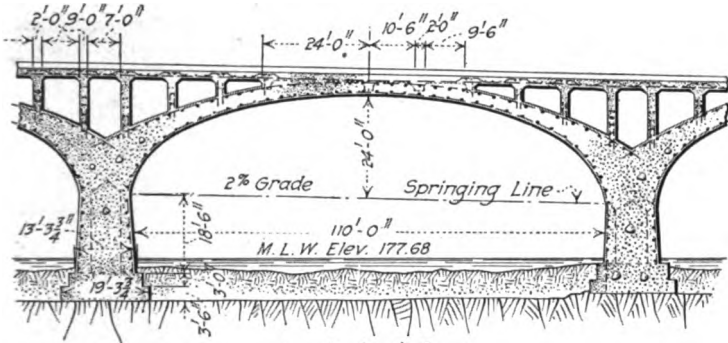

FIG. 68B.—Details of the Dallas-Oak Cliff viaduct, Dallas, Texas.

have a diameter of not less than 3 in. The minimum area of a drain in square inches may be computed by the formula

$$a = \frac{A}{200}$$

where A = area of the surface drained in square feet.



Longitudinal Section

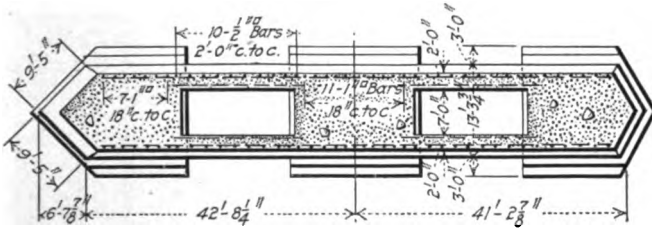

Section through Pier

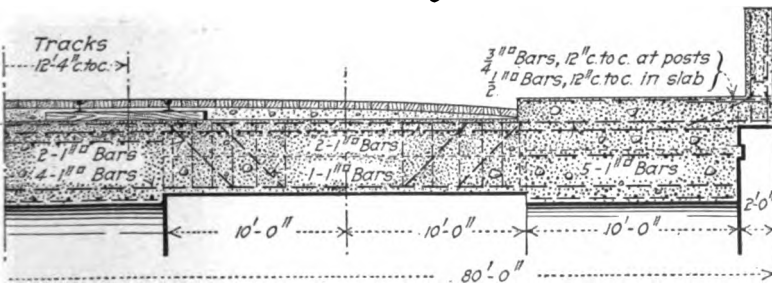

Half Section through Crown of 110-foot Arch

FIG. 69.—Details of Penn Street viaduct, Reading, Pa.

For remarks concerning expansion joints, see Art. 32. One type of expansion joint in a simple cantilever wall is shown

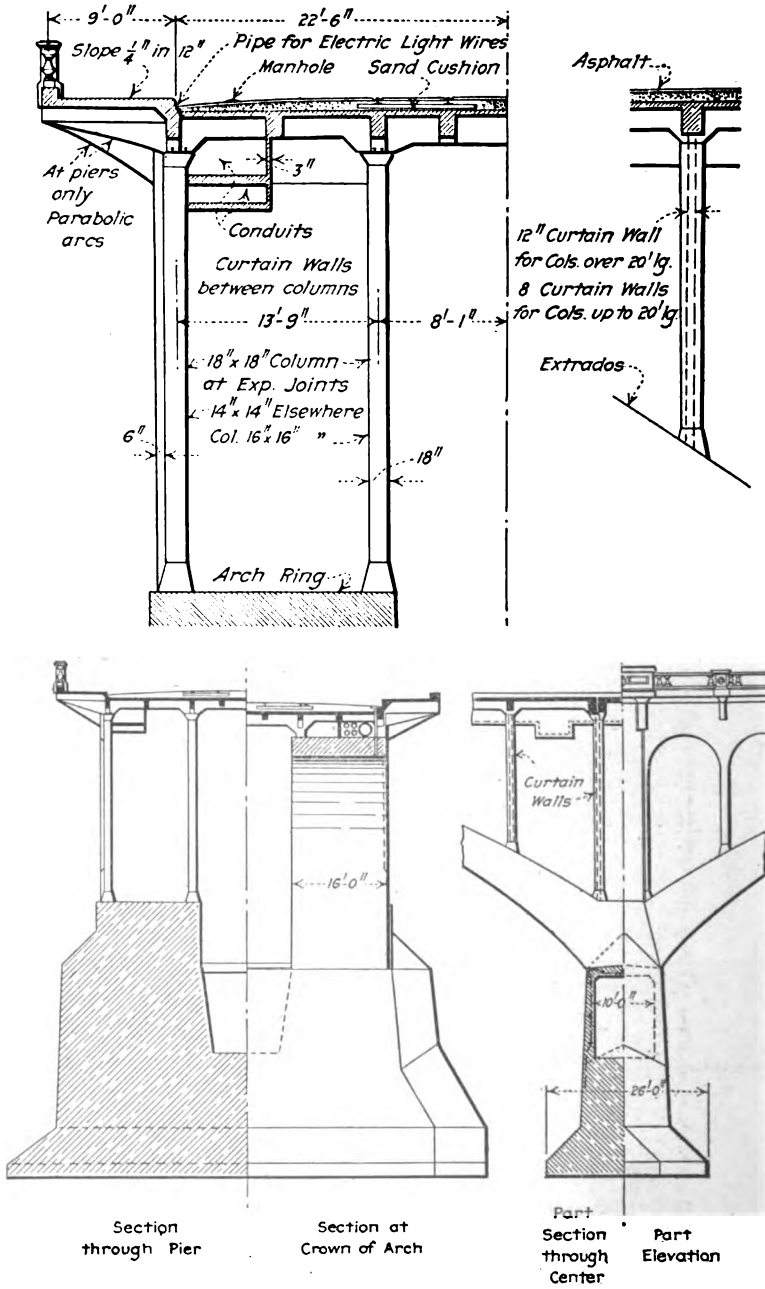

FIG. 70.—Bridge over Saskatchewan River at Saskatoon, Canada.

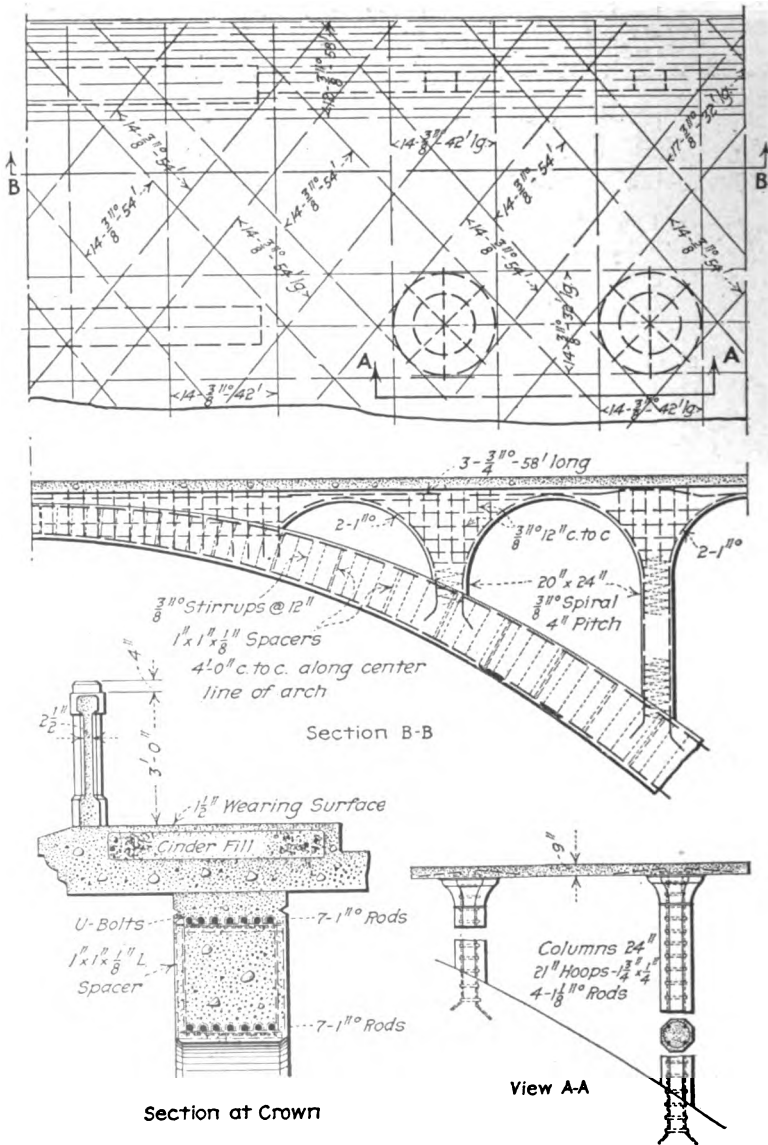

FIG. 72.—Bridge over ravine on Mississippi River Boulevard, St. Paul, Minn.

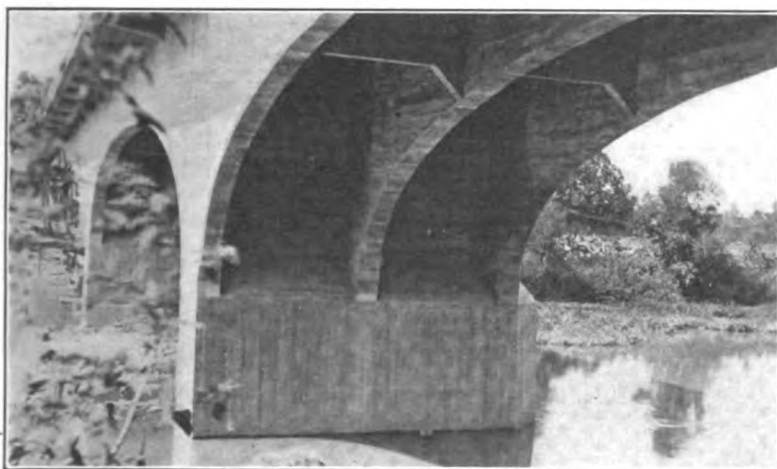

FIG. 73.—Highway bridge at Covington, Ohio.



FIG. 74.—Third Street bridge, Dayton, Ohio.

in Fig. 66. Other types of expansion joints may be found in Chapter XIII.

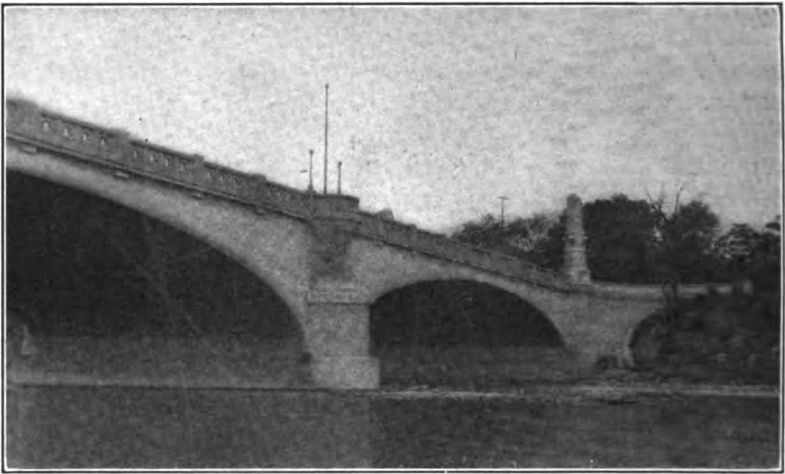
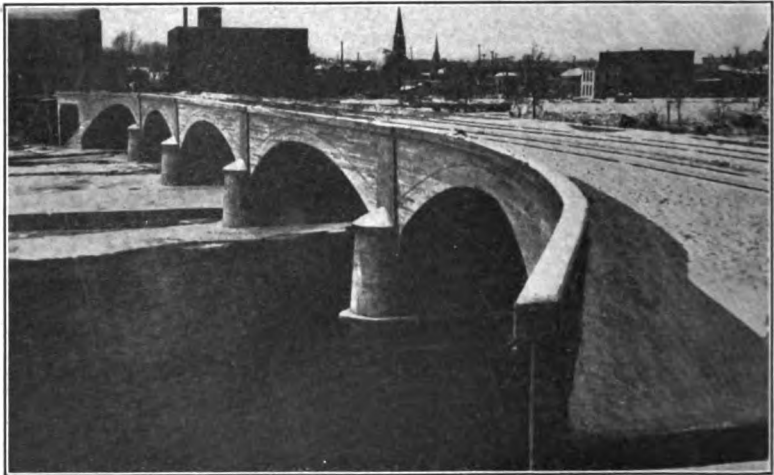

FIG. 75.—Bridge over Great Miami River at Dayton, Ohio.



Courtesy of Mr. W. C. Giffels.

FIG. 76.—Interurban railway bridge over Grand River, Grand Rapids, Michigan.

50. Spandrel Details in Open-spandrel Bridges.—The general types of open-spandrel bridges have been described in Art. 3. Figs. 67 to 72 inclusive will serve to illustrate details of some of these types. Other details may be found in Chapter XIII.

Fig. 67 shows a full-barrelled arch reinforced with typical Melan trusses made up of 3 in. by 3 in. by $\frac{5}{16}$ -in. angles and $2\frac{1}{4}$ in. by $\frac{1}{4}$ -in. lattice bars. The floor system is carried on a series of transverse spandrel walls and the floor slab is provided with expansion joints as shown. The sidewalks leave an overhang of about 3 ft. and are supported on cantilever brackets. The cantilever section of the sidewalk is cast in units 5 ft. long and laid in place. Tile conduits are provided under each sidewalk for the necessary wires, and a 4-in. gas pipe and 12-in. water main are laid in specially-designed reinforced-concrete troughs beneath the roadway.

Transverse spandrel walls with openings to save material are shown in Figs. 68A and 68B. The method of carrying the sidewalk should be noted.

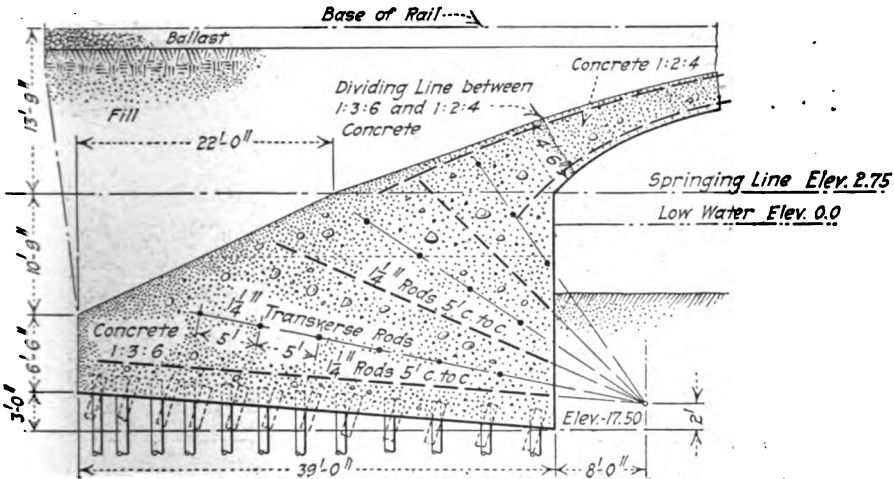

Fig. 77.—Abutment of causeway arch construction, Galveston, Texas.

The details of the ribbed arches in Figs. 69, 70, 71, and 72 should need no explanation. Fig. 73 shows a ribbed arch structure in which the ribs extend up to the floor level throughout each entire span.

The curtain walls between columns in Fig. 70 were considered simply as a bracing system. The columns were designed to carry all loads, but doubtless the curtain walls help to distribute the total loading. In taking the loading for the arch rings, it was assumed that the loading from columns was equally distributed over 12 ft. of arch ring instead of having two loads concentrated on an arch ring 16 ft. wide.

51. Piers and Abutments.—The resistance offered by piers to the passage of water varies with the type of starling. Experiments show that the value in this respect of the different shapes of piers is in the following order: first, elliptical horizontal sections; second, rectangular body with starlings formed by two circular arcs, tangent to the sides and described on the sides of an equilateral triangle; third, rectangular body with semicircular starlings; fourth, rectangular body with triangular starlings, the angle at the nose being 90° ; and fifth, rectangular body without starlings. Piers of the third type mentioned are shown in Figs. 74, 75, and 76. Other types may be found in the many illustrations scattered throughout the book.

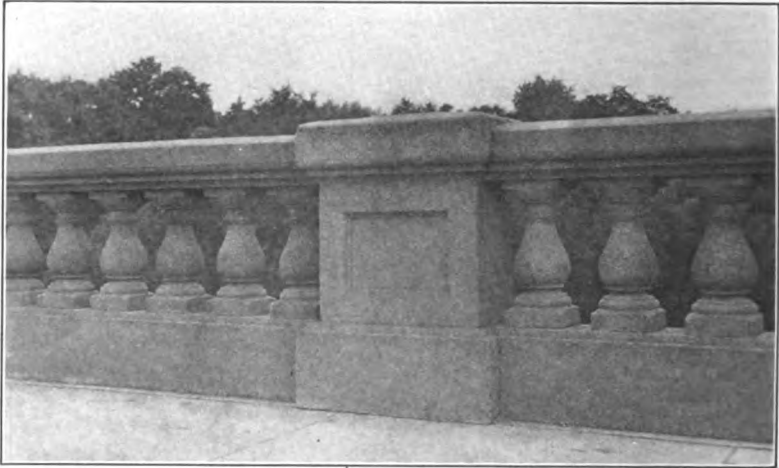
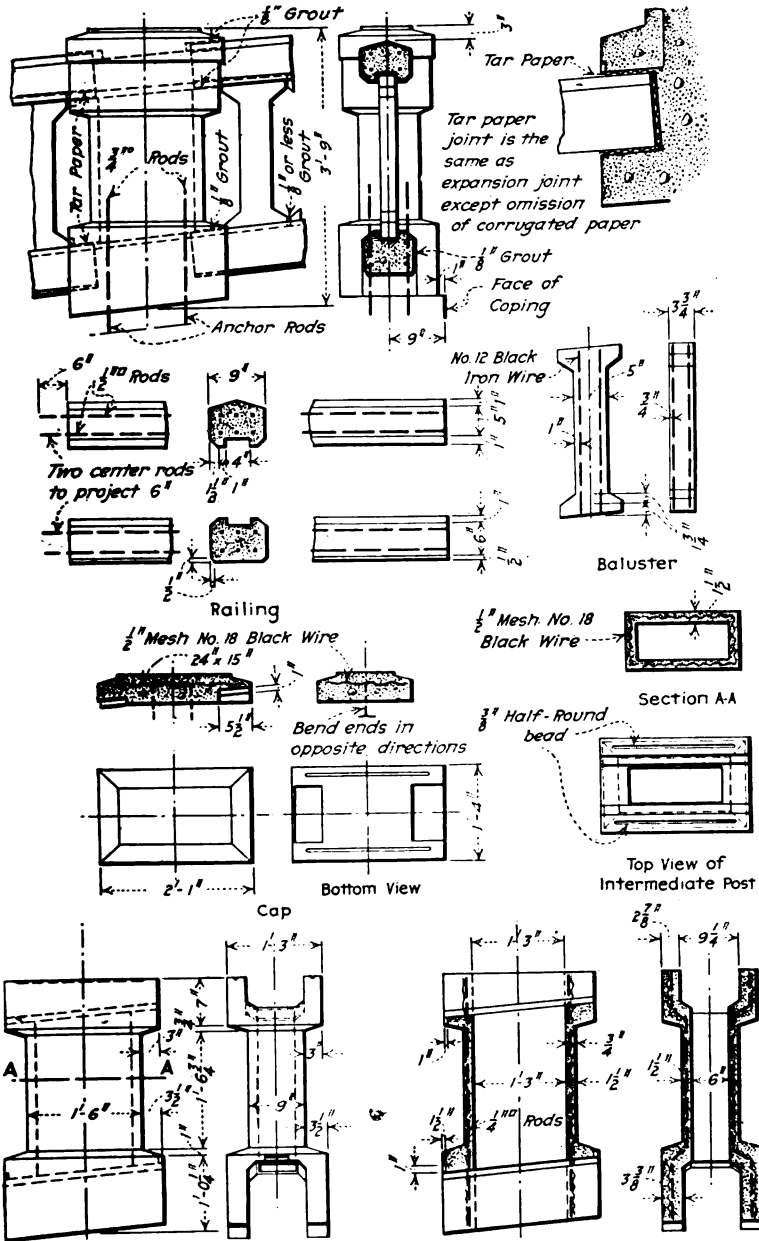

FIG. 78.

The ordinary type of abutment in earth-filled arches is shown in Plate I, Chapter IV. What might be called a buttressed abutment is shown in detail in Fig. 64*B*. Fig. 77 represents a very wide abutment in which a network of rods has been employed to make the entire abutment act as a unit. Hollow piers for ribbed-arch structures are shown in Figs. 69 and 70. See Chapter XIII for other examples of cellular construction.

52. Railing and Ornamental Details.—A common type of spindle balustrade is shown in Fig. 78. In such railings the spindles or balusters are usually the only members which are not cast in place. Expansion joints should be provided each side of the posts and also over the spandrel joints. Railing and ornamental details



Intermediate Post

FIG. 79.—Standard concrete handrail, Kansas City Terminal Ry.

of various kinds are shown in Figs. 61*B*, 64*C*, 67, 68*B*, and in Chapter XIII.

A typical unit-built handrail is shown in Figs. 79 and 80. This particular design was used on the viaducts of the Kansas City Terminal Railway Company. The following description of the design and construction of this railing is taken from the *Engineering Record*, issue of Dec. 19, 1914:

“The railing consists of a top and bottom rail set parallel to the pavement and grooved to receive the $3\frac{1}{2}$ in. by 5-in. spindles, which are set

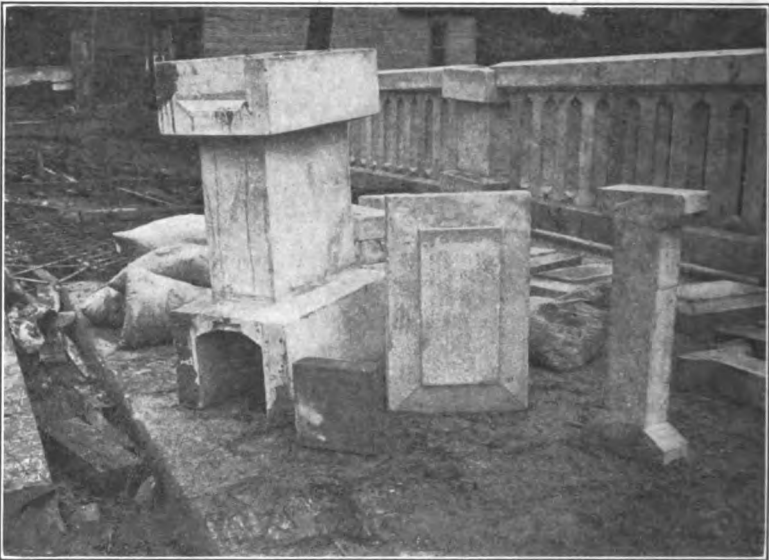

Courtesy of Horton Concrete Construction Co., Kansas City.

FIG. 80.—Unit-built handrail on Kansas City viaduct.

truly vertical, regardless of the grade of the rails. For this purpose the tops and bottoms of the spindles are shaped to the required angle.

“The panels between the hollow posts are usually 20 ft. long, but vary from 10 to 22 ft. The bottom rail rests on blocks 3 in. above the floor to give a detached appearance. Both rails extend into the post beyond the post shell. Projecting reinforcing rods in the rails entering from the high side, bond with the green concrete subsequently filled into the posts, but an expansion joint has been secured on the opposite and lower side of the post by wrapping the rail ends in tar paper.

“A basket reinforcement of four $\frac{1}{4}$ -in. rods wrapped with No. 2 wire cloth has been provided for the post shells, which are covered with a cap

held down by a wire embedded in the cap during its construction. This wire was forced down into the soft concrete after the shell was filled.

"Separate members were cast near the slab plant used to construct the large units for the subways, as described in the Engineering Record of Aug. 30, 1913, page 288. A pug mill, steam house, and gantry crane comprised the equipment. The pug mill was used to obtain uniformity of mixture, as mortar in it could be observed and the foreman was relied upon to obtain the proper consistency. Wood forms were employed to prevent craze and sand marks. In cold weather the steam house facilitated setting, while in summer 45 minutes in the steam retarded setting a sufficient amount to avoid crazing. The aggregate consisted of 1 part cement, 2½ parts Kaw River sand, considered exceptionally good, and 1 part of crusher-run soft native limestone passing a ¾-in. mesh. All measurements were made by hand in a 1-cu. ft. box.

"The rails were turned upon a sand cushion 24 hours after being poured. The posts were cast at three separate pourings so that shrinkage would not crack them at the points of top and bottom enlargement."

CHAPTER X

CONSTRUCTION OF ARCH BRIDGES

No attempt will be made in this chapter to describe at length the character of the materials required for concrete; the kind of lumber to use for forms; the types of forms for ordinary column, beam, and slab construction; the methods of bending and placing reinforcement; the proportioning, mixing, and placing of concrete; the finishing of concrete surfaces; or the various methods of



Courtesy of Mr. Daniel B. Luten, Consulting Engineer, Indianapolis.

FIG. 81.—Harford Avenue bridge over Hering Run, Baltimore, Md. Showing method of construction of arch ring in longitudinal sections.

waterproofing. These subjects are all treated in detail in Volume II. Special consideration, however, must be given in this volume to the methods of arch construction; the centering for arches; and the forms for spandrel walls, piers, and abutments.

53. Arch-ring Construction.—Arch rings with span lengths less than about 90 ft. are usually constructed in longitudinal ribs 3 or 4 ft. wide (Figs. 81 and 82), or in fact of such width that one entire rib can be poured in approximately 1 day's time. In

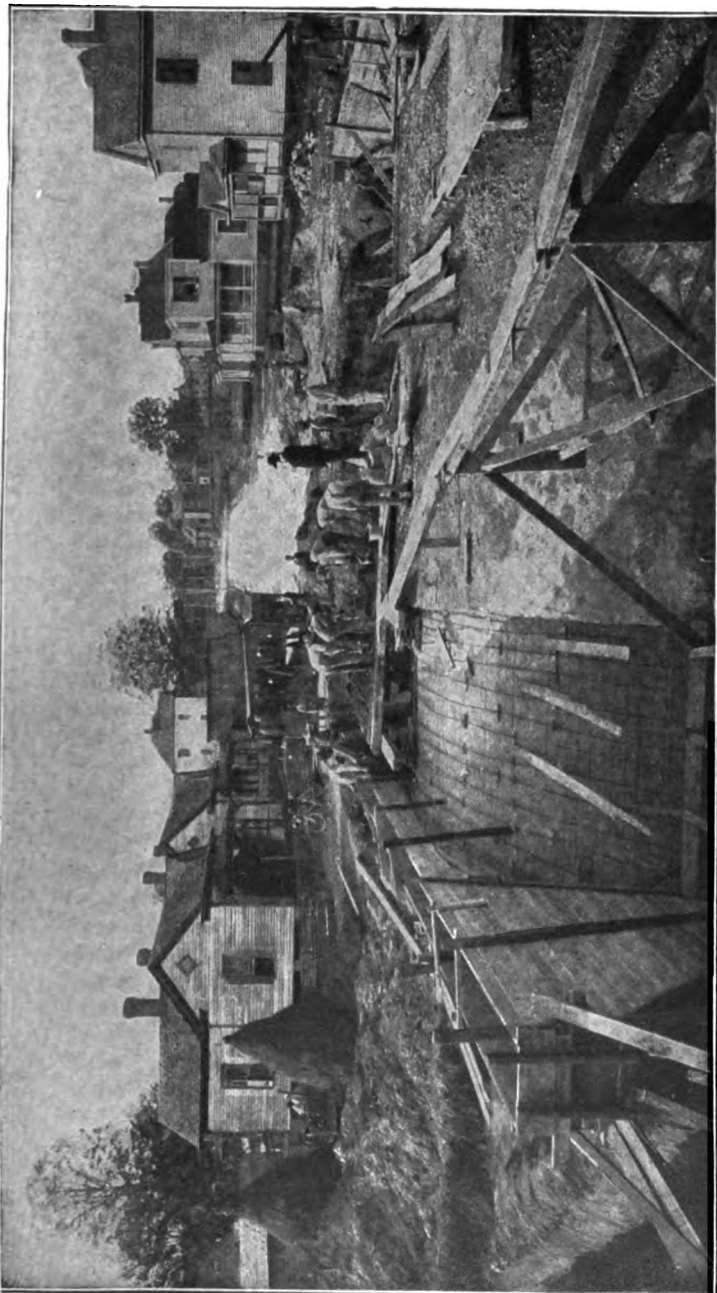

Courtesy of Mr. Daniel B. Lutten, Consulting Engineer, Indianapolis.

FIG. 82.—Elizabeth Avenue bridge, Charlotte, North Carolina. View showing arch concreted in longitudinal rings; reinforcement in place for one 12-ft. concentric ring. Forms constructed for spandrel wall.

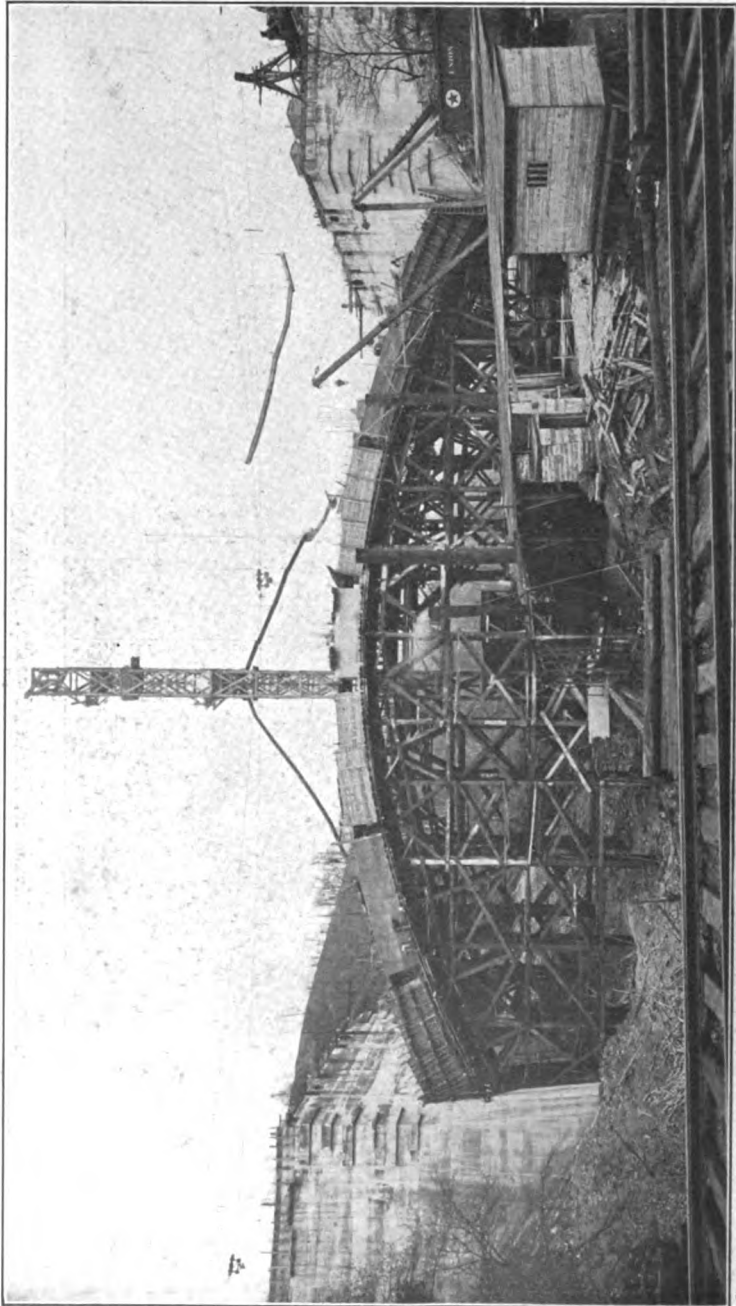

Courtesy of Mr. N. S. Sprague, Superintendent, Board of Public Works, Pittsburgh.
FIG. 83.—Construction view of the Hights Run bridge, Pittsburgh, Pa.

narrow arches the entire arch ring is sometimes poured at one operation. This method of construction has been successfully used for much greater spans than 90 ft. but, unless special care

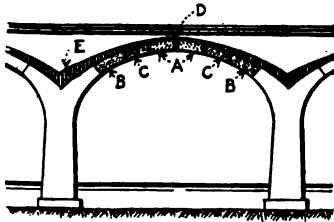

FIG. 84.



FIG. 85.

is taken to make the centering very stiff, the construction of any one rib may deform the arch center to such an extent as practically to strike the center under the completed ribs. Of course,



Courtesy of Mr. Daniel B. Luten, Consulting Engineer, Indianapolis.

FIG. 86.—Concreting longitudinal rings, 50-ft. span, Plymouth, Mass

the ribs should be poured continuously from each abutment toward the crown so as to obtain a symmetrical loading on the falsework and thus eliminate distortion of the centering as far as possible.

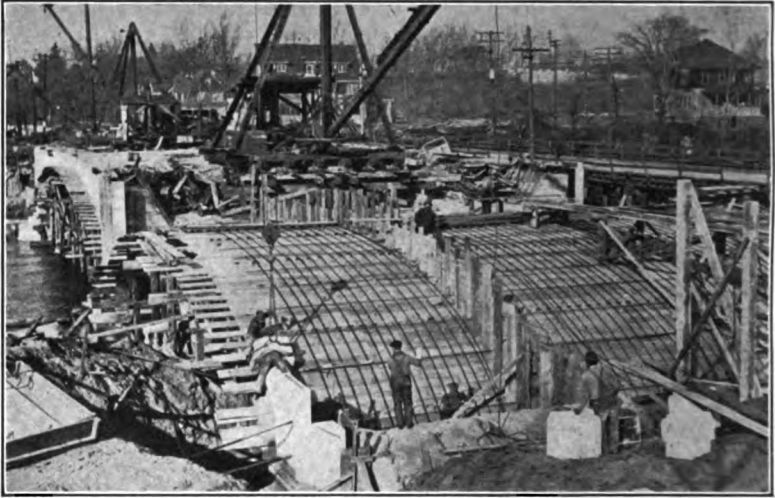

Courtesy of Mr. Charles W. Cole, City Engineer, Mishawaka, Ind.
FIG. 87.—Construction view of North Michigan Street bridge, South Bend, Indiana.



Courtesy of Mr. Charles W. Cole, City Engineer, Mishawaka, Ind.
FIG. 88.—Construction view of North Michigan Street bridge, South Bend, Indiana.

For spans of 90 ft. or over it is usually preferable to construct an arch ring or arch rib by what is known as the alternate block or voussoir method. The arch is constructed in transverse blocks (Fig. 83) of such size that each block can be completed at one pouring, or with about a day's work. Obviously this method reduces shrinkage stresses in the arch ring to a minimum.



Courtesy of Mr. Charles W. Cole, City Engineer, Mishawaka, Ind.

FIG. 89.—Construction view of North Michigan Street bridge, South Bend, Indiana.

For the best results the blocks should be poured in such order as to give a uniform settlement of the centering, and also prevent the crown of the arch from rising as the lower arch loads are placed. If blocks close to the crown section are not placed before the blocks at the haunch and springing sections, the centering will rise at the crown and the placing of the crown loads will be likely to cause

cracks at the middle of the haunch. Even in the construction of an arch by the longitudinal rib method, a temporary loading of the crown is often necessary.

The order followed in the construction of the Philadelphia and Reading R. R. bridge across the Delaware River at Yardley, Pa.—an earth-filled bridge with clear span of 90 ft. 9-in.—is shown in Fig. 84, the sections being concreted in the alphabetical order shown. The section *D* is the keying section, and the section *E* a haunching section (quite unusual construction) which was added after the lower portion of the arch ring was completed. The part of the arch ring close to the springing lines was placed monolithic

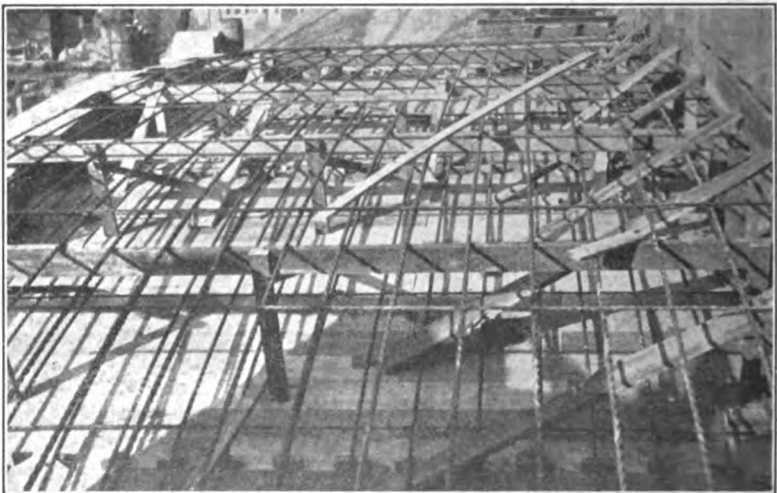

Courtesy of Mr. Charles W. Cole, City Engineer, Mishawaka, Ind.

FIG. 90.—North Michigan Street bridge, South Bend, Indiana. Reinforcement supported in place.

with the piers and abutments, making what is called an umbrella form for the piers. In large arches this umbrella type of construction is frequently adopted. The pier forms in such cases are more expensive, but this increase in expense for the piers is usually more than offset by the saving in the falsework for the arch ring.

Fig. 85 shows the method of constructing the Larimer Ave. bridge at Pittsburgh—a bridge of the open-spandrel type, with two ribs, having a clear span of approximately 300 ft. The blocks were placed in alphabetical order and later the keys between them were concreted to make the closure.

In constructing an arch rib or arch ring by the alternate block method the individual sections or block spaces are closed off at the ends by timber bulkheads. On the steepest slopes of the lagging these bulkheads adjoining keying sections are held in place by temporary struts between voussoirs. A top form is usually needed for the block sections near the piers and abutments. This top form should be laid up as the concreting progresses. Fig. 86 shows a top form being used in the construction of an arch ring by the longitudinal rib method.

If arch reinforcement for large arches is put in place in long

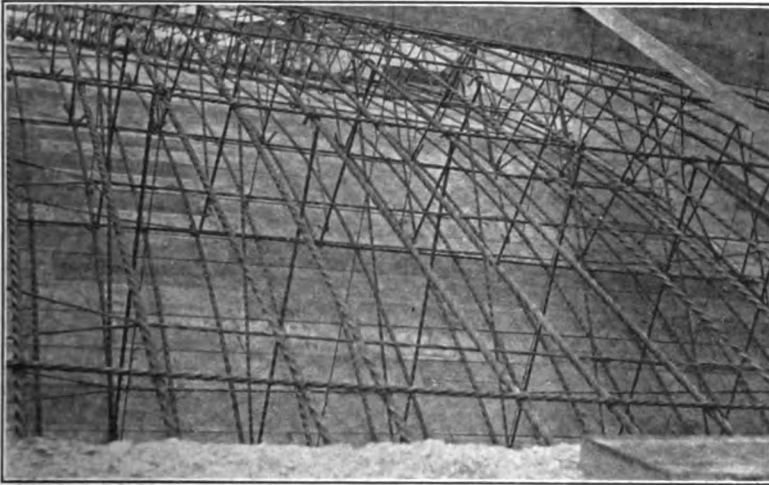

Courtesy of Mr. Charles W. Cole, City Engineer, Mishawaka, Ind.

Fig. 91.—North Michigan Street bridge, South Bend, Indiana. Reinforcement in place held by overhead timbers.

lengths, the settlement and deformation of the centering during the pouring of the concrete will cause buckling of the steel which will prevent the reinforcement from lying in its theoretical position. For this reason steel lengths should not exceed about 30 ft. and the splicing should occur in the keyways. An effort should be made to stagger the splices of adjacent rods and to locate the splices where the tension in the steel is a minimum.

Figs. 87 to 92 inclusive show the reinforcement in place in the North Michigan Street bridge at South Bend, Ind. The lower steel was wired together and blocked up as shown in Fig. 87; props were then erected for the upper steel (Figs. 88, 89, and 90); after which the diagonal rods were placed. Instead of knocking

out these blocks and spacing boards as the concrete was brought up (a method sometimes followed), all the wood used in erection

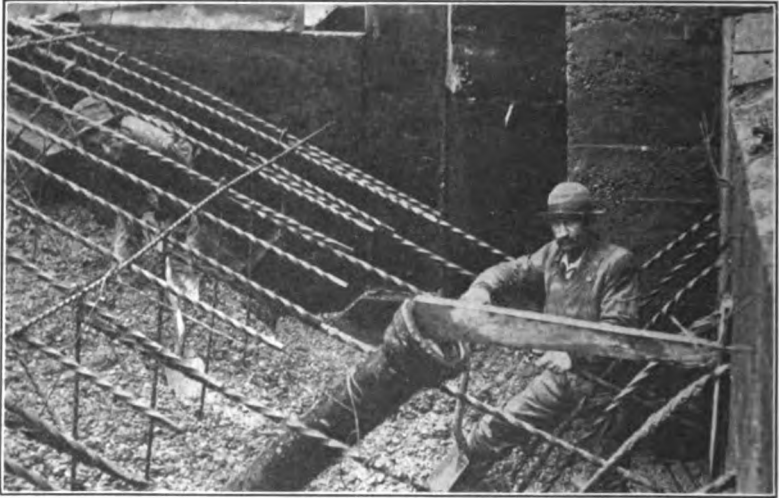

Courtesy of Mr. Charles W. Cole, City Engineer, Michawaka, Ind.

FIG. 92.—North Michigan Street bridge, South Bend, Indiana. Concrete being put in place.

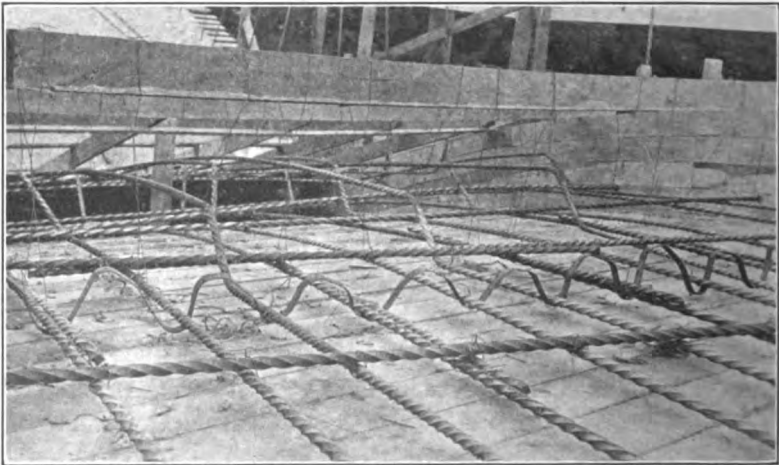
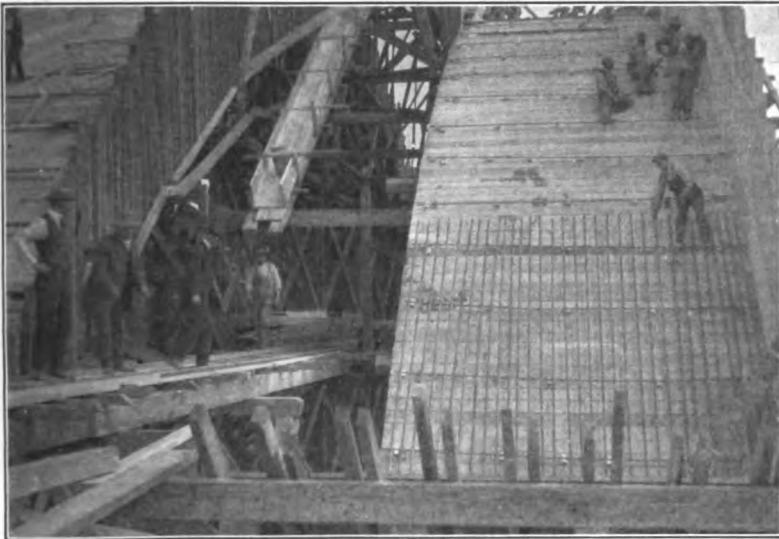

FIG. 93.—Arch reinforcement held in place by being wired to transverse timbers supported above the surface of the finished concrete. Bridge of Lutén Design.

was removed before concreting was started and the system of rods was held in place by being wired to transverse timbers supported

above the surface of the finished concrete (Fig. 91). By this method the likelihood of disturbing the steel during the pouring



Courtesy of Mr. Daniel B. Luten, Consulting Engineer, Indianapolis.
FIG. 94.—Bridge over Saskatchewan River at Saskatoon, Canada. Placing reinforcement in arch ribs.

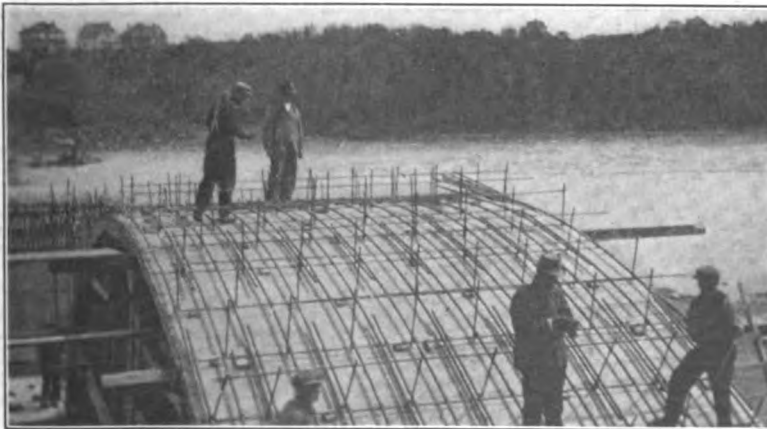

Courtesy of Mr. Daniel B. Luten, Consulting Engineer, Indianapolis.
FIG. 95.—Bridge over Saskatchewan River at Saskatoon, Canada. Reinforcement in place on one of the arch ribs.

of the concrete was reduced to a minimum and, of course, there was no chance of trouble arising from failure to remove all the

spacing blocks. The bridge in question has a stone facing. Some of the stone work may be seen in place in Figs. 87, 88, and

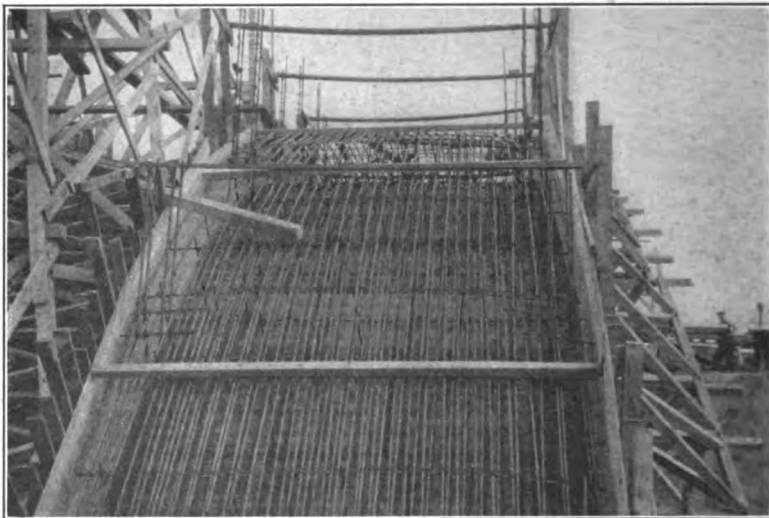

Courtesy of Mr. Daniel B. Luten, Consulting Engineer, Indianapolis.
FIG. 96.—Bridge over Saskatchewan River at Saskatoon, Canada. Arch rib ready for concreting.

89. Narrow gauge distributing track should be noted, also longitudinal bulkheads used in the longitudinal rib method of arch-ring construction. Fig. 93 shows a similar method of hold-



Courtesy of Mr. Daniel B. Luten, Consulting Engineer, Indianapolis.
FIG. 97.—Construction view of bridge over Saskatchewan River at Saskatoon, Canada.

ing steel in position employed in a Luten Design bridge (see Chapter XII) at Collinsville, Ohio.

Figs. 94, 95, and 96 show the placing of reinforcement in a two-

ribbed open-spandrel arch bridge at Saskatoon, Saskatchewan, Canada. Two tracks were used for distributing materials, one

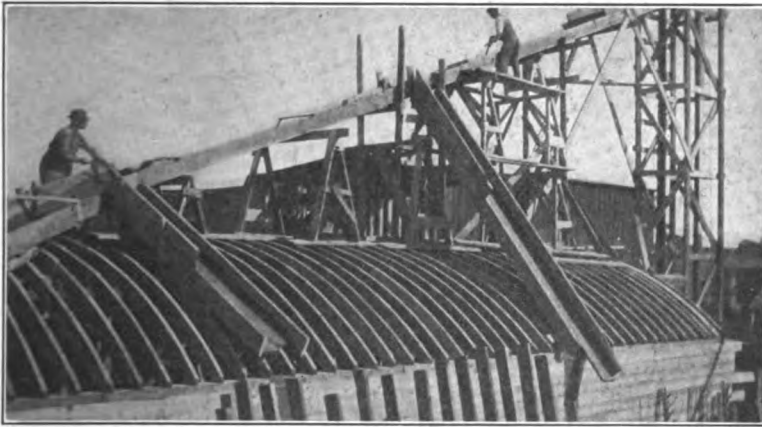

Courtesy of Mr. Daniel B. Luten, Consulting Engineer, Indianapolis.

FIG. 98.—Bridge over Saskatchewan River at Saskatoon, Canada. Placing concrete by hoist and chutes.

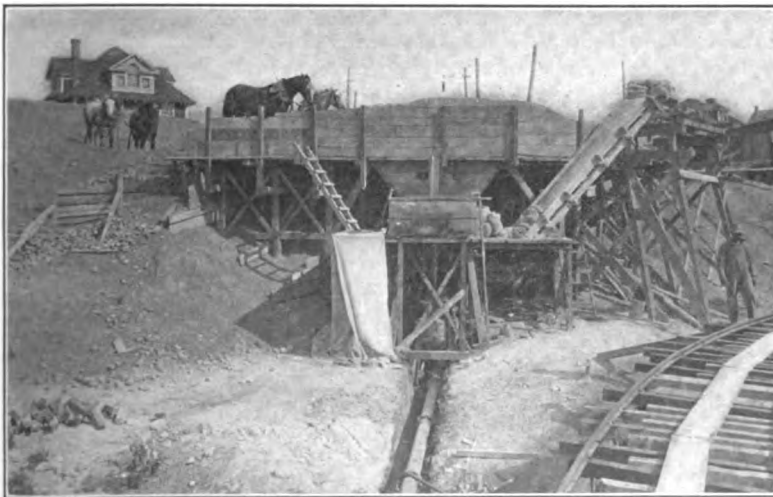

Courtesy of Mr. A. P. Linton, Asst. Chief Engineer, Board of Highway Commissioners, Sask.

FIG. 99A.—Pneumatic mixing plant at bridge over Saskatchewan River, Saskatoon, Canada. View showing hopper for measuring gravel; tank for measuring water; method used in handling cement; pneumatic mixing machine; and pipes leading to discharge box.

just above the spring line shown in Fig. 94, and another on top of the arches (Fig. 97). The major part of the concrete for this

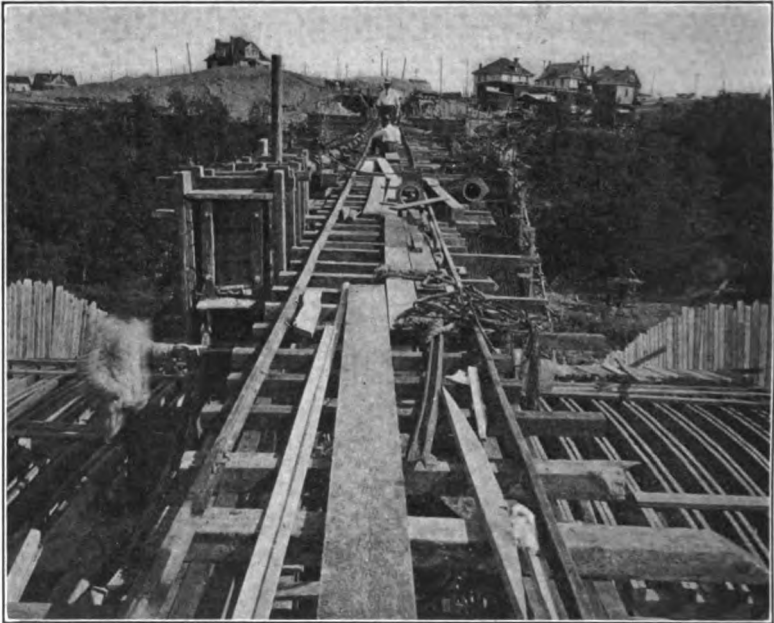

Courtesy of Mr. A. P. Linton, Ass't. Chief Engineer, Board of Highway Commissioners, Sask.

FIG. 99B.—Pipe line from pneumatic mixer at bridge over Saskatchewan River, Saskatoon, Canada. Notice discharge box. (Troughs are not shown in this view.)

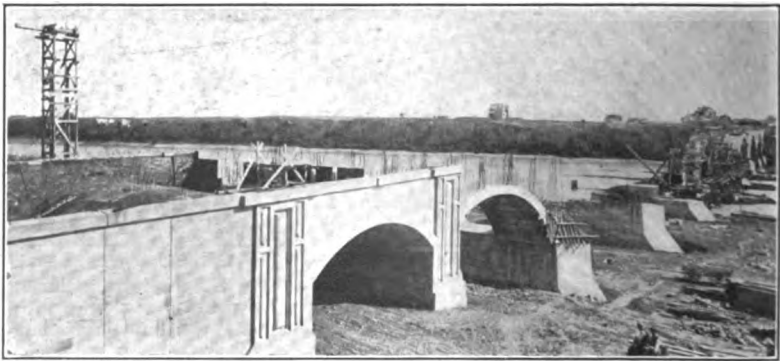

Courtesy of Mr. Daniel B. Luten, Consulting Engineer, Indianapolis.

FIG. 100.—Bridge over Saskatchewan River at Saskatoon, Canada. General construction view.

bridge was placed by compressed air; the remainder by hoist and chutes (Fig. 98). In Fig. 99A is shown the pneumatic mixing plant used in the construction of this bridge with pipes leading to discharge box on the upper material track (Figs. 97 and 99B). Troughs leading from the discharge box to the work are shown in Fig. 97 but not in Fig. 99B. In Fig. 99A should be noted

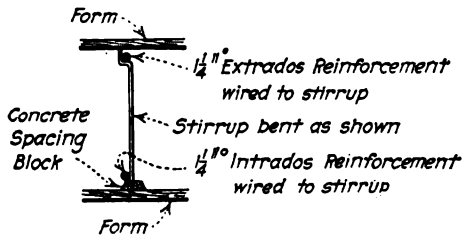

FIG. 101.

the hopper for measuring gravel, tank for measuring water, and method of handling cement. A general view of the Saskatoon bridge during construction is shown in Fig. 100.

The short radial rods in the arch ring, shown in Figs. 95, 96, and 101 were not looped around either upper or lower steel,



Courtesy of Mr. Daniel B. Luten, Consulting Engineer, Indianapolis.
 FIG. 102.—Timber falsework and centering for arches. Bridge over Saskatchewan River at Saskatoon, Canada.

but simply wired thereto. They were intended simply for framing.

When steel ribs (either rolled sections or built-up lattice girders) are used as arch reinforcement, great care should be taken to fix the ribs in the proper position, and in this position they should be braced until the concrete is placed. The use of such ribs is known as the Melan system.

54. Centering.—The bent type of timber falsework (Figs. 102, 103, 104, and 105) is the type of centering generally employed in

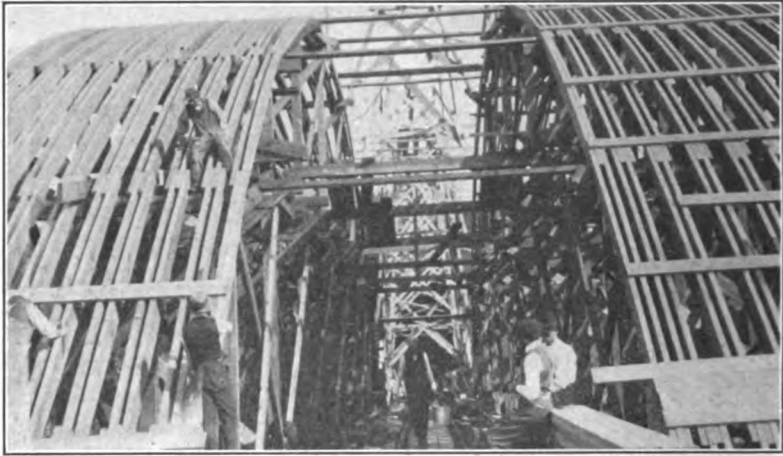

Courtesy of Mr. Daniel B. Luten, Consulting Engineer, Indianapolis.

FIG. 103.—View of upper part of centering. Bridge over Saskatchewan River at Saskatoon, Canada.

arch construction except where a deep gorge is to be spanned or where a large clearance under the arch is necessary while the

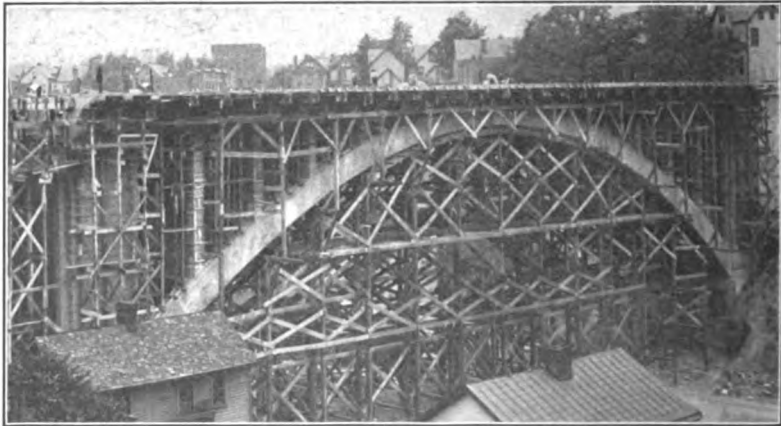

Courtesy of Mr. N. S. Sprague, Superintendent, Dep't. of Public Works, Pittsburgh.

FIG. 104.—Centering for Meadow Street bridge, Pittsburgh, Pa.

bridge is under erection. Timber arches, Howe trusses, and bow-string trusses are sometimes employed when it is impossible to use the bent type of centering, but these forms are expensive to build,

deform badly under loading, and have but small salvage value. (Fig. 106 shows a combination of the bent and Howe-truss types of centering.) Before using any of these types, consideration should be given to the use of steel centers (Fig. 107); or, in some

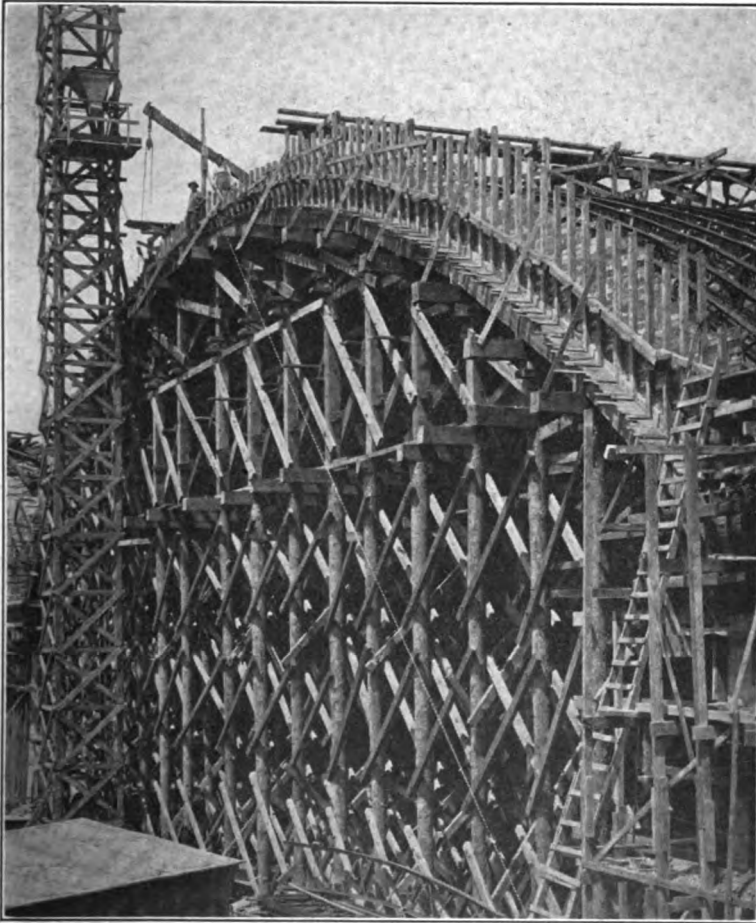

Courtesy of Marquette Cement Mfg. Co.

FIG. 105.—Centering for Grand Avenue viaduct, Milwaukee, Wis.

cases, to the use of suspended centering (Figs. 108, 109, and 110), if the writer may be permitted to refer in this manner to patented methods of arch construction. In some special cases the arch reinforcement may, with economy, be built as an arch

to carry a suspended arch form together with the dead load of the wet concrete (Fig. 111).

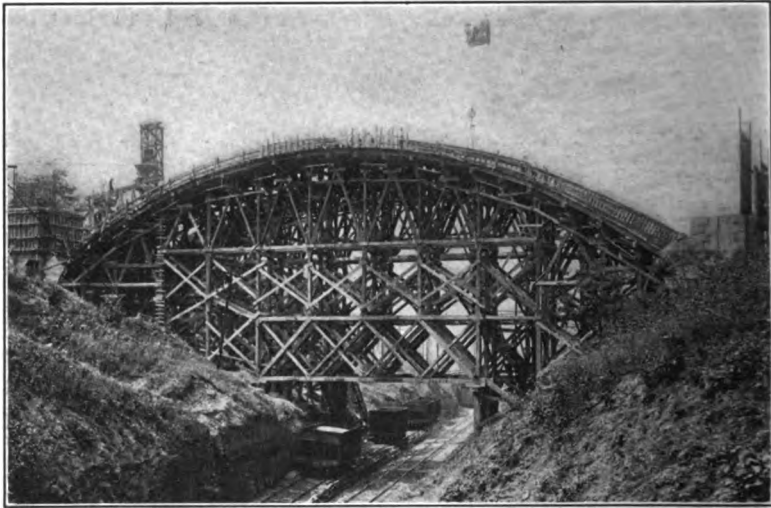

Courtesy of Mr. N. S. Sprague, Superintendent, Dep't. of Public Works, Pittsburgh.
Fig. 106.—Centering for Atherton Avenue bridge over Pittsburgh Junction R. R., Pittsburgh, Pa.

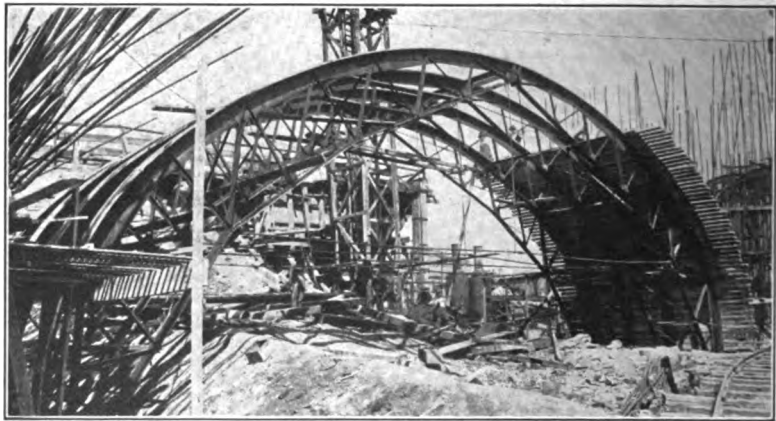

Courtesy of Mr. N. S. Sprague, Superintendent, Dep't. of Public Works, Pittsburgh.
Fig. 107.—Steel centering for North Side Point bridge, Pittsburgh, Pa.

Timber Centers.—A simple and common form of timber centering for arches of low rise is shown in Fig. 112. The lagging had not been placed at the time this photograph was taken, but some

of the joists for supporting the lagging were already in place. The joists, of course, extended from abutment to abutment and were supported by transverse bents of round timber resting on sills the full length of each bent. The falsework rested on the concrete floor of a spillway channel so that mud sills, piles, or specially-constructed concrete footings were not necessary. Wedges

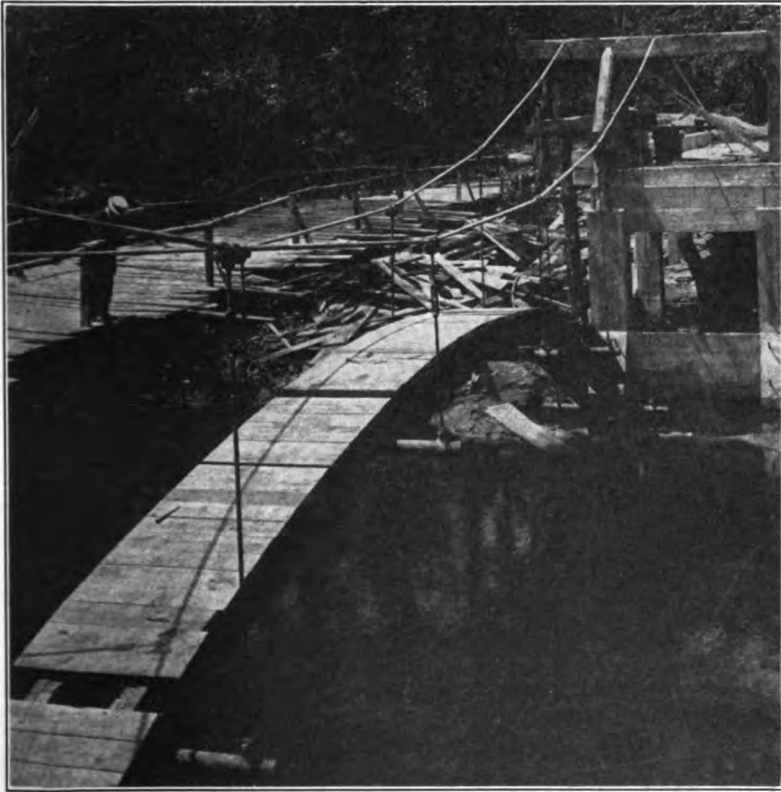

Courtesy of Mr. Philip Aylett, Civil Engineer, St. Louis.

FIG. 108.—Construction view of Chickahominy River bridge near Richmond, Va. Suspended centering in place.

were placed at the bottom of the posts so that the center might be lowered conveniently after the arch ring was completed and ready to bear its load. Fig. 113 shows a similar type of centering partly removed. In the constructing of this bridge, however, the wedges were placed at the top of the posts, as can be plainly seen in the illustration.

Timber centering varies so greatly in design to meet different conditions, that plans and photographs of a number of centers which have actually been built, with a few statements (quoted or otherwise) concerning each, will do more to give the reader a clear idea of this type of construction than any general descriptions which might be given.

The centering used in the Third Avenue bridge at Cedar Rapids, Iowa is shown in Fig. 114. In a paper presented before the Western Society of Engineers, April 13, 1914, Mr. Barton J. Sweatt described the construction of this centering as follows:

“The falsework for supporting the arches consisted of pile bents, the first bent being 6 ft. 6 in. from the face of piers and abutments, the

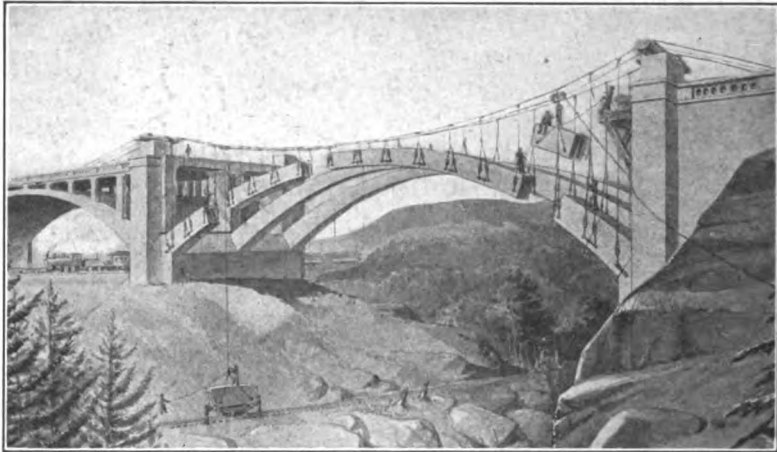

Courtesy of Mr. Philip Aylett, Civil Engineer, St. Louis.

FIG. 109.—Pre-cast voussoir method of arch construction.

second bent 12 ft. 6 in. from the first, and the intermediate bents were 14 ft. 6 in. centers. Oak piles were used and as a rule were driven to bed rock, the spacing was 6 ft. 0 in. for the three outside piles and 8 ft. 0 in. for the intermediate. The caps used were 12 in. by 12-in. yellow pine, false caps 6 in. by 10 in., joints 4 in. by 14 in., spaced 24 in. on centers and the lagging was 2 in. by 8 in. The proper curve for the intrados was obtained by the use of 2-in. strips cut to the proper curve and tacked to the regular joists. Oak wedges were used between the main and false caps. These wedges were placed in pairs and spaced about 4 ft. apart. Small wedges were used under the ends of the joists to bring them to the proper height.

“In constructing the centering, an allowance of $1\frac{1}{2}$ in. was made for

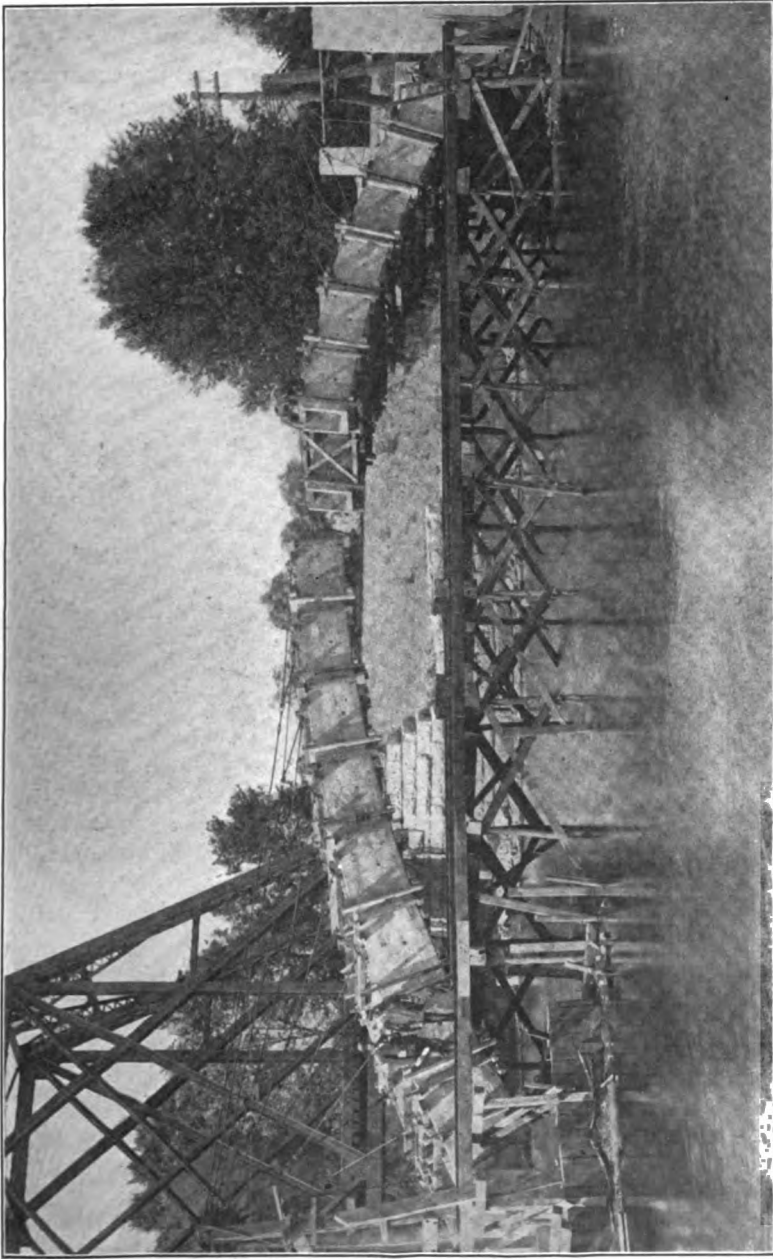

Courtesy of the Strauss Bascule Bridge Co., Chicago.

FIG. 110.—Strauss system of bridge construction.

camber and $\frac{1}{2}$ in. for settlement after the centering was removed. The actual settlement of the crown after removing the centering was $\frac{3}{8}$ in."

An article in *Cement Age*, March, 1912, describes the construction of the centering shown in Fig. 115 in the following manner:



Courtesy of Mr. John F. Skinner, Prin. Ass't. Engineer, Dep't. of Engineering, City of Rochester.

FIG. 111.—Bridge at Central Avenue, Rochester, N. Y. Structural reinforcement and arch-rib forms in place.

"The centering for the arch consisted of four pile bents of four piles each, and two center pile bents of five piles each. These bents were capped, top of caps being elevation of spring line of arch, and four lines of 6 in. by 8-in. stringers were placed continuous from abutment to abutment, the ends, at elevation of the spring line bearing 4 in. on the concrete abutments. At completion the ends of stringers were bored out and the

holes in the abutments filled with concrete. On these four lines of stringers, were placed a set of pine wedges over each pile, there being four and five sets of wedges to each bent; 3 in. by 12-in. timber was laid on the wedges over each bent through the width of the arch. On these 3 in. by 12-in. timbers, the arch bents were erected, each having four and five 6 in. by 8-in. vertical posts V-braced, with 6 in. by 8-in. caps set edge-ways, top of caps 12 in. below intrados of arch. On these caps were placed 2 in. by 12-in. ribs, dapped to take square bearing on caps. These ribs were placed 18 in. centers across the arch and were cut from timber of

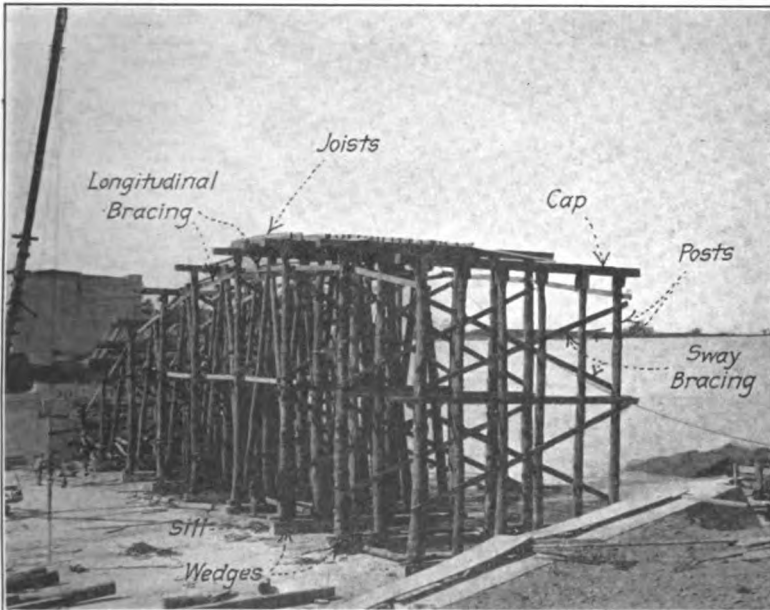

FIG. 112.—Common form of timber centering for arches of low rise.

sufficient dimensions to make them lap over alternate caps. The ribs were covered with 2-in. planking to form the intrados of the arch.

“A very simple and accurate method of laying out the ribs was used which consisted of laying out the full-size arch intrados radii on a level place near the bridge site. The timber for the ribs was, therefore, marked by a full-size drawing. Probably the most interesting feature of this arch centering was the simple straight work giving maximum strength and maximum safety in every respect at the lowest cost. The five steel floor beams of the old bridge were utilized to make an 18-ft. clear opening of maximum height in the centering. This was economical, as it saved one pile bent and one centering bent, but its main

purpose was to allow drift to pass through in case of high water during construction."

Figs. 116, 117, 118, and 119 show timber centers similar to the one just described.

A patented type of centering is shown in Figs. 120A, 120B, 120C, and 120D, known as the Luten arch centering (see Chapter XII). The idea in this center is to dispense with the usual wedges employed in lowering the falsework. The top part of the uprights consist of two thin members with major dimensions transverse

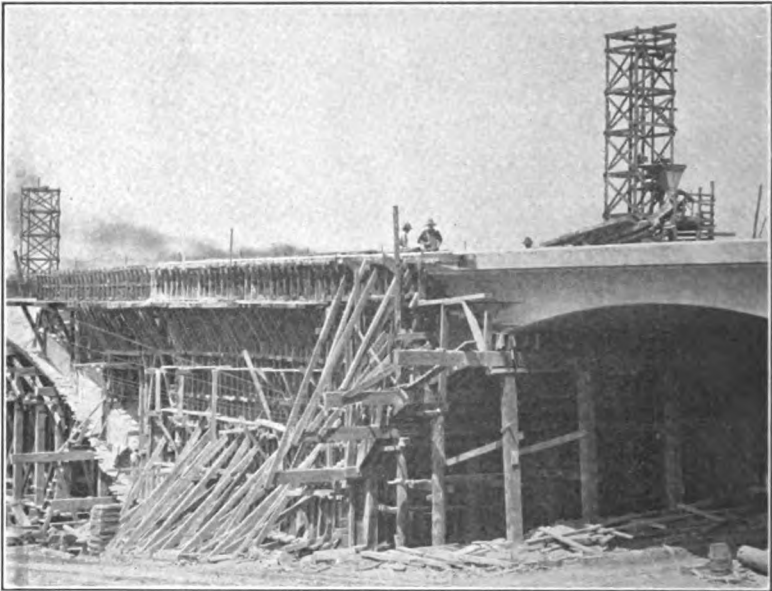

Courtesy of Marquette Cement Mfg. Co.

FIG. 113.—Centering for arches of low rise, Grand Avenue viaduct, Milwaukee, Wis.

to each other. These are arranged in the form of a T-column, and wired together at frequent intervals. Each member separately is made too light to carry its loading so that clipping the wires permits each member to buckle, which lowers the center. Fig. 120B shows the first stage in construction. The joists are nailed to the uprights which consist originally of only one member each. The transverse members of the uprights are then added to form the T-columns. The V-bracing is put in position after all the joists and uprights are in place.

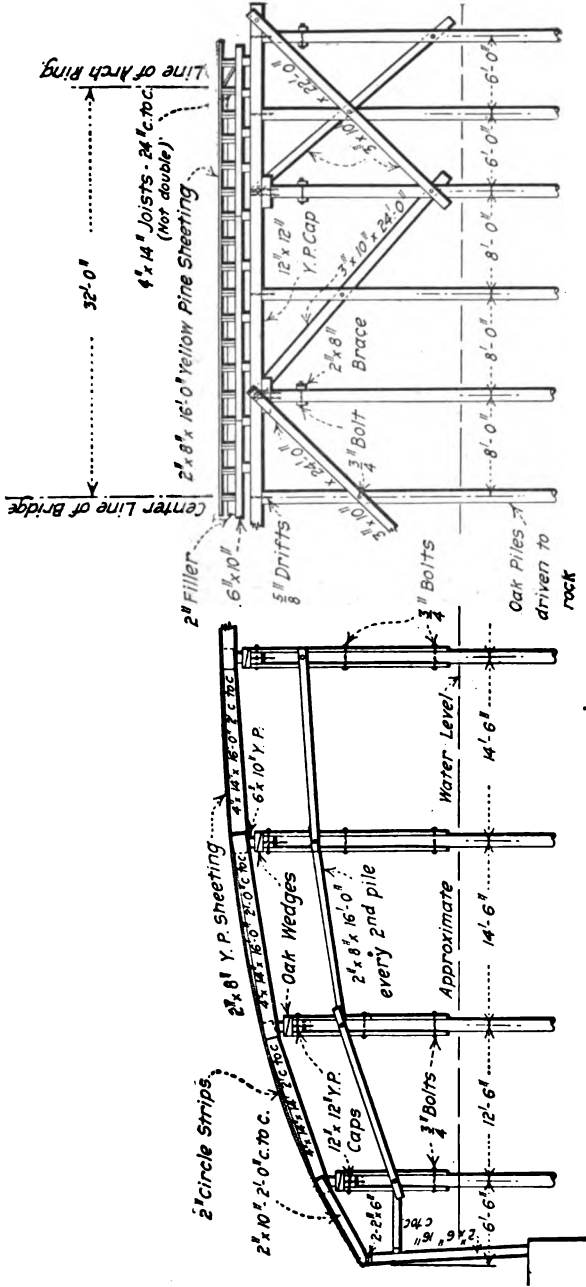

Section showing Half of Center Bent

Half Side View

Fig. 114.—Centering for Third Avenue bridge, Cedar Rapids, Iowa.

- All Plumb Posts, Caps, and Stringers - 6" x 8" Yellow Pine Timber
- All Batter Posts - 4" x 6" Y.P. Timber
- Arch Ribs - 2" x 12" Y.P. Timber
- Arch Flooring - 2" x 10" Y.P. Timber
- Other Braces - 2" x 6" Y.P. Timber

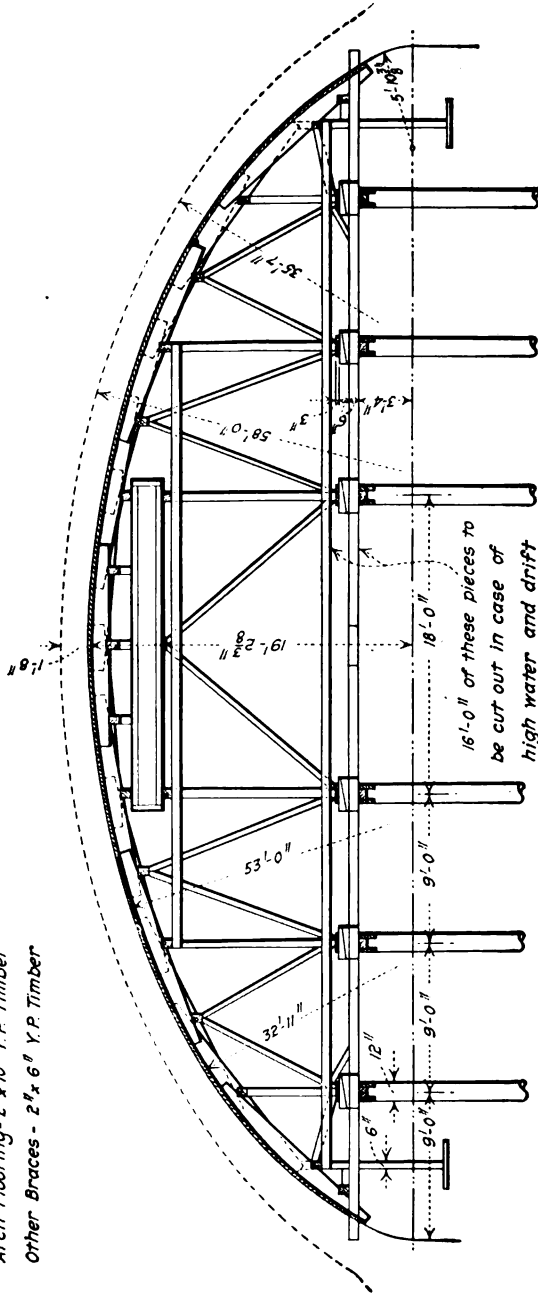

FIG. 115.—Falsework and centering for Cleveland Avenue bridge, Kansas City, Mo. Note structural steel girder carrying the center of the span to allow for flood.

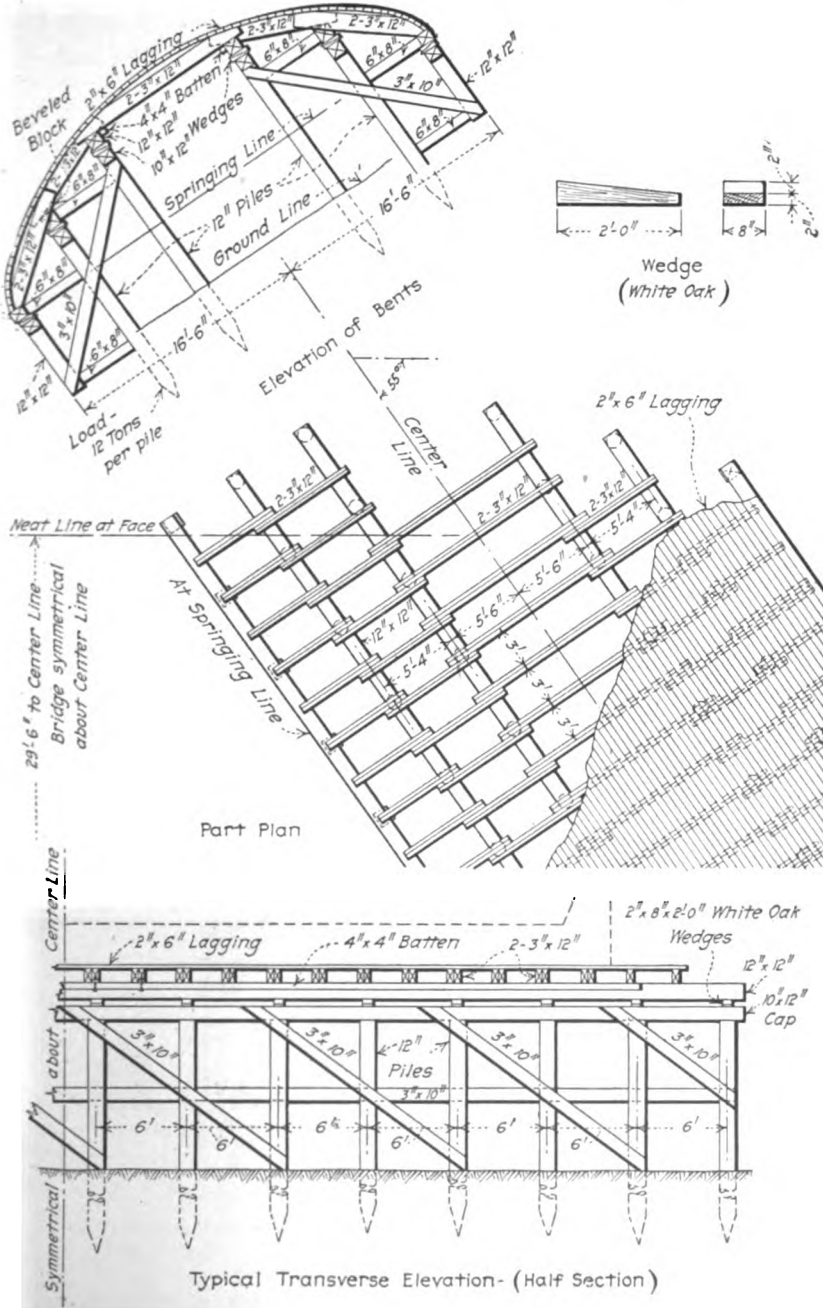
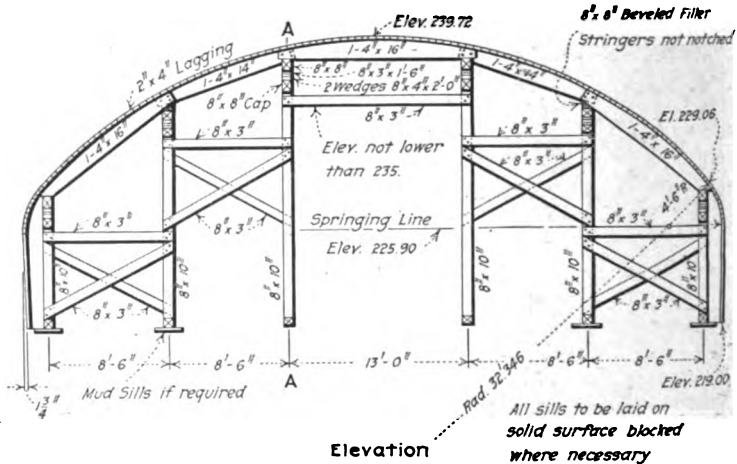
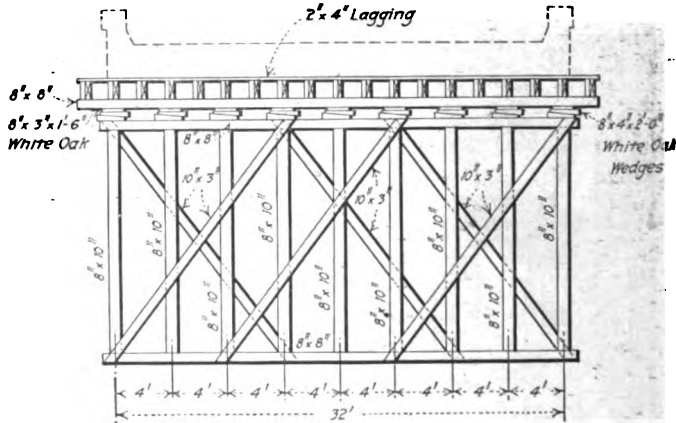
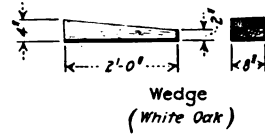

FIG. 116.—Details of arch centers for proposed renewal, C. R. R. Co. of N. J.

Mr. W. W. Washburn in an article in Concrete-cement Age, August, 1914, writes as follows in regard to the centering shown in Fig. 121:



All lumber to be Yellow Pine unless otherwise stated. All bolts, $\frac{3}{4}$ " with two standard C.I. washers. Lagging to be matched and dressed to a uniform thickness so as to form a smooth and true surface. All lagging to be 2" x 4" tongue and groove



Section A-A

FIG. 117.—Details of arch centers for Center Street bridge, Phillipsburg, N. J.

“Since Buffalo Bayou is a navigable stream, it was necessary to leave an opening in the arch centering for the passage of tugs and boats

during construction. This opening was 24 ft. vertically above average water level and 38 ft. wide. Protection piles on each side of the passage-way were necessary, consequently the total span of the opening in the arch centering was 49 ft. To carry the load over this opening nine 30-in., 200-lb. I-beams were used. These I-beams will be used in the construction of other bridges.

"Longitudinal bracing was arranged so as to counter, as much as possible, the 'bucking up' tendency of the centering at the crown as the arch was concreted. On account of the arch being skewed, special study was given during the placing of braces, etc., so as to take care of all side thrusts. Struts were placed diagonally between bents at right

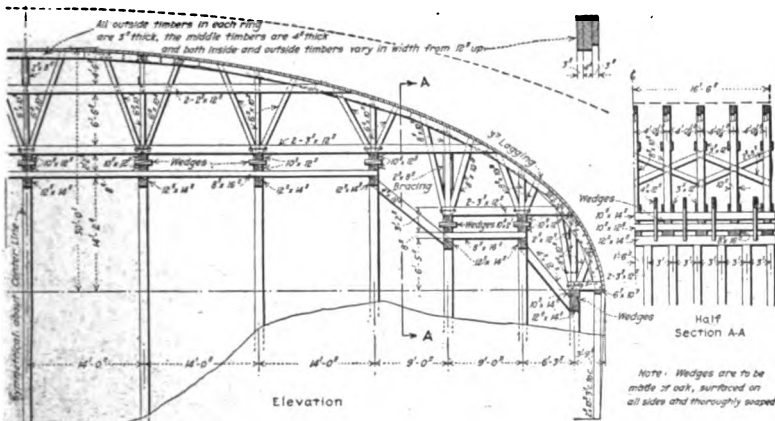

FIG. 119.—Falsework for bridge over Big Muddy River, I. C. R. R.

angles. Spacing of centering piles was such that no pile received a load of over 12 tons."

Timber centering for a bridge over railroad tracks at Fall River, Mass., is shown in Fig. 122 and described in *Engineering Record*, issue of April 26, 1913, as follows:

"In building the arch centering it was necessary to provide for certain requirements that necessitated a design similar to the one shown in the accompanying drawing.

"These requirements called for an overhead clearance of 18 ft. at a point 11 ft. 3 in. from the property line, a clear span of 40 ft. between inside vertical posts, and a minimum clearance of 15 ft. from the top of rail to the under side of the truss. The work had to be conducted without interruption of train service. The uprights supporting the centering were carried on concrete mud sills and 2-in. tongue-and-groove lagging



FIG. 120B.—Luten arch centering.

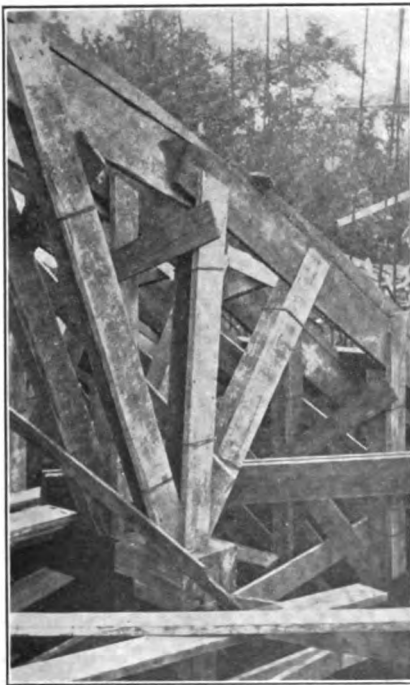

FIG. 120C.—Luten arch centering.

was used over the entire arch ring. The centering was designed for a deflection equal to one eight-hundredth of the span."

In the construction of the Hights Run bridge shown in Fig. 83 the two arch ribs were constructed in sections and each section cast at one operation. The false work consisted of braced timber posts supporting I-beams which carried the lagging for the arch ribs. All adjustments for the arch rib were made by wedges immediately under the I-beams. Two bents of posts of the false



FIG. 120D.—Luten arch centering.

work were located under each section of the arch rib, and located so that the center of gravity of the section fell between the posts which were braced together like a single tower; thus each section of the rib was independently supported and adjusted. In designing the falsework no soft lumber was subjected to cross-grain compression, hard wood being used for sills and caps. Posts and bracing were of yellow pine.

Figs. 123A and 123B show the type of arch centering used in

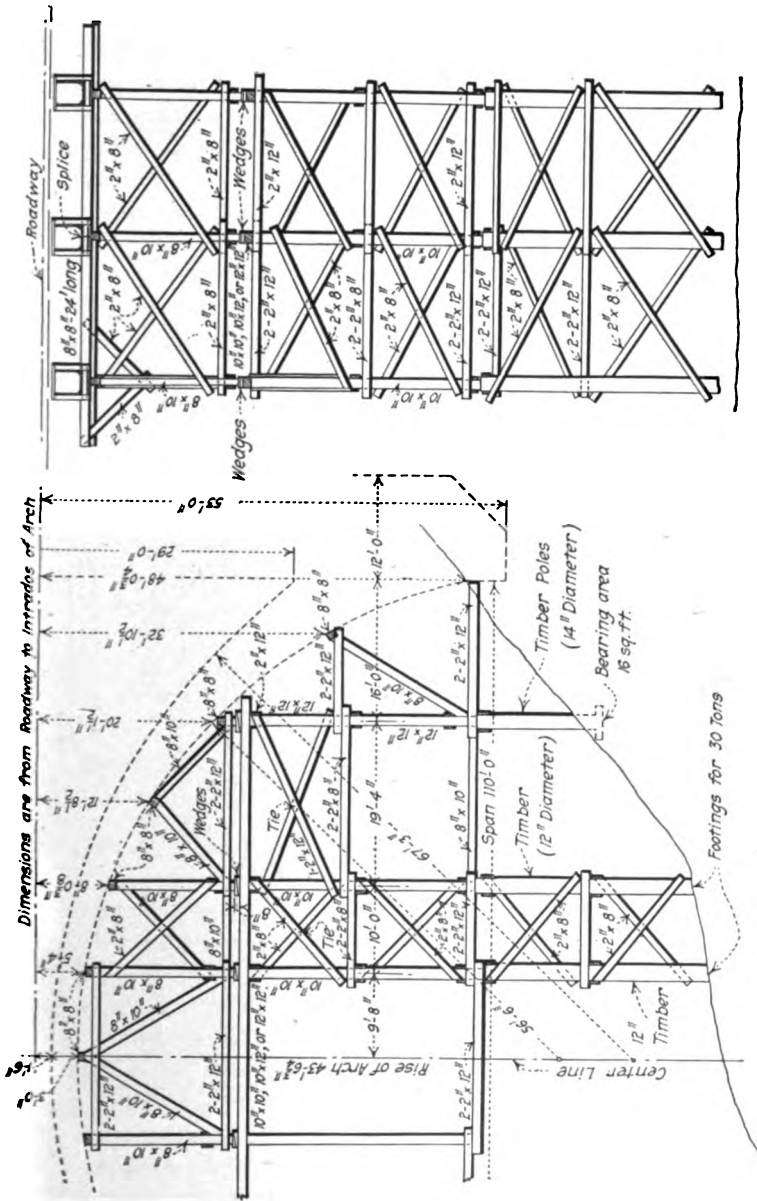

Elevation
Section on Center Line
Fig. 123A.—Centering for bridge over ravine on Mississippi River Boulevard, St. Paul, Minn.

A sand box used in the main arch of the Edmondson Avenue bridge, Baltimore, is shown in Fig. 125. The center was lowered by allowing the sand to run out through a 1-in. circular hole in the oak bottom of the steel-plate cylinder. This hole was closed by a wooden plug while the centering supported its load. A disadvantage in the use of sand boxes lies in the fact that the centering cannot be raised before the arch ring is poured in order to adjust the top members to the curve of the arch intrados.

In the design of large arch centers an uncertainty exists regarding the pressures from voussoirs placed on the steepest portions of the lagging. Either of two assumptions are usually made as to the forces acting on the centering due to the weight of such voussoirs. In the common method of design, the assumption is made

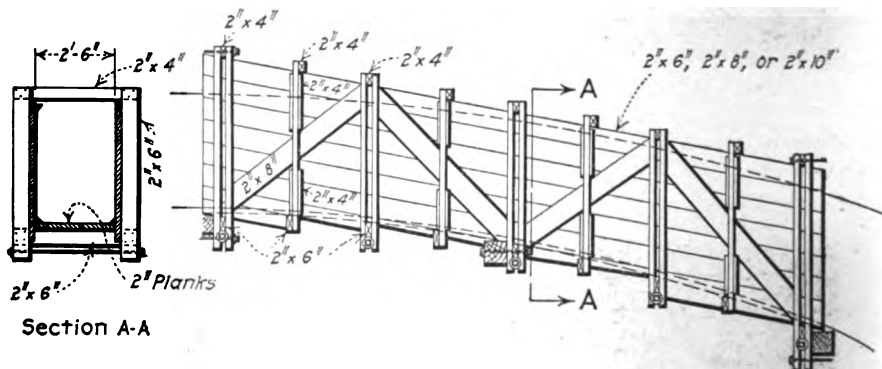

FIG. 123B.—Rib boxing for bridge over ravine on Mississippi River Boulevard, St. Paul, Minn.

that the centering sustains only the radial components of the voussoir weights, the tangential components being resisted by temporary struts between voussoirs so as to be transferred to the abutments. The more accurate method is to assume that tangential pressures (in addition to the radial pressures) act on the centering which, from any voussoir, may be as great as the product of the radial component and the coefficient of friction between the voussoirs and lagging. The original tangential component is then reduced by this amount.

Since a timber center is only a temporary structure and has a high salvage value, great accuracy in the design of the separate members is not necessary. The method of design need only be such that the size of each member is well on the safe side. Then,

too, rigidity is quite as important as strength, so that all things considered, close figuring is out of the question. Obviously the weight of centering may be omitted except for high arches. For

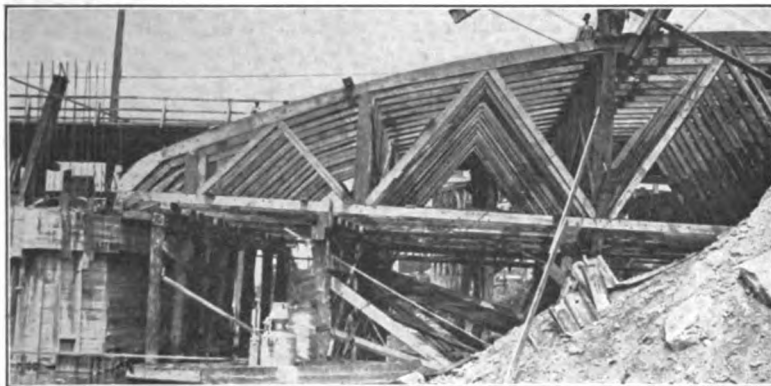

FIG. 124A.—Centering for High Street bridge, Hamilton, Ohio.

the method of designing lagging, joists, and posts see Art. 88, Volume II.

As a rule, only hard wood should be used for caps and sills,



FIG. 124B.—Centering for High Street bridge, Hamilton, Ohio.

although long-leaf pine may be sufficiently hard in many cases. Wedges, however, should be made of hard wood without exception. It is always advisable to reduce the number of joints in side-grain

compression to a minimum on account of the low bearing value of timber across the grain. Steel distributing plates are of advantage in this connection.

Care should be taken to prevent lateral displacement of vertical posts due to radial pressure from the arch ring. This may be avoided either by proper longitudinal bracing or by notching out the joists and shimming them tight against the caps.

Many practical notes on the design and erection of falsework may be found in Section 7 of the American Civil Engineers' Pocket Book.

In striking arch centers, wedges should be lowered gradually beginning at the crown and working toward the springing lines. The lowering should be done symmetrically with respect to the center of the arch ring. In a series of arches, centers between

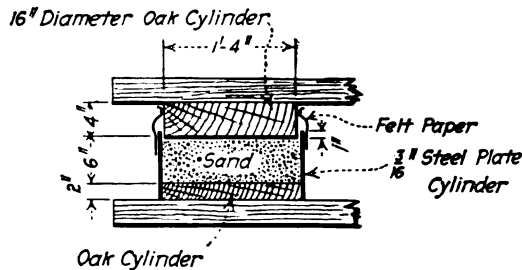

FIG. 125.—Sand box.

abutments or abutment piers should be struck simultaneously. As a rule, centers should not be struck from arches in less than 28 days under favorable weather conditions, and it is desirable that a longer period should elapse if possible.

Steel Centers.—Steel centers of the arch-trussed type (Fig. 126) should receive consideration when arches are to be built in series or where the character of the stream or crossing renders timber and pile falsework impossible or expensive. Undoubtedly the cost of a steel center is usually high, but if it can be used a number of times, as in a large series of arches, it may not prove any more costly than timber. Mention should be made of the fact that in the Cummings-Watson system, to be described later on, the steel arch centering consists of triangular units which can be adapted to any shape and can be used for any span or curve by connecting and adjusting the units to fit. It is quite likely that with these

units as part of a regular contractor's equipment, the steel center may be used with economy even in ordinary construction.

It is generally recognized that there are some well-defined advantages in using three-hinged arch centers. In the first place, the crown deflection using steel centers is usually much less than that obtained by employing timber falsework. Furthermore, it is possible to compute the deflection of each point of a steel center with some degree of accuracy while, in the case of a wooden center, the probable settlement at each bent is pretty much a matter of guesswork. Steel centers also have the additional ad-

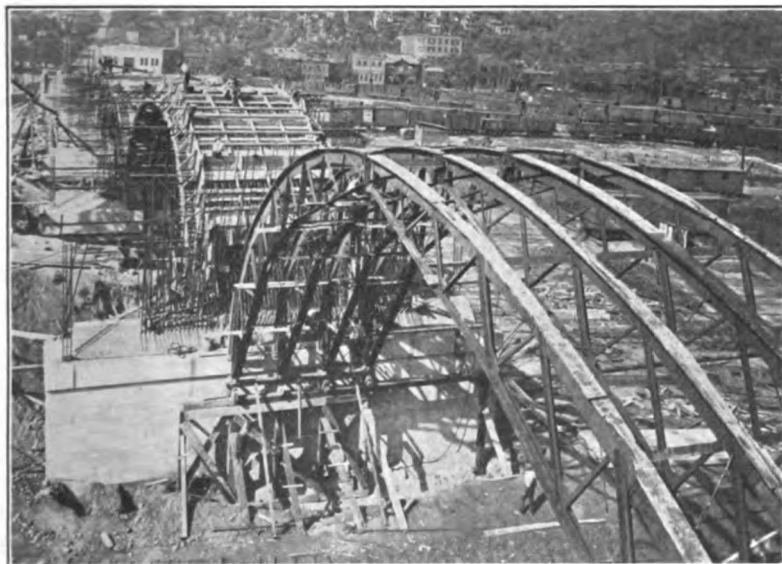

Courtesy of Mr. N. S. Sprague, Superintendent, Dep't. of Public Works, Pittsburgh.

FIG. 126.—Steel centers for North Side Point bridge, Pittsburgh, Pa.

vantages of allowing an obstructed opening for railroad or other traffic and of eliminating danger from flood and ice in the construction of arches over streams. The advantage of allowing the deflection to be quite accurately computed makes it possible to give the centers a preliminary camber so that when the concrete is in place and the centering withdrawn, the arch ring will assume its true position.

One disadvantage of using steel in arch centering lies in the fact that it is materially affected by temperature changes. For this reason, in constructing large arches, only the alternate block method should be employed.

The steel centering used in constructing the three-span earth-filled arch structure which carries Atherton Avenue in the city of Pittsburgh across the four tracks of the Pennsylvania Railroad is shown in Fig. 127. This centering, fabricated by the Blaw Steel Construction Company, consisted of steel arch trusses spaced 5 ft. 5¼ in. on centers. The trusses carried timbers and lagging, and were supported on framed trestle bents placed close to the pier faces. Sufficient trusses were at first erected to concrete one-half the width of each arch ring, then the centers were shifted transversely to themselves and the concrete placed for the second half of the structure. The method used in construction and the details of the arch centering are described in *Engineering and Contracting*, issue of February 19, 1913, as follows:

“A six-post bent was erected on the footing shelf of the pier, the idea being to have a bent-post under each arch rib. On the bent caps over each post was placed a block and double wedge and on these supports a 12 in. by 12-in. plate on which rested the ribs. Between each pair of ribs a dolly was fastened to the bent-caps.

“The shifting of the center to construct the second half of the arch was accomplished as follows: Jacks were set up on the bent-caps alongside the dollies, and a strain taken on them until the wedges were loosened sufficiently to be easily removed. The jacks were then lowered until the weight of the centers rested on the dollies. To prevent the lagging and cross timbers from being lifted off the ribs by sticking to the soffit of the arch ring, one end of the center was lowered ahead of the other so as to give a stripping action in freeing the lagging. When lowered into the dollies the whole center was shifted sidewise rubbing on the dollies, until it rested on the six-post bents under the second half of the arch. The jacks were then placed on the caps of the second bents and the center raised and the blocks and wedges inserted. A steamboat ratchet was used to pull the center on the dollies. Four men working 8 hours shifted a center. Incidentally the tie rods connecting the opposite ends of the ribs were found, when planked across, to provide a most convenient bridge for the workmen engaged in shifting and adjusting the centers.

“The lateral thrust on the centers due to their skewed position was taken care of by suitable lateral bracing of the ribs. In anticipation of the center rising at the crown in concreting from the haunches upward, the ribs were anchored back to the pier masonry as shown in Fig. 41. The joining carried by the ribs consisted of cross-timbers over which were notched stringers with curved top edges. The stringers were spaced 11½ in. apart and were lagged with ½-in. boards. The bearings of the stringer ends against the piers were formed by wedges.”

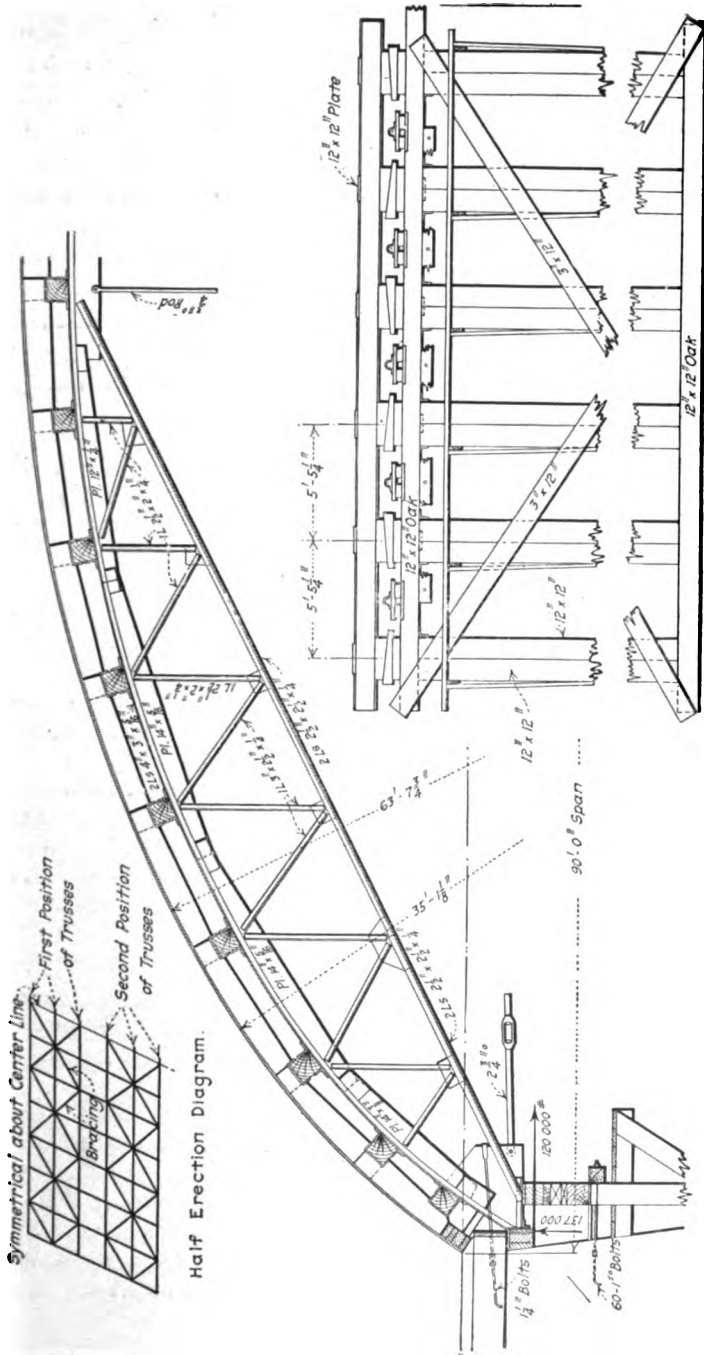

Supporting Bent for Steel Truss Centering
 Fig. 127.—Steel centering for Atherton Avenue bridge, Pittsburgh, Pa.

Steel centering employed in the construction of the South Eighth St. Viaduct, Allentown, Pa. (a two-ribbed arch structure of nine 120-ft. spans) is shown in Fig. 128. The Engineering News, issue of April 17, 1913, describes this centering as follows:

“For the nine 120-ft. arches three full sets of steel arch centers were used, using each set for three of the arches. Each set of centers consisted of two independent-trussed arches of the outlines shown in Fig. 128, each arch supporting one of the twin concrete arch ribs and being itself made up of two steel arch ribs interbraced with steel struts. Across

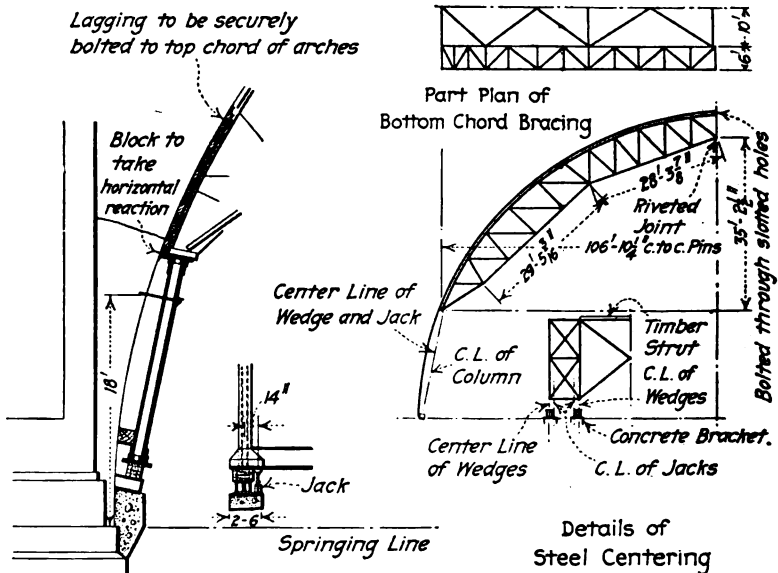

FIG. 128.—Details of steel centering for South Eighth Street viaduct, Allentown, Pa.

the upper chords of these steel ribs, which were curved to the curve of the concrete arch, was bolted the wooden lagging on which the concrete was deposited. The twin centering arches were held together by a timber cross-beam and diagonal steel rods.

“The arch trusses were fabricated in six sections and riveted on the ground into semi-arches, which were lifted by derricks into place, to be bolted at the base to the supporting columns. At the crown it was riveted solidly in the bottom chord, but bolted through slotted holes at the upper chord, to insure the stress passing through the lower chord.

“The centers were supported on inclined steel columns which footed on concrete steps purposely projected from the main section of the pier

Piers built to this line before centers are erected

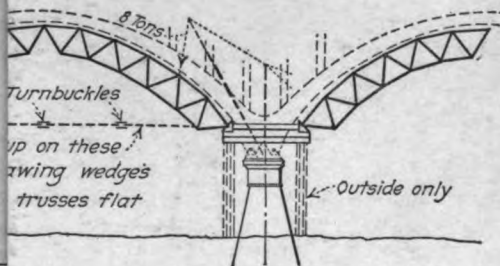

For Centering Rib
For Centering Rib
For Centering Rib

Center Line of Bridge

10' x 10' Thrust Bms. for Ins.
Conc. Seat to be built in pier and later chipped off

Tighten this nut after lowering

- 2-4" x 3" x 1/2" Ls
- 1-3" Standard
- 2-1/2" Standard
- 2-6 3/16" Fillers
- 2-6" x 3 1/2" x 1/2" Ls

Three of these rods extend across the span for each rib. They carry only the load of the centers when moving over.
15" L @ 33#
1/2" Pl.
1/2" Pins
1 1/2" Forked ends - 3 Turnbuckles
Length varies (about 115')
3" x 3" x 3/4" Ls
24" x 1/2" Pl.
Section B-B

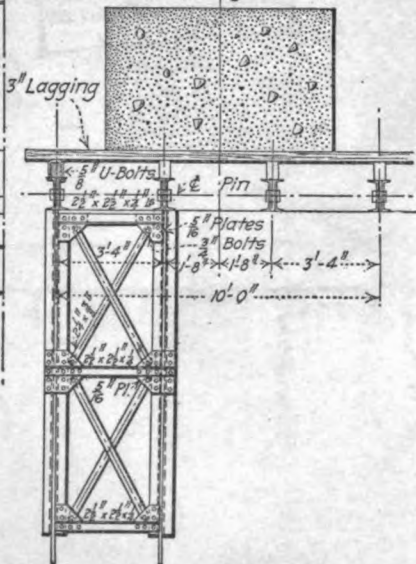

Watson System.

(Facing Page 222.)



Figure 1. Mechanical assembly diagram.

and cut off after the centers were struck. The base plates of the columns rest on cast-iron wedges which in turn rest on I-beam grillages, footing on the afore-mentioned concrete projection. Between the column base and the projection, 10-ton screw jacks are interposed to aid in the alignment and leveling of the centers; they are allowed to remain in place, though the load passes directly to the wedges which are used for striking centers. A U-shaped clamp, made of a 1-in. bolt (not shown in the drawing), is passed around each pair of wedges to prevent any possible lateral motion. A similar bolt is used for the same purpose higher up on the main column."



Courtesy of Mr. Philip Aylett, Civil Engineer, St. Louis.

FIG. 130.—View of Chickahominy River bridge during construction. Key spaces have just been filled with concrete. Forms are being taken off rib in order to hasten setting of concrete.

The unique feature in the steel centering used in constructing the Tunkhannock Creek viaduct on the relocation of the Delaware, Lackawanna, and Western Railroad was an adjustable panel at the crown of the steel arch trusses. A detailed description of these trusses and their erection may be found in Chapter XXXII.

The Cummings-Watson system of steel arch centering is shown in Fig. 129. The centering consists of triangular units, pin-connected at their apices, and with extra adjustable members which serve to connect the units and at the same time serve to form the lower chords of the arch trusses.

Suspended Systems.—Suspended systems of arch construction refer only to arches of the ribbed type.

The Aylett System (patented)¹ of suspended centering, pre-



Courtesy of Mr. Philip Aylett, Civil Engineer, St. Louis.

FIG. 131.—View of Chickahominy River bridge during construction. One rib completed and suspended centering ready to be removed.

viously illustrated in Fig. 108, is shown in detail in Figs. 130 and 131, which are construction views of the Chickahominy River bridge, Richmond, Va. (Fig. 132 is a view of the completed

¹ See *Engineering and Contracting*, June 21, 1911, or *Cement Age* for June, July, and September, 1911, for detailed account of this method of construction.

arch structure.) Another Aylett method of arch construction is shown in Fig. 133, known as the pre-casted voussoir method.

A patented system of arch erection without falsework, originated by Mr. J. B. Strauss and tried out in the construction of a bridge over the Kiswaukee River near Belvidere, Ill., in 1906, is illustrated in Fig. 110. Voussoir forms are made of reinforced concrete in sheet-metal molds (Fig. 134). After these forms are raised to position they are held in place by suspension rods which pass over A-frames supported on top of the piers and anchored by means of steel rods. The concrete forms when self-supporting form an arch trough in which the reinforcing steel and concrete



Courtesy of Mr. Philip Aylett, Civil Engineer, St. Louis.

FIG. 132.—View of completed Chickahominy River bridge near Richmond, Va.

are placed. The concrete forms are designed to safely carry their own weight and the weight of the concrete deposited therein. (Fig. 135 shows the completed Belvidere bridge.) Fig. 110, previously referred to, shows a traveller on falsework used in connection with the construction of the Belvidere bridge. This is not the way, however, that the Strauss System is intended to be used, since the particular object of the construction is to avoid any falsework whatever in the stream. In the erection of the Belvidere structure it was impossible to procure a cableway in time to start the work, and the traveller method was used on that account.

Reinforcement in the form of steel arch trusses to carry the

arch rib forms are shown in Figs. 111 and 136. These trusses were designed to carry the weight of the arch forms together with the dead load of the wet concrete, both as to tension and compression, the result being that the steel reinforcement of the arches was stressed by the weight of the forms and wet concrete

Note: voussoirs are suspended and coupled together at floor level on both abutments, L and R, simultaneously. As the resulting "voussoir-chairs" grow in length, link by link, they descend to junction at crown of arch. Final adjustment and keying of entire arch-rib then proceeds

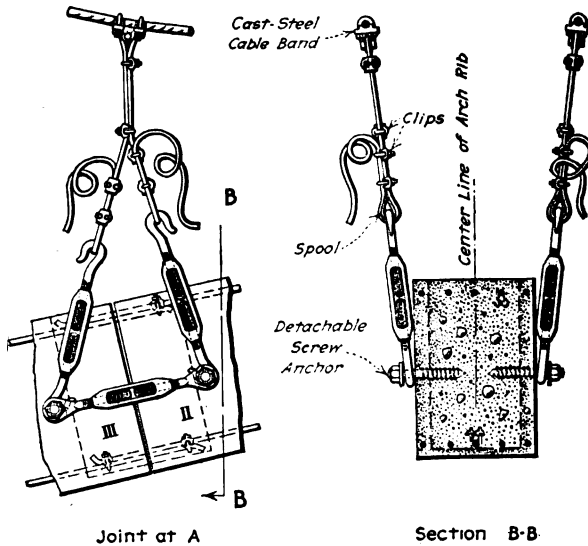
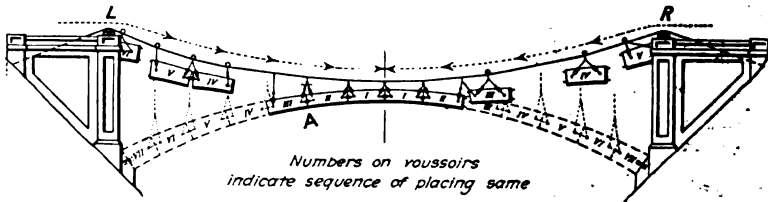
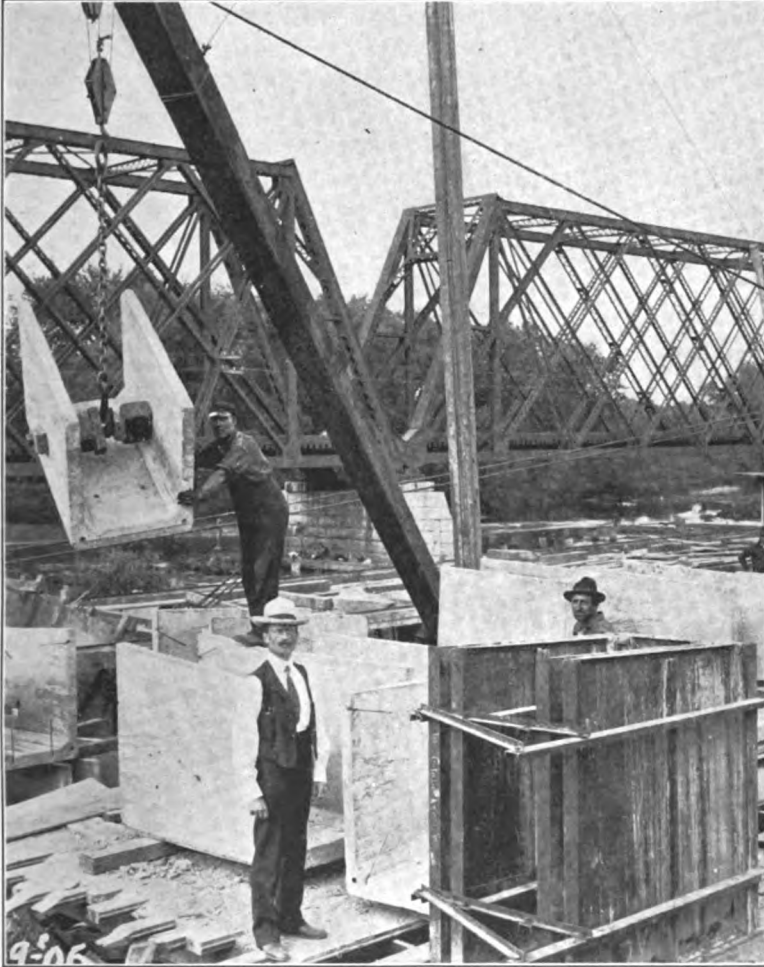

FIG. 133.—Pre-casted voussoir method of arch erection.

before the concrete obtained its set. In the finished structure the reinforcement was also considered to do its share in carrying the live load.

In Fig. 111 a wire mesh is shown on the outside of the outer line of arch ribs. This was stiffened by means of small vertical rods

and supported from the steel arch trusses at a distance of 2 in. from the face form. The white Portland cement and crushed granite aggregate were carried up next the form and



Courtesy of the Strauss Bascule Bridge Co., Chicago.

FIG. 134.—Voussoir forms used in the Strauss system of bridge construction.

outside of this mesh, a little ahead of the gray Portland cement concrete in the body of the arch. The mesh of the wire screen was large enough to admit stones from the granite aggregate passing through, but too small to allow the gray limestone of

the main aggregate from passing outward toward the face. The advantage of this construction was, of course, the carrying up of the two masses simultaneously, and did not require the pulling of an intermediate form with the consequent dislodgment of material and breaking of the bond between them.

Figs. 136 and 137 show that the upper chords at the ends of the arches were each connected by two tension rods. Boxes of clay were arranged back of the nuts of these rods, so that in case of any lengthening of the arches the rods would slide through their bearings, but would come into action in tension under heavy loads.

Figs. 111 and 136 show also working platforms suspended from

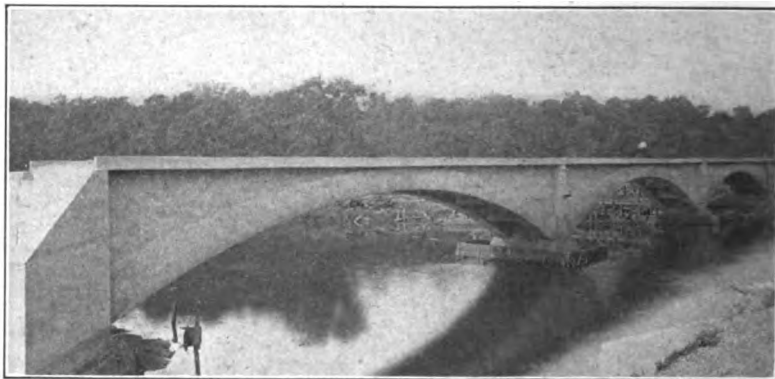

Courtesy of the Strauss Bascule Bridge Co., Chicago.

FIG. 135.—Bridge over the Kishwaukee River near Belvidere, Ill. Built by the Strauss system.

the steel arch ribs. The reason for suspending these platforms rather than building up falsework may be seen in Fig. 111, where high water is passing under the bridge and a low power dam crosses the river 10 ft. upstream. A 98-ft. fall also occurs a few hundred feet downstream. Fig. 138 is a view of the completed structure. Incidentally it might be stated that the floor has a 2-ft. camber in its entire length, the ends of the structure being at the same elevation.

55. Forms.—Forms for piers and walls are usually constructed of either 1-in. or 2-in. plank nailed to studs and held by horizontal waling pieces, with tie bolts extending across the pier or wall between opposite wales. The wales, which consist generally of two planks fastened together but separated by

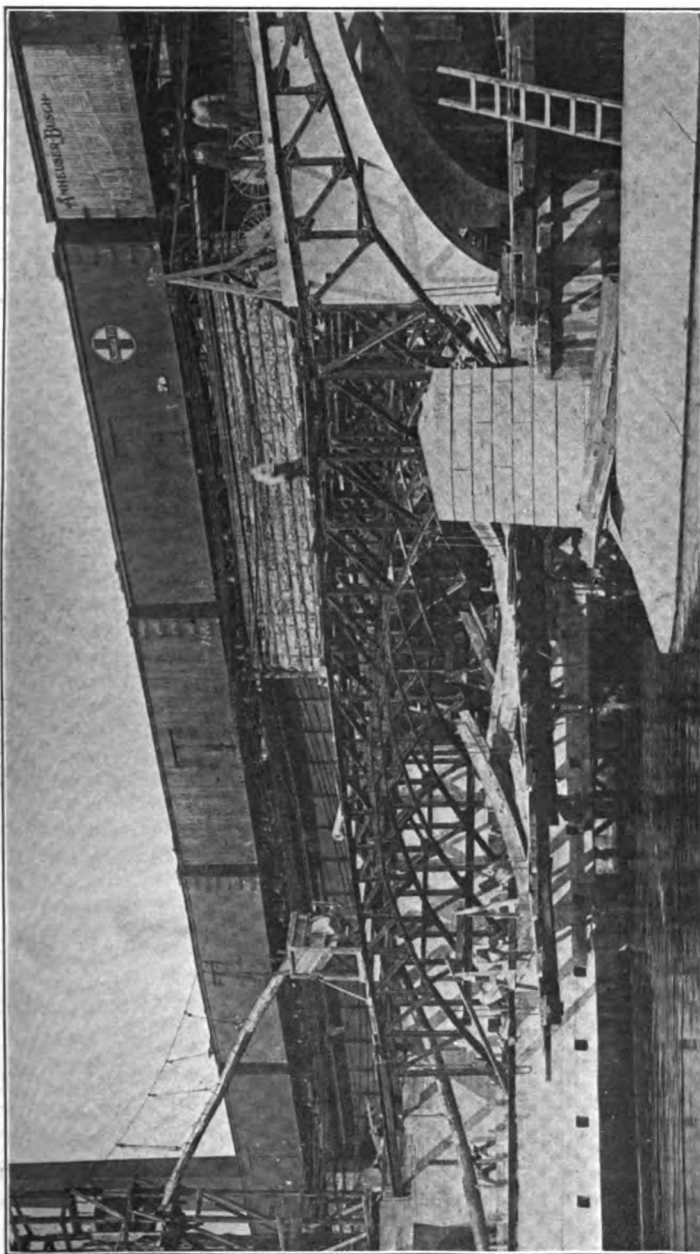

Courtesy of Mr. John F. Skinner, Prin. Ass't. Engineer, Dep't. of Engineering, City of Rochester.
Fig. 136.—Bridge at Central Avenue, Rochester, N. Y. under construction.

spacing blocks, are set edgewise against the form studs and the tie bolts are carried through the openings which occur in the waling pieces. Wire is sometimes used for bracing and is tightened either by wedges or by twisting. The wire pulls against spreaders which are inserted between forms and which are removed as the concrete level rises. As in most form work, bridge forms are either erected in sections of a size for easy

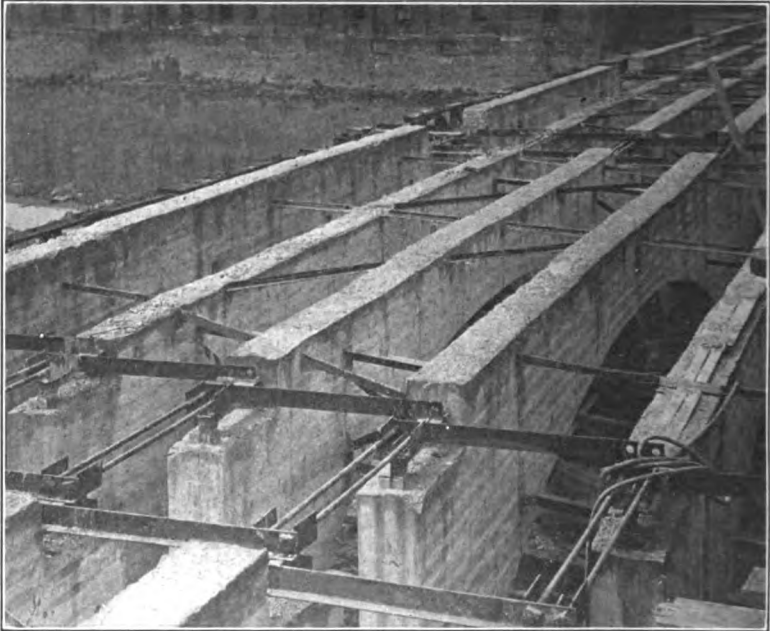

Courtesy of Mr. John F. Skinner, Prin. Ass't. Engineer, Dep't. of Engineering, City of Rochester.

FIG. 137.—Bridge at Central Avenue, Rochester, N. Y. under construction.

handling or built in place (Fig. 139). Forms of small height may be braced by only battered posts outside.

Where bolts are employed in pier and wall construction, a number of different methods are used for withdrawing the bolts. One method is to cover each bolt with old pipe cut somewhat shorter than the inside dimensions of the forms, and to place a wood washer at each end of the pipe. When the forms are taken down, the bolts are easily drawn out of the pipes, the wood washers are then cut out of the face of the concrete, and the holes pointed up. Another method is to make the bolts

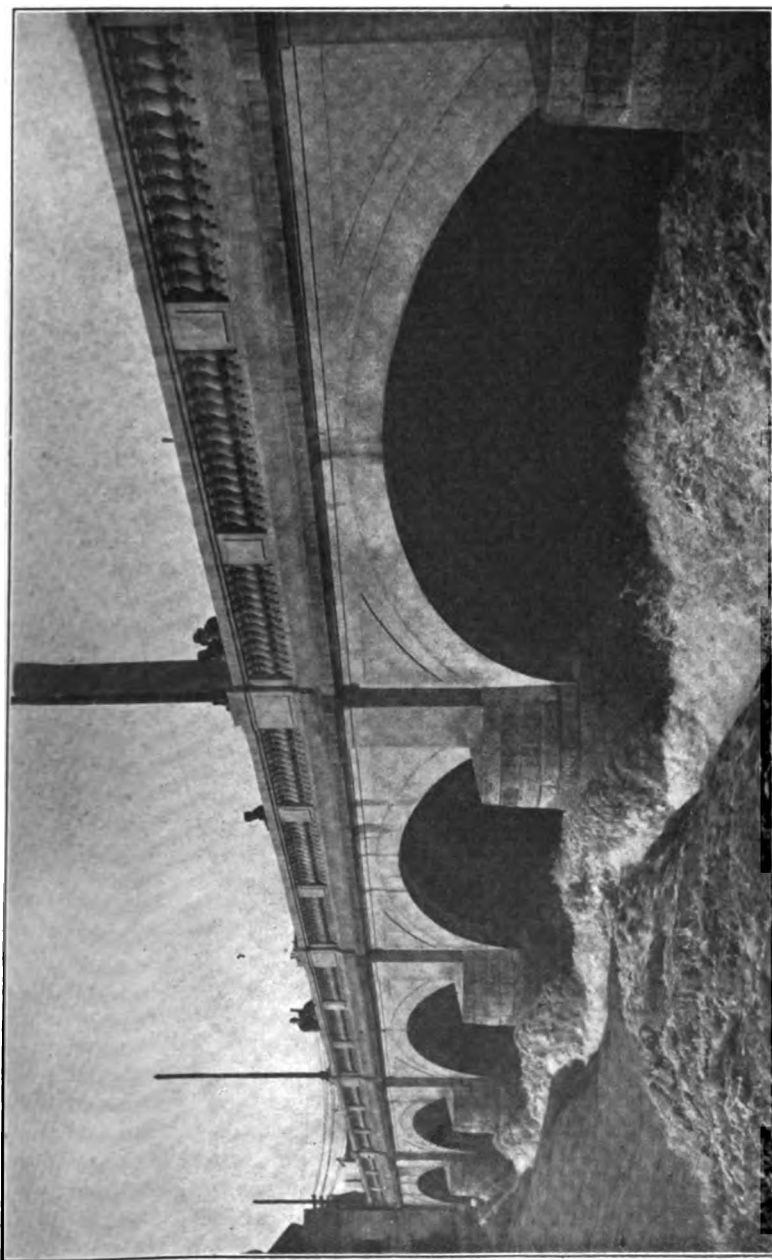

Courtesy of Mr. John F. Skinner, Prin. Ass't. Engineer, Dep't. of Engineering, City of Rochester.
FIG. 138.—View of completed bridge at Central Avenue, Rochester, N. Y.

in three pieces, with the middle piece occupying the same position between the forms as the pipe above described. This middle section is connected with the end pieces by means of ordinary unions. When the concrete has set sufficiently, one turn releases the end sections and the holes left in the work are plugged with mortar.

The following specification for the construction of forms is

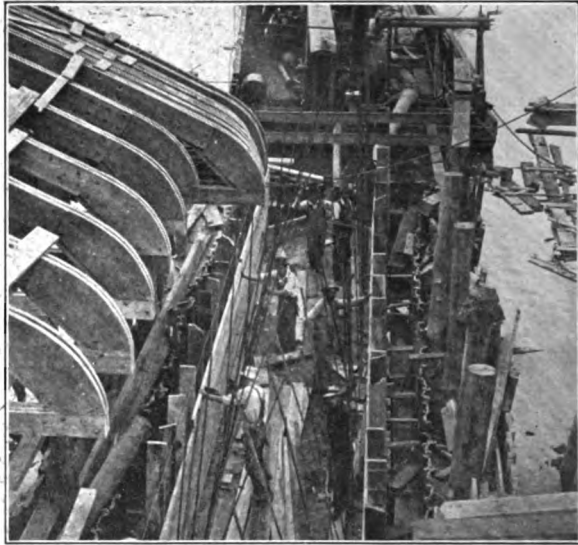

FIG. 130.—Constructing pier of Main and High Street bridge, Hamilton, Ohio.

taken from the "Specifications of the Piney Creek concrete bridge, Washington, D. C."

"All forms for all classes of concrete shall be closely laid and strongly braced. The contractor shall, before proceeding with the work, submit drawings of the forms to the engineer for his approval. All lagging shall be tongue-and-grooved, and the studding for all the work shall be dressed or sawed to an even thickness. All forms, except by the consent of the engineer, shall be held in place by means of bolts, so made that the outer 3 in. of the bolts can be removed after the forms are taken down and the remaining holes shall be filled with mortar. If $\frac{3}{4}$ -in. lagging is used, the studs shall not exceed 18 in. on centers; and, if 2 in. by 8-in. studs are used, the wales shall not be less than 8 in. by 8 in. These wales on a basis of 2 in. by 8-in. studs shall not be farther apart than

8 ft., nor shall the bolts which hold them and which have diameters of $\frac{3}{4}$ in. be farther apart than 8 ft.

"If lagging, studs, wales, or bolts are proposed by the contractor other than those described herein before, they shall be such as to make a form of equal strength and stiffness to that described.

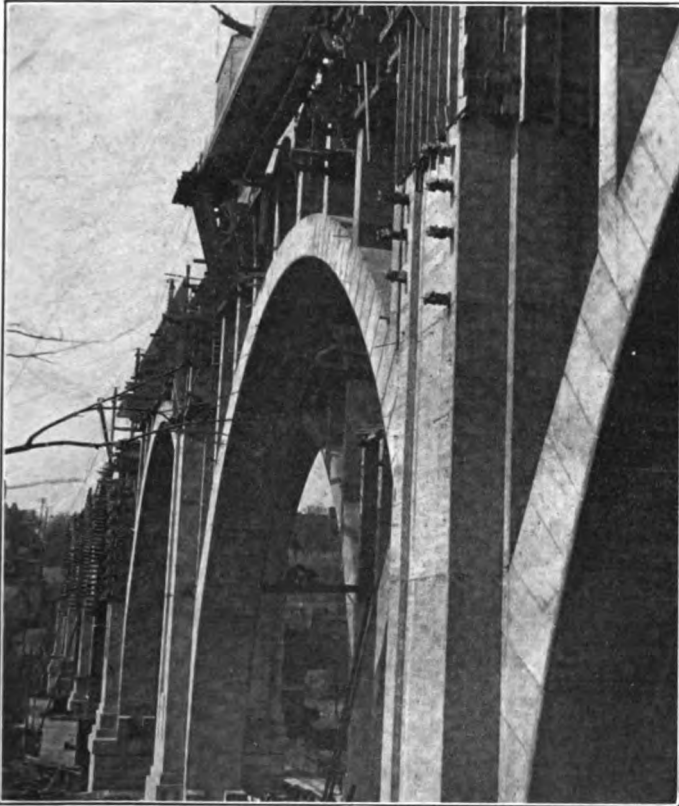

Courtesy of Lehigh Portland Cement Co.

FIG. 140.—Construction view of Eighth Street viaduct, Allentown, Pa.

"Washers shall be used under all bolt heads and nuts, and, before proceeding with the concrete work, forms shall be brought true to line and grade, and all bolts shall be taut."

Where especially good work is desired, forms are lined with galvanized iron. For high piers or walls, the forms are constructed in large panels. After the concrete has been constructed to a proper height and the last course has set several days, the panels are disconnected and hoisted to a higher posi-

tion and then reassembled for concreting, and so on. The same practice is followed in pilaster construction (Fig. 140).

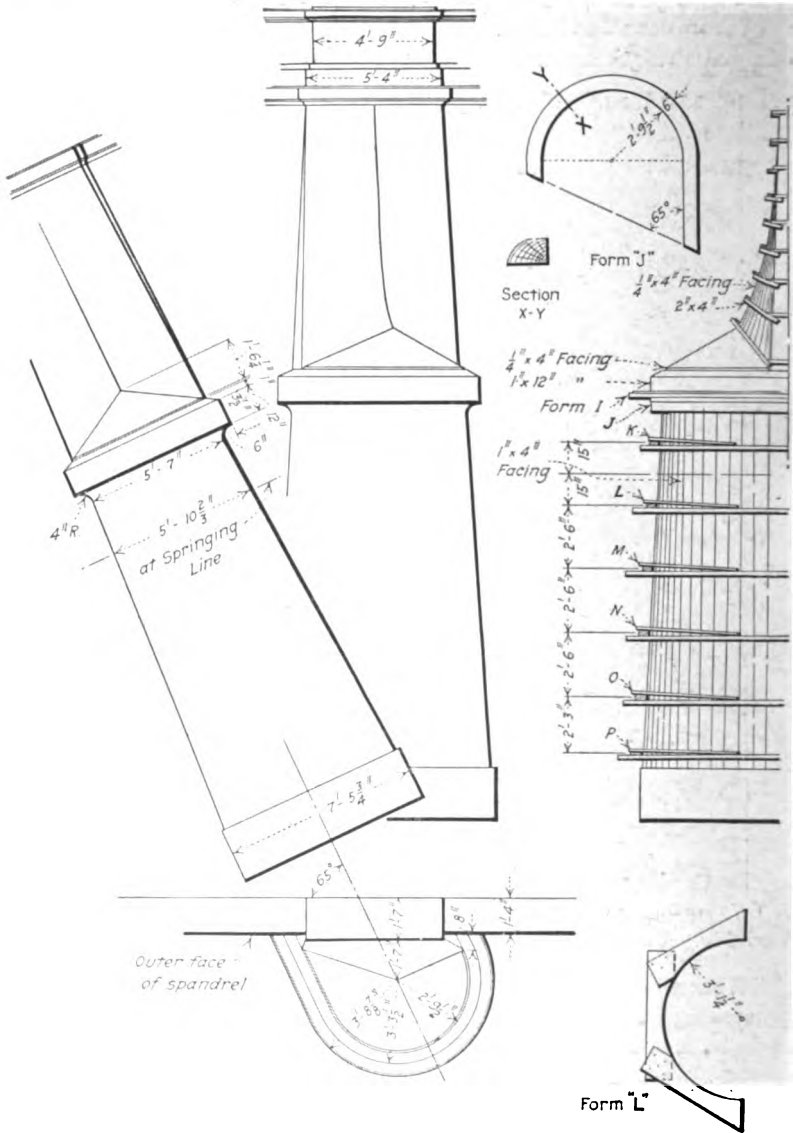

FIG. 141.—Typical pier forms used in bridges of Luten Design.

When the ends of piers are rounding, special forms are necessary. In the construction of the Atherton Ave. bridge over



Courtesy of Mr. Daniel B. Luten, Consulting Engineer, Indianapolis.
FIG. 142.—Centering and curved pier forms used in bridges of Luten Design.

the Pennsylvania R. R. tracks in Pittsburgh, the forms for the curved ends of the piers were built of 1 in. by 2-in. strips nailed to horizontal segmental wales. These wales were nailed to the wales of the side forms. The rounding forms were kept in place by wiring to dowels set in the foundation concrete. Before starting the erection of the form work, a flexible panel was made by nailing galvanized-iron sheets to the 1 in. by 2-in. strips. This panel was bent against the wales, which acted like hoops.

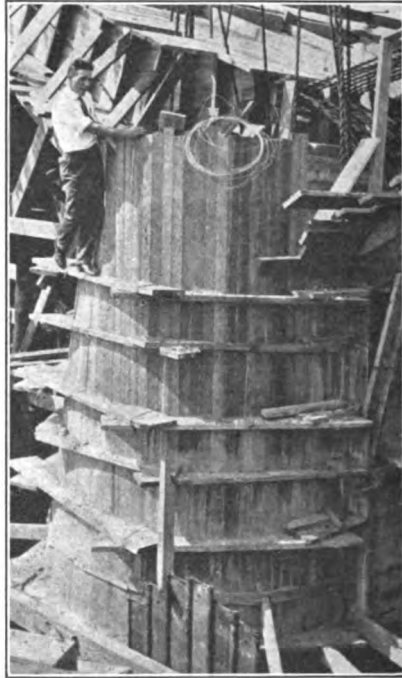
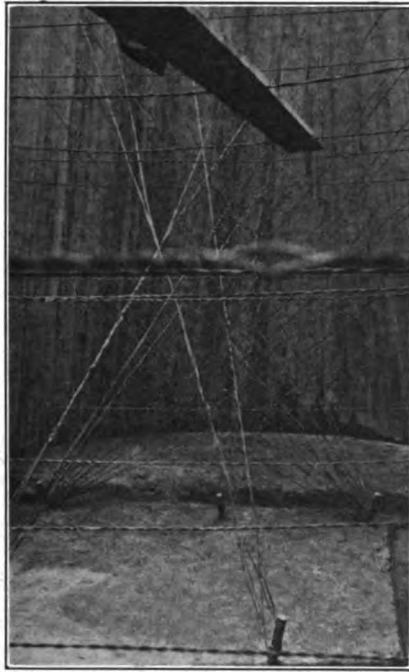

FIG. 143.—Detail view of curved pier forms.

Curved pier forms used in bridges of Luten Design are shown in Figs. 141, 142, and 143. Fig. 144 shows the wiring of the forms to prevent spreading. Fig. 145 shows the pier form removed, and Fig. 146 shows it set in place for use in constructing another pier end.

In the bridge shown in Fig. 147 the pier starlings were constructed of granite from an old bridge. Pilaster forms are seen resting on the upper course of stone.

The common form of longitudinal bulkhead used in arch ring



Courtesy of Mr. W. C. Giffels.

FIG. 144.—Wiring of curved pier forms to foundation concrete.

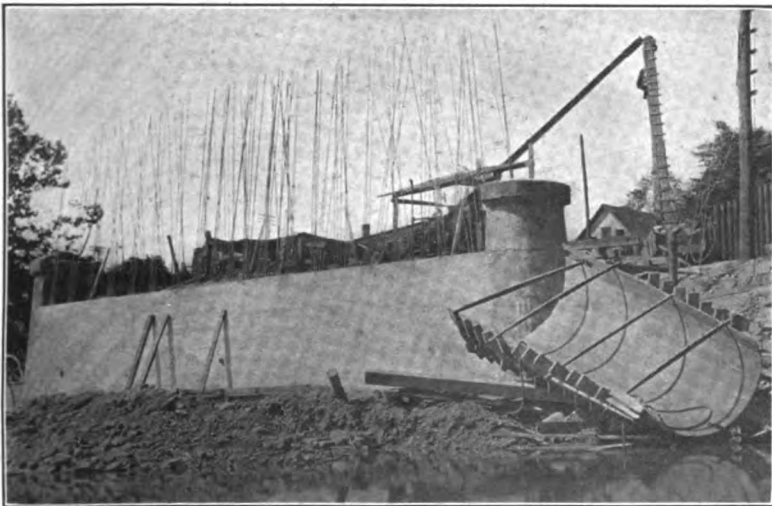
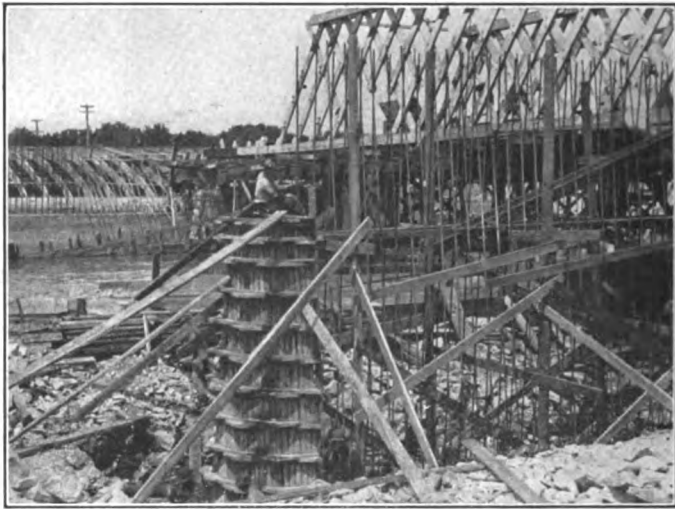

FIG. 145.—Curved pier form removed.

construction is shown in Fig. 148. Spandrel walls for earth-filled arches are either built on top of the arch ring (Fig. 149), or



Courtesy of Mr. Edward Hayes of the Hackedorn Cons. Co.

FIG. 146.—Curved pier form re-erected.

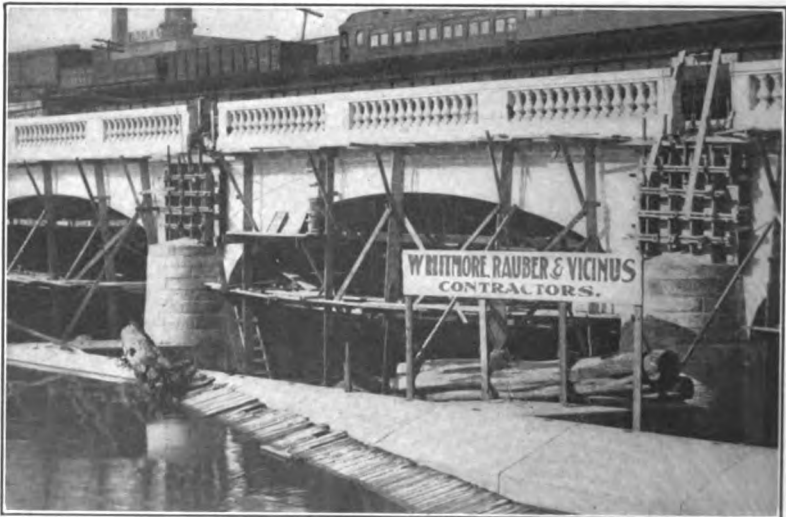

Courtesy of Mr. John F. Skinner, Prin. Ass't. Engineer, Dept. of Engineering, City of Rochester.

FIG. 147.—Pilaster forms. Bridge at Central Avenue, Rochester, N. Y.

include a portion of the arch, the bottom inner edge of the spandrel retaining wall lapping a short distance over the com-

pleted arch ring (Fig. 150). Forms for spandrel walls of the latter class are shown in Figs. 151 and 152.

Prepared sheet metal forms are often employed for special



FIG. 148.—Longitudinal bulkhead used in arch-ring construction.

work such as cantilever beams, capitals on spandrel columns, and other small projections. These sheet metal forms are fastened to the wood forms at successive positions.

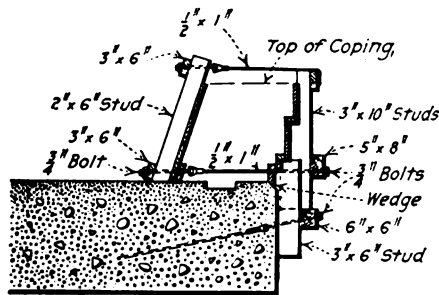

FIG. 149.—Spandrel wall forms used in constructing the Yardley bridge, Philadelphia & Reading Ry. Co.

The railing or balustrade of Greek cross panels shown in Fig. 153 was cast in units on a horizontal plane. Cement Age, issue of March, 1912 describes the construction of the panels of this balustrade as follows:



Courtesy of Mr. W. C. Giffels.

FIG. 150.—Arch ready for the building of spandrel walls.

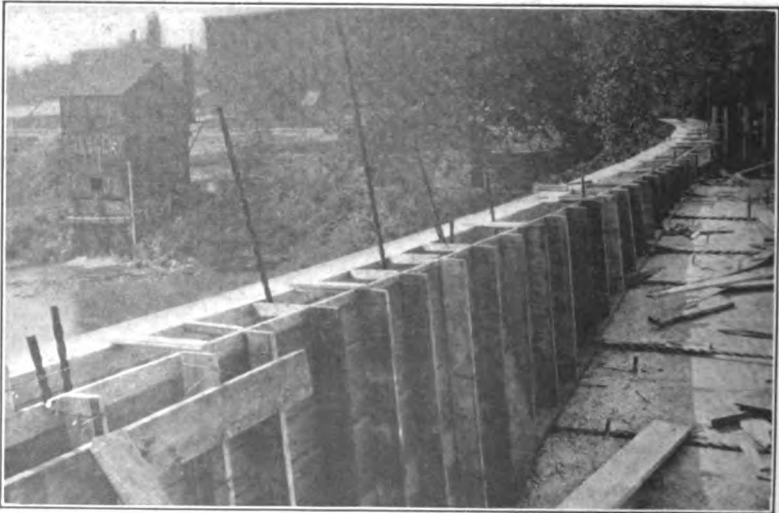

Courtesy of Mr. W. C. Giffels.

FIG. 151.—Spandrel-wall forms.

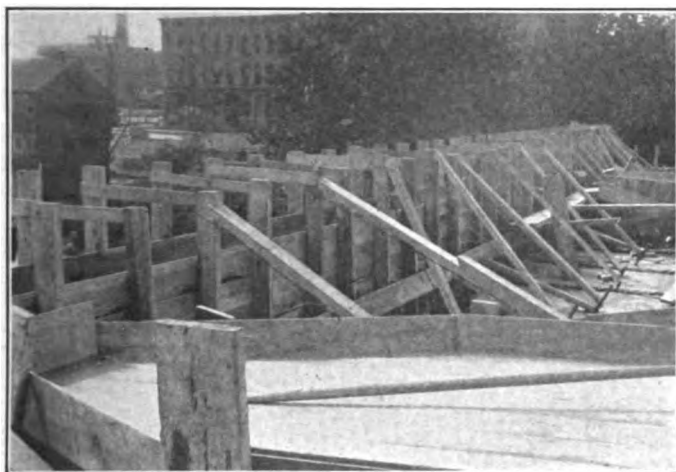

Courtesy of Mr. W. C. Giffels.

FIG. 152.—Spandrel-wall forms.

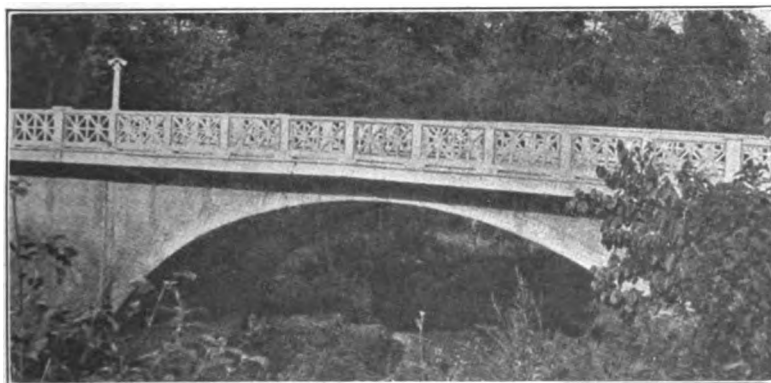

Courtesy of Waddell & Harrington, Consulting Engineers, Kansas City.

FIG. 153.—Cleveland Avenue bridge, Kansas City, Mo.

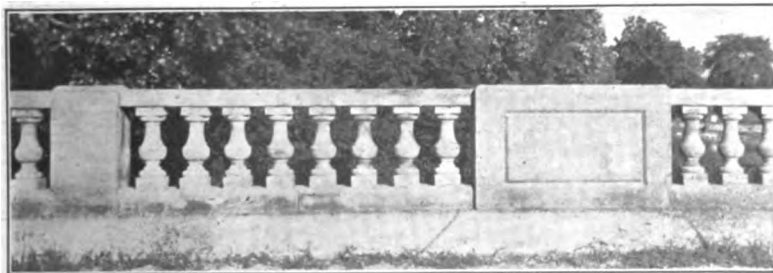

FIG. 154.

242 REINFORCED CONCRETE CONSTRUCTION

“The forms consisted of a wooden base 6 in. wider and longer than the concrete panel. A wooden rail the thickness of the panel was bolted around the outer edges of this base, the measurements between the rails being the size of the panel. On this base were also bolted triangular

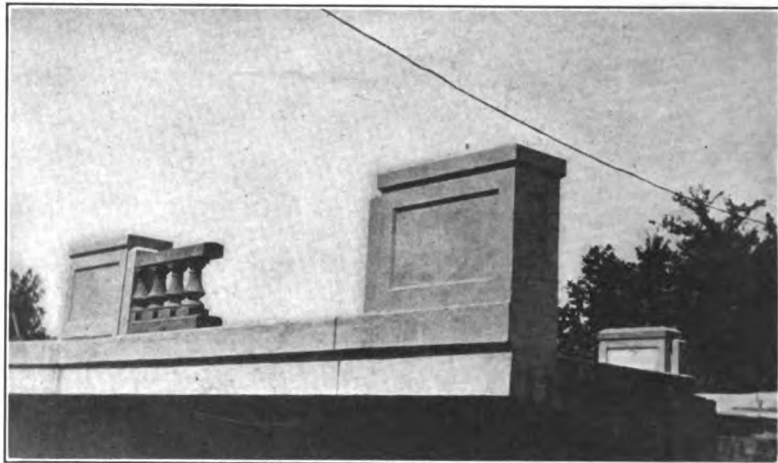

FIG. 155.

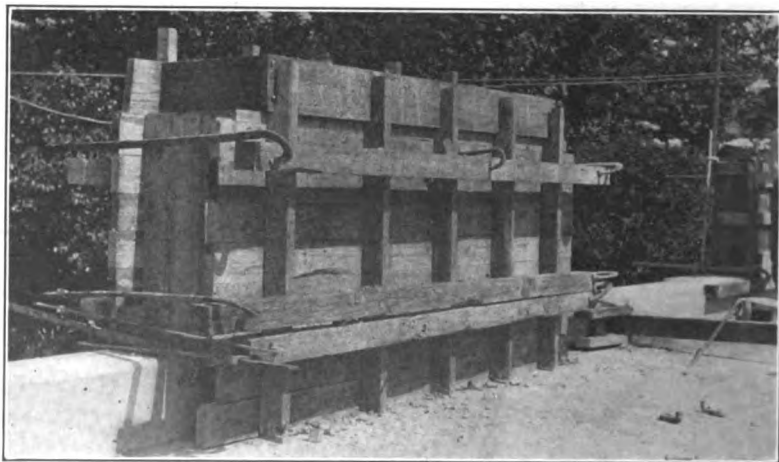

FIG. 156.

blocks, split in half horizontally, with a slight bevel or draw to each half. These blocks were bolted together, and, bolted to the base in place, form the triangular openings of the Greek cross design of the panel. After the forms were bolted together the base was laid level horizontally

on two horses or bents, about 3 ft. above the work floor level. The form was then filled with water and allowed to soak over 1 night. The following morning the water was let out; the form cleaned and re-levelled; $\frac{1}{2}$ in. of concrete was put in bottom and well-tamped with small hand tampers; one set of reinforcing wires were placed; 3 in. more concrete was put in, well tamped; a second set of reinforcing wires was then placed; concrete finally finished to the top and struck off with a



FIG. 157.

straight edge run over top of outer railing and triangular blocks, all of which were made the exact thickness of the panel. After the concrete was sufficiently set the top was finished with smoothing trowel. Concrete in the panel was allowed to stay in the form undisturbed 3 days; the outer railing of the form was then removed and the base to which the triangular blocks were bolted and on which the concrete was resting, was set up on edge, the panel resting on a piece of timber on the ground. The blocks were then unbolted from the base and the base

removed. Forty-eight hours from the time the base was removed, the triangular blocks were withdrawn from the concrete panel by taking one-half of the block out from one side and the other half from the opposite side, the slight bevel and shrinkage of the blocks allowed them to be removed without injury to the edges of the concrete."



FIG. 158.

Railing of the type shown in Fig. 154 may be either constructed entirely in separate units and afterward erected, or the spindles or balusters may be poured separately in wooden or cast-iron molds and the top and bottom rails and posts cast in place. Figs. 155 to 158 inclusive show the construction of a railing of this balustrade type.

CHAPTER XI

THREE-HINGED ARCHES

56. General Discussion.—An arch with three hinges is statically determinate and consequently can be analyzed much more readily for a given loading than is possible in the case of a fixed-ended or solid arch. Furthermore, three-hinged arches do not need to be analyzed for temperature changes, the hinges allowing contraction and expansion of the ribs without causing any stress throughout the arch. Obviously this statement does not take into account the effect which results from friction on the hinges, but such effect is usually considered to be negligible. Whether or not hinge friction is likely to cause appreciable error in the analysis of three-hinged arches is still a matter, however, in regard to which there seems to be a decided difference of opinion.

Three-hinged arches are especially adapted to sites where abutments and piers must be founded on compressible soil or on piles. The hinges permit of considerable settlement without failure of the arch or without causing the huge cracks which are sure to develop in a fixed-ended structure under like conditions. Of course, a solid arch may be designed on the assumption that the abutments are yielding, but this is rarely done and such computations in any event could not take into account such settlement as might come from an unexpected source.

Hinges in arch-bridge construction are likely to be an expensive detail, especially in short-span structures. The claim is made, however, that in arches of large span, the saving in concrete as compared with the fixed-ended type much more than pays for the hinges.

It is generally admitted that the three-hinged arch is usually awkward in appearance and has not the graceful form that is characteristic of the majority of the solid arch structures. This lack of artistic proportions is caused by the increased thickness at the haunches, and cannot be avoided in economical design.

57. Methods of Analysis.—Three-hinged arches should be analyzed for at least the same conditions of loading that are

recommended in Art. 16 for arches with fixed ends. It should be stated, however, that, for large arches, an analysis by influence lines for the exact maximum loadings is much to be preferred to the common method referred to in the above article, by reason of the fact that the common method assumes the live loads as fixed at only a few definite locations on the span.

Common Method.—Consider first the general case of an unsymmetrical three-hinged arch subjected to a number of vertical concentrated loads. By referring to Fig. 159, it is seen that there are four unknown quantities—namely: the horizontal and vertical components of each reaction—and four independent equa-

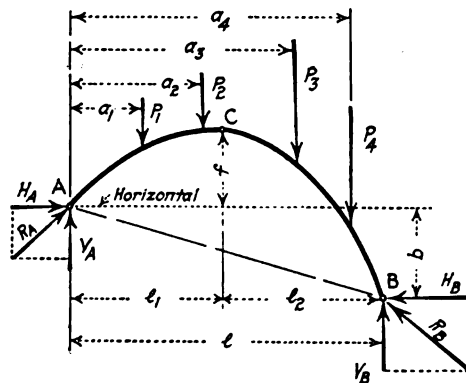

FIG. 159.

tions are necessary to solve for these unknowns. We have the following three equations from statics:

- $\Sigma V =$ algebraic sum of the vertical components = 0.
- $\Sigma H =$ algebraic sum of the horizontal components = 0.
- $\Sigma M =$ algebraic sum of moments of all the forces about any point = 0.

The additional equation may be obtained from the fact that the bending moment is zero at the crown hinge. Thus we have the following four equations with respect to the arch of Fig. 159:

$$\begin{aligned} V_A + V_B - \Sigma P &= 0 \\ H_A - H_B &= 0 \end{aligned}$$

Taking moments about the left hinge

$$H_B b - V_B l + \Sigma P a = 0$$

Since the moment at the crown hinge is zero

$$V_A l_1 - H_A f - \sum_0^1 P(l_1 - a) = 0$$

These four equations may be solved simultaneously to obtain the horizontal and vertical components of the two reactions.

The calculations may be simplified by resolving each reaction into a vertical force and a force in the direction of the closing chord (Fig. 160). The four equations in this case are as follows (since $H_A = H_B$ from Fig. 159):

$$V_1 + V_2 - \Sigma P = 0$$

$$H_1 - H_2 = 0$$

$$-V_2 l + \Sigma P a = 0$$

$$V_1 l_1 - \sum_0^1 P(l_1 - a) - H_1 r = 0$$

or
$$V_1 l_1 - \sum_0^1 P(l_1 - a) - H_A c = 0$$

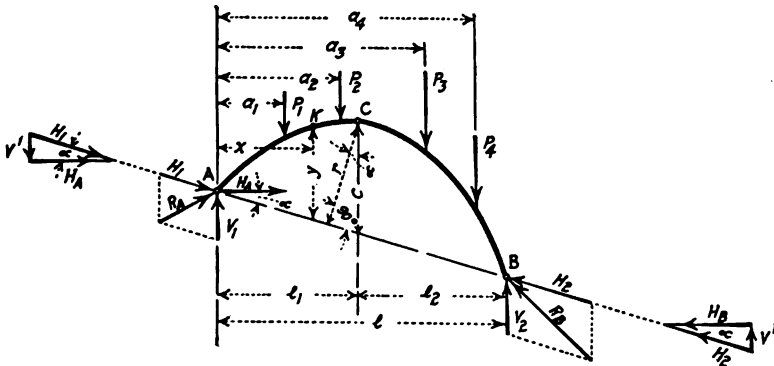

FIG. 160.

(The values of V' have not been considered in the first equation as they are equal and opposite in direction.) With the components of either reaction determined by these equations, the line of thrust may be drawn throughout the arch as described in Art. 12 for the arch with fixed ends.

It should be noted that the values of V_1 and V_2 may be obtained from the above equations (or by using $\Sigma M = 0$ at both points A and B) in the following form:

$$V_1 = \frac{1}{l} \Sigma P(l - a) \tag{1}$$

$$V_2 = \frac{1}{l} \Sigma P a \tag{2}$$

These forces are thus identical with the reactions of a simple beam of the same span and similarly loaded.

The bending moment at any point K (Fig. 160) may be expressed as follows:

$$\begin{aligned} M &= V_1x - \sum_0^x P(x - a) - H_Ay \\ &= M_K - H_Ay \end{aligned} \quad (3)$$

where M_K is the bending moment at the point K of a similarly loaded beam. At the crown hinge, letting M_C denote the moment of the vertical forces about the point C , we have

$$M = M_C - H_Ac = 0$$

or

$$H_A = \frac{M_C}{c} \quad (4)$$

Equations (1) to (4) inclusive are the formulas commonly employed in the analysis of three-hinged arches—supplemented, of course, with the force and equilibrium polygons as in the case of arches with fixed ends.

For symmetrical arches, H_1 and H_2 are horizontal and the line of thrust need be drawn for only one-half the arch when the loading is symmetrical about the crown hinge. In such a case of loading, the thrust at the crown hinge is horizontal and the line of thrust may be determined by trial in the manner described in Art. 26. This trial method gives exact results when applied to a three-hinged symmetrical arch on account of there being two known points (hinge points) on the line of thrust for each half of arch.

The computations for uniform live loading are extremely simple and should be made separately from those for dead load or concentrated live loads. For full loading, with the crown-hinge at mid-span, Formula (4) gives:

$$H_A = \frac{1}{8} \cdot \frac{wl^2}{c} \quad (5)$$

where w is the uniform load per foot. The following equation, determined by substituting in Formula (3) gives the bending moment at any point (coördinates x and y):

$$M = \frac{1}{2} wx(l - x) - \frac{1}{8} \cdot \frac{wl^2}{c} \cdot y \quad (6)$$

(For an arch of parabolic form, $M = 0$, and only axial stress occurs throughout the arch for full uniform loading.) With only one-half of the span loaded

$$H_A = \frac{1}{16} \cdot \frac{wl^2}{c} \tag{7}$$

or one-half that due to full loading. The bending moment at any point in the loaded half equals

$$M = \frac{1}{8} wx(3l - 4x) - \frac{1}{16} \cdot \frac{wl^2}{c} \cdot y \tag{8}$$

and in the unloaded half

$$M = \frac{1}{8} wx - \frac{1}{16} \cdot \frac{wl^2}{c} \cdot y \tag{9}$$

(In Equations (8) and (9), the value of x is measured from that end of the arch which is nearer to the point in question.)

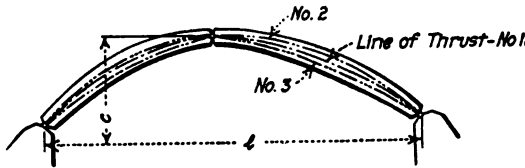

FIG. 161.

A three-hinged arch is commonly analyzed for (1) dead and uniform live load over the entire span, (2) for dead and uniform live load over the right half of span, and (3) for dead and uniform live load over the left half of span. Full loading gives maximum stresses for the sections near the hinges, while the half-span loadings give the greatest stresses near the quarter points of the span. The usual method of design is to locate the hinges at the proper points and to draw the force lines representing the load concentrations. These loads can be determined quite accurately by making a complete design of the spandrels prior to the arch design and by approximating the weight of the arch ring—the arch ring, however, need not be drawn. The lines of thrust for the three conditions of loading stated above are then drawn as shown in Fig. 161. With the lines of thrust known, it then becomes possible to determine the correct thickness of the arch at any point and decide upon a suitable arch ring which, of course, should not differ appreciably in weight or position from

the arch ring previously assumed or else a second analysis should be made.

Influence-line Method.—The method of analyzing arches by the use of influence lines is explained at length in Chapter V for fixed arches. (See also Chapter VIII.) The method is the same for three-hinged arches but is simplified by the fact that for a single concentration—as, for example, a load of unity at the point L_2 in Fig. 162—the direction of one of the reaction lines is given by the line connecting the two hinges to one side of the load. The direction of the other reaction is then known. Thus, designing sheets similar to Designing Sheets Nos. 11 and 11A

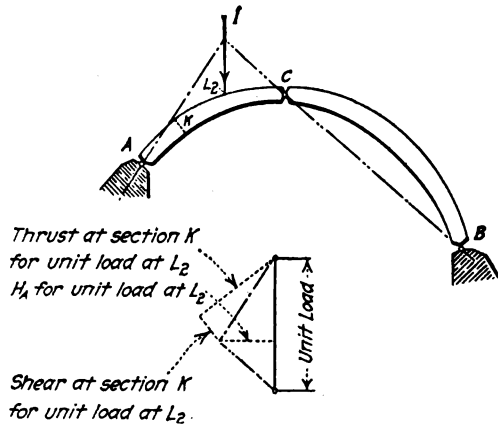

FIG. 162.

may be readily prepared and the remainder of the analysis followed in exactly the same manner as for the fixed arch.

58. Types of Hinges.—The most common form of arch hinge consists of a structural or cast-steel pin bearing on two steel castings. Hinges of this type are shown in Figs. 174 to 177 inclusive. A form similar to the one above mentioned consists of two steel castings with ball-and-socket joints. Details of this type of hinge are given on Plate XL, Chapter XIII.

A patented method of hinge construction is shown in Fig. 198, Chapter XII. The reinforcement of each section of arch rib is connected at the crown end to cylindrical plates of steel having a ball joint mated into a cup in the opposite rib. The lower hinge (see also Fig. 163) consists of a semicircular plate attached to the rib and a cast-iron shoe bolted to the pier or abutment.

A flat lead plate has been used to a limited extent in three-hinged arch construction. A plate of this kind cannot be truly



Courtesy of Mr. Wm. M. Thomas, Consulting Engineer, Los Angeles, Cal.

FIG. 163.—Thomas Method of arch construction.

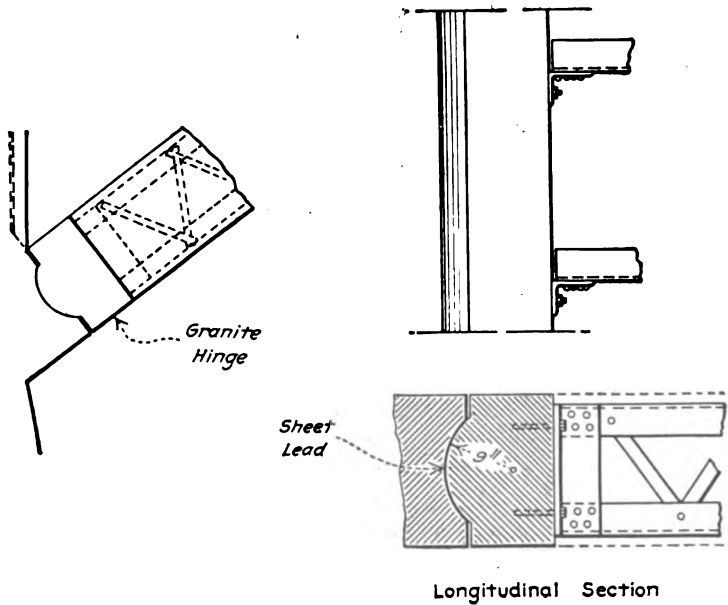

FIG. 164.—Details of stone hinge.

called a hinge, but does limit the line of thrust to a definite area. It should be used only for arches which are to be erected as three-

hinged (due to a possible excessive settlement of the centering), but which are afterward to be converted into solid arches by encasing the hinges in mortar or concrete.

A type of stone hinge which has been used in a few bridges is shown in Fig. 164. The details of an unusual hinge are given in Fig. 178.

It should be evident that all types of hinges are not equally effective in definitely locating the line of thrust.

59. Methods of Construction.—Three distinct methods of construction have been employed in the erection of three-hinged arches: (1) casting the concrete ribs in forms on the ground and then hoisting them into place; (2) erecting structural steel rein-

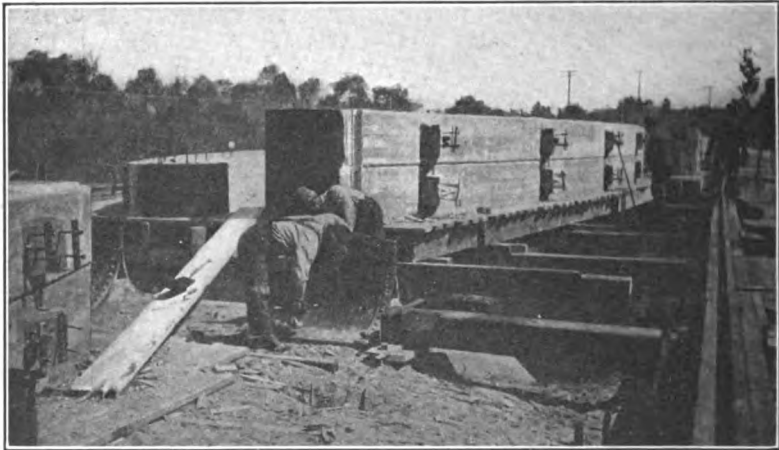

Courtesy of Mr. Wm. M. Thomas, Consulting Engineer, Los Angeles, Cal.

FIG. 165.—Thomas Method of arch construction.

forcement to be employed in the arch ribs and using this reinforcement to support the weight of the forms and plastic concrete during construction; and (3) employing the usual type of centering and casting the ribs in place. The first method is the one usually followed. Method No. 2 is of advantage when a stream to be spanned is subject to sudden freshets and a minimum of falsework is required. (See Fig. 175 and Plate XL of Chapter XIII.) Method No. 3 is necessary only under unusual conditions.

The cheapest type of the three-hinged arch and also the type that is lightest and best adapted to the use of hinges is one of detached ribs supporting spandrel columns. Such a type of arch lends itself readily to the unit method of construction should

this form of erection be desired, and also eliminates the necessity for waterproofing which is a serious problem in the case of a solid filled arch.



Courtesy of Mr. Wm. M. Thomas, Consulting Engineer, Los Angeles, Cal.

FIG. 166.—Thomas Method of arch construction.

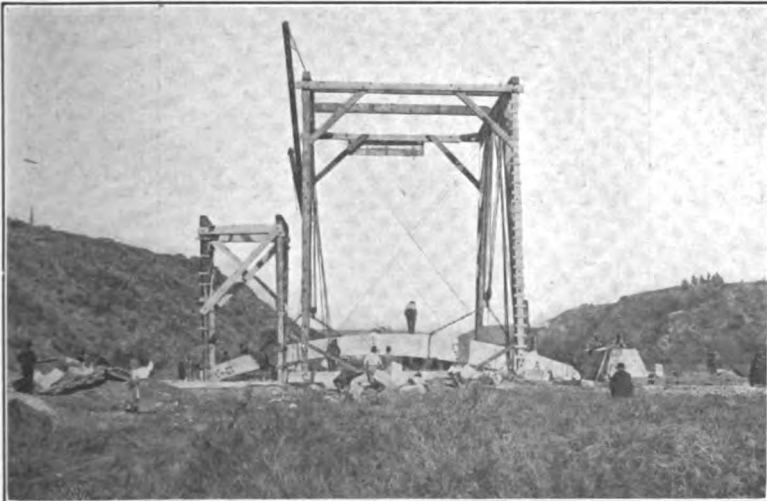

Courtesy of Mr. Wm. M. Thomas, Consulting Engineer, Los Angeles, Cal.

FIG. 167.—Thomas Method of arch construction.

The Thomas Method of unit construction is shown in Figs. 165 to 172 inclusive and the designing details in Fig. 178. The illustrations are self-explanatory.

60. Details of Design.—Figs 174 to 178 inclusive give typical details of three-hinged arches.

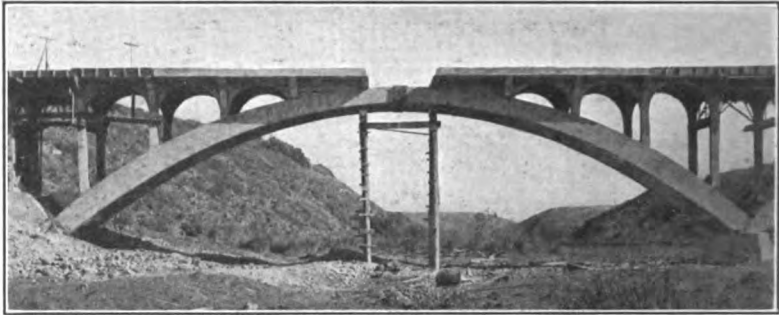

Courtesy of Mr. Wm. M. Thomas, Consulting Engineer, Los Angeles, Cal.

FIG. 168.—Thomas Method of arch construction.

The arch shown in Figs. 173 and 174 is founded on Ohio River mud, Raymond concrete piles being used for the foundations.

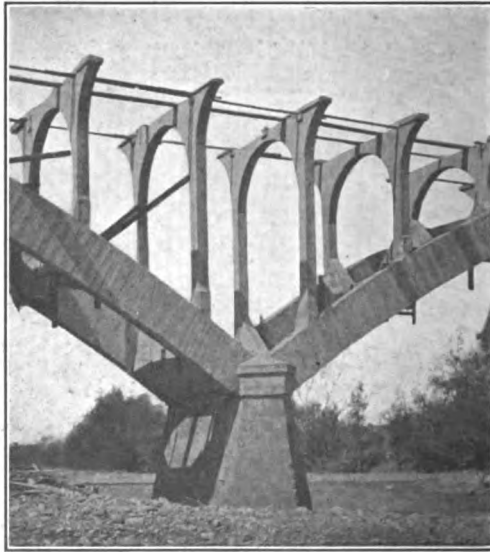

Courtesy of Mr. Wm. M. Thomas, Consulting Engineer, Los Angeles, Cal.

FIG. 169.—Thomas Method of arch construction.

The reason for the use of the cast hinges in this case is thus apparent, as settlement of foundations was anticipated. No appreciable settlement, however, has ever taken place.

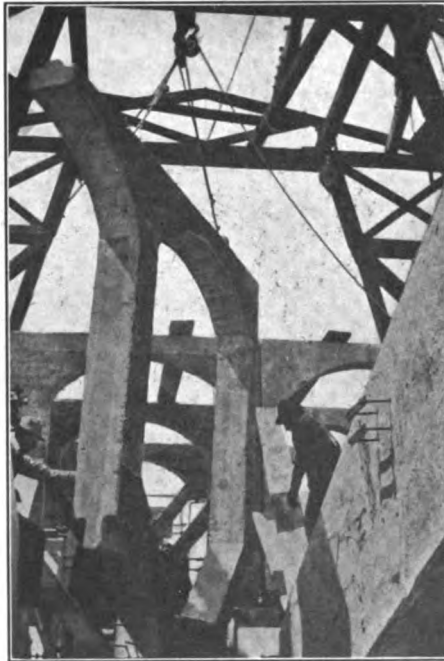

Courtesy of Mr. Wm. M. Thomas, Consulting Engineer, Los Angeles, Cal.

FIG. 170.—Thomas Method of arch construction.



Courtesy of Mr. Wm. M. Thomas, Consulting Engineer, Los Angeles, Cal.

FIG. 171.—Thomas Method of arch construction.

The two halves of each rib of the bridge shown in Fig. 175 were designed to be erected simultaneously, without falsework, by derricks on opposite sides of the stream, and to be self-supporting as soon as the crown hinge connection was made. Tem-

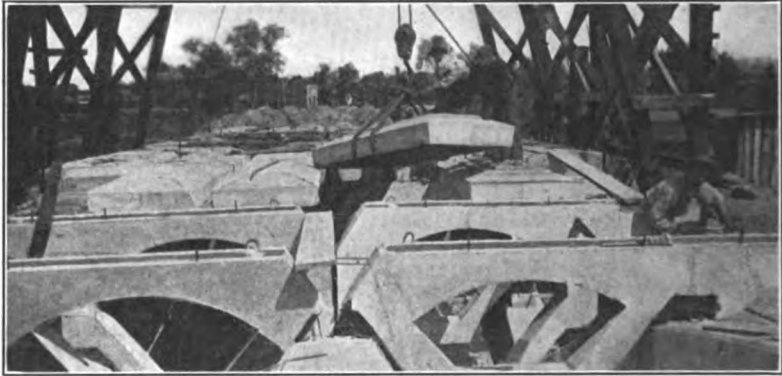

Courtesy of Mr. Wm. M. Thomas, Consulting Engineer, Los Angeles, Cal.

FIG. 172.—Thomas Method of arch construction.

porary sway bracing was provided to insure lateral stability while the forms were being built and filled with concrete.

The three-hinged arch construction with cantilever ends, shown in Fig. 176, is unusual, but was found to be more economical for an arch of this type and dimensions than a hingeless structure.

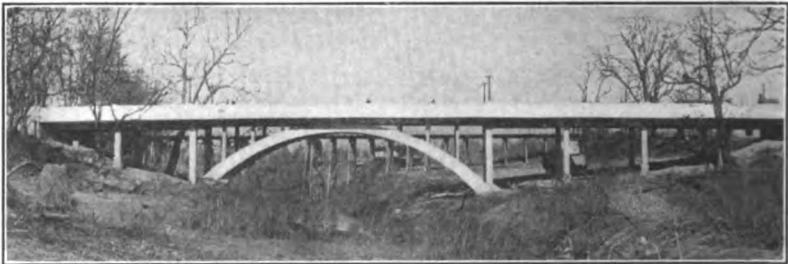

Courtesy of Mr. Wilbur J. Watson, Consulting Engineer, Cleveland, Ohio.

FIG. 173.—Fourth Street bridge over Island Creek, Paducah, Ky.

The cantilever ends were rendered necessary on account of the fact that there were no stable foundations for abutments at the top of the fill at the ends of the bridge. The cantilever ends decreased the dead load thrust on the center hinges about one-quarter and decreased considerably the angle which the resultant thrust on the lower hinges made with the vertical, thus decreasing

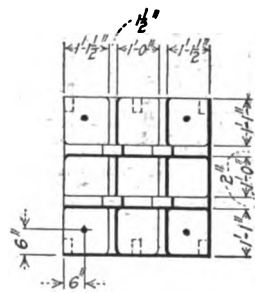
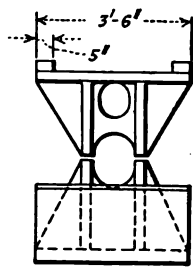
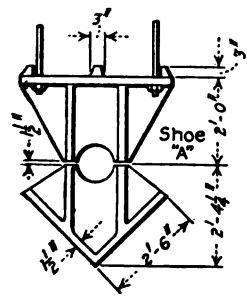
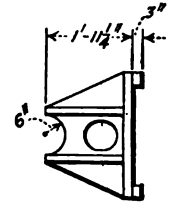
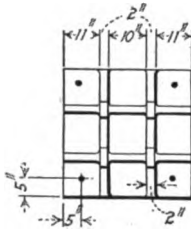
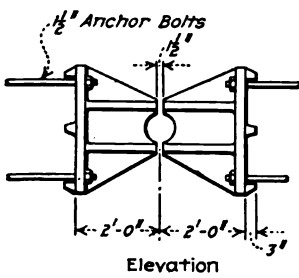
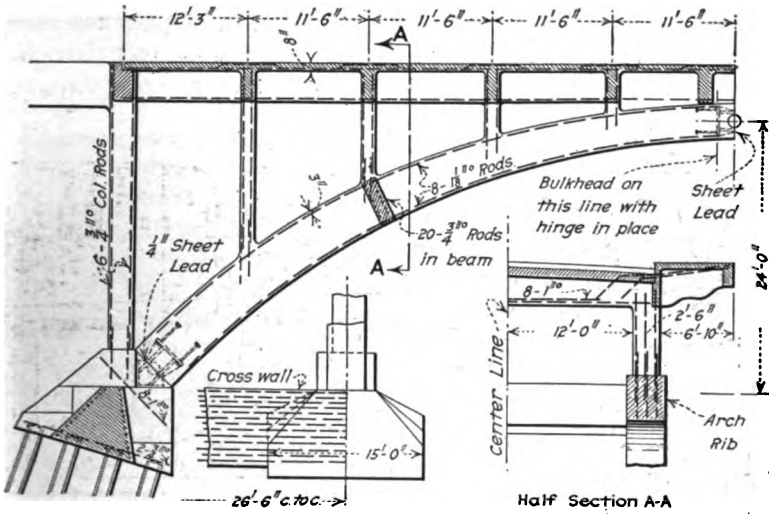

FIG. 174.—Details of Fourth Street bridge, Paducah, Ky.

the size of abutment required. The cost of the hinges necessary for the three-hinged arch was very considerably less than the cost of the additional steel reinforcing in the arch ring required

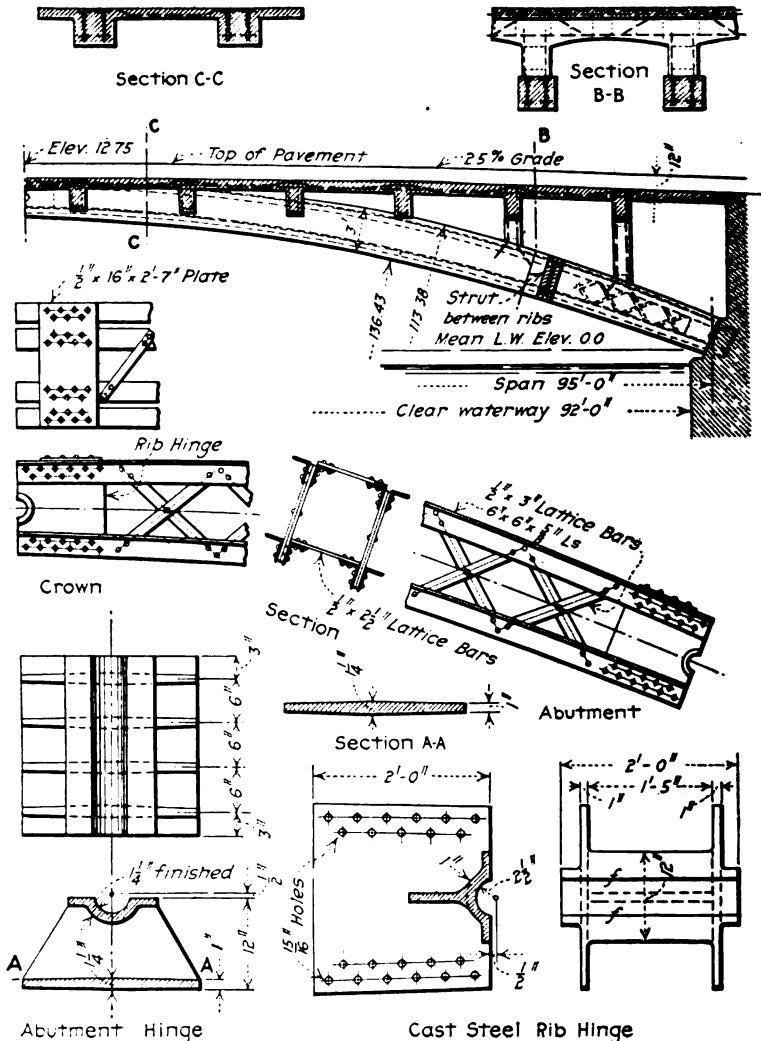

FIG. 175.—Pratt Street bridge over Jones' Falls, Baltimore, Md.

to take care of the additional bending moments in the hingeless arch. No connection whatever was needed between the ends of the cantilevers and the abutments on account of the extremely

small amount of vertical motion at these points. A common type of centering was used in constructing the arch ribs in place. The cast-steel hinges were entirely encased in concrete after the centers were struck, a $\frac{1}{4}$ -in. plate of sheet lead having been placed at the center of each hinge to allow the necessary motion of the

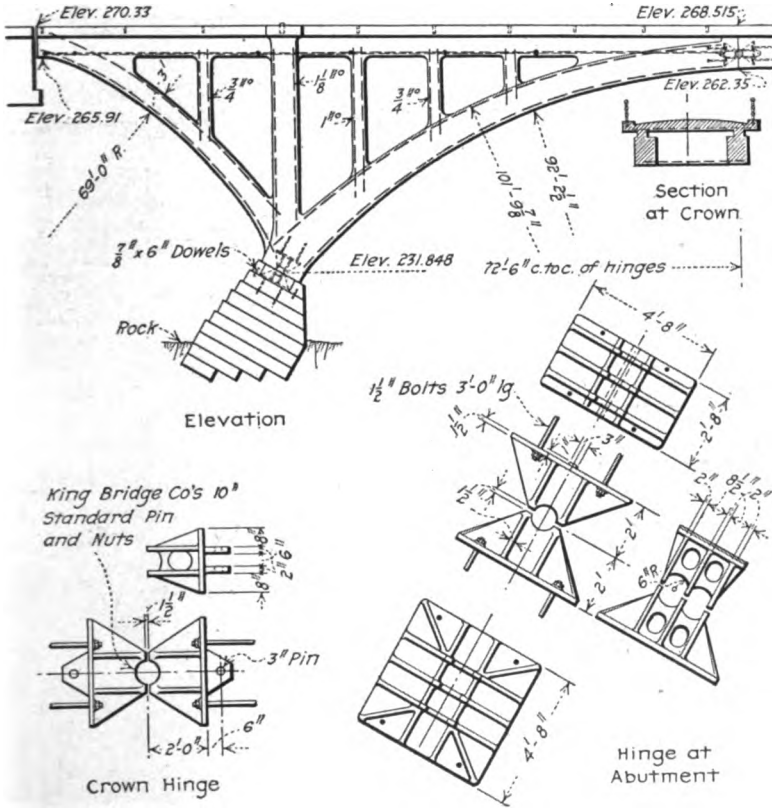

FIG. 176.—Bridge over the Vermillion River at Wakeman, Ohio

arch rib under live load and temperature stresses. In this way all possibility of corrosion of the steel hinges was avoided.

What is believed will be the longest three-hinged concrete arch ever built is shown in Fig. 177. When completed it will be one of the show bridges of the United States.

Fig. 178 gives details of the Thomas Method of arch construction already referred to in Arts. 58 and 59.

61. Design of a Three-hinged Arch.—By S. W. Bowen, M. Am. Soc. C. E., Designer of the Main Street Viaduct, Fort Worth, Texas.—To illustrate the methods employed in the design of the three-hinged arches of the Main Street viaduct, Fort Worth, Texas, the following account is given of the design of the 225-ft. arch span shown in Fig. 179. The reinforcement consisted of structural shapes which were designed to support

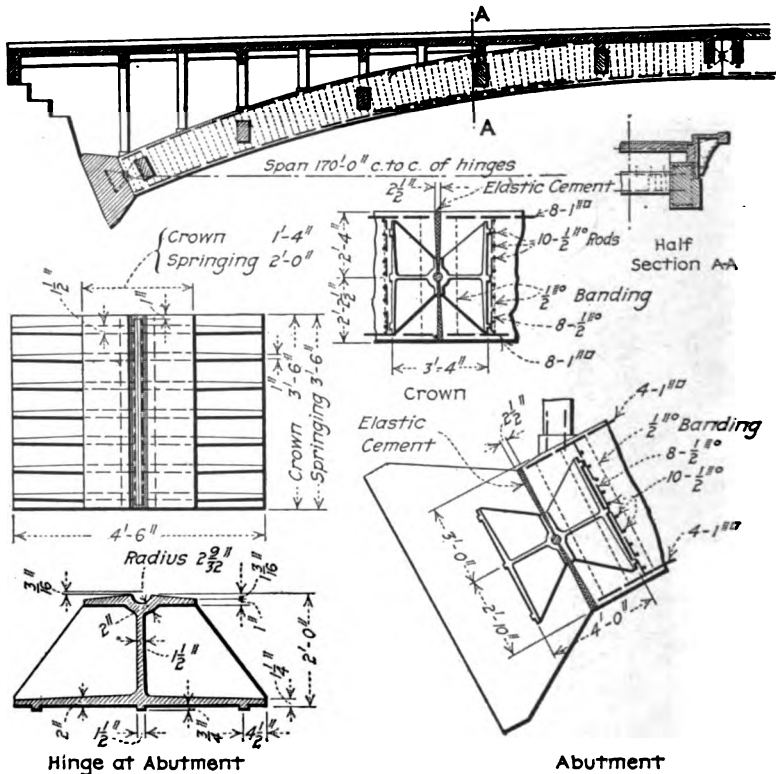

FIG. 177.—Details of Moffett Creek arch, Columbia Highway, Oregon.

the weight of the forms and plastic concrete in the arch ribs. Details of this arch are shown on Plates XL and XLI, Chapter XIII.

The entire structure, above the arch ribs, was first designed so that the dead loads coming on the ribs at each panel point could be accurately computed. The design of this portion of the work is comparatively simple, and requires no description.

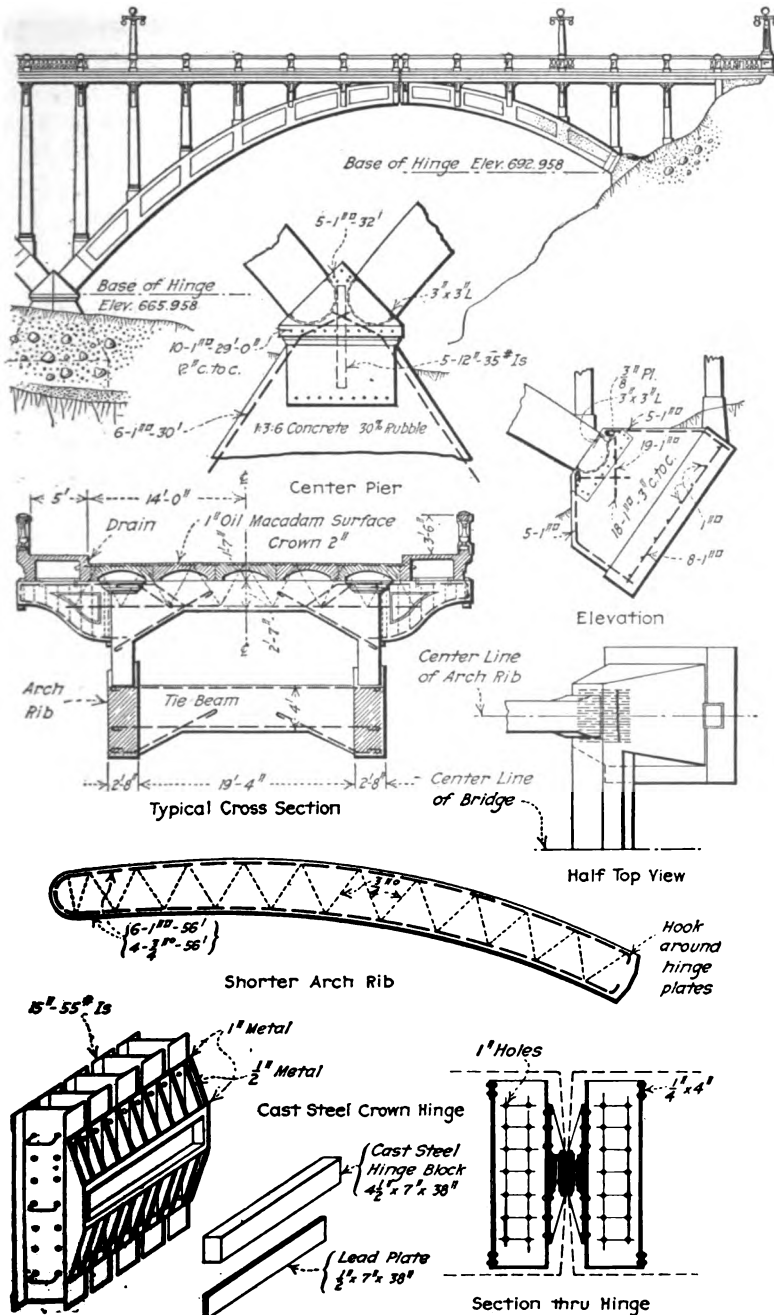

FIG. 178.—Thomas Method of arch construction.

Assumptions as to the dimensions of the arch ribs and braces were then made to determine the dead load from these portions of the structure.

The next step was to draw the lines of thrust in the arch ribs, for full live and dead load and for dead load combined with live load on each half of the span. This gave the position of the neutral axis, or center line of the arch rib, which was taken midway between the extreme lines of thrust, and coincided closely with the line of thrust for full live and dead load. It might be mentioned that the center line of the arch rib, thus determined, agreed closely with a parabola, with its vertex at the crown of the arch.

The general outline and approximate dimensions of the arch



Courtesy of Mr. S. W. Bowen of Brenneke and Fay, Consulting Engineers, St. Louis.
 FIG. 179.—225-ft. arch span of the Main Street viaduct, Fort Worth, Texas.

ribs being determined, the next step was to design the structural steel reinforcement of the ribs. This reinforcement consisted of curved lattice girders, three in each inner, and two in each outer rib. These girders were laced together in the plane of the top and bottom flanges. They were also connected under each post by vertical cross frames. The weight of the concrete in the arch ribs and braces was computed, and also the weight of the forms. An allowance was also made for the weight of the structural reinforcement. Concrete was assumed to be placed simultaneously in each half of the span, from the haunches to the crown. The stresses in the structural reinforcement were then found for each successive stage of the concreting—that is, for the forms of the ribs and braces filled with concrete up to the first, second,

etc., panel points, counting from the haunches. All of these stresses were found graphically, and the members proportioned for the maximum conditions. The unit stresses used were 12,500 lb. per square inch in compression, and 16,000 lb. per square inch in tension. No stress whatever was assumed to be taken by the concrete, as it was unlikely that the concrete near the haunches would be sufficiently set to take stress, by the time the ribs were finished.

In the design of the arch ribs, which was next undertaken, the stresses caused by the construction of the columns and deck were considered as well as those due to live and dead loads on the finished structure. The columns were assumed to be built out from each pier, panel by panel, until the crown was reached; then the deck was assumed to be concreted; panel by panel, working from the crown toward the haunches. The stresses in the rib were found for each stage of the construction. For live-load stresses, five conditions were considered, as follows: First, live load on entire span; then each half of span loaded; next the two end quarters loaded; and finally the live load on the two middle quarters of the span. A maximum unit stress of 500 lb. per square inch was used in the extreme fiber of the rib, and sufficient reinforcement was provided to keep the stress in the concrete down to this figure. In case the structural reinforcement at any point was not sufficient for this purpose, additional metal in the shape of bars was provided. The stresses and reinforcement required were computed at each panel point, and these bars were stopped off when not required. In case the computed amount of steel at any point exceeded 5 per cent of the gross area of the rib at that point, a redesign was made. It will be seen from the above that the structural steel reinforcement takes stress in two ways: (1) that due to the weight of the plastic concrete in the ribs and braces, together with their forms; and (2) that due to the construction of the columns and deck, and to the loads on the finished structure. The first of these may be called an initial stress, which remains in the steel as the concrete sets. The second must be added to the first to get the total compressive stress in the steel. In this case the maximum possible compressive unit stress in the structural steel would be 12,500 lb., plus 15×500 lb., or a total of 20,000 lb. per square inch. As a matter of fact, the total unit stress was about 16,000 lb. per square inch.

Transverse forces had to be given considerable attention, because of the fact that the high-water line comes part way up on the arch ribs. The pressure due to the water was taken at 200 lb. per square foot of each arch rib and column, and that due to wind at 30 lb. per square foot of vertical projection of the structure between high-water line and a line 10 ft. above the crown of the roadway. The braces were placed in vertical planes at the foot of each column, and were made as deep as the arch ribs allowed. A rigid analysis of the stresses in these braces would be difficult and tedious, as well as unnecessarily refined, considering the assumptions which had to be made as to the transverse forces.

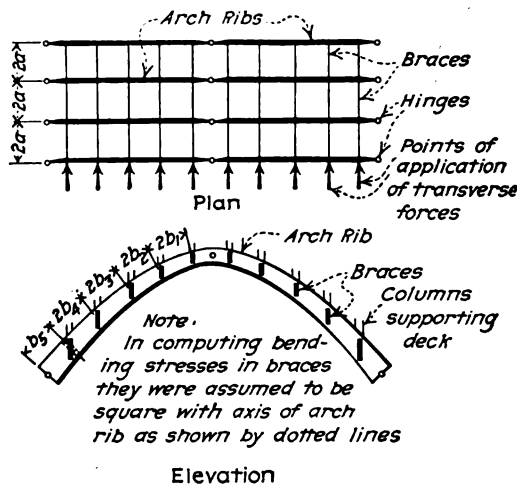

FIG. 180.

A method of computation was adopted which was comparatively simple, and which it is believed gives results reasonably close to the true ones. In order to be on the safe side, the braces and their reinforcement were made heavier than the calculations required, as this added but little to the cost of the structure.

Fig. 180 shows the general arrangement of ribs and braces and the points at which the transverse forces were assumed to be applied.

The transverse forces on the portion of the structure above the arch ribs was assumed to be transferred down the columns to the ribs and braces directly under them. None of these forces was assumed to be carried to the piers through the deck, because of the

expansion joints in the deck at each pier and near the center of the span. There is no doubt, however, that a very considerable portion of these forces pass directly through the deck to the piers, which correspondingly relieves the bracing system.

While the arch ribs were assumed to be hinged at the haunches and crown, rods were provided at these points which tended to fix them transversely. In other words, the arch ribs are three-hinged in vertical planes but are hingeless, or practically so, transversely.

Fig. 181 shows half of the bracing system developed. The similarity to the columns and girders of an office building is apparent.

Fig. 182 shows a portion of Fig. 181 enlarged with the various forces acting on it, and the points of inflection indicated.

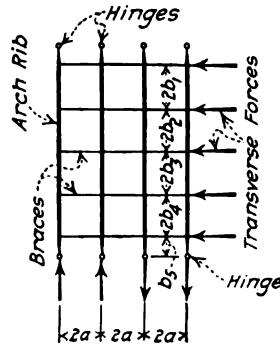

FIG. 181.

From the three conditions of equilibrium—namely: (1) the sum of the horizontal forces must equal zero, (2) the sum of the vertical forces must equal zero, and (3) the sum of the moments about any point must equal zero—and knowing the external

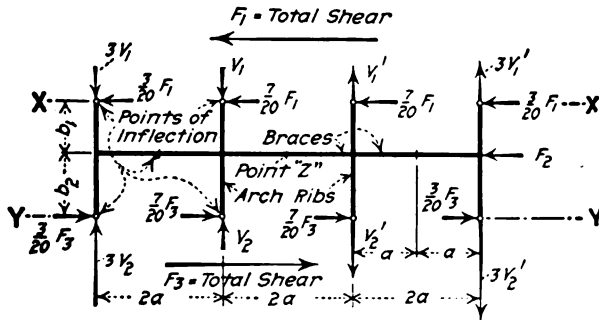

FIG. 182.

forces F_1 and F_2 and all dimensions, the thrusts, shears, and bending moments in the various members are readily calculated.

For example, the horizontal force F_1 is the total of the transverse forces acting on the structure above the plane $X - X$ where the forces F_1 are shown. F_2 is the total transverse force acting on one panel of the structure, and F_3 is the total shear at

the plane $Y - Y$. Then from the first condition of equilibrium,

$$F_3 = F_1 + F_2 \tag{1}$$

The vertical forces $3V_1, V_1, V'_1,$ and $3V'_1$ are those produced by the action of the horizontal forces acting above the plane $X - X$. Similarly, the forces $3V_2, V_2, V'_2,$ and $3V'_2$ are those produced by the action of all horizontal forces above the plane $Y - Y$. The term "vertical" has been applied to the forces indicated in the figure as acting at right angles to the forces $F_1,$ etc. These forces are, of course, not vertical in the structure, but act in the direction of the axis of the arch rib.

For the sake of simplicity, let $V_2 - V_1 = V_3$. Then from the second condition of equilibrium,

$$3V_2 + V_3 = V'_3 + 3V'_3$$

or

$$V_3 = V'_3 \tag{2}$$

From the third condition of equilibrium, taking moments about point $Z,$

$$F_1 b_1 + F_3 b_2 = 2 \times 3V_3 \times 3a + 2 \times V_3 \times a$$

or

$$V_3 = \frac{F_1 b_1 + F_3 b_2}{20a} \tag{3}$$

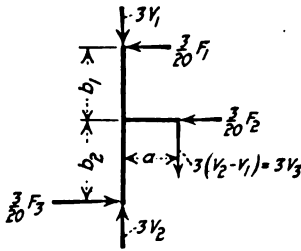

FIG. 183.

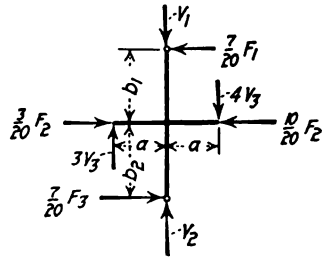

FIG. 184.

Fig. 183 shows a portion of Fig. 182. As before

$$\frac{3}{20} F_3 = \frac{3}{20} F_1 + \frac{3}{20} F_2$$

or

$$F_3 = F_1 + F_2 \tag{1'}$$

$$3V_2 - 3V_1 = 3V_3$$

or

$$V_2 - V_1 = V_3 \tag{2'}$$

$$\frac{3}{20} F_1 b_1 + \frac{3}{20} F_3 b_2 = 3V_3 a$$

or

$$V_3 = \frac{F_1 b_1 + F_3 b_2}{20a} \tag{3'}$$

Fig. 184 shows the remaining portion of half of Fig. 182. The same equations apply here.

$$\frac{7}{20} F_1 + \frac{7}{20} F_2 = \frac{7}{20} F_3$$

or

$$F_3 = F_1 + F_2 \quad (1'')$$

$$3V_3 + (V_2 - V_1) = 4V_3$$

or

$$V_2 - V_1 = V_3 \quad (2'')$$

$$\frac{7}{20} F_1 b_1 + \frac{7}{20} F_3 b_2 = 3V_3 a + 4V_3 a$$

or

$$V_3 = \frac{F_1 b_1 + F_3 b_2}{20a} \quad (3'')$$

The maximum bending moment in the upper portion of the outer rib is $\frac{3}{20} F_1 b_1$, in the lower portion $\frac{3}{20} F_3 b_2$, in the upper portion of the inner rib $\frac{7}{20} F_1 b_1$, and on the lower portion $\frac{7}{20} F_3 b_2$. The maximum bending moment in the outer brace is $3V_3 a$, and in the inner brace $4V_3 a$.

The hinge castings were designed in much the same manner as a cast column base. The area in contact with the concrete was determined by dividing the total load by 800 lb. per square inch. The diameter of the ball-and-socket joint was determined by dividing the total load by 20,000 lb. per square inch, which gave the projected area of the ball.

The shears and moments on the ribs were then computed, and their thickness and that of the base determined.

In the design of the piers, several stages in the construction of the spans were considered, as well as the conditions existing in the finished structure.

For example, with the pier finished up to the roadway, the arch ribs and braces of one span (the longer) were considered as finished, but nothing was done on the adjoining span. Next the full dead load, exclusive of paving but including forms, was considered on the long span, and only the ribs and braces of the adjoining span finished. Then the finished structure was considered, first with live load on the long span only, and second with live load on both spans. In each case the resultant force

was kept within the middle third of the base. The uplift of the water was considered in each case, the stage being taken as the top of the levee.

No impact was considered in the design of the piers.

Pier No. 2 was supported on timber piles driven into a mixture of sand and gravel overlying bed rock. This method was used instead of founding the pier on bed rock in order to reduce the cost, the amount of the appropriation being limited. The piles were not driven to rock in order to take advantage of the bearing of the pier base on the stratum of gravel, and also to take advantage of the friction to help resist sliding. The pier was protected against scour by sheet piling and rip-rap.

Piles were assumed to take 20,000 lb. each and the remainder of the load was assumed to be carried by bearing on the soil at about 5000 lb. per square foot.

CHAPTER XII

PATENTS

The number of patents that have been granted by the United States Government for improvements in reinforced-concrete construction has increased from a yearly average of three or four between the years 1890 and 1900 to about 150 per year at the present time—that is, not considering patents on concrete mixers, fence posts, and other minor structures. Undoubtedly some of these patents are worthless, impractical, and possibly invalid, but others unquestionably are of considerable importance. The mere granting of a patent does not establish its validity under the United States patent law, and many of these patents may be invalidated by litigation. In spite of this fact, however, the engineer has no right to consider any patent invalid unless he has positive proof to that effect. The fact that patents on improvements in reinforced-concrete construction may be sustained by the courts is found in the action of the C. B. & Q. R. R. in paying \$18,000 in royalty in settlement of a suit for infringement under the Bone patent No. 705,732, pertaining to cantilever retaining walls, after a thorough search had been made both in this country and abroad for all possible grounds for invalidating it.

62. Patents in General.—The Constitution of the United States contains the following clause:

“The Congress shall have power to promote the progress of science and useful arts, by securing for a limited time for authors and inventors the exclusive right to their respective writings and discoveries.”

Under this provision of the Constitution, Federal statutes have been passed authorizing the issue of a patent to the original inventor of any new and useful improvement and granting to him the exclusive right to make, to sell, or to use the patented improvement for a period of 17 years after date of issue of the patent. The patent is, in effect, an agreement between the United States Government and the inventor of a new and useful improvement, whereby the Government grants to the inventor the right to exclude others from making, using, or selling his

invention for 17 years from the date of issue of the patent, in return for complete publicity of the invention. Under this agreement the inventor's reward is valuable or worthless as the invention proves valuable or worthless to others. If the invention is one desired by the general public, the exclusion of others may enable the patentee to reap a rich reward; or, if the invention is worthless, the reward will be equally valueless.

By means of patents, publicity for new ideas is encouraged; for the owner of a valid patent is secure for 17 years, after that the subject of the patent becomes public property. It is for this reason that the patent consists of drawings and specifications to make a complete disclosure of the invention, so that anyone skilled in that particular industry may reproduce it. In addition to the drawings and specifications there are what are called claims. These claims define the actual limits to the patentee's rights to exclude others. Without adequate protection, there would be a tendency to suppress public information regarding new inventions, the inventor relying upon secrecy instead to gain his reward. The patent actually withdraws nothing from the public, but merely withholds for a limited time what otherwise might have been kept secret and perhaps lost forever. It must add to the sum of human knowledge, for in so far as it does not do that, it is to that extent invalid. All that is necessary to establish invalidity is to prove that nothing has been added to the sum of human knowledge by the patent. If it is plainly apparent to an engineer that a patent is invalid, the engineer should be able to so convince the court.

Patents pertaining to reinforced concrete may be divided into two classes: (1) those that apply to improvements in manufactured details, such as reinforcements, and which have been described in Art. 18 of Volume I and in Chapter V of Volume II; and (2) those which may more properly be called engineering patents and which relate to improvements in the structure itself as, for example, the *location* of reinforcement, or the processes of erection. Patents on manufactured details develop a field for the sale of special types of reinforcement, the royalty being included in an enhanced selling price. In other words, this class of patents is used to promote the business of the manufacturer rather than that of the engineer. The second class above mentioned is used more often by the engineer as a support for specialization in engineering, and the royalty is ordinarily

collected in the same way as engineering fees—that is, as a certain percentage of the contract price. If the patents are of value, they enable the engineer to charge a higher percentage for his services.

63. Patents Pertaining to Arch Bridges.—Although various types of patented reinforcement are applicable to arch bridges, the most of the patents that have had to do with arch bridge development are of the engineering class. The most important of these engineering patents are included in the following list, a few of which will be briefly described:

Arnold.....	749,771	Jan. 19, 1904.	Luten.....	1,060,920	May 6, 1913.
			Luten.....	1,060,921	May 6, 1913.
Aylett.....	965,357	July 26, 1910.	Luten.....	1,060,922	May 6, 1913.
Aylett.....	965,358	July 26, 1910.	Luten.....	1,089,488	Mar. 10, 1914.
Aylett.....	984,878	Feb. 21, 1911.	Luten.....	1,090,081	Mar. 10, 1914.
			Luten.....	1,106,880	Aug. 11, 1914.
Cummings.....	978,361	Dec. 13, 1910.			
			Melber.....	660,518	Oct. 23, 1900.
Luten.....	649,643	May 15, 1900.	Melber.....	672,175	Apr. 16, 1901.
Luten.....	785,676	Mar. 21, 1905.			
Luten.....	802,004	Oct. 17, 1905.	Moller.....	776,252	Nov. 29, 1904.
Luten.....	818,386	Apr. 17, 1906.			
Luten.....	830,483	Sept. 5, 1906.	Parmley.....	696,838	Apr. 1, 1902.
Luten.....	840,224	Jan. 1, 1907.	Parmley.....	709,794	Sept. 23, 1902.
Luten.....	852,970	May 7, 1907.	Parmley.....	712,841	Nov. 4, 1902.
Luten.....	852,971	May 7, 1907.	Parmley.....	764,302	July 5, 1904.
Luten.....	853,183	May 7, 1907.	Parmley.....	764,303	July 5, 1904.
Luten.....	853,202	May 7, 1907.			
Luten.....	853,203	May 7, 1907.	Strauss.....	762,361	June 14, 1904.
Luten.....	923,058	May 25, 1909.			
Luten.....	933,771	Sept. 14, 1909.	Thacher.....	617,615	Jan. 10, 1899.
Luten.....	998,704	July 25, 1911.			
Luten.....	1,004,051	Sept. 26, 1911.	Thomas.....	805,762	Nov. 28, 1905.
Luten.....	1,005,051	Oct. 3, 1911.	Thomas.....	886,666	May 5, 1908.
Luten.....	1,009,676	Nov. 21, 1911.	Thomas.....	915,316	Mar. 16, 1909.
Luten.....	1,027,742	May 28, 1912.	Thomas.....	1,097,269	May 19, 1914.
Luten.....	1,048,843	Dec. 31, 1912.			
Luten.....	1,060,917	May 6, 1913.	Watson.....	1,071,118	Aug. 26, 1913.
Luten.....	1,060,918	May 6, 1913.			

(Copies of patents may be obtained from the Commissioner of Patents, Washington, D C. at 5 cents each.)

The earliest of the United States patents on concrete arches, was the Melan patent for steel ribs (either rolled sections or built-up lattice girders) embedded in concrete arch rings. This patent expired Sept. 12, 1910.

The Thacher patent, No. 617,615, issued Jan. 10, 1899, on an application filed Oct. 17, 1896, is illustrated in Fig. 185, together with one of the claims which is typical.

(The sketches shown in this chapter are all taken directly from

the patent drawings and include more than is covered by the claims cited. The reason for this is due to the fact that a claim is for an improvement while the patent drawings must show how to construct a complete working structure.)

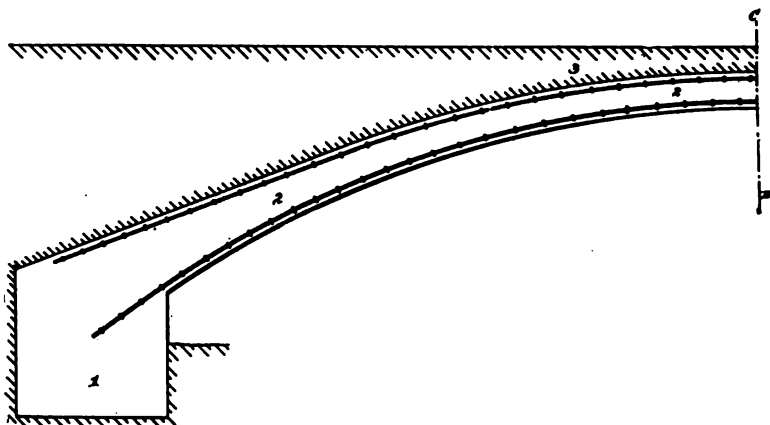

CLAIM 3.—The combination with abutments, and a concrete arch spanning the space between the abutments, of a series of metal bars in pairs, one bar of each pair above the other bar, near the extrados and intrados of the arch, each bar of a pair being independent of the other, and one bar of each pair extending well into the abutment, substantially as described.

FIG. 185.—Thacher patent.

A somewhat similar reinforcement is shown in the patent to Arnold, No. 749,771, issued, Jan. 19, 1904, on an application filed Sept. 13, 1902. The bars are arranged in pairs, but bonded

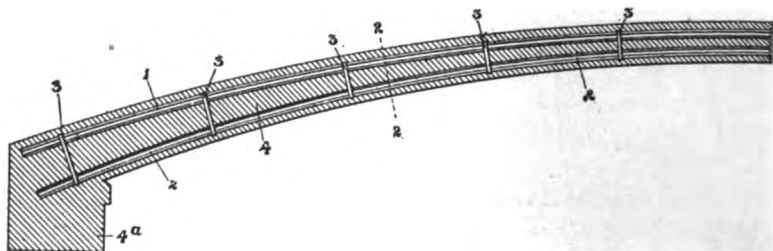

CLAIM 2.—In a bridge, an arch of concrete or other masonry, having embedded therein ribs, arranged one above but separated from each other and by the masonry and composed of railroad rails or other iron, said ribs being bonded together by metallic straps wound around them and at intervals of the length thereof, substantially as described.

FIG. 186.—Arnold patent.

together by metallic straps as indicated in Fig. 186, thus differing from the Thacher patent in which the bars are claimed as independent of one another.

Another modification of the Thacher patent is shown in Melber,

No. 660,518, issued Oct. 23, 1900, on an application filed August 24, 1899, in which shear members cross diagonally from one reinforcing member to another (Fig. 187).

The Parmley patent, No. 696,838, issued April 1, 1902, on an

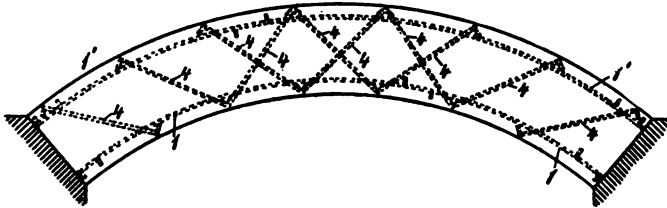

CLAIM 1.—In cement or other concrete construction metal reinforcing bars, unattached at their ends to other metal reinforcing bars, embedded therein transverse to the calculated shearing strains.

FIG. 187.—Melber patent.

application filed June 4, 1901, differs from the Thacher patent in having the bars near intrados and extrados alternating with one another instead of being arranged in pairs (Fig. 188).

A materially different form of arch reinforcement is shown in the patent to Luten, No. 1,009,676, Nov. 21, 1911; application

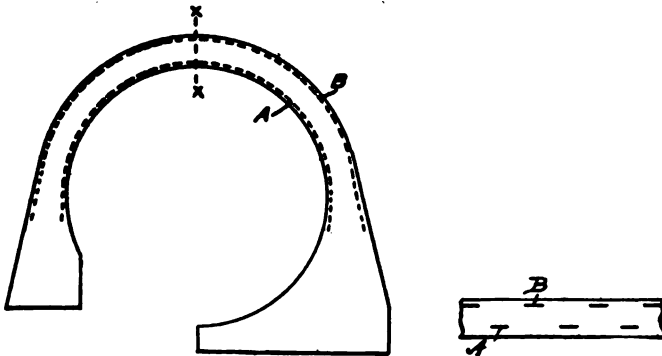

CLAIM 3.—A concrete arch having bars embedded therein, both in intrados and extrados at the regions of tension and extending continuously through the regions of tension and sufficiently into the abutments to obtain a secure anchorage, the bars in the extrados being opposite the spaces between those in the intrados.

FIG. 188.—Parmley patent.

filed April 29, 1901. This patent shows the arch reinforced with but a single series of reinforcing members (Fig. 189) instead of the double row of the Thacher, Arnold, Melber, and Parmley patents. A modification of this device is shown in another patent to Luten, No. 818,386, April 17, 1906; application filed May 17,

1902. In this patent the points of crossing the arch ring for various rods of the single series have been displaced laterally along the arch ring, so that the arch is reinforced on both sides through a short region where there is doubt as to whether the

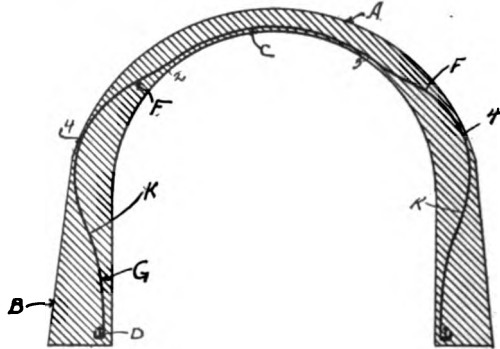

CLAIM 2.—In an arched structure of concrete the combination with a curved or arched member and abutments to support the same, of a series of tension members embedded in said curved or arched member, and passing close to the interior face of the abutments.

Fig. 189.—Luten patent.

bending moments will be positive or negative (Fig. 190). The reason for placing the reinforcement in this way is based on the theory that tension will occur at alternately opposite regions of an arch in limited regions only, and that steel is located in those regions and extends continuously from one to the other for

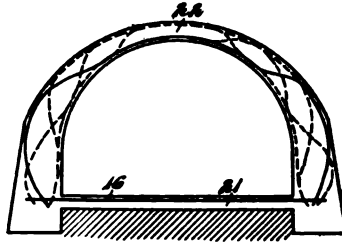

CLAIM 7.—An arch having embedded therein rods, bars, or other tension members in two or more series following one face of the arch rib, thence across and following the other face of the rib, the points of crossing for the different series being angularly or laterally displaced with respect to each other, substantially as described.

Fig. 190.—Luten patent.

convenience in placing. A similar object may be accomplished with non-continuous rods as shown in patent to Luten No. 852,971, May 7, 1907; application filed June 30, 1906. (See Fig. 191.) The difficulty of placing this form of reinforcement probably offsets the saving in metal.

The Cummings patent, No. 978,361, issued Dec. 13, 1910, on an application filed June 11, 1909, relates entirely to

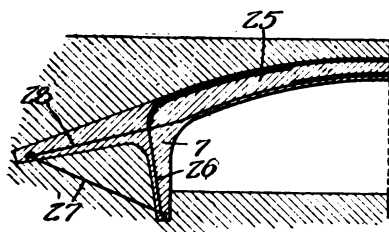

CLAIM 9.—A concrete arch having reinforcement near both surfaces alternately heavy and light on opposite sides of points of calculated change of moment.

FIG. 191.—Luten patent.

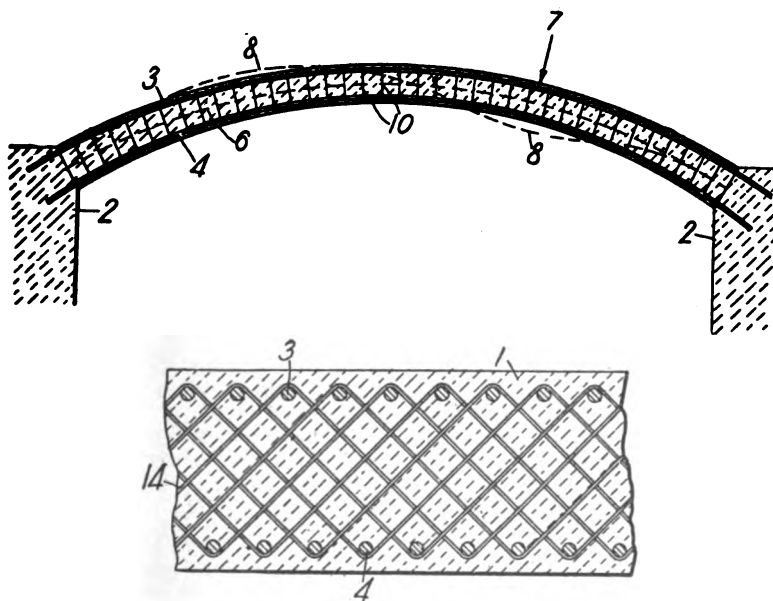

CLAIM 4.—A reinforced concrete arch or girder comprising longitudinal reinforcement bars arranged near the upper and lower surfaces thereof, a series of open metal sheet or mesh members arranged close together and all parts of each lying in substantially a single plane substantially normal to the neutral equilibrium curve of the arch or girder and extending from top to bottom and side to side thereof and comprising a substantial portion of the cross-sectional area thereof, whereby said reinforcement members resist vertical tension stresses throughout the width of the arch or girder, and cementitious material enveloping and embedding said longitudinal and transverse reinforcement members.

FIG. 192.—Cummings patent.

transverse reinforcement in the arch ring or arch rib. A typical claim is given in Fig. 192.

In any of the above patents the reinforcement may be of

almost any type patented or non-patented, but usually consists of round rods. However, there is no reason why any of the types of reinforcement described in Art. 18 of Vol. I and in Chapter V of Vol. II may not be applied in accordance with the claims of the above patents which, as far as the writer knows, are all the patents that apply specifically to arch ribs.

A patent that has nothing to do with reinforcement is that to Moller, No. 776,252, Nov. 29, 1904; application filed July 6, 1904. This patent pertains to an abutment for an arch, in which a horizontal plate is used to resist the horizontal thrust (Fig. 193).

The converse of this is shown in the patent to Luten No. 840,-

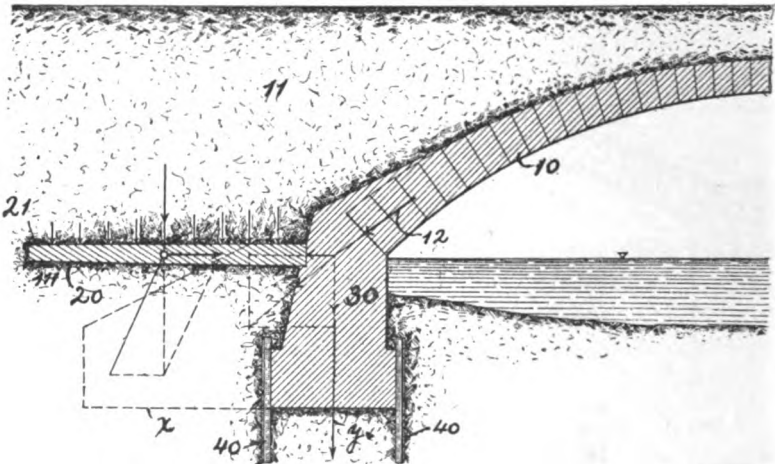

CLAIM 1.—An abutment member for arches, consisting of a plate placed in a substantially horizontal position in contact with the end of the arch adjacent to its pressure-line.

FIG. 193.—Moller patent.

224, issued Jan. 1, 1907; on an application filed Aug. 23, 1905. In this patent the horizontal thrust of the arch on the abutment is resisted by a metal tie from abutment to abutment embedded in a concrete pavement across the bed of the stream (Fig. 194). This pavement also serves as a support for the falsework in erecting the bridge and is intended to render the bridge flood proof by preventing scour under the foundations.

The application of process patents to arches is illustrated in a typical manner in the patent to Luten No. 923,058, issued March 25, 1909, on an application filed April 1, 1907, for a method of building a bridge in which the stiffening effect of the spandrel is applied to produce what is considered a more efficient structure

with elimination of possible settlement cracks. The old method was to remove the centers from beneath an arch before the spandrels, fill, and railings were added, the arch thus assuming its settlement stresses before their addition; but the erection of spandrels or fill after centers are removed is dangerous unless the arch ring is made excessively heavy. The process of the Luten

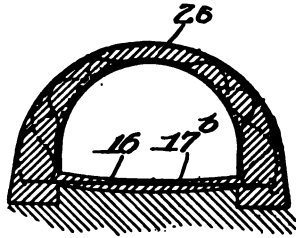

CLAIM 9.—An arch or bridge having the bed of stream paved with concrete with tension members embedded transverse to the course of the stream.

FIG. 194.—Luten patent.

patent referred to covers the building of the arch and *part* of the spandrel *before* striking centers, and the addition of the coping and railings *after* striking centers. The addition of the lower part of the spandrel walls before striking centers permits the addition of the earth fill supported by these walls and this applies

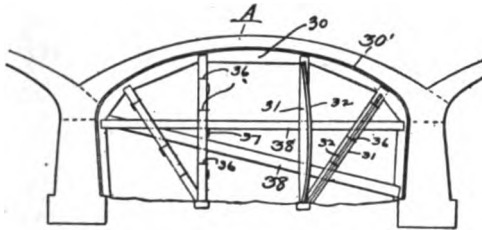

CLAIM 4.—A falsework centering containing compound-compression members for supporting a load and each composed of a plurality of pieces having major and minor dimensions transverse to their lengths, the major dimension of one piece being arranged transversely to the major dimension of another piece, and a withdrawable connection to unite the pieces of each compression member.

FIG. 195.—Luten patent.

to the arch its normal loading at the time the centers are struck. The part spandrel serves to stiffen the arch and render it secure, making possible the use of a light arch ring, yet with elimination of settlement cracks. One of the broader claims (claim 14) is as follows:

“That improvement in the art of building an arch or girder comprising erecting the arch or girder together with part of the spandrel or super-

structure on centers, then lowering the centers and subsequently adding coping or railing."

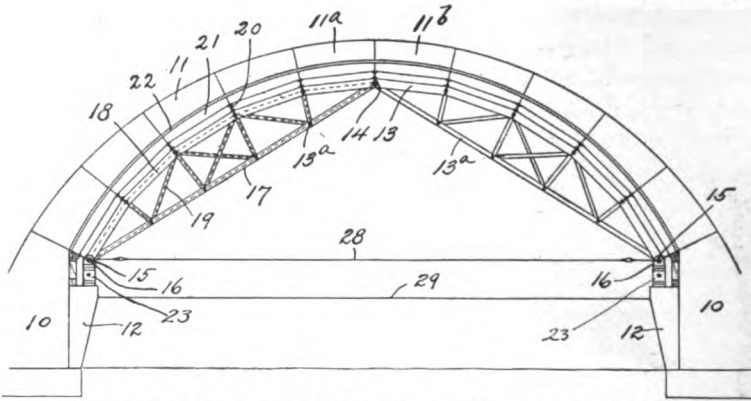

CLAIM.—A centering or temporary falsework for masonry, or concrete arches comprising a three-point pinned arch composed of two sections supported solely at their lower ends and connected together at their upper ends at the center plane of the arch by a single pin through which stresses are transmitted from one section to the other, supports at the lower ends of the two sections each connected to the corresponding section by a single pin.

FIG. 196.—Watson patent.

An improved form of centering is disclosed in Luten patent No. 1,106,880, Aug. 11, 1914; application filed Nov. 1, 1906. The uprights consist of compound T-columns fastened together with wires (Fig. 195) and consisting usually of 2 in. by 6-in. or

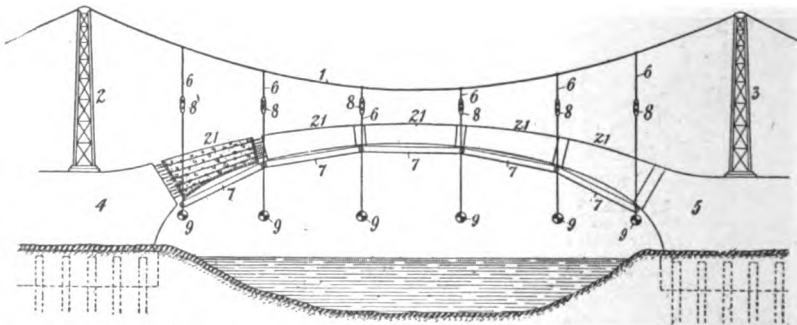

CLAIM 2.—In a system of concrete construction, the combination of supporting cables, arranged over a space to be spanned, a centering comprising a plurality of flexibly jointed sections, and hangers suspending the said sections from the cables.

FIG. 197.—Aylett Patent.

2 in. by 8-in. timbers. No wedges or sand boxes are used for striking centers, but by clipping the wires, the compound columns are resolved into their simple elements, which buckle, lowering the center, and the arch thus gradually assumes its load.

A three-pin type of centering is shown in the patent to Watson, No. 1,071,118, issued Aug. 26, 1913, on an application filed

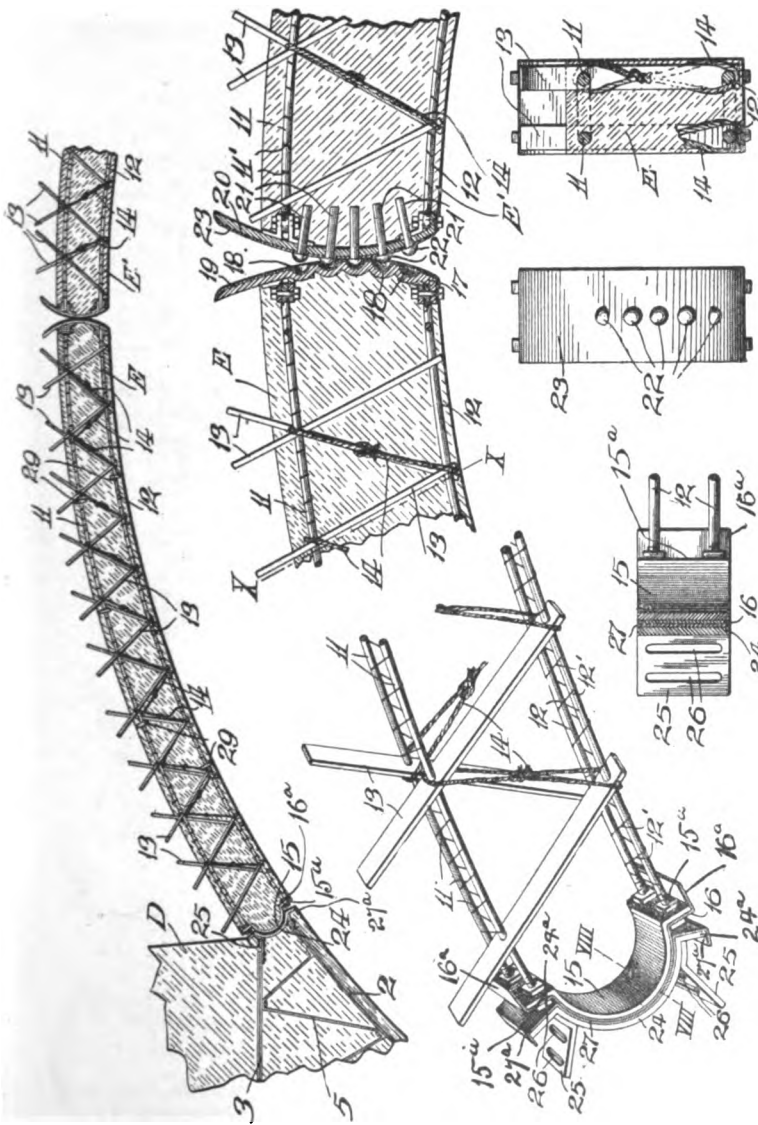

CLAIM 7.—In a bridge construction, a pair of mating concrete arch sections having hinge plates at their crown ends the hinge plate of one of the sections being provided with pockets and the hinge plate of the other section being provided with pins having heads adapted to enter the pockets in the mating hinge plate, substantially as set forth.
 CLAIM 11.—A bridge centering comprising a concrete abutment formed with a cantilever arm having reinforcing framework, segmental shaped socket plates having wings connected to the framework of the cantilever arm, and an arch section having semi-circular hinge members fitted to the socket plates.

FIG. 198.—Thomas patent.

Jan. 27, 1911. One of the objects of the invention is to provide a centering which can be used repeatedly, which has a minimum deflection when the load is applied, and which is well adapted

for construction of arch bridges where obstruction to traffic under the bridge must be avoided. (See Fig. 196.)

A suspended system of arch construction is described in the Aylett patent No. 965,358, July 26, 1910; application filed Oct. 26,

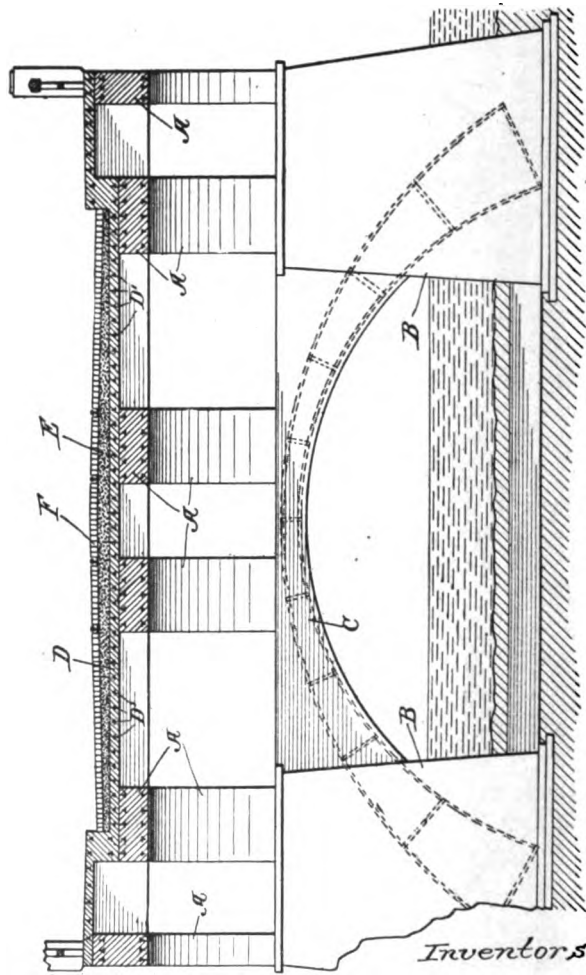

CLAIM 6.—A concrete bridge comprising a series of piers separated longitudinally and transversely, a super-structure supported upon said piers and comprising a series of longitudinal ribs connected by a floor integral therewith and having a less thickness than the ribs.

FIG. 199.—Strauss and Collins patent.

1907. (See Fig. 197.) The Aylett patents also cover the method of attaching the main cables directly to the voussoirs without any centering whatever—or what might be called a suspended pre-cast voussoir method.

A three-hinged arch patent is disclosed in the patent to Thomas,

No. 915,316, Mar. 16, 1909; application filed Jan. 30, 1908. (See Fig. 198.)

The Strauss and Collins patent No. 762,361, issued June 14, 1904, on an application filed Jan. 25, 1904, describes a special type of arch bridge, as indicated in Fig. 199.

64. Patent Litigation.—There has been much activity in litigation of arch patents. Of the suits won, many have been concluded by consent decrees, but none have thoroughly contested the validity of the patents. Many of the pending suits are being hotly contested at the present time and will undoubtedly result in decrees that will definitely determine the validity of some of the patents. A single favorable opinion in a thoroughly contested case will go a long way to fix the standing of the patents before the public. An unfavorable opinion on the other hand will not be conclusive, because it will determine the validity of only a few claims, and the Luten patents alone contain hundreds of claims. Any one suit might invalidate a possible half-dozen of these claims but would not be conclusive as to the patents themselves or the other claims that were not involved. Hence no early conclusion of litigation under these various patents can be expected.

Since a patent is a Federal grant, litigation for violation of the patent itself must always be in the Federal court. Property rights in patents and contracts under patents may come within the jurisdiction of the State courts, but infringement of a patent is a matter for correction exclusively in the Federal court. A patent is infringed by anyone who makes, sells, or uses any device that includes all of the elements named in any one claim of the patent. If any element of the claim be absent from the device the patent is not infringed. But the presence of more elements than called for by the claim does not avoid infringement. The drawings and specifications have very little to do with the question of infringement, being principally useful to the court in determining any ambiguity that may arise as to the claim. In the Thacher patent illustrated in Fig. 185 the reinforcement is shown consisting of deformed bars, but the claims are not thus limited. Hence smooth rods or bars or their equivalent would infringe the patent if arranged as claimed.

The remedy for infringement may be a suit at law before a jury to collect damages, or it may be a suit in equity before a judge for an injunction which, if granted, carries with it an ac-

counting for damages and profits. Nearly all infringement suits are consequently suits in equity, having the injunction against future infringement as their primary object. An injunction to prevent infringement may be granted either before or after there has been infringement, a past infringement being construed by the court as a threat to infringe again. If one claim of a valid patent is shown to be infringed, the court will grant an injunction forever restraining the future infringement of that patent. The suit may be against any party violating the patent. Thus the builder and the purchaser are both liable and neither can relieve the other. The designer may also be held liable under certain conditions, even though he has not actually made, used, or sold the infringing structure itself. The courts have held that there may be contributory infringement by one who assists others to make, sell, or use patented devices, as in the case of an engineer designing and supervising an infringing structure.

There are many possible defenses to a suit for infringement, but none of them are ordinarily of much practical value, except the proof that the patent was not granted to the original inventor in this country. The most convincing test of the validity of a patent is: Did it add anything to the sum of human knowledge? If it did, it is to just that extent valid. One or more claims of a patent may be found invalid and the remaining claims of the patent still remain valid. And the patent itself is not void until all of its claims have been proved invalid.

Suits for infringements are begun in district courts of the United States. From this court there may be an appeal to the Circuit Court of Appeals of the Circuit, and its decision is final. There are nine Federal Circuits in the United States and nine courts of appeal, and the decision of one of these courts is not binding upon any other, although it is persuasive. In case of conflicting decisions a remedy may be had in the Supreme Court of the United States, but this is possible only in case such court consents to a hearing. Consequently a patent may be valid in one district and invalid in another, and adverse decisions are necessary in nine district courts to completely invalidate it throughout the United States. Usually one or two thoroughly contested decisions are considered conclusive.

The damages that may be secured in a suit for infringement are usually measured by the customary royalty charged for the use of the patent. In case the infringement was done knowingly

and wilfully, treble damages may be awarded at the pleasure of the court. But even so the cost of litigation usually far exceeds the damages secured and the primary object of a suit for infringement must be the injunction to stop further infringement. Under the old rules of Federal court procedure the cost of a patent suit not infrequently ran into tens of thousands of dollars. The total cost of the suit that established the validity of the Cameron Septic Tank patent is said to have exceeded \$50,000, and the Warren Bitulithic Paving patent, \$60,000. But on Feb. 1, 1913, the new rules of Federal court procedure went into effect and infringement suits may now be tried in open court with but little delay, so that lower court decisions may now be had in 1 or 2 years, where formerly 5 years was not unusual, and Mr. Edison is said to have contested one suit through 30 years of litigation.

CHAPTER XIII

TYPICAL DESIGNS OF THE VARIOUS TYPES OF ARCH BRIDGES

The bridges illustrated in this chapter have been selected as representative of the various types of arch bridges built in this country, and much can be gained, the writer believes, by a careful study of the details shown. In fact, it is thought that the practical designing of concrete arch bridges can be taught in no other way than by requiring a well-directed study of a representative collection of typical detailed designs, such as those shown, in addition to the usual problems of analysis. The construction views included should prove instructive.

The construction in detail of the Yardley bridge (Plates IV, V, and VI) may be found in Chapter XXXI. The Third Street bridge at Logansport, Ind. (Plate VII) is a bridge of Luten Design—a patented type of bridge referred to in Chapters X and XII. The lattice girders set across the arch ring in the Atherton Avenue bridge (Fig. 207 and Plate IX) should be especially noted as they are somewhat unusual, being employed to provide positive spacing and locking together of the arch reinforcement. The analysis of the Carondelet Park bridge (Plates XII, XIII, and XIV) and also of the Main Street viaduct (Plates XL and XLI) may be found in Arts. 47 and 61 respectively. The Latah Creek bridge (Figs. 232 and 233) was included to show one method of providing rigidity and at the same time reducing the number of ribs showing on the arch soffit—this being done by connecting each outer rib with the adjacent inner one by a thin slab at the intrados. The highway bridge at Danville, Va. (Plate XXXVIII) shows a type of bridge with the arch ribs extending up to the roadway and the reinforcement so placed that the greater part of rib may be considered as effective arch depth. The Benson Street bridge at Lockland, Ohio (Plate XXXIX), is a through arch bridge with the horizontal component of the arch thrust taken by steel rods extending between the skewbacks and fastened to the steel in the ribs.

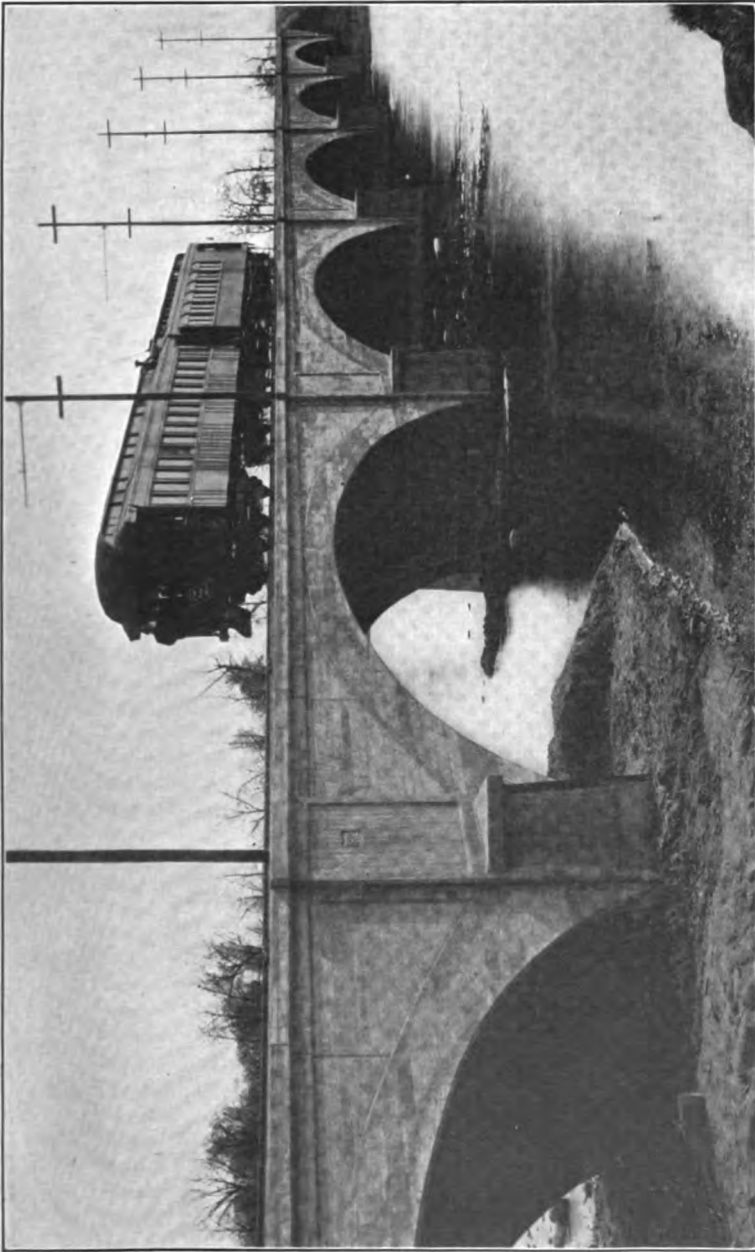

Courtesy of Mr. T. E. Rust, Chief Engineer, W. C. F. & N. Ry.

FIG. 200.—Elk Run bridge across Cedar River, Waterloo, Cedar Falls & Northern Ry. Co.

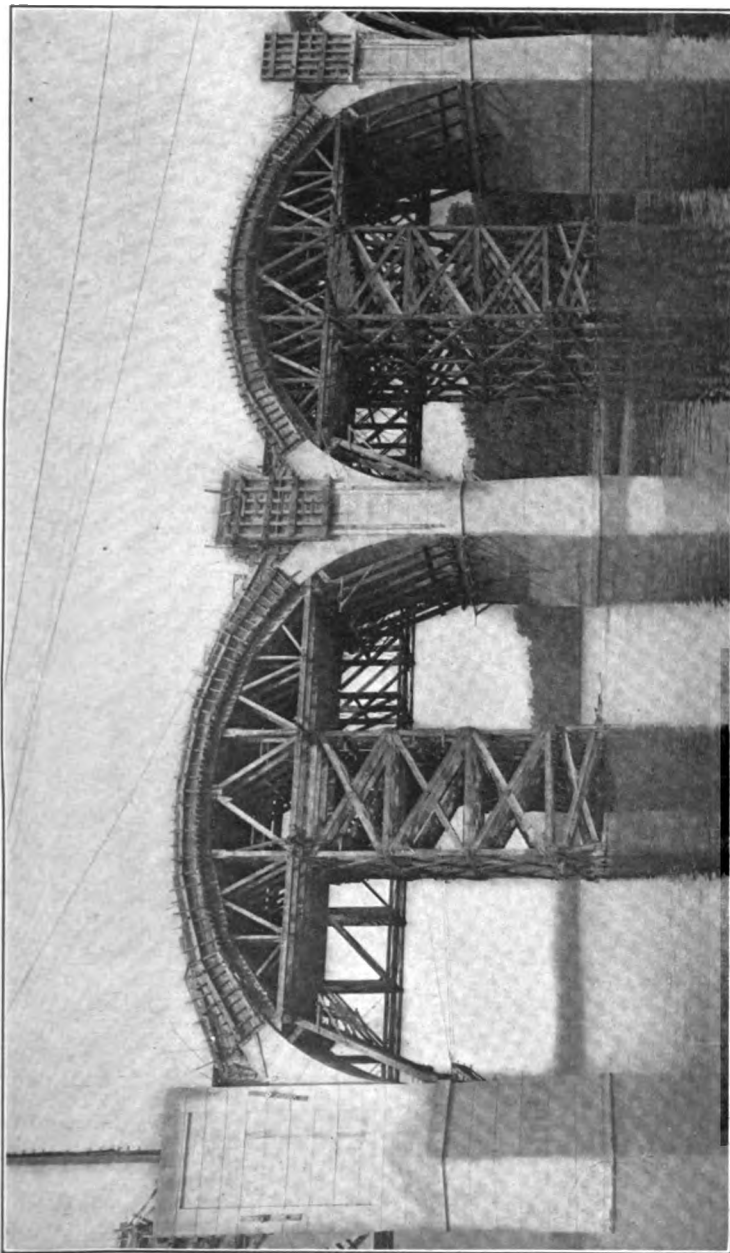

Courtesy of Mr. William Hunter, late Chief Engineer, P. & R. Ry. Co.
FIG. 201.—Yardley bridge, Philadelphia & Reading Ry. Co.

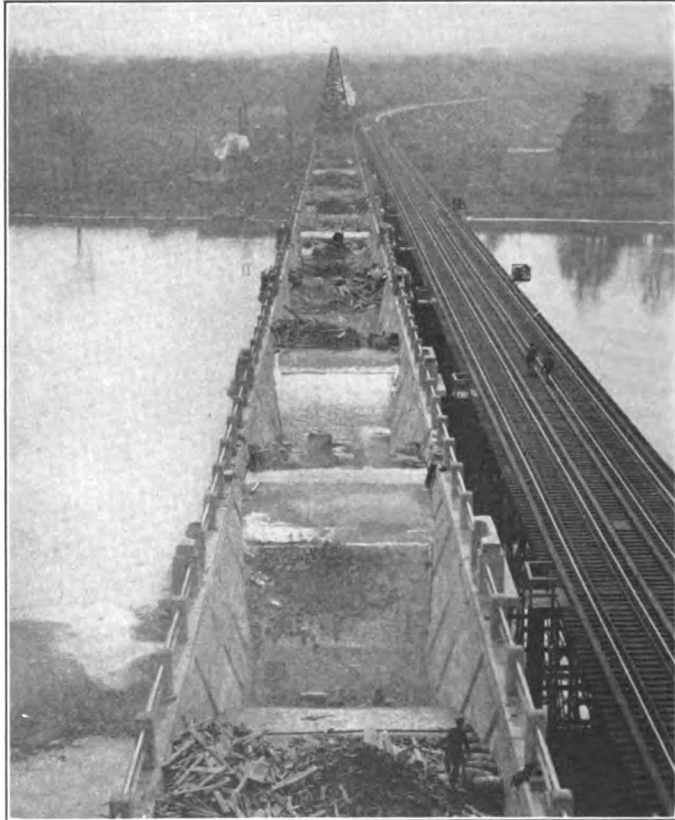

Courtesy of Mr. William Hunter, late Chief Engineer, P. & R. Ry. Co.
FIG. 202.—Yardley bridge, Philadelphia & Reading Ry. Co.

PLATE IV

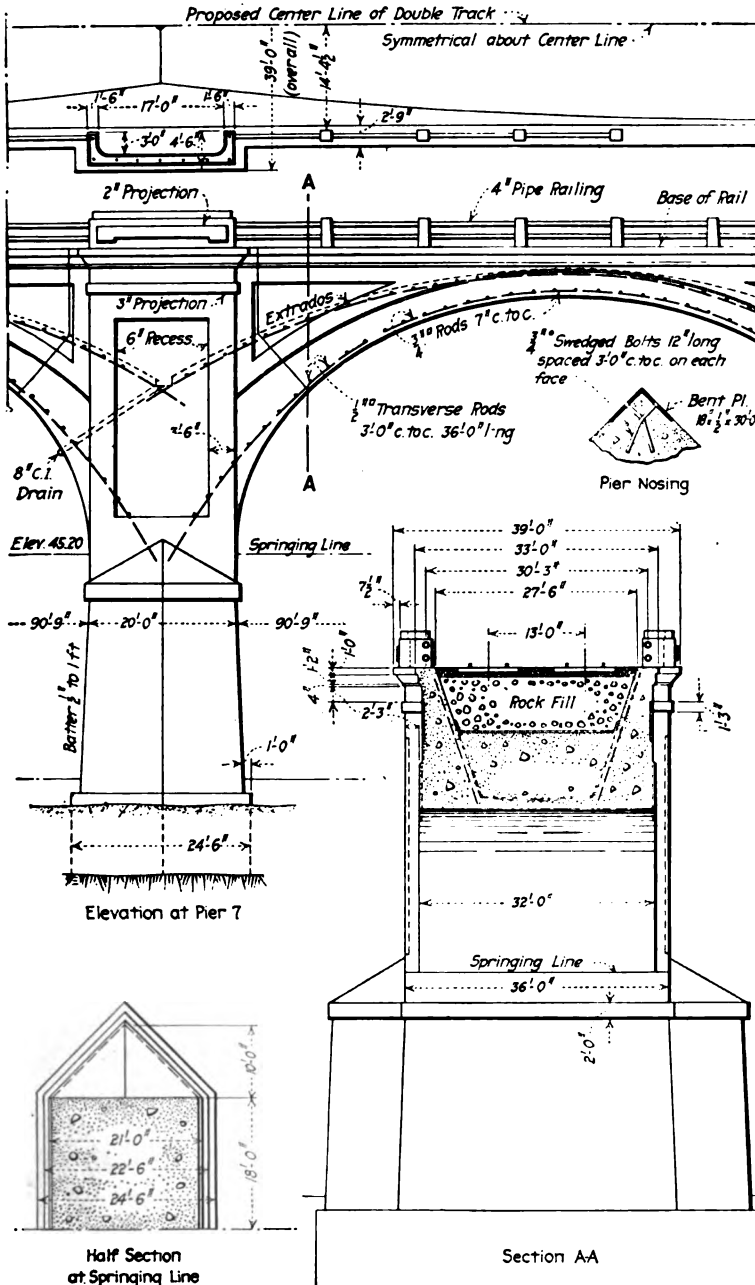

Yardley bridge, Philadelphia & Reading Ry. Co.

PLATE V

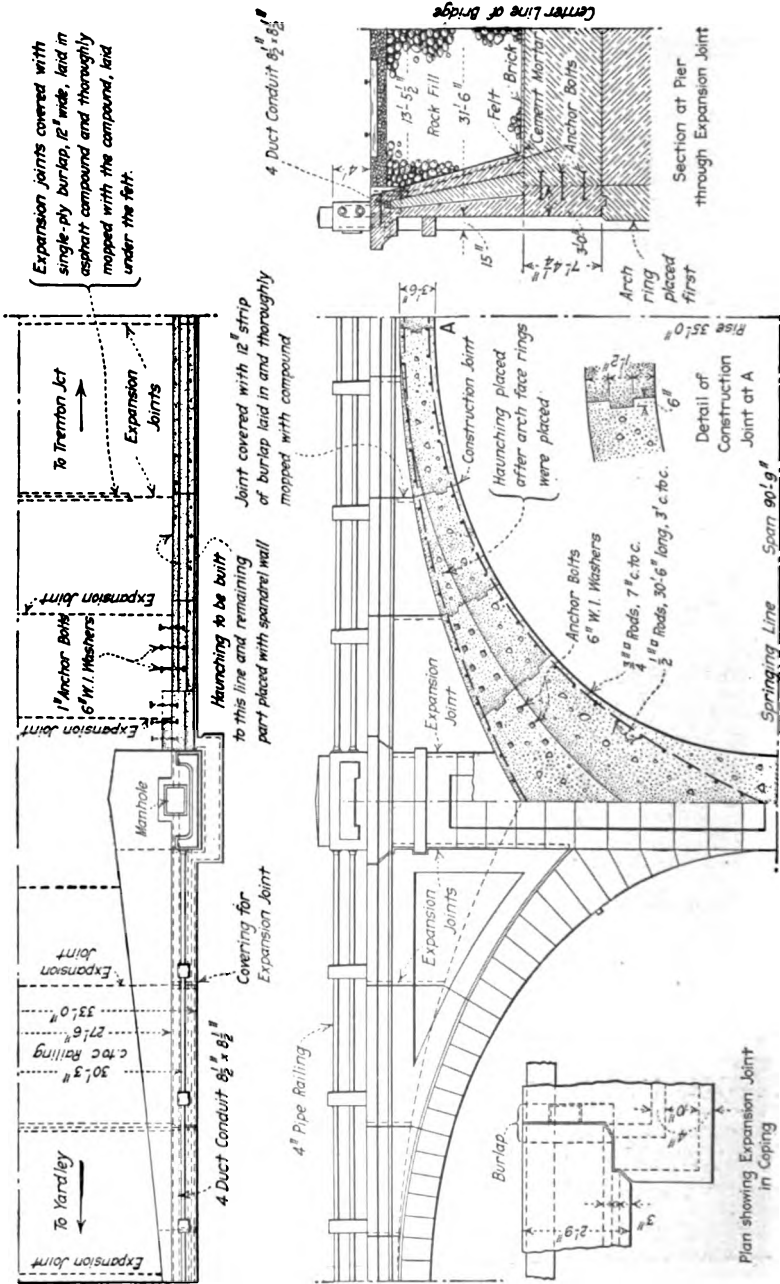

Yardley bridge, Philadelphia & Reading Ry. Co.

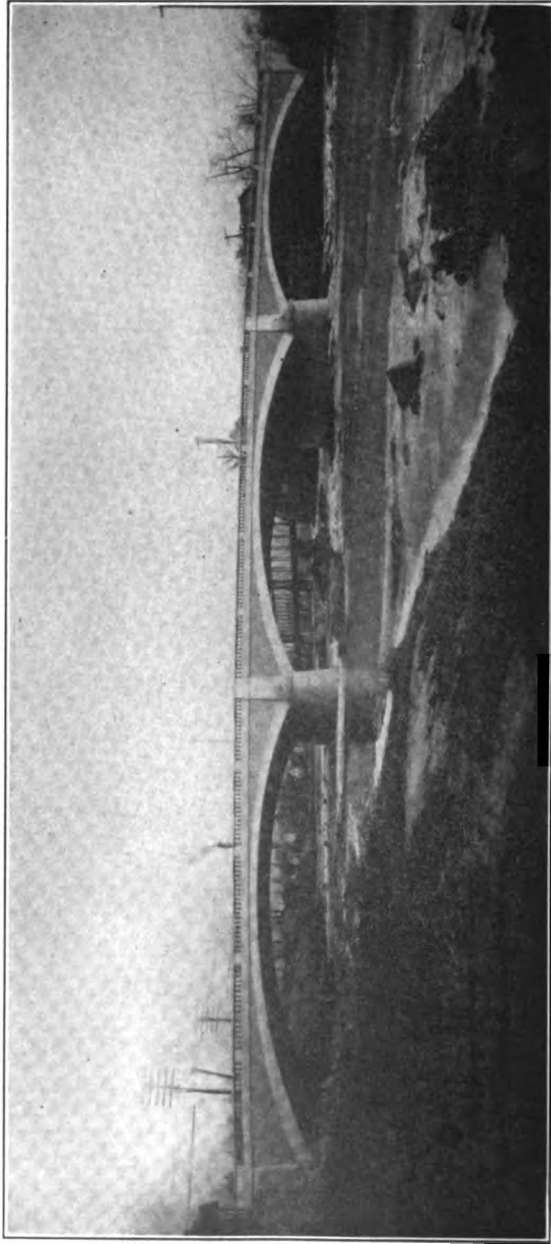

Courtesy of Mr. Daniel B. Lutten, Consulting Engineer, Indianapolis.
FIG. 203.—Third Street bridge, Logansport, Ind.

PLATE VII

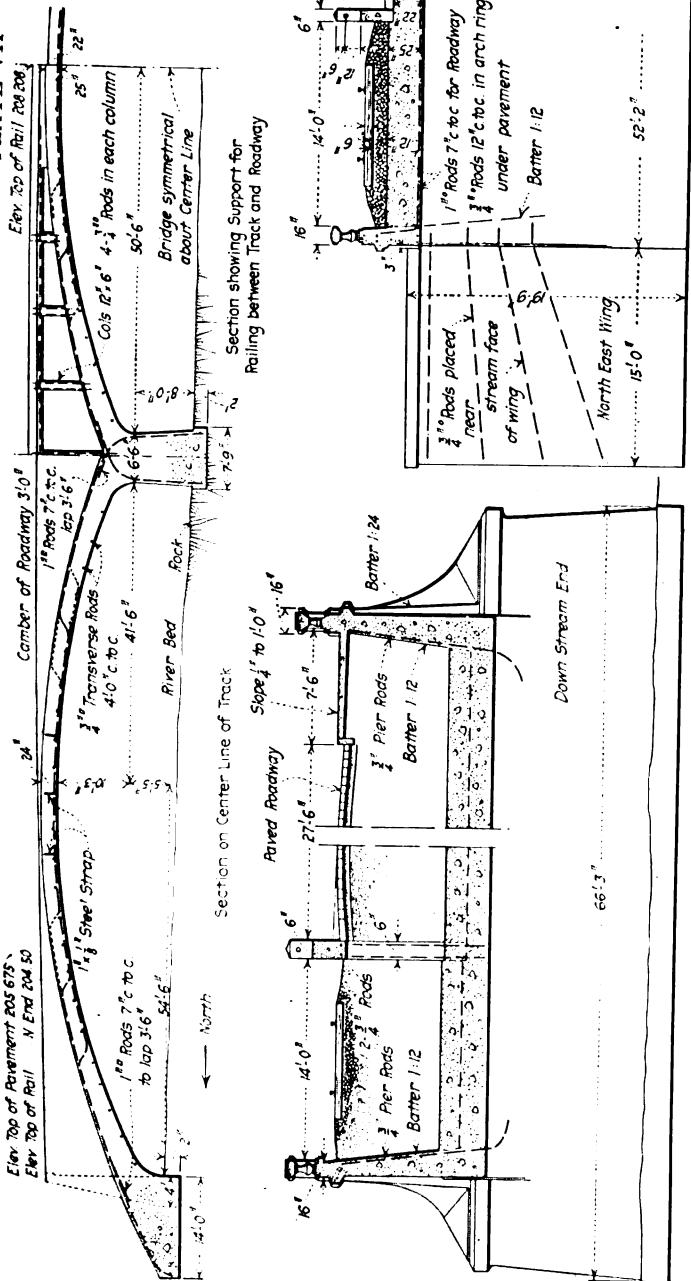

Third Street bridge, Logansport, Ind.

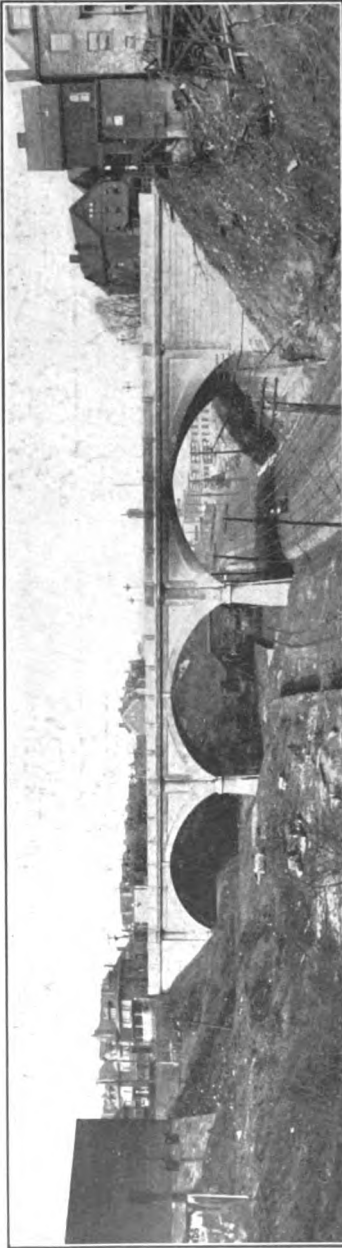

Courtesy of Mr. N. S. Sprague, Superintendent, Dept. of Public Works, Pittsburgh.
FIG. 204.—Atherton Avenue bridge over P. R. R., City of Pittsburgh.

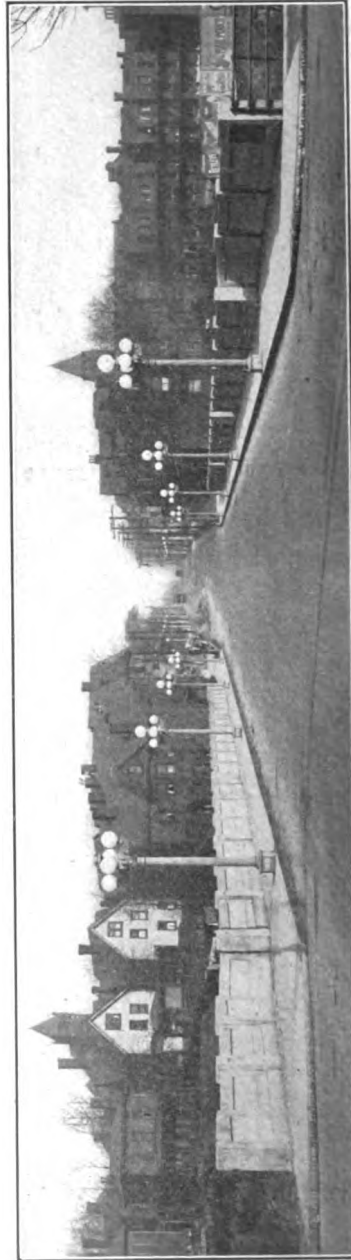

Courtesy of Mr. N. S. Sprague, Superintendent, Dept. of Public Works, Pittsburgh.
FIG. 205.—Roadway of Atherton Avenue bridge over P. R. R., City of Pittsburgh.

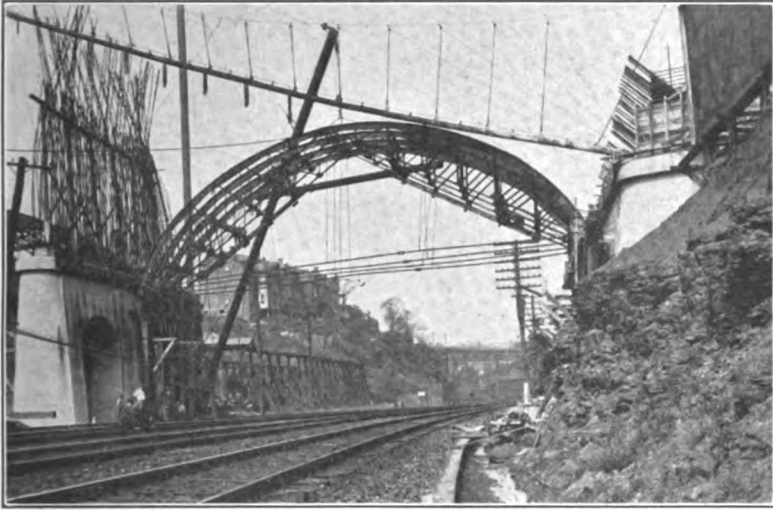

Courtesy of Mr. N. S. Sprague, Superintendent, Dep't. of Public Works, Pittsburgh.
FIG. 206.—Steel centers—Atherton Avenue bridge, Pittsburgh.

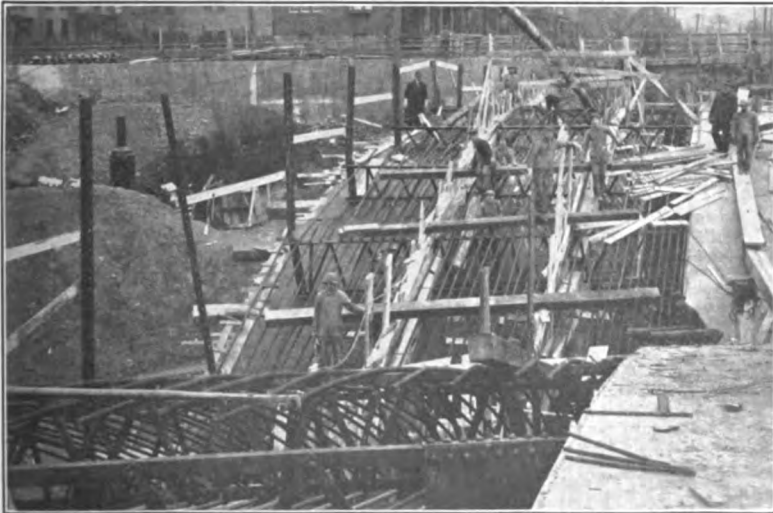

Courtesy of Mr. N. S. Sprague, Superintendent, Dep't. of Public Works, Pittsburgh.
FIG. 207.—Construction view—Atherton Avenue bridge, Pittsburgh.

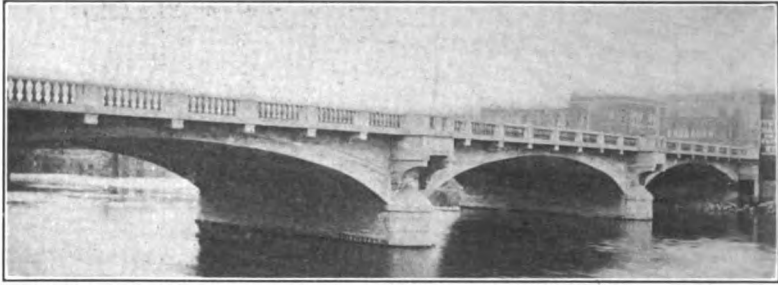

Courtesy of Engineering and Contracting.

FIG. 208.—Third Avenue bridge over Cedar River, Cedar Rapids, Iowa.

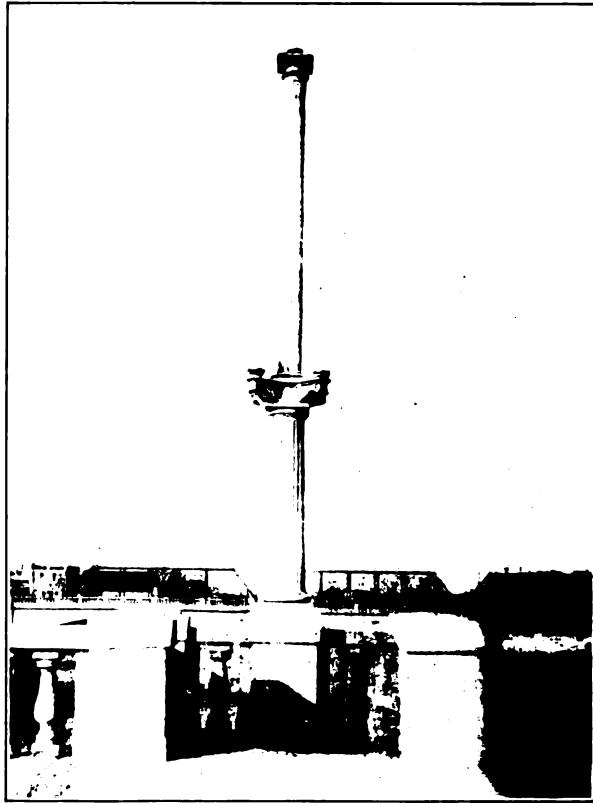

Courtesy of Engineering and Contracting.

FIG. 209.—Refuge bay of Third Avenue bridge, Cedar Rapids, Iowa.

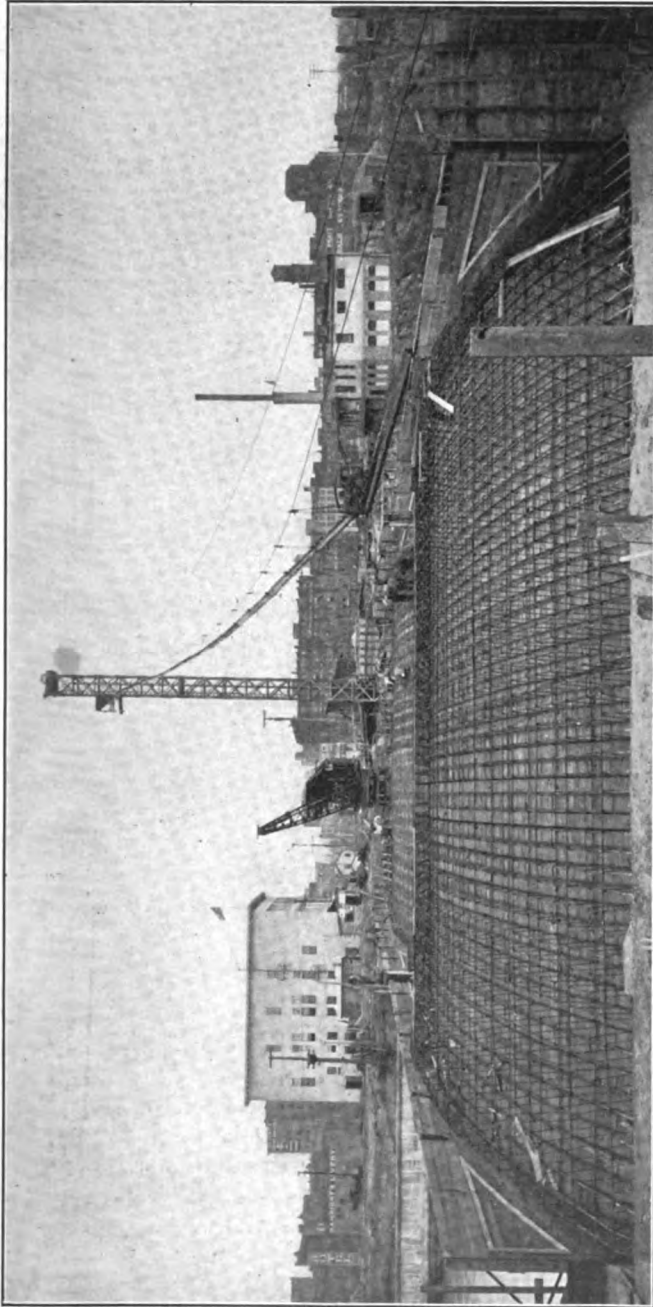

Courtesy of Engineering and Contracting.
Fig. 210.—Construction view of Third Avenue bridge, Cedar Rapids, Iowa.



Courtesy of Engineering and Contracting
FIG. 208.—Third Avenue bridge



© 1915 by McGraw-Hill Book Company, Inc.



FIG. 213.—Abutments of Carondelet Park bridge, St. Louis.

PLATE X

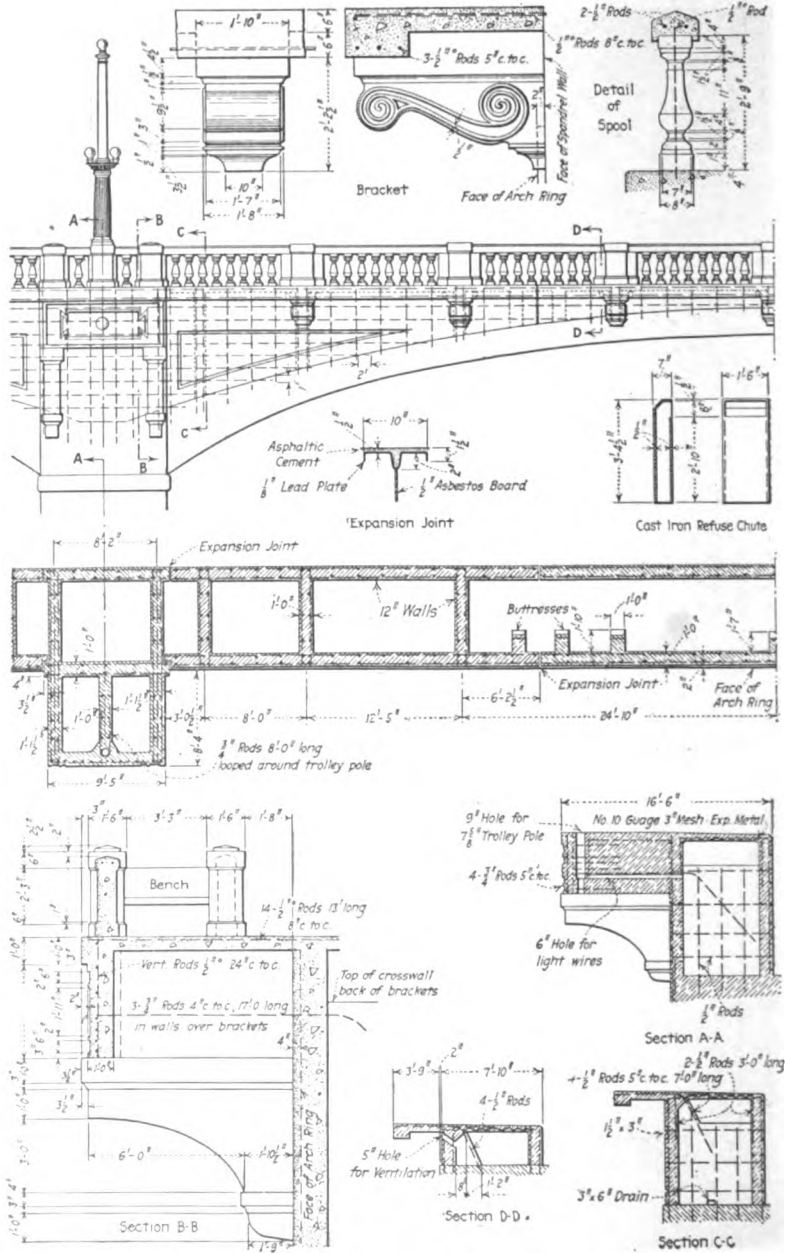

Third Avenue bridge, Cedar Rapids, Iowa.

PLATE XI

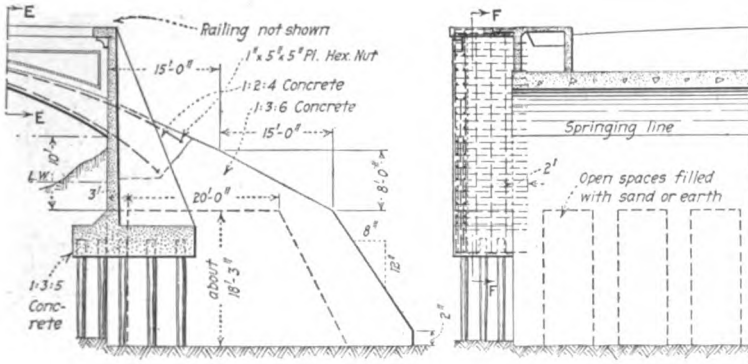

Section F-F through Retaining Wall

Section E-E

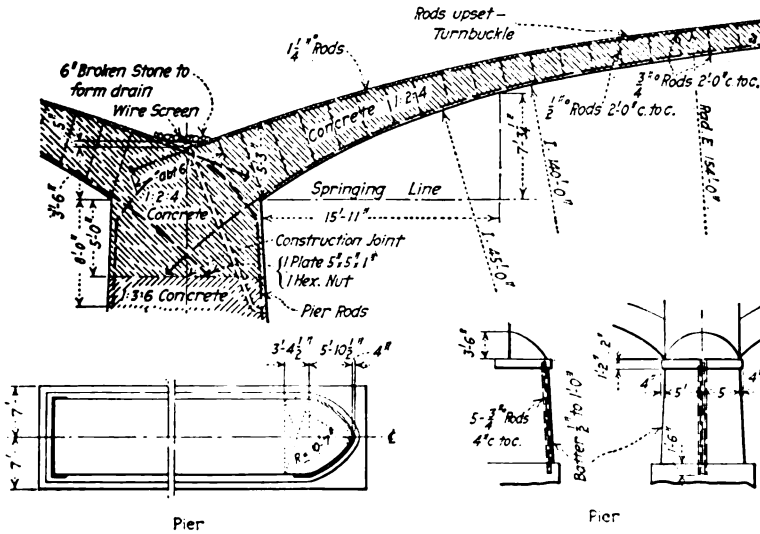

Pier

Pier

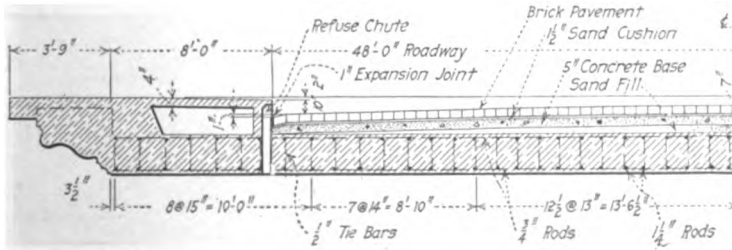

Half Section through Crown

Third Avenue bridge, Cedar Rapids, Iowa.

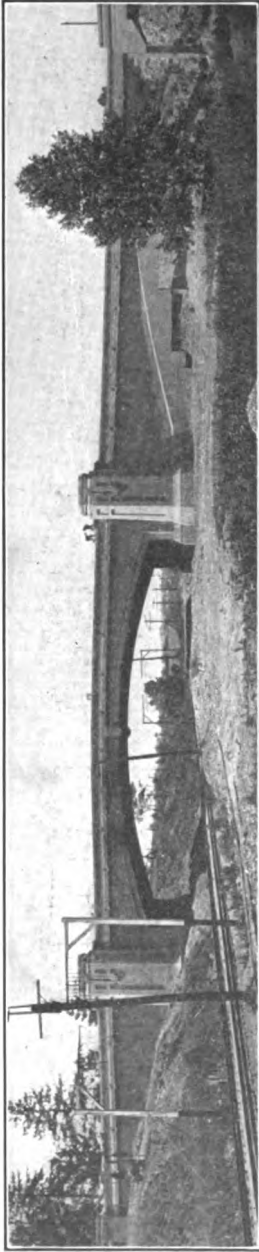

FIG. 211.—Carondelet Park bridge, St. Louis.

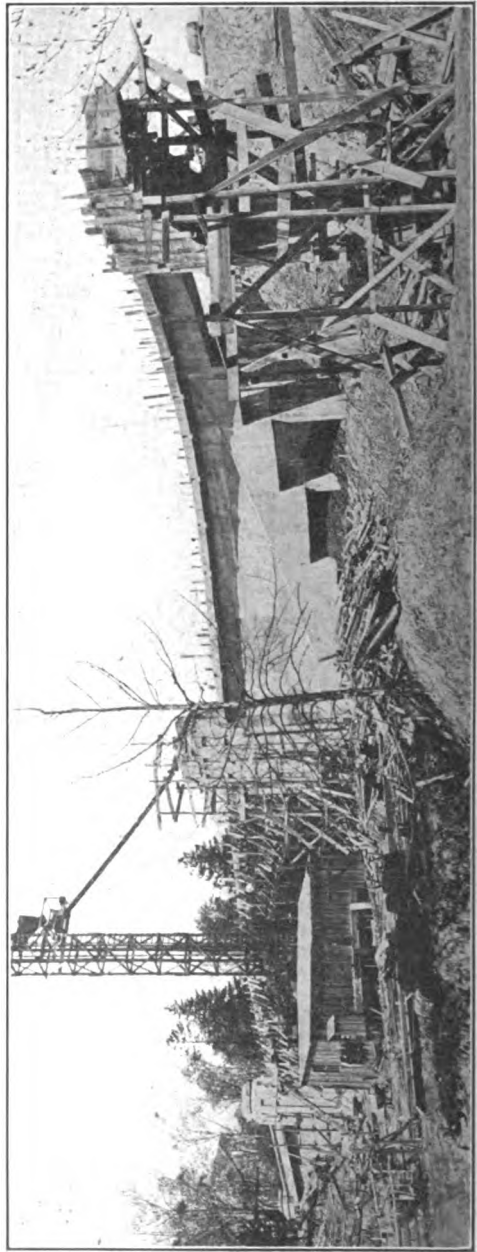

FIG. 212.—Construction view of Carondelet Park bridge, St. Louis.

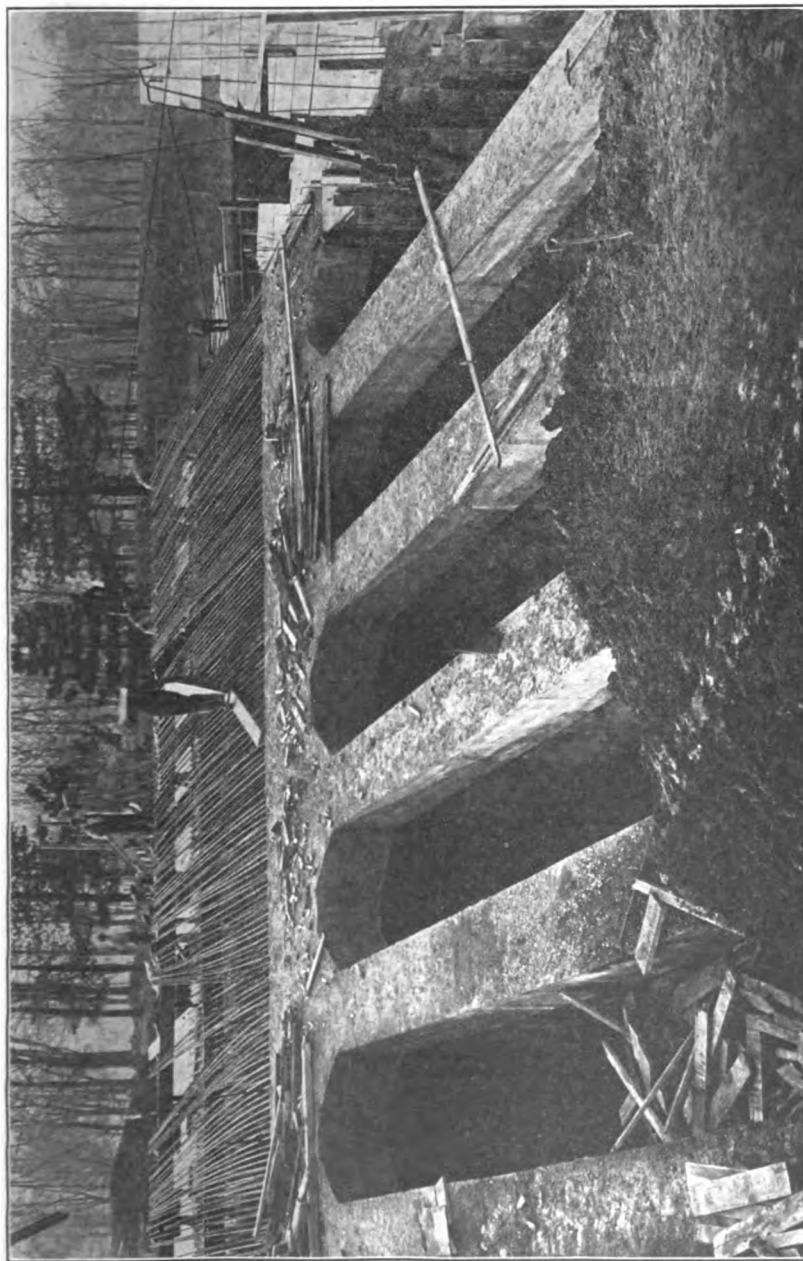
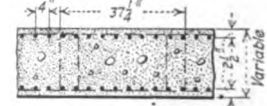
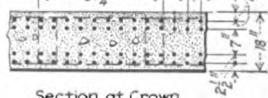
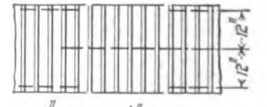
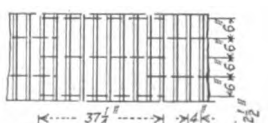
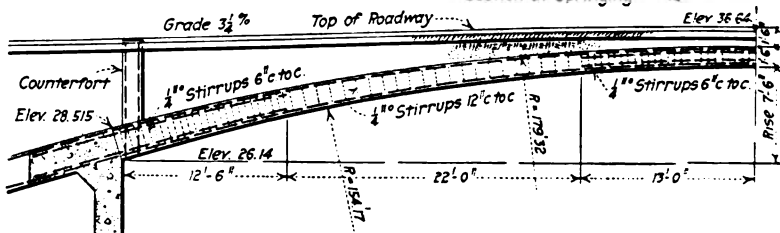
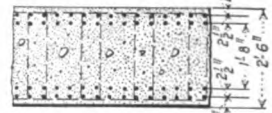
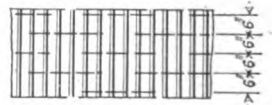
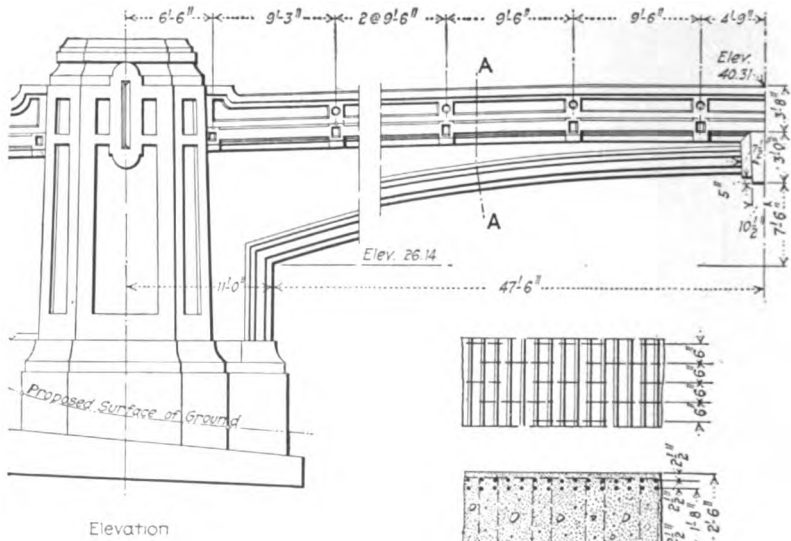

Fig. 213.—Abutments of Carondelet Park bridge, St. Louis.

PLATE XII



Reinforcement in abutment is not shown

Carondelet Park bridge, St. Louis.

PLATE XIII

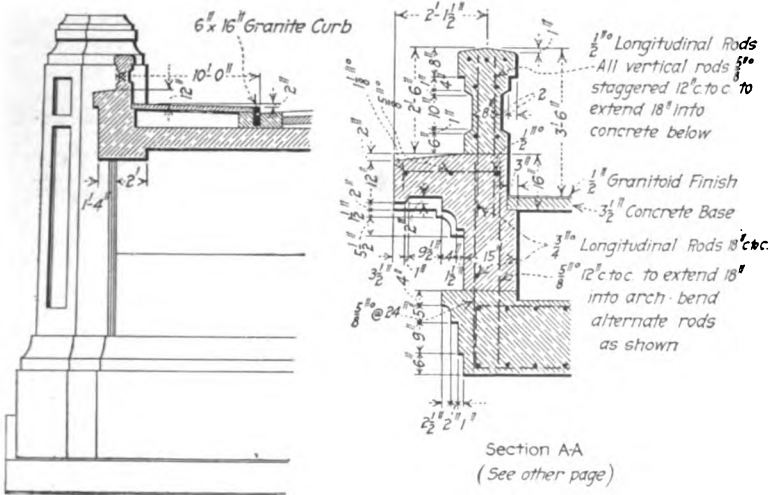

Transverse Section at Center

Elevation of Railing

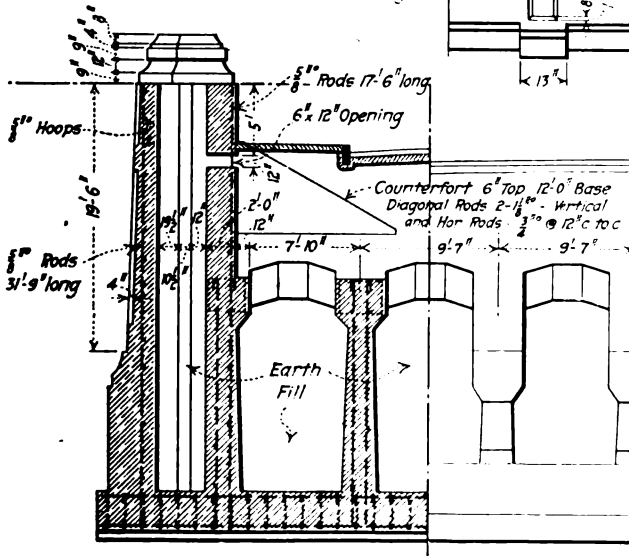

Section at Center Line of Monument

Rear View

Carondelet Park bridge, St. Louis.

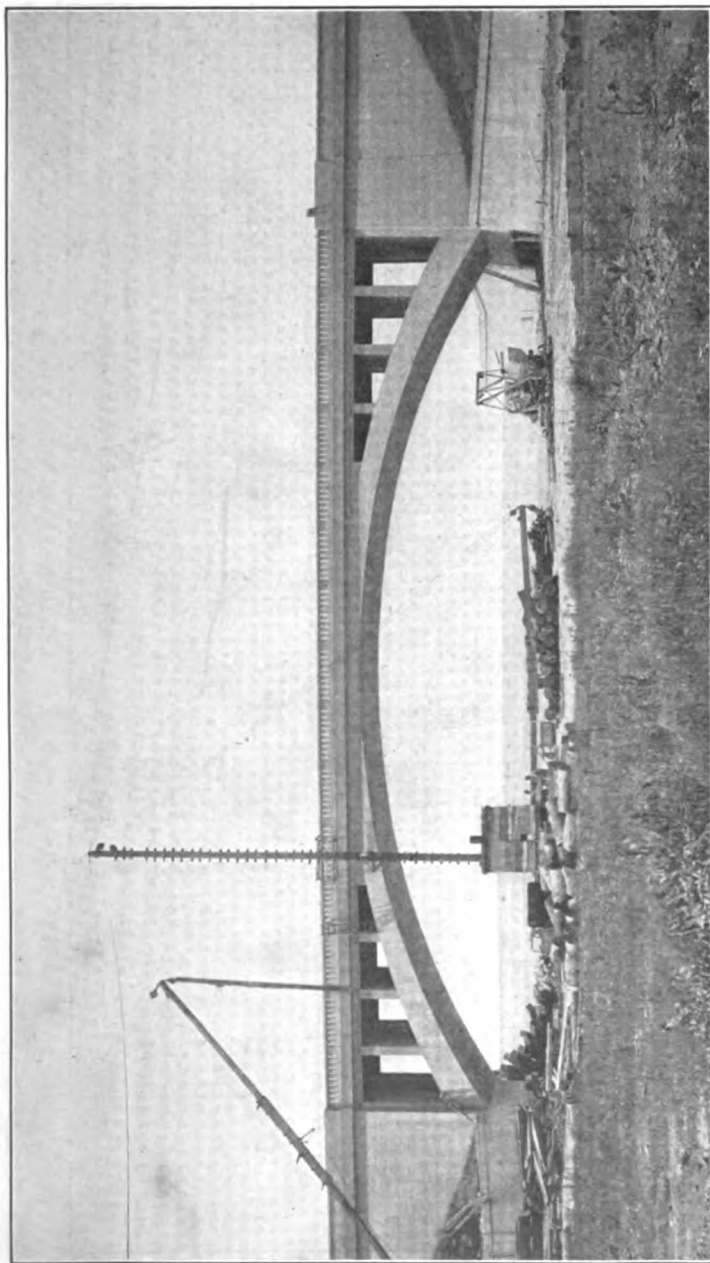

FIG. 214.—Ashokan Reservoir Spillway bridge.

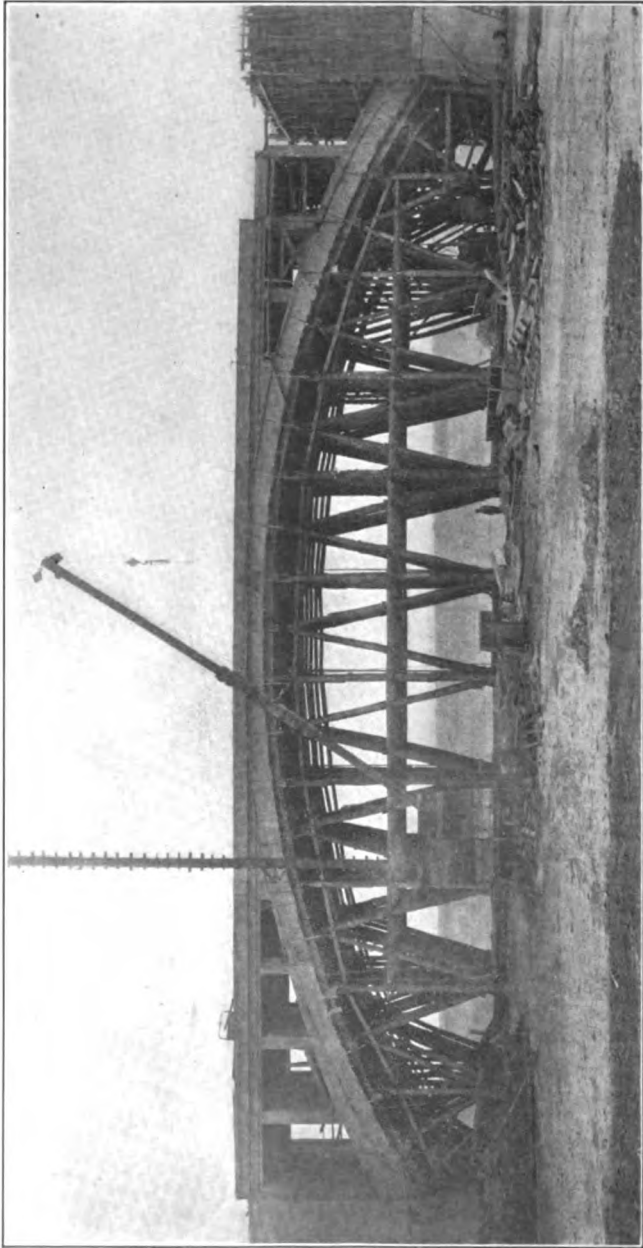
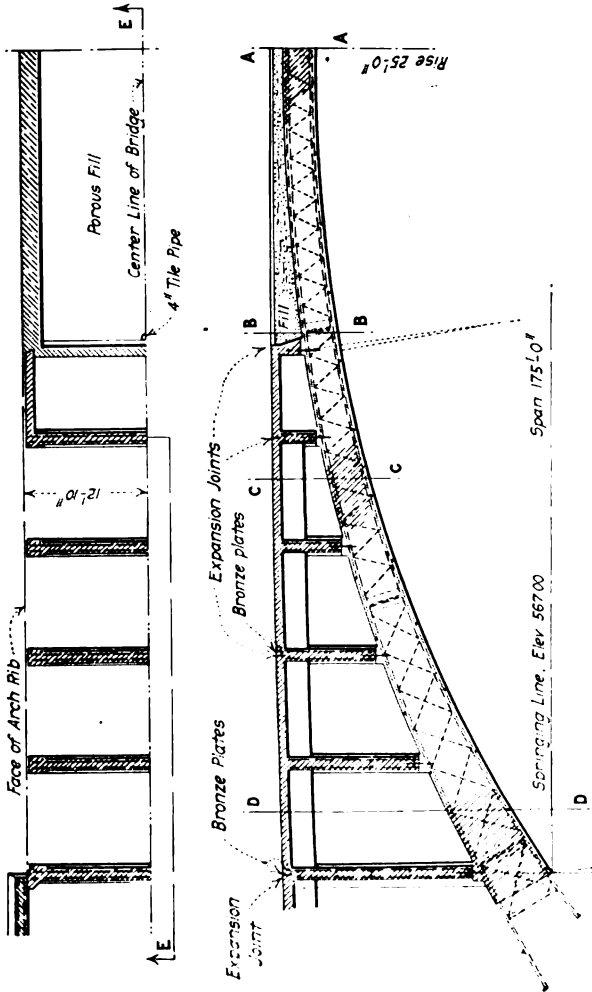
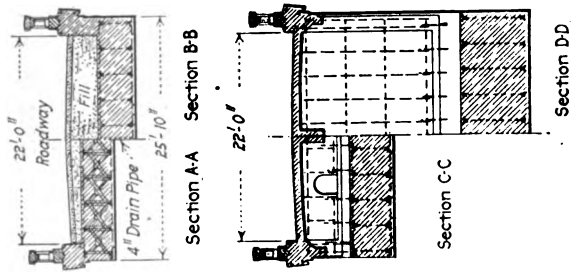

FIG. 215.—Falsework for Ashokan Reservoir Spillway bridge.

PLATE XV



Ashokan Reservoir Spillway bridge.

PLATE XVI

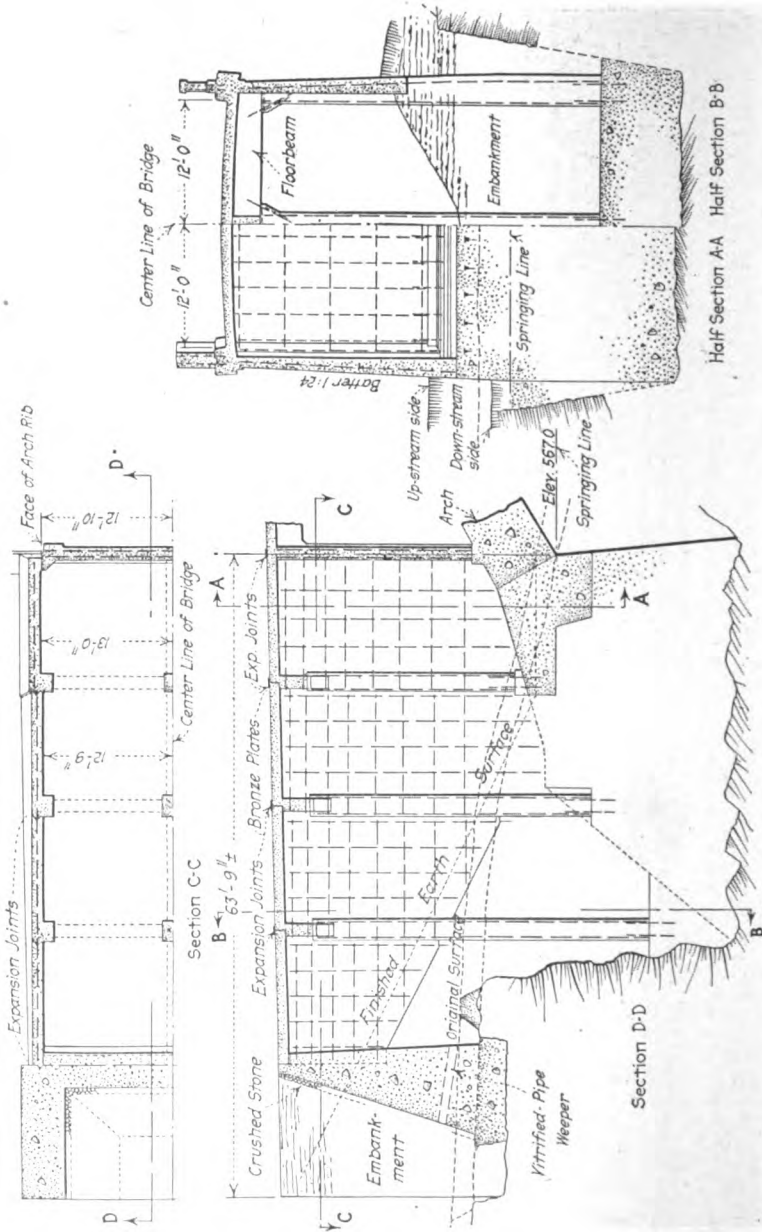

Ashokan Reservoir Spillway bridge.

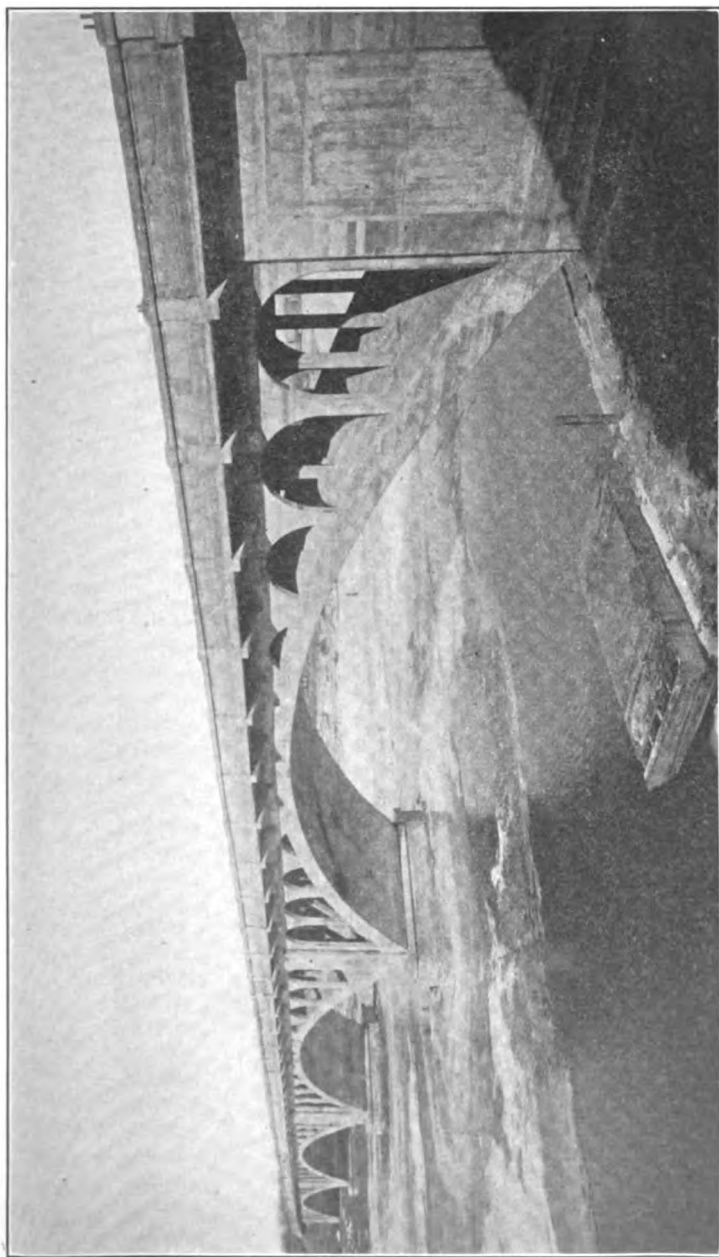

Courtesy of Mr. Louis P. Wolf, Consulting Engineer, St. Paul, Minn.
FIG. 216.—Chippewa River bridge, Eau Claire, Wis.

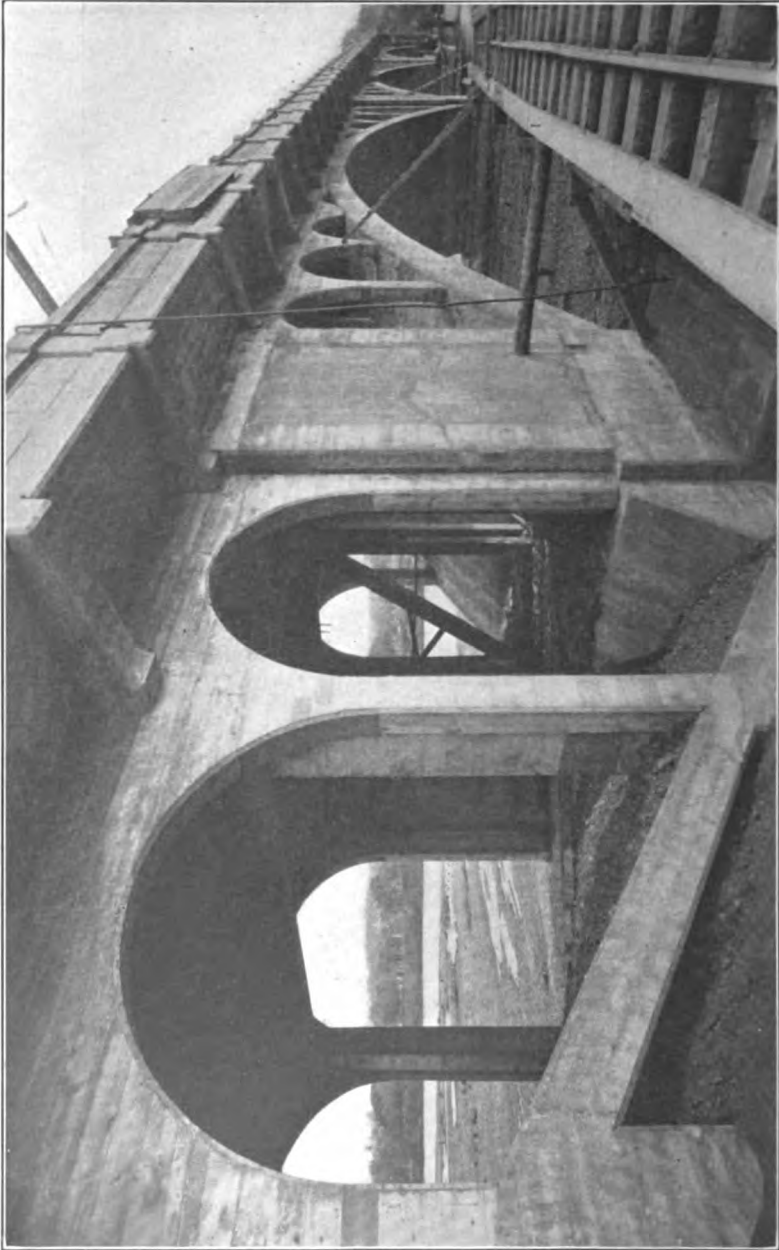

Courtesy of Sandusky Portland Cement Co.
Fig. 217.—Chippewa River bridge, Eau Claire, Wis.

PLATE XVII

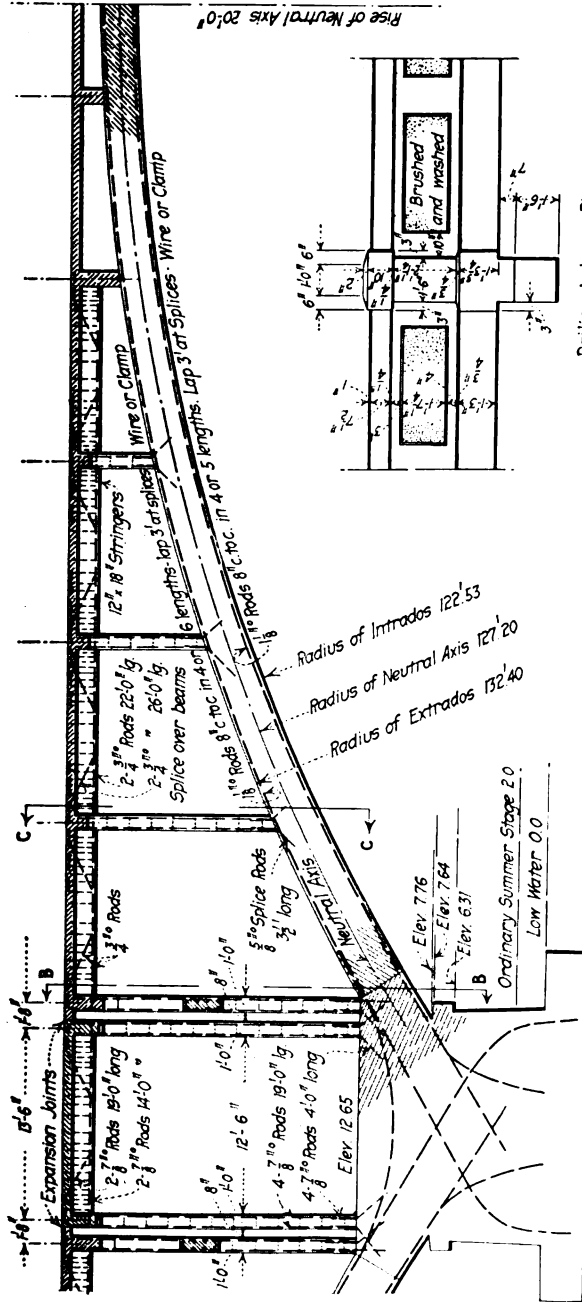

Chippewa River bridge, Eau Claire, Wis.

PLATE XVIII

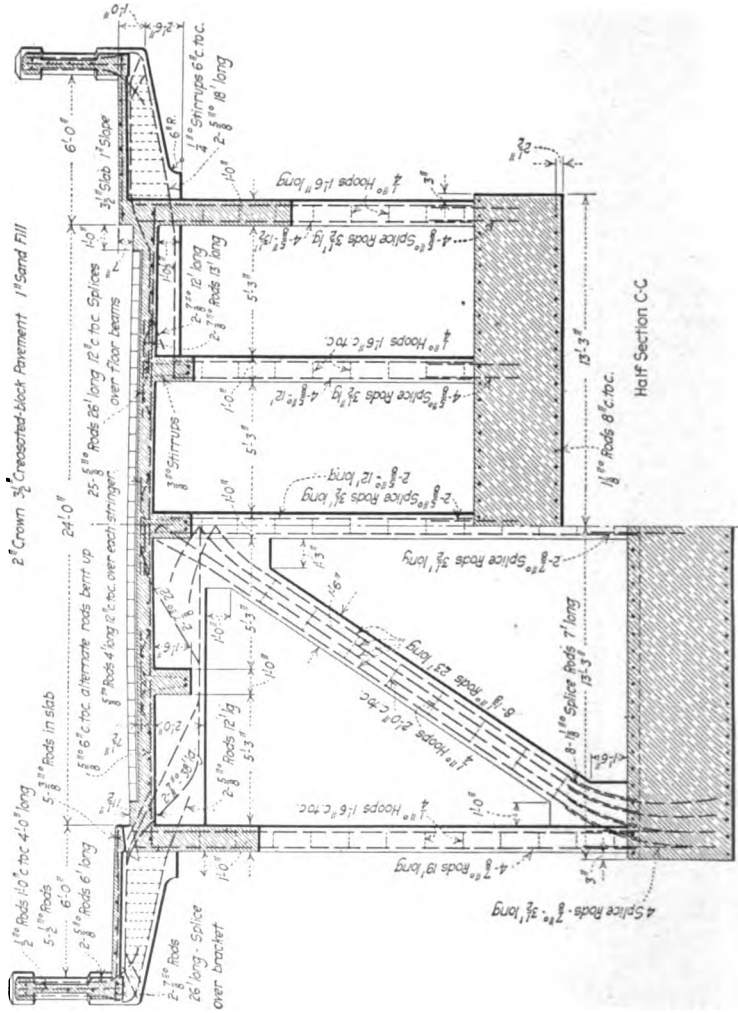

Half Section B-B
Chippewa River bridge, Eau Claire, Wis.

PLATE XIX

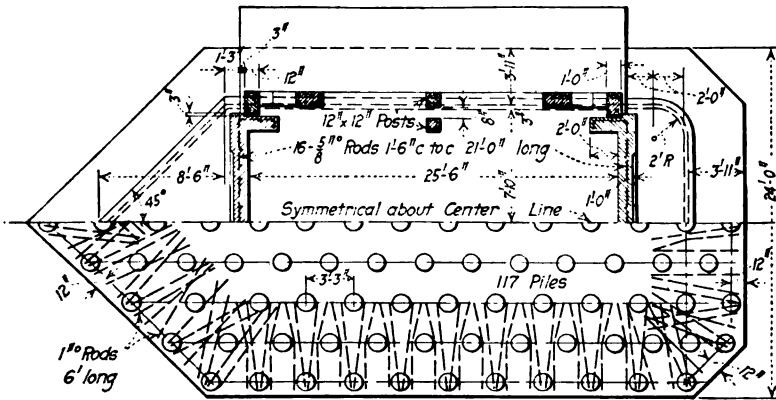
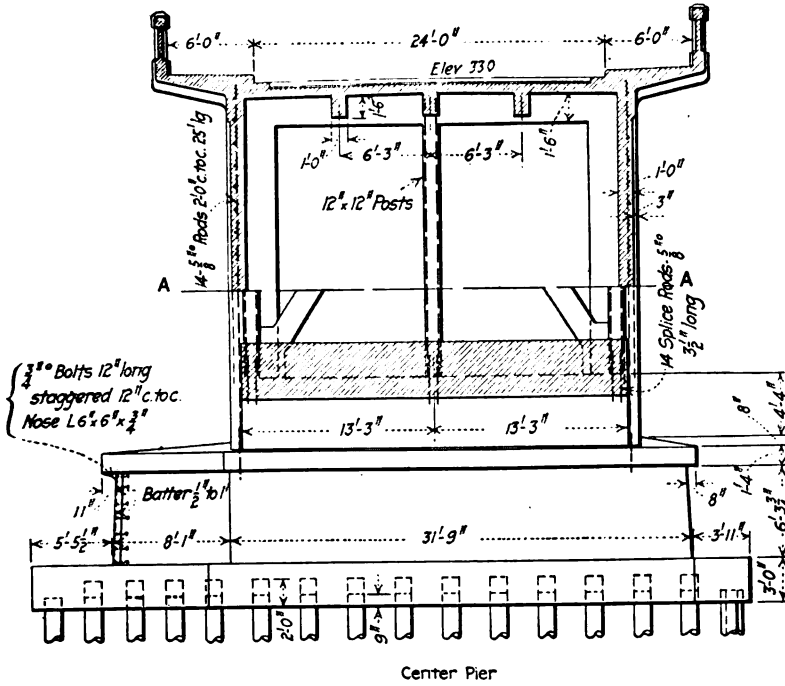

Chippewa River bridge, Eau Claire, Wis.

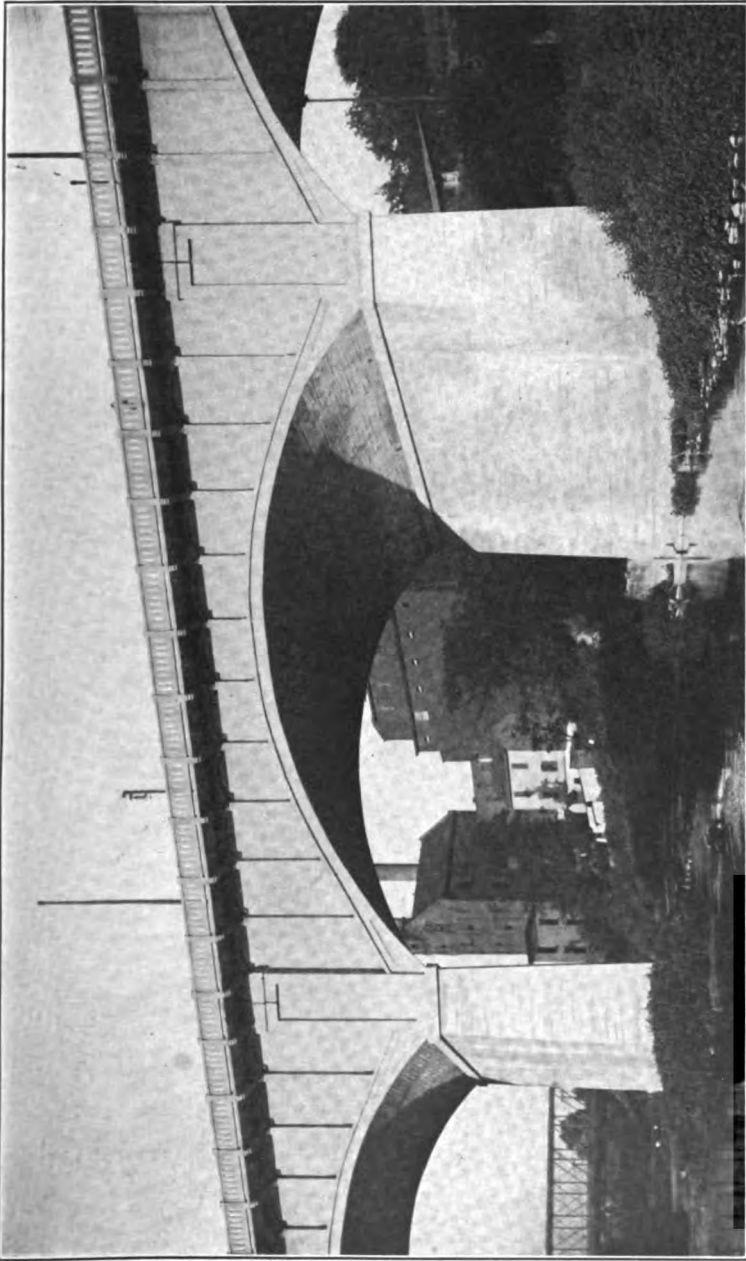

Courtesy of Universal Portland Cement Co.
FIG. 218.—Ludlow Avenue viaduct, Cincinnati, Ohio.

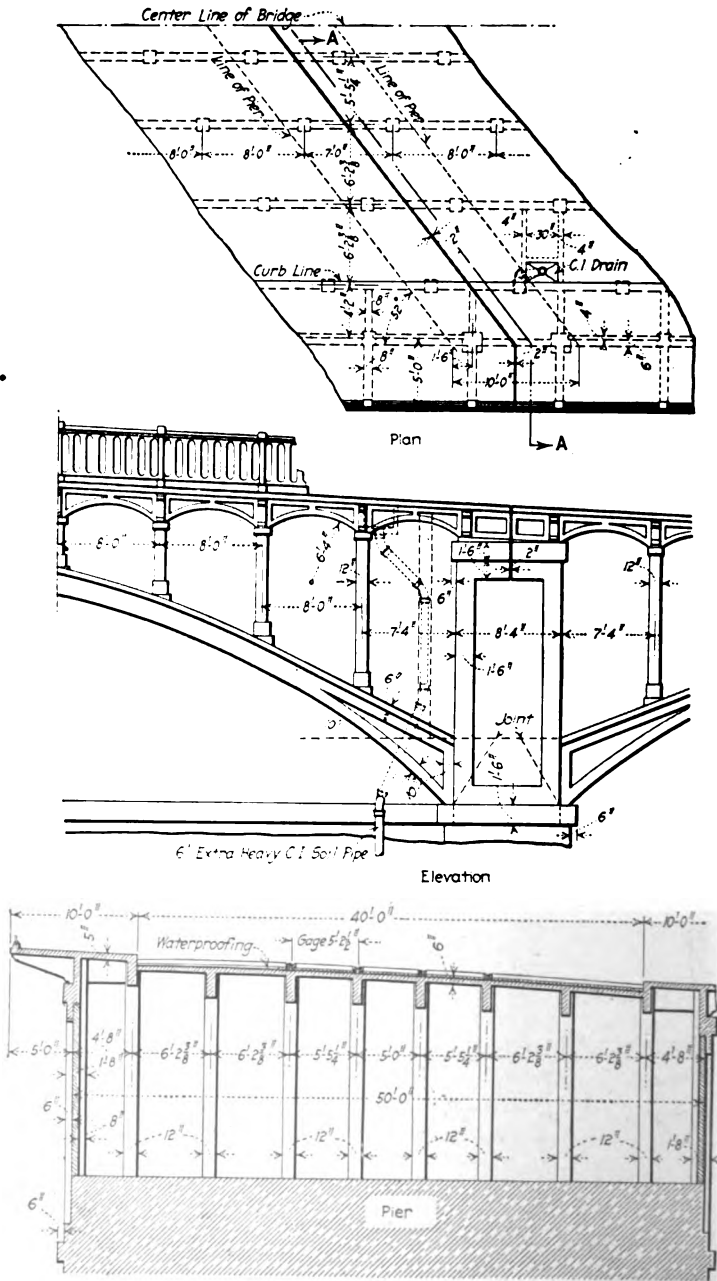

Section A-A
Ludlow Avenue viaduct, Cincinnati, Ohio.

PLATE XXII

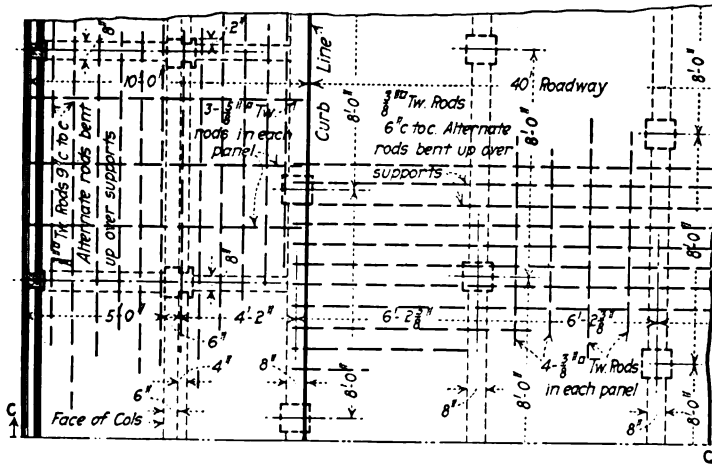

Part Plan of Roadway over Arches

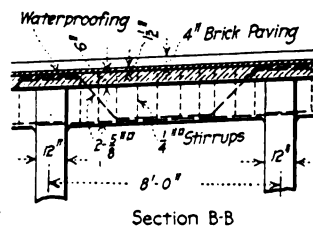
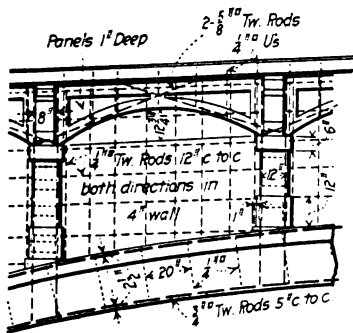

Section B-B

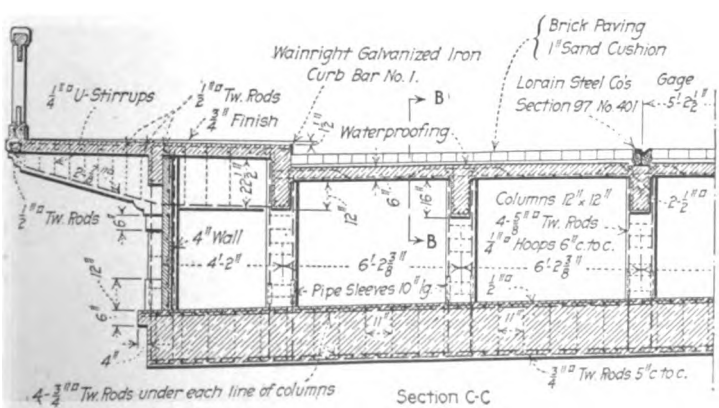

Section C-C

Ludlow Avenue viaduct, Cincinnati, Ohio.

PLATE XXIII

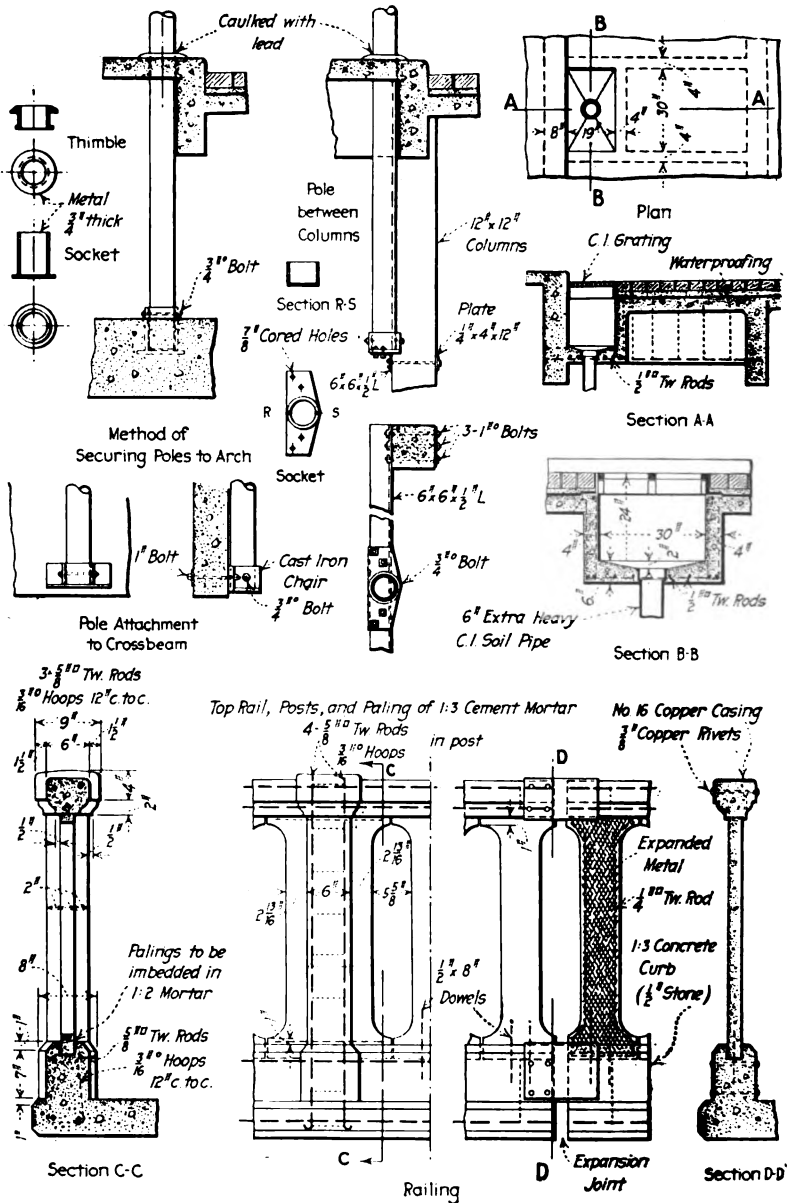

Ludlow Avenue viaduct, Cincinnati, Ohio.

PLATE XXIV

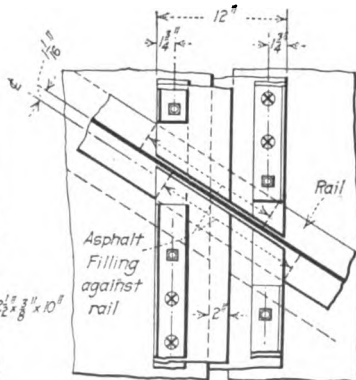
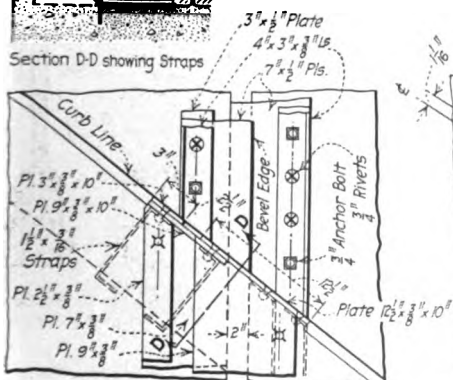
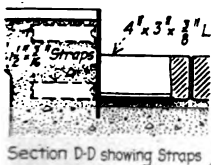
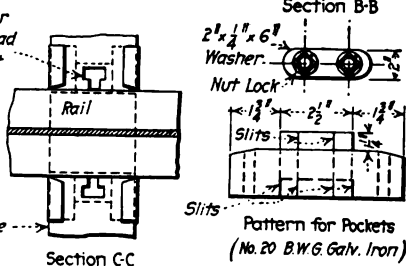
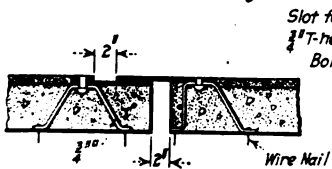
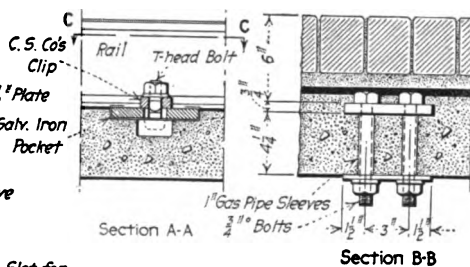
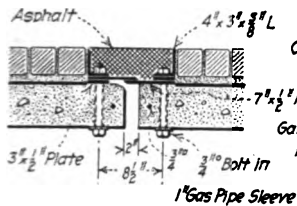
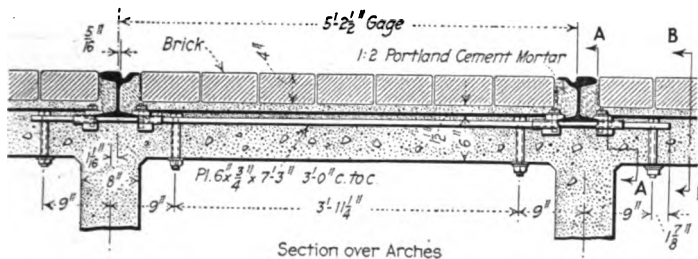

Expansion Joint Detail at Curb Line

Plan of Expansion Joint in Roadway

Ludlow Avenue viaduct, Cincinnati, Ohio.

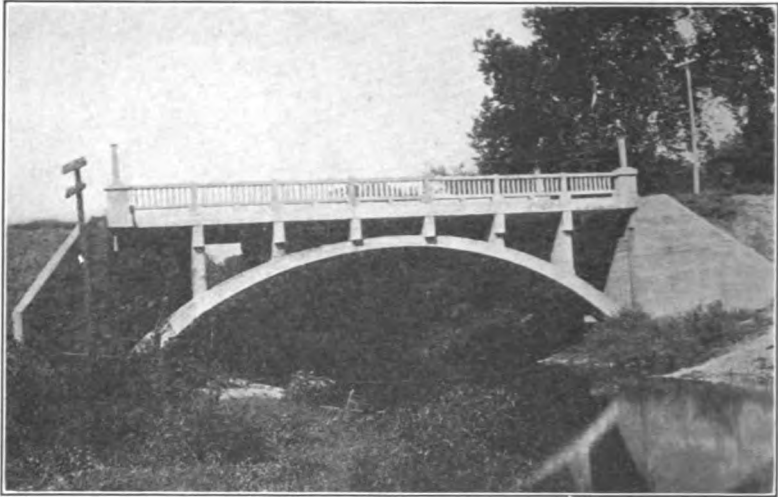

Courtesy of Mr. E. C. L. Wagner, Civil Engineer, Kansas City.

FIG. 219.—Stimson Creek bridge, Fulton, Mo.



Courtesy of Mr. E. C. L. Wagner, Civil Engineer, Kansas City.

FIG. 220.—Construction view of Stimson Creek bridge, Fulton, Mo.

PLATE XXV

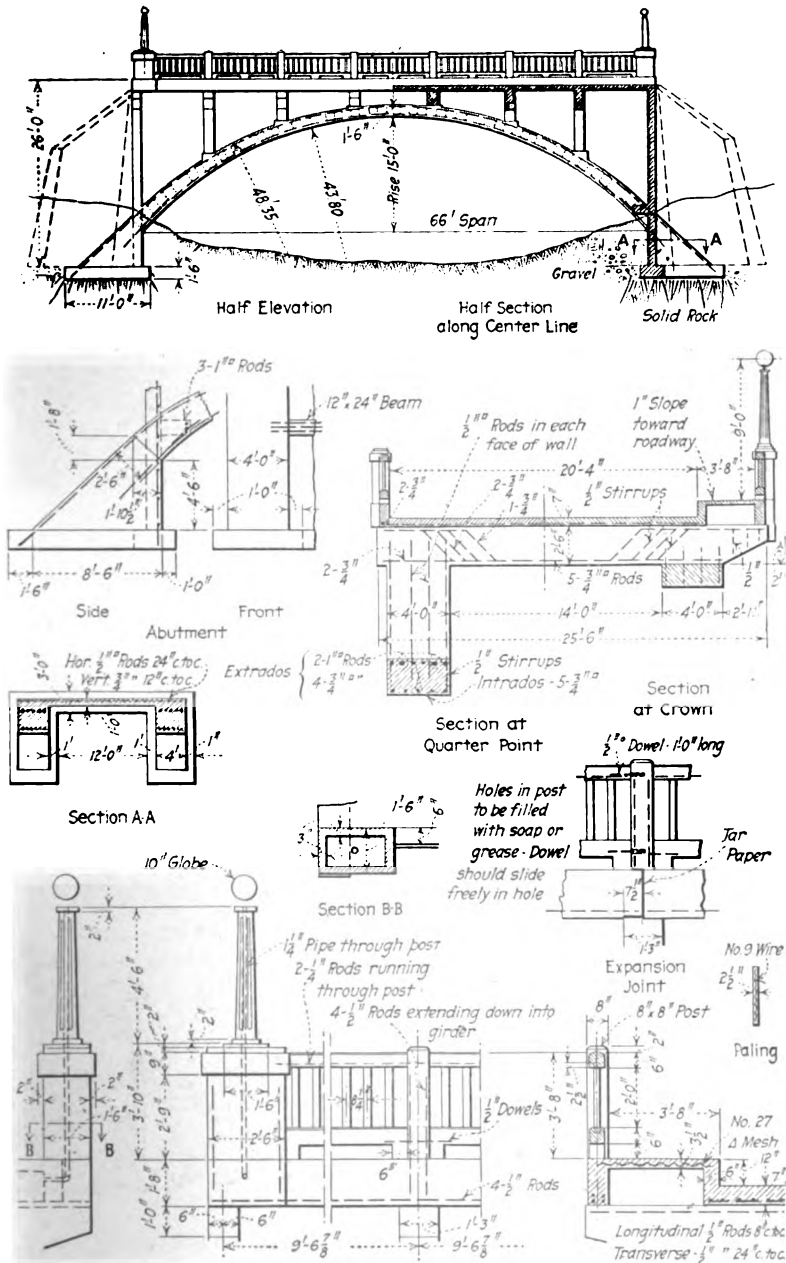

Stimson Creek bridge, Fulton, Mo.

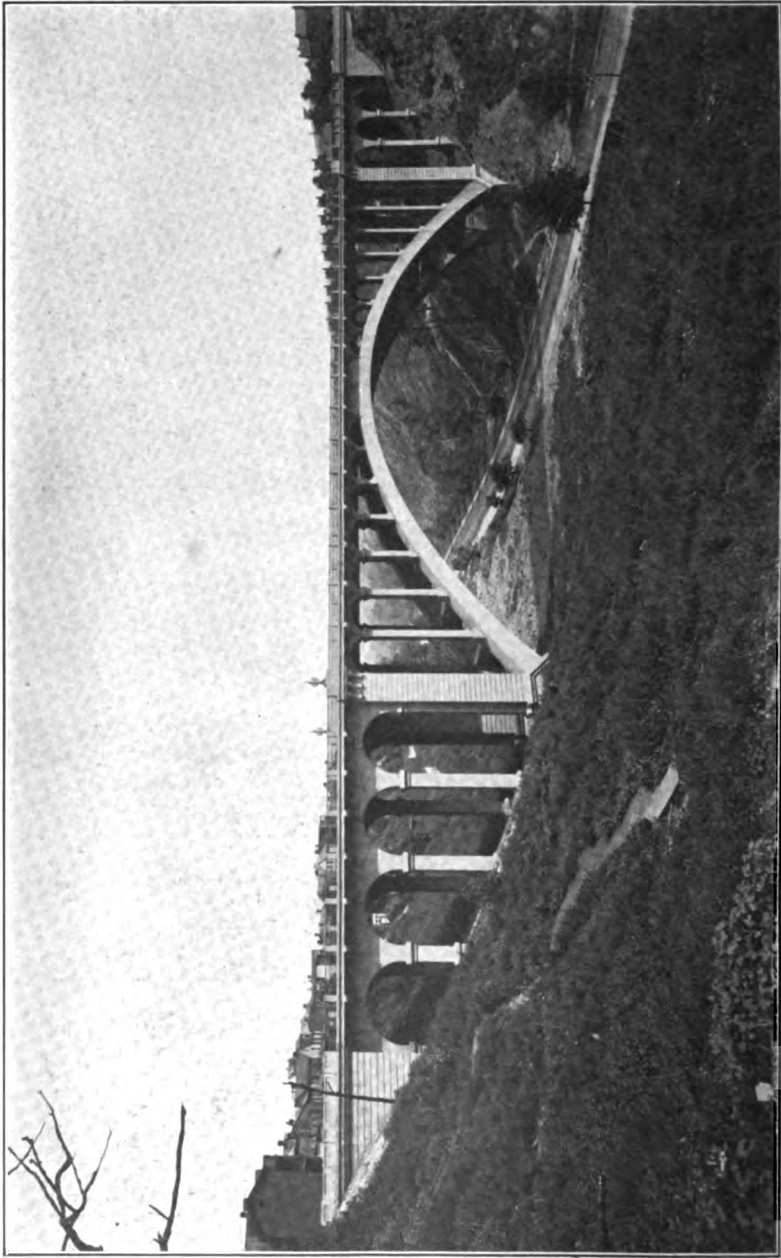

Courtesy of Mr. N. S. Sprague, Superintendent, Dept. of Public Works, Pittsburgh.
FIG. 221.—Larimer Avenue bridge, Pittsburgh, Pa.



Courtesy of Mr. N. S. Sprague, Superintendent, Dep't. of Public Works, Pittsburgh.

FIG. 222.—Arch-rib reinforcement in place, Larimer Avenue bridge, Pittsburgh.



Courtesy of Mr. N. S. Sprague, Superintendent, Dep't. of Public Works, Pittsburgh.

FIG. 223.—Concreting of arch ribs, Larimer Avenue bridge, Pittsburgh.

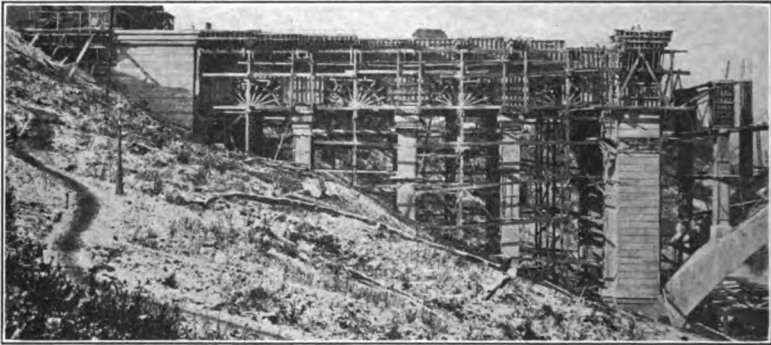

Courtesy of Engineering and Contracting.

FIG. 224.—Construction view of west approach, Larimer Avenue bridge, Pittsburgh.



Courtesy of Engineering and Contracting.

FIG. 225.—Forms for floor system over main arch, Larimer Avenue bridge, Pittsburgh.



Courtesy of Engineering and Contracting.

FIG. 226.—View of traveler for suspending working scaffolds for bushhammer work, Larimer Avenue bridge, Pittsburgh.

PLATE XXVI

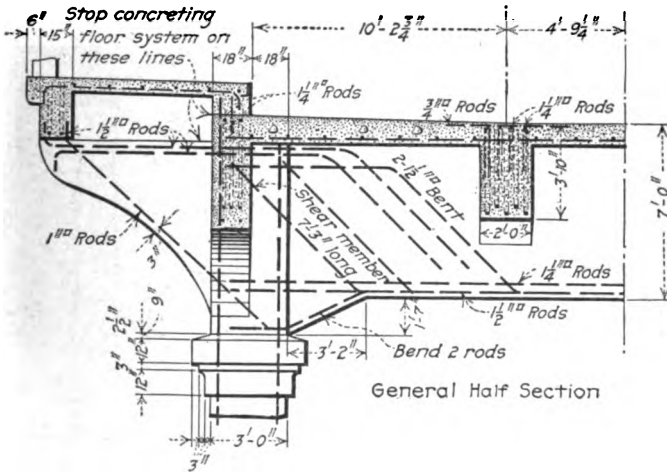

General Half Section

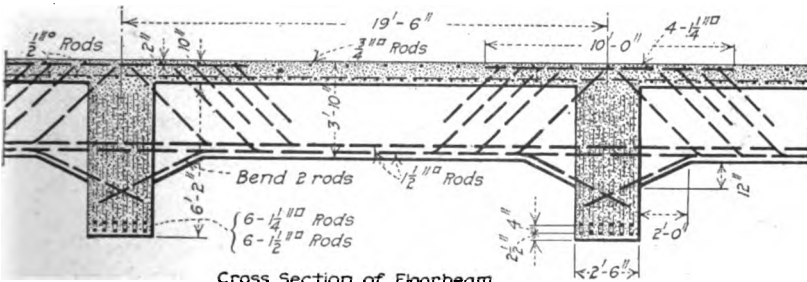

Cross Section of Floorbeam

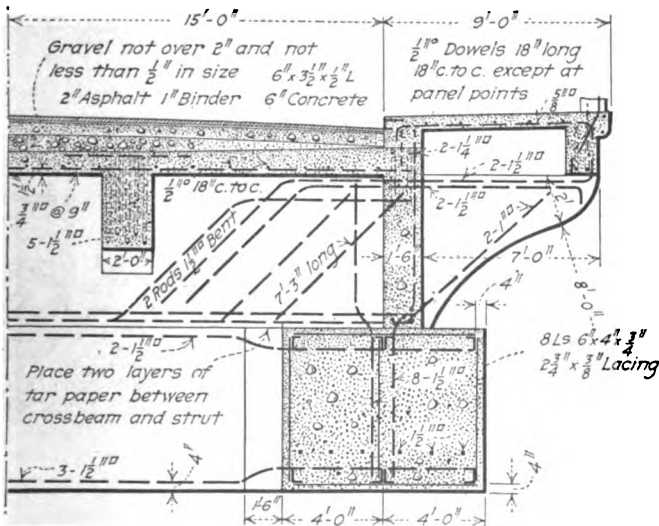

Section near Crown

Larmer Avenue bridge, Pittsburgh, Pa.

PLATE XXVII

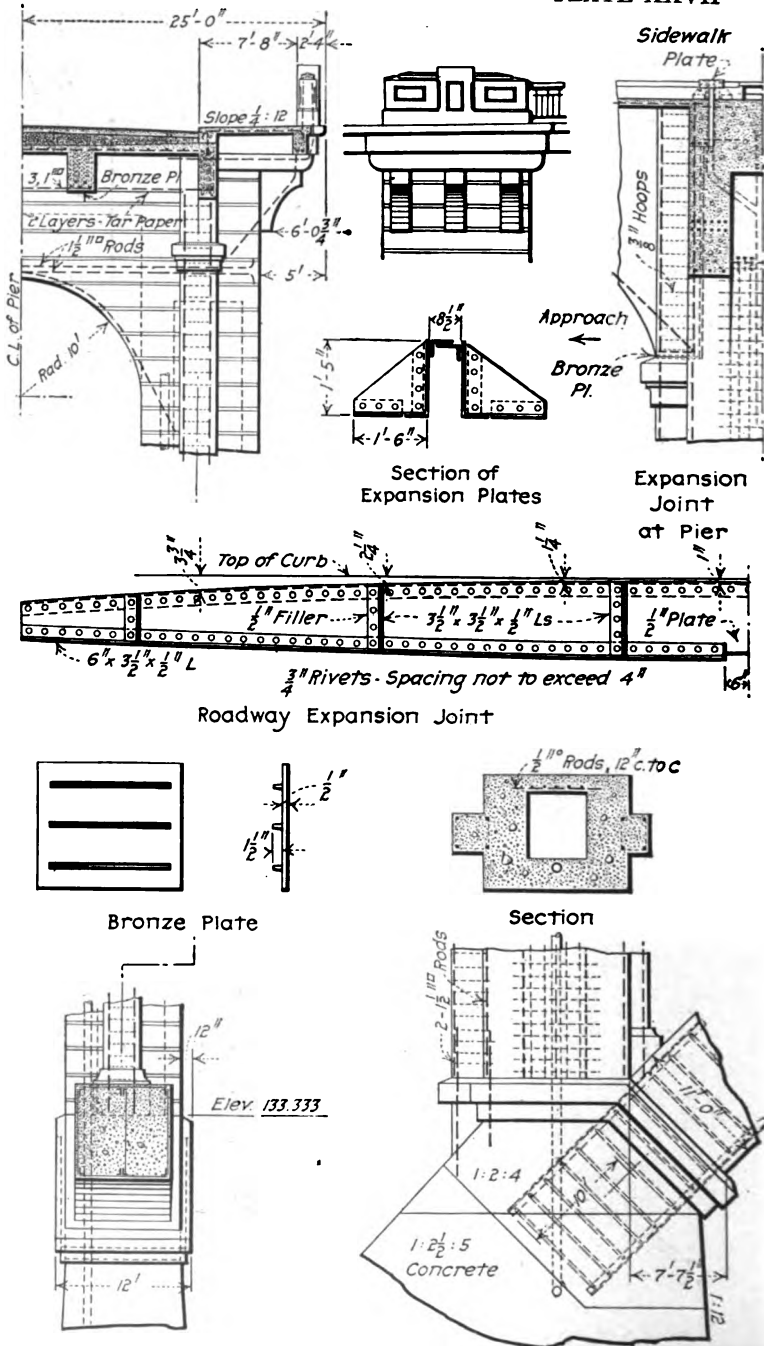

Larimer Avenue bridge, Pittsburgh, Pa.

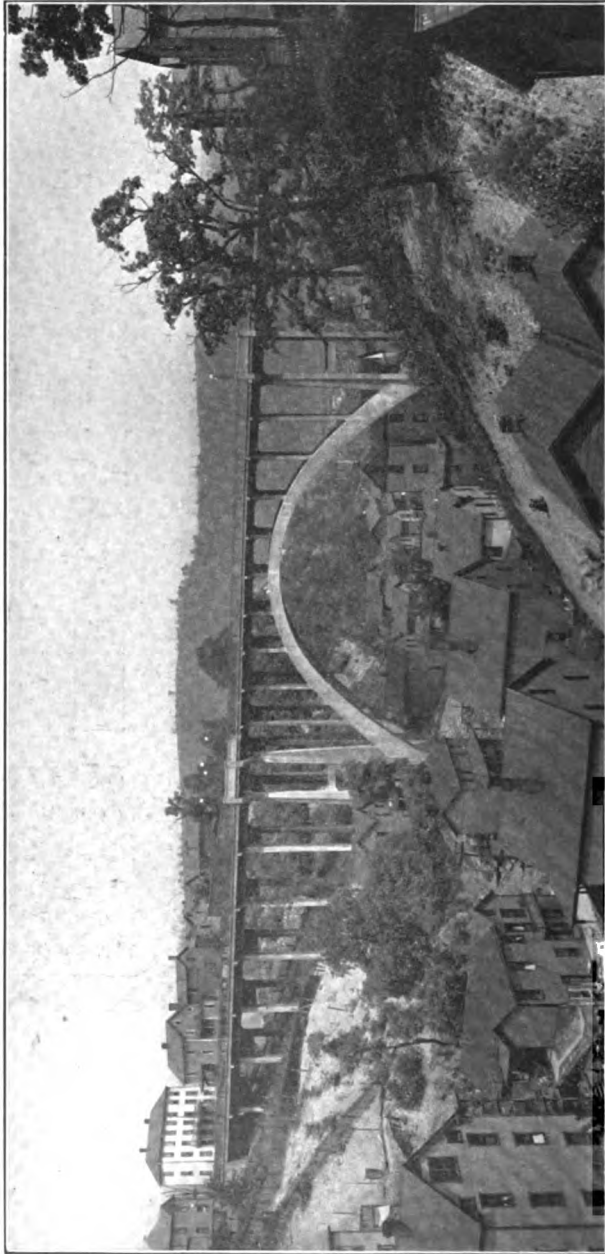

Courtesy of Chester & Fleming, Engineers, Pittsburgh.
FIG. 227.—Monessen viaduct, Monessen, Pa.

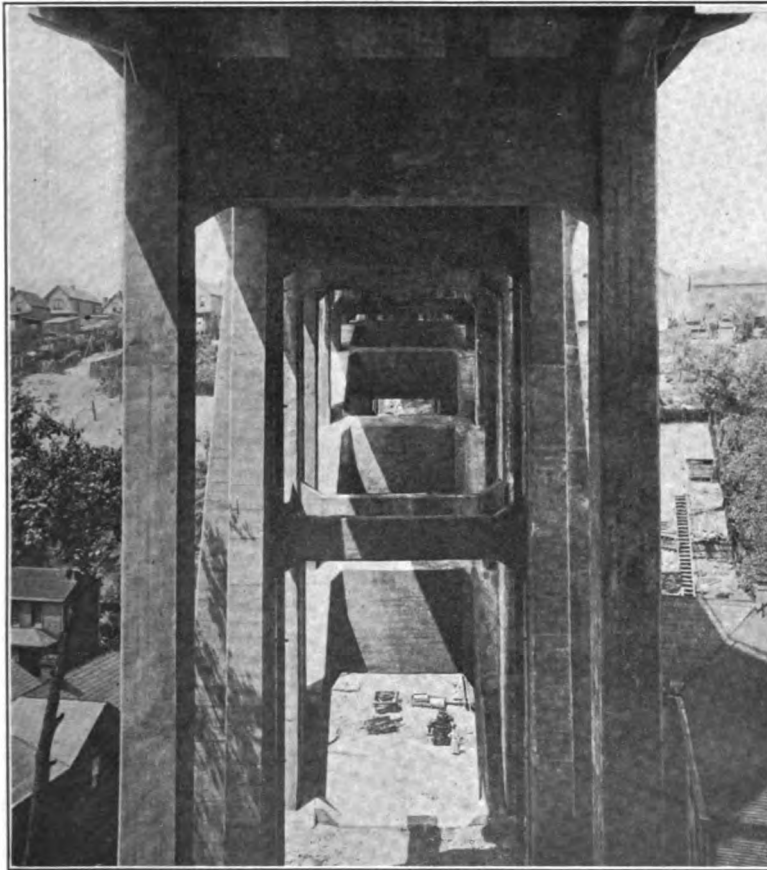

Courtesy of Chester & Fleming, Engineers, Pittsburgh.

FIG. 228.—Monessen viaduct, Monessen, Pa.

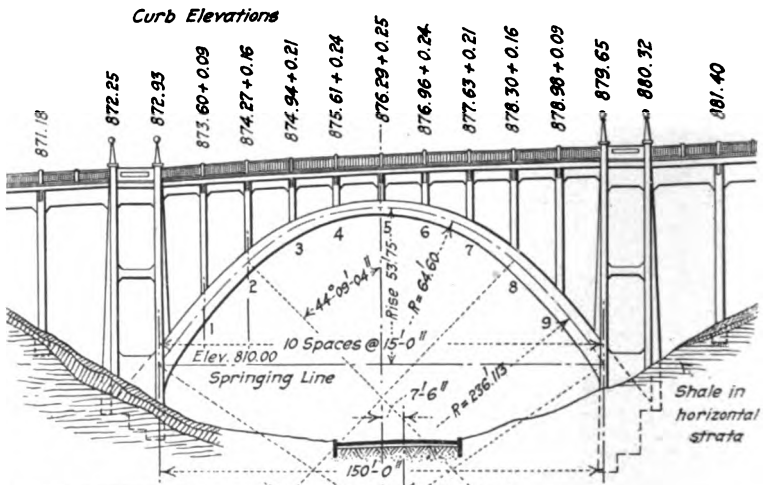

Point	Thickness of Arch Ring
1	7'-0"
2	6'-3"
3	5'-1"
4	4'-7 1/2"
5	4'-6"

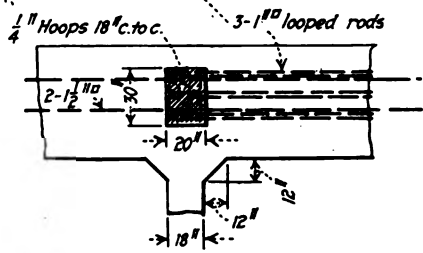

Plan at 3

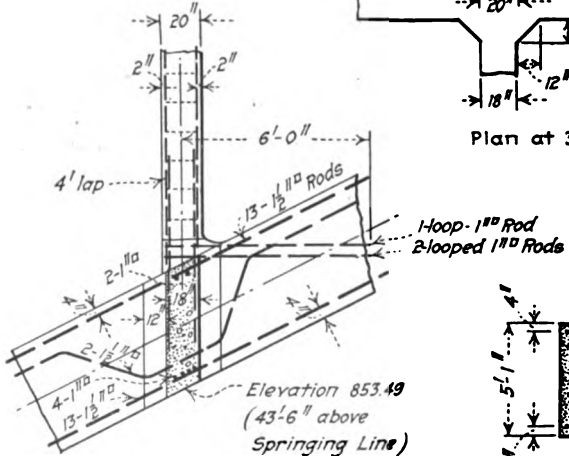

Elevation at 3
(See above)

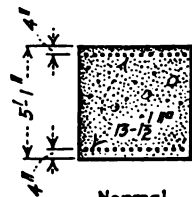

Normal Section

Monessen viaduct.

PLATE XXX

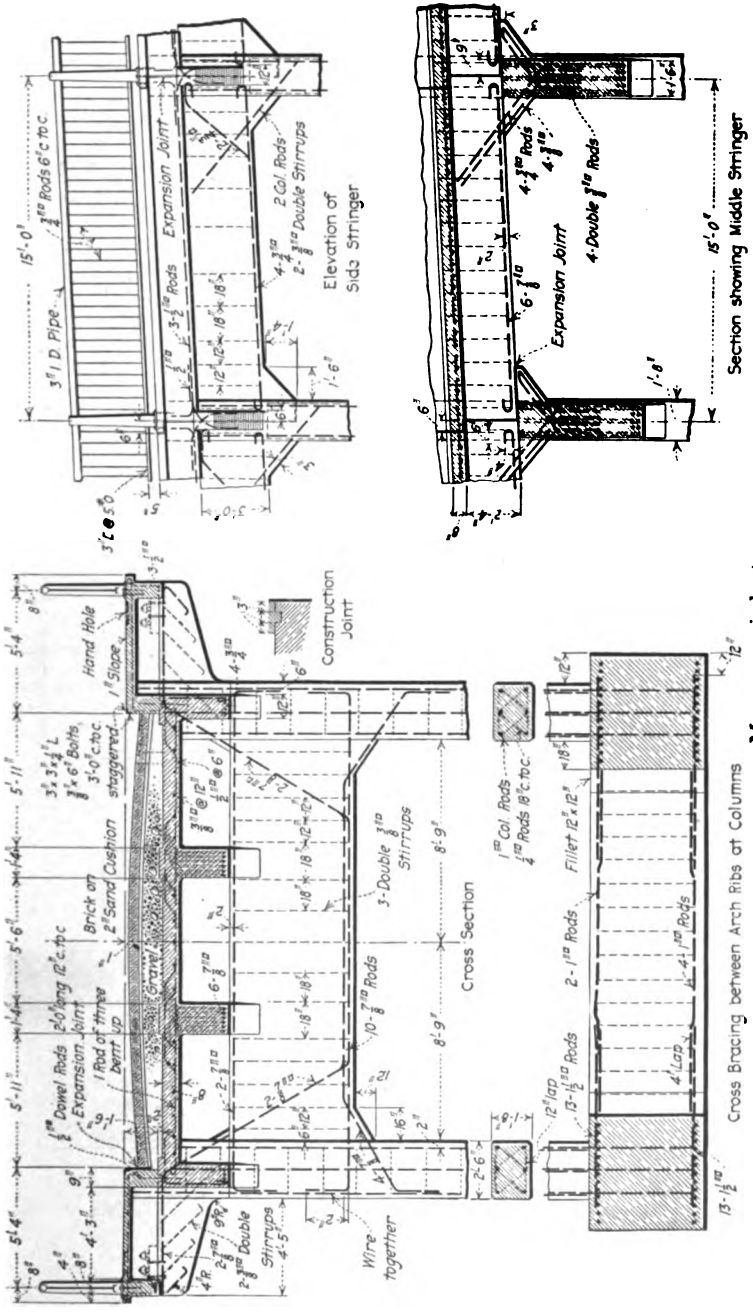

Monessen viaduct.

Cross Bracing between Arch Ribs at Columns

PLATE XXXII

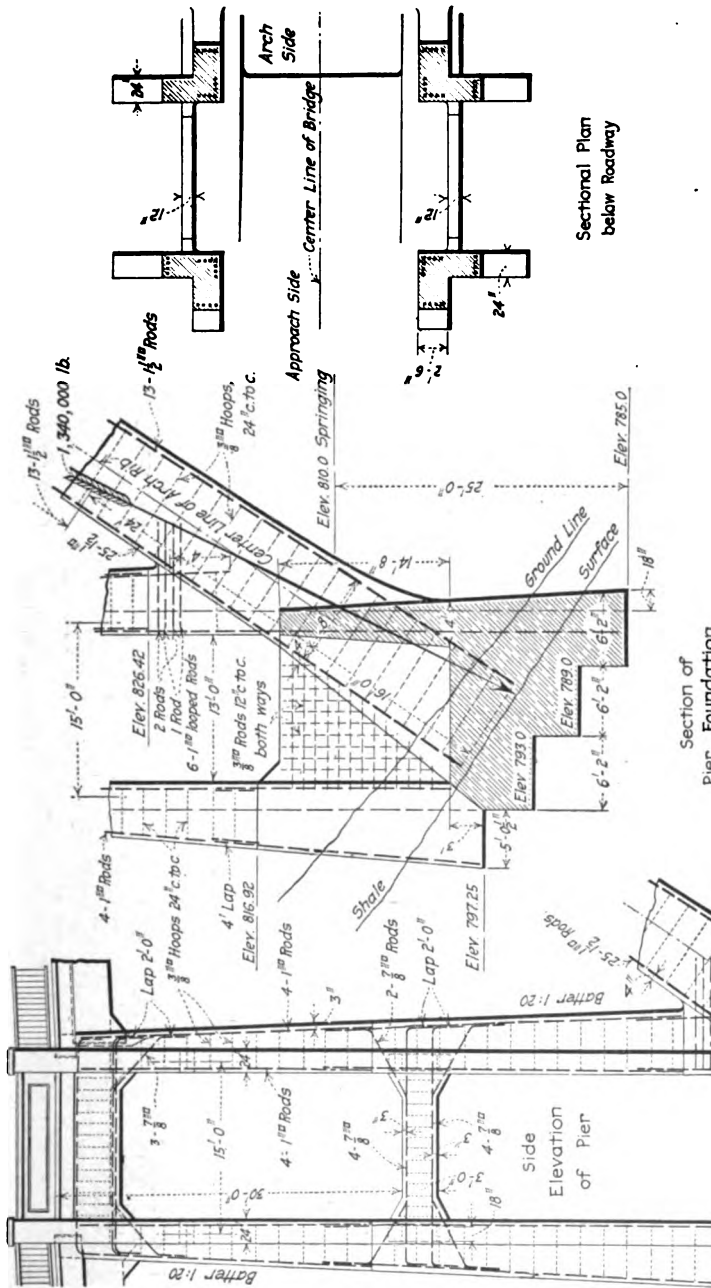
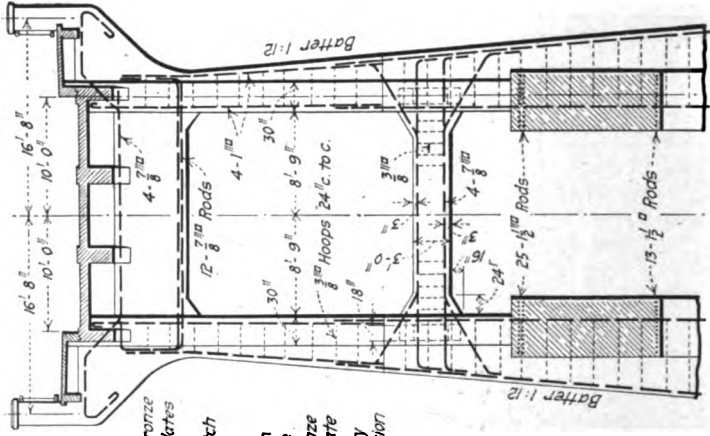
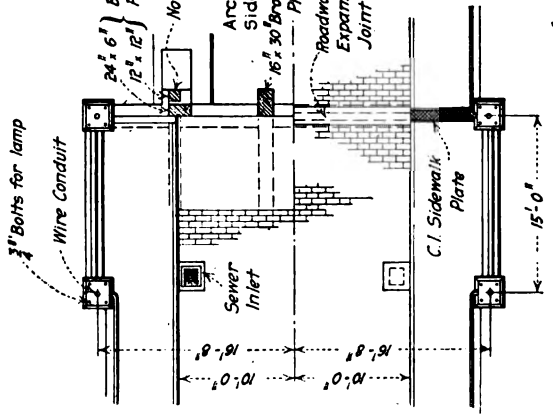

PLATE XXXIII



Elevation of Main Piers - Arch Side



Plan of Roadway Expansion Joint at Main Piers

Monessen viaduct.

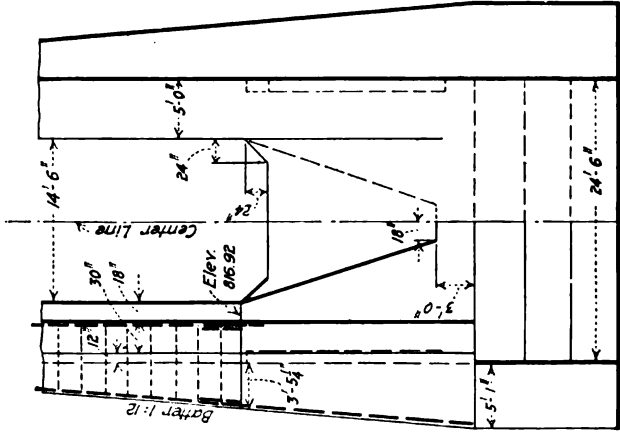

Front Elevation

Rear Elevation

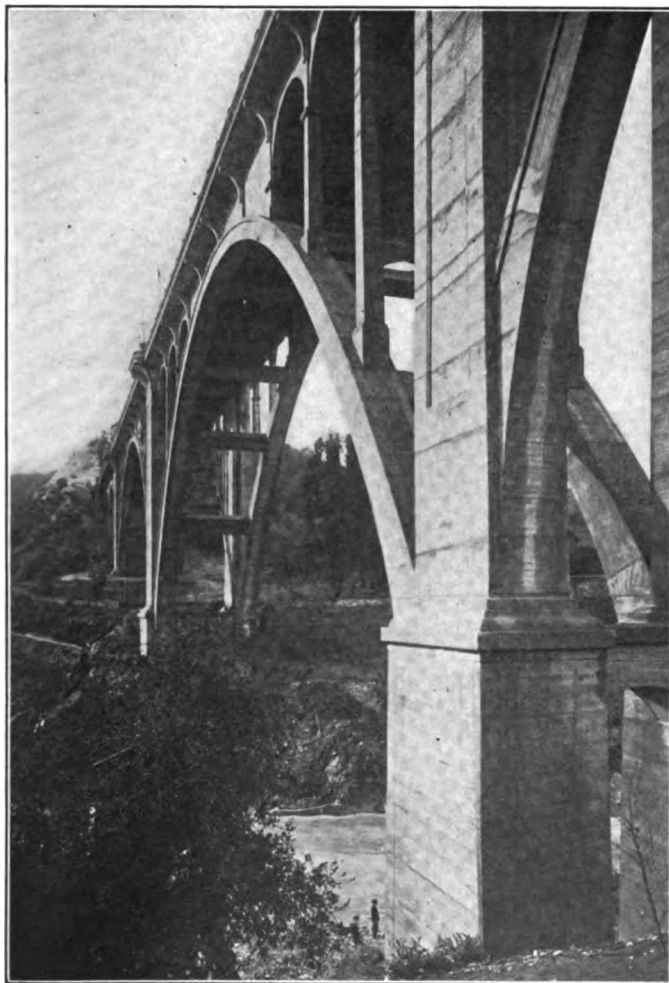

Courtesy of Concrete-Cement Age.

FIG. 229.—Bridge over the Arroyo Seco, Pasadena, Cal.



Courtesy of Mr. Charles A. Byers, Los Angeles, Cal.

FIG. 230.—General view of bridge over the Arroyo Seco, Pasadena, Cal.

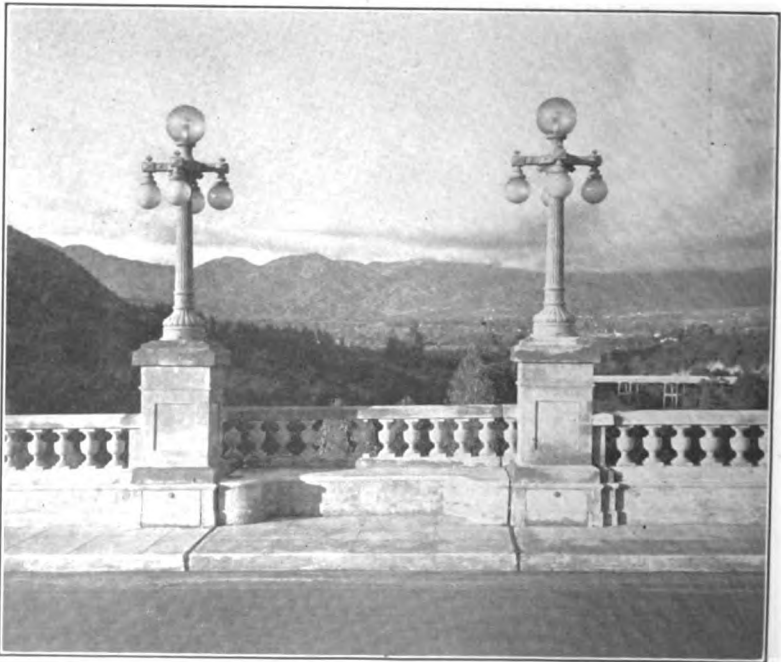

Courtesy of Mr. Charles A. Byers, Los Angeles, Cal.

FIG. 231.—Refuge bay on bridge over the Arroyo Seco, Pasadena, Cal.

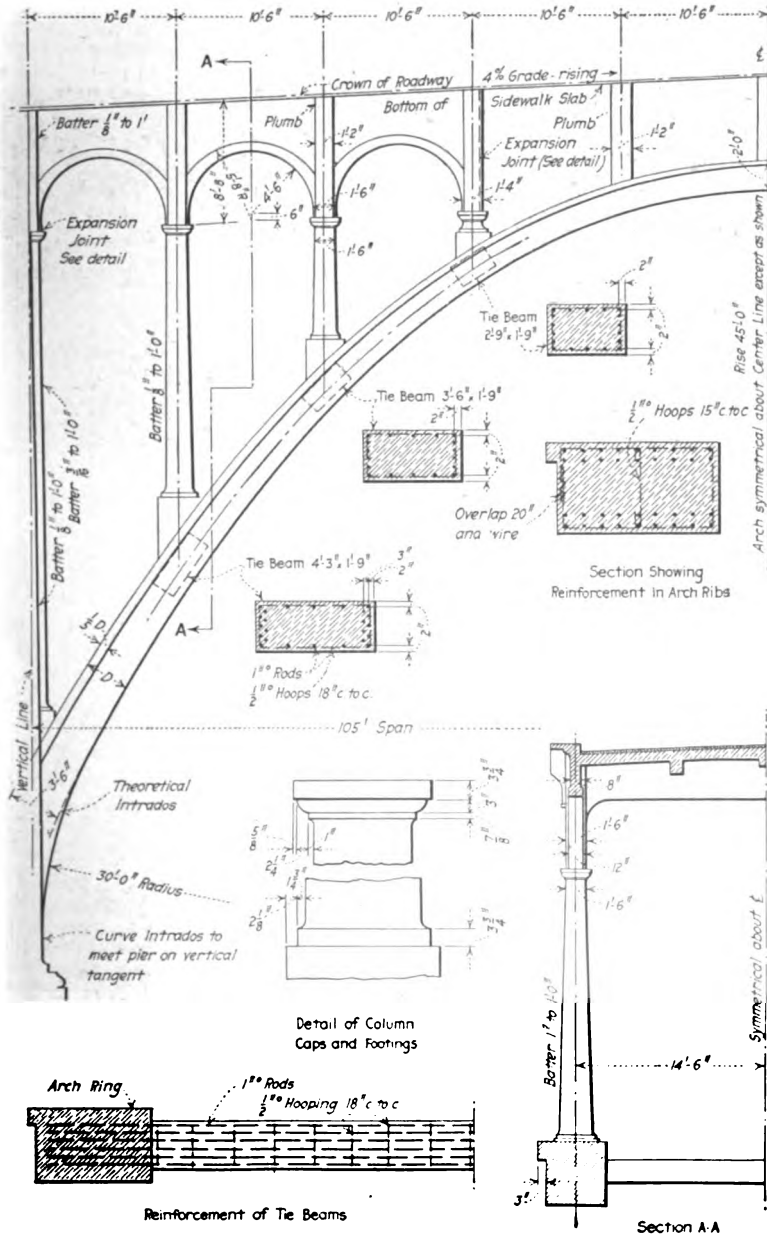

Bridge over the Arroyo Seco, Pasadena, Cal.

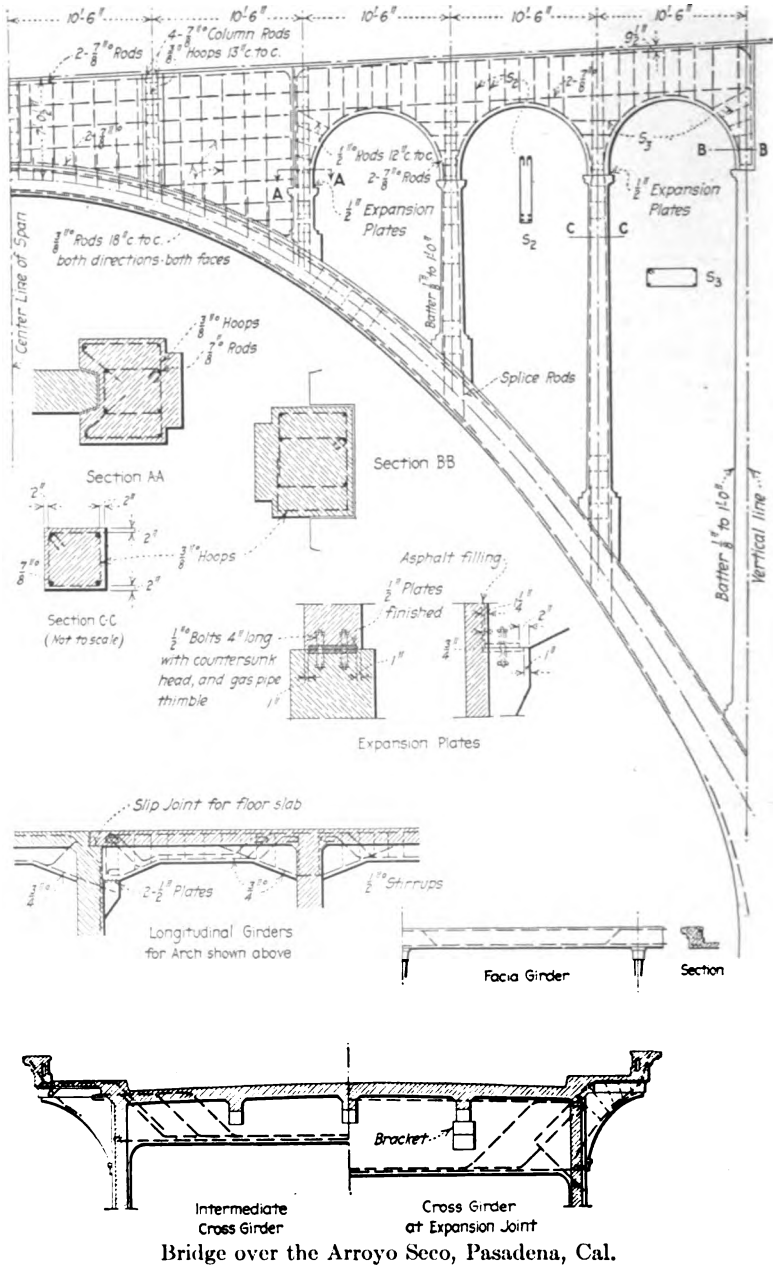

Bridge over the Arroyo Seco, Pasadena, Cal.

PLATE XXXVI

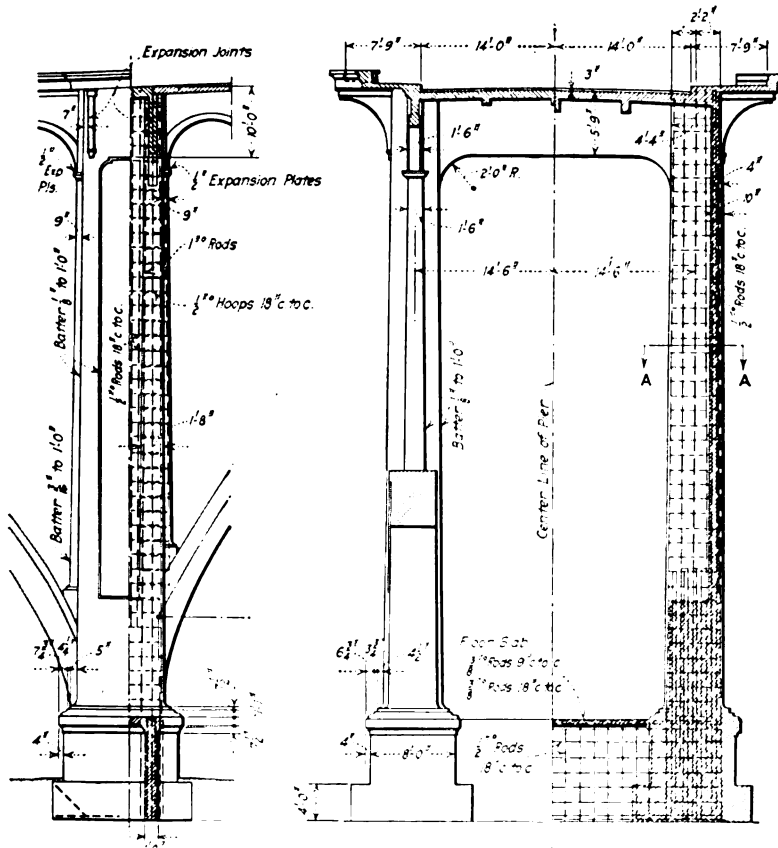

Half Elevation on Center Line of Bridge

Half Elevation

Half Section

Splice hoops on alternate sides of column, overlap 1'-8" and wire

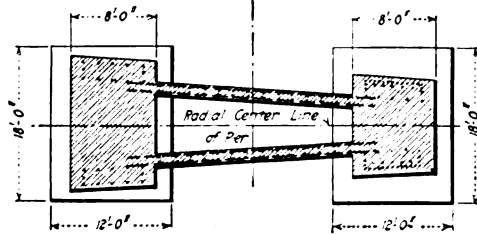
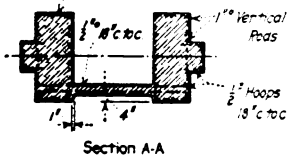

Bridge over the Arroyo Seco, Pasadena, Cal.

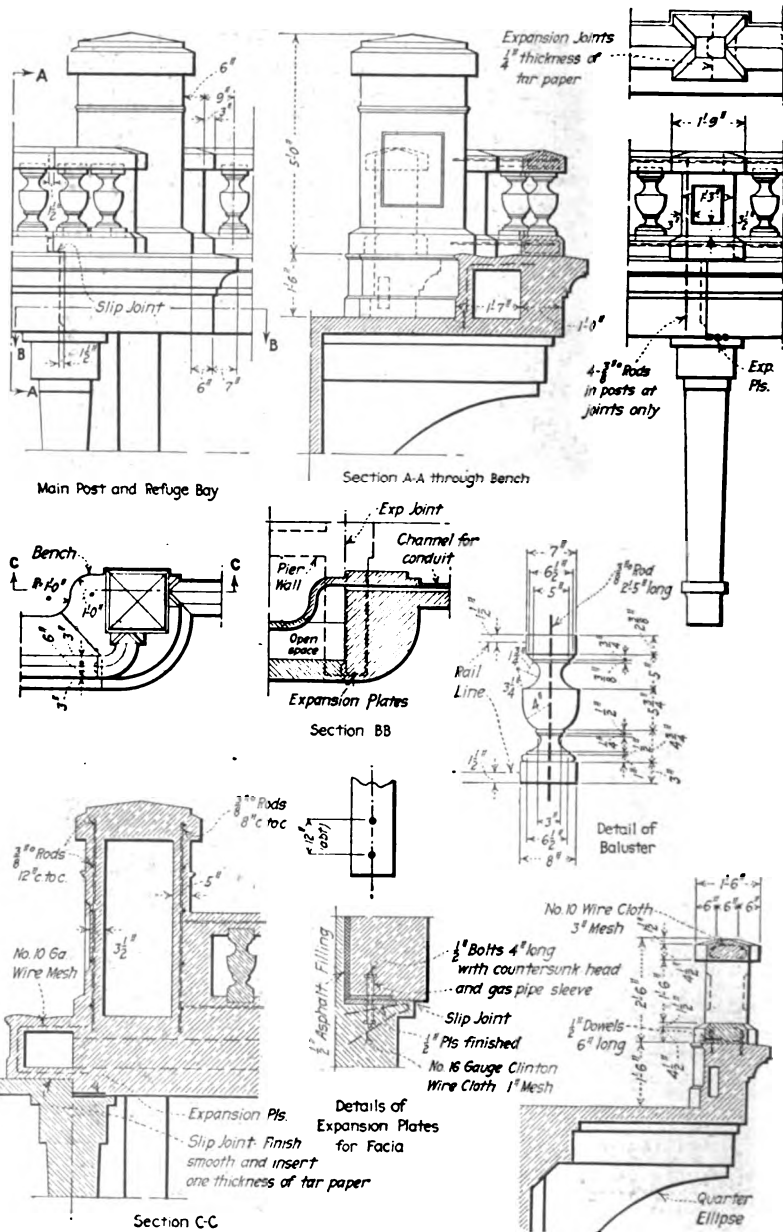

Bridge over the Arroyo Seco, Pasadena, Cal.

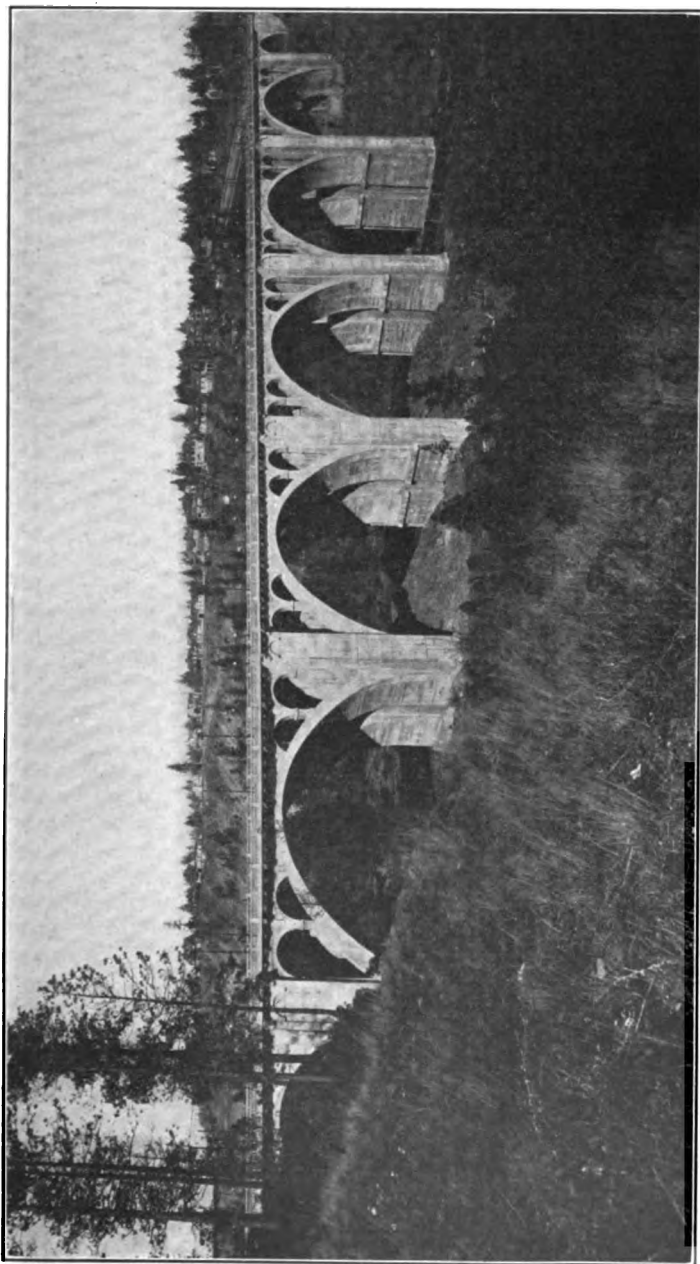

Courtesy of Mr. Morton Macartney, City Engineer, Spokane.
FIG. 232.—Latah Creek bridge, Spokane, Wash.

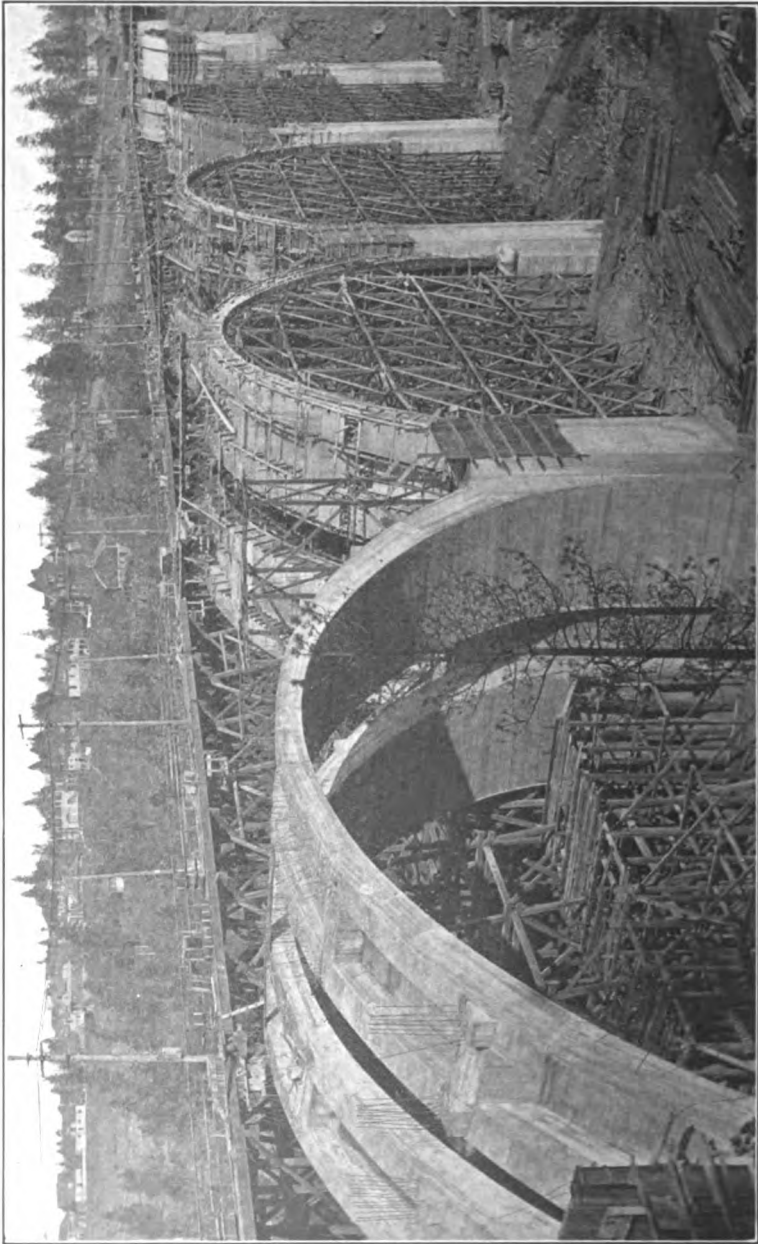

Courtesy of Mr. Martin Macartney, City Engineer, Spokane.
FIG. 233.—Construction view of Latah Creek bridge, Spokane, Wash.

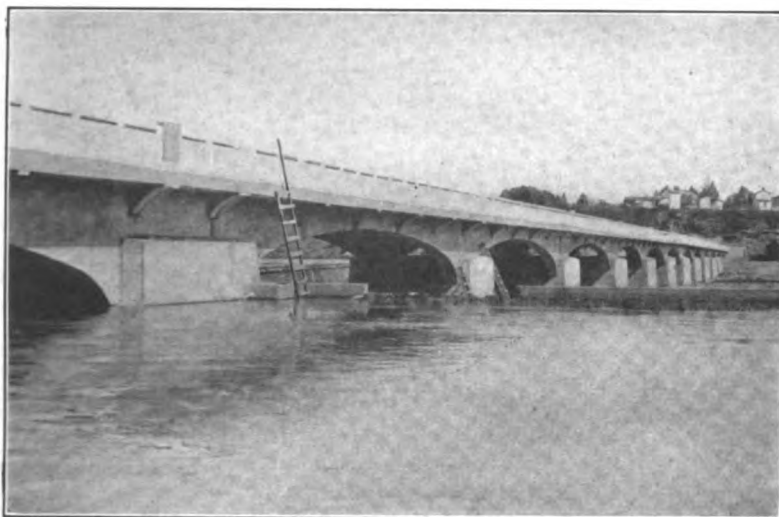

Courtesy of Mr. Wilbur J. Watson, Consulting Engineer, Cleveland.

FIG. 234.—Highway bridge at Danville, Va.



Courtesy of Mr. Wilbur J. Watson, Consulting Engineer, Cleveland.

FIG. 235.—General view of highway bridge at Danville, Va.

PLATE XXXVIII

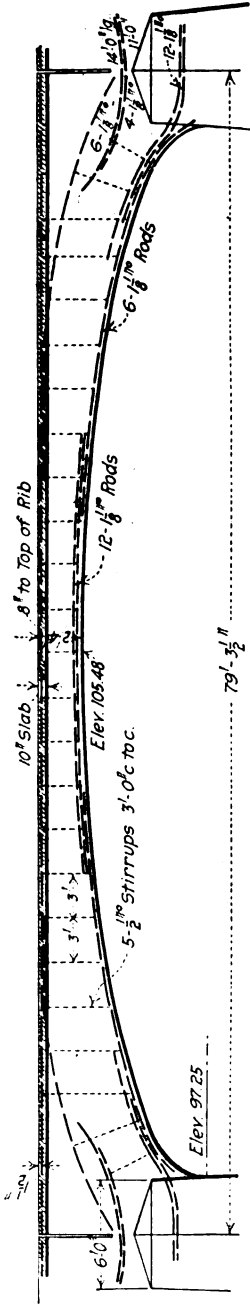

Longitudinal Section on Center Line of Bridge.

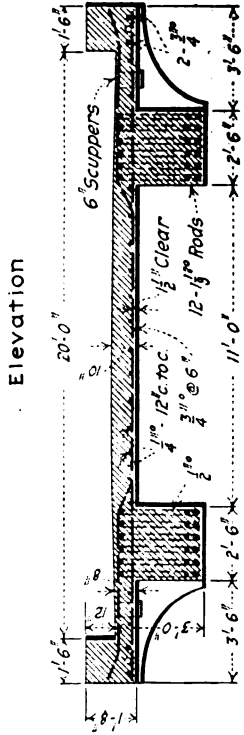
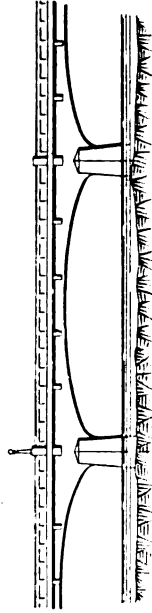

Section at Crown

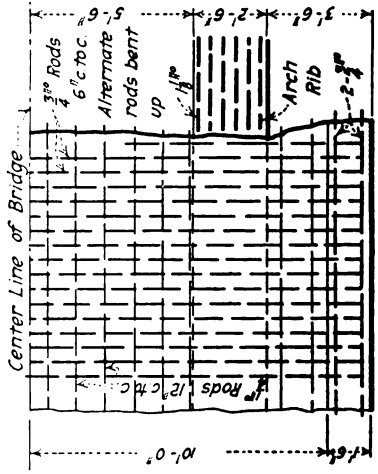

Part Plan of Floor Slab

Highway bridge at Danville, Va.

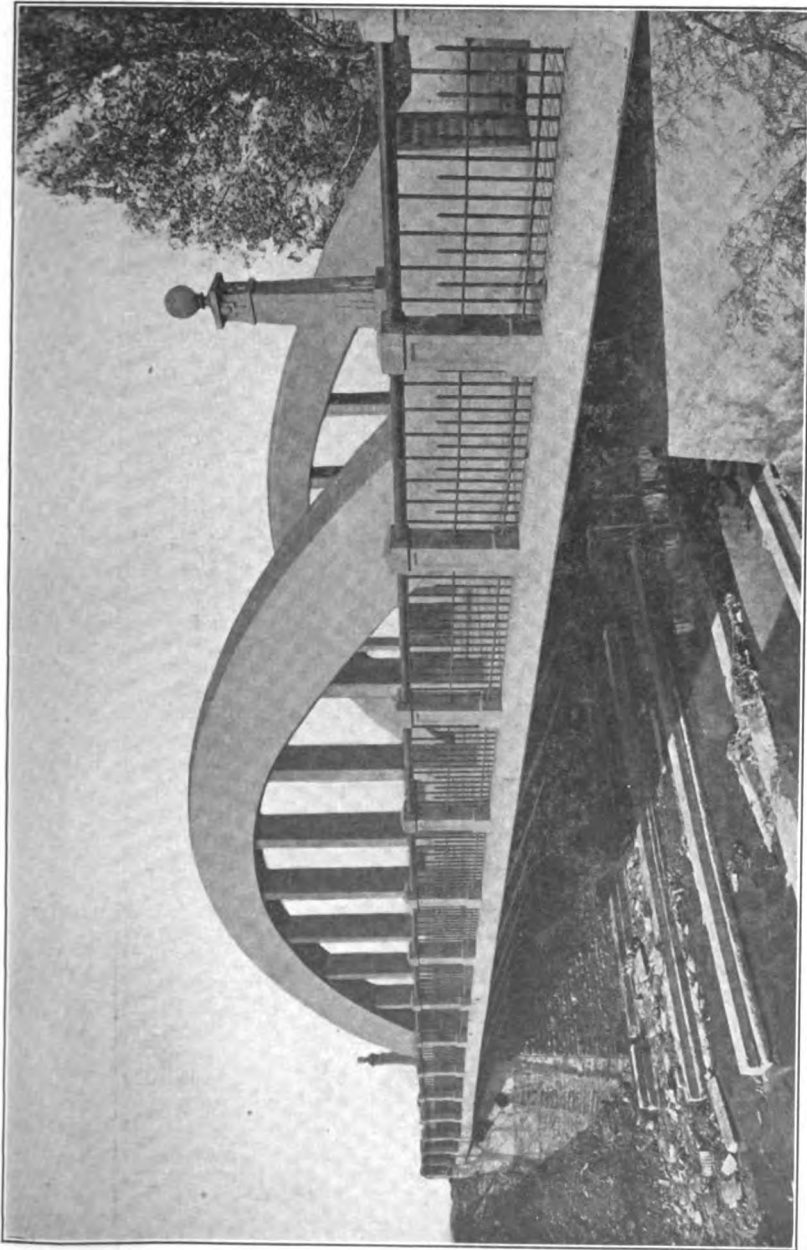

COURTESY OF ASSOC. OF AMERICAN PORTLAND CEMENT MFGRS.

FIG. 236.—Benson Street bridge over Mill Creek at Lockland, Ohio.

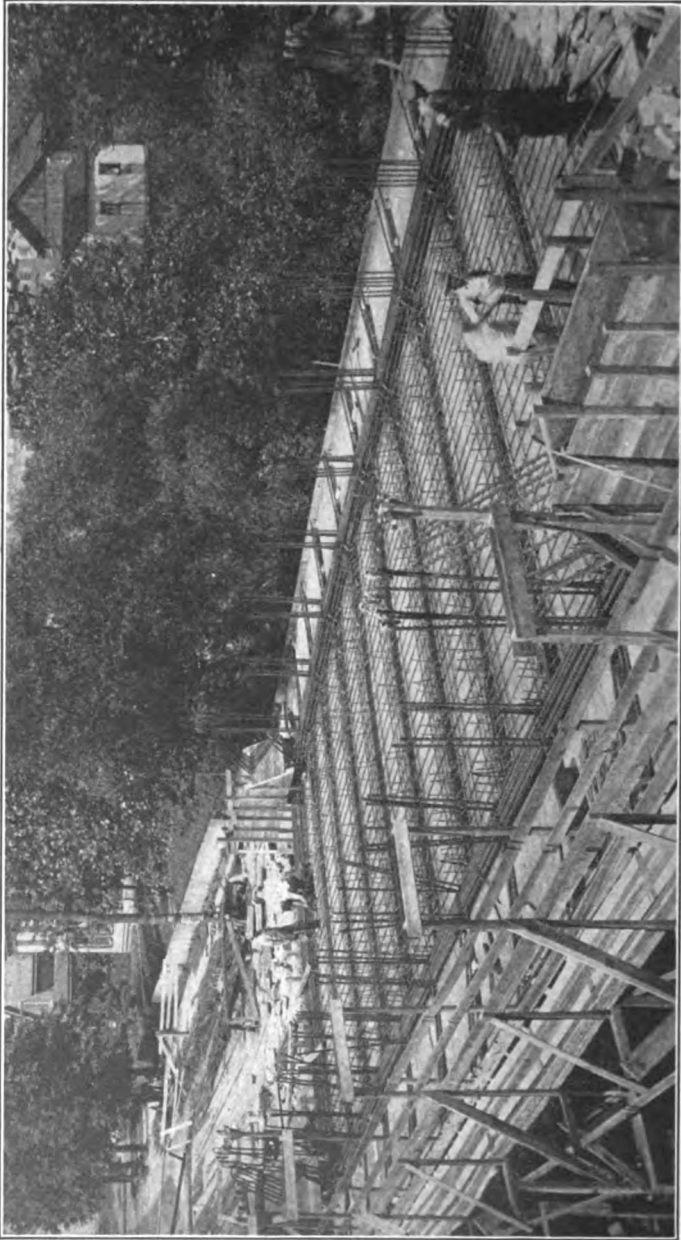

Courtesy of Mr. E. A. Gast, Deputy County Surveyor, Hamilton County, Ohio.
FIG. 237.—Construction view, Benson Street bridge over Mill Creek at Lockland, Ohio.

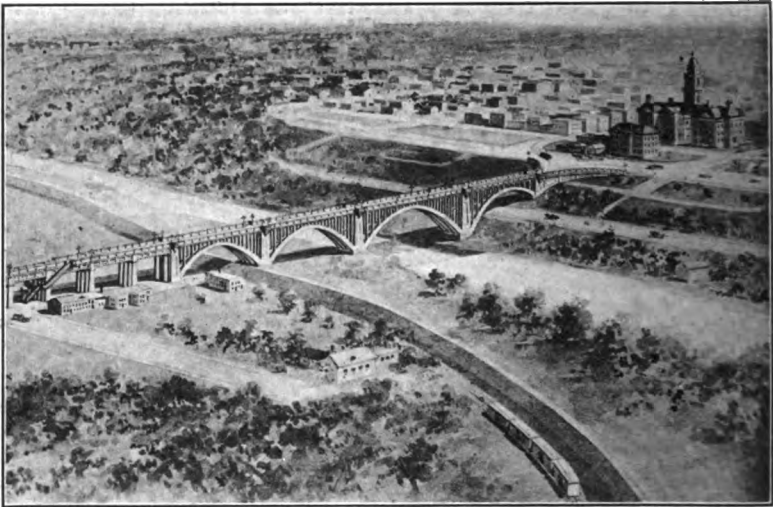

Courtesy of Mr. S. W. Bowen of Brenneke and Fay, Consulting Engineers, St. Louis.
 FIG. 238.—Main Street viaduct, Fort Worth, Texas, from an artist's perspective.

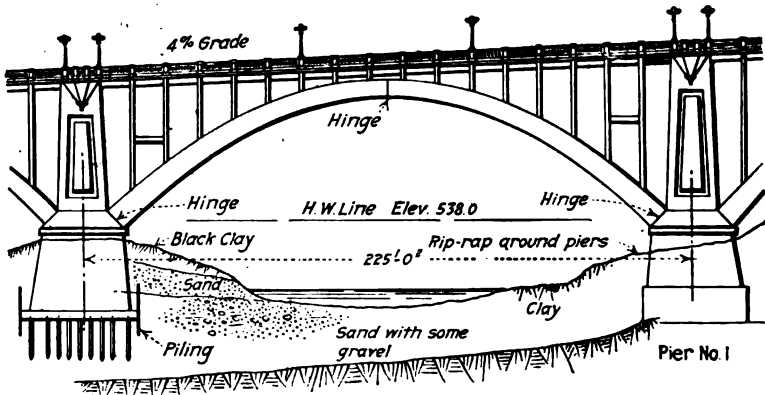

Pier No. 2
 FIG. 239.—River span, Main Street viaduct, Fort Worth, Texas.

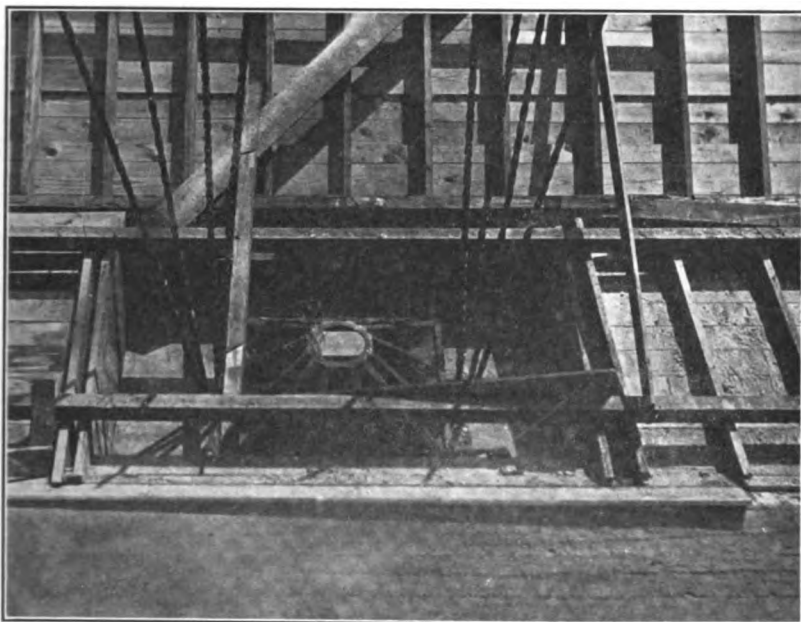

Courtesy of Mr. S. W. Bowen, St. Louis.

FIG. 240.—Pier casting of center rib, Main Street viaduct, Fort Worth, Texas. Casting ready to be concreted in.

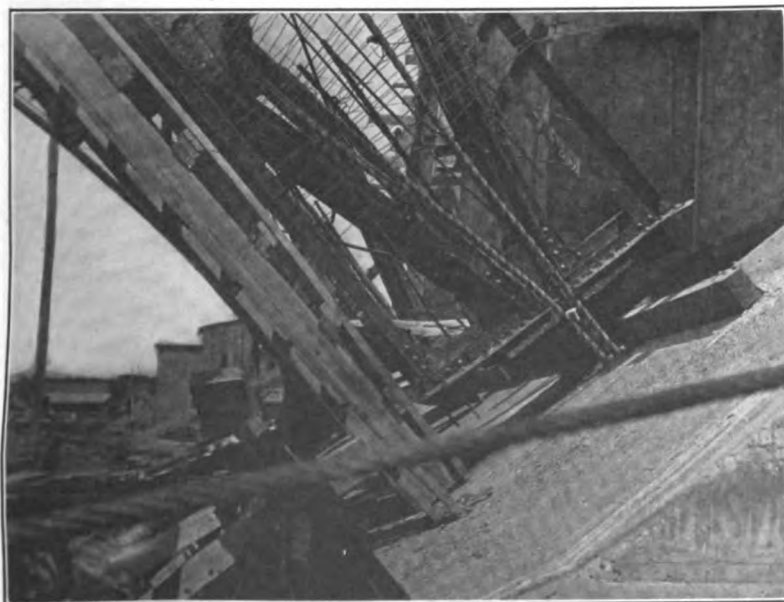

Courtesy of Mr. S. W. Bowen, St. Louis.

FIG. 241.—Haunch hinge in place, Main Street viaduct, Fort Worth, Texas.

PLATE XL

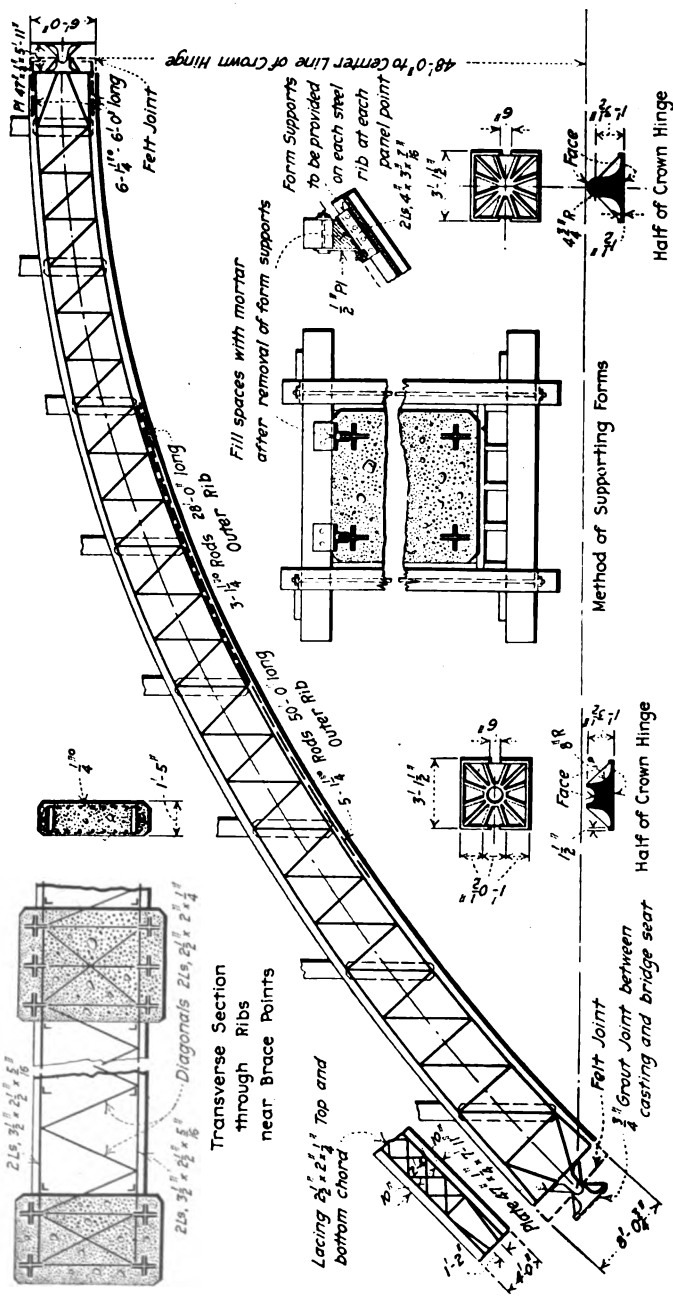

Main Street viaduct, Fort Worth, Texas.

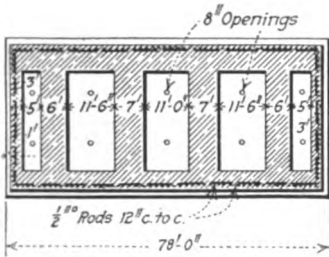

Section A-A

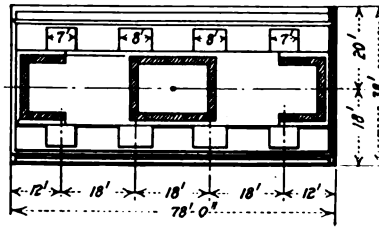

Section B-B

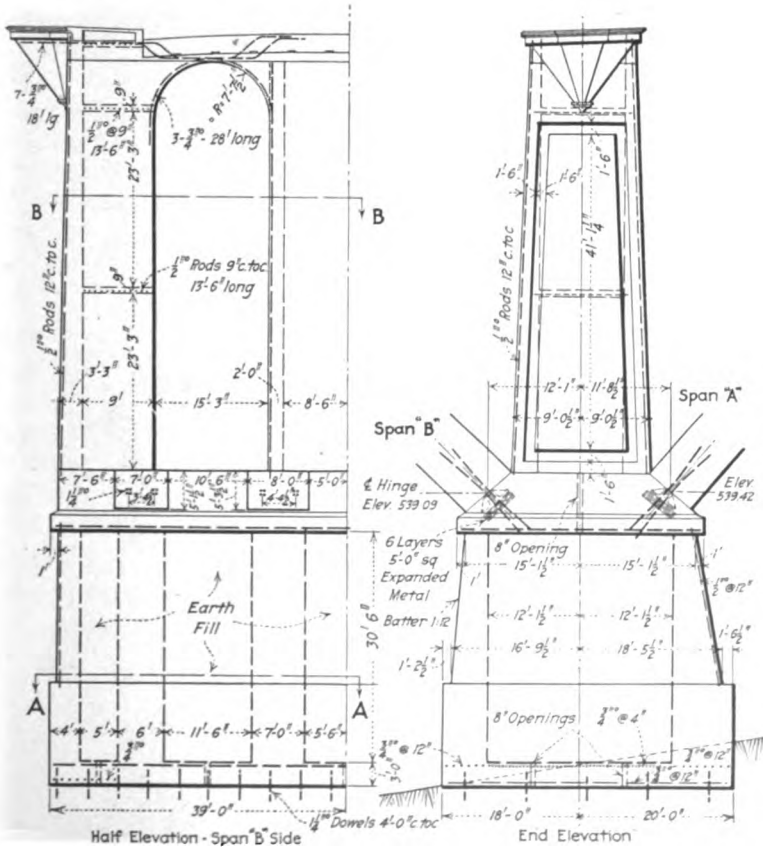

Main Street viaduct, Fort Worth, Texas.



PART II

SLAB AND GIRDER BRIDGES

Since the methods of designing slabs, beams, and girders have been explained at length in Volumes I and II, no attempt will be made in the following chapters to treat of these methods in detail. Many things must be considered, however, in designing bridges of this class, aside from the proportioning of simple and continuous beams, and such matters will be given due consideration.

The erection of forms and other operations in slab-and-girder bridge construction are essentially the same for ordinary conditions as the corresponding operations in the construction of buildings. On this account, constructional methods will be referred to only incidentally under this heading.

The loadings to use in design are, of course, the same as for the floors in arch bridges of open-spandrel construction (see Art. 7). In fact, it should be noted that the framed structure which is supported by a ribbed arch is virtually a trestle form of girder bridge and the loadings and general design are identical.

Impact may properly be neglected in arch-ring analysis but becomes important in bridge-floor design. An increase of 25 per cent is usually made in the live load or live-load stresses for highway bridges and 50 per cent in those for railroad bridges.

From the standpoint of economy, slab bridges should in general be limited in span length to about 25 ft., and ordinary girder bridges to about 50 ft.

CHAPTER XIV

SLAB BRIDGES

65. Slabs Under Concentrated Loading.—Recent tests made on simply-supported slabs at the University of Illinois and at the United States Office of Public Roads gave results in sufficient agreement to permit of simple rules being formulated for estimating the effective width of slabs supporting concentrated loads. In one series of tests, $\frac{1}{2}$ -in. plain round rods were used and the loads were applied centrally over a bearing area 6 in. in diameter. In another series somewhat similar loads were applied at the one-third points of the span. In a discussion of the tests above mentioned before the American Society for Testing Materials,

June, 1913, Mr. W. A. Slater, first assistant of the Engineering Experiment Station, University of Illinois, recommended that where the total width of slab is greater than twice the span, the effective width e (Fig. 242) be assumed as

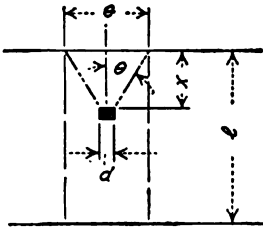

Fig. 242.

$$e = \frac{4}{3}x + d$$

where x is the distance from the concentrated load to the nearest support and d is the width at right angles to the span over which the load is applied. Mr. Slater pointed out that the tests so far made showed the effective width to be but little influenced by the depth of the slab or by the percentage of longitudinal reinforcement. He stated, however, that he would limit the latter to 1 per cent. "because of the possibility that in a beam with a large amount of longitudinal reinforcement and a relatively small depth, failure may be caused by transverse tension in the concrete and not by longitudinal steel stress."

Tests were made on beams having various percentages of transverse reinforcement, but results did not show conclusively that such reinforcement is economical when used for the purpose of resisting transverse bending stress. Additional tests are needed to

determine what increase may be made in the effective width for different percentages of transverse steel. At least a small amount should be used in every case for the purpose of distributing deformation due to variations in temperature.

The formula given above for finding effective width shows that this width is very nearly a constant proportion of the span; and consequently it follows that the depth of slab required to support a given concentrated load is approximately the same for all spans. Of course, the depth referred to here is only that necessary to support the live load. Considering both dead and live load, an increase in span length would obviously cause considerable increase in depth or in percentage of reinforcement.

The above discussion refers to a total width of slab greater than twice the span. For a slab whose total width is less than

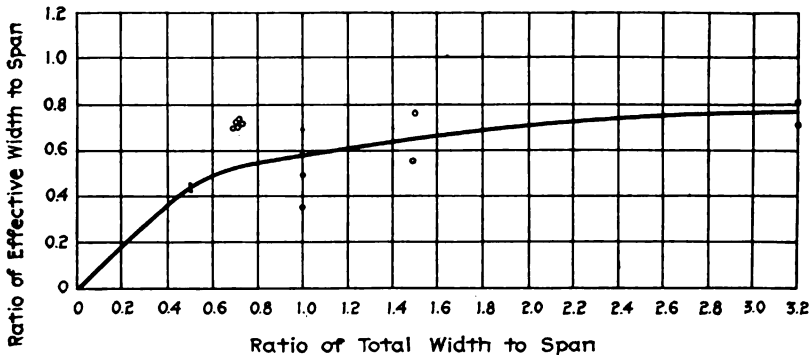

FIG. 243.

this, the effective width may be found from Fig. 243 which shows the ratio of the effective width of the span as determined from the measured steel stresses in the University of Illinois tests.

Mr. C. R. Young, Assistant Professor of Structural Engineering in the University of Toronto, in an article in *Engineering News*, issue of July 30, 1914, calls attention to the fact that the loads caused by wheels or rollers on highway bridges are applied over considerably elongated areas. In view of the tests referred to above, he presents a practical method of estimating the effective width of slabs supporting the type of concentrated loads found in practice. The following is taken from the article mentioned:

"Let a concentrated load, bearing on an area of length c and width d , be applied in any general position to a slab having a total width b not

less than twice the span length l , as shown in Fig. 244. If any small element of this load, as mn , distant x from the nearer support, be considered, it is directly evident from the experimental investigations cited above, that such part of it as is delivered to the nearer support may be regarded as wholly transferred to that support within lines drawn through the end points of the element making angles θ with the direction of the span of the slab, the tangent of which angle is between 0.67 and 0.80. For brevity, the angle between these two bounding lines, that is 2θ , may be called the *effective angle*. The reaction at the near support may thus be regarded as uniformly distributed over a width of $r = 2x \tan \theta + d$, or if $\tan \theta$ be assumed as 0.67, a conservative value in the light of experimental results, this width becomes $1.33x + d$.

“Although there is no direct experimental evidence that the effective angle to the farther support is the same as to the nearer, careful con-

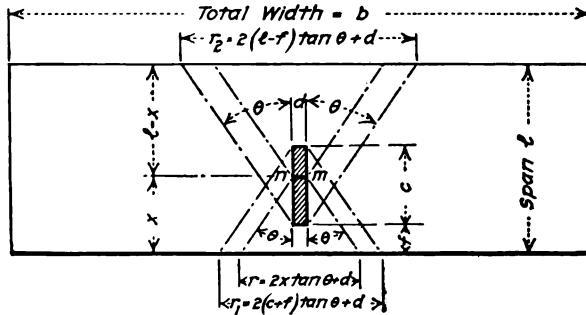

FIG. 244.

sideration of the matter leads to the conclusion that it is. If the farther support were moved in so that the element of load, mn , became central, the effective angles to the two supports would be equal. There would then be applied to the shifted support, along a length that may be called the effective reaction-width of the reduced span, a uniformly-distributed reaction which, when the first support was replaced in its original position, would become a concentrated load on the original span. The virtual load would be delivered to the support nearest to it, but farthest from the original eccentric element of load mn within the same effective angle as would apply to the nearer support in any case. It thus appears that the effective angles from any element of loading to the two supports are equal.

“When the selected element of loading is not at the center of the span and the reactions at the two supports are thus not distributed over the same effective widths, the question arises as to what should be the effective width of the slab for the calculation of resisting moment. It is probable that the average of the two reaction-widths would be the

correct width to assume for this purpose, and in the absence of direct experimental evidence on the matter, this assumption is recommended.

“Considering as a whole the concentrated load shown in Fig. 244 it follows that the part of it delivered to either support may be regarded as wholly transferred to that support within lines drawn through the remotest corners of the loaded area and making angles with the direction of the span of the slab equal to θ , one-half of the effective angle. If f be the distance of that edge of the loaded area nearest a support, from the support, the effective reaction width, r_1 , for the nearer support would be

$$r_1 = 2(c + f) \tan \theta + d$$

and for the farther support it would be,

$$r_2 = 2(l - f) \tan \theta + d$$

As in the case of an element of loading, the effective width of the slab for the computation of moment of resistance may be taken as the average of the reaction widths r_1 and r_2 .

“Where the concentrated load is a moving one, the critical position will be at the center of the span. The effective reaction-widths are then equal to each other and the effective width of the slab for the computation of moment of resistance is equal to either.

“Since loads arising from wheels or rollers are often applied over considerably elongated areas, the orientation of the load on the span is an important consideration. For such loads, the distance d is always small—in theory only the width of a line—but the distance c may, for rollers, be as much as 48 in., and is commonly from 12 to 20 in.

“The two extreme arrangements of the load, indicated in Fig. 245, will be compared. In Fig. 245(a), the axis of the machine or vehicle is at right angles to the direction of the span of the slab, while in Fig. 245(b), it is parallel to this direction. For the usual system of floor construction in a bridge, with the slabs supported on longitudinal stringers, the axis of the machine for the case shown in Fig. 245(a) would be parallel to the axis of the bridge and for the case indicated in Fig. 245(b), transverse to it. The latter is a contingency that must be considered in wide bridges. When the load is placed as shown in Fig. 245(a), it follows from what has already been said that the effective width of the slab e_1 is given by the expression

$$e_1 = (l + c) \tan \theta + d$$

and when the arrangement is that of Fig. 245(b), the effective width is

$$e_2 = (l + d) \tan \theta + c$$

Since c is ordinarily very much greater than d , e_2 is greater than e_1

and the location and orientation of a wheel load most seriously stressing a slab is as shown in Fig. 245(a) and not as shown in Fig. 245(b).

“For bearing areas differing in shape from those shown in Figs. 244 and 245, equivalent rectangles may be substituted.

“When the length b of the slab is less than twice the span length l , it becomes necessary to make some reduction in the effective width. The writer would suggest that until further experimental evidence is available the values of $\tan \theta$ in any calculation of effective widths be

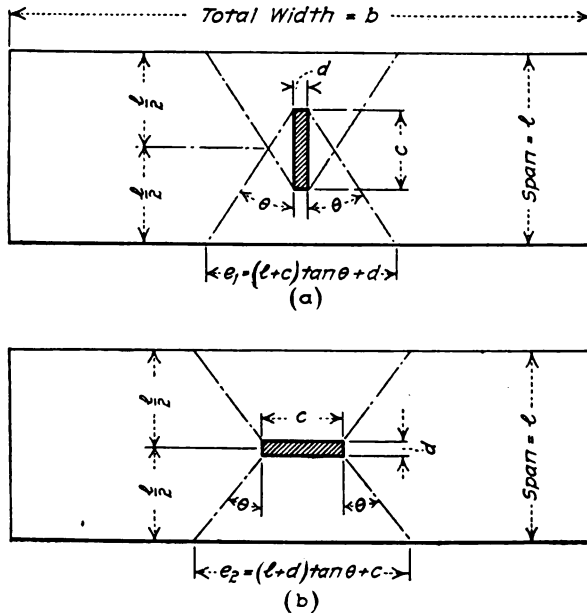

FIG. 245.

assumed substantially in accordance with those given by Mr. Slater's graph, or as follows:

b	l	$\tan \theta$
	0.4	0.35
	0.5	0.42
	0.6	0.48
	0.8	0.54
	1.0	0.59
	1.2	0.62
	1.4	0.64
	1.6	0.65
	1.8	0.66
	2.0 and over	0.67

“Although no experimental investigation of the relative distributing effects of various types of slab reinforcement has been made, it is probable that a form involving diagonal strands or rods is most efficient. Maximum stiffness along lines radiating from the load within the effective

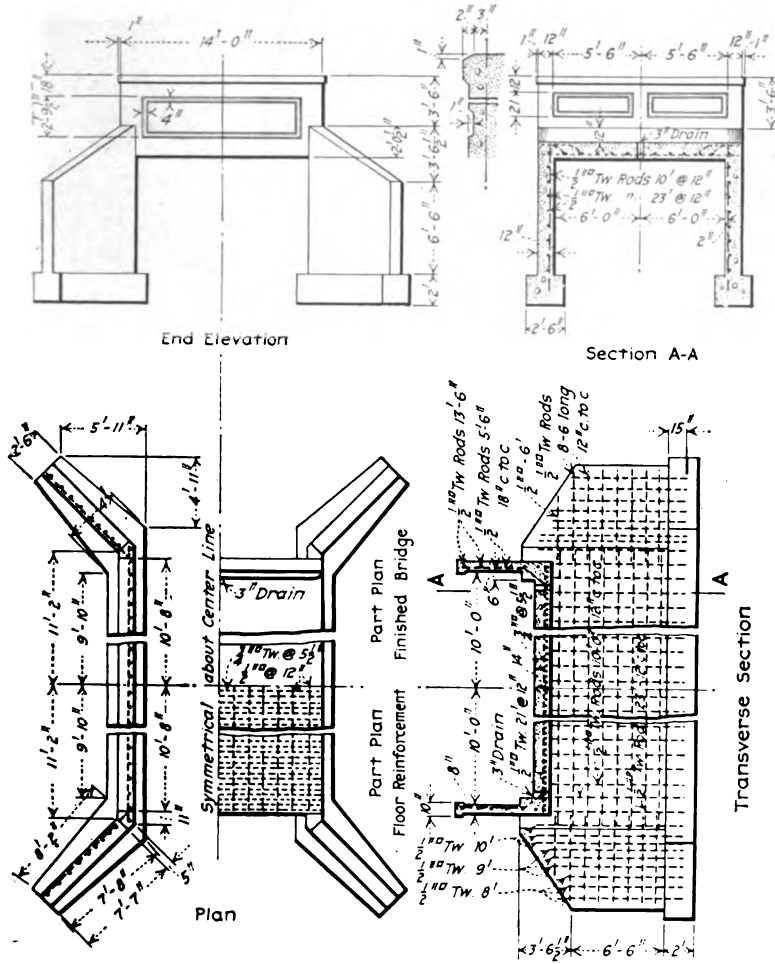

FIG. 246.—Standard design for slab bridges of 12 ft. span, Wisconsin Highway Commission.

angle and the provision of a large number of strands directly under the load would thus be secured. Upon these considerations the delivery of the load to the supports over a considerable effective width largely depends.

“The effect of a gravel cushion or other wearing surface in distributing concentrated loads over bridge floors has not been considered, as this is a matter not entering into the present discussion. Having found the area of the slab to which the load is applied by this surfacing, the problem is of precisely the same kind as arises when loads are applied directly to



Courtesy of Mr. M. W. Torkelson, Bridge Engineer, Wisconsin Highway Commission.
 FIG. 247.—Christiana bridge over Brewery Creek, Town of Cross Plains, Dane County, Wis.

the slab. The only difference is that the bearing area of the concentrated load is increased with the use of a wearing surface and consequently the effective width of the slab also becomes greater.”

66. Slab Bridges of Single Span.—The floor of a slab bridge may be designed as any simply-supported slab except that shear-



Courtesy of Mr. M. W. Torkelson, Bridge Engineer, Wisconsin Highway Commission.
 FIG. 248.—Construction view of Christiania bridge, Town of Cross Plains, Dane County, Wis.

ing stresses may require very careful attention where the live load is relatively large, as in railroad structures. The whole reinforcing system may be made absolutely rigid by wiring the main reinforcing rods to the transverse reinforcement, employing extra transverse spacing rods at the ends of the bent-up

steel. Both the straight longitudinal rods and those bent up to provide for diagonal tension should be hooked at the ends.

Practice varies in regard to the use of expansion joints between the slab floor and the abutments. There are none provided in Figs. 246, 249, and 250, but such joints are placed at both abutments in Fig. 251. In the latter figure, vertical end expansion joints are provided at the angle points between abutment wings and slab, making it necessary to cantilever the outer por-

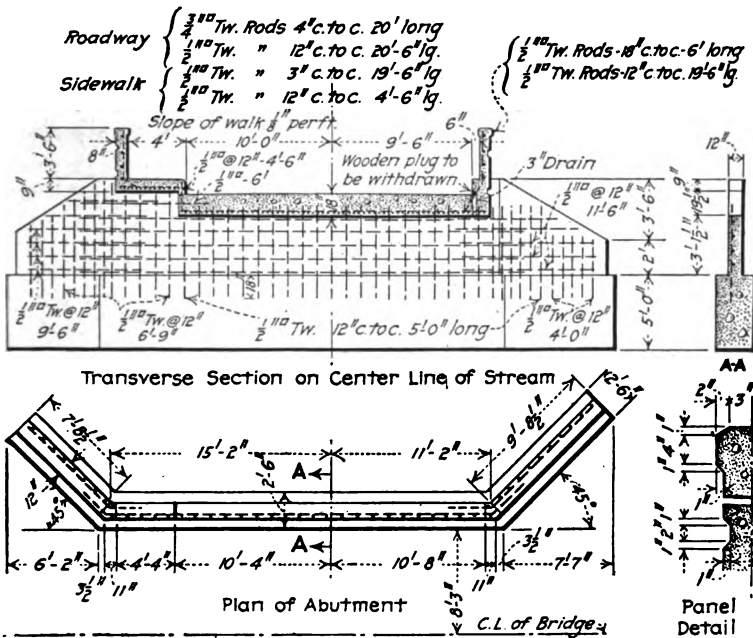

FIG. 249.—Details of Christiana bridge, Town of Cross Plains, Dane County, Wis.

tions of the slab width on account of insufficient abutment support.

In Figs. 246, 249, and 250 the main wall or vertical slab of the abutment is supported at the top by the floor and at the bottom by the footing, and may be figured for earth pressure as a simple slab with the main steel near the outer or stream face. Of course, the main wall should also be designed to act as a column to support the superstructure. Since a joint of low friction is not provided between floor and abutments, the unit tensile stress in the steel of the superstructure is usually kept low (12,000

lb. per square inch) so as to provide properly for the additional tension in the steel caused by the contraction of the bridge in cold weather. The wings may be designed as self-supporting retaining walls of the cantilever type, using the methods explained in Part I of Volume II. Theoretically the maximum efficiency of the footing for the wing walls can be obtained by placing the wing wall at about the outer middle-third point of the base, but in many cases considerable saving in excavation

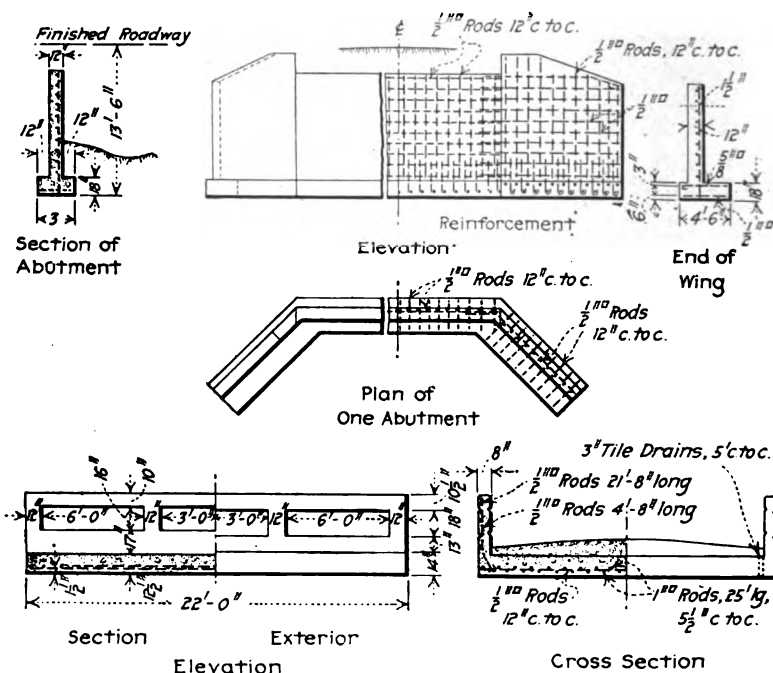
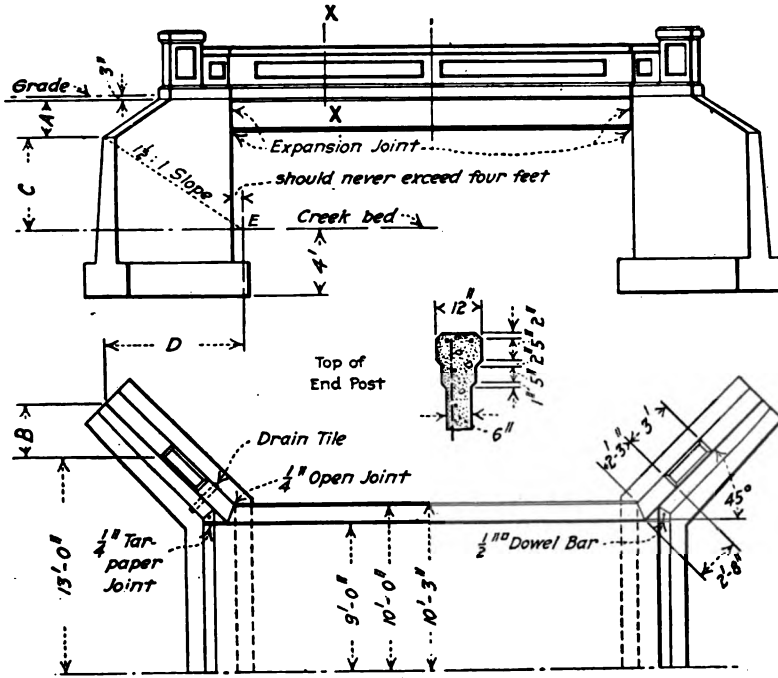

FIG. 250.—Typical slab bridge, Illinois Highway Commission. Abutment wings of the cantilever type. Main wall vertical slab supported at top by superstructure and at base by footing.

may make it more desirable to shift the footing a little toward the stream bed. Counterforted walls are advisable only for abutments over 20 ft. in height.

Figs. 251 and 252 show an unusual abutment design adopted by the engineers of the Iowa Highway Commission for both slab and girder bridges. Expansion joints being provided at each end of the superstructure, both the main portion and the wings were designed as self-supporting retaining walls. The main portion,



Half Plan View

Note: So proportion the wing length that $A:B::C:D$ as $1:1\frac{1}{2}$. The point E where the $12:1$ slope from end of wing intersects the elevation of stream bed may be varied to suit local conditions.

In streams whose channels are nearly the span width, or where there is a possibility of cutting and channel widening, the point E should be taken at abutment face.

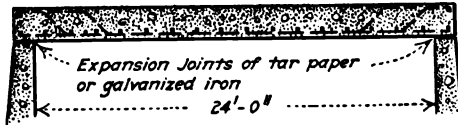

Longitudinal Section

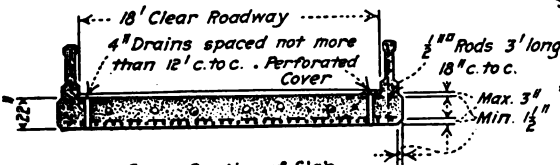

Cross Section of Slab

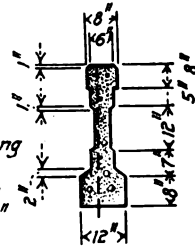

Section X-X

FIG. 251.—Typical slab superstructure, Iowa Highway Commission.

however, was not only analyzed in the ordinary manner for pressure on the base, but was also analyzed taking into account the stability due to the weight of the wings. The mean value of the maximum pressure at the toe of the foundation by the two methods being found safe, and an analysis for sliding and overturning being satisfactory, the dimensions shown were adopted.

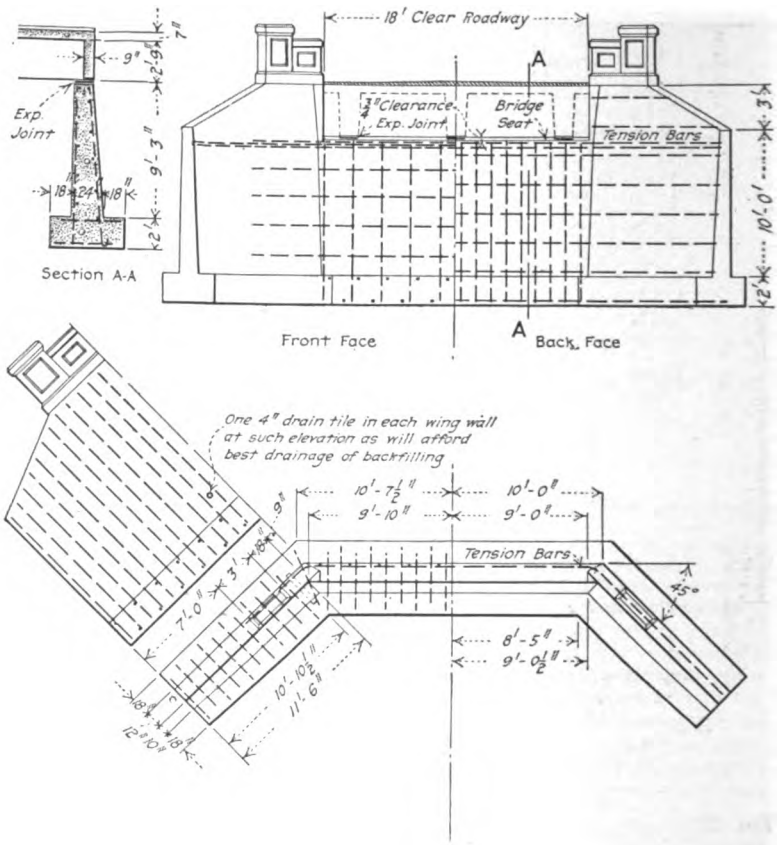

FIG. 252.—Typical substructure for slab and girder bridges, Iowa Highway Commission.

The horizontal rods designated as tension bars were inserted in order to utilize the weight above mentioned. These rods are placed in the main stem near the upper surface and extend continuously through the wings, with splices at the center of the main portion. The effect of considering the wings as a

part of the abutment body is to shift the center of gravity of the entire mass farther from the stream face and thus reduce the eccentricity of pressure on the foundation. The horizontal reinforcing rods shown near the stream face of the abutment, and which are carried about 5 ft. into the wings, were employed

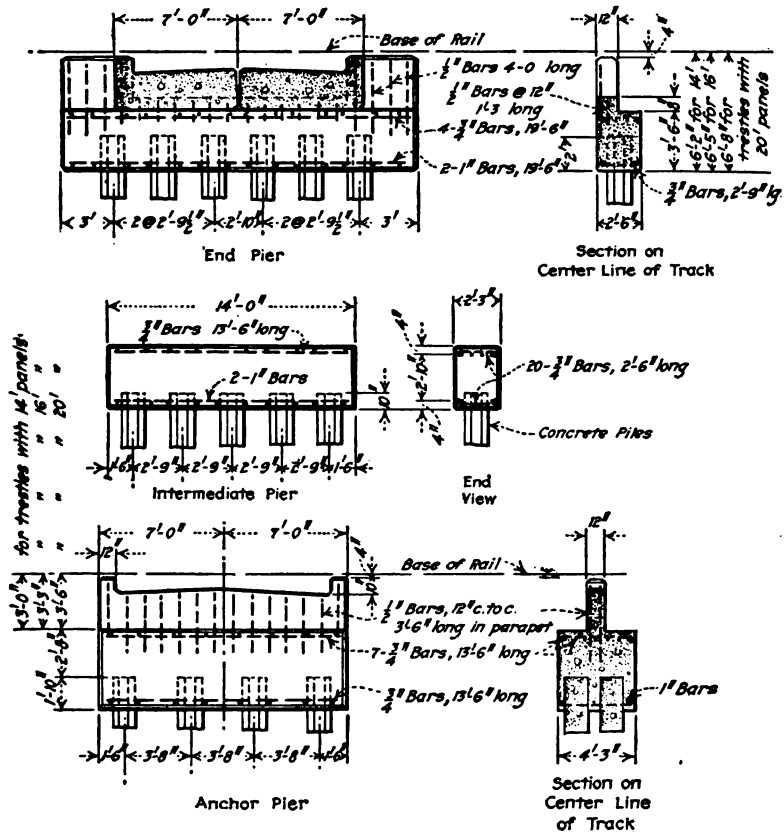

FIG. 253.—Details of substructure, standard concrete pile trestle, Illinois Central R. R.

to counteract a tendency to the formation of vertical cracks on the outside at the corner of wing and abutment. The vertical rods in the front face serve as a framework upon which to build the horizontal rods and they also prevent any tendency toward the formation of horizontal cracks in the stream face due to the clogging of an expansion joint.

67. Slab Bridges of Multiple Spans.—Slab bridges of multiple spans will be treated under the four following headings:

- Concrete pile trestles.
- Pier trestles.
- Trestles with framed bents.
- Cantilever flat-slab construction.

Concrete Pile Trestles.—Figs. 253 to 256 inclusive give the essential details of design of the pile trestles built by the Illinois

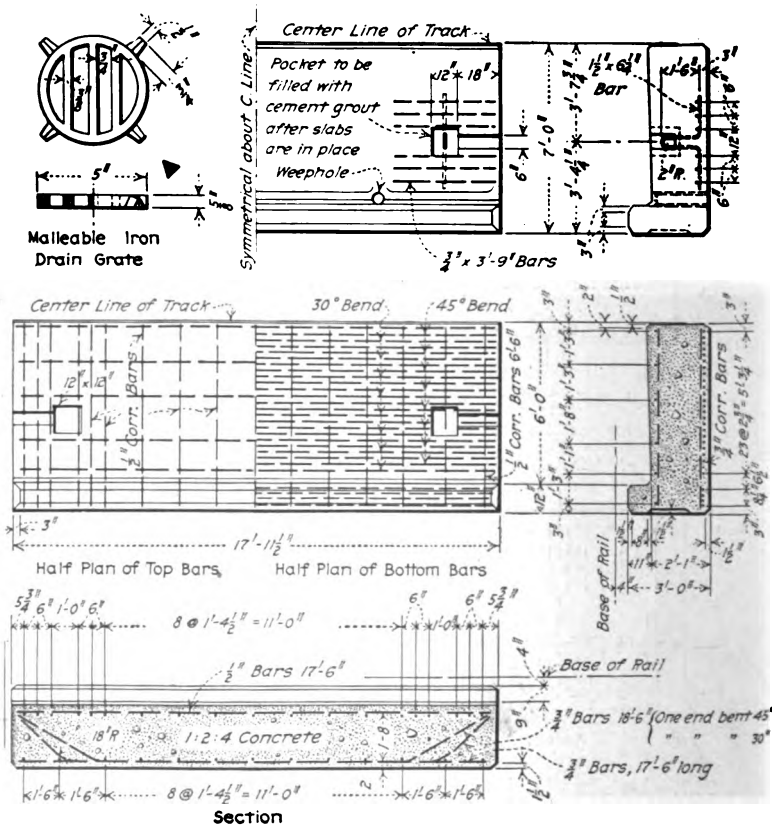

FIG. 254.—Standard slab for clear spans of 16 ft. Illinois Central R. R.

Central Railroad. They can be considered typical of concrete pile trestles in general. These trestles replace similar wooden structures over swamps and shallow streams which may not be filled and where bridges on more permanent supports would be extremely expensive because of their great length. The con-

struction consists of pile bents spaced generally from 16 to 20 ft. c. to c., and with a height above ground not greater than the span. The piles are capped with reinforced-concrete girders which support the floor slabs.



Courtesy of Mr. Maro Johnson, Engineer of Bridges and Buildings, I. C. R. R.
FIG. 255.—Construction view of concrete pile trestle on Illinois Central R. R. near Obion, Tenn. Concrete bents ready for slabs.

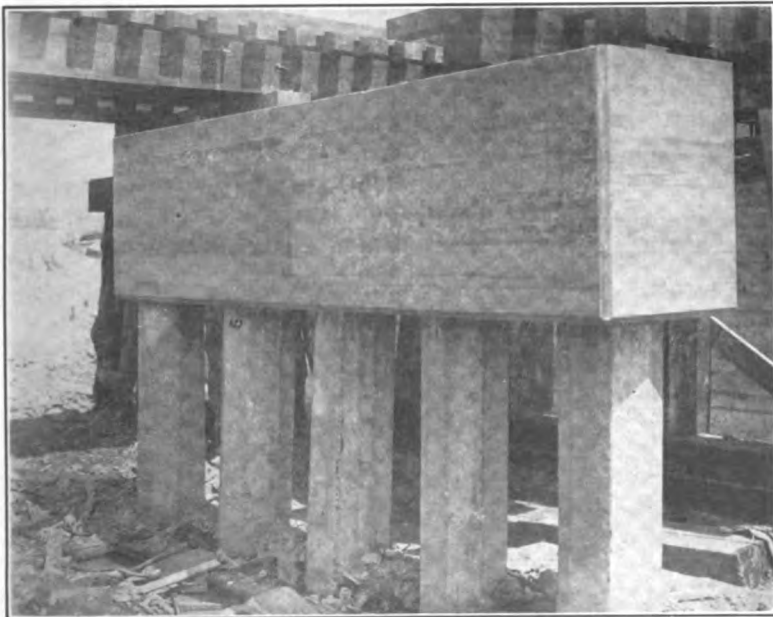

Courtesy of Mr. Maro Johnson, Engineer of Bridges and Buildings, I. C. R. R.
FIG. 256.—Typical bent of concrete pile trestle on Illinois Central R. R. near Obion, Tenn.

The piles and deck slabs are usually cast in a convenient yard, allowed to season from 60 to 90 days, and are then hauled to the bridge site. The lifting stirrups shown permit of the slabs being

set in place by a wrecking crane. The ballast and track are laid directly on the slabs after the longitudinal and transverse joints are filled with cement mortar and

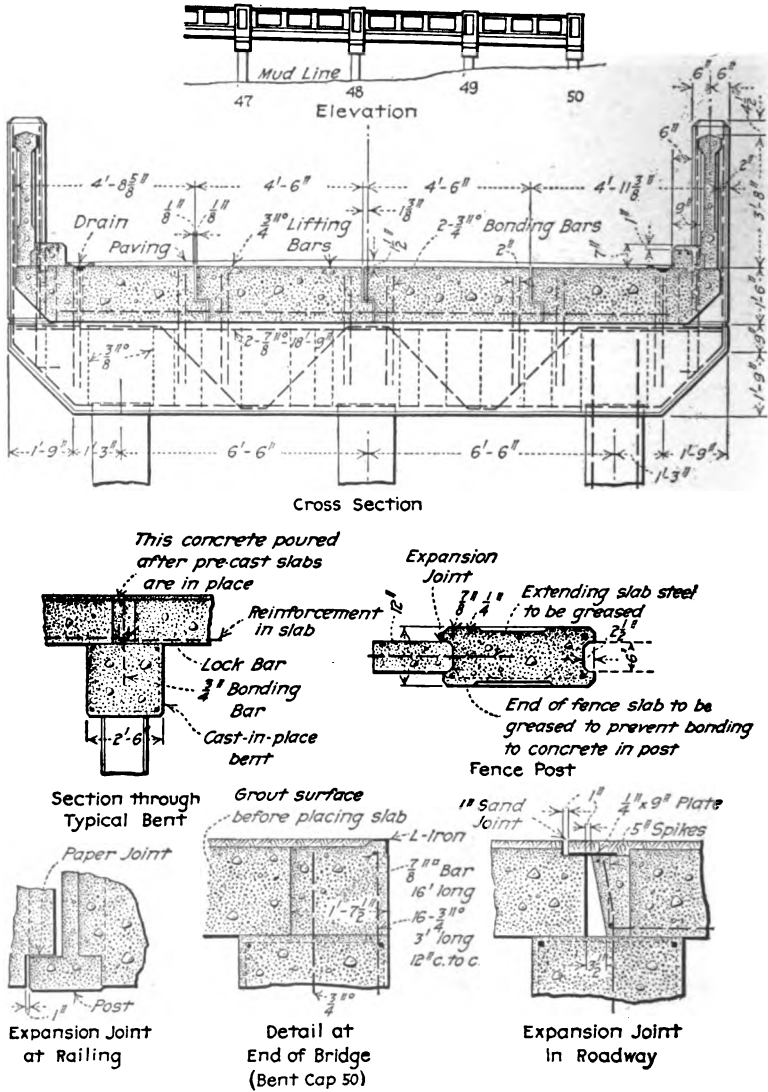

FIG. 257.—Details of pile trestle across the Miles River near Easton, Md.

after the floor surface is thoroughly waterproofed. The slabs are set on a bed of grout on the pile caps. An anchor bent is

used at suitable intervals to take up longitudinal stresses due to tractive force and, by means of an expansion joint, to prevent any great accumulation of movement of the deck due to temperature changes.



Courtesy of Raymond Concrete Pile Co.

FIG. 258.—Construction view of pile trestle across the Miles River near Easton, Md.

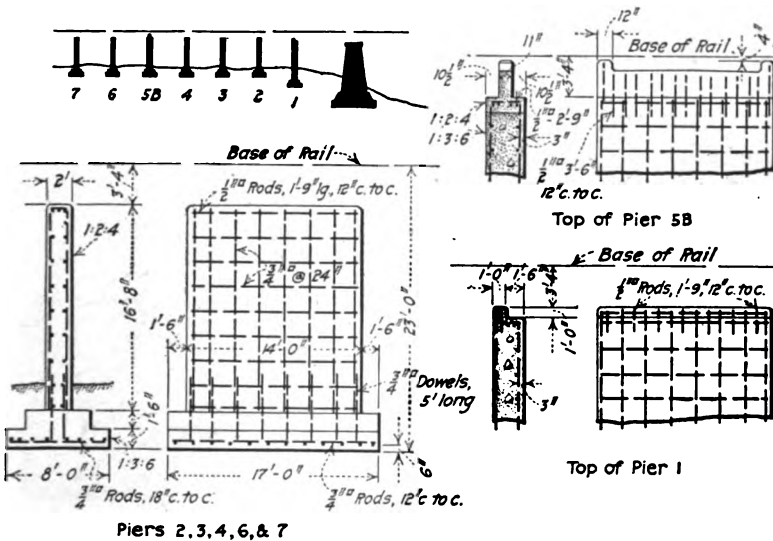

FIG. 259.—Pier details, Illinois Central R. R. trestle over Kaskaskia River near New Athens, Ill.

A concrete pile trestle for carrying a highway is shown in Figs. 257 and 258.¹ It was found economical to cast the piles, deck slabs, and railing slabs at Baltimore, 60 miles away, and transport them to the site on scows. Expansion joints were

¹ See also *Engineering News*, issue of Feb. 5, 1914.

located in the roadway slabs, curb, and railing slabs at every fifth bent.



Courtesy of Mr. Maro Johnson, Engineer of Bridges and Buildings, I. C. R. R.
FIG. 260.—Solid benchwall type of concrete trestle on Illinois Central R. R. near New Athens, Ill.

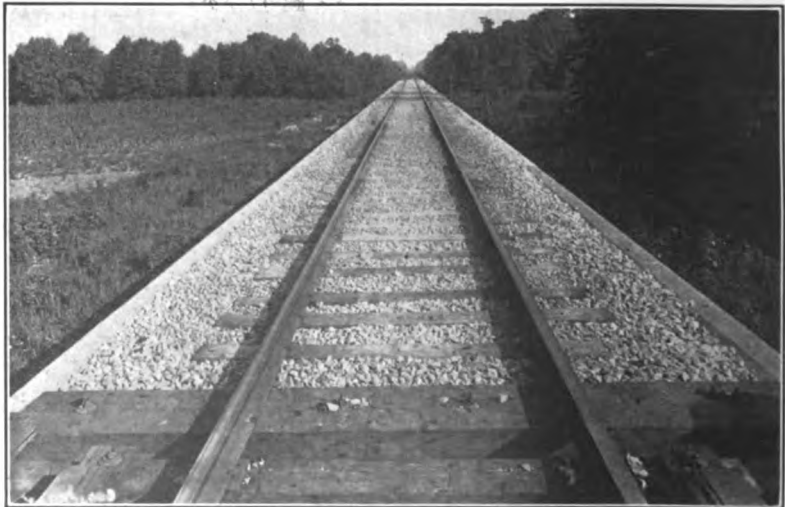

Courtesy of Mr. Maro Johnson, Engineer of Bridges and Buildings, I. C. R. R.
FIG. 261.—Roadbed of trestle shown in Fig. 260.

Pier Trestles.—Thin concrete piers are preferable to pile bents when the height of bridge above the ground line is greater than

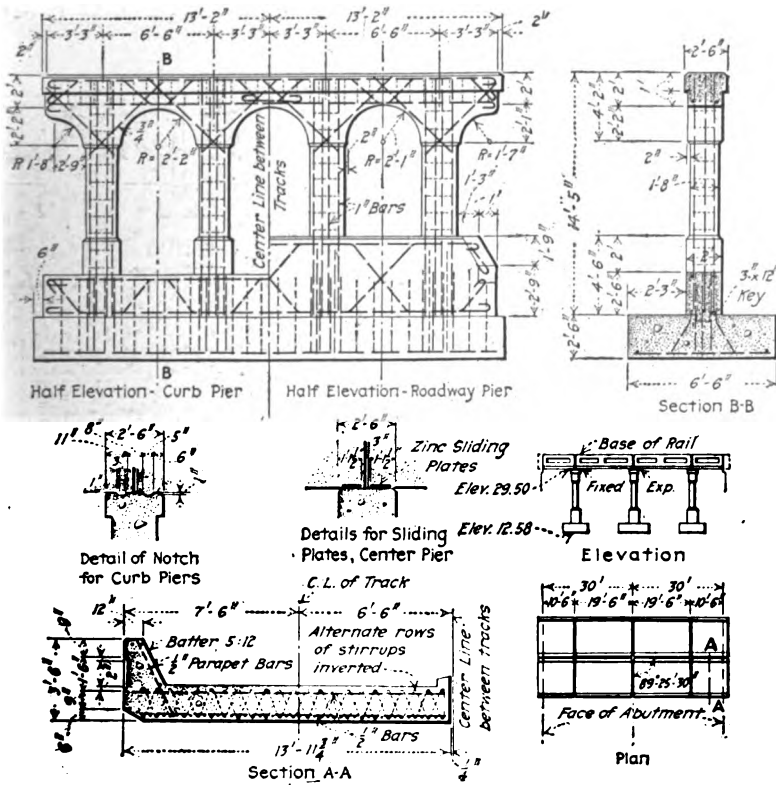

FIG. 262.—Details of Mozart Street subway, Bloomingdale Road track elevation, Chicago, Milwaukee & St. Paul Railway.



Courtesy of Mr. Maro Johnson, Engineer of Bridges and Buildings, I. C. R. R.

FIG. 263.—Illinois St. Subway, Flossmoor, Ill.

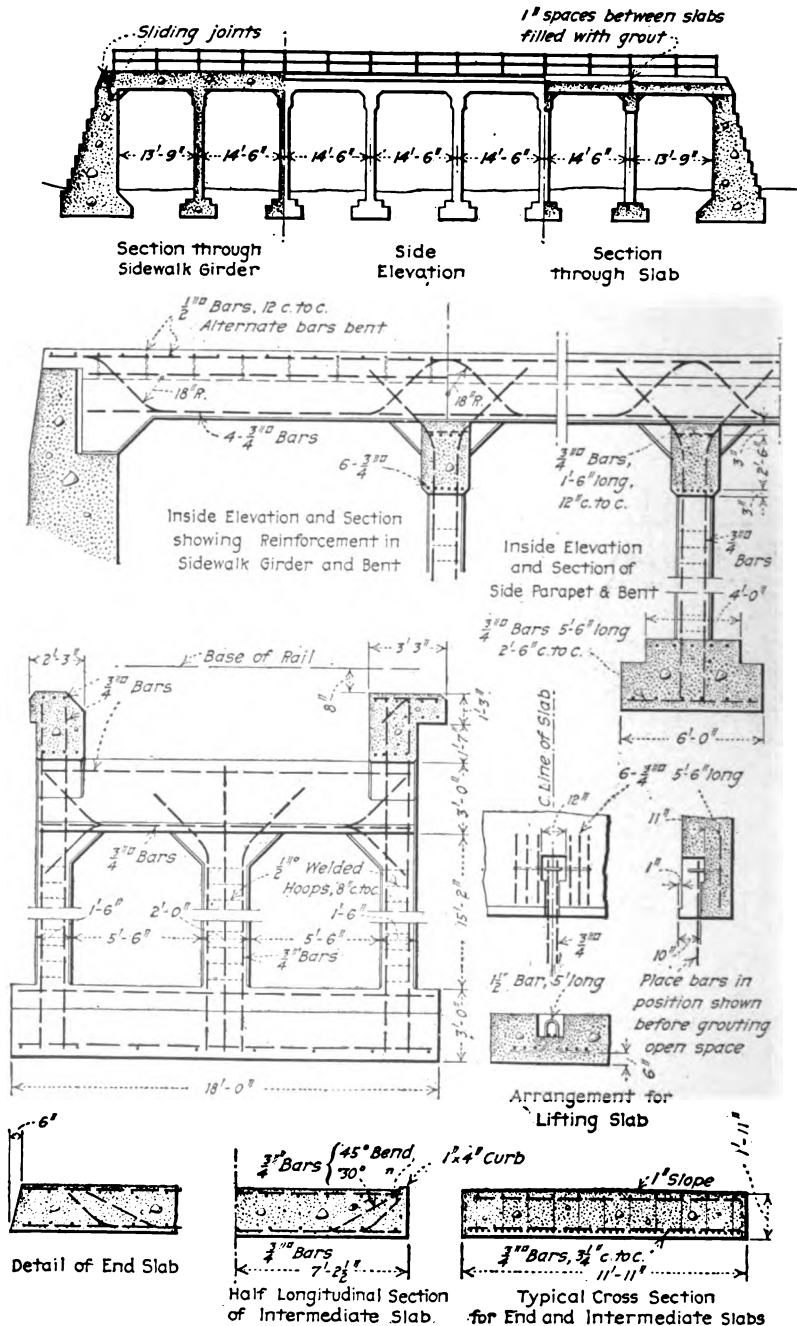

FIG. 264.—Details of trestle approach to Cumberland River bridge, Illinois Central R. R.

about 16 ft. Figs. 259, 260, and 261 show a typical trestle of the solid bench-wall type built by the Illinois Central Railroad.

Trestles with Framed Bents.—Slab bridges with framed bents forming subways are used on at least fifteen railroads in this country. A design which may be considered typical is shown in Fig. 262. The deck slabs may either be cast in place or cast at some central yard and placed in a similar manner to the slabs for pile or pier trestles. In Fig. 262 the design is shown for slabs to be cast in place. A general view of a typical Illinois Central subway is shown in Fig. 263.

A framed-bent trestle with continuous side girders to resist stresses due to traction is shown in Figs. 264 and 265. The girder on one side acts simply as a tie and parapet, while the



Courtesy of Mr. Maro Johnson, Engineer of Bridges and Buildings, I. C. R. R.

FIG. 265.—Trestle approach to Cumberland River bridge, Illinois Central R. R. Side girders continuous.

other with a cantilever projection at the side acts also as a sidewalk. The slabs were cast in a yard at some distance from the bridge site, loaded on flat cars, taken to the job, and swung into place with derricks. Expansion is allowed for at both ends by providing a sliding joint between the bridge superstructure and the abutments. The shallow 4-in. curbs at the ends of the slabs were provided to prevent seepage from getting into the 1-in. grout joint between slabs. The pier footings are reinforced longitudinally in top and bottom, and were figured as continuous T-beams uniformly loaded by the pressure on the soil. The cross girders at the top of the columns support the deck slabs previously referred to, and are made continuous.

Cantilever Flat-slab Construction.—Fig. 266 is a flat-slab structure of the Turner Mushroom type. The methods which may

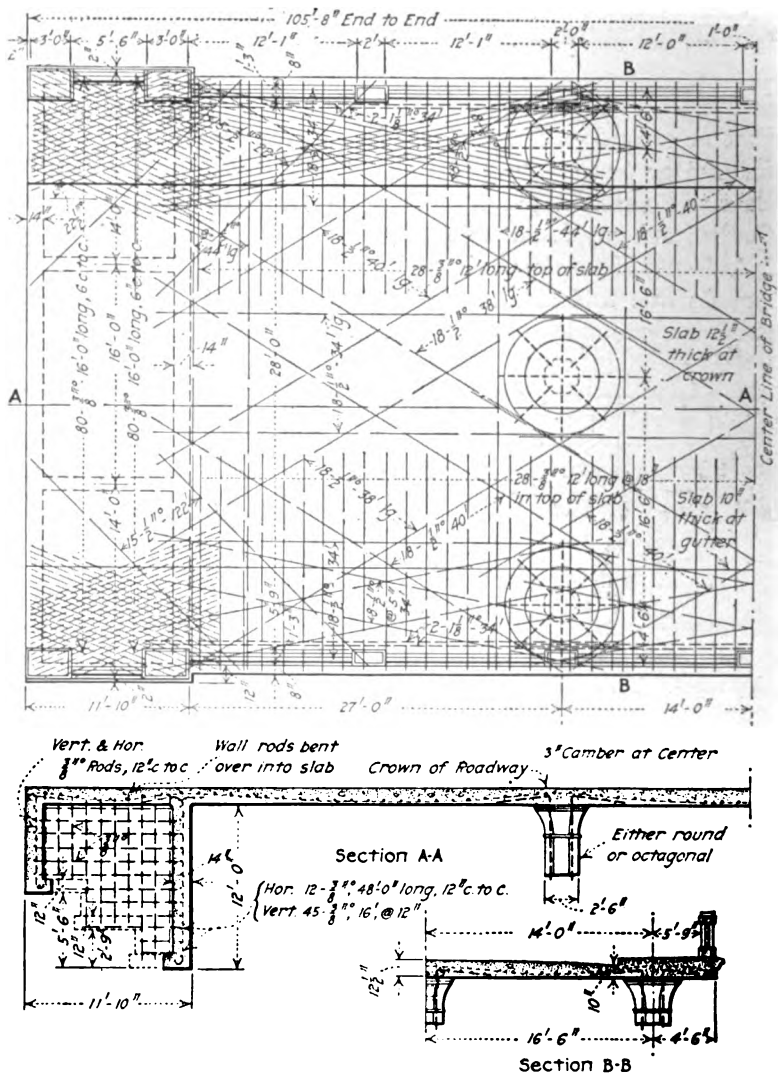

FIG. 266.—Cantilever flat-slab bridge on Mississippi River Boulevard, St. Paul, Minn.

be used in the design of the roadway slab are treated in Volume II. The hollow abutments should be noted.

A cantilever flat-slab bridge in which the abutments are of the ordinary reinforced-concrete type is shown in Fig. 267. The



Courtesy of Mr. A. M. Wolf, Prin. Asst. Eng'r., Condon Co., Chicago.

FIG. 267.—Lafayette St. bridge, St. Paul, Minn.

abutment walls are considered as held at the top by the superstructure to which they are anchored by bending the vertical rods into the slab.

CHAPTER XV

SIMPLE GIRDER BRIDGES

68. Deck Girders.—The deck-girder type of construction usually proves more economical than the through-girder type where-

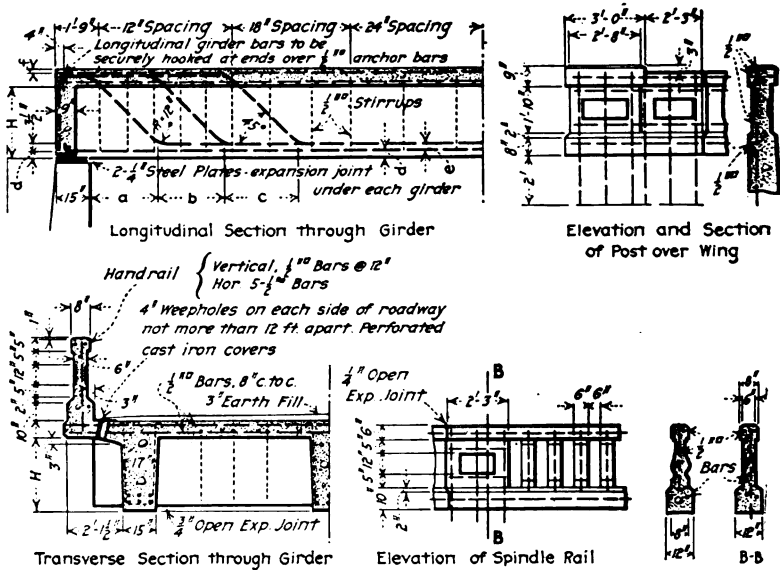

Table of Dimensions and Girder Reinforcement

Span	H	d	e	f	Stirrup Spaces			a	b	c	Girder Bars	
					12"	18"	24"				Top Row	Bottom Row
24'	2'-2"	2 $\frac{1}{2}$ "	3"	2 $\frac{3}{8}$ "	10	6	2	2'-3"	2'-3"	2'-0"	3 - 1 $\frac{1}{2}$ "	3' - 1 $\frac{1}{2}$ "
26'	2'-4"	2 $\frac{3}{8}$ "	3"	2 $\frac{3}{8}$ "	12	6	2	2'-6"	2'-1"	2'-5"	3 - 1 $\frac{1}{2}$ "	3' - 1 $\frac{1}{2}$ "
28'	2'-6"	2 $\frac{3}{8}$ "	3"	2 $\frac{3}{8}$ "	12	6	3	2'-5"	2'-2"	2'-11"	3 - 1 $\frac{1}{2}$ "	3' - 1 $\frac{1}{2}$ "
30'	2'-9"	3"	3 $\frac{1}{2}$ "	2 $\frac{3}{8}$ "	10	6	5	2'-8"	2'-6"	2'-10"	3 - 1 $\frac{1}{2}$ "	3' - 1 $\frac{1}{2}$ "
32'	2'-10"	3"	3 $\frac{1}{2}$ "	3"	10	6	6	2'-7 $\frac{1}{2}$ "	2'-6 $\frac{1}{2}$ "	3'-1"	3 - 1 $\frac{1}{2}$ "	3' - 1 $\frac{1}{2}$ "
34'	3'-1"	3"	4"	3"	10	10	4	2'-11"	2'-10"	3'-3"	3 - 1 $\frac{1}{2}$ "	3' - 1 $\frac{1}{2}$ "
36'	3'-3"	3"	4"	3"	10	10	5	3'-0"	2'-11"	3'-10"	3 - 1 $\frac{1}{2}$ "	3' - 1 $\frac{1}{2}$ "
38'	3'-5"	3"	4"	3"	10	10	6	3'-4"	2'-10"	3'-4"	3 - 1 $\frac{1}{2}$ "	3' - 1 $\frac{1}{2}$ "
40'	3'-8"	3 $\frac{1}{2}$ "	4"	3 $\frac{1}{2}$ "	12	6	9	3'-6"	3'-2"	3'-10"	3 - 1 $\frac{1}{2}$ "	3' - 1 $\frac{1}{2}$ "

FIG. 268.—Standard details of concrete deck girder bridges, Iowa Highway Commission.

ever sufficient head-room is available. The girders, of course, should be relatively thin and deep for the greatest economy, and

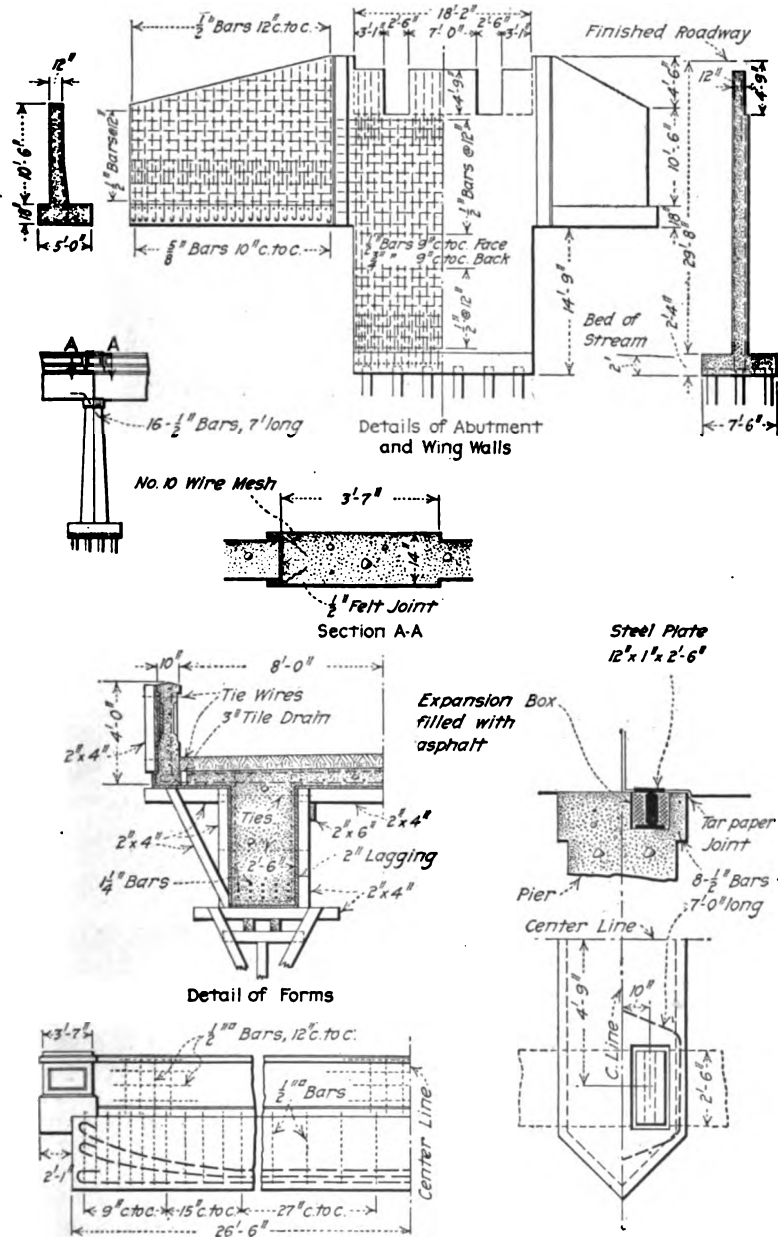

FIG. 269.—Details of Embarrass River bridge, Cumberland Co., Ill.

a curtain wall should be provided between the girders at each end of span to retain the earth fill, thereby avoiding complicated parapet walls on the abutments.

Standard details of deck-girder bridges designed by the engineers of the Iowa Highway Commission are shown in Fig.



Courtesy of Engineering and Contracting.

FIG. 270.—Embarrass River bridge, Cumberland Co., Ill.

268. The floor slab was analyzed both as fixed and as continuous, and was designed to resist maximum stresses caused by either method of analysis. The method of fastening the girder steel to anchor rods should be noted. Expansion joints are provided



Courtesy of Engineering and Contracting.

FIG. 271.—Rear view of abutment and wing walls, Embarrass River bridge, Cumberland Co., Ill.

under the girder stems by means of sliding steel plates anchored into the body of both superstructure and substructure.

Figs. 269, 270, and 271 illustrate the type of deck-girder bridge adopted as standard by the Illinois Highway Commission. The

following description of the methods employed in providing for expansion in girder bridges is given in the fourth report of the Commission:

“Two methods of providing for expansion in girder bridges have been used and both have proved satisfactory. In one method, the wing walls of one abutment are entirely separated from the abutment wall proper, the latter being free to move at the top with the expansion or contraction of the superstructure. The wing walls are designed to be self-supporting. As girder spans designed by the commission have so far been limited to 60 ft., the amount of movement either way from the normal is

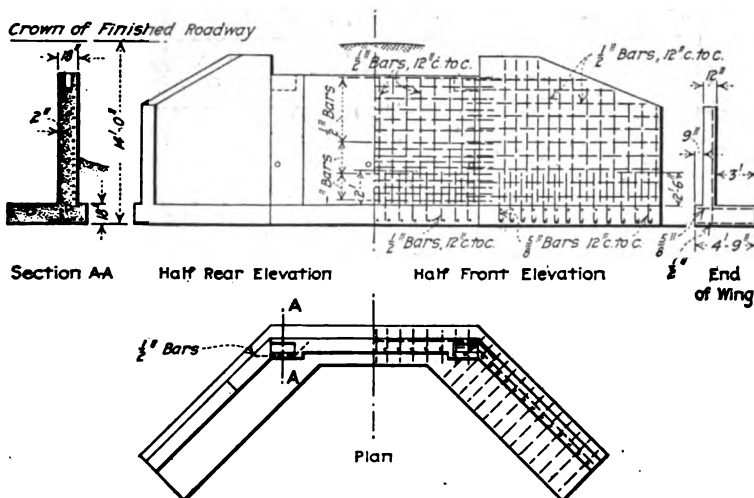

FIG. 272.—Type of abutment used for girder bridges by the Illinois Highway Commission. Wings of cantilever type. Main wall supported by wings as counterforts.

small and is taken up by deflection of the main wall or a slight rocking of the wall on the footing. Earth pressure against the wall is of little importance in this connection as it but tends to reduce the tension in the girder steel during expansion and to cause the abutment wall to follow the superstructure during contraction. It does not increase the stress in the compression area of the girder as the load is applied at the bottom of the girder, tending by this eccentricity of application to reverse the dead- and live-load stresses in the girder.

“This method has been found to be entirely successful, but is somewhat objectionable as a slight movement of the wings due to earth pressure and unequal settlement sometimes causes the wing walls to move forward slightly at the top, making a somewhat unsightly offset between the wing and abutment walls. This has never been more than

2 or 3 in. for the highest walls, but as it is not understood by the ordinary observer, an impression of weakness is sometimes caused.

"The present method of providing for expansion is to design the abutments and wings in the ordinary way, separating the superstructure completely from one of the abutments by a thick paper joint and supporting each girder at the free end on a single cast-iron rocker of large diameter. The reaction is transmitted to the girder and abutment from the rocker through planed structural-steel plates stiffened with I-beams when necessary. The rocker surfaces in contact with the bearing plates are turned to insure perfect bearing on the plates. The diameter of the rocker is made proportional to the load imposed per linear inch, in the same manner as is commonly used in proportioning roller nests for



Courtesy of Brenneke & Fay, Consulting Engineers, St. Louis, Mo.

FIG. 274.—North Samuels Avenue viaduct, Fort Worth, Texas.

steel bridges. The upper and lower plates are bedded in the concrete of the superstructure and abutment. The rocker is located in a pocket built in the abutment. This pocket is filled with a soft asphalt to prevent the entrance of water or dirt and to protect the metal from corrosion.

"The rocker method of providing for expansion has proved very satisfactory and is but little more expensive than the other method, especially when it is considered that the wings may be tied to the main wall when rockers are used and advantage taken of the mutual support thus obtained."

Fig. 272 shows a type of abutment adopted by the Illinois Highway Commission in cases where the girders are supported on cast-iron rockers and the wings are nearly parallel to the roadway or make an angle of more than 45° with the face of the abutment. The wing walls are considered to act as counter-

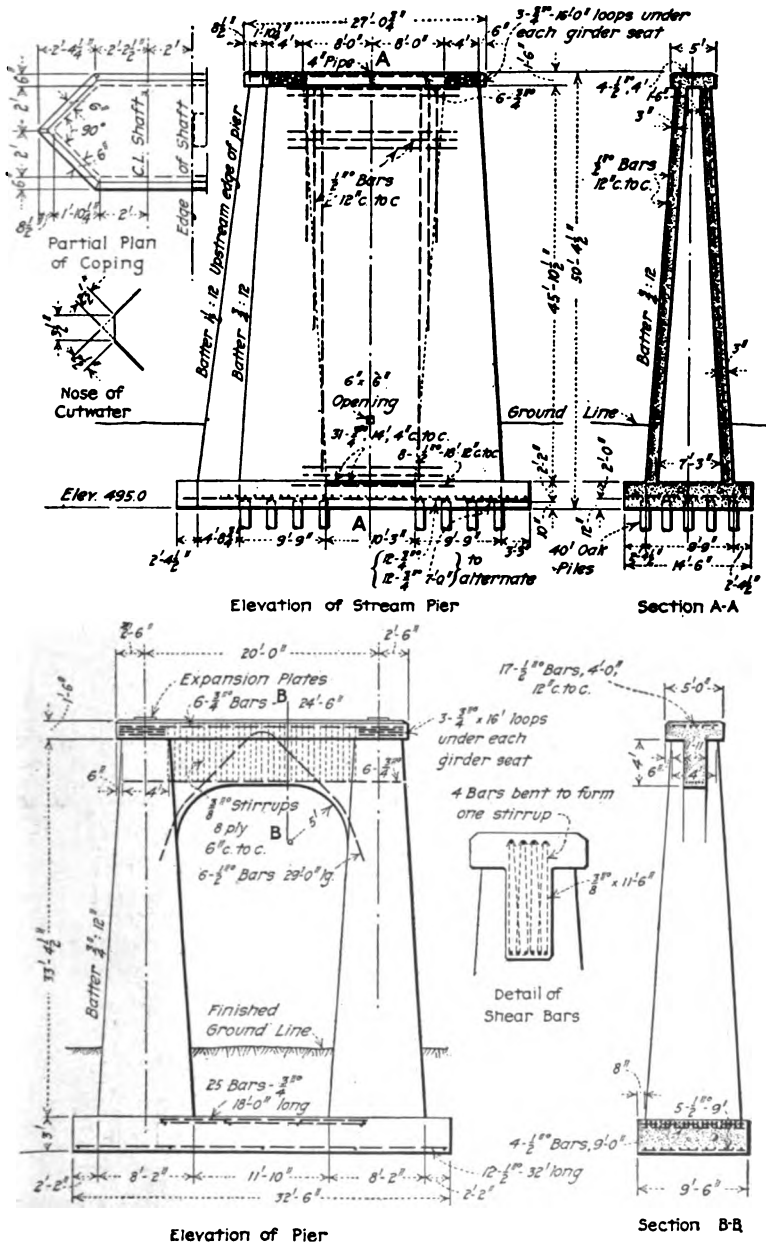
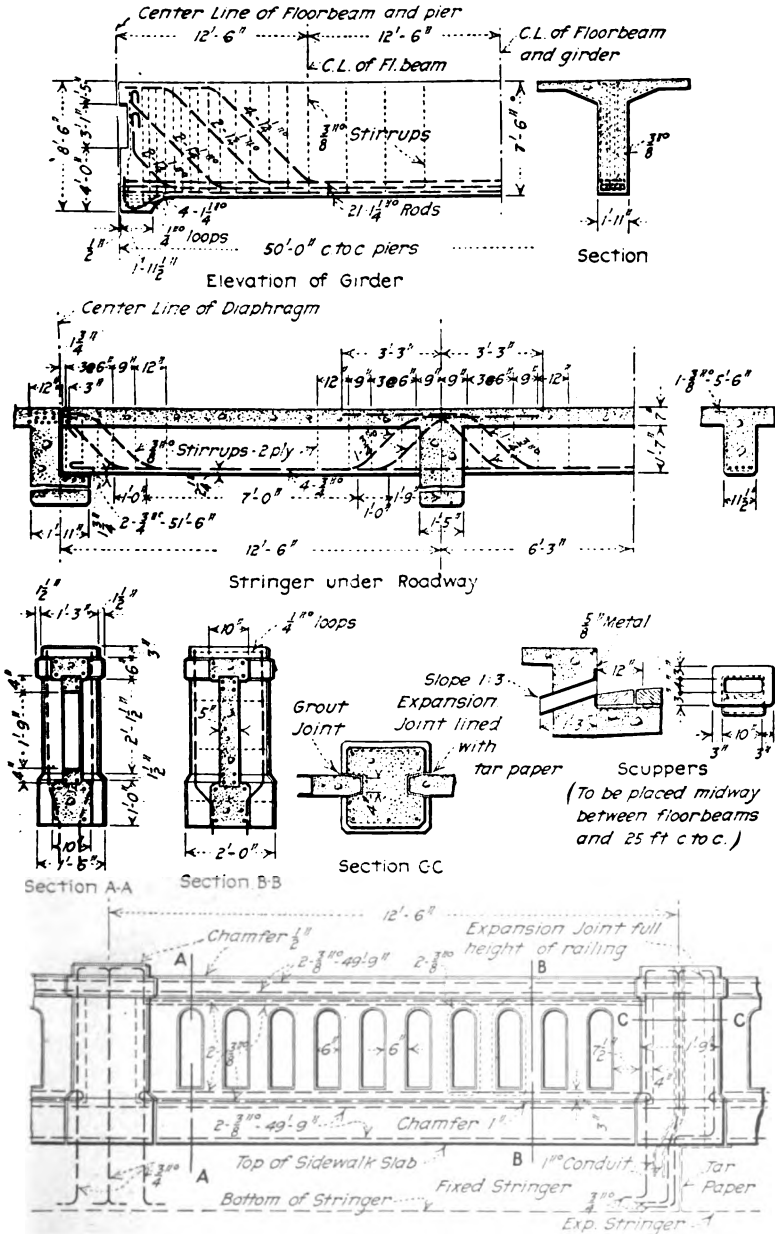

FIG. 276.—Details of typical piers, North Samuels Avenue viaduct, Fort Worth, Texas.



Typical Post Typical Panel of Hand Railing Post carrying Lamp
 Fig. 278.—Details of floor system and railing, North Samuels Avenue viaduct, Fort Worth, Texas.

girders, this type of floor system being found to be economical for wide bridges of long span. One end of each span is anchored to the pier and the other end is allowed to expand and contract in a joint packed all around with $\frac{1}{2}$ -in. of tar paper and bearing on a pair of milled steel plates. Expansion joints were also made in the roadway slab and railing. Cast-iron scuppers were placed in each curb on 25-ft. centers. For maximum stresses in the cross girders, the sidewalks were assumed to be unloaded.

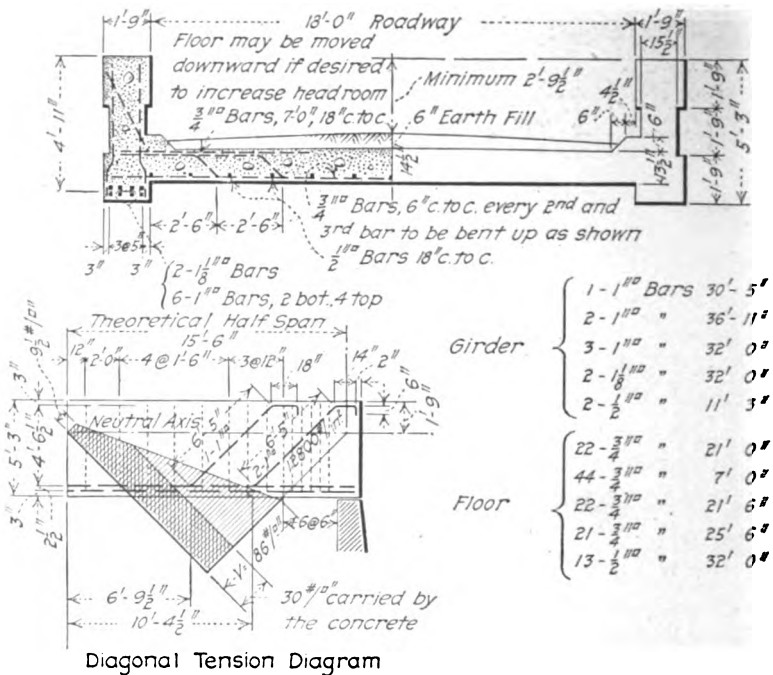

FIG. 279.—Standard sections for through girder bridges of 30-ft. span, Iowa Highway Commission.

Reinforced-concrete deck-girder bridges for railroad traffic are rather unusual, but a few such structures have been built. The superstructure in such bridges is usually supported by plain-concrete piers and abutments.

69. Through Girders.—From the standpoint of economy, the through-girder bridge should not be built except where insufficient head-room or other local conditions prevent the use of the deck girder.

The standard type of through-girder bridge, adopted by the

Iowa Highway Commission for locations where the deck type is impracticable, is shown in Fig. 279. The girders themselves were designed as simple beams and the floor as a slab partially fixed, the point of contraflexure being arbitrarily assumed at about



Courtesy of Mr. M. W. Torkelson, Bridge Engineer, Wisconsin Highway Commission.

FIG. 280.—Funklien bridge, Town of Christiana, Dane Co., Wis.

1 ft. from the edge of the girder. This is approximately in accordance with tests made by the Illinois Highway Commission in 1907.

In the tests referred to, stress measurements were made on a through-girder span with an 18-ft. roadway loaded with crushed

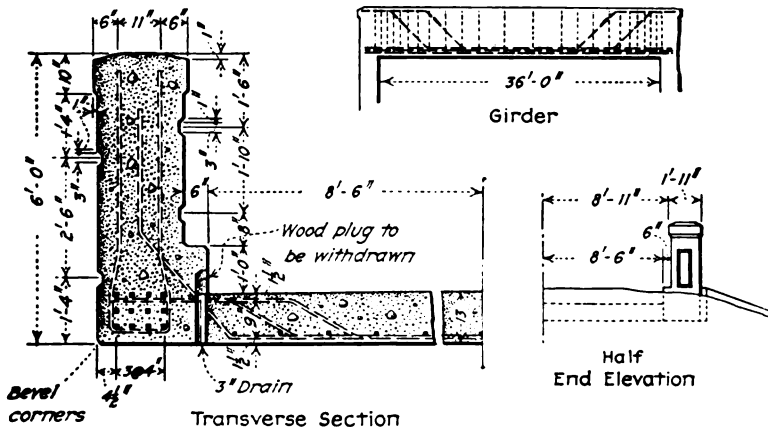

FIG. 281.—Details of superstructure of Funklien bridge, Town of Christiana, Dane Co., Wis.

stone and pig iron. The full applied load was 418 tons, which gave a distributed load per square foot of floor of 1450 lb. Deformation measurements were made in the reinforcing steel of the sus-

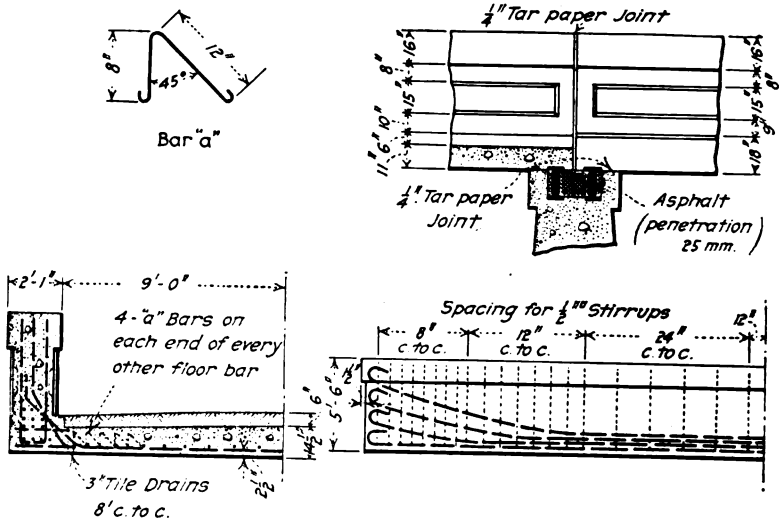

FIG. 282.—Details of through girder bridge of 45 ft. span, Illinois Highway Commission.

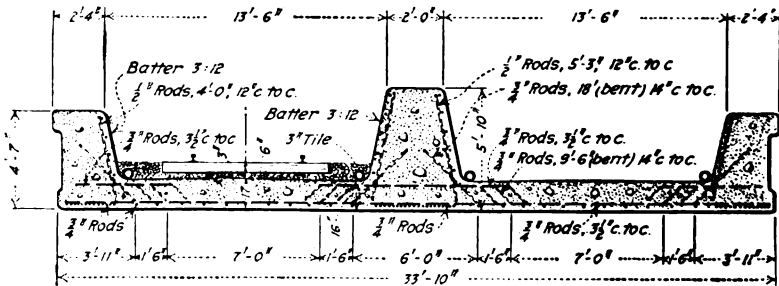

FIG. 283.—Cross-section of through girder bridge, C. B. & Q. R. R.



Courtesy of Mr. E. A. Gast, Deputy County Surveyor, Hamilton County, Ohio.

FIG. 284.—Construction view of bridge over Muddy Creek, Hamilton County, Ohio.

pended floor which indicated stress equivalent to that theoretically resulting from a simple span of 15.5 ft. In other words, since the roadway was 18 ft. between girders, the point of contraflexure was apparently about 15 in. from each girder face.

Figs. 280, 281, 282, and 283 illustrate other designs of through-girder superstructures.

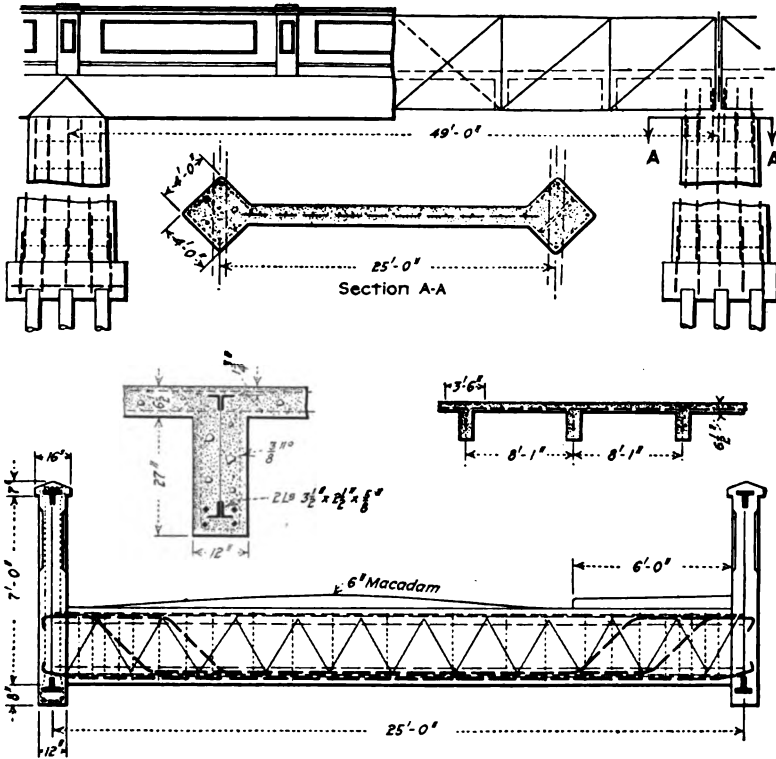

FIG. 285.—Details of bridge over Muddy Creek, Hamilton County, Ohio.

Figs. 284 and 285 show a rather unusual type of through bridge on account of the fact that the girder reinforcement is in the form of a truss of sufficient strength to carry the dead and construction loads. The piers are simply columns braced between by either a vertical slab or by struts. As no falsework is necessary, this type of construction is especially adapted for highway bridges over railroads and electric lines, or at locations where the soil is very soft.

CHAPTER XVI

CONTINUOUS GIRDER BRIDGES

70. Durability of Monolithic Construction.—The designs of most of the continuous girder bridges built monolithic with supports are conservative and safe, but still there are some bridges of this type, especially those with exceedingly high piers or bents, which are classed by many engineers as dangerously extreme considering our present knowledge of reinforced concrete. The fact that light sections in concrete construction have quite often developed cracks to a more or less extent has made these engineers hold to the conservative idea that the difficulty in providing intelligently for movement due to temperature, change in the moisture content of the concrete, etc., is so great as to make light construction something to be avoided wherever possible. It will suffice to say here that bridges of the monolithic type when carefully designed and constructed are giving entire satisfaction, and only time will prove whether or not such light structures are durable.

71. Details of Design.—Since the superstructure and the piers are usually made monolithic, the latter may be made of comparatively small cross-section if properly reinforced for bending. The piers may become in reality nothing more than two or more columns connected by a suitable portal, and the stress due to bending in the columns, caused by unintentional eccentricity of the floor loading, may be computed in the same manner as for columns in buildings. (See Chapter XIV of Volume II.) In order to prevent an accumulation of movement due to contraction and expansion, expansion joints should be provided at least every 100 ft. in length of the structure. If this is not done, severe stresses are likely to occur in the end columns. For high trestles, the columns should be braced longitudinally as well as laterally in the same manner as for high trestles of structural steel.

In most railroad trestles or viaducts, the steel in the bottom of the longitudinal girder at the center of span is proportioned for the maximum bending moment produced by the given loading

for a simply-supported beam, and six-tenths of the reinforcement thus found necessary is placed in the top of the girders over supports to provide for the continuous action developed. In view of what has been said in Art. 69 of Volume II this method requires 25 per cent. more steel than if the girders were designed throughout for $\frac{1}{2}wl^2$. The above practice, however, is quite prevalent among designers of railroad structures in cases where safety is paramount, since if the piers should settle, or cracks should develop over the piers for other reasons, there would be enough reinforcement at the center of span so that the girders would carry the load as simply-supported beams.

In long bridges an expansion joint is usually provided between the superstructure and the abutments for the reason that, if an abutment with a heavy pressure of earth against it is rigidly connected with a number of continuous spans, the expansion and contraction tend to act in one direction only—that is, away from the abutment—the earth pressure back of the abutment not allowing movement in the opposite direction. Such a condition would lead to difficulties at the center of the bridge, or over the expansion piers next to the abutments, and the abutments and piers would also be severely over-stressed due to the continuous movement in one direction. Each time an abutment would move slightly due to contraction, the earth against it by reason of the heavy moving loads would fill in the small space left by the contractive movement, and when expansion again took place, the abutment would be restrained by the earth so that enormous stresses might be developed.

72. Examples of Typical Bridges of the Continuous Girder Type.—A rather simple highway trestle, applicable to comparatively low crossings, is shown in Fig. 286. The longitudinal beams are continuous over three spans, an expansion joint occurring over every third pier. Intermediate piers are made monolithic with the floor by means of rods from the columns and stirrups from the cross beams. Because of the indeterminate degree of fixity, the lightness of the structure, and unknown construction factors, all members affected were designed both as fixed beams and as beams freely supported. The slabs were designed as continuous, with equal positive and negative steel throughout. The center longitudinal beam was designed as a T-beam with a 36-in. flange. The pier web, or wall between supporting columns of bents, is carried 2 ft. above high water.

A low trestle or viaduct type of construction is shown in Figs. 287 and 288. The slab-beam-and-girder spans were selected since arches, it was thought, would not appear to advantage

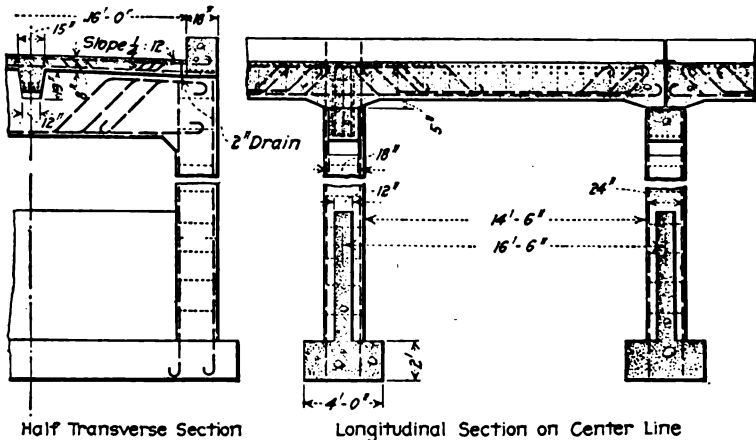

Half Transverse Section Longitudinal Section on Center Line
 FIG. 286.—Details of standard trestle spans, Engineering Department, State of Arizona.



Courtesy of Mr. Frank L. Raschig, Division Engineer, Division of Structures, Cincinnati, O.
 FIG. 287.—Gilbert Avenue viaduct, Cincinnati, Ohio. Note expansion joint near center of illustration.

for such low construction. The cost of the girder type was also found to be much less than for a series of arches, due principally to decrease in the dead weight of the structure and

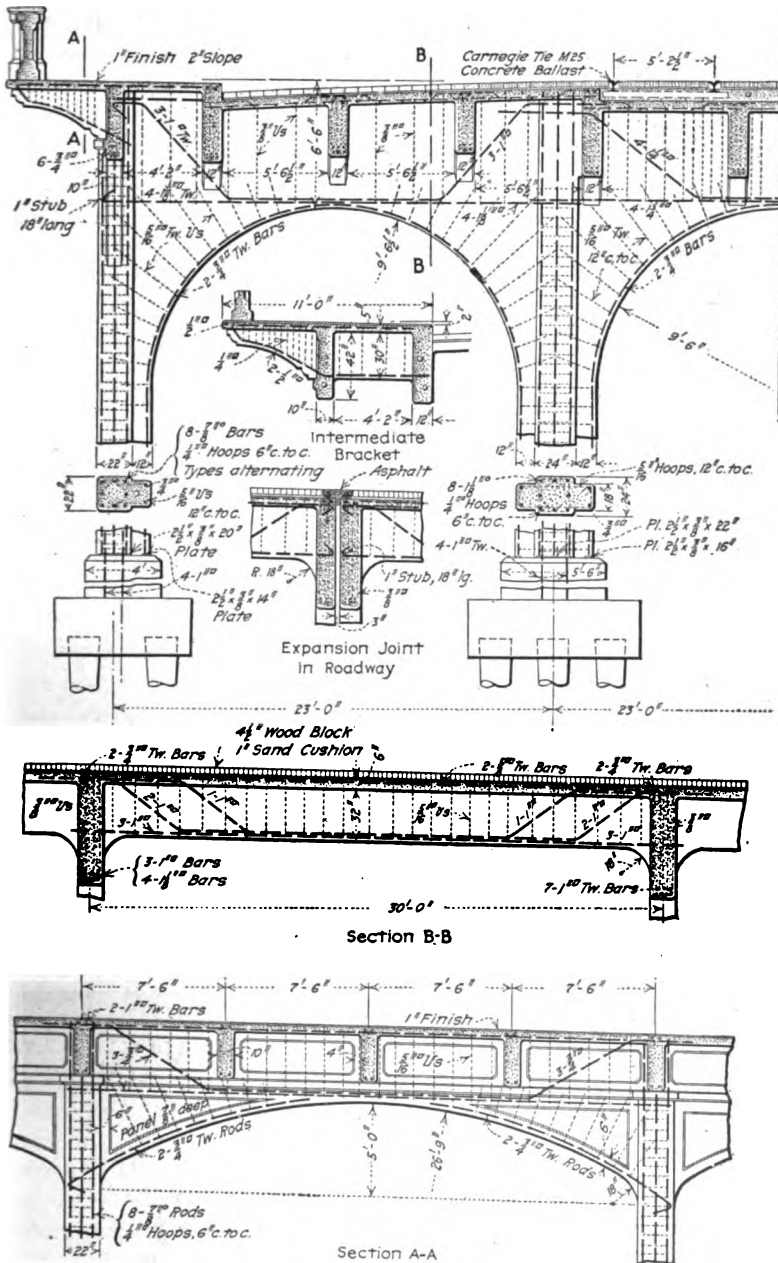

FIG. 288.—Details of Gilbert Avenue viaduct, Cincinnati, Ohio.

to simplicity in form work. Expansion joints occur about every 200 ft. and make the viaduct virtually a number of independent structures, a double row of columns being provided at each joint. The arched girders capping the column bents were designed as straight rectangular beams and no account was taken of the possible arch action. The entire top surface of the road-

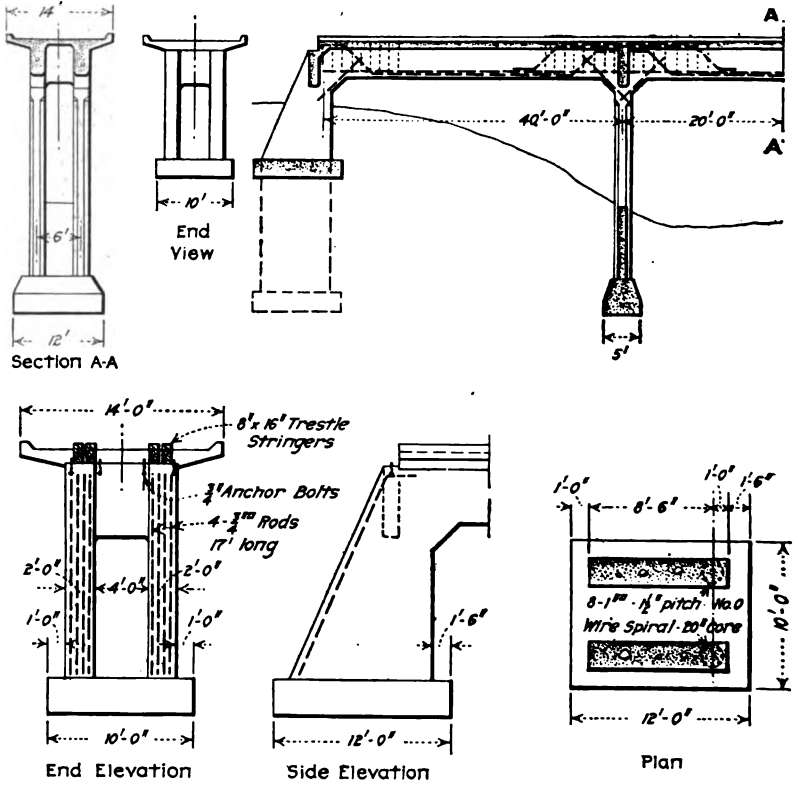

FIG. 289.—Details of railway bridge over White Rock Creek near Dallas, Texas.

way slab was waterproofed with a layer of burlap and two layers of felt laid in hot asphalt.

Fig. 289 gives the details of a continuous girder bridge to span a stream which is generally dry, but which at flood times reaches over a wide area of bottom lands. This railway bridge is also within the backwater area of the White Rock reservoir of the Dallas water supply so that ample provision had to be made for

high-water conditions. The floor consists of a double T-beam which is monolithic with the bents and the abutments. There is no expansion joint in the structure since it was considered of sufficient strength to take all movement from end to end. Both ends of the structure are open between girder supports (Fig. 290), with short trestles connecting with the bridge which at



Courtesy of Mr. Wm. E. Beilharz, Architect and Engineer, Dallas, Texas.

FIG. 290.—Railway bridge over White Rock Creek near Dallas, Texas.

some future time may be filled in if high water gives no trouble at this point. The girders were designed for Cooper's E-30 loading with an impact allowance of 100 per cent of the live load. The ribbed abutments should be noted.

A continuous girder bridge or trestle with no expansion joints and with abutments of the ordinary type is shown in Figs. 291



Courtesy of Mr. M. W. Torkelson, Bridge Engineer, Wisconsin Highway Commission.

FIG. 291.—Mill Creek bridge, Village of Cazenovia, Richland Co., Wis.

and 292. The structural steel core in the column bents is unusual but undoubtedly adds greatly to the rigidity.

Fig. 293 is an example of high trestle construction with the long columns braced both laterally and longitudinally.

Fig. 294 gives the details of one of the typical bridges in

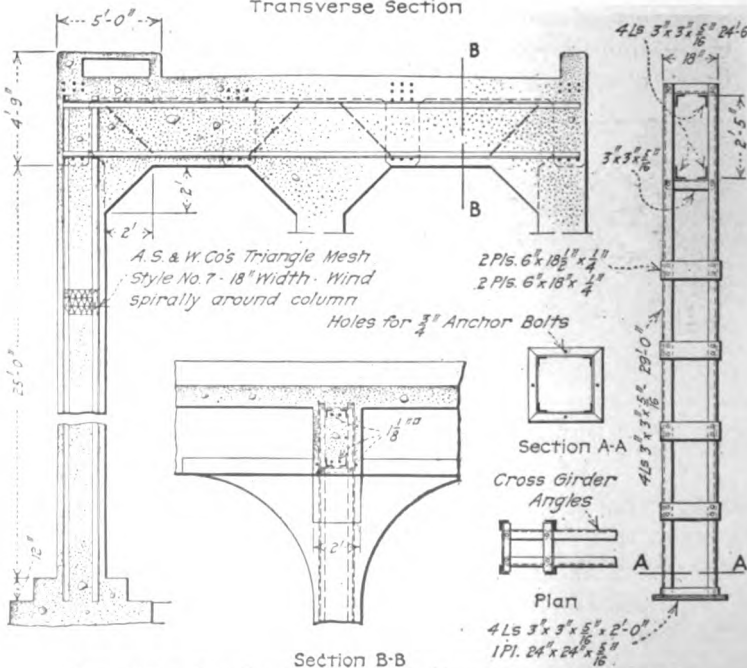
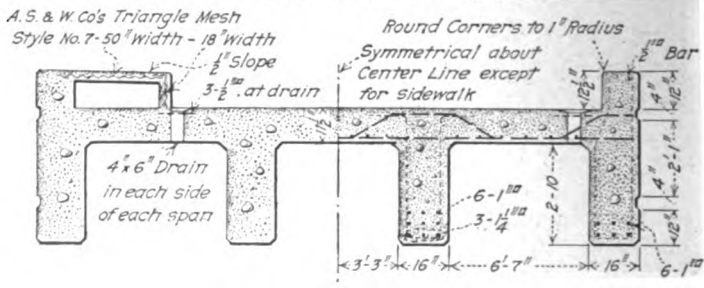
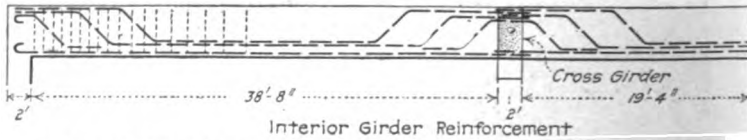
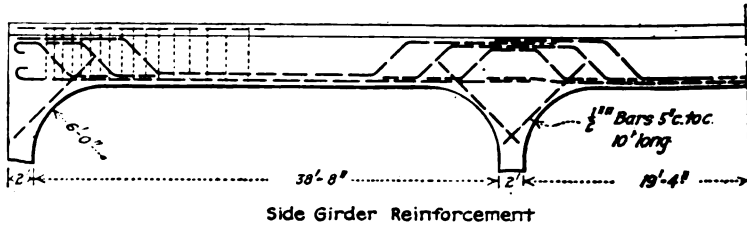

Section B-B
 FIG. 292.—Details of Mill Creek bridge, Village of Cazenovia, Richland Co., Wis.

the Chicago, Milwaukee & St. Paul track depression work at Minneapolis. The girders are continuous from end to end with expansion joints at the abutments—that is, the girders were considered continuous over the two interior supports and simply supported at the ends. The moments and shears were calculated by influence lines in accordance with the theory of con-

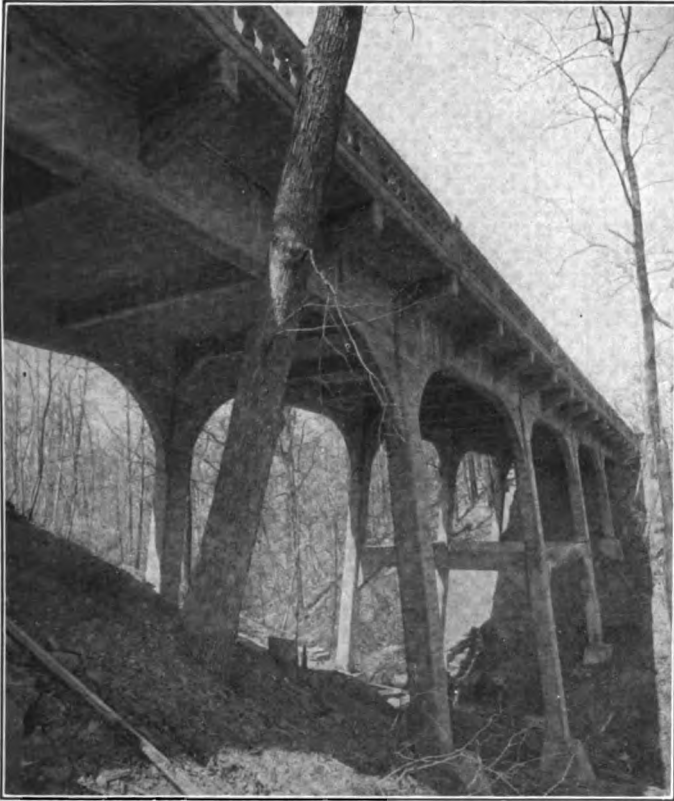

Courtesy of Universal Portland Cement Co.

FIG. 293.—Forest Park bridge, Highland Park, Ill.

tinuous structures (see Chapter XIII, Volume II) assuming constant I and unyielding supports. Corrections were made for $\frac{1}{8}$ -in. settlement of supports for variable I . An unusual feature of the bridges is a curved shelf on the outer face of the outside girder which is intended to act as a smoke shield by diverting the smoke from the parapet as engines pass under the bridge.

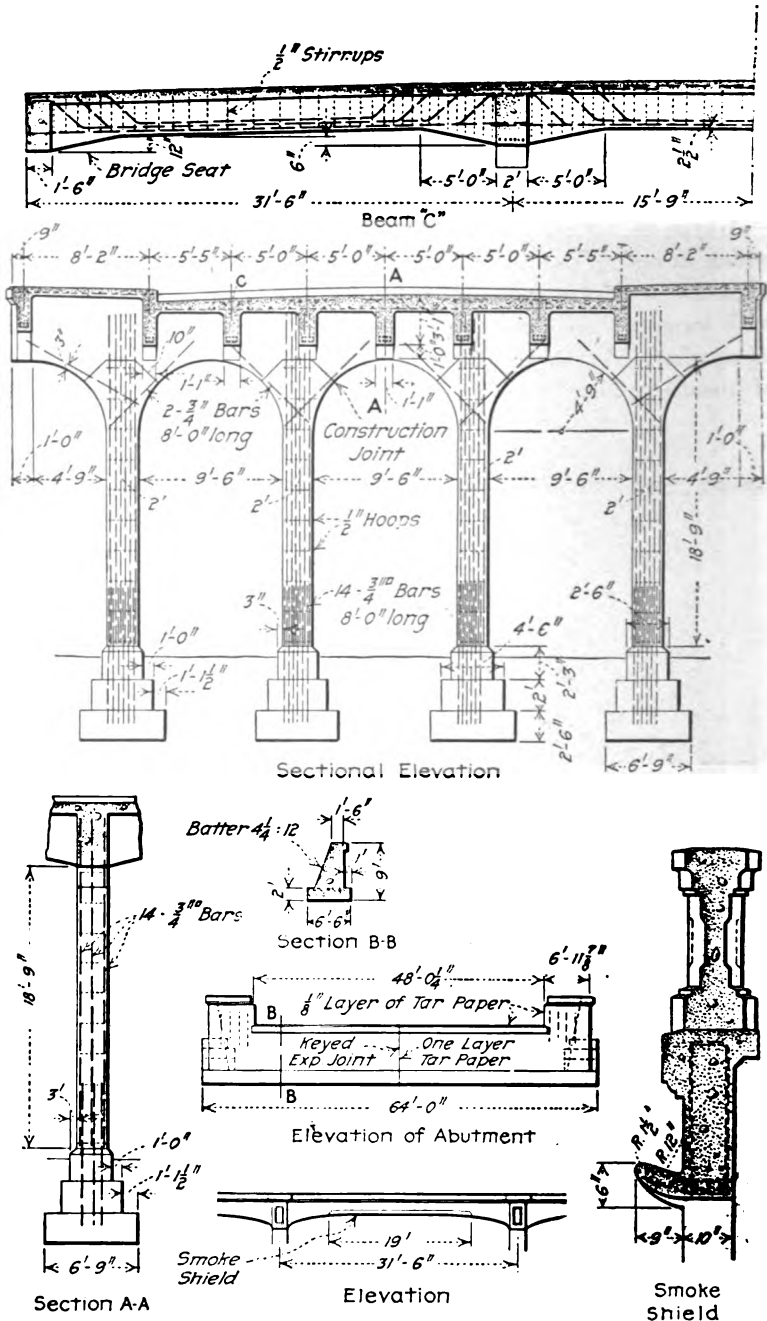

FIG. 294.—Details of Bryant Avenue bridge over tracks of the C. M. & St. P. Ry., Minneapolis, Minn.

CHAPTER XVII

CANTILEVER BRIDGES

A type of bridge which in appearance is a concrete arch, but which in reality is composed of balanced cantilevers, is shown in Figs. 295 to 301 inclusive. A structure of this type can be made with longer spans than the ordinary girder and is suited to locations where the real arch would be exceedingly costly on account of unsatisfactory foundation conditions.

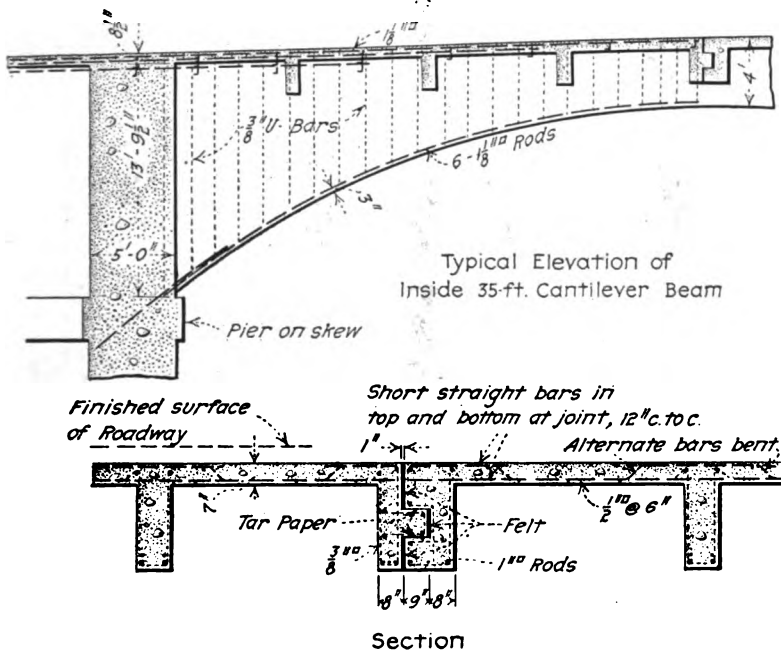

FIG. 295.—Details of Hopple Street viaduct, Cincinnati, Ohio.

73. Theory of Design.—A pier and the cantilever arms on each side compose a unit, the arms being balanced for dead load and for full live load. The piers are designed for bending due to the maximum eccentric load that can be applied, and considering the load on only one of the cantilever arms at a

time. The pier footings are designed so that the pressure on the base of a pier due to this same eccentric loading will not cause an intensity greater than the unit bearing value of the soil.

74. Examples of Cantilever Bridges.—The viaduct shown in Fig. 295 consists of twenty-five skewed spans, each span compris-



Courtesy of Universal Portland Cement Co.

FIG. 296.—Cantilever bridge over Rouge River, Wayne County, Mich.



Courtesy of Universal Portland Cement Co.

FIG. 297.—Close view of cantilever bridge, Wayne County, Mich.

ing two curved cantilever arms supported on reinforced-concrete piers. A single cantilever arm occurs at each end of the viaduct. Each cantilever arm comprises four curved ribs which were designed as cantilevers from the skewed piers. The joint at the center of each span is shown in detail. In designing, this joint was con-

sidered as transmitting only shear from one cantilever arm to another and not any bending or arch action. Since each pier and its cantilever arms are symmetrical about the center line of the pier, no bending exists in the pier due to dead load or to full live load on both cantilevers. Piers, footings, and piling were designed to withstand the overturning effect produced by the loading of a single cantilever with the full live load.

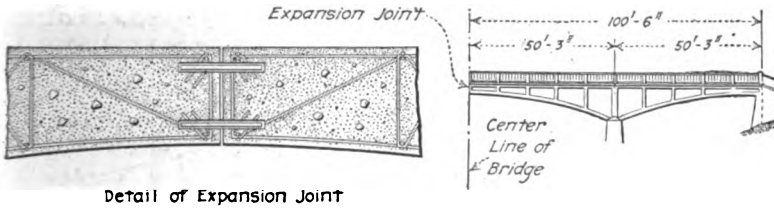

Detail of Expansion Joint

FIG. 298.—Half-elevation and detail of expansion joint of arch-shaped cantilever bridge over Rouge River, Wayne County, Mich.

The expansion joint at the center of the structure, shown in Figs. 296 to 298 inclusive, is entirely different from that employed in the bridge just described. It should be noted, however, that the same result is accomplished—that is, that the two abutting arms are permitted to move longitudinally, but not laterally or vertically. The joint consists of two 3-ft. piers of 2½-in. steel shafting each inserted in two 1½-ft. pieces of 3-in. gas pipe em-



Courtesy of Mr. Frank L. Raschig, Division Engineer, Division of Structures, Cincinnati, O.
FIG. 299.—Cantilever bridge on Runnymede Avenue, Cincinnati, Ohio.

bedded in the concrete. End joints were made by placing sheets of three-ply tar paper on top of the abutments before the end cantilevers were poured, thus permitting a slight movement of the ends of the structure under changes of load and temperature. There was no apparent deflection at any of the expansion joints due to live load.

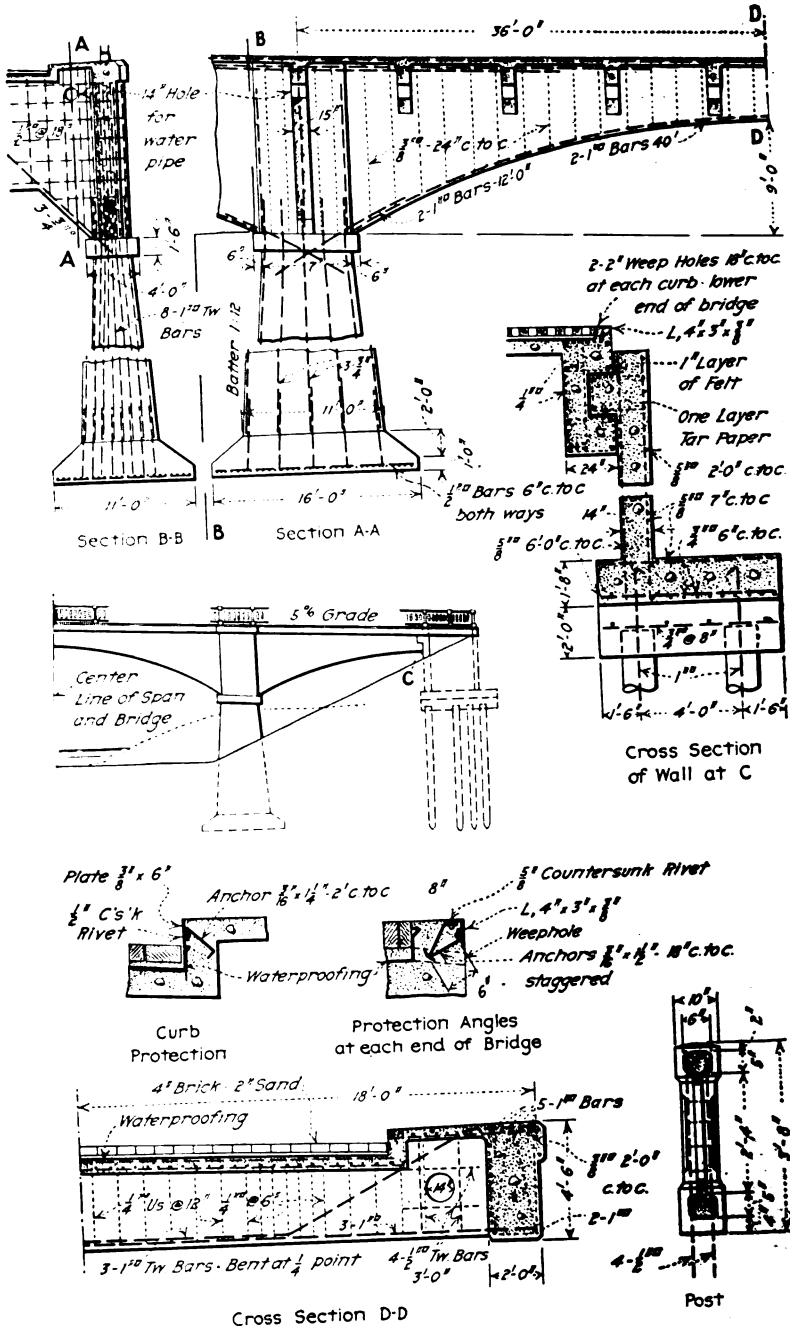

FIG. 300.—Details of Runnymede Avenue bridge over West Fork Creek, Cincinnati, Ohio.

The joints at the ends of the bridge shown in Figs. 299 and 300 are of the same type as employed in the viaduct spans of Fig. 295. The absence of such a joint at the center of the middle span is, however, the principal feature. In spite of this continuity between piers, no account was taken of continuous action upon supports and the bridge was designed in the same manner as the cantilever viaduct previously referred to. In fact, it has been

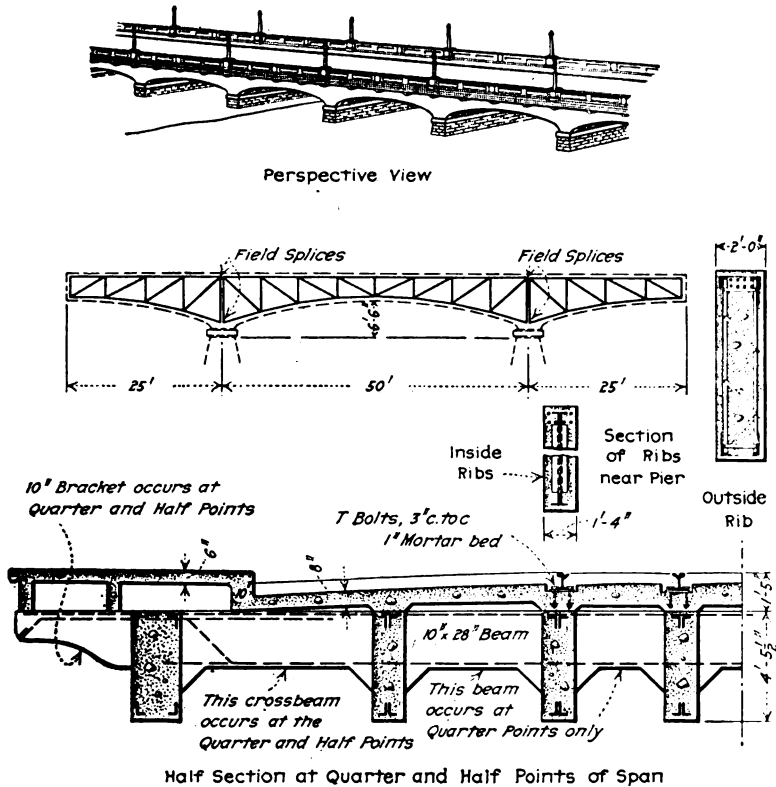

FIG. 301.—Details of Washington Street bridge, Norwalk, Conn.

found that a joint at the center of span is an unnecessary refinement in cantilever bridge design, and might be omitted. The bridge was designed and constructed so as not to rest on the abutments at all, the abutments being used merely to hold back the earthfill at each end and to serve as anchorage for the end cantilevers. A structure of this type with end openings closed

by earthfill has all the appearances of a real arch. In such a case abutments are not needed.

If a number of bridges similar to the bridge of Figs. 299 and 300 were placed end to end, the result would be essentially a structure such as shown in Fig. 301. It should be noted that the Norwalk bridge is continuous in sections of maximum length of 100 ft. The structural steel work was designed to be self-supporting during erection and to carry the erection stresses of the forms and the fluid concrete in the ribs, cross-girders, and sidewalk brackets. Although a deflection of $\frac{1}{2}$ in. at the free ends of the cantilevers was anticipated, a deflection of only $\frac{1}{8}$ in. to $\frac{1}{4}$ in. actually resulted due principally to the rigidity of the forms and to the fact that the concrete was continuously setting during the process of placing. The combined steel and concrete in the ribs was proportioned to carry the roadway slab, paving, and all live loads. The trusses were proportioned to carry all shear not safely taken by the concrete but were not proportioned to carry all the tension developed by the bending moment since extra horizontal rods were embedded in the concrete adjacent to the top chords of the trusses. The following information is given in a letter to the writer from Mr. W. Walters Pagon, Resident Engineer on the South Norwalk bridge:

“No plans were made by the contractors for the forms around the ribs, but they were of standard construction made of $\frac{3}{4}$ -in. dressed lumber secured to 4 × 4-in. studs, spaced about 2 ft. centers, and braced through the ribs by means of heavy twisted wire which passed around the waling pieces. These waling pieces were laid longitudinally and at vertical distances apart of approximately 5 ft. and consisted of 4 × 4-in. and 4 × 6-in. timbers. The bottom forms were secured to the structural-steel frames which comprise the reinforcing for the ribs, by means of pairs of $\frac{3}{4}$ -in. round bolts spaced every 12 $\frac{1}{2}$ ft. At these points 6 × 8-in. timbers were placed, supported by the bolts just mentioned, and running transversely from outside rib to outside rib, their purpose being not only to support the bottom forms but also to brace the steel ribs together until the concrete cross beams were cast. The shape of the intrados of the ribs was segmental, relieved by little three-centered fillets at the ends. The forms for these fillets were made up in advance and were supported by the bolts at the ends of the segmental curve.

“We employed two types of steel ribs both built up of structural angles, but those for the concrete ribs, 24 in. in width, were made of box section and those for the intermediate concrete ribs were of I-section. My experience was that it was possible to get much better results with

the wider beams because, owing to the fact that there was a 12-in. space between the angles of each flange, it was possible to pour the concrete into the middle of the rib; whereas in the narrow ribs the concrete while being poured was divided by the top chord into two parts which followed down the two sides of the rib, with the result that there was considerable difficulty encountered in preventing separation of the materials. I also found that it was inadvisable to use lattice bars on compression members, for in places where latticing was not used, but battens instead, the placing of the concrete was very much facilitated."

CHAPTER XVIII

REINFORCED CONCRETE IN STEEL BRIDGE CONSTRUCTION

It is not the intention to go into great detail in this chapter in treating of reinforced concrete as applied to the supports and floors of steel bridges. The idea in including any discussion on

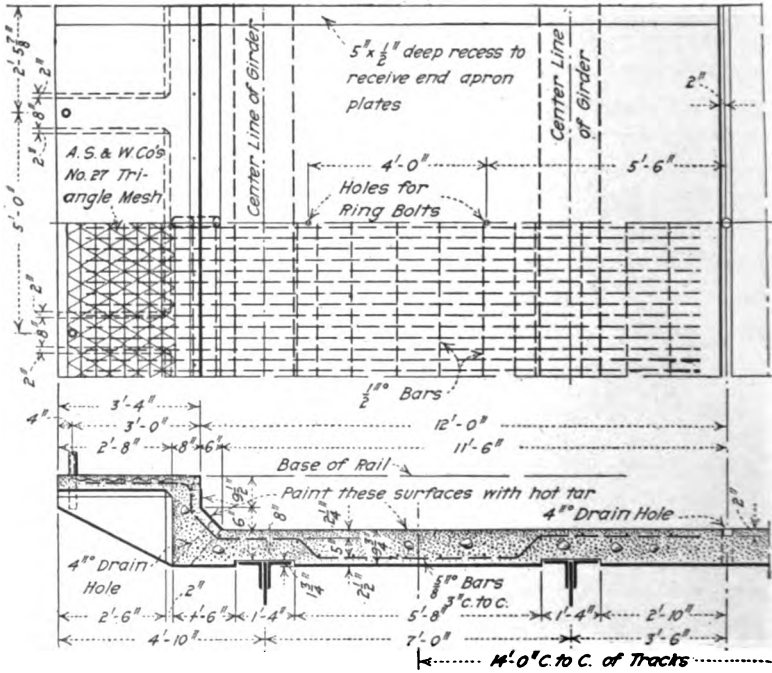

Fig. 302.—Reinforced-concrete deck for steel girder spans on
D. M. & N. Ry.

this subject is simply to call attention to the fact that reinforced concrete is not limited strictly to bridges built entirely of concrete.

75. Concrete Floors on Steel Bridges.—Within recent years it has become the general opinion among railroad engineers that a ballasted solid floor is the most satisfactory form of floor for steel bridges. Perhaps the best type of such a floor is the reinforced-concrete slab resting directly on the steel-floor members.

Figs. 302 and 303 show details of reinforced-concrete deck slabs for plate-girder spans. The slab floors are seen to rest directly

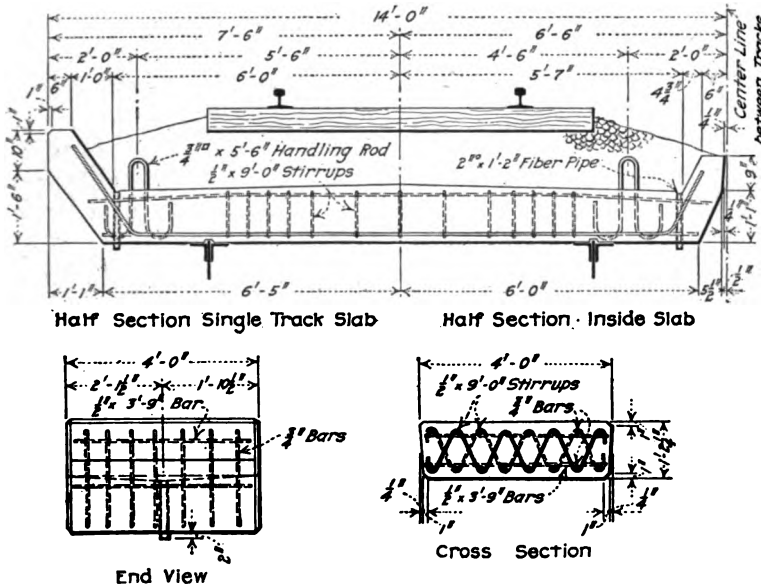

FIG. 303.—Standard reinforced-concrete slab for deck girders of C. M. & St. P. Ry.

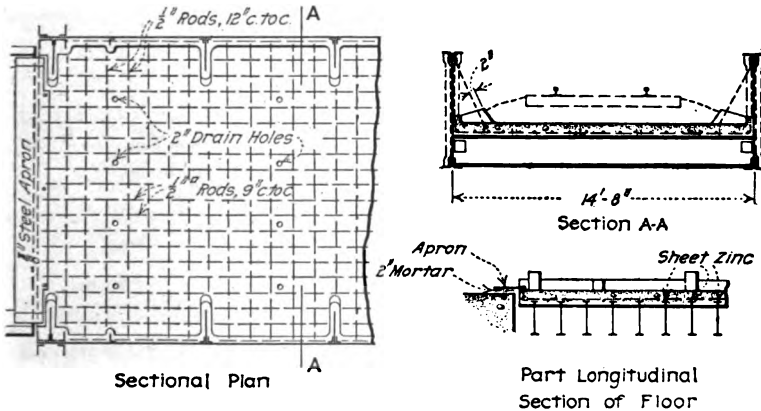

FIG. 304.—Reinforced-concrete floor for through plate girder bridge, C. B. & Q. R. R.

upon the top flange of the steel girders. Comparison of the two designs is of value since they show a wide difference in the

concrete details and in the arrangement of the reinforcement. The slabs are usually made at some convenient location and hoisted into place when sufficiently cured. Before adding the ballast, the upper surface of the slabs is thoroughly waterproofed

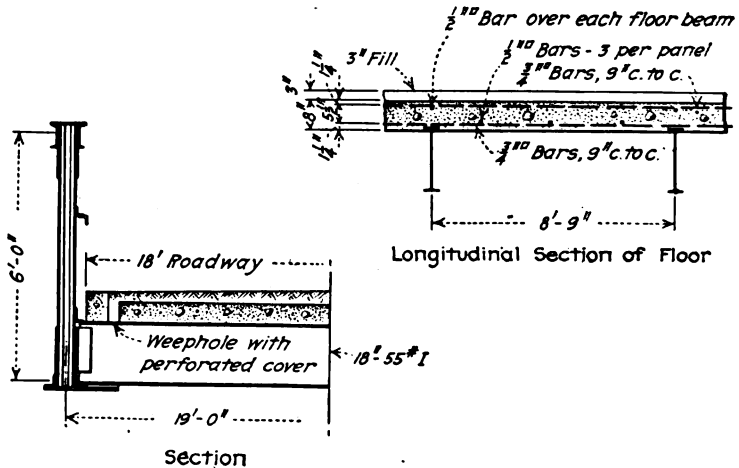

FIG. 305.—Concrete slab floor for highway steel truss span, Iowa Highway Commission.

by painting with tar paint. Drain holes are placed in such a position as to keep the drip clear of the steel members.

A reinforced-concrete floor for a through plate-girder bridge is shown in Fig. 304. The concrete of the floor slab is seen to

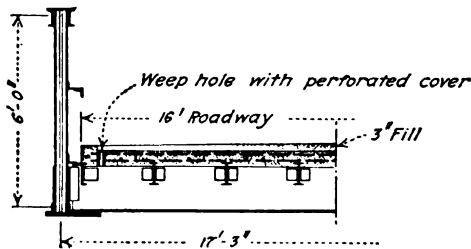

FIG. 306.—Concrete slab floor for highway steel truss span, Iowa Highway Commission.

extend up on the sides to form curbs, and these curbs extend entirely around the gusset plates.

Steel I-beams encased in concrete and supporting a reinforced-concrete floor slab is the most common type of highway

bridge with steel floor members. On account of the ease with which forms may be constructed to hold the concrete, this bridge for short spans is sometimes used in preference to slab bridges of all concrete. The only disadvantage of this bridge is in point of economy.

Timber floors for highway bridges are not in great favor at the present time. Since the expense of maintaining wood floors is considerable, the engineers of a number of highway com-

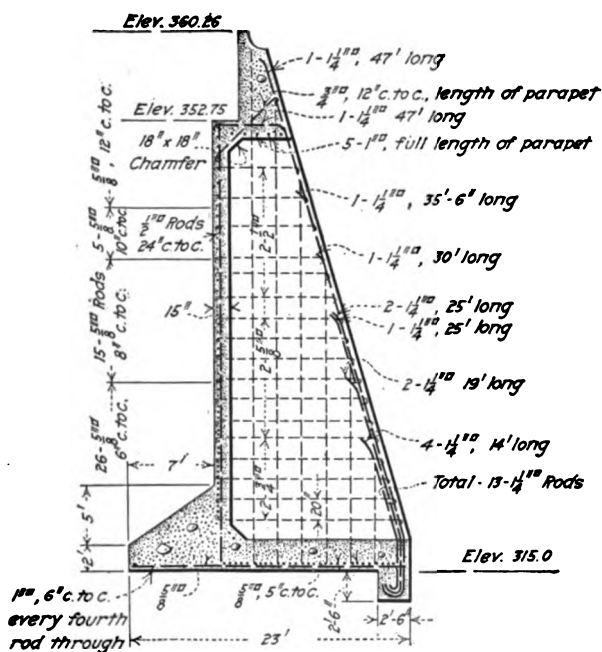

FIG. 307.—Section through bridge seat of typical reinforced-concrete abutment for steel bridges.

missions design practically all steel bridges with concrete floors covered by a wearing surface of gravel or macadam. For exceedingly light traffic on country bridges, driving is sometimes allowed directly on top of the floor slab, making an allowance of at least 1 in. in the thickness of the slab for wear and cutting transverse grooves to prevent slipping. Figs. 305 and 306 show typical designs of reinforced-concrete floors for steel-truss spans.

76. Reinforced-concrete Abutments for Steel Bridges.—For high abutments to steel bridges, the use of reinforced concrete leads to great economy. Abutments of this material for moderate heights are usually of the counterforted type (see Art. 12, Volume II) with the bridge seat formed by a heavy reinforced-concrete slab extending over the top of the supporting counter-



Courtesy of Mr. H. C. Lothholz, Engineer of Design, C. M. & St. P. Ry.

FIG. 308.—East abutment, Judith River viaduct, Chicago, Milwaukee & St. Paul Ry.

forts. A cross-section through a typical bridge seat is shown in Fig. 307.

A skeleton type of reinforced-concrete abutment has been adopted by the Chicago, Milwaukee & St. Paul Railway for steel viaducts of considerable height. Abutments of this type carry the track over the end slopes of high embankments in such a manner as to avoid the heavy horizontal earth pressures which would be developed if ordinary abutments were constructed

CONCRETE IN STEEL BRIDGE CONSTRUCTION 415

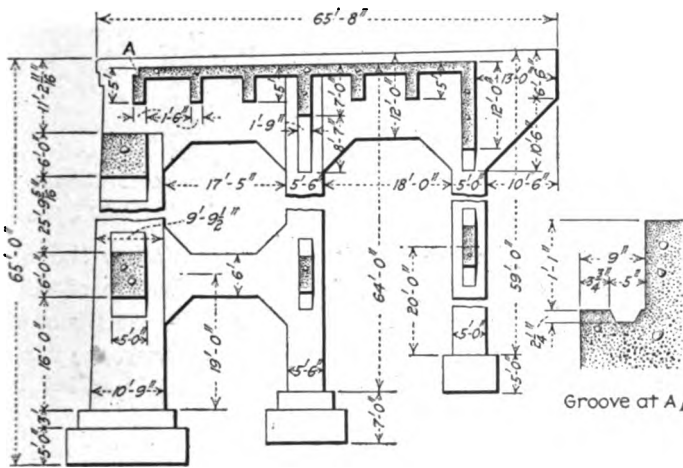
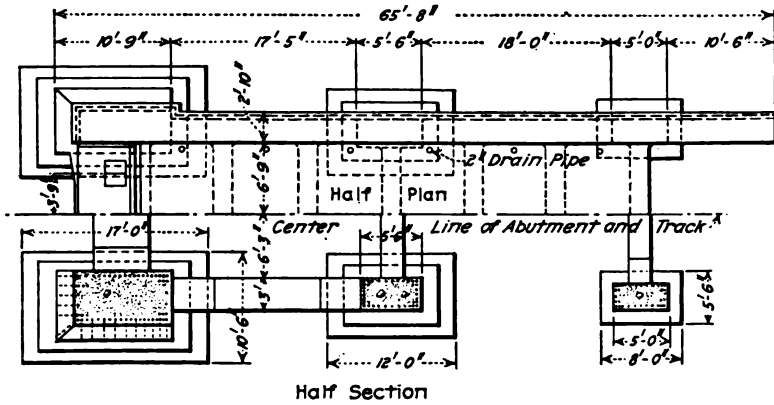

FIG. 309.—Details of abutments of the Judith River viaduct in Montana, C. M. & St. P. Ry.

under the same conditions. Views of two typical skeleton abutments designed by this company are presented in Figs. 308 and 310. The structure of Fig. 308 is shown in some detail in Fig. 309. It should be noted that in these structures a high embankment need not be brought to an abrupt termination as the



Courtesy of Mr. H. C. Lothholz, Engineer of Design, C. M. & St. P. Ry.

FIG. 310.—Skeleton abutments for steel truss span on Chicago, Milwaukee & St. Paul Ry. Timber trestle within abutments being removed.

separated concrete shafts and cantilevered girders allow the fill to assume freely its natural slope. A valuable feature of this type of abutment lies in the fact that it can be constructed in the midst of a timber trestle with very little interference with the timber work.

PART III

CULVERTS

The term culvert is usually applied to structures built to carry surface water or small streams through highway or railroad embankments. When the area of waterway required is comparatively small, a pipe culvert is usually the most economical. For the larger openings either the box or arch form should be employed depending upon the available head-room, the depth of fill, the condition of the foundation, and whether or not an artistic arch design is especially desirable.

The ordinary type of arch culvert and the box culvert without a load-supporting floor (called *open-box* culvert) are in reality small bridges, and it is sometimes a question of how large such structures may become before they should be considered strictly in the bridge class. No arbitrary division will be adhered to in the following chapters except that a culvert will be kept in mind as a structure which can be completely and economically standardized, based on a given area of waterway and height of embankment.

CHAPTER XIX

FACTORS IN CULVERT DESIGN

77. Culvert Efficiency.—A culvert to be efficient in the amount of water it can discharge should have its head-walls or wings arranged so as to facilitate the flow, and its bed should be considerably inclined for those cases where the channel below the culvert will permit the water to flow away freely. If any well-defined stream bed exists, the bed of the culvert should have the same inclination as that of the stream, as otherwise either the outlet or inlet end will clog depending upon whether the slope of the culvert is greater or less respectively than the slope of the stream bed.

Any projections in the culvert bed should be avoided as they will retard the water and diminish efficiency. It is also important

that culverts be placed across roadways in the direction of the stream flow since, if this is not done, clogging and subsequently washouts will be likely to occur.

A culvert will discharge twice as much under a head of 4 ft. as under a head of 1 ft., but water should not be allowed to dam up in this manner unless the culvert is well constructed through a water-tight embankment.

78. Waterway Required.—Assuming an efficient culvert design, the area of waterway required depends principally upon the maximum rate of rainfall, the area and shape of the watershed, the kind and condition of the soil throughout this watershed area, and the character and inclination of both drainage surface and stream bed. A number of empirical formulas have been proposed by which to calculate the required culvert opening, but obviously a problem of this kind does not admit of an exact mathematical solution and the desired size of culvert should be determined by direct observation whenever that is possible.

In a new country an empirical formula is often the only method by which the required area of waterway can be determined. Talbot's formula is the one most generally employed and is as follows:

$$A = C\sqrt{a^3}$$

where A = area of waterway in square feet, a = drainage area in acres, and C is a coefficient which varies from 1 to $\frac{1}{8}$ in the following manner: "For steep and rocky ground, C varies from $\frac{2}{3}$ to 1. For rolling agricultural country subject to floods at times of melting of snow, and with the length of valley three or four times its width, C is about $\frac{1}{3}$; and if the stream is longer in proportion to the area, decrease C . In districts not affected by accumulated snow, and where the length of the valley is several times the width, $\frac{1}{6}$, $\frac{1}{8}$, or even less, may be used. C should be increased for steep side slopes, especially if the upper part of the valley has a much greater fall than the channel at the culvert."¹

The proper area of waterway can best be determined by noting the dimensions of existing openings on the same stream and by careful observation of the stream and the amount of water which it carries at flood times. This amount of water can be determined by measuring a cross-section of the stream at some narrow place near the culvert site.

¹ Selected Papers of the Civil Engineers' Club of the University of Illinois, No. 2, page 14.

79. Length of Culverts.—The length of a culvert should depend upon the width of roadway and the depth of fill on top of the culvert. The slope of an earth fill can generally be taken as $1\frac{1}{2}$ to 1—that is, for every 1 ft. in height, the horizontal distance is $1\frac{1}{2}$ ft.

In highway construction the roadway should never be narrowed at a culvert since such a practice is dangerous and the construction unsightly.

80. Design of Ends.—The arrangement of the head-walls or wings may be substantially the same for all arch and box culverts. The arrangement should be such that the embankment is protected and the flow of water facilitated. Wing walls may be built parallel with or at right angles to the axis of the culvert, or they may be so placed as to make an angle (usually 30 or 45°) with this axis.

For the shorter spans (including spans for pipe culverts), wings parallel with the roadway are generally used for low fills and, in highway construction at least, these head-walls are carried up above the grade line to provide a low guard rail. This type of end, however, is not economical for the larger spans since the straight wings under such conditions need to be made of considerable length and height to retain the fill efficiently. A low guard rail may be formed with flared wings by raising and coping both head- and wing-walls. The top of the wings, of course, should have a slope consistent with the slope of the earth fill.

Flared wings, especially at the upstream end, are the best for hydraulic reasons and, when used, the culvert is less likely to become choked than when either of the other two forms of wing walls are employed. Straight wings—namely, wings parallel to the axis of the culvert—are of advantage in railroad construction when an extension of the culvert is likely to be made in the near future to accommodate another track.

It is common practice to design wing and head-walls of sufficient length to keep the culvert opening clear when the earth is assumed to fall around the ends on a $1\frac{1}{2}$ to 1 slope. In some cases a steeper slope could be assumed, but some soils take even flatter slopes than the standard.

Box and arch culverts are built both with and without a floor, but in almost every case the smooth waterway that can be obtained by using a concrete floor will greatly increase the capacity

of the culvert. A floor, if properly constructed, will also prevent any danger from erosion of the stream bed and undermining of the foundation. The floor at the ends of the culvert should be provided with an apron or baffle wall at its outer edge, and this wall should in all cases be carried as low as the bottom of the footings. If especially desirable, the floor should extend out to the end of the wing walls.

Mr. C. B. McCullough, Designing Engineer of the Iowa State Highway Commission, writes as follows in a letter to the writer under date of June 5, 1915:

"I had the opportunity last summer to make an inspection of some seventy or eighty concrete bridges and culverts, a large number of them being culverts. These were structures constructed before the going into effect of the present state highway law and, of course, in many cases were constructed without any engineering supervision of any kind. The foundations almost universally were carried to a very slight depth below the stream bed and in practically every case there was an utter lack of proper study of stream conditions. The most serious defects noticed in the inspection as far as the small culverts were concerned could be traced to erosion of the creek bed.

"A tabulation of some of the results disclosed by this inspection trip was published in our Service Bulletin for December, 1914. These and other observations have led me to believe that the fundamental principle controlling the design of culverts is that erosion and the destructive effects incident thereto is greater in small spans than for large ones, and that extraordinary care in placing these foundations well below the line of ultimate scour is of the greatest importance."

CHAPTER XX

PIPE CULVERTS

One or more lines of pipe with suitable head-walls to protect the embankment is the simplest form of culvert. The pipe may be of burned clay, cast iron, plain concrete, or reinforced concrete; but, on account of frequent breakages, there seems to be a tendency at the present time to discontinue the use of vitrified and cast-iron pipe (including pipes of plain concrete), except possibly in those localities where materials for making concrete are scarce. All kinds of pipe culverts have the same type of concrete head-walls, consequently this chapter will treat only of pipe culverts of reinforced concrete.

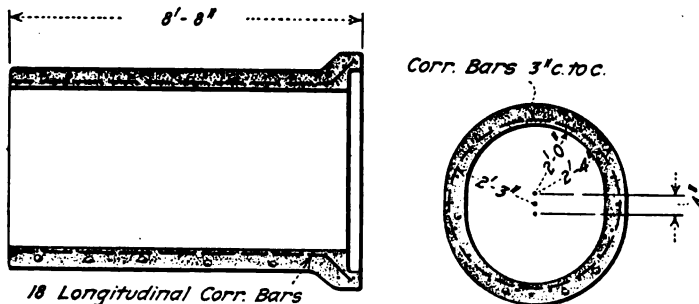

FIG. 311.—Reinforced-concrete pipe.

Since it is desirable to make as few openings as possible through an embankment, water is usually conducted along the side of the roadway until at least a 15-in. diameter of pipe is required. In the following discussion a pipe of at least this size will be assumed.

Reinforced culvert pipes are usually made in from 4 to 8-ft. lengths, and with bell and spigot joints. The largest diameter of pipe yet made is 72 in. The pipes usually have a hoop reinforcement which is near the interior surface at the top and bottom of the pipe, and near the exterior surface at the sides (Fig. 311). Pipe with a double line of reinforcing is also used,

as shown in Fig. 312. Longitudinal reinforcement is provided in pipes of the longer lengths due to the likelihood of beam action if settlement takes place.

81. Pressure in Trenches.—The most elaborate and thorough investigation of the subject of pressure on pipes in ditches was

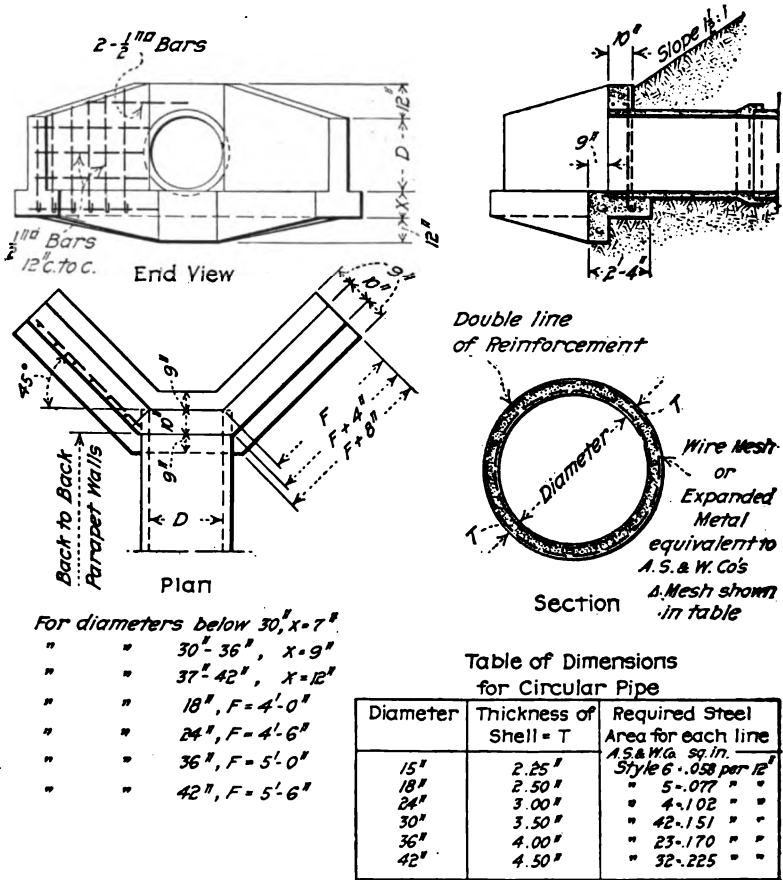

FIG. 312.—Standard dimensions for concrete pipe culverts with concrete head-walls, Iowa Highway Commission.

made a few years ago at the Iowa State College of Agriculture and Mechanic Arts, the results of which were published in Bulletin No. 31¹ of the Engineering Experiment Station. The investigation was made with special reference to drain tile and

¹ Written by Prof. Anson Marston and Mr. A. O. Anderson.

sewer pipe, but the results apply equally well to culverts laid in trenches. The following summary of the general principles of the theory of loads on pipes in ditches (a theory which was developed by reason of this investigation) is taken from the bulletin above mentioned. The correctness and reliability of this theory were demonstrated with remarkable closeness by actual weighings of loads on pipes, the pipes ranging from 12 in. to 36 in. in internal diameter placed in ditches from 0 to 19 ft. in depth.

TABLE NO 1.—APPROXIMATE SAFE WORKING VALUES OF "C," THE COEFFICIENT OF LOADS ON PIPES IN DITCHES

Ratio $\frac{H}{B}$	For damp top soil and dry and wet sand	For saturated top soil	For damp yellow clay	For saturated yellow clay
0.5	0.46	0.47	0.47	0.48
1.0	0.85	0.86	0.88	0.90
1.5	1.18	1.21	1.25	1.27
2.0	1.47	1.51	1.56	1.62
2.5	1.70	1.77	1.83	1.91
3.0	1.90	1.99	2.08	2.19
3.5	2.08	2.18	2.28	2.43
4.0	2.22	2.35	2.47	2.65
4.5	2.34	2.49	2.63	2.85
5.0	2.45	2.61	2.78	3.02
5.5	2.54	2.72	2.90	3.18
6.0	2.61	2.81	3.01	3.32
6.5	2.68	2.89	3.11	3.44
7.0	2.73	2.95	3.19	3.55
7.5	2.78	3.01	3.27	3.65
8.0	2.82	3.06	3.33	3.74
8.5	2.85	3.10	3.39	3.82
9.0	2.88	3.14	3.44	3.89
9.5	2.90	3.18	3.48	3.96
10.0	2.92	3.20	3.52	4.01
11.0	2.95	3.25	3.58	4.11
12.0	2.97	3.28	3.63	4.19
13.0	2.99	3.31	3.67	4.25
14.0	3.00	3.33	3.70	4.30
15.0	3.01	3.34	3.72	4.34
Infinity	3.03	3.38	3.79	4.50

For values of $\frac{H}{B}$ not given in table, sufficiently accurate values of "C" can be obtained by interpolation. H = height of fill, above top of pipe, in feet.

1. "The weight of the filling in a drainage or sewerage ditch at the time of maximum load on the pipe is carried partly by the pipe and partly by friction against the sides of the ditch. Cohesion greatly reduces the loads carried by the pipe at ordinary times after the ditch is refilled and partly consolidated, except in the case of clean sand or gravel filling, but does not appreciably affect the maximum loads.

2. "The maximum loads on pipes in ditches, due to the weight of ditch-filling materials, will usually occur at the time of the first very thorough surface flooding of the ditch filling after construction, when there is a large settlement of the refill, but there is possibility of their occurring later, at the time of extreme saturation of the ditch filling, by surface flooding of the ditch and by overcharging of the drain or sewer. The maximum loads may even be postponed for many years in some cases, as is frequently shown by settlement of the filling in old ditches during paving construction.

3. "Safe values of the ordinary maximum loads on pipes in ditches, due to the weight of ditch-filling materials, can be computed by the following formula:

$$W = CwB^2$$

where W = load on pipe in ditches, in pounds per linear foot.

C = coefficient of loads on pipes in ditches.

w = weight of ditch-filling material, in pounds per cubic foot.

B = breadth of ditch at top of pipe, in feet.

using the values of " C " given in Table No. 1 or, more conveniently, estimating directly from Table No. 2.

4. "In calculating the maximum loads on pipes in ditches, due to the weight of ditch filling, by the above formula and Tables Nos. 1 and 2,

TABLE NO. 2.—APPROXIMATE MAXIMUM LOADS, IN POUNDS PER LINEAR FOOT, ON PIPES IN DITCHES FROM COMMON DITCH-FILLING MATERIALS

H = height of fill above top of pipe	B = breadth of ditch a little below top of pipe									
	1 ft.	2 ft.	3 ft.	4 ft.	5 ft.	1 ft.	2 ft.	3 ft.	4 ft.	5 ft.
	Partly compacted damp top soil 90 lb. per cu. ft.					Saturated top soil 110 lb. per cu. ft.				
2 ft.	130	310	490	670	830	170	380	600	820	1,020
4 ft.	200	530	880	1,230	1,580	260	670	1,090	1,510	1,950
6 ft.	230	690	1,190	1,700	2,230	310	870	1,500	2,140	2,780
8 ft.	250	800	1,430	2,120	2,790	340	1,030	1,830	2,660	3,510
10 ft.	260	880	1,640	2,450	3,290	350	1,150	2,100	3,120	4,150

TABLE NO. 2.—APPROXIMATE MAXIMUM LOADS IN POUNDS PER LINEAR FOOT, ON PIPES IN DITCHES FROM COMMON DITCH-FILLING MATERIALS (Continued.)

<i>H</i> = height of fill above top of pipe	<i>B</i> = breadth of ditch a little below top of pipe									
	1 ft.	2 ft.	3 ft.	4 ft.	5 ft.	1 ft.	2 ft.	3 ft.	4 ft.	5 ft.
	Dry sand 100 lb. per cu. ft.					Saturated sand 120 lb. per cu. ft.				
2 ft.	150	340	550	740	930	180	410	650	890	1,110
4 ft.	220	590	970	1,360	1,750	270	710	1,170	1,640	2,100
6 ft.	260	760	1,320	1,890	2,480	310	910	1,590	2,270	2,970
8 ft.	280	890	1,590	2,350	3,100	340	1,070	1,910	2,820	3,720
10 ft.	290	980	1,820	2,720	3,650	350	1,180	2,180	3,260	4,380
12 ft.	300	1,040	2,000	3,050	4,150	360	1,250	2,400	3,650	4,980
14 ft.	300	1,090	2,140	3,320	4,580	360	1,310	2,570	3,990	5,490
16 ft.	300	1,130	2,260	3,550	4,950	360	1,350	2,710	4,260	5,940
18 ft.	300	1,150	2,350	3,740	5,280	360	1,380	2,820	4,490	6,330
20 ft.	300	1,170	2,420	3,920	5,550	360	1,400	2,910	4,700	6,660
22 ft.	300	1,180	2,480	4,060	5,800	360	1,420	2,980	4,880	6,960
24 ft.	300	1,190	2,540	4,180	6,030	360	1,430	3,050	5,010	7,230
26 ft.	300	1,200	2,570	4,290	6,210	360	1,440	3,090	5,150	7,460
28 ft.	300	1,200	2,600	4,370	6,390	360	1,440	3,120	5,240	7,670
30 ft.	300	1,200	2,630	4,450	6,530	360	1,440	3,150	5,340	7,830
Infinity	300	1,210	2,730	4,850	7,580	360	1,450	3,270	5,820	9,090
	Partly compacted damp yellow clay 100 lb. per cu. ft.					Saturated yellow clay 130 lb. per cu. ft.				
2 ft.	160	350	550	750	930	210	470	730	1,000	1,240
4 ft.	250	620	1,010	1,400	1,800	340	840	1,330	1,870	2,370
6 ft.	300	830	1,400	1,990	2,580	430	1,140	1,900	2,630	3,410
8 ft.	330	990	1,720	2,500	3,250	490	1,380	2,360	3,360	4,400
10 ft.	350	1,110	2,000	2,920	3,880	520	1,570	2,760	3,980	5,270
12 ft.	360	1,200	2,220	3,320	4,450	540	1,730	3,100	4,560	6,050
14 ft.	370	1,280	2,410	3,650	4,950	560	1,850	3,410	5,050	6,760
16 ft.	370	1,330	2,570	3,950	5,400	570	1,940	3,660	5,510	7,440
18 ft.	380	1,390	2,710	4,210	5,810	570	2,020	3,880	5,930	8,060
20 ft.	380	1,410	2,830	4,450	6,180	580	2,090	4,070	6,280	8,610
22 ft.	380	1,430	2,920	4,640	6,500	580	2,140	4,240	6,610	9,130
24 ft.	380	1,450	3,000	4,820	6,800	580	2,180	4,380	6,910	9,590
26 ft.	380	1,470	3,060	4,980	7,080	580	2,210	4,500	7,160	10,010
28 ft.	380	1,480	3,120	5,100	7,310	580	2,240	4,610	7,380	10,430
30 ft.	380	1,490	3,170	5,230	7,530	580	2,260	4,700	7,590	10,780
Infinity	380	1,520	3,410	6,060	9,480	580	2,340	5,270	9,360	14,620

the value to use for H is the height of the filling above the top of the pipe, and the value for B is the breadth of the ditch a little below the top of the pipe. The width of the ditch above the pipe makes practically no difference in the load on the pipe, which is just as great for a vertical ditch as for one several times as wide at the top but of the same width a little below the top of the pipe.

5. "In ditches of proportions customary in actual work, the diameter of the pipe used in any particular ditch of a fixed given width makes practically no difference in the load on the pipe. A 12-in. pipe will have to carry the same load as an 18-in. pipe, if both are placed in ditches 2 ft. wide under other similar conditions.

6. "The width of the ditch a little below the top of the pipe makes a great difference in the load on the pipe, which is very much heavier for wide than for narrow ditches (see Table No. 2).

7. "In case a wide ditch is necessary for constructive reasons, the load on the pipe can be diminished greatly, in firm soil, by stopping the wide ditch a few inches above the top of the pipe and digging in the bottom the narrowest ditch practicable to receive the pipe, making bell holes at the side for the sewer pipe, if necessary.

8. "The loads on pipes in ditches, due to the weight of ditch filling, increase for greater depths of fill, but the proportion of the total weight of filling carried by the pipe decreases as the depth increases, and after the depth of fill becomes equal to ten times the breadth of the ditch at the top of the pipe there is practically no further increase in the load on the pipe for greater depths.

9. "The loads on pipes in ditches, due to the weight of ditch filling, are directly proportional to the weights per cubic foot of the ditch-filling materials. Of the common ditch-filling materials, clay is the heaviest and black top soil the lightest, sand being intermediate. For safe weights per cubic foot, see Table No. 3.

TABLE NO. 3.—PROPERTIES OF DITCH-FILLING MATERIALS

Ditch Filling	Unit weight of filling, lb. per cu. ft.	Ratio of lateral to vertical earth pressures	Coefficient of friction against sides of trench
Partly compacted top soil (damp).....	90	0.33	0.50
Saturated top soil.....	110	0.37	0.40
Partly compacted damp yellow clay.....	100	0.33	0.40
Saturated yellow clay.....	130	0.37	0.30
Dry sand.....	100	0.33	0.50
Wet sand.....	120	0.33	0.50

10. "Grades or fills built over the surfaces of completed ditches, and piles of sand, gravel, and other materials having internal friction, operate to increase the loads on pipes in ditches to the same extent as an equal added height of ditch filling, for a breadth of ditch equal to that at a little below the top of the pipe.

11. "A super load is any load applied to the upper surface of the ditch filling, except loads from fills or heaps of granular materials. A long super load is one extending a considerable length along a ditch, as compared with its depth and breadth, and may be caused by piles of paving brick, lumber, etc., over the ditch. Long super loads on completed ditches cause increases in the loads on pipes in ditches by percentages of the super load which decrease as depth increases, and safe values for which can be computed by Table No. 4. Formula (4) has been closely checked by actual weighings of the increase in loads on pipes in ditches due to super loads.

TABLE NO. 4.—APPROXIMATE SAFE VALUES OF C_1 TO USE IN FORMULA $L_1p = C_1L_1$

L_1p = loads per unit of length, on pipes in ditches, due to L_1 .
 L_1 = long super loads on ditches, per unit of length.

$\frac{H}{B}$	Sand and damp top soil	Saturated top soil	Damp yellow clay	Saturated yellow clay
0.0	1.00	1.00	1.00	1.00
0.5	0.85	0.86	0.88	0.89
1.0	0.72	0.75	0.77	0.80
1.5	0.61	0.64	0.67	0.72
2.0	0.52	0.55	0.59	0.64
2.5	0.44	0.48	0.52	0.57
3.0	0.37	0.41	0.45	0.51
4.0	0.27	0.31	0.35	0.41
5.0	0.19	0.23	0.27	0.33
6.0	0.14	0.17	0.20	0.26
8.0	0.07	0.09	0.12	0.17
10.0	0.04	0.05	0.07	0.11

12. "A short super load is one extending a short distance along a ditch as compared with the breadth and depth, and may come from the wheels of wagons, traction engines, steam road rollers, etc. Short super loads, on completed ditches, cause increases in the loads on pipes in ditches by percentages of the super load which decrease as the depth increases, and safe values which can be estimated, but not very reliably, by Table No. 5. Table No. 5 has not been checked by actual weighings of increase of loads on pipes in ditches.

TABLE NO. 5.—APPROXIMATE SAFE VALUES FOR C_s TO USE IN FORMULA $L_{sp} = C_s L_s$

L_{sp} = loads per unit of length, on pipes in ditches directly under L_s , due to L_s . L_s = short super loads on ditches, per unit of length, of length A along ditch.

$\frac{H}{B}$	Sand and damp top soil				Saturated top soil				Damp yellow clay				Saturated yellow clay			
	$K_s = \frac{1}{2}K$		$K_s = K$		$K_s = \frac{1}{2}K$		$K_s = K$		$K_s = \frac{1}{2}K$		$K_s = K$		$K_s = \frac{1}{2}K$		$K_s = K$	
	A =		A =		A =		A =		A =		A =		A =		A =	
	B	$\frac{B}{10}$	B	$\frac{B}{10}$	B	$\frac{B}{10}$	B	$\frac{B}{10}$	B	$\frac{B}{10}$	B	$\frac{B}{10}$	B	$\frac{B}{10}$	B	$\frac{B}{10}$
0.0	1.00	1.00	1.00	1.00	1.00	1.00	1.00	1.00	1.00	1.00	1.00	1.00	1.00	1.00	1.00	1.00
0.5	0.77	0.32	0.70	0.12	0.78	0.33	0.71	0.13	0.79	0.34	0.72	0.13	0.81	0.34	0.74	0.13
1.0	0.59	0.11	0.49	0.02	0.61	0.11	0.51	0.02	0.63	0.11	0.52	0.02	0.66	0.12	0.55	0.02
1.5	0.46	0.03	0.34	0.48	0.04	0.36	0.51	0.04	0.38	0.54	0.04	0.40
2.0	0.35	0.01	0.24	0.38	0.01	0.26	0.40	0.01	0.27	0.44	0.01	0.30
2.5	0.27	0.17	0.29	0.18	0.32	0.20	0.35	0.22
3.0	0.21	0.12	0.23	0.13	0.25	0.14	0.29	0.16
4.0	0.12	0.06	0.14	0.07	0.16	0.08	0.19	0.09
5.0	0.07	0.03	0.09	0.03	0.10	0.04	0.13	0.05
6.0	0.04	0.01	0.05	0.02	0.06	0.02	0.08	0.03
8.0	0.02	0.02	0.03	0.01	0.04	0.01
10.0	0.01	0.01	0.01	0.02

H = height of fill in ditch, above top of pipe.

B = breadth of ditch, a little below top of pipe.

K = ratio of lateral pressure to vertical in the ditch filling.

K_s = ratio of longitudinal pressure to vertical in the ditch filling.

Values of C_s for $K_s = 0$ are given in Table No. 4.

The formula $L_{sp} = C_s L_s$ holds true only directly under L_s . Beyond L_s , in either direction, the intensity of load on the pipe diminishes rapidly.

13. "Cracking of pipes in ditches is sometimes caused by heavy tamping of the filling material over it, or too thin a cover layer. The pressures transmitted to the pipe by tamping with rammers of different weights on cover layers of different thicknesses may be estimated, but only approximately, by the aid of Table No. 5 and the following formula:

$$T_s = \frac{2TF}{f}$$

where T_s = the maximum pressure on the earth filling resulting from the shock of a blow of the rammer.

T = weight of rammer used in tamping.

F = height of fall of rammer.

f = compression of filling material under one blow of rammer at the end of the tamping.

14. "Ordinary ditch sheeting may cause some increase in the loads on pipes in ditches from fresh filling, but does not increase the probable maximum loads unless left in permanently.

15. "Freezing, and consequent horizontal expansion of the sides of ditches against the sides of the pipe, sometimes causes cracking of drain tile and sewer pipe, where they are not covered sufficiently deep.

16. "The general effect of the lapse of time after the completion of the refilling is to decrease rather than increase the loads on pipes in ditches, though the maximum loads, as indicated in principle 2 above, generally do not occur until some time after the refilling is finished, and under certain conditions may not occur for many years."

The following examples are given in the bulletin from which the above principles are taken:

"*Example 1.* What load should be provided for as imposed by a pile of paving brick 6 ft. high on a 24-in. pipe sewer, whose top is 6 ft. below the street surface, the ditch being 3 ft. wide at the top of the pipe and the filling yellow clay?

"*Solution.* The weight of the paving brick as piled would probably be about 125 lb. per cubic foot. Hence L_1 would be $125 \times 6 \times 3 = 2250$ lb. per linear foot. If the ditch filling has been deposited recently and is not in danger of saturation, C_1 would be taken from Table No. 4, for damp clay, and for a value of $\frac{H}{B} = \frac{6}{3} = 2$. Hence $L_{1p} = 0.59 \times 2250 = 1300$ lb. per linear foot.

"If the clay filling has been thoroughly consolidated for a sufficient time to develop cohesion, L_{1p} would be much smaller, unless there is danger of saturation, as by heavy rains, which might destroy the cohesion. If the soil were sand instead of clay, however, cohesion would probably not greatly affect the result, and L_{1p} would be $0.52 \times 2250 = 1200$ lb. per linear foot.

"*Example 2.* The wheel of a steam road roller is 22 in. wide and carries a load of 8000 lb. When rolling transverse to the street, what load will it impose on an 18-in. pipe sewer in a recently settled ditch, $2\frac{1}{2}$ ft. wide at the level of the pipe, with $7\frac{1}{2}$ ft. height of yellow-clay filling?

"*Solution.* The length A of load in this case is $0.73B$. The value of $\frac{H}{B} = \frac{7.5}{2.5} = 3.0$. Assuming that the longitudinal pressure in the ditch filling is one-half the lateral, and interpolating in Table No. 5 between the values of 0.25 for $A = B$ and 0 for $A = \frac{B}{10}$, we find that $C_1 =$ approximately 0.18. Hence, approximately, $L_{1p} = 0.18 \times \frac{8000}{1.83} = 800$ lb. per linear foot.

"The possible effect of cohesion may be taken into account in the case of an old ditch, with clay filling, as already noted in Example 1.

"As illustrating the possible degree of uncertainty in the above computed result, due to the fact that we are uncertain as to the proper value of K_a , the ratio of longitudinal to vertical pressure in the ditch filling, we may note that in Example 2:

For $K_a = 0$, $C_s = 0.45$, approximately (see Table No. 4).

For $K_a = \frac{1}{2} K$, $C_s = 0.18$, approximately (see Table No. 5).

For $K_a = K$, $C_s = 0.10$, approximately (see Table No. 5).

"Evidently calculations made from Table No. 5 are not very reliable, and there is great need of a series of tests of the actual loads on pipes caused by short super loads, but such tests would be very difficult to make and test results are not available.

"In the meantime, Table No. 5 will be of some value to engineers of good judgment in assisting them to make reasonable safe allowances for the probable effect on the loads on pipes in ditches from heavy concentrated loads on wagon wheels, traction engines, and road rollers.

"*Example 3.* What loads were probably imposed on a sewer pipe where a 40-lb. rammer on 6-in. cover apparently caused some cracking, and was superseded later with success by a 30-lb. rammer on 12-in. cover, the rammer being 8 in. square, and the filling material clay?

"*Solution.* Since the ramming was carefully inspected and was required to be very thorough, it seems reasonable to assume that the height of fall was at least 0.5 ft. and that the ramming was continued until a compression of about $\frac{1}{2}$ in. (= 0.01 ft.) was produced by one blow. Hence $T_s = 2 \times 40 \times \frac{0.50}{0.01} = 4000$ lb. for the 40-lb. rammer.

In Table No. 5 we find for $\frac{H}{B} = \frac{0.5}{0.67} = 0.75$, $K_a = K$, $A = B$, under damp clay, that about 62 per cent. of T_s , or 2500 lb., would be transmitted to an area of the pipe 8 in. square, directly under the rammer, with a total shock load on the pipe somewhere between 2500 and 4000 lb.

"For the 30-lb. rammer with 12-in. cover, and perhaps 0.015 ft. compression under the final blow, $T_s = 2000$ lb., with 38 per cent., or 800 lb., transmitted to an area of the pipe 8 in. square, directly under the rammer, and some further pressure outside this area.

"From these results it is apparent: First, that the 40-lb. rammer on the 6-in. cover may readily have caused some cracking of the pipe; second, that the 30-lb. rammer on the 12-in. cover was probably not much, if any, more than one-third as severe on the pipe."

82. Strength of Pipe.—The theoretical analysis of stresses in culvert pipe is that of thin elastic rings and is similar to the general method employed for arches. The difference in the

intensity of the load at the crown and at the extremities of the horizontal diameter, due to the difference in the depths of the earth, is considered negligible, and the pressure and its distribution on the lower half of the ring is assumed to be the same as that on the upper half.

Theory gives the following values of the bending moment at the top and bottom sections of a pipe:

(I) For single concentrated load (top and bottom) $M = 0.159 Pd$.

(II) For total uniformly-distributed load over entire horizontal projection (top and bottom) $M = 0.0625 Wd$.

(III) For a uniformly-distributed load over the top fourth of the circumference and with the pipe supported on its bottom quarter circumference $M = 0.0845 Wd$. Where

d = diameter of pipe.

P = concentrated load at top.

W = total uniformly-distributed load above horizontal diameter.

M = bending moment in pipe in a unit length.

The bending moments at the ends of the horizontal diameters under the above conditions of loading are:

$$\text{I} \dots M = - 0.091 Pd$$

$$\text{II} \dots M = - 0.0625 Wd$$

$$\text{III} \dots M = - 0.077 Wd$$

The above moments will be reduced for any lateral restraint or lateral pressure. In fact, for equal uniform horizontal and uniform vertical forces (which may be considered equivalent to a uniform radial pressure) the moments due to the lateral forces have equal but opposite signs to those given for Case II above, and it can be proved that the total moments at all points are zero. It is not good practice, however, to rely on any lateral restraint or pressure in the analysis of the strength of pipes. Mathematical analysis shows that the weight of pipe causes only five-eighths as much bending moment at the lowest point of the pipe as does an equal weight of earth.

Since the exact load and the nature of its distribution over the pipe surface is usually uncertain, the probable range of bending moments under actual conditions of construction is all that laboratory tests can be expected to furnish. In a series of tests

at the University of Illinois,¹ reinforced-concrete rings and circular pipe (48-in. internal diameter and 4 in. thick) were tested for concentrated loads at the top and bottom of the vertical diameter (Case I above), and for uniformly-distributed loads above and below the entire horizontal diameter (Case II above). This latter loading was obtained by placing the pipe in a tight box so as to be entirely encircled with sand and then applying a load to the top surface of the sand. The reinforcement for most of the rings tested consisted of $\frac{1}{4}$ -in. corrugated rods placed near the intrados at top and bottom and near the extrados at the sides. The rings were only 24 in. long, but the pipe sections were from 102 to 104 in. in length with the usual bell and spigot joints. To allow the circumferential reinforcement in the pipes to be circular in shape, the pipe cross-sections (Fig. 1) were made with the vertical diameter 4 in. longer than the horizontal diameter, thus bringing the reinforcement at the points of tension in the loaded pipe. Using the yield point of the steel in the common formula for the bending resistance of a reinforced section, there was found a close agreement between the theoretical and experimental values for the strength of pipe under these two methods of loading.

Marston and Anderson, in the investigation referred to in the preceding article, came to the conclusion that "the typical field bedding and loading of pipes in ditches are such that their effect on the pipe can be reproduced with practical exactness in laboratory tests by bedding the pipes in sand during the tests for 90° of the circumference at the bottom and also for 90° at the top." This method of loading is Case III above. In the Iowa investigation the weight of the pipe as well as that of the backfilling was taken into consideration.

The manner in which the formulas given above may serve as a guide to the judgment is indicated in the following extract from Bulletin No. 22 of the Engineering Experiment Station of the University of Illinois:

"If the layer of earth immediately under the pipe is hard or uneven, or if the bedding of the pipe at either side is soft material or not well tamped, as indicated in Fig. 313(a), the main bearing of the pipe may be along an element at the bottom and the result is in effect concentrated loading. The result is to greatly increase the bending

¹ See Bulletin No. 22 of the Engineering Experiment Station of the University of Illinois—written by Prof. A. N. Talbot.

moment developed and hence the tendency of the pipe to fail. This condition may be aggravated in the case of a pipe with a stiff hub or bell where settlement may bring an unusual proportion of the bearing at the bell and the distribution of the pressure be far from the assumed condition. In bedding the pipe in hard ground it is much better to form the trench so that the pipe will surely be free along the bottom element, even after settlement occurs, and so that the bearing pressures may tend to concentrate at points, say under the one-third points of the horizontal diameter (or even the outer quarter points). This will reduce the bending moments developed in the ring.

“In case the pipe is bedded in loose material, the effect of the settlement will be to compress the earth immediately under the bottom of the pipe more completely than will be the effect at one side, as indicated in Fig. 313(b), with the result that the pressure will not be uniformly distributed horizontally. Similarly, in a sewer trench, if

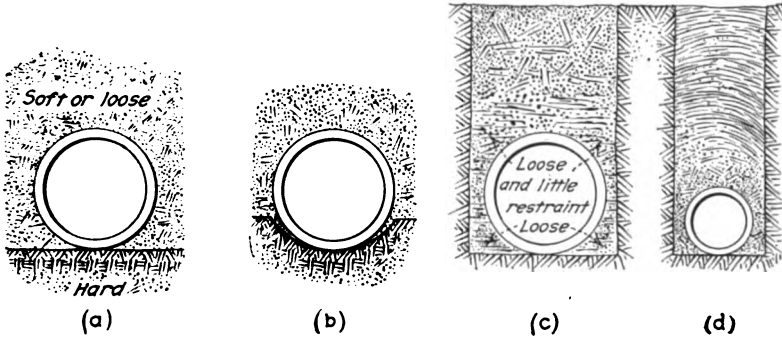

FIG. 313.—Conditions of loading.

loose material is left at the sides and the material at the extremity of the horizontal diameter is loose and offers little restraint, as indicated in Fig. 313(c), the pressure on the earth will not be distributed horizontally and the amount of bending moment will be materially different from that where careful bedding and tamping give an even distribution of bearing pressure over the bottom of the sewer.

“In case of a small sewer in a deep trench, the load upon the sewer may be materially less than the weight of the earth above, as in the case shown in Fig. 313(d), where the earth forms a hard compact mass and is held by pressure and friction against the sides of the trench.

“In case a culvert pipe is laid in an ordinary embankment by cutting down the sides slopingly, as shown in Fig. 314(a), it is evident that the load which comes upon the pipe will be materially less than the weight of the earth immediately above it. If a culvert pipe replaces a trestle and the filling is allowed to run down the slope as shown in Fig. 314(b), the direction and amount of the pressure against the pipe will differ

considerably from that which obtains in a trench or in the case of a level filling, shown in Fig. 314(c). It is possible in the latter case that the smaller amount of settlement of the earth directly over the culvert pipe, due to the greater depth of earth on the adjacent sections, may allow a greater proportion of the load to rest upon the culvert pipe than would ordinarily be assumed.

“Attention should be called to the fact that the distribution of the pressure by means of earth under and over a ring assumes that the earth is compressed in somewhat the same way as when other material of construction is given compression. Unless the earth has elasticity, the distribution of pressure cannot occur. To secure the uniform distribution assumed, the ring itself must give enough to allow for the movement of the earth which takes place under pressure. This is especially true with reference to the presence and utilization of lateral restraint, and a ring which does not give laterally, as for example a plain-concrete ring, will not develop lateral pressure in the adjoining

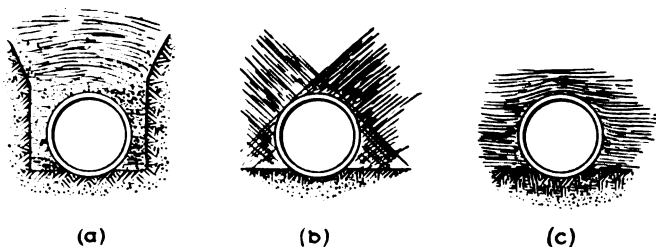

FIG. 314.—Conditions of loading.

earth under ordinary conditions of moisture and filling to any great extent. As the conditions of earth and moisture produce mobility and approach hydrostatic conditions, the necessity for this elasticity and movement does not exist, but here the lateral pressure approaches the vertical pressure in amount and the bending moments become relatively smaller.

“The discussion is sufficiently extended to indicate the importance of care in bedding culvert pipe and sewers and in filling over them, and to indicate the great difference in the amount of bending moment developed with different conditions of bedding and filling. Where there is any question of needed strength, it will be money well expended to use care and precaution in bedding the pipe and in filling around and over it. I am convinced that a little extra expense will add considerable stability, life, strength, and safety to such structures, far out of proportion to the added cost. It is possible that under careful conditions of laying, lighter structures may be used with a saving in the cost of construction.”

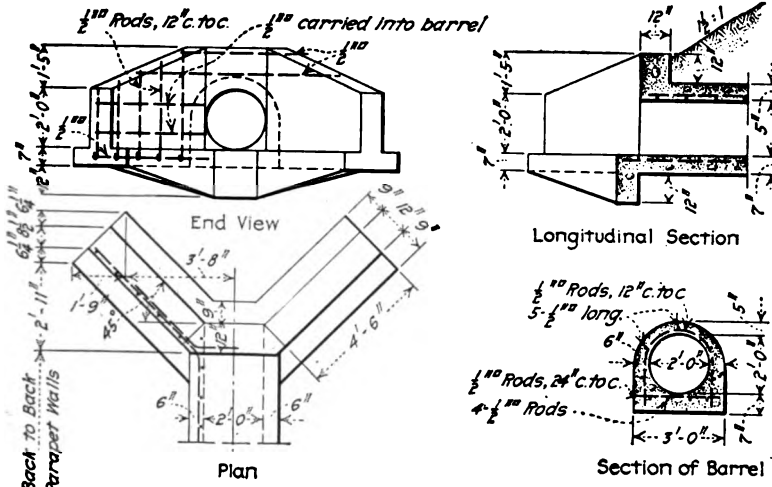

FIG. 315.—Standard design for 24-in. circular culvert, Iowa Highway Commission.

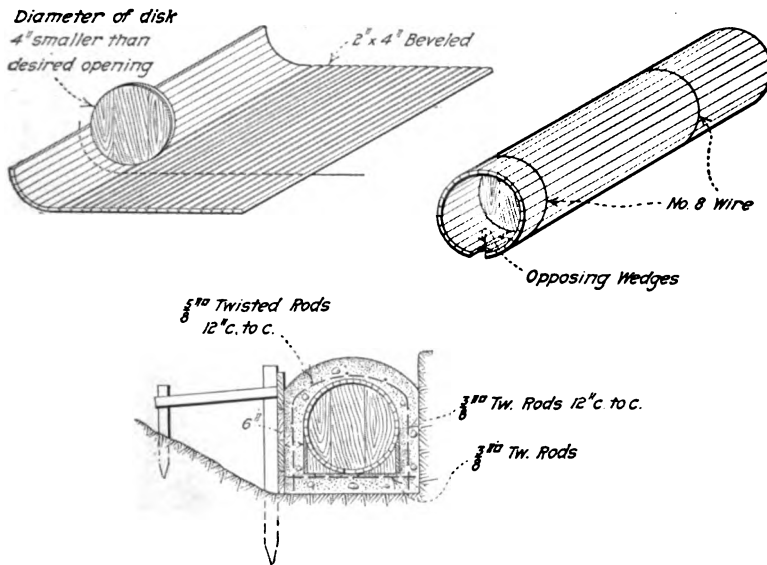

FIG. 316.—Collapsible, adjustable wood form for concrete culverts from 18 to 48 in. diameter.

83. Circular Culverts Cast in Place.—A cast-in-place culvert with circular opening is shown in Fig. 315. Fig. 316 shows an adjustable, collapsible wood form which can be very economically used for culverts of this type. It was originally designed by Mr. F. H. Meliza, Farmer City, Ill., and was mentioned in the Illinois Highway Commission report for 1907 and in a bulletin on highway improvement by Mr. W. S. Gearhart, Highway Engineer of Kansas, which was issued by the Kansas State Agricultural College.

The method of constructing and using this form is described as follows in a booklet entitled "Small Concrete Bridges and Culverts," published by the Universal Portland Cement Co.:

"This form is constructed of two by four's beveled and strung on wires, as shown in Fig. 316. The number of staves to be used, varying with the size of the culvert, are placed side by side with a wire drawn through each end of the stave as shown. The form is then rolled around a circular head size of the proposed culvert and wire bands are tied tightly around it on the outside. Wedges are then driven as shown in Fig. 316 to hold the staves firmly in position. After the culvert has been built the wedges are removed and the circular heads knocked in; the staves will then collapse and are easily removed. This form can be used over and over again and Mr. Gearhart states that its cost should not exceed \$15.00 or \$20.00."

CHAPTER XXI

BOX CULVERTS

The box type of culvert is especially adapted to locations where the head-room is limited and, when planned for such locations, has a great advantage over the arch. A culvert of this type, for example, can be built with less excavation and less

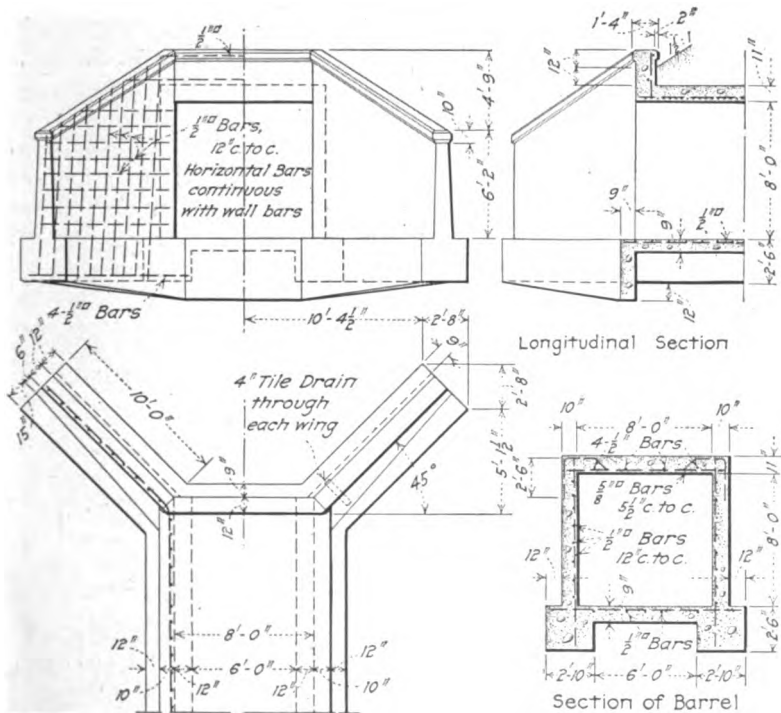

Fig. 317.—Standard design for 8 × 8-ft. box culvert, Iowa Highway Commission.

disturbance to the embankment and will give a greater distribution of load upon the foundation than the ordinary form of arch culvert. Also, the form work for this type is much simpler and the cost of construction correspondingly lower, except perhaps in some cases where the number and size of culverts to be con-

structed warrants the use of commercial arch forms of collapsible steel. Box culverts are not always employed only under shallow fills, as is evident from Figs. 320 and 321.

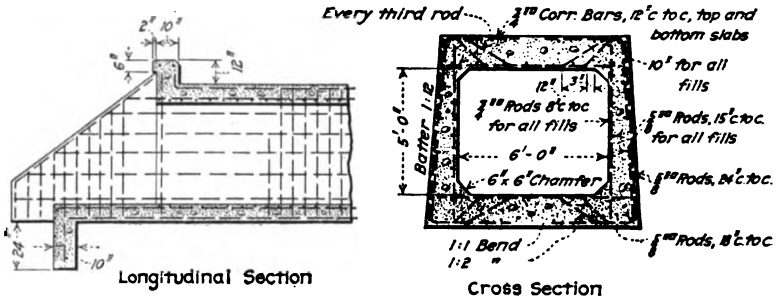

FIG. 318.—Standard culvert of 6-ft. span, Hampden R. R.

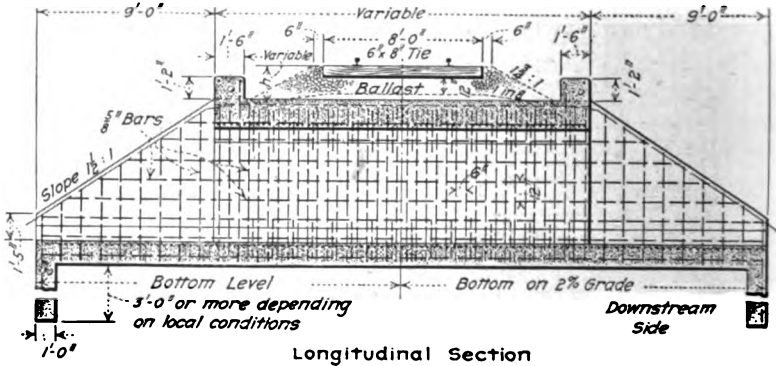

FIG. 319.—Double 6 X 6-ft. box culvert, A. T. & S. Fe. Ry. system.

84. Forms of Box Culverts.—There are two distinct forms of box culverts which may be distinguished by the terms *open box*

and *closed box*. In the open box (Fig. 317) the side walls have dependent footings, while in the closed box (called simply box) the load is supported by the floor (Fig. 318). Double-box culverts (Fig. 319) are generally used where the span is equal to, or greater than, twice the height, as the use of a single box beyond these proportions greatly increases the cost.

85. Loading.—For small box culverts built in trenches the load on the top slab may be approximately estimated by means of the formulas and tables in Art. 5. For large box culverts and for all culverts not built by trench construction, no allowance should be made for the arching action of the material, which



Courtesy of Mr. Wm. E. Beilharz, Architect and Engineer, Dallas, Texas.

FIG. 320.—Box culvert on lines of Eastern-Texas Traction Co.

means that such culverts should be proportioned to carry the entire weight of the fill above the cover slab. The lateral pressure of the earth (including live-load surcharge) is usually assumed as that due to a fluid weighing about 30 lb. per cubic foot—that is, a weight about one-fourth the weight of earth. It is obvious that the pressure due to live load does not spread out through the filling at the ordinary angle of repose of the material, but has a side slope, or line of zero stress, much more nearly vertical. It is frequently assumed that the live load is carried down at a slope of $\frac{1}{2}$ horizontal to 1 vertical. In railroad embankments this slope is taken from the ends of the ties.

any outward bending due to the bending of the cover slab. In open-box construction, cross struts are often used to assist in holding the footings against the pressures on the walls and also to provide bearing area in addition to that furnished by wall footings (Fig. 322). The struts are designed as beams with a span equal to the width of the culvert, and the struts are so

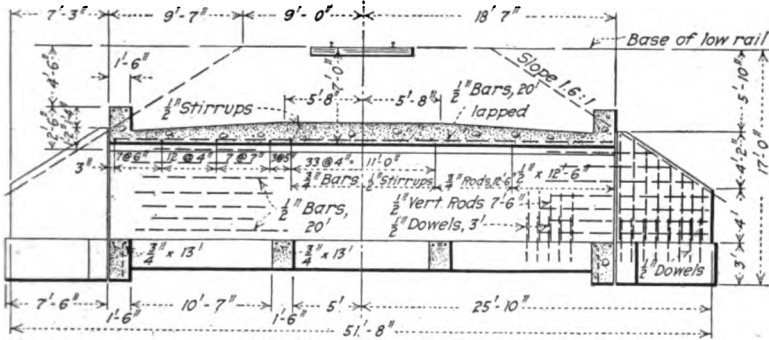

Sectional Elevation at Center Line of Culvert

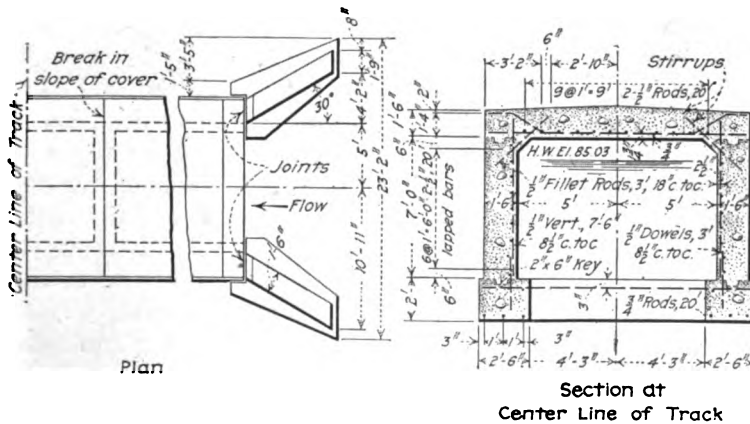

FIG. 322.—Single box culvert, C. M. & St. P. Ry.

spaced and proportioned as to obtain a uniform soil pressure throughout. When a bottom slab is employed and assumed to support the load, its thickness is made the same as that of the cover slab since the load for both slabs is substantially the same. Longitudinal reinforcement should be provided on account of the possibility of beam action due to unequal settlement. The amount of this reinforcement should depend upon the char-

acter of the foundation. Where the foundations are very bad, it is the practice of some engineers to figure the culvert as a whole to act as a beam, considering the length of beam as twelve times its depth. In long culverts under railroad tracks the load decreases beyond the ends of the ties and the cross-section should decrease whenever a material saving is found to result.

In Fig. 322, which illustrates a standard box culvert adopted by the Chicago, Milwaukee & St. Paul Railway, the cover is designed as a simply-supported slab with span equal to clear span when fillets are used and to clear span plus one-half the maximum cover thickness (but not to exceed 1 ft.) when no fillets are provided. Stirrups and bent rods are employed to take care of two-thirds of the shear when the shear exceeds 40 lb., bent rods being also used to care for any negative moments which may develop due to connection with side walls. Longitudinal steel is employed with a sectional area of about $\frac{7}{10}$ of the area of the entire concrete section. The side-walls, cross struts, and footings are proportioned in the same manner as above described. Keyways are formed in top of footings and side-walls so as to offer shearing resistance to movement of side-walls due to lateral earth pressure. For fills up to 40 ft., the load on the footings is assumed to include the live load and dead load of culvert, and the fill directly above the culvert for the width overall including footings. For fills over 40 ft. high, the total weight resting on the footings is considered as $62\frac{1}{2}$ per cent of the culvert weight plus $62\frac{1}{2}$ per cent of the fill above the footings. The live load is disregarded and, for ease in computation, the weight of culvert is taken as equal to the fill it displaces. Wing walls over 8 ft. in height or making an angle of less than 60° with the head-wall are made self-supporting cantilevers with a joint at connection with the barrel. Wing walls for all other conditions are made continuous with the main part of the culvert. The section of the culvert coming under the track is made approximately equal in length to the theoretical spread of the live load, which is equal to the distance out to out of ties (8 ft. for single track, 21 ft. for double track) plus the height of culvert plus one-half the height of fill above the cover slab. The invert is paved with a concrete slab in all spaces between struts so as to form a continuous concrete invert.

A somewhat rigorous analysis is sometimes made of the moments

in box culverts when such culverts are reinforced so as to act as monolithic concrete boxes (Figs. 318 and 321). Of course, it becomes a question of whether such accurate analysis, comparatively speaking, is especially worth while. Unless a number of

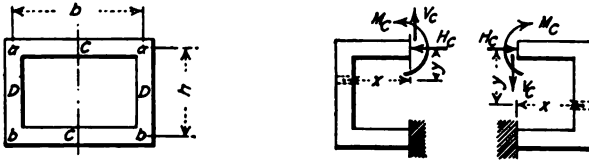

FIG. 323A.

identical culverts are to be constructed, the amount of material involved is likely to be too small to warrant any great refinement in design. In any case the following discussion will be of value as a guide to the judgment in the design of box culverts:

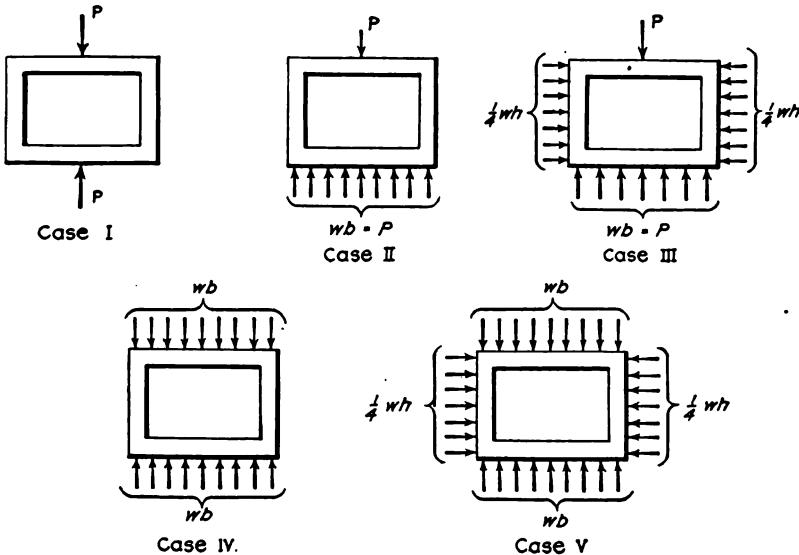

FIG. 323B.

Assume the rectangular culvert of Fig. 323A to be rigidly fixed at the center of the bottom slab. With this condition assumed, a unit length of the culvert may be treated in the same manner as a symmetrical arch with fixed ends. (See Fig. 323A.) The general formulas of Art. 14 will apply. Let

b = width c. to c. of side walls.

h = height between centers of top and bottom slabs.

I_C = moment of inertia of top and bottom slabs.

I_D = moment of inertia of the sides.

P = concentrated load.

w = uniform load per unit area.

M_C = bending moment in the top and bottom slabs.

M_D = bending moment in the sides.

M_a and

M_b = bending moment at the upper and lower corners, respectively.

H_C , V_C , and

M_C = internal forces acting at crown section.

M_L and

M_R = total bending moments at the center of any elements to the left and right of the crown section, respectively.

m = moment at any point on either half of culvert of all external loads between the point and the crown section.

Σ = summation referred to one-half of culvert only.

Since $V_C = 0$ and H_C is known for all the cases to be assumed (see Fig. 323B), a general equation for bending moment may be obtained from the fact that the changes in direction to the tangent to the axis at the crown section are equal for the two halves of the culvert, but are opposite in direction. Thus from Equation (1) of Art. 10, we have

$$\Sigma M_L \frac{s}{E_c I} = - \Sigma M_R \frac{s}{E_c I}$$

The bending moment at any point may be expressed as follows:

$$M_L = M_C + H_C y + V_C x - m_L$$

$$M_R = M_C + H_C y - V_C x - m_R$$

Substituting:

$$M_C = \frac{\Sigma m \frac{s}{I} - H_C \Sigma y \frac{s}{I}}{\Sigma \frac{s}{I}}$$

It is evident that the values of $\Sigma \frac{s}{I}$, $\Sigma y \frac{s}{I}$, and $\Sigma m \frac{s}{I}$ must be determined before the value of M_C can be found. It can be seen at a glance that

$$\Sigma \frac{s}{I} = \frac{b}{2I_C} + \frac{h}{I_D} + \frac{b}{2I_C} = \frac{b}{I_C} + \frac{h}{I_D}$$

$$\Sigma y \frac{s}{I} = 0 + \frac{h^2}{2I_D} + \frac{bh}{2I_C}$$

and for Case I

$$\Sigma m_I^s = \frac{Pb^2}{16I_C} + \frac{Pbh}{4I_D} + \frac{Pb^2}{16I_C} = \frac{Pb^2}{8I_C} + \frac{Pbh}{4I_D}$$

To obtain the summation of m_I^s for the other cases, a knowledge of the Calculus is needed. The following formulas result:

Case I

$$M_C = \frac{Pb}{4} \cdot \frac{\left(\frac{1}{2} \cdot \frac{b}{I_C} + \frac{h}{I_D} \right)}{\frac{b}{I_C} + \frac{h}{I_D}}$$

$$M_D = M_a = M_b = M_C - \frac{1}{4} Pb$$

For a square uniform section, $M_C = \frac{3}{16} Pb$, and $M_D = -\frac{1}{16} Pb$. For a square uniform section and for equal vertical and lateral forces $M_C = M_D = \frac{1}{8} Pb$ and $M_a = M_b = -\frac{1}{8} Pb$, the same as in fixed beams.

Case II

$$M_C = \frac{Pb}{4} \cdot \frac{\left(\frac{1}{2} \cdot \frac{b}{I_C} + \frac{h}{I_D} \right) + \frac{wb^3}{48I_C}}{\frac{b}{I_C} + \frac{h}{I_D}}$$

$$M_D = M_a = M_b = M_C - \frac{1}{4} Pb$$

Case III

$$M_C = \frac{Pb}{4} \cdot \frac{\left(\frac{1}{2} \cdot \frac{b}{I_C} + \frac{h}{I_D} \right) + \frac{wb^3}{48I_C} + \frac{\frac{1}{4} wh^2}{16} \left(\frac{b}{I_C} + \frac{h}{3I_D} \right) - \frac{wh^2}{16} \left(\frac{b}{I_C} + \frac{h}{I_D} \right)}{\frac{b}{I_C} + \frac{h}{I_D}}$$

$$M_a = M_C - \frac{1}{4} Pb$$

$$M_D = M_a - \frac{1}{32} wh^2$$

$$M_b = M_a - \frac{1}{8} wh^2$$

Case IV

$$M_C = \frac{wb^2}{8} \cdot \frac{\left(\frac{1}{3} \cdot \frac{b}{I_C} + \frac{h}{I_D}\right)}{\frac{b}{I_C} + \frac{h}{I_D}}$$

$$M_D = M_a = M_b = M_C - \frac{1}{8}wb^2$$

For a square uniform section, $M_C = \frac{1}{12}wb^2$ and $M_D = -\frac{1}{24}wb^2$. For a square uniform section and for equal vertical and lateral forces $M_C = M_D = \frac{1}{24}wb^2$ and $M_a = M_b = -\frac{1}{12}wb^2$, the same as in fixed beams.

Case V

$$M_C = \frac{\frac{wb^2}{8} \cdot \left(\frac{1}{3} \cdot \frac{b}{I_C} + \frac{h}{I_D}\right) + \frac{1}{4}wh^2 \cdot \left(\frac{b}{I_C} + \frac{h}{3I_D}\right) - \frac{wh^2}{16} \left(\frac{b}{I_C} + \frac{h}{I_D}\right)}{\frac{b}{I_C} + \frac{h}{I_D}}$$

$$M_a = M_C - \frac{1}{8}wb^2$$

$$M_D = M_a - \frac{1}{32}wh^2$$

$$M_b = M_a - \frac{1}{8}wh^2$$

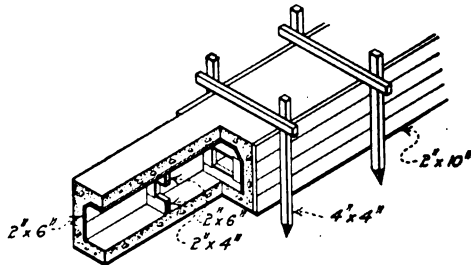

FIG. 324.—Forms for 2-ft. box culvert.

87. Construction.—The inside forms for small box culverts are usually arranged to be collapsible or at least so that the frames against which the lagging is placed may be easily knocked out after the concrete has properly set. In Fig. 324 the inner forms consist of boards placed against frames made of three pieces of 2 × 4-in. and one piece of 2 × 6-in. joists, notched as shown.

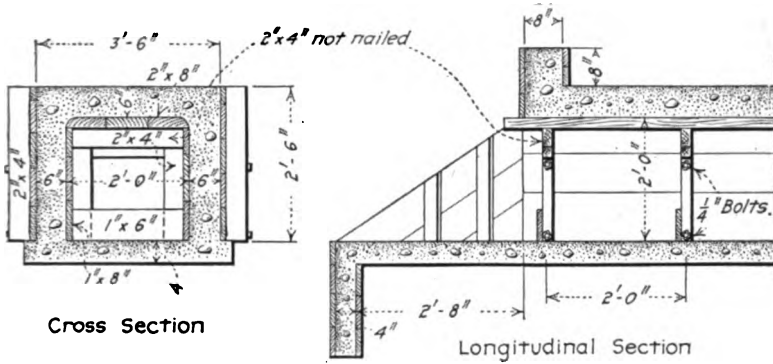

FIG. 325.—Forms for small box culverts, Iowa Highway Commission.

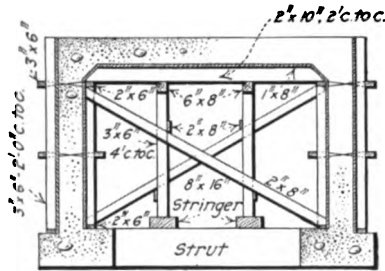

FIG. 326.—Box-culvert forms, C. M. & St. P. Ry.

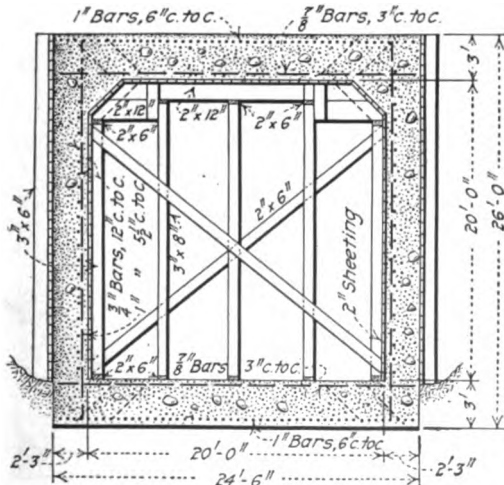

FIG. 327.—Box-culvert forms, C. B. & Q. R. R.

The 2 × 6-in. piece at the top is not nailed in order that it may be readily knocked out after the concrete has hardened. The removal of this piece allows the 2 × 4-in. joists to be withdrawn, thus releasing the boards. Where the soil is hard and compact, the outer forms may be omitted and the concrete deposited directly in the trench made to exact size of culvert cross-section. Another type of small box culvert form is shown in Fig. 325.

The forms for large box culverts need no special consideration as they are similar to the forms for walls and floor slabs in ordinary construction. Standard form details adopted by two prominent railroads are shown in Figs. 326 and 327.

If running water is encountered which cannot be temporarily diverted or dammed, the water in the case of small culverts should be carried in a new trench around one side of the back forms. In the case of the larger structures the trench excavated for the culvert should be arranged to flume the stream through between the abutments.

CHAPTER XXII

ARCH CULVERTS

The arch type of culvert should be employed where an artistic design is especially desirable, and should also be used in all cases where the fill to be supported is excessively high and the foundations suitable. High fills over box culverts necessitate a slab of considerable thickness and the arch becomes the more economical under such conditions because of the fact that an increase in fill does not produce a corresponding increase in ring stress. Arch culverts of reinforced concrete are not usually designed for spans less than about 8 ft., as plain concrete seems to answer the purpose for such small structures.

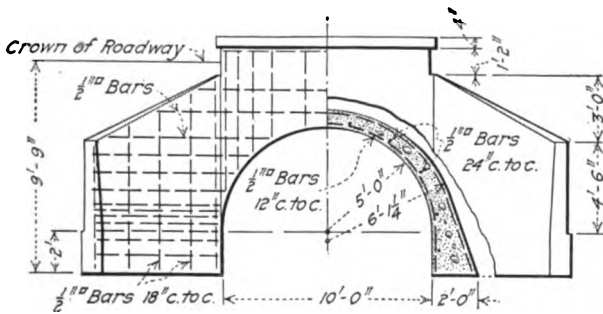

FIG. 328.—Standard design for 10-ft. arch culvert, State of Missouri Highway Department. (Actual dimensions and shape of foundations governed by conditions of soil at location of site.)

88. Design of Cross-section.—In the ordinary type of arch culvert represented in Fig. 328, the arch ring may be analyzed in the same manner as described for arch bridges in Part I of this volume. A uniform live load only is considered and this is placed over the whole span. Although steel is used, the line of pressure is usually kept everywhere within the middle third. In determining the dead load on the arch no allowance is made for the arching action of the fill, but the horizontal components of the earth pressure are taken into account. Longitudinal reinforcement is needed to prevent objectionable cracks caused

by the shrinkage of concrete in hardening and the contraction due to a lowering of the temperature, and also to distribute the load.

Inverts are employed in the designs shown in Figs. 329 and 330 in order to provide additional bearing area and thus reduce the large abutments which would otherwise be needed in order to bring the pressure on the soil to a safe value. An invert also tends to prevent any possibility of water undermining the

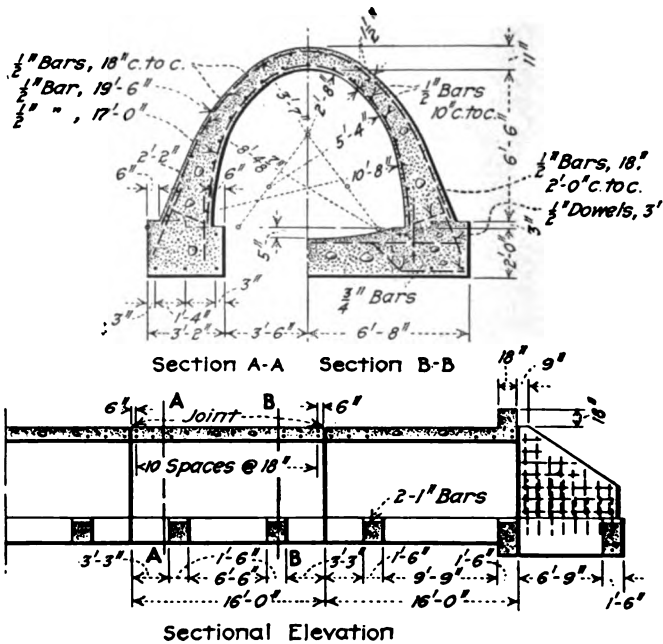

FIG. 329.—Standard arch culvert for fills up to 40 ft. high, C. M. & St. P. Ry.

structure and the foundation need not always be carried to the same depth as when the abutments are independent of each other.

When the arch ring and invert are thoroughly tied together so as to act as a monolith (a rare case except in masonry sewer design), the entire culvert may be analyzed in a similar manner to that of the monolithic box (see preceding chapter). For a complete treatment of arch structures of this type, see Chapter XIII of American Sewerage Practice, Vol. I, by Metcalf and Eddy.

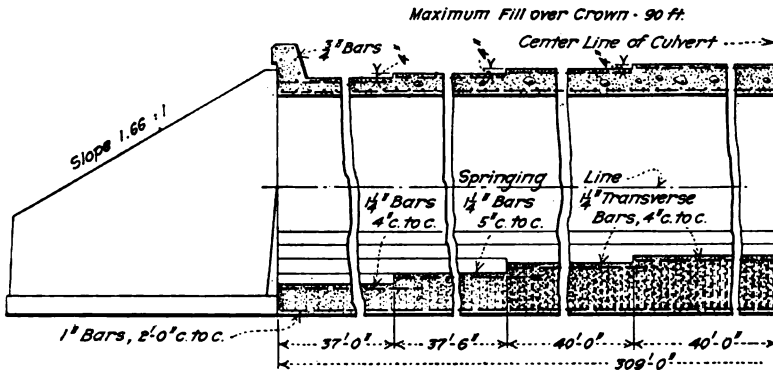
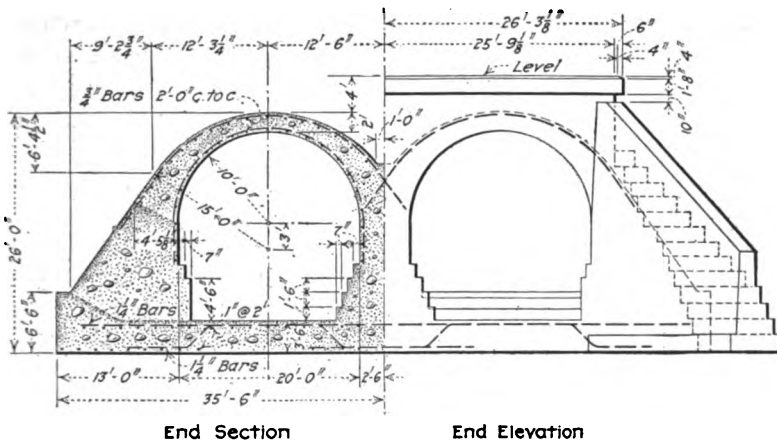

FIG. 330.—Double-barrel culvert, D. L. & W. R. R.

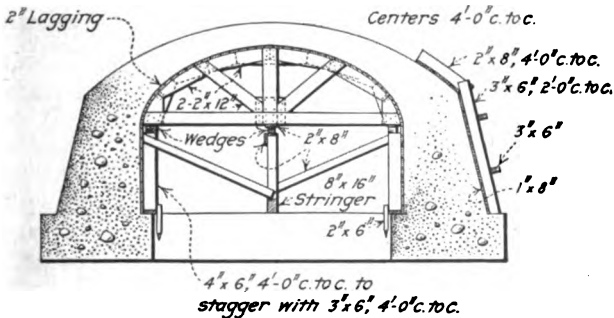

FIG. 331.—Centering for arch culvert, C. M. & St. P. Ry.

89. Forms.—The centers and forms for the arch culvert are similar to those required for the arch bridge of small span. Where inverts are employed, the concrete for the footings and floor in the stream bed should be deposited first and then the

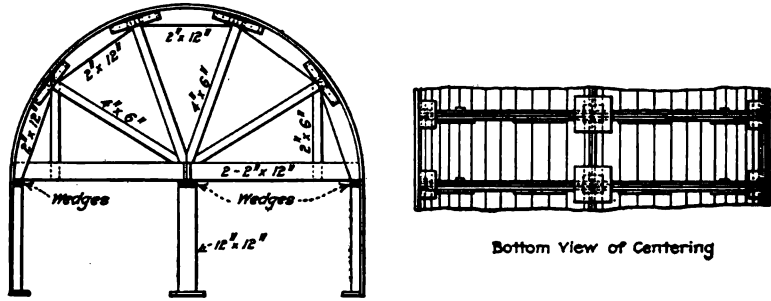

FIG. 332.—Centering for arch culverts.

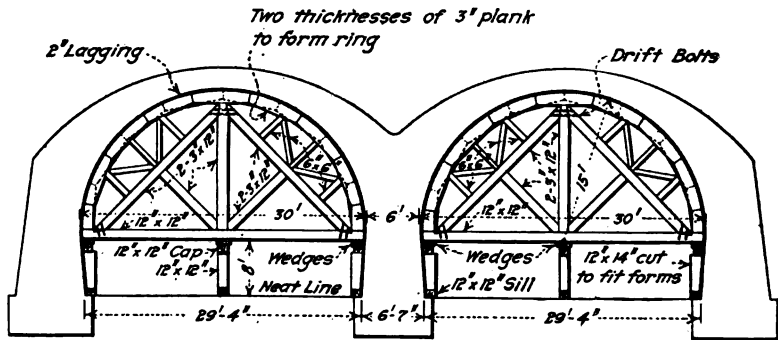

FIG. 333.—Details of centering, Canoe Creek culvert, near Cloe, Pa., B. R. & P. Ry.

centers for the arch erected on this concrete. Fig. 331 shows the type of arch culvert centers and forms used by the Chicago, Milwaukee and St. Paul Railway. Other types of centers are shown in Figs. 332 and 333.

PART IV

NOTES ON CONSTRUCTION PLANT

BY A. W. RANSOME

Vice-President of the Ransome Concrete Machinery Co.

General rules governing the selection of plant have been given in the preceding volume. Inasmuch as the rules there set forth will be found applicable to the selection of plant for bridges and culverts, the reader is advised to refer to these rules in Volume II in connection with the considerations which follow.

The primary consideration that plant is but a substitute for labor, and that no more should be invested in plant than will yield a good return on the investment, is so important as to bear repetition. This relation is apparently lost sight of in many cases. Perhaps it is too obvious, too axiomatic, and is consequently ignored; but then, again, it may be probable that this mistake is the result of lack of reliable information on which to base an accurate comparison of costs between hand labor and the various types of construction plants.

In the treatment of plant in this volume all phases of plant operation will be considered, avoiding as far as possible a repetition of the subject matter treated in Volume II. A certain amount of repetition is unavoidable, however, lest the reader be kept looking from volume to volume to the degree of discouragement.

CHAPTER XXIII

HANDLING MATERIALS

90. Aggregates.—Plant will be considered to include the cars in which the aggregate may be delivered by the railroad. The type of car used often exercises considerable influence on the cost of handling, so, where such is the case, it is important to specify the manner in which delivery is to be made. Care in this respect will be found to work a decided economy in carrying out the average contract, and the conditions of delivery may even determine the placing of the material order at a higher price.

Take, for example, two quarries located on different railroads, one railroad prepared to supply only hopper-bottom cars, the other to

furnish flat-bottom cars. Assume now that the plan of operation involves unloading the stone by shoveling, and assume also that one quarry, on railroad No. 1, quotes \$1.30 per cubic yard, and the other, on railroad No. 2, quotes \$1.32 per cubic yard. It will be found cheaper in the end to order your material at \$1.32 per cubic yard, for the reason that you can more than save the difference in cost in unloading.

A good man, under efficient superintendence, can unload 2 cu. yd. per hour from a flat-bottom car, as against $1\frac{1}{2}$ cu. yd. per hour from a hopper-bottom car—a saving of at least 3 cents per cubic yard—and this proportional saving increases as less efficient labor is employed. These figures are based on the writer's personal experience and represent average results over a number of years. A good man under a

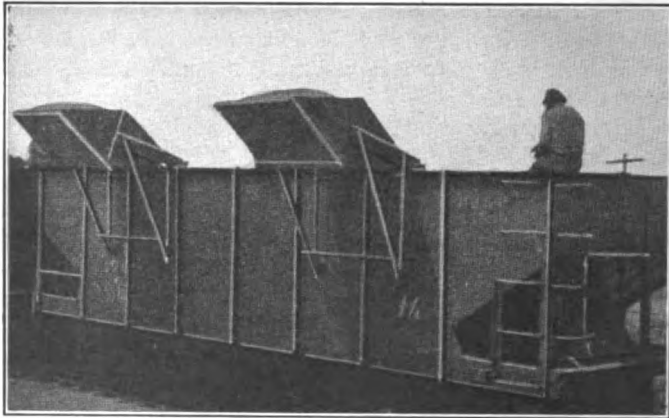

FIG. 334.

yardage or carload system will perhaps average 50 per cent more than the above, but the ratio will not change between the two types of cars.

It will also be found that the low-side cars will be more economical for unloading than the high-side, except where a wagon loader (Figs. 334 and 335) is to be used. Where a loader of this type is employed, the car side to which it is attached should either be of sufficient height to give wagon clearance, or stakes should be provided to raise the hopper sufficiently for the purpose. The use of a hopper of this type expedites unloading the car and, in these days of demurrage charges, this is an item for consideration, aside from the saving of team hours. One, two, or three hoppers may be attached to a single car and one or more men put in the car for each hopper, depending upon the number of teams available. The hoppers should be ready as the teams range alongside the car, and the material should be instantly discharged into the wagons to avoid all delay at the car.

Where a siding extends to the construction site, sand and stone may be shoveled directly from the cars onto the ground, which should have been previously smoothed. That portion of the ground designed for the

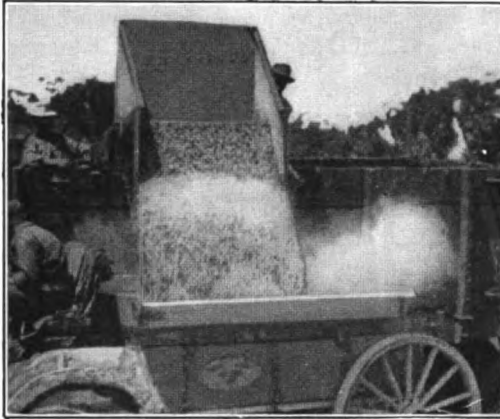

FIG. 335.

stone should first be spread with a layer of sand at least 1 in. thick, this layer serving to keep the stone clean and also working economy in subsequent shoveling. In order that materials may be piled high and

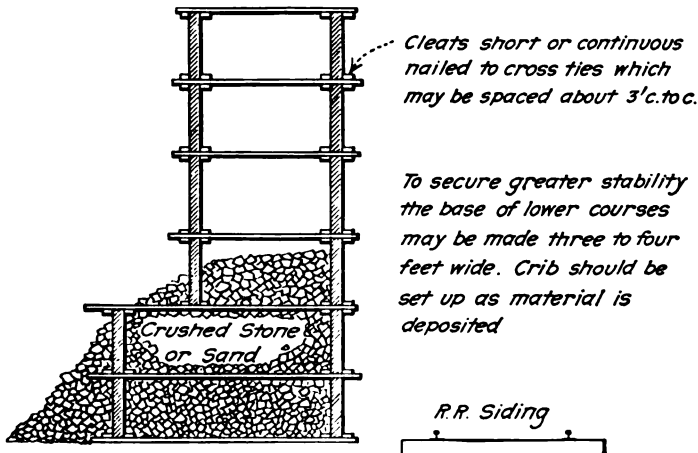

FIG. 336.

the track be kept clear, a bulkhead may be built of a double row of 2×12 -in. plank with 1×3 -in. cross ties, having stops as indicated in Fig. 336. This method requires no fitting or cutting of the plank.

The type and condition of shovel used in unloading materials will have an important bearing on the results obtained. The writer has noticed a tendency to regard the shovel as a very unimportant matter, but it is not so regarded by the workman himself. A good man will always look for a good shovel, and under a task or piece-work system he would perhaps use a larger shovel than the one with which he would ordinarily be supplied. Throughout South America it has been the general practice for each man to bring his own shovel, and this practice leads to the exploitation of tools wonderfully adapted to reduce to the minimum the actual work done while going through the motions. The practice was followed very generally in the West in early days. Our western

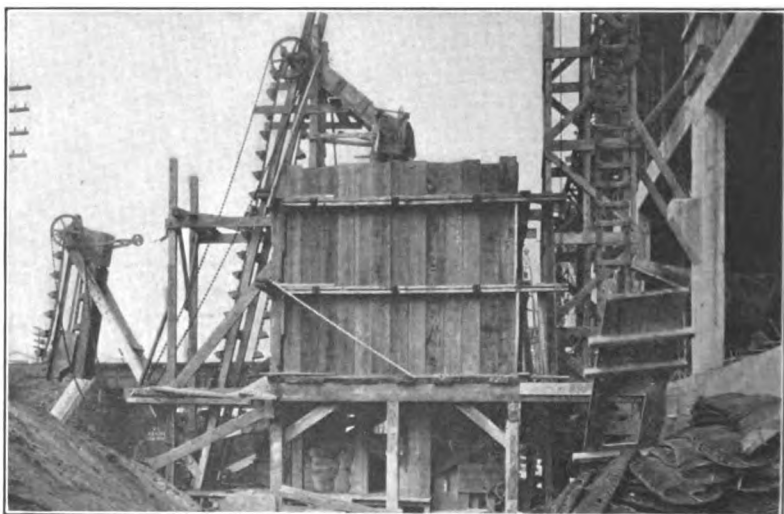

FIG. 337.

contractors, however, early found it economy to supply their men with good "workmanlike" tools.

Mr. Frederick W. Taylor in his investigations found that a shovel adapted to a load of 21 lb. gave the best results. Such a shovel for general concrete work will correspond more nearly to the standard No. 4 size shovel than to the No. 3 size most generally supplied when your order calls simply for one dozen shovels. Why not add to your order the size of shovel wanted? Why not further specify the make and grade? Why not go to the maker and learn something of shovels and then specify intelligently?

For an implement which figures so largely in nearly all concrete work, the shovel used has perhaps been accorded the least consideration, whereas it is deserving of a great deal. Contractors ordinarily

buy machinery by specification—they specify a maker known to them; but, more often than otherwise, shovels are purchased without any regard to the nature of the work for which they are to be used.

There are shovels of different sizes for various materials. For general concrete work a No. 4 shovel should be used to get the best results, and, as a general rule, the higher the grade of shovel, the better the result. No. 4 shovels of A-grade, costing \$9.00 per dozen, will prove cheaper in the end than D-grade shovels, No. 3 size, costing \$5.00.

Where the volume of material warrants the installation of an unloading device, a bucket unloader of the type shown in Fig. 337 may be used, or a clam-shell bucket as shown in Fig. 338 may be employed and operated from a derrick or locomotive crane. With a bucket unloader the labor cost, according to Mr. Turner of the Turner Concrete

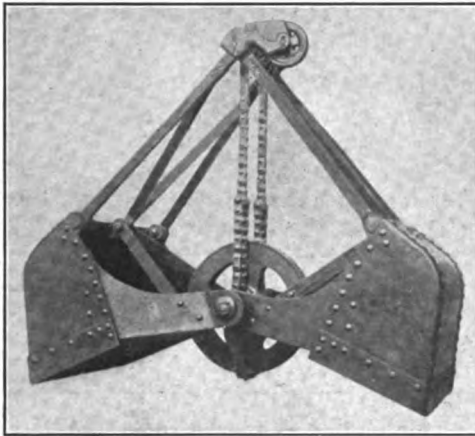

FIG. 338.

Steel Company of Philadelphia, will be 3.5 cents per cubic yard. With a clam-shell bucket it will be 4.5 cents per cubic yard.

In connection with hopper bottom cars, a trestle may be built or any of the many types of wagon loaders may be used. Fig. 339 illustrates a type of loader sometimes employed. Wagons may be loaded directly by the device shown in Fig. 339A.

In Fig. 387, page 564, of Volume II is shown a hopper placed beneath the track to serve a feeder for an ordinary bucket elevator. Any of the above types of unloaders may be used to deliver the materials into wagons or bins, and the latter may be designed to discharge into wagons or direct into mixer, as conditions may require.

91. Cement.—Cement is ordinarily ordered in cloth bags, owing to greater ease in handling. Since the price of the cloth bag will be refunded by the cement mills only for bags returned in good condition,

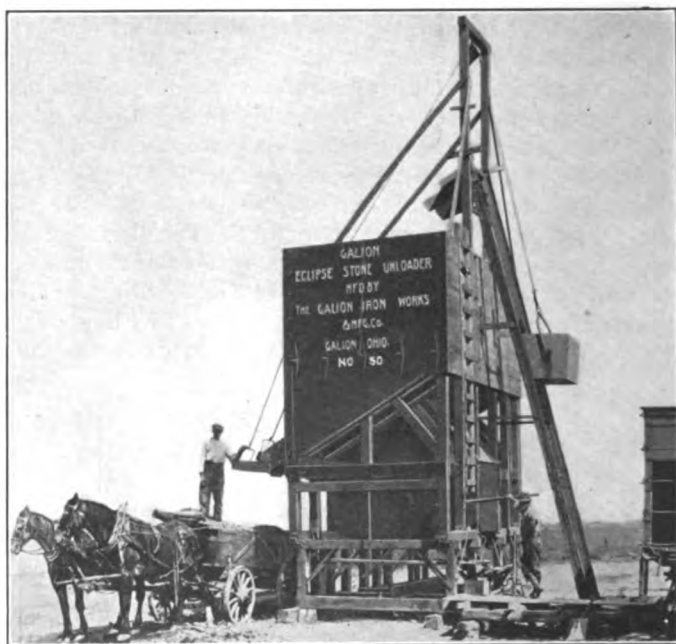

FIG. 339.

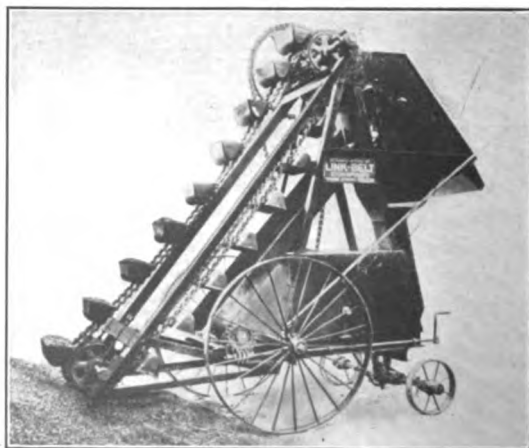
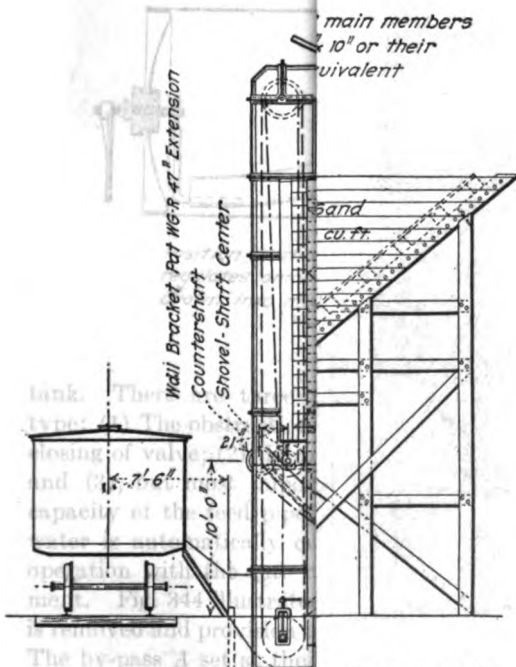
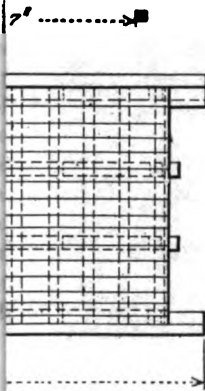

FIG. 339A.

cement, which is now to
 340 is shown a plant ar
 32. Water.—The prob
 from questions of fitness
 problem of handling wat
 plants operating at high
 the theoretical maximum
 forth in Art. 108 of Volu
 which the water can be a
 Figs. 341, 342, and 3



(Facing Page 458.)

tank. The
 types of val
 (Fig. 7-6
 capacity of the
 operation
 The by-pass A set
 water from one tank to the
 proper height. A mov
 the feed pipe into the
 point and overflows into

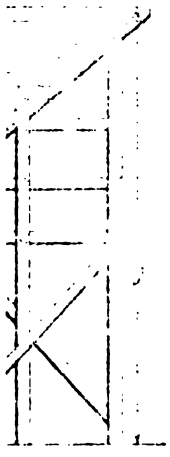
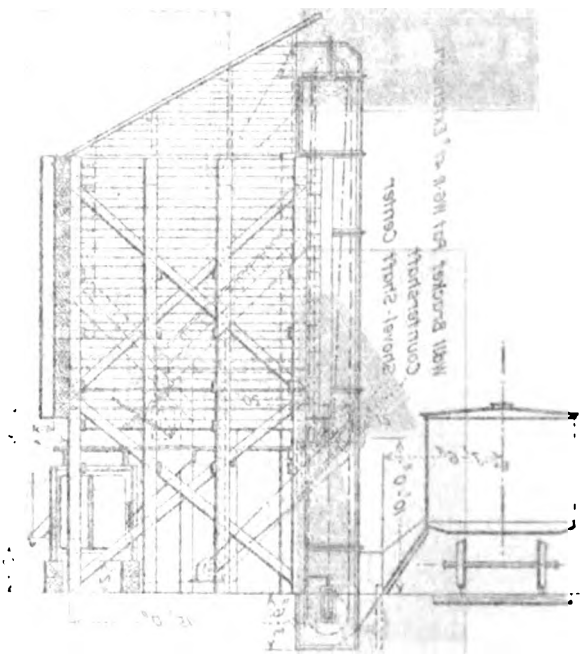

Fig. 340



provision should be made not only against loss but also against damage by water. This troublesome problem of caring for empty cement bags has been an important consideration in promoting the use of bulk cement, which is now being extensively used on large work. In Fig. 340 is shown a plant arrangement involving the use of bulk cement.

92. Water.—The problem of water is often a serious one. Aside from questions of fitness or unfitness, cost, etc., there is the ever-present problem of handling water fast enough. Probably 75 per cent of the plants operating at high efficiency—that is, at a rate approximating the theoretical maximum as determined by physical limitations set forth in Art. 108 of Volume II—have their limit set by the speed with which the water can be measured and fed.

Figs. 341, 342, and 343 illustrate the ordinary type of measuring

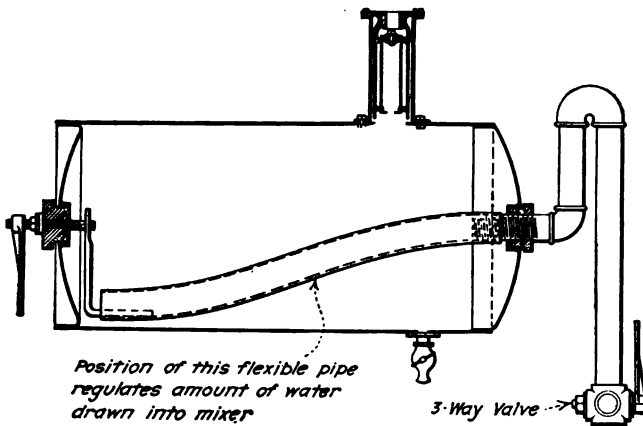

FIG. 341.

tank. There are three principal objections to tanks of the above type: (1) The obstruction offered to the inflow of water through gradual closing of valve; (2) the practical limitation set to size of outflow pipe; and (3), but most important, the impossibility of utilizing the full capacity of the feed pipe, since in all cases when the tank is full the water is automatically cut off, requiring perfect timing of the mixing operation with the rate of water flow, an ideal impossible of attainment. Fig. 344 illustrates a duplex tank in which this latter objection is removed and provision made for utilizing the feed line to full capacity. The by-pass *A* set at the proper level provides for the overflow of the water from one tank to the other, as the water in the former reaches the proper height. A movement of the lever *B* opens the valve *C* and shifts the feed pipe into the second tank which in turn fills to the proper point and overflows into the first tank. This tank further permits the

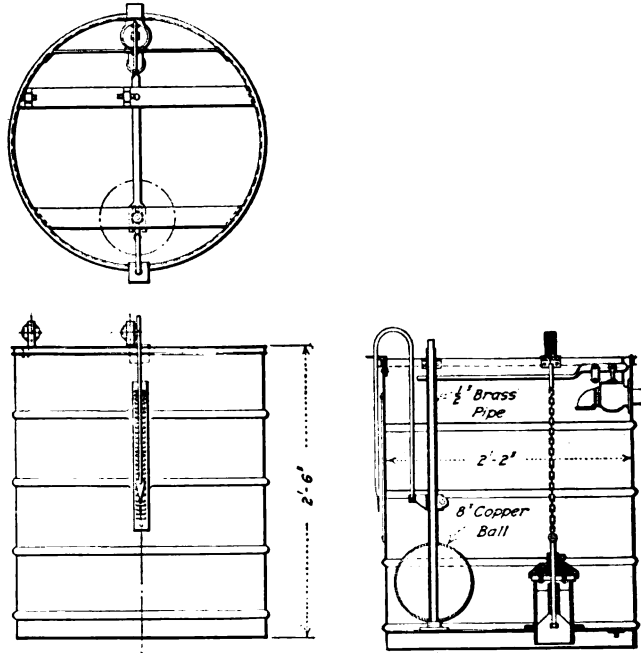

FIG. 342.

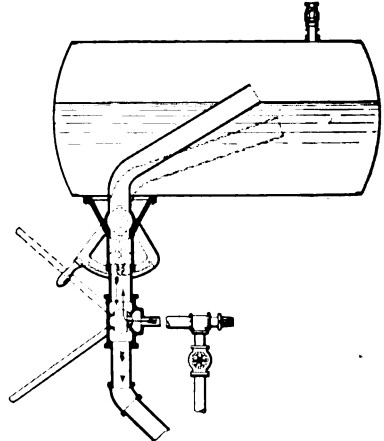

FIG. 343.

use of a large outflow pipe unobstructed by valves, etc. Water under a light head flows slowly (approximately 1 gallon to the second through a 2-in. pipe), and since common practice of today requires $1\frac{1}{2}$ to 2 gal-

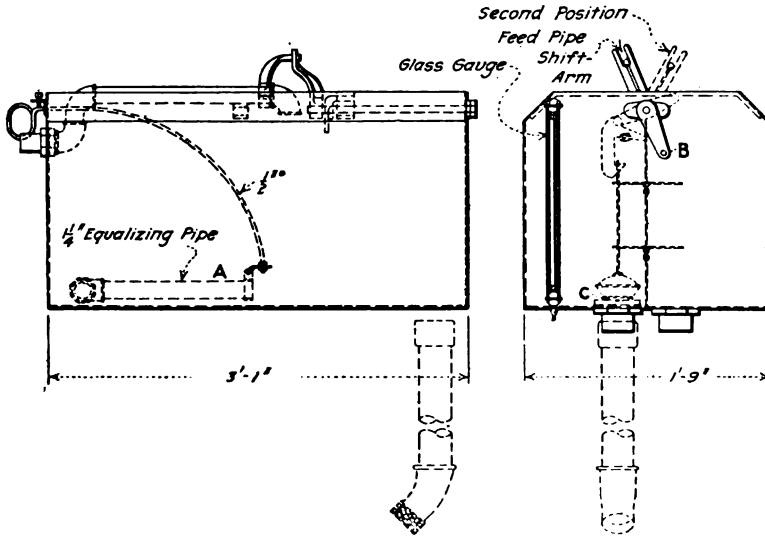

FIG. 344.

lons of water per cubic foot of material, the time of flow becomes an important matter, especially so since it is very desirable that all the water for the batch be fed into the mixer in advance of the aggregates.

CHAPTER XXIV

MIXING

93. Hand Mixing.—The present tendency in every line of activity is toward the substitution of machinery for hand labor. To this tendency the contracting and engineering field is no exception. There are, however, many small jobs on which it is more economical to mix concrete by hand. Even in large work it is sometimes advisable to resort to hand mixing; for example, at the beginning and end of a job or where the concrete is to be placed in positions widely scattered. While the cases where hand mixing is economical are rapidly disappearing for reasons to be later set forth, it is important that due consideration

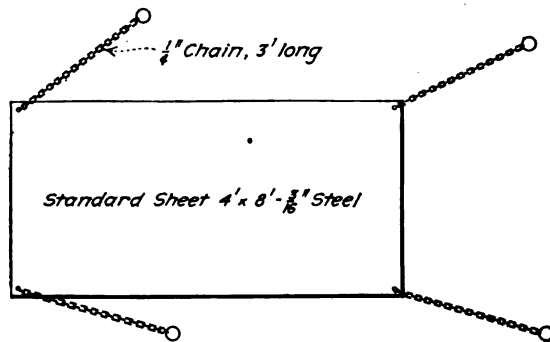

FIG. 345.

be given to the process of hand mixing wherein the plant consists mainly of the shovel, the wheelbarrow, the rake, and the mixing board.

The cost of hand mixing will vary with local conditions; but with a full knowledge of conditions, the cost may be readily and accurately estimated, for which purpose the reader will find Taylor and Thompson's "Concrete Costs" of value.

For efficient mixing by hand it is of prime importance that a suitable mixing platform be provided. This platform should be at least 48 in. \times 96 in. for single batches, or 96 in. \times 96 in. for double batches, and may be of wood or steel. The writer has a decided preference for a steel plate (Fig. 345) of size suitable for a single batch, using two or more as the number of batches to be mixed simultaneously is increased. This type of platform is readily moved, gives an excellent shoveling surface,

and if it is always kept close against the toe of the stone pile, minimum handling of materials is the result.

For measuring the aggregates, straight-topped barrows are strongly recommended as being more accurate than measuring boxes, and the barrows should be of such sizes, or assortment of sizes, as to permit struck measure rather than rounded or heaping measure. Where bottomless boxes are used, they should preferably be smaller in plan and deeper than those ordinarily employed. Also struck measurement should be insisted upon, as it is only in this way that accuracy may be obtained.

The cost of hand mixing may usually be accurately estimated by an analysis of the various operations entering into the process. The following is taken from page 278 of Taylor and Thompson's "Concrete Costs."¹

"A gang on a large subway tunnel, materials close at hand, the cement and sand being mixed into a mortar and spread on the gravel before turning it; the concrete shoveled directly to place.

"One foreman with 2 gangs, consisting in all of 19 men, each gang divided as follows:

2 men mixing mortar.

4 men shoveling stone, mixing concrete, and shoveling concrete directly to place.

1 man assisting to shovel concrete, washing gravel, and other odd work.

2 men in excavation receiving concrete and ramming it.

1 extra man working with both gangs carrying water and on odd work.

"This double gang mixed about 64 batches per day of 10 hours. The proportions were 1:2½:4, and, since for gravel concrete (gravel being assumed to have 40 per cent. voids), we find from Table 22, on page 151, that 1.40 barrels cement are required per cubic yard, this quantity divided into 64 batches per day gives an output of about 46 cu. yd. per day of 10 hours."

Now let us assume for comparison that it is proposed to use a machine such as the "Bantam" Fig. 346. For each batch there must be loaded into barrows, wheeled, and discharged into the mixer, 1 barrow of sand and 2 barrows of stone, together with water and cement for each batch. An average man will load his own barrow, wheel a distance, say 50 ft., and return every 3 minutes, allowing for average delays and rests. Taylor and Thompson's "Concrete Costs" set the figure lower than we have assumed above. If, therefore, we put on a double crew consisting of 6 men, we shall be able to deliver material for a 1-bag batch of the proportions 1:2:4 every 1½ minutes. One man will be required at the

¹ Copyright 1912 by Frederick W. Taylor.

mixer, another to handle cement. If now we assume the mixer so placed that the concrete can be discharged directly into place, we need only provide the men in the excavation to receive and ram the concrete (say 6 men, by reason of the greater amount we shall handle) and our organization is approximately as follows, allowing for 2 extra men:

1 foreman.
 6 men handling sand and stone.
 1 man handling cement.
 1 mixer attendant.
 6 men placing concrete.
 2 extra men.

—
 17 total.

With these men, 3 less than required for hand work, we can turn out 40 batches of 1 : 2½ : 4 concrete per hour. Assuming 40 per cent voids in the stone, our day's output would be 71 cu. yd. of concrete. We would thus save 3 men and do approximately 45 per cent more.

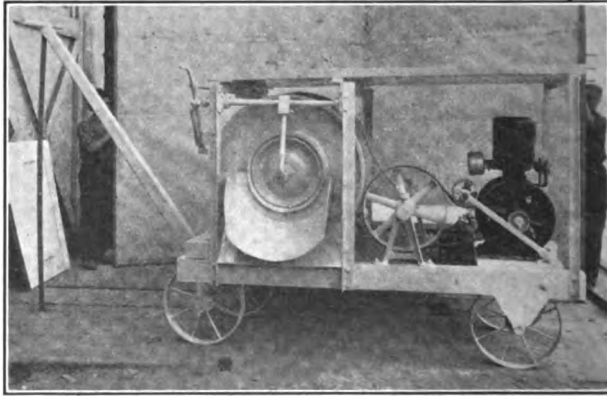

FIG. 346.

Since the mixer utilized for the above comparison can be purchased for \$275.00 complete, it will quickly pay for itself and one need not have many days' work in sight to warrant the investment of the amount involved, provided of course that maintenance charges are not going to counter-balance.

94. Machine Mixing.—Of late the field of machine mixing has been materially broadened by the introduction of small machines, such as the "Bantam" type referred to in the preceding article. These machines are low in cost, efficient in operation, and are easily transported and set up. The T. L. Smith Company's "Mascot" (Fig. 347) is another machine of this class. The Standard Scale and Supply Com-

pany also turn out a reliable machine, and doubtless there are others. In making a purchase, however, it should be borne in mind that the more simple the construction of the machine, the more satisfactory will the investment prove; but on these lighter machines which have low

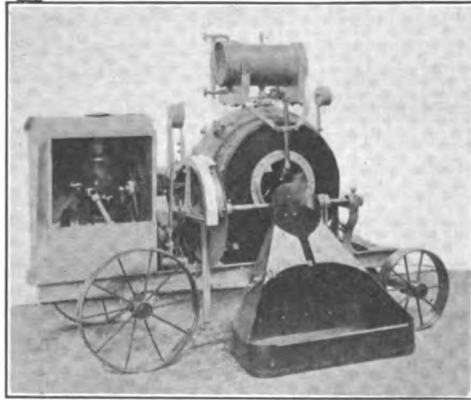

FIG. 347.

first cost and lightness for their primary requisities, the details will vary materially from similar details on more elaborate and costly machines.

To the end that the machine may be as light as possible, rolled steel and wood should replace cast steel and cast iron wherever the change

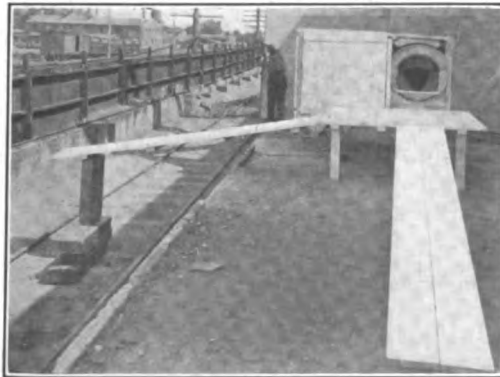

FIG. 348.

can be made without serious sacrifice of efficiency; but steel plates of lighter weight than No. 10 should not be used, save for protection against weather. Sprockets and chain should have preference over gearing on account of lightness. The carrying rollers for a similar reason should

be of the self-oiling type, and revolve loose in fixed shafts, thus saving the weight and expense of journals. It must be conceded that loose rollers of this type are not quite so durable as rollers fixed to shafts revolving in proper journals, but they are lighter and the arrangement is cheaper. The service they give will also be found fairly satisfactory.

In the development of the "Bantam" the considerations mentioned have been given due weight and, in order to increase the capacity to the maximum, a door has been perfected which permits the effective closing of the discharge opening with the result that 10 cu. ft. can be crowded into a mixer of size 1700 lb. lighter than is the case where the ordinary open-end type of drum is used.

The writer is credited with rather radical views as to the efficiency of small machines, holding that where a mixer must be charged wheel-

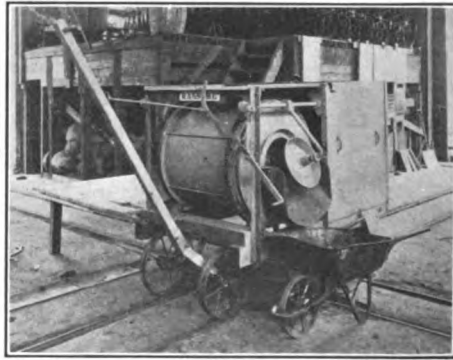

FIG. 349.

barrow at a time and the mixed material similarly handled, a mixer designed to handle a 1-bag batch will prove most efficient, and furthermore that the simplest type of machine arranged for low charging and comparatively high discharge (see Figs. 348 and 349) will prove the most efficient of its class.

	Low charger	Power loader
Assembling batch—in mixer.....	24 seconds	In hopper 24 seconds
Hoisting hopper.....		10 seconds
Flow of material, hopper to mixer.....		10 seconds
Lowering hopper.....		5 seconds
Mixing.....	30 seconds	30 seconds
Discharging into 4 barrows.....	28 seconds	28 seconds
	<hr/> 82 seconds	<hr/> 107 seconds
Allow for overlapping of operations.....		24 seconds
		<hr/> 83 seconds

The above comparison is based on actual operations, and unit times given are not exceptional. It will be further noted that, as the assembling time is reduced, the comparison becomes more favorable to the direct charged mixer, since this operation is the only one which can overlap. Conversely, as the time of assembly increases, the comparison becomes more favorable to the mixer with the power loader. In the above the time required to load the barrow has not been considered, since this is identical in both cases. The operation alone has been considered starting from the point where the barrows are loaded ready for the mixing operation.

A second comparison will be made between a 1-bag-capacity low-charging mixer and a 2-bag-capacity machine with loader, materials to be handled in barrows on both sides of the mixer. For the purpose of illustration, average men will be assumed who will load a wheelbarrow, wheel a distance of 5 ft., discharge their barrow, and return in 3 minutes. This is a conservative figure. Upon this basis the organization for the two plants will be as follows:

1-bag mixer	Operation	2-bag mixer
6 men	Assembling batch	12 men
1 man	Handling cement at mixer	1 man
3 men	Wheeling mixed concrete	6 men
1 man	Extra man	2 men
<hr/>		<hr/>
11 men, total		21 men, total

The above crews will operate as follows:

24 seconds	Assembling batch	48 seconds
	Hoisting hopper	10 seconds
	Time of flow of materials hopper to mixer	15 seconds
	Lower hopper	5 seconds
30 seconds	Mixing	30 seconds
28 seconds	Discharge of mixer into barrows	56 seconds
<hr/>		<hr/>
82 seconds		164 seconds
	Less overlap of assembling time	48 seconds
		<hr/>
		116 seconds

Reducing these operations to 1-man time gives 902 seconds per batch for the 1-bag mixer as against 2436 seconds for the 2-bag mixer, the respective batches yielding say 6 and 12 cu. yd. of finished concrete, with a time per cubic foot of respectively 151 and 203 seconds.

It must be borne in mind that, in making the above comparisons, conditions have been assumed somewhat unfavorable to the large machine; but the conditions so assumed are such as must prevail in many cases, and the comparison given merely outlines the method to be pursued in coming to a determination of the type of machine to be used.

If the entire batch is discharged directly from the mixer to place, into a car or bucket, the result at once becomes favorable to the larger machine both directly and indirectly in overheads, superintendence, etc. This point is one often overlooked and the advantage of the large machine is thrown away through failure to properly appreciate the importance of limiting the time consumed in the operations of charging and discharging. The writer observed, on a large building operation in Chicago, a case of flagrant violation of first principles in plant operation.

The organization on the work was as follows:

- 15 men loading barrows, wheeling, and charging.
- 1 man handling cement.
- 1 man operating discharge chute.
- 8 men distributing mixed concrete in barrows.

25 men, total

This crew was mixing concrete in a $\frac{1}{2}$ -yard mixer at the rate of one batch in $4\frac{1}{2}$ minutes, this limit being set by the delays incident to the manner of charging and discharging. The mixing cycle was as follows:

For a 3-bag batch of 1: $2\frac{1}{2}$: 5 concrete:

Assembling batch in mixer:

Charging 3 bags cement.....	21 seconds	
Charging 10 pails of water.....	30 seconds	
Charging 9 barrows of aggregate.....	63 seconds	114 seconds
Mixing.....		30 seconds
Discharging into 10 barrows.....		70 seconds
Delays in discharging due to incidental shifting of runways, etc.....		56 seconds
		270 seconds

It was pointed out to the superintendent of this work that he was wasting time and labor by using 6 extra men to load barrows with sand and gravel, since his wheelers were forced in every instance to wait for the discharge of materials from the mixer. He was shown that men could load their own barrows, wheel to mixer and return in 3 minutes. Installation of a batch-charging hopper was recommended. The delays on the discharge side were pointed out and a suggestion made that the batch be discharged on a platform, whence it could be pulled off into barrows with a stroke of a hoe and the number of wheelers be reduced, since they could work steadily rather than spasmodically. A water tank was recommended. These suggestions were carried out, with the results that a speed of 3 minutes per batch was easily maintained with an organization reduced to:

9 men loading barrows and charging.
1 man handling cement and water.
1 man operating discharge chute and loading barrows.
6 men wheeling to place.

17 men, total.

The above instance is not an isolated case. It is more or less typical of results which follow close upon failure to observe elementary principles, and to obtain an accurate knowledge of costs.

So far only the simplest types of mixing plants have been treated, but it is believed that a knowledge of the possibilities in this direction will lead to intelligent selection of the more highly specialized plants. The more or less standard types of equipment were covered at some length in Volume II of this series, and will not be considered here.

CHAPTER XXV

TRANSPORTING OF CONCRETE

The mixed materials may be handled in barrows, carts, or cars, or in buckets operated in connection with derricks, cableways, or spouts. For the scope of the present chapter it will be sufficient to treat of effecting distribution only by barrows, carts, and spouts, leaving the derrick and cableway out of consideration. The use of derricks, on the one hand, is ordinarily limited to work confined to limited area, or to work wherein derricks are in any case a necessary part of the equipment. Cableways, on the other hand, are high in first cost which renders their adoption inadvisable except in exceptionally large work.

95. The Use of Barrows or Carts.—A question deserving of very serious consideration is the cost of handling material in barrows or carts. This method involves less original outlay than any other and in many cases which have come under the writer's observation, the cost of installation of a more elaborate plant would cover the costs of distribution by barrow or cart.

Using the ordinary barrow, a man will handle an average of 19 cu. ft. per barrow and, including time of loading by shovel, will require (according to Taylor and Thompson) 25.4 minutes per cubic yard of concrete, with an additional 3.9 minutes per cubic yard of concrete for each additional 25 ft. that it is necessary to wheel the material.

If two-wheeled carts of 6-ft. capacity are substituted for the smaller barrow, a time is obtained of 11.28 minutes per cubic yard of concrete per 100 ft. of wheel, with an additional 1.66 minutes per cubic yard for extra distance. The above figure is based on an average load for the cart of $4\frac{1}{2}$ cu. ft., which can and should be maintained.

From the above comparisons it will be seen that, at 20 cents per hour, the cost of wheeling concrete in barrows should not exceed \$0.084 per cubic yard with an additional \$0.013 for each 25 ft. of additional wheel. For carts, results will be \$0.0376 per cubic yard per 100 ft. of wheel, with an extra \$0.0055 per 25 ft. additional wheel. There are, however, certain offsets to be made. The wheelbarrow requires less in the line of runways or scaffolding than does the heavier cart, and the cost of these runways should be carefully estimated. Average results show a cost for 200-ft. runs of 2-in. plank as being approximately \$0.03 per cubic yard of concrete for wheelbarrows and \$0.074 for carts, assuming the cost of runways as distributed over 1000 cu. yd. of concrete.

It must, however, be borne in mind that the above prices are based upon runways laid on the ground. Where the runways must be elevated, the showing becomes more favorable to carts, for the reason that the bents or supports for the wheelbarrows must be practically the same as for the carts.

96. Spouting Plants.—While there has been a tendency to exaggerate the advantages of spouting concrete, and to use it on small jobs, the present state of the art limits the use of spouting plants practically to the placing of 2500 yd. of concrete or upward. It is being recognized more and more widely that the extension of this system to smaller jobs is not a money-saving proposition, particularly when the contractor is not well acquainted with all the problems involved.

The installation of a spouting system is somewhat expensive. Under proper conditions it will make a definite saving, but it must not be rated too high by those undertaking it, for the saving will rarely reach the abnormal figures sometimes expected. Where the work is light and scattered, any attempt to spout concrete into place is likely to prove disappointing. It is principally on heavy, solid construction that it is of advantage, and each case must be considered carefully on its own merits before a decision is made to use this method.

Concrete may be conveyed a considerable distance by means of chutes supported in a variety of ways, but care must be taken that these chutes have a workable inclination. In all cases it is important to maintain a uniform pitch throughout the entire line. Unless the pitch is kept uniform, the concrete will flow faster in some parts of the chute than in others, with the result that it will pile up at some point of slow flow, and will overflow and fall to the ground. The pitch, also, must be greater when the material is to be carried a considerable distance than when it is to be carried only a short distance. If given a slight start, fairly wet concrete will flow 50 ft. with a pitch of about one in six. As the distance increases, the friction of the concrete in the chute overcomes its initial momentum. This makes it necessary to increase the pitch for greater distances, so that a pitch of one in four is needed for 100 ft. while a distance of 300 or 400 ft. will require a slope of one to three. These slopes are based upon a chute rigidly supported and of uniform pitch. Where the spouts are supported from guy lines, the slope must be a little steeper, say 4 to 6 in. to the foot for long lines.

If the pitch is too steep for the distance to be covered, the flow of concrete may be so rapid as to separate the rock from the sand and cement. The concrete should be kept in a continuous flow, moving slowly and uniformly, if a well-mixed mass is to be delivered into the forms. Crushed-slag concrete is sluggish, while washed gravel concrete is fairly rapid in its speed of travel down the chute. All of these things have to be taken into account in preparing the chute concrete.

For successful operation of any spouting system, the aggregates must

be mixed properly. There must be just as much water as the material can carry without separation, so that the stone particles will be carried in suspension in the mass. The proper amount of water is from $1\frac{1}{4}$ to $1\frac{1}{2}$ gallons to the cubic foot of material. The concrete materials must

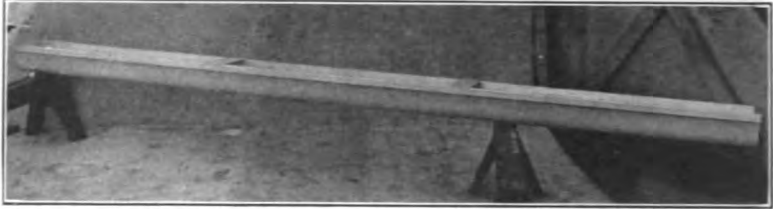

FIG. 350.

slide down the spout, without any inclination to rolling. With a carefully designed system and properly mixed concrete, large quantities can be handled by a small stream, and placed where desired, without



FIG. 351.

trouble from air pockets, without separation of particles, and without any tendency to produce laitance.

Spouting lines are carried, in general, in one of three ways: (1) by booms hung from the concrete tower; (2) by a guy line, one end of which

is attached to the concrete tower; (3) by tripods or other supports from the ground, located at the ends of successive sections of spouting. Considerations of space, and particularly of the distance to which spouting is to be carried, determine generally which method of support will be used.

In a boom spouting plant the spout is mounted upon a swiveled bracket at the tower end, while the outer end, supported by the boom, is moved freely about the work as required. A second length of spout usually completes this unit. One great advantage of this type is the flexibility and freedom of movement obtained in placing the concrete.

In guy-line plants the spouting is suspended by ordinary blocks and manila falls, from steel wire rope lines or special cables set up for the

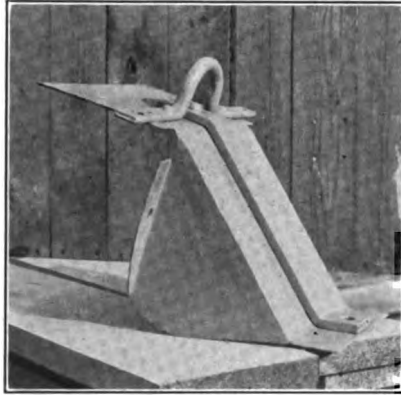

FIG. 352.

purpose. The principal advantage of this type lies in its ready adaptation to handle concrete over long lines. Its disadvantages are mainly those involved in difficulty of lateral movement.

The tripod spouting plant uses movable towers to support the ends of successive spouting sections. While this is less flexible than the boom plant, it is much more flexible than the guy-line plant, for the various supports in the line may be moved in succession, thus covering a very wide area from a single tower. In order to move the guy-line plant, and thus cover additional area, the whole line must be dismantled and set up again in the new location.

In certain special cases the combination of two of these methods might be used to advantage, carrying the material across obstructions with the guy-line plant, and then distributing from the end of that section by means of one of the other methods. This would give some of the flexibility of the other methods while retaining, for a special purpose required, the peculiar features of the guy-line plant.

It is desirable that concrete spouting be based on a series of units which may be assembled in various combinations. Continuous line spouting should be changeable to swivel-head, or swivel-head to continuous line, as the conditions of the work require, it being necessary merely to have in stock a supply of the necessary units. This interchangeability is of great value in service, for spouts wear at the head and foot of each unit of length. By reversing a trough section, end for end, when showing heavy wear at one point, a new, unworn surface may be put at point of greatest wear.

A standard trough section, Fig. 350, is made of No. 14¹ gauge steel, forming a trough 8½ in. deep by 10 in. wide on top. The bottom is curved to practically a semicircle of 4-in. radius, the upper part of the sides being straight and tangent to the curve. Each section is punched with standard spacing, arranged for connecting all of the various attachments.

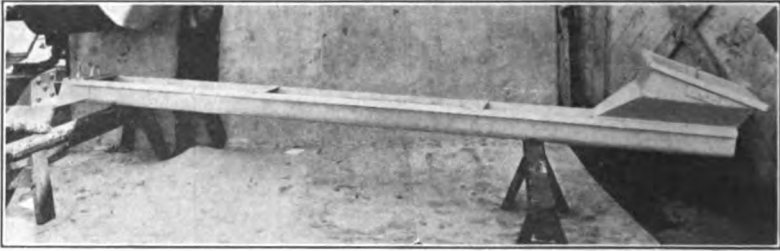

FIG. 353.

The hopper head, Fig. 351, attached at one end for receiving the concrete from the bin, or from an upper trough section, forms one point of support of the next trough section. At the other end is the splash hood, Fig. 352. By fastening the hopper head to the trough section at one end, and the splash hood at the other, we have the complete trough section, Fig. 353. These 24 by 24-in. hopper heads, as well as the splash hoods, can be bolted to either end of any standard trough section.

Standard trough sections are joined for continuous line spouting by bolting together their angle-iron yokes or flanges and bolting on the compression plate part. Thus, several sections are joined together, with a hopper head at one end of the entire group, and a splash hood at the other end, as shown in the assembly of the 48-ft. chute, Fig. 357.

Fig. 354 shows the swivel hook used in making the flexible joint

¹ Where desired, trough sections may be furnished in No. 12 or No. 10 gauge steel plates. For all ordinary conditions, however, the standard section of No. 14 gauge will be found most satisfactory. The writer, however, strongly favors the lighter plate, and is now conducting experiments to the end that the plate used may be of special high carbon steel (0.22). This should give longer life and greater stiffness. The steel ordinarily used is 0.10 carbon.

between successive trough sections for swivel-head spouting and shows one of these joints, in which the upper line of spouting is supported by a fall and tackle attached to the bail on the splash hood; while the lower line is supported by the swivel-hook, connecting the lower hopper head with the splash hood of the upper line. The swivel hook is kept clear

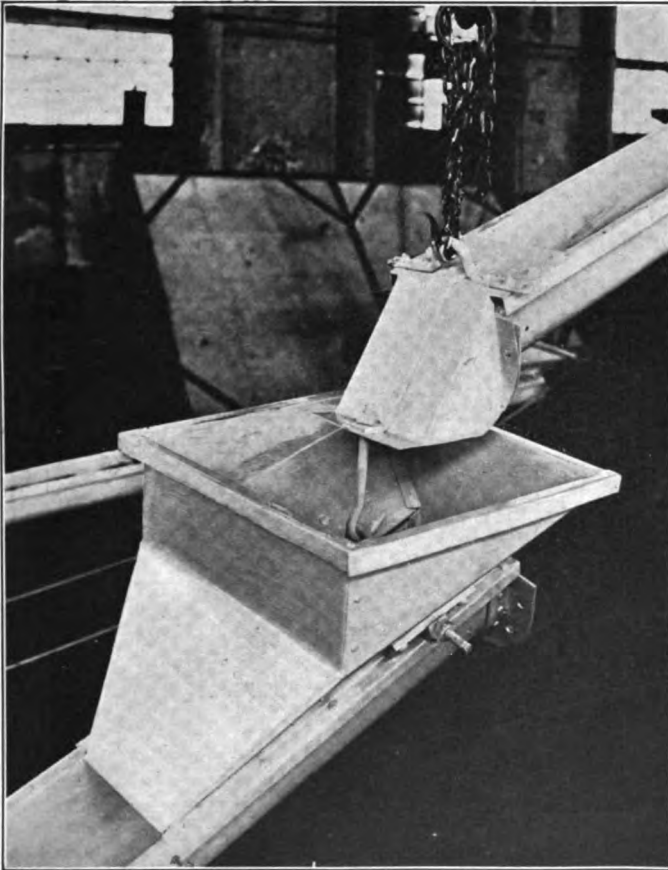

FIG. 354.

of the path of the concrete. The effectiveness of this method of support is shown clearly in Fig. 355, where the swivel hook on the splash hood is supporting a weight of 1500 lb.

In some cases it is desirable to have a flexible joint in continuous line spouting. In this case the two sections are put together in a different manner, Fig. 356, where both the hopper head and the splash hood

are dispensed with. The hanger plate is here used in conjunction with a special yoke, after one of the angle-iron yokes has been removed. This allows a slight movement sideways, without requiring the attachments for the swivel-head operation.

The stiffness of the section is well shown by Fig. 357 which is a photograph of a 48-ft. assembled unit, heavily loaded. The sand was piled in the trough, 40 lb. per running foot, and then three men, weighing together 500 lb., stood on the center unit of the section.

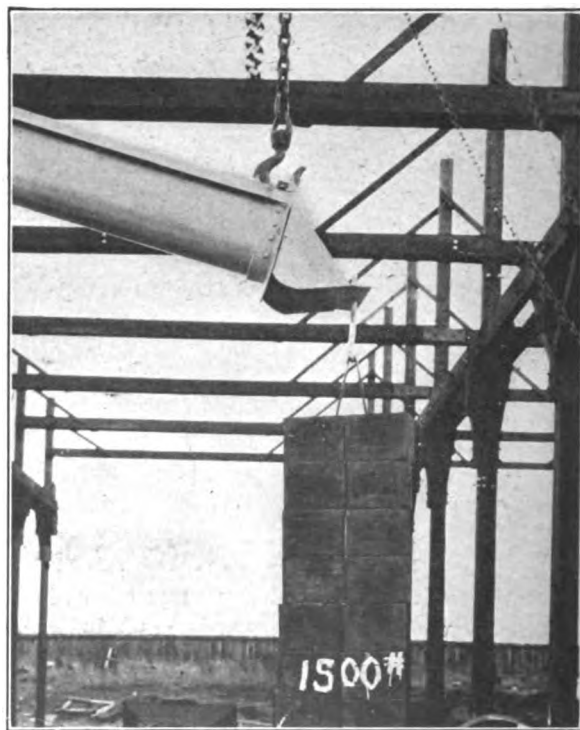

FIG. 355.

97. Hoists.—Whether the distribution is by spouts, by carts, or by barrows, it has become general practice on all work extending above ground to hoist the concrete. For this purpose a tower is practically indispensable.

Towers are constructed of steel as well as wood, the writer's preference being decidedly in favor of the wood tower. A concrete bucket is usually constructed on the simplest lines without catches or trips. A substantial bail made of two 3-in. Z-bars back to back, is arranged to

operate between two 5½-in. wooden guides, and is fitted at the lower end with journals in which rests the bucket trunnion. In setting up the tower and bucket, it is advisable in all cases to set the bucket so

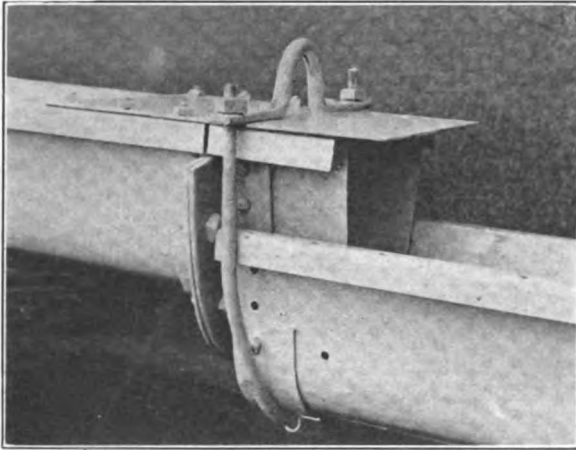

FIG. 356.

that it is practically balanced, and to this end the front guide should be so set as to be practically in contact with the nose of the bucket when the latter is pushed back to a point where the load in the bucket will tend slightly to press the stops on the sides of the bucket backward

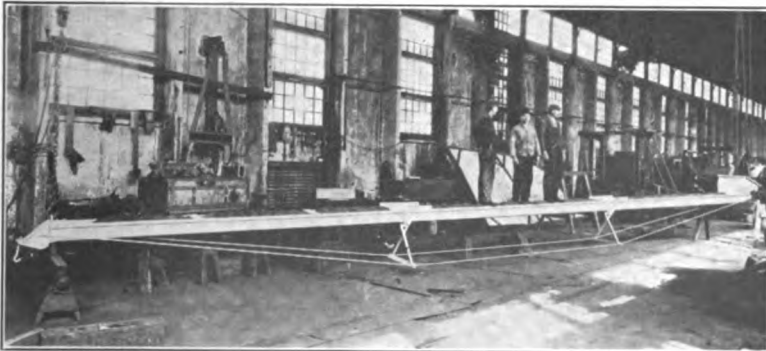

FIG. 357.

against the bail. Friction of the nose against the guides is, by this means, practically eliminated. By removing the front guide at any point in the height of the tower, and placing a block on the back of the latter,

the bucket is canted forward so that it will drop its contents out through the opening made by the removal of the front guide. The bucket automatically rights itself, and is pulled back into position by the weight

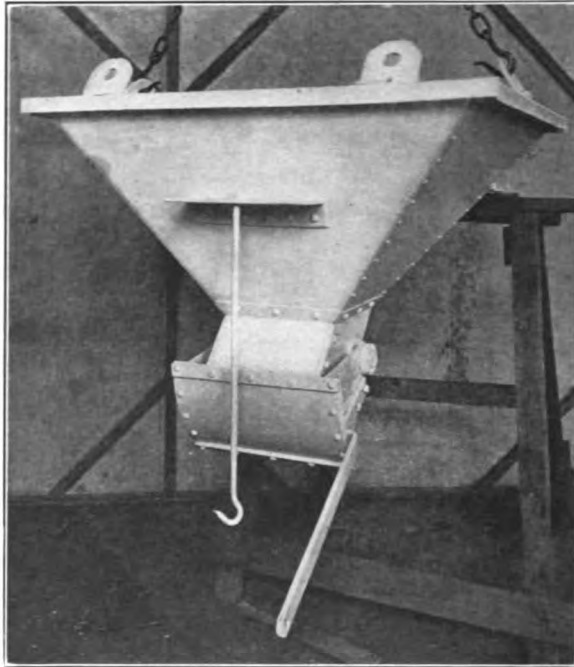

FIG. 358.

of the bail when the operator releases the brake. The concrete bin shown in Fig. 358 forms the upper end of the spouting system, the gate of the hopper controlling the flow.

PART V

NOTES ON ESTIMATING

By LESLIE H. ALLEN

Of the Aberthaw Construction Co., Boston

The estimating of quantities and unit costs has been treated in a general way in Volume II. The chapters on estimating in this volume will deal mainly with the application of the general principles, already set forth, to the work of estimating bridges and culverts.

CHAPTER XXVI

ESTIMATING BRIDGES

98. General Considerations.—Large bridges are sometimes built in places that are very difficult of access and in consequence the cost of teaming materials may be much greater than in building work. In some cases it may be found necessary to set up a crushing plant for the supply of stone. The contractor, however, always avoids this, if possible, as the cost of operating a small temporary plant is always greater than that of running a large permanent plant, and it pays to buy crushed stone from such a plant, even if rock from the excavations is available.

The cost of plant, also, will vary greatly according to the nature and size of the work. As a general rule, the plant required in bridge construction is more costly than that for building construction. This is particularly the case where cableways are used. It is best to calculate separately the cost of labor and depreciation on each item of plant in each case and add the cost for supplies, fuel, and small tools. In general, however, it will be found that the total cost of plant for bridges, as in buildings, will vary pretty closely with the yardage of concrete. In the writer's practice he has found that figures of \$6000 for plant on a 5000-yard job, \$7000 on a 6000-yard job, \$5000 on a 4000-yard job, and so on, check up quite closely with actual costs. These figures, of course, do not include plant for excavating, drilling, etc.

The labor cost of mixing and placing concrete will vary in the different parts of the structure. The abutments and piers of a bridge are usually very massive and the cost of placing concrete in same is low. In arch ribs, on the other hand, the concrete requires very careful spading and the cost of placing is considerably higher.

Assuming a large job with good charging bins and a good layout of plant, the cost of mixing concrete should be about 20 to 25 cents per yard, and the cost of transporting and placing same in abutments and thick piers should be about 35 to 45 cents per cubic yard additional.

It is usual to specify that large stones may be embedded in massive concrete work to reduce the cost of same. These stones are generally placed not less than 6 in. apart and are kept at least 12 in. away from the face of the work. Some specifications will allow stones that one man can handle; others will allow any stone that the derricks can lift. It will be found that from 25 to 50 per cent. of the volume of a massive pier can be composed of large stone in this way. The cost of placing these stones, or "plums" as they are commonly called, should not exceed \$1.25 per cubic yard. If the rock has first to be excavated for the purpose, the cost of the rock excavation must be added.

As an illustration the cost of concrete on a large typical bridge job might be estimated as follows:

Abutments and piers—1:2½:5 mix:

Cement.....	1.4	bbl....@	\$1.45 net.....	\$2.03
Sand.....	0.5	cu. yd.@	\$1.00.....	0.50
Crushed stone....	1.35	tons...@	\$1.50.....	2.03
Labor, mixing and placing.....				0.65
Plant.....				1.10
<hr/>				
Total.....				\$6.31 per cu. yd.

Abutments and piers—1:2½:5 mix—with 30 per cent. of large stones:

7 cu. yd. concrete as above.....	@	\$6.31.....	\$44.17
3 cu. yd. placing large stones....	@	1.25.....	3.75
<hr/>			

Cost of 10 cu. yd. of concrete and rock in place..	\$47.92
Average cost per cu. yd.....	\$4.79

Arch ribs and deck slabs—1:2:4 mix:

Cement.....	1.66	bbl....@	\$1.45 net....	\$2.42
Sand.....	0.5	cu. yd. @	1.00.....	0.50
Crushed stone....	1.35	tons...@	1.50.....	2.03
Labor, mixing and placing.....				1.00
Plant.....				1.10
<hr/>				

Total.....	\$7.05 per cu. yd.
------------	--------------------

The above costs do not include forms, steel, or finishing of surfaces.

The most uncertain and difficult item to estimate in bridge construction is the form work. It is best to estimate by the square foot of surface contact, as in building work, and to this add for the staging required for long arch spans.

No general rules or instructions can be given for estimating bridge form work, except to say that the labor should be estimated at not less than 10 cents per square foot, and the lumber, nails, and oil, etc., at 4 cents per square foot. Further discussion in regard to the cost of form work is given in the examples of typical estimates which follow.

It is not possible to give the cost of reinforcement accurately, any more than that of form work, but the following are approximations:

Assume, steel at mill.....	\$1.50 per 100 lb,
freight.....	0.25 per 100 lb.
	<hr/>
	\$1.75 per 100 lb.
	or \$35.00 per ton
Unloading, teaming, and piling.....	0.60 per ton
Labor, bending and placing.....	12.00 per ton
Tools, wire, and sundries.....	0.75 per ton
	<hr/>
Total.....	\$48.35 per ton

The cost of surface finish varies very little from that given in Volume II, Art. 119.

99. Examples of Typical Estimates.—Examples of typical estimates for bridges are included in the following paragraphs:

Arch Bridge Estimate.—Fig. 359 shows a small highway bridge built in 1912. The bridge was built in two sections, so as to cause no interruption to the street car service, which was maintained with one or two short interruptions at 30-minute intervals during the progress of the work.

The cost of the concrete work was as follows:

Labor, mixing and placing concrete in foundations and abutments.....	\$0.91 per cu. yd.
Labor, mixing and placing concrete arches.....	1.25 per cu. yd.
Labor, mixing and placing concrete parapet and spandrel walls.....	1.31 per cu. yd.
Labor on form work to foundations and abutments.....	0.10½ per sq. ft.
Labor on form work to arch soffits....	0.10 per sq. ft.
Labor on form work to parapet and spandrel walls.....	0.19 per sq. ft.
Labor, bending and placing steel reinforcement.....	\$15.78 per ton
Labor, rubbing surfaces of parapet walls with carborundum three times (once measured).....	0.06½ per sq. ft.
Labor, picking panels of same.....	0.07½ per sq. ft.

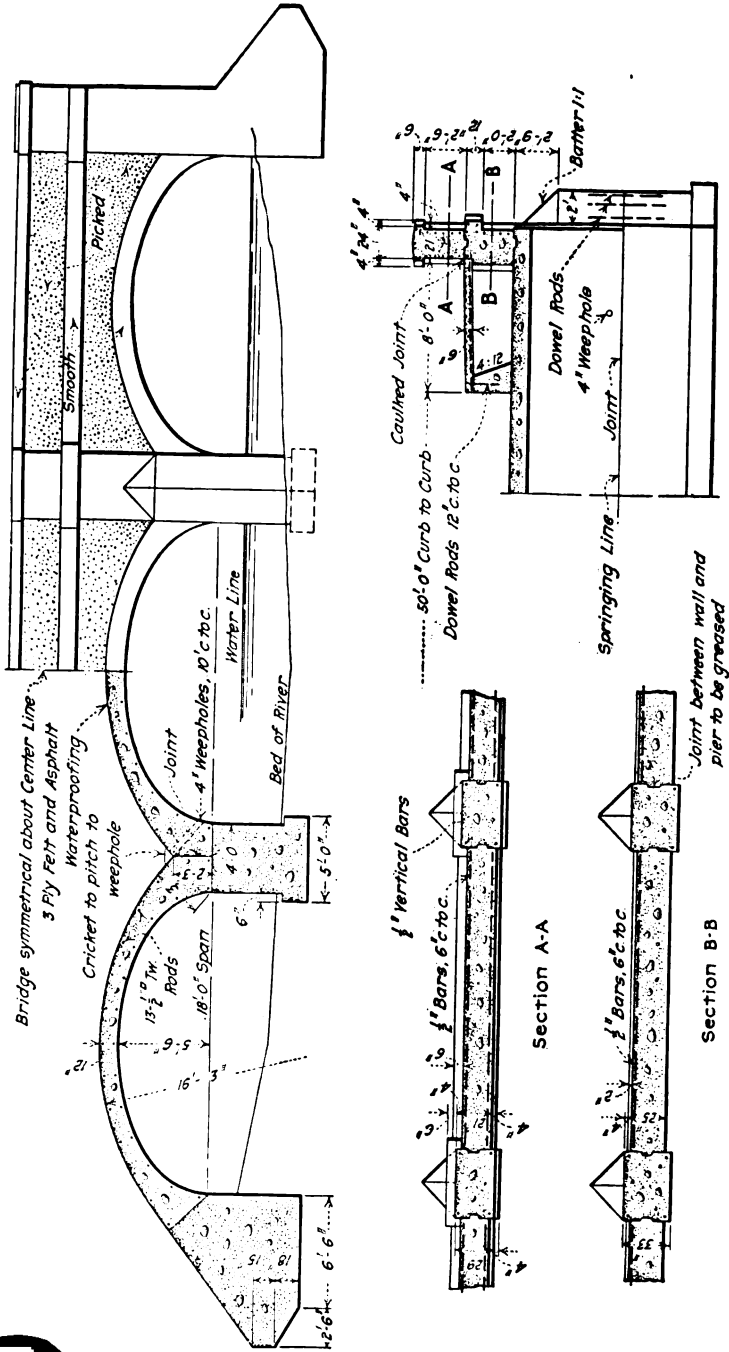

Part Section at Crown
 Fig. 359.—Details of New Broadway bridge over Spicket River, Methuen, Mass.

Cement cost \$1.50 per bbl., f.o.b. cars to nearest siding.
0.40 credit for bags.

1.10
0.09½ unloading and teaming.
0.05 testing.
0.01 freight on empties.
0.05½ loss on empties.

\$1.30⁹/₁₀ price of cement ready for use in concrete.

Sand was dug and screened and teamed to the job at a cost of \$1.28 per cubic yard.

Crushed stone cost \$1.00 per ton, f.o.b. cars at quarry.
0.48 per ton, freight to nearest siding.
0.47½ per ton, unloading and teaming.

\$1.95½ per ton, price of stone ready for use
in concrete.

The plant consisted of mixer and derrick operated by electric motor, the power being obtained from a local power station. The cost was as follows:

Labor, erecting and moving derrick.....	\$230.00	
Labor, erecting and dismantling mixer.....	89.47	
General labor around plant.....	157.50	
Freight and teaming.....	153.02	
Rental of mixer and derrick.....	360.00	
Small tools and supplies.....	527.50	
Electric current.....	210.00	\$1727.49

Deduct part cost of derrick, tools, etc., charged to excavation and coffer dams.....	620.00	
--	--------	--

Cost of plant chargeable to concrete work..... \$1107.49
Divided by 826 cu. yd. equals \$1.34 per cu. yd.

Form lumber cost for 57 M ft. b.m.....	\$1612.10
Nails, wire, and sundries cost.....	65.00

Cost of lumber for forms..... \$1677.10
Divided by 16,970 sq. ft. equals \$0.099 per sq. ft.
or practically.....\$0.10 per sq. ft.

Steel reinforcement cost \$33.20 per ton on cars nearest siding.
Unloading and teaming, 1.23 per ton

\$34.43 per ton

484 REINFORCED CONCRETE CONSTRUCTION

The total cost of the above work would, therefore, be as follows:

Concrete foundations and abutments—1:2½:5 mixture:

Cement, 1.4 bbl. @ \$1.31 per bbl.	\$1.83
Sand, 0.5 cu. yd. @ 1.28 per cu. yd.	0.64
Stone, 1.35 tons @ 1.95½ per ton.	2.64
Labor, mixing and placing.	0.91
Plant.	1.34

Total..... \$7.36 per cu. yd.

Concrete arches—1:2:4 mixture:

Cement, 1.66 bbl. @ \$1.31 per bbl.	\$2.17
Sand, 0.5 cu. yd. @ 1.28 per cu. yd.	0.64
Stone, 1.35 tons @ 1.95½ per ton.	2.64
Labor, mixing and placing.	1.25
Plant.	1.34

Total..... \$8.04 per cu. yd.

Concrete parapet and spandrel walls—1:2:4 mixture:

Cement, 1.66 bbl. @ \$1.31 per bbl.	\$2.17
Sand, 0.5 cu. yd. @ 1.28 per cu. yd.	0.64
Stone, 1.35 tons @ 1.95½ per ton.	2.64
Labor.	1.31
Plant.	1.34

Total..... \$8.10 per cu. yd.

Forms to foundations and abutments:

Labor.	\$0.10½ per sq. ft.
Lumber, etc.	0.10 per sq. ft.
	<hr/>
	\$0.20½ per sq. ft.

Forms to arch soffits:

Labor.	\$0.10 per sq. ft.
Lumber, etc.	0.10 per sq. ft.
	<hr/>
	\$0.20 per sq. ft.

Forms to parapet and spandrel walls:

Labor.	\$0.19 per sq. ft.
Lumber.	0.10 per sq. ft.
	<hr/>
	\$0.29 per sq. ft.

Steel reinforcement:

Reinforcement.	\$34.43 per ton
Labor.	15.78 per ton
	<hr/>

Total..... \$50.21 per ton

SUMMARY

Concrete foundations and abutments, 408 cu. yd. @ \$7.36	\$3003
Concrete arches, 268 cu. yd. @ 8.04	2155
Concrete parapet and spandrel walls, 150 cu. yd. @ 8.10	1215
Forms to foundations and abutments, 3800 sq. ft. @ 0.20½	779
Forms to arch soffits, 8100 sq. ft. @ 0.20	1620
Forms to parapet and spandrel walls, 5070 sq. ft. @ 0.29	1470
Steel reinforcement, 5½ tons at 50.21	276
Rubbing faces of parapet walls with carborundum, 1600 sq. ft. @ 0.06½	104
Picking panels of same, 650 sq. ft. @ 0.07½	50
Total	<hr/> \$10,672

To this total must be added the cost of excavation, cofferdams, pumping, road surfacing, waterproofing arches, watchman, temporary fences, liability insurance, and contractor's profit. These items do not come within the scope of the present work.

Beam and Girder Bridge Estimate.—Figs. 360 and 361 show a reinforced-concrete viaduct which was planned to carry highway traffic across a freight yard. The total length of the bridge was about 700 ft. It has not yet been built. The figures given below are from a contractor's bid submitted in competition.

The chief problem to be considered was the cost of carrying on work expeditiously without interruption to the freight traffic below. The method contemplated was the construction of a substantial temporary working platform about 3 ft. below the spring of the arch, the platform being constructed of steel I-beams on hard pine posts and floored with 3-in. plank. This would afford a good working platform for the carpenters and a firm base for the support of the centers and wet concrete.

It will be noted that the piers are not parallel to each other in most cases. This adds considerably to the cost of the form work, as no forms could be re-used without a good deal of alteration or re-making.

The estimated costs of the work were as follows:

Cement quoted	\$1.75 per bbl., f.o.b. cars to nearest siding.
	0.40 credit for bags.
	<hr/> \$1.35
	0.03 tests.
	0.06 unload, team, and store.
	0.03 freight on empties and loss.

Net \$1.47 bbl.

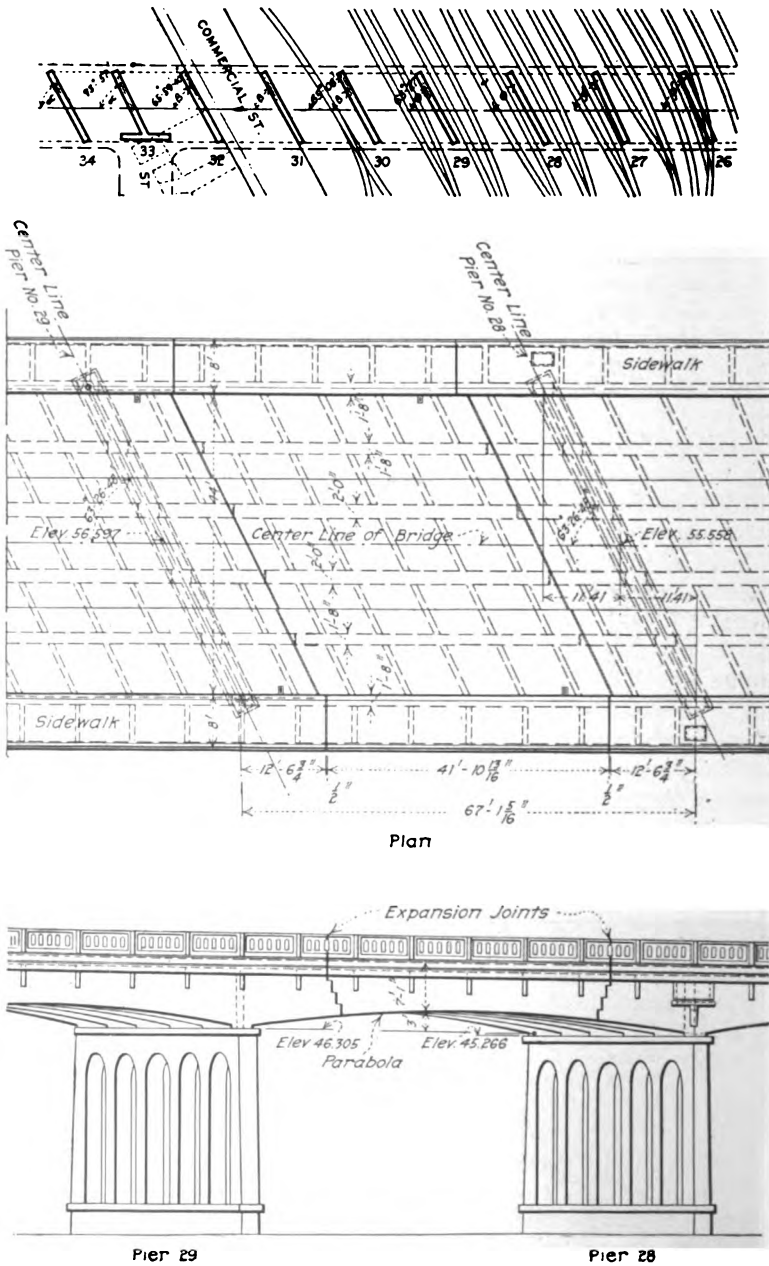

FIG. 360.—Details of Portland bridge, Cumberland County, Me.

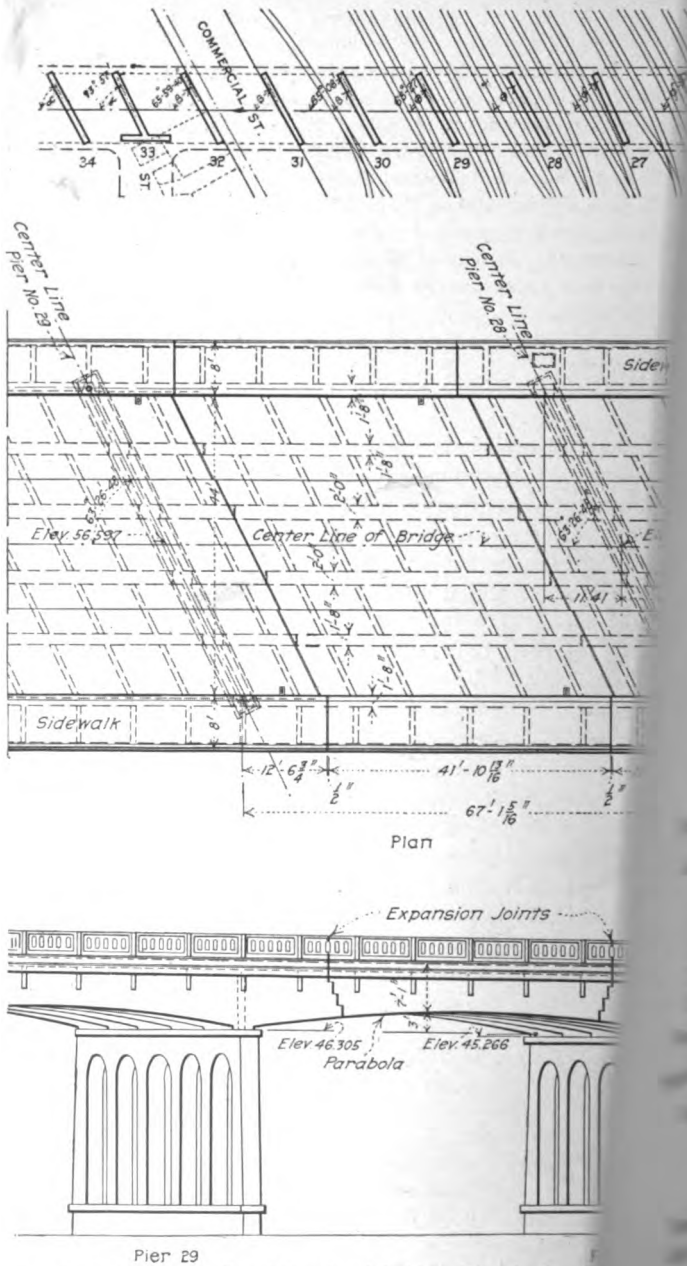
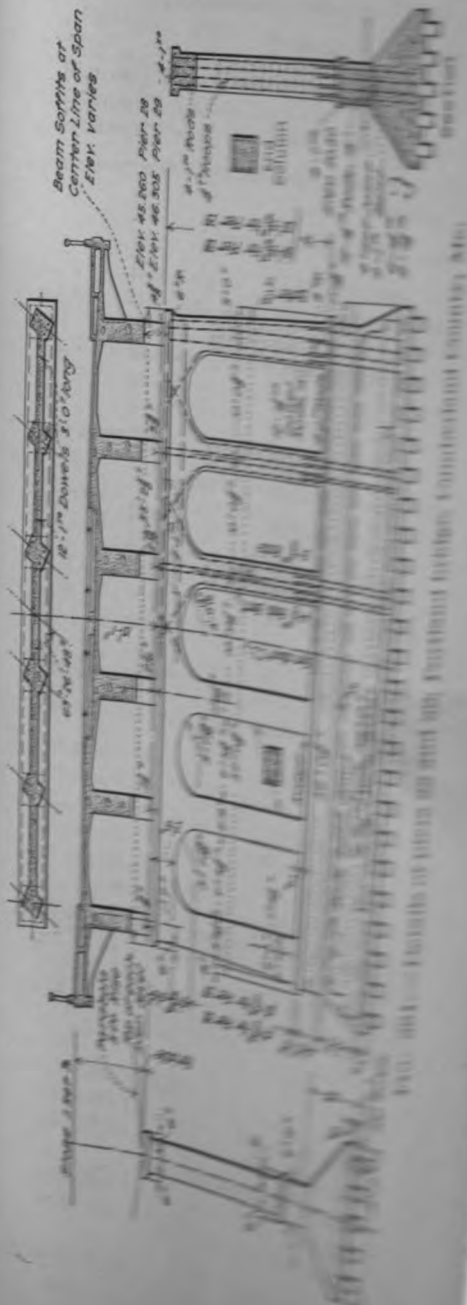

FIG. 360.—Details of Portland bridge, Cumberland

ft. 0 in. × 51 ft. 0 in. ×



... M @ \$32.00...	\$640
... .00.....	124
... 9 M @ \$24.00...	216
.....	50
.....	150
... b. @ \$0.02.....	504

.....	\$1684
at close of job...	700
.....	\$984
... used four times	2952
... ms twelve times	5400
.....	\$8,352

... at \$5.86.....	\$14,767
... 4	10,896
... 1:2:4, 3289 cu.	21,839
... .11.....	3,252
... ft. @ \$0.24.....	6,384
... sq. ft. @ \$0.14....	2,129
... @ \$0.14.....	9,302
... in. ft. @ \$0.75....	4,984
.....	999
.....	16,072
... ewalks, 16,120 sq.	403
... l and finished in	1,407
... ng, including forms	3,036
... elt course, etc., with	360
... 6000 sq. ft. @ \$0.06	2,612
... od and hoisted and	8,352
... reinforcement, 1306	
.....	2,612
... d tracks.....	8,352

..... \$106,794
 paving, conduits for cables, etc.,
 l in above items.

488 *REINFORCED CONCRETE CONSTRUCTION*

Sand quoted, 90 cents per cu. yd. delivered in teams at job. Screened gravel quoted \$1.15 per ton delivered in auto trucks at job.

Labor, mixing and placing concrete:

in foundations.....	\$0.80 per cu. yd.
in piers.....	1.00 per cu. yd.
in arch ribs and deck slabs.....	1.20 per cu. yd.

Plant—labor, depreciation, supplies, and power \$1.00 per yard, giving a total of \$7500 for the job.

Price of concrete in piers—1:2:4 mixture:

Cement, 1.66 bbl. @ \$1.47	\$2.44
Sand, 0.5 cu. yd. @ 0.90	0.45
Gravel, 1.35 tons @ 1.15	1.55
Labor, mixing and placing	1.00
Plant.....	1.00

Total..... \$6.44 per cu. yd.

Price of concrete in foundations—1:2½:5 mixture:

Cement, 1.4 bbl. @ \$1.47.....	\$2.06
Sand, 0.5 cu. yd. @ \$0.90	0.45
Gravel, 1.35 tons @ \$1.15	1.55
Labor, mixing and placing.....	0.80
Plant.....	1.00

Total..... \$5.86 per cu. yd.

Form work:

Labor on forms to foundations.....	\$0.07 per sq. ft.
Piers.....	0.10 per sq. ft.
Curved soffits to arches.....	0.20 per sq. ft.
Sides of beams and girders.....	0.10 per sq. ft.
Deck (or floor).....	0.10 per sq. ft.
Belt course below railing.....	0.50 per lin. ft.
Form lumber, nails, etc	0.04 per sq. ft.

Steel reinforcement:

Reinforcement quoted.....	\$1.20 per 100 lb. f.o.b. mill
	0.18 freight.

\$1.38 = \$27.60 per ton *base*

Teaming, unloading, piling.....	\$ 1.00 per ton
Labor, bending and placing.....	\$11.00 per ton
<i>Extra cost</i> of small sizes and small amount bought	
from stock.....	1.00 per ton
Wire and sundries.....	0.40 per ton

\$41.00 per ton in
place

Cost of working platforms, average size 57 ft. 0 in. × 51 ft. 0 in. × 28 ft. 0 in. high:

60 pcs. 12 in. × 12 in. H.P. 28 ft. long = 20 M @ \$32.00...	\$640
500 lin. ft. 8 in. × 12 in. H.P. = 4 M @ \$31.00.....	124
3-in. spruce plank for platform, 3000 sq. ft. = 9 M @ \$24.00...	216
Nails, dogs, bolts, etc.....	50
Sundry lumber, 5 M @ \$30.00.....	150
630 lin. ft. of 12-in. 40-lb. I-beams = 25,200 lb. @ \$0.02.....	504
	<hr/>
	\$1684
Probable salvage on I-beams and hard pine at close of job...	700
	<hr/>
Net cost of material for one platform.....	\$984
Cost of material for three platforms (to be used four times each).....	2952
Labor, erecting and taking down platforms twelve times @ \$450.....	5400
	<hr/>
Estimated total cost of working platforms.....	\$8,352

SUMMARY

Concrete foundations, 1:2½:5, 2520 cu. yd. at \$5.86.....	\$14,767
Concrete piers, 1:2:4, 1692 cu. yd. @ \$6.44.....	10,896
Concrete arch ribs and deck slabs, etc, 1:2:4, 3289 cu. yd. @ \$6.64.....	21,839
Forms to foundations, 29,560 sq. ft. @ \$0.11.....	3,252
Forms to piers, 45,600 sq. ft. @ \$0.14.....	6,384
Forms to curved soffits to arches, 8870 sq. ft. @ \$0.24.....	2,129
Forms to sides of beams and girders, 66,440 sq. ft. @ \$0.14....	9,302
Forms to deck or floor slabs, 35,600 sq. ft. @ \$0.14.....	4,984
Forms to belt course below railing, 1332 lin. ft. @ \$0.75....	999
Steel reinforcement, 392 tons @ \$41.00.....	16,072
Clinton wire cloth reinforcement in sidewalks, 16,120 sq. ft. @ \$0.02½.....	403
4-in. concrete sidewalk on cinder fill and finished in granolithic, 10,050 sq. ft. @ \$0.14.....	1,407
Concrete curb to same with metal nosing, including forms 5520 lin. ft. @ \$0.55.....	3,036
Rubbing outside faces of piers and belt course, etc., with carborundum, including staging, etc., 6000 sq. ft. @ \$0.06	360
Concrete railings cast by unit method and hoisted and set in place, including forms and reinforcement, 1306 lin. ft. @ \$2.00.....	2,612
Cost of working platforms over railroad tracks.....	8,352
	<hr/>
Total cost of concrete work.....	\$106,794

Excavation and piles, wood block paving, conduits for cables, etc., and contractor's profit not included in above items.

CHAPTER XXVII

ESTIMATING CULVERTS

100. **Typical Estimate.**—Fig. 362 shows a concrete culvert of a common type designed for use in highway construction. The unit cost of a single culvert of this type built independently of any other work would be very high. It is usually the case, however, that in a highway

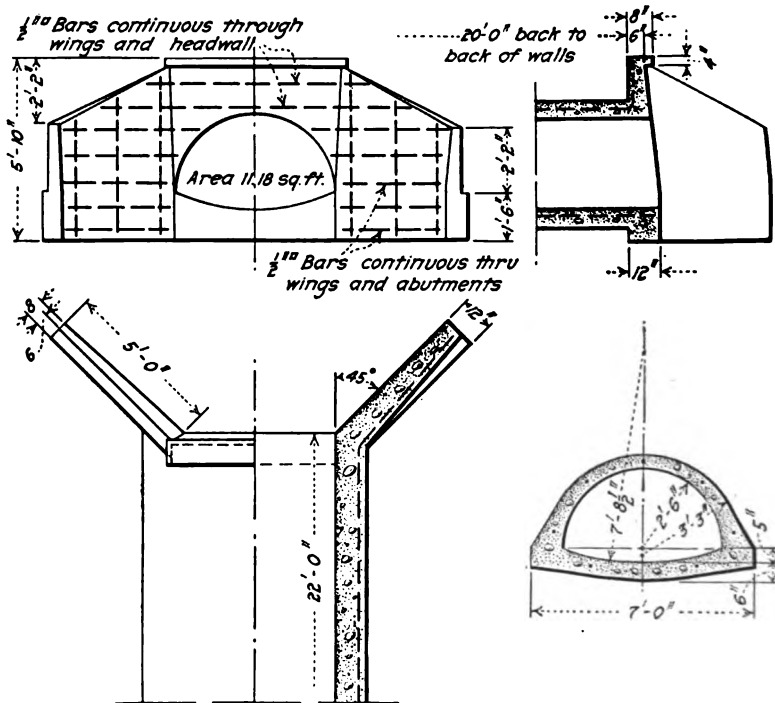

FIG. 362.—Standard 5-ft. arch culvert, State of Missouri Highway Department.

construction job of 10 miles in length there is found a large number of such culverts and they are ordinarily built by a large, well-organized contractor's force.

The analysis of the cost of cement, sand, and stone would follow along the same lines as in the preceding examples. The concrete would prob-

ably be hand mixed, and this labor of mixing and placing may be estimated at \$2.00 per cubic yard. The plant would consist of shovels, mixing boards and tarpaulins, barrows, etc., which would be used again on other work, but it is fair to charge about \$7.00 for use of these, including teaming, which is equal to about \$0.65 per cubic yard.

The price of concrete — 1:2:4: mixture — would probably be as follows:

Cement, 1.66 bbl.....	@ \$1.60..	\$2.66
Sand, 0.5 cu. yd.....	@ \$1.00..	0.50
Crushed stone, 1.35 tons.....	@ \$1.30..	1.76
Labor.....		2.00
Plant and tools, etc.....		0.65

Total..... \$7.57 per cu. yd.

Form lumber, nails, etc., for one culvert would cost about \$60.00, which is equal to 6 cents per square foot, but if several culverts were built this cost would be divided between them.

SUMMARY

Concrete—1:2:4.....	11 cu. yd @ \$7.55....	\$83
Forms to vertical faces,		
labor only.....	310 sq. ft. @ \$0.10....	31
Forms to arch labor only..	.660 sq. ft. @ \$0.13....	86
Form lumber for one culvert.....		60
Steel reinforcement.....	360 lb. @ \$0.02½....	9
		<hr/>
Total cost of concrete work.....		\$269
Excavation and road surfacing not included.		

PART VI
THE ARTISTIC DESIGN OF CONCRETE BRIDGES

BY **WM. J. TITUS**
Assoc. M. Am. Soc. C. E.

CHAPTER XXVIII

PRESENT STATUS OF THE ART

101. City Bridges.—Volumes have been written on the beautification of city bridges. Municipal Art Commissions and City Beautiful Commissions have been appointed by the score in an effort to obtain bridges of pleasing outline and artistic ornamentation. In fact, it is felt by many that the character of the bridges, streets, and public buildings of a city bespeak the character and enlightenment of the

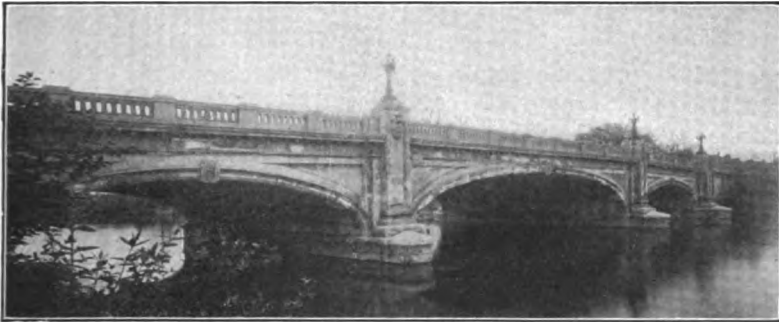

FIG. 363.—Excess of details; too elaborate panels; lack of balance in arch spans, resulting in ginger-bread effect.

inhabitants of that city. This desire to secure beautiful bridges is to be commended, but unfortunately, we have tended to load down many of our supposedly beautiful city bridges with ginger-bread ornamentation and every imaginable kind of inappropriate detail. It is better that we should be content with plain, honest, solid, useful bridges than that they should be adorned according to the standards that have governed the ornamentation of dwellings and public buildings, proper as these standards may be in such places.

102. Bridges in Country Districts.—Only with the coming of the automobile have we begun to realize that the roads and bridges of the suburban and more remote country districts are as deserving of careful and artistic design as those in our cities and other thickly populated districts. This has come about largely through the fact that our farmers are providing for themselves and their families a broader social and educational life. But even at the present time one finds in the literature on the subject many statements to the effect that "Few people would consider spending money for purely artistic features in a rural or remote district that is little frequented." The truth of the matter is, however, that the bridges in the country districts are more often designed to suit their surroundings than bridges in the city.



FIG. 364.—Dignified and harmonious structure, yet with little ornamentation.

103. Influences Affecting Design.—There have been many influences which have tended to prevent the construction of any considerable number of really beautiful bridges in America. Chief among these hindrances has been the insistent demand for more economical designs. This hindrance, however, has been largely removed by the use of concrete in bridge construction. Another great difficulty has been that most of our highway bridges (especially the earlier ones) have been built on designs inherited from the railroads, where the most popular bridge was formerly the one most easily designed and most easily and quickly erected with little or no regard for appearances.

Competition in design and the practice of allowing contractors to submit their own plans have been the reasons given for the existence of many of our flimsy and homely bridges. These are not valid reasons, however, in spite of the fact that the cheapest bid on the cheapest structure was most often selected. On the contrary, competition in design, with proper engineering supervision, has proved to be a most effective means of securing adequate and beautiful bridges. In fact, competitive designs have been received on a large proportion of the notable bridges of America.

There are today a number of consulting engineers who specialize in

or devote all their time to concrete bridges, and many beautiful, well-designed bridges throughout the country bear witness of the increasing ability of these specialists. The engineer in direct charge of the building of a bridge often feels that he is admitting his own inability by allowing experts to submit designs, but in the large majority of cases he will be held in increased esteem by his associates for having secured for his clients at a minimum expense a structure that is very nearly the ideal one for the location.

CHAPTER XXIX

MAIN FEATURES IN DESIGN

Concrete bridges today are more easily made attractive than those of any other material, for even to the average mind they have the appearance of solidity coupled with strength. Concrete is a molded material and there should be no attempt to disguise this fact. Imitation of stone arches, for example, is not to be desired. Expressiveness to most people is the chief source of beauty and when the characteristics of a material are destroyed rather than emphasized, the effect is not only flat and characterless, but may even be untruthful and in-

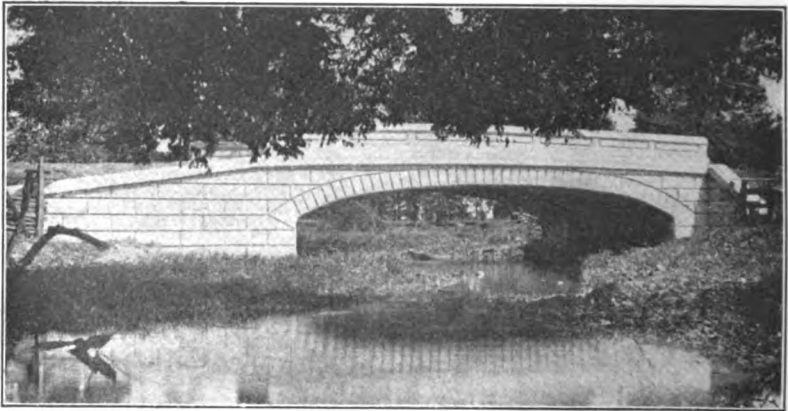

FIG. 365.—Awkwardly proportioned arch with objectionable surface treatment to imitate stone. Other bad features are the high springings and uniform thickness of arch ring.

sincere. Stepping the upper surface of a wing has no excuse from an artistic standpoint.

104. Principles of Design.—There are a number of principles which must be observed in the general design of a concrete bridge in order that the structure shall have a pleasing appearance. These principles pertain to the correct use of material, a symmetrical arrangement of the structure as a whole, and the securing of proper style and harmony.

105. The Proper Use of Material.—One of the essential features of good design is clearness of purpose. The mind of the observer should

be impressed with the visible strength of the structure and the proper use of material should be apparent. These requirements are satisfied by the use of steel in the suspension bridge and of masonry in the arch, so that bridges of this type are sure to command attention and ad-

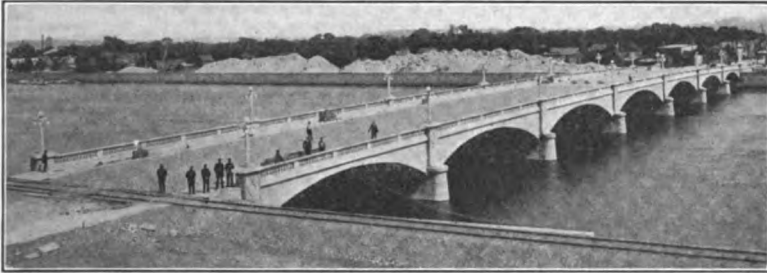

FIG. 366.—Arch bridge with beautiful lines and handsome railing and lamp posts, all of concrete.

miration. They possess a boldness and an inherent beauty of line that it is not possible to approach in a truss or girder bridge. In the case of a masonry girder, with the main strengthening element, the

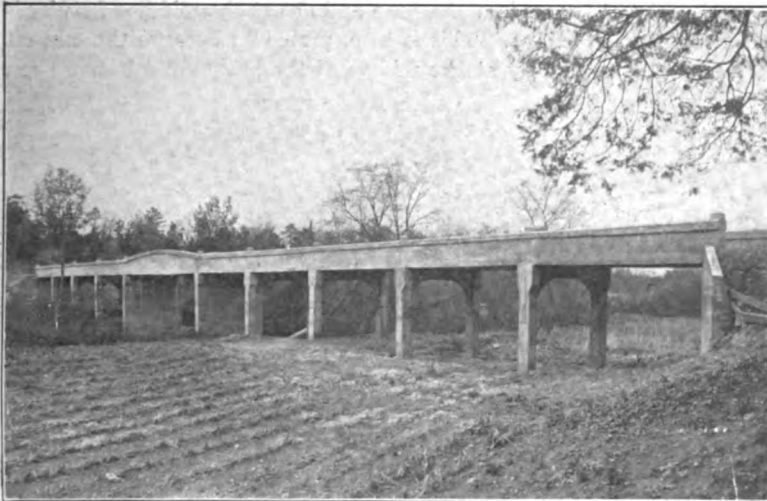

FIG. 367.—Girder bridge, well proportioned structurally, but inherently unsightly.

steel reinforcement, entirely hidden and difficult of representation in any way, it is scarcely possible to hide an appearance of weakness and obtain a truly artistic effect.

106. **Symmetry.**—Symmetry is another of the qualifications of a beautiful bridge and is an elementary idea in esthetics. A bridge should

always be symmetrical about a center line unless the contour or other conditions are such that it is impossible to make a symmetrical design. If the latter condition be the case, the arrangement should clearly show an adaptation to the natural profile. That the line of symmetry should,

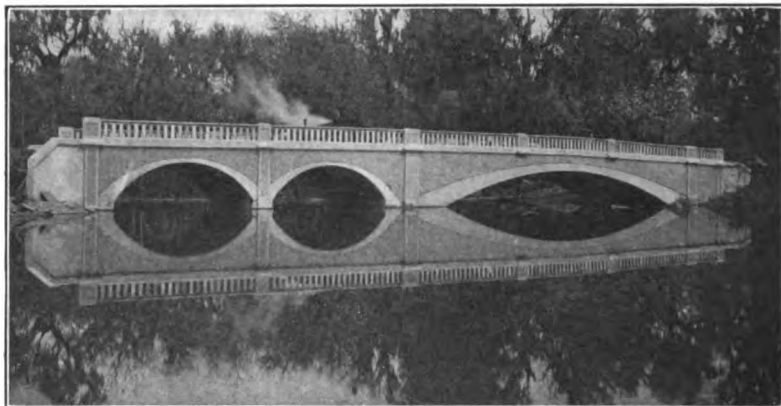

FIG. 368.—Lack of symmetry. Poor arrangement of spans.

if possible, be at the middle of a span and not at the middle of a pier is a feature of good design. This is true, probably, because the current of the river is ordinarily at the middle of the bridge and because one



FIG. 369.—Arch bridge of plain design in entire harmony with rugged surroundings.

dominating span, rather than two, gives to the bridge a more graceful appearance.

107. Style.—The style of a bridge should be in conformity with the environment, though a beautiful and appropriate bridge may often be

the means of improving its surroundings. It is only because they may be considered to harmonize with their surroundings that many of the over-decorated bridges of Europe can be called beautiful, so that the same standards of design and ornamentation applied in the United States would often be entirely out of place. However, a bridge should always dominate as well as conform to its surroundings. A bridge among rugged hills or rocky cliffs should have a simple and bold outline so that it may not be dwarfed by its surroundings. A bridge in a low level country should have long sweeping lines and be quite simply designed. On the other hand, a bridge in a park should be more graceful, ornate, or even quaint in appearance. All the details of the latter

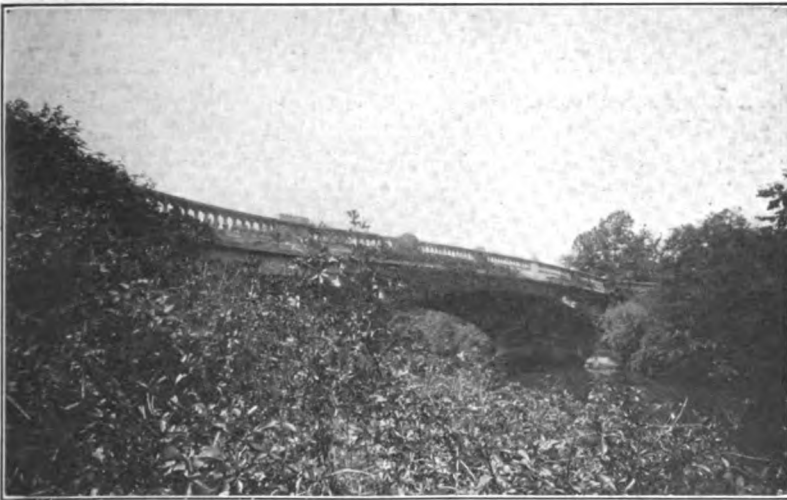

FIG. 370.—Park bridge of graceful lines and harmonious treatment.

type of bridge should be worked out very minutely, since they will be subject to much closer inspection than if the bridge is in any other location. A bridge in the city can usually carry considerable ornamentation, but must possess dignity commensurate with its importance. If there are buildings of a permanent character in the immediate vicinity of such a bridge, it should be designed in harmony with them.

108. Harmony.—In addition to harmony with surroundings, a bridge should have harmony of material, harmony of form, and harmony of dimension.

109. Harmony of Material.—Harmony of material is best secured with the use of but one kind of material. It is very difficult to obtain an appearance of balance when different materials are used, as there will be no agreement in the sizes of members performing similar duties. If

it is necessary to make adjacent spans of different materials, the piers should be considerably enlarged and extended above the roadway as posts or pedestals in order to emphasize the separation of the two types of construction. Ornaments made of different material from the main structure often appear quite out of place, though a pleasing contrast may sometimes be obtained.

110. Harmony of Form.—Harmony of form is an important element to be considered in obtaining an esthetic design. Concrete bridges have been built in three general forms: (1) arches, (2) girders, and (3) trusses. There are so few examples of concrete trusses that they are scarcely more than a novelty and will not be discussed here.



FIG. 371.—Lack of harmony due to combination of steel girders with concrete girders in the same structure.

The arch form cannot in general be combined with girders or trusses in a single structure with harmonious results. If variety is desired, it must be secured in some other way. Even the various forms of arches must be associated with great care when used in a single structure. For example, an arch tangent at the springings should not be placed adjacent an arch meeting the pier at a sharp angle; and springings at different elevations must at least conform to some reasonable order of arrangement.

Arch Bridges.—The arch is one of the most beautiful of engineering forms, but is probably the most difficult to design. There are two classes of concrete arch in general use: the earth-filled and the open-spandrel types. These types are each suitable for certain conditions and require entirely different shapes of arch ring. If the bridge be high and the spans long, a reduction in the weight of the structure may be desirable from both structural and artistic standpoints. An

open-spandrel type will probably be most suitable for this location, with the roadway supported on columns or transverse walls resting on the arch ring. With this class of construction the parabola is the form of arch ring which most closely follows the true pressure curve of equilibrium.



FIG. 372.—Appropriate design for great height and long span. Unfortunately the arches of the approaches do not harmonize with the spandrel arches.

But if the bridge is an ordinary one, with the springings of the arches below the high water line, it will be necessary to construct full spandrel walls in order to prevent the catching of débris. The addition of the weight of the fill will be desirable and the curve of equilibrium will ap-



FIG. 373.—Oval arches approximating ellipses, with solid earth-filled spandrels, suitable for locations subject to floods.

proximate an ellipse. This is probably the most graceful form for an arch, and fortunately is very nearly the proper form for the large majority of cases in America. In any case, different variations should be tried until the best result is obtained, for upon the careful selection of

the curve of the arch ring depends largely the final appearance of the bridge.

Girder Bridges.—The possibilities for esthetic treatment of concrete girders are very limited. The ends may be corbeled or made to resemble



FIG. 374.—A well-designed girder bridge showing clearly the limitations of the girder.

the arch in order to get curved lines. If further artistic treatment seems desirable, reliance must be placed on ornamentation. From an esthetic standpoint at least, the concrete girder is not suitable for bridges of very great height, because the engineering limitations are such that the span

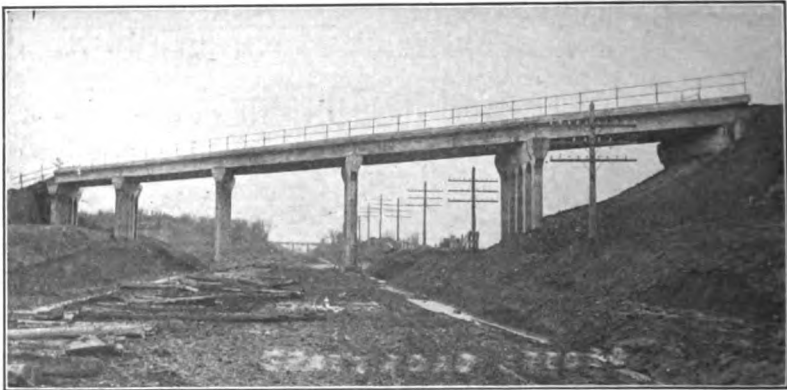

FIG. 375.—Pile trestle in concrete. Supports appear to be inadequate, and the entire effect is one of cheapness accentuated by the gas pipe railing which is not even panelled in harmony with the spans. This structure is a wooden trestle moulded in concrete.

cannot be increased in proportion to the height and therefore it is not possible to secure a clean, bold design. A series of short heavy girders supported by tall and apparently inadequate columns cannot be made to present a pleasing appearance.

Combination of Arches and Girders.—Arches and girders cannot be used in the same bridge without reducing the effectiveness of the design. The appearance of this type of bridge, however, may be somewhat

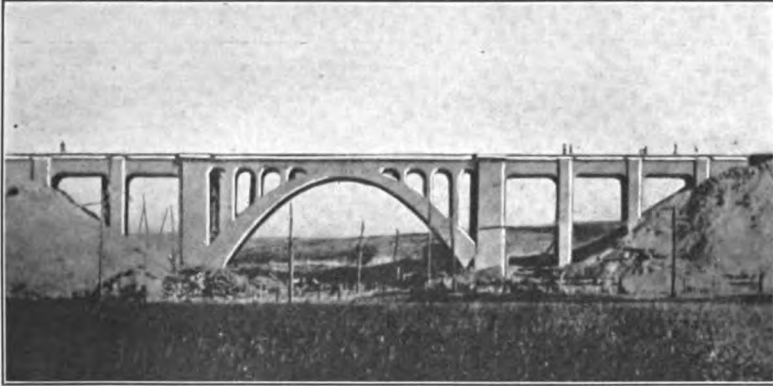

FIG. 376.—Arch awkwardly combined with girder approaches. Lack of harmony, and also lack of symmetry, with no good reason. No apparent attempt to distinguish between two types of structural members.

improved by some such method as has been suggested in case structural steel and concrete spans are adjacent to one another—that is, by emphasizing the piers which separate the two types of construction. But



FIG. 377.—Roadway with easy vertical curve—a parabola with vertex over main span.

even this will not hide the defect, when, as is so often the case, the only apparent excuse for the inharmonious effect is the difficulty of design of the type used in the more beautiful part of the structure.

The Roadway.—The roadway should be in the shape of an easy vertical curve. This provides increased underclearance and adds not only to the gracefulness of the bridge but to the appearance of stability as well. A bridge with a level floor will always appear to sag in the middle, and



FIG. 378.—Roadway with straight grades meeting in peak at center, presenting an awkward and sagging appearance.

this apparent sag is much greater in an arch bridge due to the converging lines of the roadway and the arch intrados. This camber in the roadway has sometimes been constructed as straight lines on a grade, meeting at the center of the bridge or broken at intermediate points,

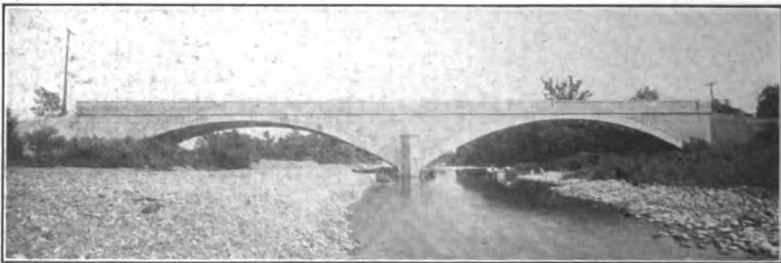

FIG. 379.—Unsatisfactory design with low and inadequate pier; awkward cutwater details; no camber, resulting in an appearance of sag in coping.

but it does not present a pleasing effect unless it is a true curve, preferably a very flat parabola.

Piers and Abutments.—The piers should ordinarily be tall and slender and without ornamentation other than a coping at the top. Their

height and stability should be emphasized with a slight batter, say 1 in 24, in both directions. An excessive batter to the piers gives the entire bridge a squatty appearance. The abutments should harmonize with the piers, but should seem enough heavier to carry the thrust coming on them. An appearance of stability may be obtained by making the

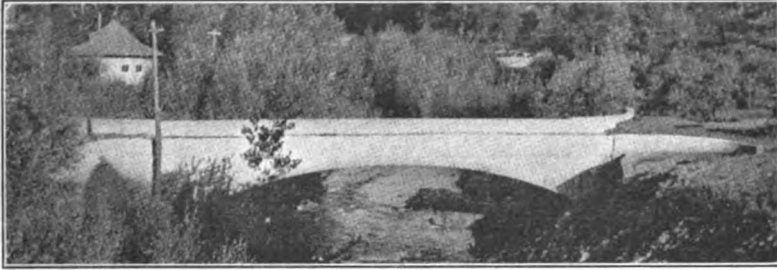

FIG. 380.—Curved spandrel extensions lend added grace and beauty.

abutments somewhat wider than the bridge and giving the front face a slight batter away from the structure. If the bridge is much narrower than the approaches, the offset may be either square or curved, though the appearance of the latter is somewhat more striking.



FIG. 381.—Poorly-designed girder bridge. Unequal spans are not easily harmonized. Inadequate supports; flimsy railing.

111. Harmony of Dimension.—Closely associated with harmony of form is harmony of dimension. For an arch bridge, the rise should bear a reasonable relation to the length of the span. The arch ring should be visible in the elevation of the bridge and should increase in thickness

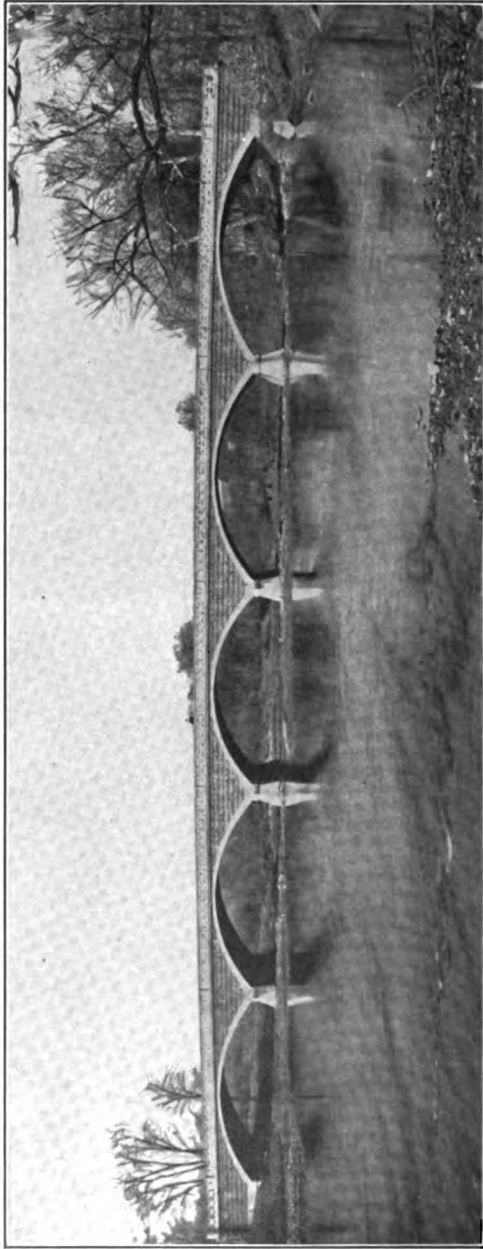

FIG. 382.—Five equal spans showing clearly the optical illusion of center span appearing shortest. The middle span should be the longest and dominate the others. Note excessive batter on piers.

toward the springings. In girder construction it is not possible to show any harmonious relation between the height and the length of span unless the bridge is a low one.

The length of the bridge should fit the width of the stream, at least the bridge should never be shorter than the stream is wide. Unless this rule is adhered to, there will be such an appearance of inadequateness and stinginess that the whole design will appear to have been slighted. If there are more than two spans, the longest should be in the middle, and adjoining spans should decrease in length toward the ends of the bridge. This applies particularly to arch bridges. By this method waterway is provided where needed and the bridge is given an appearance of balance. The span nearest the observer nearly always seems longest and the consequent loss of symmetry would necessitate a dominating span in the middle of the series. Moreover, when spans are equal, the central span will seem to be shortest because of the readier comparison with objects on the banks. To compensate for this optical illusion, the end spans should be shortest and there should be a gradual increase from span to span until the longest span is reached at the middle. Such an arrangement of spans also permits the added rise to provide for suitable camber. And there is no other satisfactory way to provide the added height for camber except possibly by placing the springings at different elevations, resulting in an awkward outline in elevation.

CHAPTER XXX

ORNAMENTATION

The last feature to be considered in the effort to secure an esthetic design is the ornamentation of the structure. It may be considered last, because if it should be forgotten entirely the result would more often be fortunate than otherwise. It is the general appearance of a bridge and not the details that make it a success or failure artistically. If all the lines are graceful and harmonious, the effect is sure to be pleasing. Ornamentation of any kind, unless it be determined upon after considerable study, is likely to dwarf the bridge and destroy the harmonious effect.

112. The Purpose of Ornamentation.—The purpose of whatever ornamentation there is should be to emphasize the structural parts and

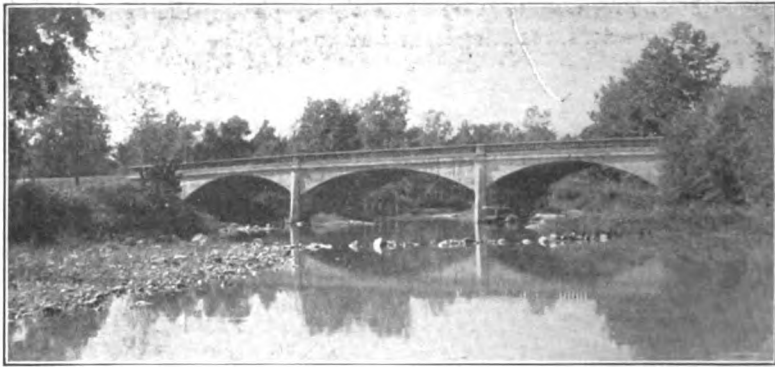

FIG. 383.—Piers with triangular cutwaters flattened at spandrel coping, presenting an artistic and efficient appearance.

impress the observer not only with their relative importance, but with their interdependence. Oddly enough, perhaps, the importance of a structural part is emphasized by the absence of ornamentation, so that the less important members only may be decorated. Mere surface decoration, without any sufficient reason for its existence, is always in bad taste. The governing idea should be structural ornamentation and not ornamented construction.

113. The Piers.—There should be no decoration on the body of the piers, but the bearing surface on top should be accentuated by a coping.

In an arch bridge, the coping should preferably be at the pier ends only, and, for arches with solid spandrels, the arch ring may preferably be made tangent to the pier surfaces. The piers should project beyond the parapet walls to serve as cut waters and in this way add to the appearance of stability of the structure. Round pier ends are particularly appropriate in concrete, though pier ends are also quite satisfactory in appearance if of triangular shape with a very flat angle at the apex. Maximum strength and beauty of line are given to curved pier ends if the batter is made greater near the base than in the body of the pier. This detail, however, cannot be successfully applied to piers with pointed ends. In the latter case the batter should be uniform to the base of the piers in order to show as a straight line from whatever direction it is viewed.

114. The Abutments.—The abutments, as well as the piers, are supporting members and should have the appearance of ample strength.



FIG. 384.—Abutments hidden, resulting in an unfortunate appearance of weakness.

For this reason they should usually be wider than the rest of the bridge and should be extended up to the roadway as wings or retaining walls for the approaches. Unless prevented by the necessity of obtaining maximum waterway between established dock walls or private property on the banks of a river, the abutments should be in full view and should be given the prominence which their importance justifies. If they are hidden behind retaining walls or adjacent buildings, there will be a reduction in the apparent stability and finished appearance of the structure.

115. The Arch Ring and Spandrel Walls.—In an arch bridge the arch ring is the important supporting member and should be made to stand out in a high light. In the open-spandrel type of construction, the arch ring is a distinct structural member and requires no special treatment in order to emphasize it. If the spandrel is filled with earth between side-walls, the arch ring can be made conspicuous by marking its outline on the surface of the walls. The arch ring should be polished and the spandrel walls darkened by removing the surface, exposing the body of the concrete. The same results may be obtained by depressing the entire spandrel walls a slight distance, although the contrast of the

two structural members will not be apparent to an observer at any ordinary distance from the bridge unless there is some variation in surface tone. If this difference in color be obtained as suggested above, it will probably be permanent as the roughened surface of the concrete will become darker with age, catching and retaining more dirt than the polished arch ring.

Horizontal spandrel coursing, always out of place on a concrete bridge, is more unsatisfactory than ever if continued unbroken between two adjacent spans. A vertical paneling has been employed in a considerable number of bridges. The effect is quite pleasing on a bridge

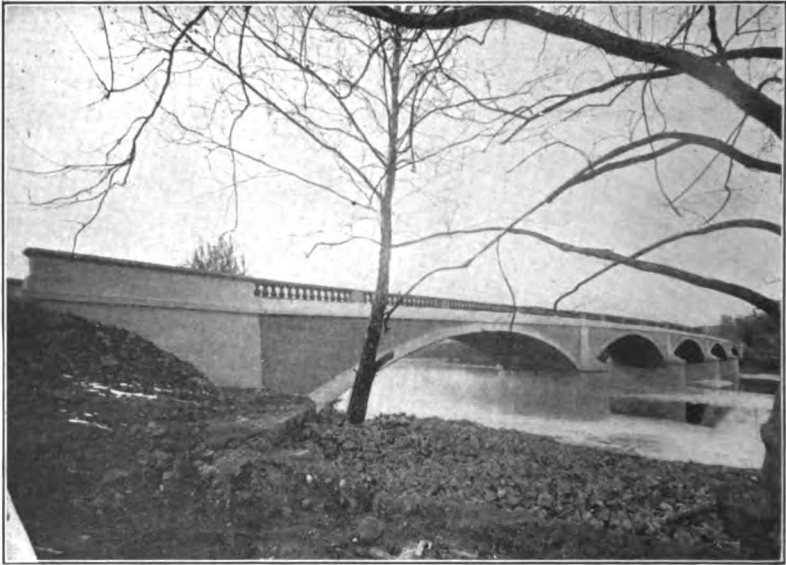

FIG. 385.—Polished arch ring contrasting with roughened spandrel wall. The accentuation of structural members results in a beautiful bridge.

with a cantilevered sidewalk where the panels come between the cantilever brackets, but there is not much excuse for this sort of surface treatment under other conditions. Figures in relief on the surface of a spandrel wall always give the impression that the would-be artist has taken advantage of his subject to display his lack of taste. Any attempt to cover up poor workmanship by applying a surface wash of mortar or neat cement is sure to check and crack off after a few seasons at most.

If open spandrels are used, the spans between columns should increase toward the springings of the arch. If the column spans are all of the same length, those between short columns over the crown of the arch will appear longer than those between the longer columns over the

haunches. Instead of using columns throughout, a satisfactory result may also be obtained somewhat more economically by placing spandrel

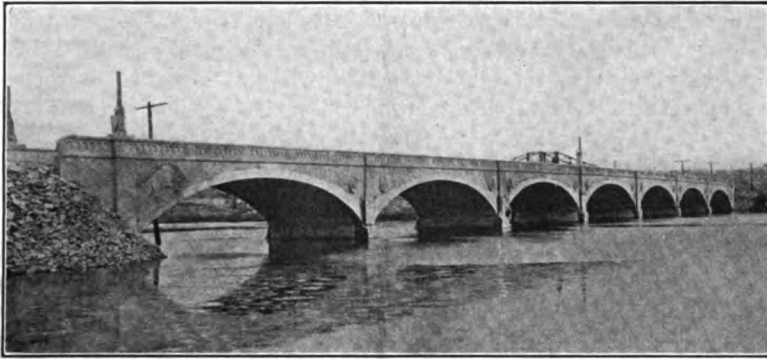

FIG. 386.—Unsatisfactory ornamentation. The spandrel of an arch is no place for a buffalo, and a single medallion on the pilaster would have been more effective than the two shown.

walls instead of columns for some distance on each side of the crown of the arch. The difference in height of the columns will then not be

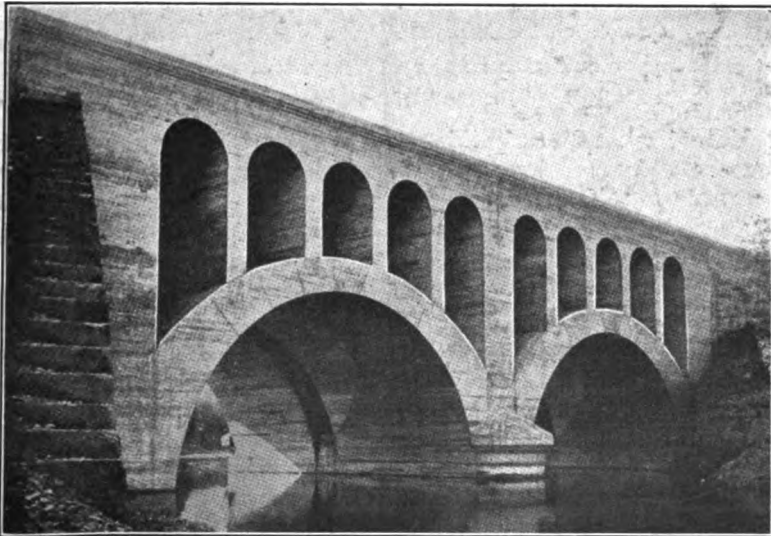

FIG. 387.—Awkward treatment of open-spandrel arches. Coping inadequate. A single span would have been the proper solution.

so great and the spans between columns will not appear so unequal. This method also has the advantage of giving a lighter and more grace-

ful appearance to the crown of the arch and, in addition, prevents the illusion of sag in the roadway at that point. This sag is due to the proximity of the straight line of the roadway slab to the curved line of the arch rib and cannot be eliminated except by the use of an excessive camber or by placing the roadway slab directly on the crown of the arch as suggested. It is believed that this latter method is better, because it is difficult to discover any reason for keeping the crown of the arch any material distance below the roadway slab.

The columns supporting the roadway should be square, or rectangular. Each column should rest on a base somewhat larger in section than the

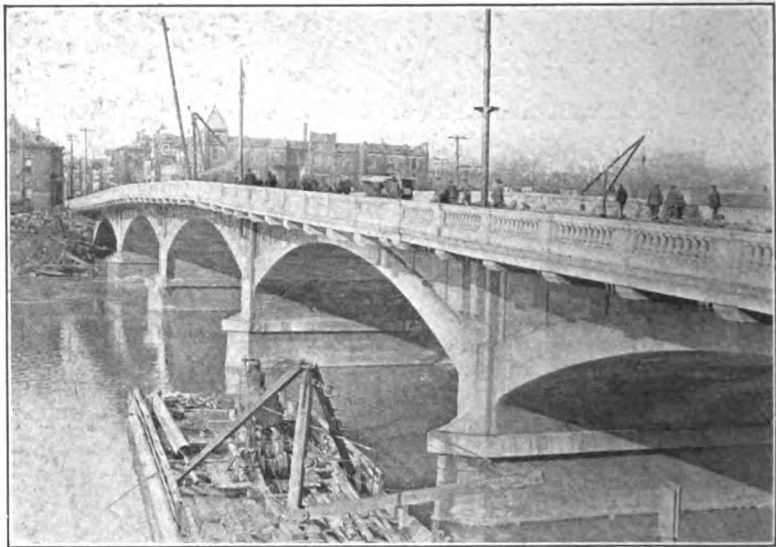

FIG. 388.—Improper location of pier coping below the springing. The arches are identical, and the camber necessitates springings of different elevations—a feature that could easily have been avoided by varying the spans. The camber of the coping line is badly treated.

column and should have a capital or coping for receiving the load of the roadway. There should be a half column only adjacent to or practically forming a part of the piers and abutments. This detail gives a much better appearance than the entire omission of such columns, which omission apparently allows the roadway to rest directly on the piers. The beams between the tops of the outside columns should be arched in order to harmonize with the rest of the structure.

The long narrow surface of the arch ring is not suitable for decorations. Besides, the arch ring is a most important structural member and should not be decorated on that account. Keystones and imitation voussoirs are inappropriate and untrue. Keystones in concrete have

the added disadvantage of putting an uncalled for and apparently heavy ornament at the crown of the arch where there should be an appearance of lightness and grace. In the concrete arch the springings should be emphasized rather than the crown. The coping at the top of the pier is sufficient for this purpose and should always be placed directly at the actual springing point of the arch ring.



FIG. 389.—Artistic treatment of round-nosed piers, with curving batter and a triangular cutwater, blending the cocked hat of the pier cap into the spandrel face.

116. The Pilasters.—A pier detail of some kind should always be carried up to the level of the roadway to differentiate the adjacent spans—mere relief decoration is not sufficient. This portion of the pier is not a supporting member, so should be less prominent and possibly have some ornamentation. But in every case it will be found that a plain,

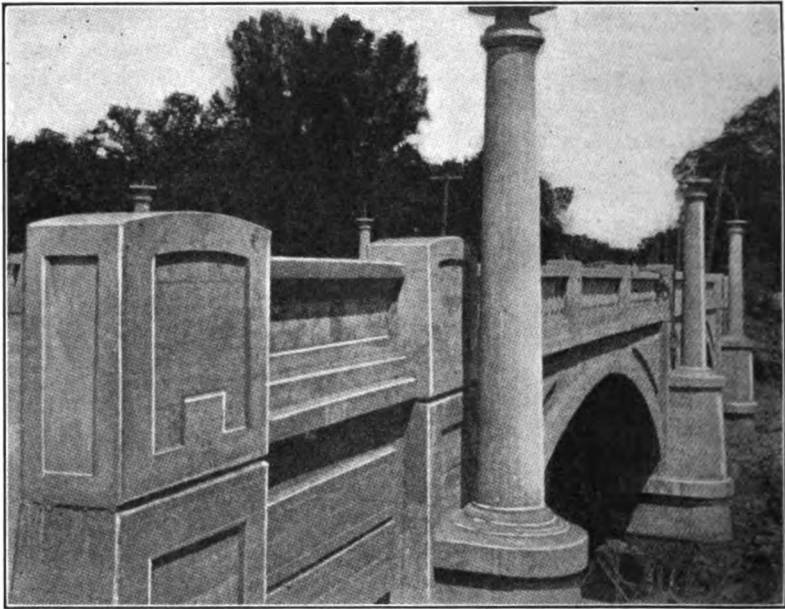

FIG. 390.—Showing bad effect of raised panels and ginger-bread treatment. Unfortunate location of lamp-posts.



FIG. 391.—Undesirable effect of triangular panels in retaining walls at each end of bridge. Raised panels on arches objectionable. Form of panels inartistic, particularly the feature that maintains a uniform thickness of arch ring. The bridge has no camber, resulting in appearance of sag at crowns. Plinth and cap of railing inadequate.

flat, or pointed pilaster will give a better effect than columns, bays, statuary, or other affected architecture. The appearance is good if the lower portion of the pilaster is formed into a curved ice-breaker to relieve the sudden break in the pier construction. Molded decorations in relief, if not too large, are appropriate and pleasing near the top of the pilasters. There should be but one ornament on each pilaster and it should be simple.

117. The Retaining Walls.—A plain or depressed panel of sufficient size to add to the dignity of the structure will sometimes agreeably relieve the monotony of the dull, flat surface of the wings or retaining walls. Raised panels do not look well, partly because of their effect on the apparent size of the wall and partly because they are not really



FIG. 392.—Unsightly combination of arch and box opening. Illustrates the necessity for proper treatment of abutments to show strength. The box opening is to provide for a canal which will ultimately flow along the back of a retaining wall to be erected at the abutment end of the span.

panels but raised ornaments. The panel should be made to contrast with the rest of the surface by exposing the body of the concrete or by using some contrasting material, though colored panels in concrete work nearly always so reduce the apparent size and strength of a member and attract so much attention to themselves that they should not be used except after considerable study of their effect. The panel on a retaining wall should be rectangular and should not be of a triangular shape in an attempt to conform with the slope of an earth fill. Arches or other openings through the walls of the approaches should never be placed near enough to the face of the bridge abutment to destroy the appearance of ample strength.

118. The Spandrel Coping.—The line of the roadway should always be marked with a coping which should usually extend around the piers

and abutments as well as along the top of the spandrel walls. If the coping is omitted from the pilasters and abutment walls, the bridge is likely to look garish and incomplete; and if the coping is omitted entirely, which may be done by extending the spandrel walls to form the



FIG. 393.—Unsightly arch in beautiful surroundings; no coping; no railing; unintentional break at crown due to careless erection.

hand railing, the bridge will have an unfinished appearance—that is, will seem to be entirely minus a hand railing.

The depth of the coping and the amount of the overhang will depend upon the size and importance of the bridge. The vertical face of the



FIG. 394.—Inartistic attempt to treat concrete as an individual material; a proper motive, but handled with no knowledge of structural ornamentation. Note absence of coping, railing, pilasters, and improper attempt at ornamentation over piers.

coping should never be decorated, but much beauty may be added to the structure by decoration of the undercoping. It should be handled as a cornice, depending on the shadows to give character to the work, but may not be developed to any such extent as in an elaborate building.

Square, quarter round, or cove moldings may be used to good effect and are readily molded in concrete. The most elaborate cornices are more suitable for use with materials other than concrete.



FIG. 395.—Lack of coping and plinth ruins an otherwise acceptable structure. Improper location of panels accentuates absence of coping. Un-sightly discoloration on spandrel face due to improper selection of construction joints.

119. The Railing.—Since the carrying of the roadway across the stream is the main object of a bridge, the line of the roadway is of enough importance in the structure that it should be further accentuated with a railing. The railing is about the only portion of a bridge that

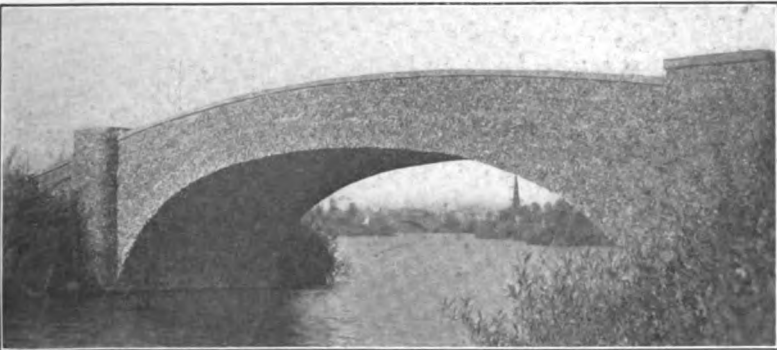

FIG. 396.—Structural ornamentation subordinated to surface finish. A typical case of gravel finish carried to excess.

is visible from the street, so should be designed with more attention to detail than the rest of the structure. It should, first of all, seem to be strong enough to serve as a protection to traffic. The flimsy pipe

railings that so mar the appearance of many otherwise handsome bridges do not even have the quality of economy to recommend them, although they do have the appearance of cheapness. On the other hand, pipe and



FIG. 397.—A fairly satisfactory design with numerous petty faults. Coping projection excessive. Appearance of arches would have been improved by tangency at piers. Panels are too deep in spandrels. Railing well designed but would have been improved by odd number of panels over each span. Lamp posts harmonious except as to material. Cocked hat on pier caps of undignified design.

other iron handrails may sometimes be used with good results, as on light park bridges or on heavier bridges when the depth of the side-walls above the middle of the span is great. The railing on a concrete bridge should more often be of concrete or stone, preferably the former. But



FIG. 398.—Flimsy gas-pipe rail compensated to some extent by heavy but awkward posts.

even then, judgment must be used or the appearance will be as much too heavy as the pipe railings look too light, particularly when a solid vertical slab is used.

120. Parts of the Railing.—To every masonry railing there should be three distinct parts: (1) the plinth or base, (2) the coping, and (3) the dado or central portion.



FIG. 399.—Graceful park bridge with iron railing in keeping with design. This railing would have been improved by another post over springing.

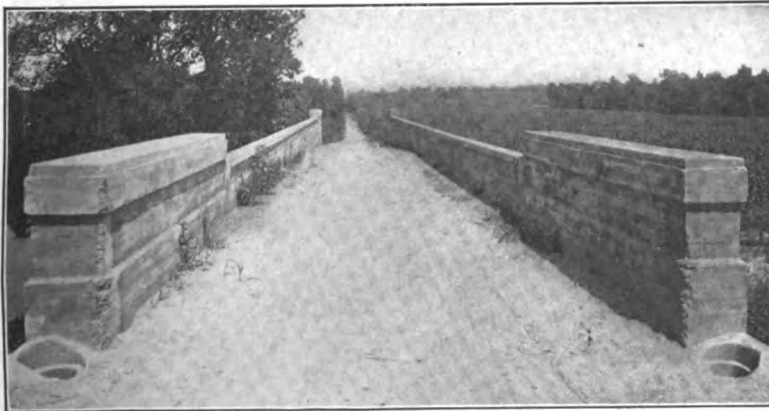

FIG. 400.—Showing railing with plinth, dado, and coping, in elemental form, with no attempt at ornamentation. The result would not have been bad except for the unfortunately excessive height of the pedestals at each end of the rail.

The Coping and Plinth.—The plinth should be plain and substantial without any ornamentation. It may shade into the dado with well-defined lines of right-angled beading which should be small since the load to be carried is evidently not great. The coping and plinth should

be of the same width and should be set so that the outside face of the railing and the side-walls of the bridge are in the same vertical plane, allowing the coping of the side-wall to serve as a projecting water-table.



FIG. 401.—A well-proportioned railing on a three-span arch bridge. Note spandrel coping, plinth, dado, cap, solid dado over abutments and pier, true line and camber of handrail uninterrupted by posts except at abutment and piers.

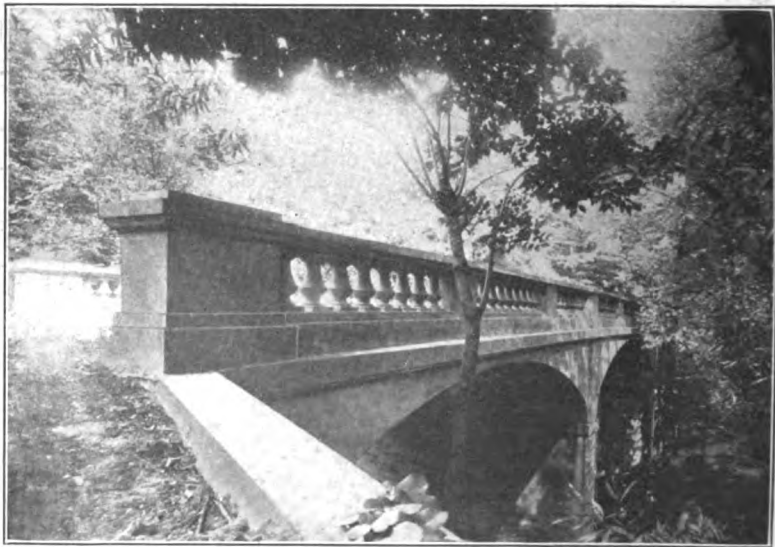

FIG. 402.—A properly-detailed railing. Pier and coping, however, not sufficiently pronounced.

The coping is a handrest, so should be smooth. It may be flat on top but presents a better appearance if slightly gabled, with a true

line at the peak. It should not be nearly so deep as the plinth nor so deep as the coping of the side-walls. Nor should the undercoping of the railing be decorated to any such extent as the undercoping of the walls, but it may have one or two lines of beading which will give sharp shades and shadows. About the only other note of individuality which may be given to the coping and plinth is to give them a more striking color. This has been done quite effectively by the use of white stone for these portions of the railing with gray stone dado or with coping and plinth made of white cement and the dado of the ordinary darker cement.

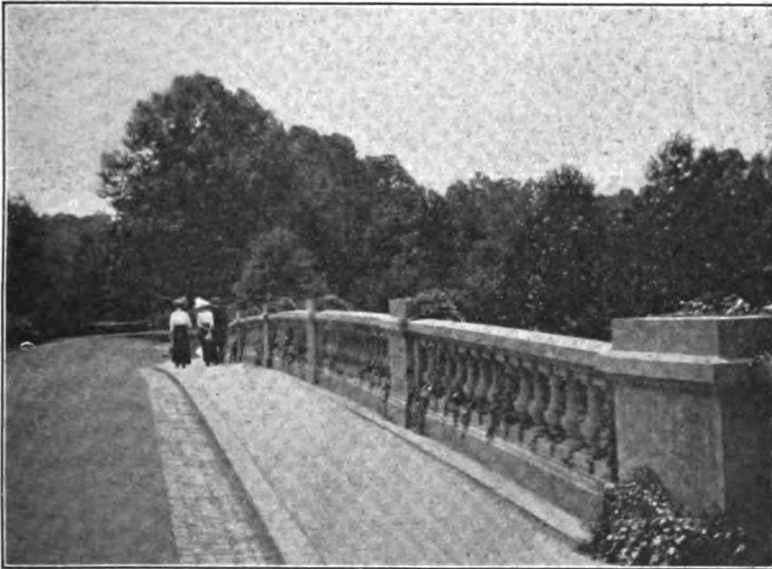

FIG. 403.—A well-designed railing that might have been improved by more-subdued posts.

The Dado.—The only portion of the railing which may receive much decorative treatment is the dado. If of masonry, it may be solid with depressed panels of a contrasting color always in flatter tone than the rest of the surface. An especially pleasing effect may be obtained on a bridge which is somewhat massive by the use of turned or molded balusters. These balusters are short columns and should have a well-defined plinth, body, and capital. They should be light and graceful because they carry no load and should not make the bridge look top-heavy. On the other hand, they should not have the appearance of being spindling and insufficient. The railing should be divided into panels by the use of plain rectangular posts unless the camber is so



FIG. 404.—A substantial and expensive structure, yet unsightly. Arch curve awkward and improperly selected for the earth fill; excessively heavy crown; the whole effect being of constricted waterway for which there is no necessity. Objectionable railing post over crown. Drainage discharge should have been through arch instead of wing.

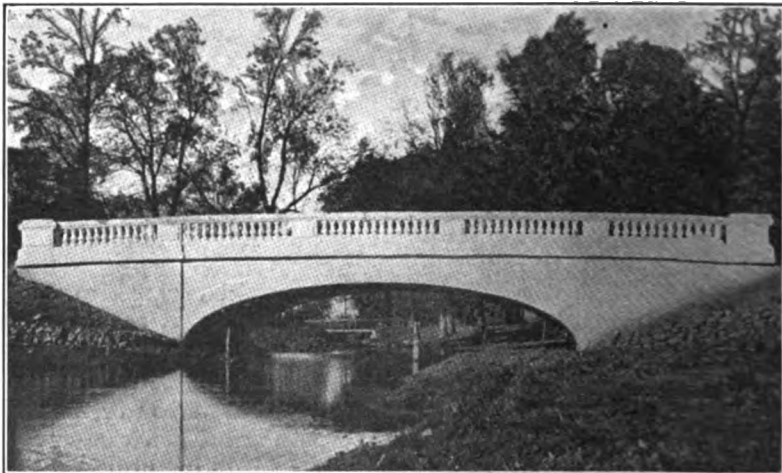

FIG. 405.—A handsome bridge except for two defects. A heavy post and closed dado would have been preferable over each abutment, and the curved camber should have ended with the span.



FIG. 406.—An example of Chinese camel-back design without sufficient apparent excuse. Lowering of crown would have increased the beauty of the arch curve and would have reduced the excessive reverse in the copings. Note the refuge bays at extreme ends of railing, and absence of railing detail to show end of span.



FIG. 407.—Detail of lamp post from bridge shown in Fig. 366. The post is made entirely of concrete including the brackets, with bronze holders for the glass globes. Cap of railing post is excessively heavy, but is necessitated for proper appearance of pier from water front.

excessive that their vertical lines are out of harmony. These posts should be the same height and thickness as the balusters and should never interrupt the lines of the coping and plinth. The number of panels of balusters should always be uneven, so that there will be a panel and never a post over the center of the span. This gives an appearance of lightness and strength and is even more pleasing if a long panel is placed at the middle with panels of decreasing length on each side.

121. Pedestals over Piers and Abutments.—The pedestals at the end of the spans should be in the nature of developments of the piers an

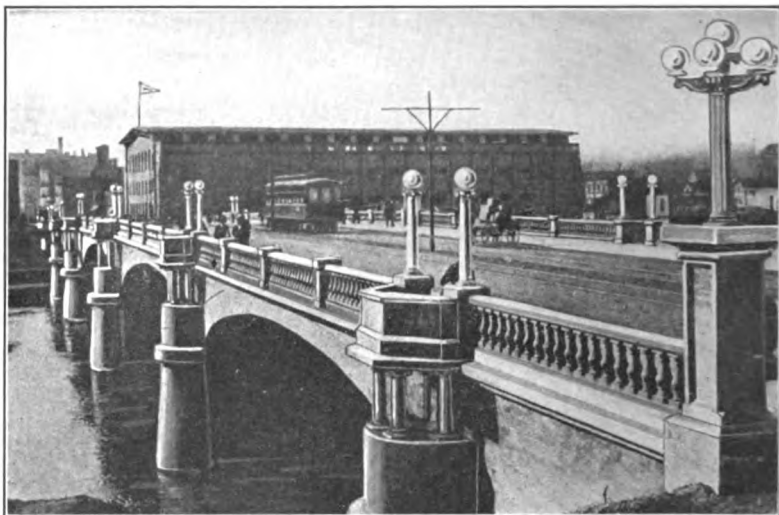

FIG. 408.—Refuge bays improperly supported, necessitating duplication of lamp posts at piers. End post of railing a failure, designed apparently to fit a previously moulded cluster light post.

abutments. They should harmonize with the rest of the railing, preferably by having the same coping and plinth, though considerably wider, especially over the abutments. But the pedestals over the piers and abutments should not be so large and out of proportion that the bridge will seem to have been built only in order to display them. The dado of the pedestals should be solid and should not ordinarily be paneled or ornamented. This is as suitable a place as any other to put the tablet inscribed with the name of the builders. The railing will have a more finished appearance if the pedestals over the ends of the spans are given additional height in the shape of raised caps on the coping. These may be either flat on top or sloping in four directions. The caps over the pier pedestals should not be so high as those over

the abutments, but on the other hand, should not be so small as to be insignificant.

122. Special Features.—There are a number of special features that are sometimes added to beautify a bridge or give it a more monumental character. These include ornate lamp posts, refuge bays, statuary, and ornamental portals.

Lamp Posts.—Lamp posts should be of the same material as the rest of the railing. This is especially desirable in concrete bridges, for iron

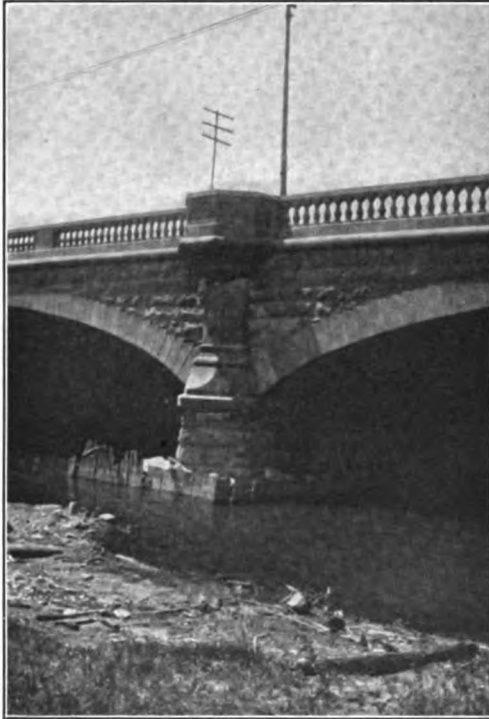

FIG. 409.—Illustrates the top-heavy appearance of a refuge bay without proper treatment of the pier support below. With omission of the refuge bay, the pier would have been satisfactory.

posts will rust and discolor the masonry. The posts should be of a height and general design harmonizing with the rest of the structure. If cluster lamps are provided, the columns and bases should be heavy enough to carry them with apparent security. A lamp post should be placed over each abutment as nearly at the end of the span as possible and not at the outer end of the wing walls. Additional lamps may be placed over the piers, but not between the piers unless the spans are

very long, and then never at the center of a span. Lamp or trolley poles at the curb lines are undesirable, because they decrease the apparent



FIG. 410.—The entrance to this bridge may be in harmony with the monumental structure, but there is nothing about the iron railings to support this appearance. Also the two totem poles at each pier might have been replaced to advantage by a single more massive detail to harmonize with the portal. The appearance of the structure from the roadway does not support the expectations aroused by the entrance.



FIG. 411.—Detail combining many undesirable features. Pier, low, and apparently inadequate from lack of cutwater; awkward panels; absence of plinth in rail; inappropriate ornaments on posts.

width of the bridge. It is scarcely possible to design a combination light and trolley pole that will present a pleasing appearance.

Refuge Bays.—The appearance of a bridge is often spoiled by the use of refuge bays. These bays serve no useful purpose, except perhaps at the abutments where they afford a view of the entire side elevation of the bridge. Even in the latter case, however, the results are much more satisfactory if the entire approach is enough wider than the bridge so that the view is provided from the approach sidewalk. Also the observer's feeling of security is much greater.

Statuary and Ornamental Portals.—The addition of statuary is ordinarily a mistake. If the bridge is a great monumental structure or is located amid a lavish display of building architecture, diminutive statuary may not appear out of place.

Ornamental portals have been much more largely used in Europe than in America. This is because European bridges have often been erected as memorials or in commemoration of some military triumph or there has been the necessity for fortification. These reasons do not seem to have existed in this country though there are bridges with massive portals at Capitol Park, Hartford, Conn. and in Indianapolis, Ind. It is believed, however, that with any but the largest structures, satisfactory results may usually be obtained with the use of less pretentious ornamentation.

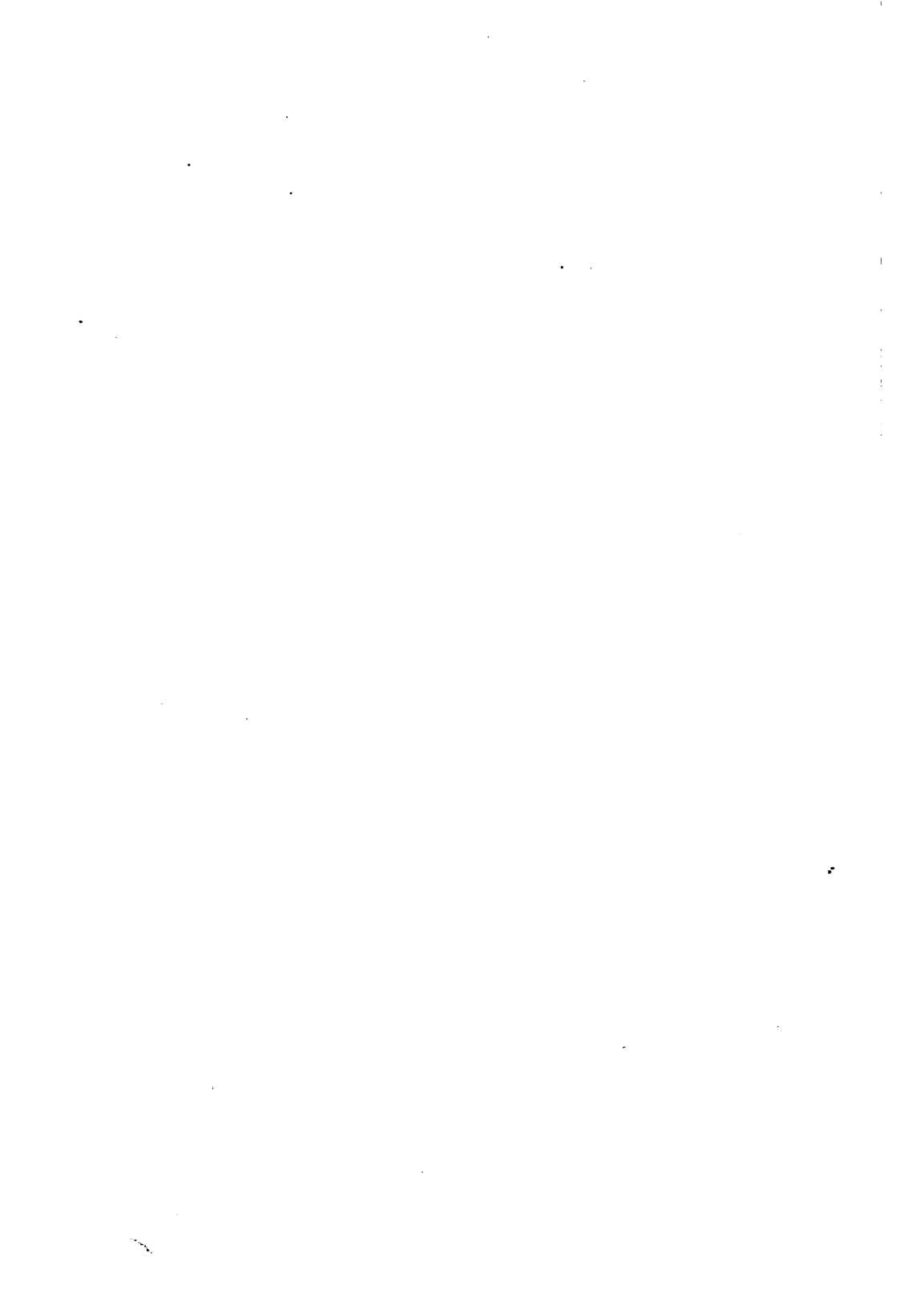

PART VII

THE CONSTRUCTION IN DETAIL OF SEVERAL TYPES OF CONCRETE BRIDGES

BY ALBERT M. WOLF, C. E.

Principal Assistant Engineer, Condron Co.¹

Construction methods and costs so materially affect the design of concrete bridges in matters not strictly theoretical, that a detailed description of the construction of several concrete bridges representing good practice can be considered an important part of this treatise.

The construction of the monumental Tunkhannock viaduct is an achievement of such widespread interest, that, although not exactly typical of extensive American practice, its detailed treatment is of exceptional value to the student and the practising engineer. This bridge is indicative of the high state of development of the concrete designing practice of the D. L. & W. R. R. and in addition reflects great credit upon the status of concrete bridge design and construction in America.

CHAPTER XXXI

CONSTRUCTION OF THE YARDLEY BRIDGE

The construction of the Yardley Bridge over the Delaware River, Philadelphia and Reading Ry. (the details of design of which are given on Plates IV, V, and VI, Chapter XIII) involved some interesting and novel methods—especially in pier excavation, arch centering, and surface finish—and these features together with other construction methods will be described in detail.

123. General Plant Layout.—On account of the extreme length of the bridge (1455 ft., 6 in.) it was deemed advisable at the outset to carry on the work from both ends, and duplicate plants were therefore built at each end of the structure, as shown in Fig. 412.

The mixing plants were of similar construction and consisted of 1½-yd. mixers mounted on a timber framework high enough above ground to permit dumping directly into cars, or into buckets on cars. The mixers were belt driven by steam engines. Above each mixer was a stone bin with a capacity of 22 cu. yd. and a bin for sand with a capacity of 14

¹ Associate Editor, Concrete-Cement Age; Formerly Associate Editor, Railway Engineering and Maintenance of Way.

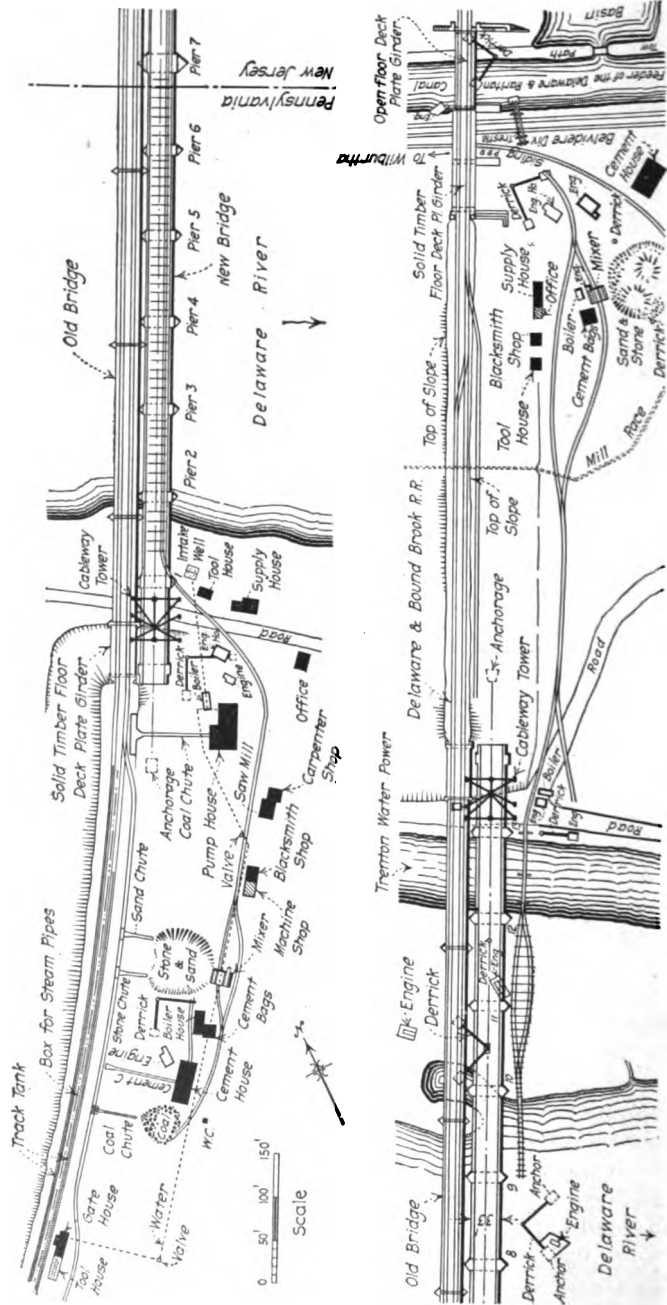

Fig. 412.—Yardley bridge. General plant layout.

cu. yd. The condition imposed by the necessity of storing considerable material on the site was responsible for the location of the mixer plants at some distance from the work, as shown in Fig. 412, which handicapped the work and curtailed the plant output. In addition to the mixing plants a cement house, central boiler house, blacksmith shop, tool house, supply house, and office were located on each side of the river; and a carpenter shop and saw mill equipped with a 44-in. circular saw were built on the Pennsylvania side. The plant on the west, or Pennsylvania side of the river, was located at the foot of a 45-ft. embankment and materials were unloaded from cars into storage piles by means of chutes. On the New Jersey side the materials were brought in on a siding of the Pennsylvania R. R. and unloaded into storage piles or mixer bins by means of derricks with clam-shell buckets. The cement, however, was unloaded by hand and placed in the cement house adjacent to the track. The sand and gravel from storage piles were transferred to mixer bins by derrick in both plants, and the cement was conveyed to the mixer platforms in skips (capacity about 50 bags) by these same derricks. On the Pennsylvania side the cement house was 100 ft. from the mixer and this necessitated hauling the loaded skips on narrow gauge cars to within reach of the derrick.

CONSTRUCTION OF SUBSTRUCTURE

124. Construction Methods.—To carry on the work of excavating and concreting piers, a temporary pile trestle was built on the center line of the new bridge to pier No. 7 (see Fig. 412) from the Pennsylvania side. Upon this was laid a track of 20-ft. gauge, for a steel traveling derrick, with an additional rail at one side forming a narrow-gauge track over which concrete, form lumber, sheet piling, etc., were transported from the shore. The traveling derrick was used in placing cofferdams, in handling the excavated material, and in transferring the buckets of concrete from the flat cars to the pier forms. Fig. 413 shows the construction trestle with traveling derrick at the far end.

The work conducted from the other side of the river was handled in a somewhat different manner from that described above. Instead of using a traveling derrick, a number of stiff-leg derricks were employed, so placed as to cover two piers each. To serve these derricks, about 1200 ft. of narrow-gauge track was laid on a temporary trestle from the mixing plant to a point between piers 8 and 9, as shown in Fig. 412. In Fig. 413 may be seen the stationary stiff-leg derricks and the plant on the New Jersey side of the river.

125. Excavation for Piers.—The excavation for all river piers was carried down to rock in cofferdams of Lackawanna interlocking sheet steel piling 12½ in. wide, with ¾-in. web and 18 ft. long. The piles in the construction trestle adjacent to the piers were driven so as to provide

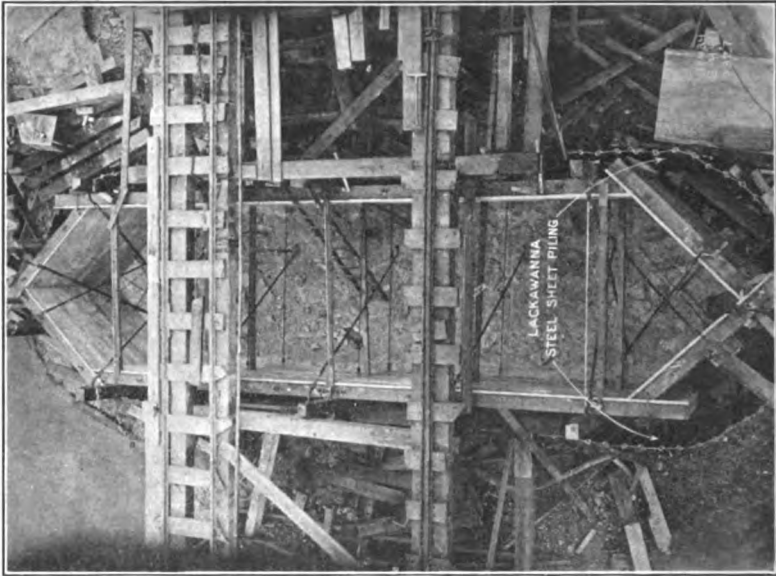

FIG. 415.—Yardley bridge. Pier forms set up inside of cofferdam.

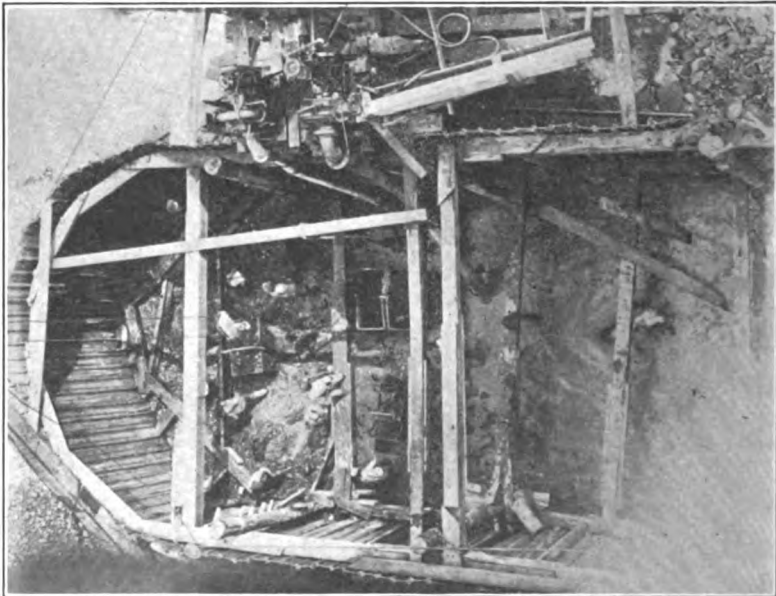
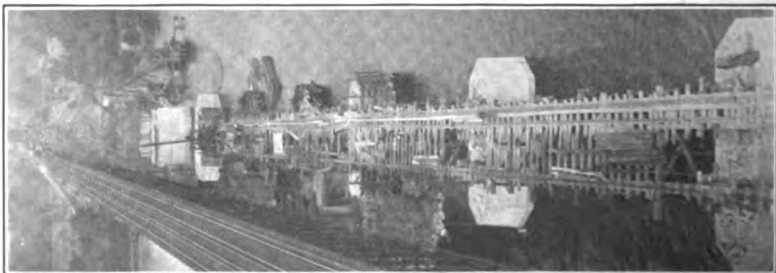

FIG. 414.—Yardley bridge. Looking into pier cofferdam.



Courtesy of Mr. E. Chamberlain, Asst. Eng'r., P. & R. Ry.

FIG. 413.—Yardley bridge. Temporary construction trestle and abutment.

anchorage near water level for 12 × 12-in. timber template, of the same general outline as the piers around which the steel sheet piling was driven. The piling was set up by the traveling derrick, or one of the stiff-leg derricks, and driven to rock by a 4200-lb. steam hammer. That this piling stood driving (which was for the most part through a material made up of heavy gravel, sand, and boulders) in an excellent manner is demonstrated by the fact that only sufficient piling for five cofferdams was purchased and so most of it was used three times. The loss by splitting and bending while driving and pulling amounted to only about 5 per cent.

The excavation, in general carried down 11 ft. below mean low water level, was made by hand, the material being shoveled into buckets which were removed by the derricks and the spoil deposited against the cofferdam to aid in reducing the leakage. (See Fig. 414.) This leakage, when excavation was first begun, was very great on account of the direct contact of several feet of water on the piling and it was difficult to keep the water down so as to allow excavation even when two 6-in. centrifugal pumps were in operation. By placing earth in burlap bags against the outside of the cofferdams and by puddling the gravel and silt along the outside of the joints, the leakage was reduced so as to be easily handled by the pumps. When the rock surface was reached, the water came in under the piling, even where it penetrated 12 to 18 in. into the shale, and interfered with concreting. Since the cofferdams were 2 ft. wider than the pier forms, a space about 1 ft. wide all around the pier was left as a sump (separated from the concrete by a low plank dam) from which to pump the water.

As the excavation in the piers was carried down, additional timbering and bracing was installed to keep the cofferdam in line against the outside pressure of water and excavated material.

126. Pier Forms.—The form work used on all parts of this work is of exceptional interest. All forms were built in units in such a manner as to permit using them several times, and methods which might be termed unusual were employed to keep the forms in exact line and position.

When the excavation was completed, heavy timber uprights to hold the forms in line were placed against the sheet piling and the pier forms, built in 12 × 16-ft. sections on shore, were placed by the derricks. These forms were built up of 8 × 16-in. horizontal timbers, spaced about 2 ft. centers and well braced, covered with two layers of 1 × 8-in. boards laid diagonally, which in turn were faced with No. 22 galvanized sheet iron. They were held in place by 4 × 6-in. horizontal spreaders and $\frac{1}{2}$ -in. rods, and the ends were equipped with wrought-iron swivels to receive the square nuts of stub bolts which extended several inches into the pier and through the forms to the outside of the waling timbers. The use of these stub bolts and swivels made the alignment and removal

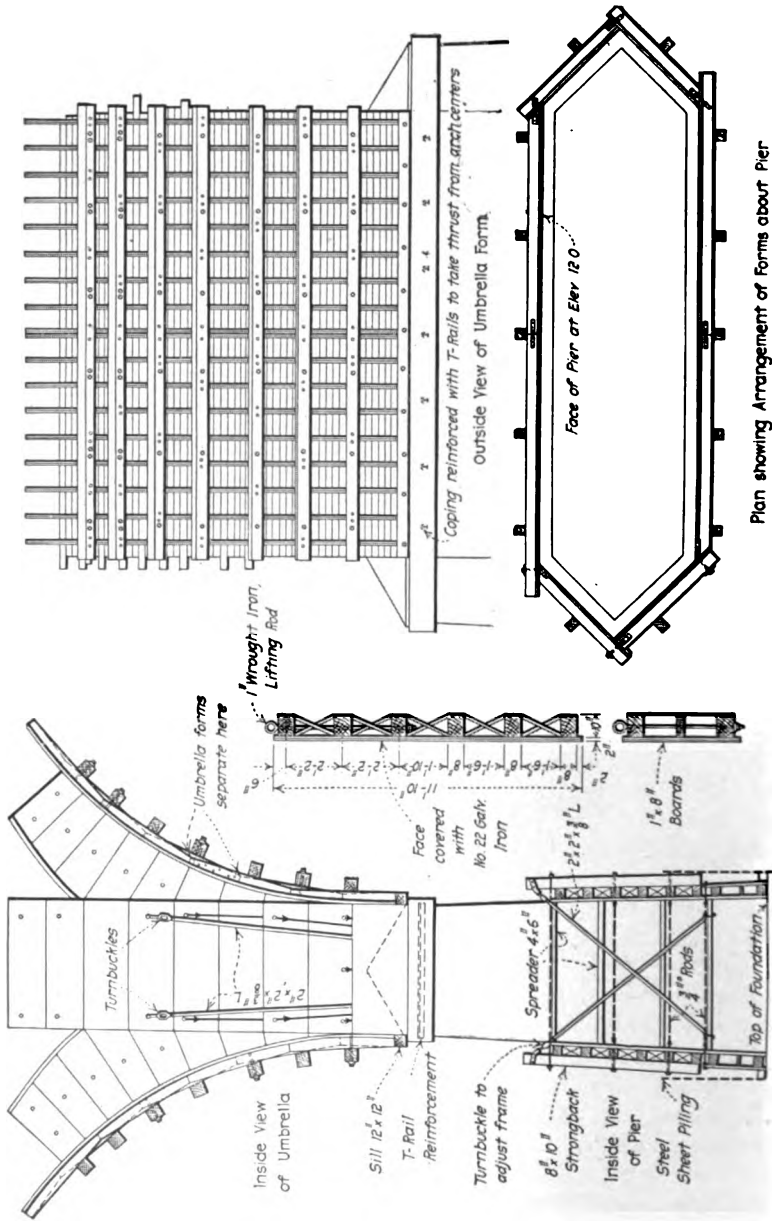

Plan showing Arrangement of Forms about Pier
 Details of pier and umbrella forms.
FIG. 416A.—Yardley bridge.

of forms easy, for, when removing forms, the stub bolts were turned out of the nuts in the swivel, and the holes left were patched up with concrete. Thus the necessity of cutting bolts was avoided, and no metal was exposed which could rust and discolor the concrete. The top portion of the forms was adjusted to line by the use of diagonal $2 \times 2 \times \frac{3}{8}$ -in. angle braces anchored to the concrete previously poured, and these were equipped with turnbuckles at the top which were bolted to collars on the upright waling timbers. By referring to Fig. 415 which shows a section of pier form in place inside the cofferdam, it will be seen how true to line the forms were kept by the braces and

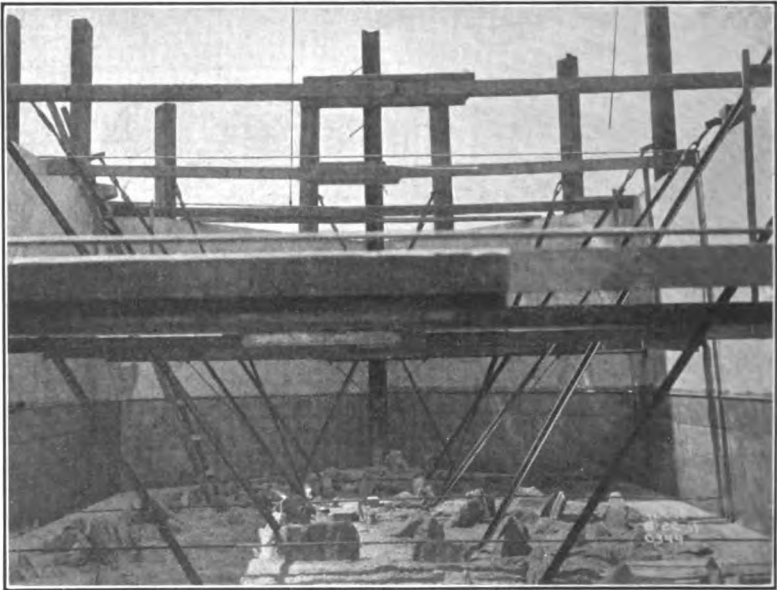

Courtesy of Mr. E. Chamberlain, Ass't. Eng'r., P. & R. Ry.

FIG. 417.—Yardley bridge. View inside of pier form showing bracing.

ties. The details of pier forms, including the umbrella sections of arches, are shown in Figs. 416A and 416B.

127. Concreting Piers.—The concrete placed in the first 4 ft. of pier footings (which were about 10 ft. deep) was of a 1:2:4 mixture, while, in the remainder of the pier to the springing line of the arches, a 1:3:6 mixture of concrete was employed with large limestone rocks (such as one or two men could handle) embedded therein. The quantity of stone used in various parts differed since the same derrick placed the concrete and the stone, and the concrete was at all times given preference, being placed as soon as delivered from the mixers.

The concrete was delivered to the derricks in $1\frac{3}{4}$ -yd. drop-bottom

buckets. Special care was taken at all times to obtain good construction joints and for this purpose triangular wooden fillets $1\frac{1}{2}$ in. wide were placed at such points as conformed with the daily output of the plants. The day's work then stopped at the inner edge of a fillet. This scheme

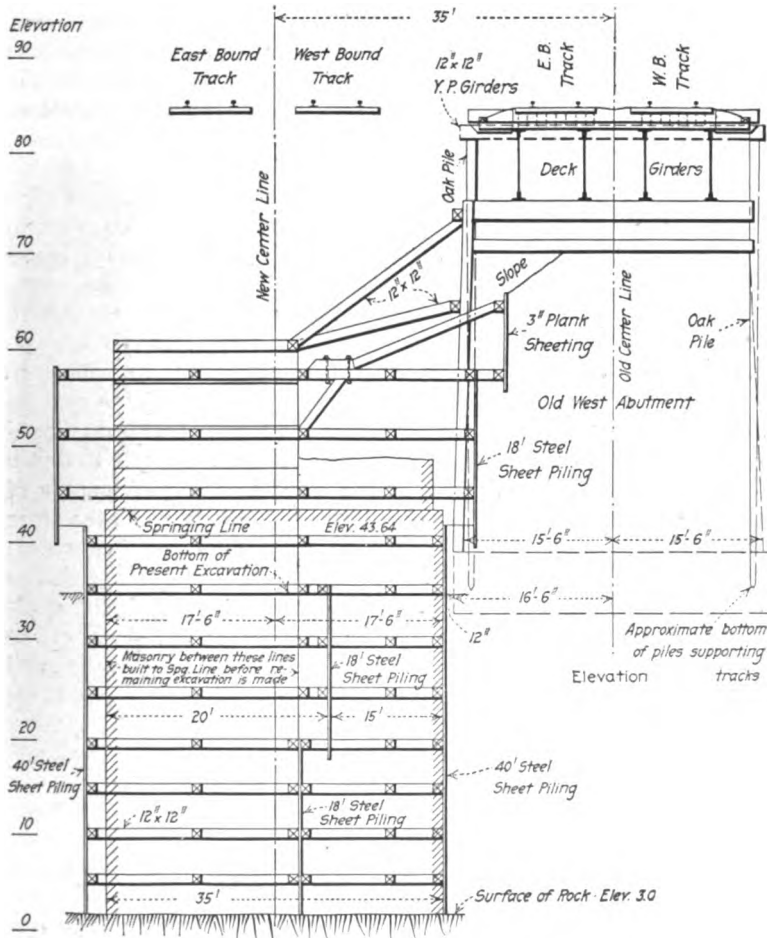

Section
 FIG. 418.—Yardley bridge. Details of abutment cofferdam.

was very effectual in hiding any irregularities in the construction joint and gave an excellent line to work to. Fig. 417 shows work stopped off at a fillet and the form bracing in detail. It will be noted in the figure referred to, that horizontal rod ties were placed just above the construction joint. These allowed the drawing up of forms after the

concrete had contracted on setting, and the fillet prevented the fresh concrete from working down between the forms and the concrete previously poured, thereby avoiding the undesirable "lips" or "fins" so hard to prevent in concrete work where the inside form surfaces are not properly constructed.

The piers were completed up to the springing line of arches and then the construction trestle and stiff-leg derricks were taken down and the remainder of the work done with the aid of a Flory cableway.

128. Abutment Construction.—On account of the great amount of excavation (nearly 50 ft.) required to carry the abutments to rock, and on account of the old abutments which were founded on gravel within a few feet of the new abutments, it was decided to use concrete piles driven to rock as a foundation. After driving about thirty piles in one abutment, many of which were broken and sheared off below the surface and badly broomed at the heads in an effort to penetrate the gravel, it was decided to abandon this method and to excavate to rock in cofferdams of steel sheet piling.

A cofferdam of 18-ft. piling was first excavated and then piling 40 ft. long with $\frac{1}{4}$ -in. webs was driven to rock, forming a cofferdam somewhat smaller than the upper one. The half of this farthest from the old abutment was first excavated down to rock using 18-ft. piling to divide the cofferdam. This half was then concreted to the springing line of arch to provide a means of bracing the old abutment while the other half was being built. Fig. 418 gives in detail the bracing of cofferdam and the shoring of old abutment. One of the old abutments settled at one end during construction but nothing serious happened, the abutment having been relieved by trestle bents driven so as to support the end of the old bridge. The general methods pursued in excavating and concreting were the same as described for pier construction.

CONSTRUCTION OF SUPERSTRUCTURE

129. Cableway.—While the piers were being constructed, a cableway with timber towers 125 ft. high was erected on the center line of the new bridge. The towers of heavy yellow-pine timber resting on concrete foundations were built between the last pier and abutment on each side giving a clear span of 1320 ft.; this length was divided into two spans by an A-frame at the center pier, each half being operated by a 50-h.p. double-friction drum-hoisting engine. The centering and forms, and all concrete above the springing line, were placed by means of this cableway.

130. Umbrella Sections.—After the piers had been carried up to the springing line, the next operation was to build the pier pilasters, and a portion of the arch rings on either side of the piers, to a point on the intrados a distance of 10 ft. (measured horizontally) from face of pier.

The ends of these sections formed the arch-ring skewbacks and they were known as umbrella sections, the main reason for their use being that the forms were self-supporting on the piers and the span, and the cost of main centering was reduced considerably thereby.

131. Umbrella Forms.—The umbrella forms were made up of ribs consisting of two pieces of 2 × 8-in. plank cut to the arch curve and spaced 2-ft. centers upon which was placed the 2 × 6-in. lagging covered with galvanized iron. The ribs were stiffened by 8 × 10-in. horizontal wales fastened to the former by $\frac{3}{4}$ -in. iron stirrups. The sections on

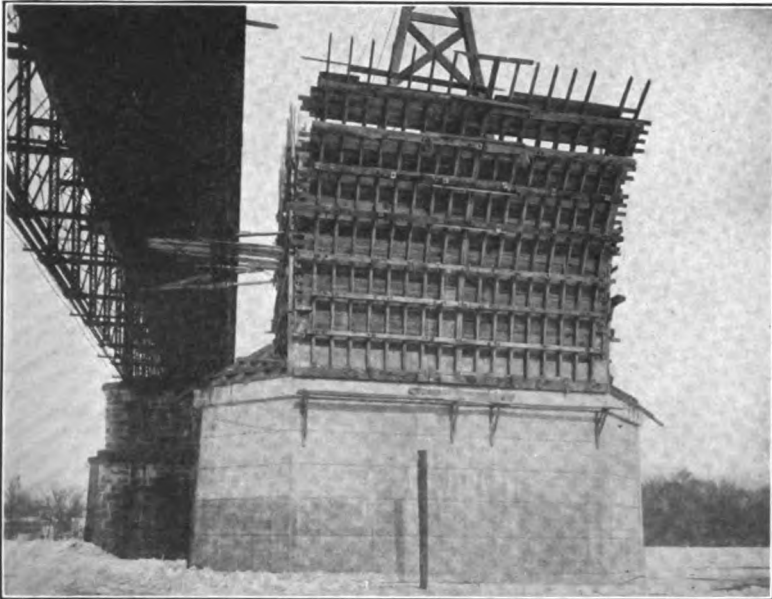

Courtesy of Mr. E. Chamberlain, Ass't. Eng'r., P. & R. Ry.

FIG. 419.—Yardley bridge. Side view of umbrella forms.

opposite sides of the pier were tied together and braced in the same manner as the pier forms, except that the bracing was heavier and more closely spaced. The end, or pilaster, forms were similarly tied and braced as shown in Figs. 416A and 416B which also give the details of umbrella forms. The general construction of the umbrella forms is also shown in Figs. 419 and 420.

The umbrella portions and faces of the pilasters were built up in sections corresponding to one or more face scorings, which were very much closer together than those on the piers in order to coincide with those on the arch rings. The concrete used in these parts was of a 1:2:4 mixture. Stub bars to lap with the reinforcing bars were embedded and keyways

1 ft. 3 in. wide and 6 in. deep were formed in the ends to key the arch ring and haunching to the umbrella sections.

132. Arch Centers.—The main arch centers consisting of seven curved-top-chord trusses of timber were spaced 5 ft. 4 in. c. to c. with a span of 70 ft. between umbrella sections. These were supported on inclined timber bents resting on the pier copings, and anchored near the top to the umbrella sections by means of seven 1½-in. bolts passing through 2-in. pipe sleeves set in the concrete, and further supported at the middle by a timber tower, 21 ft. × 33 ft. in plan and about 60 ft.

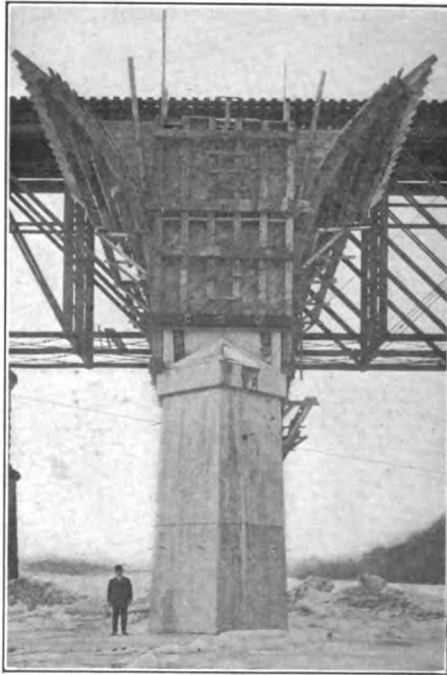

Courtesy of Mr. E. Chamberlain, Ass't. Eng'r., P. & R. Ry.
FIG. 420.—Yardley bridge. End view of umbrella forms.

high, resting on fourteen wooden piles driven in two rows. Figs. 421A and 421B give the details of arch centering including the truss framing details. It will be noted that the inclined timbers of the bents supporting trusses were also anchor bolted to the piers, and the pier copings were reinforced with old T-rails placed directly under each post to take the thrust from the arch centers.

The trusses were built of short-leaf yellow-pine timber with bolted connections throughout, and were built in half sections to facilitate erection. They were set on pairs of hardwood wedges at all points of

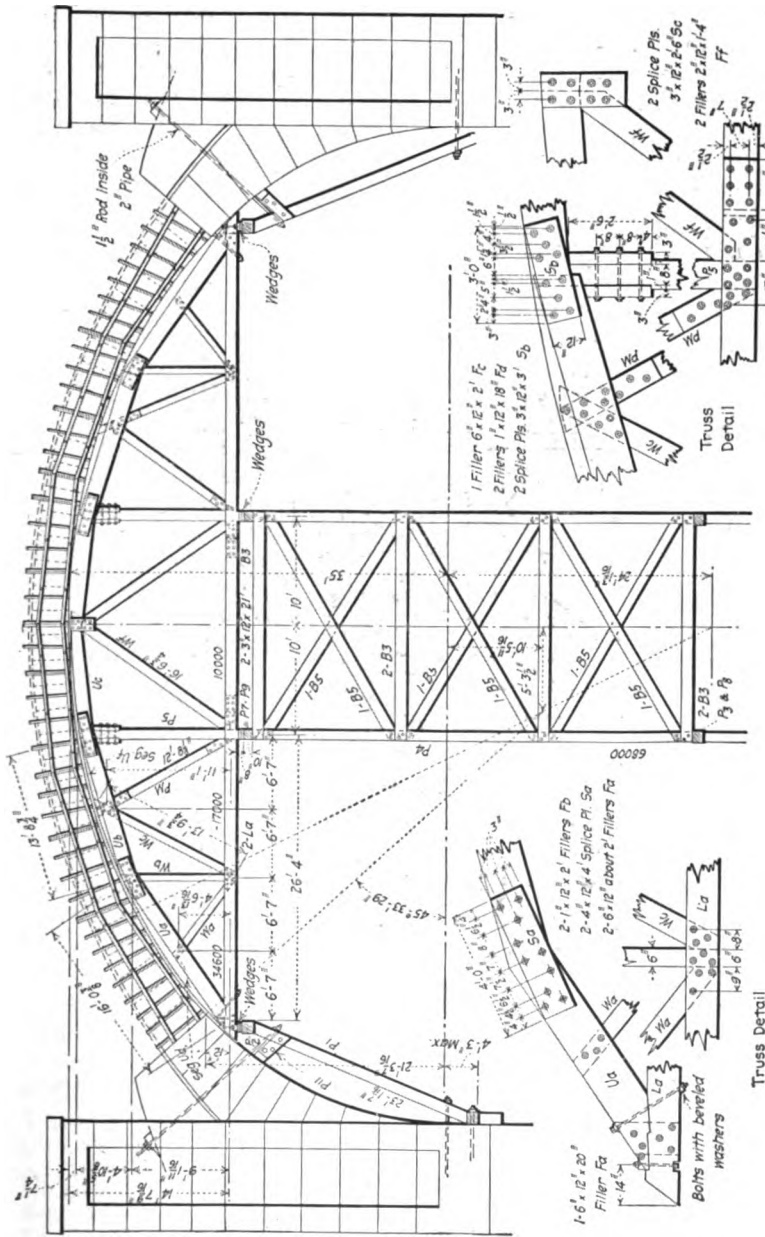
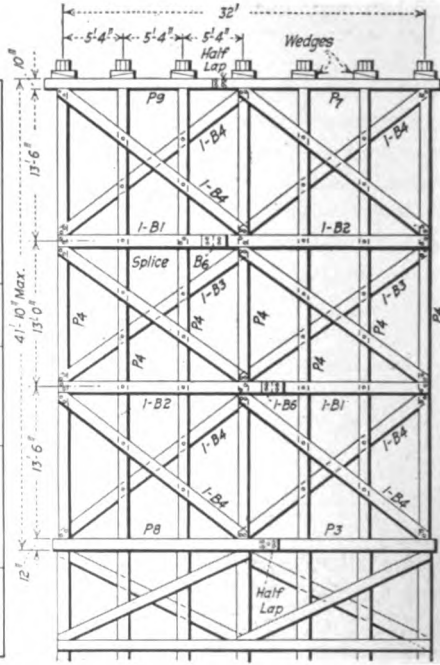

FIG. 421A.—Yardley bridge. Details of arch centering.

Schedule of Timber Required for One Complete Span

Required	Denomination	Dimension	Mark	Remarks	Y.P.
28	Top Chord	4" x 12" x 16'	Ua	"	"
14	"	3" x 15" x 16'	Ub	"	"
14	"	10" x 15" x 10'	Uc	"	"
28	Segment	4" x 10" x 15'	Ud	Cut to radius	"
28	"	3" x 6" x 14'	Ue	"	"
28	Lower Chord	4" x 12" x 32'	La	"	"
7	Tie	6" x 12" x 16'	Lb	"	"
14	Diagonals	6" x 6" x 9'	Wa	"	"
14	"	6" x 6" x 10' 6"	Wb	"	"
14	"	6" x 8" x 14'	Wc	"	"
14	"	6" x 10" x 16'	Wd	"	"
14	"	4" x 12" x 20'	We	"	"
14	Parts	15" x 15" x 20'	Pa	"	"
14	"	10" x 10" x 15' 6"	Pb	"	"
7	Knees	4" x 10" x 20'	Pc	"	"
2	Plates (caps)	12" x 12" x 20'	Pd	"	"
2	"	12" x 12" x 16'	Pe	"	"
2	"	"	Pf	"	"

Required	Denomination	Dimension	Mark	Remarks	Y.P.
2	Plates (caps)	12" x 12" x 20'	P8	"	"
2	"	10" x 10" x 20'	P7	"	"
7	Struts	12" x 12" x 6'	P9	Cut to lengths at job	"
4	Bracing	3" x 12" x 14'	B1	"	"
4	"	3" x 12" x 19'	B2	"	"
64	"	3" x 12" x 21'	B3	"	"
16	"	3" x 12" x 22'	B4	"	"
42	"	3" x 12" x 24'	B5	"	"
1	Fillers	3" x 12" x 16'	B6	Cut to lengths at job	"
10	"	6" x 12" x 12'	Fa, Fc, Fg	"	"
6	"	1" x 12" x 12'	Fb, Fd	"	"
6	Splices	1" x 12" x 12'	Sa	"	"
16	"	1" x 12" x 12'	Sb	"	"
2	Fillers	2" x 12" x 12'	Ff	"	"
60	Wedges	6" x 10" x 12'	"	"	"
14	Lagging	3.6" x 1000' B.M.	"	Oak	"
				In 12 and 16' lengths	"



Transverse Elevation of Tower below Trusses

Bolt List

No. Required	Size (Underhead)	Remarks
28	3/4" x 31" long	At heel of truss (See Mem.)
28	" x 26" "	"
28	" x 21" "	"
140	" x 15" "	For Truss Members, etc.
546	" x 17" "	"
112	" x 19" "	"
280	" x 25" "	"
70	" x 19" "	For P ₂ Knees
16	" x 9" "	For Bracing
308	" x 16" "	"
136	" x 19" "	"
20	" x 15" "	For P ₂ - P ₃ - P ₈ - P ₁₀
8	" x 13" "	For P ₇ - P ₉
28	Doek Spikes 3/4" x 20"	"
14	" x 18"	"

Fig. 421B.—Yardley bridge. Details of arch centering.

support to allow some adjustment in height and slaking down at the time of striking centers.

In framing the trusses they were increased in height $1\frac{1}{4}$ in. at the crown over that shown on the plans to allow for compression in the centers and settlement in arch rings after striking centers. This was done after it was found that the additional height could not be readily obtained by manipulation of the wedges. The centers were designed only for a load equivalent to the showing face of the arch ring (see Plate V, Chapter XIII). This necessitated the pouring of the entire arch ring to this thickness; and after keying up the ring, the haunching was placed. In Fig. 422 the completed centering for one arch is shown with center supports for two other spans under construction.



Courtesy of Mr. E. Chamberlain, Ass't. Eng'r., P. & R. Ry.

FIG. 422.—Yardley bridge. View of completed arch centering.

The center portion of the top chord of the trusses over the center tower was composed of one large piece of timber cut to the radius of the arch ring, while the other two top-chord sections on either side were composed of three pieces of timber, the center one being cut to the curve of the arch, while the outer pieces were framed without shaping.

The lagging (3×6 -in. lumber) was laid on the trusses, the side forms for rings lined with galvanized iron were erected, the lower reinforcement was put in place (see Plate V, Chapter XIII), and the concreting begun. The arch ring between the umbrella portions was divided into thirty-five false voussoirs by the use of triangular wooden fillets nailed to side forms and lagging.

133. Concreting Arches.—Each arch ring was divided, for construction purposes, into six large voussoir sections extending the full width of arch, three voussoirs occurring on each side of the 2-ft. key section.

These sections were concreted in pairs on opposite sides of the crown to balance the horizontal thrust on centers. Two of these sections

amounted to a one day's output of the mixer plant and no intermediate joints were allowed. As previously noted, the arch ring to a depth of the showing portion was concreted first and, when the key had hardened, the haunching was placed.

After centers for four arches to the left of pier No. 7 (the center or abutment pier) had been erected, the two voussoirs next to the crown of arch No. 7 were placed, in order to weight down the centers at the middle and to obtain a maximum settlement of centers as early as possible, thus avoiding excessive secondary stresses in the ring due to settlement after a considerable portion of the ring had been poured. Then two voussoirs next to the crown of arch No. 6 were placed, in order to weight down the center and enable it to better withstand any horizontal thrust which might occur while the sections at the skewback of arch No. 7 were being placed. The fourth pair of voussoirs cast was at the crown of arch No. 5, and then two were placed at the skewback of No. 6. The sixth pair then completed arch No. 7 with the exception of the key section which was next in order. This method of alternating the pouring of sections was followed throughout the entire work, as indicated in Fig. 423, which gives the pouring schedule for the first four arches constructed.

All voussoir sections were keyed together by means of 14-in. keyways, 6 in. deep formed in the ends of the voussoirs. After the crown or key section had hardened, the haunching or backing for the entire arch was poured at one time, except that the haunching was kept back $2\frac{1}{2}$ ft. from the face of the arch so as to form the extradosal joint between spandrel walls and arch ring at the top

of the arch ring instead of at the top of the haunching (see Plate V, Chapter XIII). The centers were allowed to remain under each arch for at least 30 days after completion.

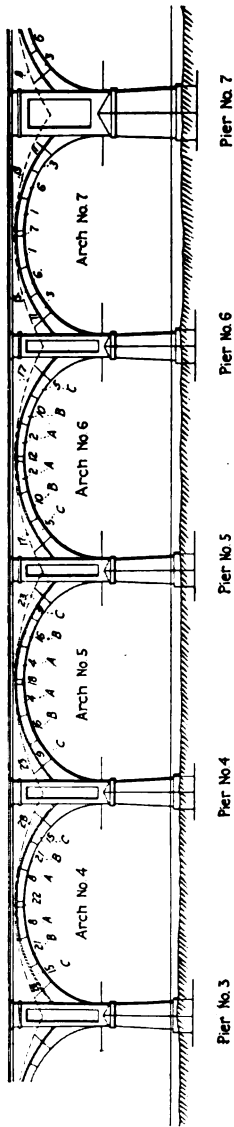

Pier No. 7
Arch No. 7
Pier No. 6
Arch No. 6
Pier No. 5
Arch No. 5
Pier No. 4
Arch No. 4
Pier No. 3

Fig. 423.—Yardley bridge. Diagram showing program followed in concreting arch rings.

During construction, levels were taken on the centers before and after completing the crown sections, also on completing the haunch blocks, the keyways, and before and after striking centers. The first set of readings gave the maximum deflection (0.6 in. to 1.56 in.) for the various arches.

134. Spandrel Forms.—When the centers had been struck and removed, forms were built for spandrel walls. The outside forms, lined with galvanized iron, were set up complete as shown in Fig. 424. The inside forms were constructed so that the spandrel walls for each arch were concreted in seven sections, not counting the pilaster section over the pier. The details of spandrel forms are shown in Fig. 425.

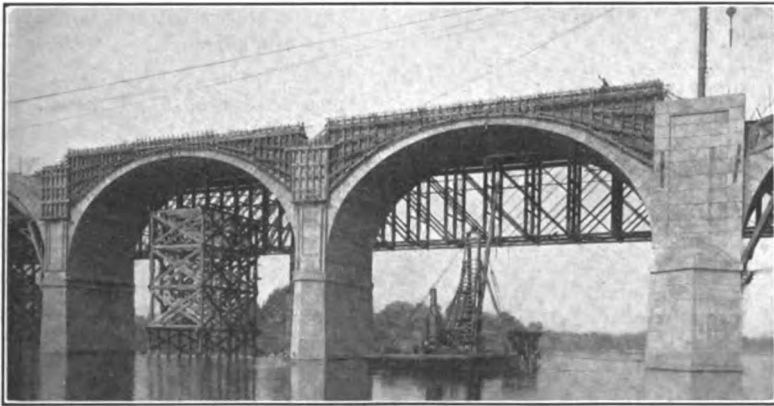

Courtesy of Mr. E. Chamberlain, Ass't. Eng'r., P. & R. Ry.

Fig. 424.—Yardley bridge. Outside spandrel wall forms in place.

135. Expansion Joints in Spandrels.—The two middle joints on each side of crown were located directly over corresponding joints in the arch ring; this, however, was not true of the other spandrel joints (see Plate V, Chapter XIII). These vertical joints which were carried up through the coping, were to provide lines at which any tendency to open up cracks due to shrinkage or temperature changes would be localized, thus preventing the formation of ragged, unsightly cracks. In order to key the sections together, tongued-and-grooved joints were used. To form a cushion between joints and to prevent one section from bending with the other, corrugated asbestos boards were placed on the faces of these expansion joints. At the junction with the pilaster a double thickness of asbestos was used.

136. Concreting Spandrels.—The spandrels were poured in alternate sections and in pairs on each side of the crown. The pair at the haunches and at each side of the crown section were poured first and, after they had hardened, the remainder was concreted. A steel traveling crane,

The felt was carried up about 12 in. on spandrels except directly over piers where it was carried up to a height of 4 ft. and flashed into recesses and covered with cement mortar. The felt on backs of arches was protected by a layer of vitrified brick laid on the asphalt-covered surface of the felt, the brick joints being filled with asphalt.

The construction joints in the haunching and the vertical joints in the spandrels, were covered with a single layer of prepared burlap, 12 in. wide and thoroughly mopped with asphalt, before the felt was placed. At vertical expansion joints the burlap was carried up under coping.



Courtesy of Mr. E. Chamberlain, Ass't. Eng'r., P. & R. Ry.

FIG. 426.—Yardley bridge. Inside view of spandrel wall forms.

The spandrel filling, consisting of large stone such as one or two men could handle, was placed by means of the cableway and carried up to within about 18 in. of the top of coping. The crushed rock ballast for track was spread on this to the level of the top of coping and the tracks placed.

The structure was started in the spring of 1911 and completed in the summer of 1913. The first year's work was the construction of the foundations and piers. By November, 1912, all the arch rings had been concreted and most of the spandrels completed. Work was carried on to some extent during the winter, when weather conditions would permit.

CHAPTER XXXII

CONSTRUCTION OF THE TUNKHANNOCK CREEK VIADUCT

The Tunkhannock Creek viaduct at Nicholson, Pa., on the Delaware, Lackawanna and Western Railroad's re-location between Scranton, Pa. and Binghamton, N. Y., the largest structure of its kind in the world and but recently completed, is representative of the most advanced methods of design and construction of concrete arch bridges. On account of the magnitude of the work and the difficulties attendant therewith, the methods of construction used in various parts of the work are especially interesting and valuable, representing as they do the best modern practice in high-class bridge construction. The quantities of material involved in its construction—namely, 165,000 cu. yd. of concrete and 1200 tons of reinforcing steel—give some idea of the unprecedented size of the bridge.

Construction plant and methods which are suitable and economical for work of this character would of course be entirely too costly for small work, but a glance at the historical record of concrete-bridge building will show that within the past two decades there has been a very steady increase in the span and general dimensions of concrete bridges. It is not at all illogical, therefore, to assume that methods which now seem uncommon and unusual, will in a few years become commonplace and be treated as accepted practice.

139. General Design.—The Tunkhannock Creek viaduct is a double-track structure 2375 ft. long, 34 ft. wide over all, and has a maximum height above ground of 240 ft. with a maximum total height of 304 ft. from bottom of deepest pier to top of highest masonry of the parapet. The bridge is composed of ten full-centered or semicircular ribbed arches of transverse-arch spandrel construction with 180-ft. clear span and two 100-ft. arches of the same type at the ends acting as "abutment arches" and completely buried in the approach fill. (See Figs. 428, 440, 441, 442, 444, and 446.) These arches spring from solid concrete piers founded on bed rock.

Piers.—The deeper piers have a section 40 ft. \times 46 ft. below the surface of the ground and all piers are 36 ft. 6 in. \times 43 ft. 6 in. in section to a point 17 ft. 6 in. below the springing line of arches. At this point a ledge 4 ft. 3 in. wide is formed in the piers to act as a seat for arch centering. This ledge was later filled out with a receding corbel to conform to that used on the ends of piers. (See Fig. 427.) The deepest pier extends about 98 ft. below the surface of the ground. The faces

CONSTRUCTION OF TUNKHANNOCK VIADUCT 549

of all piers are vertical and the portions above ground have horizontal coursing marks 4 ft. apart.

Main Arch Spans.—The main or 180-ft. arch spans, the details of which are shown in Fig. 427, are composed of two ribs 14 ft. wide (8 ft. thick at the crown and 17 ft. thick measured radially at the skewback), spaced 20 ft. on centers, with a 6-ft. opening between ribs. The reinforcement of these arch ribs consists of fourteen 1-in. square bars, following both intradosal and extradosal lines, to provide for contraction

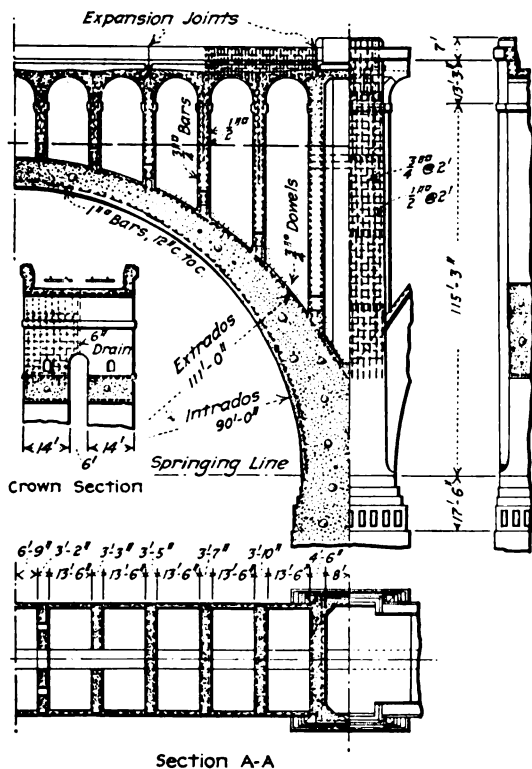

FIG. 427.—Tunkhannock viaduct. Details of 180-ft. arch spans.

and temperature stresses only. The arch ribs were proportioned so as to have the resistance line approximate very closely the arch axis and it does not, for any condition of loading, approach the outer line of the "middle third" of the ribs, thus insuring purely compressive stresses. The bridge was designed for the maximum stresses resulting either from two Mikado-type engines, each weighing 233 tons, followed by a train load of 6000 lb. per foot of track, or from two Mallet compound locomotives, each weighing 300.5 tons, followed by a train load of

6000 lb. per foot of track, both tracks carrying maximum load at the same time.

Spandrel and Deck Details.—On the arch ribs are placed transverse spandrel walls of reinforced concrete varying in thickness from 3 ft. 2 in. to 4 ft. 6 in., as indicated in Fig. 427. These spandrel walls are arched over the open space between ribs (Fig. 444) and are connected at the top by 13 ft. 6 in. semicircular spandrel arches 1 ft. 9 in. thick at the crown. In order to form a seat for the spandrel-arch centering, a 6-in. projecting belt course was placed on the spandrel walls 1 ft. 6 in. below the springing line of the arches. The floor formed by spandrel

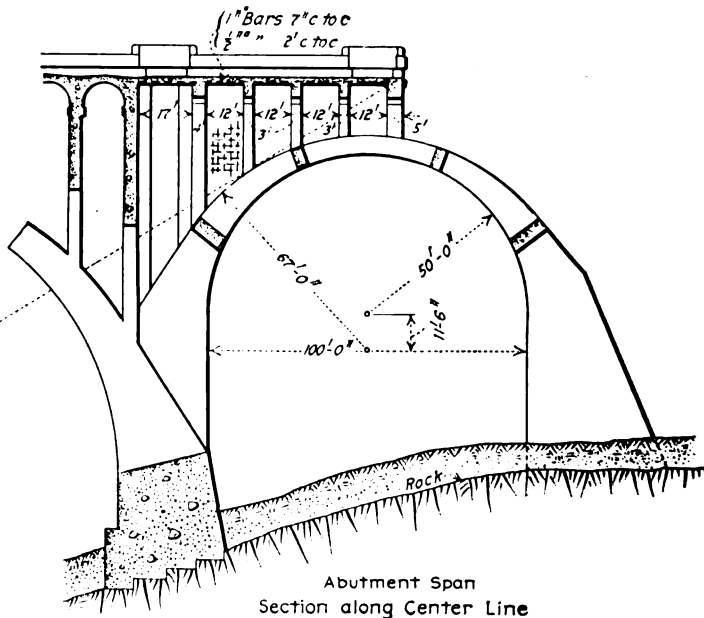

FIG. 428.—Tunkhannock viaduct. Details of 100-ft. arch span.

arches is given a 6-in. slope from crown of each spandrel arch to the center of adjacent spandrel wall for drainage, the water being carried down through a 6-in. hole in the middle of spandrel wall, discharging into the open space between ribs.

The two transverse spandrel walls over the piers are connected at each side of the bridge by a reinforced-concrete pilaster, 3 ft. thick and about 22 ft. wide, to give longitudinal stiffness to the spandrel system and to give the appearance of a solid pier.

The parapet walls of solid reinforced concrete extend the full length of the viaduct, and are 7 ft. 3 in. high above crown of spandrel arches, except at piers where the pilasters are 3 ft. higher.

CONSTRUCTION OF TUNKHANNOCK VIADUCT 551

Four expansion joints are provided in each span, as shown in Fig. 427. These joints consist of a $\frac{1}{4}$ -in. open space covered by a copper plate bent to project a short distance into the joint and having its edges turned down into grooves parallel with the joint, where it is held in place by a mastic filling. The waterproofing consisted of a 3-ply cloth and asphalt membrane protected by a $1\frac{1}{2}$ -in. layer of torpedo gravel mixed in an asphaltic binder. The waterproofing membrane is separated from the protecting coat by one thickness of asbestos felt.

Abutment Spans.—The abutment spans (see Fig. 428) are composed of two reinforced-concrete ribs 5 ft. 6 in. thick at the crown and 12 ft. wide, spaced 22 ft. centers, thus leaving a space 10 ft. wide between ribs. These ribs are tied together at four points by reinforced-concrete struts. A reinforced-concrete floor slab supported on five transverse walls extends over a little more than half of the span next to the first large arch, the tracks being carried on fill over the arch beyond this point. This floor varies in thickness from 1 ft. 9 in. to 2 ft. 6 in. The space between the floor slab and the arch ribs is closed by a longitudinal spandrel or curtain wall 18 in. thick along each outside face, thus giving the appearance of a U-abutment when the approach fill is completed, as shown in Fig. 446.

Materials.—"Class A" concrete, a 1 : 2 : 4 mixture, was used only in the reinforced-concrete floor slab over abutment spans. "Class B" concrete, a 1 : 3 : 5 mixture, was used for all other work above the springing line. "Cyclopean" concrete was used for all piers below springing and was of the same mixture as "Class B" concrete with derrick stone embedded in it.

140. Construction Methods.—*Methods of Locating Lines and Piers.*—A glance at Fig. 437 shows the nature of the bridge site which at once conveys the idea that the establishment of lines and the location of piers was no easy matter. The center line of the viaduct was established by the railroad engineers, by punch-marks on pieces of steel rail set vertically in the ground between piers. The pier centers were then located by careful measurements from these points at each side of each pier. A reference line of stakes was run parallel to the bridge center-line and 25 ft. to one side of it to provide a basis for checking measurements on the main base line or to re-establish such points as might become misplaced during construction.

Points were also established 3 ft. beyond either face of pier by the measurement of longitudinal distances, and transverse reference lines were then run through these points and marked at both ends by rail monuments. These lines provided means of locating piers and also for plumbing them by offsets from the face of masonry to the vertical planes determined by the transverse reference lines as located by transit set on the line.

Contractor's Plant.—The contractor began work on the structure

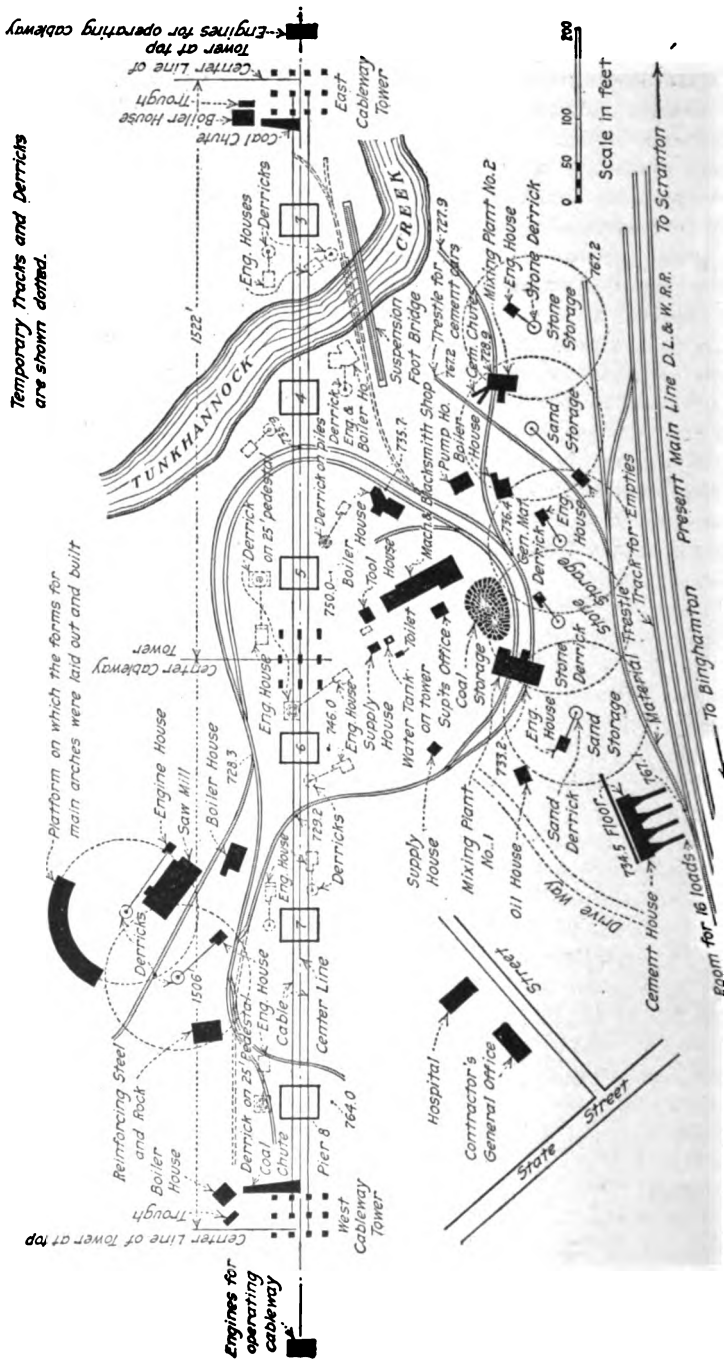

Fig. 429.—Tunkhannock viaduct. Layout of contractor's plant.

May 24, 1912. The first operations were the widening of the railroad company's embankment on the present main line nearly parallel to and about 460 ft. away from the new bridge, and the laying of the material tracks, marked "track for empties" and "room for 16 loads" in Fig. 429. After these tracks were laid, the pile trestles for material tracks were constructed. The material trestle was 30 ft. high and provided storage space for 15,000 cu. yd. of sand and crushed stone dumped directly from cars.

The general layout of the contractor's plant is shown in Fig. 429. The loop formed by the narrow-gauge track enclosed a knoll about 30 ft. higher than the general level of the valley. The general material derrick was erected on a narrow ridge connecting the knoll just mentioned with the ridge on which the present main line is located. A similar ridge extends from pier No. 6 to the high ground at the hospital. Piers Nos. 5 and 6, being located on the east slope of the knoll, necessitated about 30 ft. more of excavation on the west side of the piers than on the east. Pier No. 8 lies on a similar slope which necessitated about 40 ft. more of excavation on the north side than on the south. Piers Nos. 3, 4, and 7 are located on low ground.

CONSTRUCTION OF SUBSTRUCTURE

141. General Excavation.—Early in July, 1912, after the narrow-gauge tracks had been laid from mixing plant No. 1 to pier No. 4, derricks were erected, steel sheet piling was brought in, and the excavation and building of cofferdam for pier No. 4 were started.

About the middle of July a 40-ton Marion steam shovel, with a 1-cu. yd. dipper was run from the siding down into the valley on a temporary track. Work was started at pier No. 6 where the excavation was carried down 20 ft. below the ground level on the high side, the material being hauled away in 4-yd. narrow-gauge dump cars and used for grading up construction tracks and leveling up the mixer plant sites. The shovel was then moved to pier No. 5 and, after the excavation was carried down 35 ft. below ground level on the high side or down to ground water level, the shovel moved back to pier No. 6 and carried the excavation down to the same level. The next operation was to excavate pier No. 8 to the same depth. The excavated material was used to raise the grade east of piers Nos. 7 and 8 about 12 ft., or to the level of the grade east of piers Nos. 7 and 8 about 12 ft., or to the level of the grade at mixing plant. On this fill, a saw mill, storage piles of reinforcing bars, lumber, and other materials were conveniently located.

After completing its work at pier No. 8 the shovel excavated the material down to bedrock at piers Nos. 10, 9, and 2 successively, the rock in these excavations being found above the level of ground water and only a few feet below ground line at the lower sides of pier. In these

excavations the material, a clay and sand mixture, was allowed to take its natural slope, the excavation being extended back far enough to provide for natural raveling of the banks before completion of excavation of the construction of the piers. The steam shovel work was completed in December, 1912, about 50,000 cu. yd. of material having been moved.

For the end abutments and the piers adjacent to them—Nos. 1 and 2—open excavations were made down to rock (which on the hillsides was only a few feet below the surface) without the use of sheeting or

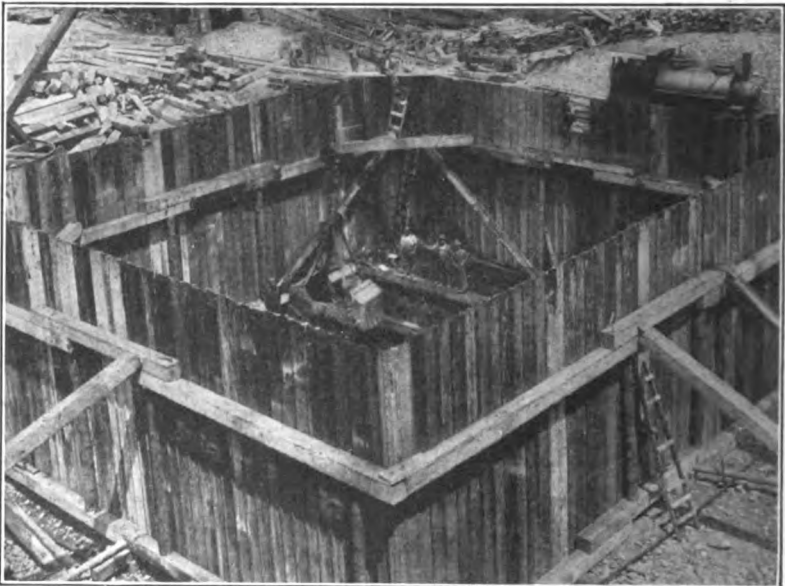

Courtesy of Lackawanna Steel Co.

FIG. 430.—Tunkhannock viaduct. Steel sheet piling (partly driven) for inner cofferdam of piers, showing timber guide forms.

derricks, the excavated material being spread out around the edge of the excavation.

142. Cofferdam Excavation.—The entire excavation for piers Nos. 3, 4, and 7 was done in open cofferdams of steel sheet pilings, as was the remaining excavation of piers Nos. 5, 6, and 8. Lackawanna steel sheet piling 12 in. wide weighing 45 lb. per linear foot was used in lengths of 30 ft., with some additional piling of shorter length driven on top of the upper 30-ft. lengths where the excavated depth was about 70 ft.

When starting the cofferdams, a 46 × 52-ft. rectangle made of 12 × 12-in. horizontal timbers spliced together was assembled. A second rectangle was then assembled on posts 16 ft. long which rested on the

first rectangle. These rectangles formed the inner waling for the piling. A similar set of waling was then built 6 in. outside of the first set to act as the outer walings and as forms for sheet piling. (See Fig. 430.) By means of two guyed derricks at each pier, the steel sheet piling was assembled between the walings and driven with a 3-ton Warrington steam hammer operating in 30-ft. leads suspended from the derrick boom, as shown in Fig. 431. The piling was driven in stages of 2 or 3 ft. penetration, the hammer working around the cofferdam until a total penetration of about 10 or 15 ft. had been reached. Excavation was then begun with $1\frac{1}{2}$ -cu. yd. Williams' clam-shell buckets and sets of horizontal-timber bracing were placed in the cofferdam at vertical intervals as the excavation proceeded (see Fig. 431), the bracing being

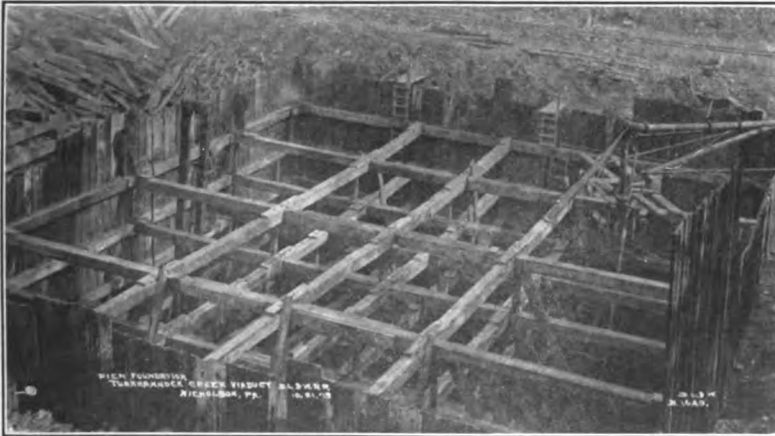

Courtesy of Mr. C. W. Simpson, Res. Eng'r.

FIG. 431.—Tunkhannock viaduct. Cofferdam for pier No. 5, steam hammer driving inner sheeting.

so arranged as to allow the operation of the bucket in the bays between braces. When the excavation had proceeded to about the bottom of piling, the latter were again driven down and the operations repeated until the top of sheeting reached the surface of the ground.

The bracing consisted of 12×12 -in. yellow-pine timbers arranged in horizontal panels approximately 7×10 ft. and spaced from $3\frac{1}{2}$ ft. to 5 ft. apart vertically, being supported at intersections by 12×12 -in. vertical posts. The braces, which were of necessity in short sections, were cut to approximate length on the ground, lowered into place by derrick with splice planks nailed to them, fitted, drilled, and bolted in position with $\frac{3}{4}$ -in. bolts. The outer bays of horizontal braces were further stiffened by diagonal bracing, as shown in Fig. 432.

After the first set of sheeting had been driven down complete, a

second rectangular cofferdam was erected about 6 ft. 6 in. outside the first and driven down part way. The material between the two sets of sheeting was then excavated with the clam-shell bucket, the space between the two sets braced, the first set of sheeting driven down, and then excavation resumed in the main pit—the upper set of sheeting being braced in the manner just described. (See Figs. 432 and 433.) As the inner cofferdam was driven down, the top bracing was removed and placed at the bottom. These operations were repeated until the inner cofferdam reached rock.

Practically all the steel sheet piling was used four or five times so that only a little more than enough for two complete foundations was re-

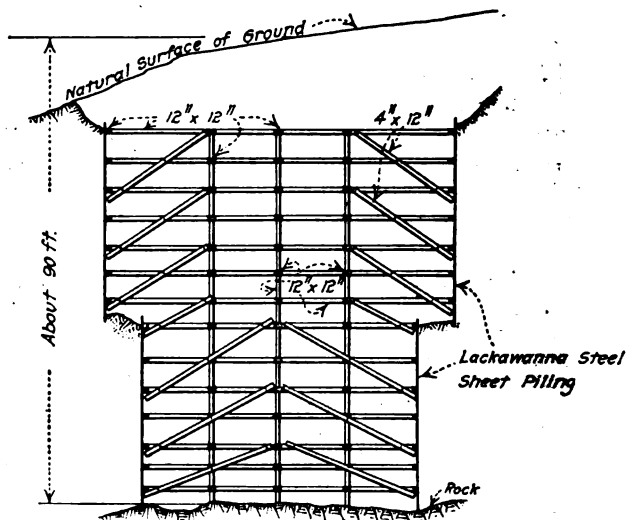

FIG. 432.—Tunkhannock viaduct. Details of cofferdam sheeting and bracing.

quired. The piling was pulled (after the concrete had been placed) by an "A" frame of 12×12 -in. timbers 16 ft. long resting on top of the pier footing and equipped with a triple block and fall rove with a $\frac{3}{4}$ -in. steel cable. The fall was attached to the tops of the sheet piling by passing a bolt through a hole in the web and through a rasp clamp. By fastening the cable to the double block on the derrick, a pull of about 60 tons could be exerted on the pile, which was sufficient in practically all cases to pull the piling.

The deep piers, with the exception of piers Nos. 4 and 5 which gave some added difficulties on account of quicksand, were excavated mainly with clam-shell buckets operated by derricks. In corners the excavation was done by hand, and boulders which were encountered under or near the sheeting were dislodged by hand or with the aid of dynamite, and

were rolled down into the deeper excavation made by the buckets. Water entered the cofferdams mainly from the bottom, but in some cases it came through the piling joints until such time as they were puddled or filled with sand. This water was at first removed by means of two 8-in. centrifugal pumps and two 10-in. Emerson plunger pumps, but after once a cofferdam was fairly free of water two of the pumps could in general keep the water down so as to allow hand excavation in the corners which were kept higher than the central portion of the pit. The material excavated was usually placed in spoil banks near piers or



Courtesy of Mr C. W. Simpson, Res. Eng'r.

FIG. 433.—Tunkhannock viaduct. View of cofferdam at junction of outer and inner sheetings, lower ends of outer sheeting visible.

used to build construction-track embankments, and to bring certain parts of the bridge site to a more or less uniform grade.

The use of open cofferdams of such unprecedented size (the largest ever used) is a remarkable engineering feat and one which proves beyond doubt the value of steel sheet piling. Steel sheet piling has been used very extensively in all kinds of bridge work and for the most part has entirely replaced timber sheet piling, the driving of the latter being difficult in hard ground or where boulders are present. The present example shows that the limit of applicability of steel sheet piling has not yet been reached.

143. Special Methods of Pier Excavation.—After carrying the excavation in pier No. 4 down to a point about 40 ft. below the surface a large pocket of fine flowing sand was struck along the west side and around the southeast corner of the pier. This sand exerted such heavy pressure on the sheeting as to distort the timber bracing and break through the bottom of the pit, causing the ground outside the sheeting to settle as much as 10 ft. At one time the cofferdam was moved bodily about 15 in. transversely by the pressure of the wet sand. The cofferdam was brought back into line by additional excavation both inside and out and by the use of jacks and additional bracing, but when the work had been carried down about 10 ft. into the sand—or to a point 12 ft. above rock—the bracing was in danger of failure and a new scheme had to be adopted in order to facilitate the work which was progressing very slowly. The cofferdams were accordingly divided by driving a line of 3-in. plank sheeting parallel to the west side of the pier and about 16 ft. therefrom. Excavation was then made to rock to the east of this row of sheeting and concrete placed to a height of 30 ft., braces being left in place in order to prevent any further distortion of the material on the west side of the sheet piling. This west portion was then divided by a transverse wall of 3-in. plank sheeting, and the northwest corner excavated and concreted to a height of 10 ft. After this was done the remainder of the excavation was made and the concrete placed.

To take care of the water entering the pit, a 4-ft. 8-in. pumpwell was left in the large portion that was first concreted and the water conducted to it by wooden drains laid close to the steel sheeting. This well after fulfilling its purpose was filled with concrete. Four pumps with a combined capacity of 200,000 gallons per hour were required to keep the excavation dry.

In excavating for pier No. 5 the usual methods were pursued until a point was reached about 75 ft. below the surface and about 17 ft. above rock, where a stratum of quicksand extending over the entire excavation was encountered. An attempt was first made to go through this quicksand by dividing the cofferdam into twenty-four compartments each of which was to be finished separately. Four compartments were started, but the sheeting was so badly bent and displaced in driving by boulders overlying the rock that the scheme had to be abandoned. It was then decided to use a pneumatic caisson on which to sink the pier to rock. The caisson (constructed in the usual manner with 12 × 12-in. timber) was divided into two working chambers each provided with one "material-lock," and was constructed with a heavy metal cutting edge 27 ft. above rock. A one "man-lock" served for both chambers since a "manway" was provided in the bulkhead. Upon this caisson the pier concrete was placed, the weight sinking the caisson as the material was excavated from under the cutting edge. The maximum air pressure required in the working chambers to keep the

water from entering was only 24 lb. per square inch as the head of water was kept as low as possible by pumping above the caisson. The material was excavated by hand and removed in buckets operating through one of the air locks in each chamber. After rock was reached and the surface cleaned off, the working chambers were filled with concrete, the air locks removed, the shafts leading to them concreted, and the procedure from that point on the same as for other piers.

The air was turned on in the caisson December 13, 1914, and on the 21st a depth of 10 ft. had been reached. The excavation was completed on Feb. 4, 1915, 7 months after all other piers had been completed up to the skewbacks of the umbrella sections.

144. Concrete Plant.—While the excavation for the piers was in progress the concrete mixing plants were completed at the locations shown in Fig. 429. The cement storehouse near mixing plant No. 1 had a capacity of 3000 bbls., the cement being unloaded from cars into four inclined chutes with forked ends which delivered it to any part of the building by means of switches in the chutes. Cement was taken from this storehouse only when shipments were delayed and when no cars of cement were at hand. Ordinarily the cement at mixing plant No. 1 was loaded directly from cars into a derrick bucket, and swung to the hopper floor of the mixer, each mixing plant being served by two derricks operating 40-cu. ft. Mead Morrison clam-shell buckets. At plant No. 2 the cement was conveyed by gravity in chutes from the cars to the hopper floor of the mixer. (In Fig. 437 the stock piles and mixing plant No. 2 appear in the middle ground.)

The sand and stone were lifted from the stock piles into small bins over the mixers, from whence they passed by gravity into a measuring hopper, at which point the cement was added and the materials dropped into a 2-yd. cube mixer. After mixing each batch for at least 2 minutes, the concrete was dumped into 2-cu. yd. bottom-dump buckets on flat cars of 3-ft. gauge and hauled by 12-ton locomotives in three-car trains to the derrick or cableway which placed the concrete in the forms. One car of the train was empty to receive the empty bucket from the derrick or cableway, the train starting back as soon as the last bucket of concrete was raised. (See Fig. 436.) Two concrete trains were used and for the mass work in piers an output of 35 cu. yd. per hour per plant was attained. The first concrete was poured on Jan. 6, 1913, and concrete work was carried on almost continuously for over a year, the mass work in piers being little affected by the comparatively mild winter weather.

145. Derricks and Cableway.—The derricks were equipped with masts from 85 to 90 ft. long and had booms from 80 to 85 ft. long. Three-drum hoisting engines with swinging gear attachment were used to operate the derricks. In order to give a greater height to some of the derricks, they were placed on timber pedestals, but in general they

were erected at ground level and all work which could not be reached with them was done by the cableway.

The construction of the cableway was started shortly after the excavation was commenced and in about 6 months the cableway was put in operation. The cableway consisted of two lines of $2\frac{1}{4}$ -in. main cables spaced 20 ft. apart, concentric with the center line of arch ribs. These cables were supported by end towers 3028 ft. apart and 150 and 165 ft. high, also by a halfway tower 260 ft. high. The center tower divided the cableway into four independent units each about 1510 ft. long and each operated by an independent engine. The cables and carriages had a normal capacity of 7 tons. An occasional load of 10 tons, however, was allowable—such loads being imposed while erecting the steel centers, as described later.

The towers were built entirely of timber resting on concrete piers and guyed with heavy cast-steel guy ropes. The end towers, located at some distance beyond the abutment arches, were wedge shaped, consisting of eight lines of battered posts with the two inner pairs intersecting, as shown in Fig. 440. The central tower consisted of nine 12×12 -in. main batter posts in three longitudinal bents, as shown in Fig. 436. The posts of this tower were so arranged as to clear the arch ribs and by the removal of a few secondary braces the arch ribs were constructed without obstruction through the tower. This tower was later raised to a height of 300 ft. by adding a 40-ft. extension at the top and raising one line of cable at a time, meanwhile keeping the other in operation.

146. Pier Construction.—In the deep piers, concrete was placed to a height of 30 ft. (or to the neatwork line) without forms. The cofferdam was entirely filled with concrete, the bracing being removed as the concreting progressed. To prevent the concrete from sticking to and entering the joints of the steel sheet piling which would prevent the pulling of the piling, tar paper nailed to vertical wooden strips was used. The concrete work up to the neatwork line was frequently carried on continuously day and night. In one case, for a period of 7 days, 2400 cu. yd. of concrete were placed during freezing weather without protracted interruption; frequent delays of 4 to 5 hours, however, being necessitated while the bracing timber was being removed.

Above the tops of the lower cofferdams, the concrete below the surface of the ground was usually placed in forms made of rough plank braced back to the steel sheeting. (See Fig. 434.) For the remainder of the pier shaft, sectional self-supporting forms were used.

One distinct and important feature of this structure is that the design is such as to permit the extensive use of sectional forms on all parts of the work. Wherever possible the designers duplicated parts so as to allow the use of the same formwork many times, sometimes even on entirely different parts of the work. This indicates very forcibly how

the designing engineer who is alert to methods and costs of construction can materially lessen the cost of a structure without decreasing its strength or esthetic beauty in the least.

The sectional forms used for the construction of pier shafts above ground are good examples of the utility and construction of the general type of formwork used wherever possible. These forms were made in two sizes, one 15 ft. 8 in. long by 17 ft. 9 in. high, and the other 18 ft. 3 in. long and of the same height as the shorter one. Two of the long sections formed the shorter sides, or ends of piers, and three of the shorter

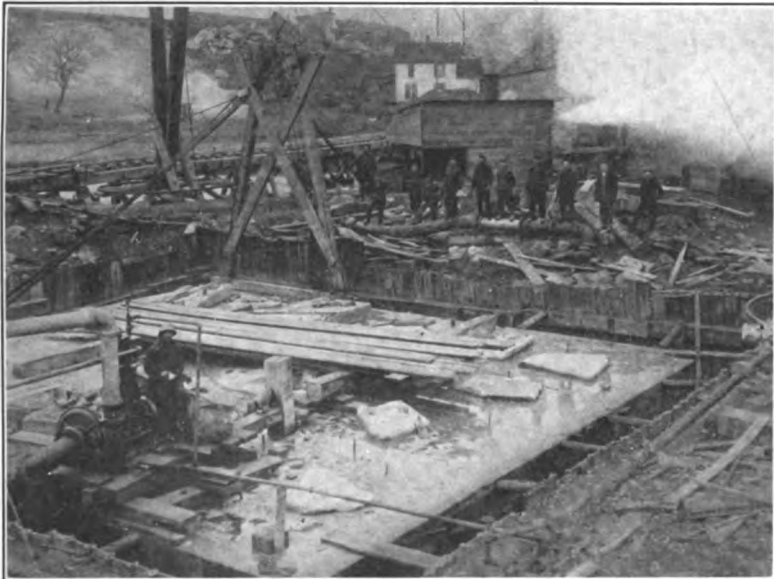

Courtesy of Lackawanna Steel Co.

FIG. 434.—Tunkhannock viaduct. Pier concreted up to ground level inside of cofferdam. Note large stone embedded in the concrete.

sections made up the form for the long side of pier. A total of ten sections therefore composed a form, providing for the concreting of a net height of 16 ft. of pier—the lower 10½ in. of the forms extending down over the concrete previously poured and no concrete being poured against the upper 10½ in. (See Fig. 435.) These precautions were taken to prevent, as far as possible, the formation of lips or fins at the junction of sections and to insure the plumbness of the finished work. A total of four complete sets of these sectional forms sufficed for the construction of piers and, after completion of same, the forms were used with little or no alteration on other parts of the work.

The sections were built up of two layers of 1 × 8-in. tongue-and-

grooved boards nailed at right angles to each other and diagonally to 8×10 -in. horizontal timbers, or studs, spaced 2 ft. 5 in. on centers. Vertical timbers 10×10 in. in section and 20 ft. long were bolted to these studs at the ends and middle of the sections—the end verticals being half on one section and half on the adjacent one, as shown in Fig. 435. The inside face of the forms was covered with sheets of No. 24

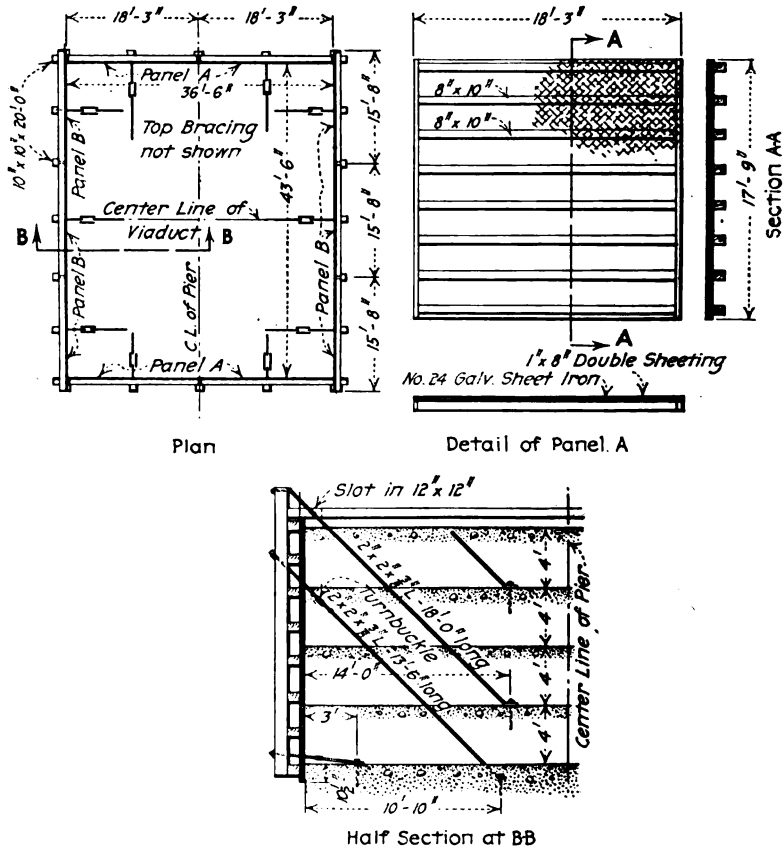
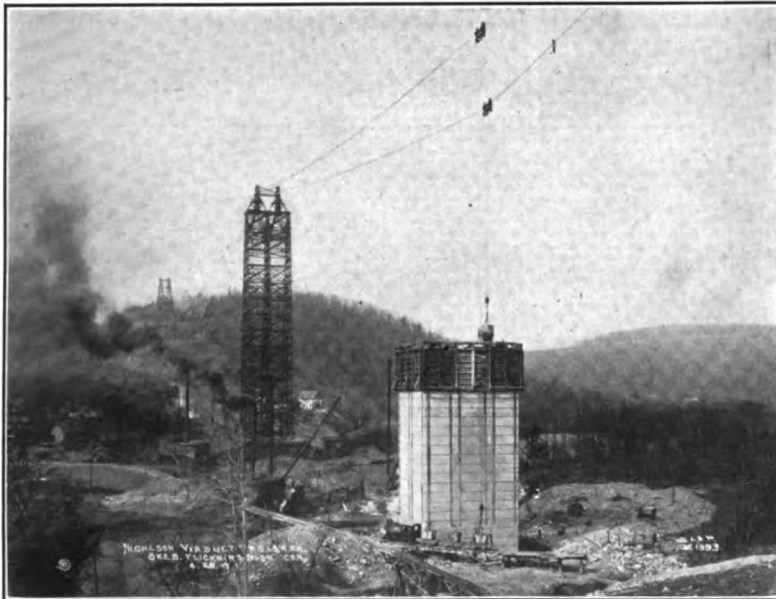

FIG. 435.—Tunkhannock viaduct. Details of sectional forms for main piers, showing methods of holding forms in line and place.

galvanized iron so as to give a smooth surface against which to spade the concrete. The weight of the larger sections was about 7000 lb.

The forms were held in line and position by diagonal ties consisting of steel angles and 12×12 -in. horizontal struts wedged against the opposite verticals. The former held the forms from moving out and the latter from pushing in at the top as the concrete was placed in the

bottom portion. Diagonal bolts with nut bearings on exterior beveled washers were connected by means of turnbuckles with the long diagonals which remained in the concrete. (See Fig. 435.) These diagonals had their lower ends bent and punched to engage permanent vertical anchor bolts built into each course of concrete. The turnbuckle permitted the tightening and plumbing of the forms and, after the section was concreted, the upper portion of the stay (which was set in a pipe sleeve) was removed by unscrewing the bolt from the turnbuckle. The hole was then grouted up.



Courtesy of Mr. C. W. Simpson, Res. Eng'r.

FIG. 436.—Tunkhannock viaduct. Concreting pier shafts in sectional forms. View also shows general plant layout and two of the cableway towers.

At first concrete was placed in these forms in four courses, each 4 ft. thick and containing about 235 cu. yd., poured continuously in about 6 hours. Later two of the 4-ft. courses were placed in one continuous run of 11 hours' duration. In the lower portions the concrete was placed with the derricks, while the upper portion was placed by means of the cableway, the buckets being lifted from the concrete train and dumped (while suspended over the forms) by a special attachment devised by the contractor for dumping with the cableway. (In Fig. 436 the pier forms are in place and the concrete is being dumped into same by the cableway.) At the joints between the sections, V-shaped strips

were nailed to the forms and the concrete stopped at the inner edge of the same; the construction joints are thus inconspicuous and the scorings relieve the monotony of the plain surface. After the top course was from 3 to 7 days old, depending on the weather, the upper ends of the diagonal rods were removed and the panels lifted by derricks or cableway to a new position and re-erected. A force of six carpenters was able to do this in 2 days, which is exceedingly rapid work when one considers the height above ground at which some of this work was done, and it shows how well the type of forms used were adapted to the conditions. That the method of holding the forms in line was a good one is witnessed by the fact that none of the pier shafts were even $\frac{1}{2}$ in. out of plumb.

The piers were carried up in these forms until a point 17 ft. 6 in. below



Courtesy of Mr. C. W. Simpson, Res. Eng'r.

FIG. 437.—Tunkhannock viaduct. General construction view, some of the piers completed.

the springing line of arches was reached. Here a temporary ledge 4 ft. 3 in. wide was formed on both sides to act as a seat for the arch centers. The portion above this seat to the skewback of arches (a total height of 54 ft. 6 in.) was carried up monolithic with the rest of the pier. These umbrella sections, though in reality a portion of the arch ribs, were concreted in special wooden forms of similar construction to those just described. These sections projected about 7 ft. beyond the springing line of the arches, as it was more economical to construct them as part of the piers due to the fact that the departure from the vertical is very slight.

The arch-rib reinforcement in this portion was placed in short sections for each lift of forms and the upper surface of the concrete at the skewbacks of arches was finished off in a radial plane with rectangular recesses or key slots to key the umbrella sections to the arch rib voussoirs placed on them later. Two inclined anchor bars $1\frac{1}{2}$ in. in diameter

were concreted in the umbrella sections of each rib to aid in erecting and securing the centering trusses against wind pressure, as described later. In Fig. 437, which gives a general view of the bridge, the pier shafts are shown in various stages, while in Fig. 440 pier shafts are shown completed up to the skewbacks of the arches.

As previously stated, the concrete used in each pier shaft up to the springing lines was of a 1:3:5 mixture with a maximum of about 11 per cent of Cyclopean stones of a size which could be conveniently handled by derricks. These stones were carefully embedded in the concrete and some were set so as to project into the course, thus binding the different courses together. (See Fig. 434.)

In very cold weather adequate precautions were taken to prevent the freezing of concrete before setting took place. The aggregates and water were accordingly heated with live steam so as to have the concrete go into the forms at a temperature of 50 or 60° F. The concrete, after being placed in the forms, was protected by packing hay between the vertical sides of the forms with strips nailed over the hay to keep it in place, and at night tarpaulins were placed over the top surface of the concrete.

CONSTRUCTION OF SUPERSTRUCTURE

147. Details of Arch Rib Centers.—The centers for 100-ft. arch spans were composed of timber trusses, one set under each rib resting on a timber tower at the center. At the ends, ledges were left on the umbrella sections to receive short wood struts braced top and bottom to the central tower by inclined struts upon which the ends of the trusses rested. Upon these centers 4-in. lagging was laid for the arch-rib forms with sectional timber side forms.

The centers for the main or 180-ft. arch ribs consisted of four pin-connected arch trusses for each rib, spaced 3 ft. 10 in. centers and braced with top- and bottom-chord laterals and radial sway-bracing frames. After completing one arch rib of the span, the entire centering was moved transversely on rollers for a distance of 20 ft. and the second rib poured. Five complete sets of centering were used, so that each set was erected twice and moved transversely the same number of times.

In Fig. 438 the sizes of the various members of the centering trusses as well as the loads coming upon them are indicated. It will be noted that the top chords were composed of two channels and a cover plate, while two latticed channels made up the bottom chords. The former were designed for local bending between panel points, due to the weight of fresh concrete. The web members consisted of latticed channels or angles. The trusses were shipped in four sections, the connections near crown and at the lower ends being made by pins while the others were bolted.

The top and bottom chords converged at the crown pin, and a rigid triangular frame at either side of crown resting on the top chords, supported the lagging over the crown panels. The space between these frames was filled with an oak block about 2 ft. long resting on bracket angles.

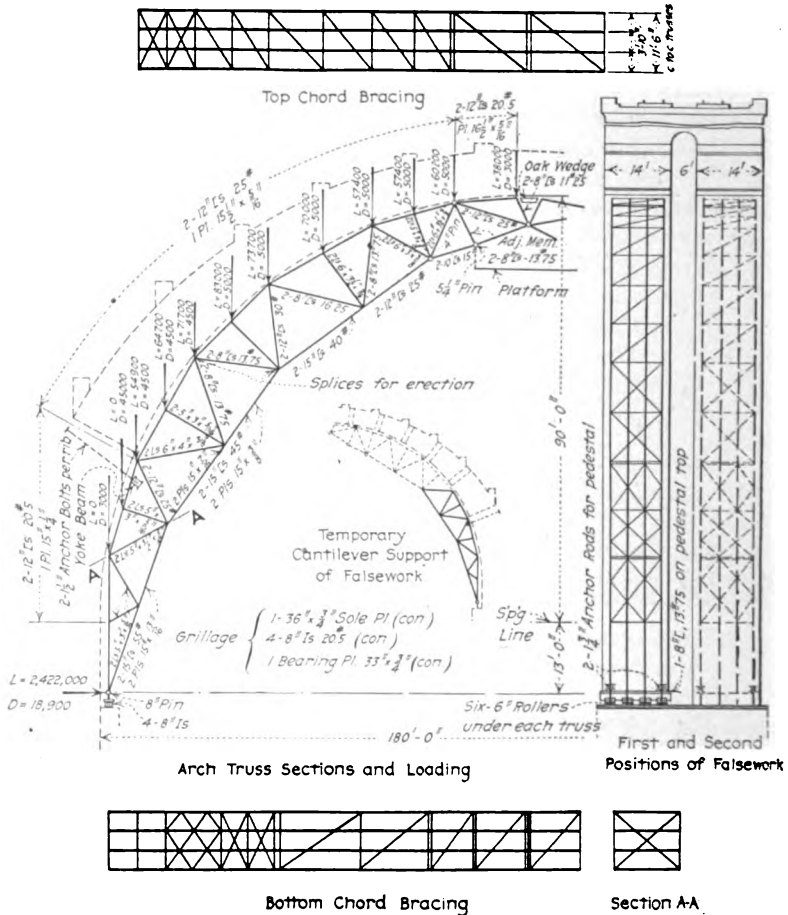

FIG. 438.—Tunkhannock viaduct. Make-up of members and loads on centering trusses, 180-ft. arch span.

The horizontal thrust due to dead load on each truss was 18,900 lb. When the trusses were being shifted to position concentric with the second rib, this thrust was taken up by two horizontal rods 1 in. in diameter connecting the base pins at each end. The horizontal wind pressure acting on the half trusses was resisted by two 1 1/2-in. vertical

anchor bolts through the pedestal at each end, and the inclined anchor bolts $1\frac{1}{2}$ in. in diameter anchored into the umbrella sections. As a further safeguard against excessive wind pressures, the trusses were guyed laterally in both directions at the crown and quarter points by wire cables attached to anchors buried in the ground.

The lower ends of the trusses rested on, and were spaced by, built-up

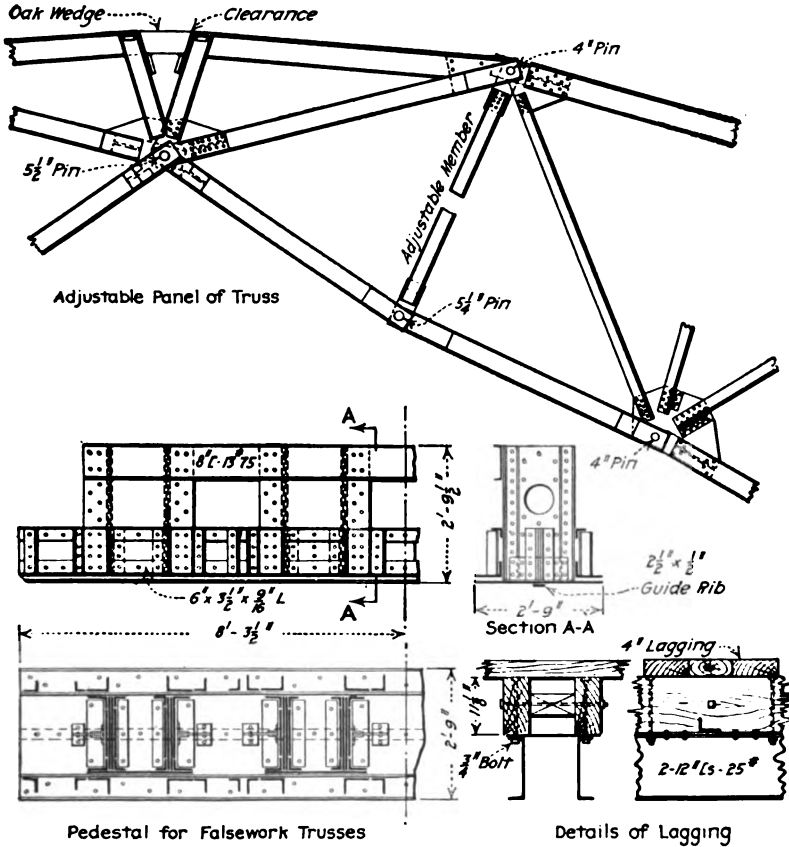

FIG. 439.—Tunkhannock viaduct. Details of adjustable panels of centers
Pedestal and lagging details.

pedestals, the details of which are shown in Fig. 439. The base plate of the pedestal had a $2\frac{1}{2} \times \frac{1}{2}$ -in. guide rib riveted to it, which engaged the shoulders of a set of six 6-in. rollers under each truss, to facilitate shifting of the centers. These rollers operated on an I-beam grillage consisting of four 8-in. beams 35 ft. 6 in. long resting on the pier ledge.

In order to adjust the height of the centers at the crown, the first web member beyond the crown normal to the top chord was built in

two pieces, connected by a right- and left-thread screw operated by a ratchet and lever to allow of easy adjustment. Since the three panel points on each side of the crown were pin connected, this adjustable member acted as a toggle to increase or diminish the chord length of the arched trusses and thereby lower or raise the crown. (See Fig. 439.) A platform was hung from U-bolts over lower-chord pins near the crown to give a working space for the adjustment of the centers.

148. Erection of Centering.—The erection of the arch-truss centering was accomplished entirely with the use of the cableway. The trusses were assembled on the ground nearby in four sections each. The pedestals were first set in place and then the lower sections were hoisted into position by the cableway and connected by anchor pins to the pedestal. After the lower sections of the four independent trusses were

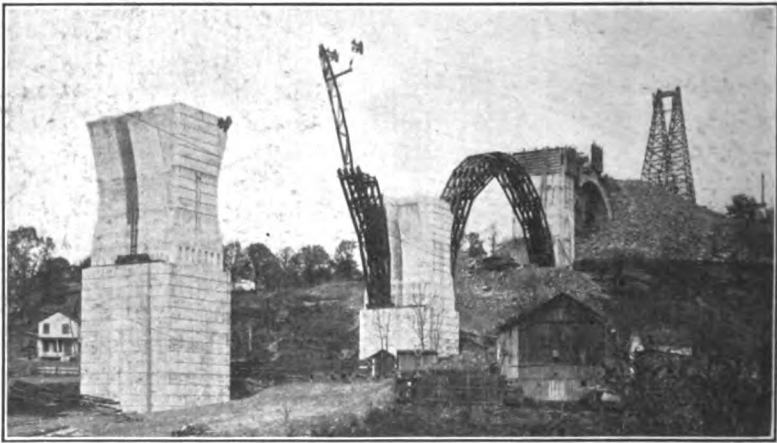

Courtesy of Mr. C. W. Simpson, Res. Eng'r.

FIG. 440.—Tunkhannock viaduct. Erecting segment of arch centering by means of double cableway. Centers for one rib in adjacent span erected.

erected and temporarily held in place with the aid of the cableway, the bracing was bolted up and yoke beams were attached to the inclined anchor bolts passing through the umbrella sections to engage the top chords of the sections of the semi-trusses at a point about 52 ft. above the base pins. (See Fig. 438.) This yoke beam held the sections securely and made the segments act as cantilever trusses. When the lower or cantilever sections of each group of semi-trusses on opposite piers had been erected, the upper halves were hoisted into position and bolted up to the first segments, as shown in Fig. 440. Until all the upper sections were erected and the crown pins driven, each half of the center acted as a cantilever truss, fulcrumed about the base pin and held by the yoke beams anchored to the umbrella sections, without any other external support.

By the operation of the inclined bolts through the umbrella sections, the semi-trusses were raised or lowered slightly until the pin holes registered and the pins could be driven. The yoke beams holding the lower portions to the umbrella sections were then released from bearing on the top chords of the trusses, and the entire centering made to act as a three-hinged braced arch; the yoke beams, however, were not drawn so far from the top chords as not to be able to act as anchorage against wind pressures. A completed arch center ready to receive lagging is shown in Fig. 441.

The 4-in. lagging of the arch ribs was laid on plank ribs cut to fit the

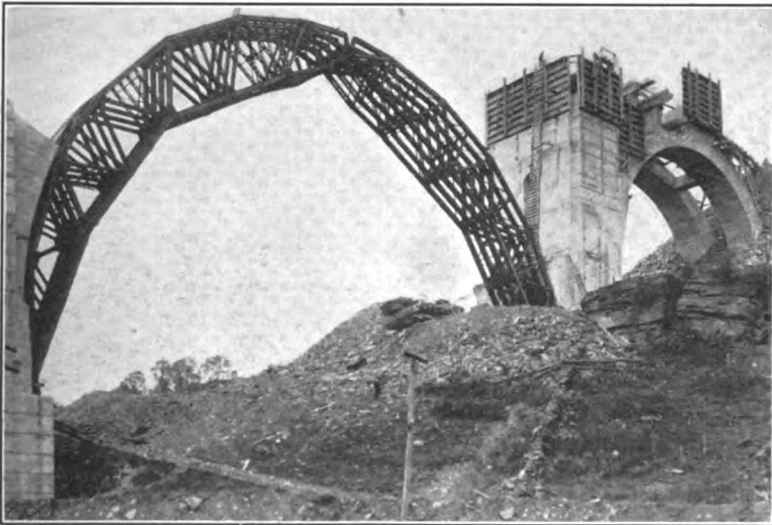

Courtesy of Engineering and Contracting.

FIG. 441.—Tunkhannock viaduct. Near view of completed arch truss center for one arch rib of 180-ft. span. Completed arch ribs for 100-ft. abutment span are also shown.

curve of the arch intrados and placed in pairs directly over the channels making up the top-chord members of the centering trusses. These ribs were anchored to the channels by $\frac{3}{4}$ -in. bolts (about 18 in. on centers) with wood spreaders and transverse bolts to hold them securely in pairs. (See Fig. 439.)

The centers were erected for arch ribs on alternate sides in adjacent spans, as shown in Fig. 442, to allow the use of both cableways simultaneously for the delivery of materials. When one rib of each span was completed, the arch centers were lowered by lengthening the adjustable members at the crown, and the entire centering was jacked over on the rollers under the pedestals for a distance of 20 ft. to a position under the second rib. After completing the second rib and allowing the proper

time for hardening, the centers were again slacked down and rolled back to a position directly under the opening between arch ribs where the lagging was removed and the trusses dismantled in sections, then lifted up through the opening and transported to the next arch to be connected by means of the cableway. After the removal of centers, the ledge on piers serving as a seat for centers was filled in with concrete in receding steps, as shown in Fig. 427, to conform to the architectural treatment of the remainder of the pier.



Courtesy of Mr. C. W. Simpson, Res. Eng'r.

FIG. 442.—Tunkhannock viaduct. Concreting keyways of arch rib in one span, erecting side forms for voussoirs in the next, lower segment of centering in the third span.

149. Constructing Arch Ribs.—The steel arch-centering having been erected and the lagging for arch-rib soffit placed, the side forms for the large voussoir blocks were erected with the aid of the cableway, as shown in Fig. 442. Each arch rib was divided for construction purposes into eleven voussoirs or blocks separated from each other by comparatively narrow keyways, as indicated in Fig. 443. The forms for the voussoir sides were built in units of similar construction to those used on the piers, hoisted into place, and held in position with diagonal braces, rod ties and timber separators connecting the forms on either side. End forms for the voussoirs were next built, forming an entirely independent form for each block so that any voussoir could be concreted entirely independent of any other. On the lower end of each voussoir form, a triangular extension was built as a side form for pedestals or seats for transverse spandrel walls so as to provide a horizontal bearing for the latter.

The arch-rib reinforcement, in lengths of about 30 ft., was placed in position before the transverse voussoir forms were built. All reinforcing bars were lapped 40 diameters. The bottom bars were held in the proper position above the lagging by the transverse rods, while the upper bars were secured by and rested on transverse rods or wires fastened to the side forms.

The concreting of voussoirs was done with the aid of the cableway, the order of concreting being as indicated numerically in Fig. 443. It will be noted that the first pair of voussoirs placed were those at the skewbacks, then the pair midway between crown and skewback, and next those adjacent to the crown voussoir. This order of placement was used so that the loading of the centers would be as balanced as possible, and would thereby prevent any undue deformation of the centers caused by unequal or improperly distributed loads. The section

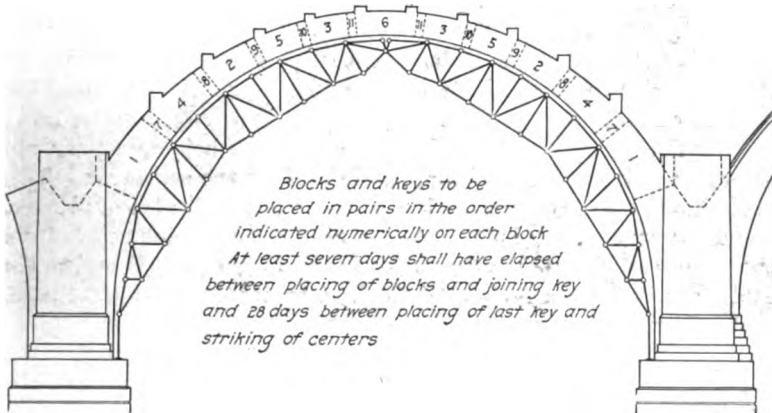

FIG. 443.—Tunkhannock viaduct. Diagram showing schedule of pouring voussoirs and keyways of arches.

at the crown was the last one to be poured. The concreting of the keyways was then begun, starting with the lower ones and working up to the crown. In every case, however, a period of at least 7 days was allowed to elapse between the concreting of the voussoirs and the adjoining keyways.

The forms for the keyways were in no way dependent upon the voussoir forms for support and the latter were therefore removed as soon as allowable and put into use on another arch. With this arrangement it was possible to construct the twenty 180-ft. arch ribs with two complete sets of arch forms. (The keyway forms are shown in position on the main-arch rib to the right in Fig. 442.) The arch centers were not struck until at least 4 weeks after the last keyway had been concreted.

150. Special Methods Used in Constructing Arch No. 6.—As previously stated the central cableway tower was located at the center of

the arch span between piers Nos. 5 and 6, and was so placed as to locate the central bent between the arch ribs and the outside bents entirely clear of these ribs. This necessitated some changes from those cited above in the operations of concreting and erecting centers. On account of the difficulties encountered in the construction of pier No. 5, the arches 5 and 6 were the last to be constructed. Instead of building one rib at a time, as with the other spans, the centers for these arches were erected so that both ribs of each span were concreted at the same time—all other arch ribs being completed and enough centers being made available to so carry out the work.

The lower sections of centers for arch No. 6 did not interfere with the cableway tower and were erected complete for both ribs in the usual manner. For the erection of the middle sections of centering trusses, one panel of cross-bracing on each face of tower was removed temporarily and then replaced after the centers were completed and properly adjusted. The formwork for arch-rib voussoirs and keyways was then placed in the usual manner, the cross-bracing in the panel above that through which the centering trusses passed being removed to allow the arch-rib concrete to be poured.

After the arch centers for this span were set no hoistways remained through which the concrete could be hoisted by the cableways. This necessitated the use of four derricks (two derricks on the top of pier No. 4 and two on the top of pier No. 6) to hoist the concrete buckets from the ground below to the bridge deck where they were transferred to the cableways and placed where desired. The portion of arch No. 6, enclosed by the cableway tower, was concreted by spouting from hoppers at the faces of the tower into which the buckets were dumped from the cableway. The economy of the cableway in handling concrete is illustrated very forcibly by the fact that the hoisting of the buckets of concrete to the bridge deck with the derricks required 90 seconds, or three times as long as with the cableway.

The central cableway tower also interfered with two of the transverse spandrel walls and, in order to erect forms for and to concrete these walls, the cross-bracing was removed in one panel on each side of the three center posts of the center bent transverse to the viaduct between the arch ribs. The tower did not interfere with the pouring of the viaduct floor except where the three posts above mentioned passed through it. Here small square holes were bulkheaded off around the posts and filled in with concrete after the tower was removed.

151. Spandrel Construction.—The construction of the deck over the arch ribs was not commenced until the main arch centers had been struck. The transverse spandrel walls supporting the spandrel arches were concreted in sections of varying height in self-supporting sectional forms (see Fig. 444) lined with galvanized iron. The concrete was delivered to a dumping platform by the cableway and was then

shoveled into the forms, the width of the same not being great enough to allow dumping directly. Just below the springing line of the spandrel arches a heavy projecting coping was placed on the walls to support the ends of the arch centers.

The spandrel arch centers were built in sections 10 ft. 4 in. long, four sections for each arch, consisting of 2-in. lagging nailed to 3×12 -in. bow-ribs spaced 2 ft. 4 in. centers, as shown in detail in Fig. 445. These sections were made adjustable to facilitate erection and removal. The bottom chords of the ribs had a 4-in. opening at the middle, covered by 2-in. fish-plates bolted on each side to allow the striking of centers. Above the second bottom chord from each end a rod and turnbuckle

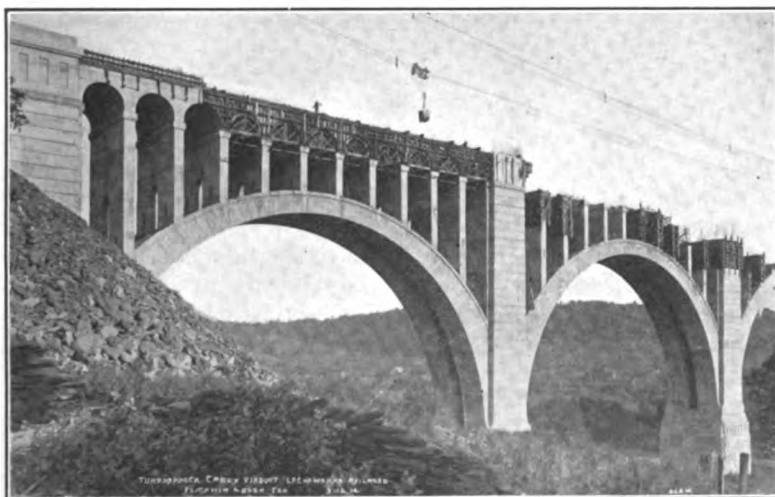

FIG. 444.—Tunkhannock viaduct. Completed arch ribs for two 180-ft. spans. Transverse spandrel walls, pier pilasters, and spandrel arches being concreted.

were placed which, when all the fish-plates were removed, were tightened up to slack the centers away from the concrete and allow their removal after the wedges were drawn. A total number of 80 sections sufficed for the construction of the spandrel arches for the entire bridge.

At the time the spandrel arches were poured, the parapet wall, up to the first offset of the coping, was also concreted in order to avoid an unsightly construction joint at the floor level. The forms for this portion of the parapet were built in sections extending from the crown of one arch to the crown of the one adjacent, as shown in Fig. 444. The reinforcement for spandrel arches and parapet was placed complete before any concreting was done. As soon as the forms for spandrel arches were removed, the wooden forms for the parapet copings were

erected, reinforcement placed, and the concreting done in the same manner as for transverse spandrel walls.

The cableway could not be readily used for removing the spandrel arch centers on account of the eccentric loading which would of necessity come upon it during such a procedure, and a stiff-leg derrick was there-

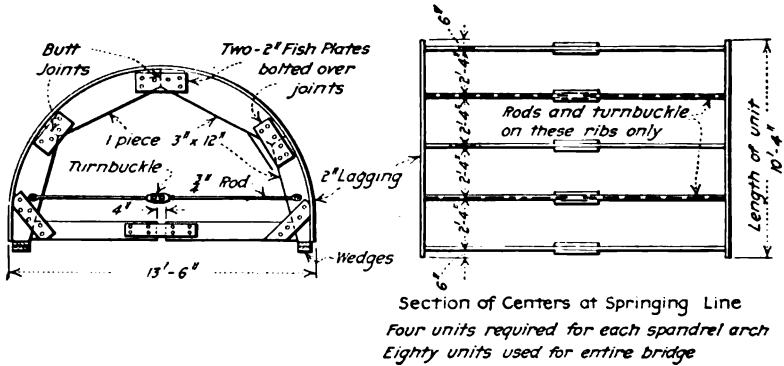

FIG. 445.—Tunkhannock viaduct. Details of spandrel arch centers.

fore erected on the finished floor to handle these centers, and moved along as the work progressed.

During cold weather the freshly poured sections of floor were covered with tarpaulins and a steam pipe run under same to keep the concrete warm until it had set. In hot weather newly constructed sections of the



FIG. 446.—Tunkhannock viaduct. Progress photograph, June 26, 1915.

floor were dammed up at the ends and flooded with water until the concrete had set. After completing the floor the waterproofing was laid, the track ballast placed, and the track laid. Fig. 446, a progress photograph of the viaduct, shows the status of the work on June 26, 1915. The entire bridge has since been completed (Nov. 7, 1915).

CHAPTER XXXIII

CONSTRUCTION OF UNIT-BUILT CONCRETE PILE TRESTLES

In the early days of railroading and even within recent years it has been the general practice to bridge small and unimportant streams, swampy lowlands, and wide flat drainage areas with timber trestles. In such localities the spans can be made relatively short, and the standard pile trestle with bents 14 or 16 ft. on centers is well adapted and economical.

Of late years timber for such purposes has become scarce and costly. For this reason and also on account of the great fire hazard in some localities, a more economical substitute for the more or less temporary timber trestle has been needed. It has been found by experience that concrete pile trestles, consisting of concrete pile bents supporting concrete slab decks of 14-ft., 16-ft., or 20-ft. span, can be constructed economically, and besides are fireproof and require no maintenance. Concrete trestles have been used also for crossings where the openings were too high to permit the use of concrete pile bents, thin concrete piers being used to support the slabs.

Concrete pile trestles have been found especially economical for the reason that the piles and slabs can be cast in a central yard, allowed to become seasoned, and then hauled to the site and put in place with a minimum amount of field work and with a plant which can be readily moved from place to place. This obviates the necessity of hauling and storing large quantities of materials and the erecting of a costly plant at each site. The central yard can be conveniently located close to the source of supply of sand and gravel, and the fact that material for many structures is fabricated at one place warrants the installation of more expensive and efficient plant as the total plant cost is distributed over a greater number of structures.

152. Details of Design.—In connection with 36 miles of double tracking between Fulton and Memphis, Tenn., the Illinois Central has recently built thirty-six concrete pile trestles (see Figs. 447 and 448) varying in length from 16 to 1648 ft. and in height from 6 to 21 ft. This railroad has also built concrete trestle approaches to three large steel bridges, with a total aggregate length of 9500 ft. for which about 4000 concrete piles were used.

The bridges in general consist of 5-pile bents at 16-ft. centers for single-track work, capped with reinforced-concrete caps 3 ft. 6 in. deep and 2 ft. 3 in. wide upon which rest the slabs, two for each span. The

slabs are 7 ft. wide, 16 ft. long, and 2 ft. 1 in. thick, with side curbs 10 in. high and 1 ft. wide to retain the ballast. For double track trestles two additional intermediate slabs were used, making the structures 28 ft.



Courtesy of C. F. Massey Co., Chicago.

FIG. 447.—Pile trestle. General type of concrete pile trestle for crossings of less than ten spans, Illinois Central R. R.

wide, the number of piles in each bent being increased to ten. The details for end, intermediate, and anchor bents are shown in Figs. 253 and 254 of Part II. These trestles were designed for Cooper's E-60



Courtesy of C. F. Massey Co., Chicago.

FIG. 448.—Pile trestle. General type of concrete pile trestle for crossings of more than ten spans, Illinois Central R. R. (Note the double row of piles which occurs at every sixth bent.)

live loading with impact equivalent to 50 per cent of the usual allowance given by the formula

$$I = \frac{L.L \times L.L}{D.L + L.L}$$

where $L.L$ = live load and $D.L$ = dead load.

Whenever a bridge consisted of ten or more spans, an anchor bent,

consisting of eight piles driven close together in two rows, was used at every sixth or seventh bent to resist the lateral stresses due to expansion of the slabs and the tractive force exerted by a moving train. (See Fig. 448.) At these bents a concrete partition wall 1 ft. wide was built integral with the pile cap to separate the bridge into six or seven panel units, thus preventing the accumulation of the expansive and contractive movement of the deck for the entire bridge at one point, the movement being limited to units of six- or seven-span lengths. Expansion joints 2 in. wide were provided to take up the movement at each anchor bent. In Fig. 253 of Part II the detail of the partition walls at anchor bents is clearly indicated, the upper portion conforming in outline to that of the top of slabs.

153. Casting Piles.—The piles of octagonal shape, 16 in. in diameter except at the point where they were tapered to 5 in. diameter, varied from 20 to 40 ft. in length. The lengths required at different points were ascertained by driving wooden test piles at every third bent. The

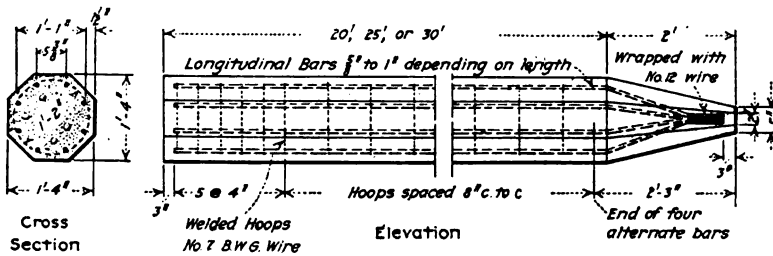

FIG. 449.—Pile trestle. Details of standard concrete pile, I. C. R. R.

piles were reinforced with longitudinal bars tied at intervals by welded wire loops, as shown in Fig. 449.

The piles were cast in collapsible forms so constructed as to allow of 2-ft. variations in length. These forms consisted of two-piece sections of sheet metal, each bent to form three sides of the pile, the width of each side being 6 in. The seventh or bottom side consisted of a 2 × 6-in. plank to which the metal forms were clamped. These planks were kept level by transverse supports placed at 4-ft. intervals. The eighth or top side was left open for placing and spading the concrete. The point of the pile was formed by a complete metal form bolted to the lower end of the sectional forms. The reinforcement was slipped in from the upper end and a wooden bulkhead clamped to the end of the form and the pile concreted.

154. Fabrication of Pile Reinforcement.—From the detail of the standard pile it will be seen that the reinforcement consisted of longitudinal bars tied together with wire hoops. The main reinforcement for most of the piles consisted of eight $\frac{3}{4}$ -in. bars, four of which extended the full

length of the pile, being bent into the point and wired together, while the other four were stopped off near the line where the taper of point began.

To fabricate this reinforcement the bars were placed about templates on a long bench, in positions conforming to that which they occupy in the completed pile. Hoops of No. 7 B. W. G. wire with welded joints were wired to the bars at spacings shown in the detail, Fig. 449. Flat iron spacers were placed at several points between the bars to prevent the unit from collapsing and to hold the bars the proper distance from the forms. The long bars previously bent to fit the taper were then wired together and the unit or *cage* as it was called was ready for placement in the form just described.

155. Concrete Plant.—The concrete train consisted of the cars containing the crushed stone and sand, and a flat car upon which was placed

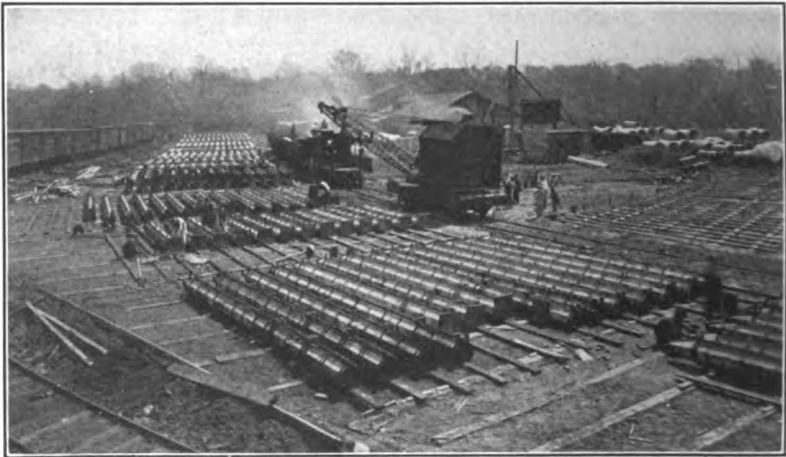

Courtesy of C. F. Massey Co., Chicago.

FIG. 450.—Pile trestle. Pouring concrete piles. Various stages of the work are shown.

a mixer with a maximum capacity of 18 cu. yd. per hour and an average capacity of 12 cu. yd. per hour. A sloping deck placed above the mixer allowed the dumping of concrete materials (hailed in wheelbarrows on portable runways supported along the sides of the material cars) directly into the charging spout of the mixer. The cement was stored on the mixer car under the sloping deck. The concrete of a 1:2:4 mixture was discharged into the bucket attached to the cables from the boom of the locomotive crane and by this means swung around to either side of the track and discharged into the pile molds. (See Fig. 450.) The concrete was carefully spaded during placement and the top surface troweled. Fig. 451 gives a near view of the mixer train and also shows concrete piling stored in piles for curing.

156. Handling Piles.—After remaining in the molds for 24 hours (although this depended somewhat on the weather conditions), the molds were removed and the piles allowed to cure on the planks for a period of 7 or 8 days, after which time they were stored in piles four and five high with wooden stringers between rows to allow air spaces on all sides so as to facilitate curing. The length of this latter curing period was about 2 weeks.

At the end of this time they were loaded on flat cars by means of the locomotive crane and hauled to the site. None of them were driven, however, until they were at least 30 days old. The weight of these piles was about 215 lb. per linear foot, or about $3\frac{1}{4}$ tons for a 30-ft. pile.

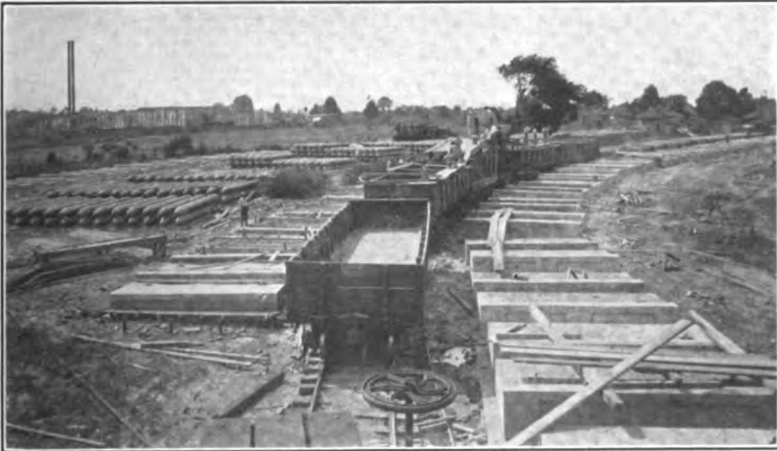

Courtesy of C. F. Massey Co., Chicago.

FIG. 451.—Pile trestle. Near view of mixer train concreting slabs. Concrete piles and slabs seasoning alongside the track.

157. Driving Piles.—The piles were driven by the railroad company's forces with five derrick-car pile drivers equipped with Worthington single-acting steam hammers with striking parts weighing 3000 lb., and a combination follower cap and hood weighing 2500 lb. A heavier hammer was tried, but the piling was badly damaged and its use discontinued. The hammers of these drivers were swung in 50-ft. leads supported by a 40-ft. boom of a derrick car, and had a drop of 3 ft. These drivers operated on a short temporary track blocked up on the piles previously driven and moved along by their own power as driving proceeded, as shown in Fig. 452.

To protect the pile heads from the direct blows of the heavy hammer, a wood and steel follower block 6 ft. long was placed in the leads between the hammer and the top of the pile, as shown in Fig. 453. The length

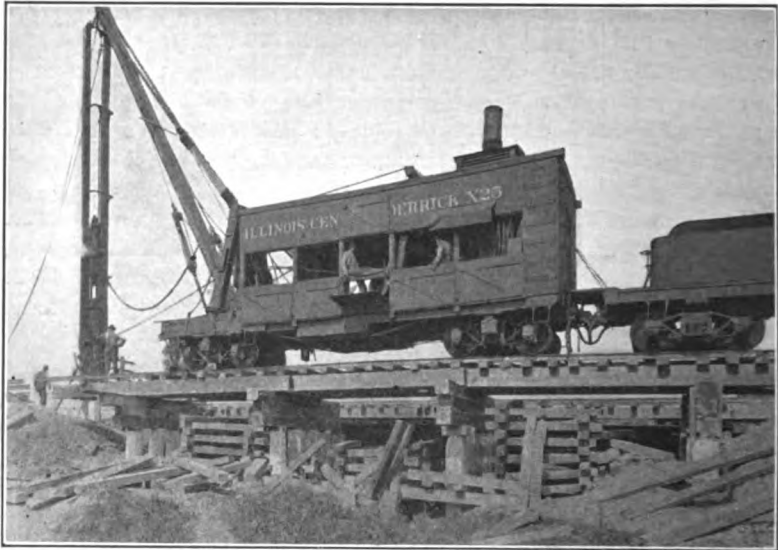

Courtesy of Mr. Maro Johnson, Engineer of Bridges and Buildings, I. C. R. R.
FIG. 452.—Pile trestle. Driving concrete piles with steam hammer.
Temporary track for driver blocked up on piles just driven.

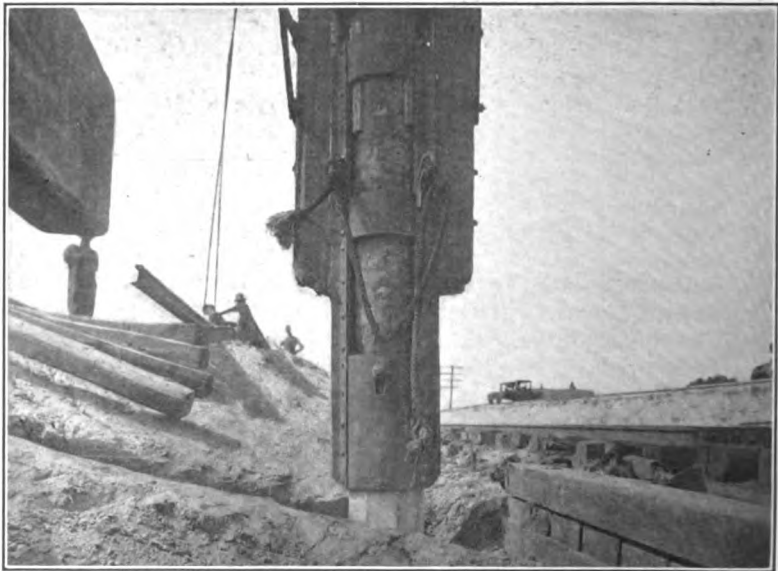

Courtesy of Mr. Maro Johnson, Engineer of Bridges and Buildings, I. C. R. R.
FIG. 453.—Pile trestle. Near view of wood cushion in metal guides fastened to driver leads to prevent breaking of pile heads.

of the hood or follower permitted driving the piles to the proper elevation without having the leads go below the track. To protect the pile heads still more while driving, cushions of one or two coils of 2-in. rope were laid directly on the pile heads. In this way piles were driven to an average penetration below ground of 20 ft. (minimum 15 ft.) without, for the most part, damaging the piles in the least. The combination of wood and rope cushions reduced the shock on the concrete and distributed the blow more uniformly over the pile head. A few of the piles broke down near the top and a few broomed so badly that they could not be used, but in general the piles stood up well and the failures occurred only under unusual circumstances. The rated bearing capacity of these piles was 24 tons.



Courtesy of C. F. Massey Co., Chicago.

FIG. 454.—Pile trestle. Pile bents ready for pile caps. (Note excellent condition of pile heads.)

On account of the material encountered it was not always possible to drive all piles in one bent to the same level and some of them had to be cut off before the pile caps were placed. This was done by chipping off the concrete to the bars, cutting the steel with hacksaws, and then knocking the concrete off with sledges. In cases where the excess length did not exceed 3 ft., the concrete was removed and the reinforcing bars bent down so as to be entirely within the pile caps. Where piles penetrated beyond the anticipated depth, the caps were deepened so as to extend down 11 in. over the lowest pile. The pile-driving outfit and a number of pile bents ready to receive caps are shown in Fig. 454.

Some crews were able to drive as many as thirty piles in 1 day under good conditions, while in some cases only eight or ten could be driven. The total average cost of these piles for four or five of the longer trestles was 99.1 cents per linear foot, divided as follows: manufacture, 66 cents; handling, 12.3 cents; and driving, 20.8 cents.



Courtesy of C. F. Massey Co., Chicago.

FIG. 455.—Pile trestle. Concreting pile caps from temporary narrow-gauge track carried on light framed bents.

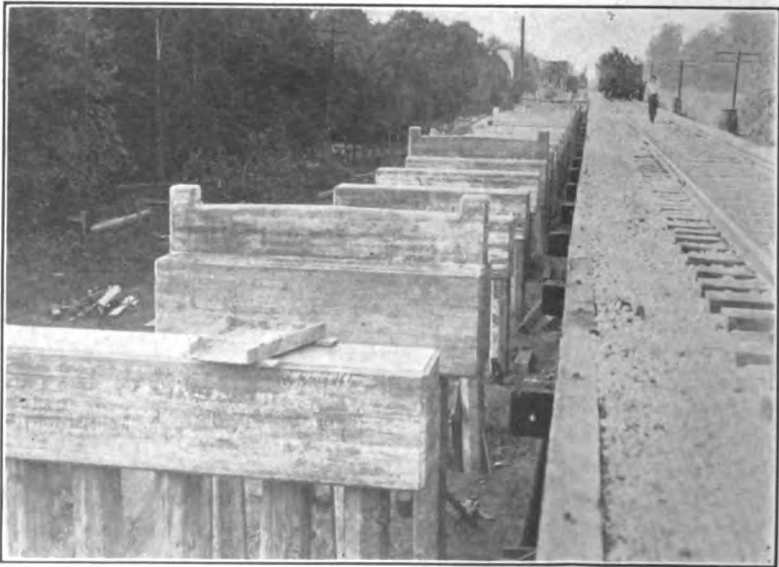

Courtesy of C. F. Massey Co., Chicago.

FIG. 456.—Pile trestle. Pile bents completed ready for slabs. (Note partition walls at anchor bents.)

158. Capping Pile Bents.—After all the piles for a bridge had been driven and brought to the proper elevation, forms were built around the pile heads, reinforcement placed, and the pile caps concreted. For short bridges the concrete for pile caps was mixed at one end of the bridge and hauled out in small cars and dumped into the forms. For the longer bridges a light trestle was built at some height above the top of the bents and the concrete was hauled out on small cars from the plant beyond the trestle and dumped into the forms. Fig. 455 shows such a construction track and the pile-cap forms in place, while in Fig. 456 the pile bents are shown completed ready to receive the deck slabs.

When the pile caps had hardened, the deck slabs (cast 2 months before in the Illinois Central slab yard at Fulton) were placed in position with a derrick car, as described later.

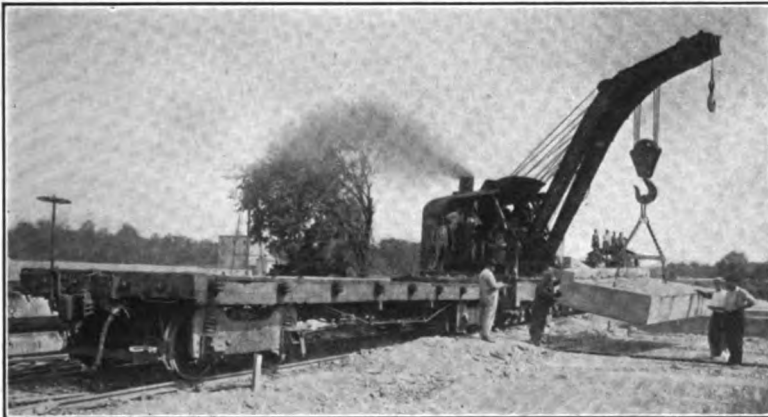

Courtesy of C. F. Massey Co., Chicago.

FIG. 457.—Pile trestle. Handling 19-ton concrete slab with locomotive crane.

159. Casting Slabs.—The slabs were cast in the yard at Fulton in single rows on each side of the track to facilitate handling. The side forms, built in units, were erected on heavy floors of tongue-and-groove lagging; the reinforcement was then placed in position and carefully wired up. The concrete, of a 1:2:4 mixture, was poured directly from the mixer train with the aid of spouts. (See Fig. 451.) A day or two after pouring, the side forms were removed to allow more rapid curing, and were again erected at other points for additional slabs, a minimum number of forms thus being required. The corners and edges of slabs were chamfered to prevent chipping and spalling of same.

160. Handling and Placing Slabs.—In order to make room in the yard the slabs were moved, 3 weeks after pouring, to the site where they were to be used but were not placed in the work until they had

hardened for 2 months. To make the handling of slabs easy, rings or hoops were embedded in the concrete at each end of slab. To move the slabs, a pair of chains with hooks at one end were hooked into the handling rings, the other end of each chain being fastened to a large link which hung from the hook of the wrecking crane. A nearly vertical pull was obtained on the handling rings by the use of a steel spreader just above the hooks, as shown in Fig. 457. The slabs were picked up, loaded two on a flat car, hauled out to the site, and placed in the work by means of derrick cars of the same type as used for pile driving, having a lifting capacity of 30 tons. The slabs were set on a bed of grout on the pile caps, and the longitudinal and transverse joints (except at anchor bents) were filled with cement mortar. The slabs were then waterproofed by the application of two coats of hot coal-tar pitch, and soon after the ballast and track were put in place.

CHAPTER XXXIV

CONSTRUCTION OF CONCRETE SLAB BRIDGES FOR TRACK-ELEVATION SUBWAYS

The construction of track-elevation bridges in large cities where traffic must be maintained at all times, and where space to carry on operations is necessarily limited, involves methods which differ greatly from those ordinarily employed. The C. M. & St. P. Ry. in connection with the Bloomingdale Road track-elevation project (1913-14) erected thirty-two reinforced-concrete trestle street crossings (commonly known as subways) of practically the same design, the construction of which involved some new and economical methods designed to prevent the blocking of street traffic.



Courtesy of Mr. H. C. Lothholz, Engineer of Design, C. M. & St. P. Ry.

FIG. 458.—Track-elevation subways. View of 60-ft. subway, Bloomingdale Road track elevation, Chicago, C. M. & St. P. Ry.

161. General Design.—These subways consist of reinforced-concrete trestle slabs built in place on plain-concrete abutments at street lines and on three intermediate reinforced-concrete skeleton piers, one pier at the center line of street and one at each curb. The majority of these bridges are 28 ft. wide and cross 60-ft. streets so that the main, or street spans, are made 19 ft. 6 in. centers and the end spans 10 ft. 6 in. from center line of pier to face of abutment. The former are slabs 2 ft. 4 in. thick, built in two sections, each 14 ft. wide; and the latter have a maximum thickness of 1 ft. 6 in. All bridges have an underclearance of 12 ft. at the crown of roadway except where street car tracks are crossed where the underclearance is increased to 13 ft. 6 in. Concrete curbs or parapets built integral with slabs retain the track ballast. The parapets are beveled off at the bottom of the slab so as to ap-

parently reduce the depth about 6 in., and the face is paneled so as to relieve the monotony of the plain flat surface. The accompanying illustration (Fig. 458) of a 60-ft. subway gives some idea of the general design, and Fig. 262 of Part II shows the details.

162. Construction of Abutments and Piers.—The excavation for piers and abutments was in general carried down by hand in open trenches to a stiff clay capable of sustaining a load of 4000 lb. per square foot, the excavated material being thrown or hauled back between retaining walls, previously built, which connected with the abutments.

The abutments are of a modified gravity type with a reinforced toe footing projecting 4 ft. 6 in. beyond face of abutment so as to avoid excess toe pressures and thereby give greater stability. The footings for abutments were poured in one continuous run from mixer trains which

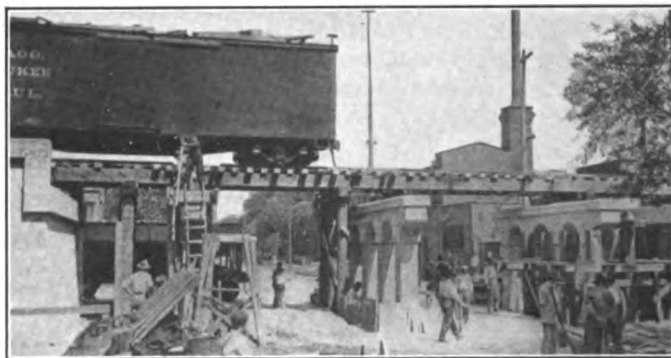

Courtesy of Mr. H. C. Lotholz, Engineer of Design, C. M. & St. P. Ry.

FIG. 459.—Track-elevation subways. Completed abutments and piers for 60-ft. subway, Bloomingdale Road track elevation, Chicago, C. M. & St. P. Ry. Centering for slab forms being erected.

operated on a temporary pile trestle built on one side of the right-of-way. Two lines of keyways 4 in. deep and 12 in. wide were formed by embedding beveled timbers in the fresh concrete to key the abutment proper to the footing and prevent sliding of the abutment on the base due to the earth pressure behind it. (See Fig. 262.) The timber forms for abutments were then erected and the concreting done in one operation, no horizontal joints being allowed in the neatwork.

The piers for all subways consist of four reinforced-concrete columns about 12 ft. high resting on a continuous inverted T-beam footing and connected at the top by a continuous girder or cap with the underside arched between columns to improve the appearance.

The pier footings were cast in rough forms in one continuous operation with the vertical bars for columns set in place in the forms. The pier forms, composed of self-sustaining metal sections, were then erected

around the column steel, the cross-girder steel set in place, and the entire pier concreted in one operation. In the early part of the work sectional wooden forms were used for piers, but these were later discarded entirely for the metal forms which were more economical, since they could be more easily erected and taken down, and were not so susceptible to damage on removal. These metal forms also required little or no repairs, which was not true of the wooden forms. The completed abutments and piers are shown in Fig. 459. At the right, next to the pier, note a line of upright posts being erected to carry the slab forms.

163. Construction of Slabs.—The slab forms were built for a slab one-half the width of the bridge—namely, 14 ft.—since the temporary construction trestle obstructed one side of the bridge above the tops of the piers and abutments. The centering consisted of heavy timber stringers carried on heavy posts resting on the footings of the piers and abutments, thereby obstructing only a small portion of the sidewalk and roadway. Across the stringers 4 × 6-in. joists were laid at about 18-in. centers and upon these dressed and matched lagging was placed. The side forms for slabs were then erected, and the reinforcement (consisting of two rows of longitudinal steel in bottom and one row in top of slab, tied together by continuous V-shaped stirrups and some transverse bars both top and bottom) was securely wired together and blocked up so as to be 2 in. clear from the forms.

A layer of 1:2 cement mortar 2 in. deep was then placed over the forms to insure adequate covering of the steel, since the close spacing of bars (3½ in. centers) would no doubt have caused the formation of stone pockets had the usual 1:2:4 mixture been used. To prevent the formation of ragged and uneven edges all corners and joints on showing faces of slabs were given a chamfer, formed by nailing a 1-in. V-strip to the forms. Each slab was poured in one continuous run but no two adjacent slabs were poured at the same time. This method was followed so as to make sure that each slab was a separate unit, a ½-in. space being left between all adjoining edges of the slabs. The roadway slabs each contain about 24 yd. of concrete and the sidewalk slabs about one-half this amount.

At crossings where it was necessary to keep the two street car tracks open for traffic as much of the time as possible, the deck slabs were not cast in their final position as was the usual case, but were cast on forms raised some distance above the tops of the piers to give the required underclearance, and were afterward let down into place.

After the piers had been completed, the slab forms for one of the roadway spans was erected on the usual type of centering, but at a higher elevation, and the concrete poured without interrupting traffic below. The second slab was then placed in the same manner and, after the slabs had cured sufficiently, blocking and hydraulic jacks were placed under

the ends of one slab, the formwork then removed, and the slab lowered into its final position by means of the jacks. The street under this slab was then torn up and excavated to the depth required to give the necessary clearance of 13 ft. 6 in., the street car track replaced, and traffic diverted to it while the other span was being lowered into position. In Fig. 460 one of the slabs is being lowered into position while the other is still blocked up above its final seat.

Expansion is provided for at the center pier, the slabs being keyed to the other piers and to the abutments by 5-in. beveled keyways 1 in. deep left in the piers and abutments at the time of concreting. At the expansion-bearing a continuous zinc plate, as wide as the pier top, was anchored to the same when concreted, and similar plates were fastened to the ends of the slabs to form a sliding joint. The expansion joint was filled with a sheet of waterproof "lith" $\frac{1}{2}$ in. thick which is quite elastic and which will readily compress, when subjected to pressure, to about

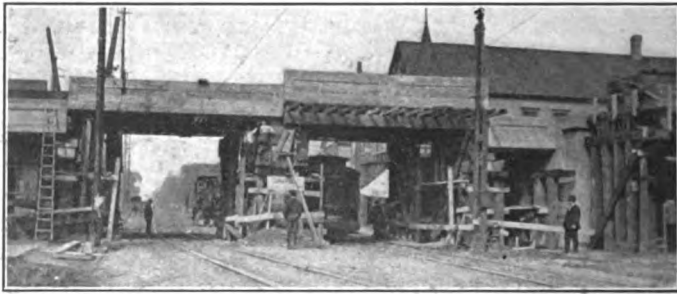

Courtesy of Mr. H. C. Lothholz, Engineer of Design, C. M. & St. P. Ry.

FIG. 460.—Track-elevation subways. Concrete deck slabs poured on forms raised to give street car clearance, C. M. & St. P. Ry.

one-fourth its original thickness, and is therefore very effective as an expansion-joint filler. The joints at *fixed ends*, and also the longitudinal joints, were filled with cement grout after the slabs had seasoned thoroughly.

As soon as the slabs for one side of a number of consecutive subways had been constructed and hardened sufficiently to bear traffic, a temporary track was laid on the slabs, the timber trestle removed, and the other half of each bridge built.

164. Concrete Plant.—The concrete plant used for most of the subway construction work was of a special type, consisting of a mixer mounted on a flat car which was fed with aggregate from storage bins on the same car. These bins were supplied by a dragline bucket, operated on a cableway, with which the sand and gravel was picked up from the cars in the train. Bulk cement, which was used almost exclusively on this work, was hauled in wheelbarrows to the mixer along runways laid on portable scaffold brackets hung from the car roof, the cement car being

placed at the head of the train. The general arrangement of this plant is shown in Fig. 461.

From the illustration it will be seen that the car at the rear end of the train carries one of the 45-ft. steel cableway towers and also the boiler and hoisting engine which operates the buckets on the cableway. The other tower is carried on the mixer car between the mixer and storage bins. The towers are set on trunnions on which they may be folded down when moving the plant for any great distance. The 1-yd. grab bucket can be so operated on the cableway as to pick up a load in any of the five gondolas in the train, and transfer it to the storage bins, which have a capacity of 30 yd., sufficient for a 1-hour run. From the bins

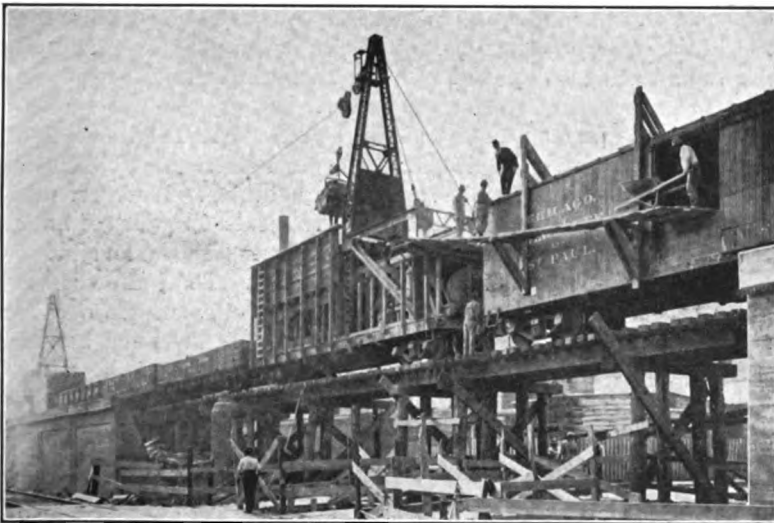

Courtesy of Universal Portland Cement Co.

FIG. 461.—Track-elevation subways. Concrete plant used in construction of concrete subways, Bloomingdale Road track elevation, Chicago, C. M. & St. P. Ry.

the aggregate is conveyed by a belt conveyor (driven by a gasoline engine) to the $\frac{1}{2}$ -yd. mixer operated by another gasoline engine. In the work in question the concrete was in general placed through a spout or chute, directly into place.

With this plant, operation may be continuous even when the material cars attached are so few in number that switching is necessary during the day. In such cases the cableway has been taken down, empty cars taken out, and full cars of material switched into the train in 45 minutes. Under average conditions 60 cu. yd. of aggregate per hour can be handled with the yard bucket and 75 per cent. of the material may be unloaded without assistance; the remainder, however, must be shoveled

into the bucket. With a crew of 14 men to operate it, this plant has a capacity of 200 cu. yd. per day.

165. Drainage and Waterproofing.—The tops of the main slabs are sloped 2 in. from the center each way to side gutters which slope down so as to discharge on to the sidewalk slab which is sloped to discharge the drainage over the abutment, where it is collected in drain tile, connected through manholes with the street sewer. Seepage into longitudinal joints between slabs is prevented by 4-in. curb walls.

When slabs last poured had seasoned for some time they were prepared for waterproofing by patching up the surface, filling the joints as mentioned above, and rounding out all re-entrant angles and pockets with cement mortar. The surfaces to be waterproofed were thoroughly cleaned with wire brushes, care being exercised to remove all laitance to which the waterproofing did not adhere properly. Before applying the waterproofing the concrete had to be thoroughly dry, hot sand being used where necessary to dry out corners, gutters, and wet surfaces. The deck was then mopped with hot pitch and a "Barrett Specification" five-ply waterproofing applied, the layers of felt being laid with wide laps transverse to track and covered with hot pitch. Wherever practicable, the waterproofing was laid in one run for the full width of bridge and flashed into recesses in parapets. Wherever possible, longitudinal joints were made at the center line of the slabs. The $\frac{1}{2}$ -in. expansion joints between slabs were covered with two continuous strips of tar paper 3 ft. wide, care being exercised not to get any pitch between layers. The top layer of felt was then mopped with pitch and the waterproofing carried over it in the same manner as if no joint occurred at that point.

To protect the waterproofing layer it was then covered as soon as cold with a $1\frac{1}{2}$ -in. layer of 1 : 2 : 3 concrete, with $\frac{1}{2}$ -in. stone or gravel for the coarse aggregate. This covering of concrete was troweled smooth and the surface protected from the direct rays of the sun for 24 hours. When the concrete had hardened, the rock ballast was spread over it and the permanent tracks were laid.

For subways of similar design built in connection with the Evanston track-elevation work of this road in 1909, the slabs were built in a central yard, transported to the site, and erected by a specially-designed train. In this case it was impossible, on account of the great volume of traffic which had to be maintained, to use any method which would make it necessary to utilize the second track during construction. This at once precluded the building of slabs in place, as was done on the Bloomingdale work. For any scheme that could be evolved, based on the use of wrecking cranes or derrick cars for placing the slabs weighing 65 tons, it was found that either traffic would have been blockaded to an un-

desirable extent or that considerable change would have been necessitated in the cranes or derricks before they could have operated successfully under the conditions.

In the Bloomingdale Road track-elevation work, the traffic, other than that of construction trains, was not very heavy and was diverted to a track on one side of the right-of-way outside the wall. Thus the

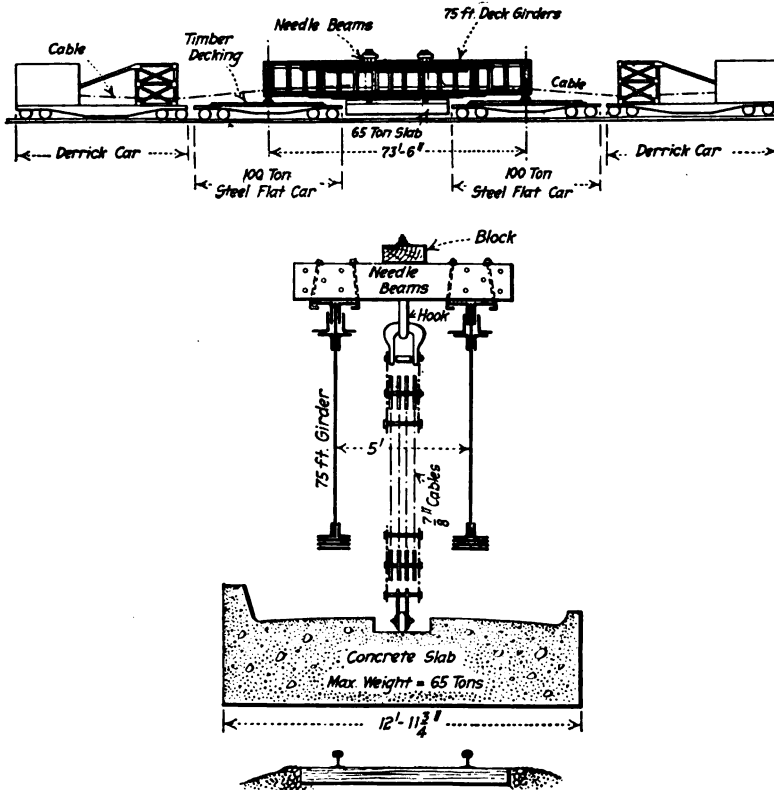

FIG. 462.—Track-elevation subways. Special car for transporting and placing concrete slabs for subways, Evanston Division, C. M. & St. P. Ry. 1909.

maintenance of traffic put little handicap on the methods of subway construction so that pre-cast slabs could have been placed without difficulty. From past experience, however, it was deemed best and more economical to concrete the slabs in place, and this was accordingly done.

The device used on the Evanston work to transport and set slabs consisted of a 75-ft. plate-girder span mounted on two 100-ton steel flat cars equipped with special timber decks, spaced far enough apart to

allow the hanging of the slabs from the girders by means of two four-sheave tackle blocks operated by two hoisting engines in two derrick cars, one at each end. (See Fig. 462.)

With this apparatus the placing of slabs was accomplished in the following manner: The slabs were blocked up in the casting yard and placed on girder carriages which were mounted on rails; then they were run out under the 75-ft. girders and the sheave blocks fastened to the lifting hooks embedded in the ends; finally the slabs were lifted clear of supports and transported to the bridge site. The slab was spotted directly over the piers on which it was to rest, the temporary track removed, the slab lowered into place on a stiff bed of mortar, and the track blocked up on the new slab to allow removal of train.

CHAPTER XXXV

CONSTRUCTION OF THE NORTH SAMUELS AVENUE VIADUCT, FORT WORTH, TEXAS

The North Samuels Avenue viaduct at Fort Worth, Texas, a beam-and-girder bridge over the Trinity River made up of nine 50-ft. (c. to c. of piers) girder spans, the designing details of which are shown in Figs. 275 to 278 inclusive of Part II, no doubt ranks among the largest of structures of this type involving such unusual spans. A novel feature of the construction was that the widths of all beams and girders were made to conform to stock, or actual sizes of lumber, instead of with utter disrespect to sizes of lumber as is usually the case. This effected quite a saving in the cost of form construction.

CONSTRUCTION OF SUBSTRUCTURE

166. Excavation.—The excavation for land piers and abutments was done mainly with slip and wheel scrapers through a heavy black clayey loam which when dry was quite hard and would stand up with a vertical face for a height of 15 or 20 ft. without caving.

The river piers were excavated by hand with pick and shovel in timber-sheeted holes to a depth of about 12 ft. below the river bed. The excavated material was shoveled into 1-yd. turn-over buckets and lifted out by a 5-ton A-frame derrick with 60-ft. boom mounted on a car. (See Fig. 463.) The material encountered was alternating strata of mud and gravel, which contained much water after heavy rains and which required considerable pumping to keep the holes fairly dry. The sheeting (2 × 10-in. lumber) was driven down with hand maul as the excavation proceeded, and was braced to hold same in line, as shown in Fig. 464. The water was handled by a duplex steam pump.

167. Piling.—The piles for the river piers were driven with a 2500-lb. drop-hammer driver in 25-ft. leads swung from the derrick boom, as shown in Fig. 465, the driver in this case being used to drive falsework piles.

These piles, originally specified to be 25 ft. long, averaged only 10 or 12 ft. in length and were driven until they struck a bed of hard compact gravel. On reaching this stratum the average penetration was about $\frac{1}{4}$ in. under the last blow of the hammer and the tops of the piles tended to broom badly. After the piles were cut off to the proper elevation, the footing reinforcement was placed and the footings concreted.

168. Forms for Piers and Abutments.—The forms for neatwork of piers and abutments consisted of 1 × 8-in. or 1 × 10-in. shiplap on



Courtesy of Mr. E. W. Robinson of the McKenzie Cons. Co., San Antonio, Texas.

FIG. 463.—Samuels Avenue viaduct. Various stages of pier excavation.

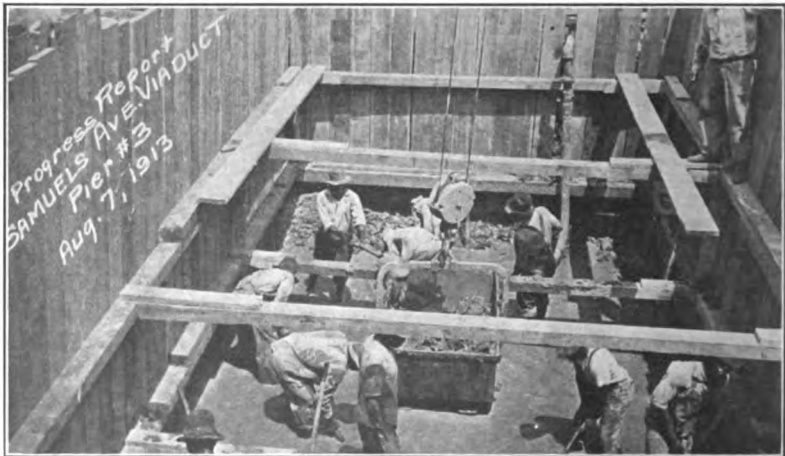

Courtesy of Mr. E. W. Robinson of the McKenzie Cons. Co., San Antonio, Texas.

FIG. 464.—Samuels Avenue viaduct. Inside view of cofferdam for river pier.

2 × 6-in. vertical studs held by 4 × 4-in., 4 × 6-in., or 6 × 6-in. wales tied at alternate studs by 4 strands of No. 8 or No. 3 black annealed iron wire. The forms for different portions of the structure were designed

CONSTRUCTION OF FORT WORTH VIADUCT 595

for the rate of filling which could be obtained with the mixing plant used. These designs were made on typewriter paper and copies were

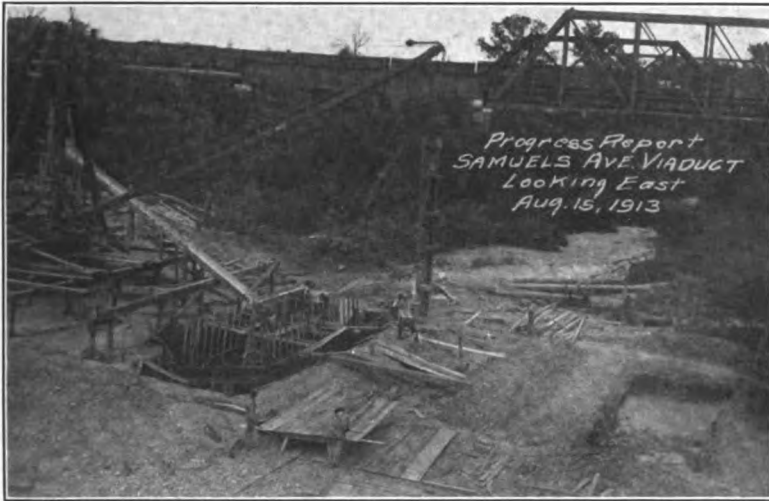

Courtesy of Mr. E. W. Robinson of the McKenzie Cons. Co., San Antonio, Texas.

FIG. 465.—Samuels Avenue viaduct. Pier footing poured and pier forms erected inside of cofferdam. Driving falsework piles with drop hammer in swinging leads from derrick.

given to the superintendent with a notation of the head they were designed to withstand. Fig. 466 gives a detail of a typical section of pier and abutment forms. Built-up sections or panel units of forms

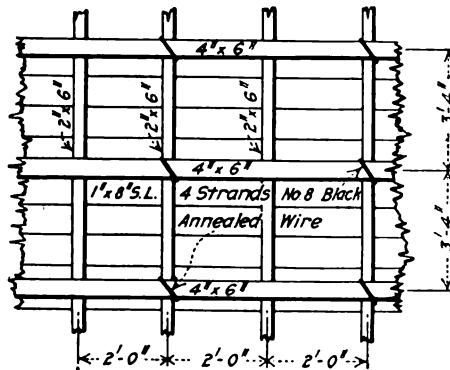

FIG. 466.—Samuels Avenue viaduct. Typical detail of pier and abutment forms.

which were used several times were advantageously employed on the lower lifts, or where they could be handled by the derrick. In general,

however, it was found more economical to build the forms in place. In constructing forms care was exercised to obtain as smooth an outside



Courtesy of Mr. E. W. Robinson of the McKenzie Cons. Co., San Antonio, Texas.
FIG. 467.—Samuels Avenue viaduct. Pulling pier forms with derrick, showing also spouting equipment for substructure work.



Courtesy of Mr. E. W. Robinson of the McKenzie Cons. Co., San Antonio Texas.
FIG. 468.—Samuels Avenue viaduct. Pulling cofferdam sheeting with derrick.

surface as possible to avoid the necessity of much refinishing of surfaces after removal.

169. Concrete Work on Piers and Abutments.—The concrete for piers and abutments was of a 1:2½:5 mixture, with limestone passing a 2-in. ring as coarse aggregate. In this, some 250 tons of one-man stone

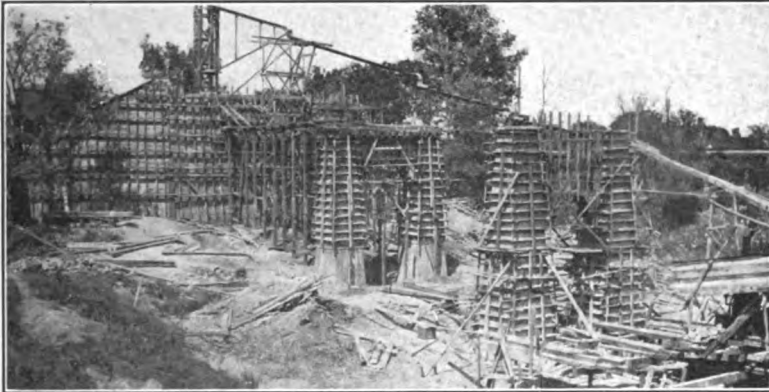

Courtesy of Mr. E. W. Robinson of the McKenzie Cons. Co., San Antonio, Texas.

FIG. 469.—Samuels Avenue viaduct. View of south abutment and land pier forms.

were embedded. The high cost of handling it on account of the small yardage used at each pier resulted, however, in a very small saving.

The concrete was mixed in a 9-cu. ft. mixer driven by a gasoline engine, hoisted to the top of a 110-ft. hoisting tower, and then discharged into

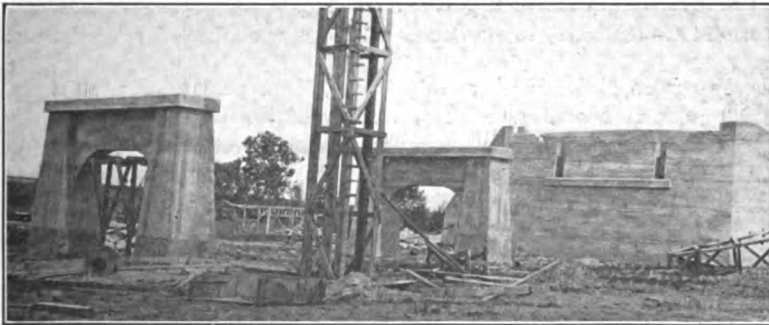

Courtesy of Mr. E. W. Robinson of the McKenzie Cons. Co., San Antonio, Texas.

FIG. 470.—Samuels Avenue viaduct. Finished piers and abutment, ready for girders.

place by means of Wylie trussed steel chutes and wooden troughs placed at a grade of not less than 1 in 4. The main chutes were so attached to the tower as to allow swinging over a considerable radius and the wooden troughs, to give a still greater radius of distribution, were set up on timber A-frames, as shown in Fig. 467 which also shows the derrick

being used to remove the lower section of pier forms before pulling the wooden sheeting. In Fig. 468 the pier forms are shown removed and the sheeting pulled. In Fig. 469 may be seen the abutment forms in place, also those for upper portion of the two-pillar land piers, and the falsework for the first span of the superstructure in course of erection. In Fig. 470 the north abutment and adjacent land piers are shown, stripped of formwork, with stub bars for anchoring girders protruding from the top. In this view the construction joints in the concrete are plainly visible, but these joints were afterward quite effectually hidden by a method which will be described further on.

CONSTRUCTION OF SUPERSTRUCTURE

170. Forms and Centering for Superstructure.—A construction load of 50 lb. per square foot, in addition to the dead load of concrete, was assumed for the design of the forms. The total load of one span was thus about 333 tons, and was carried on twenty-two 6 × 6-in. posts under

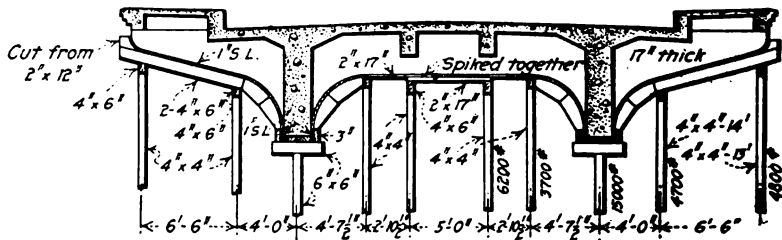

FIG. 471A.—Samuels Avenue viaduct. Forms and supports for floor-beams.

the two main girders and seventy-two 4 × 4-in. posts under the slabs, stringers, and floor-beams. The spacing of the posts and the loads which they were assumed to carry are indicated on the accompanying detail drawings. Figs. 471A and 471B show the forms and supports for floor-beams, and also for stringers, girders, and the slab between floor-beams. In Figs. 472A and 472B are shown the floor-beam form details and supports under stringer forms, also the forms and supports for girders. The posts were well scabbed together (that is, extra pieces nailed on) at all splices and they were braced by horizontal lines of braces in both directions, with some diagonal bracing in addition, as indicated in Fig. 473.

The main girder posts (carrying from 5.5 to 7.5 tons), and those for land spans, rested on footings of concrete 6 in. thick designed for a unit bearing of 2 tons per square foot. The smaller posts with loads of from 0.9 to 2.4 tons were placed on pieces of 3-in. plank embedded in mortar.

From the illustration (Fig. 473) it will be noted that a comparatively large number of form supports were used. These were decided upon as

giving a more economical form construction than a few number of large posts capped with timbers, due to the increased cost of erection of posts of the latter type, and also because of the fact that no special

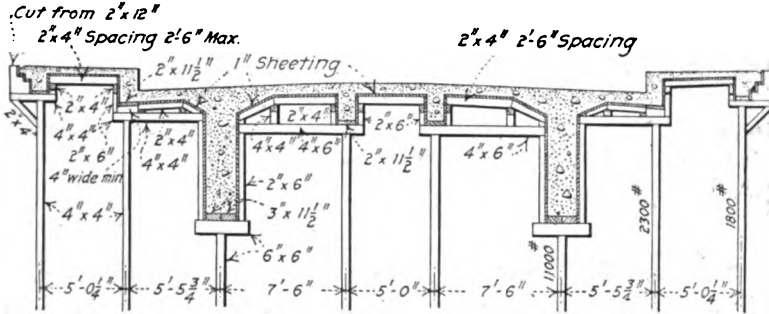
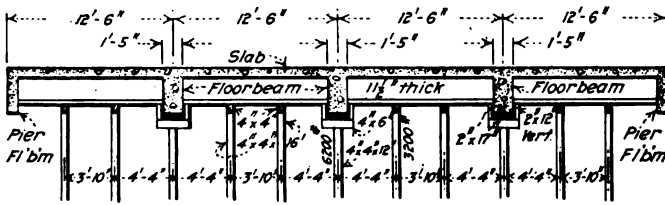

FIG. 471B.—Samuels Avenue viaduct. Forms for stringers, girders, and slab between floor-beams.



Note: Spacing of posts under walk and curb stringers same as above

FIG. 472A.—Samuels Avenue viaduct. Forms for floor-beams and stringer supports.

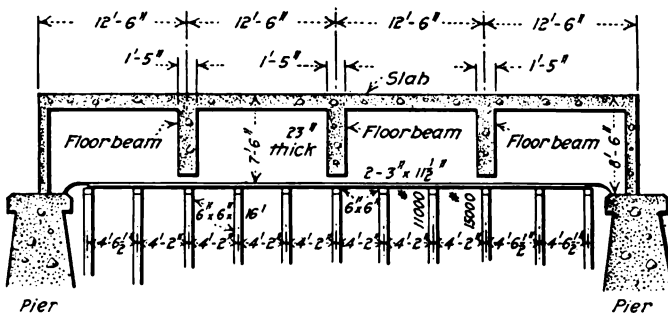
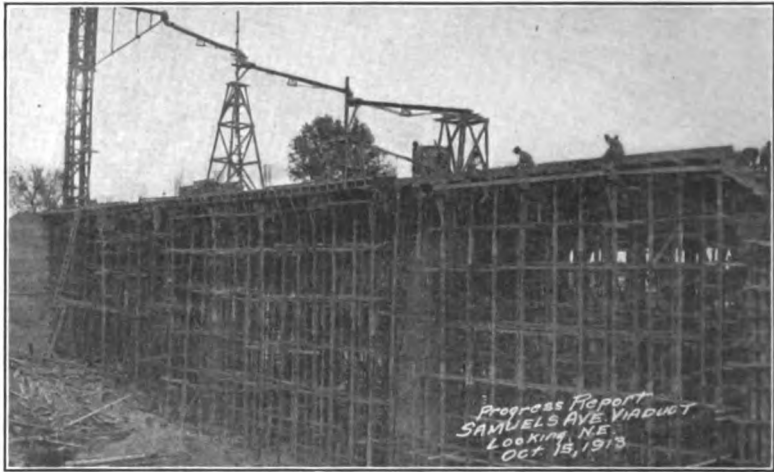

FIG. 472B.—Samuels Avenue viaduct. Forms and supports under main girders.

mechanical means of raising these posts was warranted on account of the size of the job. Then again it was shown during construction that the type used tended to neutralize the effect of unequal settlement which

took place, the large number of posts employed making it possible for one post to settle considerably without affecting the structure due to the



Courtesy of Mr. E. W. Robinson of the McKenzie Cons. Co., San Antonio, Texas.

FIG. 473.—Samuels Avenue viaduct. View of falsework for superstructure.

fact that adjacent posts were close enough to take practically all the additional load. On another job of similar construction in the same city, where the other method of supporting forms was used, two main



Courtesy of Mr. E. W. Robinson of the McKenzie Cons. Co., San Antonio, Texas.

FIG. 474.—Samuels Avenue viaduct. View of river span falsework, showing also the difference in construction of river and land piers.

girders cracked, presumably due to the settlement of one post after the concrete had taken its initial set. On the bridge here described, the

CONSTRUCTION OF FORT WORTH VIADUCT 601

settlement of land forms varied from $\frac{3}{8}$ in. to $\frac{7}{8}$ in., due almost entirely to tightening of the joints and compression of the wood.

For the river spans the same type of falsework as was used for the land spans was supported on twenty-one temporary timber piles, capped with 4×12 -in., 6×12 -in., and 8×12 -in., timbers, as shown in Fig. 474, the load on the piles varying from 6.5 to 15.5 tons. In Fig. 475 one span of the falsework in river is shown wrecked by driftwood; the concrete, however, was sufficiently set at the time of the failure to carry its own weight so no harm was done. This illustrates one of the dangers to be met with in the use of many-post centering in streams subject to floods.

Due to the fact that piles were not driven to proper penetration, through an error on the part of the pile-driver foreman, the first river



Courtesy of Mr. E. W. Robinson of the McKenzie Cons. Co., San Antonio, Texas.
Fig. 475.—Samuels Avenue viaduct. View of wrecked river span falsework.

span concreted settled $4\frac{1}{2}$ in. This happened before initial set in the concrete had taken place so no damage resulted; a slight bow, however, shows in the girders. To guard against similar settlement in the other river spans, extra posts, resting on concrete footings, were placed at points of greatest load.

On another job of similar construction over the same stream, supports for river spans were arranged so as to leave the channel entirely free from obstruction, thereby avoiding danger of loss by high water, also the excessive settlement encountered on the North Samuels Avenue viaduct. This construction shown in Fig. 476 consisted of 6×6 -in. inclined posts supporting the formwork and resting on 8×8 -in. waling strips bolted to the piers with $\frac{3}{4}$ -in. bolts 20 in. long with a nut on each end embedded in the concrete, the bolts being wrapped in tar paper to allow their

removal. This centering was given a 2-in. camber in anticipation of settlement or deflection of inclined struts, but none occurred.

In the design, sizes for beams and girders were selected with a view to make use of stock widths of lumber for the bottoms of the forms and the sizes were accordingly made 11½ in., 17 in., and 23 in. Planking 3 in. thick was used under the main girders and 2-in. material under the beams. The side forms and also the slab forms were of 1-in. shi lap supported

by 2 × 4-in. and 2 × 6-in. studs and joists. Some ½-in. bolts were used to tie side forms of the beams and girders to prevent spreading, but in general No. 3 or No. 8 black iron wire ties proved more economical and satisfactory. In the building forms, 0.104 lb. of nails and 0.107 lb. of wire were used per square foot of form surface.

171. Placing Reinforcement.

—After forms were complete for an entire span all reinforcement was placed and securely wired to prevent any displacement. To further insure the proper location of steel in the finished bridge, small beveled concrete blocks were used as spacers at beam bottoms and sides. Fig. 477 shows the reinforcement for a portion of the reinforced concrete for a portion of the beams and girders in place ready for slab steel.

172. Methods of Concreting Superstructure.—In pouring the

superstructure, the portion between the curbs for one entire span was placed in one continuous run, the remaining portion (consisting of curb stringer, sidewalk stringer, and sidewalk slab) being poured a few days later. This procedure was adopted on account of the difficulty of supporting the side forms for the curb to an accurate line or grade while the concrete of the roadway slab was still green. Machine bolts 1 in. in diameter were set in two rows and spaced 2 ft. 3 in. centers for each rail of a street car track located over each girder. At first boxes were set on the forms to provide slots into which each pair of bolts was grouted after the slab had hardened. The closeness of the slab bars made this a slow and expensive method and it was finally decided to use these boxes every 10

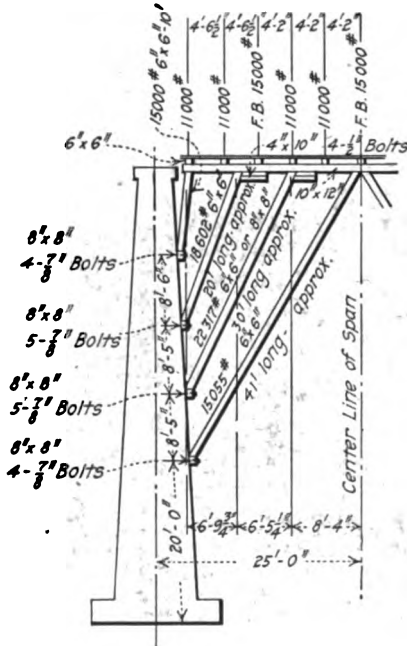
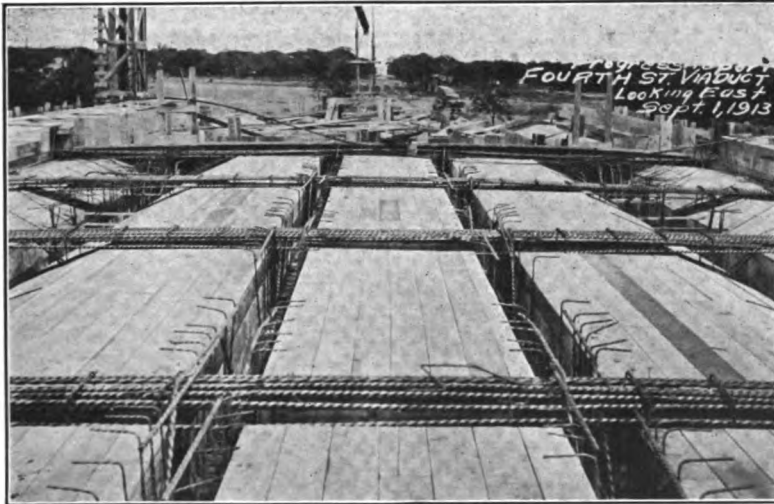

FIG. 476.—Samuel's Avenue viaduct. Detail of river span falsework used on the Fourth Street viaduct (Ft. Worth) of the same type of construction.

CONSTRUCTION OF FORT WORTH VIADUCT 603

or 12 ft. to support an inverted T-beam composed of two 2×6 -in. planks on which the bolts were hung to line and grade. This also formed a platform from which the men could work, and also a support for the movable wooden chutes with which concrete was conducted from the end of steel chutes, attached to the tower, to all parts of the work.

All the concrete, with the exception of that in a part of the railing, was mixed at the central plant, at the distributing tower previously mentioned. Only one plant was used, this being moved from its original position two spans north of the south abutment to the north end of bridge and then back again, in order to reach all parts of the work with a maximum distance of 250 ft. for chuting the concrete. With this length of



Courtesy of Mr. E. W. Robinson of the McKenzie Cons. Co., San Antonio, Texas.
FIG. 477.—Samuels Avenue viaduct. Beam and girder reinforcement in place.

chute the concrete was distributed without difficulty except when a dry batch was followed by a wet batch, in which case the latter batch would spill over the sides of the chutes. The stone and sand were dumped as near the mixer as possible and wheeled in barrows to the hopper of the mixer, which was self-loading. Concrete was mixed and placed at the rate of 20 cu. yd. per hour with the following average organizations: three men wheeling sand, six men wheeling stone, two men bringing and emptying cement into mixer, two men to run mixer and hoist, and four men on the deck working the concrete around the reinforcing steel and shifting the chutes. A mixture of the proportions 1:2:4, with 1-in. limestone as coarse aggregate, was used for the entire superstructure.

173. Progress Chart.—The progress chart, Fig. 478, shows very clearly

the general progress made in excavation and the sequence of construction of the various parts of the structure. A chart of this nature will be found a most excellent record and one which will demonstrate its value many times (even after a structure is completed) to settle questions that may arise as to time and sequence of construction and many related questions.

174. Surface Finish.—In carrying on the concrete work the concrete was well spaded next to the forms, but no special pains were taken to conceal construction joints. After the forms were removed and before the concrete had become too hard, all showing faces were gone over and

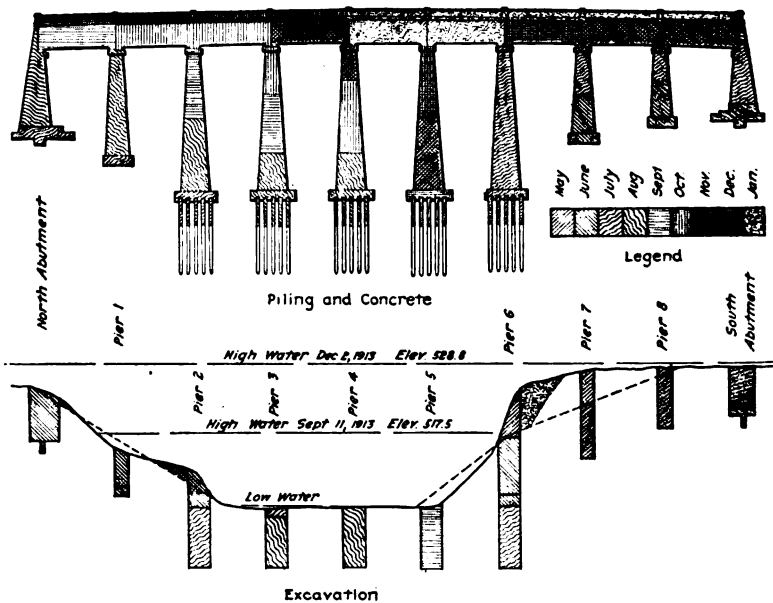

FIG. 478.—Samuels Avenue viaduct. Progress chart for entire construction.

the fins and lips removed with a bushhammer, or carborundum stone, and smoothed off carefully. All holes were pointed up with mortar and later rubbed down to give a surface of uniform color. After undergoing this treatment, the construction joints are very inconspicuous at a distance of 100 ft., which was not the case before treatment, as indicated in Fig. 470.

175. Expansion Joints.—At the expansion end of each span the girders rest on a pair of milled-iron bearing plates and the $\frac{1}{2}$ -in. expansion joint between end floor-beams is packed with tar paper. In the roadway and sidewalk slabs a U-shaped strip of 16-oz. sheet copper was embedded in the concrete near the top for the full width at expansion joints, and the "U" filled with asphalt to prevent seepage into the joints.

CONSTRUCTION OF FORT WORTH VIADUCT 605

176. Concrete Railings or Parapets.—The parapets or railings were constructed in three operations. First the foot rail was cast in place without anchorage to the walk, with an opening at each post about 8 in. less than the width of the post. Next the open-spindle panels 5 in. wide, previously cast in units, were set up in the groove in the footrail, and the handrails with grooved bottoms set up on the panels. Finally, the post forms were erected and bolted in place and the concrete poured in around the other members, the vertical reinforcing steel for posts being anchored into the outer stringer.

When the forms were removed, all the joints were pointed. A few days later the concrete was painted with grout and rubbed down with carborundum brick to give a surface of uniform and pleasing texture, free from small defects and holes.

Wooden forms were used for all parts of the railing with the exception of the semicircles at the top of the 6-in. openings in the panels, which were of galvanized iron. The bed of the panels consisted of tongue-and-groove flooring nailed to 2 × 6-in. joists. The openings for all panels are vertical, and, since the grade of the bridge varies from level to 2 per cent, the cores had to be shifted with a change of grade. The cores were removed as soon as possible after pouring to allow dressing up the defects.

Expansion joints were provided in the railing, directly over those in the deck, by wrapping the ends of the panels and rails with tar paper before pouring the post.

ACKNOWLEDGMENT

The writer wishes to express his appreciation and thanks to all those who have so kindly furnished data, plans, and photographs used in the writing of Part VII, as given herewith and as listed under illustrations.

Mr. E. Chamberlain, Ass't. Engineer, Philadelphia and Reading Ry., also Railway Engineering and Maintenance of Way—material on Yardley bridge. Mr. C. W. Simpson, Resident Engineer, D. L. & W. R. R.—photographs and data on Tunkhannock viaduct. Mr. C. W. Malcolm, Assoc. Editor, Engineering and Contracting—detailed drawings of the Tunkhannock viaduct and of the North Samuels Avenue viaduct. Mr. E. W. Robinson, C. E.—data and photographs of the North Samuels Avenue viaduct. Mr. H. C. Lothholz, Engineer of Design and W. A. Kellner, Ass't. Engineer—material on track elevation work of C. M. & St. P. Ry. Mr. Maro Johnson, Engineer of Bridges and Buildings, Illinois Central R. R.—material on concrete pile trestles. C. F. Massey Co., Chicago—photographs and data on Illinois Central pile trestles.



PART VIII

EUROPEAN CONCRETE BRIDGES

BY

PHILIP AYLETT, ASSOC. M. AM. SOC. C. E.

AND

P. J. MARKMANN, C. E.

American engineers who have followed European progress in the design and construction of concrete bridges must have admired their esthetic merit and wondered at the light, bold design.

A number of epoch-making practical applications of theoretic principles in the design of concrete bridges within the last decade have to be credited to European engineers. Hinged arches, free-ring (barrel or ribbed) arches, and the subdivided system of concreting, etc, all originated in Europe and were all looked upon at first with disapproval in America, and are even today not approved of in some quarters.

Within the last few years European bridge engineers have made another and more remarkable departure, one which has attracted attention far and wide. Briefly, it may be generally described as the successful founding and construction of reinforced-concrete arch bridges upon soils so insecure in character that the new type of construction has been referred to in the American technical press as "floating foundations." This practice at the time of its first appearance, like other European innovations which have preceded it, met with the disapproval of American engineers and is still looked upon unfavorably. Foreign engineers, however, have always been noted for their thoroughness and conservatism, and it appears inconsistent, therefore, to believe that in the so-called "floating foundations"—radical as such construction may seem—they should have departed from their usual thorough analysis and safe procedure.

It has been the aim of the authors of these chapters to point out some of the most marked characteristics and features of European practice and to show, both by description and illustration, the ways and means which have contributed to the excellent results secured. In doing this it has been the intention to emphasize the thoroughness of the scientific research work accomplished in Europe, and to comment at length on the architectural form of the European bridges and their admirable harmony with surroundings.

The material for these chapters has been collected during an extensive tour abroad devoted exclusively to the design and construction of

concrete bridges. This tour included England, Belgium, Holland, Germany, Switzerland, and France.

Many of the photographs have been taken by one of the authors at the bridge sites. The descriptive matter has been partially prepared from personal inspection notes, records, and interviews with foreign engineers and others, supplemented by material from the foreign technical press and works of reference, which has been rearranged and abridged.

The authors take great pleasure in acknowledging their obligation to Wilhelm Ernst & Sohn, Berlin, Germany, for their kindness in allowing the authors to reproduce illustrations and to make extracts from the *Handbuch für Eisenbetonbau*, 2d revised edition, Vol. VI.¹

The authors further desire to express their sincere thanks to railway and public officials, to the American and British Consulates in various cities, and to engineering societies for their valuable assistance in obtaining and supplying photographs and data.

Acknowledgment for various favors and assistance is also especially due to the following engineers: M. Léon Lebec, Secrétaire technique de la Société, Ingénieurs Civils, Paris; M. Hennebique, Paris; H. Schütze, Wattwil, Switzerland.

The following technical publications and works of reference have been consulted; *Annales des Ponts et Chaussées*, Paris, France; *Le Génie Civil*, Paris, France; *Annales des Travaux Publics de Belgique*, Brussels, Belgium; *The Engineer*, London, England; *Concrete and Constructional Engineering*, London; *Engineering*, London; *Engineering News*, New York; *Engineering Record*, New York; *Beton and Eisen*, Vienna, Austria; *Le Cément*, Paris; *Schweizerische Bauzeitung*, Zurich, Switzerland; *Allgemeine Bauzeitung*, Vienna, Austria; *Christophes "Le Béton Armé,"* Emperger's "*Handbuch für Eisenbetonbau.*"

CHAPTER XXXVI

EUROPEAN VS. AMERICAN PRACTICE

177. General Discussion.—One cannot travel abroad, especially on the Continent, without being struck with the conscientious care given to the finished appearance of bridge structures. This is true not only of prominent structures in or near centers of concentrated wealth and artistic taste, but also of comparatively modest structures at places remote from any large centers of population. Although a number of well-designed structures have been built in American cities and parks within recent years, it must be acknowledged that in Europe there are

¹ For contents and review of this thorough and comprehensive treatise see "*Engineering News*" Literature Supplement, Oct. 17, 1912.

a great many such structures, and that they are the rule and not the exception.

The American engineer, on account of the rapid development of concrete construction in his own country, is apt to overlook similar work in foreign lands, and probably never realizes fully what goes on there. He believes naturally, inasmuch as the same conditions and problems met with here also exist in foreign lands, that the methods employed and results attained there are probably somewhat similar to his own; that, if differences do exist, they are due to the inferior practice abroad and the superior practice in his own country. Any such opinions, however, are very far from the truth. While American practice does excel in some respects, these relate exclusively to plant, machinery, etc.—that is, to methods and things economic or utilitarian—and seldom to the esthetic or scientific, so far as reinforced-concrete bridge construction is concerned.

In the design, manufacture, and erection of the typical American structures, the steel truss and girder, we excel and reign supreme without a rival—but there our supremacy ends. In fact, in the design and construction of bridges in reinforced concrete, foreign practice is far in advance and the European engineer in this is still our master, and we have much to learn from him.

Although the problems and conditions met with here are similar to those encountered abroad, nevertheless, certain essential differences exist in methods employed and results obtained—especially the latter—which are bound to be of interest and value to the American bridge builder. It must be remembered that Europeans were the pioneers in concrete and reinforced-concrete bridge construction, and that they originated and developed nearly every important advance and expedient in connection therewith—in both theory and practice; many of these progressive ideas have been imported and adopted, more or less, by American practice; others are still comparatively unknown or little used. When reinforced-concrete construction was younger—that is, before the introduction of European methods—differences were more marked and comparisons less favorable to American practice than they are at present, but wide differences still exist.

When the methods or results attained by one nation or people in commercial or industrial affairs differ with those of another, we usually attribute the difference to conditions affected by the cost of labor and material—that is, to the laws of supply and demand. These relative conditions, however, do not fully account for the difference in results in the field of modern reinforced-concrete construction. The principal reasons for the marked superiority in the scientifically economical and esthetically beautiful results which European engineers have to their credit may be found by analyzing the European work with respect to the scientific, esthetic, and economic elements involved.

178. The Scientific Element.—Scientific differences are due principally to the more thorough technical training of the European engineer and to the painstaking scientific investigations, researches, tests, and experimental work by government institutions, the results of which are at the engineer's disposal. These conditions lead to a superior knowledge of the properties of materials and the laws of design, and to the rational use and application of concrete and reinforced concrete. The definite knowledge of the qualities of the materials assures a greater confidence in them and has led within recent years to the European tendency toward the adoption of those light, bold, open forms of the steel arch in concrete design, rather than the massive, heavy masonry forms. This fact, no doubt, accounts for the original introduction and present widespread use of those types which, from the American viewpoint, appear daring and reckless. The position of the European engineers, however, is based upon their superior knowledge and experience in reinforced-concrete design, and is comparable with the position of the American engineers with respect to the design and construction of those types of steel bridges of which the European engineers have never fully approved.

Following the Austrian experiments,¹ which furnished the knowledge that the elastic theory could be confidently applied to reinforced-concrete arches, European engineers directed their attention toward the simplification of the design of the structural system, both in theory and practice. This has resulted in the development and introduction of many new features and devices. These, together with the Austrian experiments, may be considered as the pioneer work of reinforced-concrete construction—the breaking of the trail for others to follow.

The examination and study of many concrete bridges throughout the Continent and Great Britain has disclosed many novel features and interesting methods and devices, both in design and construction. All of these originated in Europe and are now preferred practice there. Some of them are well known, more or less, to American practice; others are comparatively of limited use; while others are still entirely unknown. The European features of design and construction which pertain to the scientific element are listed below and will be considered in the order given:

¹ A comprehensive series of experiments by the Austrian Society of Engineers and Architects in 1890 on arches of various materials, including brick, stone, concrete, and reinforced concrete, with spans ranging from 4.5 ft. to 75 ft. These experiments were carefully made under the supervision of some of the most eminent European engineers and architects. Their report, published in 1895, is the most valuable contribution to the theory and practice of reinforced-concrete construction that has ever been made, and its far-reaching effect is felt to this day. These tests of arches disclosed the fact that the *calculated* elastic deflection corresponds with the *actual* deflection, thus establishing the applicability of the *theory of the elastic arch* to arches of reinforced concrete.

- (a) Theory.
- (b) Hinge construction (related also to the economic element).
- (c) "Free-ring" construction (related also to esthetic and economic elements).
- (d) Cellular construction (related also to esthetic and economic elements).
- (e) "Unit" or subdivided erection—that is, dividing the arch ring or rib into blocks or voussoirs (related also to economic element).
- (f) Bowstring girders (or trusses) and open-web (cored) girders (related also to esthetic and economic elements).
- (g) Special construction features:
 - Rigidity and connections of reinforcement.
 - Temperature influence and compensating devices.
 - Drainage and waterproofing.
 - Bearings.
- (h) Special falsework and erection features.
- (i) Tests.

(a) *Theory*.—Following the Austrian experiments, the wide application of the theory of elasticity in reinforced-concrete construction led various authors to develop simplified methods of solving the three equations of elasticity.

Among the principal methods used for the solution of an elastic arch of any form by foreign engineers, may be mentioned the graphical method of Prof. Eddy, subsequently developed by Prof. Cain, and the analytical methods of Mohr and Breese and other writers. Turneure and Maurer's analysis of the hingeless arch, making use of the constant "arch magnitudes", $\frac{\delta s}{I}$, originally pointed out by Schönhöfer (*Oesterr. Wochenschrift für den öffentl. Baudienst*, Heft 14, 1904) is also used extensively, especially in Great Britain.

The simple German method is extensively used for parabolic, circular, and segmental arches. Professor Mörsch's simple method of computation is largely used, as is also that originated by Professor Melan. The latter was employed in the design of the Montbenon-Chauderon bridge at Lausanne (Fig. 479). In all cases the check calculations are the reverse of the method used for design—that is, an analytical check is given if the first investigation is graphical, and *vice versa*.

(b) *Hinge Construction* (Refer also to Chapter XXXVII "Hinges of Arched Concrete Bridges").—The use of hinges in connection with stone masonry arches was already known in Europe prior to concrete arch construction. This experience in hinge construction afforded the European engineers a preliminary training—a stepping stone—in their advance from the older, massive, stone, hinged type to the newer, lighter, open, hinged structures of reinforced concrete. Naturally, in

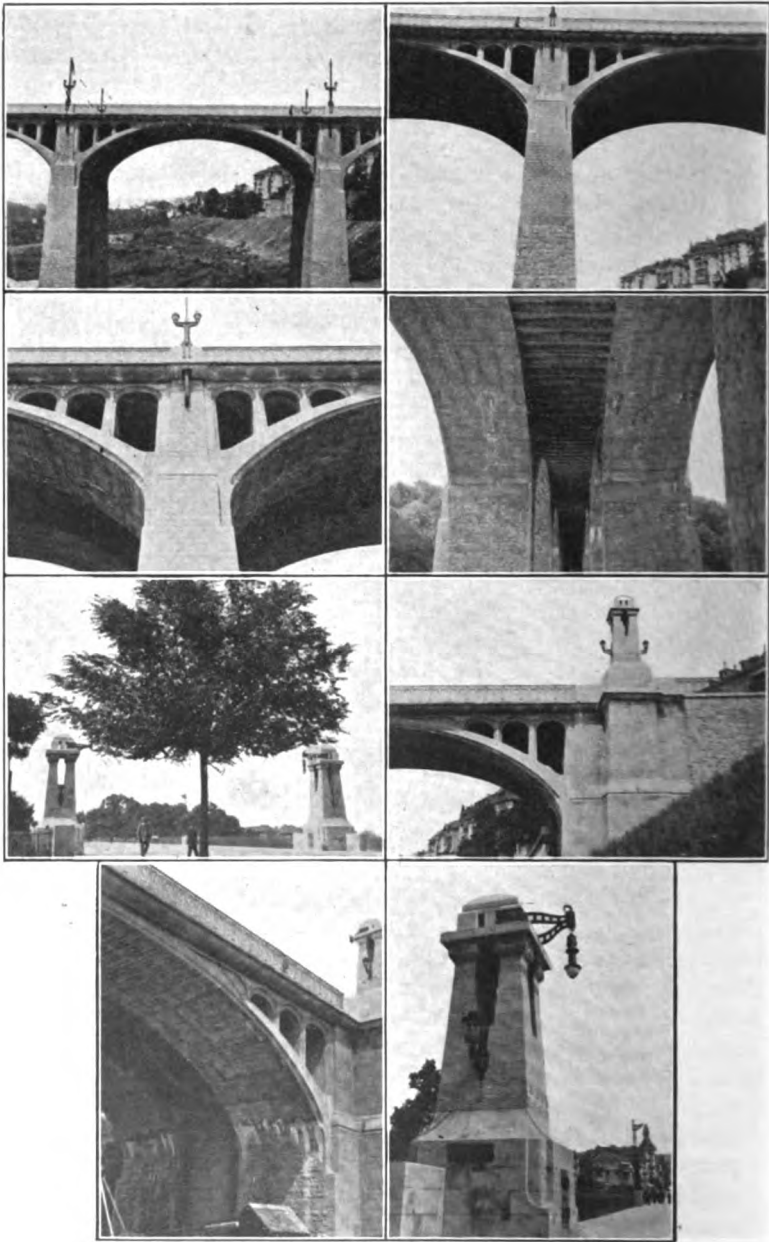

FIG. 479.—Montbenon-Chauderon bridge, Lausanne, Switzerland.
(Terminal pylons of stone.)

their first hinge applications in the newer materials, they desired to follow, as far as possible, those beaten paths which had led them to success in the old. Consequently, the first concrete hinged arches were of the solid spandrel type and were not monolithic structures, for the arches were built of pre-cast concrete blocks or voussoirs varying from 2 ft. to 5 ft. in length, these being treated just as if they were of stone. Three hinges were preferred, as it was the safer practice, in that it enabled the stresses to be determined more definitely (without recourse to the theory of elasticity), and also avoided the serious effects of any slight yielding of abutments. This was simply the application of the older and better known methods to the newer and comparatively unknown material. Some of the most important bridges constructed between 1890 and 1900 were built in this manner. The monolithic concrete fixed arch succeeded the voussoir hinged structure, after which the application of hinges to the former logically followed.

A hinged concrete arch was built in Germany as early as 1873. It was not until 1906—33 years afterward—that the 90-ft. three-hinged concrete arch was built in Brookside Park, Cleveland, Ohio—the first in North America. The advantages of hinged construction have never been properly appreciated in the United States; in fact, there appears to be prejudice or lack of confidence here in such construction and its use is now comparatively limited—and even looked upon with distrust by many. This, partially at least, is due to the fact that no hinged stone masonry bridges have ever been built in the United States, and consequently the American engineer has never enjoyed the European advantage gained by contact and experience with such construction, and hence his progress and advance have been beset with more doubt and difficulty, and confidence and progress have been somewhat retarded.

In addition to this, the failure some years ago of the Maximilian bridge at Munich, Germany (a three-hinged voussoir masonry structure of two 144-ft. spans) during construction, with the unfavorable comments of the technical press upon hinged construction, did much to strengthen American prejudice and discourage progress in hinged construction; although this accident involved no constructive principle whatever—in theory or practice—being due entirely to faulty design and erection.

Fortunately, soon afterward, over the same stream and within gunshot of this accident, the great three-hinged Grünwald bridge with its two 230-ft. record-breaking concrete spans was successfully completed. The time, the place, and the circumstances which marked its completion—the world's mightiest three-hinged concrete structure—formed no small factor in counteracting the prejudice produced by the Maximilian accident—and through it, confidence was largely restored in hinged concrete construction throughout the Continent. There are

many forms and features of hinges and hinged construction which have never been introduced into American concrete practice at all. The subject is so important that Chapter XXXVII has been devoted exclusively to it. It will only be necessary, therefore, to refer briefly to same here. The various types of hinges which have been introduced in European concrete bridge construction comprise:

Stone and concrete hinges which represent the *rolling* type.

Lead and asphalt plate hinges which represent the *quasi-rolling* type.

Iron or steel hinges of the *rolling*, the *revolving*, or the *flexural* type.

The stone (rolling) and the lead and asphalt (quasi-rolling) hinges are almost unknown in American concrete bridge construction, and the flexural type entirely so.

Concrete hinges (rolling) have been used here to a very limited extent—there being only several cases and these are not very important structures. Hinges of steel or iron (rolling or revolving) are about the only ones used by American engineers thus far.

The flexible or semi-hinge of steel is peculiar to structures of reinforced concrete and has been used only by French engineers in France and England. (See Figs. 568, 569, 570, 571, 574, and 575.) This type has proved superior to any other form of hinge, both in service and cost.

The use of hinges and hinged construction of any type in connection with concrete-bridge construction is still in its infancy in the United States, although it is one of the most important features or devices which has ever been introduced in concrete-bridge construction. When we come to fully realize and appreciate the extensive use of this important scientific feature throughout Europe and Great Britain, with its combined scientific and economic advantages and sweeping possibilities which we see represented and realized in so many magnificent foreign examples, it is hard to understand how such a device, so far-reaching in result, can be so largely ignored by the American engineer who usually is so energetic and so alert to seek out and find improvements in methods, especially those of scientific and economic value.

The use of hinges has made possible many arched structures in reinforced concrete, in cases where foundation conditions would have rendered them altogether impracticable and unsafe but for the hinges. Such sites, without the use of hinges, would necessarily have been surrendered to the steel structure of the girder or truss type, thereby sacrificing esthetic possibilities and durability.

(c) "*Free-ring*" Construction.—Free-ring construction is another advance in simplification of the structural system of the arch, and is second only to hinges in importance. By means of this type of construction the weight of the roadway and its loading are transmitted directly to the arch ring or rib through independent spandrel columns or walls of concrete, except perhaps near the crown where the roadway in many cases rests directly upon the arch ring.

The many disadvantages and difficulties associated with the old solid spandrel form (due to heavy loads, pressures, and settlements of spandrel filling which often cause derangement of drainage systems, resulting in face discolorations, cracks, and even failures) are thus avoided, and the loading is fixed more definitely in both distribution and in amount.

Both the solid ring (or barrel) and the ribbed type of free-ring construction are much used in Europe, although the latter is preferred at present. The enormous combined advantages arising from the scientific, esthetic, and economic considerations of this type have been recognized and used with telling effect throughout the Continent and in England, and now predominate all others.

With the elimination of unnecessary spandrel dead load (filling, solid spandrels, etc.), it became possible to greatly reduce foundation loads, stresses, and sectional areas, and thereby obtain a weight reduction of

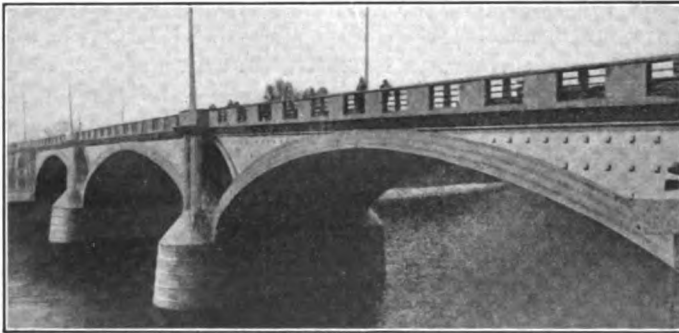

FIG. 480.—Stvanice Island bridge at Prague.

the arch itself, which in turn permitted a great increase in span length. The use of the ribbed type still further reduced the weight of the arch and has simplified the structural system. Probably the most important advantage scientifically is that the ribbed arch affords a means toward a more careful and accurate disposition of the material to secure maximum efficiency.

The hinged, open-spandrel, ribbed type is the simplest and most advanced structural system yet devised in reinforced-concrete bridge construction.

There is still another form of construction found in Europe which may be designated as a combination, solid-open-spandrel type. The Stvanice Island bridge at Prague is an example of this. (See Fig. 480.) In this type the spandrel facewalls are solid with the exception of intervening arches (*voutes d'élégissement*) located over the piers, with a

view to lightening the structure above the piers and adding to its decorative appearance.

From the American viewpoint, the modern European concrete bridge is most striking on account of its lightness in comparison with the American structure. The difference is so great that the observer who has familiarized himself with the practice on both continents naturally asks—Has scientific design been disregarded on both continents resulting in structural weakness on one side and in an excessive use of material on the other?

The answer lies in the causes mentioned above—that is, greater confidence in the material resulting from greater thoroughness in scientific methods of testing, proportioning, mixing of materials, and workmanship, and also especially in the rigidity of reinforcement and the thoroughness of its connections combined with careful scientific design and the placing of material to attain its greatest efficiency.

These, with the further enormous advantage that such work in field and office is in the hands of skilled specialists exclusively, are the reasons for European superiority in reinforced concrete. To similar reasons may be attributed American superiority and confidence in steel construction.

(d) *Cellular Construction.*—Cellular construction is another popular and important feature in European design of concrete bridges, and, in some form or other, is found in nearly every structure built within recent years. It not only possesses strong scientific advantages but it also affords an important means in the attainment of esthetic and economic results. To some extent cellular construction has been used in connection with stone masonry, but only to an insignificant extent as compared to that attained in reinforced concrete. The very nature of masonry construction opposes its use, for strength and massiveness in stone masonry are synonymous and inseparable.

The facility with which concrete, and especially reinforced concrete, can be substantially built in comparatively thin walls, slabs, and masses makes cellular construction possible. In no class of construction is it so peculiarly adapted as in bridge construction, where it has added another potent scientific means of simplifying the structural system, the reduction of weight, and the placing of material to secure maximum efficiency.

The present day practice does not limit its use to any single portion or type of foreign concrete bridge. We find it in superstructures as well as in substructures, in beams, columns, or arches, balustrades and pylons. The European concrete bridge practically begins and ends with cellular construction.

Open and closed (spandrel walls enclosing hollow interiors) spandrels are nothing more than cellular construction, although the latter is solid in appearance. The world's largest concrete arch—the great 328-ft. Tiber River bridge at Rome (Figs. 481, 482, and 483)—is merely a large

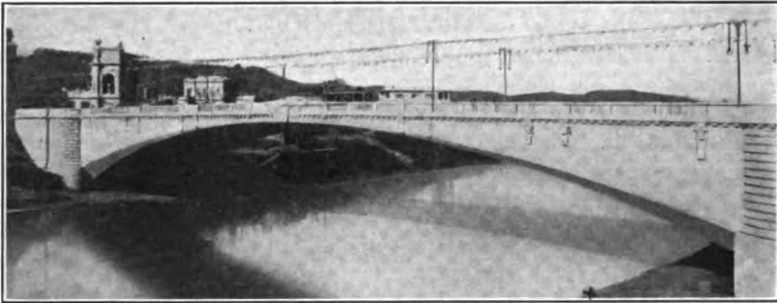
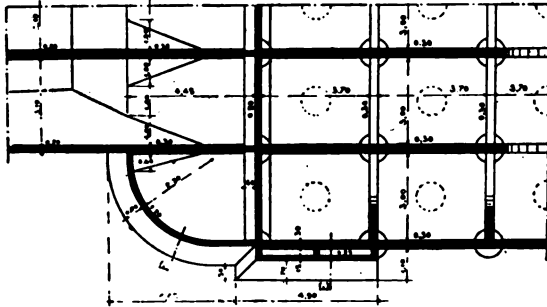

FIG. 481.—Tiber bridge at Rome, Italy.

COUPE HORIZONTALE DE L'ARC ET D'UNE CULEE



COUPE HORIZONTALE A LA BASE D'UNE CULEE

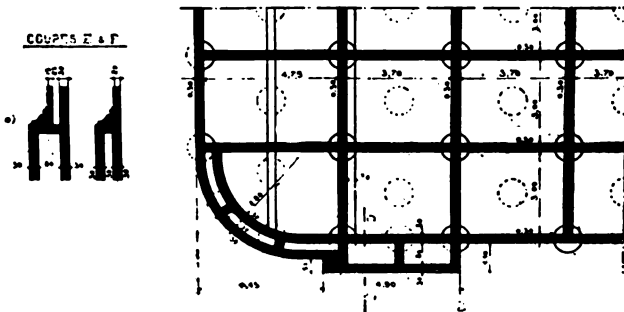

FIG. 482.—Tiber bridge at Rome, Italy. (Horizontal section through base of abutment.)

hingeless arch-shaped, subdivided cellular box, formed by its arch-barrel, spandrel walls, roadway-slab, and abutments. This structure is of the closed (hollow), non-filled, spandrel type. The scientific application of cellular construction on a large scale alone made this structure possible in reinforced concrete. In fact such construction has entered into its design so extensively that an eminent French engineer stated that it was built of "three parts air to one part reinforced concrete." It is not only noted throughout the world for the slenderness of its members and length of span, but also because of its so-called *floating foundation*.

(e) "*Unit*" or *Subdivided Erection*.—Subdivided erection is another expedient originally introduced and used extensively in European

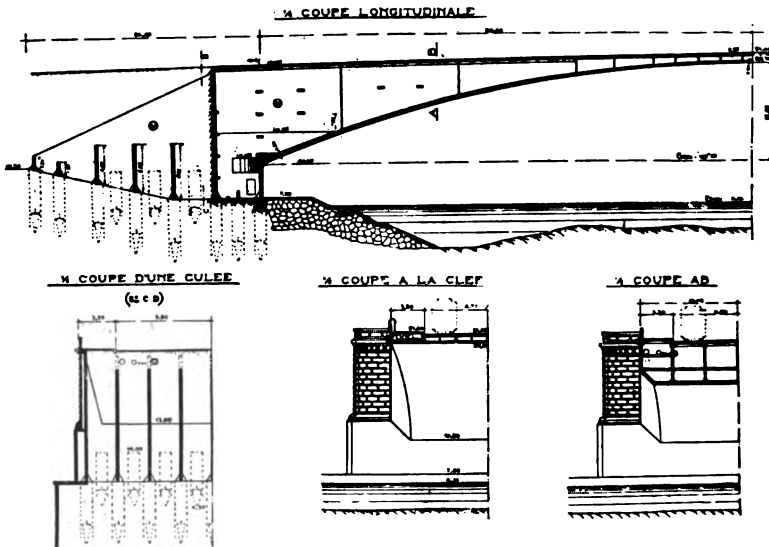

FIG. 483.—Tiber bridge at Rome, Italy. (Abutment section, section at crown, and section A-B. Note compressol piles.)

construction, in order to avoid internal stress in the arch ring or rib arising from deformation of the centering by settlements, shrinkage, etc. Since such troubles cannot be avoided, even with the best of workmanship, the only alternative was to render them harmless as far as possible. This has been done by dividing the arch ring or rib into a number of units (blocks or voussoirs) and placing these at symmetrical points of the arch simultaneously in order to produce uniform symmetrical deflection of the centering; thus providing at various points between the units, a number of temporary hinge points which are finally closed simultaneously.

This practice has been used in stone arch construction by European engineers for many years. It is considered there not only as a safeguard against injury and accident, but as a means of securing accuracy of the intrados curvature as well. This practice also avoids the old, time-consuming, awkward method of placing temporary load at the crown and at other points of the centering.

Continuous or monolithic construction of arch rings and ribs has passed out of European practice, even in short spans. In fact, experience has shown that such construction was responsible for so much harm that in recent specifications it has been prohibited. "Unit" erection is not only required, but the exact procedure and sequence is laid down in the specification by special diagrams, and such information is repeated on every drawing which affords an opportunity. Illustrations of this may be found in a number of important structures shown in the following pages. It is a matter of regret that American construction should be deprived so extensively of such a simple and effective safety expedient which is so sound in principle and practice, especially after years of precedent and success in many structures in many lands. Yet we still find many American specifications containing such clauses as "The arch ring must be deposited in one monolithic mass, by continuous work, night and day if necessary" (extract from a recent specification). When long and heavy arches rendered this "continuous work" impracticable, the "monolithic mass" is still considered so important that the arch barrel, ring, or rib is divided into *longitudinal* sections of such widths "that each section (longitudinal) will constitute a day's continuous work," the "days" often being 24 hours long. The failure to recognize and apply this important and sound expedient has been responsible for more troubles (such as cracks and even failures arising from irregular deformation and settlement of centering) than any other cause.

Subdivided or "unit" erection is far more important to American construction than to European, for in the former the greater capacity and superiority of plant equipment, transportation, and machinery enables the concrete load to be deposited upon the centering far more rapidly than it is in Europe, and hence the centering is given less time to accommodate or adjust itself to its load at this most critical stage of its service.

(f) *Bowstring and Open-web (Cored) Girders*.—Many engineers have considered the trussed- or bowstring-girder type in reinforced concrete to be a somewhat questionable type of construction, on account of the greater difficulty in constructing the forms, in depositing the concrete, and in making connections in the reinforcement; and also because some members are subjected to direct tensile stress. Notwithstanding these disadvantages, however, there are many cases where such types are more economical than solid webbed girders, and many fine examples

of successful applications of these types are found throughout Europe. They, of course, are never preferred to the arch, and their use is limited to those cases where conditions make arch construction impracticable on account of limited underclearance over waterways, highways, or railways, or where unstable foundation conditions exist.



FIG. 484.—Bowstring truss over railway tracks, Friedrichsfeld, Germany.

In such cases, but for the bowstring- and girder-type structures, it would be necessary for concrete to give way to steel structures. Over the railway between Heidelberg and Mannheim, Germany (Fig. 484) a beautiful example of the bowstring type has recently been completed

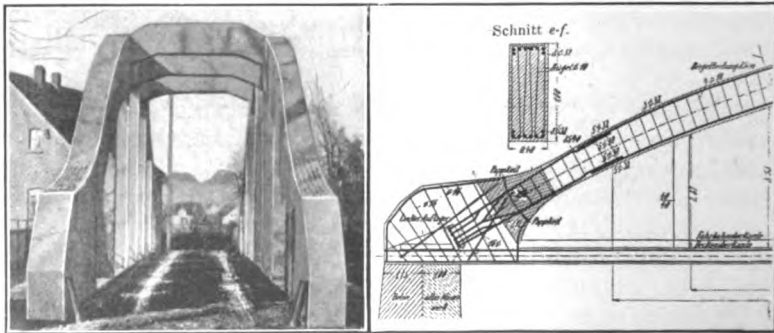

From "Handbuch für Eisenbetonbau."

FIG. 485.—Highway bridge over the Werle near Salzuflen.

and is an unusually well-designed and graceful structure, although located in a rural neighborhood, at a railway junction.

The street bridge over the Werle near Salzuflen in Lippe is an interesting and unusual type. It is one of the few "hinged" bowstring struc-

tures which have been built (Fig. 485). This arch structure with suspended roadway was selected on account of the limited clearance between roadway and water level. Span 28.0 m. (= 92 ft.), rise 4.6 m. (= 15.1 ft.). The clear distance between arched trusses is 2.80 m. (= 9.2 ft.). There is a cantilevered sidewalk on either side of 90 cm. (= 35.4 in.).

The static system is that of a pair of two-hinged arches, with hangers and tie members, which latter also serve as roadway stringers.

The truss is of hooped reinforced concrete; the bottom chord (tie member) is composed of steel channels. Transverse struts are used to brace the top chord as shown.

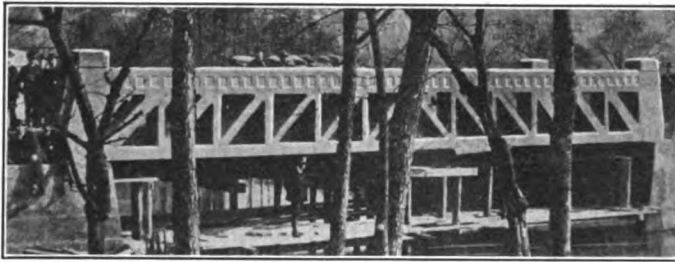

From "Handbuch für Eisenbetonbau."

FIG. 486.—Street bridge in Walding near Lintz, Upper Austria.

The open-web (or cored) girder is frequently used on account of its open and more attractive form, and also on account of its economy. When length and weight of the girders are such that they can be handled with facility and without the use of machinery, a considerable saving in

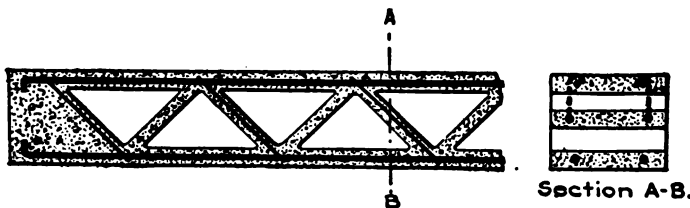

FIG. 486A.—Visintini system.

falsework results by pre-casting the girders and then placing them in their final positions, as is done in the case of steel girders.

The highway bridge in Walding near Lintz (upper Austria) is an example (Fig. 486). This is a through-structure of the Visintini type (Fig. 486A). The compression members (top chords, end posts, and end panel struts) are very massive compared with the tension members. The injurious effect of the usual secondary stresses has been obviated by the massiveness of the upper chord.

(g) *Special Construction Features.*—Rigidity and Connections of Reinforcement.—A number of interesting and valuable features of European practice have been noted by inspecting work in progress, by studying original designs, and by reading many of the contributions to the foreign technical press. Rigid connections of the reinforcement appear to be the most distinguishing feature of foreign construction (especially in Germany, Belgium, and Holland), and European practice is far in advance of American practice in this regard. The rigidity or thorough connections of the reinforcement in some structures is such that the complete skeleton erection of same precedes the form construction and the placing of the concrete. This enables the reinforcement to be more accurately placed and connected without the usual interference of the form work. The Rotterdam electric railway viaduct (Fig. 487) was built to a large extent in this way.

Temperature Influence and Compensating Devices.—Much investigation and attention has been devoted to the influence of temperature on completed concrete bridges of both the hingeless and the fixed types. Such tests, covering long periods, are now being extensively made.

It is well known that the influence of heat upon large sectional areas is less than upon smaller areas. The low conductivity of concrete is a quality which has not been taken sufficiently into consideration. A concrete bridge is heated principally on its exterior surfaces. On account of the low conductivity of the concrete this heating does not apply to the whole body and the lower interior temperatures are changed but little, if any; hence the steel, which is a good conductor, may not be affected at all.*

In view of the low conductivity of concrete a rise in temperature of more than 30° C. in a long arch ring or floor-slab, with its surface mostly shaded against the sun or covered by filling or pavement, appears very improbable. A number of recent experiments upon arch bridges have confirmed the small influence of heat on the deformation of the arch.

German engineers recommend for computation, a temperature variation of from:

- 25° C. to -15° C. (40° C.) for arches 8 in. in thickness.
- 22° C. to -12° C. (34° C.) for arches 20 in. in thickness.
- 17° C. to -7° C. (24° C.) for arches 40 in. in thickness.

It will be of interest to refer to an American example, the Walnut Lane bridge in Philadelphia, as an illustration. Measurements by electric thermometers between August, 1908 and May, 1909 have shown a maximum fluctuation of 24° C. in the temperature of the concrete,

* *Referenc:* "Handbuch für Eisenbetonbau," 2. neubearbeitete Auflage, Band VI. Copyright, 1911, by Wilhelm Ernst & Sohn, Verlag, Berlin.

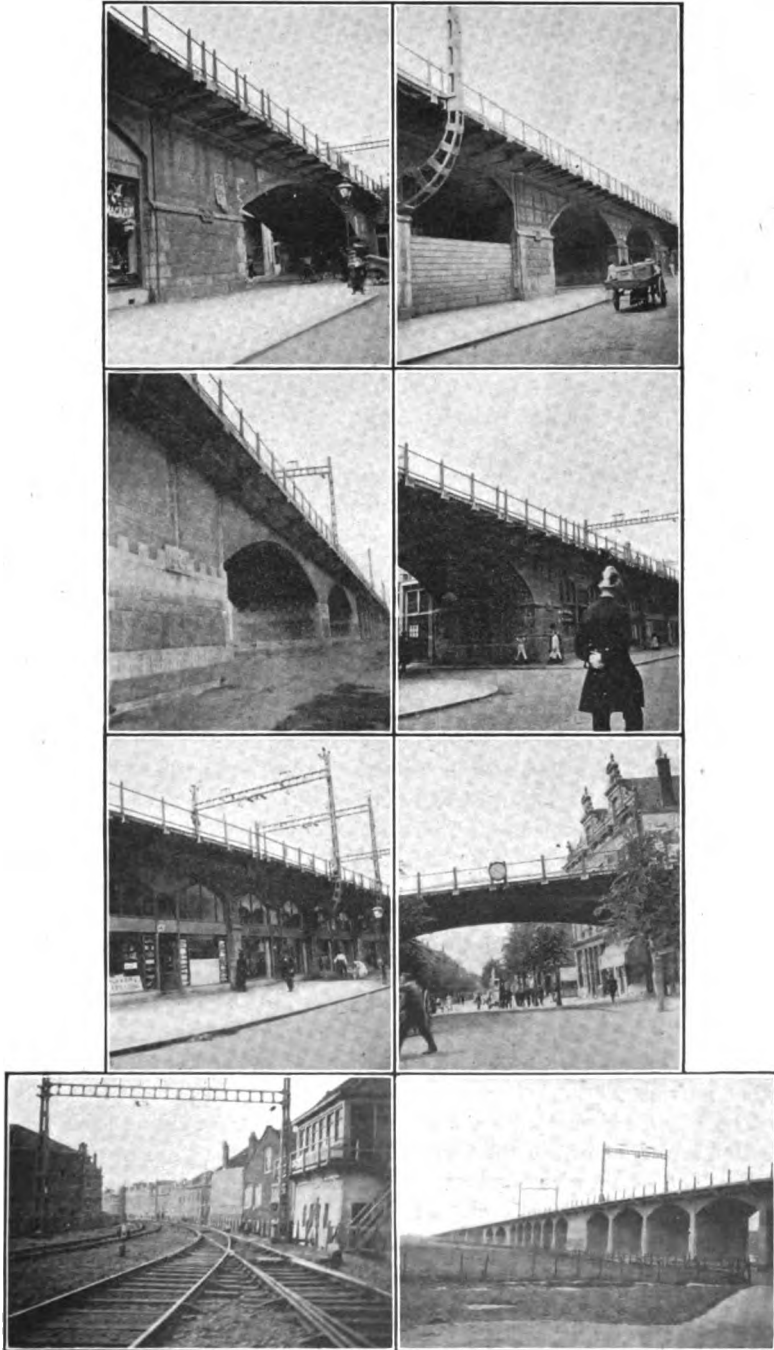

FIG. 487.—Rotterdam viaduct, Holland. (Combination stone and concrete.)

while the outside temperature between these dates varied by 52° C.; furthermore, the greatest rise of the arch crown, as actually measured, agreed fairly well with the value computed for the variation of 24° C. A variation of 40° C. between extreme temperatures of concrete has been recommended by the Committee on Reinforced Concrete of the Austrian Engineers and Architects Society. The Swiss regulations provide for a total variation of temperature in the concrete of 35° C.

In order to guard against the influence of temperature variations and to prevent injury to completed structures, compensation or expansion joints are provided, at which joints changes in length can be compensated without excessive stresses and injury.

The high temperatures of the middle of the day followed by the lower temperatures of the night are not so serious as are the long spells of continued cold weather which always cause cracks unless properly provided against.

European structures are remarkably free from temperature and shrinkage cracks, due to the fact that suitable and positive provision is always made for same. The idea held by some that an expansion joint is something which should be concealed is not entertained by the foreign engineers for in almost every structure such expedients are found in full view. It is recognized that expansion joints have an important duty to perform, a purpose to fulfill, and the location and construction of the joints are such as to make their purpose evident.

Bridges are subject to the free play of air currents and the rays of the sun which cause greater and increased shrinkage. The provision of compensation joints against shrinkage cracks is considered of as much or even more importance than for temperature variation. Reinforced concrete is usually richer in cement than plain concrete and hence shrinkage in the former is greater. This, fortunately, is counteracted by the reinforcement which serves to moderate and equalize same—a function in itself which would amply justify the use of steel. In balustrades and parapets especially, compensation joints are essential, not only on account of their exposed location above the roadway, but also on account of their relatively smaller sectional areas and richer concrete. Thus, such portions of the structure are subjected to greater temperature and shrinkage movements than the other portions.*

The European recognition and thoroughness of providing such protection is well shown in the following illustrations:

Fig. 488—Langwies viaduct, the expansion joint is seen entirely through the structure at a distance of 500 ft. away.

Fig. 489—Expansion joints in balustrade of the New Neckar bridge at Heidelberg.

* *Reference:* "Handbuch für Eisenbetonbau," 2. neubearbeitete Auflage, Band VI. Copyright, 1911, by Wilhelm Ernst & Sohn, Verlag, Berlin.

Fig. 490—Halen bridge balustrade joints.

Fig. 491—Reinforced-concrete trestle in Paris, where double columns are provided solely for the sake of affording an effective means of compensation.

With three-hinged arches, temperature influences do not affect the arch proper injuriously, since the hinges themselves afford an ideal

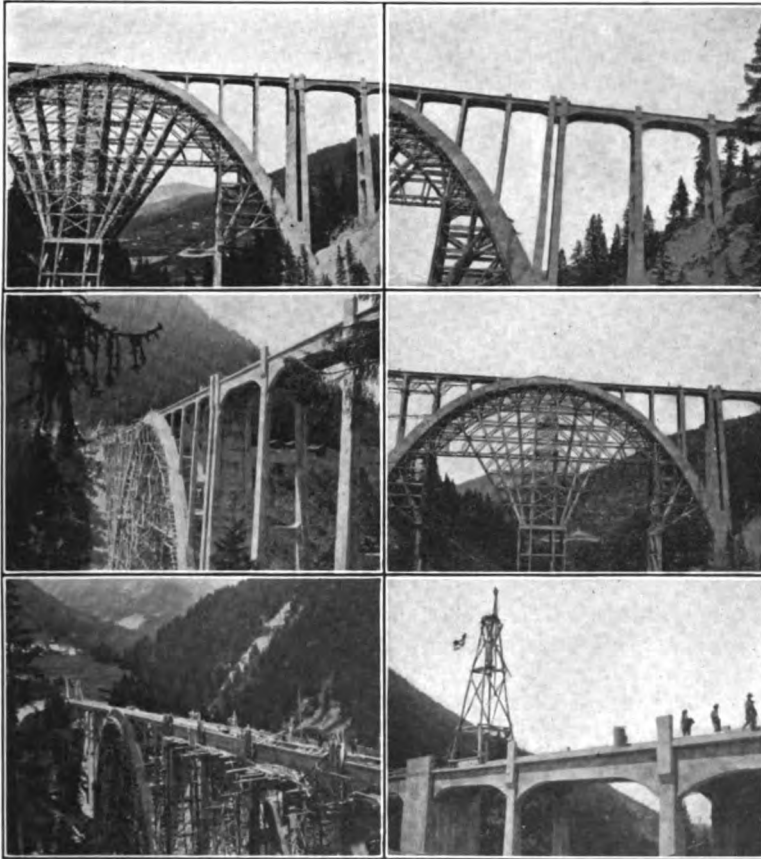

FIG. 488.—Langweis viaduct, Switzerland. Chur-Arosa Electric Line. 314.92-ft. span. (Note reinforced-concrete framework for falsework support. Approach spans 48.2 ft.)

means for compensation. In fact, this advantage alone justifies the use of hinged construction. It must be remembered, however, that while the hinges protect the arch, they do not protect the superstructure above—and their presence really makes such protection there more necessary even than in hingeless arches. Injury to the superstructure

by the arch movements is eliminated by provision of expansion joints from the arch up through the spandrels, roadway, and balustrades.

Fig. 492 shows the thorough manner in which this has been effected in the New Neckar bridge at Mannheim by German engineers.

Drainage and Waterproofing.*—Much attention has been given to the safeguarding of concrete structures against damage by water. The first consideration, of course, should always be a good drainage system. In addition to proper and adequate drainage of the roadway surface, further precautions are necessary to protect interior surfaces and masses of concrete from seepage water. This is attempted by means of various methods of waterproofing.

Concrete is not water-tight, but pervious—somewhat similar to a very fine sieve—and possesses the property of capillary attraction to a

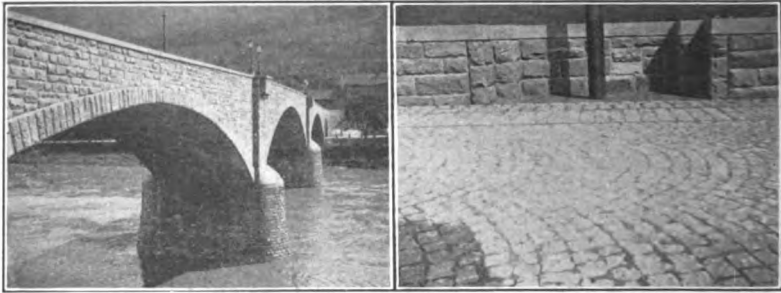

FIG. 489.—New Neckar bridge at Heidelberg, Germany.

remarkable degree. Perviousness depends largely on the amount of cement contained. The richer the concrete, the less pervious it becomes. It is particularly important to waterproof concrete structures which are reinforced in order to protect the steel reinforcement against water or even dampness, and it is usual to embed same in mortar somewhat richer than that in the general mass of the work. Another means of protection is the application of a cement-mortar plaster on the exterior surface of the mass or member. Various waterproof preparations are substituted frequently for this—with more or less success. The greatest disadvantages of the otherwise satisfactory cement-mortar coating arises from its richness in cement causing it to shrink, crack, and scale when exposed. Cracks also result from the movement of the structure itself due to temperature and vibration. Hence the unsatisfactory results obtained from cement-mortar waterproof coatings led to the use of other tougher and more elastic coverings for the exclusion of water and dampness. The most important of these in use at the present time in foreign practice (with average cost) are the following:

* *Reference:* "Handbuch für Eisenbetonbau," 2. neubearbeitete Auflage, Band VI. Copyright, 1911, by Wilhelm Ernst & Sohn, Verlag, Berlin.

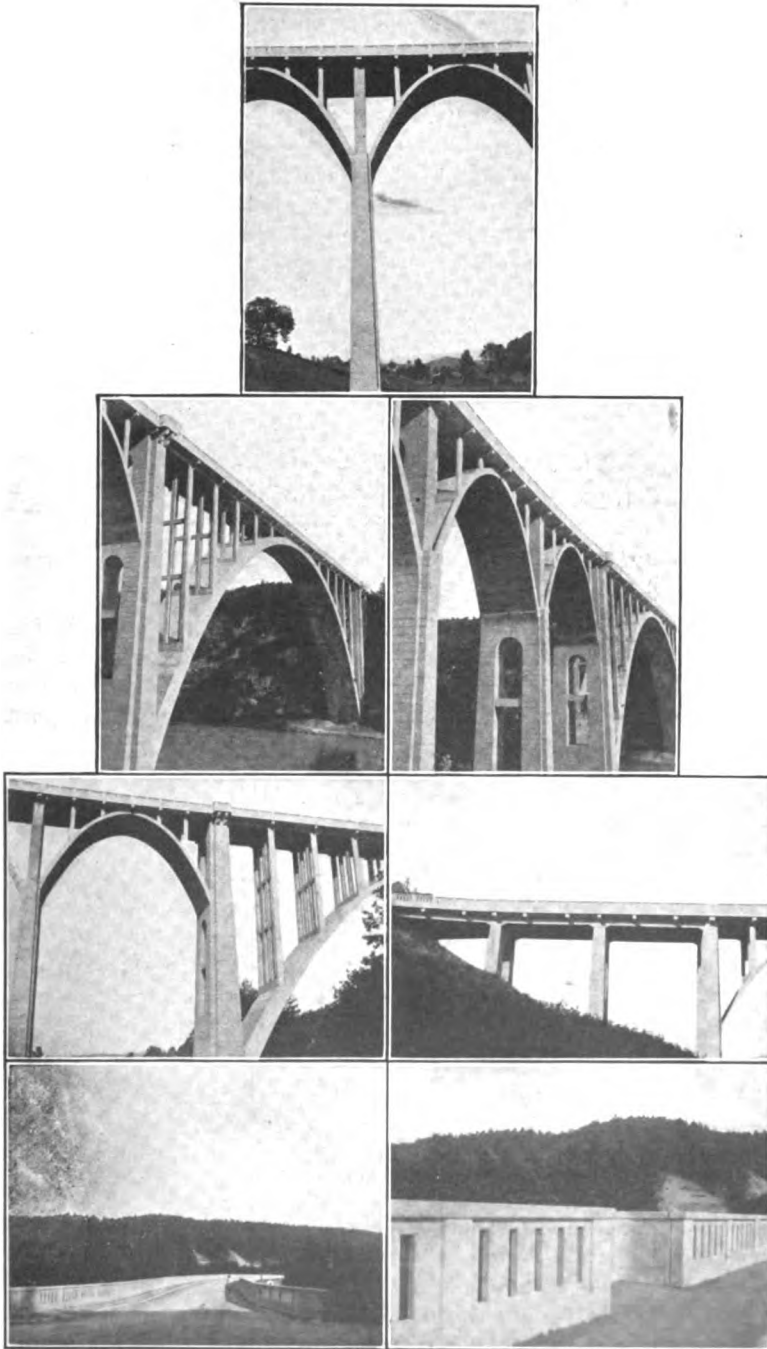

FIG. 490.—Halen bridge, Berne, Switzerland. (Note concrete block facing at piers. Gravel finish. Main span, 285.92 ft. Approach spans, 3-32.8-ft. girders.)

1. Two applications of hot tar or an asphalt preparation (asphalt dissolved in oil), applied cold or hot, is considered the cheapest and simplest. Cost 20 cents per square yard.

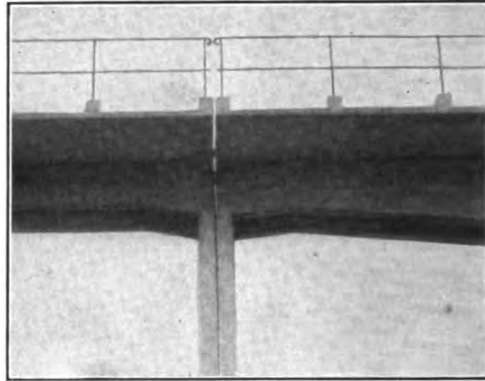

FIG. 491.—Reinforced-concrete trestle, electric plant, Paris. (Note expansion joint.)

2. The application of one thickness of burlap covered on both sides with hot tar. This method is found especially adapted to steep sloping or vertical surfaces, where No. 1 would not prove satisfactory on account of slipping under its weight. Cost 25 cents per square yard.



FIG. 492.—New Neckar bridge, Mannheim, Germany. (Note hinge and expansion joint through spandrel and balustrade. Also note building under arch containing apparatus for experiments.)

3. The application of a double layer of burlap coated with hot tar above, below, and between the layers. This affords better protection than No 2. Cost 36 cents per square yard.

4. The application of a single thickness of asphalt felt (felt saturated with asphalt). This is made from flax and wool fiber in thicknesses of

approximately $\frac{3}{8}$ in. It is preferable for light grades, while Nos. 2 and 3 are best for heavy grades or vertical surfaces. Cost 28 cents per square yard.

5. The application of a double thickness of asphalt felt, of approximately $\frac{1}{2}$ in. in thickness of unsanded asphalt roofing paper less than $\frac{1}{8}$ in. in thickness. It has been found that this adheres to the concrete surface much better than felt, but is inferior to it in strength and toughness. Cost 25 cents per square yard.

6. The application of a double thickness of unsanded asphalt paper.

7. The application of "Siebel" plates. These consist of plates formed by alternate layers of thin sheet lead and asphalt-coated felt. These lead plates are stuck on the concrete surface and are joined (or more properly spliced together) by $2\frac{1}{2}$ -in. overlapping joints. The splice joints are made by separating the layers of felt and lead for $2\frac{1}{2}$ in. back from the edges, then the layers of adjacent plates (likewise sepa-



FIG. 493.*

FIG. 494.*

FIG. 495.*

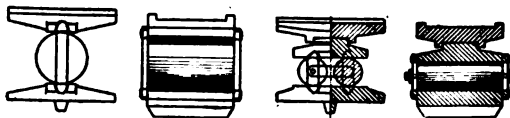

FIG. 496.*

FIG. 497.*

rated) are passed between one another and closed down tightly. In this way a continuous covering is afforded which is both durable and absolutely waterproof. Cost 75 cents to \$1.25 per square yard.

Bearings.—In all cases where no monolithic connection between a bridge girder and the supporting abutments or piers is intended, the transmission of the bridge loads to the foundation has been accomplished by *bearings*. In addition to transmitting the vertical forces to the supports at the desired points, these bearings must also permit a rocking motion of the beam ends, corresponding to a deflection of the beams resulting from any loading. In long bridges they must also provide for a horizontal movement of the beam ends resulting from temperature changes.

Where no provision for expansion has to be made, the bearings may be designed as *rockers* (Figs. 493 and 494). The contact surfaces in such bearings are either cylindrical (Fig. 493) or spherical (Fig. 494) in order to transmit the reactions exactly at right angles to the abutments and at fixed locations. This type of bearing is essential with small

*From "Handbuch für Eisenbetonbau."

The dimensions of the bed-plate bearings on the abutment, as well as the dimensions of the bearing on the underside of the girder end, follow from the permissible unit pressure upon the masonry—say about 350 lb. per square inch—and from the value of the bending moment, taking as the allowable extreme fiber stress about 3500 lb. per square inch for cast iron and 14,000 lb. for cast steel.

The number and the diameter of the rollers are to be taken so that the pressure (p) in kg. for 1 cm. of each roller length does not exceed $45d$, where d is the roller diameter in centimeters—or, expressed in units of pounds and inches, the pressure (p_1) in lb. for 1 in. of each roller length does not exceed $640d_1$, where d_1 is the roller diameter in inches.

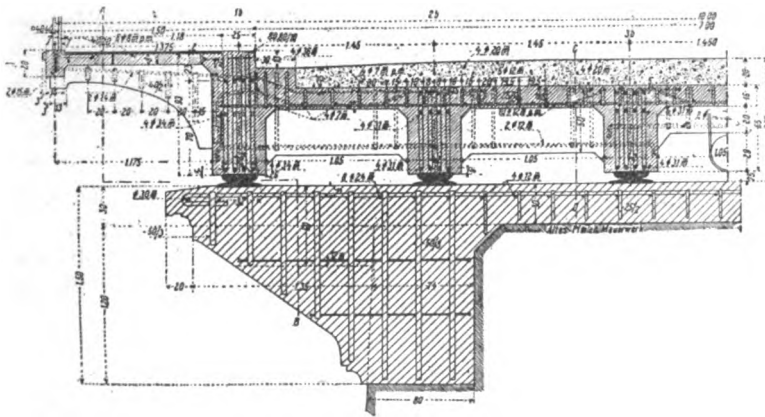

From "Handbuch für Eisenbetonbau."
 FIG. 500.—Details of Montbrillant bridge, Lausanne, Switzerland. (Section over pier. Note double cantilevers to secure width of roadway.)

The Hertz-Weyrauch analysis (Hütte, XX Aufl., III Teil S. 438) furnishes for the stress in the pressure line

$$\sigma = 0.42 \sqrt{\frac{pE}{r}}$$

- where σ = stress per unit area.
- p = pressure per unit length of roller.
- E = coefficient of elasticity.
- r = radius of rollers.

The equation is homogeneous. σ is the stress per square centimeter when p , E , and r are given in the metric units, and σ is the stress per square inch when p , E , and r are given in pound and inch units.

Using the metric units and taking $p \leq 45d \leq 90r$

$$\sigma \leq 0.42 \sqrt{90 \times E} \leq 3.98 \sqrt{E}$$

$$E = 2,250,000 \text{ kg. per sq. cm.}$$

$$\sigma \leq 6000 \text{ kg. per sq. cm.}$$

Using the American units, $p_1 \leq 640d_1 \leq 1280r_1$

$$\sigma_1 \leq 0.42\sqrt{1280 \times E_1} \leq 15.026\sqrt{E_1}$$

$$E_1 = 32,000,000 \text{ lb. per sq. in.}$$

$$\sigma_1 = 85,000 \text{ lb. per sq. in.}$$

This stress may be considered as permissible, taking into account the fact that this compressive stress is limited to a very small area and that a lateral flow of the metal is impossible, also assuming that the best cast steel is used for plates and rollers.*

(h) *Special Falsework and Erection Features.*—The most striking feature connected with continental practice in falsework construction is the extensive use of round timber. It is truly a strange sight to an American engineer to see those forests of poles, branching out fan-like in all directions, supporting a long high concrete arch in construction.

The great Langwies arch (Fig. 488) is an example of this and it is said to be the largest centering ever constructed of round timber. (These photographs were taken in July, 1914.) The center pedestal is built of concrete to the hub of the timber fan.

While the use of round timber is extensive, it is not exclusive, for much sawed timber centering and combinations of both are used. The large use of poles is, of course, due to the scarcity and cost of lumber. Round poles are also used (tied together) in scaffold work for buildings, etc., thus avoiding damage to timber by bolts and spikes.

In this way such falsework, scaffolds, etc., become a portion of the contractor's plant. When sawed timber is used—especially for smaller spans—small sizes of a cheap merchantable grade are generally found.

Another marked feature observed in all falsework construction is the great care and skill used, both in its design and construction. In important structures of long, heavy spans the falsework design, framing, etc., is more nearly like American structural-steel practice than timber construction. The wooden members are detailed in the office, and the holes are bored and the framing done by templet before the falsework is assembled. The designs are so proportioned that all columns bear uniform compressive intensities and are computed as carefully, almost, as the columns of a building. Falsework settlements, distortions, etc., are reduced to a minimum by excellent workmanship in framing and by the reduction of cross-grain crushing of caps and sills at all post bearings. This reduction in cross-grain crushing is accomplished by using bearing pieces of hardwood, steel plates, or channels between posts, caps, and sills of such dimensions and thickness as to distribute the column loads within safe limits. Where there are several spans of varying lengths, the centering of the longer or main spans is so designed that same can be used in the adjacent spans, as it is taken down—that

* *Reference:* "Handbuch für Eisenbetonbau," 2. neubearbeitete Auflage, Band VI. Copyright 1911, by Wilhelm Ernst & Sohn, Verlag, Berlin.

is, the upper portions of the main-span centering (first removed) are designed for use in the lower portions of adjacent spans. Thus the operations of dismantling and erection are continuous and result in great saving in timber, time, and handling.

The European methods of field and office practice in laying out the work for framing and assembling are worthy of note. With arches of long radii, where it is impracticable to work from the centers of curvature (by radii), the field layout-plan is previously computed and prepared in the office to scale, using a system of coördinates, the origin usually being at the center of the long chord. From this plan the arch curvature is laid out on a nearby selected site by transit—using coördinates—the chord distances usually being approximately 2 meters in length (6.56 ft.). The points on the curve thus established are then connected by templates cut to proper curvature.

(i) *Tests.*—In most foreign countries—on the Continent, especially—no structure is accepted and paid for until it has been subjected to the prescribed governmental tests, which are usually very severe. These are carried out under the supervision of expert officers representing all concerned, and are carefully and methodically conducted and recorded. Such tests involve the application of rolling as well as quiescent loads.

In Germany and Austria usually three cases of loading are prescribed. For instance, in the Gemstal bridge, Austria (115-ft. arch), and in others illustrated in the following pages, the loading and procedure were as follows:

Case I Loading.—Steam roller over the crown and uniform load (95 lb. per square foot) on one-half of the bridge.

Case II Loading.—Steam roller over the crown and uniform load on the entire bridge.

Case III Loading.—Steam roller over the crown and uniform load on the middle third of the bridge.

Temperature readings were taken simultaneously, and the level readings corrected by the amount of the calculated temperature influence. The deflections were computed according to Müller-Breslau (*Neuere Methoden der Festigkeitslehre*, 3 Aufl., par. 17). Temperatures in the interior of the arch were read simultaneously with the reading of the apex movements, on thermometers placed into horizontal holes 20 in. deep and $1\frac{1}{4}$ in. diameter on both the up- and down-stream sides of the crown face with complete exclusion of the outer air from same during tests.

The French methods of final tests are made usually in conformity with the decree of the Minister of Public Works and often, in addition, special tests are required in the specifications of the structure in order to meet its particular service and conditions. Stationary and moving loads are also covered in the French tests. In Fig. 501 is a table

(original supplied by M. Hennebique, Paris) showing the system of recording the observed deformations of dead load tests upon the Chatellerault bridge over "La Vienne" (Fig. 502). This is an open-spandrel ribbed structure built entirely of reinforced concrete (Hennebique System). It has three arches, the two side arches having a span of 40 meters (131 ft.) and the central arch having a span of 50 meters (164 ft.). Ratio of rise to span of each arch = $\frac{1}{10}$.

Bridge of Chatellerault - Tests by dead load.
Table of observed deformations

Date and time of observations	Observations									
	1	2	3	4	5	6	7	8	9	10
A Thursday March 29 th 3 PM
B Friday 30 th 11 AM
C Friday 30 th 5 PM
D Saturday 31 st 9 AM
E Saturday 31 st 2 PM
F Saturday 31 st 6 PM
G Sunday April 1 st 9 AM Work interrupted at noon
H Monday 2 nd 9 AM
I Monday 2 nd 5 PM
J Tuesday 3 rd 1 PM
K Wednesday 4 th 9 AM
L Wednesday 4 th 11 AM
M Wednesday 4 th 2 PM
N Wednesday 4 th 6 PM
O Thursday 5 th 11 AM
P Thursday 5 th 2 PM
Q Thursday 5 th 6 PM

◆ Dotted spaces represent the loaded surfaces at time of observation.
◆ designate the position of fixed points.
Deformations are measured in millimeters, - for deflections, + for rises

FIG. 501.

The tests were made at two different times: (1) With stationary loads, using 600,000 lb. of sand; and (2) with moving loads, using one steam roller weighing 16 tons, two four-wheelers with two axles weighing 16 tons, and six two-wheeled vehicles with one axle weighing 8 tons.

The load in the vehicles consisted of cast iron. The vehicles were formed in two lines—one line composed of one steam roller of 16 tons

and four vehicles of 8 tons, and the other line composed of the two vehicles of 16 tons and two of 8 tons.

The maximum deflections allowed in the specifications were: for 131-ft. arches, 2 in.; and for 164-ft. arch, 2½ in.

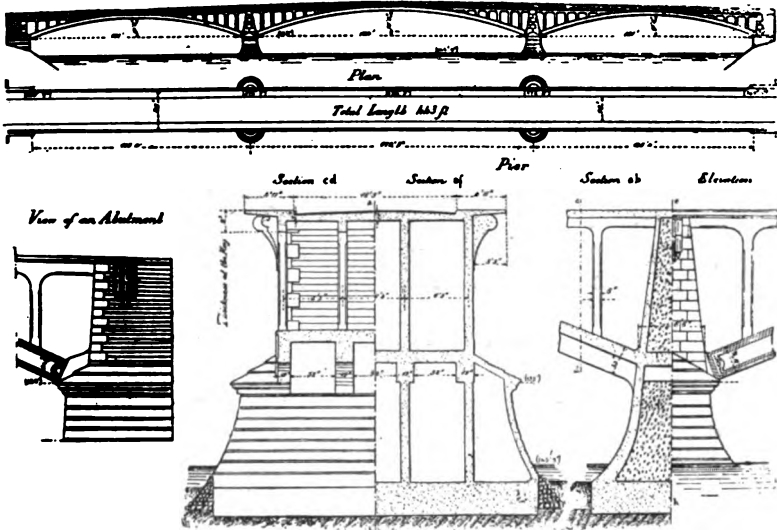

FIG. 502.—Chatellrault bridge over "La Vienne," France.

The measuring apparatus were of two kinds. To the crown was attached a *registering* apparatus, and to the spandrel a *direct-reading* apparatus amplifying five times the deformations. All the apparatus were fixed to the ribs and distributed as shown in Fig. 503.

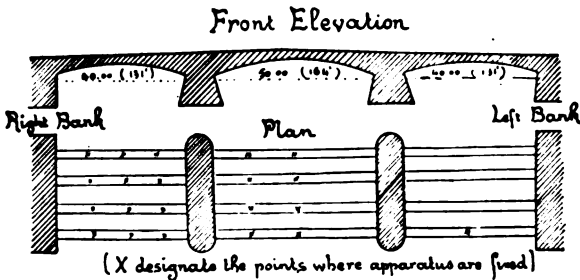

FIG. 503.

Three kinds of moving load tests were required:

1. The vehicles first passed over the bridge and returning afterward stopped there for a certain time.

2. A troop of 250 soldiers passed at a quick step and also at a run.

3. The vehicles and the roller passed over wooden strips so as to produce a series of shocks (by continuous bumping). In this case all the tests were entirely satisfactory and the arches resumed their initial position immediately after the removal of the load, no signs of cracks or injury showing during or after the tests.

In Fig. 504 are diagrams registered by the self-recording devices during the second tests. These are self-explanatory.

In many cases on the Continent, experiments, tests, etc., have been conducted for years after completion, by the use of thermometers and devices for recording continuously the influences of temperature, traffic, etc., upon the structure after it has passed into service. An

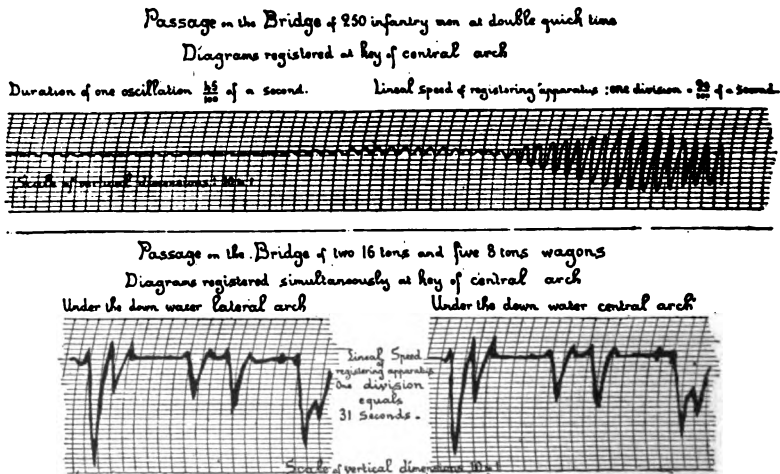

FIG. 504.

interesting example of this is shown in Fig. 492, which is a view of the three-hinged arch bridge over the Neckar River at Mannheim, Germany. The little building shown under the center of the span contains the automatic recording apparatus. The movements of the arch, temperature, etc., are transmitted from crown of arch through the gas pipe shown. All data are tabulated for future use, and the fact that it covers the behavior of the structure under actual conditions through long periods renders it invaluable to engineering knowledge and investigations.

179. The Esthetic Element.—The first and most lasting impressions in connection with foreign bridge structures are produced by their pleasing appearance—the superiority of esthetic merit. Fundamentally, this is due to the European artistic instinct and refined taste for beauty

in line, form, mass, and environment as developed by cultivation and contact with high standards, thus creating a widespread demand for structures of artistic merit and architectural effect. Economic conditions also play an important part, for the prevailing moderate wages of labor and mechanics permit much care and attention to the artistic finish of structures at comparatively reasonable expense.

In the United States comparatively little attention (isolated and unimportant cases excepted) is given to this subject. The chief considerations usually seem to be fulfilled when the conditions of stability and least cost have been met, the attainment of which, apparently, leaves nothing more to be desired, while the appearance of the structure is usually left to take care of itself. This practice has resulted in numberless structures (even within densely populated territory) which are simply *utilitarian*—mere *tools of transportation*. Thus, of course, the two standards are very far apart. It is desirable to point out here, in some detail, the usual means or methods employed by European engineers in the attainment of their excellent artistic results in concrete bridge construction.

In the design of bridges the first consideration of European engineers is concerned with the proper selection of a design with a view to its esthetic merit and fitness, consistent with the conditions extant. In this selection there is always a strong tendency toward arch forms (especially the light, bold, open forms), bow-string girders, reversed arch (or fish belly) girders, or open-webbed (cored) girders.

Having selected the type of structure, attention is next directed toward adapting or fitting the same pleasingly to its natural setting and purpose by the logical applications of the proper architectural principles.

Architectural treatment of the design involves considerations of symmetry, proportion, harmony in the main lines, forms, masses, and surfaces of the structure as a whole, combined with special study of the character of the surroundings, landscape, etc. The usual visible means and expedients employed to obtain the desired end are:

(a) *Emphasis or Accentuation*.—Obtained by relative massiveness or perpendicular effect through the use of pylons, pedestals, massive or obelisk-like lighting standards, etc.; also by adding vigor, character, and strength to the design by deep-shadow effects, the use of overhangs, off-sets, projections, pilasters, etc.

(b) *Combinations of Concrete with Stone, Brick, and Concrete Blocks*.—Stone, brick, or concrete blocks (often varying in shade and form) used as facings, copings, columns, balustrades, belt-courses, cutwaters of piers, quoins, and arches.

(c) *Surface Finish and Texture*.—Obtained by:

Picking or axing (pointing and bush-hammering)—see Figs. 505, 506, and 507.

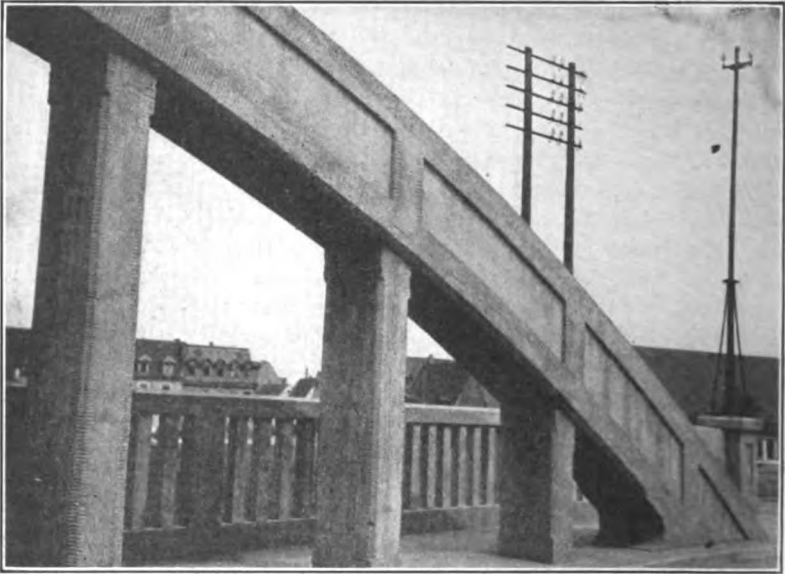

FIG. 505.—Bowstring truss, Friedrichsfeld, Germany. (Note surface finish and direction of scoriations on edges. Use magnifying glass and note effect.)

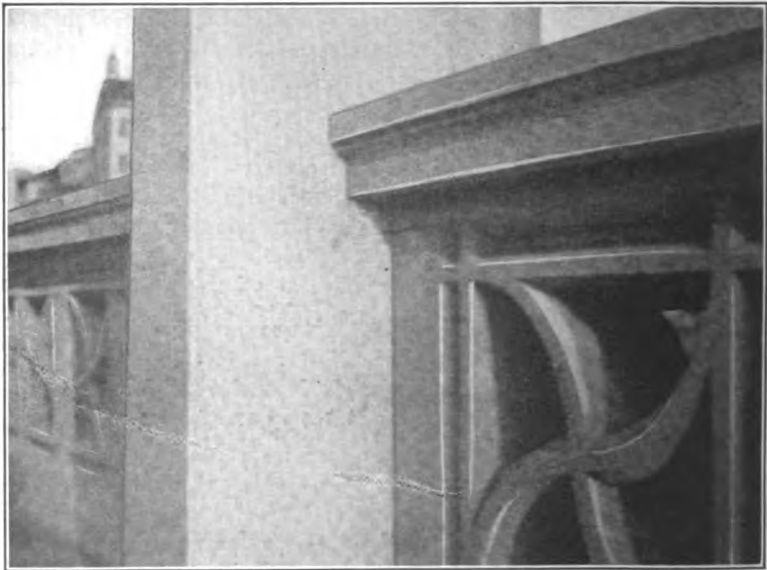

FIG. 506.—Detail view of balustrade of Urania bridge at Zurich. Note finish.

Special methods, such as gravel finish—see Figs. 490, 508, and 509.
Washing surface with water or acid solution when green.
Stubble rough finish—see Figs. 510 and 511.



FIG. 507.—Detail view of entrance balustrade and standards, Urania bridge at Zurich. Note surface finish.

(d) Ornamental Detail.—Used where necessary by employing such features as paneling, inlays of tile, stone or concrete slabs, ornamental

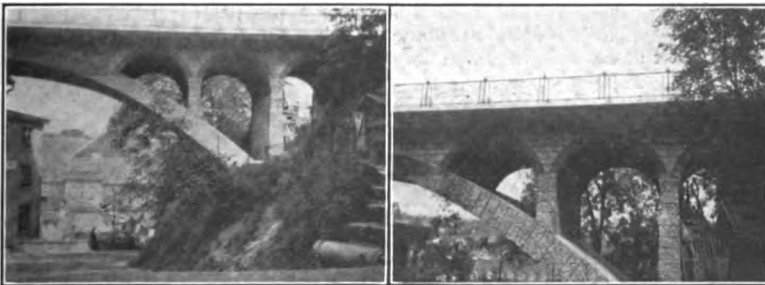

FIG. 508.—Steinach bridge, St. Gallen, Switzerland.

standards, heraldic emblems, busts, medallions, bas-reliefs, and statuary occasionally.

Selection of Design.—It has long been the customary practice in

Europe to give much attention to the artistic design of steel bridges, a practice which has resulted in many pleasing structures of that character. Even the homely truss and girder forms have been rendered pleasing by artistic and skilled use of the arch, combined with suitable treatment of surfaces and effect. Naturally, therefore, European engineers lead without comparative effort in the attainment of excellent results in this newer material—reinforced concrete—which affords such an ideal medium for artistic effect and so readily adapts itself to such treatment even with ordinary skill and experience and without the addition of

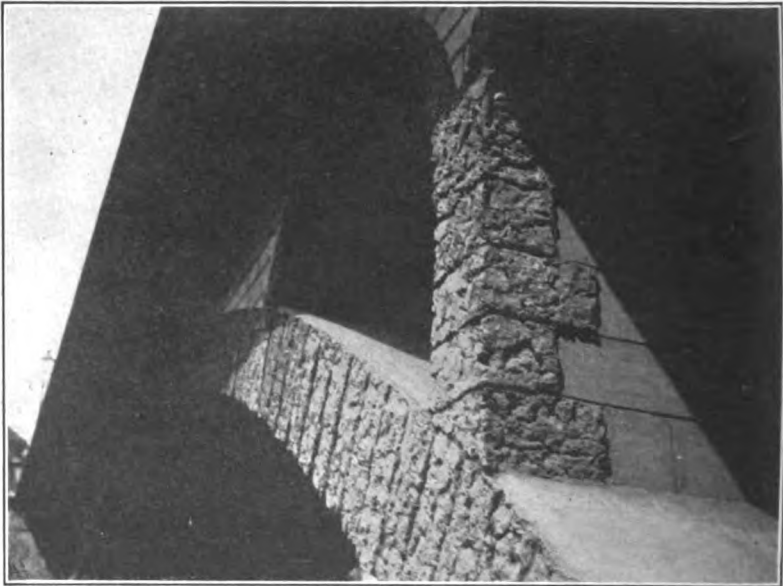

FIG. 509.—Steinach bridge, St. Gallen, Switzerland, showing facing blocks of cemented gravel. (Use magnifying glass for effect.)

special embellishments. The recognition of this great opportunity for pleasing effect (afforded by the esthetic fitness of the reinforced-concrete open-spandrel arch, in combination with other great scientific and economic advantages) led to its original introduction and present widespread use throughout Europe, especially on the Continent. This tendency for arch forms of construction is so strong and widespread, and rooted so deeply throughout the Continent, that apparently other important considerations are often disregarded in order to use them.

The American engineer has always firmly believed that a stable and unyielding foundation (soil or rock) is the first and most important consideration in the selection and preparation of a design for any structure, especially a reinforced-concrete arch bridge. This idea has been

completely overturned by European practice. Concrete arch bridges are often found in locations that would be considered in America distinctly unfavorable to arch construction in any material or form.

A most striking instance of this is the 328-ft. Tiber bridge at Rome (Figs. 481, 482, and 483), with its "floating foundation"—that is, it is founded upon material so unstable that it had to be enclosed by sheet-piling in order to be retained under the load. From the American point of view, one of the most unfavorable conditions for arch construction exists when one of its piers or abutments is founded upon rock or gravel while the other rests upon piles driven in soft material. This, however, is a common occurrence on the Continent. The 164-ft. Munderkingen



FIG. 510.—Highway structure, St. Gallen, Switzerland. (Note rough stubble finish.)

bridge is an example, one of its abutments being upon solid rock and the other upon batter piles driven in soft material. The presence of rock or hard material is no longer necessarily a condition precedent to concrete arch construction in European practice. Some of the most important reinforced-concrete bridges in Europe are founded upon piles driven in soft material. The handsome Rudolfinum bridge at Prague is a good example (Figs. 512 to 517 inclusive).

The introduction of scientific features and expedients in the design for weight reduction and safety, such as open spandrels, ribbed arches,

cellular and hinge construction, have alone made these beautiful, bold, light, open structures possible in reinforced concrete—that is, esthetic merit has been attained through scientific and economic means, and

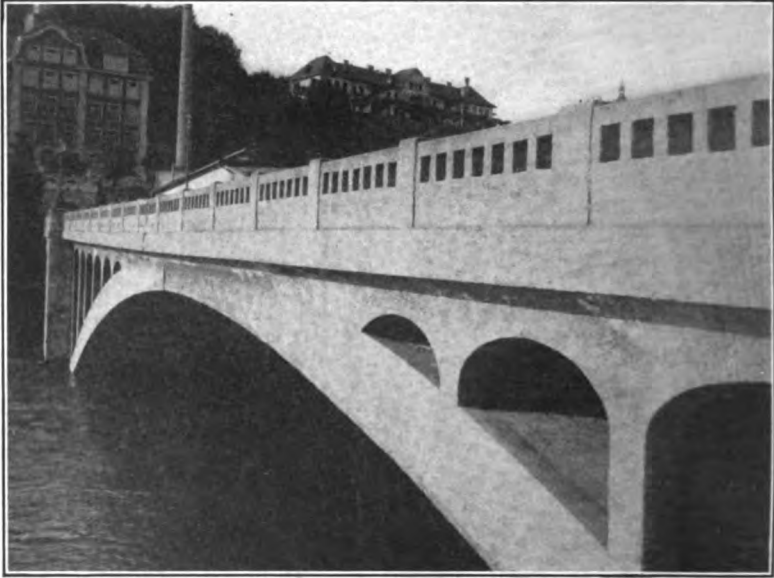

FIG. 511.—Reuss River bridge at Lucern, Switzerland. (Note rough stubble finish.)

vice versa. The arch type of structure is the first choice for any location, and it is not abandoned until thorough investigation has shown it

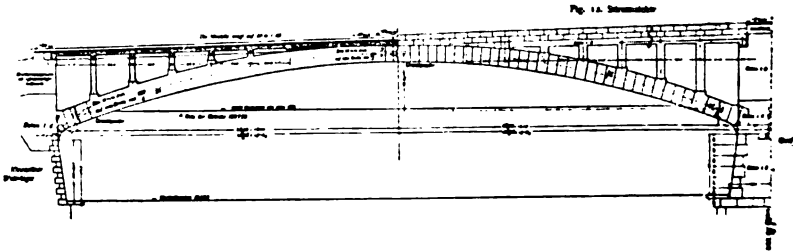

FIG. 512.—Bridge over the Moldau near Rudolfinum in Prague. (Longitudinal section on center. Elevation.)

impracticable, which rarely happens with the present light, open forms of construction.

In American practice the reverse of this is usually the case—that is, the steel truss or girder type is often the first and only choice and, unless

rock foundations exist, no other type is considered, and sometimes not even in that case. Steel construction lends itself to artistic construction far less readily than does stone or concrete, so that there is less need of constantly impressing the esthetic obligation.

Fig. 16. Schnitt X-X.

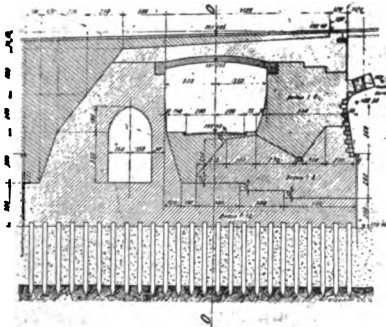

Fig. 17. Schnitt O-O in der Achse des Durchlasses.

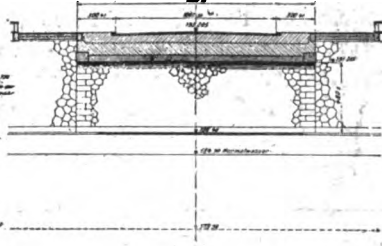

Fig. 18. Schnitt Z-Z durch den Träger.

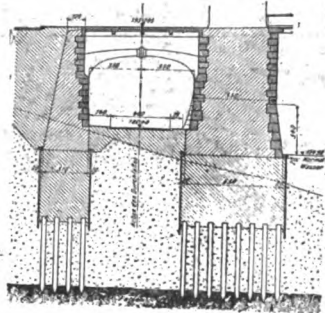

Fig. 15. Grundriss des Fundamentes.

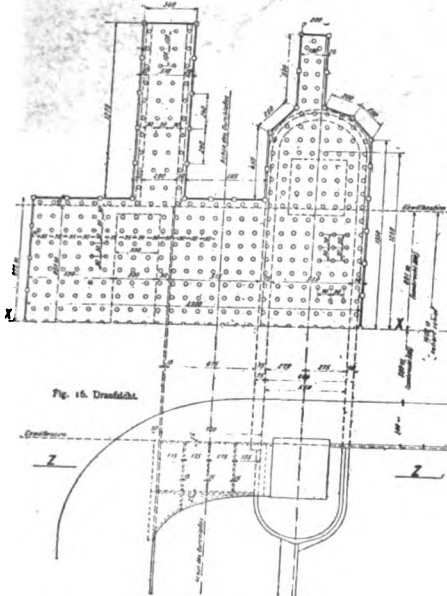
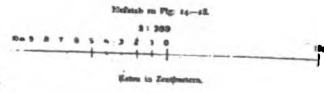

Fig. 16. Draufsicht.



15. Plan of foundation.
16. Top plan.

17. Section O-O.
18. Section Z-Z.

FIG. 513.—Bridge over the Moldau near Rudolfinum in Prague.

Once built, the permanent piers and abutments of a comparatively short-lived steel superstructure will rarely ever be revised or adapted

for use in connection with permanent structures of stone or concrete at subsequent renewals of the steel superstructure. Therefore, when a steel or wooden structure is built upon any site where a permanent

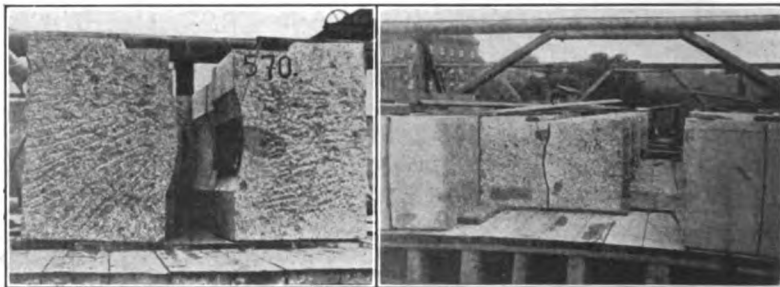

FIG. 514.

FIG. 515.

Bridge over the Moldau near Rudolfinum in Prague.

FIG. 514.—Crown hinge with lead plate in place.

FIG. 515.—Crown hinge blocks in their final positions on the falsework.

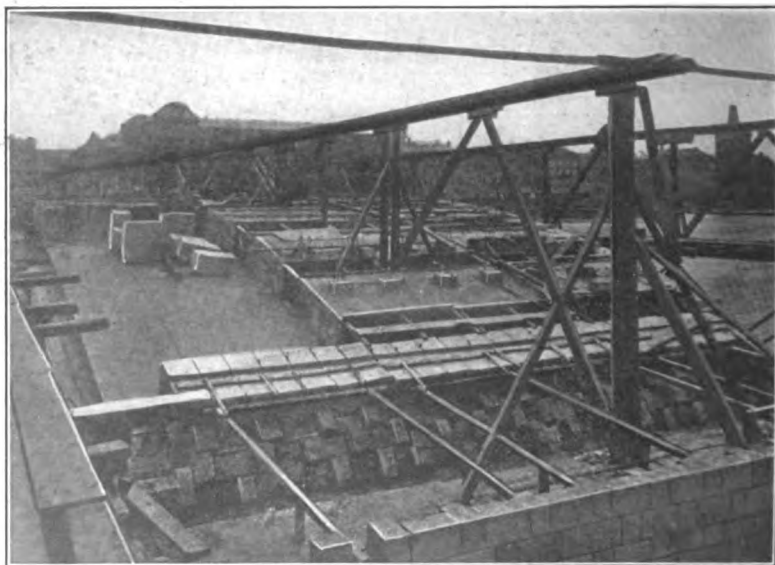

FIG. 516.—View of Rudolfinum bridge at Prague under construction, showing skewback hinge blocks, also subdivided erection (or placing) of arch in progress.

structure would have been possible, not only has a costly mistake been made with an esthetic opportunity lost, but also one which will rarely (if ever) be corrected in the future, since the permanent piers and abut-

ments, which are only suitable for steel re-construction, already exist, and competition of the concrete arch becomes impossible from an economic standpoint.

The European tendency for the arch of light, open forms in reinforced-concrete construction is shown in other ways. For example, even in those rare cases where foundation or underclearance considerations render deck-arch structures impossible, the through-arch or bowstring type, is extensively used (Figs. 484, 485, 518, and 519). Then, again, when conditions are such that neither through nor deck arches are possible, we find that the arch tendency still prevails by the selection of



FIG. 517.—Rudolfinum bridge at Prague. View showing skewback-hinge blocks and spandrel column bases. (Note that the intermediate concrete columns have concrete bases and the exterior cut-stone face columns have cut-stone or voussoir bases. Also note round timber framework.)

the graceful reverse curves afforded in the *fish-belly* girders of the Möller system (Figs. 520 and 521). Also, when the conditions are such as to render all of the above types unavailable, the light, open forms of the Visintini system (Warren or Pratt forms) are selected, or even the ordinary form of concrete girder is used and treated artistically by cores (Figs. 522, 523, and 524), by arched top or bottom lines (Figs. 525 and 526), or by accentuated detail and panelling, etc. (Figs. 526, 527, 528, and 529).

Those structures which exhibit gently curved steady profiles of

the upper outline afford the best impressions. These curves are circular, multicentered, or parabolic. An elliptical curve is also effective,



From "Handbuch für Eisenbetonbau."

FIG. 518.

FIG. 519.

FIG. 518.—Béja bridge in Tunis (Hennebique system).

FIG. 519.—Larg bridge in Brünighofen.

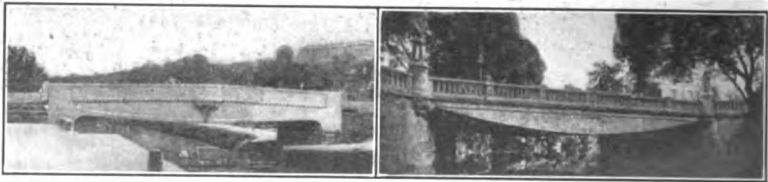

From "Handbuch für Eisenbetonbau."

FIG. 520.

FIG. 521.

FIG. 520.—Nuns bridge in Bamberg.

FIG. 521.—Fallerslebertor bridge in Braunschweig.

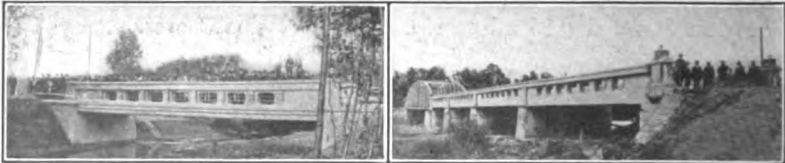

From "Handbuch für Eisenbetonbau."

FIG. 522.

FIG. 523.

FIG. 522.—Bridge over the Pottingbach, Austria.

FIG. 523.—Overflow viaduct Ybbs bridge near Kimmelsbach.

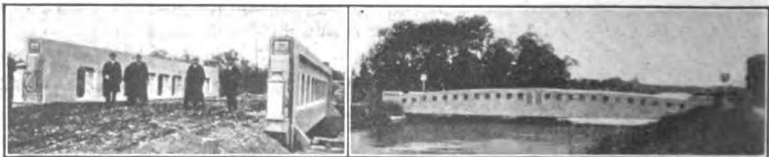

From "Handbuch für Eisenbetonbau."

FIG. 524.

FIG. 525.

FIG. 524.—Great Laben bridge near Kimmelsbach.

FIG. 525.—Fieldway bridge over Upper Water Canal near Freising.

but its steep end grades make its use prohibitive except for foot bridges. In the case of through bridges or girders, reversed curves are sometimes used in their upper outline (Fig. 530).

By decreasing the height of truss at abutments with a steady curvature of upper contour, a lighter total effect is always attained.

The lower contour or under-outline of the structure is either a straight line, an arch, an inverted arch, or a combination of curves and straight lines (Figs. 520, 521, 531, and 532).

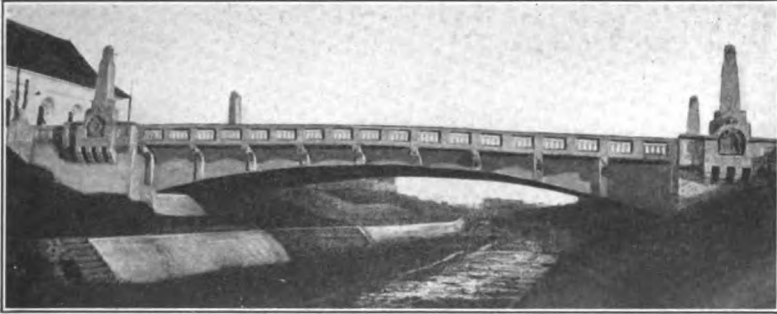

From "Handbuch für Eisenbetonbau."
 FIG. 526.—Mühlplatz bridge over Béja Canal in Temesvár, Hungary.



From "Handbuch für Eisenbetonbau."

FIG. 527.—Bridge over the Kraichgan Ry. near Bretten, Baden.
 FIG. 528.—Bridge in Reichenau.

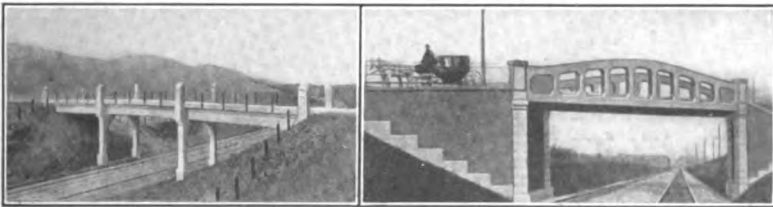

From "Handbuch für Eisenbetonbau."

FIG. 529.—Viaduct over the South Holland Electric Ry.
 FIG. 530.—Highway bridge near Taulow (Jütland).

In structures having horizontal bottom contours a small construction camber is always provided in order to avoid the impression of deflection which is always associated with structures or even beams having straight bottom outlines. Such rise never exceeds $\frac{1}{25}$ of the span which

is considered sufficient to eliminate the unsatisfactory impression of deflection and at the same time avoid the deceptive appearance of an arch. Generally this ratio is between 1 : 50 and 1 : 100. In the case of continuous structures, however, a stronger bottom curvature fits the moment line better (Fig. 533). Such slight arching affords a lighter



From "Handbuch für Eisenbetonbau."

FIG. 531.—Olt bridge near Felsősebes, Hungary.

impression to the structure (Fig. 534). On the other hand, the inverted arch (*fish-belly*) gives a heavier impression by shifting the surfaces and mass of the structure toward its center (Fig. 521).*

The handsome Urania bridge at Zürich (Fig. 535) is a series of continuous girders, although often mistaken for an arched structure. The

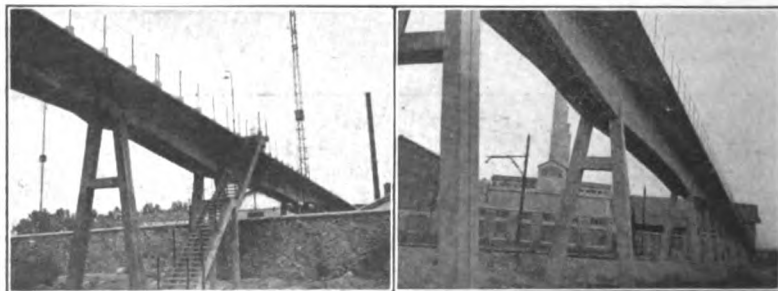

FIG. 532.—Reinforced-concrete trestle, electric plant, Paris.

view clearly shows the effect and method by which same has been obtained.

Architectural Form.—Applied ornamentation proper is not resorted to in the design of concrete bridges to the extent that it has been in connec-

* *Reference:* "Handbuch für Eisenbetonbau," 2. neubearbeitete Auflage, Band VI. Copyright, 1911, by Wilhelm Ernst & Sohn, Verlag, Berlin.

tion with steel bridges. It is not so necessary with the former since they lend themselves readily to artistic treatment without it.

The main and often the sole effort of the European engineer for esthetic effect is placed, as far as possible, in the pleasing arrangement of main lines, forms, and masses of the structure which shows that he



From "Handbuch für Eisenbetonbau."

FIG. 533.

FIG. 533.—Detail over columns, standard overhead bridge, St. Gallen, Zürich, Ry.

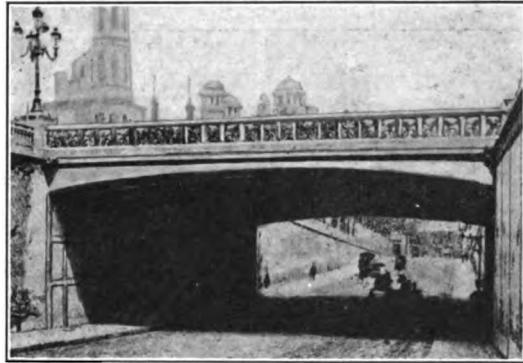

FIG. 534.

FIG. 534.—Quai Debilly bridge, Paris.

holds constantly in mind the principle that: "There is beauty in any useful structure, designed on lines of true economy, with the utmost simplicity and fewest parts." Among the illustrations will be found a number of examples where simple, almost utilitarian structures have been lifted up and rendered pleasing and often even impressive merely

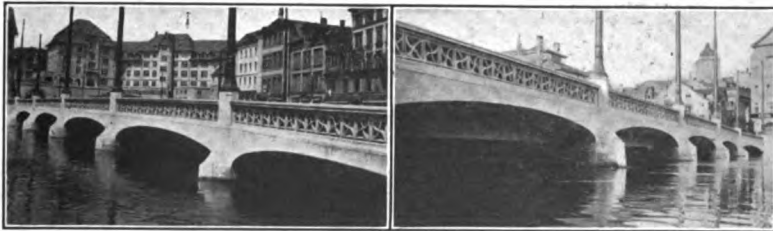

FIG. 535.—Urania bridge, Zurich, Switzerland. (Note arch effect of this series of girder spans.)

by pleasing outline and surface finish, combined with good taste and judgment in fitting it to its natural setting.

The distant view as one approaches the bridge should always be attractive; and the care and study given to this, with a view to creating this striking first appearance, is always in evidence on the Continent,

... of the ...
 ... of the ...
 ... of the ...
 ... of the ...



FIG. 56. Stone arches (left) and stone bridge (right).

... effect as a whole when viewed by an observer from afar ...
 ... of detail ... with the structure ...

Emphasis of Architectural Detail—Emphasis or accentuation of detail is an important feature employed by European engineers to secure



FIG. 57. Canal bridge, Rotterdam, Holland. (Combination stone, brick, and concrete.)

pleasing architectural effect. In fact, it is often observed that even structural requirements are exceeded to acquire such effect. Thus, relative massiveness in piers and abutments is extensively resorted to, in order to attain pleasing contrast by comparison with the light, open spans and forms of their superimposed arches.

Accent is also afforded by the perpendicular effect of pylons, pedestals, and massive or obelisk-like lighting standards. Attention is called to

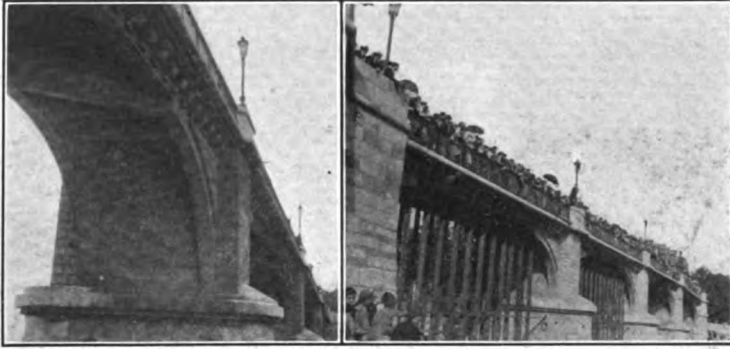

FIG. 538.—Bridge over branch of Seine, Paris. (Combination stone and concrete.)

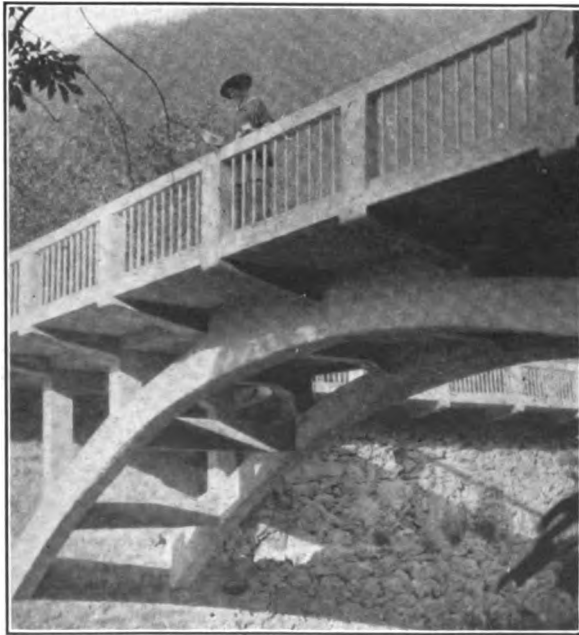

FIG. 539.—Plessur bridge at Chur, Switzerland.

examples of each in the following pages. At first thought, *cellular construction* would hardly be associated with esthetic considerations,

652 REINFORCED CONCRETE CONSTRUCTION

since it is usually considered as having originated from scientific and economical necessities. It may be considered, however, as being closely related to the esthetic element of design. Thus its advantages become



FIG. 540.—Bridge over the Glenner River near Ilanz, Switzerland.



FIG. 541.—Process of surface finishing and tools required. (Note direction of tool for vertical scoriation under coping.)

threefold and, this being recognized, its extensive use in European structures naturally followed on a large scale.

There is reason to believe that the first use of cellular construction was inspired by esthetic demands.

The construction of the Chatellerault bridge in France was the first structure which attracted attention to this expedient. Its use there,



FIG. 542.—Highway bridge, Zurich, Switzerland.

and in many other structures, subsequently afforded an economical means of accentuating the piers by increasing their apparent massiveness, their hollow interiors being filled with a weak concrete, dry rubble, or earth (Fig. 502).

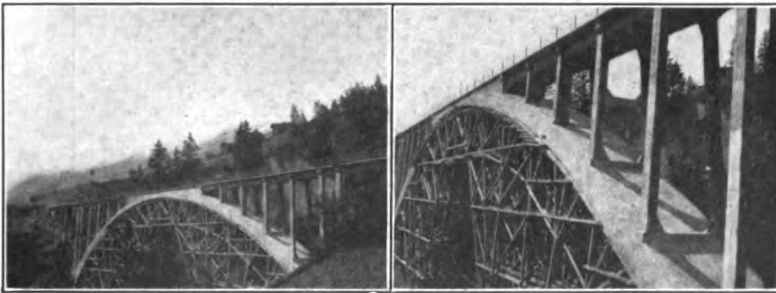

FIG. 543.—Grundje-tobel viaduct. Chur-Arosa Electric Ry., Switzerland. Arch of 282-ft. span.

The structure is indeed rare on the Continent today which does not utilize this valuable expedient in some form or other. Nor is this alone confined to piers and abutments, although the effect and economy, of course, is greatest there. It is also employed, for example, to great advantage in pedestals, columns, floors, spandrels, and arches.

In America this expedient has been introduced to some extent within the last few years—almost entirely, however, for economic purposes only. Probably the most beautiful application in the United States which has ever been made in which its threefold advantages were combined and realized fully is to be found in the Kingshighway viaduct at St. Louis, Mo., designed and built by Mr. A. C. Janni, M. Am. Soc. C. E.

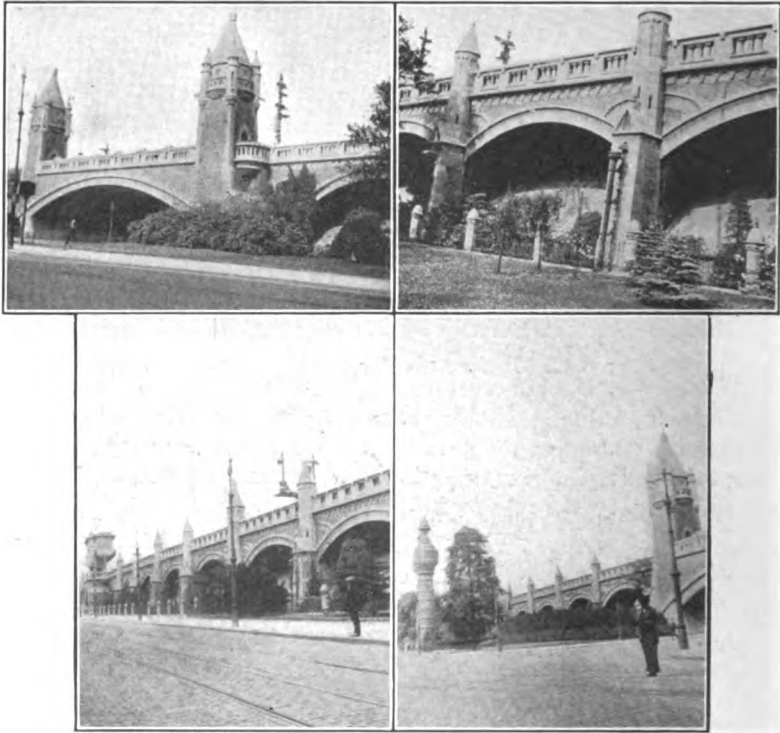

FIG. 544.—Antwerp viaduct. (Note horticultural and landscape architectural effects. Note also inclined tile enclosures.)

An eminent French reinforced-concrete specialist remarked that “the failure to use cellular construction in any reinforced-concrete bridge results in a threefold loss to all concerned.”

Combinations of Concrete with Stone, Brick, and Concrete Blocks.—Another characteristic feature of European-bridge practice is the extensive use of stone, brick, and concrete blocks in concrete-bridge construction. Such combinations are not confined to copings or massive construction such as piers and abutments, as is usually the case in the United States, but extends to every portion of the structure—in spandrel

walls and columns, balustrades, pylons, belt-courses, pier cut-waters, arch barrels, and ribs. The effect is always splendid and impressive, which can be appreciated better from an illustrated description of representative structures. The Neckar bridge at Heidelberg, Germany (Fig. 489) is a composite structure of quarry-face stone and concrete. The solid arch rings are concrete, all exposed surfaces being faced with granite. The balustrade is also stone.

Special attention is directed to the Steinach bridge, St. Gallen, Switzerland, between Wildeggstrasse and Felsenstrasse (Fig. 508). Its treatment is so unusual, simple, and charmingly harmonious with its natural setting that we may consider it in a class by itself. The arch spans a street and the Steinach brook, between natural cliffs of cemented

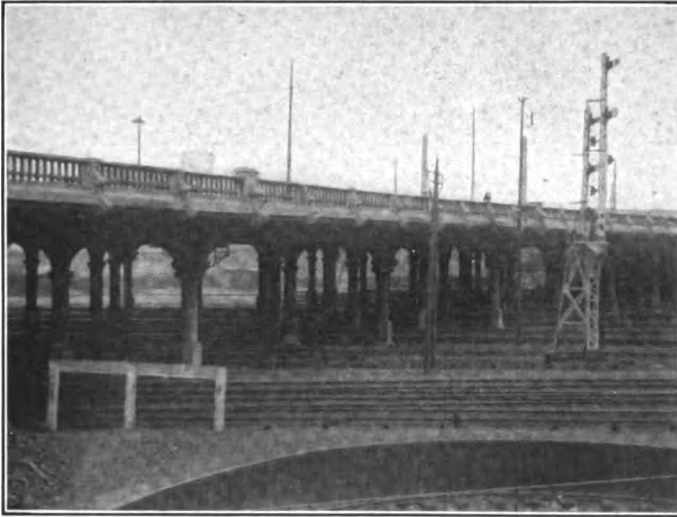

FIG. 545.—Street viaduct over railway yard, Brussels, Belgium.

gravel on either side. Fragments of this material ranging in size from 2 in. to 8 in. have been cemented together to form rectangular blocks. This has been so skillfully done that no trace of artificiality can be observed—the blocks appearing as if they occurred naturally in the rectangular shape. These cemented-gravel blocks are used as facing for all exposed lateral surfaces of the transverse spandrel walls and arch. The spandrel walls are of concrete blocks with V-joints, and the combination between these and the cemented-gravel blocks is very striking.

Near the Steinach bridge is another unusual structure where a combination of stone and concrete has been effectively used. A highway has been constructed along the face of the cemented gravel cliff shown in Fig. 510. The roadway is supported upon a series of transverse

beams, the outer ends of which rest upon the arches shown, while the inner ends are supported by shoulders excavated in the cliff. The balustrade is concrete, with an attractive rough finish. The railing bars shown are steel angles with the apex upward, giving the appearance of solid rectangular metal bars.

The 180-ft. combination stone-concrete block bridge at Wiesen, Switzerland over the Landwasser (Fig. 536) is another notable structure. The central span of this structure is 320 ft. above the river bed and is flanked by six 66-ft. spans. Total length 689 ft. The bridge is on the line of a meter-gauge railway between Davos and Filisur. The arches are

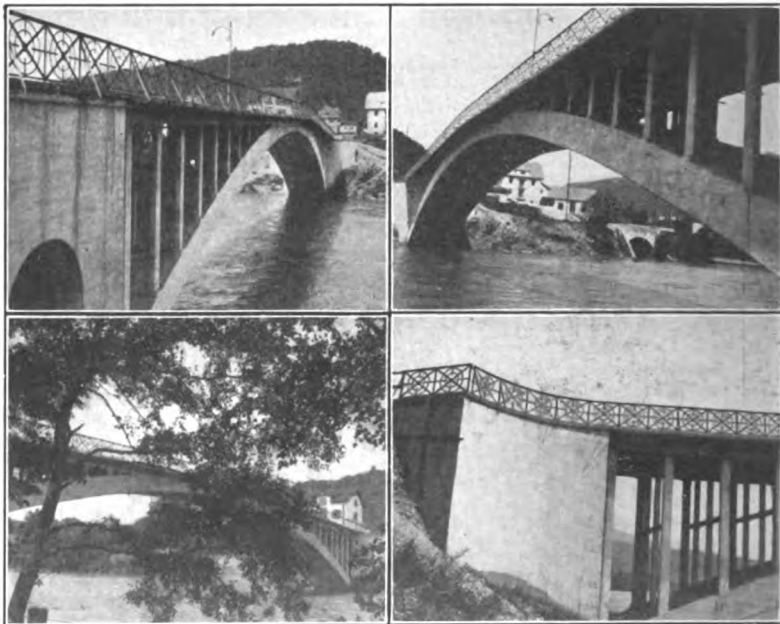

FIG. 546.—Aare River bridge at Olten, Switzerland.

built of concrete blocks faced with stone and are the largest of their kind in existence. Concrete blocks were considered better than stone for constructing the arch ring, in that they afforded better joints and better bond. The transverse bonding was supplemented by steel tie-rods, bedded in the arch ring, tying the face walls together. The thickness of the arch ring at the crown is 5.9 ft. and 9.9 ft. at the skewbacks of the main arch. The main piers are built of cut-stone facing with a concrete core. An interesting and valuable feature of the design comes from the fact that the main arch was designed to be built in three concentric rings. The first was designed of sufficient strength to carry the

second without transmitting any portion of its weight to the centering. In this way much timber was saved in the centering which could thus be designed to support one-third of the total weight of the arch. The crown of the main arch was waterproofed with sheet lead flashed against the spandrel walls.

An artistic combination of stone, brick, and concrete is shown in the canal bridge at Rotterdam, Holland (Fig. 537). The balustrade is a well-designed massive combination of brick and stone coping.

In the girder bridge which crosses a branch of the Seine near Pont de Sully, Paris, is an interesting combination of concrete, concrete blocks, and stone masonry (Fig. 538). This combination of materials and the manner of their disposition, together with the heavy cornice and the

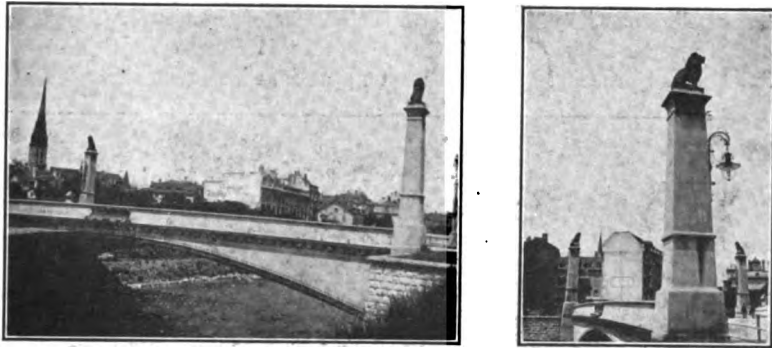

Fig. 547.—The New Stauffacher bridge, Zurich, Switzerland.

graceful massive brackets of reinforced concrete, produce an effect which even the severe girder-like structure cannot dispel.

In Switzerland, where stone is so plentiful, the preferred practice naturally is that of concrete-stone combinations. Such structures are found in every part of Switzerland, even in the remote rural districts. An example of this is seen in the light, graceful rib arch over the Plessur at Chur, Switzerland, the ribs being 12 in. in depth and 8½ in. in width throughout (Fig. 539).

Fig. 540 shows a fixed solid-ring arch of 120-ft. span which crosses the raging Glenner near Ilanz, Switzerland ("first town on the Rhein"). The abutments are masonry. The roadway is supported by transverse spandrel walls of solid concrete. The type shown appears to be the standard construction for post-road traffic in that portion of Switzerland along the Vorder-Rhein and its branches. The arch rib is uniformly 15 in. in thickness throughout.

European Methods of Surface Finish and Texture.—A structure is never seen left with its rough unsightly construction finish showing "honey combing" and the imprint of forms. While the appearance

of European concrete bridges depends mainly on their structural form—that is, upon the main lines of the structure—in a secondary degree it depends also upon the surface finish and texture of the material.

Except in special cases, the general methods employed in this are similar to those used in the United States, the difference being that such treatment is given to all bridges whatever or wherever they may be. The work also is thoroughly done, as a rule, and not confined to a few important structures within densely populated communities.

Picking or axing the surface is a method which is extensively used, and the manner and thoroughness with which it is done gives the surface a natural granite-like glittering surface which in many cases is difficult to distinguish from real granite. A beautiful example of this finish is shown in the views of the Friedrichsfeld bowstring truss (Fig. 505). The tooling can be plainly seen on the surface of the top chords, posts, etc. The tooled surface of this structure has been so thoroughly and skillfully executed that it almost appears as if it were a monolith of

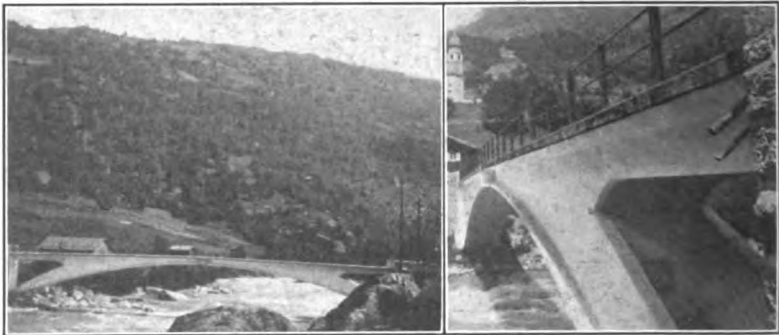

FIG. 548.—Tavanosa bridge over Vorder-Rhein. (Note transverse tie wall and entrance through same.)

living granite, though the photograph cannot convey the real glittering effect. (These, and all other much-reduced photographs will show their finer details under a reading glass.)

In Fig. 541 is shown the wing-wall of a bridge structure near Mannheim, Germany, in process of treatment. All of the necessary tools are shown, only three in number. The surface finish of the coping has been completed and the workman is beginning upon the face of the wall. Note the difference between the finished coping surface and the unfinished wall surface below.

One of the most magnificent finishes is that of the handsome balustrade of the Urania bridge at Zurich, Switzerland (Figs. 506 and 507). In this case not only has the tooling of the surface been splendidly executed, but the ingredients of the plaster material were proportioned with a view to perfect imitation of stone.

The surface finish of the highway bridge in Zurich (Fig. 542) has been given with a view to show its harmony with the architecture of the surrounding buildings. It has been so well done that the difference, if any, cannot be detected by the eye.

Ornamental Detail.—The use of ornamental detail in connection with reinforced-concrete bridges is limited, compared to its use in steel structures. Originally such decoration was used to a greater extent when the design was confined to a solid-spandrel construction, as these offered considerable space to be relieved by decorative features, such as paneling, heraldic devices, medallions, etc. With the advent of the open-spandrel type, this flat surface has been replaced by columns,

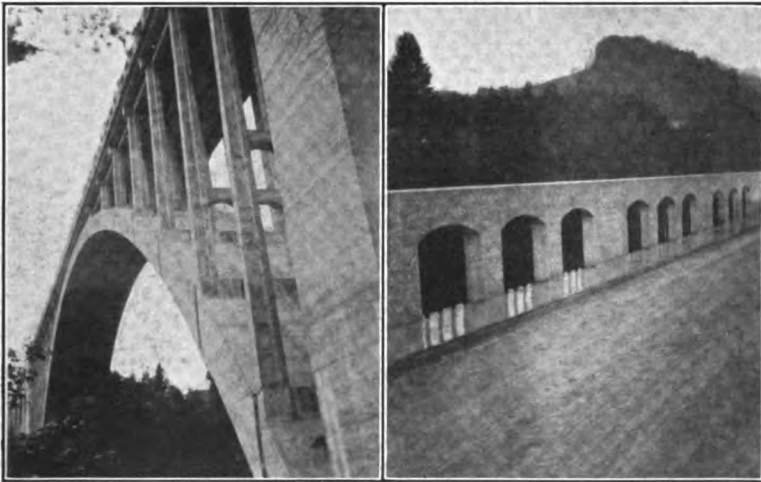

FIG. 549.—Stein-Teufen bridge over Sitter River. Fixed ended arch of 259.12-ft. span. (Note balustrade and 2-ft. sidewalk.)

openings, and relieving arches, which in themselves constitute satisfactory effect.

When decorative detail is applied to open-spandrel structures it is usually found at such locations as the crown of the arch, the ends of the piers, the entrance pylons; and the standards and balustrades.

180. The Economic Element.—The costs of labor and material are responsible for many radical differences between European and American practice. For example, the fact that skilled labor can be obtained in Europe at a comparatively moderate price accounts largely for the superior, and frequently exquisite, finish of the European structures, in that much time and attention can be given, at comparatively small expense, to the dressing and finishing of the raw structure as it issues forth from the forms. On the other hand, the high cost of labor in the

United States has resulted in great superiority in labor-saving machinery and appliances for transportation, hoisting, and handling materials. In these features the United States is unexcelled. Germany approaches nearer than do other nations, but even there the difference is still marked.

American superiority in these things was developed first in connection with steel construction. It was, therefore, an easy step to apply such knowledge and experience to construction in another material. The comparative status of the European and American concrete-bridge construction plant is very much like the comparative status of the two

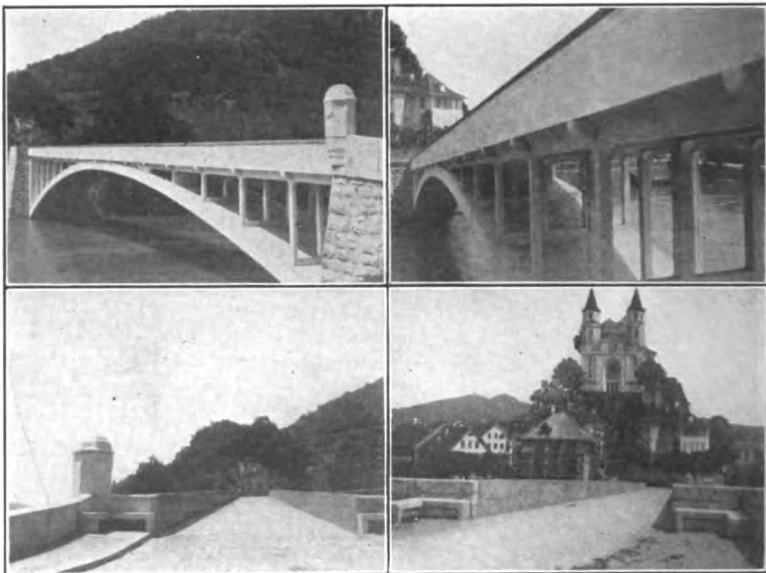

FIG. 550.—Aare River bridge at Aarburg, Switzerland. (Note terminal pedestal seats.)

systems of railway transportation and methods. Little attention, comparatively, is given in Europe to methods and machinery which insure economy of construction and rapidity of erection. On account of the comparative lack in experience in erection and erection facilities, Europeans are willing to go to greater length and expense to avoid difficulties always associated with such work.

On account of the higher cost of material in Europe, its conservation becomes a more important factor, and is ever foremost in the mind of the designer and builder. Consequently, they make their material go further and they get more out of it. What their structures lack in mass, quantity, or sectional area of members is usually more than offset by

reduction in dead weight and greater strength of material accomplished through scientific design, proportioning, and disposition; through superior mixing and workmanship; and especially through the greater rigidity of reinforcement and the thoroughness of its connections.

While these several facts appear trivial in themselves, when taken collectively, they are the cause of the difference between the heavy American and the light European structures which, while varying so widely in mass and sectional area of members, are equivalent in capacity for equal span lengths.

There is a general belief with many European engineers that in not a few cases the factor of safety of the American structure is decreased in the great efforts to increase it.

CHAPTER XXXVII

HINGES OF ARCHED CONCRETE BRIDGES

*When an arch without hinges is analyzed by the elastic theory, the uncertainties of computation and the influence of temperature and probable lateral movements of the abutments (except when resting on rock) make it highly advisable to keep the stresses well within the safe strength of the materials, so as not to run the risk of unsightly and possibly injurious cracks in the concrete. This is not true, however, when analyzing the arch with three hinges. The use of the hinges makes it possible to determine the thickness of the arch and the mix of the concrete so as to make use of the full safe strength of the material.

With hinges at the springs and at the crown, three points of the lines of pressure for all systems of external forces (including the temperature influences) are fixed, these lines all passing through the hinge centers. The three-hinged arch is able to adjust itself to movements of abutments and to changes in the length of the arch axis, which latter may result from the sensible compression under stress of the arch material, or from shrinkage in hardening, or from the contracting and expanding effect of falling or rising temperature.

While the lateral movements of the abutments and the shortening of the arch due to compressibility and shrinkage of the concrete will cease after a certain length of time, the alternate shortening and lengthening of the arch axis due to temperature variation will continue to occur for all time. Thus the practice of filling the hinge joints solid with cement mortar some time after the centering has been removed and no further lateral movement of the abutments is expected (or if no such movements have shown up at all) can only be approved of under special conditions. As a rule, particularly in the case of longer spans and low arches, the hinges should be left in free operating condition, and the superimposed structure and roadway should be provided with open joints allowing sufficient free play for the hinges to operate.

The hinges which have come into use may, as to their detail and their motion, be distinguished as (1) rolling hinges, (2) revolving hinges, or (3) flexural hinges. Hinges may also be distinguished by the material from which they are fabricated, as (1) hinges of stone and of concrete (plain and reinforced), (2) hinges of lead and asphalt felt plates, and (3) hinges of iron.

Stone and concrete hinges are of the rolling type. Lead and asphalt

* *Reference:* "Handbuch für Eisenbetonbau," 2. neubearbeitete Auflage, Band VI. Copyright, 1911, by Wilhelm Ernst & Sohn, Verlag, Berlin.

felt plate hinges are quasi-rolling hinges. Iron hinges may be either rolling, revolving, or flexural.

181. Stone and Concrete Hinges.—The stone or concrete hinge is formed by a pair of stone or concrete blocks fitted together with convex and concave cylindrical surfaces which can roll on each other. The convex surface has a somewhat smaller radius than the concave surface.

This type of hinge is the first type of a real hinge introduced into arch construction (by Köpke, in a three-arch railroad bridge near Langenhennersdorf in 1880). Many years before that time, in the erection of stone bridges, it was the endeavor, in order to obviate ruptures, to compel the line of pressure to pass through the center of the so-called joints of rupture. These joints were shaped hinge-like by chamfering them above and below their center part and by inserting metal plates. Dowels were also let into the voussoirs to guard against slipping. As the contact between the curved hinge stones (in order not to exceed the safe crushing strength) must be a finite area, the line of pressure is not exactly located—its transit point through the hinge joint varies, in fact, with varying loadings. For this reason, this type of joint can only be recommended for moderate spans of about 100 to 125 ft.

Careful tests have been made showing that stone used for masonry, when in contact over a small area as is the case in hinges, can be stressed much higher than elsewhere. Such tests made by Bauschinger in 1876 with cubes of about 4 in. side (16 sq. in. area of cross-section), of very fine-grained sandstone, showed the following results:

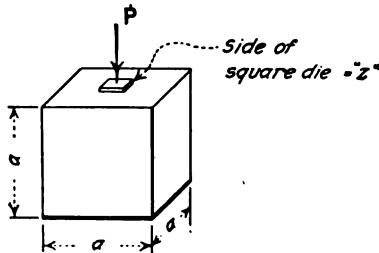

No.	Cross-sect. of cube in sq. in.	Face of sq. die in sq. in.	Tot. crush. press. in lb.	Crushing per sq. in. $\frac{P}{a^2}$	Strength in lb. $\frac{P}{z^2}$
1	15.5	2.38 (15.3%)	35,300	2,280	14,840 (137.5%)
2	15.5	5.17 (32.2%)	66,300	4,275	12,800 (119%)
3	15.5	9.60 (61.8%)	103,500	6,670	10,780 (100%)

These interesting tests show that with a smaller die relative to the

cube cross-section, the crushing strength of the material, referred to the die surface, increased. For example, the crushing strength of the area under the die, when the die was 15.3 per cent of the cube cross-section, was 37.5 per cent greater than when the die was 61.8 per cent of the cube cross-section.

Other tests by Bach in 1905, on cubes of another kind of sandstone, showed, for a die the full size of cube surface, a crushing strength of 9300 lb. per square inch; and for a die of the same length as the cube but only one-fourth of the width, a crushing strength of 13,200 lb. per square inch. Crushing strengths for other widths were found to be as follows:

$\frac{1}{2}$ of the width—	13,400 lb. per square inch.
$\frac{1}{3}$ of the width—	14,900 lb. per square inch.
$\frac{1}{4}$ of the width—	17,000 lb. per square inch.
$\frac{1}{5}$ of the width—	17,160 lb. per square inch.

These tests show that for a bearing of one-fourth of the thickness of the stone blocks (a proportion which has been used in the stone hinges of some bridges) an ultimate crushing strength of the material can be considered which is 42 per cent greater than that found when the pressure is exerted over the entire face of the block.

While these tests verify the stated fact that the pressure upon small areas may be assumed greater than that under uniform loading of cross-section, they nevertheless give no correct representation of the stresses actually existing in hinges, as the elasticity of the stone is very much involved. To get further information in this direction, it was necessary to make tests with *actual* hinges. Tests made during the erection of the four large Moselle bridges near Hauconcourt, Mallingen, Moulin, and Sauvage (1908) have furnished a very valuable contribution to the investigations of concrete hinges, especially as to their allowable stressing and the limits of their applicability. These tests merit especial attention, as they were the first tests to destruction with full-sized hinge blocks—that is, with hinge blocks of the same dimensions as those placed in the bridges.

The statical computation of the first of the four structures, near Hauconcourt (five openings of 108 ft. span and 14 ft. rise), gave a maximum crown thrust of 107,000 lb. and a maximum spring thrust of 129,000 lb. for 1-ft. width of arch. The crown thickness of the arch was determined from an allowable compressive stress of 356 lb. per square inch ($\frac{107,000}{12 \times 356} = 25$ in.). The greatest pressure in the crown hinge was not allowed to exceed 1700 lb. per square inch. The blocks were made 61 cm. (= 24 in.) in length (in the direction of the span), 65 cm. to 70 cm. (= 25.6 in. to 27.6 in.) in height, and 50 cm. (= 19.68 in.) in width. The concrete for these blocks was mixed with 1 part cement, $2\frac{1}{2}$ parts clean Mo-

selle river sand, and 2½ parts very hard broken quartzite of 1½-in. ring measure; the core was given a richer mix of 1:1½:1½.

The test made later on with two pairs of hinge blocks of equal size and 5 months old gave the following result:

	First crack	Second crack at pressure of	Failure
First test hinge.....	520,000 lb.	573,000 lb.
Second test hinge.....	463,000 lb.	1,100,000 lb.

The cracks appeared both times in the concave block, in the middle axis of the blocks—that is, in the direction of the greatest pressure. As the blocks were 19.65 in. wide they received a pressure (in the arch) of $107,000 \times \frac{19.68}{12} = 175,000$ lb. The safety, up to the appearance of the first crack, was therefore $\frac{520,000}{175,000} =$ approximately 3, and $\frac{463,000}{175,000} =$ approximately 2.6, respectively. (Later tests for the bridge at Sauvage showed that *failure* determines the measure for the safety, and a safety of five to six could be assumed.)

Besides the described tests, cubes of the same mixture were tested which gave very high strength values (cubes 15½ in. side, 4450 lb. per square inch). For the bridge near Moulin a hard dolomite which had a rougher surface, and therefore afforded a better adhesion for the mortar, was used in place of the quartzite. Test cubes (11½ in. side) made of this concrete showed a compressive strength of 5120 lb. per square inch after 59 days and 6640 lb. per square inch after 87 days.

The limit of the applicability of concrete hinge blocks was concluded to be a hinge pressure of 135,000 lb. to 155,000 lb. per 1-ft. width of arch.

For the computation of rolling hinges of stone or concrete, three methods are in use—those of Köpke, Barkhausen, and Hertz—all of which are approximate methods in view of the assumptions made and the uncertainty of the modulus of elasticity, etc. Values for the crown hinge of the Moselle bridge near Hauconcourt, computed according to the three methods mentioned, are as follows:

Method	Compr. stress in the center of contact area (lb. per sq. in.)	Width of the contact area converted into a plane (in.)
Köpke.....	1466	9.08
Barkhausen.....	1722	5.84
Hertz.....	3260	3.48

The comparison of these results shows them to be quite different, according to the method employed, under otherwise equal assumptions.

The modulus of elasticity (E) has been taken at 200,000 kg. per square centimeter (= 2,844,640 lb. per sq. in.). The assumption of this E is of great influence on the stress to be computed.

Each one of the three analyses yields its own values for the greatest stress in the center of contact area and for the width of said area. The formulas derived by Hertz are the simplest ones for practical use. His analysis had been prepared originally for roller bearings of iron bridges (*Zeitschr. d. Arch. u. Ing. V. in Hannover, 1894, S. 135*) and has from there been taken over into stone and concrete construction.

Designating

- p = the hinge pressure for unit length.
- r_1 and r_2 = the radii of the cylinder surfaces in contact.
- E = the coefficient of elasticity.
- m = the ratio of elongation to reduction of cross-section of a prism in tension.

he finds the width b of the contact area due to the pressure p to be as follows:

$$b = 4 \sqrt{\frac{2p}{\pi E} \cdot \frac{1 - \frac{1}{m^2}}{\frac{1}{r_1} + \frac{1}{r_2}}}$$

and the greatest stress (pressure) in the middle of the contact area (directly under p) per unit area,

$$\sigma = \frac{4p}{\pi b}$$

that is, $\frac{4}{\pi}$ times as great as under uniform distribution of pressure.

The radii are to be taken positive or negative, as the centers of curvature are respectively inside or outside of the respective hinge block. The value of m may (for isotropic bodies) be assumed sufficiently accurate as $m = 3$. This gives the width of the pressed (flattened) surface as

$$b = \frac{16}{3} \sqrt{\frac{p}{\pi E} \cdot \frac{1}{\frac{1}{r_1} + \frac{1}{r_2}}}$$

and

$$\sigma = \frac{3}{4} \sqrt{\frac{pE}{\pi} \cdot \frac{1}{\frac{1}{r_1} + \frac{1}{r_2}}}$$

With one contact surface a plane, $r_1 = r$ and $r_2 = \infty$,

$$b = \frac{16}{3} \sqrt{\frac{pr}{\pi E}}$$

$$\sigma = \frac{3}{4} \sqrt{\frac{pE}{\pi r}}$$

The equations are homogeneous. It may be stated for guidance that the Hertz formula with

$$E = 200,000 \text{ kg. per sq. cm. (2,844,640 lb. per sq. in.)}$$

$$\sigma = 200 \text{ kg. per sq. cm. (2845 lb. per sq. in.)}$$

gives practical dimensions for concrete hinges.

It has been stated above that the hinge blocks under test commenced to fail by cracks along or parallel to the middle axis—an indication that the destruction occurred by the tensile strength crosswise being overcome. Bach, in his tests, came to the conclusion that the tensile stress perpendicular to the direction of the pressure is $0.28p$. The ultimate tensile stress per square inch of the hinge blocks tested to destruction of three of the Moselle bridges, when figured by this ratio, are 32.6, 34.3, and 36.7 kg. per square centimeter (463, 488, and 522 lb. per sq. in.) respectively.

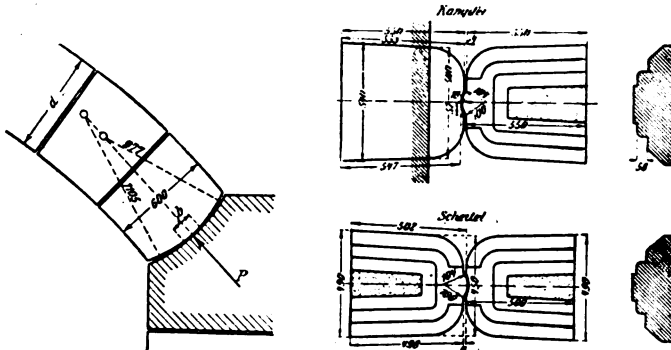

From "Handbuch für Eisenbetonbau."

FIG. 551.

FIG. 552.

FIG. 551.—Skewback hinge, Langenhennersdorf. (Used by Köpke in 1890.)

FIG. 552.—Granite hinges, Eyach bridge, near Imnau.

Examples.—Bridge near Langenhennersdorf (Fig. 551): three arches of 42.6-ft. span, 9.85-ft. rise, three hinges in each arch, thickness of arch at crown 19.7 in., at spring 23.6 in., skewback blocks concave with $1\frac{3}{8}$ -in. rise, the arch starters convex with $1\frac{3}{8}$ -in. rise, open joint at intrados and extrados about $\frac{3}{8}$ in., radius of the skewback block 3.53 ft., radius of the arch starter 3.21 ft., hinge blocks of sandstone.

Bridge across the Eyach near Imnau (Fig. 552): one arch of 98.5-ft. clear span between hinges, rise 9.85 ft., thickness of arch at crown 17.7 in., thickness of arch near spring 19.65 in., thickness of arch in the spandrel 31.3 in., width of bridge 4 m. (= 13.12 ft.), roadway 2.5 m. (= 8.2 ft.),

two walks—each 0.75 m. (= 2.46 ft.), arch 2.5 m. (= 8.2 ft.) wide at crown and 3.5 m. (= 11.5 ft.) at springs. The spring and crown hinges are of granite blocks, 0.5 m. (1.64 ft.) wide crosswise, set close together, with cylindrical polished contact surfaces 0.1 m. (= 3.94 in.) wide. Between the lead inserts and the blocks, copper sheets have been placed to prevent the lead being pressed into the pores of the stones. The blocks, prior to being set in place and after inserting the lead, were bolted up tight with iron bolts; these bolts were removed just before striking the centers. The blocks on the face of the arch were moulded to match the arch faces. The computation for a street roller and a uniform load of 360 kg. per square meter (= 73½ lb. per sq. ft.) gave a total crown thrust of 350,000 kg. (= 771,500 lb.) for the 2.5-m. (= 8.2 ft.) length of crown hinge; therefore the 1.64-ft. hinge blocks had each to transmit a load of 154,300 lb. $\left(\frac{771,600}{5}\right)$, corresponding to a pressure of

$$\frac{154,300}{(3.94)(1.64)(12)} = 1990 \text{ lb. per sq. in.}$$

The Saxon state railways have had especially favorable experience with concrete hinges in the construction of the four-track railroad bridge across the Elbe in Dresden (1894). The concrete arches of elliptical form have clear spans up to 31 m. (= 101.8 ft.). The skewback joints are arranged some distance above the springing line, where the joint is at an angle of about 60 degrees with the vertical. The thickness of the large arches is 1.1 m. (= 3.63 ft.) at the crown, 1.3 m. (= 4.27 ft.) at the skewback hinges, while the legs of the arch in the middle are 1.5 m. (= 4.93 ft.). The concave hinge blocks in the skewbacks are made of concrete with a radius of 3.2 m. (= 10.5 ft.), the mates with a radius of 2.5 m. (= 8.21 ft.).

Of late it has become common practice to reinforce the concrete hinge blocks, in order to prevent the splitting of the hinge blocks along the line of the greatest pressure. The reinforcing bars are placed crosswise to the direction of pressure, or in the shape of hooping. Fig. 554 shows the former arrangement—Fig. 553 the latter.

The lead plate inserts between sheet copper (to prevent the dangerous penetrating of the lead into the pores), as used in granite hinges (see Figs. 514 and 515) are only for the purpose of maintaining the mobility of the hinge—to act as a permanent lubricant, as it were.

182. Hinges of Lead and Asphalt-felt Plates.—Another device, though effecting only imperfect hinge action, is the insertion of lead plates. It has been used to quite an extent in Württemberg in the erection of large arched bridges.

Tests made by the Experimental Station of the Technische Hochschule in Stuttgart in regard to the permissible compressive stress of

lead, with cubes of 8 cm. (=3.14 in.) side showed that the ordinary cast lead could be loaded with 50 kg. per square centimeter (=712 lb. per square inch) for 26 hours without showing any change whatever. With a pressure of 72 kg. per square centimeter (=1023 lb. per square inch) it began to yield slowly.

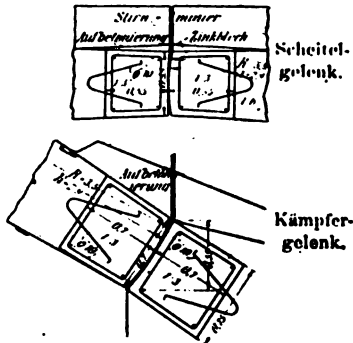

From "Handbuch für Eisenbetonbau."

FIG. 553.

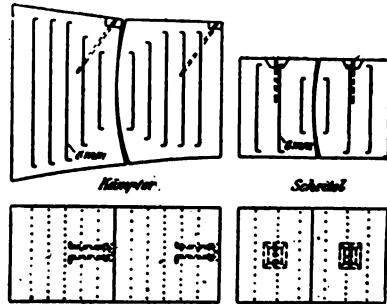

FIG. 554.

FIG. 553.—Reinforced-concrete hinges, bridge in Rothenburg.

FIG. 554.—Reinforced-concrete hinges, Friedrich-August bridge, Dresden.

Further tests were made later by Prof. Bach with cylinders of cast lead, with the following results:

No.	Height (in.)	Dia. (in.)	Area (Sq. in.)	Spec. gr.	Load in pounds per square inch at which the material	
					does not yield	yields (flows laterally)
1	2.77	1.39	1.51	11.37	655	727
2	1.47	1.39	1.52	11.36	840	983
3	0.40	1.37	1.48	11.35	1495	1795

These tests show that the pressure of the cylinder may be essentially raised from 655 to 1495 lb. per square inch when its height decreases from 2.77 in. to 0.40 in. Cast lead in disk form of about 6½ in. diameter and 0.59 in. thick could be loaded with 1422 lb. per square inch, while at 2133 lb. per square inch the lead flowed very slowly.

Thus disks of cast lead stand a far greater stress than cubes or cylinders. By admixture of antimony the *flow limit* moves up con-

siderably. Soft rolled lead in disk form showed similar qualities of strength. The durability and resistance of lead is not questioned.

The breadth of the inserted lead strips, which in the first bridge treated in this manner (1885) covered the middle third of the joint, was reduced as much as the stress of the lead permitted; by doing so the hinge

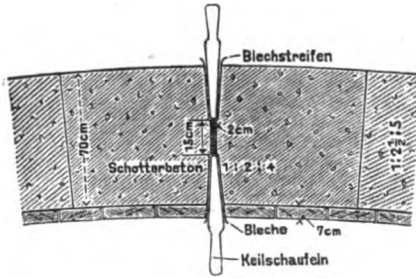

From "Handbuch für Eisenbetonbau."

FIG. 555.

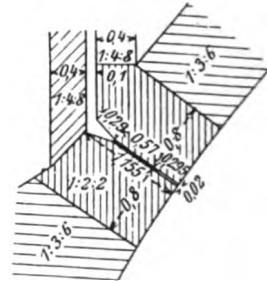
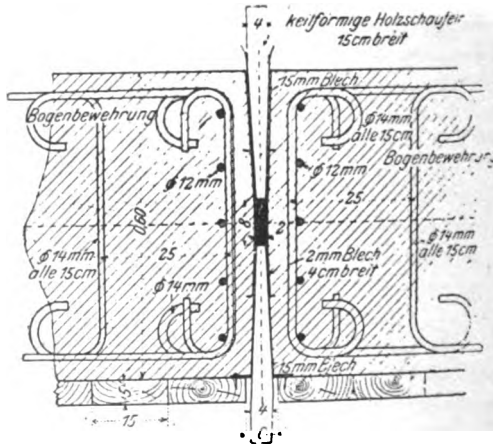

FIG. 556.

FIG. 555.—Lead plate hinge, Danube bridge, near Ehingen.

FIG. 556.—Hinges of side arch, Iller bridge, near Kempton.

action was improved and the course of the line of pressure was further confined. In one of these Württemberg bridges across the Danube near Ehingen—arch 7.5 m. (= 24.6 ft.) wide, middle span of 20 m. (= 65.6 ft.)



From "Handbuch für Eisenbetonbau."

FIG. 557.—Crown hinge in the end span of Strümpfelbach viaduct.

and 2.2 m. (= 7.22 ft.) rise, and 2 side spans of each 21 m. (= 68.6 ft.)—the crown and spring joints have lead plates of 15 cm. (= 5.9 in.) breadth, and 20 mm. (= 0.79 in.) thickness; the joints were grouted later on. The pressure on the lead plates is 73 and 83 kg. per square

centimeter (= 1038 and 1180 lb. per square inch) respectively. (See Fig. 555.)

The side arches of the railroad bridges across the Iller near Kempten have also lead plate hinges. The theoretical span of the arches is 18.5 m. (= 60.7 ft.), the rise 5 m. (= 16.40 ft.), and the thickness of the lead plates 8 mm. ($=\frac{3}{8}$ in.). (For other dimensions see Fig. 556.)

The Strümpfelbach viaduct (Württemberg), completed in 1909, has six semicircular reinforced arches of 15.2 m. (= 50 ft.) span each. The end arch, to compensate for any movements of the abutment, was built with three hinges. Hard lead plates of 8 cm. (= 3.15 in.) breadth, and 2 cm. ($=\frac{3}{4}$ in.) thickness were placed in the crown hinge (Fig. 557).

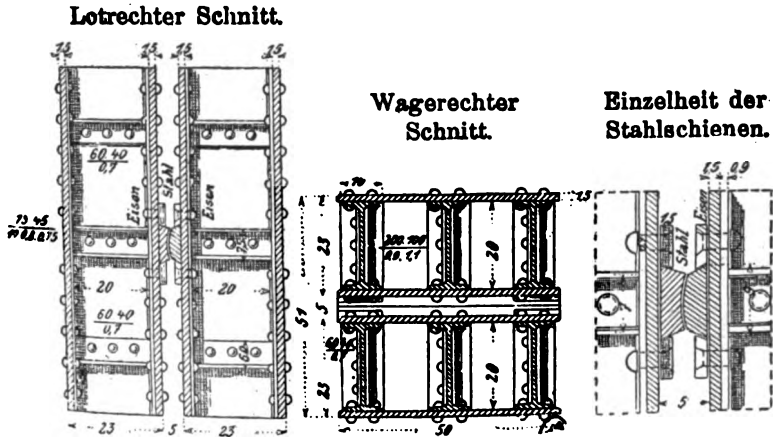

From "Handbuch für Eisenbetonbau."

FIG. 558.—Crown hinge in Danube bridge, Munderkingen.

A concrete bridge over the Westrach near Erbach (Württemberg), with a span of 29 m. (= 95.3 ft.) and a rise of 4 m. (= 13.13 ft.), had asphalt felt plates laid in through the full depth of the joint. The crown thickness was 50 cm. (= 1.64 ft.) and the greatest concrete stress 30 kg. per square centimeter (= 428 lb. per square inch.)

The firm of Maillart & Co. in Zürich also uses lead and asphalt plate hinges in the crown and spring joints.

183. Hinges of Iron.—The rolling hinges of cast steel may be considered as nearly perfect hinges, as they come nearest to offering no friction. They have an advantage over the stone hinges in requiring smaller radii, hence smaller contact surfaces, due to higher allowable compressive stresses. For this reason the friction is less, and the line of pressure is more precisely located. The placing into correct position of these hinges, however, is more difficult, and their cost is considerably

higher than concrete hinges, because naturally their fabrication and finish requires greater care.

Fig. 558 shows the iron crown hinge of the Danube bridge in Munderkingen. It consists of two steel bars of respectively concave and convex cylindrical bearing surfaces, mounted on riveted structural-steel chairs of box-girder shapes. These latter distribute the pressure acting upon the rolling surfaces over a larger area and then transmit it to the concrete. The width of arch, 7.5 m. (= 24.6 ft.), is carried by twelve steel plates 50 cm. (= 1.64 ft.) long, 70 mm. (= 2½ in.) wide and 25 mm. (= nearly 1 in.) thick—pressure on the base of the steel bearing plates being 659 kg. per square centimeter (= 9380 lb. per square inch).

The Reichenbach bridge and Maximilian bridge in Munich have cast-iron chairs into which cast-steel rolling pieces are fitted. The one

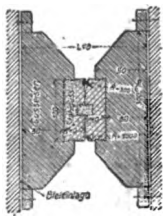

From "Handbuch für Eisenbetonbau."

FIG. 559.

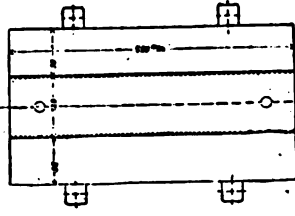

FIG. 560.

FIG. 559.—Crown hinge in Maximilian bridge, Munich.

FIG. 560.—Crown hinge in Isar bridge near Grünwald.

rolling surface is plane. Dowels prevent lateral displacement. (See Fig. 559.)

In the Isar Bridge near Grünwald the two component parts of the hinge are each of one steel casting. Dowels are provided against lateral displacement, of such cross-sectional area that they cannot be sheared by components of the hinge pressure (Fig. 560).

Noteworthy are the hinges of the Igelsbach and Laufenmühle viaduct, built in 1909. The hinge proper is of cast steel, placed upon reinforced-concrete blocks for distributing the pressure. The setting of the hinges was accomplished by carefully aligning the steel-hinge halves (bolted together) and by firmly holding them in place with the aid of angle bars, which permitted an immediate back filling and tamping with concrete. The fabrics for the reinforced-hinge blocks were placed as a whole into the forms. As a protection against entry of moisture the

joints are filled with impregnated cork plates. (For further details see Fig. 561.)

The computation of rolling hinges of iron is made by the "Hertz" formula (see Art. 181) on the assumption that the cylindrical bearing

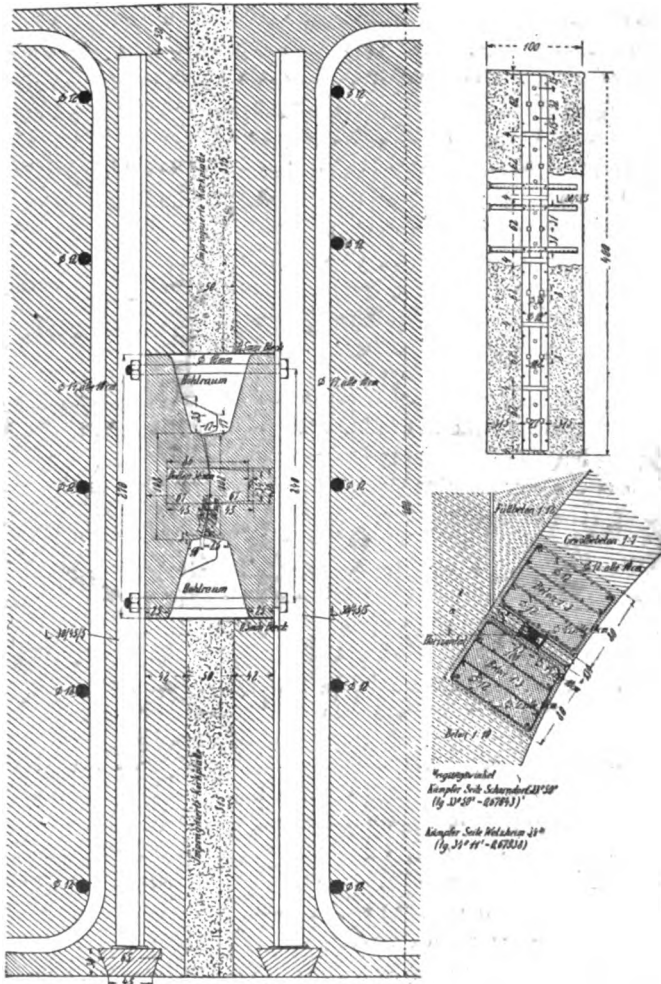

From "Handbuch für Eisenbetonbau."
 FIG. 561.—Skewback hinge in Igelsbach and Laufenmühle viaduct.

surfaces are in contact along a generating line. As the greatest pressure in a line is the condition considered (which pressure decreases immediately outside of said line, and any considerable flow of the material

is out of the question), far higher stresses of the material are admissible than otherwise customary. The following values may be taken: For cast iron, a compressive stress not to exceed 4 tons per square centimeter (= 57,000 lb. per square inch)—wrought steel 5.5 tons per square centimeter (= 78,300 lb. per square inch)—cast steel 7.0 tons per square centimeter (= 99,600 lb. per square inch).

Pin Bearings as Hinges.—The pin bearings consist of two cradles which half envelop a cylindrical pin between them, so that a rotation of the two cradles around the pin can take place. The cradles are either cast-iron or steel, the pin is always of steel.

The opinion, that pin hinges, on account of the high friction, are ineffective, has been refuted by tests of Föppl, which tests have proved an easy rotation around the pin.

Computation.—Assuming that actual contact as far as 45° to either side of the pin center takes place, and following Müller-Breslau's analysis, the condition for equilibrium becomes

$$P = \frac{5}{4} \sigma br.$$

where P = the hinge pressure in pounds.

r = radius of the pin in inches.

b = length of the pin in inches.

σ = the compressive stress (lb. per square inch) in the center of the contact surface.

Suppose $b = 1$ in., $r = 1\frac{1}{2}$ in. (pin 3 in. diameter), and $\sigma = 18,000$ lb. Then

$$P = \frac{5}{4} \times 18,000 \times 1 \times 1\frac{1}{2} = 33,750 \text{ lb.}$$

Assuming a distribution of the total hinge pressure upon the projection of the 180° arc of the pin (90° to either side of the pin center in lieu of 45° assumed above), and, moreover, assuming this distribution as uniform, upon which assumption pins are customarily dimensioned for "bearing value," the above pin would be dimensioned at a bearing stress of 11,250 lb. per square inch.

Or, taking another example, a pin figured for a bearing stress of 24,000 lb. per square inch (according to tables in use) will bear a greatest pressure at the rate of $\frac{5}{4} \times 24,000 = 38,400$ lb. per square inch along the line of greatest pressure. It seems worth while to call the attention of designers in steel to this analysis. Generally speaking, however, the computation of these pin bearings presents no problem new to engineers.

A number of varieties in the detail of these rotary pin bearings can be evolved. Refer to Figs. 562 to 567 inclusive for illustrations of executed work. In Fig. 565, bridge over the Jesenica creek, the crown hinge is entirely of steel, while in the case of the skewback hinge the upper

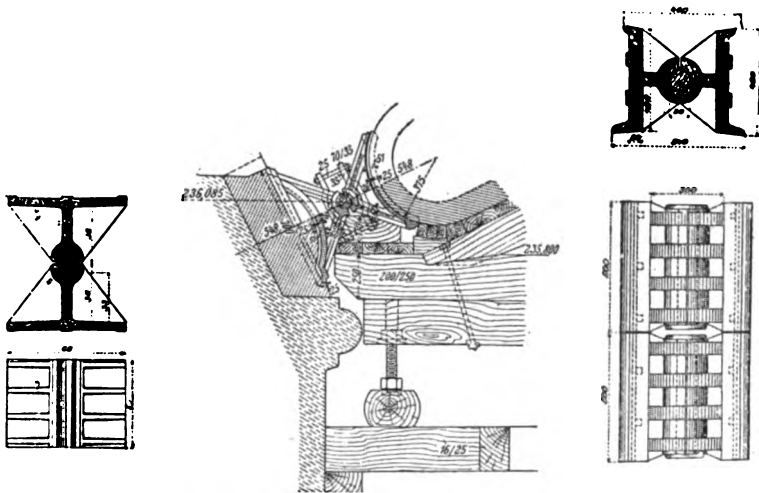

From "Handbuch für Eisenbetonbau."

FIG. 562.

FIG. 563.

FIG. 564.

FIG. 562.—Skewback hinge in Danube bridge.

FIG. 563.—Skewback hinge in Doller bridge near Burzweiler.

FIG. 564.—Hinge in railroad bridge, Wilmersdorf.

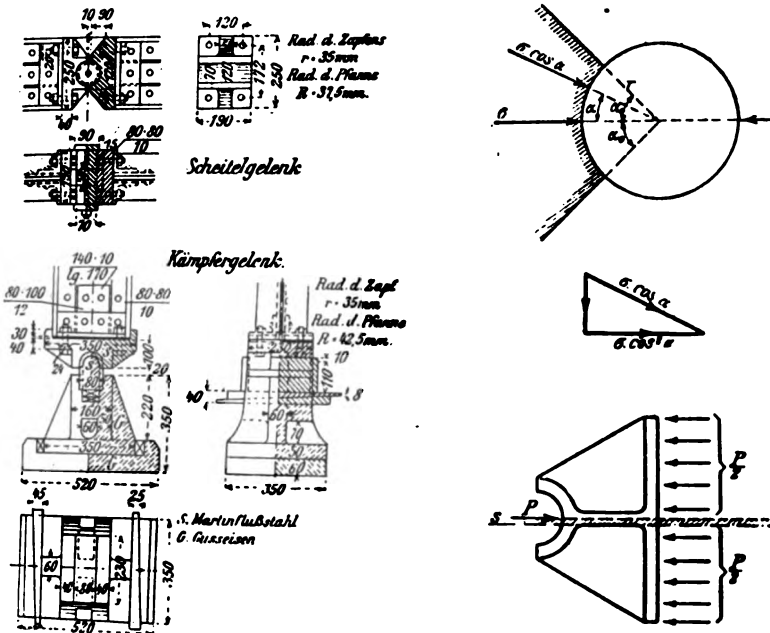

From "Handbuch für Eisenbetonbau."

FIG. 565.—Hinges in bridge over Jesenica Creek.

Ordinarily, the hinges in an arch are located at the springing lines and crown. In reinforced-concrete arches the sectional area at any one of these points may be so much reduced that it will offer only a very small

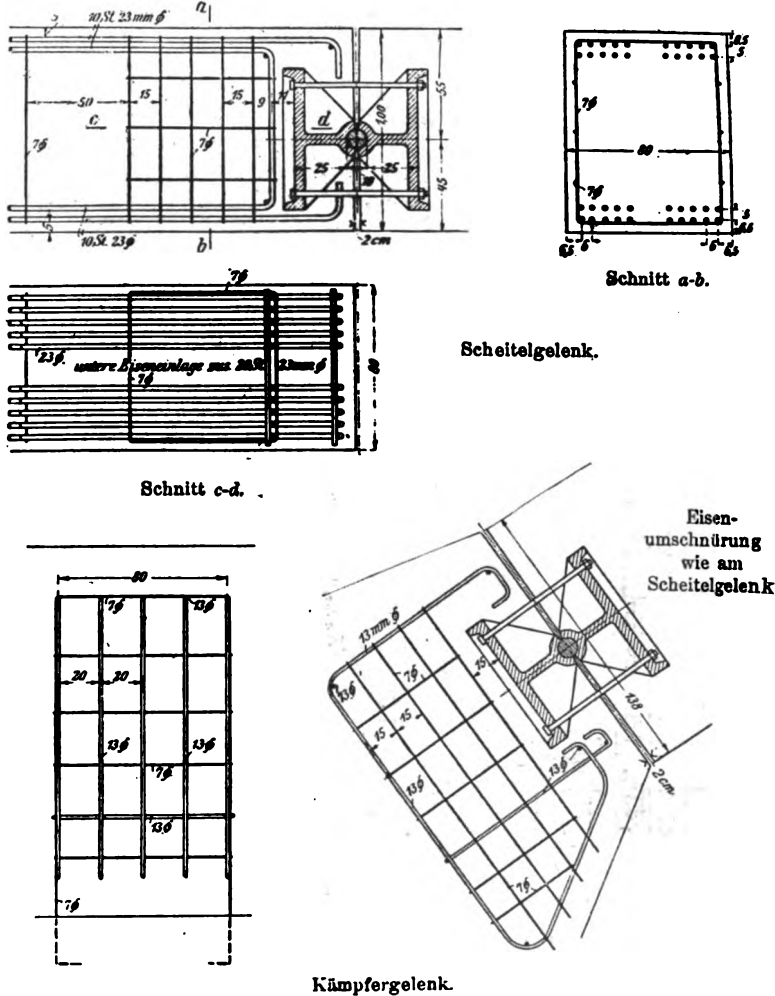

From "Handbuch für Eisenbetonbau."

FIG. 567.—Details of hinge of Niedernholzer bridge.

resistance to bending—so small a resistance in fact, that the distance between the pressure line and the center of the reduced section can be neglected, and under this assumption the reduced cross-section, becomes a hinge through which the line of pressure must pass in order to have

equilibrium between the external forces and the stresses in the arch. Any movement of either or both of the skewbacks, or of the crown, which causes a change of position of these hinges relative to one another, has to overcome the small resistance which the reinforcing bars offer to a very slight bending. By embedding the proper number and size of

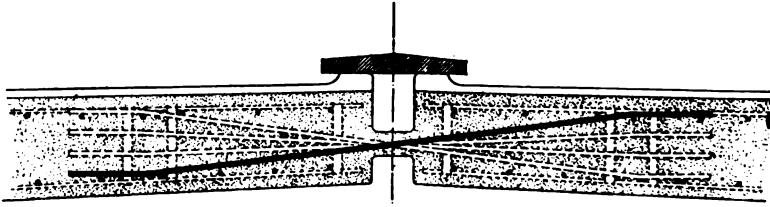
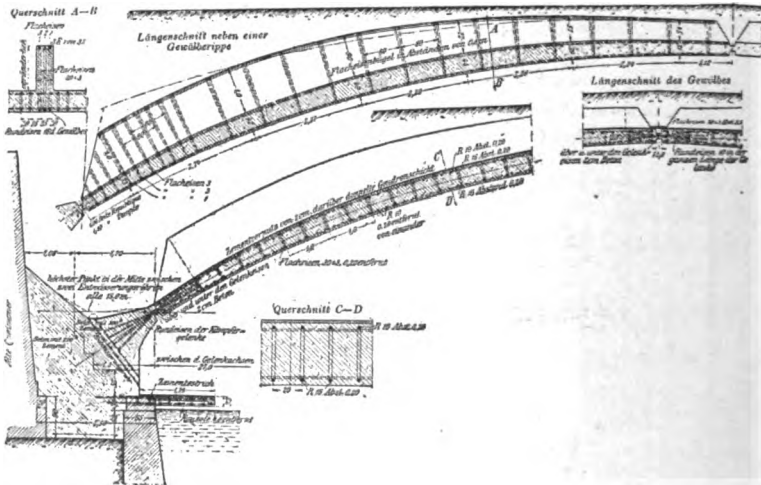

FIG. 568.—Crown hinge, Canal St. Martin, Paris.

steel bars required for the compressive stress to be transmitted from one side to the other of a hinge, the concrete arch at such points is really converted into a short segment of a steel arch of minimum depth in the plane of bending.



From "Handbuch für Eisenbetonbau."

FIG. 569.—Reinforcement details of the vaulting of a part of Canal St. Martin, Paris.

The hinge bars are grouped in the concrete in such a manner that they cross and pass through the reduced section (Figs. 568 and 572) thus affording a limited, though sufficient, amount of bending combined with great compressive resistance. Thus, the arch may readily alter its form and respond without injury to those deflections or movements which

always accompany construction due to foundation and falsework settlements, shrinkage, or temperature variation.

Inasmuch as these hinges depend upon the flexibility of round or square steel bars connecting the legs of the arch, or the arch with the abutments, the hinge action is imperfect to the extent of this resistance.

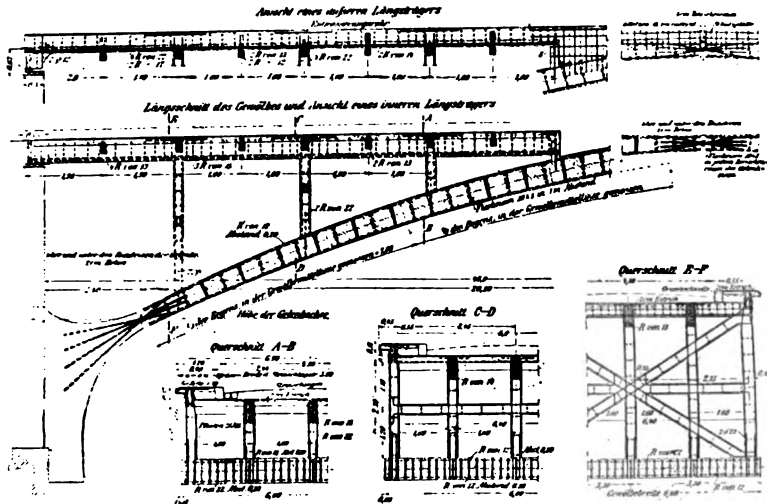

From "Handbuch für Eisenbetonbau."

FIG. 570.—Hinge and reinforcement details, bridge near Amélie-les-Bains.

The first use of this type of flexural hinge is found in the arched roof over the Canal St. Martin in Paris—a 90-ft. reinforced-concrete span. (See Figs. 568 and 569.)* Probable movements of the abutments were

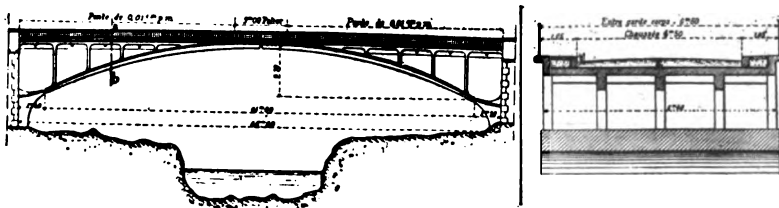

From "Handbuch für Eisenbetonbau."

FIG. 571.—Elevation and cross-section of three-hinged arch bridge over the Tech, at Amélie-les-Bains.

decisive for the adoption of three-hinge arches. Span between hinges 27.0 m. (= 88.7 ft.), rise 3.75 m. (= 12.3 ft.). The vault is 45 cm. (= 17.7 in.) at the quarter point, decreasing to 27 cm. (= 10.6 in.) at the crown, and 29 cm. (= 11.4 in.) at the skewbacks. The vault, however, is

* Reference: "Handbuch für Eisenbetonbau," 2. neubearbeitete Auflage, Band VI. Copyright, 1911, by Wilhelm Ernst & Sohn, Verlag, Berlin.

further strengthened by ribs in the extrados, spaced 13 m. (=42.7 ft.) apart, which were added at the demand of the authorities on account of the shocks of traffic loads. The depth of the embedment of the hinge bars was determined from the bond strength between the concrete and bars. By the French regulations of 1906 the allowable bonding stress was 4.48 kg. per square centimeter (=63.8 lb. per square inch), which

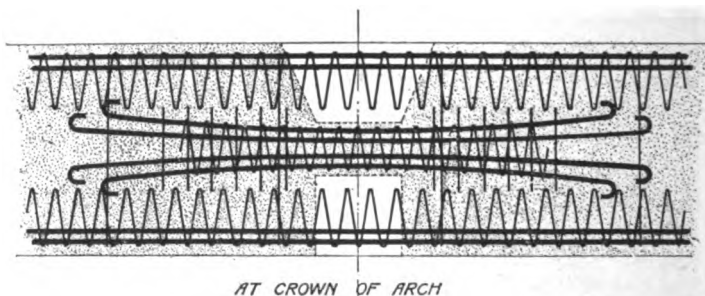
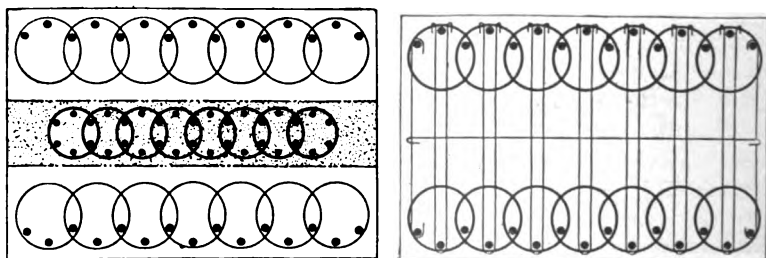

FIG. 572.—Detail of crown hinge, Chateau Thierry arch (Considère type).

gives the depth of embedment for round bars as $\bar{7}44.6d$. However, the hinges under discussion antedating said regulation were figured for 5 kg. per square centimeter (=71.2 lb. per square inch), which gave $1\bar{7}40d$. The crown hinges of Saint-Martin are bundles of 4–22 mm. ($=\frac{1}{8}$ in.) round bars, spaced at 14 cm. (=5.5 in.), embedded to 90 cm. (=2.94 ft.). The skewback hinges are bundles of 4–24 mm. ($=\frac{1}{4}$ in.)



SECTION THROUGH HINGE

SECTION OF ARCH NEAR CROWN.

FIG. 573.—Sections of Chateau Thierry bridge.

round bars, embedded 1.0 m. (=3.28 ft.). The four bars were tied together with band iron and put in place in bundles.

The bridge near Amélie-les-Bains (Figs. 570 and 571) is another example of flexural hinge structure—span 41.0 m. (=134.7 ft.) between hinges, rise 4.70 m. (=15.4 ft.), width of arch 6.40 m. (=21.0 ft.),

crown thickness 40 cm. (= 15.7 in.), at skewback 45 cm. (= 17.7 in.), at joint of rupture 65 cm. (= 25.6 in.). Though the span is greater than the Saint-Martin canal vault, practically the same type of hinges could be used; only the size of the bars was larger—27 mm. ($=1\frac{1}{4}$ in.) at the crown, 28 mm. ($=1\frac{1}{3}$ in.) at the skewbacks. The reason for these nearly equally-strong hinges was the much smaller dead weight, a light open superstructure as against a heavy backfill in the Saint-Martin.*

Stone, lead-plate, and asphalt-plate hinges have been built by German engineers for some years, in connection with stone masonry arches; after completion of these arches the joints were filled in to produce a fixed arch. To Considère, however, is due the credit of converting the

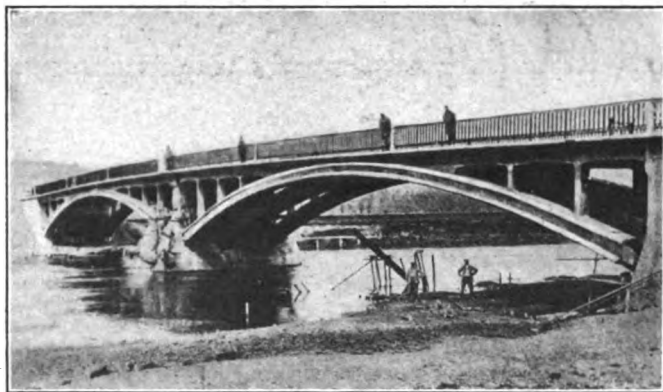

FIG. 574.—Chateau Thierry bridge. (Note hinge spaces open.)

flexural hinge concrete arch into a fixed arch by completing the concrete work in the reduced sections, after the completion of the arch and the removal of the centering. This latest type of the flexural hinge, as used by the Considère Construction Co., is shown in Figs. 572 and 573. Figs. 574 and 575 show the hinges used in connection with the bridge at Chateau Thierry.

In this later type the regular upper and lower reinforcement of the arch is continuous through the gap of the hinge—the flexural hinge itself being a special insert of reinforcing bars, similar to the arrangement previously described and illustrated. The concrete at the hinge is placed and shaped, as shown by Figs. 572 and 573. The action in this hinge during the deflection of the centering and at its removal must be assumed to be (for the crown-hinge) a buckling of the exposed upper bars, making them ineffective, a compressive resistance of the (central)

*Reference: "Handbuch für Eisenbetonbau," 2. neubearbeitete Auflage, Band VI. Copyright, 1911, by Wilhelm Ernst & Sohn, Verlag, Berlin.

hinge bars, and a tensile resistance of the exposed lower bars. At the spring hinges the exposed upper bars would offer tensile resistance and the exposed lower bars would be buckled and become ineffective. The action of this temporary hinge would include a *resisting moment* by a section of only half the effective depth of the arch, as long as the tensile stress in the lower or upper bars is within the elastic limit. When the

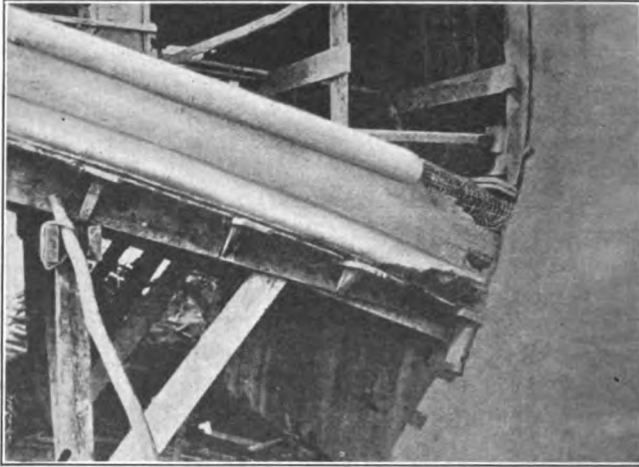

FIG. 575.—Portion of Chateau Thierry bridge. Armouring exposed (before filling).

elastic limit is exceeded, the only action of the hinge would be the transmission of the thrust (by the hinge bars), and the line of pressure would pass through the hinge. After the centers are struck and movements have come to a stop, the concreting of these hinge gaps is completed to make the arch continuous and fixed. Figs. 574 and 575 show these hinges still open with centers in place (Fig. 575) and with centers removed (Fig. 574). The filling in is done subsequently.

APPENDIX

General Notation Used in Part I

l = span of arch axis.

E_c = modulus of elasticity of concrete.

E_s = modulus of elasticity of steel.

$$n = \frac{E_c}{E_s}$$

Deflection (curved beam or arch with one end fixed and one end free):

k = total angular change of tangent to axis at free end.

k' = angular change at free end caused by bending of a single element.

Δx = total horizontal deflection of free end.

dx = horizontal deflection of free end caused by bending of a single element.

Δy = total vertical deflection of free end.

dy = vertical deflection of free end caused by bending of a single element.

Divisions of the arch ring:

G = elastic weight of an element.

n = number of elements or divisions in the entire arch.

n_h = number of elements or divisions in one-half the arch.

s = length of an element or division measured along the axis.

At crown:

H_c = thrust.

V_c = shear.

R_c = resultant of H_c and V_c .

M_c = bending moment.

At any point on the arch axis with coördinates x and y :

N = thrust (normal) on radial section.

S = shear on radial section.

R = resultant force on radial section, resultant of N and S .

x_e = eccentricity of thrust on section, or distance of N from arch axis.

t = total depth of section.

b = width of section.

I_c = moment of inertia of concrete section about arch axis.

I_s = moment of inertia of steel section about arch axis.

I = moment of inertia of section (including steel) about arch axis = $I_c + nI_s$.

a_c = area of concrete section.

a_s = area of steel section.

A = area of section including steel = $a_c + na_s$.

ρ = radius of gyration of section = $\sqrt{\frac{I}{A}}$

p_s = steel ratio for total steel at section.

k = ratio of depth of neutral axis (from compression surface) to total depth t .

d' = depth of embedment of steel from both upper and lower surfaces.

f_c = maximum compressive unit stress in concrete (at upper or lower surface).

f'_c = unit stress (sometimes tension) in concrete at surface opposite to f_c .

f_s = tensile unit stress in steel.

f_e = unit stress at extrados.

f_i = unit stress at intrados.

L = coefficient in formula $f_c = \frac{M}{Lbt^2}$.

K = coefficient in formula $f_c = \frac{NK}{bt}$.

K' = coefficient in formula $f'_c = \frac{NK'}{bt}$.

M = moment = Nx_o .

m_L = moment at any point on left half of arch axis of all external loads between the point and the crown.

m_R = moment at any point on right half of arch axis of all external loads between the point and the crown.

m = moment at any point on either half of arch axis of all external loads between the point and the crown.

Temperature:

t_c = coefficient of linear expansion.

t_D = number of degrees rise or fall in temperature.

Rib Shortening:

c_s = average unit compression in concrete due to thrust.

INDEX

Numbers refer to pages

- Abutments, arch, 10-14, 54-57, 142, 143, 147, 178
- Analysis, arch (see *Table of Contents*)
arch culvert, 449, 450
box culvert, 440-446
pipe culvert, 430-432
- Antipolar, definition of, 115
- Antipole, definition of, 115
- Arch bridges (see *Table of Contents*)
- Arches, analysis (see *Table of Contents*)
classification of arch rings, 19
construction of, 182-228
definitions, 2, 3
division for constant $\frac{s}{l}$, 32-34, 48
intrados curves, 3-6, 9, 10
loads, 14-18
method of procedure in design, 42, 43
thickness of arch ring, 18, 19
unsymmetrical, 86-95
with elastic piers, 96-106, 148-156
- Artistic design, harmony, 499-507
main features in, 496-507
ornamentation, 508-527
present status of the art, 493-495
principles of, 496
proper use of material, 496, 497
style, 498, 499
symmetry, 497, 498
- Cantilever bridges, examples of, 404-409
theory of design, 403, 404
- Cantilever flat slab, 377-379
- Centers, steel, 218-223
suspended, 224-228
timber, 198-218
- Circular arch, definition of, 116
- Circular culverts, 436
- City bridges, artistic design of, 493
- Conjugate diameters (axes), definition of, 116
- Construction, arch bridges, 182-244, 252, 253, 529-574
arch culverts, 452
arch forms, 228-244
arch ring, 182-195
beam and girder bridge, 593-605
box culverts, 446-448
centering, 196-228
North Samuels Avenue viaduct, 593-605
pile trestles, 575-584
plant (see *construction plant*)
steel centers, 218-223
suspended centers, 224-228
timber centers, 198-218
track-elevation subways, 585-592
Tunkhannock viaduct, 548-574
Yardley bridge, 529-547
- Construction plant, barrows, 470
471
carts, 470, 471
handling materials, 453-461
hand mixing, 462-464
hoists, 476-478
machine mixing, 464-469
mixing, 462-469
spouting plants, 471-476
transporting concrete, 470-478
- Crown, definition of, 3
depth of filling over, 14
- Culverts, arch, 449-452
box, 437-448
circular culverts cast in place, 436
construction of box, 446-448
design of cross-section, arch, 449, 450

- Culverts, design of cross-section, box,**
 440-446
 pipe, 430-432
 design of ends, 419, 420
 efficiency, 417, 418
 factors in design, 417-420
 forms of box, 438, 439
 length of, 419
 loading on box, 439, 440
 pipe, 421-436
 pressure in trenches, 422-430
 strength of pipe, 430-434
 typical estimate of arch, 490, 491
 waterway required, 418
- Deck girder bridges, 380-390**
Definitions, arch bridges, 2, 3
Deflection of arch, 41
Deflection of curved beams, angular change, 20-22
 components of deflection, 22-24
Design, abutments, 54-57, 66, 142, 143, 147, 148
 arch culvert, 449-450
 artistic, 493-527
 box culvert, 440-446
 culvert ends, 419, 420
 earth-filled arch, 44-66
 method of procedure in arch, 42, 43
 pipe culvert, 430-432
 three-hinged arch, 260-268
Designing sheets, arches with elastic piers, 101, 105
 earth-filled arch, 58-66, 144-147
 method of influence lines, 73-85
 unsymmetrical arch, 90-95
Designs, typical arch bridge, 285-355
Details of arch bridges, 157-181, 254-259, 286-355
 abutments, 178
 culverts (see *Table of Contents*)
 ornamental, 178-181
 piers, 178
 railing, 178-181
 slab and girder bridges (see *Table of Contents*)
- Details of arch bridges, spandrel, 157-177**
 three-hinged arches, 254-259
Diameter of ellipse, 115
Drainage, 167-171
- Elastic piers, arches with, 96-106, 148-156**
Elastic theory, fundamental formulas, 20-24
 Janni method of analysis, 107-156
 method of the ellipse of elasticity, 107-156
 reliability of, 42
 Turneure-Maurer method of analysis, 25-32, 41
Elastic weights, definition of, 108
 moments and products of inertia of, 121-124
Ellipse-of-elasticity method of arch analysis, 107-156
Ellipse, properties of, 114-117
Elliptical arch, curve of, 5, 6
 definition, 4
Estimating, bridges, 479-489
 culverts, 490, 491
European bridges, economic element, 659-661
 esthetic element, 636-659
 European vs. American practice, 608-661
 scientific element, 610-636
Expansion joints, 5, 7, 171, 176
Extrados, definition of, 3
- Flat slab, 377-379**
Forms, arch, 228-244
 arch culverts, 452
 box culverts, 446-448
 piers, 228-236
 railing, 239, 242-244
 walls, 228-239
Formulas, arch, 28-32, 60, 71, 87, 90, 91, 101
 curved beams, 20-24
Girder bridges, 380-409
 cantilever, theory of, 403, 404
 examples of, 404-409

- Girder bridges, construction in detail of typical structure, 593-605
- continuous, details of design, 394, 395
 - durability of monolithic construction, 394
 - examples of typical bridges, 395-402
 - simple, deck, 380-390
 - through, 390-393
 - typical estimate, 485-489
- Handrail, 178-181
- Haunch, definition, 3
- Highway bridges, artistic design of, 494
- Hinges, 250-252, 662-682
- Hoists, 476-478
- Influence lines, advantages of using, 67
- arch analysis using, 67-85
- Internal temperature investigations, 34-38
- Intrados, curve of, 3-6
- definition, 3
 - parabolic, 6
 - semi-elliptical, 5, 6
 - three-centered, 4
- Loads, arch bridges, 14-18, 34, 45, 46
- box culverts, 439, 440
 - pipe culverts, 422-430
 - slab bridges, 357
- Materials, handling of, 453-461
- Maximum stresses, arch, 53, 54, 65, 79, 81, 82, 140-142
- diagrams for finding, 70, 84, 85
 - formulas for, 65, 71, 80, 129
- Mixing, hand, 462-464
- machine, 464-469
- Moments and thrusts, arch formulas for, 28-32, 60, 71, 87, 90, 91, 101
- values of, 48-53, 92-95
- Multi-centered arch, definition, 4
- three-centered curve of, 4
- Notation, arch, 27, 28, 99, 100, *Appendix*
- Ornamental details of arches, 178-181
- Ornamentation, abutments, 509
- arch ring, 509-513
 - pedestals, 524, 525
 - piers, 508, 509
 - pilasters, 513, 515
 - purpose of, 508
 - railing, 517-524
 - retaining walls, 515
 - spandrel coping, 515-517
 - spandrel walls, 509-513
 - special features, 525-527
- Parabolic arches, curve of, 6
- definition, 4
- Patents, in general, 269-271
- litigation, 281-283
 - pertaining to arch bridges, 271-281
- Piers, arches, 10-14, 178
- elastic, 96-106
 - forms for, 228-236
- Pipe culverts, 421-436
- Pipe, strength of, 430-434
- Polar, definition of, 115
- Pole, definition of, 115
- Railing, 178-181
- Reinforcement in arch rings, 2
- Right arch, definition, 3
- Rise of arch, definition, 3
- Sand box, 216
- Segmental arch, definition, 4
- Semicircular arch, definition, 4
- Semi-elliptical arch, curve of, 5, 6
- definition, 4
- Shrinkage stresses due to setting, 38-41, 140
- Skew arch, definition, 3
- method of analysis, 43
- Skewback, definition, 2
- Slab bridges, cantilever flat-slab construction, 377-379

4-25-18

- Slab bridges, concrete pile trestles, 370-374, 575-584
 of multiple spans, 370-379
 of single span, 364-369
 pier trestles, 374-377
 track-elevation subways, 377, 585-592
 trestles with framed bents, 377
 under concentrated loading, 358-364
- Slabs (see also *slab bridges*)
 on steel bridges, 410-413
- Soffit, definition, 2
- Span, definition, 3
- Spandrel, arrangement of, 6, 7
 definition, 3
 details, earth-filled arch bridges, 157-176
 open-spandrel arch bridges, 176, 177
 walls, design of, 57
 forms for, 238, 239
- Spouting plants, 471-476
- Springing line, definition, 3
- Stresses in arch, 53, 54, 65, 79, 81, 82, 140-142
 diagrams for finding, 70, 84-85
- Stresses in arch, formulas for, 65, 71, 80, 129
- Symmetrical arch, analysis of, 25-43, 67-85, 107-129
- Temperature investigations, 34-38
- Three-hinged arches, 245-268
 design of, 260-268
 details of design, 254-259
 methods of analysis, 245-250
 methods of construction, 252, 253
 types of hinges, 250-252
- Through girder bridges, 390-393
- Thrusts, arch (see *moments and thrusts*)
- Trestles, pier, 374-377
 pile, 370-374, 575-584
 with framed bents, 377
- Unsymmetrical arches, examples of
 computations, 88-95
 method of analysis, 86-88
- Walls, spandrel, 57, 157-177, 238, 239
 design of, 57
 forms for, 228-239

3-215
477
12

