

Bookbinding for beginners

Florence Ordway Bean, John C. Brodhead

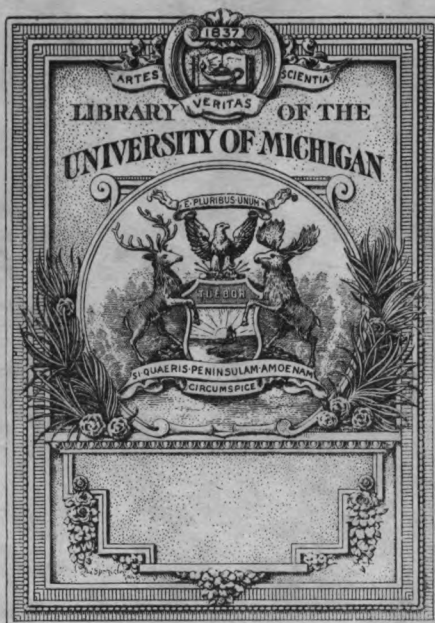

BOOKBINDING FOR BEGINNERS

By FLORENCE O. ^{rdway}BEAN

Assistant in Manual Arts
Boston Public Schools

JOHN C. BRODHEAD

Assistant Director of Manual Arts
Boston Public Schools
Collaborating

PUBLISHED BY
SCHOOL ARTS PUBLISHING COMPANY
BOSTON, MASS.

Copyrighted 1914
SCHOOL ARTS PUBLISHING COMPANY

INTRODUCTION

THE present day demand for industrial education has had the effect of somewhat discrediting the more formal manual training commonly found in the upper elementary grades and early high school years. This work is usually conducted in special shops and by special teachers, and the question is being raised whether, with all these advantages, more vital results might not be attained.

Whether these criticisms are justified or not, the present interest in industrial education is strengthening the demand for more effective construction work in grades four, five and six. It is a growing conviction that there must be laid, in the earlier grades, a strong foundation on which to build a practical education in the later grades whether directed toward industrial, commercial or professional life.

The appearance of this book, therefore, is timely because it outlines a course suitable for grades five and six which stimulates constructive activities and develops industrial intelligence. It should be noted that its industrial significance is much wider than its title, "Bookbinding for Beginners," would indicate, as even a hasty examination of the book will show, and also that it is so planned that it may be used successfully in schools where special teachers and expensive equipments are impossible.

The book is different from, and, I believe, superior to others of its kind for the following reasons:

First, because the projects it presents, the methods it advises, and the results it anticipates have all been worked out by actual experience with thousands of boys and under conditions which may be duplicated in almost any school-room. The author's personal experience with the problems

incident to the giving of manual training by the grade teacher includes that which she gained as a successful grade teacher herself, supplemented by some years of supervisory work in a large city system. She is therefore conversant with every possible phase of the school problem.

Second, because the methods of instruction which the book employs are such as to develop in the pupils the very qualities which are the surest foundation for subsequent success in manual or mental work of any kind, namely initiative and originality combined with intelligent, logical, careful attention to details.

Third, because it gives the teacher just the help needed to save her from all unnecessary work in securing and handling suitable material, in stimulating the pupils to intensive activity and self-expression, and in judging or measuring the results of her work, without relieving her of the necessity of intelligent effort on her part. It thus gives the overburdened teacher the maximum help, and the specially interested, the maximum opportunity for original supplementary work.

For the above reasons, I confidently recommend the volume to the attention of all who are seeking to introduce an inexpensive but effective form of manual training into the middle grades of the elementary schools.

Frank M. Leavitt

Associate Professor, Industrial Education.
University of Chicago.

FOREWORD

THE growing demand for various forms of manual training in the lower elementary grades has led to the publication of this little volume of "problems in elementary bookbinding," based on the work done in the fifth grade of the Boston public schools, where their practicability has been fully demonstrated. Some of the most valuable suggestions have been obtained from the teachers and are an outgrowth of their class-room experience. Nothing is here presented which is simply theoretical.

To Mr. John C. Brodhead, a deep appreciation of his keen criticism, his helpful suggestions, and his never-failing interest cannot be too strongly expressed. For their valued suggestions, thanks are due the teachers of Boston whose efficient labors have insured the success of the course. Acknowledgment is also made of indebtedness to the Sloyd Training School for material, and to Miss Helen E. Cleaves and Mr. Ludwig Frank for their interest and assistance in the details pertaining to design.

THE AUTHOR.



BOOKBINDING
FOR BEGINNERS



AMONG the various materials which lend themselves readily to a manual training course with large classes are those of the bookbinders' craft. They are inexpensive, easily handled, and require no tools or equipment that cannot be used in an ordinary class-room. The operations necessary in the use of these materials not only give excellent training in manual dexterity, but present remarkable opportunities for the practical application of studies in proportion, space division, color, lettering and applied design. The craft itself is one that comes in touch with everyday life and any skill acquired in the use of these materials is of permanent value.

The lessons to be outlined in the following series presuppose some instruction in paper-folding, cardboard construction, and simple mechanical drawing. Though desirable, this is not essential. While in some ways better suited to the middle grades of the elementary schools, selection may be made from the lessons here outlined which will give excellent training to the upper grades in those schools where the curriculum does not include shop-work, cooking, or sewing.

To secure this flexibility of the course, each problem is outlined in several ways, with varying degrees of difficulty. The selection should depend upon the grade in which it is to be given. Some of the more dexterous pupils may be able to work out a problem in several ways.

In each lesson outlined, there is a chance for the exercise of individuality in the details of the model as to size, shape, decoration, and color. Concerning choice of material, it seems wiser that this should be exercised by the teacher or supervisor rather than by the pupil.

The object of the course is educational, not industrial, therefore, those methods which stimulate inventiveness, ability to plan simple work, and dependence on one's own initiative are most desirable.

The directions given under each problem have been so worded that they call for the greatest amount of thought and initiative on the part of the worker. The use of such instruction develops power to think, to plan constructive work and to carry it to completion. At first, it may be necessary for the teacher to elaborate some points especially in connection with the working drawings or sketches, but after a little training, each pupil should be able to lay out and cut all parts from his own drawings; as the work progresses, he should depend less and less upon the teacher's assistance in making his plans.

High standards of work and correct processes should always be set before the pupil, and these are best assured by the teacher becoming thoroughly conversant not only with the general construction of an article to be made, but with the best methods of securing neat and accurate results. Eventually, the pupil's mental attainments will show in the tangible work of his hands.

Two hours each week for one school year may profitably be devoted to this work. It is advised that in the intermediate grades no attempt be made to sew a book on a frame, nor more than one book without a frame. In the upper grades some of the easier problems should be omitted.

EQUIPMENT

This equipment is sufficient for the whole course and should last for several years. A strong, wooden box with compartments insures an orderly arrangement of tools and prevents breakage. Several rooms may use one equipment and by means of the box, transportation is greatly facilitated. Some system of distributing and collecting material should be devised, and not more than five minutes consumed in making preparations for work.

One for each pupil

Rule

Pr. 6-inch Scissors

Pencil, medium

Tapestry Needle, No. 17

Wooden Triangle, 45°, 7-inch

For class use, the number to be governed by the way in which they are to be used, by the amount of money to be expended. For twenty-five pupils, 12 paste-brushes and 5 punches answer very well.

Paste-brushes 1 inch flat

Eyelet Punches

One of each helpful, but not necessary

Paper Cutter, 12 inch to 15 inch

Straight Edge

Large Shears

MATERIALS

The materials necessary for this course may be purchased from any of the large school supply houses, or from dealers in bookbinders' supplies. Before an order is given, it is recommended that the materials be seen, at least in sample, as names sometimes vary in different commercial houses. The sizes and prices are also liable to variation. In selecting colored papers, avoid brilliant hues, and choose soft colors.

	Approximate size	Approximate cost
FOR STIFF FOUNDATION		
Newsboard	26" x 38"	\$1.25 per bundle
<p>Newsboard is in reality a box board, and differs from binders' board in the quality of the fiber. But for such articles as are described in this course, it is the more satisfactory of the two. Both newsboard and binders' board are sold in bundles each weighing 50 lbs. The board is numbered according to the number of sheets in the bundle. Thus No. 50 means that the bundle contains 50 sheets. Board of this number is light in weight, easily handled by small children, and is well suited to the articles here described. Most book covers are made of No. 30 (30 sheets to the bundle), which is twice as thick as No. 60. The sheets of newsboard are rather large to be handled conveniently. If desired, they will be cut in quarters by the dealer at slight expense.</p>		
FOR COVERING FOUNDATION		
Vellum de luxe	38" wide	12c to 15c per yd.
<p>Vellum de luxe is a sized and tinted cloth of an inexpensive grade of cotton, which is quite suitable for the purposes of this course. If material of a higher grade is desired, art canvas (21c per yard), art vellum (17c per yard), etc., may be purchased. These come in a great variety of colors. It is better to use but one color in the class for economy's sake, but, if this is not to be considered, different articles may be of different colors. Choose quiet colors such as "old blue," "dull green," "deep red."</p>		
Cover Paper (light weight)	22" x 28"	\$1.25 per 100 shts.

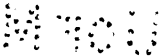

MATERIALS

	Approximate size	Approximate cost
FOR LINING		
Marbled Paper	20" x 25"	1c per sheet
Bark wove Paper	24" x 36"	1½c per sheet
FOR LIMP COVERS		
Screenings	24" x 36"	½c per sheet
Cover Paper	22" x 36"	\$1.25 per 100 sheets
Kraft Paper	24" x 36"	\$1.00 per 100 sheets
Drawing Paper (gray)	9" x 12"	50c per ream
Red Rope manila	24" x 36"	2½c per sheet
Oak tag stock	9" x 12"	25c per 100 sheets
Tough check	22" x 28"	12c per sheet
FOR INSIDE		
Page Paper	17" x 22"	8½c per lb
Page Paper	8½" x 11"	8½c per lb
Drawing Paper (white)	9" x 12"	80c per ream
Drawing Paper (gray)	9" x 12"	50c per ream
Drawing Paper (man.)	9" x 12"	40c per ream
Newspaper (white)	6" x 9"	13c per 1000
FOR STITCHING AND SEWING		
Linen Thread	40 yds. to skein	5c per skein
Silk	4 yds. to skein	5c per skein
Raffia (plain)	4 oz. package	10c per pkg.
Raffia (colored)	4 oz. package	10c per pkg.
ACCESSORIES		
Eyelets	250 in box	10c
Purchase eyelets of the same make as the eyelet punch (see list of equipment), since those of a different make are not always an exact fit.		
Macreme cord	8 oz. ball	15c per ball
Tape (white)	4 yds. in a piece	4c per piece
Tape (colored)	10 yds. in a piece	15c per piece
Stay Tape (cloth)	¾" wide	45c per 100 yds.
" " (paper)	¾" "	8c " " "
" " (cloth)	1" "	55c " " "
" " (paper)	1" "	10c " " "
" " (cloth)	1¼" "	65c " " "
" " (paper)	1¼" "	12c " " "
Super	1 yd. wide	8c per yd.
Bookbinder's Twine	½ lb. ball	25c per ball.
Head Bands	Different widths	35c to 50c per piece, 12 yds.
Gummed Tissue	Roll or Envelope of 5 or 6 yds.	10c

Problem I

BOOKLET

TIME: 4 hours.

MATERIALS: For the inside, any of the paper so listed.

For the cover, any of the paper so listed.

For stitching, any material so listed.

The simplest form of a book consists of a cover and inside sheets in a single fold, sewed through the center. Choose materials from the lists given.

Three definite methods of working out this problem are here outlined, arranged in the order of their difficulty. Other combinations will suggest themselves.

METHOD A. First determine the purpose for which the booklet is to be used, and decide on shape and size of page best suited to this purpose. If for spelling or pocket memoranda, it may be long and narrow; if for language a larger page is desirable; or if for map work, the size and shape of the maps should be considered. Take any sheet of paper and experiment in folding to obtain satisfactory size and proportions.

A single sheet of paper folded through the center is called a folio. This sheet will be twice the width of a page and of the same length. (Commercially, a folio is made from paper varying from 22 x 16 to 44 x 32. Therefore, books to which this term is applied are generally of large size.)

With pencil and rule draw a plan of the open folio and properly dimension the drawing. (See Plate I.)

If there has been no previous training in simple mechanical drawing, the use of extension and dimension lines, arrow heads, and the proper placing of figures should be explained. If some proficiency in this kind of drawing has been acquired, a freehand sketch may take the place of an accurate drawing.

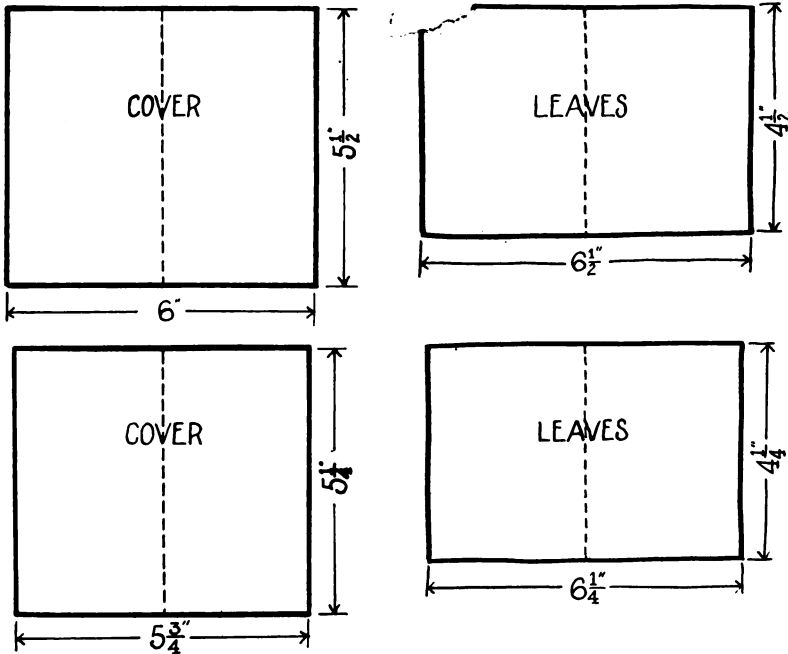

PLATE I. Accurate working drawings and freehand sketches such as children should produce before making the booklet.

Plate II shows some of the line conventions used in making a working drawing.

In the same manner as for the pages, draw a plan of the cover, which should project beyond the pages from $\frac{1}{8}$ to $\frac{1}{4}$

CONVENTIONS FOR WORKING DRAWINGS.

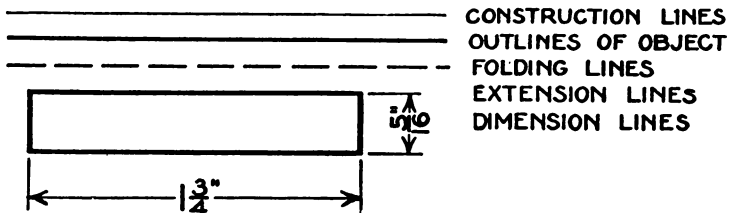

PLATE II. Line Conventions.

of an inch. Lay out and cut the cover and one sheet for the inside, keeping carefully on the lines.

Having cut one sheet of the inside, lay the sheet on as many pieces of the paper as are needed, (from three to seven make a booklet of desirable thickness); then make a hole with a pin or needle at each corner, piercing all at one time. On each sheet draw the four sides, using rule and pencil. This is easier than to measure each one. The folded sheets should be placed one inside the other to form the

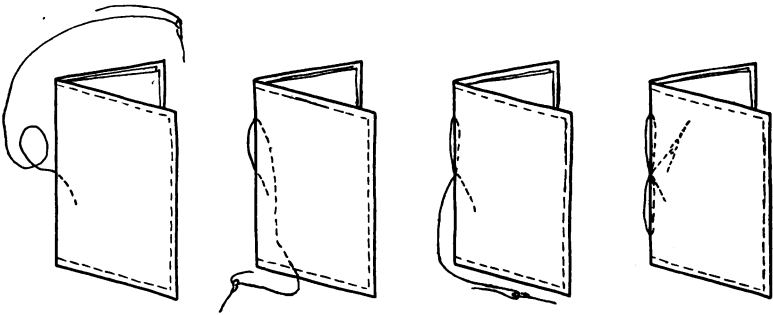

PLATE III. Sketches illustrating a simple method of stitching a booklet.

inside of the booklet, and the whole placed inside the folded cover, with the edges of the cover projecting slightly.

With a needle make a hole through the center of the fold, and another near each end of the fold (from one-half an inch to an inch and a half from the end) according to the size of the booklet, as shown in Plate III. With thread or raffia sew through the center hole, from the inside out, back to the inside through an end hole, outside through the center hole, inside through the other end hole, and tie the ends in a square knot (see illustration, Plate IV) near the center of the fold. Other equally satisfactory methods of sewing may be worked out.

B. Determine the purpose of the booklet first and then its size and shape. As in A draw plans of the inside and

cover. With rule and pencil lay out parts on materials to be used. Cut and sew as in A.

Simple lettering on the cover adds much to the appearance of the booklet. Choose a title appropriate to its contemplated use, as "NOTES," "SKETCHES," etc., which should be executed in rather large Roman capitals. On a separate sheet, mark out an oblong of height and width desired for the title and practise on this. If title is long, make letters narrow, if short, letters may be broadened, to fill up more space. When satisfactory results are obtained, cut out and place on the cover, moving up and down to

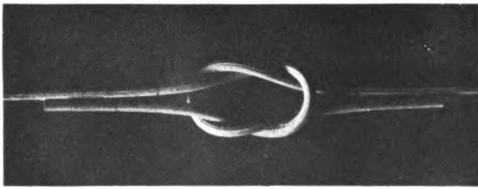

PLATE IV. The position of the threads
in tying a square knot.

determine its best position. The base line of the title should be placed below the top at one-fifth to one-quarter of the entire distance from the top to the bottom of the cover. After the position is determined, the title should be transferred either by tracing or copying. The pupil's name in much smaller capitals should be worked out in the same manner and placed below the center with a somewhat wider margin at the base than at the top. Do not enclose the title in an oblong or other figure. A single or double line as a border around the cover looks well, if carefully done. (See illustration, Plate V.)

C. For the cover use gray drawing paper, tinted, other materials as desired.

Draw plans as in A and B. A larger surface than required for the cover should be tinted before it is marked out,

so that any streaking along the edge may be cut off. To mix a wash of the color selected, put two or three tablespoonfuls of water in the water-cup and add a little paint until the desired tone is produced, being quite sure to have enough

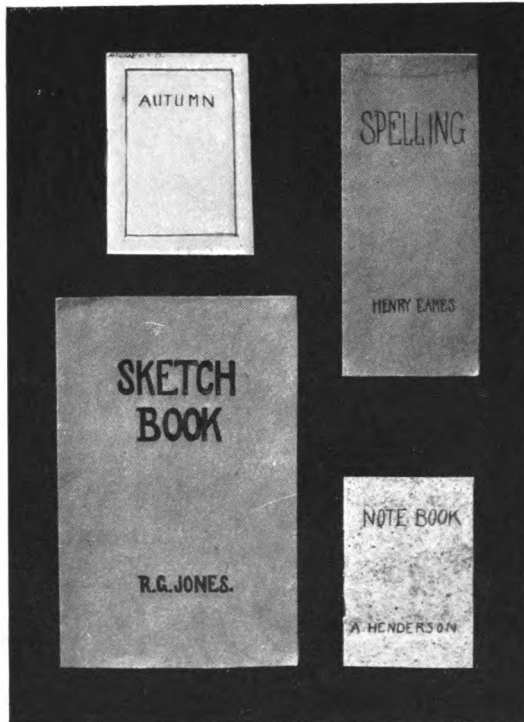

PLATE V. The simplest possible designs for book covers, involving good spacing and careful lettering.

to cover the whole surface. Try to have the wash clean, not muddy, and beware of too much paint! The colors should be soft, not crude, and somewhat neutralized by the addition of the complementary color. The best results are produced by the use of green, pale yellow, brown, dull orange, and red. Blue is very likely to streak and is seldom satisfactory.

When ready to apply the wash, place the paper on an inclined surface—45° or more from the horizontal. A sheet of heavy cardboard or a book answers this purpose admirably. With a full brush make a horizontal stroke across the top of the paper. The second stroke should be just below this leaving no dry spots between. Being careful to keep the brush full of paint, continue in this manner until the entire surface is covered. The surplus amount of paint which will settle along the lower edge should be taken up with the brush, which has first been squeezed dry between the thumb and finger. When the paper is dry, mark out the cover and cut. Cut out the leaves and sew as in A. The cover may be lettered as in B.

Problem II

A HOLDER FOR THE PARTS OF A MODEL

Before proceeding further, some kind of a permanent holder should be provided to keep all together the various pieces of the model. This prevents the confusion and loss of time incident to passing several kinds of materials each by itself.

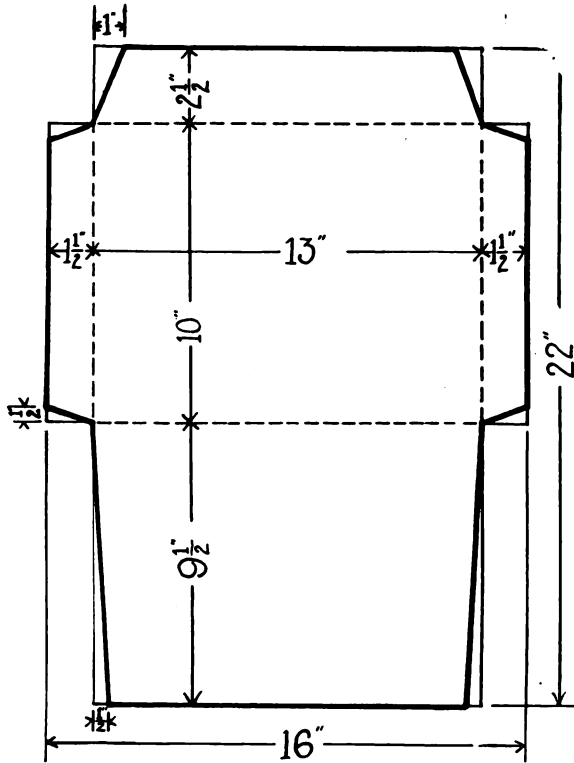

PLATE VI. Pattern for a simple envelope.

One lesson might be used for the making of a portfolio for this purpose, cut from screenings or heavy wrapping paper, and patterned after an envelope, from 6" \times 9" to 9" \times 12" in size. (See Plate VI.) If large pads of paper are used in the schoolroom, their cardboard backs may be utilized. Take two of the same size, punch holes along three sides of each, near the edges and lace them together. If one of the long sides of the resulting holder has been left open, materials can be removed with greater ease than if a short side is so used. A set of holders thus made is very durable. New paper bags make good holders although less desirable than either of the other two.

Problem III

MOUNTS AND PADS

TIME: 6 hours.

MATERIALS: Newsboard, vellum, and paper for memorandum pad, or calendar, or pad to be mounted.

We shall now begin to deal with materials that are more exclusively employed in bookbinding work. The simple articles considered at first are not books; but because the processes involved and the materials used will be used later in the more difficult work of binding a real book, they are made a part of this course.

The wise teacher will become somewhat familiar with handling the required materials before attempting to give instruction. It is recommended that two or more models from each problem be made by the teacher before selecting one for the class.

The articles described in Problem III (See Plate VII) consist of a foundation of a single piece of newsboard, covered back and front with a bookbinding cloth.

A. MOUNT OF A CALENDAR OR PICTURE

First secure the article to be mounted and then determine the size and shape most desirable for the mount. Never make the mount first and then attempt to find something to fit it.

To determine the size of the mount, place the calendar or picture on a sheet of paper and find the most pleasing margins by laying a pencil on each side of the article. Increase or decrease this margin by moving the pencils back and forth until a satisfactory position is found, as shown in Plate VIII. Indicate this position by a line on each side.

In the same manner, establish top and bottom margins, illustrated by Plate IX. The margin at the top may equal that at the side, or be a trifle wider or narrower;¹ the one at the bottom may equal the side margins or be wider, but

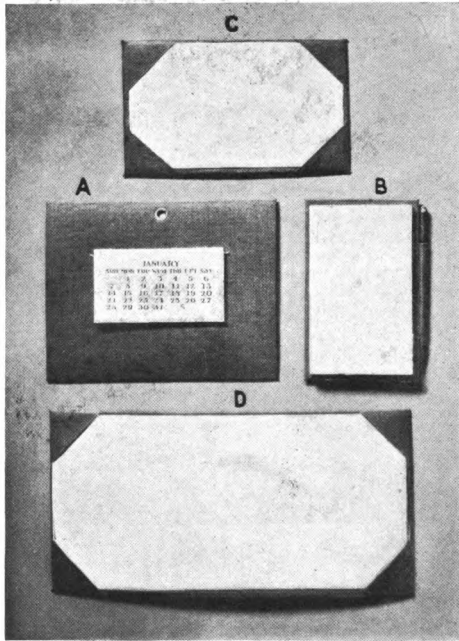

PLATE VII. Mounts and pads made by children.

never narrower, and always greater than the top margin. Draw lines for top and bottom and the size of the foundation is indicated. A fraction of an inch may be added or subtracted to give even measurements.

Working drawings should now be made of the completed model, showing the location of the calendar, also of the front and back.

¹ In a vertical sheet, wider; in a horizontal sheet, narrower.

Make them either accurately or freehand as described in Problem IX. If the latter method is used, some sense of proportion should be observed. That is, do not draw 3 inches as long as 6 inches, nor 4 inches longer than 7 inches.



PLATES VIII AND IX. Deciding upon the right size mount for a picture by experiment with pencils.

The size of the foundation has already been determined. The front covering should be $\frac{1}{2}$ inch larger on each side than the foundation, to allow for laps which are to fold onto the back of the newsboard. The back covering should be from $\frac{1}{16}$ to $\frac{1}{8}$ of an inch smaller than the foundation on each side, as the finished product looks much neater if no raw edge is visible from the front.

In Plate X, the first drawing is of the face of the completed model showing the location of the calendar. This also shows the size of the foundation. The other two drawings show the size of the two pieces of vellum. If the first drawing seems too complicated, omit the location of the

calendar, and draw and dimension only the outside rectangle to give the size of the foundation.

The pieces of material given out should be a little larger than the finished size, although unnecessary waste should be avoided. No attempt should be made to cut these pieces

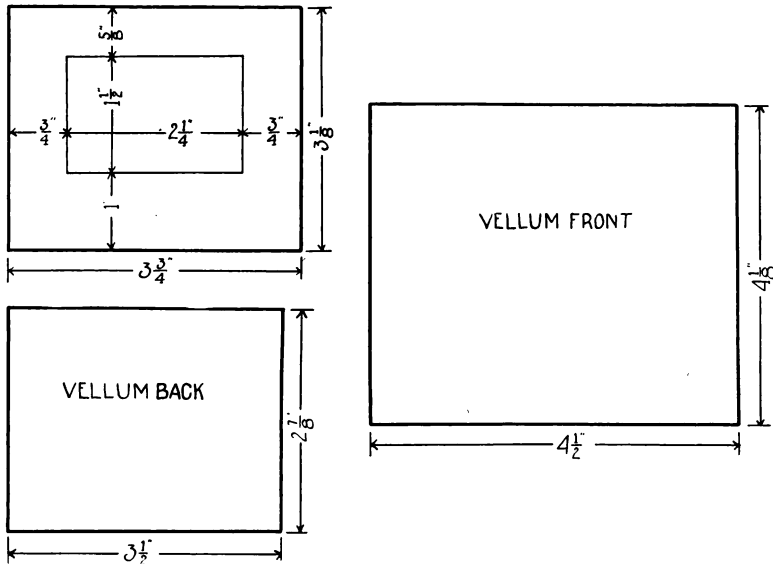

PLATE X. The completed mount showing the location of the calendar, and the two pieces of vellum.

carefully or regularly. Each pupil should be led to depend on his own initiative in the use of the rule and triangle. An irregular edge which is not a guide, is more educational than straight-edges and right angles which are of considerable assistance.

With rule, triangle, and pencil, carefully lay out each part from the drawings already made, and cut the coverings with the scissors.² The foundation is more successfully cut

²Selvage should never be allowed to remain on a covering of vellum. A "raw edge" pastes down more closely and is, therefore, less apparent. Vellum tears very easily lengthwise, and a torn edge may be allowed if it is to be covered. If not to be covered, all edges should invariably be cut.

with the paper cutter, as to cut it with scissors is a very difficult task for little hands and likely to loosen the scissors at the joint. The most desirable way is for each pupil to cut his own newsboard, in which case the ruler fastened to the cutter may be used to insure the correct size without any preliminary measuring. If the cutter is deemed unsafe for the pupils' use, the proper size may be marked on the newsboard with pencil and the pieces cut by a large boy or by the teacher.

When the pieces have all been cut, place the newsboard on the back side of the front piece of vellum, with the margins equal, and draw around it. Cover the surface inside the pencil lines with a thin, even coat of paste.

Much of the success of the work depends on the pasting and rubbing. The paste is of the right consistency when put up by the dealer, and if it dries somewhat after being opened, a little water thoroughly stirred in will make it all right. The brush well filled with paste should be passed over the surface of the covering material with long even strokes. No dry spots should be left, and especial pains should be taken to cover the surface close to the pencil lines. Look across the pasted surface toward the light to see if it is entirely covered; looking directly down upon it does not reveal the dry places. Rub the brush rather heavily over the surface to make the paste sink into the cloth.

While pasting, several sheets of newspaper are invaluable to protect the desk, the model, and the fingers. With a few quick strokes of the card-cutter, cut off the folds of a newspaper, leaving loose sheets the size of half or a quarter page. Each desk should have several sheets, placed one on top of another. When the top sheet has become sticky, discard it. A perfectly clean surface beneath it is ready to be used in the same way. Press the newsboard on the pasted

surface, turn it over,³ and rub it down very hard on the right side of the vellum. When rubbing the vellum on the right side, a small piece of cloth for each pupil prevents finger marks, and enables the pupil to rub harder as the cloth protects the hand.

Before pasting projecting parts, the corners should be cut. Two methods are shown in the illustrations. In the first, two adjacent projections are turned onto the back of the foundation. Be careful that they fit very closely to the sides of the newsboard, press down with the fingers, and hold



PLATE XI. Clipping the corners.

them very firmly. At the corner will be a surplus piece which should be pinched to stand upright. Slanting the scissors very slightly upward, cut from the corner toward the center. (See Plate XI). The second method is to make slanting cuts from the outside of the vellum toward the corners of the newsboard. (See Plate XII). Apply paste to the projecting sides, fold over and rub down; treat the ends in the same manner.

If it is desired that the completed mount shall hang on the wall, make a loop of ribbon, tape, or vellum. If tape or ribbon is used, choose the color very carefully; that which matches the vellum is the best choice; but, if a contrast is

³When turning over any part of the model which has a pasted surface, take hold near the center as far as possible, as handling by the edges or corners is likely to remove paste from the places where it is most needed.

preferred, choose a soft color which has some quality in harmony with the vellum. Paste this loop to the back of the foundation, allowing it to project above the top. Apply paste to the back covering and rub it down very firmly, being careful that no loose edges are left. Instead of pasting on a loop, a hole may be punched near the top with the eyelet punch, and an eyelet inserted. This should be done after the back is pasted on.

According to plan, paste on the calendar or picture. Dry all under a weight. If several mounts are to be placed

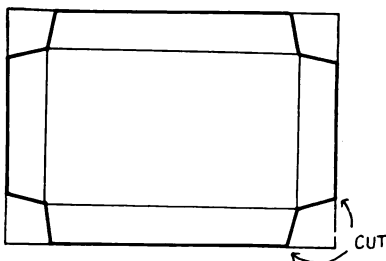

PLATE XII. One method of cutting the corners.

under the same weight, it is better that each should be separated from the others by a sheet of blotting paper, or several thicknesses of newspaper. Allow them to stand over night. In the morning they will be found sufficiently pressed.

B. MOUNT FOR MEMORANDUM PAD

Secure a small pad, and plan a mount to extend beyond the pad $\frac{1}{8}$ inch or more on each side. Draw plans, work out, and paste as in A. Instead of a loop by which to suspend the pad, make a holder for a pencil to be placed on the right side of the mount. Cut a strip of vellum one-half or three-quarters the length of the mount. At each end of the strip turn about $\frac{1}{8}$ inch onto the wrong side to give a finished edge. To secure the correct size, fold the strip over the pencil to be used, and, with the pencil still folded in, paste

the two long edges of the strip together, and then to the back of the newsboard, having it placed midway between the top and bottom edges. The pasting of the back covering then follows. Remove the cardboard back from the pad before pasting it to the mount. Dry under weight.

C. POCKET MEMORANDUM PAD

This is intended to be carried in the pocket, and its size should be governed by its use. Avoid rectangles which

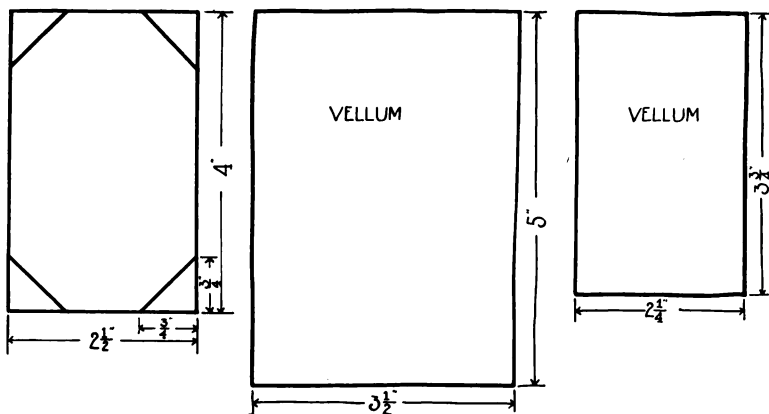

PLATE XIII. A front view of the memorandum pad accurately drawn to show proportions; also drawings of the vellum coverings.

approximate the square, but choose rather such proportions as 2:3 or $2\frac{1}{2}:4$. As in A, make working drawings for the three pieces. If desired, the first drawing may be of the completed face. (See Plate XIII.) Lay out and cut all parts.

On the front piece of vellum lay the newsboard as in A, and draw around it. From the corners indicated by the pencil lines measure equal distances along adjacent lines, and connect the points by straight lines. Be careful not to make these lines too near the corners, $\frac{3}{4}$ of an inch to 1 inch being a good measurement for a small pad. Cut on

these lines with a sharp knife, or folding the ends of the line together, cut along the line with scissors.

Apply paste to the front piece, being careful not to paste outside the slanting lines at the corners, for this space should be left free to hold the sheets of paper. One way to protect these corners is to insert a piece of newsboard or paper in the slits, from the right side of the vellum, so that the corners on the wrong side are covered. The paste may then be applied with freedom. Remove the protecting piece of newsboard and paste the vellum to the foundation. Finish as in A without the hanger, or, if desired, add pencil holder as in B. Cut several sheets of white paper $\frac{1}{8}$ of an inch smaller than the newsboard, and, when the paste is thoroughly dry, insert them in the slits.

D. BLOTTER

Like C except that it should be large enough to hold a school blotter. Increase the size of the corners to be proportionate to the size of the blotter.

Problem IV

TIME: 8 hours.

MATERIALS: Newsboard, vellum, and lining paper.

Note: As in Problem II, each of these models has a foundation of a single piece of newsboard, covered on the front with vellum, but on the back with lining paper.

A. A NEEDLECASE

As shown at A in Plate XIV, the needle case should be planned to hold four papers of needles, two at each end. The size of the case will depend on the size of the papers of needles, and must be planned accordingly. Make the width a little more than twice the width of a paper of needles, and allow a little space lengthwise between the papers of needles to permit their easy removal. The pockets are formed of strips of vellum pasted on to each end of the foundation, and their depth should be a little more than half the length of a paper of needles.

An accurate working drawing of the completed case should be made (see Plate XV). From this, mark out and cut the newsboard to the correct size. The front covering of vellum should have laps on the sides only and may well be a little shorter than the foundation. Make freehand, dimensioned sketches of this piece, of the vellum pockets, and of the marbled paper. The pockets should have $\frac{1}{2}$ inch laps on three sides for pasting to the back. On the other edge, which is to be free, allow at least an eighth of an inch to be turned over like a hem onto the wrong side for a neat finish. The paper for the back should be one-fourth of an inch narrower and shorter than the foundation.

Mark out and cut with the scissors, the pieces of vellum and marbled paper. The front covering should be pasted on first. Before pasting the pockets (which should be fastened

to the back only) turn over the hem, and crease it hard, but do not paste. The hem will extend onto the side laps. From these laps cut off the under side of the hem that it may not

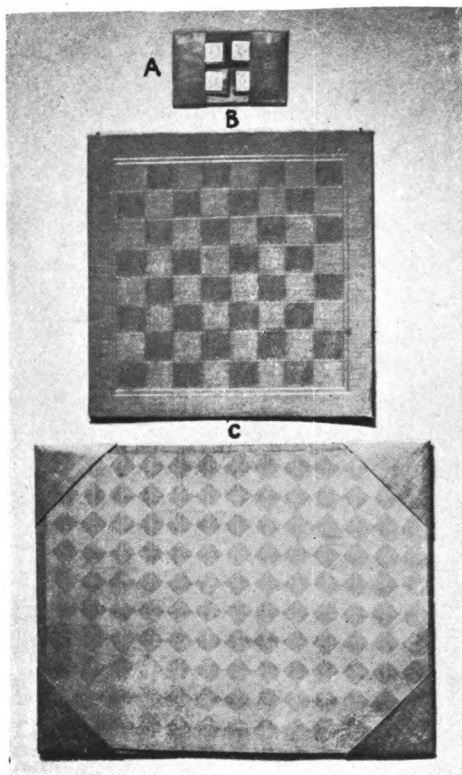

PLATE XIV. A needlecase, a checkerboard and a blotter. Good problems upon which to practise the processes involved in bookbinding.

be double. Paste on the pockets and the back. Dry all under weight.

B. A CHECKERBOARD

First decide on the size of the small squares, remembering that there are eight in each direction. Also allow for a

margin, outside the squares, which should vary in proportion to the size of the squares. A single or double border line enclosing the squares is a desirable addition. (See B, Plate XIV.)

Make working drawings of the foundation, the front covering of vellum, and the back covering of lining paper. In selecting vellum for this model, have in mind the applica-

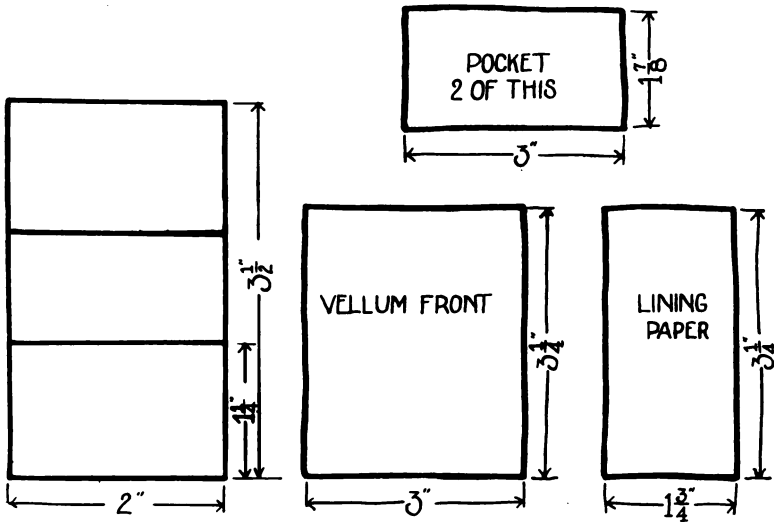

PLATE XV. An accurate working drawing of the completed needle-case, and dimensioned sketches of the pieces used for covering.

tion of a color which is to be used on alternate squares. Either a deep red vellum with alternate squares of black or a dull green vellum with alternate squares of red is a good combination.

Lay out and cut all parts, using the card cutter for the newsboard, and the scissors for the vellum and the lining paper. As in previous models, lay foundation on the back of the piece of vellum, draw around it, and cover with paste the surface enclosed by the pencil lines. Again place the

foundation on the vellum, press it down hard, turn over both pieces and rub the vellum on the right side until it is smooth. When thoroughly rubbed down, paste laps, being careful to make neat corners. Paste on lining paper and dry under weight.

During a subsequent lesson, mark out the checkerboard, accurately, with rule and pencil. Only alternate squares need be colored, and this may be done with water colors, crayon, or pencil. If water colors are chosen, they should be used with as little water as possible. Before applying the paint to the vellum, the glaze of the surface may be reduced by rubbing over it the powder which comes from common white chalk. Rub the powder in with the fingers and lightly brush off what remains. On a separate piece of vellum, practice the application of color before applying it to the checkerboard, both to test the color itself, and to become somewhat familiar with the best method of application. After the paint is thoroughly dry, the surface may be cleaned by rubbing carefully with a piece of cloth. Finish by putting on the outside border line with pencil.

C. A BLOTTER

This is to be a more elaborate production than the blotter described in Problem III (D). Compare C, Plate XIV.

First determine the size of the foundation, which may vary from small-blotter to desk-blotter size. Consider proportions very carefully. A small blotter admits greater variance between length and width than one of larger size. Make dimensioned drawings of foundation, front covering of vellum or cover paper, and back covering of marbled paper.

When the foundation has been cut and the front covering pasted on, plan the corners which are to consist of separate pieces. Determine their size by setting off a triangle

at one corner with a rule or pencil, moving the rule or pencil to vary the size of the triangle until one of satisfactory size is decided upon. Lay out on paper a triangle of the chosen size. The thickness of the foundation, plus the thickness of the one or more sheets of blotting paper which are to be placed under the corners, must be taken into consideration. Before adding the laps which are to extend onto the back for half an inch or more experiment with patterns cut from paper (see Plate XVI).

The corners may be made of linen, vellum, cover paper, or skiver (a prepared leather which has been split by ma-

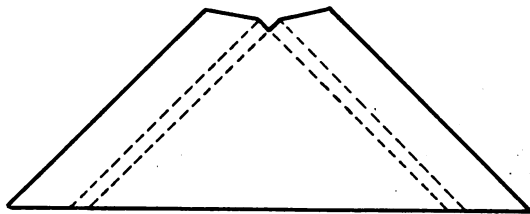

PLATE XVI. Diagram for blotter corner.

chinery). Cut them out by the pattern. To give a finish to the edge which is to be free, turn it over about $\frac{1}{4}$ of an inch. If leather is used, a portion of the under side along the edges should be additionally skived off, before turning over, to make the laps very thin. Cover paper, if used, may be re-enforced by pasting a piece of muslin onto the back.

These corners present an opportunity for applied design. The most satisfactory decoration for leather is "tooling." On the other materials suggested, a design may be applied by stenciling or block printing.⁴

The designs should be simple and appropriate, (see Plates XVII), and the color scheme carefully planned. Un-

⁴Simple directions for these processes may be found in the *SCHOOL ARTS BOOK* as follows: Tooling, June, 1908, Stenciling, June and October, 1908, March, 1912; block-printing, June, 1907.

less a special study has been made of color harmonies, a combination of analogous colors or complementary colors is a wiser choice than a more complicated combination. Practise on paper until a pattern is secured, and apply it to the corners by the method decided upon.

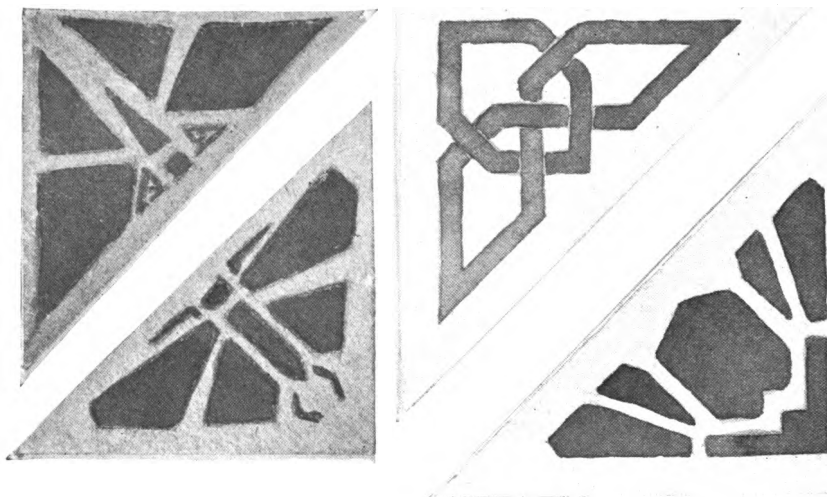

PLATE XVII. Blotter pad corners with original units by grammar-school children.

When pasting on the decorated corners, the sheets of blotting paper should be placéd on the foundation so that there will be room for their use. Paste the laps to the back of the foundation, being very careful to place the corners in exact position. Leave the sheets of blotting paper under the corners until after the whole has been pressed; otherwise the weight would crush the corners. When putting in new sheets of blotting paper, they can be more easily slipped under the corners if a small triangle has been cut from each corner of the blotting paper. A sheet of lining paper about $\frac{3}{8}$ of an inch shorter and narrower than the foundation should be pasted to the back. Dry all under weight.

Problem V

MOUNTS AND COVERS

TIME: 6 hours.

MATERIALS: Newsboard, vellum, and lining paper.

NOTE: Each article in this problem has two foundation pieces covered by a single piece of vellum, which forms a hinge between them, and the whole is lined with marbled paper.

A. A CALENDAR STAND

First make or secure a calendar, which should be of small size. If desired, a picture may be used with the calendar, but it should harmonize with it in size and color. In such a case plan to have the space between the two much smaller than the margins, so that the eye will take them in as a group, and not as two separate objects. Decide on the margins as described in Problem II, and thus arrive at the proper size for one of the foundation pieces of newsboard. (See Plate XVIII.)

Make a dimensioned sketch of this piece, and plan to have two made of newsboard. For the outside covering plan a strip of vellum which shall be long enough to cover both pieces of newsboard when placed about one-eighth of an inch apart, and to make half-inch laps on each side and end. Plan a strip of vellum about an inch wide and as long as the width of the foundation pieces to form the back of the hinge; and two pieces of lining paper, each one-eighth of an inch smaller in both directions than the foundation pieces. Make dimensioned sketches of these pieces (see Plate XIX), lay out and cut all parts.

In the center of the narrow strip of vellum mark off a space one-eighth of an inch wide, extending lengthwise of the

strip. Apply paste and lay the two pieces of newsboard on the vellum and with edges against the lines drawn. Press hard on the newsboard, turn it over, and rub down the vellum. A hinge is thus formed for the two pieces of newsboard. Lay these pieces on the large piece of vellum and draw around the whole. Apply paste to the vellum inside the pencil lines. Lay the double foundation on the pasted surface with the narrow strip of vellum on top. Rub down



PLATE XVIII. Calendars.

the outside surface very hard, leaving no wrinkles or rough places; clip the corners as described in Problem II, paste the laps, fold them over, rub them down, and line the mount with the pieces of marbled paper. Connect the front and back halves of the mount by a single or double strap of vellum pasted to the inside of each. Finish by pasting on the calendar and picture.

NOTE. If the calendars are made for Christmas, a most appropriate time, the children are sometimes desirous of decorating with Christmas seals. These are not so desirable as a decorative picture, but if the teacher feels that to forbid their use would be dispiriting to the child, she should insist that only one seal should be used and that on the back of the standard where it will carry its message, but will not detract from the appearance of the face of the mount. An envelope, might be made in which to present the calendar, and the seals used on the outside of the envelopes.

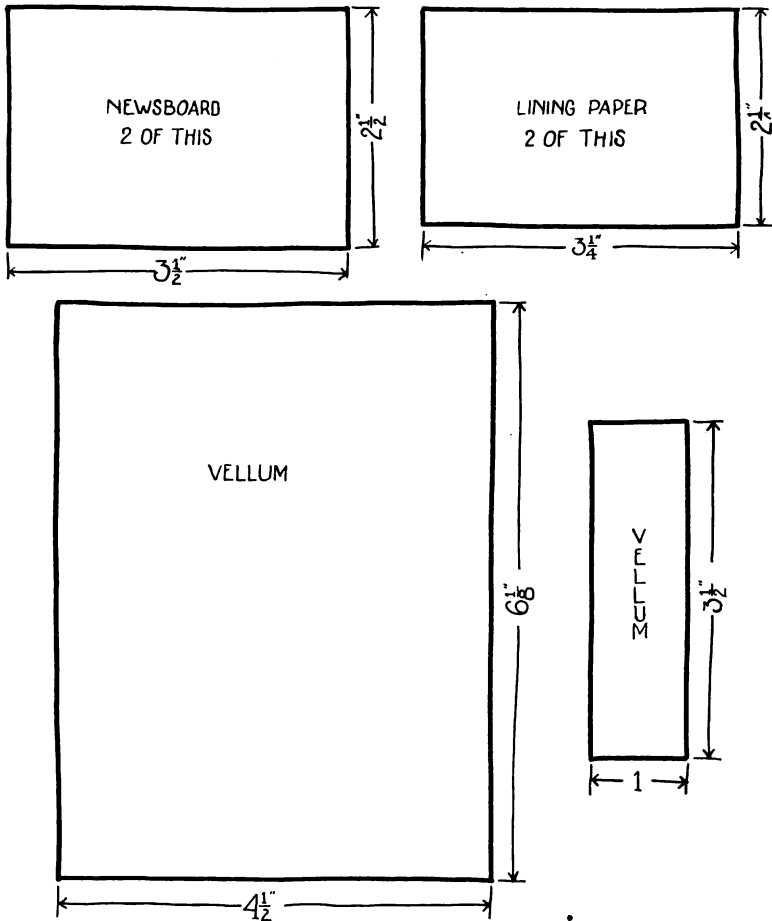

PLATE XIX. Freehand sketches of the parts of a simple calendar mount.

B. ANOTHER CALENDAR MOUNT

Plan the back standard to be smaller than the front instead of the same size. Plate XX suggests a suitable trapezoidal shape. In this case the vellum must be of the same length as before, but cut to fit the different widths of the newsboard (compare Plate XXI).

Plan a narrow strip of vellum to line the hinge, as in A. Paste this piece and the outside covering as before. Cut the lining paper of the correct shapes and apply to the back.

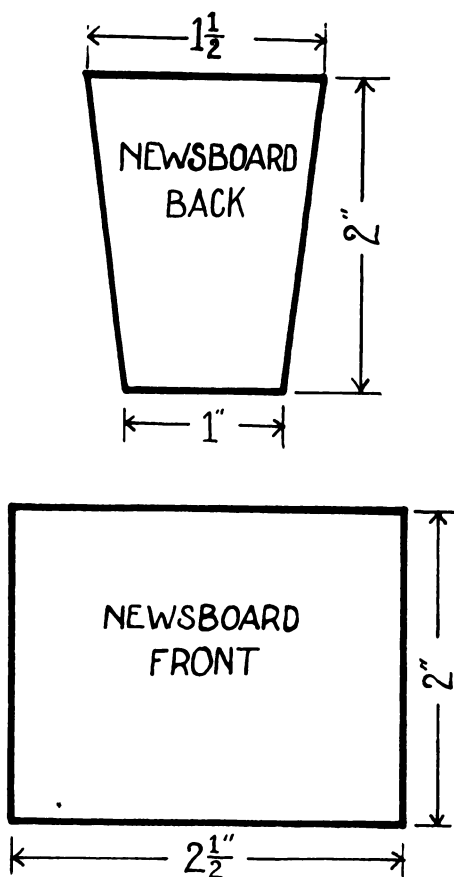

PLATE XX. The foundation pieces for an easel mount.

C. A NEEDLE-BOOK

This consists of covers with leaves of flannel. Decide upon the size of leaves, which should not be too large and in good proportion. One piece of flannel should form two

leaves, as in booklets described in Problem I. Plan the covers to be one-eighth of an inch larger in each direction than the leaves. These should be constructed like the calendar mount already described in A, but the space between should be greater, perhaps three-eighths of an inch. Make dimen-

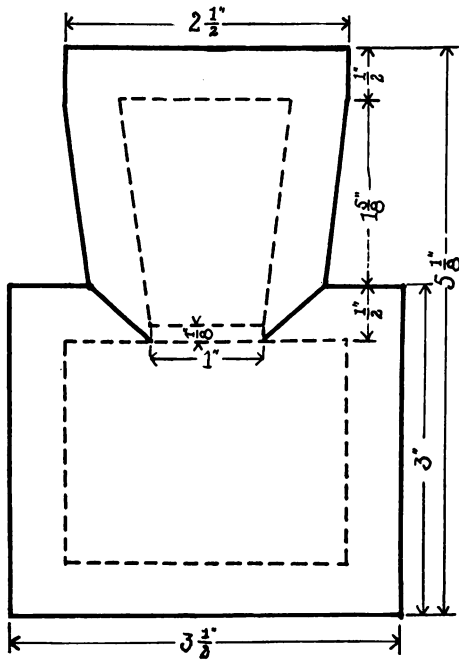

PLATE XXI. The flat of vellum for covering the foundation.

sioned sketches of all parts. The parts should then be laid out, cut, and pasted. Finish the edges of the leaves by pinking (cutting in small points). Four leaves are sufficient. Sew them to the cover as described in Problem I.

D. A COVERED MEMORANDUM PAD

Secure a small pad. Plan covers, as described in B, which shall project about one-eighth of an inch in each

direction beyond the pad. Plan to have the space between them about $\frac{3}{8}$ of an inch more than the thickness of the pad. When the covers are finished, paste the pad firmly to the inside of one cover. If desired, loops of vellum to hold the pencil may be pasted on the side of the pad, as described in Problem I.

Problem VI

HINGED COVERS

TIME: 8 hours.

MATERIALS: Newsboard, vellum, paper for leaves, eyelets, cord, and (if desired) cover paper for C and D.

NOTE: In selecting materials, choose those which harmonize with each other, i. e., the vellum, cover paper, and lining paper should be of the same hue.

The problem is to make two separate hinged covers between which loose leaves may be bound, the whole to be fastened together with macrame or other cord. This may be designed for one of many uses, suggestions for several of which follow (see Plate XXII).

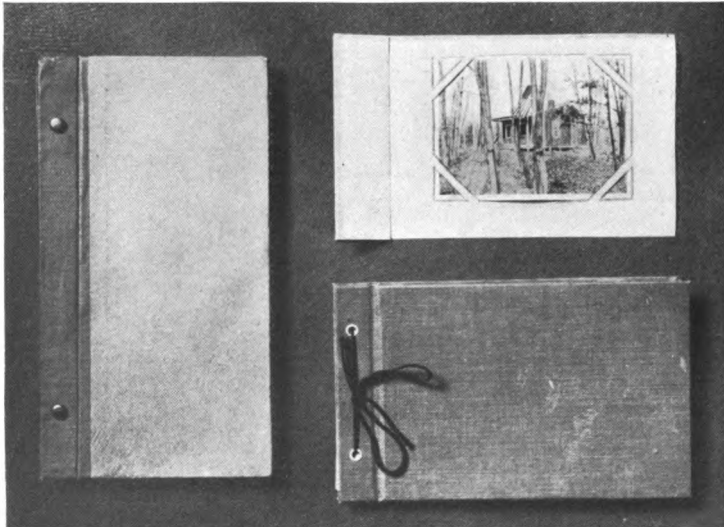

PLATE XXII. Examples of hinged covers made by grammar school children.

A. A SKETCH BOOK

In making dimensioned sketches for the various parts (see Plate XXIII) determine first the size of the pages and plan the covers to extend beyond them about one-eighth of an inch. Make the sketches of the pages and the news-

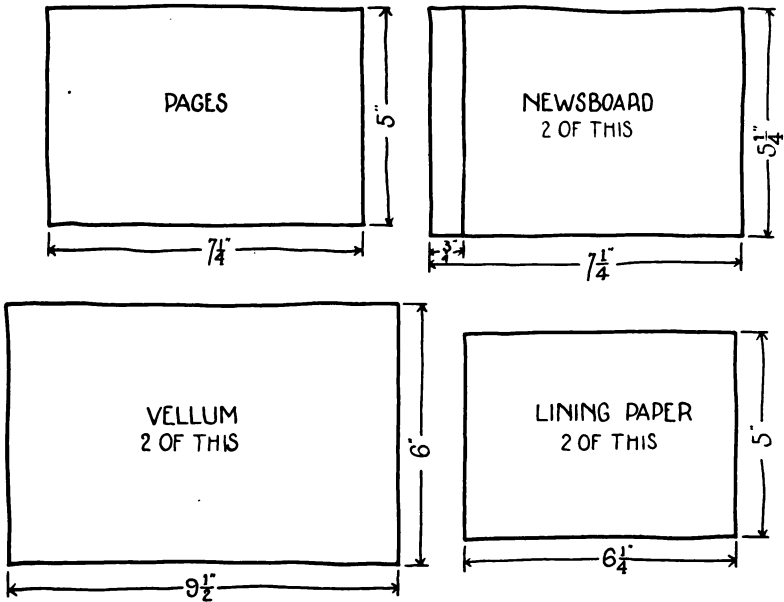

PLATE XXIII. Freehand dimensioned sketches showing parts of a sketch book cover.

board foundations. Lay out and cut the latter, of full size, and then from either a long or short side of each, in accordance with plan, cut a strip to form a hinge. The width of these strips may be from three-quarters of an inch to one inch. Vellum should be planned to cover completely one side of both pieces of each cover, to fold around the small piece and to lap over onto the large piece about one-half inch. It should also fold over the other three edges about one-half inch. (See Plate XXIV.) The lining paper should

cover to within about one-eighth of an inch of the edges of the large pieces and should not extend onto the hinge. Constant bending soon breaks paper, but with ordinary use does not affect the tough vellum. Make dimensioned sketches of these pieces (see Plate XXIII) and lay out and cut all remaining parts.

Properly place main part of newsboard on vellum, drawing around it. Lay small part one-eighth of an inch from main part and draw around it. Remove the pieces of news-

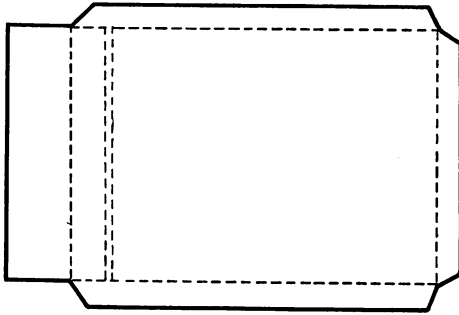

PLATE XXIV. A diagram showing the position of the two pieces of newsboard on a piece of vellum.

board and apply paste to vellum inside the pencil line, being careful to cover the surface smoothly and evenly; lay both back pieces in place, turn the vellum over and rub down. Cut from the projecting vellum on the hinged side a small piece even with the edges of the hinges as far as the outside corners (see Plate XXIV), and clip off the outside corners as before described. Apply paste to projecting vellum, fold over first the hinged side and its opposite, then the other two sides, and rub down. Paste the lining paper in and dry the covers separately under weight. Remember to place newspaper or blotting paper between each pair, otherwise the moisture from one will cause wrinkles in the other.

For the leaves, use drawing paper, which may be cut singly or in folio (with single fold). The latter method is preferable, as folded sheets are easier to place at the back, look better, and are more secure.

Two holes in each cover are sufficient for the cord, but a little care should be taken to determine the best position for them. The distance of each from the end of the hinge strip should be from one-fifth to one-sixth of its length, and,

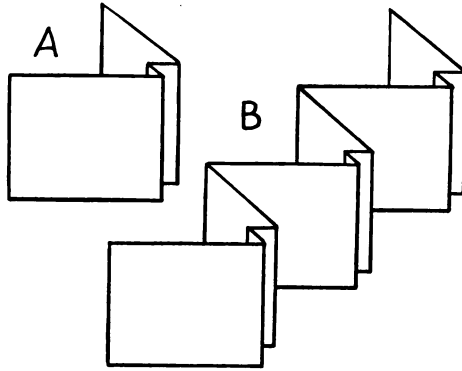

PLATE XXV. Two methods of cutting and folding paper for the pages of a scrap book or postcard album.

of course, they should be placed midway between the long edges. After punching the holes, see that the leaves are properly marked so that the holes in them will exactly fit the holes in the cover. To do this, place one sheet on the cover, leaving correct margins, and through the center of each hole mark the paper which should then be punched. Treat the other sheets in the same manner. Eyelets should be inserted in the covers only, and for that purpose a good eyelet punch is necessary. Directions for its use and sample eyelets accompany punches when sent from the dealer.

Complete by tying all together with a piece of cord. Make a small flat bow on the front cover.

B. A SCRAP BOOK

This should be planned and worked out in the same manner as the Sketch Book, but it should be somewhat larger, possibly $6 \times 8\frac{1}{2}$ inches. For the leaves, screenings or wrapping paper may be used.

To prevent covers from flaring after the book has been filled, the thickness at the back should be increased by additional folds in the paper, as shown in Plate XXVA. The "stub" should be about one inch wide after it is folded. The Japanese method, which is to fold a very long strip many times in the same manner, forms a pleasing arrangement (see Plate XXVB).

C. A POSTCARD ALBUM

Make the covers described in A and the leaves of a heavy paper. Green or brown screenings look well and give a background generally harmonious with colored postcards. The size of the leaves should be sufficient to leave a generous margin around the card. If two are to be placed on one page, have the space between less than the margins around the edges. A little additional margin at the bottom is always pleasing. Slits for holding the cards may be made in the following manner: cut a blank sheet of paper of the size of a postal card and from each corner measure both vertically and horizontally 1 or $1\frac{1}{4}$ inch and connect the adjacent corners with straight lines. Place this pattern in proper position and use the ends of the lines on it to locate the lines to be drawn on the page itself. If a hole is punched at each end of the line, it gives a neat appearance and prevents the paper from tearing easily. The lines on the page should be cut with a sharp knife. Insert each card by placing its corners in the slits.

A second set of oblique lines parallel to those already described may be drawn and cut three eighths of an inch farther

from each corner. This will form a strap to hold the cards in place, and on the opposite side of the leaf cards may be inserted in the outside slits.

D. A CLIPPING FILE

Between two separate covers several envelopes — say five — are to be fastened and used for holding clippings, etc.

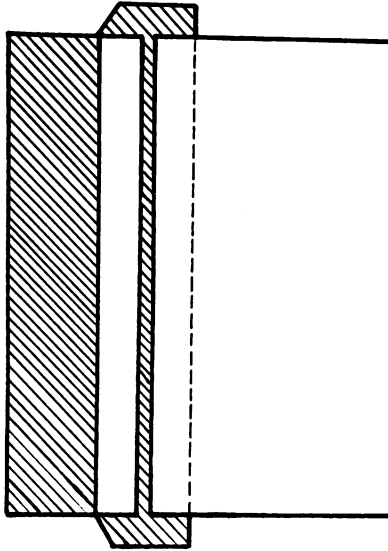

PLATE XXVI. Relative positions of newsboard and vellum in making the cover of a clipping-file.

Select the envelopes — $3\frac{1}{2}$ by 9 inches is a convenient size. Plan covers to be about one-eighth of an inch longer on each end than the envelopes and seven-eighths of an inch wider. This allows three-quarters of an inch for the guard and also a projection of one-eighth of an inch on the opposite side. Strips of vellum should be planned to cover completely both sides of the hinge, to lap over onto the large piece about one inch both outside and in, and to extend beyond

each end about one-half inch. To cover the rest of the newsboard, cover-paper should be used and the pieces should lap over the vellum about three-quarters of an inch on the side next to the hinge and fold over the other edges about one-half an inch. The lining paper should cover to within one-eighth of an inch of the edges of the large pieces of newsboard. Make dimensioned sketches of all pieces and lay out and cut all parts.

Draw a line through the center of the vellum showing where the back edge of the small piece of newsboard should come. Lay main part one-eighth of an inch from this line and draw around the edges of both pieces except where the large piece projects beyond the vellum (see Plate XXVI). Apply paste to vellum, lay pieces of newsboard in place, turn it over and rub down. Cut from the projecting vellum a small piece even with the ends of the hinges as far as the outside corners. Apply paste first to projecting ends, then to long strip; fold over and rub down.

Properly place cover on cover paper and draw around it. Apply paste to cover paper and finish as when vellum is used for entire cover. Paste in the lining paper and dry under weight.

Strips of vellum about $2\frac{1}{2}$ inches wide and one inch longer than the envelopes should be folded lengthwise down the middle to form guards. Cut strips of newsboard three-quarters of an inch wide, and of the same length as the envelope. Apply paste to half the vellum and lay the newsboard on it with one edge against the center fold. Against the other edge of the newsboard lay the lower edge of the envelope with its ends and the ends of the newsboard in the same straight lines. Treat the ends of vellum in the same manner as on the covers. Punch holes in covers and guards, insert eyelets, and fasten together by tying, or with paper fasteners.

Problem VII

BOXES

TIME: 6 hours.

MATERIALS: Newsboard, stay-tape or vellum, and a thin paper.

First determine the size of the box, which should be made for a definite purpose. Consider the proportions of the width, length, and height; also the height of the sides of the cover.

A box consists of foundations of newsboard, the edges of which are stayed with strips of tape or vellum, and the outside covered with paper. The cover should be larger than the bottom by $\frac{1}{8}$ inch in both directions to allow it to slip over the box. This amount will vary somewhat with the thickness of the newsboard, the paper with which it is covered, and the skill of the worker.

The foundation for each part is to be developed from a single piece of newsboard. The box and cover are to be covered with a thin paper. A great variety of paper for this purpose may be purchased, either figured or in plain colors.

For the box plan a strip of paper long enough to extend around the four sides and to provide for a lap where the ends join. Be generous with this lap, as it will be found that the paper "takes up" when it is pasted on. The width of the strip should be at least one inch more than the depth of the box. For the cover, plan covering paper like the newsboard development, but with its sides $\frac{1}{2}$ inch or more wider to fold over the edges. Let the corner squares serve as laps. Make dimensioned sketches of all pieces and lay out and cut all parts. (See Plate XXVII.)

Along folding lines of the foundations score deeply with a knife, one blade of the scissors, or with a pin, and fold with the crease on the outside. It is essential to the success of the box to have this crease on the outside to insure a sharp straight, and strong edge, which might otherwise be rounded, irregular, and weak.

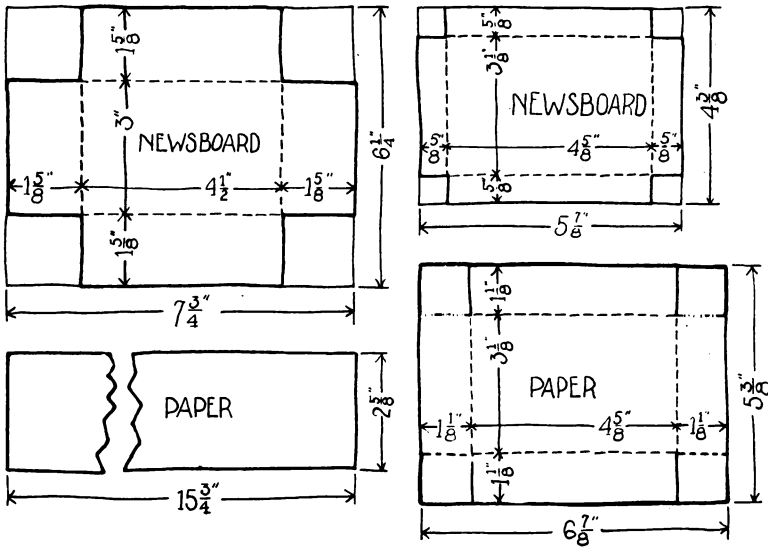

PLATE XXVII. Drawings of the pieces required in making boxes.

Fasten the corners of both box and cover together with pieces of stay tape or strips of vellum, lapping onto the sides. (See Plate XXVIII.) If possible, allow the corners to dry before proceeding further.

Paste the strip of paper around the box, allowing $\frac{1}{2}$ inch to project beyond both top and bottom edges. Rub down well. Make a vertical cut at each corner of upper projection and fold and paste laps down on the inside. (See Plate XXIX.)

Make a V-cut at each corner of the lower projection, fold and paste the laps against the bottom. (See Plate XXX.) It will probably be necessary to apply more paste before finally rubbing these laps down.

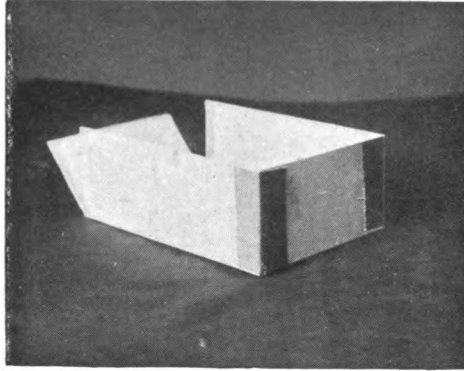

PLATE XXVIII. The box in process of construction showing method of "staying" the corners.

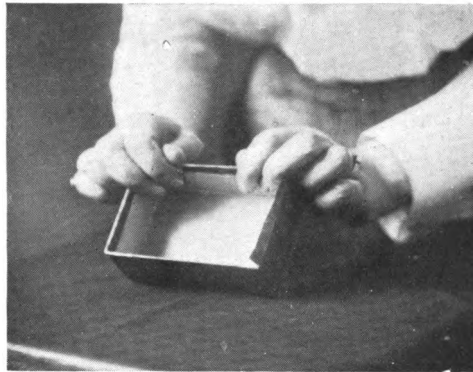

PLATE XXIX. Showing method of pasting the laps to the inside of the box.

Paste top of cover to the paper, leaving equal margins on all sides. From the two long edges make cuts to the corners of the newsboard foundation at right angles to its

edges. Fold and paste paper over the ends of cover first, and then onto the inside, using the thumb to push the paper over the edges. (See Plate XXXI.) The cuts made from the



PLATE XXX. The laps are being pasted to the bottom of the box.

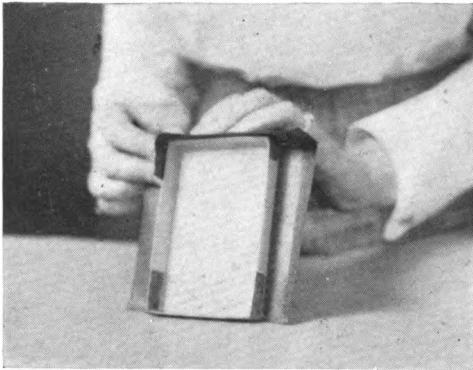

PLATE XXXI. Here the paper is being pasted to the side of the cover.

long edges give an extra length to end coverings. Paste this extra piece onto long sides and then paste the part naturally to be used to cover these sides. The appearance of the box

will be greatly improved by running the thumb and finger along the folded edges of the cover to sharpen them.

In this manner, boxes of any size may be made. Small boxes may be covered with linen, cretonne, or other kinds of cloth. In this case it may be better (after making the foundations as already described) to paste the covering to the inside of the foundation only, otherwise the surface might be discolored by the paste oozing through the cloth.

Problem VIII

POSTCARD HOLDER

TIME: 8 hours.

MATERIALS: Newsboard, vellum, and lining paper.

Before beginning this holder, it may be well to have collections made of cards relating to a definite subject. Interest in the study of various industries, history, and geography is greatly increased by the use of pictures, and in many places sets of cards prepared for such a purpose may be purchased.

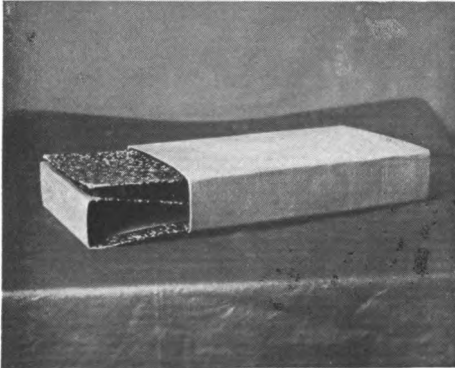

PLATE XXXII. The postcard holder partly open.

This holder consists of an outside case into which the inner holder slips. (See Plate XXXII.) The size of the faces may be determined by individual pupils, but, if the blocks to be described later are used, it will be quite essential to have a uniform size so that the blocks may be used interchangeably among the pupils. For this reason, it is recommended that the broad faces of the outside be about one

inch larger in each direction than a postcard, and the narrow faces $1\frac{1}{4}$ " wide.

Plan the foundation of a single piece of newsboard, as wide as the outside length of the holder, scored to divide it into the four faces above referred to, and a fifth division the exact size of one narrow face. Arrange these faces to be joined at their long edges with a narrow face on each end of the strip of newsboard so that when folded together one narrow face will be double, which gives greater stability to the shape of the holder. Plan a strip of vellum 2 inches wider than the length of the case, and long enough to extend around it, allowing for a lap at one corner. It will be found in putting on this vellum that it will require a piece longer than the sum of the width of the faces as, however closely it may be put on, it "takes up" at the corners. Therefore be generous with the lap as a little extra length does no harm.

For the inner holder plan a strip of newsboard $\frac{1}{8}$ " narrower than the case, scored to divide it into five parts. Two parts are to be of the same length as the case, alternating with two narrow faces $\frac{1}{8}$ " less than thickness of the case (that they may fit inside) and the fifth piece about one-half the length of the long faces.

Plan two strips of vellum to cover the narrow faces, and lap onto the adjoining faces about 1". Allow $\frac{1}{2}$ " at each end to turn over the edges. For each of the three broad faces, plan a covering of lining paper which shall allow an edge of vellum to show at the joints, and shall lap over the other edges of the newsboard. Notice that these three pieces are of three different sizes.

Make dimensioned sketches of all pieces (See Plate XXXIII) and lay out and cut all parts. Along the folding lines of both newsboard foundations, score and fold as explained in connection with the box.

When pasting the vellum onto the outside case, it will be found of great advantage to have blocks of wood to work

around. If there is a woodworking room in connection with the school, these blocks may well be made there. They

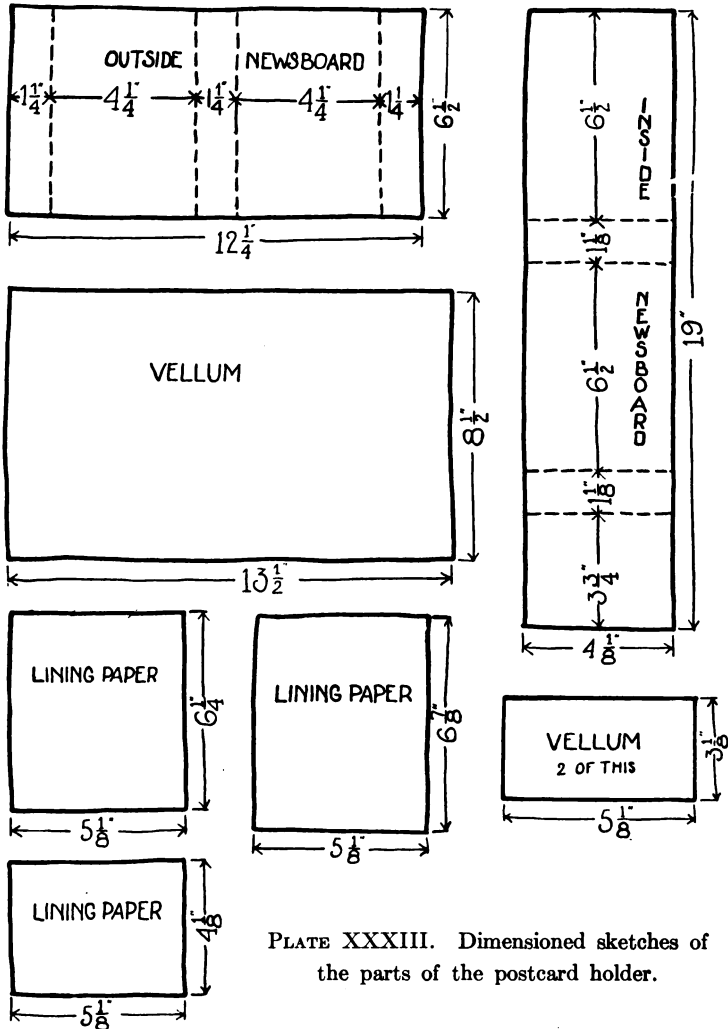

PLATE XXXIII. Dimensioned sketches of the parts of the postcard holder.

should be at least the full length of the case and may project beyond the ends. Their thickness should be the width of the

narrow faces, and their width may be the same as that of the broad faces, or narrower. If narrower, the blocks may be slipped along as the vellum is being rubbed down.

The strip of vellum for covering the outside is so large that it is difficult for a child to cover it with paste, before a part of it has dried. It is better, therefore, to paste a little more than enough for one face at a time, rub this down, apply paste again, and so on to the end. By putting the paste a

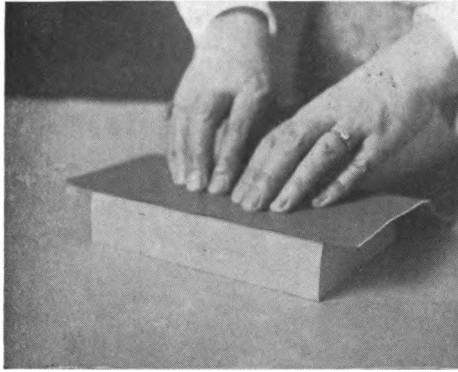

PLATE XXXIV. An illustration of the method of covering the outside of the case when a block of wood is used.

little beyond where it is needed there is a certainty of leaving no dry areas at the corners.

If blocks are to be used, paste together the two end divisions of the newsboard, put the block inside, and paste on the strip of vellum. Place one end of the vellum flush with one edge of the case, and cover one broad face first. (See Plate XXXIV.) Before rubbing down the vellum on the next face, be sure that it is pulled as closely as possible over the edge, leaving no wrinkles or loose places. When all the faces have been covered, there should remain a margin of vellum to lap onto the face first covered. If this is pasted down very closely, it will be almost invisible.

If no blocks are available, three faces should be covered before joining the two end pieces of newsboard, which should then be covered as one piece. Lay each face as it is being pasted so that one edge is at the edge of the desk or table, and allow the rest of the case to hang over the side. (See Plate XXXV.) In this way the faces may be easily covered.

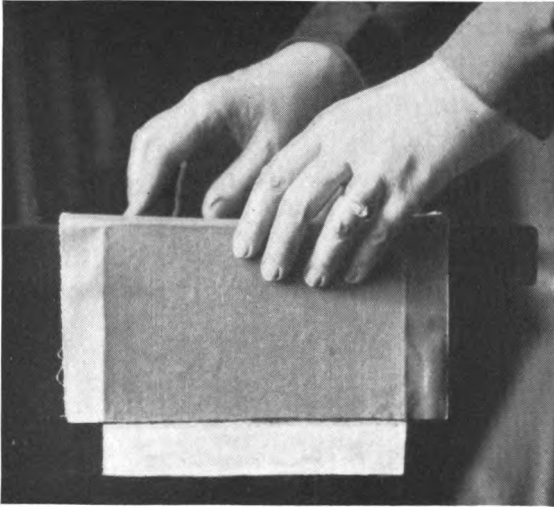

PLATE XXXV. An illustration of the method of covering the outside of the case when no block of wood is available.

Next make a longitudinal cut on the projecting vellum as far as the newsboard at each corner of the case. The resulting laps may then be easily pasted down onto the inside of the case.

Over the narrow faces of the inner holder paste the strips of vellum, cut for this purpose. Paste and fold their ends over the edges of the newsboard. These ends fit a little better if two slits are made in each at the fold of the newsboard. Cover the broad faces with the lining paper, turning

and pasting the laps over the edges closely. The corners should be cut as in the flat objects described in previous articles. This inner part should not be pressed as a flat piece as this would cause the paper to crack open when folded for use.

If desired, the inside may be lined with white paper, in which case the pieces should be put in separately instead of in one long strip. This is difficult for any but most skillful workers.

B. A holder of similar construction, but of convenient size to hold note or letter paper makes an excellent filing case.

C. A Scholar's Companion may be made by substituting an open box for the inside.

Problem IX

A PORTFOLIO

TIME: 6 hours.

MATERIALS: Newsboard, vellum, cover paper, lining paper, tape.

(A). This portfolio consists of two foundation pieces of newsboard, covered and lined with paper and joined by a back of vellum. Let the size and shape of these covers be determined by the use to which they are to be put. They may be for drawings, maps, compositions, etc. The size of the newsboard will practically be the size of the finished portfolio, and should be somewhat larger than the papers it is to hold.

Plan the back, which consists of two pieces of vellum, wide enough to allow for the space desired between the covers, and also to lap onto each cover at least one inch. One piece of vellum should be long enough to lap over the ends of the newsboard about $\frac{1}{2}$ an inch, and the other piece should be about $\frac{1}{8}$ of an inch shorter than the newsboard.

Plan the cover paper to be large enough to allow for $\frac{1}{2}$ inch lap to fold over the three free edges, but remember to allow a margin of vellum to show at the other edge. Plan the lining paper to be small enough to allow the foundation to extend beyond it at least $\frac{1}{8}$ of an inch on all sides.

Make dimensioned sketches of all pieces and lay out and cut all parts. (See Plate XXXVI.) Place the newsboard foundations on the short piece of vellum the proper distance apart, with equal amounts of vellum extending under each. The newsboard, of course, will extend at each end a trifle beyond the vellum. When the proper position is determined, draw pencil lines lengthwise of the vellum indi-

cating the edge of each cover. Put paste on the vellum and rub down well onto the newsboard forming the inside of the hinge. To make sure that the upper and lower edges of the covers are in a continuous straight line, place a rule or straightedge against one cover, extending across and beyond the vellum; place the second cover against the rule and the

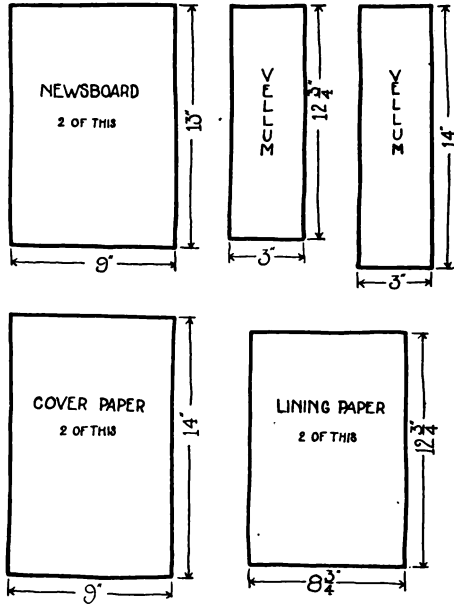

PLATE XXXVI. Dimensioned sketches of the parts of a portfolio.

edges will be in a straight line. (See Plate XXXVII.) Paste the second piece of vellum onto the outside and turn the projecting ends over the newsboard, pasting them down.

Properly place one foundation piece on the cover paper, allowing the vellum to show where it laps onto the newsboard, and draw around it. The amount of vellum which is to show is a problem in space division. Just how much will look well on the particular cover under consideration should be carefully thought out.

Apply paste to the cover paper, noting that it requires more skill to spread paste uniformly on a heavy paper than on vellum or lining paper. Place one piece of newsboard on the paper as previously marked, turn them over and rub down. A piece of cloth held in the hand and used for rubbing the surface prevents finger marks; or the rubbing may be done on a piece of paper laid over the surface. The paper should cling firmly to the foundation at every point, and this should be assured before proceeding. Apply paste to



PLATE XXXVII. Pasting the newsboard to the vellum back.

the projecting laps, fold them over and rub down. Treat the other half in the same manner.

It is desirable to tie the portfolio together on one side at least. For this purpose secure tape of harmonizing color and $\frac{3}{8}$ or $\frac{1}{2}$ an inch in width. About $\frac{1}{2}$ an inch from and parallel to the front edges cut a slit through both paper and newsboard of the same length as the width of the tape. (This needs to be done with a knife or, better yet, with a chisel.) Insert a piece of tape from 6 to 9 inches long in each slit and securely paste at least 1 inch to the inside of the newsboard, allowing the greater length to project from the outside. Paste the lining paper on the inside of each half and this will

cover the pasted end of the tape. The portfolio is then complete.

(B). By a different arrangement of tape the same kind of portfolio may be used as a magazine holder or cover for a paper book or pamphlet. Plan the newsboard foundations to project $\frac{1}{8}$ of an inch beyond the book on three sides. The space between the two pieces of newsboard should be at least an inch greater than the thickness of the book so that the covers will lie flat when the book is inside. It will be seen

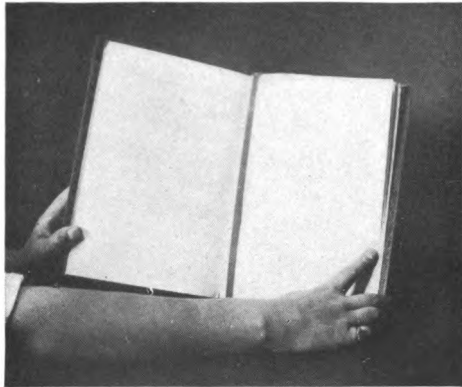

PLATE XXXVIII. A magazine in a stiff cover.

that with so wide a space the inner edge of the newsboard will not extend as far back as the back of the book, and in planning the newsboard it should actually be narrower than the book. Make dimensioned sketches of all pieces and lay out and cut all parts.

Construct the covers as for the portfolio, but insert the tape as follows: About $\frac{3}{4}$ of an inch from both upper and lower edges of the back cover, and just where the cover paper laps onto the vellum, make slits of the same width as the tape and parallel to the edges. Push one end of the tape through from the outside and paste, with the end turned toward the edge. Carry the tape over the adjacent edge

along inside of the cover and over the opposite edge where it should be inserted in the second slit and pasted on the inside as at the other end. A little slackness of tape is not objectionable. The lining paper may come to the edge of the tape, or, with more difficulty, be slipped under it.

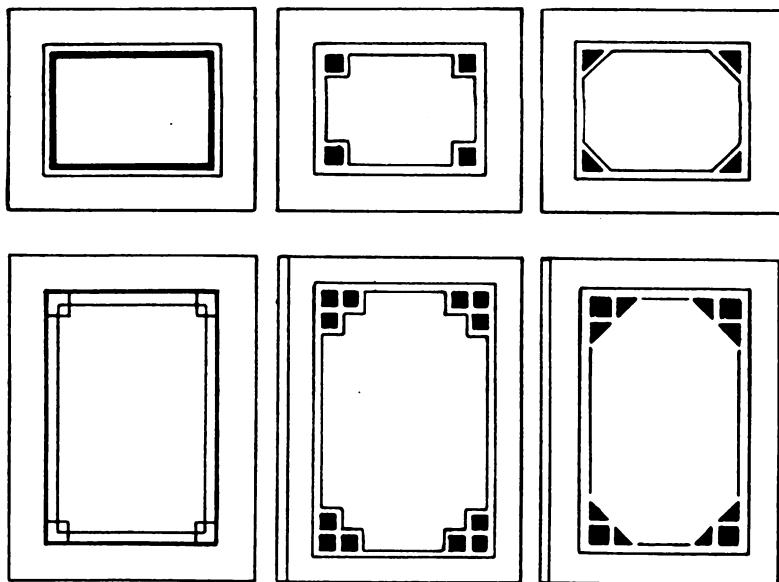

PLATE XXXIX. Simple borders suitable for use on a portfolio.

When one cover of the book has been placed under the tape, it should hold it securely. (See Plate XXXVIII.)

If desired, there is here an excellent opportunity for the application of a cover design. This may consist of simple straight line borders in lower grades, or of more elaborate designs in upper grades. (See Plate XXXIX.) Lettering also may be used either singly or combined with decorative figures. The design should be carefully planned before any attempt is made to place it upon the finished cover. Erasures are always noticeable and should be avoided. It is

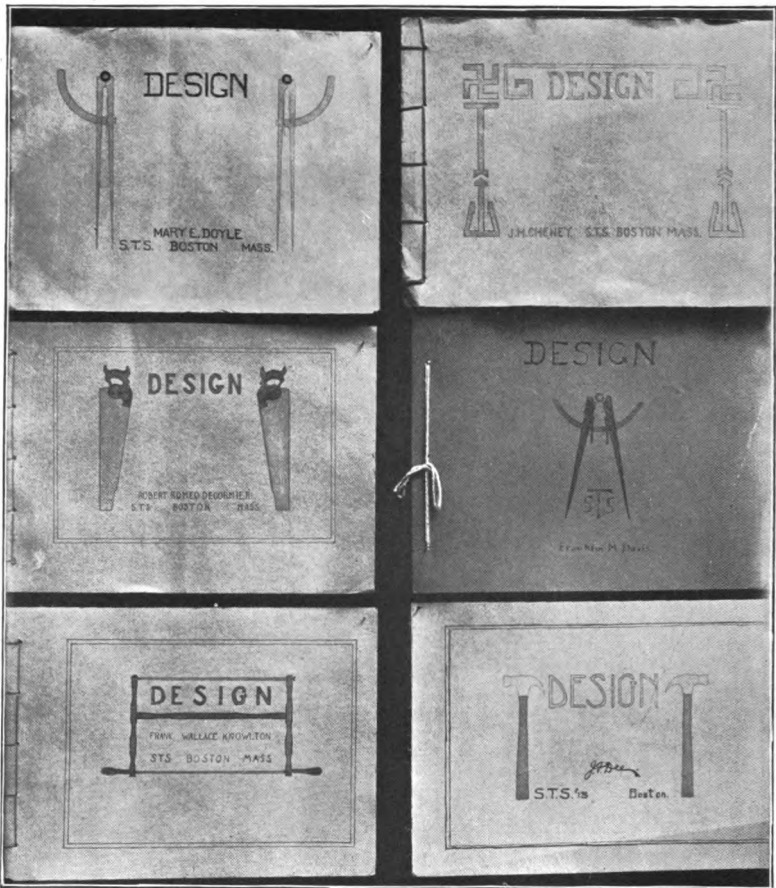

PLATE XL. Some cover designs made by students at the Sloyd Training School, Boston, Mass.

recommended that straight lines should be drawn with a rule, and the distance of the border from the edge measured either with a rule or a piece of paper. The decoration may be applied with ink, crayons, or water color. Common ink diluted gives the effect of a darker tone of the color of the paper and as it is easily obtained it is on the whole a satisfactory medium. (See Plate XL.)

Problem X

SEWING AND BINDING A BOOK

TIME: 10 hours.

MATERIALS: Newsboard,⁵ vellum, cover paper, white paper, tape, sewing linen, and "super."

There are several ways of sewing a book and even more ways of binding it after it is sewed. The first method here given is the simplest, and is such as is feasible in a fifth or sixth grade without a sewing frame, a press, or other apparatus than the simple tools required in the previous problems.

First determine the shape and size of the book. It is better at first not to attempt a book which is very thick, seven to twelve signatures being sufficient for a beginning. A "signature" is the name applied to a folded sheet, several of which go to make up the inside of a book. If the sheet is folded once it is called a "folio"; if twice, a "quarto"; if three times, an "octavo." (See Plate XLI.) These signatures, when sewed together, form what is technically known as "the book," and the covers and back "the case."

With a piece of cheap paper experiment a little, folding it one or more times and if necessary trimming the edges to change size or proportions. When the size is determined, cut a sufficient number of sheets, fold, and "stack" (pile) them for sewing. If the paper provided is too small to be used for a "quarto," place one "folio" inside another which will give two thicknesses of paper at each fold and will have the same effect as a "quarto." If desired, two or three

⁵A book-cover may be made of heavier newsboard than the articles previously described, although in elementary grades it will probably be more convenient to use one weight only. Number 30 is commonly used for books of ordinary size (say $7\frac{1}{2} \times 5\frac{1}{4}$ inches), while for larger books (10 x 7 inches) a still heavier board is used.

sheets of paper may be placed together before folding so that there will be several thicknesses at the back.

These signatures are to be sewed over three pieces of tape, one to be at the middle of the fold, one from 1 to $1\frac{1}{2}$ inch from each end, according to the size of the pages.

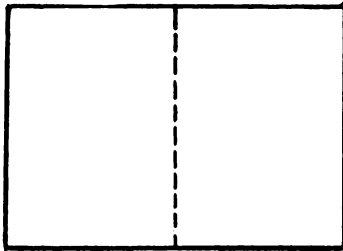

FOLIO

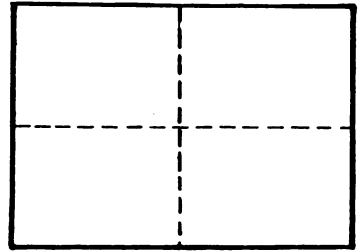

QUARTO

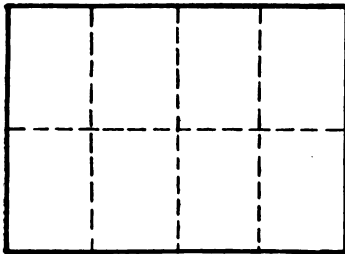

OCTAVO

16_{MO}

PLATE XLI. Diagram to show methods of folding sheets of paper.

On the back of the first signature mark carefully the position of the edges of each piece of tape, and additional points $\frac{1}{2}$ an inch from each end. The latter points show the location of the "kettle stitches."

Replace this signature on the others and mark across the backs of all, locating similar points on other signatures with as much accuracy as possible. (See Plate XLII.) The major folds should then be "jogged up" evenly at the back, and the minor folds at the "head" or top.

At each point on each signature make a hole for sewing by opening the signatures and piercing through with a needle from the back. Replace the signatures in the same order as before. Cut three pieces of tape about three inches long. Place the first signature on the desk or table with the fold of the back toward the operator. The left hand should be placed inside the signature to receive and return the

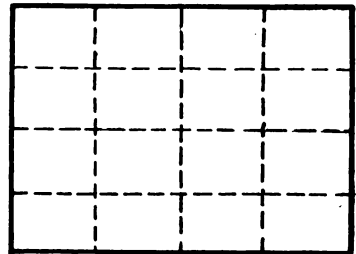
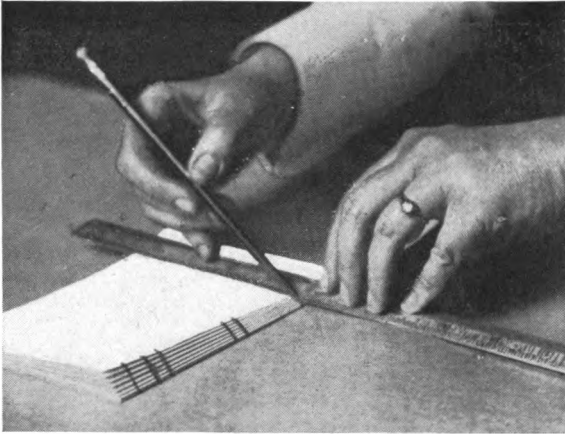

PLATE XLII. Marking the signatures before stitching.

threaded needle which is pushed through from the outside by the right hand. (See Plate XLIII.) Pass the thread **in** through the first hole (leaving an end long enough for tying), **out** through the second hole, over the tape, **in** through the third hole, **out** through the fourth hole, over the second tape, **in** through the fifth hole, **out** through the sixth hole, over the third tape, **in** through the seventh hole, and **out** through the eighth or last hole of the signature.

Close this signature and place the second signature on top of the first; then pass the thread **in** through the eighth hole of the second signature, and **out** through the seventh hole, over the tape, **in** through the sixth hole and so on until

the thread comes out through the first hole. Tie the thread to the loose short end in a square or hard knot. Place the third signature on top of the second and proceed as before. On reaching the end of the third signature, pass the needle under the stitch connecting the first and second signatures and through the loop formed by the thread. (See Plate XLIV.) Pull tightly to form the "kettle stitch" which should be made at the end of every signature hereafter.

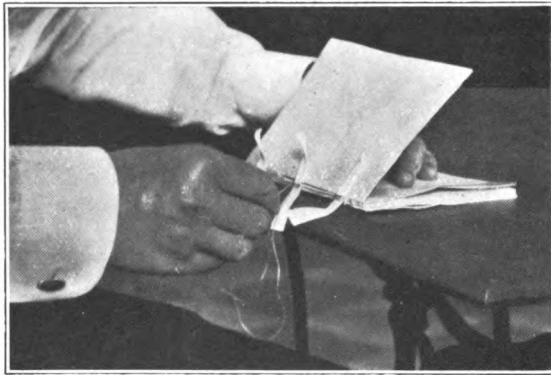

PLATE XLIII. Sewing a book over tapes.

In the same manner any number of signatures may thus be sewed to form a book.

For fly-leaves, prepare four single sheets folded once, to be of the same size as the leaves of the book. Place these folded sheets one on top of another leaving about $\frac{1}{8}$ of an inch of the folded edge of each exposed, the upper sheet being protected by a piece of waste paper. Rub paste over the exposed surface of all four at the same time. (See Plate XLV.) Remove the upper sheet and with its pasted edge downward place it upon the front signature of the book, its folded edge being flush with the folded edges of the sewed part, and the tapes thrown back out of the way. After rubbing this sheet well down, open it and place the second sheet

inside the first, having its pasted edge downward also. See that the folds exactly fit, and rub down the second sheet. Turn the book over and repeat the process on the opposite

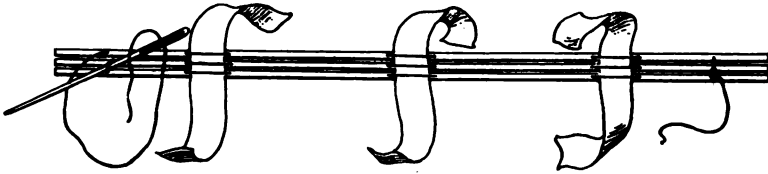

PLATE XLIV. The needle is in position to form the "kettle stitch."

side. If possible, allow the "book" to dry before proceeding farther.

Lay the "book" flat on the desk and with a wooden mallet hammer the folds at the back which will make the



PLATE XLV. Applying paste to the folds of the fly-leaves.

signatures lie close together. Turn the "book" over and repeat the process. A few strokes are sufficient. Cover the back with paste (or, if available, hot glue; do not attempt cold), and rub it well in with the fingers that it may hold the

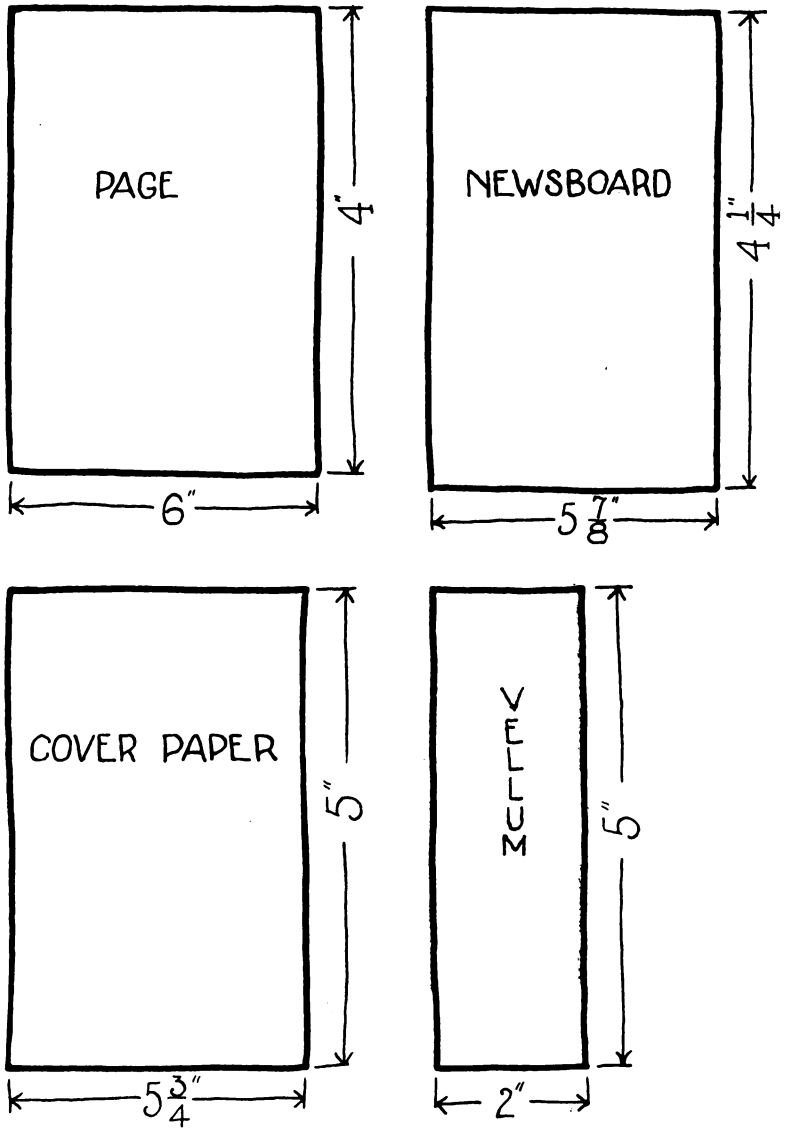

PLATE XLVI. Dimensioned sketches of the parts of a book.

signatures together and prevent their spreading. Use only a thin, even coat of paste and see that the tapes are pulled tightly across the back.

Cut a strip of "super" a little shorter than the length of the back, and wide enough to extend on to the fly-leaves about 1 inch. Place this over the freshly pasted back and rub it well on. Paste the part of the "super" which extends onto each side, and the tapes to the outside leaves. Also paste together the first and second fly-leaves in both front and back of the book. This double leaf will strengthen the back and if the paper is thin make the tapes and "super" somewhat less apparent. While covering one page with paste insert a piece of newspaper, considerably larger than the book under it to protect the remaining parts.

The "case" which should be a trifle longer than the "book" should be constructed similarly to the portfolio but without tape or lining paper, and with but **one** strip of vellum (the long one) on the back. Plan to have the covers extend beyond the front and ends of the book about $\frac{1}{8}$ of an inch, but at the back they should lack about $\frac{1}{8}$ of an inch of reaching the fold. Make dimensioned sketches of all pieces and lay out and cut all parts. (See Plate XLVI.)

Place the pieces of newsboard on each side of the "book" in the exact position they are intended to occupy. Take a narrow strip of paper and attach its ends to the outside of the pieces of newsboard (see Plate XLVII) so that when the latter are removed from the "book" they will be attached to each other the correct distance apart. Place them on the vellum and trace along the inner edge of each after ascertaining that the distance between them is the same at both ends. Remove the paper which connects the covers and paste them to the vellum in the position already marked out, but do not yet turn over the ends of vellum. Cut a strip of heavy paper of just the width of the back of the "book" and paste in the middle of the piece of vellum, after which the ends of vellum

should be turned over and pasted down. Complete the "case" by pasting on the cover paper.

Place the "book" in the "case" at the proper position. Lay it on the desk and turn back one cover. Using newspaper as already described, spread paste over the surface of the outside page on which the tapes and "super" are already pasted (see Plate XLVIII), and fold the cover back



PLATE XLVII. Determining the distance between covers.

on. See that the edges of the covers are in alignment. When this is assured, press the cover firmly to the pasted leaf, then open and rub down thoroughly this double leaf which forms the lining of the cover. Turn the book over and repeat the process with the other cover.

The book should now be well pressed. If two thin pieces of tin, zinc, or blotting-paper are placed between the "case" and the "book" while in press it will prevent the moisture from being absorbed by the leaves, causing them to wrinkle.

VARIATIONS

Several variations of the "case" are possible.

(A). The simplest is to cover the outside corners with vellum. If this is to be done, the vellum corners are to be applied before the cover paper. The width of the corner-piece, exclusive of the laps and measured on a line bisecting the right-angle, should equal the width of the strip of vellum



PLATE XLVIII. Pasting "book" inside the "cover."

which shows at the back. This rule holds true in all high class bindings such as morocco, Levant, calf, etc. (See Plate XLIX.)

By experimenting a little, a pattern (trapezoid) may be made for the corner pieces by which to cut them. (See Plate XLIX.) Plan these pieces to extend under the paper at least $\frac{1}{4}$ of an inch.

After the cover paper has been cut in rectangular shape, according to the original plan, the two outside corners should be trimmed to allow the proper amount of vellum to show. This may be accomplished in one of two ways. Using the same pattern as for the vellum corners, fit its two opposite

non-parallel edges as close to the corner as possible and cut along the inside edge of the pattern. Or, one may place the newsboard on the paper and trace around it, lay off the size of the finished corner and cut on the resulting oblique line. After the vellum corners have been pasted on firmly, place the cover paper carefully and paste it on as already described.

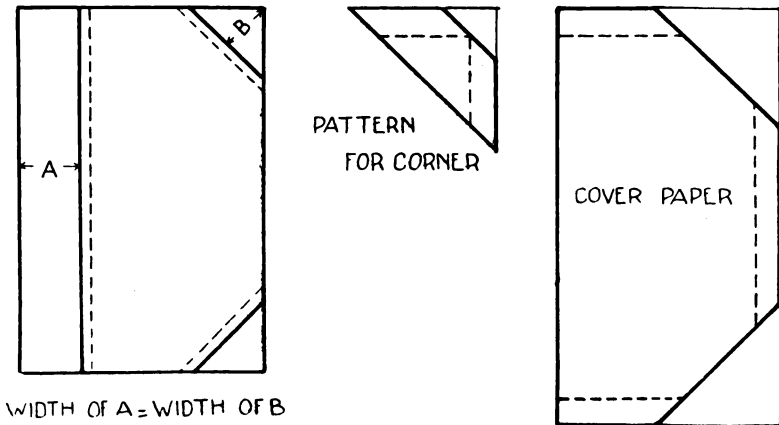

WIDTH OF A = WIDTH OF B

PLATE XLIX. Diagram to illustrate the size of separate corners, also method of cutting them.

(B). After the "case" is completed in either of the two ways described, it may be decorated with lettering or by the application of other design. In this instance the suggestions given in connection with the portfolio should be followed.

(C). The entire "case" may be covered with vellum. Generally a cloth covering is not desirable on a hand-sewed book, but if for a special reason one is to be used, have a single piece of vellum cut large enough to cover both back and sides. After finding the correct distance between the two pieces of newsboard, lay them on the vellum, in the manner already described, trace around them, and complete the "case" by pasting.

Problem XI

SEWING A BOOK ON A FRAME

TIME AND MATERIALS: As for Problem X, except bookbinder's twine is to be used instead of tape.

To carry out this problem a few common wood-working tools will be necessary. A sewing frame may be made by older pupils, a working drawing for which is here given. (See Plate L.)

The wooden upright screws may be purchased. Instead of tapes the book is to be sewed on bookbinder's twine. Cut three pieces 6 inches longer than the distance between the upper and lower bars. Tie one end of each securely to the upper bar and slide them along to position. (See Plate LI.) Tie the other ends to the lower bar, pulling them as taut as possible.

The signatures should be "jogged up" and carefully placed in a vise, back up and extending above the jaws about half an inch. It may be better (depending on the shape and size of the vise) to place the signatures between two boards, and then the whole in the vise. On the back of one signature mark off the position of the "kettle stitches" and twine 5 points in all — and, if T-square, try square or triangle are available, square lines across; otherwise lay off these points on both outside signatures and thus insure cuts which shall be "square across" the back. At each point saw across all signatures with a back saw, making a cut about $\frac{1}{8}$ of an inch deep. Hold the saw perfectly horizontally, that the cuts may be of uniform depth on all signatures. If vise and saw are not available, V-cuts may be made on each signature with scissors instead.

To sew a printed book, begin at the front with the "head" toward the right. Place the first signature on the

frame (page 1 down), with the back toward the operator and the three inside cuts against the twine, leaving the cuts at the ends for the "kettle stitches." If necessary, move the pieces of twine along the bars so that they exactly fit the cuts and sink into them. (See Plate LI). Tighten the twine by turning the wooden nuts and commence to sew.

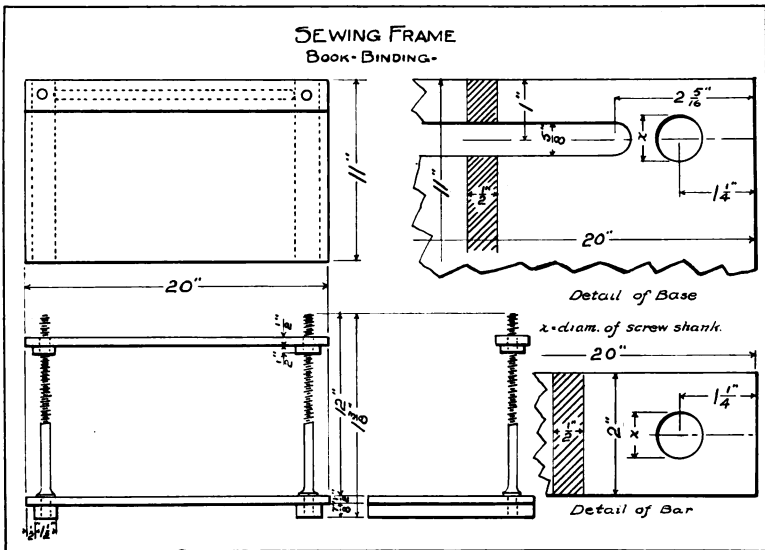

PLATE L. Working drawing of sewing-frame.

Hold the signature open with the left hand, and, commencing at the head, (right) insert the needle from the outside through the first hole. Bring the thread out through the second hole on the right of the twine, cross it, and return the thread through the same hole on the left of the twine. It will be seen that this process is virtually the same as sewing over tapes. Continue across the first signature and, when completed, close it, lay the second signature on top, and, in the same manner, sew across it from left to right. Pull the sew-

ing threads tightly and always **forward** in the direction of the sewing. If they are pulled **backward**, the paper will be torn.

After sewing across the second signature, tie the thread to the loose end as in a book sewed on tapes. When the third signature has been sewed, make loop stitch as already illus-

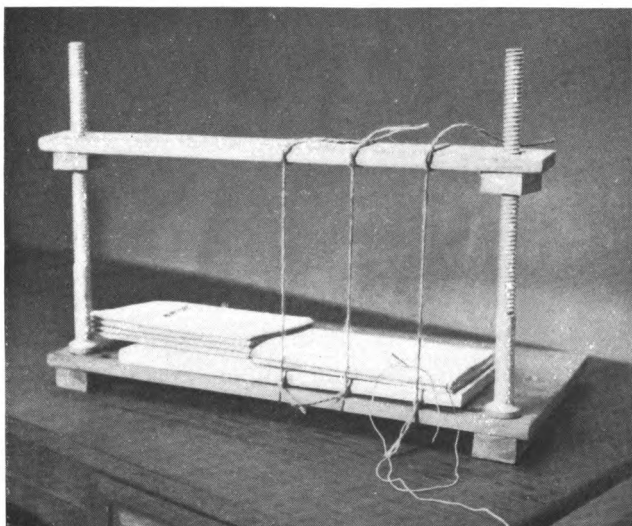

PLATE LI. * A sewing-frame in use.

trated, (forming a part of the “kettle stitch”) and repeat this stitch at the end of each signature. When the sewing is finished, grasp the book firmly and slide it up on the cords about $1\frac{1}{2}$ inch; then cut the twine from the frame, leaving about $1\frac{1}{4}$ inch projecting beyond the book on both sides. Pull the twine with both hands to straighten it. Put in fly-leaves and “super” and bind as before. The ends of the twine should be frayed out, and, after the fly-leaves are in, pasted in fan-shape to the outside leaf. Put on the case as shown in Problem X.

ADDITIONAL POINTS

(A). The binding may be made stronger by "whip-stitching" the fly-leaves after they are pasted in. For this purpose, take an ordinary sewing needle (about No. 2) and linen thread (No. 35). Begin at the right and, with "over-and-over" stitches about $\frac{1}{4}$ of an inch apart, sew through the outside signature and the fly-leaves. A knot should be made at each end to fasten the threads. Turn the book over and repeat the operation on the opposite side.

(B). If heavy paper is used for the fly-leaves, the outside leaf should be torn or cut off carefully before putting on the case. Leave just a narrow margin at the fold to hold the other half from coming out. This being done, there is but one thickness with which to line the cover, but two free leaves are left as before.

(C). Head-bands may be used on a book sewed on a frame. Cut pieces to fit across the back of the book and paste one at each end after the "super" has been pasted on.

Problem XII

REBINDING A PAPER-COVERED BOOK

TIME and MATERIALS: As for Problem X or XI except the "book."

Signatures for sewing may be obtained by taking apart some good paper covered book. Foreign books frequently come in this shape, and are much less expensive than in any other binding.

Carefully remove the cover and the sewing threads, if any, and scrape the glue from the back. Then proceed with the sewing and binding as already described.

It may be desired to have fly-leaves of lithographed or lining paper. In this case have two rather heavy sheets of such paper folded once with the plain side out, and two folded sheets of white paper. When pasting these onto the book, place a white sheet first, and then place a figured sheet inside it. When completed, each cover will have a lining of figured paper faced by a fly-leaf of the same, and a plain second fly-leaf next to the printed pages.

Problem XIII

BINDING NEW PRINTED SHEETS

TIME and MATERIALS: As for Problems X or XI except the "book."

Unsewed but printed signatures may sometimes be obtained from a printer or publisher. Fold and assemble the sheets, using great care to observe the correct order. Sew and bind by one of the methods already given.

Problem XIV

REBINDING AN OLD BOOK

TIME and MATERIALS: As for Problem X or XI except the "book."

A school book whose leaves are still in good condition, but with broken cover or loose binding, may often be preserved for much longer service by rebinding. Sometimes one has a worn book which has personal value, and a new cover is desired.

First remove the old covers, being careful not to injure the leaves, pull out the sewing threads and remove glue, "super," and fly-leaves.

Some repairing may also be necessary. Torn edges may be pasted together or faced with gummed tissue, or, if the tears are not too deep, the edges may be trimmed off.

Broken places in the folds may be mended if necessary by using strips of paper about 1 inch in width and as long as the leaves. If many strips are pasted onto the folds, the back of the book will be thick and bulky. For this reason, a thin tough paper should be used. Paste the fold of two adjoining leaves lengthwise on the center of one of these strips, so placed that, however badly torn, the leaves will assume their proper position, and the extra piece will be on the outside of the fold.

Illustrations are usually printed on a single sheet, often of paper different from the leaves of the book. To insert these, cover the back with a piece of waste paper, leaving a margin along one edge as in the case of the fly-leaf. Cover this margin with paste and insert the leaf in its proper place, pasting it down to the adjacent leaf. The illustration should usually be on the right of the book.

When all repairing has been done, re-assemble the signatures and bind as a new book.

ORIGINAL PROBLEMS

A final test of the pupil's efficiency lies in his ability to plan and carry to completion an original project. Originality does not consist in making an article never heard of before, but in adapting to one's specific needs, principles and processes already learned through class instruction.

A fitting close to a course in elementary book-binding is such a problem. If pupils choose to make articles such as the memorandum pad or the hinged covers which have already been taught, they should be accepted as original work, provided that each pupil selects the size and proportions himself, and does not depend on the teacher to repeat the instruction in detail. Yet more credit should be given one whose originality extends further as in the case of a boy who made for his father's use a holder for conductor's checks, or the one who made a mount for telephone numbers.

All articles constructed should be such as are appropriately made of the materials used. Models, such as are sometimes made of cardboard, to be constructed later of different materials should be excluded from this course.

It is by no means essential or desirable that originality be held in abeyance until the end of the course but rather, it should be fostered during each succeeding lesson. The pupils who work more rapidly than the average of the class may always have on hand an extra piece of work to be done when the regular assignment has been completed.

The adaptation of any problem to a specific purpose should always be considered an opportunity for the development of class originality. For example, a principal may want several portfolios in which to keep a particular kind of

papers; or a set of hinged covers to hold a "Course of Study" may be desired for each teacher's desk. These should be considered class problems and worked out as such.

It should be continually borne in mind that the object of the course is the development of the child. When he is conscious of the ability to make an article of intrinsic value a long step has been taken. "To help the pupil to help himself" is the highest aim of education.

TEAM WORK

Some of these problems may be given, especially in older classes as "team work." The class may be divided into sections doing specific parts of the work under a foreman.

This method is a good one when the aim is the output or when an insight into the construction of articles in large quantities is desired.

AFTERWORD

The border-line between educational handwork and technical bookbinding has now been reached, and it is not the writer's purpose to cross it. If this book of problems assists others in solving the quest for interesting and educational handwork, its mission will have been accomplished.

