

*Bookbinding and
its auxiliary branches*

John J. Pleger

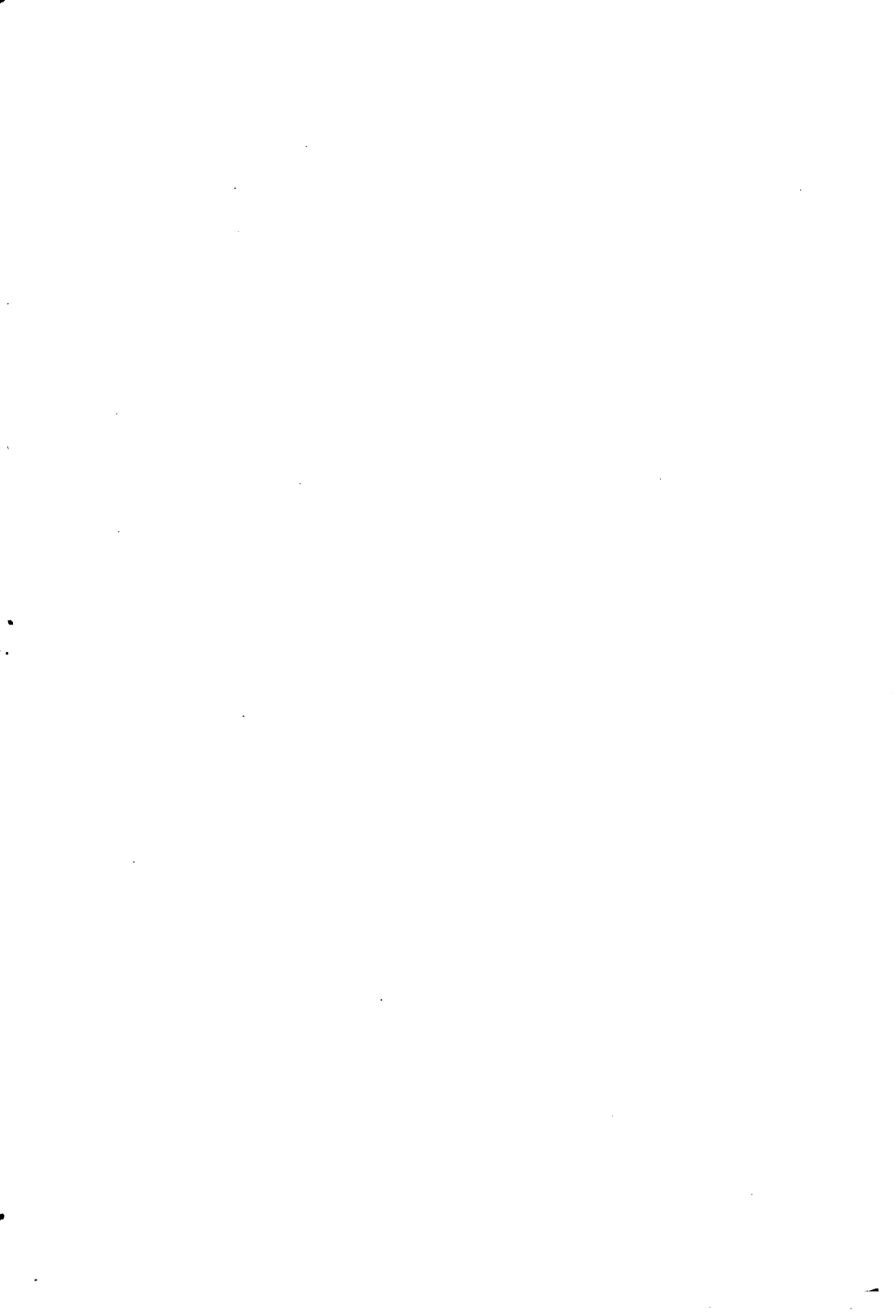

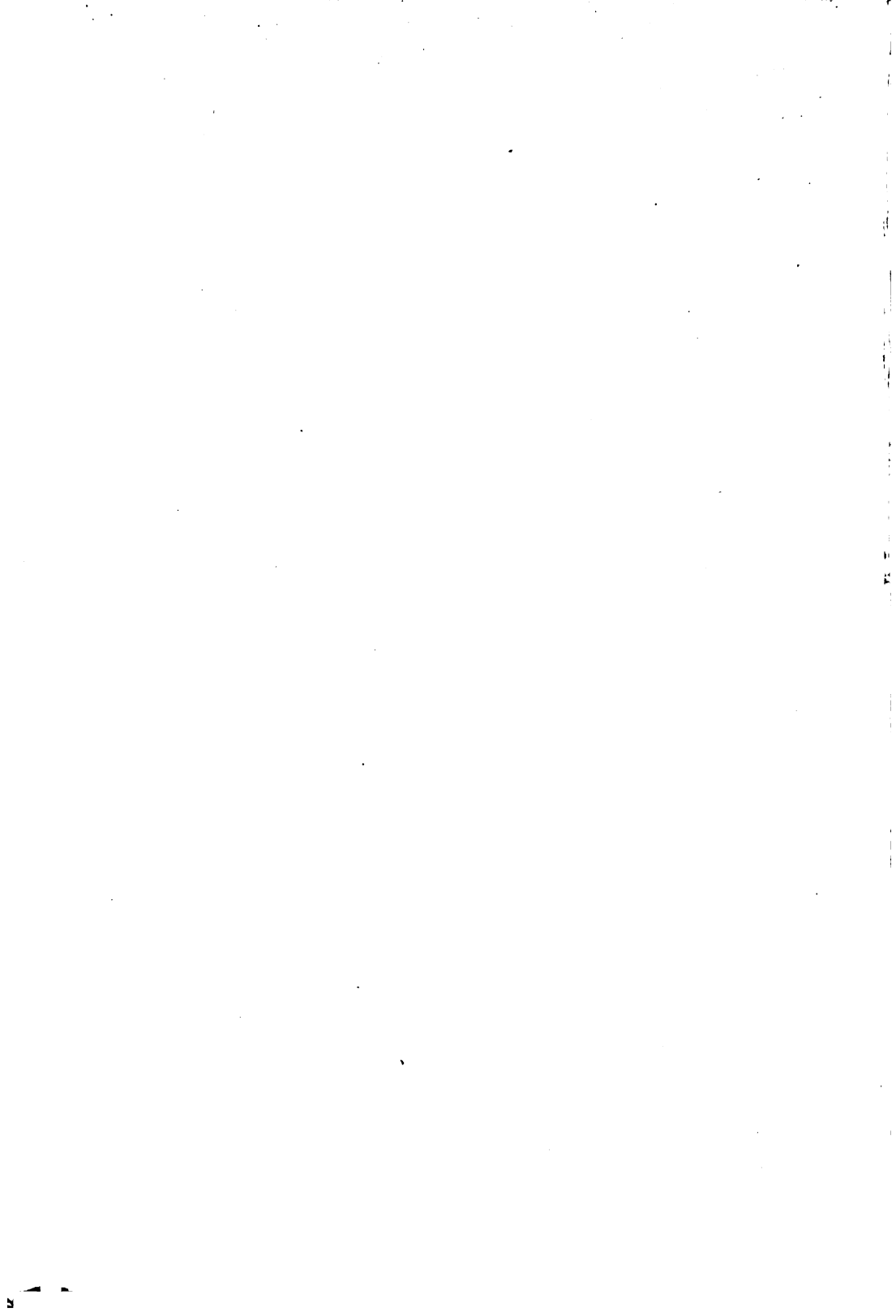



BOOKBINDING



JOHN J. PLEGER.

BOOKBINDING
AND
ITS AUXILIARY BRANCHES
(IN FOUR PARTS)

BY
JOHN J. PLEGER

PART FOUR

GILT EDGING, GOFFERED EDGING,
MARBLING, HAND TOOLING
AND THE CARE OF BOOKS

CHICAGO
THE INLAND PRINTER COMPANY
1914

B.C. 1915

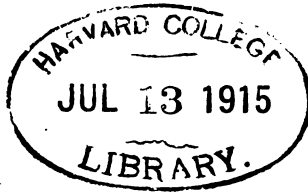

Subscription fund

Copyright, 1915, by
The Inland Printer Company
Chicago

FOREWORD.

It is not laudation of any trade to say that it follows in a beaten path when there is no reason therefor except that methods of procedure are habitual. That the present-day craftsman leaves too much to precedent and habit, and does not exercise enough his power of initiative, is demonstrated clearly by experience in bookbinding. To improve ought to be the constant aim; to do this, the continuation of steadfast methods and styles must be merited by sufficient reasons.

The invention of machinery has given impetus to all branches of manufacturing, and, by the displacement of hand labor, has given a possibility for further development of modern methods, yet we find there is in many binderies labor performed by hand which, with a proper understanding of hand and machine methods, might be done more expeditiously and perfectly with machines. Modern conditions and demands, however, are not an unmitigated advance; coupled with the opportunity for improved methods have come the pressure of competition and the slipshod makeshifts to economize in material and time without regard to the fineness or durability of the product, which puts on the appearance of a genuine article and is a good seller because of the cheapness in price. "Art with cheapness" was the motto of the ancient Greek, and it would be well for the modern man also to adopt the slogan. Cheapness, in contrast to extravagance, is meant, not to be confused with shoddiness. The Greeks believed, as we should, that simplicity and plain durability were the methods of attainment. Art in bookbinding should never be overlooked, for art means wholesomeness, and wholesomeness is lost by resorting to shabby, albeit gaudy, styles and materials, but is

gained by better and quicker methods of execution and suitability of design to the theme.

So, changes in, as well as continuation of, methods and styles of bookbinding must be merited by sufficient reasons. The terms of bookbinding are sometimes technical, but at other times are local or accidental. To have terms of value it is necessary to make them universal, so that a science may be based upon them, and one man may profit by the experience of another. It may seem strange, yet it nevertheless is true, that terms are at variance in different localities, and there seems to be no harmonious plan of description.

A demand has arisen for a book for use as a text. The growing generation is composed of students, and there is a demand not only for advanced knowledge among those practicing the art but among many would-be learners for a school, and, more essential still, a text. Craft education is of importance in these days of appreciated handiwork; moreover, among those whose livelihood is earned by such labor, competition is so keen that each laborer must needs strive to perfect himself in order to obtain the rewards of success.

It has been my aim in compiling these pages to treat the subject in a concise and comprehensive manner, defining consistently terms and processes in a way which may be grasped by novices and serve as an aid to bookbinders, librarians and printers who are more or less in charge of office work. To instruct the printer and binder, serve as a court of appeal for the man in the bindery when he should question erroneous work orders, and to aid both in satisfying the requisitioner, these pages are written. The wail for "the prostitution and the decadence of the once proud art of bookbinding" should be quelled by the improvements of to-day succeeded by those of to-morrow in the advance of a "modern bookbinding."

TABLE OF CONTENTS

EDGE-GILDING.		PAGE
Aluminum edges		16
Bolus preparation		7
Burnishing		13
Filler		7
Goffered edges		16
Gold Cushion		8
Gold knife		10
Illustrated edges		17
Laying on		12
Laying-on apparatus		10
Laying on gold leaf.....		8
Patching		15
Placing books in press.....		3
Round corners		16
Scraping		5
Sizing		8

HAND-TOOLING.

Blind-tooling		52
Gouges and lines.....		43
Hand stamps	44,	45
Inlaying		49
Marking in design		46
Proper way of handling tools.....		47
Substitute for hand tooling.....		49
Tree calf		55

MARBLING.

Marbling accessories		22
Alum water		28
American marble		37
Bouquet marble		38
Brushes		23
Combs		25
Combs, peacock		26
Comb edges		35
Colors		30
Blue		35
Bluish gray		35
Bronze		30
Brown		35
Gray		34
Grayish green		35
Olive gray		35
Red brown		35
Yellow		35
Violet		35

	PAGE
Hair-vein edges	33
Machine marbling	39
Ox gall	28
Peacock marble	37
Press stand	22
Rake	27
Size	31
Skimming	27
Sprinkling-water	29
Snail marble	37
Sun spots	38
Trough	22
Turkish marble	34
Care of books	39

LIST OF ILLUSTRATIONS

Book-cover designs	50, 51, 52
Brushes	23
Whisk	22
Burnishers	14
Carved and illustrated edges.....	18
Carved and tooled edges (insert).....	after 18
Clamps	37
Color dropping machine.....	24
Combs	25
Peacock	26
Cushion, gold	9
Portable	10
Edge tools	17
Electric finishing roll, automatic feed.....	57
Examples of binding (insert).....	after 58
Finishing tools	43
Gilder's tip	11
Gilding press	4
Goffered edges	16
Hand stamps	44, 45
Laying-on screen	12
Marbling — American, comb, hair-vein, peacock, snail, Turkish (colored insert)	after 32
Marbling stand	21, 22
Printing machine	39
Rake	27
Scrapers	6
Skimmer	28
Steel creasers	56
Trough	22, 37

EDGE-GILDING.



EDGE-GILDING.

The lustre of gilt edges harmonizes with almost any color of binding material. Publishers have long since recognized that gilt edges frequently enhance the value of cheap bindings and make the book attractive to the intending purchaser. Defects in the paper can be hidden, and it is the saving grace when publishers are compelled to accept two shades of paper in the same book.

The gilding-rooms in many large establishments are a revelation to amateurs, who would probably spend as much time producing one edge as the experienced gilder does a hundred. Extreme solidness is absolutely necessary in gilt-edging, and all books should be thoroughly pressed for at least twenty-four hours before sewing. To neglect this will cause the lustre and brilliancy of the edge to vanish after another pressing.

To prepare an edition of the letterpress books for gilding, jog the books on the back, and glue on both ends. This holds the signatures in place, prevents starts, and saves much time in scraping. Then trim the books on the fore edges, avoiding nicks. The sticking of leaves in gilt-edging can be avoided if the edges of the books are given a filler before putting them in the gilding press.

PLACING BOOKS IN PRESS.

The boards must not be made from open-grain wood; firs and oak are not serviceable for this purpose. They should be cut different lengths for different sizes of books, and should be beveled, and rounded on one end. This is done to prevent the sharp edges of the board being pressed into the leaves on both sides. That edge of the board which is always placed even with the edge of the books should be perfectly smooth. In scraping, it frequently

happens that the edge of the board loses its squareness; in that event it should be planed. This may be done with a carpenter's plane, or it may be trimmed in the cutting machine. The knife must run with the grain in the board, and not more than 1-32 inch should be trimmed at a time. A hard surface is required in gilt-edging, and

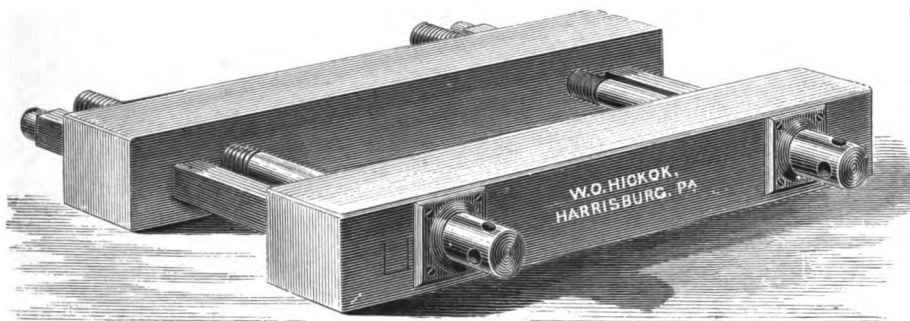

W. O. HICKOK, N.Y.

when gilding is done in large lots these boards must be placed between the books 3 or 6 inches apart. Jog the books with a board on top and bottom, and lay in the center of the gilding press. Then take up another lot and lay on top; this to be repeated until the entire press is filled. Then tighten the press with the bar as firmly as possible.

Thin books, either letterpress or memorandum, do not require a board between every 3 or 6 inches of the pile, but it is preferable to obtain that solid foundation so necessary to successful gilding.

Some books are not rounded, but backed flat; while others, especially thick books, should be gilt-edged after the book is rounded and backed. Such books are trimmed after the backing operation is completed. Take two binders' boards, the thickness of the backing ridge, and place against the ridge; jog the book at the back; then put it in the cutting machine carefully and trim the fore edge. When the book is taken out it will be concaved at

the fore edge without starts, which would have been difficult to do if the book were first trimmed and then backed. The ends can be trimmed by filling in the concave and convex with paper scraps. The gilding operation for the fore edge is more difficult because of the concave. The head and tail are treated in like manner, except that a flat surface is gilded.

Books gilded on the fore edges have the backs glued and rounded. The heads and tails are trimmed and put back into the press. This must be carefully done, and the backs placed a trifle lower than the fore edges to avoid the size running down upon the gilt edges and spoiling them. The books can be put together in lots of 3 or 6 inches, and the pile reversed alternately to even up the sewing swell. The next operation is scraping.

SCRAPING.—Scrapers are best made of steel of the same quality and temperament as the back saw, as such hold their edge better than other steel. The most convenient size is 2 by 5 inches, cut elliptical shape, one end rounded to fit the concave of thin, the other of thick, books. These must fit the concaved book so that all parts of the edge can be scraped. Another scraper about 6 inches long, with the corners rounded, is made for flat scraping. Some gilders prefer a round scraper, 2½ inches in diameter. The scrapers must be sharpened on one side, leaving one side flat; a fine edge, such as carpenters' tools possess, is not desired. The sharpening may be done by rubbing the beveled side on a piece of steel until the edge is turned. Because of the ease with which glass is nicked, scraping with that material is not recommended. A fine steel file and very fine sandpaper are frequently used by experienced workmen.

There is a wide difference of opinion in regard to wetting the edges before scraping. Some gilders contend that it should be employed only on writing papers, and that on all other papers it will cause the leaves to stick. Others claim that to dampen the edges will pre-

vent heating, which is the cause of the leaves sticking in gilding. It matters not which contention is correct if satisfactory results are obtained. However, dampening the edges is advisable on the majority of papers, as the blade of the scraper takes hold better and the scraping is thus facilitated.

The scraper is held with both hands, slantingly, the

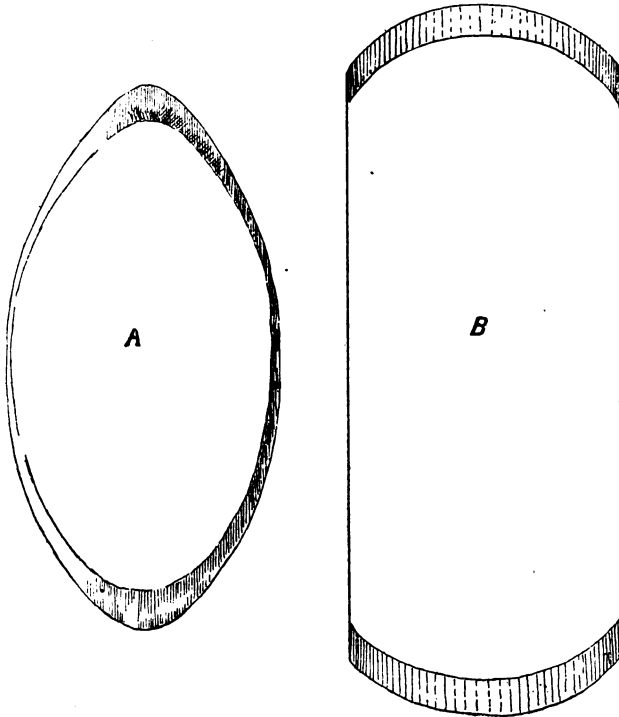

A — Scraper for concaved edges. B — Scraper for flat edges.

flat edge against the book edge, and is pushed away from the body. This is done until the entire surface presents a smooth appearance; fine sandpaper puts the finishing touches to the edge. The next operation is applying the filler.

FILLER.

There is necessity for a filler on paper in gilding; when placed under a microscope, small holes are visible, which must be filled in before any presentable gilded surface can be made. The theory is that all paper, before it can be gilded, must possess a surface as hard as stone, so that the size will not be absorbed but remain on the surface and bind the gold to the edge. The filler consists of a thin paste about the consistency of thick syrup, and is applied to the edge before the books are placed in the press. This is claimed to prevent the sticking of leaves in gilt-edging, provided that the subsequent operations are carefully executed. After the edges are scraped, they are given another filler and rubbed with soft paper shavings until dry. The next operation is applying the bolus or color.

BOLUS PREPARATION.—The brilliancy of gilt edges is enhanced by color previously applied to the edge. To supply this need, Armenian bole or bolus (sold prepared as "Poliment") was discovered to possess desirable properties because of its brick-red color and its possession of gliding properties, which facilitate burnishing, upon which the beauty of the production depends.

To prepare, scrape it into a bowl; mix with egg glair to a consistency of syrup. Then strain through a loosely woven cloth, apply to the edge with a sponge or camel's-hair brush very evenly, avoiding streaks. When dry, rub down with a stubby brush to remove dust, dirt and hair.

Some gilders prefer a mixture of plumbago (black lead) and chalk. Another preparation which possesses excellent burnishing properties is as follows: In one-half pint of warm water dissolve two cakes of gelatine; then add two spoonfuls of bolus and one spoonful of plumbago; allow to cool, and add two spoonfuls of alcohol. Bibles and prayer-books have colored edges, and

these are executed as described under "Coloring edges" after the filler has been applied. This is done so that in the open book the edges will appear a bright red. Bolus is then eliminated. The next operation is sizing and laying on the gold leaf.

SIZING.

The size is spread on the edges with a camel's-hair brush $1\frac{1}{2}$ inches wide. A wider brush may be used when the quantity of books warrants.

The best binding medium is a size made of white of egg. This is prepared by separating the white of a fair-size egg, and mixing it in one pint of water with an egg-beater; then it is left covered to stand over night. Before using, remove the froth, and strain through a cloth. Soft or absorbent papers require a trifle stronger size, consisting of one part of the white of an egg to three or four parts of water. Some gilders attribute unsatisfactory results, such as spots, streaks, scratches and dull edges, to thick size. A thicker size than that mentioned will not be satisfactory, and should not be used.

The commercial egg albumen commonly used in book-binding establishments may also be used. It is prepared by taking two quarts of water and adding thereto five teaspoonfuls of albumen; stir this occasionally, and let it stand covered over night. Remove the scum and strain through cloth. Some claim that this requires a preservative, and add a few drops of muriatic acid and camphor. Enough of the edge for one leaf of gold is sized flowingly with a brush. In applying this, avoid froth and bubbles by rubbing the brush on the hair. This, although a dirty personal habit, is beneficial to the work.

LAYING ON GOLD LEAF.

GOLD CUSHION.—The gold cushion is made by taking four layers of cotton batting and laying them on a board $15\frac{1}{2}$ inches long and 8 inches wide, placing a sheet of

blotting paper on top, and stretching a piece of calf which has been dampened with the rough side out over the board, and tacking on to the sides. Cut the ends flush with the bottom edge of the board. This will dry smooth. Before using, it should be carefully rubbed with pulver-

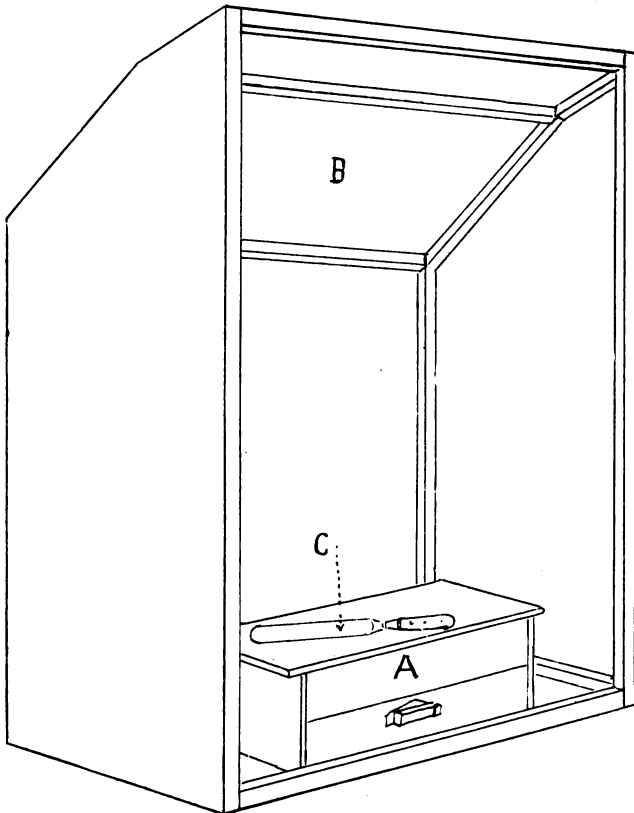

A — Gold cushion. B — Gold cushion protector. C — Gold knife.

ized chalk to prevent the gold from sticking. A box 7 inches high should be made to support the cushion and bring it up to a convenient height.

The greatest vigilance must be maintained to obviate

drafts. The frame for a cushion protector can be made of $\frac{1}{2}$ -inch-square strips and covered with white muslin, leaving the front open. This does not shut out the light, and gives plenty of working space. The dimensions are: Height, 31 inches; length, 27 inches, and width, 17 inches.

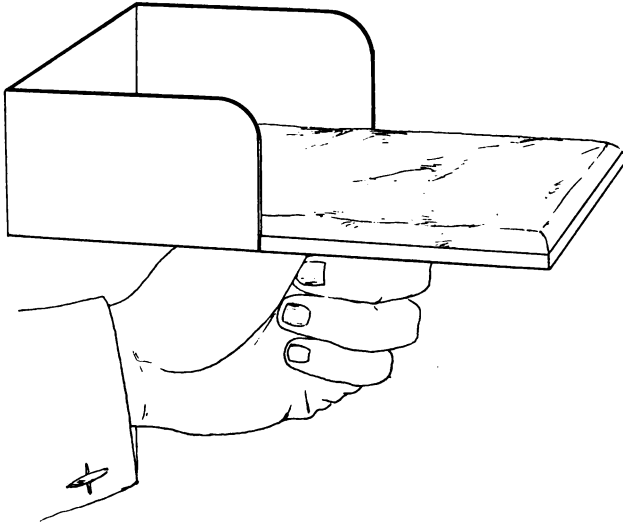

Portable Gold Cushion.

GOLD KNIFE.—The blade of the gold knife is thin, pliant and two-edged. It is 8 inches long, $1\frac{1}{4}$ inches wide, with a handle about $4\frac{1}{2}$ inches long. The blade should be blunt and honed on a piece of steel from time to time; sharp edges are not desirable, as they will ruin the gold cushion.

LAYING-ON APPARATUS.—There are different methods employed in laying on the gold leaf. One apparatus consists of a wooden axle with two finger cranks on each end, with a piece of thread the length of the axle put in the grooves of the finger cranks. To pick up the gold, spread out the finger cranks so that they will touch the

edge of the leaf, then rub the thread on the hair and lay on the leaf; raise the apparatus, close the finger cranks slightly, and lay on the sized edge. This contrivance is preferable for concave edges, as the cranks may be closed enough to fit the round of the book.

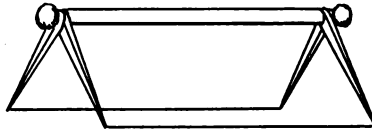

Laying-on Apparatus.

The gilders' tips are made of long badger hair, stuck between two pieces of board. These are largely used in gilding signs and picture frames, and are preferred by

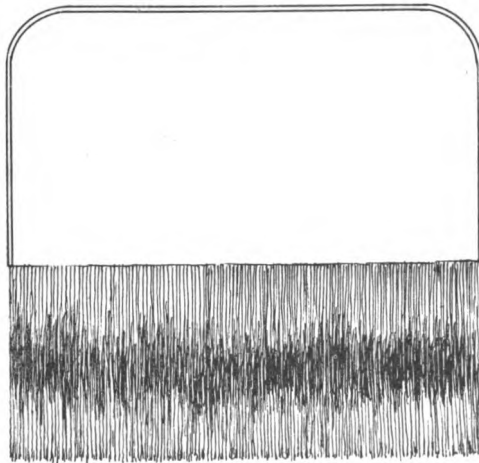

Gilder's Tip.

some edge-gilders. To pick up the leaf, rub the tips on the hair, lay on the gold leaf, raise, and put down upon the sized edge.

The screen consists of gauze or silk of a stiff variety, stretched on a frame about the size of a gold leaf. To pick up the leaf, rub the screen on the hair, lay on the gold, raise, and put down upon the sized edge.

Stiff paper cut a trifle larger than the gold to be picked up is recommended on single books. It has the

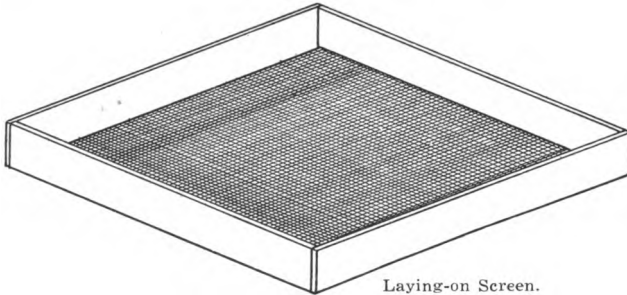

Laying-on Screen.

advantage of allowing a larger number of gold strips to be made ready for laying on with one sizing.

The simplest method is to cut the surplus margin of the book containing the gold leaf close to the edge of the gold. The leaf will adhere to one side of the paper, which can be picked up and laid on the sized edge.

LAYING-ON OPERATION.— A book of gold is laid on the left end of the cushion. The leaf is taken from the book by turning back the top paper leaf, giving a few light taps on the cushion with the knife to curl one-third of the leaf over, placing the blade near the turned-over leaf, and gently blowing so that the end of the leaf will fall flat on the blade. Turn the left edge of the blade up slightly, and bring the leaf over to the right on the cushion; blow gently on the center of the leaf, and it will lay flat. Picking up gold with the finger is difficult, because of the moisture and grease; neither can it be done with a greasy knife. Both sides of the knife should be rubbed on the liberally chalked edge of the cushion. Spotted edges are sometimes the result of poor gold; hence only the best, free from pinholes, should be used.

The operation is simple, yet requires speed and accuracy. The laying-on of leaf will be difficult for the novice, as the size will draw and tear it. It must be done quickly, or the results will be unsatisfactory. Lay out enough leaves to cover a portion of the space between the gilding boards and also plenty of strips to cover abrasions. If paper is used, the operation is simple; if screen, tips, or axle with cranks, the gold must be picked up one strip or leaf at a time. Take the size brush in the right hand, holding the laying-on apparatus with the left; size the right-hand corner, lay the brush aside, and gauge the spot on which the gold is to be laid, and, with a quick movement, lay it on. The size draws the gold, and if the operation is not quickly performed, breaks will result. This is repeated until the entire surface of the edges is covered with gold, the leaves slightly overlapping each other. Should there be any breaks in the gold, tilt the press to allow a little size to run under the gold to the spot, then lay a piece of gold on top. If the size gets dry, the abrasion must be resized with a small camel's-hair brush. Alcohol is sometimes used for patching. For laying-on gold on concave edges, only the axle and cranks can be used. After picking up the leaf, close the finger cranks about $\frac{1}{2}$ inch, and aim for the center with a quick downward movement. After all the gold leaf is laid on, stand the press on one end, and allow the size to drain. This draining on the head and tail, when books are rounded, must never be permitted toward the back, as it is too open and would absorb all the moisture. The next operation is rubbing-down and burnishing.

BURNISHING.

The tools necessary in burnishing are agate and blood-stones; there are two shapes — one flat, and the other toothlike. The agates are used in the preliminary burnishing, and the blood-stone to produce the brilliancy and lustre. Some contend that burnishing must be done

while the edge is still moist, in order to obtain a lustre; others say that such a procedure spells ruin to the edges of coated paper, as the leaves will stick. The time when

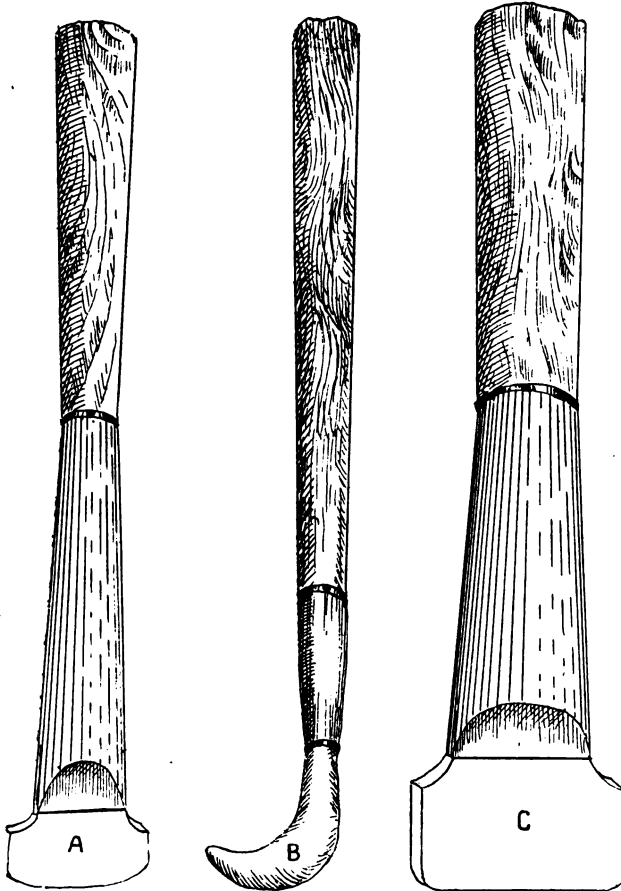

A — Flat agate. B — Tooth agate. C — Blood stone.

rubbing-down should begin depends on the atmosphere. Ordinarily, the edges may be rubbed down in from fifteen to thirty minutes after the laying-on of the gold. To determine the proper time to commence rubbing-

down, blow upon the edge; if the lustre of the gold is dimmed for several seconds, the edge is still too moist; but if the cloud vanishes immediately, the edge is sufficiently dry. An edge which is not sufficiently dry will exhibit breaks after burnishing, and an edge which is too dry will rarely have the desired lustre.

Wax a piece of paper on one side, and place on the book edge, waxed side up. This is done to protect the gold, and the wax enables the agate to glide freely. The agate is gently rubbed crosswise over the waxed paper. If the gold and moisture adhere to the paper near the board, it is too damp and must be laid aside. If the process has been satisfactory, take a piece of linen on which beeswax has been rubbed, and carefully go over the edge to remove the surplus gold. The burnishing can then commence without the waxed paper, and the pressure can be increased until a sufficient lustre is obtained. Hold the agate level, put the handle against the shoulder, and grip the lower end firmly with the right hand above the metal fastening; then holding at an angle, slide over the surface. The glide must be even and gradual in order to obtain uniformity. After the edge has been burnished crosswise, the same method should be employed lengthwise. Quick burnishing should be avoided, as it heats the gold, rubs it off, and causes abrasions. For lustre and glow, the blood-stone is employed, and the operation is the same as described for the agate burnishing. Care must be taken in burnishing on the fore edges and backs of rounded books, as the surface, due to the concave and convex ends, is not hard. The books are then taken from the press and are ready for forwarding.

PATCHING.—All abrasions which appear before applying the wax can be mended by breathing upon the place and laying on the gold leaf quickly. The spot is rubbed down and burnished as described in the regular operation. Abrasions which are discovered after the book is burnished can be mended by applying alcohol

with a small camel's-hair brush and immediately laying on the gold leaf. It must be rubbed down and reburnished in the regular manner, preferably lengthwise of the sheet.

ROUND CORNERS.—All round-cornered books should be put in the press with boards exactly the size of the books. The boards can be cornered with a chisel. The scraping is done in the regular manner. Sandpaper is used, perhaps, to better advantage than scrapers. Books which are gilt-edged after rounding require greater care. Small pieces of gold should be cut and applied in rapid succession after the corner is sized. Rubbing-down and burnishing is the same as described for straight edges. The tooth agate is sometimes handier to use than the flat agate.

ALUMINUM EDGES.—The operations are the same as described under "gilt edging," except that aluminum leaf is used instead of gilt leaf. It is laid on with a solution of one cake of gelatine, dissolved in one-half pint of water. The aluminum can be laid on the edges with the hands, as the leaf is heavier than gold.

GOFFERED EDGES.

To produce designs on gilt edges by means of indenting with finishing tools is termed "Goffering." To do



this, place the book between two gilding boards, and put in a gilding press or backing machine. Trace the design

on tracing cloth, tip the side ends on the gilding boards, then dot the outlines by tapping a dull awl or hand tool with a small wooden mallet. To bring out the design and produce different colors of gold, remove the tracing cloth, and use a small checkered tool, tapping lightly with a mallet. This will produce a different shade of

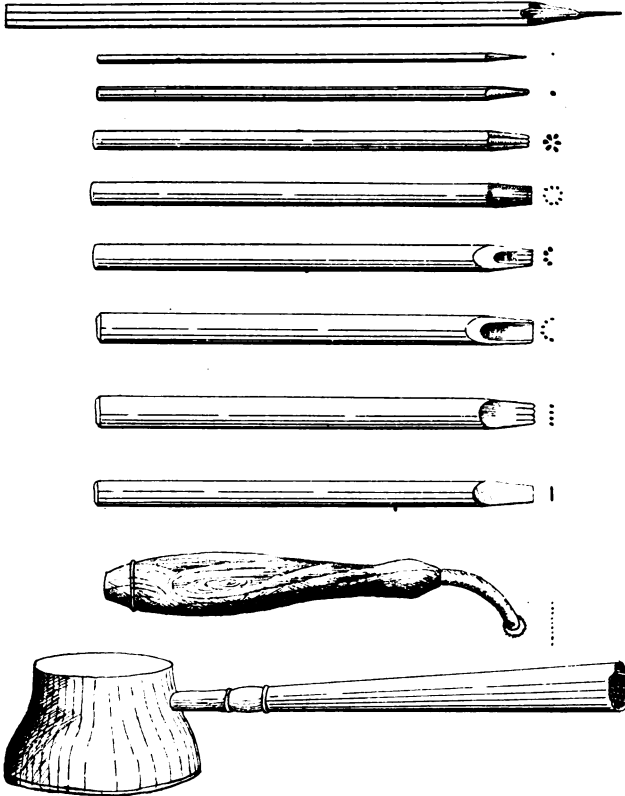

gold with a somewhat rough appearance, which is pleasing to the eye and which brings out the design.

Illustrating the edges can be done in like manner, but care must be taken to obtain a uniformity of dots. To do this, a small wheel, $\frac{1}{4}$ inch in diameter, similar in appear-

ance to a dressmaker's tracing wheel, can be made in any machine shop; and with this, any kind of scroll or design may be produced in one-tenth the time required by the dull awl and mallet.

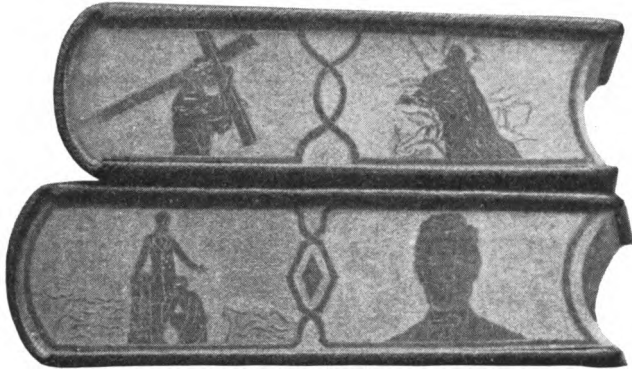

The painting of flowers, etc., can be accomplished by removing the gold with a small scraper, and then paint-

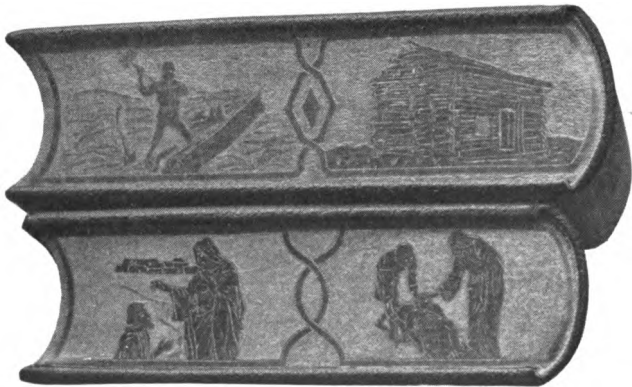

ing with water-colors. One may also enhance the beauty of books by gilding with a usual or lemon gold first, and then gilding with bright deep in the usual manner.

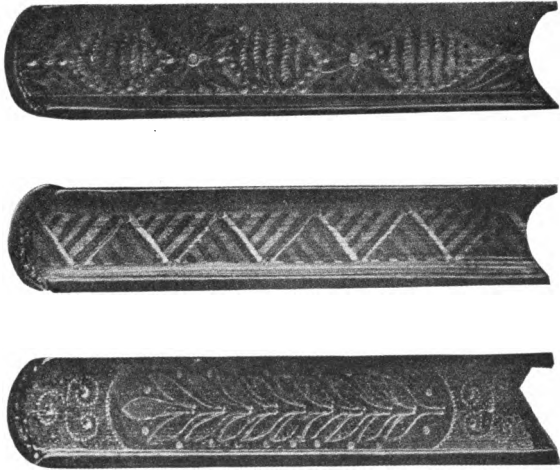

Carved and tooled edges by Ernwein, Strassburg.

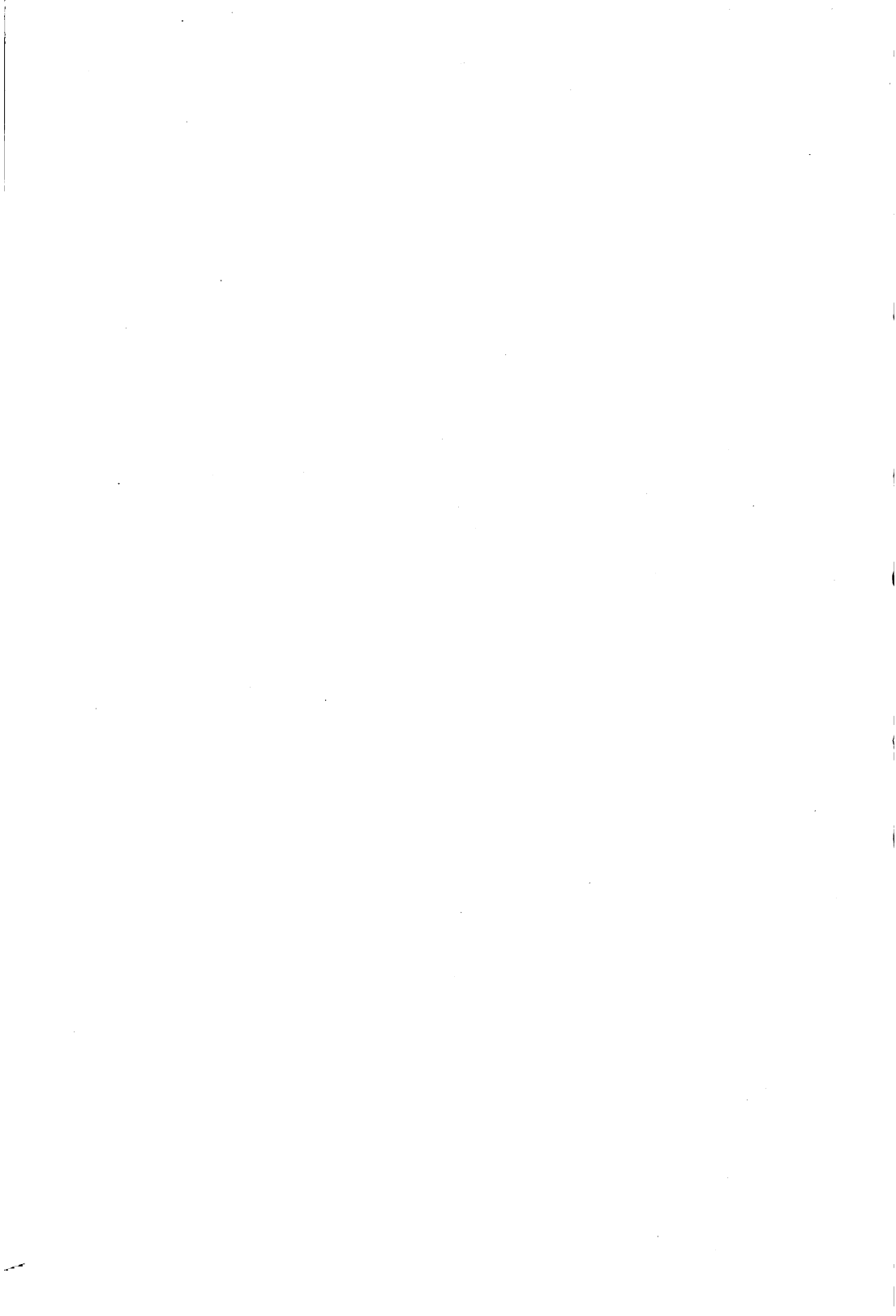

MARBLING.

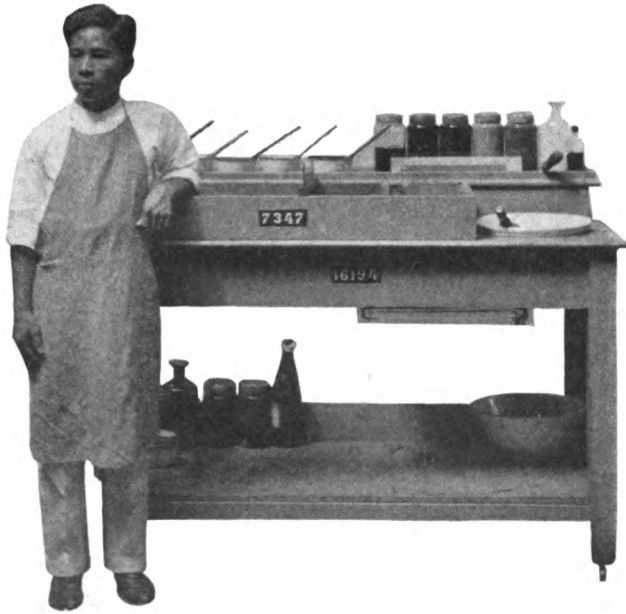

Filipino Marbler, taught by the author.

MARBLING.

The harmony of colors when arranged in different patterns is pleasing to the eye, and the skill required in execution calls forth appreciation from the beholder. The seeming disuse into which marbling has fallen may easily be attributed to the marblers themselves, as they zealously guard their secrets, and make it difficult to spread the beautiful art. The average shop can ill afford

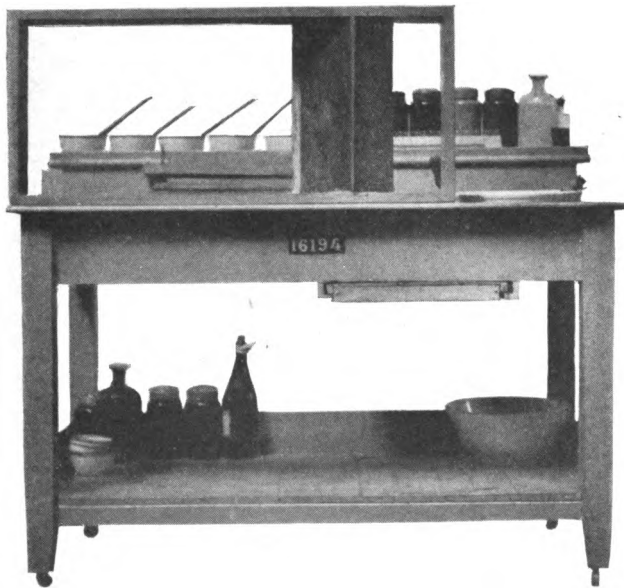

to employ a specialist, and efforts of novices to produce marbling have usually resulted in unsightly edges and in condemnation of the process as expensive. A concise explanation will here be given, which, if followed and with sufficient practice, should produce satisfactory results. No matter how intelligent a person may be and with what

care these pages are studied, there still remains the most essential feature to successful marbling, namely, "practice."

MARBLING ACCESSORIES.

TROUGH.—The trough should be large enough to accommodate a double-medium book. The illustration shows a trough that has a glass bottom, the purpose of which is to give light where most needed, so that bad spots can be avoided in dipping. It also enables the

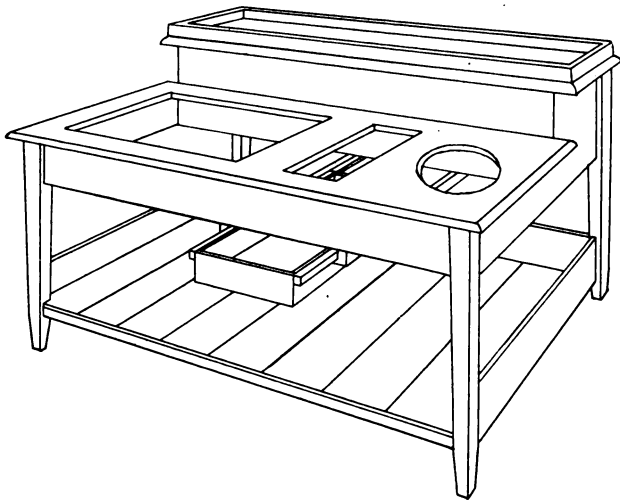

marbler to judge the intensity of the colors, and to see the designs. This is especially appreciated when the size becomes soiled. The trough is made of well-seasoned wood and dovetailed at the ends.

STAND.—The stand is shown in the illustration. It is made for the trough to rest on. There is an opening in the top board the size of the glass in the bottom of the trough, and one at the right of it through which the skimmed size drops into the waste pan. There is also an opening at the right of the trough for a bowl in which sprinkling-water or the ground color for Turkish marble

is prepared. The waste pan is removed when full without disturbing the trough, and, when papers are used for skimming, the hands are not soiled in removing them. The stand is on rollers, which enables the marbler to move it where the light will be the best. The opening in the stand enables the light to strike the glass.

BRUSHES.—Marbling brushes are from $\frac{3}{8}$ to $\frac{1}{2}$ inch in diameter. The larger brushes are used for ground-color in drawn marble, while the smaller brushes are



used for the subsequent colors. These brushes should be made of a fine bristle, set in hard rubber, and mounted with tin. The bristles should be curved to give a freer motion when dropping the color. To curve the brush, wind the bristles with thread $\frac{1}{2}$ inch from the handle; pull them over, and fasten the thread to the handle. Put in hot water for a time; then remove, and let dry.

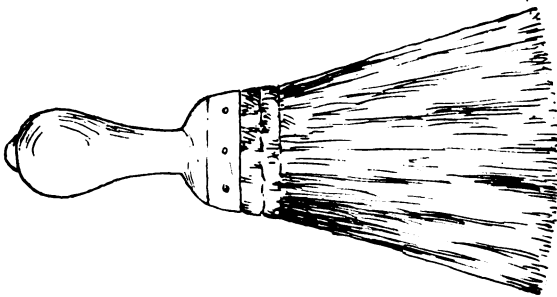
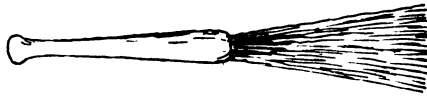

WHISK BRUSH.—For sprinkling water and the ground color in Turkish marble, the ordinary whisk broom used in brushing clothing will be found serviceable. For

throwing on the second and subsequent colors, gall for white spots, whisk brushes of rice straw are made about $\frac{3}{4}$ inch in diameter and 5 inches long. These brushes should be inserted in 6-inch wooden handles.

COLOR-DROPPING MACHINE.

The throwing on of colors in drawn marble requires considerable practice to produce uniformity of drops and patterns. The recent invention of a machine for throwing on colors has greatly facilitated this operation. It



consists of a four-compartment reservoir and a system of tubes connected with the reservoir. These serve as outlets and distribute drops of color at regular intervals on the size. Three and five outlets are provided for the two principal colors, and two outlets each for the sec-

ondary colors. To operate this machine, prepare the colors for drawn marble as directed in that chapter; then fill the compartments with color of equal amount; then slide the machine on the rims of the trough, press two levers which form part of the handles of the machine, and open the outlets by a slight pressure. The colors become free, and fall on the size. The tube ends must not come in contact with the size.

COMBS.—Combs used in drawn marble are made as follows: Cut two pieces of No. 20 binders' board, $2\frac{1}{2}$ inches wide and the length $\frac{1}{4}$ inch narrower than the width of the trough. Draw a pencil line $\frac{3}{4}$ inch from

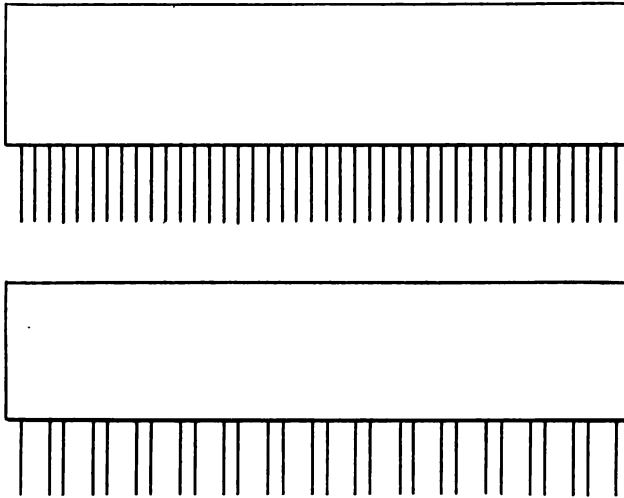

the edge on one board, and divide the length into eighths of an inch; then with an awl scratch the end sufficiently to embed a fine steel needle. Glue the board, and lay the needles into the grooves even with the pencil-mark; then glue the other piece, and press until dry. The combs should be made in four different spacings; one in $\frac{1}{8}$ inch, one in $\frac{1}{4}$ inch, one in $\frac{3}{8}$ inch, and one in $\frac{1}{2}$ inch. A double comb, consisting of wide and narrow

spacing, alternately, one $\frac{1}{8}$ inch, then one $\frac{3}{8}$ inch, until the length is covered, should also be made.

PEACOCK COMB.—This consists of two independent combs put in a holder with the projecting ends pulled out and pushed in, alternately. To make it, cut four pieces of No. 50 binders' board 12 by 2 inches. Draw a

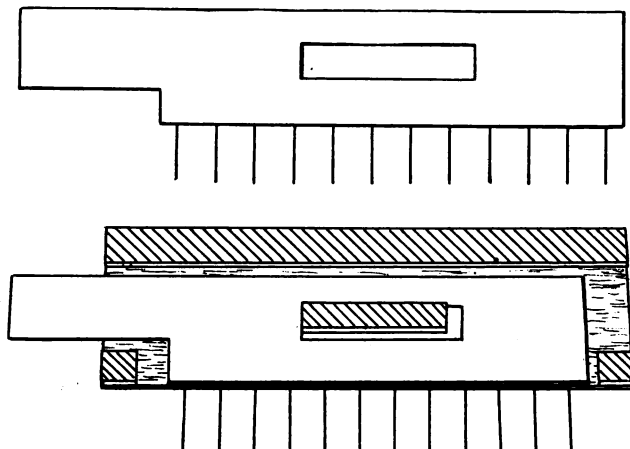

pencil line $\frac{3}{4}$ inch from the edge on two boards, and divide 10 inches into fifteen divisions. With an awl, scratch the board from the line sufficiently to embed fine steel needles. Glue the board, and lay the needles into the grooves even with the pencil-mark; then glue the other pieces, lay on top, and put in press until dry. This will leave one end of 2 inches without needles on both combs. Cut two pieces of No. 25 binders' board 10 by $2\frac{3}{4}$ inches, and a piece of board the same thickness as the two combs, 10 by $\frac{3}{4}$ inches. Cut exactly out of the middle of both combs a strip 4 by $\frac{1}{2}$ inches, then with the cutting machine trim to $3\frac{1}{2}$ by $\frac{3}{8}$ inches. Lay the comb on the 10-inch No. 25 binders' board centered with the 2-inch handle to the right, leaving $\frac{3}{4}$ inch on the top, to which binders' board the combined thickness of the two combs is glued. Then glue the strip cut from

the center of the comb, and lay it to the right of the slot. This is done in the same manner to the second comb; the $\frac{3}{4}$ -inch end of the No. 25 binders' board is then glued, and the two combs put together with the projecting end to the left, and pressed until dry. This leaves two handles on both ends when pulled out $1\frac{1}{2}$ inches long. The needles in the two combs are thus exactly on each other. It can be finished by sandpapering or covering, and will be found serviceable for a long time.

RAKE.— This is made by taking a board $\frac{3}{8}$ inch thick, about $1\frac{1}{4}$ inches wide, and about 1 inch narrower than the width of the trough. Drive thin wire nails along both

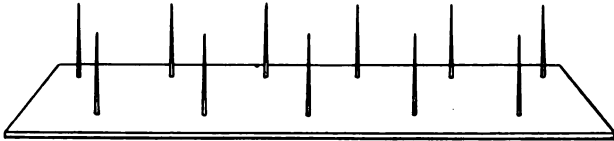

sides 1 inch apart; the nails on one side are placed between those of the opposite side.

STYLUS.— This is a piece of hard wood about 6 inches long, 1 inch in diameter at the top, tapering to a fine point at the bottom. It is used to draw the colors across the trough in comb marbling, and for other designs as described under the various heads.

SKIMMING.

Before the colors can be thrown on the size, the top must be skimmed to remove the film. This film is caused by evaporation, and any color thrown on will not expand. It is obviously necessary to skim all size before throwing on or preparing colors. No matter how careful the worker, it can not be properly done with paper. Trouble arises when the size is disturbed, for that causes a delay and necessitates another skimming. To obviate this, the skimmer as shown in the illustration, fills all require-

ments. It may be raised or lowered on both ends, according to the quantity of the size in the trough. The rubber on the end enables a clean skim, and, being supported on the rims of the trough, assures an even and quick pull which will not disturb the size.

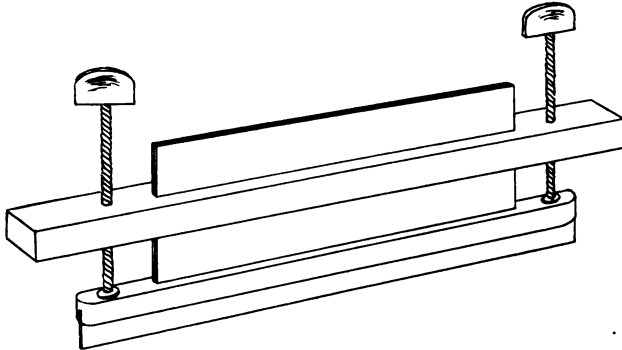

Skimming must be quickly executed, and colors thrown on immediately, to prevent another film forming on the size.

ALUM WATER.

Marbling colors require a binding medium, or they will run. Alum is known to possess properties which attract and bind the ox gall and color to paper. To prepare, dissolve one ounce of alum in one pint of water by boiling. This is allowed to cool off before using, and is applied to the edges with a sponge. From five to ten minutes must elapse before dipping prepared edges, and at no time should more books be prepared than can be marbled in one-half hour. This preparation should be kept in a corked bottle.

OX GALL.

All marbling colors to be serviceable as such require a binding and expanding medium. No known chemical preparation can take the place of ox gall and produce like results. If colors are thrown on the size without gall, they will sink.

The preparation of ox gall must be carefully executed, for on it the entire success of marbling depends. Gall bladders can be purchased from any slaughter house. The contents of the bladder should be emptied and filtered through paper or cloth into a jar or bottle. To one quart of bile add one-half pint of alcohol; shake well, and leave for three or four weeks before using. The gall should then be carefully poured into another bottle. The fatty particles on the bottom should not be disturbed, as they are useless. Ox gall for use is placed in a small bottle with a quill in the cork, so that a few drops at a time can be shaken out into the color.

SPRINKLING-WATER.

For hair-veined and Turkish marbles, a stronger expanding medium than the gall used for the first color is required. More gall is used on the size than for drawn marble, because a greater area is required. Hence it is clear that a stronger expanding medium, the sprinkling-water, is required to force the color and gall into veins. Aside from this, sprinkling-water produces oval spots which enhance the beauty of the veins.

Scrape two ounces of castile soap in fine particles and put in a vessel, then add one pint of ninety per cent alcohol, and set the vessel into a water tank, and boil. Direct heat must not be employed. When dissolved, add two and one-half quarts of water, and put aside. A less troublesome method is to purchase eight ounces of spirits of soap, and mix with about one quart of water. This preparation is used for hair-vein marble and added to the ground color in Turkish marbling. In using, this should be reduced to give the proper expanding medium. To determine the proper strength for hair-vein, put a pint of water into a bowl, and pour a little of this solution into it; then throw the colors on the size, dip the whisk broom, and throw the sprinkling-water upon the colors. If it expands rapidly and tears the veins, it is

too strong and should be reduced by adding water. Too much should not be thrown on, as it will produce too large spots. Should it fail to force the color into the veins, more of the mixture must be added until the required strength is obtained. A little paraffin may be added when there is trouble with frothing.

COLORS.

There are two classes of colors—mineral and lake. Lake colors are easily prepared, as the addition of gall and water is all that is required. Mineral colors are insoluble in water, are finely ground, and require a glutinous matter to effect a union of particles. Take two-thirds of an ounce of gum tragacanth and dissolve in one pint of water; then add a fairly thick solution of gum arabic. This is mixed with color until a solution of thick paste is obtained, then carefully ground. Then reduce with water, and put into a closed vessel in a cool place.

The bottle containing the colors should always be shaken before using, and enough color taken therefrom to marble the work on hand. Prepared color should never be returned to the bottle. Color exposed to the air will quickly spoil. All color is reduced with water, and gall is added as an expanding medium in the preparations required for the different marbles. Stir all color before throwing on the size, as its tendency is to sink to the bottom and thicken.

The amateur marbler is prone to condemn the colors as old or unfit for use when the least bit of trouble appears. In nine cases out of ten, the fault will be with the size or from the addition of too much gall.

BRONZE COLORS.—These colors are of recent origin and can be purchased from supply houses. Their treatment is exactly the same as other colors, but they must always be carefully mixed or shaken before using. The color is heavier and sinks to the bottom. They are primarily used in Turkish marble, but may be used on other

marbles as well. In comb marbles, in drawing the bronze colors with the stylus, long strokes should be made, or their effect is lost. The entire execution must be done quickly, and the size carefully skimmed after each operation, as the size takes on a bronze tinge.

SIZE.

The first process in marbling is the preparation of the size on which the colors are to be floated. There are a number of vegetable mucilages suited for this purpose, but experience has demonstrated that carrageen moss is better adapted to edge marbling than any other glutinous substance. It is sensitive and requires specially prepared colors which produce excellent results.

Gum tragacanth can be recommended for ordinary work, as it will give passable results with much less exertion, and will last longer in hot weather than carrageen moss. However, the colors will not spread as well, and their effect will be deadened. Gum tragacanth is dissolved in cold water in the proportion of one-fourth of a pound of gum to one gallon of water. This must be stirred frequently and allowed to stand for thirty-six hours before it can be used. It is then strained, and water is added until the required consistency is obtained.

Carrageen moss is dissolved by boiling water, then putting in six ounces of moss to six quarts of water, and leaving to boil for five minutes. Then add three quarts of cold water and stir for a few minutes. This has a clarifying effect on the size, as otherwise it will look muddy. Some marblers claim that boiling the size is responsible for the muddy appearance; hence boil the water and pour it over the size. This has much to recommend it, but it does not dissolve the seeds and strings sufficiently to release the gum, and, consequently, much of the best gum is wasted.

When necessary to preserve the size, the following ingredients may be added: Arsenic, borax, formalde-

hyde and sodium sulphate. These should be added to the size before boiling. The proportions required vary in different localities according to temperature, and can be easily arrived at by cautiously trying and gradually adding should it be necessary.

The size when boiled must stand without a cover for at least twelve hours to cool off. It may be reduced to the proper consistency for the different style edges. It is then strained through a loosely woven cloth. When ready for the marbling, put a bag or cloth in the marbling trough and fill it, allowing space for dilution, should that be necessary. In reducing the consistency, do not take hot or warm water; the ordinary hydrant water will answer the purpose. The temperature of the size must be the same as the room in which marbling is to be executed. If this condition does not prevail, small spots will appear in the color when thrown on the size, and the rim will look ragged.

In winter the size is apt to become briny, and a common error is to warm it before using or to reduce with warm water. The difference in temperature will produce unsatisfactory results, and energy thus expended is useless. To remedy this, strain the size through a loosely woven cloth, and add a little cold water. The size should be a solution entirely free from undissolved strings and seeds.

The room in which marbling is to be executed should be of an even and mild temperature; a cold atmosphere hinders the spreading of colors, and a hot room causes a rapid formation of film on the size, which, likewise, retards the spreading and produces irregular shapes.

Under ordinary conditions, the size for drawn edges will last four or five days, while that for the Turkish or stone marble will last six or seven. The time can be considerably extended by the addition of preservatives as above mentioned. When the color is spread on a new

size, it somewhat contracts, and it expands on an older size. Account books should be marbled on an old size, which gives a larger marbling surface.

HAIR-VEIN EDGES.

This style is largely used on account of its beauty and its easy production. The size should be much thinner than for other marbles. To determine the proper consistency of the size, put the thumb and index finger in the trough and, after removing, put them together and spread out about $\frac{1}{4}$ inch; if the size adheres to the finger and thumb for one second, it must be diluted with water. A little experience will enable one to determine the proper consistency without any difficulty. The size should be mixed a few days, as the color spreads more easily on an older body. For hair-vein edges, one or two colors are employed, which are diluted with water to one-third their volume. If two colors are used, black is always the first color. If a combination of other colors is required, the darkest color must always be used as the first color, and the others sprinkled on. Black and blue, brown and blue, brown and green, red and blue, are proper combinations. The black or first color is prepared by taking one and one-half ounces of color to thirty drops of water and twenty drops of ox gall. The blue or second color requires one ounce of water and twelve drops of gall.

In preparing the color and throwing on the size, too much color in the brush will cause it to sink, as the size is thin and the amount of color heavy. Thick color will, likewise, sink. A lighter color is required than for other marbles, as it is forced into veins, and a heavy color will lack the fineness required in this marble. In the operation of the first color, enough gall is added so that in throwing on the size, after having been skimmed, it will expand sufficiently to form a ribbon 8 to 10 inches wide. In throwing on the second color, a whisk is

employed, and care must be taken that the drops are not too large and that they are evenly distributed. The sprinkling-water is prepared as described on page 29. Dip the whisk broom into it and tap out a little; then sprinkle over the floated color by hitting the brush on the left hand. This will produce veins. The size of the veins can be gauged by the amount in the brush, and the stroke. A hard stroke will produce small veins, while a light stroke will produce light veins. If the veins tear or fail to hang together, the sprinkling water is too strong and must be reduced with water. The uniformity of the veins depends on the amount of sprinkling-water and the stroke. All this can easily be gauged with practice.

TURKISH MARBLE.

The size is prepared in the same manner as described in the chapter on hair-vein marbling. The black is the first color, and is prepared so that a drop will expand to 7 inches; this should be possible with about twelve drops of gall to one and one-half ounces of color. The other colors are prepared by adding to one-half ounce of color one ounce of water and twelve drops of gall. These must be stirred, and are thrown on the black with a whisk—first blue, then yellow and red. If white is desired, reduce ox gall with water, and throw on with a whisk in like manner. All colors thrown on with a whisk should be carefully stirred and be thrown in small drops. The ground color is prepared with gall and sprinkling-water, and is thrown on with a whisk broom, as in hair-vein marbling. This forces the other colors into a neat net of veins. Fine or coarse veins may be produced according to the strength of the sprinkling-water in the ground color. Combinations of color for the ground are prepared as follows:

GRAY.—One part black, two parts sprinkling-water and ten drops of ox gall.



GRAYISH GREEN.— One part green, one part black, two parts sprinkling-water and ten drops of ox gall.

BLUIISH GRAY.— One part indigotine blue, one part black, one part sprinkling-water and ten drops of ox gall.

OLIVE GRAY.— Two parts black, one part green, one part sprinkling-water and ten drops of ox gall.

BROWN.— Two parts brown, one part sprinkling-water, and ten drops of ox gall.

RED BROWN.— One part carmine red, one part sprinkling-water and ten drops of ox gall.

BLUE.— One part indigotine blue, one part sprinkling-water and ten drops of ox gall.

YELLOW.— Two parts yellow, four drops of carmine red, one part sprinkling-water and ten drops of ox gall.

VIOLET.— One part indigo blue, one part carmine red, one part sprinkling-water and ten drops of ox gall.

DRAWN MARBLE.

COMB EDGES.— These edges are appropriately used on blank-books, and should never be put on letterpress books. The size is more dense than for hair-vein or Turkish marble, and may be tested in the same manner, allowing, of course, a greater expansion of thumb and index finger, because of the greater density of the size. A safe test is to prepare the black by adding about six drops of gall to two-thirds of an ounce of color. When thrown on the size, a drop should expand to a diameter of 4 or 5 inches. If it does not, the size may be too thick and should be thinned by adding water. It is safe to say that if, for any reason, the necessary expansion is not obtained, the size is either too thick or there is not sufficient gall in the color. Take the stylus and draw it into wavy lines. When the color can be drawn into straight lines, without following the stylus, the size possesses the proper consistency, and gall must be added to the color until it reaches the diameter given. When the

size is too thick, the color will mix with it when attempting to skim the surface. If the color is drawn along by the stylus or can not be easily cut, the size is too thick and must be diluted with water; if, in drawing with the stylus, the color should run or the size quiver, it is too thin and thick size must be added. Thin size is useless for this purpose, as the colors will expand beyond the natural requirements and will look pale; besides, the pattern will be drawn out of proportion with the stylus. Four colors are usually employed and thrown on in the following order: black, blue or green, yellow and red. White is added, but not as a color, as it is formed by the stylus in drawing the colors. Enough color should be prepared for the work in hand. Prepare all other colors with gall in the same manner, except that much less expansion is required. When the first color, black, has spread to the desired dimension, throw on a drop of blue (or green), then yellow on the blue, and red on the yellow, each of which must expand to a diameter of about $1\frac{1}{2}$ inches.

The size is skimmed, and the black color is thrown on in such a way that the first drop comes in contact with the rim of the second, the second with that of the third, the third with that of the fourth, etc., so that a color ribbon 4 or 5 inches in width is formed. Throw the blue on both sides of the black, and avoid the joining of the drops. Yellow is thrown on at both rims of the black in such a way that each drop of blue has a yellow center. The red is thrown on so that each drop of yellow has a red center. By taking the stylus and drawing the colors in wavy lines through each other past the black, white lines will be produced between the colors; the comb is then drawn across, producing scales. Dip the comb not more than $\frac{1}{4}$ inch, and draw it slowly the length of the trough. Both ends of the comb should be of equal depth in the size.

The books, having first been coated with alum water,

are placed between boards and dipped from left to right in the trough; the surplus size is removed by scraping from the edge with a piece of paper, and the edge is left

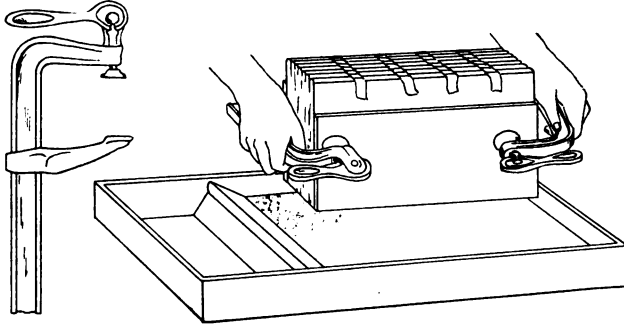

to dry. The remainder of the color on the size is skimmed, and the operation repeated as above described. The fore edges are marbled before the heads and tails are trimmed. After the books are rounded, proceed with the heads and tails in the same manner as with the fore edges. To avoid getting a portion of the color on the fore edges, dip a sponge into the size and apply it to the corner of the fore edges, which will be dipped in the size. If air bubbles should appear, dry the spot and redip immediately. The color will only bind to the dry spot.

SNAIL MARBLE.—The colors are thrown on as in comb edges, and drawn into wavy lines by the stylus, after which the snails are produced one at a time by dipping the stylus into the size at regular intervals, twisting it to the right and forming scrolls. The comb may also be drawn through the color and snails produced as above described.

AMERICAN MARBLE.—This marble is made exactly as the comb, with the additional drawing of the comb the width of the trough.

PEACOCK MARBLE.—The method of preparation is the same as that for the comb, except that after the colors

have been drawn by the stylus into wavy lines, they are alternately drawn wide and narrow by the peacock comb. Draw the comb for about 1 inch, then close it, then draw for another inch, and open.

BOUQUET MARBLE.— Proceed as for the comb marble. Draw a fine comb through the colors, and use the rake in such a way that the teeth of the second row will trace those of the first. Repeat this operation by moving the rake from right to left. The sliding or peacock comb may be substituted for the rake with equally good results.

SUN SPOTS.

The sun spot can be produced on any Turkish, snail, or wave marble by sprinkling the preparation after the ground colors have been thrown on. To prepare this, add a few drops of kreolin chalk water to a small quantity of color. Boil a little potash in one-half pint of water and add to the color and chalk water. To test the strength, try the color and chalk by sprinkling on the size. The chalk water will spread the color according to the strength, and this can be regulated as desired. Then add a little of the potash, which has been dissolved in water; this will draw the color together in the center of the spot. The reward for patiently trying out the different strengths of the preparation will be ample in the production of beautiful edges.

Sprinkle a few drops upon the size, and the sun rays will appear. These will spread out until the expansive force is expended; then diminish in size, and gradually vanish. If a second drop is put exactly upon the first, the rays will be more vivid. If two colors are prepared with this preparation and thrown one on the other, a still more beautiful effect is obtained. There is no limit to the extent to which this may be used, and the methods of procedure are as fancy suggests.

BOOK-EDGE DECORATING MACHINE.

A machine has been recently designed to decorate book edges in imitation of marble. The principle is somewhat on the order of the platen press, in which the books are laid and withdrawn by the operator. The book is

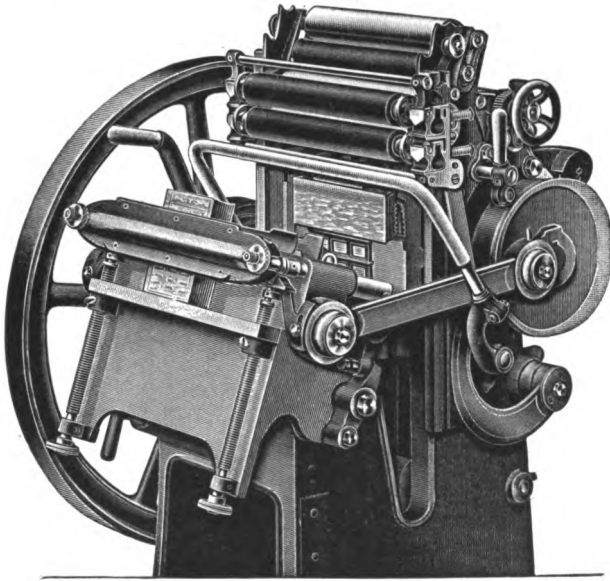

clamped and carried forward to the printing surface, which has been inked by the form rollers. After the impression is made on the edge, the book is unclamped to be withdrawn and another inserted. Adjustments are simple, as there are but two changes required for different thicknesses of books. Any design, color, or combination of colors can be used to ornament the edges of books. This enables the selection of designs which harmonize with the end-papers and covering. The machine is equally useful for city directories where advertising matter appears on the edges. Three hundred books can be decorated on three sides in one hour.



HAND-TOOLING.



HAND-TOOLING.

No other trade can furnish the abundance of material for artistic execution that letterpress book-designing affords. There is no limit to the employment of artistic

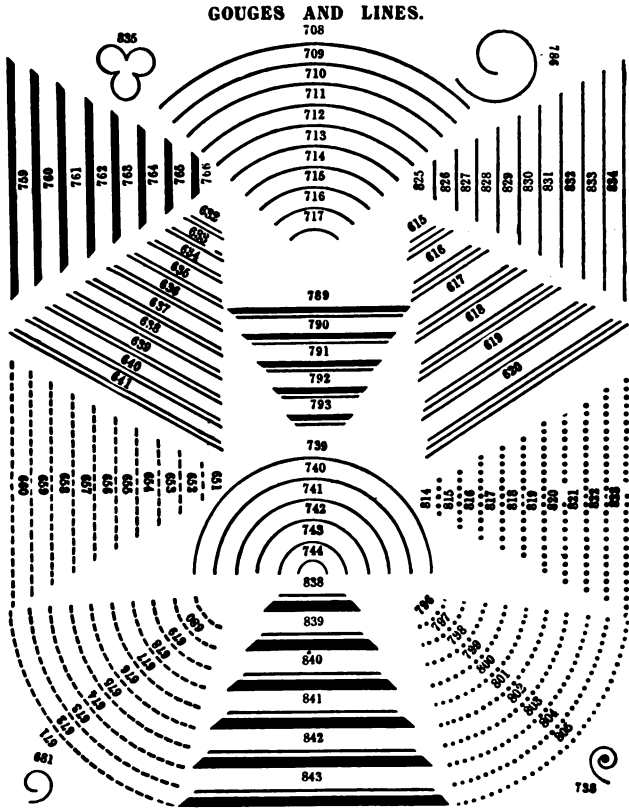

talents in the execution of engraved hand dies or stamps in making complete designs. The artisans of old spent weeks and months in ornamenting single books of special

value. The tools employed must be governed by the character of the work. A flower pattern could be appropriately employed on a work on botany, but would be out of place on almost any other kind of work. Books on natural history may have trees, flowers, insects, or

HAND STAMPS.

1379	1380	1381	1382	1383	1384	1385	1386	1387	1388	1389					
2.10	1.80	2.25	1.50	1.50	.90	1.40	2.25	1.25	1.90	2.25					
1390	1391	1392	1393	1394	1395	1396	1397	1398	1399	1400	1401	1402	1403		
1.20	1.35	1.25	1.60	2.10	1.60	1.60	1.50	1.25	2.10	1.25	1.80	2.25	1.60		
1404	1405	1406	1407	1408	1409	1410	1411	1412	1413	1414	1415				
1.50	1.50	1.40	1.50	1.40	2.00	1.50	1.40	1.50	1.40	1.50	2.00				
1416	1417	1418	1419	1420	1421	1422	1423	1424	1425	1426	1427	1428	1429	1430	
1.50	1.50	1.50	2.00	1.60	1.40	1.40	1.30	1.50	1.40	1.40	1.40	1.60	1.30	1.40	
1431	1432	1433	1434	1435	1436	1437	1438	1439	1440	1441	1442	1443	1444		
1.30	1.40	1.40	1.15	1.15	1.25	1.15	1.30	1.40	1.40	1.30	1.40	1.30	1.50		
1445	1446	1447	1448	1449	1450	1451	1452	1453	1454	1455	1456	1457	1458	1459	1460
1.40	1.30	1.30	2.00	1.50	.90	1.40	1.40	.90	.80	1.30	1.40	1.50	1.30	.90	.90

anything indicating the contents. The object in design should be to assist the person in determining the contents by the exterior decoration. The design on the back should always be in harmony with the sides. In lettering, large

type are out of harmony with requirements, and small type are not legible on the shelf.

The first care of the finisher should be to determine the style in which the book is to be finished. Then draw the design on a piece of closely ruled cross-section bond

HAND STAMPS.

1262	1263	1264	1265	1266	1267	1268							
1.50	1.00	1.25	1.25	1.25	1.00	1.25							
1269	1270	1271	1272	1273	1274	1275	1276	1277					
.90	.70	.60	1.00	1.00	1.10	.90	.90	.90					
1278	1279	1280	1281	1282	1283	1284	1285	1286	1287	1288	1289		
.70	.70	.75	.35	.70	.70	.80	.90	1.25	.90	.70	.65		
1290	1291	1292	1293	1294	1295	1296	1297	1298					
1.40	1.60	1.60	1.40	1.50	1.10	1.15	1.10	1.50					
1299	1300	1301	1302	1303	1304	1305	1306	1307	1308				
1.20	1.10	1.25	1.25	.90	1.00	1.00	.60	1.20	.80				
1309	1310	1311	1312	1313	1314	1315	1316	1317	1318	1319	1320	1321	
.60	.75	.75	.30	.50	.50	.40	.30	.50	.90	.70	1.05	.60	
1322	1323	1324	1325	1326	1327	1328	1329	1330	1331	1332	1333	1334	1335
.50	.50	.60	1.00	.40	.50	.50	.80	.90	.50	.40	.30	.45	.60

paper the exact length and width of the book back. The cross-section paper is used in mechanical drawing, and facilitates freehand drawing. Lay the book on its side,

and mark the straight line near the joint with a straight-edge and pointed folder the length of the back. Turn the book over, and repeat the operation for the other side. This done, take the design for the back, lay it on the back, tip it on the sides, indent the beginning and end of all straight lines, gouges and stamps. Then divide the space between the lines, and mark the exact center of each panel where center stamps are desired. After the outlines have been made, take the lines, gouges, stamps, and impress them on the paper with ink so that the impression will be visible on the leather. Then remove the paper, and take a strip of thin board, and with a pointed folder mark the position of the lines so that the ends meet; heat the tools, and impress them on the leather.

Next draw the design for the sides the exact size of the cover on a piece of cross-section paper large enough to permit the ends being turned in on the boards when in the exact position. Place the pattern sheet for the sides on the board, apply glue to the ends, and turn in over the edges of the board. This should be done before the end-leaves are pasted to the boards, or else the gluing can not be done, as it would spoil the end-leaves. All straight lines or dots for which there are rolls can be done without blinding-in by marking the ends and running the rolls against a straight-edge. Heat the gouges and stamps slightly, and impress on the paper so that it can be seen on the leather when the paper is removed. Another method is to impress the cold tools on a composition ink pad, and then on the paper firmly enough to be visible on the leather. This on difficult patterns has an advantage in that omission can be seen before the paper is removed. If the pattern is such that the bottom half is the same as the top, perform the operation for the upper half only, turn the pattern around, and repeat the operation. This is done in the same way as above described. Before removing the paper, lift up

one corner at a time to see that no part of the design has been missed. Remove the paper, and with a straight-edge and pointed folder mark the position of the straight lines, then impress the hot rolls or tools.

Should the grain be prominent, it might be necessary to make another impression by dampening the leather in the same way as described in "Blind-tooling." If any portion of the design is to be in blind, it should now be executed, then take a small camel's-hair pencil, and pencil the glair in the impressions where gilding is desired on the back; this must be carefully executed, so that no glair appears on the sides of the impressions. Never glair more than can be executed in one day.

The laying-on of the gold is described under that head, and is performed after the glair ceases to be tacky. The gold leaf should be impressed with absorbent cotton into the impression of the design. The design, being visible through the gold leaf, can be followed with the tools. All long straight fillets should be executed with a mitered roll; all long scallop lines with a small penny wheel; sharp curves with gouges; and all other ornaments with hand stamps. The filleting, rolling and proper degree of heat have been fully described under those heads.

The tools should be bright and free from dirt before impressions are made. Rub them on a piece of leather on which powdered charcoal and vaseline have been rubbed, then clean with an oiled flannel rag. To secure good corners, lift the roll before reaching the mark, and use a corner tool. The beginning or ending of fillets, and the joining of gouges or sharp curves, must not be noticeable. The impressing of hand stamps requires a steady hand and firm pressure, and will produce better results when worked while a little moisture remains in the leather. Pick up the tool, test the heat, which should hiss slightly, and hold it with the right hand, bringing the shoulder over the tool, thus assuring a firm impression, and, at the same time, guiding it with the thumb-

nail of the left. On large stamps, a slight rocking motion will prevent the possibility of any portion of the stamp not adhering, provided all other conditions have been met. Small surface tools, as gouges, dots and lines, should have a slight impression; otherwise the leather will be cut. Gouges need extra care because of the curve; they should be gouged from the inside of the curve.

The tools or stamps should not remain too long on the gold leaf, as this tends to dry up the albumen and prevent the adherence of the gold to the leather. A hot tool will be devoid of lustre. A cool tool will fail to adhere the gold leaf. A sharp, quick impression will add lustre to the gold leaf. The conditions described in the preceding heads as to heat and material need to be carefully studied; then with sufficient practice good results may be obtained. The novice will do well to gain this experience by diligent practice on leather glued to board before attempting the execution of designs on bound books.

Should a false impression be made on morocco leather, dampen the leather, pick up the impression with a needle, and beat it with a small, stubby-bristle brush.

Burnt impressions may be mended by applying moisture on the leather and picking out the gold with a toothpick. If the burn is too deep, cut a piece of very thin leather, and inlay it on the spot; allow to dry, and make another impression. After the design has been executed, remove the surplus gold with the rag or rubber; then saturate a piece of absorbent cotton with gasoline or benzine, and remove the remaining specks which are held by the oil or vaseline. This done, reclair the imperfect impressions, and go over the weak places.

Patching can be done by applying benzine or gasoline and quickly laying on the gold leaf. This will give no trouble in removing the surplus gold leaf; however, it must be tooled within fifteen or thirty minutes.

The inside margins of the board are then tooled in the same manner.

SUBSTITUTE FOR HAND-TOOLING.—Hand-tooling is an expensive operation, requiring the highest skill and workmanship. There are very few finishers able to execute a full gilt cover without blemish. In most establishments the finishers are rarely called upon to do such work, and great difficulty is experienced because they lack confidence and are unaccustomed to such work. To spend weeks and months in decorating a single book puts the product beyond the reach of most book-lovers and makes a luxury for the extremely wealthy. This operation can be simplified and the cost greatly reduced on difficult patterns by drawing the design in ink and having zinc etchings made, from which extra-heavy-shell electrotype plates can be made. These should be routed out deeply enough to prevent any but the face impressions. Place the plates in the stamping machine, make a blind impression, glair the leather, lay on the gold leaf, and take another impression. If patching is necessary, reglair, and repeat the operation. Hand-tooling can not be executed as uniformly as is possible in this way, and there is less danger in making a false move, thus spoiling the work and wasting the labor. This has many advantages in addition to those mentioned, as the plates can be used again on similar work; besides, beautiful bindings can be executed by other than the most skilful of workers. See “Making backs with bands off the books” and “Short cuts to eliminate hand-lettering.”

INLAYING.—To produce color variations on tooled covers, inlaying of other colors of leather on the surface is frequently resorted to. Flowers, leaves, borders and panels afford a pleasing combination of color on most cover-designs. All leather for inlaying must be pared very thin, and this is best done by dampening a strip with a sponge and employing a sharp, pliant knife. Allow the leather to dry between pulp-boards, then impress the

stamps for leaves or flowers, and cut with a sharp-pointed knife, and pare the edges. For large surface inlay, proceed as above, and, when dry, paste a piece of paper on the right side, and place between pulp-boards

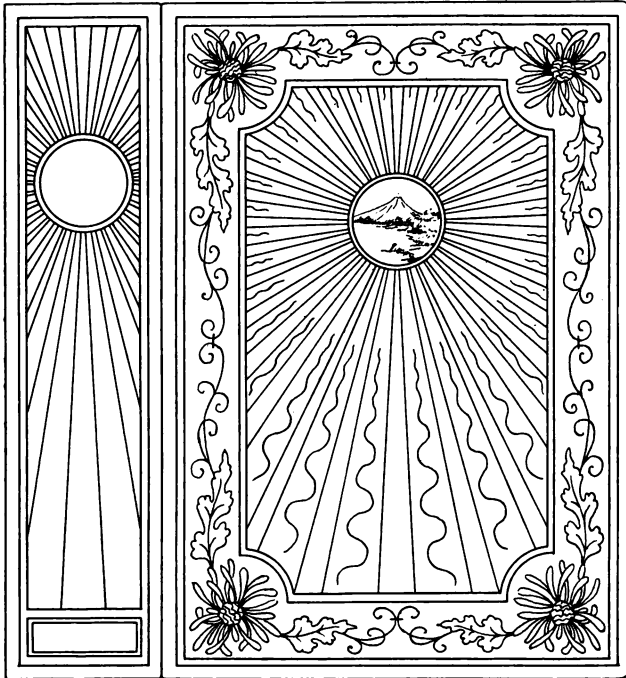

to dry. Then mark the exact size of the panel, border or space to be inlaid, cut it out, and pare the edges. Paste a piece of board or paper, lay on the inlays, and rub down to enable the paste to adhere to the leather. Then lift it up, lay on the required space, and rub down with a folder. The inlaying is always done after the blank impressions have been made.

A large inlaid design, the outer edge of which is composed of curved lines, is best executed by taking the paper on which the design has been drawn and from which the blank impression was made on the cover, pasting it on

the thin leather, and allowing to dry. Then with a sharp-pointed knife cut out the designs, and carefully pare the edges. This is then pasted on as above described. The object of the paper on the surface of the thin leather is to prevent stretching; this should be removed when the leather is dry on the cover by moistening with a sponge. This will soften the paper, and it can be easily removed. In all inlaying, the edge of the leather should be covered by the outer tooling so that the joining can not be seen. If the leather be a smooth grain or a crushed grain, place the book in a press between two smooth boards with the

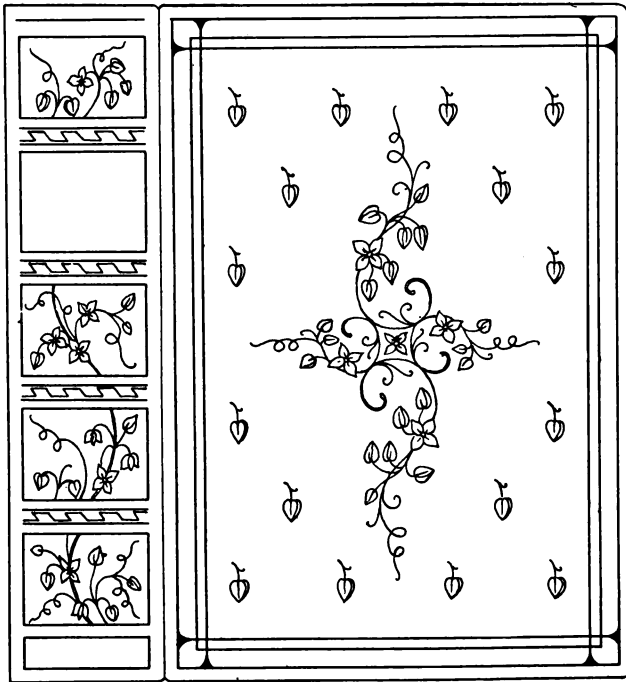

back out for about an hour. Remove it from the press, retool the part in blank, proceed with glairing, laying-on of gold leaf and tooling, as described under the preceding head.

BLIND-TOOLING (ANTIQUE).

This is a popular style for religious books, and consists of impressing hot tools on the leather so as to form designs. It may be executed upon any color of leather,

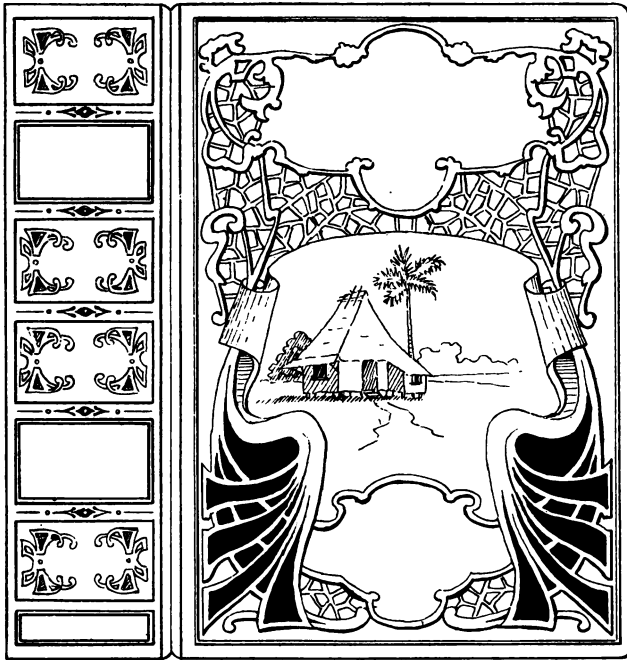

but a more attractive effect is produced on light colors. Blind in combination with gilt is still more attractive. The lettering is always done in gold. No special tools are required, and those used in gilding will answer, with possibly few exceptions, all demands made upon them.

To blind-tool the back, dampen the leather with a sponge, and rub the moisture in with a soft, stubby brush. Mark the position of the lines on the back, as described in the chapter on filleting and rolling. Then warm the creaser, which is a hand tool faced with lines; for this

purpose a wide and narrow line is required. All tools must be heated uniformly. The first impression is made with a slightly warm tool, and the temperature is increased with each subsequent impression. The final impression is taken with hot tools when the leather is dry. If the die remains too long on the surface, the moisture is lost, and further deepening of the color is impossible without applying more moisture. The moisture when applied to the creaser should vanish slowly. Hold the creaser firmly in the right hand, rub it with an oiled rag, and impress on the back with a circular movement. The arm is held tightly to the body, which bends forward, and the movement is directed with the wrist, while the book is supported with the left hand. The impression should be uniform and appear brown; if it is lighter at any part, the tool is not hot enough or the leather is not damp enough. If the line appears darker at another point, there is too much moisture. It is sometimes necessary to wet the leather a number of times and proceed with the hot tools in the same way in order to obtain the proper color. A high polish can be obtained if the creaser is worked forward and back a number of times rapidly. The creaser must, of course, remain in the impression, or the result will be unsightly. The first impression is made at the head, then another close to the first band, then close to the subsequent bands, after which the book is reversed in the finishing press. Impress the creaser at the tail and $\frac{1}{2}$ inch from the edge, which should be provided for when forwarding; or, if the back is plain, it must be marked off by the finisher. Repeat the operation as above described for the remaining bands.

Center stamps are impressed in the center of the panels except in the second and fourth, and sometimes the fifth panel, when five bands are used. To guide the eye in impressing the stamp in the center of the panel, take a piece of paper and measure the width of the back, then fold it in the center, and place it in the center of the panel,

and make a slight mark with the folder. Lay a straight-edge on top the length of the book, and mark the center of each panel just enough to serve as a guide. The mark must be covered up when the stamp is impressed. Rub the stamp on an oiled rag, or leather to which oil has been applied, to brighten up the impression. Then take up the stamp, heat it, and place it on the leather so that the marked lines appear in the center. A steady hand is needed to make the second and subsequent impressions in the first. Dry leather requires a hot tool, and wet leather a warm tool.

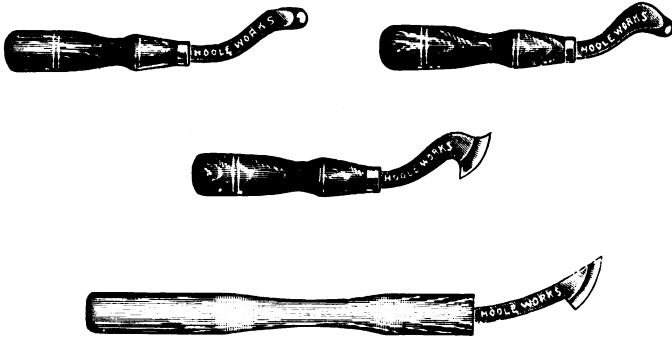

Steel Creasers.

The operation for the sides is accomplished in a similar manner, except that the position of the lines to be creased is marked with a pointed folder, and a long-handled creaser is used. The fillet rolls may be substi-



tuted by placing a wedge between the arm holders of the roll. Ornamental dies may be impressed in the same way as above described for the back panels.

TREE CALF.

This embellishment is done on the sides of full light-colored-calf books. The object is to produce a tree effect with limbs and branches. To prepare the books, wash the sides with water, and, when dry, apply a wash, consisting of a teaspoonful of pearl ash, mixed with one pint of paste-wash the consistency of thick cream. Allow this to dry, and apply a coat of thin glair. Prepare the different solutions in china or earthen crocks.

(1) To one pint of water add twelve parts of liquid pearl ash.

(2) Mix a solution of copperas, which will produce a black color somewhat like iron rust. This is, likewise, used in sprinkling sheep. For delicate calfskin this is too strong.

(3) To produce a brown effect, mix a solution of pearl ash, which should be used in conjunction with copperas.

These two colors are primarily used; insert a sponge and a small bristle brush in each color. Other colors sometimes used are a weak solution of eosine (red) and yellow. Aside from these, a small can of tallow should be melted and a pointed stick inserted.

Make a paper cap to protect the book edges, then place the book in a finishing press, with the boards above the jaws. The press should be placed with one end resting on the bench and the other on a support one foot lower—a board can be tacked on for this purpose. A pan should be placed under the book to catch the surplus water which will flow from the covers and the surface of the exposed leather. Bend the covers a trifle outward to serve as a gutter. If there is a border to remain untreed, cut a piece of tag-board the size of the open cover, and remove the portion to be embellished. Take the pointed stick, dip it into the melted

tallow, and touch the cover in the places intended for the knots of the tree. Fill a sponge with the first solution, consisting of pearl ash and water, and squeeze out on the cover, so as to wet it evenly. The surplus will run down the bend in the board into the receptacle beneath. Then take the brush quickly from the second solution, copperas, and, beating it on the left hand, sprinkle the cover. The color will run toward the center of the board, thus forming the branches, and run down the center, forming the trunk of the tree, the solution passing off into the receptacle below. Then again apply the first solution of water and pearl ash.

The subsequent colors are treated in the same way. Remove the book, and allow to dry. The finishing operation is the same as for the ordinary calf books.



The finest binding in the world, showing the cover of "Omar" before it was completed by Mr. Sangorski. This book was bound for Messrs. Sotheran & Co. and lost in the Titanic disaster.

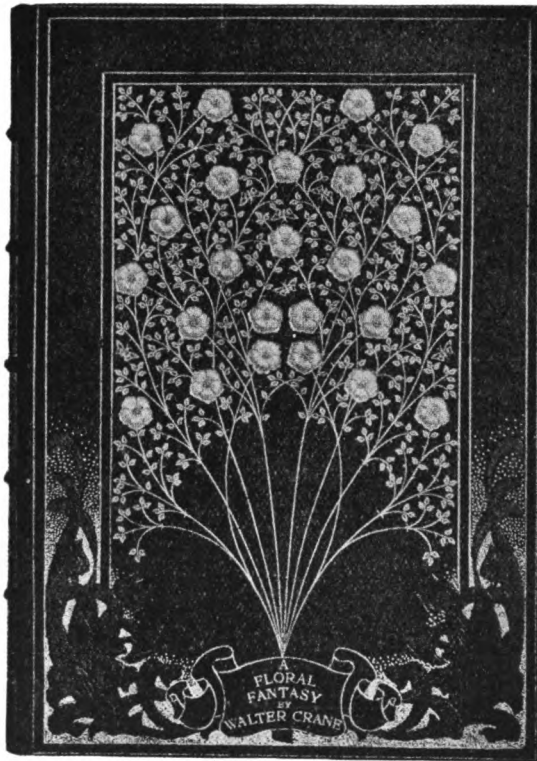

A modern binding by Mr. De Sauty.



Resolution, with inlaid carved and modeled leather panel, by Karl Lion.



Light-blue morocco binding design by L. Suetterlin. Forwarding by
H. Kramer and finished by Fr. Fahren, Berlin.





Orange-colored morocco, with light-blue inlaying.
Binding by Paul Kersten, Berlin.



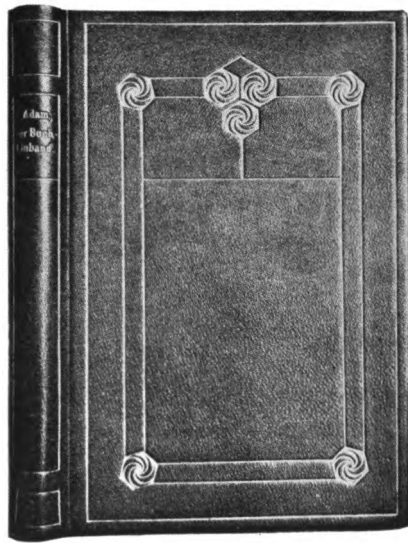

Morocco binding. Finished by K. Hirth and Fr. Reischle.



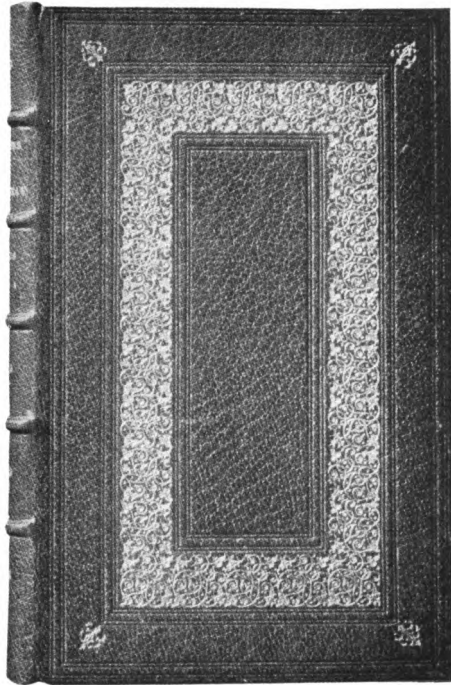

Blue morocco binding, finished in gold and antique,
by Trautz-Bauzonnet, Paris.

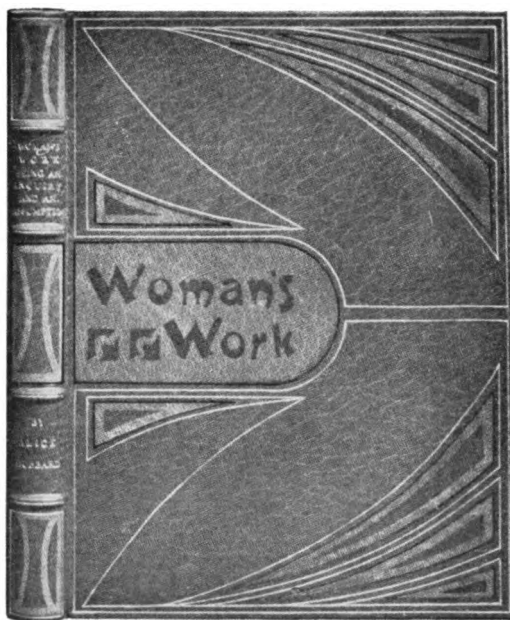

Dark-blue morocco, with inlayings in yellowish-gray and claret.
Binding by Lorenz Schwartz, East Aurora.



Binding by Otto Schulze & Co., Edinburgh.



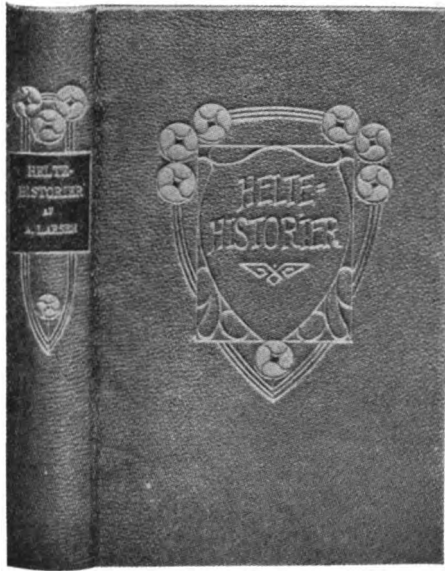

Light-blue morocco, with inlays. Roses in white and red. Ornament in light brown. Work of students in the Gera School for Bookbinders.



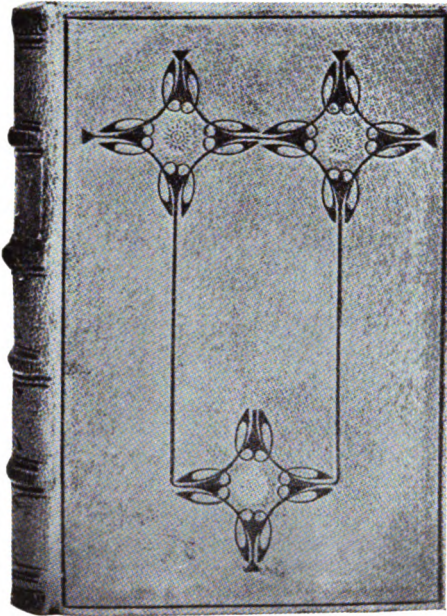

Pigskin binding, blind-tooled. Bound in the Gera (Germany)
Trade School for Bookbinders.

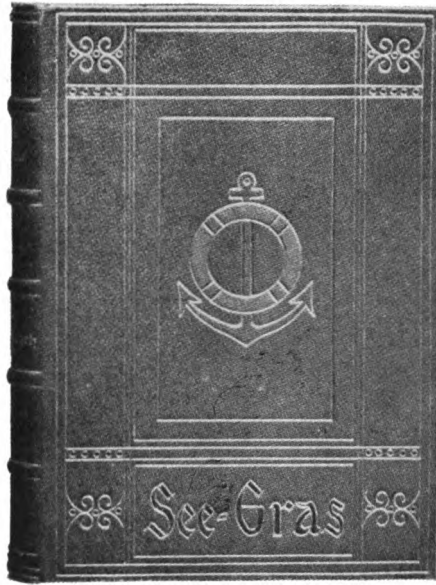

Clay-colored morocco, with inlaying in dark red for the lettering ; steel-blue anchor ; life-preserver in gray. Binding and finishing by pupils in the Gera School for Bookbinders.

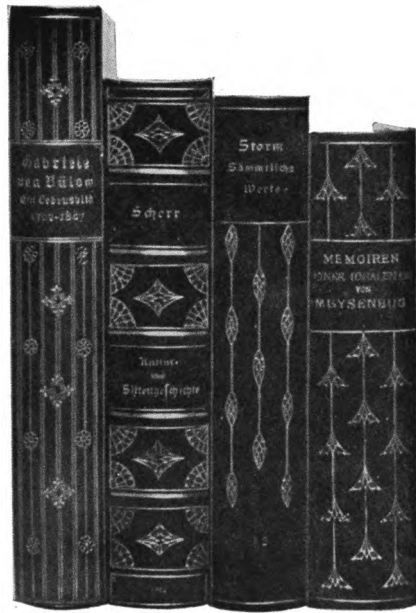

Half-bindings by Wilh. Stein.



Doubleure Finishing by Ernwein Strassburg.

CARE OF BOOKS.

No other commodity plays as important a part in our daily lives as books, yet a glance at almost any book-shelf will reveal ignorance as to their proper care. No book should be handled as if rivets and nails were used in its construction. Dropping a book on its edges or corners will mash the board; putting a book, especially a large book, on a shelf with force, will cause the joints to loosen and eventually break. To slide a lot of books on their edges will invariably result in peeling the leather. Sliding books on the table is bad usage, as sand or dust will scratch them.

When taking a book from a tightly arranged row upon a shelf, do not pull the head-band, but rest the index finger on the edge, and bring it forward until the book can be grasped with the hand. The necessity for re-binding so many volumes is due to pulling the head-bands off the back and tearing the leather or cloth, because of uncalled-for force in taking books from the shelves. Librarians should provide sufficient space on the shelves to permit the withdrawal of books with ease.

To prevent the leaves from sagging, thereby pulling the rounding from the back, at the head, a piece of board should be fitted in under the lower or bottom edge before placing on the shelf. This should be equal in thickness to the size of the square projecting over the edge. This applies to thick books only.

The back of a book should not be dropped on the table before opening, as it flattens the back, and the round will disappear, and on blank-books the spring-back will eventually become soft and the hubs become loose. Either tossing a book or dropping it on the floor may break its back.

The ordinary book should not be used as a scrap-book for clippings or notes. There is no provision in the back for additional space between the covers or leaves. This practice invariably results in broken joints and the book falling out of the cover.

When opening a new book, should the fly-leaves stick to the board, bend it a trifle inward, and insert a knife or folder, and loosen the leaves. To hold both parts of an open book tight while forcing the center up will break the back. To open a new book, begin at the front, and turn over a few leaves at a time, resting the left hand lightly on the pages as turned, until the middle is reached; then close the book, and repeat the operation from the back. A book thus treated will open flat and maintain its shape; there will also be less likelihood of breaking the back.

Anti-vermin varnish applied to bindings has a tendency to prematurely deteriorate the material, and will not insure immunity from attack by croton bugs.

A little vaseline rubbed into the pores of the leather with absorbent cotton once or twice a year will prolong the life of any leather binding.

p-book
e back
This
: book

eaves
ert a
parts
will
ront,
left
'e is
tion
and
of

en-
ill

er
'g





3 2044 011 620 381

A FINE IS INCURRED IF THIS BOOK IS NOT RETURNED TO THE LIBRARY ON OR BEFORE THE LAST DATE STAMPED BELOW.

<p>3 CANCELLED JUL 31 1973 32009</p>	<p>BOOK DUE - WID CANCELLED JUN 18 1980 JUL 19 1980</p>
--	---

	<p>CANCELLED WIDEN JUN 29 1991 JUL - 3 1991 BOOK DUE</p>

