

SF523

W59

1908A

In compliance with current copyright law, Etherington
Conservation Services produced this replacement volume
on paper that meets ANSI Standard Z39.48-1992 and ISO
9706. Preservation facsimile printing and binding
by Etherington Conservation Services
Browns Summit, North Carolina.

www.thehfgroup.com

2008

∞



THE HFG Group



J. J. Wilder

Southern Bee Culture

BY
J. J. WILDER
CORDELE, GA.

1908

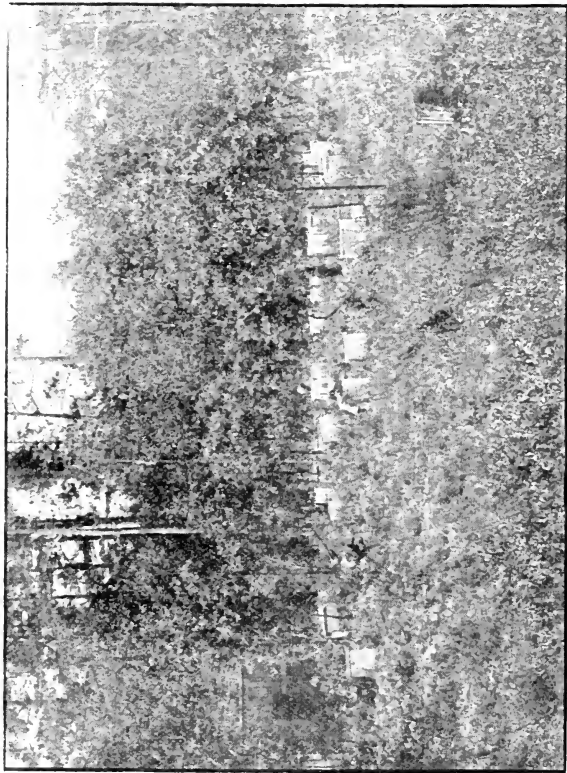

One of the Author's Apiaries

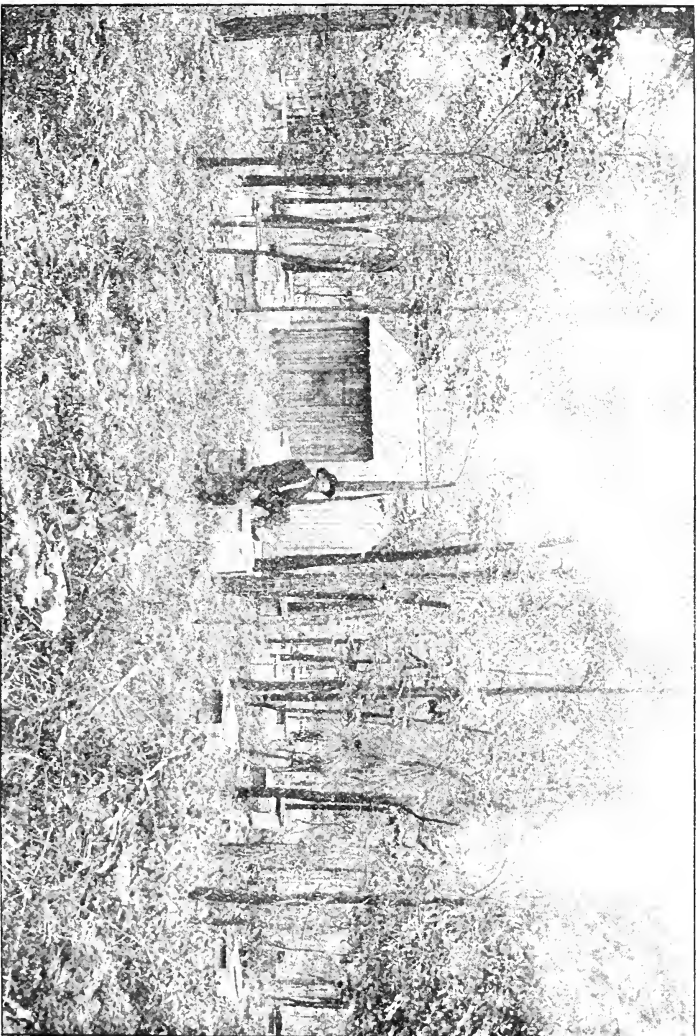

One of the Author's Apiaries

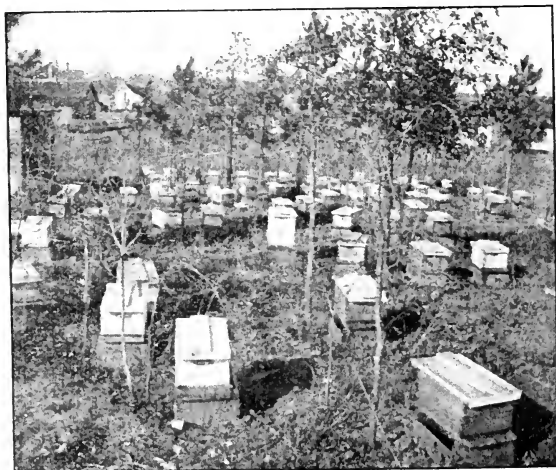

Views of the Author's Apiaries



Views of the Author's Apiaries

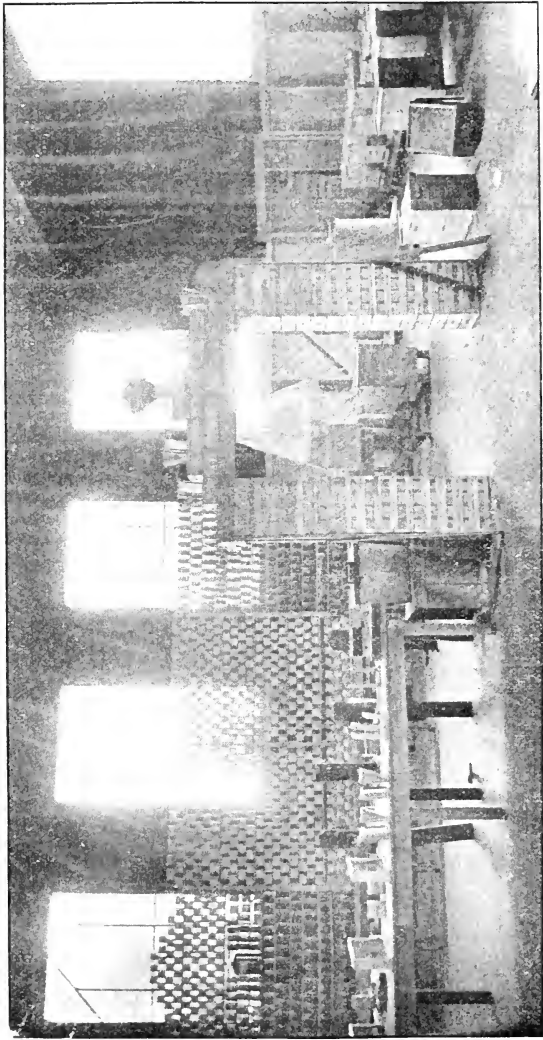

The Author's Apiarian Exhibit at the Georgia State Fair in 1907

TABLE OF CONTENTS

Apiaries, Modern.....	15
Apiary Work.....	33
Appliances, Apiarian.....	61—70
Bee Culture in General.....	13
Bee-keeping, Pleasure in.....	72
Bee-keeping, Profits in.....	73, 74
Bee-keeping as a Side Issue.....	74
Bee-keeping, Extensive.....	75
Bee-keeping, Old Way of.....	102
Bee-keeping in the South.....	112
Beginning in Bee Culture.....	17
Bees, Uniting.....	80
Bees, Wintering.....	81
Bees, Shade for.....	83
Bees, Races of.....	10
Bees, Black.....	11
Bees, Italian.....	11
Bees, Carniolan.....	12
Bees, Caucasian.....	12
Bees, Hybrid.....	13
Bees, Buying.....	18
Bees, Transferring.....	20
Bees, Subduing.....	30
Bees, Moving.....	41
Bees in Texas.....	113
“ in Oklahoma.....	122
“ in Arkansas.....	123
“ in Indian Territory.....	123
“ in Mississippi.....	124, 125
“ in Louisiana.....	127, 128
“ in Tennessee.....	129
“ in Alabama.....	130, 132
“ in South Carolina.....	133, 134
“ in North Carolina.....	137
“ in Georgia.....	137—139
“ in Florida.....	140—143
Cells, Capped and Uncapped.....	7
Chunk Honey.....	59
Colonies, Weak.....	85
Comb, How Bees Build.....	71
Diseases of Bees.....	46
Economy in Bee-keeping.....	7
Enemies of Bees.....	7

INTRODUCTION.

My memory begins with standing in front of a colony of bees, with a brush-broom in hand; and until I was large enough to take interest in the apiary work, whenever I saw a colony of bees they commanded my attention, and my gratification was not appeased until I had seen the owner and questioned him (or her) concerning the bees; and many times I have been rebuked for continual questioning. At that time we were traveling in an ox-wagon over Texas, where I saw much of the bee and honey industry, and my interest in the honey-bee grew deeper, and it is needless to say that driving a sleigh around over the wood while the bee-hunters were finding bee-trees, and cutting them, was the joy of my boyhood days. Whenever bees were robbed in the settlement I was always on hand, ready to take part. I soon became a bee-hunter myself, and all spare moments were spent at this; and many times I have looked up trees on Saturday evenings (for it was about all the leisure time I had) so constantly that I would have a "crick" in my neck and all the following week. Many times I have cut and robbed rich bee-trees, and no one with me to share the pleasure.

Besides looking after bees for others we established an old-style box-hive apiary (for it was the best we could do then, for there was no better hive known to us.

I took a leading interest in this apiary, and a few times we had a good apiary established. Then they would die back to only a few colonies, and I did all I could to save them. Finally one spring we had only one hive left, and later in the spring I turned it bottom end up and found it a mass of moth. I went down in the pine thicket and sat down beside a tree and took a long cry over the death of the last colony, and then and there I resolved that, if I ever had another start of bees, I would give them even more and better attention.

Then I tried to buy another start of bees, but failed. I found many bee-trees, but failed in saving the bees; so for several years we had no bees, and farm life was not what it once was to me; for when we had the apiary I would spend my leisure moments at noon under the shady mulberry-trees where it was located, doing all I knew how to help the bees, and I would watch the little streams of them as they would pour in and out of the hives, and listen at night to their heavy roar. But now this inspiration was a thing of the past, and farm life had lost its greatest charm to me.

Several years elapsed, and I looked after bees only for others.

Finally a widow lady gave me a colony for giving her bees such good attention. One cold winter night I carried the hive of bees home. The bees were in an old-style box hive, so badly decayed on one side at the bottom that

I had to brace it with two sticks to keep it from tumbling over. I made some crude movable-frame hives (for I had not yet seen a patent movable-frame hive). With this outfit I began bee-keeping anew, studying them by handling them on their combs. My bee business began to grow; and after keeping bees thus for several years I heard of a bee-keeper who had bought some patent factory-made hives. I paid him a visit at once, and I saw that the hives were just what I needed, so I bought a lot of them. Next season I transferred my bees into them. From the old crude hives I transferred bees; and what I had on hand extra, furnished me fuel during the summer and following winter.

From the old decayed box hive my bee business has spread until bee-keeping is my business or sole occupation. Besides establishing five apiaries of my own around in this section (as many bees as I can give proper attention to), I have furnished foundation stock from which many apiaries have been established in various sections of the South from the old mother hives.

The ups and downs I had during this time, I have not space to describe in this small volume.

If there is such a thing as a man being called to do certain work, I have been called to the field of bee culture, for I feel out of my calling at any thing else. Although I have mastered no little at eight other occupations, yet I feel more as if I am at my allotted work when I am among my bees than I do at any other of my trades.

I have applied myself to bee-keeping in almost every conceivable manner, keeping colonies of bees in glass hives in my bedroom and on my veranda, keeping close and constant watch on them by day and by night. I have operated bees successfully and extensively for extracted chunk and comb honey in sections; I have traveled to and fro across the South, investigating bee-keeping and the honey-plants in many sections; and if I did not know that there is a great future for the bee and honey industry here I would not attempt to write this book. While methods of apiary work and bee-keeping differ in sections and locations, I hope to give you at least some practical thoughts along bee-keeping in your own location.

HONEY-BEES.

Honey-bees are necessary and profitable insects, and possess many interesting and beautiful traits to be studied and learned. Their nature, habits, and field of work furnish a broad and interesting field of thought for those who love nature-study.

Their culture gives to man perhaps the most fascinating and healthiest pursuit known. The more any one studies them and works among them, the deeper his interest will grow in their culture, and the more interesting it will be, for he is not likely to give up bee-keeping entirely if he does not embark upon it too extensively.

The roar of the honey-bee over our heads as they prey upon the blossom of certain trees in the forest is inspiring; and to watch the little stream of bees as they pour in and out of the hive is interesting, as it furnishes us inspiration. I have often seen very old people sit in the shade about the apiary and watch the bees as they passed to and fro. It furnished them an inspiration, and interested them when nothing else could.

Then to remove the cover of the hive and see what their little masterly hands have accomplished is simply wonderful; and the observant person can not help sympathizing with them in the undertaking and accomplishing of the great tasks, and, at the same time, reflect back to the creation and Creator of all things.

The honey-bee's nature, habits, source, and manner of living, and its mission in the world, prove it to be the most marvelous insect of all the insect world.

Truly the honey-bee is worthy of the title "the most industrious of all living objects."

It is often said that bees work for nothing and board themselves. I do not know whether this is a true saying or not; but I will say it is true where they receive no attention or culture.

A normal colony of bees is composed of three kinds of bees—a queen, the workers, and the drones.

We will first consider the queen from the time she is hatched until she has an army of her own bees around her. Worker bees can develop a queen-bee from a fertile egg of any queen. A fertile queen is one which has encountered a drone-bee (the male bee), and will lay two kinds of eggs—fertile and unfertile. The fertile eggs will produce workers or queen-bees. The unfertile eggs will produce only drones. Just how it is that a queen-bee laying fertile eggs can all at once stop laying them and go to laying unfer-

tile, is a question yet unsolved by scientists; but in some unknown way she passes the eggs out without their coming in contact with the germs of the drone.

There is no one who has handled bees who has not noticed the tiny elongated white eggs of queens sticking endwise in the bottom of the cells, in the center of the comb, or wherever the bees are rearing their young or brood-nest, as it is called. The queen deposits these eggs there by inserting her abdomen down into the cells, and in a moment the egg is laid, and her abdomen is drawn out and inserted into another cell, and on she goes over the comb, laying from one thousand to three thousand eggs each day during the height of egg-laying, which is nearly twice her weight in eggs, every 24 hours.

Now going back to our subject, how queens are reared, in three days after the egg is laid, the temperature the bees keep in the hive, and the attention given it, will hatch it, when it will be a tiny larva. At once the nurse-bees deposit around and over this tiny bee the richest and most thoroughly digested food possible, which food is called royal jelly. The nurse-bees continue to deposit this rich food on the larva, and it continues to lavish itself on it, and in about three days the bees will begin to enlarge the cell, and they will continue enlarging it and feeding the larva for about three days more, or six days from the time the egg was hatched. By this time the larva has developed wonderfully, and is lying in a mass of this rich food; and a wax cell as large as the smallest finger on an adult's hand, and half as long, has been built out from the comb, extending downward and capped over their future mother. Now the queen enters her larval state in her cell, and continues thus for about ten days; but let us look at this cell for a moment, which shows that the bees have built in with great care, and that it contains something that they prize greatly. The instinct of the bees has guided them in this work, and they have done the best they could, and did what man can not do for them; but he can assist them in this very important work, so that they will raise as fine a mother as possible (see "queen-rearing").

Now, at the end of the ten days, or about sixteen days after the egg is hatched, the young queen will gnaw her way out of the cell; but the bees generally thin the cell down at the end so the queen can easily gnaw out. The first four or six days after the young queen emerges from her cell she will remain in the hive or the comb, crawling about over the interior of the hive. At the end of this time during the middle of a warm sunny day, she will be seen on the alighting-board, then she will be seen out flying around the hive in a circling manner, then back into it again; but in a short time she will take another flight; and after she has taken several of these short flights she will disappear in the element, and during this flight she is encountered by a drone (the male bee), and returns to the hive, and is never again encountered by the drone, though she lays thousands and thousands of eggs, and never again leaves her hive unless it is to go out with a swarm of bees.

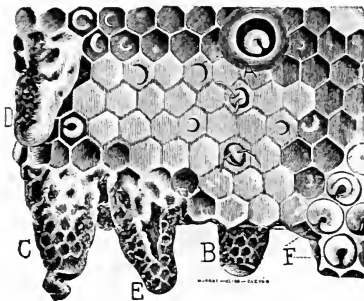

Capped and Uncapped Cells

In six or eight days after she returns to the hive from her mating-tour she will begin to lay and keep up her colony of bees. While she is subject to death at any time, she may live to be the mother of the colony for four or six years.

Though there is plenty of honey in the cells which the queen crawls over, yet she is mostly fed by her daughters. Especially is this true during a honey-flow or when the bees are breeding fast or rearing young bees rapidly. They will keep her fed up to the highest egg-laying point possible. It seems that worker-bees can not show their affection for their mother enough. As she crawls around over the comb they move out of her way and give her passing room; and as soon as she halts to rest, one more will offer her food, and others will gather up around her in a loving manner, giving her loving touches and strokes.



Queen and Retinue

The queen is the only perfect female bee in the hive. The large amount of rich food which is deposited around her, and which she consumes while in the cell, develops her ovaries, and therefore she is a perfectly developed bee.

We will next consider the worker-bee, or the bees which gather all the honey, build all the comb, carry in all the pollen and water, feed all the young, and perform all the work about the colony except the egg-laying, which the queen does.

Worker-bees are reared in the smaller size of cells on the comb; but before the queen lays eggs in them they are cleaned out and polished by the bees; then the queen, making trips over the comb, looking for cells to deposit her eggs in, finds them thus made ready for her, when she deposits eggs in them. In three days the eggs are hatched, and for the next three days the tiny larva is fed as they would feed one to develop a queen; but at the end of three days they change the food of the larva and give it much coarser diet (a milky-looking substance), then feed it on this food for three days more. As it lies coiled up in the bottom of the cell, the nurse-bees are constantly

depositing food around it, and on the sixth day after the egg hatches the cell is capped over, and soon the larva uncoils itself and eats up all its food, then begins to spin its cocoon about as other insects do. In about 24 hours this task is performed, and it is incased in its silken home. Then it varnishes it, and turns its head toward the capped end of the cell. Now the larva is in its pupal state, during which time the legs, wings, etc., are formed and colored; then in about six days the pupal skin will become loose, and be cast to the bottom of the cell, and then the worker-bee is developed and begins to move about in the cell, and soon acquires strength enough to gnaw its way out. In about 21 days from the time the queen deposits the egg the worker emerges from the cell; and as soon as it does, by the use of its legs it frees itself of the particles of pupal skin, which may be yet clinging to it; and during the time it is moving about on the comb it thrusts its head down into the cells, eating, and feeding the young larvae. Thus it goes from cell to cell, giving nourishment to the younger, for about eight or ten days; then it changes from a nurse-bee to a field-bee; and if there is any pollen or honey in the field it will wear its life out in a few days. Honey-gathering is perhaps the highest work a worker-bee aspires to; and when it begins this work its energies are excited beyond its physical power to save as much honey as possible to tide them over in the future. In a few days it may be found dead in a blossom or under a tree where it was gathering honey or pollen, or in the forest or field over which it was flying, or on the ground in front of its hive in which it died, or give away under its heavy load of work, and it is dragged out by its sisters and dropped on the ground to die; or it may be overtaken by some of its enemies and killed.

The average life of a worker-bee is estimated at 60 days from the time it hatches from the egg. If it is raised late in the fall, or during winter, it will live longer, or over the winter, perhaps. But if it is raised during the honey-flow, or the bees' busy season, it will live less than 60 days.

The worker-bee is an imperfect bee because its sisters change its diet when it is about three days old, and give it such food as will not develop it to a perfect bee.

We will next consider the drone, which is the largest bee in the hive, and possesses no sting. It is known everywhere and by nearly every person as an idler, loafer, or a lazy bee. But he is the male bee, and by no means a worthless one, but the only purpose of his existence is to fertilize the queen; and in performing this act he imparts his life to the queen and instantly dies, so it is said.

The drones are raised in larger cells than the workers. They can be easily detected by examining the comb of a colony of bees, for the cells are much larger. The comb containing these large cells is called drone comb. The drone is raised about as the workers are; but he is in the cell about three or four days longer, or about 24 days from the time the queen deposits the egg in the cell; and, as previously explained, the egg that produces a drone is an unfertilized one; consequently the drone has only one parent—a mother—but no father.

Drones are raised only during the spring months and summer, when bees are spreading their brood rapidly, and when they are expected to be needed to fertilize queens.

Drones have a very easy existence. They stay in the hive and eat honey when they feel like it; then when it is uncomfortable in the hive they leave it and sail around in the cool air and return when they feel disposed to do so. Then during winter or cold weather, if there are any drones in a hive they will be found about the middle of the cluster, where they will be sure to keep warm; so it is the nature of the drones to keep comfortable, have plenty to eat, and do nothing. Then, too, the drones are the only bees which have the privilege of going into any hive they wish in the apiary, and go from hive to hive if they desire; but they are apt to stay where they are given the best reception; but, unfortunately, his days are numbered; for as soon as the bees decide not to swarm, and that drones will not be needed, the workers will turn their vengeance upon them, and soon the colonies are about rid of them. The bees do not kill many of them, but they pull them out of the hives and torment them by pulling them around by the wings, and continue to hold to them, even after the drones consent to leave, and are often on the ground near the hive. Sometimes these drones will collect in great numbers in the weak and helpless colonies, and especially those which are queenless, and soon eat up their honey. But this is not a common occurrence; for I believe that, when drones are not wanted, they will wander off and die; for it seems to be the instinct of the bee to do this, for the workers, as soon as they realize that they are of no more service to the colony, will leave it to die. I have seen many of them drop from the cluster, and crawl to the edge of the alighting-board, then drop on the ground and die, wandering, may be, a few feet from the hive, but never making any effort to return to it.

There is a worthless bee of no importance, and a hindrance to its race, which we will consider under "Queen-Rearing."

RACES OF BEES.

THEIR GOOD AND BAD QUALITIES.

Better stock for our apiaries has not been considered enough in the South. There have been too many empty or light hives on hand at robbing-time to expect great progress in the bee and honey industry. There have also been too many poor honey years for it to take a rise. Locations have too often been considered poor for bees. Honey-plants have been abused for not secreting honey. The forest has been cleared too much to keep bees successfully, etc. Everything has been brought up against bee-keeping except the scrubby stock of bees that are most commonly found in our apiaries.

Now, dear reader, right here is where the trouble lies in bee culture in the South. The run-down race of bees has been tolerated too long. Conditions would have been much better if even this race of bees had been looked after; and as soon as this is done you will see progressive apiaries appear all over the Southland.

BLACK BEES.

The black or German bees are the most common ones found in the South, and there are two varieties of them. One has a brownish waist, and short dubby abdomen. Another variety is black, and has a longer and smaller abdomen. We will first consider the brown variety, as it is most common. They are gentle where they receive constant attention, and are very good honey-gatherers when they receive culture and there is plenty of honey in the fields; but they will not exert themselves to get it when it is not plentiful, or the honey-plants are yielding sparingly. In most sections in the South we have a long slow honey-flow during summer and fall, and they will live in a hand-to-mouth manner during this time, and will store very little if any surplus honey. Therefore they die heavily, during fall, winter, and spring. They have two good qualities. One is that they are good comb-builders, and cap their honey beautifully white; and their other good quality is that they can be easily built up to a non-swarming point, and a large comb-honey business established and easily operated.

The queen of the brown bees, even when they are raised under the most favorable conditions, are not very prolific, and for this reason they can easily be brought up to the non-swarming point.

We will next consider the black bees, which are not as common as they were many years ago when the South was mostly a forest. They are very spiteful and furious stingers—so much so that brimstone has almost exterminated them in many sections. They seem to be a wild race of bees and love the forest, and are too spiteful to be cultivated to any great extent, and so are considered the uncultivated race of bees.

I have noticed that comb built by them sometimes has cells not uniform in size, and that many of the workers are very small and uneven in size. Perhaps they are no more prolific than the brown strain, and on account of their spitefulness will never receive much cultivation.

The queens of the German bees do not lay as many eggs as queens of more prolific varieties do; and especially is this true after spring at the close of the first honey-flow. They seem almost to stop egg-laying, and do not get it to its height again before the following spring, and therefore there is not much honey saved during the summer and fall honey-flows.

ITALIAN BEES.

The Italian bees are the next most common race here, and there are several varieties of them—five-banded, three-banded, golden, and leather-colored Italians, etc. They are better known as yellow bees, because they

have yellow bands around their abdomens. The queens of this race are very prolific. They will continue to spread their brood, and keep egg-laying at a high pitch from flow to flow, or the entire season for bees to work, and will store a surplus of honey during summer and fall, and go into winter quarters strong and in good condition.

The different varieties of Italian bees are about alike as honey-gatherers; but they are all hard to get to work in comb-honey supers, while the blacks will easily enter them, and many times will store nearly all their honey in them, so they will have to be fed soon after the honey-flow if the honey is all removed from the supers. The Italians, being very prolific, will swarm before they will enter the supers. Their swarming is hard to control, and will give the extensive comb-honey producer a lot of trouble in this respect. Then, too, most varieties of them are poor comb-builders, and cap the honey flat, or down on it in the cells, which gives it a watery appearance, and spoils its looks; and they do not attach the comb well to the sections, especially at the bottom, and will pull the honey too far away from the sections, and build it thin at the bottom, and thereby make too many light-weight sections.

The golden and five-banded Italians are worse in these respects than the other varieties. The three-banded and leather-colored Italians, or the darker strains of them, give better satisfaction in the production of comb honey. The Italian bees are very gentle where they are kept pure, are great honey-gatherers, and large crops of chunk or extracted honey can be secured by them.

The Italian bees have another failing. In their haste to gather and store honey, they cap the poorer grades too soon, and do not evaporate or ripen it enough, or quit it before they have done enough to it; consequently it soon sours, or ferments, in the comb, and is unwholesome; but they will secure or keep good grades of honey as well as any bees.

Honey will granulate, but will not sour if the bees give it proper care or keep it spread out in the comb until it is thoroughly evaporated. In many sections of the South we have a flow of this honey during summer or fall, which requires more evaporating than other honey.

CARNIOLAN BEES.

The queens of this race of bees are very prolific, and their workers are gentle and great honey-gatherers, and they cap their honey beautifully white. They are good comb-builders, and in other respects are about like the Italians.

CAUCASIAN BEES.

This is a new variety of bees which of late years has been imported into the United States by the Government. Their queens are very prolific, and their workers are very gentle and great honey-gatherers. They have a very compact brood-nest, and are still and quiet on the comb while they are

being handled; and it is a pleasure to handle them, as they do not sting, run, fly, and boil out of their hives as some other races do. They are great comb-builders, and cap their honey snow-white, making it a fancy article in appearance. They are also great cell-builders. A strong colony will build from 20 to 40 large cells containing queens well developed. This is one thing to their credit, showing that they are a very prolific race, are easily kept up, and better for slipshod bee-keeping than some other races of bees. They not only behave themselves well in and around the hives, but around the apiary, even while they are being molested.

The Caucasian bees will come as near gathering honey every day in the year as any bees, and at the same time they will keep it spread out in the comb uncapped longer than any other bees I have ever had any experience with; and even the poor grades of honey are thus made wholesome. But being very prolific they are great swarmers, and hard to control in this respect. Their only failing is that they will carry into their hives a lot of propolis or bee-glue in the fall of the year if there is no honey-flow on.

HYBRID BEES.

These are crosses between races of bees which sometimes make a great improvement in the honey-bee, combining the good qualities of two races in one; but generally these crosses are too cross, and it is considered best to keep stock as nearly pure as possible. The crosses between blacks and Italians show great improvement in the prolificness of the blacks; but at the same time they are very spiteful and unpleasant to handle. Crosses between blacks and Caucasians remain gentle and pleasant to handle, and show a great improvement in the blacks. While the Caucasians possess all the good qualities of the blacks, and are, besides, very prolific, it would not pay to mix the two races; but if it were done it would also be a desirable strain of bees. A cross between Italians and Caucasians makes good workers but very furious stingers—so much so that they are not desirable bees.

If any reader is not satisfied with his race of bees, and is not getting returns from them he should, the above may help him to select a better race.

There are other races and strains of bees, but not common in the South.

BEE CULTURE.

We will begin bee culture from a bare swarm of bees which has just issued, and settled on some object about the apiary. Now, the aim of this swarm is good, for they propose to go into some crevice or hollow place, and there establish for themselves a permanent abiding-place and be rich in honey, and also send out other swarms to other places, and thereby continue the

existence of their race. But they are subject to failure. Why? Because they are dependent on man for culture and weather for progress, which I wish to prove. As soon as this clustered swarm of bees is hived in a good box, log gum, box hive, a neat modern hive, or reaches its future abiding-place in a crevice or hollow in a tree in the forest, the bees will at once begin to build comb from the top of the hollow or some other seemingly good place to them, or in the top of the hive, should they be hived, and store their honey and rear their young. As they build the comb downward they will form what bee-keepers call a brood-nest, which will be about the center of the mass of comb when it is completed. This central portion of the comb called the brood-nest will be occupied by the queen and the nurse-bees in rearing the young. In the comb around this they will store the honey upon which they live. Now the colony of bees is established in its new quarters, but not permanently, unless man comes to their assistance. At the time this swarm issued from their parent colony there was a honey-flow on, and prosperity was smiling upon them with a great glare, and even the weather conditions seemed favorable to their progress; but soon after they are in their new quarters, weather conditions may change, the wind, cold, or rain may drive them in from their pasture where they are gathering honey; and by the time the weather changes in their favor the honey-plant that was yielding honey is done blooming, and they haven't enough honey saved to tide them over the honey-dearth until some other honey-plant begins to blossom. The result is that the once strong vigorous swarm of bees, so full of life, and destined to accomplish so much, is now on the road to destruction, and will soon reach it if men do not intervene and feed them. Should they scrimp along and not all perish until the next honey-plant came in bloom they would not be in any condition to gather honey; consequently they would die soon afterward, or be cleaned up by the bee-moth.

Suppose the weather conditions remain favorable after this swarm issues, and they save plenty of honey to tide them over any honey-dearth, the queen, which does all the egg-laying for the colony, is likely to die at any time; and very often, during a honey-dearth, she will cease egg-laying for a short time, and may die during this time, and leave the colony with no eggs or very young bees from which to rear them another mother. The colony will speedily go to destruction if man does not come to their assistance and give them another queen and some eggs or young bees from which they can rear them another queen.

If the queen does not fail in this way she may for some cause cease laying worker or fertile eggs, and lay unfertile ones; and before the bees are aware of the failure of their mother they have nothing from which to rear them another queen except unfertile eggs or young drones, which can not produce a queen. So the swarm is again at the mercy of man.

Then, again, suppose the colony would thrive and cast a swarm. The old queen would go with it and the parent (or old) colony would be left in the care of a young queen which, on her wedding-tour during which she is mated, is lost or returns to the wrong hive and is killed by the bees. The

colony has no brood or eggs; and if they are not supplied with some eggs from another colony, or a young queen is given them, they will go to nothing, and the colony will be lost. Then, again, the bees may not supersede their mother, when she is old and failing, with another queen, thinking that, may be, she will do better until they dwindle down so low that the bee-moth will destroy them unless the failure of their queen is detected and she is killed and the colony supplied with another. So there can be no question that bees need a guiding hand and culture; and if they have it, great progress will be made in the industry.

Now let us look into the culture and the progeny or race of this swarm of bees as we have traced it and pointed out some of its needs to prolong its existence; and mark too, that it was located in the brood-nest and could not be supplied unless we had access to it; or, in other words, could take the combs out one by one and examine them. So it is very necessary that the swarm be hived in a modern hive, and that the comb be movable, or their culture will be at an end, and the loss of them may be expected at any time. Now that the swarm is in a modern hive with combs built and the brood-nest established, it should never be lost as long as a good queen is occupying it with plenty of stores around it; and, as previously explained, this can easily be done by inserting combs of eggs and brood and queens into it at these critical times of the colony; and to keep it in the best possible condition it must be constantly examined during the bees' working season. In examining this brood-nest from time to time it should never be allowed to be filled up with honey. Bees will often do this for lack of room somewhere else to store their honey and crowd the queen out with it or narrow it down to a very small space. Don't let this happen; and should it happen, remove the honey at once and keep it large and in a thriving condition—that is, full of eggs and young bees in all stages of development during spring, summer, and fall. Nothing but a prolific queen of any race of bees should be allowed in a colony of bees; so the race of this swarm of bees should be taken into consideration as soon as it is hived; and if it is not of some leading honey-gathering variety a queen should be ordered for it at once, for it does not pay to cultivate bees if they haven't good qualities; and the results will never be satisfactory in cents and dollars from the culture of a rundown or inferior race of bees; and this should be kept in mind along as we give them culture and fresh blood added to the apiary from time to time.

MODERN APIARIES, BUT MODERN METHODS NOT APPLIED.

There are many small apiaries scattered all over the South where modern hives have been adopted but modern methods of apiary work have not been applied. The bees in these hives are in various conditions, and the comb built in various ways in them. Some bought the hives for the purpose of

giving their bees culture, but never got around to it. Others bought them because they were sustaining heavy losses by using the old-style box hives, thinking that the hives were the cause of the loss. And some bought a few hives just to try them. The fact is, we have a part or all of our bees in patented hives, and we don't know their condition any more than if they were in old box hives; and from a bee-keeping standpoint they are no better off except a few dollars tied up. No decision as to bee-keeping or the patent hives can be reached.

Dear reader, the adoption of modern hives is one step in the right direction if they are properly put together when the bees are hived in them; but if this step is all, invest the money you expect to buy more patented hives with in some other direction and hive your bees in boxes. But a better thing to do would be to get in touch with your bees. Know how to lay your hand on them and what to depend on.

THE INTERESTED BUT NON-PURSUANT.

It is astonishing to know how many there are interested in bee-keeping, but who are not pursuing it to any extent for reasons they can not always assign. There are but very few who are interested in bee culture; and yet there are but few who are so situated in life that they could not keep and care for as much as one colony somewhere about their premises, and several times a season they could get a taste of new honey at home; and during that time they could acquire no little knowledge of the nature and habits of bees, so that, when they were differently situated in life they could establish and operate successfully an apiary large enough to supply the table at home at least. This would assure a pure article and the children and other members of the family could be easily taught bee culture, and learn it, combining theory and practice. There are many people grown and growing up in the world who have no correct ideas of giving bees culture. This lack of general information could be overcome to a great extent if we had a lot more small bee-keepers. Besides bee education, more honey would be consumed and take the place of some of our inferior sweets, and more vigor and health would be added to the human family.

There is no excuse for the great shortage in honey-saving; and, dear interested reader, deepen your interest in the little honey-bee by keeping a colony or a small apiary, and reach out your hands for at least a small portion of the heaven-sent food, for nature needs it and is calling for it, and it is going to waste.

THE BEGINNER AND THE BEGINNING IN BEE CULTURE.

Who is the beginner in bee culture? There are many people interested in bees and are buying bee-literature, and reading and studying bee culture in view of some time establishing and operating an apiary when they get better located in life. There are many who are keeping bees in old-style box hives, but who are interested in their bees, and are entertaining the thought of establishing a modern apiary. There are some who already have their bees in modern hives; but there is a mountain of doubts rolled up between them and their apiary, and they are in a quandary whether to continue to cultivate them or not. Then there are many who are deeply interested in their bees, but somehow never get around to give them attention. And there are also some who are enthusiastic over their little industrious objects, and have modern apiaries established, and are endeavoring to cultivate their bees.

Evidently I have classified the beginner in bee culture somewhere, and we will next consider the beginning. Of course, we must have foundation stock or a starting of bees—see "Buying Bees," in order that we may properly apply what we read, and see the actual results so we may practice as we learn. The greatest essential in learning a new line of business is applying the methods of work already outlined, and not by experimenting. In other words, apply what some one else has learned, and follow instructions as close as possible, and not go down to the bottom and begin by experimenting, and suffer the great loss that is usually sustained by experimenting, and during the time sustain a whole lot of unpleasant and unsatisfactory experiences.

If I have a beginner student in bee culture who starts off to experimenting I lose hope of him, and nine times out of ten he will fail. But if I have one who is studious, and who follows instructions, I have great hope of him, and nine times out of ten he is sure to succeed.

If any one takes up a new line of business he is sure to make some mistakes and to have some unpleasant experiences and unsatisfactory results. So it is with bee-keeping, even when we have followed directions or instructions as closely as we can.

My experimenting with bees has cost me enough to establish an apiary, the returns of which would be between 200 and 500 gallons of honey a year; and, besides, I came near, two or three times during the struggle, giving up the idea of being an extensive bee-keeper.

Dear beginner, study some book of information or give yourself a blank to some progressive bee-keeper, and follow instructions closely, and let some other bee-keeper do the experimenting, and you benefit thereby. Buy or keep but few bees at first, and invest no more capital in them than necessary, and soon you will attain a success with your bees that will put to shame the old-style box-hive bee-keeper who has kept bees all his days. Elsewhere in this book you will find the needed instructions to guide you on to success from the right starting-point.

BUYING BEES.

Buying up bees in box hives and gums, and transferring them into modern hives, is a common practice among bee-keepers. If bargains can be obtained, this is a very good practice; otherwise it is poor practice. Often box hives are heavy with honey, and contain a good-sized swarm of bees; and if they can be bought for \$1.00 or \$1.50 it may pay to buy them, and transfer them, feeding back the honey to the bees (it is usually unfit for anything else), and let them build a set of combs from it, and be in good condition for the honey-flow. The wax saved will pay for the transferring, and the colony may cost you only \$3.50 or \$4.00. But generally you will not find the prolific varieties of bees in such hives, and a young queen will cost \$1.00 or \$1.25 for it. Considering that there is usually some loss sustained in transferring and introducing queens, there could be only a very small bargain, even if the best or heaviest hives that could be bought, and if the transferring were not done by some experienced bee-keeper there would not be anything saved by buying up such hives, except, perhaps, transportation on colonies from some bee-keeper who may have them to sell.

Box hives should be examined well, before they are bought, by removing the cover and turning the hives down, so that the light will shine through the comb from the bottom, and give you a clear view of the contents of the hive. If the hives are constructed so that you can not remove the bottom, part the comb and turn the hive so the light will shine between it, so that you can make close inspection. Now, when a hive is thus examined set your price on it so that, when all hives have been examined, you will know what to offer for the apiary. The material used in the construction of box hives sometimes is very heavy, and you should not buy them by weight.

Sometimes bargains can be obtained in buying bees in modern hives from bee-keepers who are going to move away, or are not so situated as to keep bees, and want to sell them, or for some other reason wish to dispose of their bees. There are always people in the market for bees, and such bargains should be made known to them, or taken up by some one who is interested in bees.

Transportation on bees is high, and they should be bought as near home as possible.

The question is often asked, "Should I buy my increase or make it?" If you have the experience and time it might pay you best to make it; but if you can get a bargain in a lot of bees somewhere near you it would pay you best to buy your increase if it is in good condition. In making your own increase you have the variety of bees you want, and the size hive and frames you desire, which can not always be had in buying bees for bargains. Some bee-keepers buy nuclei (small swarms of bees), and build them up to full colonies and make their increase in this way.

But how should the beginner buy his bees? The cheapest, safest, and best way is to buy full colonies from some progressive bee-keeper who may have them to sell, for then you would be almost sure to get a good stock of bees.

Another good way is to buy a few heavy old-style gums from some old-style bee-keeper near you, and put the new swarms from them in modern hives; and, as soon as possible, buy some young prolific queens for the new swarms, and kill the old queens and introduce the new ones to the colonies. Soon the old box hives will die out, and you will have a modern apiary, and good stock.

Many beginners have bought two-frame nuclei for foundation stock, and built them up to full colonies. This is a good way for beginners to buy bees if they will give them the proper attention; for they will gain much valuable information while building the small swarms up to full colonies. Before the nuclei are ordered, a hive for each one should be set up in readiness, and full sheets of foundation put in the frames (starters will not do for this purpose, for the small swarms of bees must have as much help as possible); and as soon as the nuclei arrive remove them from the case they were shipped in, and set them in the hives next to one side and set the division-board next to them. A beginner should never order less than two-frame nuclei, which would consist of two frames of completed comb filled with brood in all stages of development, and honey, and contain a young prolific queen and enough bees to cover the two frames of comb well. After they have been in the hive for a day or so, separate the two combs and insert a frame filled with foundation in between them, and push them up together with the division-board behind them, and put the feed to them (see "Feeding Bees"). The bees dislike this space between the combs; and the foundation being a great inducement to start them to comb-building, and plenty of feed for them to eat to secrete the wax, they will at once begin to draw out the cells on this sheet of foundation, and in a few days it will be a beautiful white comb filled with the feed, young bees, and eggs, for the queen will begin to lay in it as soon as the bees get the cells built out far enough for her to deposit eggs in them, and as soon as this comb is about completed, separate two more combs and insert another frame containing a full sheet of foundation between them and continue feeding. As soon as this comb is about completed, insert another frame of foundation, and so on until the bees have completed for themselves a set of combs.

Now, it is the feed that is enabling them to accomplish this great task, and it should be kept up until all the comb in the hive is completed; and by this time the bees will be built up to a booming colony, and be in the best possible condition for the approaching honey-flow. If there is a honey-flow on, the bees are not likely to remove the feed, because they are getting better feed from the field, and they will build the comb as if they were fed. But it is best to order the bees and build them up to a strong colony before the honey-flow so as to secure a crop of honey, if possible. If the weather is cold when the nuclei arrive, or during the time they are building up, they

should be protected from the cold as much as possible by contracting the entrances so that only two or three bees can pass at a time; also a sack folded up and placed over the tops of the frames, and folded down over the division-boards, as the sides will greatly protect them from the cold; and as they require a high temperature to secrete wax and build comb this will help them to keep it up. During this time the beginner should learn much about his new line of business.

TRANSFERRING BEES.

This is an important subject in bee-keeping in the South. It is one about which many questions have been asked and answered. Many good populous colonies have been destroyed by the operation, and at this point many have turned back to old-style ways of keeping bees, and here many have become disgusted and abandoned bee-keeping entirely. It is a job that almost all bee-keepers dread. Some will not undertake it at all for fear of a failure. Others do not want to come into such close contact with the bees. It is a subject upon which I have meditated much, and first and last have had extensive experience, having transferred some of my bees three times from different hives. Besides, I have transferred many apiaries for others. I have put into force every plan I have ever heard or read of, and the one I find best, simplest, and easiest I will give.

In early spring, when the poplars begin to bloom; or the first honey-plants begin to bloom and yield honey in your locality (I mention poplar trees as they are the most common honey-plant in the South), then is the best time to transfer bees, because some honey is coming in and they are not so easily discouraged. Remember a great change has taken place when they are transferred. Things don't look natural in their new hive, as they did in the old one, either on the inside or outside. There has been a great change in the household affairs, and their instinct does not make provision for such an unexpected and unnatural change. But if there is honey coming in they will likely go right to work with renewed energy if they have been transferred. So the time to transfer has much to do with it.

Another good time to transfer is in the summer when cotton begins to bloom.

The method of work is as follows: One day before transferring, rob the bees closely so as to have but very little if any honey to contend with; but don't rob any more colonies than you think you can transfer the following day. By next morning they will have all the scattered or broken honey cleaned up, and the bees will be in the best possible condition to transfer.

Then with the proper number of hives in readiness, each containing five frames, fill with full sheets of foundation the remaining three, empty, to receive the transferred comb. An ax, long-bladed knife, a ball of cotton wrapping-twine, a burlap sack folded and laid on a box or small table two or three feet square, must be in the apiary in readiness. Also a pail of water and towel. Put the veil on well. Cord your pants legs and sleeves, then with the smoke in good trim tilt a hive over a little; send up through the comb a few whiffs of smoke, then remove the hive, setting it on the ground a few feet away; then remove the stand and set the new hive on the ground where the stand was with the three empty frames and division-board and cover removed. Now turn to the old hive, and again smoke the bees well from the bottom; ease off the cover from the old hive (which should not be nailed), and dump the bees on it into the new hive where the frames were removed, and put the cover on it; then take hold of the old hive by the top and bottom, and reverse ends with it, jarring one of the top corners against the ground just in front of the new hive, thus dislodging the most of the bees, and they will at once go into the new hive where the others are.

If there is yet a good number of bees in the old hive, repeat the smoking and jarring until there are only a few if any bees left. Then take the old hive away a few steps, lay it down on its side so that the comb will extend upward, and split it open with the ax; then spread it out each way on the ground. Now you have access to all the comb, and remove the straightest pieces of comb containing brood and may be a little honey, and lay them on the folded sack; then lay one of the empty frames over the best portion of the comb, and cut down around on the inside of it with the knife; then press it into the frame well and give it a few raps from the bottom-bar to the top-bar, with each end of the cord fastened. Set this frame to one side, and proceed in like manner to fill the two remaining empty frames, using only the best comb; then if you should like any, you will have some comb over from some other hive, and you can finish filling the frame and put it in its place; but as soon as you get the other two frames filled, put them in the hive and keep the cover on. Now wash your hands and dry them, and proceed thus from hive to hive until you have transferred the apiaries. Kill as few bees as you can, for they are very valuable at this critical time. I have found it best to begin on the strong colonies first, and transfer the weaker ones last. Be sure, when you give the frames of transferred comb back to the bees, that they do not touch, and that the bees may have access to all the comb surface, for they dislike very much to have their comb pushed together so they can not pass over it; and often transferred comb will bulge and do this; and it is best to leave the division-board out until you examine them again in two or three days; then you can better straighten the comb in the frames, for the bees, by this time, will have them well attached to the frame. Also at this time you can insert two frames of foundation between these frames of transferred comb, and the bees will at once draw out the foundation, and the queens will occupy them.

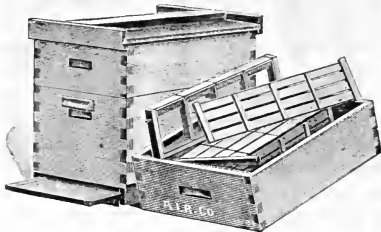

No. 1 — Hive arranged for Comb Honey

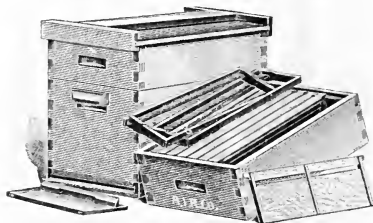

No. 2 — Hive arranged for Chunk Honey

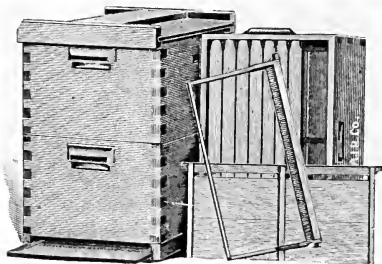

No. 3 — Hive arranged for Extracted Honey

The whole operation for each colony is very short, simple, and easy, and not much unpleasant work is involved. If there is any honey left in scattered comb around the apiary, let the bees eat it out as you go, and they will give no trouble by robbing. Of course, contract the entrances of the weak colonies after they are transferred. I have transferred 147 colonies in one apiary thus, with good results. I have given the method to other bee-keepers and farmer bee-keepers, and they claim it a success, and have adopted it.

MODERN BEE-HIVES.

Modern or patent hives, as they are better known, are the only hives bees can be kept in successfully, for they are induced to build their comb straight in movable frames in them, thus giving the bee-keeper access to all comb, which can be easily removed, and the needs of the bees detected and supplied. The old-style box hives have been sufficiently tried in all sections of the South, and they are a part of the cause of bee-keeping being where it is here now; and prejudice against the modern bee-hives has also been a part of the cause. The needs of the bees are always located somewhere in their comb, and the old-style hives debar the bee-keeper from supplying them.

People have been eager to reach after modern improvements along their lines of business; but modern hives have not been bought for their apiaries, and bee-keeping has not had what was due it in the way of improvements. Modern hives are the foundation upon which bee culture is built; and how can it stand or make progress without adopting them? Our forefathers in bee culture invented them and handed them down to us at a reasonable price; and all along improvements have been added until it seems perfection has been reached, and that they are as convenient for the bees as they are for the apiarist.

THE CONSTRUCTION OF MODERN HIVES.

There are several styles of modern hives in use, but I will give only three, which are most commonly in use for comb, chunk, and extracted honey here in the South.

Modern hives are complicated, constructed or made up of many pieces, which can not be avoided; and if they are not properly put together, their good qualities are spoiled. Many of them have been thus put together here, and the result is there are many dissatisfied purchasers, because the hives are not what they expected them to be in construction, and they failed to

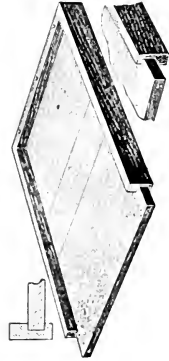
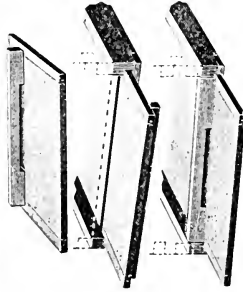
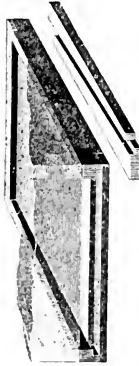

Bottom-boards.

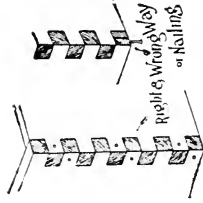

How to nail hives.

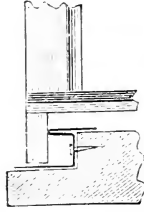

The Rabbet in position.

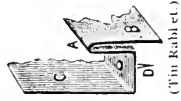

(Tim Rabbl et.)

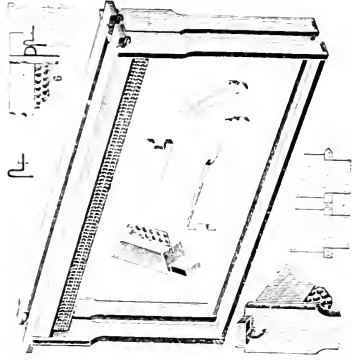

Hollman Frames.

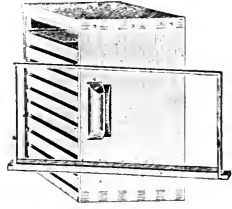

Brood Chamber.

get them properly put together. As stated elsewhere, the hives are the foundation of bee culture, and it is very important that we start it right from the hive, and for the benefit of those who know nothing of their construction I will try in the simplest manner possible to help you over this obstacle by the use of engravings showing each part, how it is cut out, where it should go, and how it appears after it has been properly placed and nailed, and set in the hive.

Carefully open the packages of hives and lay similar pieces together around on the floor or bench, and proceed as follows: Take up this book; turn to this page, and look over and over the cuts or pictures showing the different pieces, how they are cut out and where they go, then look over your piles of similar pieces and see if they are not similar to the pictures of those in the book. Continue thus until you have located every piece and learned where it goes in the hive. Now with the hive clearly laid out in your mind, don't start to nailing until you have read and reread "The Construction of Modern Hives," so that you may nail them right and they will stay thus.

First, nail the bottoms together. The hive manufacturers usually send out two styles of bottoms with the standard hives, and you will have one of the styles.

Next put the hive-body together, nailing it well; then nail the tin rabbits in it, using four nails from the top and four through the sides. Also nail the little molded cleats on just above the hand-holds in the ends, and set it on a bottom and then start to nailing the brood-frames together by first nailing end-bars to the top-bar with two nails at each end. It will be seen that these end-bars have a V edge, and in nailing them to the top-bar be sure you turn the V edges opposite, or one on the right side of the top-bar and one on the left, and nail all the end-bars to the top-bars just as you did this one. The object of this V edge is to keep the bees from gluing the edges so tight together, and thus be a hindrance in handling them; and if you do not put the end-bars on all top-bars, and the V edge extending in the same direction, some square edges will come together and thus spoil the good feature. Next nail the bottom-bars on with four nails. Now drive the little staples, which you will find with nails, into the end-bars just under the extending ends of the top-bars, using the little gauge which you will also find somewhere among the hive parts. There will be found a bundle of wedges, and also a bundle of long, narrow strips of foundation, and on the bottom side of the top-bars will be seen two grooves. Place a strip of foundation in the tenter one, and press a wedge in the other one; then drive it down below the surface of the wood or it may work out. Set the frame in the hives as they are thus completed. Then put together the division-boards, nailing them well, and set them in the open spaces between the last frame set in and the side of the hive, and put a wedge in behind it.

Now the brood apartment is finished, and we are ready to begin on supers or top stories. We will first construct a super for comb honey as on hive No. 1. Carefully put together the bodies of the super and it will

be seen that the ends of the super have rabbets in them similar to those in the ends of the bottom story. This is the top of the super. Turn it over and nail the section-holder supports on which are narrow strips of tin. Nail these on well, letting them project over on the inside of the super not less than $\frac{1}{2}$ inch. These are to hold all the fixtures in the supers. Next put the section-holders together, using four nails to each one, and be sure that the ends are nailed on the bottom slats not less than 17 inches between them, or the sections will not fit in them. Now set these in the supers, putting a separator between each two. The separators will be very thin pieces of soft wood about $4\frac{1}{2}$ inches wide, slotted on one edge, and this slotted edge turns down. Sometimes the factories send out hives with slat separators which are made of four thin narrow slats supported at ends by a piece of tin, and it will be seen that these end supporters project more on one edge than the other. This longer projecting edge goes down. Next put the followers in behind the last section-holder, which is a board about $\frac{1}{4}$ inch thick and as long as the hive is wide, and about $4\frac{1}{2}$ inches wide.

The supers are now ready for the sections, which are thin slotted pieces of wood with three V-shape grooves cut across them about the same distance apart. Wet the sections, at the grooves by pouring water through them, holding ten or fifteen at a time edgewise over a pail of water, or dampen them at the grooves with a sponge or piece of cloth dipped in water; but be sure not to wet the sections all over or they will warp and twist.

Now with the section-former, squeeze or press (see machines for this work under "Apiarian Implements"); put the sections together, or this can be done by folding them carefully together, and knocking the lock corners together with a mallet or hammer; but the machines are better for this work.

Now with the foundation-fastener (see machines for this work under "Apiarian Implements"); put the starters or full sheets of foundation in the sections, and be sure that they are fastened to them well or they may drop down and the bees disregard them or build a crooked comb in the section. Set the sections thus filled carefully into the section-holder, and key them up by putting a wedge or spring behind the follower. Now put the tops together, nailing them well, and the hive and super for comb honey is then completed and ready for the bees.

The next hive for consideration is No. 2 for chunk honey. The bottom story, or brood-apartment, is constructed as hive No. 1 for comb honey; but the super contains shallow frames which hang in the wood rabbets (no tin ones to be used), and the top-bars of which are thin, with a small shallow groove in them, which are to be turned down. Nail the frames up as you would the brood-frames in the bottom story. You will find smaller staples, to be driven in the ends to space the frames, than those used in the brood-frames; and when these have been driven in the proper depth (using the same gauge on the brood-frames), the frames will be ready for starters or full sheets of foundation; now take a light board the size of the frame on the outside, and tack on this a thin board the same size as the frame

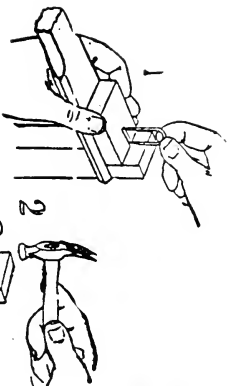

How to nail the Staple-spacer.

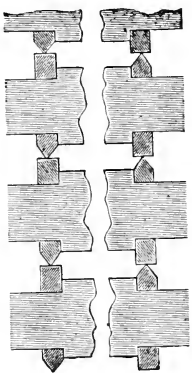
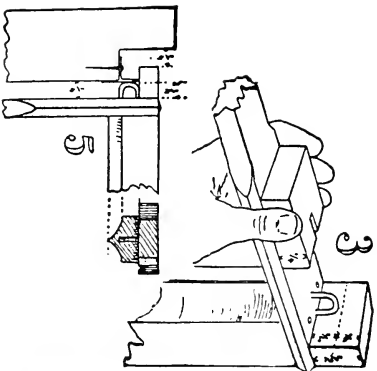

Mode of arranging Hoffman frames.

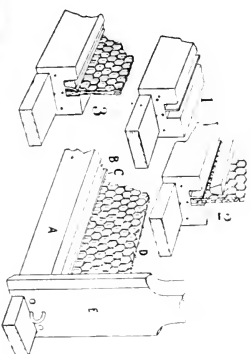

Method of Fastening Comb-foundation.



Division board.

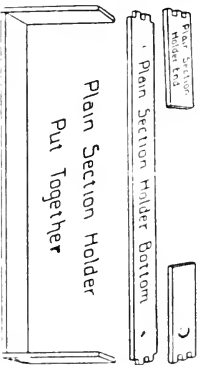

Plain Section Holder
Put Together

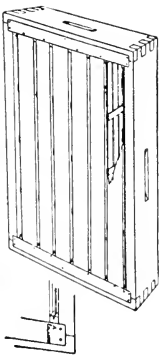

Slats showing the Tin Rest.

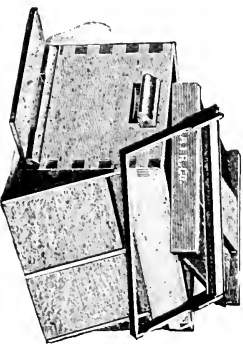

One-story Hive Ready for Use.

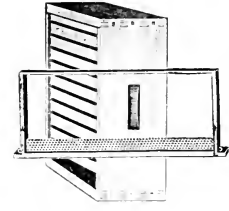

Shallow Extracting super.

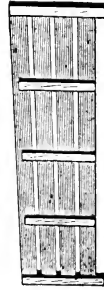

slotted or Fence Separator.

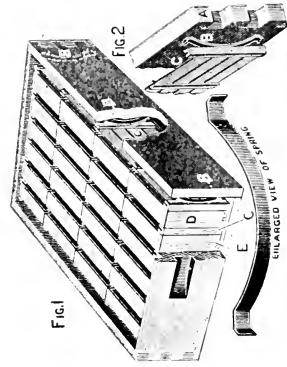

Fig. 1

Super for Comb Honey, with Fences and Springs.



FIG. 2



FIG. 3

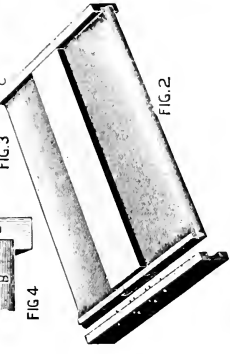
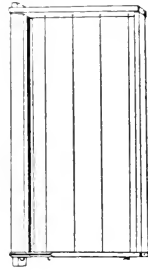

FIG. 2

Hive Roof or Cover.



Wired Frame.



Spur Wire-imbelder.

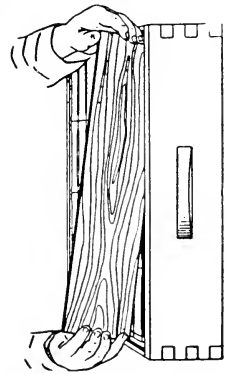

Putting in the Following-board.

is on the inside, and just as thick as the top-bar is wide from the groove out. When the frame is placed over this board it will serve as a gauge to hold the foundation in place in the groove while it is being attached. A small vessel of melted beeswax should next be prepared and kept warm over a lamp. Now lay a frame on the prepared board and place the foundation in the groove and lift all up carefully and hold in the left hand; then dip out the melted wax in a spoon, or a Van Deusen wax-tube is much better (see under "Apiarian Implements") with the right hand, and pour a little into the groove at the top, holding the frame so it will be on the decline, so that the melted wax will run fast down the groove and thus attach the foundation at the top-bars. As the frames are filled, set them in the supers and put the followers in behind the last frames put in, and then wedge them close together. Nail the tops together as previously described, and the hives for chunk are completed.

Hive No. 3, for extracted honey, is constructed the same as the bottom stories or brood-apartments in hives No. 1 and No. 2, for comb and chunk honey, except that the frames are filled differently. Set up the hives complete as previously explained, but do not put the foundation in the frames. It will be seen that the end-bars have four small holes drilled through them, which are to receive the wire. Now fasten a frame down on a convenient place on the bench so it can be easily and quickly fastened and unfastened. Also about six or eight inches from one end of the frame fasten the spool of wire by driving a large nail through the hole in the spool into the bench enough to hold it while the wire is being removed.

Now drive a small nail into the bench between the spool of wire and end-bar about half way down, and bend it over so that, when the wire is cut, the end can be brought under the nail and hold it, and keep it from getting tangled. Drive a very small tack about half way up, near the top and bottom holes in the end-bar nearest to the spool of wire; and when the wire has been run through all the holes, beginning at the top, wrap it a few times around the tack near the bottom hole, and drive the tack down; then draw the wire until all the slack is out, and give it a few wraps around the other nail, and drive the tack up; then cut the wire near it, and bring the end under the bent-down nail, and the frame is wired, which can be removed and another wired in like manner. Then when all the frames have been thus wired the foundation can be put in, which can best be done by nailing a short plank down on the bench on the edge so that the top edge will take two or three inches, being perpendicular, so that, when the frame lies on its top-bar beside this plank the bottom-bar can rest over on it, then a beveled-edge strip can be put under the bottom-bar, which will give it a solid foundation and hold it in place. This inclined position of the frame will keep the foundation in its groove and out of the way while the wedge is being driven in beside it; and when this is done carefully, remove the frame and lay it on a board cut just the same size as the inside of the frame, so that it will go down over it with the strands of wire and the foundation next to the board. Then carefully run the wire-imbedder (see under "Apiarian Im-

plements") over the wire pressing down just enough to imbed them well into the foundation; but be sure, before this is done, that the wires rest tightly across the foundation, which can be done by pressing the frame down over the fitting piece under the foundation. As the frames are finished, set them in the hives and wedge the division-boards up against them, and they are ready for the bees.

As previously stated, there are other styles of modern hives and supers, and some of them are used in the South; but I have given the construction of the three most commonly in use here. Some of our Southern bee-keepers use what is called a ten-frame hive, which is constructed the same as I have described, only they are just a little wider. There is no doubt that these ten-frame hives are the best for extracted honey in locations where they sometimes have overwhelming crops of honey; but generally the eight-frame hive will answer all purposes. There are also many bee-keepers who use shallow frames and shallow supers for extracted honey. The hive I have described for chunk honey can also be operated for extracted honey and the frames wired if desired.

The close observer, as he puts his hives together, will notice a small space all around and through the fixtures of the hive. This space is called a "bee-space," allowing them a passage all through and around in the hive, making the hive as convenient and suitable for them as possible; and notice, too, how quickly and easily all the fixtures can be removed from the hive and set back, giving the bee-keeper a quick and easy access to the bees and all parts of the hive.

The writer will never forget the first modern hive he constructed, and the length of time he was at it; but he soon learned the "kinks," and hive-construction has always been a pleasure to him.

SUBDUING BEES.

Bees are irascible insects; but they can be so completely conquered or subdued with smoke that they will not offer resistance, even to an intruder upon them removing their young or their only source of living (honey) With proper precautions and protection (using vests and gloves), and a good smoker, any one can be safe and feel comfortable among bees. But he must let them know on approaching them that he is to be master of the situation. Never go out into the apiary to molest the bees without having the smoker full of good fuel and well burning.

On approaching a colony of bees to do certain work in it, send in a few whiffs of smoke at the entrance; then with the hive-tool pry the cover loose and send in smoke along the crack a few moments before you raise it high enough to let the bees escape; for if you let any out at the opening of the hive they will be sure to give you trouble. As soon as they have been

smoked a few moments remove the cover and send a few whiffs of smoke over the frames so some of it will reach the bees along on the top of the comb; but don't send strong whiffs down between the frames, for this will be too much smoke, and will cause them to become confused. Now begin frame manipulation, inspection, or whatever there is to be done; but keep the bees subdued, whenever they show signs of resistance, by mounting the top-bars from below and giving you a straight look. Another whiff of smoke will send them back down, head foremost. Repeat the dose as long as these mounters appear while handling their comb. Usually bees will offer resistance but a minute or so after they have been disturbed, for they will hustle about over the comb until they find uncapped cells of honey, and then they will gorge themselves on honey, and lose all inclination to fight or resist their intruder.

The art of subduing bees is soon learned after a few painful stings have been endured.

Smoke should not be used in hiving swarms or in handling bees after they have settled, any more than possible, for they don't need subduing, but rather, gentle treatment.

FRAME MANIPULATION.

Handling frames of comb, honey, and bees intelligently is where the wheel of fortune begins to turn in bee-keeping. Bees are subject to failure at any time; but by handling their comb from time to time, inspecting the condition of each colony, these failures, either on their part or the part of their keeper, or Providence, which seems not to make a provision for man's part, can be easily detected and supplied before the colony fails or soon after it has started to. The needs or failures of a colony of bees will be fully explained elsewhere in this book, which can be and should be supplied from an outside source, or have the bees help each other by making the "strong bear the infirmities of the weak" by changing and interchanging frames of comb, honey, and brood from one hive to another, equalizing them.

There is no supposition in bee-keeping. If the frames are manipulated we know what to depend on, for the condition of our bees is clear to us, and we know that we can have them in good condition or in shape to gather honey previous to each honey-flow, and that we shall save as large an amount as possible with our force of bees if the weather condition is in our favor.

Then, too, frame manipulation is interesting—so much so that it never gets to be monotonous. Each hive of frames handled offers new ideas in bee culture for our consideration; and the art of handling them is soon learned by any one who will apply himself.

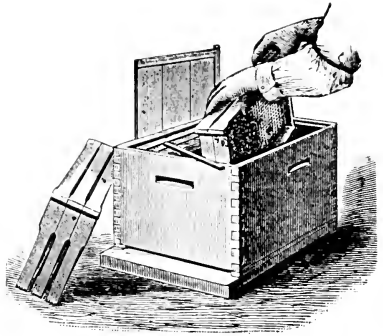

How to Handle the Hoffman Frames.

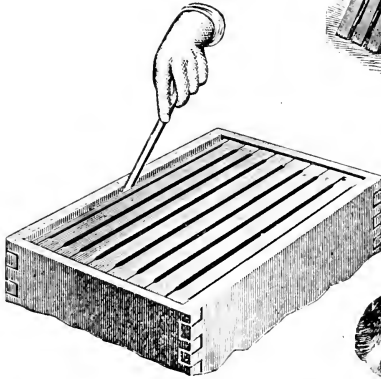

Tightening the Hoffman Frames with a Wedge.

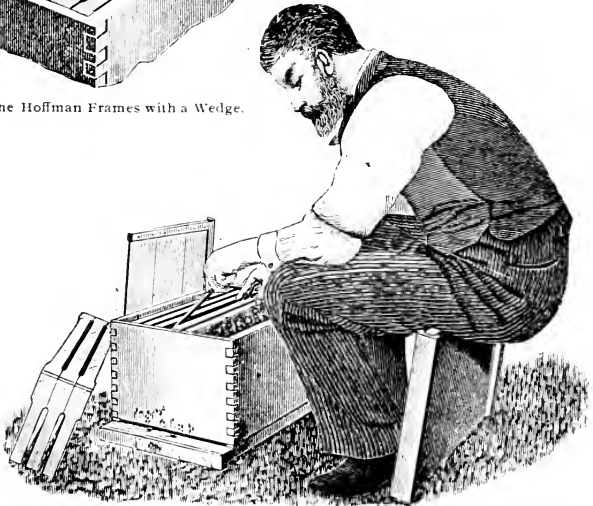

How to Remove Hoffman Frames.

If it is desired to make an inspecting-tour over the apiary, one or two of the center frames are all that is necessary to be removed to reveal the condition of the colony. This can be done by lifting out the division-board, or one frame on the outside, and then prying the others away from the frame we wish to inspect, and lift it out; and the inspection of this frame should show the colony to be in good condition (plenty of eggs and food in all stages of development in it, as other colonies have, although sometimes bees don't carry much brood; and if this be the case none of them will be carrying much), but if the inspection of this frame is not satisfactory, lift out the next one; and if that is, set it back in the hive carefully, and set the outside frame or division-board back in the hive, and wedge the frames up and put on the cover; but if the inspection shows the colony not to be in good condition, lay something on the cover. When all the colonies have been thus examined, then turn back and supply the needs of those that are not in a thriving condition. If they need stores, give them a frame of honey from some colony which may have it to spare, or feed them (see "Feeding"). If there are no eggs or brood in the hive when there should be, give them a frame of brood, for they may have lost their queen, or there may be a young queen in the hive which has not begun to lay yet. Inspect the frame of brood next day; and if they have started queen-cells, give them another queen as soon as possible, or a ripe queen-cell, or you can put them to raising them another queen (see "Queen-rearing"). If the bees do not start queen-cells, there is a young queen in the hive which should begin to lay in a few days; but examine the hive often as possible, and see that they do have a queen.

Then, again, if the colony should have plenty of stores (remember, a good queen without plenty of stores can not keep up her colony), but be behind the average in eggs and brood, then the queen is old or failing, and another one should be given the colony, also one or two frames of sealed brood, if the colony has run down any. Strong colonies should never dwindle down if they are kept supplied with stores and young prolific queens; but should any colonies run down in bees they should be given frames of sealed brood from strong colonies from time to time.

The observant bee-keeper can soon learn the needs of his bees, and how to supply them by handling or manipulating the frames containing the comb of his bees, changing and interchanging them from hive to hive from time to time over his apiary.

APIARY WORK.

To give a modern apiary the necessary attention to prolong the existence of all colonies, and to obtain the greatest amount of surplus honey possible, requires more time and work during the year than the average bee-keeper may suspect; but the bulk of the work comes at intervals just before and dur-

ing the honey-flow, and at the close of them. Work to get the bees in readiness for the honey-flow. Work to give them the proper room to store honey during the flow, and work to remove and market it at the close of the flow. Of course, the amount of work is governed by the size of the apiary and the extent of the honey-flow.

There are three essential things to know in successful apiary work, and they are: 1. To know what to do.

2. When to do it.

3. How to go about it to accomplish it best. First, let us consider our duty to our bees, if we owe one, and we surely do for they are very useful and necessary insects in the vegetable or plant kingdom upon which we so depend. Then, too, their products are very valuable and necessary. Our appetite calls for honey, and our frail bodies need it to nourish them; and the mission of the honey-bee and its field of work, and the usefulness of its products, show conclusively that it was not sent among us as a pest to be brimstoned, or its culture ignored. Notwithstanding, thousands of colonies have been killed in various ways, as all they had to subsist on was taken away from them, which soon resulted in their death. Yet a few are left awaiting cultivation and to do this we must read, study, think, and apply ourselves to apiary work, so that we may know the needs of our bees.

Second, while we are applying ourselves to know apiary work we must not forget there is a time to do all things; and to do it properly it must be done at the right time or loss will be the result. It is necessary that we walk about the woods and know about when to expect the honey-plants, that yield a surplus of honey, to bloom.

The time to do apiary work in the South varies considerably; and the time to prepare bees for the honey-flow varies greatly in different sections and locations; and even the honey-plants are by no means the same everywhere. Different plants here and there yield honey at different times of the year all over the South, so there is much for every bee-keeper to solve in his own immediate location, especially as to the time of apiary work.

Third, next is applying the work properly. With the needs of the bees clear in mind, and the time of supplying them known, the apiary work ought to glide along smoothly, and the bees make great progress under the guiding-hand of their keeper; but the work should be done considerably, watching the bees closely that the work may bring progress to them.

With these ideas in mind, what to do, when to do, and how to do apiary work, and with a feeling that, if we keep bees, it is our duty to give them a small portion of our time at least, let us take up apiary work for one year in as simple and condensed a form as possible.

APIARY WORK FOR JANUARY.

This is usually our coldest month, and about all that can be done is to paint the hives if the weather is dry and not too cold to work. Also honey-houses might be erected and supplies ordered for the season, and some of them set up during the latter part of the month, if they arrive in time.

APIARY WORK IN FEBRUARY.

The remainder of the supplies should be set up and in readiness during the first part of the month. If bees are to be moved it should be done during this month. If the weather warms up during the latter part of the month, all colonies should be carefully gone through, and their condition noted during the warmer parts of the days when bees are flying briskly. By this time the earliest pollen-plants are in full bloom, and breeding is going on at a rapid rate if the weather permits; and if the first honey-plant will begin to bloom in about six weeks it should be under headway. If pollen is coming in rapidly, and no honey, and there are any colonies not spreading their brood as rapidly as they should, feed them a little.

APIARY WORK FOR MARCH.

There should be a good many warm days in this month, during which all colonies should be looked through carefully again, and their condition noted; and if any of them are running short of stores, feed them; and if any are behind in brood-rearing, insert an empty clean comb in the middle of the brood-nest; if it has a rim of honey along the top-bars and end-bars it will not hurt; and when they are given the frame, still continue to feed them slowly. In three days look over the colony again; and if the inserted frame is full of eggs, lift it out and set it on the outside of the last frame which has brood in it; then insert another frame, and in three days remove it and set it on the other side of the hive beyond the last frame of brood on that side; then insert another frame of empty comb, and keep up feeding. By the latter part of this month all colonies should be strong in bees, and rearing a lot of brood.

APIARY WORK FOR APRIL.

During this month honey-plants will be blooming in almost all sections of the South, and all hives should be boiling over with bees, and the brood-apartment full of young bees in all stages of development; and as soon as the honey-plants begin to bloom, put the supers or top stories on; then don't molest the bees any more than you can help while they are storing honey; for it will detain them in their work; and don't let them fill the supers and need store-room; but don't give them too much room to heat up.

APIARY WORK FOR MAY.

In many locations in the South, the honey-flow will extend on through this month. By the first of this month we usually have settled warm weather, and great progress should be made by the bees. Well-filled and capped-over frames of honey can be extracted, and finished supers of honey can be removed.

APIARY WORK FOR JUNE.

By the first of this month the honey-flow is off in most locations, and all surplus honey should be removed and put on the market. In locations where

there is not another honey-flow during summer or fall, requeening should be done as soon as possible at the close of the flow.

APIARY WORK FOR JULY.

During the latter part of June and the first of this month there is a honey-dearth in most locations in the South, and there is not much apiary to do; but in sections where the flow begins during this month, every thing should be in readiness for it; but it is not so much trouble to get the bees in proper shape for it, as the weather is warm and no setbacks from cold snaps such as we have in early spring. All colonies with young prolific queens and plenty of stores should be strong, and ready for honey-saving. The "weaklings" can be easily bought up as we bring them up in spring. During the latter part of this month the flow from cotton will start; and in all cotton locations, bees and the proper storing room should be ready for it.

APIARY WORK FOR AUGUST.

Summer and fall honey-flows are not in "jerks," as are spring flows, but slow and long in duration in most sections, and not so much swarming to look after and rushing apiary work to do; and we can and should give our bees better attention during this month. If there is a lot of honey capped in the hives, don't be in any rush to extract it, for usually our summer and fall honey is inferior to the honey secreted in spring; and the longer it is left with the bees the better it is. Comb honey should be removed as soon as it is well capped, for at this season it will get travel-stained faster than it will in spring.

APIARY WORK FOR SEPTEMBER.

In most locations the honey-flow will slack up during this month, and it is the best time during the season to requeen and make increase (see "Increase and Requeening"). The weather is still warm, and some honey and pollen are coming in. The apiarist has more leisure time; also, at this time there is always a large number of drones in the apiary; and, in fact, it is the best all-around time to requeen and make increase, and it should be done by all means. During the latter part of this month honey can be removed when the flow is over.

APIARY WORK FOR OCTOBER.

All surplus honey should be removed and rushed on the market during this month, for it will soon granulate; and bees should be properly and snugly put up for winter (see "Wintering Bees"). This is our last busy month in the apiary, and we should be able to look back over the preceding ones with but few if any regrets; but if we have made blunders we should mark them and overcome them next season; and if we have learned anything, impart it to other bee-keepers.

APIARY WORK FOR NOVEMBER.

As apiary work includes the work we do in our honey-houses and work-shops, all supers, sections, section-holders, separators, frames, etc.,

should be cleaned up, or the propolis removed from them by scraping them with a knife or scraper; then stack them up nicely in the shop.

APIARY WORK FOR DECEMBER.

This month is a good time to look up and do the repair work in the apiary. If the hive-stands will not last another season they should be replaced by new ones; or if the old ones need overhauling it should be done. If the bottoms, tops, or any parts of the hives need overhauling or to be supplied with new parts, the work should be done now, so that it can be painted next month. All hives should be raked around and cleared of rubbish, so that if fire were to get out it would not destroy the apiary; and it is a good time to plant vines or trees to shade the apiary.

Now, dear reader, I have touched here and there on seasonable apiary work, or, in other words, outlined it; but a deeper and clearer insight to it can be obtained by familiarizing yourself with what is said under other heads, such as "Hive Manipulation," "Bee Culture," "Queen Rearing," "Wintering Bees," etc.

APIARY SYSTEM.

Bee-keeping is a business or a profession, and should have a business consideration, and some system adopted, even if it is pursued only on a small scale. Every bee-keeper, large or small, should have a record-book for his apiary; and whatever has been expended on the bees should be placed against them, and the return from them should be placed to their credit, so that, at the end of each season, we can see the results of the apiary. Many pounds and panfuls of honey have been removed from our hives, and not placed to the credit of our bees, and many chunks of the desired and wholesome sweet have been eaten about the apiaries, and the industrious bees have received no credit for it.

Every colony in the apiary should be numbered, and a record kept of each one—the number of swarms it has cast, and the amount of surplus honey that has been removed from each season; and if it has not furnished any surplus honey, give it a blank and cultivate it more and better next season, that it may make a good record. Also, in the record of each hive should be kept the age of the queen and her progeny, etc., so that we may not carry her over one season too long, and thereby lose a surplus of honey from the colony that season. Give every colony a good queen and every queen a good chance, and the apiary record will be an interesting one. Apiary work is many times done too late, and sometimes done too soon; so it is very necessary that it be done at the right time, or loss will be the result. We should take a look through every colony every two weeks at least during the bees' busy season, for often a colony in a

prosperous condition will suddenly need attention; and if it does not receive it, it will start backward. A queen may fail during the height of her egg-laying, especially if she is old. I have seen very prolific queens all at once cease laying fertile eggs and fill the comb with unfertile ones, and soon the hive would be full of drones and the colony in a hopeless condition. Sometimes bees will clog the brood-nest with honey, and crowd the queen out, and soon the number of bees is greatly diminished; especially will they do this if they get crowded for room to store honey. Hence it is necessary that we look over our apiary at least every two weeks during warm weather, and supply the needs of our bees; and if there are any hives which need attention sooner than two weeks it should be set down in the hive-record book the day the visit should be made, and what is to be done, etc.; then all we have to do is to refer to the record-book, and treat the colonies that need attention, and not molest those which do not need it. A bee-keeper will not advance far in bee culture before he will learn that there is much apiary work to be done at certain times and days or the result will be a great loss. Suppose a queen is laying 2,000 eggs a day, and then fails, and the colony loses the use of her for four or five days: the result is a heavy loss. Then suppose we have a batch of queen-cells that need grafting, or a batch of ripe cells to be removed and distributed on a certain day. If we fail to get around, the result is a loss.

Again, suppose there is a sudden change in the honey-flow and it is very heavy, and the bees are not supplied with the proper room: the result is a loss. So systematic bee-keeping is the best and safest way to keep bees.

Hives should be arranged in the apiary to suit the convenience of the apiarist as much as possible. He should stand at the back or on either side of the hive while examining it, and never in front of it. Hives should never be arranged in front of each other closer than six or eight feet, and further is better, so that, while looking through one colony, other colonies will not be molested; and these should be arranged in pairs, or two set about 18 inches apart, so the apiarist can work or pass around them; and one hive can be used to set the smoker on, or to lay the hive-tool and other things on while doing work in the other hive.

Hives should be arranged in pairs and rows, and never scattered promiscuously, for it is better in appearance, and the bees can mark and find their own hives better; and it is more convenient for the apiarist. Where an apiary is located under natural shade the hives should be arranged so as to get the benefit of the shade as much as possible, and at the same time arrange them in pairs and in rows if possible. Apiaries should never be located in thickets, for it will obstruct the flight of the bees. Small bushy trees, scattered somewhat, furnish the best natural shade for an apiary.

The rows of hives should run southwest and northeast, so that the hives will face toward the southeast, which arrangement seems to be best, for the bees will get the benefit of the morning sun; then should the sun

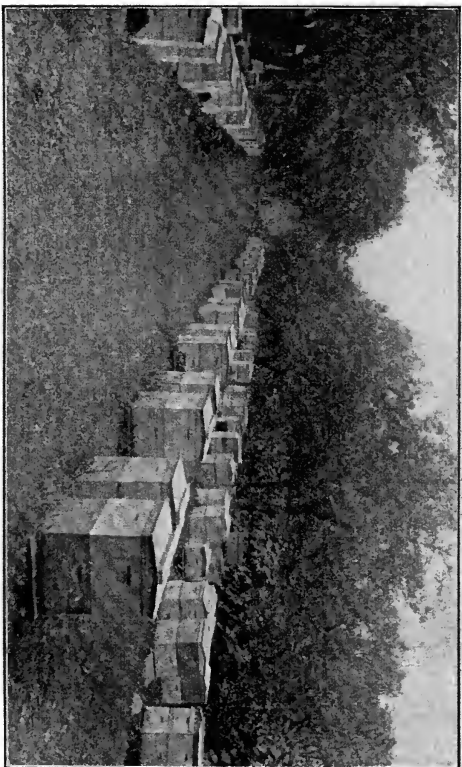

A Neatly-arranged Apiary.

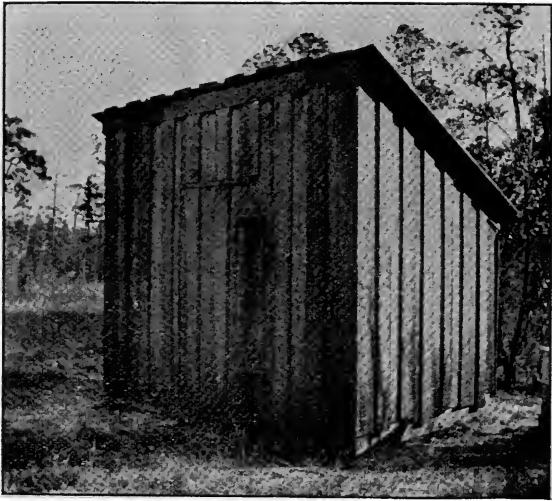

A Serviceable Honey-house—see page 86.

strike the hives in the afternoon the hives will shade the entrances, and the sun will shine more directly on the back of the hives than the sides, and there will be less danger of the comb melting down. Hives should be arranged on their stands so that they will be $\frac{3}{8}$ or $\frac{1}{2}$ inch higher at the back than the front, so that water will drain out and not stand puddled on the bottoms, which would soon cause them to rot, and at the same time be very detrimental to the bees. But the hives should stand level on the stands the other way, or the bees will not build the comb straight in their frames.

MOVING BEES.

Moving bees is dangerous work, and the safest time to do so is at night, when they can not see to fly and sting; but they can be moved at any time if they are properly prepared.

If bees are to be moved only a short distance, move them about one foot each day until they are located. By moving them this way no field-bees are lost; for after bees once mark their location they will return to it; and if their hive has been moved they are lost and will wander around and perish, or try to get in some other hive, and be killed; but when it has been moved only a few inches they will find it and not be lost. If the hives are moved at night only a few steps the bees are not aware that they have been moved, and next morning they will come out and go to the field just as they have been doing; and, of course, they will return to the old location and be lost. But bees can be moved successfully a short distance during very cold weather when they have been confined in their hives for several days; but a handful of grass or weeds should be placed over the entrance so that the bees would have to crawl out through it and thus cause them to mark their new location, and, of course, if this is done during the busy season it will be a hindrance to them, and many would be lost too; and we must not forget that hive bees are valuable, especially in the busy season.

If it is desired to move bees some distance during winter, all that is necessary to assure safety to bees and stock is to fasten the covers and bottoms on the hives well and see that there are no openings where the bees can escape, then tack a strip of gauze wire over the entrance so no bees can escape, but at the same time enable them to get air. As soon as the bees discover that they are shut up they will all begin to try to effect an escape; and by this effort they will shut the circulation of the air out of the hive, and soon the temperature will be so high in it that the comb melts and the bees are drowned and smothered to death, and so the bees, honey, and comb will be lost. If bees are to be moved during warm weather, prepare them in the same manner, but cover the entire top of the hives with gauze wire, so that they can have plenty of fresh air,

or they will melt the comb down in a few minutes; and even then they must be shaded while on the wagon, to be sure of their safety.

If old-style box hives are to be moved, set them on burlap sacks, pulling them up on the sides of the hives until they are tight over the bottom of the hives, and nail strips on each side of the hives over the sacks about six inches from the bottoms. These strips will hold the sacks to the hives; then nail the tops on well and see that there are no places about the hives where they can escape, and lay them on their sides on the wagon, and the bees will be safe, for they can get plenty of fresh air through the sacks.

If an accident should happen on the road, or the bees effect an escape, the team should be removed from the wagon as soon as possible.

THE STING OF BEES.

We have now come to the bitter part of bee-keeping, for all dread the sting of bees; and for this reason bee-keeping has not made the progress it should, for many will not keep bees for that reason, and many have killed their bees because they would sting, and a great number have sold them for the same reason.

The sting of the bee is the greatest if not the only objection to its cultivation; but should it be an objection, or a thing in favor of its cultivation? I claim that its weapon of defense is a great thing in favor of its cultivation, and it could hardly be cultivated without it; for the Creator certainly did not make any mistake when he gave it a sting, and the knowledge to use it as it does.

Honey as food is considered a luxury by the majority of people, and it can not be obtained in all sections and at all times; and colonies of bees could not stand around unmolested if the bees did not have some way to defend their hives; and if there were no honey in the hives, the intruders would unnecessarily molest them and cause the keeper of the bees a loss.

There are many reasons why the sting of the bees should not affect its cultivation; and enduring a little pain now and then is no great objection to their cultivation. It is possible, but not practicable to keep bees and never get stung while molesting or working among them, by the use of veils and gloves, and keeping them well subdued with smoke.

The pain of bee-stings is soon easy to endure, and not so much to be dreaded, for we get used to them, and endure them about as the old ox does the lash.

The sting of the bee has barbs similar to those on fish-hooks; so when it inserts it into the flesh it is unable to remove it, and tears itself from it; and when it is removed the tiny barbs will pull through the flesh or break off and remain there. I have been stung many times, when the sting

was inserted in my flesh so deep that I would have to remove it with the sharp point of my knife; then many times they would break off and be so deep in my flesh that I could hardly remove them. The stings that are inserted deep into the tender portions of the flesh are the ones that give the most pain. While the sharp end of the sting is being inserted in the flesh, there is a tiny sac of poison at the other end emptying its contents around the sting and penetrating the flesh. The sooner the sting is removed, the less of this poison gets into the flesh, and the less painful the sting will be; but if it is removed by catching it between the fingers all the poison will be squeezed out of the sac into the wound made by the sting, and, of course, it will be more painful than if it were removed with a knife or scraped off against the corner of the hive so that the poison would not get into the wound made by the sting any more than possible.

As yet there has been no remedy discovered that will kill the effect of bee-stings; and the best we can do is to avoid as many of them as possible, and, when stung, remove them in the best and quickest way possible. Bees do not always sting as soon as they alight; and if they are given a quick mash, many painful stings may be avoided. If one alights on your hand or arm, dislodge it at once by giving your hand a quick jerk, or sling, and many stings will thus be saved.

By watching the bees closely you can tell when their intentions are to sting you, and they should be thoroughly subdued before they are further molested.

If a bee is slightly pressed it will endeavor to try to release itself by stinging the object pressing it; and while handling bees they should not be pressed or mashed.

It is a well-known fact that bees have stings and the knowledge to use them whenever they see fit; and if we go about their hives or molest them without using the proper precaution, and get stung, we should endure it as the ox endures the sting of the lash, and consider that it was our fault and not so much the ill will the bees may have for us. While bees consider all living objects about their hives as intruders, yet they do not swarm out on them in an unmerciful manner and sting them because they have stings, and can use them. They give their intruders a chance to move on; but if they remain and disturb them, and the defense of their hives and contents is forced upon them, naturally they will sting. I have been stung by bees thousands of times, but I do not lay one sting to their charge, for I have been an unmerciful intruder many times.

ENEMIES OF BEES.

The enemies of honey-bees are many, and every apiary in the South is infested by them more or less. Fowls and insects of various kinds to some extent depend on the apiaries for their daily food at certain times of the year, and more so than the majority of the bee-keepers may sup-

pose. The question is often asked, "Why is it that my apiaries are so hard to build up in early spring? The brood-nests are large and well filled, but the old bees seem to disappear in great numbers."

If you will go out in the forest under the trees where the bees are working upon the blossoms you will at once locate the trouble by seeing birds of various kinds flying about over and through the tree-tops, sitting on the boughs, devouring bees in great numbers. If you are not satisfied from what you can see from the ground, climb up into the tops of the trees where the slaughter is taking place, and you will see the birds seizing the bees by the waist, and, with a quick stroke against the limbs, the bees' abdomens are removed and fall to the ground, and their waists are swallowed. This will be done so constantly by the same bird that their depredations upon the bees will be found to be very great. The birds will catch the bees near the end of the bill, so there will be no chance for them to sting them; but the helpless bees will twist around in their bills and try to sting themselves loose; but their abdomens are quickly removed, and then they make a sweet morsel for the hungry birds. I have sat in tree-tops many times and watched the destruction of my bees going on, and wished that I could come to their assistance; but the multitude of their enemies was so great that it was impossible. I have seen these birds flock into my apiaries in spring during a cool spell, so that the bees could not get out in the field, and kill so many of the bees before I was aware of it that the covers on the hives would be nearly covered with their abdomens, and piles of them would be lying on the alighting-boards. I have killed these birds and picked off their feathers and scattered them, birds and all, on the covers, and yet they would catch and eat bees right beside their dead comrades. This depredation will not happen in the apiary if the birds can get them in the forest. While there are many kinds of birds that are enemies of bees, the redbirds seem to be the worst of all. My observation is that they eat more bees than any other birds, and they are numerous all over the South, and wherever they are seen they may be known as the honey-bee's worst enemy. There is a small long white-breasted bird with long bill and gray beak which appears in the South in early spring, and disappears before winter; and it stays mostly in branches of trees, and raises its young there, in nests made of moss, feeding mostly upon insects. These birds (I know no name for them) are great enemies of bees.

Bee-martins, cat-birds, whitter-birds, cow-pea birds (as they are better known), and many others I know no name for get their share of bees.

Insects, such as dragon-flies, ants, spiders, etc., come in for their share of the bees; and mice will eat them when food is scarce. And, lastly, the bee-moth (or wax-moth it should be called) comes then and eats up the comb which they built to live, store honey, and rear the young in, but they will not destroy the comb in strong colonies with prolific queens; for the bees will keep them from making progress in their comb. The old or flying moths may be seen about the hives during warm weather, es-

pecially in summer and fall, depositing their eggs in cracks and crevices about the hives and on the comb too at every opportunity; for they can dart about over the comb where the bees are scattering over it, and keep out of the way in places where the bees can not go, and deposit their eggs all through the hives; but if the colonies are strong, and kept so, the bees will be constantly passing over the comb, and the interior of the hives, removing these eggs or the tiny moths should any of them hatch; but if there are any cracks in the interior of the hives large enough for them to develop in they will do so, especially about the bottoms, where the lodgments may collect, for they will be food to them, and the cracks will be a place of refuge, and the moths will develop in them. Should any colonies become queenless, and remain so for a few weeks, there being no bees raised, and the old ones dying out fast, soon they will be too weak to crawl constantly over their comb, and soon it is unoccupied; and the moths, old and young, are present, and at once begin their destructive work by eating and webbing their way through the comb and rearing their young in great numbers, and soon they will completely destroy the colony; for the combs will be nothing more than a mass of webbs and large fat moths. As seen elsewhere in this book, as soon as a colony of bees loses its queen it is on the road to destruction until it is supplied with another queen; and even then it will be lost if she is not given to the colony in time, or the comb all removed and given to strong colonies, except just enough for them to occupy well. So it will be seen that the moth only hastens the destruction, for ruin is already upon them, and if a colony of bees runs short of stores it will, in like manner, go to destruction because no small amount of honey is consumed in rearing young bees; and if they haven't it they can not raise them; and as the old ones are fast dying the comb will soon become unoccupied around on the outside of the brood-nest, when the moth will take it, and soon the young queen and her bees will be lost because there was no honey in the field which they could gather, nor any in the hive, or it was not supplied with food to raise young bees to keep the hive populated. All colonies are subject to the moth at any time during warm weather, but they can not destroy a single colony in all the South unless the keeper of the bees neglects the duty he owes to his bees. Thousands of colonies are lost in the South every year in this way, and this great loss of bees is laid to the bee-moth when they have done only a very small part of it. Let me advise right here, dear reader, that the cultivation of bees is the most reasonable work that I have any knowledge of. It is necessary and advantageous to them; they soon take advantage of the proper care they receive, and adhere to it as long as they can. Take a colony of bees that, for some cause beyond its power, has run short of stores, with no honey anywhere that they can gather, and on the way to destruction, will cease rearing brood except, perhaps, a very small batch, and it scrimps along, thinking perhaps that something will happen for its betterment. Now feed them and note results. They will at once begin to feed their small, dried-up, half-dead queen, and soon she will be large, and her abdomen extend to its fullest

capacity with fertile eggs which are being deposited in the cells over the comb in great numbers, and young bees are soon seen in all stages of development, the colony in a prosperous condition again, and the moth (the bees' ever present enemy) is kept off, and destruction is delayed. The more prolific varieties of bees will keep their comb rid of moth better and longer than the less prolific varieties.

The best way to keep rid of the moth is to keep the colonies all strong, and not leave any comb out of the care of the bees, for the moth will take to very small pieces of comb left out, and, of course, if they raise in it the number of moths will be increased that much. If a frame of comb should be carelessly left exposed to the moths, or allowed in any way to get moth, it is given to a strong colony, when the bees will rid it of moth in a short time; but to do this they have to tear the comb out from around them, and therefore they will leave the comb looking ragged; and if it is very moth, it will be very ragged after the bees clean it up, and unfit to be used as a comb; but it can be rendered into wax. The moth, as it eats its way through the comb, builds webbed passages to protect itself from the bees, and they have to tear the comb down from around the webbed passages before the moth can be removed.

The bee-moth is a very small or insignificant enemy of the honey-bee in well-cared-for apiaries. The honey-bee has another great enemy which it seems to recognize at once but man does not. This enemy is in the shape of a human which calls himself a bee-keeper, but who is a bitter enemy of the blessed little honey-bee. Many and many a dishpan and bread-tray full of honey have been removed from their hives, and eaten by people who were not worthy of it. Many strong colonies have starved to death because an unworthy hand removed all the honey they had stored to subsist on. Sulphur in the hands of brutish keepers has killed thousands of colonies. In many other ways man has proved himself a very active enemy of the little bees which were sent among us for us to cultivate and make our land more fruitful, and to save honey, Heaven's sent food, for us.

DISEASES OF BEES.

Very, fortunately the bee family is not diseased to any great extent; but it is subject to disease if proper precautions are not used to prevent it. In most sections of the South, cane-growing is a great industry among the farmers, and each settlement has from one to six syrup-mills in it, and along late in the fall they are all put in operation; and if the weather is warm the bees will take to them in great numbers and carry to their hives some amount of the inferior sweet which they can gather up around such places. This is stored in the comb, and not sealed; and by spring it will

be fermented; and, being uncapped, and nearer around the brood-nest, the bees will consume it first; and the weather being changeable, and the bees confined to their hives a few days, it will give them the dysentery, and they will die off in great numbers right at a time of the season when they are mostly needed. Their abdomens will become swollen to their full capacity, and it will affect them as if they had paralysis, and they will shake as if they had palsy until they are dead. I have had strong colonies die from this disease, and many to weaken down to mere nuclei from the effect of it. When bees take to these cane-mills, the best thing to do is to resort to slow outside feeding during the middle of the warm days; then if they get a little of the inferior sweet it will be mixed with the feed, and there will be no bad effect from it. Besides, they are destroyed in great numbers around these cane-mills, and are a nuisance to the syrup-makers, and may cause trouble, when feeding will draw them away.

There is a contagious disease known as foul brood which affects and kills the young bees while they are developing; but this disease is not prevalent in the South. I have never seen a hive affected with it and have heard of but a few apiaries that had been affected with it. Then the apiarist claimed that it was introduced to them by picking up, at random, bargains in cheap honey which was fed to the bees. It has also been reported that foul brood has been introduced into some apiaries with queens or nuclei brought abroad. If proper precautions are used this contagious disease can be kept from bees. While there is a loss more or less of young bees in all stages of development, in many apiaries in the South, yet it is not always owing to disease, but to the source of feed, for there are certain plants that yield a little nectar or pollen which seems to poison the young bees, and they die rapidly for a short time, but soon it is all over, and no more symptoms appear until about the same time next season. This loss of bees is usually small, and not of enough consequence for treatment.

FEEDING BEES.

Feeding bees is the safety-valve to bee-keeping. Nothing can be more essential in bee-keeping than feeding when necessary. Why is it that thousands of colonies of bees die each season, and hundreds of apiaries pass out of existence each year, and so many hives are light at robbing-time? Because the bees have not been fed.

If bees are not to be fed when necessary they need no good hives, and surely no cultivation. Perhaps the honey-bee gives to the world the greatest lesson in economy; and the reason they run short of stores, and perish, is not because they are extravagant, but because something has befallen them that was beyond their control, for they will lay aside a supply of food, if possible, to tide them over in the future.

It is explained elsewhere that, if bees are neglected, they may dwindle down and not be in condition to store up a supply of honey for future

use; and bees are depending on certain plants that bloom at certain times of the year for their supply of food, and this plant is also depending on weather conditions to secrete honey. Suppose the weather conditions are not favorable, and little or no honey is the result; then the bees may starve. Bees should not be fed unless they need it; and even then it should be done in season, for, if fed too much, they will fill the brood-nest with it and crowd the queen out. The portion of comb around the brood-nest, where the bees usually keep their ready supply of stores, should never be allowed to become empty; for if it does, some loss will be the result. Even when the bees go into the honey-flow they should have this amount of stores, so that the new honey may go into the supers. Let me emphasize this point, dear reader, keep this rim of stores around the brood-nests. Don't think that, when bees are fed, they will waste the feed, for they will at the proper time turn it into bees that will gather honey, or utilize it to the best possible advantage. A great lesson in economy is given to us by the honey-bees.

I know nothing better to feed bees in than feeders sent out by the bee-supply manufacturers. They are simple, cheap, and durable, and no progressive apiary should be without them.

There is no feeder better to build up nuclei with than the Doolittle division-board feeder. It rests in the hive like a frame, and can be used in place of a division-board, and placed close to the outside frame, the feed is handy to the bees, and the heat of them will keep it warm, which is a great help to the bees in removing and utilizing it. This style of feeder is also good and handy to feed full colonies in, as it can be set in the hive next to the outside, and it will not be necessary to remove the cover more than two inches to fill the feeder, and will disturb the bees but little.

If heavy feeding is to be done, there is no feeder more convenient for the bees and the apiarist than the Miller feeder, which is set on top of the brood-frames in a super. It holds 15 or 20 pounds of feed.

If no feeders are bought to feed the bees in, tin pans about two inches high, 10 or 11 wide, make very good feeders; but they must be filled with straw or hay, or the bees will get into the syrup and drown. These pans of straw are set on the brood-frames in empty supers, and filled with feed; but in refilling the pans the bees should be smoked out of them, as many which are down in the straw after feed will be drowned when more feed is added.

In feeding nuclei, the pans should be smaller, and rest right over the cluster of bees on the brood-frames in empty supers; but these empty supers contain too much space for the small cluster of bees to keep at the proper temperature, so a few sticks should be laid across the pans, and sacks folded up and placed over them and the brood-frames so as to give them as condensed a space to keep warm as possible. The sticks across the pans will hold the sacks up so that the bees can easily get to the feed. If full colonies were to be fed in this way during cool weather it

would be necessary to use sacks or some kind of cloth to condense the space in the supers. It must be remembered that bees have to keep the temperature up in their hives during cold or cool weather in order to exist; therefore the more we help them do this, the better it is for them, and the less food they have to consume to do it.

There are two objects in feeding bees. One is to avert their starvation, and the other is to stimulate them and cause them to spread their brood more rapidly than they otherwise would. But this is not necessary in the South, for the early honey-plants will do this except, perhaps, in a few sections where they have no early pollen or honey-plants.

Some bee-keepers practice outdoor or wholesale feeding by placing the feed out where all the bees have access to it. This is a good plan where all bees need feeding, or where it is desired to feed them to stimulate them; otherwise it might not be good practice, for some colonies will get too much feed, and crowd the brood-nest with it, and if colonies have plenty of stores they should not be fed. So by feeding them in the hives we can feed the colonies which need it, and stop as soon as they have been fed enough. If wholesale feeding is done, it should be during the middle of the day and not when the weather is cool, or the bees may be chilled and many of them lost. Such feeding is likely to excite robbing, while feeding them in their hives late in the evening will not excite robbing, and there can be no better or safer way to feed bees; and, besides, you have the consolation of knowing that your own bees get all the feed, and that you are not feeding your neighbors' bees as you would be sure to do in outdoor feeding.

Before feeding weak colonies the entrances should be contracted so that only one or two bees can pass at a time; then feed late in the afternoon, and there will be no danger of robbing. Also the covers on the hives of colonies fed should fit down well all around, for such an opening is the best place around hives for robbers to collect and rob out the weaker colonies.

Bees should never be fed anything but honey or syrup made of equal parts of granulated sugar and water. Stir the sugar until it is well dissolved, and it will be a thick clear syrup, ready to be poured into the feeders. There can be no better feed for bees than this syrup; and, in fact, it is preferred to honey.

Never feed bees common cane syrup; for, as long as there is any in the comb, it will give you trouble. I have tried it to my sorrow. I have also tried a syrup made of light-brown sugar, and the sugar made of the common cane; but results were not satisfactory, for, when the bees fed on it were confined to their hives for a few days by a cold snap they were threatened with dysentery. So the best feed is none too good.

OUR BEE PASTURE.

The idea that bees gather honey nearly the entire year prevails among the public or those less experienced in bee culture. They know that bees gather honey from blossoms; and at times of the year when the forest is full of bloom it is natural for them to think that the hives are being filled with new honey. These natural ideas are false ones; for at times of the year, and especially in early spring, when the forest is illuminated with blossoms of various kinds and colors, bees may starve to death during this seemingly good honey time. The blossoms are dry (destitute of honey), and the plants that are in bloom are not honey-plants.

Bees may gather a small amount of honey at various times; but only a few days in the year do they gather it in large quantities, as only a few blossoms of the blooming forest secrete honey, and these few particular trees, bushes, and weeds that come in bloom at various times of the year which our bees may gather some honey or pollen from are what we call our pollen and honey-plants, and these compose our bee-pasture.

While bees may gather only pollen, and may be a little nectar (raw or unevaporated honey) from some of these plants, they are a great help. It stimulates them, and causes them to spread their brood and be great in number of bees when our great honey-plants come in bloom.

These plants that furnish pollen and a small amount of honey for our bees to build up on are called our lesser honey-plants; and those that our bees gather a surplus of honey from are called our greater honey-plants. If we have high cool winds or a rainy season, or a cool spell while these particular plants are in bloom, the result is a honey failure, whence comes the uncertainties of bee-keeping, because such weather conditions waste the nectar, should the honey-plants secrete any during such unfavorable conditions; and, besides, bees can not get out in the field during such weather. But if the weather is calm, warm, and sunny during the blooming of the greater honey-plants, a large crop of honey will be the result if the bees are in proper condition. A dry warm season is apt to be a good honey season, and a cold wet season a poor one. Because bees are flying in and out of their hives briskly is no sign that they are gathering honey, for they will do this whenever the weather is warm enough for them to fly, perhaps searching for honey or pollen. Then to see them prying around on blossoms is no sure indication that they are gathering honey from them, for they may be only searching for it; but when the honey-plants come in bloom the bees will take to their blossoms and will be seen tumbling about the entrance of the hives, loaded with honey. Then to be sure that they are gathering honey, lift out a few frames in some strong colony and jar them a little; and if there is new honey in the comb it will drop out; and whatever blossoms the bees are seen on mostly are secreting the honey, and the plant that is blooming is a honey-plant. It is interesting to roam the forest and study our bee pasture and the relations that exist between bees and plants, how they are dependent on each other, and that they sleep together in the winter and awaken together in early spring; for as soon as the first buds

begin to swell with new sap the bees are present on them, and so they thrive together during spring, summer, and autumn, and again rest together in winter. And it is interesting to note the condition the earth or soil is in when honey-plants are secreting honey. It is also interesting to note the atmospheric conditions under which the honey-plants secrete their nectar, sparingly or heavily.

Our bee-pasture is an interesting subject, and studying and learning it is very essential to successful bee-keeping; and every bee-keeper should master as nearly as possible, the sources, of honey and pollen in his location, and note the times during the season when these particular plants begin to bloom, the duration of their blooming, and the amount of pollen and honey the bees usually secure from them, etc., in order that he may operate his apiary accordingly, have his bees built up to a honey-gathering condition by the time the honey-plants begin to bloom, and to have them supplied with proper room. While Mother Earth has blessed some sections and localities with more honey-plants than others, yet there are but few localities in the South that will not justify beekeeping if they are the right kind of bees, and receive the proper culture.

An inferior run-down race or strain of bees will make a poor location anywhere. I remember that back in my earlier bee-keeping days, the queen-breeders often mailed me price lists of their queens, and I also saw them advertised in bee journals, but thought they just wanted to speculate on me; but finally I did place an order for a few, and introduced them to colonies around in the apiary in early spring. I did not get any more honey from them during the spring flow, but they swarmed not a little. At the end of the spring flow I put the supers back on all hives, and got busy at something else; and when I went back in the fall to remove the supers and look over the apiary I found to my great surprise the supers on the hives where I had introduced the queens, and the supers on the hives I had put new swarms in, all full of capped honey. I removed these heavy supers and examined the brood-apartments, and found them full of sealed honey, and the queens nearly crowded out. I distributed the most of this honey around in the apiary, for the old race of bees was nearly on the point of starvation, while the new race was heavy with stores and had a large surplus, the source of which I did not know at that time, but found out the next season that it was mostly from the cotton-plant; and I have been obtaining a good surplus from this source each season since, from the prolific varieties of bees.

Dear reader, I mention this to help establish the fact that you do not know the value of your section as a honey location until you have tried it with prolific bees. The idea of poor locations without ever testing them has burdened bee-keeping in the South. There is a wrong prevailing idea about bee pasture among those less experienced in bee culture; and that is, that they should plant something for their bees to gather honey

from. Let us keep prolific bees to save the honey that is already secreted and wasted in our bee-pastures before we plant anything for them.

Clover can be planted, in sections where it grows, for its forage and honey.

Wherever cotton is grown in the South it will not be necessary to plant anything for our bee-pasture; and, very fortunately, it is extensively grown nearly all over the South; but, very unfortunately, its great value as a honey-plant is not well known.

ECONOMY IN BEE-KEEPING:

Economy in bee-keeping is what the beginner and the outsider may call extravagance; but, so far as I know and can learn, extravagance has never been practiced on bees in the South; but I know economy has, and its effect is well known. The prevailing idea among the majority of bee-keepers now is, "Why should I buy a bee-smoker, and bee-veil, and pay \$1.75 or \$2.00 for a patent hive to put my bees in when I can hive them in an old-style box hive or drygoods-box, and they will build comb and store honey in it?" Yes, and they will store just as much honey in it as they will in a modern hive if they are just hived and robbed once or twice a year so long as they exist; but this is not economy in bee-keeping, but it is extravagance to let large vigorous swarms of bees dwindle down and finally be lost when there is so much honey going to waste each season which can and should be saved.

Economy in bee-keeping is giving the bees the very best possible chance by keeping them in good hives in good condition, which can be done by constant and proper care. Even where modern hives are adopted or used, there is often too much so-called economy practiced. This is true in the use of foundation, for it is too often used too sparingly. Very narrow strips of it used in the sections and brood-frames are not enough inducement or help to the bees in their work; and right here is where a lot of dissatisfaction arises in the use of modern hives. As stated, the narrow strip of foundation is not enough inducement to get the bees to go up into the top stories and build comb in sections and frames in which to store their honey. By all means the sections and frames should be well filled with foundation to expect the best results. Even in the brood-apartments or bottom stories it pays to use full sheets of foundation in the long run; but it is not necessary where bees are allowed to swarm naturally, for large vigorous swarms will quickly build a set of nice comb in the brood-chamber; but where artificial increase is made, full sheets of foundation are very necessary. Then in equipping our apiaries after modern hives have been adopted and bought it is economy to buy the best modern implements. It is not economy to make hives which we think would be just as good as modern factory-made hives, for the best hives we can buy are none too good.

SWARMING.

Every living thing has some way of multiplying or reproducing its kind, and swarming is the way the honey-bees have extended their species from year to year. It is imbedded in their instinct to do so, and they may at any time when things look favorable to them, for they certainly have a desire to do so which can never be removed from them. But conditions can be brought about that will greatly lessen swarming, though they desire to, yet conditions do not seem favorable to them to do so. Our earliest pollen-plants will begin to bloom in January, and the bees will begin to rear young; and along in February they will have a large batch of young bees in all stages of development; and during March some honey will be coming; and usually we have some warm days and nights, and the bees will spread their brood rapidly, and by the first of April the brood-nest is full of young bees, and is kept this way until the first heavy honey-flow begins; and by this time the hive should be boiling over with bees, and will at once begin to make preparation to swarm by starting queen-cells; and if there are any old ones about over the comb the queen will lay eggs in them; and by the time the honey-flow is well on, the bees may begin to swarm, because conditions are favorable, there being plenty of honey in the fields, and a good supply in the hive, and plenty of old and young bees, and all things appear in a prosperous condition to them; and the young queens in the cells (one of which is to be the mother of the colony) are fast developing. It is natural then to suppose they may swarm.

Some time during this period they will come to an understanding in regard to the matter, and cease feeding their queen so highly, so she will slack up egg-laying and be able to fly and go out with the swarm. Then some time during the first warm sunny day they will boil out of the hive in an excited manner and the old queen with them, leaving a portion of the bees with the old colony to keep it in a thriving condition. The great army of bees are soon out, making a heavy roaring noise, and after flying in a circling manner for a few minutes they will settle on some object. Sometimes they do not settle at all, but soon are off, going in a straight direction to their future place of abode, which they have previously picked out. But this does not often happen, for they generally settle first, and sometimes they remain settled but a few minutes, and take to parts unknown. I do not know that all swarms that issue have a future abiding-place picked out; but it is sure that some of them do, and it is also true that all swarms take some steps in this direction. for they send out certain bees to rove the forest for a hollow. Sometimes a swarm will remain on the settling-place for two or three days, but usually they will remain there only a few hours or over one night.

Sometimes bees will naturally swarm excessively, and but little if any surplus honey will be the result; but it should not be allowed unless increase is desired. The cause of so much swarming is due to the fact that the bees haven't the proper room to store their surplus honey, and this can be overcome to a great extent by supplying them this needed room.

Swarms of bees should be hived as soon as they settle well; therefore it is very necessary to have the hives in readiness; and, besides, it is a nerv-

ous job to fix up hives when there are large swarms of bees hanging about the apiary. Other swarms also may issue or come out and settle on them, and give you a whole lot of trouble in dividing them.

Settled swarms of bees should be handled or removed from their settling place as gently as possible. A swarm-catcher is a good device for this purpose (see "Apiarian Implements"), or a tin can may be used; or if they settle on a small limb it can be sawed off and the bees dislodged gently in front of the hive.

In preparing hives for natural swarms a few should be prepared with full sheets of foundation in the brood-frames, and all small swarms hived in them; but all the large swarms can be hived on starters, as they are prepared for comb-building, and will soon build them a set of good combs, while the small swarms are not so well prepared to build comb; and, if not given full sheets of foundation, they may build a poor set of combs; and, besides, they need this great help.

When a colony of bees swarms, the most of the vigor or strength of it goes out with the swarm, therefore it will not recover from this great loss, perhaps, until the next honey-flow; and to get the best results from the new swarm, remove the old hive which swarmed, and set the newly hived swarm in its place as soon as the bees are in it. The field force will come from the old hive back to the same location, and increase its force; and in two or three days after the new swarm has been hived give them a super; for, if the weather is favorable, by this time they will have nearly a full set of combs built in the brood-apartment, and nearly filled with brood and honey, when they will soon enter the super, building comb and storing honey.

It is natural to suppose that, when bees swarm, they are expecting to search and find them another abiding-place and go to it, and that they are not expecting to be supplied and put in it; and, as they have a wonderful instinct, they may decide that it will be removed from them, and that they had better go to the forest for a home, where their instinct leads them. So they may come out and leave, although they were gently put into a well-prepared hive. But a well-prepared hive (containing full sheets of foundation, etc.), will greatly lessen the number of absconding swarms. As soon as a swarm begins to issue, if you will go to some colony and get out one frame containing eggs and very young tiny bees, and insert it in the middle of the hive you have prepared for the new swarm, when hived they will not leave the brood. If the frame is removed from another colony which has been hived but a few days it will be new, tender, and contain no sealed brood, but some new honey scattered around in the cells, and lots of eggs and tiny bees; and it matters not if the comb is not built down near the bottom-bar nor the cell built out. This is an ideal comb, and you may be sure your new swarm will not leave it.

NATURAL SWARMING.

Natural increase is nature's way of increasing the number of swarms, and is the best way for a bee-keeper to increase the number of his colonies until he is advanced in bee culture and knows what he is doing when he

begins to tear up his strong and vigorous colonies of bees; for it would require constant and intelligent attention, and heavy feeding would have to be resorted to, if any surplus honey could be expected from them; for it must be remembered that all increase is made at the expense of the honey crop.

If a bee-keeper will practice natural increase, and give his bees the necessary attention, and lose no colonies, by neglect, his bee business will soon be running over him, and he will have bees to sell if he does not care to spread his business out over the country. Besides, he will save large crops of honey in good seasons.

Of course, where natural swarming is practiced the apiaries require close attention during swarming time, which is only a short time each year, and only through the middle of each day.

By keeping the colonies strong and giving them only a limited amount of storing room, they will naturally swarm more than they otherwise would. If only a very moderate natural increase is desired, give the bees ample storing room, and elevate the hives from the bottom-board about $\frac{1}{4}$ inch all around. This will give the bees more ventilation, and lessen their desire to swarm; but hives should not be ventilated until the bees begin to lie out on the front of the hive.

There is another way to have only a moderate natural increase from the bees; and that is, to run some colonies for extracted honey, some for comb, and some for chunk honey. So natural increase can be governed nearly to suit any bee-keeper, and it is a good and safe way for the amateur bee-keeper to increase the size of his apiary, and he at the same time will obtain satisfactory results in honey and bees.

ARTIFICIAL SWARMING.

Artificial increase is man's way of swarming bees. If a bee-keeper has plenty of young prolific queens available, and does not mind the expense of feeding his bees, he can do wonders along the line of increasing his bees artificially if at the same time he does not mind to hustle. There are many ways to do this; but I must stay on the economic side of bee-keeping and let the bees pay their way as they increase, and not swarm nor increase them excessively, for it is unwise and imprudent to do it for pleasure or money; for we should be satisfied with a reasonable amount of increase. In most sections in the South we have light honey-flows during the season, and in some sections the main flow comes in early spring, and other sections during summer; and it comes during fall in some sections. We should not let our artificial increase interfere with the main honey-flow any more than possible; and if it comes in early spring, make the increase after the flow, for there will be light honey-flows to follow, and if it comes in summer or fall, make the desired increase as early in the spring as possible.

If the main honey-flow comes in spring, keep all the bees together and save as much honey as possible; and as soon as you get it on the market, turn your attention to the increase by first preparing an extra hive for each strong colony, using full sheets of foundation in brood-frames; or if you

are running for extracted honey you can use the ready-built combs in the top stories, and have another set built next season. The prepared hives should be set on top of the strong colonies, or the ones you desire to divide, as soon as they are completed; for you might have an unexpected honey-flow and they would start to work drawing out the foundation. There is apt to be enough honey coming in to start the strongest colonies at this work any way.

After this has been done, turn your attention to queen-rearing; and by the time the summer honey-flow from cotton, sumac, and other summer honey-plants is coming to a close, have a batch of young prolific queens laying, or one for each increase you wish to make, and a few extra ones. Of course, the queens are raised during the long slow honey-flow, and should be as good as can be raised; and during this flow the strong colonies will be building a set of combs in these extra top stories and filling them with honey, which is generally of a poor grade, and to turn it into bees is the best thing that can be done with it.

At the close of the flow, when there is yet a little honey coming in, remove the top stories and set them on the bottom beside the same hive, and divide the comb, brood, old bees, and honey up between them, and give the colony which has no queen one of the young laying queens you have raised for this purpose, giving her to the bees in a cage, and letting them release her. Do not molest the bees any more for three days; then go through them again, and if the old bees are not equally divided up give the weakest colony the most of the brood from the stronger colony, or change the hives; and if any of them have not accepted their queen give them another one of the extra ones you had on hand. In a few days more make an inspecting-tour again and see that all have queens. Examine them later; and, if any of them are short of bees, give them another frame of brood or change the hives again. During this time there is a slow honey-flow on from fall flowers, and bees will not consume much honey, but will go into winter quarters in good condition. It is a well-known fact that bees will store more honey when they are kept together than when they are divided; so it is best to leave them together until at the close of the flow in order that they may have as much honey as possible when they are put up for winter.

The same results can be obtained in localities where the main honey-flow comes during summer and fall by starting early in the spring to raising a batch of queens and having a set of combs built over each strong colony during the flow which will come along some time in the spring; then you will have time to get the bees in a good condition for the approaching summer or fall flow.

Of course, if the apiary is operated for extracted honey you have the advantage of having the combs ready built.

I have torn up many colonies of bees in various ways and at different times of the season, and fed many pounds of sugar; and I have fallen upon the method I have outlined, and I make a lot of valuable increase in this way each year.

Strong colonies should not be divided more than once, and the weak ones not at all, for they are already struggling.

CONTROLLING SWARMING.

It is very often the case that a bee-keeper has as many colonies as he desires or has time to care for properly, and desires a plan to control the increase of colonies. Then it happens very often that a bee-keeper desires to control swarming that he may obtain more surplus honey; and it is often desired to control swarming in extensive bee-keeping to save the expense of hiring some one to stay at each yard and hive swarms during the swarming season. It is not difficult to control swarming in the production of extracted honey, and all that is necessary is to keep them supplied with empty comb to store honey in.

It is also easy to control swarming in the production of chunk honey by using full sheets of foundation in the supers, and not permitting the super next to the brood apartment to be completely filled before it is lifted up and another empty super put under it; for they will sometimes swarm if the super next to the brood-apartment is full of sealed honey before they will enter the next super, or before they do much work in it; and it is necessary to keep the hives well ventilated at the bottom during warm spells.

In the production of comb honey in sections with the brown German bees, the non-swarming point can soon be reached by raising queens from colonies less inclined to swarm, and keeping the stock pure. They are less prolific, quick to enter sections and store their honey, and all that is necessary is to keep the hives well ventilated during very warm weather, and use full sheets of foundation in the sections; and four or five bait sections (sections with comb partly built in them, or cull sections from last season) in the middle of the super next to the brood-apartment in order to get them started to building comb and storing honey in it.

Permit me to say right here that, to control swarming successfully, we must first remove the drone comb from out-apiaries and replace it with worker comb. Drones are reared with the view of swarming, and certainly they are connected with it in some way. The greatest number of them are always present during swarming time, and more or less drone brood is in the hive when they do swarm. It is also a fact that they take a great part in swarming, and there can be no doubt that they have something to do with it.

Controlling swarming in the production of comb honey in sections, with the more prolific varieties of bees, is a rather knotty problem, and a satisfactory method of doing this has not yet been given to the bee-keeping world so far as I know. I have tried time and again almost every conceivable way by which this might be done, and yet sooner or later all methods of work would fail, even when all conditions seemed favorable.

But swarming of very prolific varieties of bees can be greatly reduced by treating them as you would the brown German bees to control their swarming by removing the drone comb, by ventilating, and giving them the greatest inducement possible to enter the sections or supers. Bees usually start queen-cells before they swarm; and by going over the apiaries every four or six days, tearing out the queen-cells swarming may be delayed until they can

start cells again; and by constantly doing this they will often give up the notion of swarming and take to the field to gather honey. But in going through the hives the supers should be removed gently, and no more smoke used than possible, and the covers not removed at all, so as not to disturb the bees in them any more than possible. Sometimes bees will swarm without starting queen-cells, leaving this for the remaining bees to do; so we have greatly reduced swarming, but not controlled it; and if it is not reduced enough, clip about a third of one of the queen's wings off, so she can not fly out with the swarm, and it will return; but the queen may be lost unless it is very convenient for her to crawl back up into the hive; then if she does, after the swarm comes out two or three times it will return and may ball her to death because she did not go out with it.

Now, this nearly controls swarming; but sometimes they will wait a few days until a young queen hatches in the hive, and then comes out with her, for her wings must not be clipped until she has taken her wedding-trip, during which she is mated.

Clipping queens' wings to control swarming is a bad practice unless all other means possible to control it fail, for often a swarm will remain clustered out for some time before it returns, and other swarms may issue and join them, and all return to one hive and give no little trouble; or a strolling queen about the apiary may join them, and all take to parts unknown, and thereby a great loss is sustained by the bee-keeper.

THE PRODUCTION OF COMB OR SECTION HONEY.

The production of comb honey in sections is the most common way of securing honey here in the South in modern hives. This is the most tedious way of saving honey. It involves more work and thought on the part of the bee-keeper, and also the bees, for it requires no little work and inducement to get the bees to storing honey in the sections, and then it is tedious work for them to manufacture the little delicate blocks of honey.

In order to get the best results, colonies must be as strong as possible, or brought up to the honey-flow; then the queen should be occupying all the comb in the brood-apartment, or the comb full of young bees in all stages of development. There being no room below, the bees will carry the surplus honey above and store it in the sections. The supers (top stories) should be prepared as well as possible so as to help the bees. Each section should be filled with surplus foundation, and well attached to it, for this is a help to them, and a great inducement; while the little narrow starter attached to the top of the section is not much of either. I know that the narrow starter is most commonly used, but it is poor economy in bee-keeping. Two supers should thus be prepared for each colony during the winter; then in the

spring, when poplar-trees or your first honey-plants begin to bloom, put on one super; but if it is a very warm spring, and bees begin to lie out on the outside for lack of room put on one super about two weeks previous to the blooming of the first honey-plants, for they should not be allowed to get in the habit of lying around on the outside. When the honey-plant is in its height of blooming, raise the cover on the strongest colonies and see what progress has been made; and take that, the force of the colony, the weather conditions, and honey-plants under consideration; and if these seem favorable, give them another super on top; if not, examine them again in three or four days, and add a super if things look favorable. If, during this time, the weather is very warm and the temperature in the hives seems to be very high, raise them up and put a piece of section under each corner. Watch the progress of the bees closely; and if they need more sections give them more; but don't disturb them any more than you can help, for it hinders them in their work. If time permits, remove the supers which have all the sections well filled and capped over. At the close of the flow, when the bees begin to cap the unfinished sections, remove all supers as soon as possible so as not to give the bees time to cap them, and they will be in the best condition for them to finish during the next flow; but if they are capped over they are spoiled for their purpose unless they are uncapped.

All sections should be removed from the supers, and scraped until they look as nearly like new ones as you can get them; then the marketable ones should be packed in standard shipping cases (for if they should get mashed up on the railroad you could get damages; otherwise you could not), and put on the market, and the unfinished ones should be packed away for the next flow. If the flow which is to follow is usually heavy, use the unfinished section as baits in the supers of sections, dividing them equally. If the flow is usually light, just let the bees finish them, giving them to the strongest colonies.

At the end of the last flow all supers should be removed and treated as you did those at the previous flow; then should you have unfinished sections, extract the honey from them or leave them in supers and set them out and let the bees remove the honey; but should they begin to tear down the comb, stack them up and leave an opening so only a few bees can pass at a time, and save the sections thus cleared of honey for baits next spring, to be used in the supers given to the bees.

THE PRODUCTION OF CHUNK HONEY.

In operating an apiary for chunk honey the bees should be built up to the highest possible honey-gathering condition just as we would expect to have them in producing comb honey in sections, then supers containing shallow frames of the same dimensions as those used in the brood-department, only about half as deep, and their top-bar thin. These shallow frames should be

filled well with light brood or thin surplus foundation, and attached well to the top-bar with melted wax. Two or three of these shallow supers (according to the surplus-honey flow in your location) should be thus prepared for each colony, and one given the bees a few days in advance of the honey-flow with a queen-excluding honey-board between it and the brood-nest, or the queen might enter the supers and deposit eggs in some of the combs as they are being built, and establish a portion of her brood-nest there, and thus spoil the appearance of the comb.

As soon as work is under full headway in the first super, give them another super on top; then by the time the bees get to storing it in well, the bottom super should be full and the honey capped over, which can then be removed; and, if the flow justifies, give them another super and remove the second super of honey. At the close of the flow leave the remaining unfinished honey on the hives until it is capped over well; then remove all and cut it out of the frames and put it up in glass jars or cans in as large pieces as possible; then pour in enough strained or extracted honey to cover all the comb, filling up the jars and cans. Pack the jars up well in straw, sawdust, or shavings, and put it on the market. Chunk honey put up in jars and cans, nicely labeled, makes an attractive package, and should bring a good price on any market. I have been able to sell more of this honey to the retail trade than either comb or extracted honey.

All frames should be cleaned up, and those from which honey had been removed should be refilled with foundation and put back in supers in readiness for the next flow; then operate as for the previous flow. At the end of the season take off all supers and remove the honey; then during the winter get them in shape to give the bees next spring.

This is an easy, simple, and cheap way to produce honey, and at the same time it brings a good price; and those intending to begin bee-keeping should give it consideration.

THE PRODUCTION OF EXTRACTED HONEY.

An apiary operated for extracted honey should be equipped with two full-story hives, each story containing frames of the same dimensions so they can be changed from one story to another, if necessary; and both sets of frames should be well wired, and a full sheet of foundation in each frame. If the apiary was previously operated for chunk or comb section honey, and the frames unwired, put the extracting top story on top of it; and if it be necessary ever to have to use the unwired frames in the bottom story, the comb, being old and tough, will stand the strain of the extractor; but hive all new swarms in one of the prepared stories; and as soon as the bees have nearly completed this set of combs, give them the other story. By not adding this top story as soon as hived you have contracted space and thus helped

them in the work; and, besides, they now have the brood-nest established in the bottom story; and if the honey-flow is still on they will soon enter the top one and build a set of combs there and store their surplus honey up there so it can be easily removed.

In order to get the best results during the honey-flow, the bees must be prepared for it as for section and chunk honey, having as large a field force as possible at the beginning of the honey-flow, and at once they will commence storing their surplus honey in the top story. If time permits, as soon as the comb is well filled, and the honey about capped, start the extractor; if not, defer the extracting until the close of the honey-flow; but see that the bees have plenty of room by changing full frames of honey from the colonies that have advanced for empty comb from those that are behind or store them in the honey-house and give the bees frames of foundation, or add another story on top. If honey is extracted during the flow, the empty frames can be immediately returned to the hives; but if extracting is done at the end of the flow, or during a honey-dearth, the combs should be returned to the bees late in the evening unless the apiary is very small; then it would not matter when they were returned, and it could better be done along as the honey was extracted from them.

It is customary to return the combs to the bees when the honey has been extracted from them, and left in the care of the bees during summer and winter.

It is often necessary to remove an extracting-story on account of the condition of the colony, and set it on top of some strong one, and set it back as soon as constant attention is not required.

Extracted honey should be put in tanks or open-top barrels, and allowed to remain thus for a day or two, and thus give all impurities a chance to rise to the surface and be removed; then it should be drawn out from the bottom into two-pound cans, quart, half-gallon, gallon, and five-gallon cans, kegs, or barrels, and put on the market.

The production of extracted honey is the least difficult and the most profitable and satisfactory way to produce honey here in the South. It costs more to equip an apiary for extracted honey than it does for either section or chunk honey; but when once equipped this expense is over.

APIARIAN APPLIANCES.

Aside from the invention of the movable frame or modern hives there have been useful and necessary implements invented from time to time to be used in modern bee-keeping to make it a more profitable, interesting, and comfortable pursuit; and every apiary should be equipped with some of them, as they are so necessary and cheap; but what we need in the way of implements depends on what we are operating our bees for—chunk, comb, or ex-

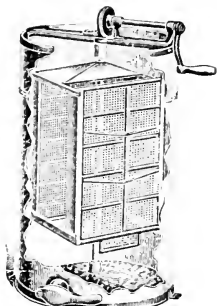

Novice Extractor.

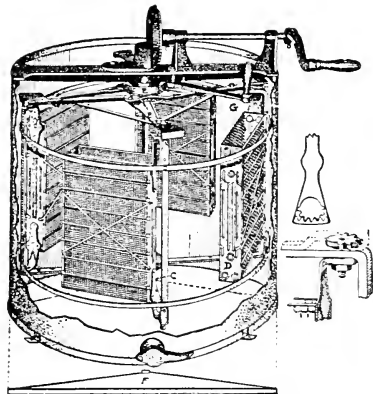
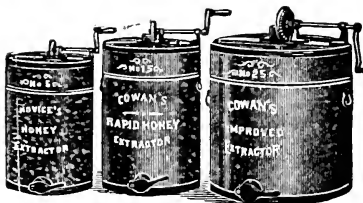

Four-frame Extractor with Automatic Reversing Gear.

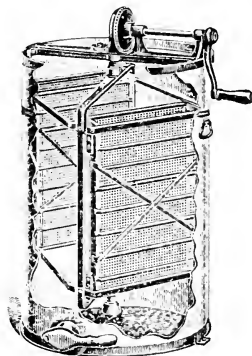

Common Cowan Extractor.



Dadant's Uncapping Can



Comb-bucket.

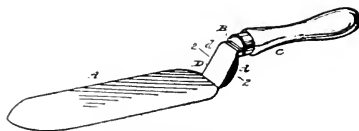

Uncapping Honey-knife.

tracted; but a good bee-veil and bee-smoker are as necessary in any kind of bee-keeping as a hammer and saw are in carpentry.

We will first describe the honey-extractors and the advantage of their use in the apiary. By the use of the extractor the apiarist can, to a great extent, control the swarming of his bees by extracting the honey from the comb and setting it back in the hive for the bees to refill and thereby save over one-third more honey each year. If it is desired to operate an apiary for extracted honey it would depend on the size of it as to what size of extractor to buy for it. If it is not to consist of more than 25 or 30 colonies the No. 5, or Novice extractor would be large enough. If the apiary were to consist of 40, 50, or 75 colonies, No. 15, or the rapid honey-extractor would be best, because more honey could be extracted in the same length of time. If several out-apiaries were operated for extracted honey, a still larger size of extractor would be necessary—No. 25 or improved extractor—in order to extract the honey rapidly should the bees be crowded or need empty combs.

If the apiary is small, and there is not much honey to extract, erect at a convenient place in the honey-house a small platform about 2 x 3 feet, and high enough from the floor so that a bucket will go under the honey-gate of the extractor in which the honey is to be drawn. Anchor the extractor on this platform so that the honey-gate will be on one side and the anchors run out toward the ends or three-foot way. Now anchor it down to the platform well so it will not rock about when frames of honey of uneven weight are being extracted. If the apiary is large, and much honey is expected to be extracted, arrange the platform as conveniently to the door or small gate through which the honey is passed as possible, and at the same time have it as convenient to the uncappers as possible, so that the handling of honey will not be any more laborious than possible.

UNCAPPING-VESSELS.

Uncapping-vessels of some kind should be fixed up to receive the cappings as they are cut from the comb, and also the honey which may be removed with them. If it is not desired to buy a tank made for the purpose a cheap one can be made out of a tub, barrel, or box having a wire-gauze strainer somewhere sufficiently attached to it to catch the cappings and let them drain and also have a bottom to catch the honey; and whatever is bought or constructed to catch cappings should be large enough so at least two can work at it at a time.

COMB-BUCKETS.

Nothing is more convenient than comb-buckets in which the frames of honey can be set as they are removed from the hives; and when filled the lids can be fastened down and the honey in them will be unmolested by robbers, and easily carried into the honey-house.

HONEY-KNIVES.

Honey-knives are indispensable for uncapping honey, for no other knives can be used successfully for that purpose. The honey-extractor throws the honey out of the comb by revolving, and it is very necessary that all the

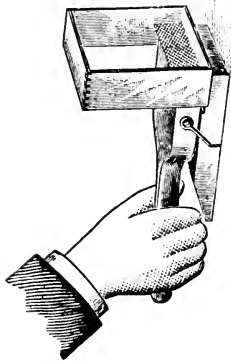

Baker's Foundation-fastener.



Spur-wheel Comb-foundation Wire-embedder.



VanDeusen Hot-wax Tube.

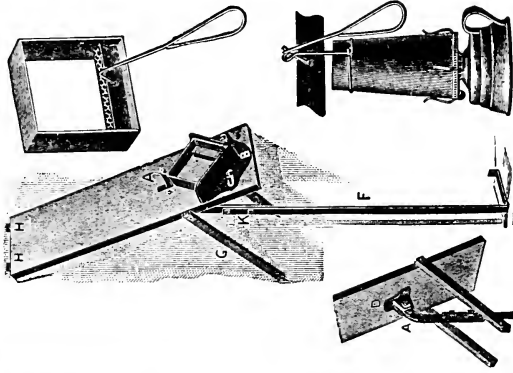

Section-press

Comb-foundation
Fastener
for Sections.

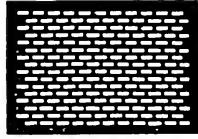
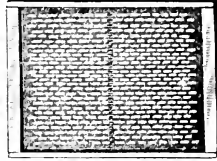
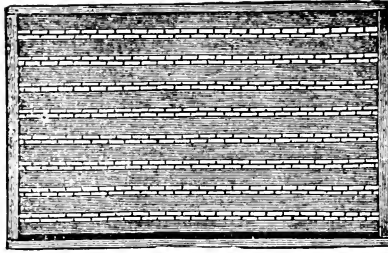

Honey-boards, Slotted, Bound, and Unbound.

cells of honey be uncapped or the extractor will not remove it; and it is by no means a quick and easy job to uncap heavy tender combs of honey without damaging them.

HONEY-BOARDS.

Honey-boards are used to confine queens to certain parts of hives, and will allow the worker bees to pass through it to any part of the hive. In the production of extracted honey, queens will sometimes enter the extracting-apartment of the hive and establish her brood-nest for a short time at least, because she has not room in her apartment to deposit her eggs. The young bees that are not capped over in the cells will be thrown out with the extractor into the honey if it is not run very slowly; therefore they are a hindrance in extracting. If honey-boards are used between the brood-apartment and extracting -apartment the queens can not enter them and their hindrance is overcome. I do consider this hindrance much to me, and do not use them now, although I have used them, and there are many bee-keepers who do not. But they are indispensable in the production of a nice article of chunk honey, and should by all means be used.

SPUR WIRE-IMBEDDERS.

Where full sheets of foundation are used in the brood-apartment and the extracting-supers or top stories, the frames should be wired and the wire imbedded well into the foundation with this implement.

WAX-TUBE FOUNDATION-FASTENERS.

In fastening foundation in shallow frames, or frames which do not have the advantage of fastening it to the top-bar by means of wedges, and also in fastening full sheets of it in sections, this tool is nearly indispensable.

FOUNDATION-FASTENER.

These machines are indispensable in the production of comb honey, and it is very necessary that the foundation be well fastened at the proper place to the sections, which they will do. Aside from the best improved implements for this work there is a simple cheap one called the Parker foundation-faster which is used by bee-keepers who keep only a few colonies of bees. To do the best work with this implement it should not be used in cold weather while the foundation is brittle unless it is placed in the sunshine for a few minutes or heated up before it is used. Then to operate, put a section in place on the bottom part, and then push the lever over on it so that the end of it will admit of the foundation being pushed between it and the section, under about $\frac{1}{4}$ inch; then raise the lever up and it will pinch the foundation to the section and thus fasten it. Keep the wax removed from the lever and it will do satisfactory work. The other foundation-fasteners are easy to operate.

SECTION PRESS AND FORMER.

In order to stand handling, and to fit well in the supers, sections should be well put together and be square. These implements are for this purpose; and, besides, by using them there will not be so many sections broken up.

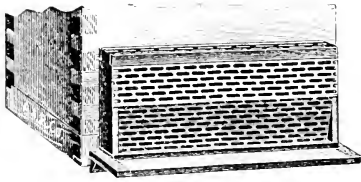

Alley's Drone and Queen Trap.

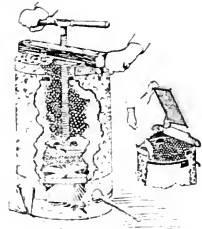

German Wax-press.

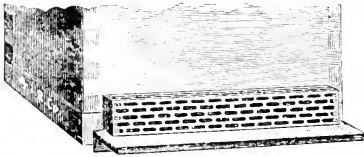

Entrance Guard.

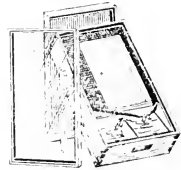

Doolittle Solar Extractor

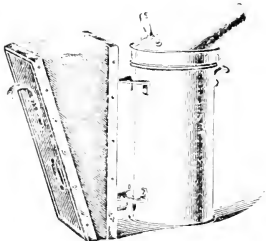

Bee-smoker.

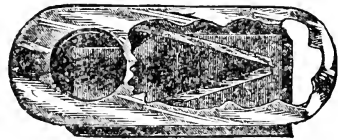

Porter Bee-escape.

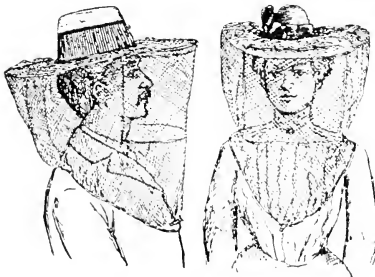

Tulle Bee-veils.

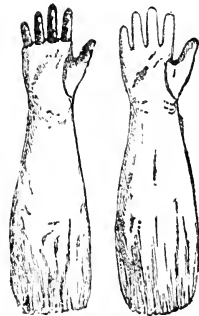

Bee-gloves.

BEE-ENTRANCE GUARDS AND DRONE-TRAPS.

These implements are to be used over the entrances of hives when the apiarist is away from his bees during swarming-time. The queens can not go out through them should the bees swarm, and the swarm will return; and they are good to confine inferior drones to their hives while the queens are being mated.

WAX-EXTRACTORS.

Saving wax is no small item in bee-keeping, and every particle of comb should be saved and rendered into wax. The most convenient wax-extractor is the solar, which should be set in the middle of the apiary where all the scrapings from the interior of the hives and the pieces of comb can be easily dropped into it, when the heat of the sun will melt them up. One of these extractors will render up all the comb in a small apiary. Where the apiary is large, and much comb is to be rendered into wax, the solar cannot do all the work. Then a wax-press is necessary to render up the bulk of the comb. These presses are simple, and easy to operate, and do away with the sticky and mussy work we had in the old-style way of making beeswax; and, besides, all the wax is saved.

BEE-ESCAPES.

In the production of comb honey it is no small job to clear the supers of honey or bees, for it requires time to smoke them down out of the supers; and the whole hive is molested; and to shake the bees out is laborious. When the supers of honey are ready to be removed, set them on top of those that are not ready to be removed, and slip the board with the bee-escape under it, and one by one the bees will march out of it.

BEE-SMOKERS.

There is no implement in the apiary more handy than the bee-smoker; and every one who has only one colony of bees should by all means have one. I have seen people blow smoke among bees with their breath, to conquer them, from a bundle of burning rags, until they would exhaust themselves and be sick from being strangled on the smoke, and it has been attributed to the honey they ate.

BEE-VEILS.

Bee-veils are next to smokers in usefulness, and no one should keep bees without them or go among the bees to do any work without one on, for they will save many painful stings, and, to a great extent, remove the fear of bees. A few of them should be kept on hand to put on our interested bee-keeping friends when they come to see us handle bees.

BEE-GLOVES.

Bee-gloves are a great protection to the hands while handling bees. Timid bee-keepers very often receive painful stings about the hands, and especially about the wrist around the bottom of the sleeves, where it seems

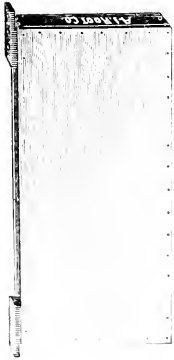

Frame or Division-board Feeder.

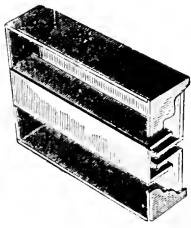

Miller Feeder.

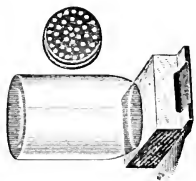

Entrance-feeder.

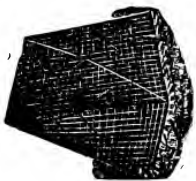

Tent to Cover Hives.

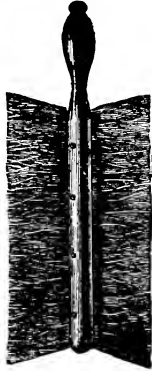

Double-edged Bee-brush.



German Hair Bee-brush.

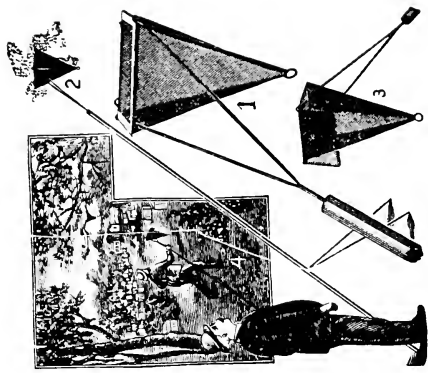

Manum's Swarm-catcher.

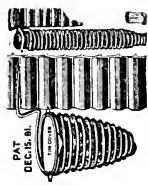

West's Queen cell Protector

bees love so much to deposit their stings. This can all be avoided by wearing a pair of gloves while handling bees.

BEE-BRUSHES.

In the production of extracted or chunk honey, bee-brushes are very necessary to sweep the bees off the comb, and very often it is better to brush bees from an object than to smoke or jar them from it.

SWARM-CATCHERS.

When bees are allowed to swarm naturally, very often they will settle high up on the trunks of trees or away out on limbs and it is no small task to remove them from such inconvenient places to hive them; and many times they are not removed at all, but allowed to go to the woods.

Many large vigorous swarms have been lost in this way which could have been easily, quickly, and safely removed from their settling-place and saved. No apiary where bees are allowed to swarm naturally should be without one; and even where they are settled low or conveniently, nothing is better to remove them with.

BEE-TENTS.

No one but those who have used a bee-tent knows how useful they are about the apiary. Should a comb melt down in a hive, robbers take to one, or an accident happens, nothing could be done better than to set a tent over them. Very often it is handy to set over honey or to feed about the apiary; and it is often used to set over a colony to do certain work.

QUEEN-CELL PROTECTORS.

In every apiary where queen-rearing is practiced or requeening done, queen-cell protectors are indispensable. They are to protect the queen-cells after they have been removed from the comb, and distributed over the apiary until the young queens emerge from them. By the use of these, any bee-keeper can keep his stock of bees from running down after good blood has been introduced into his apiary. Or by the use of them he can introduce good blood into all colonies from one good breeding queen.

BEE-FEEDERS.

In every apiary some colony needs feeding at certain times; and if not done with great care robbing will set in, and the result will be that some colonies will be eaten out by robbing bees, and be lost. By the use of these feeders any colony in the apiary can be fed syrup until the bees have stored as much as they need, without starting robbing. A few feeders (according to the size of the apiary) should be included in each order for bee-supplies.

I have now given a list of the leading implements used in modern bee-keeping, and their usage; and every well-regulated apiary should be supplied with them, for they go to make up modern bee-keeping, and are great labor-saving devices. The prices of many of them are insignificant, and that is true

of all of them as compared with their usefulness in bee-keeping. The majority of them are indispensable in modern apiculture, and apiarian implements should be considered before placing orders for bee-supplies; and some of them (depending on what you are operating your bees for) should be included in orders.

HONEY.

Honey is the sweet sap of certain plants called honey-plants, which have nectar-glands to convey this sweet sap into their blossoms, buds, tender joints, etc., where the bees or nectar-loving insects can reach it. At the extremity of these glands the sweet sap may ooze out and stand in a ring around the tiny berry or fruit, as it may be, in small drops about the blossoms and tender growing parts of the plant. Honey-bees remove this sweet sap, or nectar, as it is most commonly called, with their long delicate little tongues, which work in a folded tube. If you will give a bee a drop of honey it will show you its tongue better than I can explain it; but it will be seen that the tongue will work out at the end of the folded tube, and feed about in the honey, and soon the drop of honey will disappear if it is a small one, and be nicely cleaned up. In like manner it removes the nectar from plants; and as it is licked up it goes from the tongue through the folded tube into another tube which conveys it through the waist of the bee into the honey-sac, which is located in the front part of the bee's abdomen. This sac or honey-stomach holds only a small drop of nectar; and when it is full the bee will rise in a circulating manner and soon disappear toward its hive. But when honey is first gathered it is very thin sweet water, and has an unpleasant sappy taste; but from the time it is removed from the honey-plant it is undergoing an evaporating or ripening process. As soon as the nectar-laden bee reaches its hive it goes up on the comb among its busy sisters and there deposits its load of nectar into a cell by belching it out of its honey-sac, or it may give its load to some attending bee if there happens to be one present, and this second bee will deposit it in a cell. If this is among its first loads of honey from the field it is apt to act in a frisky manner, shaking itself about as it crawls around on the comb for a few moments before giving its load to another bee or depositing it. As soon as a field-bee disposes of its load of honey it may take a few moments of rest somewhere in the hive before returning to the field, or it may look around over the comb, and then return to the field. Thus the tiny drops of honey are pouring into the comb, which, if jarred, will rain out on the bottom; or if the comb is turned to one side it will run out. As soon as it is stored in the comb no time is lost in turning it into honey by fanning it or sending a current of air through and over it, and by moving it from place to place in the comb, and by injecting it into the honey-stomach and throwing it back out, etc. Thus they keep it in a vibrating state for several

days and nights, spread out over the comb, in uncapped cells, and at the same time the temperature is kept high in the hive. Now, when the bees have removed or evaporated about all the water from the nectar so it will keep without souring, or have done about as much as they can with it, it is capped over, and then is honey.

HOW BEES BUILD HONEY-COMB.

The lover of comb honey is not apt to stop eating it and take notice of the beautiful small thin hexagon-shaped wax cells it is stored in. When bees need wax to cap their honey, or more comb to store it in, some special bees seem to be appointed, or take up at this particular time, wax-secreting; but any worker-bee in the hive can and may secrete wax; but I have never seen very young or field-bees do so. Wax-secreting bees may be found anywhere in the hive, but mostly where the comb is being built; but they do not seem to take an active part in the work of comb-building. Wax-secreting bees keep



WAX-POCKETS.

themselves gorged with honey or nectar and are sulky, clumsy, and can scarcely fly at times. Wax is secreted in eight tiny pockets under the bee's body, between the rings, and extending out from these pockets or certain places between the rings in tiny white thin scales which are nearly round. These little specks of wax are removed by the attending bees, or the wax-secreting bees themselves will very often remove them; and it is done with their front feet. Then it is placed edgewise between the jaws of the bee, and carried thus to where it thinks it is needed; and as the temperature is high in the hive or cluster, and the little scale is very soft, it will easily adhere where it is placed, and thus make a part of the comb. At times they seem to have a surplus of these scales, and they will fall like tiny flakes of snow from the cluster, and collect on the bottom so thickly that it can be gathered up. This is often the case where new swarms have been hived, but generally they are very saving of it, and will often remove it from the bottom and carry it back up to where the comb is being built. Wax-secreting bees consume no small amount of honey while performing this duty.

Just how bees build comb is hard to explain; but every one who has watched the interior force of bees at work knows that they do a little work

here and there, moving in a nervous manner over the comb. So it is in comb-building. Every bee that passes along does something toward the building of the comb, and the little scales of wax are fast placed along where they are to go, many of which it seems would drop off if touched; but the passing bees put them in place by use of their jaws and feet; and when they finish working it, it is as thin and white as the finest paper, and the cells are hexagonal in shape, and built on the incline. So the work goes rapidly along, each passing bee doing a little here and there, the tiny scales being rapidly placed along, then worked into the straight parts of the cells and into the hexagonal corners, etc., and so on the work goes day and night until they need no more comb, when wax-secreting and comb-building will stop.

PLEASURE IN BEE-KEEPING.

The question might be asked, "Where is the pleasure in handling stinging bees and enduring their stings?" This is the first interesting problem for a bee-keeper to solve. He can get badly stung and endure it, or he can avoid it. The greatest pleasure in any pursuit is in mastering it, and so it is with bee-keeping. The more we master of it, the more interesting it is, and the more pleasure we derive from it. But bee-keeping is unlike many other pursuits in life, for it is never mastered. There are always new and interesting problems arising for our solution in the culture of our bees. I have worked many long days in my apiaries, and not eaten my dinner until on my way home at night, as the work was so interesting, and seeing that the bees were prospering me under my guiding hand. I was totally absorbed in my work, and did not care to stop to eat.

Pleasure is one of the essentials of any successful business; and if the pursuer is not deriving any pleasure from his pursuit he is not apt to aspire to higher office in that line of business, and, of course, sooner or later he will abandon it. But this is rarely the case in bee-keeping. It is not only a pleasant pursuit, but it is a fascinating one—so much so that but few who ever embark upon it abandon it. I don't think any pursuit should be taken up, even on a small scale, just for the pleasure alone it may afford; and surely bee-keeping never can, for bees are too industrious and sure to make their culture profitable as well as pleasant. I have often seen colonies of beautiful yellow bees sitting in front yards or convenient places about the premises; and when the keepers were asked about their bees they remarked that they were keeping a few colonies for the pleasure of cultivating them, but at the same time the bees were furnishing their homes with honey.

It is often remarked that farming affords more real pleasure than any other pursuit in life; and it seems to be a fact when we see the farmer following along behind his plow, whistling and singing, and every thing flourishing around him, and the singing birds cheering him with their sweet songs;

but yet the bee-keeper in his apiary, supplying the needs of his bees, with millions of tiny drops of honey pouring into his apiary from a thousand hills, may be the happiest man in all this world.

PROFIT IN BEE-KEEPING.

Profit in any kind of business is apt to be the first thing considered by the prospective or enterprising man; and if he concludes from what he can learn from others who are engaged in a certain line of work that there is profit in it he will embark; but if he concludes there is but little if any profit in it he may try it on a small scale, or turn his attention to something else. Bee-keeping seems not to have been considered as a profitable business but by few of our enterprising men in the South.

The common public here is skeptical when it comes to consider the honey-bee and its usefulness. It may be that they have not been sufficiently educated or informed in regard to the industry, or it may be that the honey-bee is too insignificant-looking an insect to be considered profitable. Many bee-keepers are skeptical when it comes to the cents and dollars in bee-keeping; but I have yet to meet a bee-keeper or a man who has kept bees who says they did not pay him a greater per cent. of profit than any other investment he ever made so long as he gave them intelligent attention. No one in the South has ever lost any money by investing it in bees, and this is more than can be said of any other industry here. Many times has the question been asked, "Is there any money in bee-keeping?" I always answered, "Yes, if it is done with enthusiasm and intelligence." Then, again, another question comes, "Can I get rich by making bee-keeping my business?" I always answer that there is such a thing as a bee-keeper spreading his bee-business out over the country, and saving enough of the vast amount of honey that is going to waste each season to gather up a large amount of this world's goods around him; but, like all other business, the profit can be estimated only by the amount of capital invested in it, and the constant care it receives. If bee-keepers would work in their apiaries as the farmer works in his fields I don't know what the results would be; but I can safely say that they would be satisfactory. When it comes to giving the profit in cents and dollars on bee-keeping in the South I can not do it, for in this respect locations and sections vary much here; but go to your nearest bee-keeper and find out what he has got invested in bees, and the amount of intelligent attention he gives them, and the amount of honey, wax, and swarms he gets from them, and this will give you some idea of the profit in bee-keeping in your location.

BEE-KEEPING A PROFITABLE SIDE BUSINESS.

I am glad that I can conscientiously recommend bee-keeping as a profitable side line of business for people engaged in almost all callings of life.

This is a progressive age, and progressive people are considering other lines of business, and adding them from time to time. Bee-keeping is worthy of consideration, and should be added to other main lines of business far more than it is. It is true that progressive business men have but little time to spare to side issues, and that they are likely to be neglected; yet it would not require much time to give a small well-established apiary the necessary attention.

There are but few enterprising or business men who do not have a few spare moments every two or three weeks which could be profitably spent in the apiary, and surely the work would be recreative. Such apiaries should be operated for chunk or extracted honey so there would be no swarms to hive, and the honey could be removed from the hives at leisure. Of course it would be necessary to read up some on bee culture; but this could be done during spare moments at business or at night. It must be remembered that children love the study of bees, and to work among them; and if they are supplied with veils and gloves they will take great interest in the bees, and be of much assistance in apiary work.

I have a list of names of people who are mayors of cities and towns, railroad employees, bankers, lawyers, doctors, ministers, merchants, etc., and, in fact, men engaged in almost all pursuits of life who are succeeding with bee-keeping as a side line. I have a long list of farmers who are successful bee-keepers and many of them are realizing better results from their apiaries than their farms. There is no reason why any one interested in bee culture should not succeed in following it to some extent as a side line to their main business; and especially is this true with our farming class of people who are scattered out over the country, and who live surrounded by honey-plants so convenient for the bees, and, as a rule, they have more spare time which they could devote to their bees than any other class of people; and, too, they are better situated to keep bees. The farmers usually produce what they consume, and honey on their tables as food would certainly be an addition of great value. Many of them raise something for market, and honey to sell would be quite an item. It is customary for farmers to borrow money in early spring to make their crops on, and they have to pay large per cent interest on it. Suppose they operated progressive apiaries, the products of which could be marketed in early spring when the returns could best be expended on their farms, and the amount of borrowed capital greatly diminished if not completely covered.

BEE-KEEPING AS A SIDE ISSUE.

Bee-keeping is looked upon with much distrust by the uninitiated. The bees are supposed to be desperate in disposition, attacking any one in sight; and any one seen handling them with apparent ease and indifference is sup-

posed to have some charm over them, or, as is often said, "The bees don't sting him." But if such a one is persuaded to go close enough to see what is going on he will learn that the secret of the operator's immunity lies in the fact of his composure and in his care not to jar the hive or mash the bees, which would be sure to anger them.

Persons may often become interested in bees by some such chance acquaintance, and become bee-keepers in a small way, and occasionally quite extensive ones devoting their whole time to it. This is a very natural consequence and we only wonder that more people are not bee-keepers. Bees are, perhaps, the most interesting and useful insects, and bee-keeping can be made both pleasant and profitable. It is on account of ignorance of the habits and disposition of bees, and the lack of an introduction, you might say, because, when once interested, a person is hardly satisfied till he has a hive of his own. There is no reason why the hive should not be as common as the chicken-coop at our homes. One or two hives would furnish a home with honey, which is, at the same time, a luxury and of value; as food it can not be too highly estimated, and would, perhaps, furnish more pin money than the "old hen" herself. The pleasure they afford to those who take an interest in them is not to be overlooked either.

Bee-keeping offers peculiar advantages to persons already engaged in some occupations. They require very little attention, and that can be given at leisure. The capital invested is small, and the profit proportionately large. Most important of all, they would add to a person's capacity for money-earning, and thus better his condition. It is an outdoor pursuit, and consequently beneficial to the health. It is an absorbing occupation that makes you forget other cares and worries, as it has been said you can not work with bees and think about something else.

Bee-keepers are not an exclusive set, but welcome any new recruits to their ranks. They are generally religious, and stand for principles that make the highest type of citizens. Our organizations believe that, in the multitude of counselors, there is safety. Every one who is interested in bees should belong to at least one of these organizations. The stronger in numbers the more potent they are to benefit their constituents.—H. M. Parker, Jr., James Island, S. C.

EXTENSIVE BEE-KEEPING.

The above subject is only a dream of the future with many of the bee-keepers of the South; but a great number of them are pulling for the mark, and some of them are joining us each season, and soon we shall have a large list of professional bee-keepers. Extensive bee-keeping is spreading bees out over the country, or reaching out and saving honey by successfully operating out-apiaries.

Bee-keepers are like people in all other callings of life. Some have the ability to manage successfully twelve or fifteen out-apiaries, and some can

not operate more than the home apiary; so a bee-keeper should consider his ability or capacity to do apiary work before he begins extensive bee-keeping.

It is hard to get assistance in the apiary, and we can not always depend on it; and this should be a matter for consideration.

Experience is also a matter of consideration. No one should think of jumping into extensive bee-keeping without several years' practical apiary work.

Location is also a matter of great importance. If you are not getting satisfactory results from the home yard, and you see no better locations around or near you, you should not attempt to spread your bee business unless you move into a more favorable location.

A large honey crop should not induce you to enter an extensive bee business, for it might have been an exceptional season, and another crop like it may not be harvested in that section or locality for several years. The crops for successive years should be added, and see what the average has been, and if it will not justify the establishing of an extensive bee and honey business, it should not be embarked upon.

Very often a bee-keeper with only a few colonies will get so much interested in them, or enthusiastic over the bee business, that he is completely captivated by it, and then he is apt to invest too much money in bees at once, which he should not do, but grow gradually into an extensive bee business. Bee-keepers sometimes invest money in bees beyond their ability to manage them. This is a very unwise step to take for extensive bee-keeping.

Of course, no one should sell property or borrow capital to go into extensive bee-keeping, for good honey seasons do not come often, and we could not expect more than a good living from our bees except during good seasons when a large crop of honey might be harvested; then we might be able to pay something on back indebtedness, or it might be a long time before we could meet our financial obligations; so it is best to let the bees pay their way into an extensive business.

If a bee-keeper will let bee-keeping be a side business and invest his surplus money from his main business in bees and apiarian appliances, he can soon have a large business established; and during that time he will gain much valuable experience in handling bees.

A bee-keeper can work with his bees during spring and summer, then do something else during fall and winter, and establish himself in extensive bee-keeping in this way; but he should never let his other business cause him to neglect his bees.

These are only a few things a bee-keeper should consider before he launches out into extensive bee-keeping, and with these few admonitory remarks we will now turn our attention to extensive bee-keeping. After the home yard has been established with 50 or 75 colonies of bees, and equipped with a good honey-house and a large work-shop in which to set up supplies we should make a survey of our section of the country in every direction, and especially take notice of the varieties of honey-plants, and note locations where they are the most abundant. After the survey has been made,

and all desirable locations marked on the map which you make while viewing the country, the apiary should be established in the most convenient and favorable location on the map; then as soon as you have bees enough, establish another apiary at the next most favorable location, and so on until you have as many bees as you want in that section. But in occupying this home territory we should not interfere with any other bee-keeper; and it should be occupied to the greatest advantage possible for the bees. Bees penetrate the location they are in, for honey, for three or four miles; but when the honey-plants are in bloom, and honey is coming in, the penetration is not extended so far—one, one and a half or two miles, perhaps, so the apiaries should be located over three miles apart, so that the bees in one yard will not gather the honey the bees in the other yards would get. Bees, like other living things that feed upon whatever mother Earth may send forth for them, may not do well in one pasture; for only a certain number are required to remove the supply, and all over that number will only save what others would; so too many bees should not be put in one yard. The number of colonies required to secure the honey in one location depends upon the number of honey-plants there are in it; also the uncertainty of seasons is a matter for consideration. If it is a good season there is plenty of honey in the blossoms, and it will require a large number of bees to gather it; but if it is a poor season the honey-plants will yield sparingly, and a great number of bees will visit the blossoms too often, and only a very small amount will be obtained by each bee; while if the visits were not so often the amount obtained by each bee would be greater. Some of our Southern bee-keepers keep from 75 to 200 colonies in one location; but the most successful ones are keeping only from 40 to 60, but located two or three miles apart, or somewhat closer than large apiaries. I have obtained better results by operating small apiaries, so I do not advocate large ones, taking the uncertainties into consideration. I would not be willing to risk my bee business if too much compacted.

There is another thing of great importance in locating out-apiaries; and that is, they should be located close to a lasting spring or stream of water, for bees consume a large amount of it during the season, especially at times when brood-rearing is at a high pitch. Apiaries should not be located on open land some distance from the forest, because in early spring we have much high cold wind that usually plays havoc with our honey crop; and if the bees have to go across untimbered land they are beaten down by the high wind, and many of them never reach their hives. But if they are located along branches or creeks the growth will protect them while flying. My apiaries are located on creeks; and when the wind is high the honey-laden bees will mostly come in low on the opposite side of the timber from the wind. The most of the creeks and branches have a heavy growth along on either side of them, and certainly furnish great protection to bees in their flight.

Every outer apiary should also have a good honey-house to do extracting in, or to keep honey in for a short time, and to keep extra supplies in, and to get in out of bad weather while working over the apiary. There should also be a smoker, veil, and hat at each honey-house for convenience. The

extensive bee-keeper must control the increase of his bees, and, of course, should have a conveyance to go from yard to yard ministering to the needs of his bees.

How to make increase at these apiaries to establish others, see "Artificial Swarming."

After you have as many apiaries as you want in the home territory, and decide you can care for more bees properly, take a trip over the railroads running by your station or town, and get off at each one, and view the surrounding territory for some distance out; and after you have surveyed the country as far as you wish to in this way, making a memorandum of the amount of honey-plants at each station, and the convenience for establishing an apiary there, locate an apiary at the most favorable station, as close to it as possible, so as to be convenient to the depot. Then establish another apiary at the next favorable station, and so on until you have as extensive honey business as you desire. If you wish you could have your entire business scattered along the railroads and make the visits to the apiaries on the train, and transportation would be good. Your bee business would be much better if scattered, and you would be almost sure to have a good crop at some location. While transportation might be rather high, yet you could do thorough work at each apiary, and make but few visits.

ESTABLISHING AND MANAGING OUT-APIARIES.

The location is, evidently, the first thing to consider. Of the sources of nectar that may be found, whether it is in the forests containing basswood, poplar, or other nectar-bearing trees, or in cultivated areas of sweet clover, alsike clover, buckwheat, etc., I have found here that white clover and buckwheat are of very little value, owing to a climate too warm and too dry.

The kind of soil has considerable bearing on the subject. It is necessary for the production of nectar that there should be a certain amount of humidity in the ground; and it follows that a gravelly or sandy land, being naturally dry, is unfavorable. Along the streams and rivers is a better place than the upland, partly because the bottom lands do not dry as fast as the highlands, partly because there are in such places quite an amount of nectar-bearing wild flowers, and also because the soil is richer, for, remember that, the richer the ground is, the more nectar the flowers will produce. The European writers claim that more nectar will be produced on limestone grounds than on other kinds.

The distance between the apiaries should be two or three miles, or they should be that distance from the apiary of somebody else, should there be any in that neighborhood—that is, apiaries of some size, not half a dozen box hives kept by a farmer. Such do not count.

To work to advantage there should be enough colonies in an apiary to give the operator a full day of work when he goes there, even if that would

be somewhat too many for the best yield per colony. That number is usually given at one hundred. I think it is rather too much than too little.

We will now consider what might be called the situation—that is, the particular place in the location selected, in which you will plant your apiary. In the first place you must select good people as far as possible—those who own the land that they cultivate. Renters are, as a rule, not a very desirable class of people to deal with. Besides that, they move often, and the next one might not care to have your bees.

How much should be paid for the land occupied? I do not know. All the people with whom I have had bees, or those to whom I have spoken on the subject, have positively refused any pay. Needless to say, that, if you don't pay any cash, you must see that they should be compensated in honey or otherwise. Even if you pay, don't be too stingy, and be sure to be on good terms with the people who have your bees, and also with the neighbors. You don't know when your bees will sting somebody or somebody's horse; and should it happen, the good will of the people will go a long way toward fixing up the matter.

Put the apiary as close to the house as possible without interfering with the people and the stock. This is to prevent too much stealing. If too far from the house, you may find some of the honey gone and some of the bees destroyed. But they should be where they can not give trouble or be in the way.

I prefer a grove of trees to any other place. The shade is a considerable help to the bees and to the apiarist during the day; and, what is usually overlooked, they are a protection against the cold and the dampness of the night—at least in the early spring and in the fall.

Water should be close by. A running creek or spring is not exactly what is wanted. The bees sip the water from the mud or damp earth, and preferably in a warm place well exposed to the sun. Even in the hottest days they will go where the sun shines if they have the choice.

In the early spring the bees need a considerable amount of water, and they will go out in quite cold weather to get it; and if the water is not warmed up by the sun, the bees may get chilled and perish.

I put my hives on benches about eighteen inches high, with the legs driven into the ground to some depth. The bottoms and hives are fastened to the benches so that they will hold well, and yet can be unfastened when desirable, which with my method of management very rarely happens. This enables me to work standing instead of stooping down. It helps against the depredations of ants, toads, lizards, etc. But the greatest advantage is that the hives can not be upset. I have not yet obtained a location where the owner did not want to turn in occasionally some hogs, or calves at least, and sometimes even the cows. With the hives thus placed, there is no danger of a disaster—only an occasional sting. It is the upsetting of a hive loosely placed on the ground that causes serious trouble.

As to the management, there is no difference between the home apiary and the out-apiaries except in regard to swarming. To pay somebody to watch

the swarms and catch them would cost too much; besides that it would often be difficult to find somebody who could be depended on to do it carefully.

The only way is to put queen-traps on all the hives during the swarming season. In order to obtain sufficient ventilation it is necessary to have the entrances two inches high by the whole width of the hive. The traps should also be of the width of the hive, and sufficiently high. The drones must be destroyed as fast as caught, because they obstruct the passing of the bees through the zinc. It will not do to turn them outside, for they will congregate on the traps and be in the way even worse than they were when inside.

Clipping will not do at all in out-apiaries. A swarm issuing in the absence of the apiarist will, if it has a clipped queen, return to the parent hive; but usually the queen is lost. Later on, a second swarm will issue with a virgin and go to the woods unless the apiarist happens to be there just at that particular time; and in the majority of cases he will not discover it until the colony is practically ruined.

The use of queen-traps does not necessarily prevent him from shaking swarms or unqueening, or doing something to prevent or reduce swarming. It is better to be on the safe side, and be sure that no swarm will be lost.

When I established my second apiary I took the bees from the other. I shook them into wire-cloth cages, and carried them to the new place. I did not move any hives or combs.

ADRIAN GETAZ,

Knoxville, Tenn.

UNITING BEES.

Uniting two or more weak colonies into one strong populous colony previous to the honey-flow is quite an item when we keep bees for cents and dollars. No one should keep bees scattered about in hives just for the sake of saying that he has so many colonies of bees, for he has more money tied up in bee-supplies than necessary, and it requires too much time to look after these small swarms or weak colonies of bees, and then very often not get a pound of surplus honey from them. This is not a satisfactory way to keep bees; but if the weak colonies are united into strong ones, there will be less money invested in supplies, and the time required to give the bees necessary attention will be much less. All colonies, being strong, will store a surplus of honey, and bee-keeping will be in every respect more satisfactory. If you are keeping bees as a side issue, and haven't much spare time to give them you should adopt uniting them. The extra hives left empty from uniting can be scraped or cleaned up to put new swarms in. Bees should be united in early spring in order to get as much honey as possible during the spring flow; then in the fall of the year, just before we put the bees up for winter.

When two or more colonies are united, all the queens will be killed but one; and if you have no choice among the queens, just unite them and the bees will make a choice and kill the others. But if you have a choice among

the queens in the colonies you wish to unite, kill all others some time during the day you wish to unite them, and at the same time inspect all the weak colonies closely and see how many strong colonies they will make, or how many colonies you want to make out of them; then cut enough pieces of screen wire the same size of the hive (or a little larger would be better) to go between each two hives to be united. Then later in the afternoon, when all bees are in, remove the covers from the hives you wish to remain on their stands, and put a sheet of wire over it; then lift a hive gently from its bottom and set it on top of this one; and if there is to be another hive united with these, remove the top from it and put a sheet of wire over it and set another hive on it. Now there is nothing but wire between each two colonies of bees, and they will at once begin to acquire the scent of each other. Be sure that you have one of the choice queens in one of these hives thus prepared.

Now let the bees remain thus over night, next day, and the next night; then early in the morning they are ready for uniting. Slip the wire out from between each hive and give them a good smoking through the entrance of the bottom hive, and the bees will all run together; then in fifteen or twenty minutes give them another good steady smoking and they will not know one from another; but watch them for a while to see that they do not get to fighting; but it is not likely that they will; and if they do, give them another good smoking, and this will unite them. Let them remain thus until the following day, then put the frames of brood and choice frames of honey all in one hive, and you will have a good strong colony of bees which will be ready for the approaching honey-flow. The frames of comb and hives left on hand can be used as the apiarist may see fit, but should be left in the care of the bees if the weather is warm. There are too many weak colonies tolerated in the South, and the plan of uniting should be adopted.

WINTERING BEES.

Bees will winter safely on their summer stands anywhere in the South; but they should be properly provided with stores, for they will consume considerable honey during the warm spells which come often during even our coldest months. Then in the early part of winter, or very early in spring our earliest pollen and honey plants will begin to bloom, and bees will begin to spread their brood more rapidly, and consume stores fast, for the flow which may be on will be very light and at intervals. If bees get a setback at this critical time it will be a hard matter to get them over it before our heavy honey-flow in the spring; so bees must be supplied with plenty of stores when they are put up for winter to expect the best results from them during the spring flow. Of course, it is best to put them all up strong colonies for winter; but weak ones, and two, three, or four frame nuclei will winter safely almost anywhere in the South if they have plenty of stores.

Bees should not be wintered on the north side of a building nor where they will not get the full benefit of the sun during the winter; for it is very

essential to their progress; and the entrance should be turned toward the south, so they can crawl out on the alighting-boards and sun themselves, which they seem to love so much to do. If there are any cracks or crevices about the hives that will let the cold wind in on the clusters of bees they should be stopped, and the bees molested no more than possible during winter.

During October is the best time to put bees up for winter, and to outline the work. Look over the apiary and see where your surplus honey is, or where feeding will have to be done, and mark the colonies thus; then take an empty hive body and bottom, also a box or bench to set the hives on while you are preparing it for winter, manipulating and cleaning up the frames. Remove a hive and set it on the box or bench, and put the extra bottom on its stand and set the extra empty hive-body on it. Now remove the cover and smoke the bees down and scrape the tops of the frames if there is any comb or any wads of propolis on them; then remove the division-board and cut the burr comb off, if there is any, along the side of the frame, and pry it loose with the hive tool (a plane-bit is a good tool for this purpose), and clean the other side of the frame off; then lift it out and set it in the empty hive body, put it to one side, and take special notice of the honey there is in it. Clean the next frame up in like manner, and set it in beside this frame, and so on until all the frames have been cleaned up or scraped well, and set them in the extra hive-body in the same position they were in the old hive, so as not to upset them in household affairs. If all the frames have been closely inspected as they were cleaned up, a very accurate estimate can be made on the bees and honey in the hive; but weak colonies will consume about as much honey during winter and spring as strong ones, so the bees should not be a matter of consideration unless they are very weak; but the amount of stores is a matter of much importance; and if the two outside frames, or the two frames on either side of the brood-nest, are not from a half to two-thirds full of honey one of them, at least, should be changed for a full frame of honey from some colony which may have it to spare; then if there is a good rim of honey around the brood in each frame the hive may be marked "O. K. for winter," when the division-board has been cleaned up and set in and wedged up behind the frames, and the cover cleaned up and set on. If there is no surplus frames of honey in the apiary this amount of stores can be fed them (see "Feeding Bees").

Now clean up the bottom and hive-body which you have removed the bees from, and you will have extra ones for the next colony, which should be treated in like manner, and so on until all the colonies in the apiary have been put up for winter. Then you can rejoice over the fact during the winter months that your bees will be in the best possible condition next spring on your first inspection tour; and the frames will be cleaned up and in readiness for their manipulation during the coming season.

There is another thing we must not overlook in preparing our bees for winter, and that is to see that all hive entrances are contracted enough so that they will not let mice into the hives, for they will eat up no small

amount of honey, and pollen too, should there be any in the comb on the outside of the cluster of bees; besides, they will tear down the comb and perhaps build a nest in it; and they will kill many bees, pulling them apart at their waist, and eat out their interior parts.

SHADE AND LOCATION FOR BEES.

There can be no doubt that bees need shade here in the South during our warmest weather, for many colonies and no small amount of honey are lost here each season by the hives being exposed to the direct heat of the sun. In locating an apiary we should have this subject in mind and, if possible, locate it in some thinly shaded place, for a dense shade such as scuppernong or grape-arbors, and the shade of the umbrella china-trees and other low dense trees is not good shade for bees, for there is too much dampness under it for bees; and, besides, such a shade would be a hindrance to the flight of the bees. Fruit-trees furnish good shade for bees, but usually the land is cultivated in orchards, and for this reason it would not be a good place to locate an apiary. Small low pine-trees furnish good shade for bees during summer; but as they should not be shaded in winter this would not be a good place for the apiary. Under large tall timber is not a good place, because bees will often settle in the tops of such trees. There is no better location for bees than under small oaks of any kind, for they furnish shade during warm weather and shed their leaves in the fall and give the bees the full benefit of the sun in winter, which they need. If it is desired to plant out some trees in a suitable place to furnish shade for the bees, there is nothing better for this purpose than the pecan-trees, for they furnish good shade and nuts too.

If there is no available shade, bees can be shaded by laying boards or planks over the hives; but it is no small job to remove these every time we look through them. They should be just as light as possible, and extend far enough out to shade the alighting-board and the side of the hives most exposed to the evening sun, as well as the cover of the hives.

Bees should never be placed in some out-of-the-way place, for they are much gentler where they see you constantly passing; and besides, it is more convenient to give them attention.

There is nothing more attractive about a home than a well-cared-for apiary located in the same grove as your home, in full view of the road or public highway; and it will furnish the passers-by a source of many long interesting conversations; and if the apiary is located near your home, where you can see the little streams of bees pouring into and out of the hives, and hear the heavy roar of the mighty army of busy toilers at night, it will furnish an inspiration that could not come from any other source.

HIVE-MAKING.

Hive-making is poor economy in bee-keeping, as they can be bought from agents in nearly every section in the South, at a reasonable price. To make a home-made hive that would be equal to a factory-made one, and as convenient for the bees and the apiarist, is no small job, and the work is very tedious, for it has to be accurate or it will never give satisfaction, and the job would not be too well done by our best workman; and if the fastest cheap workman were to take the job of making them they would cost more than factory-made ones. And, besides, suitable material to make them of is not always available. If they are not made of very soft material the nails will split them up so much that it will not stand handling nor give satisfaction. The soft material required would be hard to get in many sections in the South. So it is not good economy for bee-keepers to make their own hives, and we will not enter on the construction of home-made hives. But there are two parts of a modern hive that every bee-keeper should know how to make; and they are the cover and bottom. Very often these parts of a hive will give way, and considerable damage be done before we can get more from the bee-supply dealers. The construction of the bottom is simple, and almost any

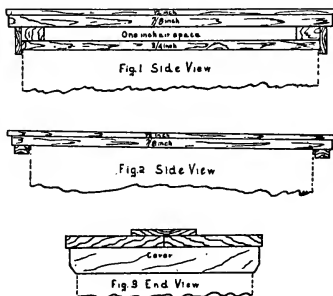

one can make them; so we will go into the construction of the covers. As they are exposed to all kinds of weather they are likely to give way and let the water into the hives on the bees, comb, and frames, at any time, which would be very detrimental to the bees; and so nothing but a good cover should be allowed on hives at any season of the year.

I have made many covers; but the two I shall describe give me better satisfaction than any I have ever made, and are simple and easy to construct. But caution should be used in selecting the material; and it would be best if it were seasoned in the open air; and mostly heart, and soft; and it should also not be warped, and should be free from knots and other defects. Lumber from goods-boxes makes very good covers, as it is soft and not easy to

split; but it should be kept painted well, for, as it is very soft and sometimes thin, it will let the water or dampness through.

In putting the covers together, great care should be exercised to turn to the weather the side of the board which grew nearer the center of the tree, else they will warp much more, and you will have to nail them well with small-bodied flat-headed nails, long enough to go through and clinch on the other side. Finishing nails are not good for this purpose, as their heads are too small, and will pull through the wood should the board be inclined to warp, and they would not hold it in place. After the covers are made they should be painted well before they are put on the hives.

Where hives are exposed to the sun more or less, Fig. 1 is the best cover, as it has a one-inch air-space between the top of it and the bottom, admitting a current of air through it. Hives with covers on them like this one, and well vented at the bottom, will stand the heat of the sun anywhere in the South.

Nearly every bee-keeper has had some experience with heavy combs of honey melting down in his apiary, and many large vigorous colonies of bees, and full hives of honey, have been lost by the heat of the sun.

Fig. 3 is an end view of cover Fig. 1. Fig. 2 is a still cheaper cover, very easy and simple to make, and is durable, but should not be used except when hives are shaded.

Permit me to say here that, if there had been as much time devoted to the study and care of honey-bees as there has been lost in hive-making, bee culture would not be where it is to-day. But bee-supply manufacturers have not had many agents in the South, and supplies were hard to get; but we now have plenty of supplies near, and let us avail ourselves of them.

WEAK COLONIES.

Weak colonies are those that are below an average in bees, and they can be found in nearly every apiary. "Weaklings," as they are more commonly called, are hard to get rid of, for a populous colony will often get a back-set; and as bees are very short-lived insects they soon dwindle down below an average. Especially is this true if they do not receive prompt attention at the time they start backward. So it is common occurrence, even at the close of the honey-flow, to have some colonies four stories high, some three, some two, and some with only one story. The apiarist who has a large number of colonies to look after has more of these weaklings to contend with than the apiarist who has only a moderate number of colonies to care for. It is hard to get rid of the weaker colonies, and stay rid of them, but they can be used to advantage, for good queens can be mated or kept in them until they are needed elsewhere. Sometimes they will store a few pounds of surplus honey during a heavy flow. But generally they require much

attention to keep them from running short of stores, or to keep the beemoth out of them or keep them from dwindling out.

There are two ways of getting rid of these weaker colonies. One way is to unite two or more of them together and make strong colonies of them; and the other way is to build them up to full colonies from the strongest ones.

The question now is, "Does it pay to remove some sealed brood from the strongest colonies, thereby weakening them, and give it to the weaker ones to build them up?" Yes, and no, if it can be done long enough before the approaching honey-flow, and the bees given constant and proper attention. A populous or strong colony has a prolific queen and plenty of bees to nourish her brood; and if an empty clean comb is set in the middle of the brood-nest it will soon be full of eggs and brood, and the colony will get over its loss of a frame of brood if the honey-flow is not too nearly on them; but if it begins in less than three or four weeks it would be best to leave the brood with them, for the weak colony would just about get built up ready for honey-gathering at the close of the flow; but if the work was done in time it would be ready for the flow, and the other colony would be over its loss. All colonies thus treated should be stimulated by feeding them a little. If the weak colonies are very weak they could not be built up in this way in early spring, for the weather would not be favorable, and it would be better to unite them.

During summer, when bees are living in a hand-to-mouth manner, or a very light honey-flow is on, it is a good time to build up colonies.

HONEY-HOUSES.

Every progressive apiary should have a honey-house conveniently located in or about it so that it will be as convenient to carry the honey in as possible, and to get to with a wagon to haul it away. Honey should not be kept or stored in our dwelling-houses, for several reasons. It will draw the ants and bees into the house, and soil the floor should any drip on it or be accidentally dropped on it. And propolis, or bee-glue, and particles of comb will get mashed on it, and be hard to remove; and, in fact it is too messy to have about dwelling-houses. It is not a good idea to keep bee-veils, smokers, hive-tools, and all kinds of bee-supplies about the dwellings or premises, for they are likely to get misplaced or be in the way. So there can be no question that every bee-keeper needs and should have a honey-house to keep all his apiarian supplies and honey in, only as they are used.

Honey-houses are variously constructed, and of different sizes to suit the needs of apiaries, and for the convenience of the bee-keeper; so each bee-keeper can best plan and build his own honey-house.

But perhaps a few suggestions will not be out of place. If a bee-keeper operates only one small home apiary, and does not care to keep any

more bees, a small house 6 x 8 feet will be large enough to keep honey and supplies, and to set them up in, and everything used in bee-keeping can be kept in there out of the way, and safe. Of course, if the apiary is a large one the honey-house should be larger; and if out-apiaries were established the honey-house should be still large at the home apiary, so that the honey from out-apiaries could be stored in it. Honey-houses at out-apiaries should be constructed of 1 x 12-inch plank in sections small enough to be hauled on wagons. It is not necessary to put a floor in these outer honey-houses; but the main honey-house at home should have a wood or cement floor, because there is always more or less dampness arising from the earth, and honey-houses should be kept dry. All honey-houses must be constructed bee-proof, or have no openings about them that will admit bees through them; for after the honey is put in you will not want to go to the trouble of putting it up bee-proof; besides, you could not work with honey during the day if the house were not bee-proof, for the bees would come in on you. Each honey-house must have a door and one or more windows in it, covered with screen wire on the outside, making it bee-proof, and a glass or wood shutter on the inside. The door should have a wooden shutter on the outside, and a sliding screen-wire door on the inside that will make the opening bee-proof. These shutters should be opened while working in the house during warm weather. If the apiaries are operated for extracted honey there should be small sliding windows with only a wood shutter in each house; for if the honey is carried in at the door a few bees will get in every time there is any carried in, and they will be killed or in the way; but the window can be opened and shut so quick that only a few if any bees can get in it. On the inside of these small windows there should be a small platform or shelf built so that the comb-buckets containing the honey can be pushed in on them, and the buckets containing the empty comb set on them to be carried back to the hives.

Perhaps the cheapest and most durable honey-houses can be constructed out of 1 x 12 plank set up perpendicularly, and strips nailed over the joints; and if the roof has a very good pitch to it, the same kind of plank will make a good cover for it, nailing down wide strips over the joints well; but if the roof is nearly flat the strips should be left off and the plank covered with some kind of prepared roofing. In constructing a honey-house out of this kind of material there is but very little framing used in it, and it makes a good strong durable honey-house, and is easily kept bee-proof, and costs but little, and is easy to construct.

WAX-RENDERING.

Beeswax is a part of the product of the apiary for which there is always a great demand, and it brings a good price. All undesirable combs, fragments of combs scrapings from the frames and interior of the hives should be saved and rendered into wax, and the bees given credit for it.

In going over the apiaries, all scrapings should be balled up at each hive, and, when the cover is put on, the ball should be laid on top of it; and, after the work is done, gather up the balls of scrapings and comb, and dump them into the wax-extractor. In transferring bees the empty comb can be left in the old hives until the transferring is over; but if there is any honey in the comb it should be placed in sacks or in boxes, for the bees will tear the comb up while removing the honey, and much of it be lost if it is left scattered about. As soon as the transferring is over, all comb should be rendered up.

Almost all old people understand how to make beeswax in the old-style way, and it is a very good way too, but very messy, and sometimes they get tired of the job, and a lot of wax is lost in the slumgum.

A wax-extractor is the best device to render comb into wax. It saves labor and wax, costs but little, and is simple to operate.

After all the inferior comb has been rendered into wax in an apiary a solar wax-extractor will do all the wax-rendering for it; but where transferring is done, or a lot of old comb is to be rendered, a wax-extractor is necessary, or some other device; and the best one I have ever tried was made out of an old box-hive that was made out of twelve-inch plank. I nailed a bottom on it so that it would extend out five or six inches on the same side the entrance was on; then I tacked two small strips on this extended portion of the bottom so that, when the wax would run out at the entrance, it would run off in a narrow stream. I make a stout lattice bottom and put it down in the hive on the bottom so that it will not interfere with the flow of the wax, elevating it from the bottom with a small strip under it at each side. I set the hive on a solid foundation where I could use a pry to press the slumgum. In this I put a new strong burlap sack which had been used to put corn in, and spread the mouth of the sack over the top of the gum, and tacked it to the hive so that, when the slumgum was poured in it, it would not fall down in the gum.

Then two lard-cans were filled about a third full of water, and set on the fire; and as soon as the water was warm, comb was added from time to time until they were nearly full. As soon as all the comb was melted, a tub was set under the extended portion of the bottom so as to catch the wax and water; then the cans of melted comb were melted into the sack in the gum, the mouth of the sack closed, and the slumgum moved around in the gum so as to let all the water and wax escape that would, then the sack was well folded down on top of the slumgum, and a plunger, made about the same size as the interior of the gum, and the pry put on this, and the slumgum well pressed, then the pry removed, and the slumgum shaken up well and pressed again. Now the cans were again partly filled with water, and set on the fire; and, while the water was heating, nearly a cupful of sulphuric acid was poured into the tub of water and wax to drive or settle the impurities to the bottom of the tub; then the wax is dipped off the top of the water and poured into vessels to cake.

By this time the water is warm in the cans, and the comb can be put in; and, during this time, the slumgum can be removed from the sack and it is placed back in the gum and preparations made for another pressing.

I have made several hundred pounds of wax in one season with this device; but if only a small amount of comb is to be rendered, a much smaller device of the same kind can be constructed. Care should be exercised in melting comb around stoves; for when hot it will burn like oil. It should be melted in pots and cans over a slow fire.

COMB FOUNDATION.

Comb which the bees have built to store honey and rear their young in is saved by bee-keepers all over the United States, and rendered into beeswax by them; and then it is gathered up by agents and shipped to the manufacturer of bee-supplies, and there it is refined and all the impurities removed from it; and it is also bleached by the heat of the sun, and then



Extra thin Super.



Thin Super.

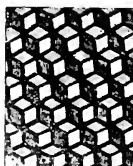

Light Brood.



Medium Brood.

run through a roller process which forms the bottom and starts the walls of the cells just as the bees would do it, and therefore is no artificial comb, as it is often called, but a pure article of comb made by bees, and purified and formed by man.

Perhaps next to the invention of movable frames or modern hives comes the invention of comb foundation. By the use of it the bee-keeper can have the comb built where he wants it and as he wants it in the hives. Otherwise, if it is left to the bees to start their comb they will build it angling or crosswise of the frames, and thus spoil the greatest feature of the modern hive, because the frames can not be handled, and the needs of the bees investigated and supplied. But if only a small strip or starter is used in the frames and sections, the bees will, from this, build their comb straight, the foundation guiding them.

Another important feature in the use of foundation is that you can have all your comb built with cells worker size by using full sheets of it.

Otherwise, if it is left to the bees they will build more or less drone comb (comb with large cells), and each season rear a large army of drones which are useless consumers. For further benefits derived from the use of foundation, see "Economy in Bee-keeping."

ROBBER BEES.

I once heard a veteran bee-keeper remark that honey-bees are in some particulars more like the human race than any other living object. I do not know that this is true; but I do know that they are similar in some particulars; and one is, taking what is another's, or robbing each other, whenever occasion permits. The bee's desire for honey seems to be about as strong as man's desire for money, and will go right between the jaws of death for it. Bees in one hive have no feeling at all for bees in another hive; and if they are permitted they will enter each other's hives and remove the last drop of their honey, showing no mercy at all. There are more or less robbers in each apiary, but the larger the apiary the more robbers there will be, and, of course, the more mischief they will do. There seem to be some bees more roguish than others; and as soon as they get to stealing from some poor helpless colony the fact is made known to all their sisters, and they all prove to be robbers. Strong colonies will defend themselves; but the weak ones are subject to them at any time, and for that reason the entrances of nuclei or very weak colonies should be kept contracted to a very small opening so that they can better defend themselves.

Robber bees can be easily detected by the way they behave around the entrances of other colonies. They fly with outstretched legs, collect around the bees which are standing guard at the entrances, and even alight near and sometimes right among the guards which are awaiting their chance to kill them, and many of them are thus killed. Sometimes robber bees have their profession so nearly mastered that they can alight down among the guards as the field-bees do, and pass in the hive and fill themselves with honey, and escape out without seeming to be detected by the bees; but these "slick" robbers are scarce, and soon disappear, or can be found on the ground in front of some strong colony dead, their bodies punctured with stings. After the robber bees have overpowered some helpless, weak colony, and are fast carrying out their stores, it is more difficult to detect them; but it will be seen that they fly from the alighting-board heavy, and some of them have made such "hogs" of themselves that they attempt to fly, but fall on to the ground, and a number of them may be seen climbing up on grass or weeds, so that they will have a start to fly. Then if you will open the hive you will see them at their mischief, carrying out the honey, tearing down the comb, and running over the helpless

inmates of the hive. The best treatment for a hive thus pillaged is to remove all frames containing honey, and the robbers will soon disappear; then exchange these removed frames for frames of hatching brood from other colonies, and set them in the hive and close the entrance up completely with wire cloth for two days; then, remove the wire entrance near night, and contract it so only one bee can pass. By this time the bees will be over their struggle with the robbers, and, more bees being hatched out, they will set up a defense and protect themselves.

If the hive thus affected by robbers should be a strong one, all that is necessary is to fill the entrance with some grass or weeds until night then they can be removed and the entrance contracted. During the night the bees will come to their senses and kill the robbers (those that do not escape) and will set up a strong defense next morning, and likely will defend themselves.

Sometimes bee-keepers cause robbing by carelessly leaving honey cut around the apiary, or the honey-house door open. When there is no honey-flow on, bees are much worse to rob, and just a little sweet carried into the hives by the professional robber will cause a great excitement in the apiary, and some damage is sure to be done; hence great caution should be used in handling sweets about the apiary. Bees should not be fed until about night; for if the fact is made known to them that there are obtainable sweets, many of them, not knowing where the feed is, will rush out of the hives and make great efforts to get in other hives, and perhaps will, and many bees will be lost.

If robbers collect too thickly about hives while extracting, the combs should be stacked up in the honey-house until about night, then given back to the bees, for this will greatly decrease the number of them; then if they should collect too thickly, the extracting should be postponed until the next honey-flow, or done at intervals.

FERTILE WORKERS.

Fertile workers, or, rather, laying workers, may appear in any neglected apiary. When a colony of bees loses its queen and has no brood, or is not supplied with any from which to raise them another queen, they are hopeless, and they fully realize it, and their last and only resort is for some worker or workers to take upon themselves to lay eggs to continue the existence of the colony. But this last effort is a failure, because worker bees can lay only unfertile eggs, which hatch drones or useless consumers, and soon the colony is in the hands of the bee-moth, and destroyed, for the bees fast diminish, and soon the colony is weak.

It is not difficult to tell when a colony of bees is affected by laying workers, for they will not deposit their eggs in regular order in the cells as a laying queen will, for sometimes they will lay more than half a dozen eggs in one cell, and very often more than one; and to be sure that the colony

is affected by them it can be easily examined; and if there is no queen present, there are fertile workers. It is useless to try to introduce laying queens to colonies thus affected, for the bees will kill them, and they will not always accept a queen-cell, especially if the colony has been affected by them for some time; but if not, they may accept a ripe queen-cell (one nearly ready to hatch), and the colony be saved; otherwise it had better be broken up and the combs given to colonies, for the bees are very old, and will soon die, and not be of much value anyway; but if the colony is strong, exchange the frames for hatching brood from strong colonies, and in a few days there will be many young bees in the hive, and they will accept a queen or a queen-cell, and perhaps already have cells started, if there should be any very young bees in the cell of the proper age to raise a queen from.

Fertile or laying workers are a pest, and no apiary or colony of bees should be so neglected as to be become affected by them.

QUEEN-REARING.

Queen-rearing is a very important part of bee-keeping, but comes on later, after the bee-keeper has done considerable practical work among his bees and has given them much thought, and has his apiary in a progressive condition. If queen-rearing is taken up at the same time bee-keeping is, you have bitten off too much at one time, for it is enough to study and care for your bees at first, and, later, you will gradually grow into queen-rearing anyway. But don't wait until you acquire this knowledge before you supply your colonies with good queens, select yourself a queen-breeder or a bee-keeper who raises a surplus of queens, and has some to sell. He will furnish you with good queens at a reasonable price, and at the same time give you all needed instructions to introduce them successfully to the colonies.

It is not a good idea to buy queens from different queen-breeders, for you are likely to get your stock mixed, and it will give you a lot of trouble. So it is best to select yourself a queen-breeder who is making a specialty of the strain of bees you wish to keep.

It is poor policy to begin bee-keeping with an inferior or run-down strain of bees to practice with, or to gain knowledge from, for it is uphill, and steep at that, and results are not at all satisfactory; and I want to emphasize this fact, because it is the cause of there being no more progressive apiaries in the South than there are. So it is very necessary to have a good tested queen in each hive as soon as we start bee-keeping.

But going back to the subject of raising queens, it will be noticed that, under the heading of "Honey-bees," a queen bee is developed by the worker bees by highly feeding her, and by the care they give it, and, of

course, the more bees there are in the hive to feed and care for it while it is developing, the better the queen she will be. So to expect the very best queens, we must have strong populous colonies to develop them.

It is not necessary for me to call your attention to the fact that queens should be raised from the very best queens obtainable, as we would breed from the best stock of animals to expect the best results of them. If we develop queens in strong colonies from the larvæ, or very young bees, of a queen whose workers are great honey-gatherers, we may expect good prolific queens, and that their workers will also be good honey-gatherers.

On the other hand, if a queen is raised by a small colony of bees from poor stock we could expect only a poor queen. So whatever the characteristics of the queen are, her offspring will possess; and if she is not properly cared for while developing she will be dwarfed, and her colony of workers will be small, and results will not be satisfactory. If we will look after our queens, and give them the proper showing, we need not fret about the honey that is going to waste around us, for she will produce bees and save it, if weather permits.

It is evident, from what has been said, that the queen is the main bee in the hive, and that her progeny is a matter of great importance in keeping bees for cents and dollars.

In a few hours after a colony of bees has been made queenless they will start to raise them another queen; and to make sure of this they will start a number of cells. Or if their mother is old, and shows signs of failing to keep up the colony, they may set to work to raise them another queen to supersede their mother. Or if they decide to swarm they will begin to raise them another queen to take the place of their mother after she goes out with the swarm.

Good queens can be raised in strong colonies almost any time during spring, summer, and fall when there is some honey coming in and the weather is warm.

Now, if you have the experience and desire to raise queens in a wholesale way for the market you should get a queen-rearing outfit and book of instructions, and read it over several times, and study it until you have the work clear in your mind and then proceed, following instructions as nearly as possible. If you desire to raise only a few good queens to supply your own apiary or apiaries, and perhaps a few surplus ones to sell, and the queens are desired in early spring before swarming time, as soon as the weather warms up a little and some honey and pollen are coming in from the earliest honey and pollen plants, kill or remove the queen in the apiary that is giving the poorest results, then on the next day go to the strongest colony and lift the frames out carefully, and examine them closely for the queen; and when you find her, set the frame she is on carefully beside the hive to itself. Now lift out all the remaining frames in the hive which have any brood in them of any consequence; then set the frame containing the queen back in the hive, and all the frames of honey, and those that may have a small patch of brood in them, pushing them

up close to get her to one side of the hive with the frame the queen is on in the middle. Now put a queen-excluding honey-board on the hive, and an empty hive-body on top of this; then set the frames of brood and the adhering bees in the empty hive and push the frames to one side of the hive just over the frames in the lower hive. Now set the division-board in the top, hive close beside the outside frame of brood; then set a feeder in this open space between the side of the hive and division-board, and fill it full of feed and put the cover on.

On the evening of the next day go back to the hive you had killed the inferior queen in two days previously, and lift out all the frames except two or three which have only scattered honey around in them; and as you lift the frames out, brush all the bees off the comb back in the hive and put the cover back on. Now take these five or six frames from which you have brushed the bees and carry them to the hive you had, one day previously, divided into two parts, and lift the top story off gently and remove the queen-excluding board; then look over carefully the frames you have carried to the hive, and set all of them to one side in which the bees have started queen-cells (it is likely they have started a nice batch of them by this time). Then set the frames that have no queen-cells in them in the bottom story of the hive, which will be about enough to finish filling it, and the queen you have confined to the bottom story now has another full set of frames to occupy.

Now put the queen-excluding board back on the lower story, and set back the top story on this. Now make a little grafting-tool by sticking the sharp end of a pin in the hollow of a broom straw, and with the head of the pin remove all the larvæ, or young bees, you find in the queen-cells started about on the comb which you brought to this hive.

Now take out one of the frames in the top story; then begin to graft the cells by inserting the grafting-tool, or the head of the pin, down in the cells, gently working the head up under the tiny larva; then lift it out gently and insert it in the queen-cell and leave the larvæ down in the bottom of the cells from which you removed the other young bees. Be careful in this operation not to mash the tiny bee, but gently remove it from the head of the pin on to the royal jelly.

The larvæ for this purpose must be very small, or not over three days old, and two days is better. After you have thus grafted all the queen-cells started in the comb you have brought to the hive, set the frames in the top story, and again fill the feeder up and put the cover on.

Now, as there is no queen present in this top story (she being confined to the bottom story by the queen-excluding board), the bees seem queenless; and the feed being scattered plentifully over the comb, the bees will feed the larvæ well, and good cells will be built. Bees will often build cells when their brood is put up in top stories and no queen present; and they are sure to if started cells are given them, and they may build a nice batch of fine cells. But during this operation the weather must not be too

cool or the tiny bees in the cells will get chilled and not produce good queens.

Let us now go back to the colony we made queenless and left two or three frames of honey with. As soon as we get through grafting the cells in the other colony, and the cover is on, they should have a little attention. Part the frames so the bees can cluster between the combs; and as soon as they are all in the hive late in the afternoon, they are in the best possible condition to unite, and should be united with the next weakest colony (see "Uniting Bees").

Eight or nine days after the cells are grafted, go back and look over the comb and see how many cells they have finished, and you will know how many places to prepare for them; then if you have some inferior queens you wish to supersede, kill them, but not to exceed the number of cells you have. Then on the next day, or ten days from the time the cells were grafted, remove the cells from the comb by cutting around them carefully with a knife; but be sure not to cut into them or you may injure them. Then lift them from the comb and place them in cell-protectors; and be sure not to tumble them about, for it is best to keep them as nearly as possible in the same position that they were in on the comb.

After all the cells but one have been removed from the comb and placed in the cell-protectors, they are ready to be distributed around to the colonies made queenless the day previous. The object of making the colonies queenless previous to giving them cells is that they have had time to discover that they are queenless; for should the young queen emerge from the cell before they were aware of their queen being gone, they might kill them as soon as they emerged.

Queen-cells should be inserted in the comb among the bees where they can care for them and keep them warm until they hatch.

Now, the top hive with all the frames and adhering bees and the one queen-cell can be put on another stand; and the bees confined in it for a day will cause them to mark their new home, and you will soon have another good colony of bees. If you have no need of all the cells, and would like to turn them into a little cash later, divide the frames in the top story into two, three, or four frame nuclei, and give each one a cell, and confine them in the hive as you would a full colony, so that they will mark their new home.

In one or two days the queens will emerge from the cells, and in ten or twelve days will be laying.

This is a plan to raise good queens at any suitable time of the year; but the same result can be obtained by watching the cells closely in hives where bees have swarmed; and as soon as the bees begin to thin them down at the ends, remove all the cells but one or two, and requeen with them or distribute them about in nuclei (hives with only two, three, or four combs in them, and a part or a very small swarm of bees). When bees are superseding their queen you can also get a good batch of queen-cells which can be used in like manner.

It is not good policy to remove a good queen from her colony just to get her bees to build queen-cells when you can get the same results by

keeping her in the hive laying, and keeping up the colony. If it is desired to keep the bees in the prepared top stories building queen-cells, keep them brooded and supplied with started cells, and feed slowly if there is no honey coming in.

In commercial queen-rearing, queen-breeders usually use cell-cups, and not have the bees to build the cells around over the comb. This is more convenient, and does away with the cutting of holes through our nice combs to remove the cells. Of course, the same results will be obtained by having the bees to build the cells over the cell-cups in top stories debarred from queens, and full of young bees and brood.

Where bees are allowed to build queen-cells over the comb, some precautions must be observed or the bees may build cells over undesirable larvæ. To avoid this, when a batch of cells are grafted insert a small nail in the comb above each one; then if it is desired to graft another batch three days later in the same top story, insert the nails in the comb to the right of the grafted cells; then if it is desired to graft another batch of cells three days later, insert the nails in the comb to the left of the cells. In this way you know the contents of the cells, and when each batch should be removed. In nine days, and not later than ten from the time the cells are grafted, they should be removed and placed in cell-protectors and distributed around in nuclei or wherever they are to be placed, to emerge from the cells and be mated.

Many of the queen-cells built around on combs can be removed without cutting through the segment of the comb by using the small blade of a knife, cracked near the point; and if a cell should be slightly punctured where it was connected with the segment of the comb it should be immediately squeezed together; and when inserted in the cell-protector the cover should be placed down on it.

If holes are made through the comb to remove cells, sooner or later the bees will fill them up and the comb will not be damaged much.

Queens should not be allowed to emerge from their cells in the cell-building colonies, for they will destroy the other cells. During heavy honey-flows as much as two empty combs should be kept in the cell-building supers or top stories to keep the colonies from swarming, or a super of shallow frames can be inserted between the two stories.

HALL'S METHOD OF QUEEN-REARING.

THE HIVE FOR CELL-BUILDING.

Make the hive wide enough to hold fifteen or twenty full-depth brood-frames, and make the entrance at the side of the hive instead of the end, with a wide alighting-board; then make a close-fitting division-board of queen-excluding zinc, so that, when the cover is on the hive, there is no chance for the queen to pass from one apartment to the other. Place the

division-board in the hive so there will be just room enough for six brood-frames between it and the side of the hive where the entrance is. This six-frame apartment next to the entrance is for the queen to occupy, and she should never be allowed to enter the other twelve or fourteen frame apartments of the hive, which is for cell-building. The cover for the hive should be made in two sections—one covering the queen's apartment and the other the cell-building apartment, so that the bees will not be disturbed in both apartments by removing the cover when it would not be necessary.

THE COLONY OF BEES FOR THE HIVE.

A very strong colony should be selected for this hive, one that will build a large number of very fine^{*} large cells. Place the queen and six frames of unsealed brood in her apartment of the hive close up to the division-board and put the cover on her apartment; then place the frames of sealed and hatching brood in the cell-building apartment close up to the division-board, and keep the frames on either side jammed up to it, and put the cover on this apartment.

DIPPING-STICKS AND CELL-MAKING.

Make as many dipping-sticks as you think you will need, out of wood that will finish up smooth; then round them up so that they will be about as large as a pencil, or just a little larger, and round them off at the dipping ends so that they will be as near the shape of natural queen-cells as possible; then tack them on a small thin strip of soft lumber by driving the nails through the strip into the dipping-stick. The apparatus now resembles a very small close tooth-rake. Clean the dipping-sticks up well so they will be as smooth as possible; then place them in water, before using, long enough for them to be thoroughly soaked, and the hot wax will not adhere to them.

The wax for cell-cups should be thoroughly clean, and just hot enough to run freely; then insert the prepared sticks into it about $\frac{1}{2}$ or $\frac{3}{8}$ inch, and continue to insert them in it until they are thick enough to stand handling; then remove them. The kink of forming cell-cups is soon learned by a little practice.

GIVING THE CELLS TO THE BEES IN THE CELL-BUILDING APARTMENT.

Select two of the best frames of unsealed brood from the queen's apartment, or any other colony in the apiary that may have choice combs of unsealed brood (always leaving the queen in her room), and insert two other frames in their places.

Now stick as many of the prepared cells as you desire on one side of these combs, and press them in the comb so that the mouth of the cell-cups will extend downward, and just a little out beyond the surface of the comb, so that they can be easily grafted. If you have a large batch

of cells, place them in rows on the comb about $1\frac{1}{2}$ inches apart, and about one inch between them. When all the cell-cups have been carefully placed in the face of this side of this comb, move all the combs except two back from the division-board in the cell-building apartment, and put in the two frames of unsealed brood, one of which contains the prepared cell-cups inserted in one side of it, close up to the two frames left next to the division-board, so that the cells will be between the two frames of unsealed brood. In about two hours the bees will have the cells polished, trimmed round and even, and attached well to the comb; and they are warm, being of the same temperature as the interior of the hive, and in the best possible condition for grafting.

THE GRAFTING-STICK.

A piece of green hickory or white oak, or any kind of wood that will bend and not break, will make a good grafting-stick. Make it about three or four inches long, and about the size of a toothpick made out of a feather, and shave one end down to a feather edge, and trim it until it is about as wide as the point of a pen; then curve the end so it will dip out tiny larvæ.

GRAFTING CELLS.

Select a comb containing very small or tiny larvæ from the colony containing our breeding-queen, and remove the comb from the cell-building colony which contains the prepared cell-cups, and place it in position so that the mouth of the cells will extend upward, and the bottoms be clearly and easily seen. Now take the selected comb of tiny larvæ in hand, and, with the grafting-stick, proceed to dip out the larvæ carefully, and place them gently in the bottoms of the cells by giving the stick a side move.

When all the cells have been thus grafted, set the comb back in its place in the cell-building colony. The other frame of unsealed larvæ should not be so close to the side of the comb containing the grafted cell-cups that the bees will attach them to it while building them out. Make the date of grafting on the top-bar so you can tell when the cells are ripe. Place the cover on, and in 24 hours examine the cells and remove those that the bees have not accepted, and they will do for the next grafting, which can be done six days later.

Grafting should be done during the warm part of the day, and the larvæ should never be exposed to the direct rays of the sun.

In nine or ten days the cells will be ready to be removed and placed in cell-protectors, and distributed out in nuclei or queenless colonies prepared for them.

If it is desired to raise queens in a wholesale way, have the cells started in three or four frame nuclei which have been made queenless for 24 hours previous to the time the prepared cell-cups are given them to be polished, trimmed, and cleaned up. Of course, the cells should be inserted on the side of the comb containing most unsealed brood, and

grafted as previously explained, and given back to the nuclei for 24 hours, then removed to the cell-building colony and placed between two frames of unsealed brood as previously explained.

This process of cell-building can be carried on throughout the season, but a honey-flow or feeding is absolutely necessary. Thus you see the cells are between two solid walls of unsealed brood, and right in the comb; and it is the nearest method to nature's way of building cells of which I have any knowledge. No royal jelly is necessary, and no cell-holders or cell-bars are to be bothered with. Large queens are not always developed in large cells; but large cells are most likely to contain large queens.

T. S. HALL,
JASPER,
GA.

FINDING AND INTRODUCING QUEENS.

The queen is the only perfectly developed female in the hive, and her size is between that of a worker and a drone; but her abdomen is about a third longer than that of a worker and about a third larger; is richer in color than the worker, and can easily be distinguished from a drone because she is more in the shape of a worker. Usually there is only one queen in a hive; and sometimes, but not often, two, for the bees discover that their mother is failing, and raise them another one to take her place, when she will be permitted to remain in the hive with her daughter for a while.

The queen is the mother of all bees in the hive, which are from 30,000 to 50,000 strong; and, of course, to find her in this mighty army of bees is often no small task. Remove the cover from the colony you wish to find the queen in, and use no more smoke than just enough to keep the bees subdued; for if you use too much smoke it will cause them to leave their quiet position on the comb and go to crawling about over the interior parts of the hive, and boiling out of it on the alighting-board and over the top of the hive; and the queen will, of course, join them and be much more difficult to find than if you had used only enough smoke to keep them subdued.

Remove the division-board and lift out the frame next to it and look over it well and set it beside the hive on the outside, and lift out the next frame: look it over, and set it back in the hive; then lift out the next one and look over it well, and so on until all the frames have been carefully lifted out and looked over for the queen. If the queen has not been found during this search, look the frames over again carefully; then, if she is not found, set them all back in the hive and put the cover on; and after an hour or more repeat the search until she is found. Usually the queen is found on the first or second search; and during the search keep a close watch on the bottom and sides of the hive, for often she will be found there.

Of course, queens are more easily found in a nucleus, or small swarm of bees. If the frames or comb in a patent or similarly constructed hive

are not movable, disturb the bees and let them fill themselves with honey; then send the smoke down between the frames until the bees set up a march to go out on the alighting-board to escape from the smoke. Continue the search by sending a little smoke down on them, and at the same time watch the marching bees closely until the queen marches out; then you can pick her up. If it is desired to remove a queen from an old box hive, remove the top and send in the smoke at the entrance, and soon the queen will be seen crawling around on top of the comb or the sides of the hive; then she can be caught. A queen should never be handled roughly, nor mashed, for it will greatly injure them, unless it is desired to kill them. It is not a good idea to catch or handle queens at all unless it is necessary.

INTRODUCING QUEENS.

Bees have a very great sense of smell and in this way they seem to know each other, and, of course, they know when a strange bee or queen is among them; and as they allow no intruding bees except drones among them they will kill them. It matters not how much they need a queen, if a strange one is given them they will soon ball her to death.

Queens are sent through the mails in small wood and wire cages, with directions on each cage how to introduce them to a colony; and if these directions are carried out there will not be many lost in introducing them. And if queens are to be introduced from one hive to another in the same apiary, or carried from one apiary to another, they must be put in similar cages with plenty of candy (a very stiff dough made of strained or extracted honey and pulverized sugar), and then introduced in the same manner you would queens sent through the mails. Queens sent through the mails should be examined as soon as they arrive, to see that they are alive and in good condition, for sometimes they will die in the mails or be badly daubed or smeared with the candy. The cause of this is that the mail has in some way been exposed to the direct heat of the sun, which, of course, would soften the candy, and the queen and her escorts would be daubed or smeared with it, and be in poor condition to introduce.

If the queens arrive very badly daubed or dead they should be mailed back to the sender, who will make the loss good by sending more queens in their place. But the queens in good condition should be introduced as soon as possible according to the directions found on the under side of the pasteboard which is tacked over the wire cloth and which contains your address. It will be seen that there is a very small strip of pasteboard tacked over hole filled with candy on one end of the cage. This should not be removed. The object of it is to delay the releasing of the queen, for they would soon eat the candy out of the cage and release the queen before the bees can get acquainted with her, and, of course, they would kill her. It usually takes bees and queen more than 24 hours to form an acquaintance.

After the pasteboard has been removed from over the wire cloth, introduce the queens as follows:

Remove the undesired queens and kill them, and give the bees the caged queens by slipping the cages between two top-bars of the brood-frames con-

or to keep for home use, but put it up in small jars, 25 or 50 cents' worth in each one; for after the comb gets torn up, stirring through it to find ice chunks, its beautiful appearance is spoiled, and it will not bring a fancy price. See "Chunk Honey."

The first large swarms that are hived can be robbed as soon as the honey-flow is over; but if they are small swarms, or are hived late, they should not be robbed the first year, for they will need what surplus honey they have; and, besides, small swarms rarely build their comb very far down the first season; and if the tops are removed the combs are apt to break loose and fall; and the result is the colonies are lost. Hundreds of colonies are destroyed in this way each season. Bee-keepers should know about how much honey there is in hives when they are robbing them, so as not to rob them unmercifully. Sometimes bees store all their honey in the top of the hive; and if it is removed they are soon starved. If a colony has not plenty of stores it should not be robbed at all, for they need what little they have. Also, a more prolific variety of bees can be introduced—see "Finding and Introducing Queens." After the old queens have been removed, place the caged queens down in the comb just in the edge of the cluster of bees or the brood-nest.

The care that bees can receive in old-style gums or box hives is very limited, and I have mentioned only these few things that you may keep the bees along until better hives and appliances can be obtained for them.

SOUTHERN HONEY FLORA.

The South is rich in honey resources, and many sections and locations are a paradise for bees, and there are many of them that have not one colony of bees in them, to save any of the vast amount of honey that is wasted each season. Truly, if honey-saving were given its due attention the South would flow with honey, and a vast amount of the wholesome sweet would be saved and consumed in place of other inferior sweets. Our natural appetite calls for it from childhood up; and our weak bodies need it to nourish them. There are thousands of farmers scattered over the South who are tied fast to the post of constant toil for the necessities of life, and the children of many of them are deprived of educational advantages to help stay the "wolf" from the door, when there is enough honey going to waste in the fields, along the ditches, and the fence-corners, and over the waste land and around in the forest to help or make them independent if they would only turn a little of their attention toward saving it.

The field for hustling bee-keepers is extensive and rich, and transportation, health, and climate are all that could be expected; and there are located here and there all over the South progressive bee-keepers who are reliable, and ready to give information to those who desire and ask for it.

There are many kinds of blooming plants which yield some nectar and pollen, and are of some value to bee-keepers; but to go into full details on

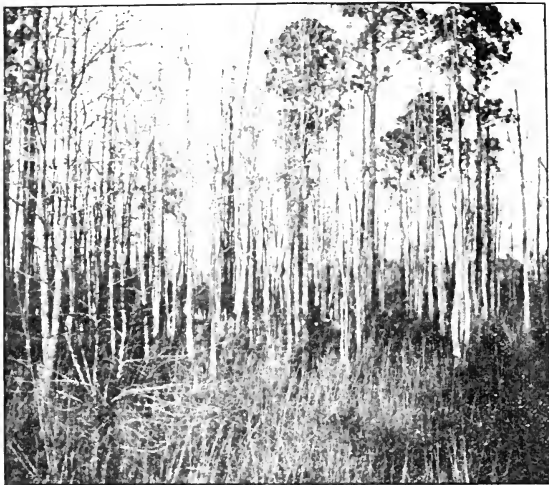

Black Gum or Tupelo.



Carpet Weed (*Lippia Repens*).



Catclaw.



Century Plant.
The richest in nectar of any American plant.



Gallberry.



Horsemint, of Texas.



Marigold, of Texas.



Jasmine, of the South.

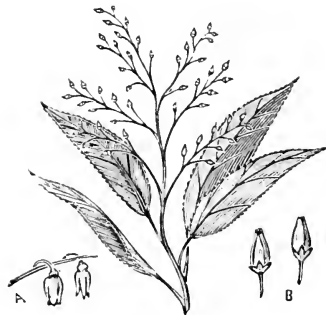

Sourwood.

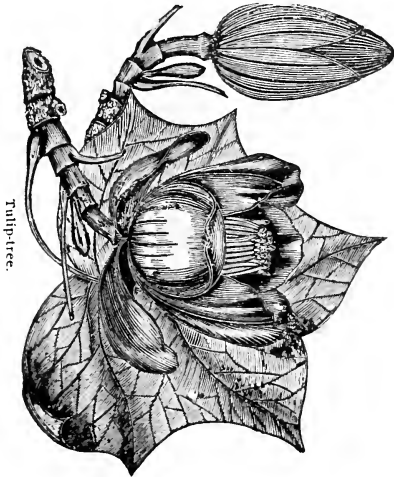

Tulip-tree.

these various plants would take up too much space; and as the contributors to this book give much information on the Southern honey flora I will not list the honey and pollen plants.

BEE-KEEPING IN THE SOUTH.

I am proud of the South as a bee and honey country, and of the possibilities there are here for the bee and honey industry, and the wonderful progress it is making. Until late years but little has been known of modern hives and bee-keeping appliances which were invented and first manufactured in the North. Now the Northern bee-keepers' supply manufacturers have branch offices in many sections of the South from which bee-keepers are supplied, saving heavy transportation charges. The majority of these agents were reared in the South, are progressive bee-keepers, and are doing all in their power to promote the industry here. We have also Southern bee-keepers' supply manufacturing plants, one in Alabama and one or two in Texas, which are manufacturing bee-keeper's supplies and distributing them all over the South. With this large amount of available bee supplies, which are sold at a reasonable price, it assures a rapid progress for the industry. Thousands of bee-keepers have already adopted modern appliances for their bees, and the number is greatly increased each year.

Then literature, to enlighten the people's mind along the lines of bee-keeping or bee culture has been slowly penetrating the South; and bee-keepers have been backward in expressing themselves or giving their views or experiences in the culture of bees. But these conditions have changed, and it is hoped that the honey-bee and its culture will soon be better known.

The Southern climate seems to be ideal for bees and bee-keeping; there is no heavy loss sustained from cold, even if they are wintered on their summer stands; and there are but few days during the winter when bees are confined to their hives; and the constant flights assure good health for them. Spring brings with it many blossoms laden with rich pollen upon which bees build up rapidly; and with just a little attention they will be in splendid condition for the spring honey-flow.

The bees' working season is long, and sometimes it seems rather long to us bee-keepers; but great progress can be made with our bees during this time; and there are honey-flows heavy or light at intervals along during the season, assuring that great progress can be made in bee-keeping.

Spring usually brings with it a long and heavy honey-flow, and during summer there is a long and heavy honey-flow in many locations; and fall also brings a heavy honey-flow which furnishes some surplus honey and winter stores for bees.

Long seasons with honey-flows at intervals assure a crop of honey at some time during them; and in but very few sections has there ever been a total honey failure.

cool, a colony can be formed in the same way over a strong colony with wire cloth between them, so that they can get the benefit of the heat of the colony below. In five or six days it can be removed and set on its desired stand, and a small entrance made for only one bee to pass at a time.

Queens will be accepted better when there is a honey-flow on than when there is a honey-dearth; and during summer and autumn is perhaps the best time to requiren.

Caged queens should never be allowed to remain in a cool place, for they are likely to be chilled and injured; and they should remain in a cage but a short time before being introduced.

OLD-FASHIONED BEE-KEEPING.

There are thousands of bee-keepers who keep their bees in box hives and log gums just as bees were kept many years ago, and they will never put a swarm of bees in a modern or up-to-date hive, but continue on the old-fashioned way of keeping bees.

There is not much culture we can give bees in such hives; but they can receive much more than they usually do, and should be examined a few times during the year to see that they have plenty of stores and the proper room to store honey in. In the fall of the year the light hives should be fed by removing the tops and setting small pans, 1½ or 2 inches deep, in on the comb in the top of the hives; then fill them with straw or hay, and fill them with feed (see "Feeding Bees"), until they have been fed enough. The tops must fit down well on the hives or the robbers will get in and eat up the feed. In early spring they should be closely examined again; and if they need feeding, feed them again. Then just before the first heavy honey-flow clean out the tops of the hives, removing all the comb down eight or ten inches below the tops, so that the bees will build new comb to store their honey in. If there is any honey in this old dark removed comb, stretch a burlap sack over a tub and bind it well with a strong cord or small rope so it will not sag down much, and then pour the honey on it; then work it up thoroughly with your hands, mashing up all chunks of comb well and let it stand and drip for twelve or fifteen hours; then the comb and honey will be separated, and you can render the comb into wax, and the strained honey can be put in the feeder and fed back to the bees as you would feed, filling the pans well with straw to keep the bees from drowning in the strained honey. The bees will carry the honey down and store it in the old comb around the brood-nest; and as soon as new honey comes in they will start comb-building in the top, and store their new honey there. Of course, the most of this honey should be fed to the lighter colonies. As soon as the first honey-flow is over, rob the bees and you will have all nice new honey in white comb. Then do not remove it and put it in lard-cans or large vessels to carry it to market

taining most brood, with the side of the cages covered with wire down, so that the queen and the bees in the hive have access to each other, and thus form an acquaintance. The frames must be pressed up firmly against the cages so that the cages will not drop down between the combs on the bottom of the hive.

Do not molest the bees any more for three or four days. During this time the bees and queens will form acquaintance, the queens will be liberated, and all be quite at home together; and if any queens should not be received they have queen-cells, and soon have a laying queen anyway; then she can be killed, and another one introduced. If the bees have not accepted the first queen introduced to them it is not likely that they will accept another one; but just let them raise them one; and as soon as she begins to lay, give them another one.

Usually bees will start queen-cells with a queen caged in the hive; and if she is not accepted they will be safe any way. But if queenless bees are supplied with frames of brood in all stages of development from time to time, they will be much more likely to accept queens than if they have been broodless and queenless for some time. Queenless bees should always be supplied with brood or young bees to feed, because it will keep them from becoming hopeless, and at the same time will keep them built up, and likely they will accept a queen at any time. But when queens are given to such colonies, all queen-cells should be torn down at the time the queens are placed in the hives, for the bees will not be so apt to accept queens with ripe queen-cells in the hive at the time the queens are placed in the hives.

Sometimes bee-keepers have or buy a choice queen they want to introduce in a sure way. Prepare an empty hive body, bottom, and cover, and set it on a stand, and look over an apiary and select the choicest frames of sealed hatching brood, and fill the empty hive with them, and close up the entrance so no bees can escape. Then with the small blade of a knife remove the candy through the small hole at the end of the cage so the queen and her escorting bees can easily pass out; but keep your finger over the hole, for the queen may fly out and be lost; and place the cage firmly between two frames; remove your finger, and quickly slip the cover on. In five or six days make an opening so only one bee can pass out. By this time there is a good-sized cluster of bees hatched out, the queen is safe among them, and they are strong enough to defend themselves if the entrance to their hive is very small. In seven or eight days from the time the colony is formed, look over the comb; and if the young bees have nearly all emerged, give the frames of comb back to the colonies you took them from except the three which have the most young bees in them. Let those remain, and from time to time add to this small colony frames of sealed brood until it is a full colony. When you first remove the frames of hatching brood to make the colony, be sure there is not even one old bee on them, for it might kill or injure the queen; and do not add any old bees at any time while building the colony up. The hives where these frames are removed from can at once be supplied with extra frames of comb which may be about the apiary, or frames of wiring full sheets of foundation can be used for this purpose. If the

Now let us look over the statistics and see what is being done in the bee and honey industry here in the South at present.

	Number Colonies	Pounds honey per annum.	Pounds wax per annum.	Value honey and wax.
North Carolina	250,000	2,500,000	150,000	\$300,000
South Carolina	100,000	900,000	50,000	100,000
Georgia	200,000	1,800,000	80,000	200,000
Alabama	250,000	2,500,000	150,000	300,000
Mississippi	100,000	900,000	50,000	100,000
Louisiana	50,000	500,000	30,000	60,000
Texas	500,000	5,000,000	300,000	500,000
Arkansas	150,000	1,500,000	75,000	200,000

These figures are interesting, and show that our industry is a paying one, and by no means a small one; yet it is nothing compared to what it should be and will be. The great amount of honey saved by the bees is not much more than a drop compared to what is wasted for lack of bees to save it.

The outlook for the bee and honey industry at present in the South is certainly a bright one. There are progressive apiaries in operation here and there all over the South, and men are devoting their entire time to the industrious bees, and wondering why a greater number of people are not more interested.

I have asked a few of these progressive bee-keepers located in different sections of the South to send me a write-up of bee-keeping, and the prospects of it in their location; and they responded, giving some names of other progressive bee-keepers located in the same section.

I thank them, one and all, for their kindness, and I am sure that their enthusiastic write-ups will be interesting to you.

BEES IN TEXAS.

NEW BRAUNFELS, TEXAS.

THE PAST, PRESENT, AND FUTURE OF THE BEE-KEEPING INDUSTRY IN THE GREAT LONE STAR STATE.

Not only is Texas the greatest honey-producing State of the South, but of the United States; for in its large annual output of honey products it surpasses all other States, producing crops of honey much more regularly than any other in the Union.

BEE-KEEPING OF THE PAST.

There are no available records of the beginning of bee-keep- Texas, hence it is not positively known when the first bees came into this State. The industry for a long time progressed very slowly, and remained in its

infancy for many years. Not a score of years ago there could be seen in many dooryards a few "bee-gums," or sawed-off hollow logs, standing on end, while some box hives were also used. There was no way of examining the colonies domiciled in these, nor of ascertaining their condition at any time without tearing asunder hive, combs, and all to gain access. To obtain the little surplus honey necessitated the cutting-out of the combs, much of it contained "bee-bread" and brood, which were then mashed up, and the honey separated from the comb by straining through a cloth. The resultant product had in nearly all cases a strong taint of bee-bread, or pollen, left, both in the color and the flavor of the honey.

For the bees the removal of the honey meant either the brimstone-pit, long in vogue, over which the bees met their fate, or, if they escaped this method, the mashing of honey-comb and flowing honey over bees, brood, and all of the hive, to be righted again by the bees as best they could. In many cases the bees from other colonies would rob the disturbed ones and weaken them so that the wax-moth larvæ, or "worms," soon overpowered them and destroyed the poor colonies entirely.

Thus it was that slow progress was made in bee-keeping. An owner with a dozen or more colonies increased them by letting them swarm and reswarm—a process which so weakened the mother colonies for the honey harvest that a very small harvest was obtained.

In the fall and winter the loss of colonies would bring the apiary back to its original number of a dozen or less, and the bee-keeper (?) thought he had done well if he had "13 colonies—12 three years ago—the web-worms killed them." There are large numbers of these bee-keepers still, but these are waning slowly, the movable-frame hive coming more and more in evidence everywhere.

STATISTICS ON BEES.

There are no statistics at hand to show the extent of bee culture in Texas at the present time; but we know that the industry has developed rapidly and steadily during the last score of years.

From one of our State College Apiary Reports is quoted the following, printed in 1902:

"Texas excels every other State on her honey production; yet to one who has studied that situation and vast territory and vegetation of this State, it is evident that as yet Texas does not produce one-tenth the honey which it might through proper management and further development. A careful estimate shows also that at least 90 per cent of the bee-keepers of the State are not practicing up-to-date or modern methods of bee-keeping, thereby getting less than one-half of the possible amount of honey from the colonies already at hand. * * *

"Some of the possibilities of honey production in Texas may be better understood from a study of Uvalde Co., which is practically the only county in which bee-keeping has been developed to anything like its possible extent. In this county and immediately adjoining, according to Mr. J. K. Hill,

of Uvalde, there are located about 15,000 colonies of bees, representing, with apparatus and fixtures used in their care, an investment of at least \$120,000. In average seasons under competent management, these colonies yield from 100 to 220 pounds of honey each. Aside from honey sold and consumed locally, there is shipped from Uvalde annually an average of 546,000 pounds, representing from \$54,000 to \$60,000. There are in Southwest Texas at least thirty counties that would, if properly developed, equal or excel this yield. In addition to this there is valuable honey-producing territory along the Colorado, Guadalupe, Brazos, Trinity, and Sabine rivers that is as yet almost totally unoccupied. The entire East Texas territory, some parts of North Texas, as also the timber belts, are promising for future development. * * *

"The United States census for 1900 (U. S. Census Bulletin No. 229) gives the total number of colonies in Texas for that year as 392,644. Estimate at \$3.50 per colony, their value is seen to be \$1,374,254. The amount invested in honey-houses and other apparatus connected with bee-keeping, exclusive of hives, will doubtless approximate 5 per cent of this amount, or \$68,712 more. The State Bee-Keepers' Statistics, as compiled by Prof. F. W. Mally, show that, in 1900, 150,000 colonies under Texas conditions produced 11,250,000 pounds of honey, or an average of 75 pounds each. For all the colonies in the State, this would, without doubt, be too high an average. Thirty pounds per colony would seem a conservative estimate. This makes the production of the 392,644 colonies 11,779,320 pounds, which, at an average price of 6 cents per pound, aggregates \$706,759.20. Also about \$3,500 worth of queens are annually raised and shipped from Texas. No estimate of the wax produced, or colonies shipped from Texas, is given, but these obviously amount to considerable. Summing up we have the total capital invested, and annual output of the bee-keeping industry in Texas:

"Bees	\$1,374,254.00
Appliances	68,712.00
Honey	706,759.20
Queens	3,500.00
"Total	\$2,153,225.20

"These figures serve to show the importance of the industry which has been rapidly developing within the past few years, and great developments are possible and probable in the future."

This was half a dozen years ago. Since then Texas has made great strides in bee-keeping. The number of practical apiarists has greatly increased, and with it the number of colonies. As these are kept in frame hives, and with up-to-date methods, it is safe to say that there are now more than 400,000 colonies with a better average of honey produced per colony than six years ago.

LEADING BEE-KEEPERS.

There are numerous bee-keepers in the State who number their colonies by many hundreds. The largest owner at present is Willie Atchley, of Beeville, who owns 1600 colonies; W. O. Victor, of Hondo, owns about 1500 colonies; W. H. Laws, of Beeville, 900; O. P. Hyde, Floresville, 800,

and D. C. Milam, Noalde, 500. There are several others with 500 colonies or less, among which are F. L. Aten, Round Rock; C. A. Butts, Normanna; J. E. Chambers, Vigo; A. H. Knolle, Hondo; H. Pipev, Calaveras; T. P. Robertson, Bartlett; the Louis H. Scholl Apiaries, New Braunfels; L. Stachelhausen Bee Co., Cibolo; J. W. Taylor, Beeville; D. M. Edwards, Uvalde; Udo Toepperwein, San Antonio; W. H. White, Blossom; A. I. Davis, San Antonio; L. Jones, Uvalde; W. H. Madely, Gindale; H. A. Mitchell, Shepherd; J. A. Simmons, Oakville; M. E. Van Avery, Maxwell; and A. L. Krueger, New Ulm. A large number are listed with from one to two hundred colonies. These are all progressive bee-keepers, and the majority of them depend mainly on the pursuit for a livelihood. Others diversify, combining farming, dairying, truck, or fruit-growing and other lines with it.

MAIN SOURCES OF HONEY.

There are several main sources for surplus honey in this State, owing to the large territory contained in it of varying soils, altitudes, climatic conditions, and the consequent different flora adapted to these. Southwest Texas can well be considered the most important section for bee-keeping, as the honey-yielding flora is here most abundant. Although an arid section of country, there are numerous kinds of plants and trees, almost all of a shrublike nature, and bearing thorns or spines, characteristic of desert plains. The most abundant and widespread honey-yielder is the mesquite-tree (*meskeet*), *Prosopis juliflora*, which covers the plains and prairies of all Southwest Texas. The honey is of a very light amber, and the flavor not a distinct one as is generally characteristic of other sources. As some have put it, "the honey from mesquite is mild-flavored, and has no characteristic flavor like other honeys, of which a person sooner or later tires; hence it can be eaten more like bread at all times, making it an excellent honey for everyday all-around table use." It has two and sometimes three distinct blooming periods in each year. The first begins in early April, sometimes earlier or later, according to the season, and lasts for several weeks. Then seed-pods are formed, so that even ripe and unripe beans are on the trees when its flowers of the second blooming period open up for the bees in June and July. The yield from this source is abundant, and can be depended on as a more regular yielder than our other sources.

Considered the most important in this section is the "guajilla" brush (*Zygia brevifolia*), pronounced "wa-he-ah." This blooms in April, and yields an abundance of nectar for about two weeks, during which time, in favorable seasons, it is impossible for the bees to gather it all. This is a light-colored honey, of mild flavor, with a delicate aroma, and has become famous for its quality.

Another main source of the three most important is the "catclaw" (*Acacia Greggii*). Immense quantities of excellent honey are obtained from this source early in the season, April and May. Sometimes late cold weather cuts off this source to some extent. Besides these there are hundreds of more or less important honey-yielding and pollen-producing plants,

shrubs, and trees, some of which begin blooming in December and others ending the season with that month or January, so that actually there are "thirteen months of bloom in each year."

For Central Texas the mesquite-tree predominates. With this and the cotton-fields and horse-mint (*Monarda clinipodioides* and *M. punctata*) it is also well adapted to bee-keeping. The cotton honey-flow begins about July 1, and continues until frost. The honey is the lightest in color of the sources here, and has a characteristic flavor much liked in the well-ripened honey. When first gathered the flavor is very characteristic of the juice of the cotton-plant itself, but which disappears as the honey ripens. When granulated the honey is almost pure white, and very fine-grained. Horse-mint honey is clear, light amber in color, with a greenish tinge, and has a characteristic flavor, stronger than those mentioned, and compares well with basswood honey in character and flavor. This plant is not so abundant now as it was years ago when the prairies were covered with it everywhere. This is owing to the dry summers, as this plant is a perennial and comes up from the seed in the fall. It begins to bloom in May or June.

The cotton and horsemint are the main sources for surplus honey for North Texas. In addition, sumac, "shumack," of the genus *Rhus*, of which there are several species, blooms in the fall of the year, August and September, while one species blooms in October and November. This honey is of excellent quality.

East Texas is not so abundant in main honey-plants, but there are numerous kinds of lesser importance. The great expanse of fruit-orchards is of importance, as thousands upon thousands of acres of fruit-trees prevail here. In the southern portion of this fruit belt basswood abounds in many localities. This is the same as the well-known northern basswood, or linden (*Tilia Americana*). This tree yields more honey in favorable seasons than the bees in a locality can begin to store. It gives a very rapid flow of rather short duration. The honey is strong, aromatic in flavor, especially when first gathered, and grows milder with age. The comb honey is most beautiful, as the combs during the flow are very white.

In South Texas, especially the coast country, the rattan-vine is very abundant (*Berchemia scandens*), and is a heavy yielder of amber honey which goes mostly in barrels in biscuit-factories. The chinquapin (*Castanea pumila*) is also of considerable importance.

OTHER IMPORTANT HONEY-PLANTS.

The earliest bloomer, important for early brood-rearing, is the mistletoe, a parasite on most of our hard-wood trees (*Phoradendron flavescens*). It yields pollen and some honey in December and January. Triple-leaved barberry (*Berberis trifolata*) is a bush that blooms next in importance for brood-rearing for its immense quantities of pollen in February. Then fruit-bloom begins with the plums (*Prunus*), of which there are many species, both wild and cultivated, followed by peaches and other fruits for several months in succession. In February and March the oaks (*Quercus*) of many

species also yield much pollen. The willows (*Salix nigra*) and others, and the elms (*Ulmus*) aid much in stimulating brood. Hoarhound (*Marrubium vulgare*) begins blooming in February, and lasts until summer. This yields an amber honey of a rather nauseating flavor, claimed to be bitter in some localities, but which is lost in time, making it salable. As it is generally mixed with mild honey from other sources, no serious complaint is made against hoarhound honey.

The trees belonging to the hickory family (*Hicoria*), to which the pecan and hickorynut belong, and also the walnut (*Juglans*), yield pollen and some honey; also the cottonwood-trees (*Populus monilifera*). These are followed in March and April by a carpet over the entire open country and prairies of our State flower commonly known as "blue-bonnet," the blue lupine (*Lupinus subcaruosus*), which yields pollen of various colors from the palest yellow to the deepest red and orange. Redbud is another early stimulator early in the season, otherwise known as Judas-tree. (*Cercis Canadensis*).

Along regions where light, stony, and doby uplands prevail, what is known as rock-brush yields an abundance of excellent honey in April and May. This is *Eysenhardtia amophoides*; several species of holly (*Ilex*) also bloom during this time. Two species of persimmons are very common in Texas, and yield much honey, especially the black Texas persimmon (*Diospyras Texana*) of the western part of the State, while the yellow kind (*Divirginiana*) is more common in East Texas. Several species of crotons in May and June yield pollen. These are mentioned as some of the species found in most parts of the State, and they furnish some pollen even during severe drouths.

The cacti, of which the large kind, with its thick, fleshy, green, and pear-shaped leaf-like stems (*Opuntia englemanii*) known as prickly-pear, is most common, sometimes yield much honey, and are great pollen-yielders nearly every season. The honey is not considered good for surplus, as it is astringent in character and strong in flavor; but it is valuable for sustaining the colonies during the summer when very little else is in bloom.

A rich golden honey is produced by a small plant of the *Composita*, known as "marigold" (*Gaillardia pulchella*), which often covers the prairies in May and June. The flavor of this honey is rather marked. The vast fields of Indian corn and sorghum are much visited by the bees during their bloom in May and June, and these yield immense quantities of pollen. Of some importance are also the melons, and all of the members belonging to the gourd family (*Cucurbitacea*), both for pollen and honey. *Lippia ligustrina*, known as white brush, is most common and abundant in Southwest Texas. It is a very frequent bloomer during the season, depending upon the abundance of rain, and is so fragrant that the whole adjoining country is perfumed with its fragrance.

In East Texas abounds the bitter-weed (*Helenium tenuifolium*) which begins to bloom in June, and lasts until frost. This plant is not affected to any great extent by drouth and blooms very regularly every season. Bees rarely work on it except during a dry season, when there is nothing else, and

then the bright golden-colored honey is so bitter it can not be eaten. The comb built during such a flow is of a characteristic bright yellow.

Another common weed is the ragweed (*Ambrosia*), of which there are several species. These are much like the crotons in distribution, and yield pollen.

A valuable fall bloomer in most parts of the State is the broom weed (*Gutierrezia Texana*), beginning to bloom in August and until frost. The honey is amber in color, and strong-flavored, but is most excellent for winter stores, coming at this time, and the colonies build up on it in splendid condition with their hives full. This plant is sometimes not so abundant during a dry season, but comes quite regularly year after year. Where abundant, much fall honey is obtained from Virginian crownbeard, or often called wild tobacco (*Verbesina Virginiana*). It blooms in October; but the dry summers cause a stunted growth of the flowers in many seasons, when it yields sparingly.

CULTIVATED HONEY-PLANTS.

Alfalfa is being planted a great deal, and yields honey under favorable conditions with or without irrigation. Not enough of it is grown yet, however, to make it an important source; but with the advent of irrigation in the arid sections, all of West Texas should rival the Western States, where alfalfa honey is abundantly produced. None of the other clovers thrive well here except sweet, white, and yellow; and since there is so much waste land it would mean much to increase our honey-flows and to tide the bees over the summer months. However, the southern dry climate does not seem to agree with its growth unless cultivated, hence it soon disappears.

In the northern part of the State a good deal of it grows, having been first planted many years ago.

Another valuable cultivated plant is the cowpea, generally planted in the cornfields for fertilizing purposes after that crop is made. As these bloom during the dry months the bees are kept out of mischief. Cowpea planting should be encouraged.

Some thirty varieties of honey-yielding plants were tested at the Texas A. and M. College Experiment Station; but only the above proved of sufficient value for planting for bee-forage. It is also not profitable to plant for bee-forage alone.

THE OUTLOOK FOR THE INDUSTRY.

Never before were the chances better for bee-keeping in Texas. With its great area and varying conditions the immense flora provided by nature, and the coming of irrigation of the more arid regions—this, together with a more progressive lot of people who will make better bee-keepers, makes the prospects for the future in apiculture in this State most promising. The markets for the bee-keepers' products were never better, and a demand has been worked up for the different kinds of honey produced here that has never been filled. A strange fact is that Texas does not have to depend on the markets of the North for an outlet, thus saving the enormous freight rates,

and the danger of an overstocked market where honey from all sections comes together. The greater portion of the annual output is consumed in the State, North Texas being the best market, as few bees are here, and that part is more densely populated. Large quantities are shipped out to Oklahoma, Indian Territory, and Arkansas, while very little of it, comparatively, goes beyond these States.

THE KINDS OF HONEY PRODUCED.

Comb honey in sections was once one of the main products of the up-to-date bee-keeper's hives; but the great risk of shipping it safely in a hot climate, on account of the frailness of the article, resulted in frequent smash-ups, and often in melting down when left out in the hot sun. Besides, section honey is expensive to produce. To obviate these objections comb honey is now produced in the regular frames, cut out, and packed in cans, liquid extracted honey being poured over the whole to fill the crevices, so that the combs are kept buoyant in it, and kept from mashing. This kind of honey brings more dollars into the bee-keeper's pockets than section honey. It is easier produced, and more will be made by the bees in the frames. The demand for it is better, also, as the consumer gets more for his money; hence its production has replaced the section honey almost entirely.

Extracted honey is produced on a large scale here, and is still the old standby. More of it can be obtained with the extractor, and the real profits are greater than from comb-honey production. The only obstacle heretofore has been the idea generally prevailing that such honey might be adulterated. Since the pure-food laws have been in effect, this has been removed to a great extent, and now there is a tendency to resort more and more to producing extracted honey. In time this will largely replace comb honey here.

Granulation of the honey has been a great drawback toward successfully marketing a crop later in the season, when prices were stiffening; and to prevent the trouble of having comb honey granulate in the cans, making it unsalable, it was moved off rapidly by many bee-keepers to their detriment, regarding the prices of the markets. With extracted honey, educating the public how to reliquefy the granulated honey, and showing that it is the best proof of its purity, is all that is needed. Then such honey can be kept over the winter for better prices if need be.

STANDARD HONEY-PACKAGES.

Texas has its own standard-size packages for honey, both comb and extracted. These are all figured on a basis of 120 lbs. to the case, or 60 lbs. per half-case. For extracted honey the regular 60-lb. square can, two to a case prevail. For comb honey the same size of cans, two in a case, have large eight-inch screw caps to admit placing the comb honey in it. Twelve-pound friction-top pails, ten in a case, making 120 lbs.; six-pound friction-top pails, ten in a case, making 60 lbs., and three-pound friction-top cans, 20 in a case, also making 60 lbs., are used for both comb and extracted honey in smaller-sized packages for retailing in the original package. This stand-

ard is so well known now that orders are always made in accordance with the price lists which appear as follows:

PRICES OF HONEY.

60-pound cans, 2 in a case, per lb.
 12-pound cans, 10 in a case, per lb.
 6-pound cans, 10 in a case, per lb.
 3-pound cans, 20 in a case, per lb.

Comb. Extracted.

Terms:—Sight draft, bill of lading attached, subject to examination.

The freight rates on honey put up in this way are very low as it goes at fourth-class rate, while section comb honey must go in glass shipping cases properly crated at double first-class freight and at owner's risk; the can packages are much safer.

WORK OF THE ASSOCIATION.

A great deal of good has been done toward furthering the bee-keeping industry here by the State and local bee-keepers' association. The Texas Bee-keepers' Association is the largest of its kind in the State, and comprises all the local associations. To it belong the North Texas Bee-keepers' Association, the South Texas, the Southwest Texas, and the Uvalde Bee-keepers' Association. While these local associations have their annual and some their semi-annual, meetings, in their respective territory, the State Association meets annually in July at the Agricultural and Mechanical College and Texas Experiment Station, at College Station. Delegates from the other associations attend.

This association has been instrumental in obtaining several measures, chief among which is the experimental apiary at the A. and M. College; then the Texas foul-brood law was due to its efforts. The adoption of the standard honey-cans was a move of this association, as well as obtaining at the large fairs at San Antonio and the State Fair at Dallas premium lists for bee-keepers' exhibits to the amount of \$300 at each of these. The association has also a special committee to look after exhibits at fairs; hence large and creditable exhibits of bee-keepers' products represent the industry at such places, with the result that the industry is furthered thereby.

"In union there is strength," so it is with a State Association of bee-keepers, and every State should have one. The Texas association at the same time is affiliated with the Texas Farmers' Congress, of which it is the bee-keepers' section. This congress comprises some two dozen State agricultural associations, each representing its industry. All the members of the State association become members of the National Bee-keeper's Association, by joining it in a body, at 50 cents each, thereby receiving all the privileges and the protection of that great association. Besides this, special low rates are given on subscriptions to the different bee-journals, as an additional inducement. The membership to both associations in the above way is only \$1.00; and if several journals are subscribed for, enough is saved on them to pay for this. *Gleanings in Bee Culture*

is given for 50 cents; *American Bee Journal*, 50 cents; *Bee-keepers' Review*, 75 cents, and *American Bee-keeper* for 25 cents a year, if ordered through the secretary, with the annual dues to the association.

The officers are elected annually, and at present consist of W. O. Victor, of Hondo, President; D. C. Milam, Uvalde, Vice-president, and the writer has been for ten years Secretary and Treasurer.

LOUIS H. SCHOLL

BEE-KEEPING IN OKLAHOMA.

MENDON, OKLA.

Bee-keeping is certainly not crowded in this part of the new State, although from the name of our new county, Alfalfa, one would naturally think it would be a favorable place; and there are many acres of alfalfa grown in this country, though not much in this exact location, the sand hills.

Alfalfa and cow-peas are the chief sources of honey, though there are black-locust trees, some sumac, and various wild flowers. There is a yellow flower that grows thickly about pasture lands, and blooms in August and September. It has a sweet odor, and is surrounded all day by bees and other nectar-loving insects. It is called broom-weed here because of its umbilical top, I suppose.

I had a season of reverses, so I haven't much to report. However, one swarm that came off the 18th of July stored 122 lbs. of honey, although I fed some late in the fall to induce them to draw out foundation and seal stores, part of which I used for a weak colony that had had foul brood, and had been shaken into a new hive and requeened too late to store sufficient for winter.

There are a few other bee-keepers in this vicinity, of whom W. B. Uptegrove, near Byron, is probably the most extensive. Mr. Uptegrove is located in the edge of the alfalfa belt, and has sixty acres on his own farm, also sixty acres of black-locust trees. He cultivates hoarhound as a honey-plant too, and I am told that he is a generous feeder with granulated sugar when the honey-flow is short.

He has been retailing honey at 20 cents a pound, as prices are good any way.

The Angle brothers also keep bees. John Angle, near Mendon, was reported to have had a good yield last year, but I did not learn the amount. His brother who keeps bees is located near Byron. I have not much information regarding the extent of his bee-keeping.

With the increasing amount of alfalfa and cow-peas, I think our bee pasturage is sure to improve. There is a long season with cowpeas, as they begin blooming in June and continue till frozen in the fall. Fruit-bloom comes in March, and is soon followed by dandelion and various wild flowers.

MARY L. HAWLEY,

BEE-KEEPING IN THE INDIAN TERRITORY.

It was once the author's good pleasure to make a prospecting-tour through the Indian Territory, and he was favorably impressed with it as a bee and honey country. I saw some traces of bee-keeping in many locations, and the reports were good and encouraging. The most extensive bee-keeper we saw was a widow Cherokee Indian; but as she could speak American language but little we did not get much information regarding her bees; but she was tending a small plot of land with a hoe, and keeping bees to support herself and four small children. Her apiary consisted of about 100 colonies in home-made hives, constructed with two apartments. The bottom one, she said, was for the bees, and the top story for the honey. The hives were not modern in design, but they were well constructed and neat in appearance. There were no cracks or openings about them chinked up with cotton or rags, and the covers fit down well, being made of wide lumber, and another wide board nailed on top of the cover crosswise so as to keep them from warping. The covers were not nailed or pegged to the hives. The apiary was nicely arranged in a grove of small trees, and swept and cleaned out as well as we could expect a house-keeper to keep her house swept out. No plank, trash, nor boards were found about it. From the outside appearance the apiary received all the care or attention that a good honest apiarist could give it, and undoubtedly the bees received some modern care. We camped over night near her house, and I went up to her house for a small amount of honey for supper. She said, "run out or stay in?" I said, "stay in," and she filled the small bucket with nice chunks of honey. The honey was fine in flavor and color. We ate it up at supper, and in the morning I went back to her house for a supply to carry with us, and called for "run out," and she filled the bucket with strained honey.

That apiary and poor widow, depending largely upon her bees for her own and her children's support, made a strong and lasting impression on my mind. We found a few in the Choctaw Nation engaged in bee-keeping, on a small scale, and who reported good returns from their bees. We felled a few very rich bee-trees during our travel there, and the general outlook for bee-keeping seemed to be all any one could expect, except transportation, which was poor.

BEE-KEEPING IN ARKANSAS.

The author lived in that State eight years, and was connected with bee-keeping which proved to be profitable. Unquestionably Arkansas has some of the finest bee pastures the writer has ever seen; but transportation was not sufficient to justify extensive bee-keeping at that time in the best

locations. Honey was plentiful in the forest, and it was not necessary to keep an apiary to have honey for home use or for the market. At certain times of the year there were men who did nothing but ramble in the forest hunting and felling bee-trees, and who sold the honey to other settlers or to steamboat proprietors at boat-landings along the navigable streams, or to any one at any price. In some sections there was not only a great variety of honey-plants, but they were in great abundance. Especially was this true in the prairie sections, for the forest along the edge of the prairie contained much basswood and other honey-plants common in the Southwest; then the points or scopes of timber extending out on the prairie were lined with hazelnut and sumac, and other small shrubs which were great bloomers and good honey-plants for which I know no names. Then along on the prairies were large bodies of land covered by sumac. From early spring until late in the fall the prairies were lined with flowers of all kinds, colors, and sizes, and many of them were honey-plants. Horse-mint was also in great abundance, so the bees continued to work upon blossoms. In Arkansas Co., near Violet, on the edge of Ball Prairie, a colony of bees made the best record I have ever known one to make. G. W. Rush, a farmer, found a bee-tree, late in the fall, and early the next spring he felled it, sawed it off below and above the bees, and nailed a bottom and top on it and carried it home and set it up under a tree. During that season that colony swarmed several times, and its swarms swarmed, and seven swarms were cast in all, and six of them were hived in box hives and one absconded, about one barrel of surplus honey was removed from the lot, and they all went into winter quarters heavy with stores. Henry Williams, in the same location, operated an apiary of about sixty colonies in log gums, and always had more honey than he could dispose of. He had some in an earthen jar, several years old. I sampled it and it was fine in flavor and nearly light in color. The last season we were in that location we gave their apiary the necessary attention. Many swarms were saved, and we obtained for our part a wagon load of honey which we carried to Little Rock and sold at a fancy price.

We came into this section from the Indian Territory; and after this we continued to travel and saw a great future for the bee and honey industry in that State, and I am glad to know of the progress it has made, and the possibilities that are yet ahead.

Statistics given elsewhere in this book show that bees give a good surplus of honey in that State, and that a large amount of it is saved.

BEE-KEEPING IN MISSISSIPPI.

Leota, Miss.

Bee culture in the South is remunerative, interesting, and enjoyable. The flora of the South is varied, and supplies great quantities of nectar and pollen. Bees gather the nectar with ease, and store it by the ton. They

multiply rapidly by the thousands—a benefit if handled with skill, but an injury if handled with negligence. Best results are obtained by having enough room all the time for honey and brood. Increase works like a charm. Negligence brings on bad results immediately. Nothing in the world responds with more celerity, certainty, and safety than bees under the care and direction of man. The subject-matter is intensely interesting if viewed either from the work involved or the thought required to study the nature of the bees. It is enjoyable because it necessitates outdoor work, thereby giving invigorating health, strength, and contentment. The balmy sun of the South and the gentle breezes do the rest.

The flora of this vicinity begins to bloom the last of February, and extends to the last of November. One set of blooms dovetails into the others, so that there is a continuity of flowers for ten months. A tremendous honey-flow extends over April, May, June, and July.

Fruit and forest trees secrete a great quantity of nectar. We have vast forests; innumerable wild vines, plants, and shrubs yield delicious nectar. The cotton-plant, the producer of the renowned fleecy staple, is at home upon our fertile acres, and yields a vast amount of superior nectar.

Many and varied blossoms supply nectar at the same time, hence it is impossible to differentiate and tell the exact source and quantity whence any particular honey is obtained. That fact is eagerly seized by the North, who imagine it is a stinging fling at us to brand ours as "Southern Honey." We accept the same as a badge of honor, and will wear the same worthily.

Dr. O. M. Blanton, Greenville, Miss., is a pioneer among bees, and has successfully handled them for thirty years. He has about 300 colonies. R. J. Adams, Greenville, Miss., is an old bee-man, and has about 200 colonies. Joel Johnson, Leota, Miss., is a genius in an apiary, and is very successful. He has about 150 colonies. I successfully handle 164 colonies, having made money every year. I extracted this year 21,600 lbs of honey. Bees winter upon their summer stands, and are never diseased. This is a bee paradise.

THO. WORTHINGTON,

BEE-KEEPING IN EAST MISSISSIPPI.

Penn, Miss.

There are few bee-keepers in Mississippi of consequence, owing to the fact that the field is new and the territory has been limited up to the last few years. Of late years, with the introduction of sweet clover (*melilotus*), or botanically known as *Melilotus Alba*, for the renovation of poor run-down and wasted lands, bee-keeping has been growing rapidly, and the crops being made in East Mississippi are proof that this section is destined to be one of the principal honey-producing parts of the United States.

In addition to sweet clover as a honey-plant we have Spanish needle, cotton bloom, and other plants. Fall aster is the last bloom we get. Bees usually get enough from this plant to go into winter quarters in good shape.

For surplus honey we depend entirely on sweet clover, Spanish needle, and cotton bloom; but the most important of all is sweet clover, which has been a never-failing source. There are thousands of acres of this plant in East Mississippi that would be a paradise for expert bee-keepers to get into.

One of the largest bee-keepers in this section has told me time and time again that his ten-year average has been over 100 pounds. He also said that he made an average of 140 pounds one season. He handles comb honey entirely. The party in question is Mr. Geo. A. Hummer, of Prairie Point, Miss.; but by the time this article reaches the press Mr. Hummer will be a resident of Colorado. He is not quitting this section to embark in the bee business in Colorado, as he has other interests that are drawing him to that State.

Mr. J. S. Cavett, of Macon, Miss., is making a success in bee-keeping, and has produced some large yields of surplus honey.

Most of the honey produced is comb honey. Very few bee-keepers run for extracted honey.

The writer of this article has several hundred colonies of bees and made a 90-lb. average this season, notwithstanding the spring was one of the hardest ever experienced in this section, and bees were in very bad shape when the honey-flow commenced.

There is no section of the United States that is more promising to the man who depends on his own labor than East Mississippi. The land is very productive. All kinds of crops can be grown with success. Alfalfa hay is being grown extensively in this portion of the State, and commands a good price; and at the present time choice alfalfa hay is bringing \$20.00 per ton to the producer. The deep prairie soils of East Mississippi will produce from three to six tons of this hay every season. The mild winters experienced here are very conducive to stock-raising, as stock do not have the attention here they do in the North, and can pasture nine and ten months in the year. The land is reasonably cheap; in fact, it is not bringing half value.

What better opportunities could a good hustling bee-keeper want than as outlined above, bee-keeping, stock-raising, and farming? These three are usually followed by the bee-keeper on the farm; that is, the man who owns his own farm.

W. P. SMITH,

LIST OF SOME OF THE LARGEST BEE-KEEPERS IN MISSISSIPPI, AND ADDRESSES.

J. B. Cunningham, Cliftonville; R. V. Goss, Shannan; Lawrence Gould, Crawford; W. P. Smith, Penn; C. D. Pritchard, Penn; R. A. Whitfield, Weathersby; Bat Williams, Mayhew; J. S. Cavett, Macon; Francis Stiles, Sessums, and Dr. J. C. Roberts, Agricultural College.

BEE-KEEPING IN LOUISIANA.

Hineston, La.

The valleys of the Mississippi, Ouachita, Black, and Red Rivers are best for bee-keeping, as the soil is richer and produces a much more vigorous plant; hence, naturally, they yield more nectar.

The honey-plants most common along these valleys are the clovers, rattan, wild grape, and a few others.

Of the above-mentioned honey-plants the clovers are most to be depended on. They commence to bloom generally about the first of March, and bloom more or less throughout the summer, the seasons having nearly all to do with the amount of nectar they yield. The best colonies under the most favorable conditions will probably give a surplus of fifty pounds from this source of the finest flavor, and very clear, almost water-white. The above-mentioned plant commences to bloom anywhere from March 1 to June 1, and give more or less nectar, according to the conditions of the weather.

There is, however, a vine known to the writer as black vine, growing in the swamps along some of these rivers that yields more nectar than the clovers or any other plant that I am acquainted with; but, unfortunately, the honey from this source is very dark, and has a poor flavor. This vine commences to bloom, as nearly as I remember, about June 1, and blooms on till frost; and the yield from this source will probably exceed 100 lbs. surplus per average colony.

There are numerous other honey-plants throughout the State, yielding some honey each year, but only a small quantity, and of a poor quality. Among these I will mention the horsemint, goldenrod, sumac, holly, black gum and bitterweed. The holly and black gum are the best, and the only source giving a surplus throughout the pine-woods portion of Rapides Parish; and the honey from these sources has an excellent flavor, and is almost water-white.

The best average surplus I have ever been able to get from these plants was about 50 lbs. from my very best colonies during the most favorable seasons. These plants generally commence to bloom about April 15 to 25, according to the weather, and continue to bloom for from fifteen to twenty days.

I will next say something of the bee-keeper; and by special request of Mr Wilder it is necessary for me to make mention of my own business, which I will, notwithstanding this is not pleasant to me. There are very few practical bee-keepers in Louisiana, and only two queen-breeders of whom I have any knowledge. In regard to my own business I am running 72 colonies of Italian bees in three yards as follows: 40 at my home yard (Hineston); 20 at the Barrington yard, and 12 at the Talbert yard. The latter yard is five miles west of Hineston, and the former six miles south. I am also running quite an extensive queen-rearing business at Hineston. I use the eight and fifteen frame Langstroth hive exclusively, and produce chunk or bulk honey principally. I have been running a bee business here for twelve years, and this year, 1907, has been the first year to fail completely. Out of

72 colonies, of which the most were in fine shape, I failed to get one pound of honey, and have fed the 40 colonies at home 350 pounds of granulated sugar. Those at the outyards were able to pull through till spring without help. I am selling a few bee-supplies to accommodate the few bee-keepers around me.

Following is a list of bee-keepers in the State, with their postoffice addresses:

Elijah Williamson, Leesville; H. T. Hitch, Pineville; J. Davenport, Tioga; R. H. Martin, Pawnee; Edwin Orr, Quitman; J. P. Odom, Farmer-ville; O. A. Lilly, Montrose; David Gordy, Provincial; Henry Andries, Many; Lewis Thomas, Boyce; John Boswell, Stille; Joe Price, Hineston; Daniel Andries, Elmer; H. L. Melder, Melder; Clinton Bass, Sycamore; W. H. Ragan, Donaldsonville; J. W. K. Shaw, Loreauville; J. H. Meads, Cheyneyville, and R. O'Shea, Alexandria.

W. T. CRAWFORD,

BEE-KEEPING IN LOUISIANA.

Benton, La.

I have never written anything for publication on bees, but can give you my own experience if that is of any value.

I bought two colonies in box hives in 1872—the only kind of hives in use in the State at that time. I sent to A. I. Root for some Simplicity-frame hives and transferred them, and in a few years from their increase, and others that I purchased, I had 500 colonies—400 of them at one yard—and have secured as much as 5000 gallons in one season of extracted honey. At that time the range was all natural growth; but since then the land has been cleared and is now in cultivation, and does not produce honey, though there are yet locations in the State that would probably do as well. There was not much attention paid to bees in this State until within the last few years, and I suppose that now two-thirds of the bees are in box hives. They are left on their summer stands. Once a year they are robbed, then left for next year, producing about 20 or 25 lbs. of honey, sometimes none, and maybe two swarms which generally go to the woods; and there is about as much honey taken from trees as box hives; but it is very inferior and dark, all mashed up, and then strained, and sold at a very low price, thus injuring the sale of good extracted honey.

Bees are free from disease here. I have heard of but one case of foul brood in the State, and that was at the experiment station among some bees brought from Texas, and they were destroyed at once.

The honey produced here is a light amber, and of fine flavor, when handled right. We are getting a large amount now from alfalfa; but the principal plants are vines of all description, and timber of natural growth. I was awarded a gold medal and diploma at the Jamestown Exposition for

highest award on honey and beeswax; also a diploma of honor at Portland, Ore., and have eleven other diplomas for first premiums at parish and State fairs, showing you that our honey is good when handled right.

WM. J. DAWSON,

BEE-KEEPING IN LINCOLN CO., TENN.

HARMS, TENN.

As this is not considered a very good bee and honey section it may pay all who are thinking of coming from other sections of the South or from the North to select carefully a location with reference to what they wish to follow in connection with bee-keeping. We have a great variety of soils, from the very best alluvial in the river-bottom lands, to the poorest highlands or barrens. Between these two extremes we have beautiful hills and valleys that will produce fruits and grain of nearly all kinds produced in this latitude. These hills and valleys have been denuded of their dense covering of primeval forest growth to a very great extent.

One who comes here to start in bee-keeping should be prepared to follow some other vocation in connection with it, although there is one man in this county who keeps bees alone as a business, and his average is about 12,000 lbs. of honey per annum. This man is Jim Moyers, of Fayetteville, and he is a very prosperous citizen. But there are quite a number of others who keep bees in connection with other pursuits, such as farming and poultry-raising, and fanciers, etc.

The reason I refer to the loss of our primeval forest growth is because, back in my younger days (I am now 38 years old) here in this county there were numberless quantities of gigantic poplar and basswood trees to bloom, which give us a very heavy honey-flow. Now there is scarcely any poplar except small growth, and the basswood is also going; but we have other sources of honey to come in their stead, and in time we may come up to our old-time place as a bee-keeping land.

Our new sources of honey are the white aster and alsike clover. The aster makes one of our finest varieties of table honey. It came to this country in hay from the Northern States; and the first appearance of it was during the Civil War. It has fast spread all over this country; and, aside from its great value as a honey-plant, it makes a good pasture for cattle. If good seasons prevail just about a fortnight before the aster comes in bloom, and then if the nights are cool when the plant blooms well, you may get busy, for the bees will fill their hives in a week. I took 1080 lbs. of honey from 29 colonies from the aster flow of 1907, and did not extract any from the brood, the brood-nests, or bottom stories of my hives, which are eight and ten frame Langstroth.

White clover is next to aster as a honey-plant; and about every three years it gives a good crop; 1906 was its good season, and I took off about

35 lbs. per colony of honey from this source. Sometimes we have a good flow from basswood; but as chestnut and sourwood bloom about the same time we do not often get any pure basswood honey. Often we get about 35 lbs. per colony from these several sources, which is our summer flow. I usually take off honey twice a year—once about June 1, and again in August. The first is white-clover honey, and the latter is from basswood, asters, chestnut, etc. The sourwood yields honey in the pea-ridge, or "barren" sections.

Our honey and pollen plants are quite numerous, and bloom about as follows: First, water-maple, elm, red cedar, fruit-bloom, redbud, box-elder, black gum, crimson clover, poplar-trees, white clover, alsike clover, persimmon, capel-tree, or paradise-bush; sumac, chestnut, basswood, sourwood, cotton, cowpea, boneset, many varieties of melons; aster, goldenrod, rabbit-foot clover, toy-weed; and, about every third year we have honey-dew from aphides on hickory.

The progressive bee-keepers in my section are, James Moyer, Joe Montgomery, John Pigg, Mr. Parker, Col. Galoway, D. J. Douthit, Joe Thomison, and myself.

J. H. BEARDEN.

BEE-KEEPING IN ALABAMA.

Fort Deposit, Ala.

Replying to yours asking for a write-up of bee-keeping in my State, owing to the short time you have given me I will confine myself to my county (Lowndes), which was once a fine bee country.

Our first flow after fruit-bloom is poplar, which sometimes yields 100 lbs. of surplus, commencing in April and lasting until about the 15th of May. We then have a dearth of honey until about June 1, when wahoo or basswood begins to yield, lasting from fifteen to twenty days, in good seasons coming in such quantities that the bees fall in heaps in front of the hives, and the whole yard has that peculiar aromatic smell that basswood alone has. I have taken more than 100 lbs. from that source alone of extracted honey, without any special attention. Oh, if all the trees were poplar and basswood, wouldn't we bee-keepers be happy! But, alas! the timber-men have invaded our happy hunting-ground, and the cotton-planter has followed close on the heels and turned a once fine bee-range into a cotton farm which soon turns rich black fertile land into a red-gullied unsightly region.

But this same cotton-plant on rich bottom land, some seasons, gives us a nice surplus; but the hill lands do not amount to much for surplus, but yield enough for queen-rearing. This plant commences to bloom about the 15th of June, continuing until frost, making a beautiful sight with its dark-green leaves and cream-colored blooms covering millions of acres. We can always tell when it is yielding well by the appearance of the bees when they enter the hive, as their coat is covered with the yellowish dust; but I do

not consider the honey the best. In a damp season it has a way of fermenting, or working in the combs. I have seen the cappings somewhat raised from the combs from this cause. While some seasons the honey is light in color and good flavor (mind you, I am giving only facts in this immediate location) a great many tell me from other sections that the honey is fine in color and flavor.

But still there is a bright side to this seemingly dark picture. In the lime lands or prairie belt of our State, where the land has got too poor to grow cotton or other crops, melilotus, or sweet clover, has stepped in and commenced to rebuild what cotton has torn down. It takes hold of all waste places such as roadsides, ditch-banks, and flourishes in deepest gullies where nothing else will grow. I have seen it six to seven feet high in the deepest gullies, which it soon fills up and again produces fine crops. I have known land that made only about eight bushels of corn per acre, which when run in sweet clover for a few years, would yield from 25 to 30 bushels; so it seems as if nature were giving us something back to take the place of our forest; and the beauty of it is our farmers are not fighting it as I see they do in some States. How a farmer can be so blind to his own interest I can't see. Our farmers are mowing hundreds of tons of hay from it, and say it is the very best. They are the very ones who introduced it here; but the bee man has begun to reap a rich harvest from it. It begins to bloom about June 1, here, and yields a light-colored and fine-flavored honey when well ripened on the hive. I think it is as fine as we can produce here. The yield varies according to the amount of waste land and the location. I can give you some idea by mentioning one instance.

A few years ago a friend of mine bought an apiary, paying \$500 for it, taking possession in June. He paid for it in sixty days with melilotus honey, that being his only source. You can see by this it is a fine yielder, and has the fewest off years of any plant I know of, consequently the prairie belt is becoming dotted with beautiful up-to-date apiaries with modern methods; and business men are not only investing their hundreds but thousands in the business. A few whom I will mention are located in my county, some twelve miles north of me. The Letohatchee apiaries, the owners of which are putting in something like 700 colonies with up-to-date hives and methods. Sweet clover there is the only source; also two enterprising young men, Messrs. Brown and Knight, of Hayeville, Ala., who own several large apiaries, something like 500 colonies, besides several large apiaries outside the county. Mr. Brown is a New York man; Mr. Knight, a native Alabamian; also a Mr. David S. Hurst, of Letohatchee, Ala., who is engaging in the business quite extensively, owning several hundred colonies, besides being extensively engaged in the queen-business. Besides these is Mr. C. M. Berry, of Morganville, Ala., who owns several hundred colonies, making a success of the business. I think he is a native of Georgia, and full of Southern grit.

Besides these are hundreds of small apiaries too numerous to mention.

Now comes the most difficult part of this article, that is, trying to tell you something of my own experience. I have been interested in bees since

my earliest recollections, putting them in log gums, box hives, and sawing holes in the columns of verandas, etc. Until the Root Co. sent out their simplicity hive I had never heard of a frame hive, which I was quick to adopt, seeing at once the value of the movable frame, and have kept up with every improvement that has been put out.

My first venture after adopting the movable-comb hive was to produce comb honey, which I studied with all the enthusiasm that an enthusiastic bee-keeper ever had; but I soon decided that my location was unsuitable for comb honey, it being too dark. My next was extracted honey; but did not like that. All this time I was studying the most important part of modern bee-keeping, the queen. I have bred queens by every known method, and some never given to the public. I have worked untiringly for the last twenty years at the business, having been a queen specialist for fifteen years, furnishing some of the largest dealers in the business. I have never advertised extensively, owing to the above fact; but some of my old customers are still giving me their orders, which shows I am trying hard to please; but I think it more from the love of the pursuit and a good location for queen-rearing than anything else, which is a long-drawn-out honey-flow. I would almost as soon have no honey coming in as a heavy flow for queen-rearing. I can bring about ideal conditions by feeding better than I can counteract the conditions of a heavy flow. I have had flows so heavy as completely to cover up cells with comb and honey, killing all the queens I have; also had all the unsealed brood covered in honey in a few hours, making it impossible to get larvae of the right age to graft from; besides the thousands of other hard problems in queen-rearing, I have tried all of the mating-hives that have been before the public from the smallest baby to the ten-frame hive, and can hardly tell what I like best; but I think I like the Root twin baby the best; but after trying it more extensively I may find some serious objections to it.

All this goes to show the reason why so many queen-breeders desert the business. One must have a love for it, and be made of some tough material, and not be too anxious to get rich.

W. J. FOREHAND,

BEE-KEEPING IN ALABAMA.

Greenville, Ala.

Bee-keeping in the South is not carried on very extensively in my section, although we have a good country for bees, as our winters are very mild as a general thing. There are not many days at a time when bees can not fly, so the outlook for bee-keeping is very good, as our farmer bee-

keepers are adopting the latest styles of supplies, and doing away with the old box hive.

As to our pollen and honey plants, bees begin to gather pollen here about the first of January, and it lasts about four weeks. Our next is red elm in February which furnishes abundance of pollen. Maples are our next. Maple begins blooming in March, and furnishes some honey for two weeks; and fruit bloom and blackgum furnish a little honey. Then our main honey-flow is from poplar, beginning about the middle of April. It gives us a heavy flow, and lasts from three to four weeks. Honey from it is of a dark-amber color, and of a good quality. Then we have a flow in June from wahoo and rattan, which is of a very fine grade. Our surplus generally runs from 50 to 100 lbs. per colony. Then we have a little all along during the summer and fall from cotton and wild flowers.

This is a sketch of my locality. I will now give the names of some Alabama bee-keepers:

R. O. Cox, Greenville; Elix Whitten, Greenville; B. L. Perdue, Greenville; W. J. Forehand, Ft. Deposit; Holmes & Garret, Letohatchee; D. S. Hurst, Letohatchee; Brown & Knight, Haneville. The last four names are located in Lowndes County, in the sweet-clover reigons. It begins blooming in May, and lasts three weeks. The yield per colony is from 150 to 200 pounds. They also get some fine cotton honey in Lowndes County on the prairie lands. It is very light in color and of excellent flavor.

E. A. SIMMONS,

THE POSSIBILITIES OF BEE-KEEPING IN SOUTH CAROLINA.

Woffler, S. C.

South Carolina is not famous as a honey-producing State, and we have not as large apiaries as some other States; but although modern bee-keeping is in its infancy, yet enough has been accomplished to show that bees, properly managed, can be made to give large yields of splendid honey; and in this locality we usually are able to get two crops—one in the spring, the other in the late fall. In the lower half of the State, where they do not have the wild aster, the fall flow may not be so heavy; but in that section where the gall-berry abounds along with other splendid honey-bearing flora the crops of honey are often heavy. In this locality, middle-western South Carolina, we usually harvest crops of very distinct and different grades, but which have about the same market value. In the spring the bees build up rapidly on the elm; then the maple, and then comes fruit-bloom, poplar, black-berry, black gum, then the persimmon, from which we get most of our surplus.

THE FALL FLOW.

The bees keep in strong condition during the summer months on sourwood and field crops, such as corn, peas, melons, and, best of all, summer

plants, cotton, which brings them to the great goldenrod and wild asters from which we almost always secure a heavy crop about the first of November which always granulates in a few days or weeks after extracting. My honey now in fruit-jars looks almost like snow, and it takes a very strong spoon to get it out; but if one prefers it in the syrup state it can readily be heated to near the boiling-point, which renders it back to the syrup state, and, when heated to very near the boiling-point (do not boil it), it rarely granulates again.

WINTERING.

This is not a serious problem with us by any means compared with what Northern bee-keepers have to do, as the bees hardly ever fail to go into winter quarters with plenty of wild-aster honey in the brood-chamber to carry them through winter. In my experience of some fifteen years of bee-keeping I have never had to feed for winter except the nuclei. We have these in good snug single-wall hives with a water-proof cover. We leave them on their summer stands—no chaff packing nor other protection; close the entrance to $\frac{1}{4}$ by 3 or 4 inches, and there you are till spring opens; then throw the entrance wide open; put on your super and you are ready for the spring flow. It seems to me that, with everything so favorable, we might make bee-keeping even more profitable than we do.

Well did the poet write:

Full many a flower is born to blush unseen,
And waste its sweetness on the desert air.

For, go where we may, we can not but see the great lack of bees to gather the sweetness that goes to waste on the desert air. If people only knew the great value of honey as a food for men, and would only learn how easily the little pets can be handled and managed, we should see hundreds of bee-hives when we now see hardly any at all.

Some of the bee-keepers in this part of the State are Mr. Philip Markert, near Augusta, Ga., across the river, who has, perhaps, something like one hundred colonies in modern hives, run, I think, for comb honey.

Mr. Pierce Mather, near Kirksey, Greenwood Co., who has some twenty colonies in Dovetail hives run for comb honey.

Mr. F. L. Timmerman, who has just begun modern bee-keeping in Danzenbaker hives.

Mr. W. A. Cheatham, at Troy, S. C., has about a dozen hives for comb honey.

As for myself, I have some 80 colonies in ten-frame dovetail hives, run almost exclusively for extracted honey.

S. CHATHAM.

BEE-KEEPING IN SOUTH CAROLINA.

Catawba, S. C.

The first recollection I have about bees is when I was five or six years old, in 1865 or 1866. Father had three or four old box hives in the back yard.

and for some cause I began throwing stones at them; but I failed to get a safe distance from them, and the bees filled my head full, stinging me. You bet mother came out and took me to the house and combed the bees from my hair. The next vivid recollection I have of bees was in 1874. Father had eight or ten bee hives, one or two of which I claimed as mine. Some of the colonies had become crammed and were lying out at night very much. I was going to school at the time. The bees were located at the side of what is known in this section of country as a smoke or meat house. It was at one edge of the apple orchard, and there was a young apple tree near the bees, with a very thick foliage of leaves. One morning before I started to school I was looking at the bees, and I said to father, "I bet the first swarm of bees that comes off will settle on that apple-tree," and, sure enough, a swarm came off and settled on that tree, and father made some prophetic remarks about what I had predicted. I was only 13 years old then. My father died that fall, on the 21st day of September, 1874.

The real beginning of my bee-keeping was in 1880, when I adopted the American frame 12x11. I afterwards, in 1883, adopted the Langstroth simplicity frame which I still am using, and I bought my first Italian queen from Dr. J. P. Brown, of Augusta, Ga., getting her in August of that year. I paid \$2.50 for her. I afterward bought three untested queens from him. I bought an imported queen from A. I. Root in 1886, paying \$6.00 for her. I bought 19 untested queens from W. S. Cauthen, of Pleasant Hill, S. C., in 1886 and 1887, all of which proved to be good.

My best record year was in 1888, when I secured 2,780 lbs. from 40 colonies. The best colony gave me 133 lbs. of extracted honey.

In the fall of that year I took a crate of section honey to our County Fair at Chester, S. C., and put it on exhibition. Some other parties had already placed theirs, but when I arrived mine was so much superior to theirs that they removed theirs by the second day.

My yearly average was about 35 lbs., two-thirds extracted and one-third comb honey. That was about what I secured for a ten-year average. It seems to be somewhat less now.

To show the propensity of the native bees to swarm more than the Italians, in 1888 or 1889 I had 25 pure Italian and 15 black and hybrid colonies. Two of the Italian colonies swarmed, and thirteen of the fifteen black hybrid colonies swarmed; and I think the other two would have swarmed if I had not taken combs of brood from them. Four thousand pounds of extracted is the most honey I have ever taken in one year. In 1896 I secured that from 95 colonies.

I have had two apiaries for the last 16 years, one located on Turkey Creek, Chester Co., at my old home.

My home apiary is here at Catawba, York Co., where I have resided for the last 16 years.

There was some linden, or basswood, on Fishing Creek, but only a few dozen trees in reach of the bees—just enough to create a little excitement among the bees when it was in bloom; but the bees would lick it up in 20

or 30 minutes every morning. The basswood usually bloomed from June 20 to 30. There may be a few trees of it there yet.

The first fifteen years of my bee-keeping I usually secured half of my crop from the poplar bloom; but of late years it has been cut down, and the honey-flow is light from it. The aster is our best yielder, poplar second best; cotton third, cowpeas fourth, persimmon fifth. The cotton bloom is a good yielder some seasons, but only when the cotton has gotten a good start in blooming, and then cut short by a dry spell.

The best record from one hive in one day was in 1888, when I had a good colony on scales during aster bloom. It pulled down 11 lbs. in one day; but the scales stood only 9½ lbs. by the next morning. The bees had evaporated 1½ lbs. during the night. That hive gained 55 lbs. during the 20 days when the aster was in bloom; but I have had colonies beat that twenty-day record on aster.

The year 1905 was nearly a failure. I secured only 1,000 lbs. from 160 colonies; and the season of 1906 was a complete failure, I not securing any honey at all, and I lost one-third of my bees by starving, although I fed 1,000 lbs. of granulated sugar. I now regret that I did not feed more liberally, as my bees have given 2,600 lbs. of honey since August of this year, and are heavier in winter stores than I have had in a long time.

About equal parts were secured from cotton and aster. I have about 100 colonies now. I have been doing a local trade in bee-keepers' supplies for a number of years. I make the half-joint hive the same size as the eight-frame dovetail hive. I also keep the A. I. Root Co's goods for sale. The trade was light the last season, on account of the honey crop being a failure. I think nearly three-fourths of the bees in this section have starved the last two years.

I have always found a good demand for my honey in Rock Hill, S. C., a city of six or eight thousand inhabitants. I am getting 10 cents per lb. for all my honey at wholesale. I sell most of my honey in two or three pound buckets, labeled nicely. I usually sell it to two or three grocery stores there, and sell it straight out.

Capt. J. C. Foster, of Lancaster, S. C., has had some success with bees; also W. B. Crosby, Esq., Catawba. There have been numbers of men who have started bee-keeping since I did, but they have fallen out of the ranks for one reason or another. Most people who keep bees don't know when a honey-flow is on until it is over. I always practice clipping my queens' wings to control swarming. I have hunted up and found 33 queens in 3½ hours in strong average colonies. I have only the three-banded Italians and some good honey-gathering hybrids. I ordered some five-banded bees some years ago, but I have never seen a five-banded bee yet, and I got them from a native breeder. The ones that I did get would come at me like bullets from a gun.

I think the three-banded Italian bees are about the best yet. I never use any protection when among the bees, except a good smoker and a light-colored suit of clothes and a straw hat. I hardly ever get stung.

H. C. SIMPSON,

NORTH CAROLINA.

Crouse, N. C.

The general outlook for bee-keeping in this section of the South is good, and, if it is properly followed, profitable. Our honey is of a good quality, and brings a good price. The average from old-style box hives is from 15 to 25 lbs., and such honey sells at 10 and 12 cents per pound. The average from patent hives is from 25 to 30 lbs., and sells at 15 to 18 cents.

Honey-plants in this location are not very plentiful. The most common ones are poplar, persimmon, sourwood, sumac, melons, ironweed, cotton, and some buckwheat; but it is not extensively planted here.

Below is a list of some of the most successful bee-keepers in my section:

W. H. Hoover, G. Anthony, A. H. Black, J. H. Hearner, F. E. Carpenter, J. Harve, Rev. M. Carpenter, Mrs. Lee Brown, T. Lackey, H. S. Sellers, B. Black, M. Stroup, A. Tasour, C. Rhine, Wm. Bullinger.

We are located southeast of the South Mountains, which lie in Burk Co. Hard wood is plentiful, and sometimes we have lots of honey-dew and pollen from the hard-wood trees.

We have a heavy loss of bees each season in old box hives, and we must adopt patent hives to expect a great success in bee-keeping.

C. C. RAMSEY.

BEE-KEEPING IN NORTH GEORGIA.

Jasper, Ga.

Bee culture in North Georgia is carried on in a very limited way. There are a good many bees scattered about the country. King bees and log gums, or square plank gums, reign supreme with but few exceptions. The number of colonies kept in hollow logs or gums ranges from one to fifty. Very few keep fifty. The bees are blacks, mostly. Some are hybrids, or crosses with Italian stock. There are a few bee-keepers who have Italian stock who have their bees in up-to-date hives, and modern methods are used in the management of their bees. With these few exceptions the bees keep themselves and work for nothing and board themselves, and are regarded as a kind of mysterious insect ruled by a "king;" and there is a prevailing idea with some, that, when their owner or master dies, the bees will soon die out; and there is another idea among some of the bee-keepers that bees must be robbed or their honey must be taken at certain stages of the moon, and unless this rule is observed the bees will not do any more good after being robbed. Improved hives and methods are not known to many, and are considered a nuisance. It is not for the lack of pasturage for the bees that keeps the people from engaging in bee culture in a commercial way or as a business. It is for the lack of knowledge. Superstition and ignorance are in the way of many. All the well-to-do farmers, or most of them, have their dozen or so of log or box gums. There is more money to be made with bees in this

section, according to the capital invested, than any other pursuit. A colony of bees will pay for themselves in one season if the conditions are reasonably favorable. Frame hives with good Italian stock in the hands of an apiarist who looks after his bees, average 50 lbs. in ordinary good seasons. In the best or most favorable seasons, 100 lbs. is the average. In poor seasons, 30 lbs. is a good average. In 1905 we had a total failure so far as surplus honey was concerned. In 1906 there was a surplus of about 30 lbs.; in 1907 the average was about 50 lbs. Some colonies gave 100 lbs. of surplus. These figures do not apply to log or box gums. The average for them is from 15 to 20 lbs. of surplus. Any locality where bees do well in log gums is a good location for the modern bee-keeper with his movable-frame hives.

The honey-flow is slow in this part of the State. There are no heavy flows all at once. The flow lasts according to the duration of blooms. If weather conditions are favorable for the secretion of nectar, and for the bees to get out and gather it, in our locality the first honey and pollen come from maple and tag-alder anywhere from the first of February to the first of March. It all depends on the weather conditions. The next honey and pollen come from huckleberry and fruit-bloom the last of April and first of May. Our next is from poplar and blackberry the middle of May, or about that time, sometimes earlier and sometimes later. Our next is from what is called warweed, the last of May to the middle of June. The next honey and pollen are from sumac, from August 1 to September 1; also cotton and persimmons furnish considerable honey at this time, and cowpeas. Some seasons furnish some honey until the last of September.

Bees swarm some during this time of the season, and this is the part of the season for rearing the best queens, and is the best time to requeen or supersede old queens. October brings our last flow of honey. It is from aster, and there are such quantities of bloom that bees almost always store a sufficiency to winter on, and for rearing brood in early spring. Honey from huckleberry and sourwood is white, while all the rest of the honey we get **is amber colored, cotton being the lightest.**

This is a mountainous country, abounding in springs of clear soft water. The streams or water-courses have more or less rich bottom lands, a very healthy country for bees or man; a mild climate. We rarely have any zero weather. There is no disease among the bees of this section. Black or foul brood is unknown in this part of the State. Bee-moths and robbers are the worst enemies the bees have in this section. The bee-robber, or the fellow with his bees in sections or hollow logs, arms himself with a roll of rags, ties up his head, hands, and pants legs, proceeds after dark to knock off the heads or tops of the gums, and blows smoke into the top end of the gum until he gets most of the bees down, and his eyes almost smoked out, and cuts out the honey and sometimes brood, sometimes drowning all the bees, or a part of them. Very often the queen or "king," as it is sometimes called, is drowned; and in many cases the bees if they are not drowned are so discouraged with the operation that they let the wax-moth get in its work of egg-laying and then there is a fine crop of moth larvae produced, which will

eat up the combs, the colony is destroyed, and all the blame is laid on the worms, while it is the bee-keeper or bee-robber that is to blame.

Another drawback to the log gum is the excessive swarming. The gums, as a rule, are too small. Black bees and some strains of Italians will swarm themselves to death when the swarming fever strikes them if crowded into small hives. Large hives will prevent swarming to a great extent—so much so it is not worth while to bother looking after swarms. Our golden stock seldom swarms. Some of our colonies have never attempted to swarm, even when they superseded their old queens. They are the nearest to a non-swarming strain we ever saw.

This section is improving in the supply of nectar under stock law, as there are more honey-bearing weeds and shrubs that are not destroyed by stock than there formerly were while fencing the crops was in vogue. While this section does not produce as heavy flows as some parts of the country, the honey is as good and fine as the best, except red shank and aster. The flavor of these two honeys is not liked by many. Especially is this the case with the red shank. The sourwood produces the mildest honey with the most pleasant flavor known. Poplar, sumac, and huckleberry produce a fine-flavored honey with a good body. There is room for lots of good bee-keepers, and any progressive bee-keeper who will give his time and talent to bee culture in many sections of North Georgia will be amply rewarded, not only in dollars and cents, but in health and pleasure, the best of water, and a fine climate. The demand for both comb and extracted is good. There are fine openings for outyards, and a nice healthy business can be enjoyed among these hills and mountains. Thousands of tons of the finest honey is wasted for the want of bees and a bee-keeper to take care of it or gather it. There is a demand for all the honey that will ever be produced whenever the cost of production is reduced so as to put it in the list of the necessities of life, at a price so that the common class with small means can afford to buy it and use it as they do sugar and butter. It is the most healthful sweet there is. It is better for the children of our land than sugar or syrup, or candy made from sugar of any kind. Honey is good for the old folks as well as the young ones.

Bees are wintered on their summer stands without any packing of any kind. All that is needed is plenty of bees, 25 or 30 lbs. of honey, and a hive that will keep the rain and snow out.

T. S. HALL,

BEE-KEEPING IN SOUTH GEORGIA.

The most of South Georgia is a newly developed section. Only a few years ago it was a dense pine forest which has made thousands of turpentine and sawmill men rich as well as railroad companies. While it was being lumbered the agricultural industry took a rise and it has made great progress;

but there is great room yet, and much fertile land to be developed. Naturally, apiculture is in its infancy here, but it is making great progress, and soon we shall have a long list of extensive bee-keepers.

To the prospective bee-keeper South Georgia presents a poor appearance, for somehow they have been wrongly informed, and are looking for dense swamps, along large streams. Hundreds of letters of inquiry have come to my desk asking about the Okefenoke Swamp in the lower edge of South Georgia, as a bee pasture. It is a poor one, of course, and other dense swamps are no better. South Georgia is well watered, and contains much waste land not in or near dense swamps and here we find our best bee-pasture along creeks and their sources. What will be found in such locations in the way of honey-plants will be about as follows. In January, alder, our first pollen-plant, will begin to bloom. About the first of February maple will begin to bloom, which is plentiful, and great pollen-plant. It yields some nectar if the weather is warm during the height of its blooming, and great progress is made in the brood-nests. It continues to bloom until wild plum, redbud, May haw, and fruit-trees around farm houses begin to bloom. Then cypress, beech, and sweet gum continue the supply of pollen and a little nectar until about the first of April. By this time all colonies that have received the proper attention are boiling over with bees, and in the best possible condition for the first honey-flow, which now begins from tupelo gum, which is plentiful in the beds of the creeks and branches as well as along the banks, and scattered through the narrow swamps. This flow is followed by another one, about the 10th of April, from poplar which is plentiful all over waste or low lands; also holly and black gum, which begin to bloom, and the heavy flow is continued on from these sources until the 5th or 10th of May, when the gallberry, which covers the forest from three to five feet deep, unbosoms mother Earth of her much desired treasure, nectar, and continues the flow on until about June 1. Then the ti-ti, which is in abundance along creeks, branches, and low wet land, begins to bloom, and continues the flow on for forty or fifty days. During this time the farmers have thousands of acres of the fleecy staple, cotton, in reach of our bees, growing and flourishing, and about the 10th of July it has bloomed enough for the bees to leave the ti-ti and take to the cotton-fields, which extend the flow on to frost.

South Georgia honey is nearly all light in color, and has a good body and flavor. But honey from the cotton-plant turns to sugar the first cold spell, if it is extracted, but will remain liquid if sealed in the comb.

Our annual average per colony is between 40 and 100 pounds. The flow from cotton is long and sure; and bees winter on cotton honey, and but little if any feeding is ever required.

THE AUTHOR.

BEE-KEEPING IN FLORIDA.

Ft. White, Fla.

As I begin to write I would rather give this another headline and say

what is being done in bee-keeping; but as there is very little doing I feel compelled to give a truthful statement.

I commenced to keep bees eight years ago last May, and to-day I own 350 colonies. I am making more profit out of my bees than any other man I know of on their fleecy staple, cotton. I averaged this year (which has been a little better than the average) 85 sections to the colony of comb honey. We have here a lot of different plants that yield honey and pollen in the early spring. About the first thing the bees go to is the hammocks, and find a lot of early bloom the names of which I am unable to give. This gives them a start, and stimulates brood-raising. Then comes fruit-bloom, such as peaches, pears, plums, etc. On this they begin to swarm, which is about the first or second week in March, and we generally have swarming for about six weeks; but we never have a rush of swarms, or, as some term it, the swarming fever.

About the first of May the chinquepin commences to bloom, and then you see the bees begin to rush; and they will put a good feeling on their keeper, for he knows there is going to be a lot of brood raised, and the hives all filled, and all his new swarms are going to get ready for the good honey-flow as I term it. The chinquepin yields both honey and pollen, and it is gotten from the bloom entirely. The honey has a peculiar smell, a bitter-sweet taste; and has a reddish color. I have found but few people who like it. In some parts of the country we have some gallberry that yields honey about the same time the chinquepin does; and where the gallberry grows we have no chinquepin. The gallberry is found in flat woods, and the chinquepin on the hilly woods of this country. Chinquepin generally gives us some surplus from a few pounds to as much as 50 lbs. to the colony of comb honey. I do not know what it would do for extracted, as I run only for comb. The only extracting I do is to extract this chinquepin honey from the sections and let the bees refill the combs with good honey.

Now we come up to the good honey-flow, which begins about June 15, or about ten days after chinquepin bloom is over. Sometimes the bloom of the chinquepin about meets or comes up to the good honey-flow, which is gathered from the partridge-pea weed, and then we have another good feeling brought over us, as we know we are going to get something for our labor. The bees gather honey from the stem, buds, and bloom of the partridge-peas, and it is a steady flow from about June 15 to Sept 15, and sometimes as late as Oct. 1, and this is our main stake; and without them we could hardly make much profit on bees, although we get some honey from cotton and field-peas, which are both grown here to some extent, but not enough to make any show in our honey crop, as it comes along with the partridge-peas, and we never see the effects on the honey, as the partridge-peas predominate over everything else. The woods are a perfect yellow sheet when they are in full bloom, and they grow in the field after the oats are cut off, in fence-corners, and almost everywhere.

There is one thing I have not mentioned, and I will give it here. It is the blackberry, which blooms ahead of the chinquepin; but we never get any

surplus from it. It is generally used up in brood-rearing and refilling the combs in the beginning of spring.

The last of September and first of October we have a bloom here that I do not know the name of. It is a weed and grows about 18 inches high; has a white blossom on top and yields some honey. I have heard them called summer farewells, as they bloom at the very last of summer. The honey that we get from this has a peculiar flavor, something like fresh turpentine, and it is as white as snow. The honey we get from the partridge-peas is very fine in color and flavor. When the bloom first opens we sometimes get a pale-yellow honey, and I think it is fine—so rich and sweet. The first and last of the partridge-pea honey is very white.

We have no bee-keepers in this country to speak of. I suppose I have more than the rest of the country. Mr. J. M. Hall, six miles east of me, has some forty colonies and he is making a very good success on a small scale, and will increase his stock from time to time, as he has a pretty good case of bee fever. Mr. Crawford Truluck, two miles southwest, has sixteen colonies which have been paying him finely for the little trouble he has given them. He is employed in the phosphate-mining business, and does not take much time with the bees; and what bees he has are the common blacks.

Mr. Wm. Kinard, two and a half miles northeast, has some thirty or forty colonies in both improved and old box hives, which are paying him finely for the expense he is at with them, and these men cover almost all the bee-men who have improved hives. Some few others have from two to six in the improved hives.

There is a Mr. Bates in Lake City, our county-seat, who has several colonies in improved hives, and has Carniolan bees, I think. I have not seen him to talk with him for over a year.

There are a few bees scattered about in old box hives or gums, but they get very little attention. What we lack here is men who will get out of the cotton-field and give bee-keeping a little study, and take on a little courage. We could raise honey, not by the hundred pounds in Columbia Co., but by the carload.

There is thousands of dollars worth of honey going to waste for the want of experienced bee-men, or men who will learn the business and put bees on the ranges to harvest the sweets.

I agree with our experienced bee-men, that we can get a race of bees and improve our stock of bees to where we could accomplish wonders here and in adjoining counties in the amount of honey that could be gathered and put to a profit on the right side. Our county needs it, and should have it; and I hope to see the time when we may have the needed men for the business, and when the honey that to-day is going to waste may be gathered and put on the market where families can get it, as I am satisfied it is the most healthful sweet we have.

R. W. HIRHENY.

BEE-KEEPING IN WESTERN FLORIDA.

Vidalia, Ga.

Bee-keeping in Western Florida has been one of the principal industries in some districts, and along the Apalachicola and Chipola Rivers there are still a good many large apiaries; and the number of colonies one place will provide range for is equalled by very few places in the United States. There are several apiaries in this territory, of upward of 500 colonies, all placed on less than an acre of land.

The season in Western Florida commences by the bees starting to build up with the blooms of the maple in February, and once in many years this source will allow the bees to accumulate a little surplus. The next thing of interest to come into bloom is the ti-ti, which is generally pretty well open by the first day of March, and the opening of this bloom will often bring swarms which have been known to cover the last days of February. Ti-ti is generally followed by the black tupelo gum. Why it is called "black tupelo" is a mystery to the writer of this, for the only difference to be seen is in the color of the leaves, which are a shade darker green than those of the white tupelo, which blooms a month later. The weather is often so cold and backward that the bees succeed in getting but a scant living from the ti-ti and black tupelo; but when the white tupelo commences to bloom, about April 15, if the weather is settled warm the bees become suddenly alive; for with a good full bloom and favorable weather this is one of the fastest yielders of honey known; and extracting-hives have been filled up in three days or less, and most of it capped over; but the apiarist has to move in a hurry, for his living for a year depends on a few days of good weather and his ability to take care of a crop of honey in ten days' time—occasionally a little more and sometimes less. If it should last two weeks in full bloom it means a fine crop; but if there should be a rainy spell just at the opening of white tupelo it means that the apiarist will have to bear many disappointments and wait for another year to roll around.

After the tupelo is through, which is generally by May 1, there is nothing to amount to anything; but about once in five years there is a late flow from an almost unaccountable source. As a general thing, about June 1, bees commence to weaken down, and by September 1 the strong colonies on tupelo are reduced to mere handfuls; but at this point, as if to save themselves from destruction, they commence to build up, and by November 1, have bees enough to go through the winter months.

Nearly every one in this section uses the standard Langstroth hive, or frames, rather, and the bulk of the bees are Italian.

The worst enemy of bees here are the mosquito-hawks, which, during the rainy season, July and August, become very numerous—seemingly as many of them as there are bees; but they disappear about September 1 and so give the bees a breathing-spell.

R. L. TUCKER.

Bee-keepers

I Can Supply You with Modern

**Bee-Hives, Honey-Extractors,
Wax-Extractors, Bee-Smokers,
Bee-Veils, Bee-Gloves, Foundation,
Foundation-Fasteners, Sections,
Section Presses and Fasteners,**

and everything used in up-
to-date Bee-keeping. Also

**Full Colonies of Italian and
Caucasian Bees; and Nuclei
and Queens of either Variety.**

If you have a poor bee-pasture
give me an order for some

**Gallberry Seed, the South's Surest
and Greatest Honey-Plant.**

It multiplies fast and is a great
bloomer when two years old.

Send for Prices and Particulars

J. J. Wilder,

Cordele,



Georgia

Get Acquainted

WITH THE

Bee-Keepers' Review

by sending ten cents for three late but different issues, and the ten cents may apply on any subscription sent in within a year.

W. Z. Hutchinson



Flint, Mich.

THE LOUIS H. SCHOLL APIARIES

PRODUCERS OF AND DEALERS IN

**Comb and Extracted
Honey, and Beeswax**

FOURTEEN APIARIES

Comal, Bulverde, Hunter, Yorks Creek, Zorn, Staples, Santa Clara, Solms, Bracken, Schertz, Cibolo, Marion, Fountain, Bottoms.

We shall try to keep both Comb and Extracted Honey, also Beeswax, on hand the whole season, and Solicit your Orders.

NEW BRAUNFELS,

TEXAS

BEE-SUPPLIES

FOR SOUTHERN BEE - KEEPERS

I HAVE been over 20 years in the Bee-supply business, manufacturing hives and fixtures, and raising bees and queens. With all this experience and the excellent facilities I have, I am able to fill your orders promptly, and give absolute satisfaction. Though I make my own hives I carry a complete stock of The A. I. Root Company's manufacture. Just specify "Root's Goods" and you will get them.

Bees and Queens

I breed with scientific, intelligent methods, from the best Imported and Long-tongued stock. Cheap queens can be had elsewhere. My stock is worth every cent of the price. You will be pleased with it. I GUARANTEE IT.

64-Page Catalog

of Supplies and Bees sent free.

J. M. Jenkins, Wetumpka, Ala.

Queens = Italian = Queens

and Bees from Root's Red-clover stock and
Golden Italian Queens. Better than ever

Selected Untested	- - -	\$.75 each, six, \$4 00
Tested	- - -	1.00 " " 5.00
Select Tested	- - -	1.25
Two-frame Nuclei with Untested Queen	-	2.00

Orders filled in rotation.

Send orders to

E. A. SIMMONS,

-

Greenville, Ala.

The Highest Quality of Bee-Supplies

Prompt Shipments and Low Prices. All Styles of Hives,
Frames, Sections, Extractors, etc. Illustrated Catalogue
and Price List FREE, also copy of the American Bee-
Keeper, a 36-page Monthly, 50 cents a year. 🐝 🐝

W. T. FALCONER MANUFACTURING CO.,

- **Jamestown, N. Y.**

I Make a Specialty of Producing

FANCY TABLE HONEY

And I Solicit Your Orders

W. J. DAWSON, Benton, La.

~~~~~ FOR SALE ~~~~~

A Full Line of Bee-keepers' Supplies; also Italian Bees and Queens, and

Honey a Specialty

Write for Catalog and Particulars. Choice melilotus, (White Sweet
Clover) Seed for sale at 8 cents per pound.

W. P. SMITH,

🐝

Penn, Miss.

QUEENS

Of the best 3-Banded Italian stock, reared by the best methods and fully warranted.

One Untested, 75c; six, \$4.00; doz., \$7.50
One Tested, \$1.25; " 7.00; " \$12.00

W. T. CRAWFORD, - Hineston, La.

Italian Queens

Bred for Honey - gathering by the best-known methods; Golden and Three-Banded stock; mated in separate yards. :- :- :-

Tested, \$1.00 each; Untested, 65 cents each; \$6.50 per dozen.

W. J. Forehand, Fort Deposit, Ala.

For Sale. . .

Honey-bearing Forest Trees; Wax, Honey, Land.

Land is very fertile, being located in the famous cotton section of the Yazoo delta. :- :- :-

Tho. Worthington, Leota, Miss.

Georgia Queens

Of superior Golden and Leather-Colored Italian stock; reared by the best method known, in full colonies. :- :-

Write for Prices and List

T. S. HALL, - Jasper, Pickens Co., Ga.

SOUTHERN BEE CULTURE

OLDEST BEE PAPER IN AMERICA

AMERICAN BEE JOURNAL

ESTABLISHED IN 1861

Those who write for it are among the most extensive and best bee-keepers in the world. Many of them produce honey by the ton, and make money at the business, hence their experiences are valuable.

The American Bee Journal

has the following departments, each of which shows its nature by its name:

**Editorial Notes and Comments
Miscellaneous News Items
Contributed Articles
Convention Proceedings
Our Bee-Keeping Sisters
Beedom Boiled Down
Dr. Miller's Question-Box
Southern Beedom
Canadian Beedom
Reports and Experiences
Honey and Beeswax Market Quotations**

Every bee-keeper, whether he or she has one colony or a hundred, should read the old American Bee Journal every month.

Only 50 cents a year; or 20 cents for a trial trip of six months to a new subscriber.

*Sample Copy Free. Ask for it.
Address*

American Bee Journal

George W. York, Editor

118-132 W. Jackson Blvd.

Chicago, Ill.

Lewis' Beeware

**The Best Beeware in the South
The Best Beeware in the World**

Beginners Should Use It, Experienced Beekeepers Do

Lewis Beeware has been on the market 30 years.
It always fits, made of the finest material,
packed neatly, always standard,
always the same.



**We Say to You!
Mr. Beekeeper in the South,
Lewis Beeware is Now at Your Very Door**

J. J. Wilder,
Cordele, Ga.

Southwestern Bee Co.
San Antonio, Tex.

DISTRIBUTING HOUSES

SEND FOR FREE CATALOG

“Dadant’s Foundation”

IT EXCELS

**EVERY INCH
EQUAL TO SAMPLE**

Beauty, Purity, Firmness,
No Sagging, No Loss,
27 Years of Experience,
We Guarantee Satisfaction.



Wax Worked into Foundation



Bee-Supplies of all Kinds
Beeswax Wanted at all Times

DADANT & SONS,
Send for Catalog Hamilton, Ill.

