

\* UMASS/AMHERST \*

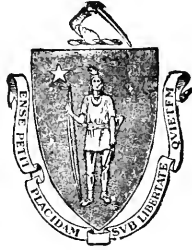

312066 0333 3316 1

LIBRARY  
OF THE



MASSACHUSETTS  
AGRICULTURAL  
COLLEGE

SOURCE

College Funds

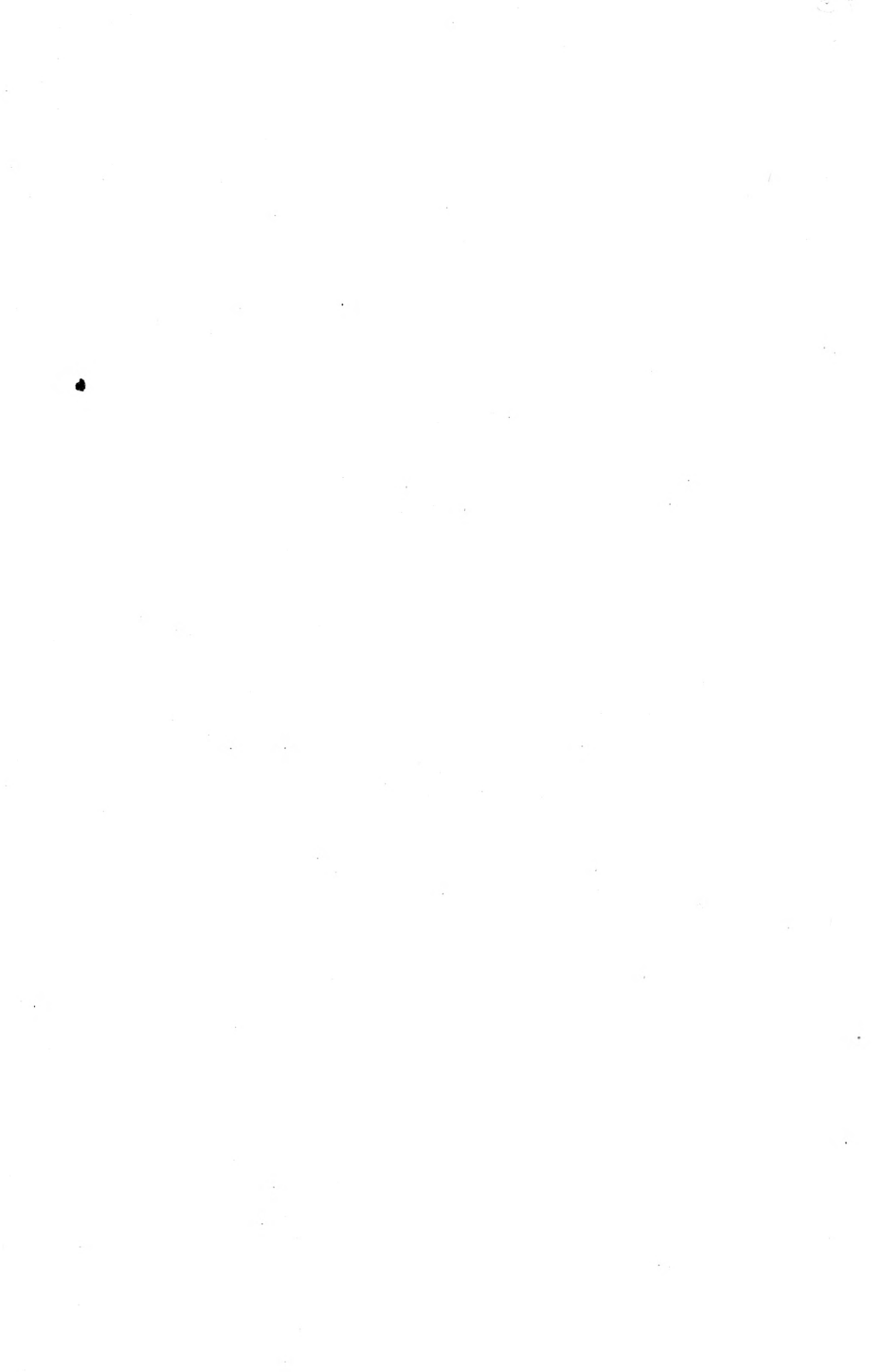









No. 1958. Vol. XLVIII JANUARY 1, 1920. [Published every Thursday, Price 2d.]

**CONTENTS.**

	PAGE		PAGE
BRITISH BEE-KEEPERS' ASSOCIATION .....	1	Do Bees Recover from "Isle of Wight" .....	7
INTERMEDIATE EXAMINATION .....	1	Disease? .....	7
CHESHIRE'S BEE-KEEPING .....	1	Wanted, Remedy for Ants .....	7
A DORSET YARN .....	2	Queen, or Laying Worker .....	7
JOTTINGS FROM HUNTINGDONSHIRE .....	2	Frames .....	8
THE FORWARD MOVEMENT IN BEE-KEEPING .....	3	Trading Schemes .....	8
NOTES ON BEES .....	5	QUESTIONS FOR BEE-KEEPERS .....	9
ECHOES FROM THE HIVES .....	5	COMBS FROM OTHER HIVES—	
CORRESPONDENCE—		Paratyphus in Honey Bees .....	9
Bee Clubs .....	6	Eggless Honey Muffins .....	9

**DO NOT LET YOUR BEES STARVE.**

**Use Taylor's Soft Candy**

1-lb. 1/6, post free ; 6-lbs. 6/-, post free ;

12-lbs. 10/6 (11/6 carriage paid, 12/- post free.)

SYRUP—7-lbs. 7/6 ; 14-lbs. 10/6 ; 28-lbs. 20/- SUGAR VOUCHER must be sent with order.

**BEESWAX BOUGHT,**

2/- lb. Cash, or 2/1 lb. allowed if taken out in goods.

Also Cleaned and Sterilised and made into Foundation.

No. 77. Compressed  
**NAPHTHAFORMA TABLETS,**  
The Germ-killing Remedy for Foul Brood  
1/9 Bottle, Post Free.

**TAYLOR'S NEW REGISTERED  
ZINC EXCLUDER**  
giving 50% freer access to supers  
16 x 16 squares 3/-, post 6d.  
8-ft sheets 15/-, post 1/-.

**BACTEROL' & YADIL,**  
For "Isle of Wight" Disease.

Bacterol, 2/6 per bottle, post 6d.

Yadil, 3/6 per bottle, post 6d.

Syrup should be fed medicated with above in  
**Taylor's Registered Feeder,**  
Specially designed for above cures,  
Post free, 3/10.  
or Bottle of Bacterol and Feeder, 6/- post free

TAYLOR'S No. 12 HIVE, Dovetailed, at 29/- Carriage Paid. In the Flat, 28/-  
BEST VALUE IN HIVES EVER OFFERED.

NEW CATALOGUE FOR 1919 POST FREE.

**E. H. TAYLOR, WELWYN, HERTS.**

**The New Year's Surprise!**

¶ On another page of the JOURNAL we make an announcement relative to the supply of Metal Foundation for the coming season. Do not defer its study. *You may be disappointed if you do not give it your immediate attention.*

¶ Only one type of Metal Foundation (standard size, and milled) will be produced at first. Other types and sizes may follow later. An original new mill of hardened steel will be employed for the purpose. The mill is costly, yet the prices we quote are well within the purchasing power of the average beekeeper.

**MAIN ADVANTAGES.**

(1) Indefinite durability with reasonable care ; (2) Greater comb stability in quick extracting ; (3) Greater safety of bees in transit on new combs ; (4) Control of drone cells ; (5) The production of even combs ; (6) Easy removal of queen cells without the slightest injury to the foundation ; (7) Cleanliness and adaptability to sterilisation by boiling ; (8) Economy of labour and time in fitting and detaching ; (9) An ideal compromise between the metal comb and the wax foundation.

**LITERATURE.**

“The British Bee Journal,” November 13 ; “Bee Craft,” December ; and “The Bee World,” September and October, 1919.

---

\* \* \* The non-wax foundation, including the Metal Foundation, is protected.

**JAMES LEE & SON, Uxbridge, Middlesex.**

*Telegrams: "Graphically, Uxbridge."*



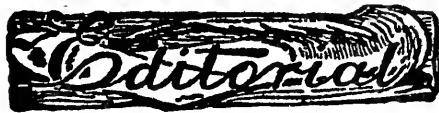

## British Bee-Keepers' Association.

As will be seen from the report of the Council meeting held on December 18, the B.B.K.A. have decided to carry out experiments with larger frames during the coming season. The Kent B.K.A. are also carrying out a valuable series of experiments in the same direction. It would be a great help if the leading associations would carry out experiments on similar lines and report the results.

### MONTHLY MEETING OF COUNCIL.

The monthly meeting of the Council was held at 23, Bedford Street, Strand, London, W.C.2., on Thursday, December 18, 1919.

Mr. W. F. Reid presided, and there were also present Miss M. D. Sillar, Messrs. G. Bryden, A. G. Pugh, T. Bevan, G. J. Flashman, G. R. Alder, J. Herrod-Hempsall, F. W. Watts, G. W. Judge. Association representatives, R. R. Babbage (Middlesex), G. Thomas (Gloucester), Major C. C. Lord (Kent), and the Secretary, Mr. W. Herrod-Hempsall.

Letters of regret at inability to attend were read from Messrs. T. W. Cowan, C. L. M. Eales, W. H. Simms, J. B. Lamb, G. S. Faunch, and Major F. Sitwell.

The following new members were elected:—Mrs. E. M. Hood, Mrs. B. E. Lister, Miss A. Parker, Miss F. Collins, Messrs. E. G. Gristwood, E. L. Peirce, J. H. Phipps and J. Nash.

The report of the Finance Committee was presented by the Secretary, who stated that the receipts for November were £28 1s. 7d., and the bank balance on December 1st, £103 1s. 8d. Payments amounting to £68 11s. 7d. were recommended.

The Chairman said he had a very pleasant duty to perform in the presentation of the Silver Medal of the B.B.K.A. and Certificate of Merit to one of the members of Council, Mr. G. Bryden; and also the Bronze Medal of the Association to another member, Mr. G. J. Flashman. It had often been said that members of the Council were not even up in practical bee-keeping, but the presentation he had now to make proved the fallacy of that statement, as both the recipients had won premier honours! in fact, had swept the board in all the classes at one of the most important honey shows in the country; while one of them, Mr. Bryden, had won the W.B.C.

Gold Memorial Medal at The Royal Show this year.

The presentation having been made, Mr. Bryden and Mr. Flashman expressed their thanks in a few well-chosen words, both stating their pleasure at being able to demonstrate in a practical manner that members of the Council could practice what they preached.

Mr. Pugh, in felicitous terms, supported the remarks of the Chairman.

The Chairman expressed the pleasure of all those present at having Mr. Pugh back amongst them again after his serious illness, and that his repartee proved he had apparently recovered his usual health and spirits.

It was agreed to undertake the Hives and Honey Department at The Royal Show at Darlington on the same terms as prevailed this year at Cardiff.

It was resolved that it would be inadvisable to send bees to France to restock the devastated areas, owing to the possibility of exporting infection in the form of "Isle of Wight" disease.

A letter was read from Mr. Claridge *re* the importance of approaching "The Merchandise Marks Committee *re* labelling foreign honey with the name of the country of origin. It was resolved to instruct the Secretary to write the Committee to this effect.

A letter was read from Dr. Abushady *re* the testing of frames of various sizes, and after a lengthy discussion it was resolved to test the 16 in. by 10 in. and the 14½ in. by 12 in. frames in the Association's Apiary, and also to ask practical bee-keepers throughout the country, through the medium of THE BRITISH BEE JOURNAL, to do the same, and forward their experiences to the Council for consideration.

Next meeting of Council January 15, 1920, at 23, Bedford Street, Strand, London, W.C.2.

---



---

## Intermediate Examination, B.B.K.A.

Through a clerical error in Section A question 4 the word Sight was spelt Light. The Examiner wishes to intimate to candidates that no candidate will fail on account of this being misread.

---



---

## Cheshires Bee-Keeping.

I lent the Scientific Volume of this to some person. The record of the loan has been mislaid. As I am in urgent need of the book will the borrower kindly return it *at once* to W. HERROD-HEMPSELL, Old Bedford Road, Luton, Beds.

## A Dorset Yarn.

Saturday, December 20, bees were flying round the Christmas rose, proving that they do not sleep, but are only waiting till all things are favourable for them; then all will be as other years. All reminds me of the old promise, which I have many times repeated: "Seed time and harvest shall not cease as long as the sun and moon endure," proving the words of the Old Book, "All things work together for good with them that love God." Our love for bees has borne fruit. The returns show, on the year's working, that bees have again given the most for the least expenditure. This is as it should be. Granted the fine prices have made this so, but then everything that the grower produces has realised good prices. Still, honey is a long way beyond other units on the farm. Cows pay well, eggs bring in high prices, fruit panned out well, but for minimum of outlay and maximum profits there is nothing on the farm like bees.

This may be the dull time for bees, but those who have their well-being at heart will not forget them; they will make quite sure that the covering on the bars is sufficient for warmth, that it is dry, that mice are not doing mischief. Many growers of flowers only take keen interest in them when they are bringing in money, but those who have the true interest in them are keen all other times. It is the same with the bees; winter care is without a doubt the best for summer production. I notice our lot have thrown out a lot of dead bees; the sharp, cold week in November must have finished off a lot of the old bees that had worked so hard in the honey season. The deduction I make is that bees must have plenty of food in September in order to raise as many young bees as possible to carry on until brood is plentiful the following season. The young bees of late summer and autumn have more warmth in them; they crowd more into the cluster, and the old ones as a sequence soon perish on the approach of cold.

We are again filling up the manure yard with leaves from Merley Woods. I wrote of them last year. These woods are beautiful at all times. The immense trees, with undergrowth of rhododendron and holly, all produce huge quantities of leaves; these, with the excreta of cows, horses and pigs, all turned over together, give many hundred loads of humus to feed the crops for the next season. We find, to grow crops of a high order of excellence, we must enrich the soil. Each unit of production must have what is necessary to promote its growth luxuriantly with humus in the soil. One can add fer-

tilisers to the soil with so much better advantage to the crops, particularly if the season is a dry one like this last year. To get the very best to sell, each unit must be well looked after, and then the results are worth the extra cost of production, as the weight of the fruit is so much more. Take a line of gooseberries, for instance. If you do not loosen the soil round them, and add a modicum of manure, they will have the same number of flowers and fruits, but the latter will only grow about half the size, so the harvest, when sold by weight, must be half what a well-tilled and well-dressed row would be. I think the same with our bees. Let them be well stocked with stores in winter; they will give us better returns next season.—J. J. KETTLE.

[This was received too late for publication last week.—EDS.]

## Jottings from Huntingdonshire

"It was agreed that on ye occasion of ye wedding of ye mistress K —, a full peal should be rung from ye church tower, and whereas ye trebel bell hath been silent for full ten yeares, it being full of bees, John Hamer shall be payed ye sum of fivepence to cleare out ye bees and honey from ye said bell, one full half the honey to be his; that which remaineth to be divided betwixt ye poore of ye parish. William Gray shall be payed eightpence to plaster up ye hole in ye wall through which ye bees are seen to go." (Money had 20 times present purchasing power.)

Many church towers have been selected by bees as a suitable home; it would be interesting to know how often they have chosen one of the bells as a suitable habitation. Talk of metal combs; the bees anticipated us centuries ago by adopting a metal skep. Going back to the past, Mr. Editor, I was looking through an old parish register the other day, and was struck by the names given to baby girls 300 years ago, Dorothee, Wynyfred, Joan, Amee, Unita, Malina, and such like. Mary Ann, Sarah Jane and Maria Jane, do not make their appearances until some 200 years after. When we speak of Sarah Ann as an old-fashioned name we are wrong, it is quite modern. What, however, struck me most was to find in the seventeenth century girls christened Apia, Mellis, and Mellifica, evidently the daughters of a bee enthusiast, as Avis, Birdee, and Larkid testify to a bird lover. Did bees escape diseases in those days, one wonders? Not till about 1790 does one come across a record "that the bees of late years have been troubled with a nasty dysentery which doth destroy a full stock in a very short time, which doth greatly distress

the owners." Thirty years later we learn that "many diseases are wont to seize bees in these days, and Mr. Woods hath concluded that as intermarrying doth tend to weaken the offspring and cause much suffering in human beings, so inbreeding of bees has resulted in these diligent insects being greatly weakened in their constitution, he, therefore, proposes to get a number of stocks from Bavaria and Denmark and to use the queens in his English stocks." This did not evidently result in a disease resistant bee being evolved, for a "dysentery in our bees doth greatly trouble us, and a traveller from Holland reports that many thousands of stocks of bees have died in that country, which is attributed to a method they have in that country of relieving the bees of making wax," is written shortly after. Legislation in those days might have saved us a lot of trouble in our day and generation.

Well, bees have ever been an object of interest to mankind, not to say profit, and yet it's wonderful how little we know of them—little compared with what there is yet to learn. I'm afraid I do not agree that comb cells take their shape from outside pressure. Last summer I took a swarm of bees out of a hawthorn bush which had been there a couple of days on two large branches. The bees had commenced building cells. The branches were just filmed over, but the cells were hexagonal, or rather the foundations of the cells were.

In October we had our harvest tea. The tables were decorated with vases of single dahlias. From one of these flowers fell a mason bee—chilled. Children sitting near seemed afraid of her, so I picked her up and warmed her back to life in my hand. When she was quite revived I flung her towards the window, but she flew back to me—a mason bee can fly backwards, sideways, upwards, downwards; in fact, any way it wishes. After a while, I placed her outside on a window sill thinking she might seek out her hard rocky nest. About half an hour after, however, she was patiently crawling up my arm. Now what enabled her to locate me out of the other people in the room? Had she needed more warmth she could have got it from any other body. I fancy the pretty insect grateful for what I had done for her had located me by her organs of scent.

There is a fair demand for honey just now, sections having jumped up to 3s. 3d. Honey comes in handy at this season of the year for sore throats and coughs, and it is certainly a pleasant addition to, or substitute for, inferior margarine.

How one hopes that ere another Christmas is here the whole world will be enjoying a righteous and lasting peace! To help forward such a peace we must all

be producers. Bee-keepers must do their share. Given a good season we ought every one of us to eclipse our former "takes." Honey is so very much an article of food that the more we produce the more help can we give to those countries which are on the verge of starvation. This reminds me of a story I once heard of a certain bishop who once stayed a day with one of his poorer clergy. The sumptuous repast provided shocked his Lordship, who chastised his host for his extravagance. "It's all right, my Lord," the cleric replied, "I have the money for these festivities given to me. I will introduce you to the givers after dinner." The dinner over, the bishop was taken and shown hives of bees. "These, my Lord, enable me to be generous to my guests."

To you, Mr. Editors, to you, all gentle readers, a very happy Christmas, and may you all experience that joy which comes of serving others rather than oneself!—E. F. HEMMING, The Rectory Steeple Gidding.

[As we had to go to press earlier last week on account of Xmas, these "Jottings" arrived too late for publication in the last JOURNAL.]

---



---

## The Forward Movement in Bee-Keeping.

The movement in favour of an extensive trial of a larger and deeper brood frame than the British standard, disclosed in a recent issue of THE BRITISH BEE JOURNAL, prompts me to write you a few words, because I believe this is one of your most evident lines of progress. Here in Canada we are scarcely satisfied with the size of our most widely used brood chamber containing ten Langstroth frames 17 inches long by 9½ in. deep, and we are studying the merits of one containing twelve of these frames, or one containing ten frames 2 inches deeper, known as the Jumbo size. The deeper frame has undeniable advantages both for breeding and wintering. In Britain, where the standard frame is much smaller and somewhat shallower than the Langstroth, the need for a larger and deeper frame than the standard would seem still greater than here, although the black race, being less prolific, can do with a smaller hive than the Italian, which is the popular bee in southern and central Canada. In Canada, we have quite a number of sizes of frames, and so great confusion is caused. In Britain, there surely is room for two! The British Bee-keepers' Association would not lose anything, on the contrary, it would show that it is maintaining the

elasticity of youth if it countenanced the extensive trial of a brood frame, say 16 inches long and 10 inches deep, which seems to me to be a very reasonable and sensible size. Of course, in settling on a new size of frame, many questions would have to be considered, amongst them its bearing on the size of the comb honey super. A 16-inch frame might not be the best for the  $4\frac{1}{4}$  inch by  $4\frac{1}{4}$  inch sections, but it would suit the 4 by 5 sections, a size that, personally, I think looks more attractive, and being larger is more readily worked in by the bees.

In the larger and deeper frame and hive that I feel you are going to get sooner or later, such essential British features as the comparatively thin and narrow top bars (but not so thin as  $\frac{3}{8}$  in.), the long lugs which the bees are not permitted to crawl over, the W.B.C. metal ends, and the outer case must be retained. Protecting the super with an outer case, as is done in practically all patterns of British hives, has undoubtedly advantages for a changeable climate. The plan of protecting the brood chamber as well, the feature of hives of the W.B.C. pattern is being adopted in the Canadian north. The only improvement that might be suggested would be to protect the floor as well as the sides.

The race question is evidently one of growing interest and importance in Britain. Taking the British Isles as a whole, the cool summer climate demands a black bee rather than a yellow one—we have regions on the coasts and in the north of Canada where the same is true—and the breeding of an industrious, prolific, disease-resisting strain of the black bee seems to be a matter of great importance at present. As many of your readers will remember, my efforts in breeding bees at Ripple Court Apiary, near Dover, were confined to goldens and half-breeds, largely because it was only by a differential colouring that purity could be maintained. Blacks can only be bred by mating in isolated places. Every year since the Bee Division of the Dominion Experimental Farms has been established, we have been carrying on mating experiments. Last year matings were obtained in isolated places in northern Ontario. This year Duck Island, at the eastern end of Lake Ontario, 8 miles from the nearest land, was selected. The results show that the queens mated with our selected drones only, and there was no heavy loss of queens. They also showed that queens mated with hand-picked drones not more than about two weeks old became drone breeders, producing from about 50 per cent. to less than 1 per cent. of workers. Now that a number of difficulties in regard to the size and make-up of the nuclei, the

best date to carry out the work, the age and number of drones required, etc., have been cleared, we hope to make rapid progress. In considering the island mating proposition in England, I remember reaching the conclusion that from the point of view of size, isolation, and climate, Herm Island seems to be one of the most promising for experiment.

Shortly before I left England in 1912, you published an article from me on the two kinds of foul brood that are recognised here under the names of European foul-brood and American foul-brood. In recent years, the distinction between these two diseases has become of increased importance, because the best methods of treating them have become radically different. European foul-brood is treated by removing the queen, and after a shorter or longer period of no brood, introducing a young Italian of resistant strain. There is no destruction of combs, and if the apiary is kept Italianised, this disease usually gives no further trouble. But with American foul-brood, which spreads more slowly, the regular "shaking" treatment is necessary, the combs being boiled. There is also a third brood disease, very common in Canada, called sac-brood, for which no treatment is necessary.

Have any of your travelling experts tested these New World conclusions on brood diseases under British conditions and reported results? The results should be interesting because we know that the laboratory men on the opposite sides of the ocean have not reached the same conclusions, and that climate and race favour certain diseases and alter their symptoms. Especially is this true in an unstable disease like European foul-brood, and in the adult diseases. As a bee breeder tied closely to my work, I had little opportunity to study disease in England, but I recognised European foul-brood in my apiary, and found that Italians resisted it.

The names European foul-brood and American foul-brood are not very appropriate. Better names would be melting foul-brood and rosy foul-brood, because they are to some extent descriptive. It would be better still, as suggested to me by Mr. Turnbull at a recent meeting of foul-brood inspectors at Vancouver, to eliminate that unpleasant and really unnecessary word "foul" in connection with a product we eat.

Melting brood, rosy brood, and sac-brood make short, clear, descriptive names for the three brood diseases we know and treat respectively by Italianising, "shaking," and leaving alone. Drugs are not used here to treat bee diseases.—F. W. L. SLADEN, Apiarist, Dominion Department of Agriculture, Ottawa, Canada, October 11.

## Notes on Bees.

Now that the dead season is upon us ordinary dysentery can be looked for. This is produced from various causes, such as unwholesome food and dampness, mostly the former. A mild autumn, such as we have been experiencing this season, causes the bees to uncap too much of their stores, as they are spread about more on their combs, and if the mild weather is followed by a cold snap, close clustering is the result, thus leaving exposed to the air a great amount of uncapped honey, which eventually turns sour. I have noticed in early spring when examining combs, honey and pollen with a sour taste, which must prove unwholesome food for bees to feed upon. Often disturbances occurring during what ought to be a lengthened period of semi-hibernation, preventing the repose necessary at such a time, they consume a much larger quantity of honey than is natural for them, and having, on account of the bad weather, no chance of going abroad to relieve themselves, their bodies become distended with the consequent accumulation of fæces, which causes inflammation, dysentery, and death. The signs of dysentery are similar to "I. O. W." disease. Soiling the combs, inside of the hive, and around the entrance with a dark brown substance having a very nauseous smell. Unlike "I. O. W." disease, the cure for ordinary dysentery is very effectual. It is simply to remove bees to a better environment. Place in a warm room, and house in a clean, dry hive, on warm combs of honey, cover with warm, dry quilts, and place on original stands. According to various distinguished bee-men's reports, the above is very effectual. The signs of dysentery must not be confounded with the natural marks made by bees outside a hive after they have been confined to it by bad weather for some considerable period. These marks are quite in accordance with what might be surmised, but they are always on the roof, or surrounding objects, and very little around the entrance. Malignant dysentery, *i.e.*, "I. O. W." disease, is a far more infectious disease than the ordinary dysentery. Of this there is overwhelming evidence. There have been cases where *Nosema apis* has been revealed by the microscope, and stray swarms have taken possession of the combs and survived, but I am strongly of the opinion that in a great number of cases given to us where bees have died out of "I. O. W." disease and stray swarms taken possession and survived, it has not been "I. O. W." disease, but ordinary dysentery, as the symptoms of

the two diseases are so alike, only that the former is of a deadlier character.

I notice, out of my four stocks one is affected with "I. O. W." disease, a few crawlers, while those on the wing seem to possess a peculiar hum, appear heavy, unsteady in flight, and drop on the alighting board as if loaded with honey. I find that bees in the early stages of this disease seem to be unable to discharge their excreta in the open air, even when in flight, and return to the hive with the bowel still loaded. This is no doubt due to the parasite in the infected bee, before it reaches the spore stage, because after a time an acute diarrhoea seems to set in, and the combs and inside of the hive are soiled. The cause of this malady has never yet been satisfactorily determined, nor up to the present, according to my mind, has there been any reliable cure put forward. If we could be assured of the true source of this disease, then our pathologists might be able to give us some reliable prescription to ward off it and its effects. There is no doubt, owing to the infectious nature of this disease, it is greatly spread in this country of ours by idle bee-keepers, and it is here where legislation would step in and compel this class of bee-keeper to work clean. What is the use of one bee-keeper destroying bees and combs, or disinfecting, etc., when the next-door neighbour leaves his diseased hives exposed for one's own bees only to be re-infected again. This is the cause of many giving up the craft. In conclusion, we bee-keepers believe that legislation will be an accomplished fact and greatly reduce the evils in bee life.—P. LYTGOE, Padgate, Warrington.

---

## Echoes from the Hives.

How glad I was to see the name of our old friend, Mr. Loveday, a few weeks ago. We miss him—and also Mr. Woodley—we old readers, as much as we do Mr. Kettle when he cannot write. My wife always looks in the JOURNAL for Mr. Kettle's yarn, and when there is not one, such a sigh goes up!

I remember cycling to Hatfield Heath about 25 years ago to see Mr. Loveday. What a show he had for a new starter to see, and what a lot I learnt in a few short minutes about bees! I remember, too, he showed me the stings of about a dozen bees on the alighting board of one hive, and how he told me the large Tit caught his bees, pulled out the stings and then ate the bees, and many another bit of news he told me. I quite thought by now he must have left us for that brighter Home as we have not seen his name for so

long, but I am glad to know he is still well, although I fear his back, which was hurt years ago, must still pain him and restrict his activities very much. His age, too, must be getting to a high number. Even so, we were very glad to see the name of friend Loveday.—C. REED, Wickford, Essex.



*The Editors do not hold themselves responsible for the opinions expressed by correspondents. No notice will be taken of anonymous communications, and correspondents are requested to write on one side of the paper only and give their real names and addresses, not necessarily for publication, but as a guarantee of good faith. Illustrations should be drawn on separate pieces of paper. We do not undertake to return rejected communications.*

### Bee Clubs.

[10074] I have enclosed my scheme for co-operative bee club. If you can find space for it in THE BRITISH BEE JOURNAL I shall feel favoured. It will save time and postage to those inclined to take up the scheme. I have received applications, and according to replies I think it has a future. I admire Mr. Hemming's remarks and I have talked it over with our members. We feel that any sane bee-keeper would burn up old diseased combs and the affected stock, if every attention appeared to be a failure. Of course, it's up to any club to add to these rules, but if any readers take up the idea, I would like to see a line or two in THE BRITISH BEE JOURNAL to say how they are progressing.

Mr. Kettle says: "Why don't we who are demobilised write our great knowledge to the JOURNAL?" Well, I have read a many of his articles and I thank him for them; but I feel that the reason we demobilised men don't write is because we have not the writing talent. I have had a varied experience on the battlefields of France, but not being much of a scholar keeps me from writing, and as our Editor mentioned the other day, they can't keep a staff to make good reading out of our badly-worded sentences, or that's what I think he means. If it would interest readers, and Mr. Editor will be as kind to me as he was over my last epistle, correct my wrong-spelt words, and put in the stops, well, then, I will do for you in writing what I tried to do for you on the battlefields of France—"my best." You

will bear with me a little when I tell you the trouble. I've been at work ever since I left standard III., and they don't teach one much in the way of writing and composition in that hard school of experience—the world. I am just on 50, still at the bees, and hope to be more so, once I am able to be about again. I notice the bees are busy on the wing these last few days, one came in to have a look at me to-day in my sitting-room. I was glad to hear it hum, but sorry to see them out so late. Still I trust all's well with the bees. There are quite a lot on the wing.

Going back to the subject. Some of the boys did not get a chance hardly to see France. I have seen too many of them just come up the line at night, and away the next day with a "Blighty" to last them for life, all within seven days, and sometimes less, from the time they have said "bye-bye" to mother, sisters, wife, or sweetheart, and others, alas! it cuts to the heart of it that thousands will never, never return at all. I would feel bright if I could only think these heroes had secured the precious golden crown. Alas! who knows? And all this makes thousands of the dear lads who have returned whole in limbs, etc., more silent than the bees in winter.—G. H. CLEWLOW, Codsall, late Corpl, R.A.S.C., M.T.

[Needless to say we shall be very pleased indeed to hear from Mr. Clewlow, or any other ex-soldier, and only wish all the letters we receive were as good in composition, spelling, etc., as this, as in neither have we had to make any alteration.—Eds.]

#### CO-OPERATIVE BEE CLUB.

To bring together all men and women who are interested in bee-keeping.

To instruct the new beginner in the craft in all its branches, by lectures, pamphlets, demonstrations, etc.

To co-operate in buying all appliances at wholesale price through the bee club, and the disposal of all produce, such as honey, wax, bees, etc.

A membership fee of 1s. per year will be found sufficient, as there is 2½ per cent. for cash with order, and 2½ added to order will be found to clear all clerical expenses.

All orders to be accompanied with cash. Member to be notified when the club will be in a position to receive produce.

All inquiries for swarms to be tabulated by the secretary, who will supply in rotation. All members who intend to sell their swarms and surplus stocks to inform the secretary as early in the season as possible.

The club may provide wax smelters and honey extractors, and charge a small fee for the hire of the same.

Labels bearing the name and district of the club may be obtained for honey jars,

tins, and sections' carriers at a nominal fee.

All members are requested to report to the secretary all known derelict apiaries, and also bee-keepers who have not cleaned up their apiaries after having attacks of disease, as these old apiaries are detrimental to good bee-keeping in any district.

The club shall consist of a president, secretary, and not less than five members as an executive committee.

G. H. CLEWLOW,  
Hon. Secretary,  
The Bee Club,  
Codsall.

### Do Bees Recover from "Isle of Wight" Disease.

[10075] If not too late, I should like to thank Messrs. G. W. Avery (10052) and Mr. Greig (10056) for their replies to my inquiry as to recovery of bees from "Isle of Wight" disease. Mr. Avery asks me two questions:—1. How can a bacteriologist confirm "Isle of Wight" disease? Of course, he cannot do so, unless *Nosema apis* or some other definite and recognisable organism be accepted as the cause, or at any rate as a specific manifestation of the disease. (The last is a clumsy phrase, but I think Mr. Avery will understand my meaning.) 2. What is the overwhelming evidence which proved that *N. apis* is the cause of "Isle of Wight" disease. Here I am afraid that Mr. Avery has caught me tripping, for I cannot give it! But Leaflet No. 253 of the Board of Agriculture says: "It (referring to 'I.O.W.' disease) is caused by a microscopical animal parasite. . . . This protozoon has been given the name of *Nosema apis*, Zand." Several ailments, including "Isle of Wight" disease, are then enumerated; then occurs the following: "All these ailments are, however, due to *Nosema apis*." Now I was under the impression that the experiments on which this leaflet is based included the finding of *N. apis* in every case, and successful inoculation experiments, and were considered conclusive as regards the cause of the disease. I am aware that this not giving the evidence, but it will explain why I made the possibly rash statement alluded to above. I was not aware that the present investigators under the Board were not satisfied as to the cause. However, I take Mr. Avery's word for it.—G. R. STRONG.

### Wanted, Remedy for Ants.

[10076] We shall esteem it a favour if you, or any of the readers of the B.B.J., will give us a remedy or sure cure for preventing the small black ant from infesting beehives.

For the past seventeen years we have

had Devonshire Villa Apiary, of from fifty to seventy colonies, and it is only this season that the ants have worried us.

They so irritate and disturb the bees that fifteen colonies have deserted the hives, and in many cases leaving frames of unhatched brood.

We have tried unslaked lime, underneath and around the hives, but found it useless. Then we used a solution of "War on Vermin," sprinkled through a watering can, which was also useless. Next we tried a few hives with legs in tins of water, but this did not prevent their appearance in thousands on the alighting boards. Lastly we tried the American method as published in your B.B.J. of October 16 last, without the slightest effect. Your journal we handed to one of our leading chemists, and from the prescription given therein it was made up at a cost of 1s. per tablespoonful. We found, as soon as the solution painted on the legs became dry, the ants passed up and down in hundreds without showing any signs of discomfort.

As we are at a loss to know what to do now, we are therefore appealing to you in the hope that you or your readers may know of something more effective than what we have tried.

Several other bee-keepers in and around Pretoria are suffering in the same way.—CAIRNCROSS AND ZILLEN, Pretoria, South Africa.

[Can any of our readers give any help to our correspondents. As a rule, bee-keepers in this country are not troubled by ants to anything like the extent above, and our own practical experience with them is only slight. We have, however, read that standing the hive feet in a shallow vessel containing a mixture of oil and carbolic acid has proved effectual. We shall be pleased to receive and publish anything that our readers may have found useful.—EDS.]

### Queen or Laying Worker.

[10077] An experience with one of my hives has been out of the usual, and I thought would interest some of your readers.

On July 26 the stock swarmed for the third time this year. Previously I had put them back after removing four combs with bees and brood and all queen cells, but this time I hived them on two racks of drawn-out shallow combs, leaving only one queen cell to the old stock. I was leaving home next day, and did not examine the old stock again until August 24, when I decided they were queenless and gave a comb of eggs from another stock. Next day queen cells were started. On August 31 I was given an old queen

which was caged on the frame, and on September 4 I received a queen by post. I placed a piece of close-fitting perforated zinc in centre of hive. The old (?) queen was one side with five combs, and the later queen released by the bees on the other side. On September 9 I found both queens, no eggs, only sealed drone brood in worker cells on side with old (?) queen. I placed a bottle over each side, and examined again on the 13th, finding with the old queen strong evidence of a laying worker, but no eggs from either queen, both of which I saw again on the combs. But a few hours after, the queen received by post was thrown outside very badly battered. This left the stock with an old (?) queen which refused to lay, and hatching drones, miserable little things stunted in growth. Things remained thus until the 24th, when I noticed a complete change outside—bees rushing in and out and collecting pollen, and inside on five combs were good patches of eggs. The following day was cold, but about four o'clock, when other hives were quiet, this hive was working hard. There had been no eggs laid since July 26, and Nature seemed to be telling them of the importance of getting new life before their own end came.

On the following morning, outside, I found an abnormally large worker, about the size of a queen, which I enclose, and suggest is to be the mother of the drones in the hive. I also suggest that from the frame of eggs given them on August 24 a queen was raised, which destroyed the old queen introduced on August 31, and she is now laying. I am waiting until the brood is sealed to decide if it is worker, as, being in the smaller cells, the larvæ may, to me, be insufficient proof of its sex.—H. E. WARREN.

[We cannot say if the bee was a laying worker. Usually they are no different in appearance to the other workers, so cannot be found, unless caught laying.—Eds.]

### Frames.

[10078] Much has been written of late about frames, but I think it is the brood chamber which is at fault. I make all my own hives—never bought but one—and I make them all to hold twelve frames and the following board. I find that a good queen wants more than ten combs—often twelve. What a muddle there is when trying to take out a frame when the brood chamber will only hold just ten, and the frame is full of brood and well covered with bees, and what a lot of stings a new hand gets! If the chamber will hold twelve frames and a good, thick following board, one can take out the board, pull back the frames one at a time, and just do what one likes.

So far our bees, and all bees under my charge, seem well, but how they, and we too, would like to see a bright, sunny day, so the bees could get out for a flight such as some of our friends write about. Our bees have not had a flight for eight or nine weeks. I never remember them kept in for so long this time of the year.—C. REED.

[We agree with Mr. Reed on the question of a brood chamber to hold up to 12 frames. Our own hives are of the same size, and we find them a great convenience in manipulating. The ordinary section rack or shallow frame box is used, if more than 10 brood combs are needed those not covered by the super have a strip of wood or calico laid over them. We have had to examine those hives, generally cheap (?) ones, that will barely accommodate 10 frames. When crowded with bees, and combs drawn out to the utmost, it is a difficult matter to get the first comb out at all, more difficult still to do so without crushing and exasperating the bees. Even old hands often get a goodly number of stings at times when manipulating under such conditions. The discomfort of small hives does not end there, but is present throughout the season. There is not room to work when putting on, or taking off supers. In fact, the bees are upset every time operations are undertaken.—JUN. ED.]

### Trading Schemes.

[10079] In reference to the letter [10,048] by G. H. Clewlow, in which mention is made of "Women's Institutes," would it be possible to learn details of any trading scheme which is in actual operation, so that a start could be made for the coming season. There are several reasons why such a course cannot be lightly undertaken, in spite of the enormous demand for honey and great need for economy. [£2,700,000 was spent on imported honey last year, whilst most of the nectar in the flora of this country was ungathered.]

Firstly.—A county association is usually dead against trading, as such, and affords no assistance to that end.

Secondly.—Such a scheme depends for its success upon the strenuous work of a capable and willing organising secretary, or committee.

Thirdly.—Some sort of guarantee, or some system of credit is absolutely essential.

There are thousands of people, who, knowing little of the subject, are situated in ideal districts for bee-keeping, and are ready and willing to take it up, providing that some definite information as to the possibilities of success is forthcoming. They are hopeful, yet philosophical, want-



ing to know the worst, but looking for the best, and, therefore, requiring no glowing accounts of huge profits, but straightforward information and hard financial facts.

Now, as to those reasons against:—

Firstly.—It is hoped that the county associations will relax a little, and help by calling a meeting, or, at least, by giving such information that would enable members to get in touch with one another.

Secondly.—No doubt, a glowing enthusiast, optimistic to a degree, is the real *sine qua non*, but surely most bee-keepers are enthusiastic and, shall we say, supermen, too.

Thirdly.—Once a committee is formed, a small sum, say 5s. as the first instalment of a £1 share, would cover preliminary expenses, pay for a few small appliances, or books for general use, and allow of the placing of orders for hives. Ordered in bulk, goods should be cheaper; but perfection in quality is the one thing to be looked for, though it is not easily obtained in these days of profiteering. Incidentally, there is many a genius hidden under the humble cloak of a village carpenter.

Individual ownership, or a co-partnership arrangement, can be made to suit the pocket of each member, but in any case, cash should be paid to the committee on receipt of goods, unless the scheme has a financial backing to provide sufficient credit for an instalment plan. Of course, the bees should be raised by breeding, and the formation of nuclei.

Perhaps someone interested will send along particulars of any such scheme.—E. A. H., Bristol.

---

### Questions, etc., for Bee-keepers for Self-Examination.

443. What eggs laid by a queen are unfertilised?

444. In what circumstances may a large number of drone cells be found in or near the centre of a skep hive?

445. Describe the honey derived from the following sources:—Buckwheat, clover, asters, Canterbury bells, heather, lime, willow herb, apple, sage.

446. State the purpose for which frames are wired, and explain minutely how the wiring is done.

447. What is about the daily rate of mortality of a colony during a honey-flow?

448. Describe fully the process of painting a new box hive.

449. Make a brief but full list of what was done when wintering down last season, for reference next season.

450. State fully the rationale of fanning.

451. For what are the following celebrated: Dzierzon, Doolittle, Berlepsch, Langstroth, Huber?

452. Show why a full study of the bee, its instincts and activities, is essential to profitable bee-keeping. J. L. B.

---

## Combs from Other Hives.

### Paratyphus in Honey Bees.

Bahr (L). Paratyfus hos Honningbien (Paratyphus in Honey Bees).—Skandinaviske Veterinar-Tidsskrift, ix., 1919, pp. 25-40, 45-60.

An acute enteritis of bees in the vicinity of Copenhagen has been found to be due to bacillus paratyphi-alvei, the bees showing symptoms of debility, inability to fly, and sometimes diarrhoea, and dying in from 24 hours to a few days. The disease was introduced with purchased infected bees, and in eight beehives 50 per cent. of the bees succumbed in a fortnight. Bacillus paratyphi-alvei was found in great numbers in the gut of all the infected bees, often almost as a pure culture, and was also found in the blood. It is not identical with the forms of B. paratyphi found in man and domestic animals.

The feeding of healthy bees and of *Vespa* with pure cultures dissolved in 5 per cent. sugar solution showed positive results, but mice, guinea-pigs and rats were not susceptible. While the organism is not normally found in healthy bees, it has occurred exceptionally. In these cases the infection has possibly been present earlier in such hives, and it is certain that many cases of paralysis and dysentery recorded in bees have been due to paratyphus.

This somewhat infectious and malignant disease can be spread (1) by purchase of infected bees and of apparently healthy bees that originate from a hive that some time previously has been attacked by the disease; (2) through foreign infected males; (3) through bee-keepers carrying the infection from attacked apiaries to healthy ones; and (4) through infected frames, tools, or hives. The author therefore proposes measures controlling the purchase of bees and the prohibition of the importation of foreign bees and queens.

[From the "Review of Applied Entomology," Vol. VII., November, 1919.]

---

### Eggless Honey-Muffins.

One cup bran, one cup corn meal, one cup flour, three tablespoonfuls shortening, one-third cup honey, half teaspoonful salt, half teaspoonful soda, water to make thin batter. Bake in hot oven in muffin tins.—*The Western Honey Bee*.

## Special Prepaid Advertisements. One Penny per Word.

Advertisements must reach us **NOT LATER** than **FIRST POST** on **TUESDAY MORNING** for insertion in the "Journal" the same week.

Orders for three or more consecutive insertions in "The Bee Journal" entitle advertisers to one insertion in "The Bee-Keepers' Record" free of charge.

### PRIVATE ADVERTISEMENTS.

**50** SECTIONS, clover and heather.—Stamp for price and particulars, W. FORBES, Rheeves, Forres, Morayshire. x.37

**7** CWTs. LIGHT CAMBRIDGESHIRE HONEY, £8 10s. cwt., on rail, 28-lb. tins; tins free; sample 6d.—GEORGE BARNES, Burwell, Cambs. a.1

**SIX** 28-lb. tins prize English Honey, granulated, solid, 40s. per tin; carriage extra.—VINCENT, 132, Croydon Road, Anerley, S.E. a.2

**THE** GRAMOPHONE RECORD EXCHANGE will exchange Records 5s. dozen; return postage free.—Address, 6, Rood Lane, London. Particulars stamp. x.28

**WANTED**, new Cycle Chain, 1 in. pitch by 1/2 and 5 ft. 6 in. long, twin roller, or block.—Price to A. J., B.B.J. Office, 23, Bedford Street, Strand, W.C.2. x.32a

**WANTED**, portable Greenhouse.—Price and particulars to W. HERROD-HEMPSALL, Old Bedford Road, Luton, Beds.

**WANTED**, Auster rear Wind Screen for motor car.—HERROD-HEMPSALL, as above.

**FOR SALE**, seven Motor Car Tubes, valves complete, 760 x 90, 9s. each, post free; one Exhaust Whistle, 11s., post free; one Wood Milne Motor Foot Pump, 45s., carriage free; one 760 x 90 Cover, 15s., carriage free; one small Motor Horn, 5s., post free.—HERROD-HEMPSALL, as above.

**CORRESPONDENCE** Course in Bee-keeping.—MISS F. E. PALING, Golden Square, Henfield, Sussex. rw.31

**WILL** all those bee-keepers possessing 25 stocks of bees and upwards kindly send particulars to SECRETARY, B.B.K.A., 23, Bedford Street, Strand, London, W.C.2. ? v.42

**WILL** all those who are not in favour of legislation please communicate with Box 48, BEE JOURNAL Office, 23, Bedford Street, Strand, W.C.2. ? v.28

### BUSINESS ADVERTISEMENTS.

1½d. per word.

**HAVE YOU READ "THE BEE WORLD"?** If not, why not? Every number in itself is a useful literary work for practice and reference. Specimen copy free.—Offices: THE APIS CLUB, Port Hill House, Benson, Oxon.

**ITALIAN QUEENS** direct from Italy. Price list for 1920 on application.—Address, E. PENNA, Bologna, Italy. w.39

**ENRICO BOZZALLA** invites readers of the B.B.J. to write to his Agent, H. M. Stich, Riccartbar Avenue, Paisley, for a copy of his 1920 Catalogue of Bozzalla purely mated Italian Queens. Customers will be supplied with a copy shortly direct from Crevacuore. a.3

**BUY** our Guaranteed Bees and Queens, and ensure success. Catalogue 3d., which will be returned on first order.—PEARSON & GALE, Marlborough. a.4

## The Metal Foundation.

For the benefit of readers of the JOURNAL and the RECORD we have arranged with the manufacturers of the Metal Foundation to accept all orders received through our offices at a consideration in the shape of a 25 per cent. deposit to begin with, and the balance by mid-March, or prior to delivery, if earlier. All orders are guaranteed by them to be executed *not later* than April, 1920.

Prices:—(1) BRITISH STANDARD FRAME, fully fitted with "worker" Metal Foundation: Single, 2s. 4d.; per two dozens, 2s. 3d. each frame; per four dozens and over, 2s. 2d. each frame.  
(2) STANDARD SHEET of "worker" Metal Foundation: Single, 2s.; per two dozens, 1s. 11d. each sheet; per four dozens, 1s. 10d. each sheet.

Packing & Carriage Extra.

\* \* Since the Metal Foundation will be produced only to order, no order will be subject to cancelling.

## INSURE YOUR STOCKS

### AGAINST "I.O.W." AND OTHER INFECTIONS.

Science has now placed within reach of every Apiarist a safe and certain preventive of infection in "Yadil" Antiseptic.

For **SPRING FEEDING** "Yadil" may be added freely to Syrup.

For **DISINFECTING** Bees and Combs a five-per-cent. solution in tepid water should be used with a fine spray.

ASK FOR GREEN LABEL.

Our Bee Brochure sent Free on Application.

CLEMENT & JOHNSON, 19, Sicilian Avenue, W.C. 1.

The certain cure for and Preventative of "Isle of Wight" disease.

## 'BACTEROL'

Proved by Bee-keepers generally after testing on the most hopeless stocks.

Manufactured by "Bacterol" Limited, London, N.

MENLEY & JAMES, LTD., MENLEY HOUSE, FARRINGDON ROAD, LONDON, E.C.

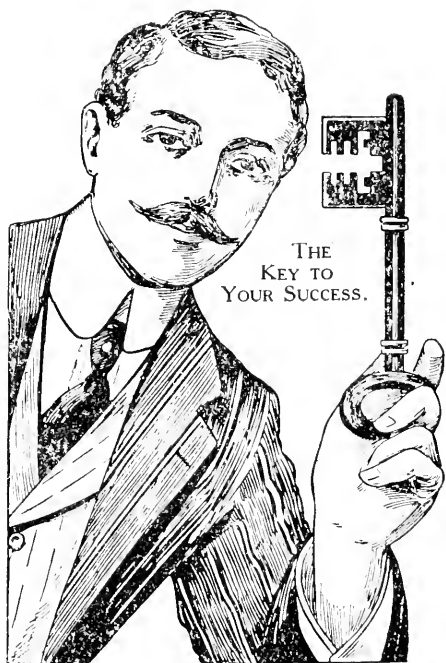

# The Metal Foundation

(Protected.)

Earlier than our expectation, we have pleasure in announcing that we are now booking orders for Metal Foundation (framed and otherwise) for the 1920 season. Special frames for its accommodation are supplied only by ourselves.

As the particular aluminium sheets needed for its production have to be specially manufactured at a notice of no less than 3 months, bee-keepers are advised to give their order *at once*, so that all orders may be executed before the season begins.

The Trade is recommended to order without delay the *maximum* quantity which is needed or is likely to be required. Judging by the numerous inquiries that are being received, we respectfully suggest to every large Bee Appliances Establishment placing an order of 10,000 framed sheets, to

begin with. *No order, however, is too small and none is too big, provided it is immediately given. All orders, whether large or small, will be executed in strict rotation.*

## RETAIL PRICES.

	Single.	For Two Dozens.	For Four Dozens and over.
(1) British Standard Frame fully fitted with worker Metal Foundation.	2/4	2/3	2/2 <small>Per fitted frame.</small>
(2) Standard Sheets of worker Metal Foundation.	2/-	1/11	1/10 <small>Per sheet.</small>

Subject to a five per cent discount to all members of the Apis Club.

Cash with Order.

Carriage forward.

**A FINAL REMINDER!** To avoid disappointment give your order **NOW.**

# JAMES LEE & SON,

UXBRIDGE, MIDDLESEX.

(Telegrams : Graphically, Uxbridge.)

**Don't Order "W. S." Queens until you have seen the "Queenland" Revised List for 1920. 3½d. post free.**

## **NUCLEUS STOCKS—Same Price as 1919.**

The only Pedigree Bee-Stock Registered in direct line for more than 25 years.

**"AMALGA" is the name of our Queen breeding-mother for 1920**

**"ALTA" is the name of our Drone parent for 1920.**

PRODUCE OF ONE NUCLEUS  
REALISES OVER £40 IN CASH.

"The three-frame nucleus I purchased from you had increased last autumn to two strong stocks. I supered one on April 23rd of this year, and the other a few days later. I sold two swarms, and made up the others to five stocks. Of these I also sold three stocks. The original lot gave 198 lbs. of honey, and in all I have taken 365 lbs. My sales amounted to over £41 in actual cash."

(Miss) H. G. MOYSEY.

Somerset, Oct. 9th, 1918.

EXCEEDS 500 PER CENT. INTEREST.

"We have now 12 stocks to winter, besides selling one, out of the two three-frame nuclei supplied June 20th last year." (August 15th, 1917).

Miss B. D.

Quainton, Buck.

THREE TO SEVENTEEN.

"It may interest you to know that the three stocks to which I introduced your queens (the only stocks saved in the apiary) in 1916, produced in all 17 stocks, and a good surplus in honey in 1917; this under the care of my wife who knew nothing about bees. I simply directed her as to management from there (France)."

OLIVER G. PIKE.

April 9th, 1918.

FIRST AND BEST.

"Your White Star strain was the first to enter the sections, and all the honey I got was from them."

G. H. S.

Heddon House Dairy.

APRIL 19TH.—BOILING OVER.

"The hive is simply boiling over with W. S. bees. They are at work when my other stocks are idling, and they are stronger than any of my other stocks."

Aberdare, Wales.

E. T. W.

ARE THE W.S. PROLIFIC?

"In 1904 I got a W.S. queen from you, and last year (1905) by the first week in June she had brood in *twenty-five* standard frames."

J. H.

Higher Kimmerton, Chester.

NUCLEUS DELIVERED IN JUNE;  
40 FRAMES BY AUGUST.

"The three-frame nucleus of bees now occupy 40 Standard Frames. They have exceeded beyond anything I believed possible. I have never had anything like them before, and if the other queens on order turn out the same I consider my fortune made."

JOHN JONES.

Llancarfan, Aug. 21st, 1918.

SEVERAL STOCKS FROM ONE  
NUCLEUS.

"It seems almost ridiculous that this nucleus of the previous season (Aug.), before I was prepared for it, swarmed in April, and I now have several stocks from that investment."

J. W. MCKAY.

Croydon.

EIGHT STOCKS FROM ONE W.S.  
NUCLEUS.

"I now have eight stocks from the one nucleus you supplied last year."

J. JONES.

Llancarfan, May, 1919.

BEST IN THE COUNTY—NEVER  
SAW THE LIKE!

"May 26th.—The two queens you sent me have exceeded anything that I ever thought of. The stock chambers are full and crammed with brood, and all three supers crowded with bees; but even with this the bees are boiling over. I have not fed them at all, and have removed several frames of brood for another lot. The County Expert called yesterday, and said he had never seen such bees, and they were certainly the best in Hampshire."

D. D. P.

NO SPRING-FEEDING, BUT AGAIN  
FIRST.

"The W.S. bees on eleven 16 x 10 frames were full and boiling over at the middle of May, and were the first to enter supers out of 23 stocks; and last, but not least, they required no spring feeding."

U. W.

Arnold, Notts.

Revised 1920 "White Star" List, 3½d., of S. SIMMINS, Queenland, Heathfield, Sussex.

**HONEY AND BEESWAX PURCHASED.**

Run Honey in bulk. Sections per gross.

**HONEY FOR SALE.**

Cuban, Californian, English, Irish.

Free tins and cases, carriage paid. Cash with order. Samples, 1s. Prices on application.

A. GORDON ROWE, 28a, Moy Road, Cardiff.

The products of the Apiary, of Poultry and Farm Stock, of the Fruit and Vegetable Garden can be Advertised and Sold through

**THE BAZAAR, EXCHANGE & MART**  
*Newspaper.*

Get a Copy—Thursday and Saturday 3d. The "Bazaar" publishes also practical handbooks by experts. Send for full catalogue, post free from—

WINDSOR HOUSE, Breams Buildings, LONDON, E.C.2.

**THE British Bee-Keepers' Association.**

The recognised centre of practical and scientific bee-keeping in Great Britain. Particulars and conditions of membership may be obtained from the Secretary,

W. HERROD-HEMPSELL, 23, Bedford Street, Strand, London, W.C.2.

**Books for Bee-keepers**  
**NOW IN STOCK.**

		Postage
A Modern Bee Farm	7/6	6d.
Bee-keeping (DR. E. F. PHILLIPS)	10/6	6d.
<b>BEE-KEEPING SIMPLIFIED FOR THE COTTAGER AND SMALLHOLDER</b> (W. HERROD-HEMPSELL, F.B.S.)	1/-	1½d.
<b>BEE-KEEPERS' PRACTICAL NOTE BOOK</b> (T. W. COWAN)	1/-	1½d.
<b>BRITISH BEE-KEEPERS' GUIDE BOOK</b> (T. W. COWAN) (paper covers only)	2/6	3d.
Dissectible Model of Queen Bee	4/6	3d.
<b>FERTILISATION OF FRUIT BLOSSOMS BY BEES</b> (T. W. COWAN)	-/3	1d.
Honey and Health (A. HORN)	-/6	1d.
Honey Vinegar (REV. G. BANCKS)	-/2	1d.
How to Keep Bees (ANNA B. COMSTOCK)	5/-	6d.
Productive Bee-Keeping (PILLET)	10/6	6d.
<b>PRODUCING, PREPARING, EXHIBITING AND JUDGING BEE PRODUCE</b> (W. HERROD-HEMPSELL, F.B.S.)	2/-	3d.
Queen Rearing in England (F. W. L. SLADEN)	1/6	2d.
Snelgrove's Method of Re-Queening	-/6	1d.
The "Townsend" Bee Book	2/6	2d.
<b>WAX CRAFT</b> (T. W. COWAN)	2/-	1½d.
Wilke's Book on Swarming	1/-	1½d.
<b>MISCELLANEOUS.</b>		
Maeterlinck's Life of the Bee	3/6	3d.
The Lore of the Honey Bee (TICKNER EDWARDS)	2/-	2d.
The Humble Bee (F. W. L. SLADEN)	12/6	6d.

British Bee Journal & Record Office,  
23, BEDFORD STREET, STRAND, LONDON, W.C.2.

- - THE - -  
**BRITISH BEE JOURNAL.**

ESTABLISHED 1873.

**THE NEW VOLUME COMMENCES JANUARY 1st.**

THE BRITISH BEE JOURNAL is supplied direct from the Office every week, post free for One Year, 10s. 10d.; Half Year, 5s. 5d.; Three Months, 2s. 9d. (payable in advance). Posted on Wednesday evening in time for delivery on Thursday.

Money Orders and Cheques should be made payable to W. Herrod-Hempshall and crossed "London County and Westminster Bank."

**SUBSCRIPTION FORM.**

(To be filled up by intending Subscribers, cut out, and returned to the Office.)

Please send me "THE BRITISH BEE JOURNAL" for \_\_\_\_\_

Commencing \_\_\_\_\_ 192\_\_\_\_, for which I enclose

\_\_\_\_\_ \*Name \_\_\_\_\_

Date \_\_\_\_\_ Address \_\_\_\_\_

\*Please state whether Mr., Mrs., or Miss, etc.

*It will considerably facilitate our publishing arrangements if subscriptions are dated from the beginning of each year; the proprietor will therefore be obliged if subscribers will fill up and return the above form as early as possible.*

**COVERS FOR BINDING**  
"BRITISH BEE JOURNAL" or "BEE-KEEPERS' RECORD," 1/8 post free.

**British Bee Journal Office, 23 Bedford St., Strand, London, W.C.2.**

## QUALITY.

The difference between a good bargain and a bad bargain is not so much a matter of money as of quality.

All our goods have the "Hallmark of Quality" resulting in a large clientele of SATISFIED customers. Does this mean anything to you? If so, send for our large Illustrated Catalogue for 1920, free on application.

R. STEELE & BRODIE,

Bee Appliance Works, WORMIT, FIFE, SCOTLAND.

# THE UXBRIDGE W.B.C. HIVE.



We originally introduced this type of W.B.C. Hive over twenty years ago, and offered it for several years as "Lee's Waterproof Cover." Beekeepers of those days did not care for it. Hence it was withdrawn from our list. We now offer it as illustrated. Lifts and covers are square and dovetailed.

Price, including stock box, ten frames with ends and dummy, two shallow frame boxes with eight frames in each, 48/6. We will also supply this hive without inside fittings, to enable beekeepers to transfer existing stocks to the new covers, for 30/-. Carriage paid, 2/6 extra.

**PROMPT DELIVERY.**

**JAMES LEE & SON, LTD.,**  
UXBRIDGE, MIDDLESEX.

## The 'Kent' Standard Model Hives & Appliances

### TESTIMONIAL.

*May 12.*

DEAR SIR,—I have had an opportunity of comparing the material and workmanship of your hives with others on the market, and in my opinion there is no sort of comparison between the two, yours being altogether superior in every particular.—Yours faithfully,—

*S. J. BALDWIN, Stanley Road, Bromley, Kent.*

**BURTT, Gloucester, FOR BEE APPLIANCES.**

*New Illustrated Catalogue Free on application.*



No. 1959. Vol. XLVIII

JANUARY 8, 1920.

[Published every Thursday, Price 2d.]

**CONTENTS.**

	PAGE	CORRESPONDENCE—	PAGE
SEASONABLE HINTS .....	13	What's Wrong with the Craft? .....	16
SPRING FEEDING FOR BEES .....	13	Cotswold Notes .....	17
A DORSET YARN .....	13	Labelling Honey with Country of Origin .....	17
JOTTINGS FROM HUNTINGDONSHIRE .....	14	Bee Legislation .....	18
NOTES ON BEE-KEEPING .....	15	COMBS FROM OTHER HIVES .....	20
TRADE CATALOGUE RECEIVED .....	20	HONEY (Poem) .....	22

**DO NOT LET YOUR BEES STARVE.**

# Use Taylor's Soft Candy

1-lb. 1/6, post free; 6-lbs. 6/-, post free;  
12-lbs. 10/6 (11/6 carriage paid, 12/- post free.)

SYRUP—7-lbs. 7/6; 14-lbs. 10/6; 28-lbs. 20/- SUGAR VOUCHER must be sent with order.

## BEESWAX BOUGHT,

2/- lb. Cash, or 2/1 lb. allowed if taken out in goods.

Also Cleaned and Sterilised and made into Foundation.

**No. 77. Compressed NAPHTHAFORMA TABLETS,**  
The Germ-killing Remedy for Foul Brood  
1/9 Bottle, Post Free.

### TAYLOR'S NEW REGISTERED ZINC EXCLUDER

giving 50% freer access to supers  
16 x 16 squares 3/-, post 6d.  
8-ft sheets 15/-, post 1/-.

### BACTEROL & YADIL,

For "Isle of Wight" Disease.

Bacterol, 2/6 per bottle, post 6d.  
Yadil, 3/6 per bottle, post 6d.

Syrup should be fed medicated with above in  
**Taylor's Registered Feeder,**

Specially designed for above cures,  
Post free, 3/10.

or Bottle of Bacterol and Feeder, 6/- post free

TAYLOR'S No. 12 HIVE, Dovetailed, at 29/- Carriage Paid. In the Flat, 28/-

BEST VALUE IN HIVES EVER OFFERED.

NEW CATALOGUE FOR 1919 POST FREE.

**E. H. TAYLOR, WELWYN, HERTS.**

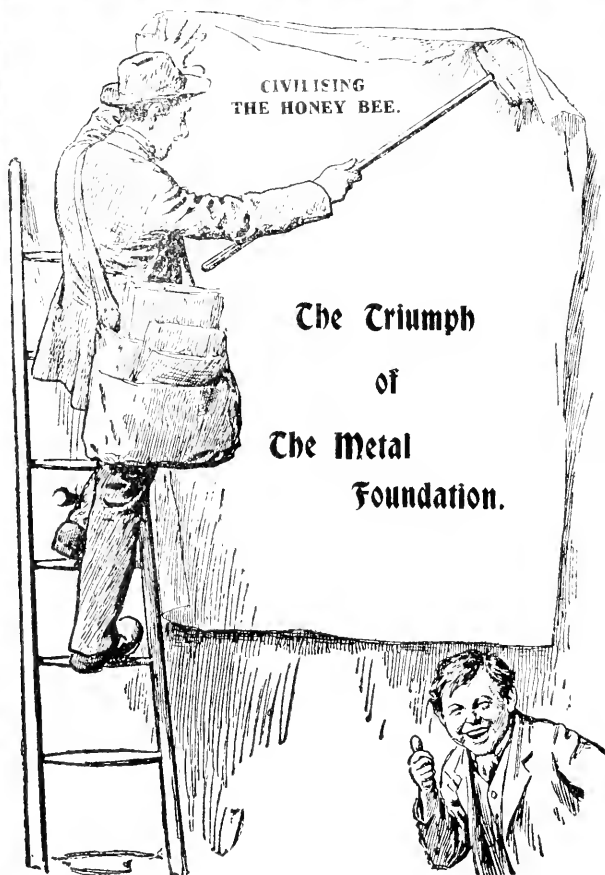

## The New Year's Surprise!

¶ On another page of the JOURNAL we make an announcement relative to the supply of Metal Foundation for the coming season. Do not defer its study. *You may be disappointed if you do not give it your immediate attention.*

¶ Only one type of Metal Foundation (standard size, and milled) will be produced at first. Other types and sizes may follow later. An original new mill of hardened steel will be employed for the purpose. The mill is costly, yet the prices we quote are well within the purchasing power of the average beekeeper.

### MAIN ADVANTAGES.

(1) Indefinite durability with reasonable care ; (2) Greater comb stability in quick extracting ; (3) Greater safety of bees in transit on new combs ; (4) Control of drone cells ; (5) The production of even combs ; (6) Easy removal of queen cells without the slightest injury to the foundation ; (7) Cleanliness and adaptability to sterilisation by boiling ; (8) Economy of labour and time in fitting and detaching ; (9) An ideal compromise between the metal comb and the wax foundation.

### LITERATURE.

"The British Bee Journal," November 13 ; "Bee Craft," December ; and "The Bee World," September and October, 1919.

\* \* The non-wax foundation, including the Metal Foundation, is protected.

## JAMES LEE & SON, Uxbridge, Middlesex.

Telegrams: "Graphically, Uxbridge."





## Seasonable Hints.

The most critical time of the winter, so far as bees are concerned, is the first eight weeks of the New Year. The food stored up will have been more or less used up, and as breeding commences during the first few weeks, the remaining stock will be used up still more rapidly, as the larvæ need much more food than adult bees. If bees were packed up for the winter with abundance of stores, and a free passage was left over the top bars of the frames, they will be all right, but if there is any doubt as to the adequacy of the food supply, a cake of candy should be placed over the cluster, on a mild day. Better make it a good-sized one, not less than 2 lbs., as it is quite possible we may have several weeks of very cold weather during January and February, when it will be too cold to even renew the candy. See, also, that the coverings are dry, and if not change, or dry them. Keep entrances clear, and look out for mice finding a way into the hives.

A further grant of sugar has been made for spring feeding, and though it does not err on the side of being too much, it is as much as can be given under present conditions. If made into candy flour should not be used with it at present.

Any goods needed should be ordered as soon as possible. Those who defer ordering frames, and foundation, etc., until they are needed in a hurry are asking for trouble. Appliance dealers are busy even now, so bee-keepers may guess what opportunity they will have of sending of "rush" orders in, say, April, May and June. Those who are wise will order early.

## Spring Feeding of Bees, 1920.

The Board of Agriculture and Fisheries, by arrangement with the Royal Commission on the Sugar Supply, have been able to secure for registered bee-keepers a ration of 6 lbs. of sugar per stock for the period January-May, 1920.

Bee-keepers already registered for the autumn ration will not have to re-register. They should apply direct to their Local Food Office, where the autumn feeding certificates will be referred to, and sugar vouchers will then be issued to them on the basis of the number of stocks certified.

Bee-keepers who did not apply for the

autumn ration, but who desire to obtain the spring ration, must first register with the Local Food Committee. The addresses of these Committees for the various districts in England and Wales were given in the JOURNAL for August 14, 1919.

The ration is available until May 31, 1920, and should be used immediately or deferred until later in the season, according to the requirements of the bee-keeper's stocks.

## A Dorset Yarn.

The first days of the New Year were wet and cold, no bees to be seen, but we conclude that all is well.

It is one of the peculiarities of disease that when the bees have it, all want to run away from the hive rather than spread it to others. A lady this week asked what could be done, as hers "were crawling out in great numbers." All soon will perish when away from the winter cluster. One year, when it was very bad with us, they streamed out in March, yet in some there were enough left to cover some of the brood, and they recovered, others went under. Another neighbour says that one of his has gone under; he had built his up from a very small cast of Italians, in 1917. He did not say if it was disease, it may have been exposure, his cow was in with them one morning. One should always have them where they are safe from stock.

One always looks on winter as a dull time with bees, it certainly is one of apprehension, but the optimist who leaves them right, believes that they will come out right. Some of us still believe "that all things work together for good with them that love God." Many will tell you, "God's in His Heaven, all's right with the world." That is so, but the teaching of the talents is that God has given us them to use for our advancement, or we shall be exploited for the advancement of others. We who know what is for the best wintering of bees, try to give them that which will keep the winter cluster warm. We all have different methods, but all tend to the one essential, warmth. I once bought some bees at a farm sale that were covered down with newspapers and seed catalogues. The roofs of these hives were exceptionally well made, or paper would have been one of the worst coverings for bees. These all did well. I bought some more skeps when the snow was on the ground. These were a very active lot, were round the entrance all the time of the sale. The covering these had was a hessian potato bag, and a round earthenware platter of red, about 1½ ft. across, to keep off wet; all these skeps had a hole

in the top for extra supers. Others have shallow coverings of wood to fit the brood chamber closely, giving them space over the combs to give them freedom in getting to the food by going over the top of combs instead of having to go down to the bottom, where the cold comes in. All this is done to make them safe for the winter; if all is done, then we may well say, "God's in His Heaven, all's right with the world." We who plod on each year with bees, carry on with what we find is best, we study their habits and economics; all this gives pleasure to life. Tolstoy wrote: "Life is the mill which man wishes to study, the mill is necessary only in order to grind well." I have many times repeated "Life is real, life is earnest." Life is not an empty dream. The great God has given us brains (or "talents" as the Old Book teaches) to work out our own life, not alone in selfish pleasure, but in finding pleasure in the work of the world. The keen study of bees will give both pleasure and profit, if only we use the talents God has given us. An old Chinese proverb has it, that he who will save the spade given him to procure food for supporting life, will lose both the spade and his life. I reckon we shall lose our bees if we do not give them all the care we can for winter warmth.

J. J. KETTLE.

## Jottings from Huntingdonshire

Dear Mr. Editor.—You will notice the handwriting is different this week. I am writing these jottings for Daddy, who is very busy. I don't think I know very much about bees. They will most certainly be "jottings" this week, as all I know about their doings at present is that they are fast asleep in the hives—at least one is led to think so by what one hears. I must say my private opinion is that they are not fast asleep. I was with Daddy the other day when he opened the hives of a friend, and the bees were buzzing out in a moment. I expected them to be quiet and sleepy, so I thought it must be a phenomenon, and said "ta-ta." But finding other people were quite unmoved, I returned, and got quite interested. Now I will try and write some sense. Tell your readers that they had better make certain that the hive is not infested by "eery-wigs" as the old lady said, for I saw a hive the other day that was. Daddy says that he thinks one of his queens has begun to lay. Fancy their laying so early in the year, as there are only such a few flowers out! But still, although it is only January, we have a wallflower out, and a precocious primrose or two. We had some rosebuds for Christmas, a few periwinkle

flowers, some arabio and lots of yellow jasmine.

Daddy has a moss-carding queen bee hibernating in a tin in his cupboard; she is such a funny little thing. She rests on her back, and when you look at her she rubs her eyes in such an amusing way, as much as to say, "Go away, I'se sleepy." In another tin we have a mason queen, and a tapestry bee keeps her company. I suppose by the end of April they will want to fly away and build nests for their progeny. It seems a shame to lose sight of them, when their nest and family will be so interesting. I wish there was some way of retaining them so they will make their home's near to us. How nice to go to sleep in autumn and wake up to find it spring! But, after all, if we did the same we should miss Christmas, shouldn't we? The insects that attract me most are moths and butterflies, because one gets more satisfaction out of them. To see anything of bees one has to do the thing properly and sacrifice comfort and good looks. Who cares to look like a Chinaman half the summer months, just when you see everyone and everyone sees you? For my pains I have a case of ladies in bright array to show. But all Daddy has to show is some lovely honey, which, at the end of a meal, the section is possibly no longer to be seen. I have many specimens of English butterflies, and would love to get hold of a marble white. I am not so rich in moths, and my chief ambition in that direction is to get all the hawk moths. There is one species I think that robs the hives, namely, the Death's Head Hawk Moth. That is a rare moth, I think, but surely I have a chance of getting one with all these hives about. In the summer I found several big, chubby, white grubs in some wax which Daddy had found in a roof. I took two, and put them in a box with a large lump of their former home to feed on. They very soon retired to a corner, and there shut themselves in. One made its cocoon lengthways round the corner, the other upright. The first I called "latitude" and the other "longitude," and with such names as that, I fondly hoped they would fulfil my expectations. Alas! they still sleep on. Perhaps they knew something about this old world coming to an end on December 11, and thought that "latitude" and "longitude" would no longer be needed; if so, I think I will give them a shaking up to remind them that I, at least, am still on the globe.

I wonder if these "jottings" will help to fill up your waste paper basket or light the office fire; they might even be raised to the dignity of lighting your pipe in the form of a spill. I've never seen a real live editor; what sort of creatures are

they? I always imagine them old, with mutton-chop whiskers, sitting solemnly at a desk in an upper room, with a gasometer sort of arrangement which reaches down to the basement, into which the contents of the waste-paper basket are periodically thrown. It must be horrid to have to interview an editor; I'm sure if I had to do so I should shake like an aspen leaf or collapse on the stairs—is that why editors always live in upper stories?

Perhaps when I am home for the Easter holidays bees will be out and busy; then I might be again tempted to worry you with more effusions. Until then, Mr. Editor, you may consider yourself safe. With best New Year wishes, yours sincerely,—LOIS E. HEMMING.

[We are sure our readers will, like ourselves, be delighted with the foregoing "jottings," and congratulate Rev. E. F. Hemming on having such a capable, though young, helpmate. We certainly could not throw such a charming letter into our somewhat capacious W.P.B.; and as turning tobacco into smoke is not one of our accomplishments, we could not use it for spills as suggested; as our fires are gas fires, we do not need any firelighter beyond a match, so the only thing to do is to print the letter. We hope some day to have the pleasure of meeting our correspondent and her father and prove that even editors are only after all very ordinary folk.—Eps.]

### Notes on Bee-Keeping.

I took up a paper the other day giving the census of beehives stocked with bees in the United Kingdom, and I thought how comparatively few of the people in rural districts interested themselves in bee-craft, although many advantages can be gained in this intellectual pursuit, for no one can watch a hive of bees, whether skep, bar-frame, or observatory hives, without gaining intellectually. Notice the bee as it brings home its load of pollen, packed into its pollen baskets, just at a time when it is most needed for the hungry larvæ within; then step into the garden and watch it gathering these loads of pollen, not first on this species of flower and then on that, but choosing all those of the same family—passing from a dandelion right over that willow-tree, choking with pollen, to another dandelion close by, dusting itself all over, and then, flying in the air, removing the pollen grains from its body and packing them neatly into its pollen baskets situated on its hind legs, then returning to its home. Look into the observatory hive and examine the bees hanging in clusters, secreting the wax, and then with busy feet and

jaws building their snow-white combs obtained from wax pockets underneath their bodies. Note the energy of the sentinel bees at the entrance detecting a stranger with hostile intent, driving it away, or perhaps killing it. The industry of the bees in that little home day and night, never tiring for a moment—what an example to the onlooker! How dense must be his mind if he fails to gain something intellectually from these examples. Bee-keeping is an aid to health; fresh air, plenty of sunlight, healthy occupation for the mind, and a moderate amount of exercise are all conducive to our well-being. Then apiculture offers us financial success. I am strongly of the opinion that no description of stock-keeping is such a success financially as bee-keeping. Our forefathers made the old straw skep a financial success; how much more should we, that work to modern bee-keeping methods? One feels it a satisfaction gazing on the snow-white sections and run honey, the latter with a market value of £10 per cwt. Honey produce is not the only source of profit; wax finds a ready sale, and when one does get a swarm a good price is usually obtainable on the market. For the farmer and fruit-grower bees play an essential part as to the profits, such as fertilising crops and fruit blossoms and making them more productive, all adding to his pocket. Generally, of course, bees are kept mostly for honey supply, and those who can eat honey at any time—and there are few who cannot—will find it a nourishment of the most agreeable form; it is one of the best of foods for human consumption. Scientists tell us all food, if not soluble in water, requires to be changed within the body before its nutritive parts can be received into the system. This change is made by the process of solution and is termed digestion. Starch, which forms three-fourths of the bread we eat, is useless as food while it remains in the form of starch, undissolved. In the act of eating saliva changes part of the starch into sugar, which in due course, being supplied in solution into the blood, supplies heat and power. Honey in its natural state is all ready to be absorbed into the system, therefore no labour is required to render it a heat-producing power, hence the superiority over other sugar foods. Every cottager can have his own pure honey, and none of the compounds, consisting of glucose, which have been sold in this country during the war. As an example, a lady came to my house last February and wished to purchase some pure honey. She related to me how she had bought some so-called pure Australian honey, which had given her eczema; the trace I could plainly see as she stood before me. Every man who keeps his own

bees is assured that his honey is pure, minus compounds that we see so much of to-day. Pure, unadulterated honey, extracted from clean combs, or eaten in the form of sections, will produce a healthy condition of the body which no other food can offer in like degree.

I was not aware, until I read it in these columns, that the swallow (*Hirundo Urbica*) was addicted to killing bees. It is a pity that this beautiful harbinger of spring should be guilty of such a charge. I have noticed swallows flying over the hives, but rather too high to detect any mischief. Fortunately for the bee-keeper this country contains very few bee-enemies. Last winter I was pestered with the blue-tit (*Parus-caruleus*) catching bees, and tearing away the head and thorax from the abdomen, the former was greedily eaten, while the latter was cast away. In the present winter I have, so far, only seen one, and this was placed *hors-combat* with gunshot. It is with regret that we have to destroy some of these bee-enemies, as they render valuable assistance to the gardener in destroying insects. The toad should never be allowed in sufficient numbers in an apiary to do any very serious damage. I have seen these on two occasions upon the alighting boards, waiting to devour any bee coming within reach of their long tongues. Every gardener knows the value of the toad as an insect destroyer. Mice at this time of the year work havoc in hives if not kept under, they seem to have a particular taste for honey, besides destroying the combs. If the entrances to hives are too large, as a good preventive place a wire across the entrance; this will prevent the entrance of mice, at the same time allowing sufficient space for the egress and ingress of the bees, and for ventilation. Under the coverings of straw skeps is a favourite place for mice, holes being gnawed through the crown, and the combs tainted with their excreta. This latter must frequently cause the bees to vacate the hive. In autumn wasps are very troublesome to the apiarist, and all nucleus hives should have their entrances contracted; of course in strong colonies this is not necessary, as they are usually able to protect themselves against these intruders. Moths are a great nuisance in the store-house where empty combs are kept. These will be quickly spoilt by the moth larvæ drilling holes along the mid-rib and through the cells, if they are not destroyed. If there is any trace of moth in combs, they should at once be exposed to the fumes of formalin. In autumn, during the cool part of the day, I have noticed moths trying to gain an entrance, and being repelled by the sentinel bees. The larvæ, whenever seen, should be killed, they will frequently

be found between the folds of the quilts, or anywhere the bees are unable to dislodge them. They are a kind of white maggot, and according to entomologists vary in size from 1-16 in. to the full-grown one of 1½ in. or more. There is yet another enemy bees and the bee-keeper have to contend with. The careless and indifferent class of bee-keeper. To my mind the latter is doing more harm to bees and bee-keeping, than all the foregoing put together. The worst feature about this enemy of the craft up to the present is that we have no machinery in vogue to check her or his devastating work. The vast majority of bee-keepers in this country believe that the best machinery to assist us against the above is "Government Legislation," and it is with this object in view that we are drawing up a signed petition to urge on the Government to protect our craft. By the way, the Secretary of the L.B.K.A. writes me that he has only one copy of the petition, and that this is out. At this speed of petition signing we shall travel a long way in a long time; there seems to be slackness somewhere. It is to be hoped that bee-keepers will not linger in giving us their signatures, but sign and return same to the Secretary, that others may follow suit. Can any individual bee-keeper obtain a copy upon application? — P. LUTHGOE, Padgate, Warrington, Lancs.

[Copies of the petition may be obtained by applying to the Secretary, B.B.K.A., 23, Bedford Street, W.C.2.—Eps.]



The Editors do not hold themselves responsible for the opinions expressed by correspondents. No notice will be taken of anonymous communications, and correspondents are requested to write on one side of the paper only and give their real names and addresses, not necessarily for publication, but as a guarantee of good faith. Illustrations should be drawn on separate pieces of paper. We do not undertake to return rejected communications.

### What's Wrong with the Craft?

[10080] What is wrong with bee-keeping, or, rather, with bee-keepers?

When I joined the ranks, I was assured that the company was genial, and that bee-keepers were happy alone in helping each other over doubts and difficulties. That was before the war. More recent writings of some of the bee-masters call to mind Gilbert's "mildest mannered man who ever cut a throat or scuttled ship." We have had teacup storms about rival

antiseptics, skeps, the price of bees, the standard frame, and now legislation, the last of which can only be settled, if we are to take some writers seriously, by burning the Editors on a pyre of the JOURNAL.

What is the matter? Has a long course of acid injections from our little six-legged friends worked in some of our bee-masters a change for the worse? Or is it they have forgotten that conditions vary in nearly every apiary, and that no two bee-keepers' requirements can ever be exactly alike?

I sometimes wish the space given to unprofitable controversies could be devoted to extracts from the writings of those at home and abroad who are doing real research work. To put it metaphorically, the bee-keeper who is past the text-book stage would like more nectar and less honey-dew.—G. B.

### Cotswold Notes.

[10081] It may be news to those readers with whom I had correspondence prior to 1915 to know that I have now returned to Cheltenham on demobilisation, and intend to take up bee-keeping and build up the apiaries which were formerly devoted to raising bees and queens on the Cotswold Hills.

During the period I was away my business was completely closed down and all operations suspended.

This fact will explain why those orders which were sent in from time to time had to be returned, as no bees of any kind were being sent out. At the same time, I should like to express my regret for any delay there might have been in dealing with inquiries. The last summer and autumn was very agreeably spent in the vicinity of Charleroi, Belgium; but it was not my good fortune to see much of bee-keeping in France and elsewhere, as apparently so many have done from time to time. The few skep apiaries I noticed in the tiny hamlets of back areas were quite modest, and the style of keeping did not excite much curiosity. Nevertheless, in some places the well-tilled and open farm country, with all sorts of honey-producing plants in bloom, looked very favourable for keeping bees. Especially so, along the valley of the Meuse, between Namur and Liège, and I expect many little apiaries were hidden away among the quaint hamlets which hereabouts are clean and inviting.

I remember, however, noticing more modern hives around Cologne than elsewhere.

Generally under a cover of some sort to shield them from the bitter spring wind, they looked well cared for. My temptation to talk to the owners themselves was not

to be satisfied just then owing to the restrictions upon fraternising, so I did not get much information of interest. And as to honey I never remember seeing any on sale in the shops, but perhaps some of your readers who were there during the summer were more fortunate than myself.

With all good wishes for a record season in 1920.—A. H. BOWEN (late Lieut. R.A.S.C.), Cheltenham.

### Labelling Honey with Country of Origin.

[10082] The following notice appeared in the *Grocers' Gazette* for November 1, 1919, which should interest all producers of foodstuffs in the Mother Country:—

“Merchandise Marks Committee.—

The President of the Board of Trade has appointed a committee to consider—(1) whether any extension or amendment of the Merchandise Marks Act is required in respect of the provisions relating to indications of origin; (2) the utility and effect of national trade ‘marks’ or other similar (collective) marks, and how far they should be authorised or encouraged in this country; (3) how far further international action may be necessary for the purpose of preventing the false marking of goods.

“The secretary is Mr. M. F. Levy, of the Industrial Property Department of the Board of Trade, and all communications on the subject of the Committee should be addressed to him, at the Patent Office, 25, Southampton Buildings, W.C.2.”

At first glance such a notice might not appear very important to bee-keepers, but I should like to remind all the readers of the JOURNAL how we stand with regard to competition with foreign honey (and Colonial for that matter) now coming into this country in huge quantities, and practically all of which is vastly inferior to the home-produced article, a very small proportion being of higher grade, which might rank with medium grade British honey.

Now all bee-keepers are noticing that the prices readily obtained last year are not being maintained this season, notwithstanding the shorter crop, generally speaking, and the higher prices of sugar and jam, and I think we can trace this directly to the “dumping” on the market of large supplies of foreign and Colonial honey. To the vast majority of the public, “honey” is always “honey,” and they do not appear to realise (until actually tasting side by side) the vast differences that occur in qualities of nearly every foodstuff, occur also in honey.

What I wish to emphasise in this letter

is that all this foreign and Colonial honey is allowed to be put on the market and sold, in various packages, simply as "Honey," often mis-labelled "Finest Quality," without so much as a hint as to its country of origin, and also incidentally, when in small packages for retail trade, without any statement of the net weight of contents—and I should like to see all readers of the JOURNAL and all associations take up the matter of "country of origin," asking the Board of Trade to pass regulations compelling every salesman to see that all such honey is correctly marked with the name of the country from whence it came; and, further, to point out the malpractice of packing in "nominal" (nett weight unmarked) packages.

I have myself already written to Mr. Levy at the address mentioned, and have received a courteous reply, in which he states that he will put my suggestion before his Committee; but the "nett weight" suggestion does not come within their province, so he has forwarded that suggestion to the Department of the Board of Trade concerned. Of course the inference connected with the suggestion of marking the country of origin on all packages, is that many, if not most, people will prefer to buy the home-produced article, and upon seeing the label would generally ask, "But have you no English honey?" and further, if they bought the imported stuff, knowing what it was, they would be more likely to be critical, and compare with English produce if that could be obtained about the same date the foreign was purchased.

In my humble opinion, we home producers are rather slack in respect to the labelling of our honey; and I think we should take the initiative and label the nett weight of all packages, giving a guarantee of purity and not be afraid to put our names on the label.—F. M. CLARIDGE.

[Mr. Claridge's letter was placed before the Council of the B.B.K.A. at their last monthly meeting, as reported last week, when they unanimously decided to take action in order to try and have all honey labelled with the country of origin. We, and no doubt all British honey producers, hope they will be successful.—Eds.]

### Bee Legislation.

[10083] I see from THE BRITISH BEE JOURNAL that you want bee-keepers to say whether they want bee legislation or not. Well, I am one of the nots. It seems to me to be putting up another Government appointment, or whatever you like to call it; and they will all have to be paid. I am a cottage bee-keeper, have kept bees for over 30 years, have suffered through

foul brood also "Isle of Wight" disease, but still I don't see the use of legislation. For many years I fought foul brood and mastered it at last, so have not seen it anywhere for the last 20 years. "Isle of Wight" disease no one seems to know what it is, or the cure. If we have inspectors coming around, what about the colonies that are in hollow trees and roofs of buildings? If bee diseases are so infectious, these would be always a menace, and it would be impossible to deal with them. If we want a law on bees I think first it would be best to amend the law on ownership of swarms.—A. J. BROWN.

[It would be an easy matter to deal with bees in hollow trees, roofs, etc.—Eds.]

[10084] I feel doubtful of advisability of legislation for following reasons:—

(1) Infectious nature of "Isle of Wight" disease not proved. I have known one hive out of ten badly diseased, finally perishing—the other nine close around, quite unaffected—and the same kind of bees. There are neighbourhoods where few bees are kept, and in an instance, where there were no bees within a radius of three or four miles, the bees all perished five years ago. No fresh attempt was made till last year, yet the plague reappeared. There are the neighbourhoods where the plague (?) is unknown.

(2) Legislation would put an end to attempts to cure.

(3) It would add one more set of highly-paid officials, doing their work hurriedly and summarily.

(4) Board of Agriculture experts, with their ultra-microscopes have failed to discover the microbe, and have no more knowledge of the disease than the man in the street. A cure is likely to be found by the patience, observation, and empirical experimenting of the man who loves his bees as by anyone.

(5) Would not local associations with strict bye-laws be as effective as cast-iron legislation?

(6) I think we want closer study and observation and the jotting down of all points of interest. In my case, for instance, a warm, close, muggy day, in several instances, brought out a crowd of crawlers, as if the atmosphere of the hive had something to do with it.—D. DAVIES.

[(1) The cause of leprosy is not yet known, therefore we suppose our correspondent would suggest that until the cause is found lepers should not be treated or segregated. It would be just as feasible.

(2) Who said so?

(3) Ditto?

(4) How does this compare with No. 1.

Microscopes evidently must not be used to discover the bacteria causing the disease. Then we suggest a garden spade.

(5) This is a suggestion, but will our correspondent draft the scheme for carrying it into effect, and how is he going to compel all bee-keepers to join an association?

(6) A common sense suggestion.—Eds.]

[10085] I am not in favour of the proposed legislation, for the following reasons:—

That the proposed Bill, according to the copy before me, is in agreement with the theory that all clever, sensible, etc., etc., bee-keepers belong to the B.B.K.A., and that their hives are free from disease.

That outside the hive I have no control (ownership?) over my bees, nor can I guide the flight of wasps, bumblebees—all susceptible to disease—after they leave my premises.

That in a badly infected district I have kept my stocks free from disease, while the local expert, living half a mile away, has had to re-stock each spring since 1916, and will have to do so again next year.

That I strongly object to the local expert, whose diploma was granted by a more or less self-elected junta, examining my hives, either in my absence or presence. A few weeks ago this beauty informed me: "Just you wait until that Bee Bill passes, then me and a bobby will see your stocks when we want, and may Gawd help you." What does a Leicester Bee-keeper say to this?

That certain men have kept bees for 30, 40 and, in one case, 54 years without disease, or the intentional admission of any fresh blood. The modern man yearly purchases queens, nuclei or driven bees, just to keep his stocks from extinction. Why should the latter, who cannot keep his own bees, try and rule the former, whose only fault is that of having prevented the race from extinction.—J. TRUMAN.

[Will our correspondent please read our Editorial and other matter. A number of times we have clearly stated *there is no proposed Bill.*]

[10086] I have kept bees for many years. I lost 13 hives because my neighbours neglected their diseased bees. Nevertheless, I am against legislation and Government Inspectors. I never knew these officials to do any good. Government inspection is a great system of waste and corruption. If a good bee-keeper has a careless neighbour with a diseased hive, the former should go at night with a rag well soaked in kerosene oil and stuff it into the entrance and set fire to it and destroy the diseased hive. If

detected, he can apologise and explain. But why be detected?—A. E. STALEY.

[Which is the greater sin, being a Government Inspector, or inciting to incendiarism by stealth. Will our correspondent undertake to pay the penalties of all those caught and convicted for following his advice? Also, by the way, what did his bees die of? And did he clear the infection? If not, why not? And what would he say if he found the charred ruins of his hives on going out one morning? Bee-keepers in his neighbourhood should note his advice in case they wish to celebrate the next fifth of November.—Eds.]

[10087] Please add my name to those who object to Government interference with bee-keeping. As it appears to me, the Government has failed in everything they have touched upon—meat, butter, milk, cheese—and now the poor bee-keeper is to be harassed so as to get rid of the English honey.—MABEL GOODACRE (MRS.).

[10088] As I am a bee-keeper of many years' standing, and a reader of THE BRITISH BEE JOURNAL, I write to ask, if not too late, could you send me a paper to get signatures to the petition for legislation to try and stamp out the "Isle of Wight" disease? It has nearly wiped out all the bees in this part. I have lost all mine, but have re-stocked eight frame hives. So far as I know, they are all right at present, but I fear there are a great many who have lost their bees who leave the hives out for healthy bees to take the disease into other hives, and so spread it. If I can be of any help to get signatures, I think there are many who have lost their bees who would be pleased to sign, so that they can once more keep their bees free from disease.—CHAS. LITTLE.

[10089] Not having written for years, possibly many have thought that the old bee master had passed away; but no, he still liveth, with plenty of bees, crops of honey, and no diseases, being so secluded in the country, only occasionally receives visitors, and right welcome they be too. At your invitation, on the above subject I beg to exude these few lines. It appears from what one reads in the columns of the last few issues of THE BRITISH BEE JOURNAL that we are again to have a repetition of all the odd controversies that have previously appeared, either pro or con. Your space I should have thought too valuable for such idiosyncrasies, with practically no result, but personalities that should be excluded. I notice you have "hewn" Hewitt, however. Would it not be a good idea to take a postcard

vote, viz., owner, name and address, number of stocks, for or against. Take this as a simple basis, form a committee, and put it in order and forward to the proper authorities. The above, to my mind, would be much more simple, and certainly quicker than the present wait and see tactics. No bee-keeper in this or any other country (having visited a few) cannot but admit that where legislative laws are in force concerning bee diseases that they have reaped great benefits, or otherwise we should have heard its disadvantages ere this by certain opposition that would have been brought forward against them. Trusting above may not be too lengthy for insertion.—“THE BEE MASTER OF WARRILLOW.”

[10090] Regarding legislation, will it benefit the bee-keepers of this country? That I take to be the motive the promoters have in view. No doubt it would not be necessary, if bee-keepers were bee-keepers, in the true sense of the word. I will not weary you with my experience of “Isle of Wight” disease since 1912—during the autumn of that year I lost the six stocks which composed my small apiary, and have made a fresh start each year since, with like results until 1917. The stock I then had was also affected, but, thanks to Flavine, and perhaps owing to the few bees kept in my immediate neighbourhood and the consequent absence of infected hives, they are still going strong.

Although I have kept bees for fifteen years, I do not pose as an authority either on bees or bee diseases. I may be wrong in thinking that my bees have been infected through robbing diseased stocks; but I have noticed that it is the strongest stocks that are first affected, and it generally begins after the honey flow is over, when robbing usually commences. If that is so, and no doubt it is at least a contributory cause, then legislation will be of benefit to all genuine bee-keepers, who love those little insects, stings and all. I notice one of your correspondents says legislation would not be successful owing to infected stocks living in buildings and trees. Now, sir, are they a source of infection? Being a plumber by trade, I have been asked to remove lead from many buildings in this neighbourhood, when the bees have become a nuisance to the owner or tenant, and so far as my knowledge extends, I have never seen any sign of disease. As a matter of fact, there are two stocks of bees, one beneath a lead gutter, and one beneath a slate roof, that have been there for the past fifteen years, and to my knowledge have never shown any sign of disease, although the whole of the bees number-

ing many stocks kept in the gardens belonging to the house have been destroyed with the “Isle of Wight” disease pest. Perhaps, sir, you could enlighten me on this subject. However, I am prepared to accept and work for legislation, and will do all I can to help bring it into existence.—WILLIAM G. WELLS.

[10091] Engaged as I have been during the autumn months inspecting apiaries in Lancashire, I have had a good opportunity of getting the views of bee-keepers on the subject of legislation. I have not, in all my experience, come across one who objected to it. All of those I spoke to were in favour of such a measure of legislation that would safeguard bee-keepers from the careless bee-owners, and my opinion is that it is long overdue.—“LOVER OF BEES.”

[10092] It is quite a pleasure to me to find you such a strong champion for the cause of legislation, and I am sure you have the support of nearly all the bee-keepers in this district, for the loss of bees has convinced them of the necessity of legislation. I have lost all my bees from time to time, and the cause could always be traced to their raiding diseased stocks, or hives in which stocks had died, and had neither been cleaned nor closed. To give you details of my experience with bee-keepers who have had diseased stocks and my efforts to get hives cleaned and disinfected, would take up too much space, but I give my address, and shall be pleased to reply to anyone interested.—A. W. WESTROP, President, Bridgnorth and District B.K.A., Bridgnorth.

### Trade Catalogue Received.

Messrs. Pearson & Gale, Marlborough. This catalogue is of bees and queens. A speciality is made of queens, and guaranteed six-frame stocks. A special reduction of 12½ per cent. is offered to persons disabled on active service. The price of the catalogue is 3d., which is refunded on first order.

### Combs from Other Hives.

#### Malaria and Bee Stings.

I think of starting to keep bees next spring, and have been told that it would be dangerous if my husband were stung, as he often suffers from malaria, and that in his condition a bee-sting would poison him.—L. M. C. W.

We have never heard of this curious superstition before; for that it is purely



a superstitious delusion we do not hesitate to assure our correspondent. If she will reflect for a moment on the fact that in many tropical countries *all* the black inhabitants suffer from malarial infection, and that most savages are inordinately fond of honey, which they obtain by ravishing the wild bees' stores, very scantily clad and with the complete certainty of sustaining many stings, she will see that what she has been told is hardly consistent with the continued existence of many large and flourishing native tribes in Africa and elsewhere. Bee-stings are often believed to be good for rheumatism; and some eminent medical men have evolved a theory to account for it. Whether the fact in this matter is really as it is alleged to be, and whether the suggested explanation holds water, we should not like to be too positive.—From the *Nursing Mirror*.

### Cruelty to Bees.

A report from Beckenham states that a swarm of bees belonging to a local apiarist alighted on a stake in a neighbour's garden.

The owner obtaining permission to enter the garden, found that the bees had been smothered in pepper and were writhing in agony on the ground.

The swarm was lost, and, apart from the needless cruelty, swarming bees being quite harmless, the food value of the lost home was considerable.—From the *Star*.

### Honey.

Delectable sweetness, queen of the palate;  
Essence of Nature from each bursting  
flower;

Cunningly cradled for manifold purpose,  
Tenderly nurtured by sun, breeze and  
shower.

Eagerly sought for, this incomparable  
nectar,

And joyously sipped at its perfumed  
font;

Gratefully the bee hums thanks to its  
Creator,

Who lovingly provides for every want.

With rapturous zeal, and wondrous in-  
dustry,

The limpid sweet they garner in the  
hive;

When tiered in waxen cells of perfect  
symmetry.

To matureate with gentle heat they strive

Graded and sealed in mature condition,  
Attaining that taste and aroma so rare;

For winter's dark months, kind Nature's  
provision,

Food for the harvester: the surplus  
man's share. L. W. W.

## MORE HONEY WANTED

Reports indicate that sugar is to be dearer and supplies shorter than ever this year, hence the demand for honey will no doubt be greater, with a corresponding increase in price.

Moreover, little sugar will be allowed for bee feeding, and this shortage must of necessity be met by the use of more honey in feeding.

The best way to maintain or increase honey production is to have healthy bees. And to keep your bees free from disease, their surroundings—hives, skeps, combs, brood-chambers, floor-boards, drinking fountains, and all utensils of the apiary—must be kept in a clean and antiseptic condition. For this purpose 'Bacterol' has been successfully used by many prominent bee-keepers. It is harmless to bees but kills disease germs. Of slight, but pleasant, odour, non-poisonous and non-staining, 'Bacterol' may be used freely and with perfect safety.

The medication of candy and syrup with 'Bacterol' has done much towards the decrease of I O.W. disease in this country. Bees like 'Bacterol,' and thrive on it. Experts have proved its value so you need not hesitate to profit by their experience. To insure against loss of bees and increase your honey output

USE

## 'BACTEROL' FOR BEES

To be obtained in half-pint bottles, 2/6 each, post free from E. H. TAYLOR, Welwyn, Herts; JAMES LEE & SON, LTD., George Street, Uxbridge; A. W. GAMAGE, LTD., Holborn, E.C.1; THE BRITISH BEE JOURNAL, 23, Bedford Street, W.C.2; or

MENLEY & JAMES, LTD.,  
39, Farringdon Road, London, E.C.1

## Special Prepaid Advertisements.

One Penny per Word.

### PRIVATE ADVERTISEMENTS.

**PURE** light Cambridgeshire Honey, 14-lb. tins, 22s. 6d.; 28-lb. tins, 42s.; tins free; sample 4d.—**J. YOUNGER**, 6, Maid's Causeway, Cambridge. r.a.5

**HONEY**, clover blend, highly commended Grocers' Exhibition; 28-lb. tins, free, 49s.—**THOMAS**, Causeway, Burwell, Cambs. a.6

**FINEST** quality light Norfolk Honey, 2s. per lb. in 28-lb. tins, carriage paid; sample 6d.—**E. W. D. MADOC**, Mattishall, Dereham. a.7

**THREE** Wilkes' Aluminium Feeders, 2s. 6d. each; four pieces  $\frac{1}{2}$  in. plate glass, 15 in. by 15 $\frac{1}{2}$  in., suitable observation hive, 12s. 6d.; four Stocks Hybrid Italians, 1919 Queens, delivery now or after spring examination, £4 each; 5-cwt. Honey Cask, 10s.—**L. 14**, Newstead Road, S.E.12. a.8

**WANTED**, six Lees' W.B.C. Interchangeable Hives, four Brood Boxes, and sufficient Lifts to each live; must be in good condition and clear of disease.—Details and price to **H. V. BAKES**, Brandsby, Easingwold. a.9

**WANTED**, for scientific purposes, a few live Bees from diseased or dwindling stocks; cages sent and expenses paid.—**SNELGROVE**, Quadrant, Weston-super-Mare. a.11

**LEGISLATION?**—Levitation! Gravitational and other Light Bending!—Personally speaking, the last thing we take off before going to bed is our "feet" off the floor. The tabulated reports show 85 per cent. of bee-keepers lifting the right foot first; 27 per cent. lift both simultaneously (bee-keeperettes only). But whether the right foot went before or behind everyone who mentioned "feet" got a "pretty."—**SMITH**, Cambridge. a.14

**WANTED**, Geared Extractor; good condition.—Price and particulars to Box 57, B.B.J. Office, 23, Bedford Street, W.C.2. a.16

**7 CWTs.** LIGHT CAMBRIDGESHIRE HONEY, £8 10s. cwt., on rail, 28-lb. tins; tins free; sample 6d.—**GEORGE BARNES**, Burwell, Cambs. a.1

**THE GRAMOPHONE RECORD EXCHANGE** will exchange Records 5s. dozen; return postage free.—Address, 6, Rood Lane, London. Particulars stamp. x.23

**WANTED**, new Cycle Chain, 1 in. pitch by  $\frac{1}{2}$  and 5 ft. 6 in. long, twin roller, or block.—Price to **A. J.**, B.B.J. Office, 23, Bedford Street, Strand, W.C.2. x.32a

**WANTED**, portable Greenhouse.—Price and particulars to **W. HERROD-HEMPSELL**, Old Bedford Road, Luton, Beds.

**WANTED**, Auster Rear Wind Screen for motor car.—**HERROD-HEMPSELL**, as above.

**FOR SALE**, one Exhaust Whistle, 11s., post free; one Wood Milne Motor Foot Pump, 45s., carriage free; one 760 x 90 Cover, 15s., carriage free; one small Motor Horn, 5s., post free.—**HERROD-HEMPSELL**, as above.

**CORRESPONDENCE** Course in Bee-keeping.—**MISS F. E. PALING**, Golden Square, Henfield, Sussex. rw.31

**WILL** all those bee-keepers possessing 25 stocks of bees and upwards kindly send particulars to **SECRETARY**, B.B.K.A., 23, Bedford Street, Strand, London, W.C.2. v.42

**WILL** all those who are not in favour of legislation please communicate with Box 48, **BEE JOURNAL** Office, 23, Bedford Street, Strand, W.C.2. v.23

### BUSINESS ADVERTISEMENTS.

1gd. per word.

**"INTENSIVE BEE-KEEPING** for Honey Production, or Disease Control," price 6d., post paid. "Let the Bees Tell You!" price 2s., post paid.—**S. H. SMITH**, 30, Maid's Causeway, Cambridge.

**HIVE MAKERS** Wanted.—Apply, letters only, stating age, experience, wages expected, to **LEE**, Beehive Works, Uxbridge, Middlesex. a.13

**BEEs ON APPROVAL**—We guarantee our Bees and Queens to give complete satisfaction. Special terms to disabled men. Catalogue 3d., which will be returned on first order.—**PEARSON & GALE**, Marlborough. a.12

**QUANTITY** amber-coloured Granulated Honey in 1-lb. glass jars at 21s. dozen,  $\frac{1}{2}$ -lbs. at 11s. 6d. dozen; also in tins, 7 lbs., 11s.; 14 lbs., 20s. 6d.; and 28 lbs., 37s. 6d.; carriage paid.—Apply, **MEADOW BROS.**, Shirley Road, Shirley, Surrey. r.a.10

**HAVE YOU READ "THE BEE WORLD"?** If not, why not? Every number in itself is a useful literary work for practice and reference. Specimen copy free.—Offices: **THE APIS CLUB**, Port Hill House, Benson, Oxon.

**ITALIAN QUEENS** direct from Italy. Price list for 1920 on application.—Address, **E. PENNA**, Bologna, Italy. w.39

## The Metal Foundation.

(Protected.)

For the benefit of readers of the **JOURNAL** and the **RECORD** we have arranged with the manufacturers of the Metal Foundation to accept all orders received through our offices at a consideration in the shape of a 25 per cent. deposit to begin with, and the balance by mid-March, or prior to delivery, if earlier. All orders are guaranteed by them to be executed *not later* than April, 1920.

Prices:—(1) **BRITISH STANDARD FRAME**, fully fitted with "worker" Metal Foundation: Single, 2s. 4d.; per two dozens, 2s. 3d. each frame; per four dozens and over, 2s. 2d. each frame.  
(2) **STANDARD SHEET** of "worker" Metal Foundation: Single, 2s.; per two dozens, 1s. 11d. each sheet; per four dozens, 1s. 10d. each sheet.

Subject to a 5 per cent. discount to members of the Apis Club.

*Packing & Carriage Extra.*

\* \* Since the Metal Foundation will be produced only to order, no order will be subject to cancelling.

### 1920 ORDERS CAN NOW BE BOOKED FOR SELECTED 3-STANDARD FRAME NUCLEI.

Young healthy Bees guaranteed, also plenty of food. Nuclei to include 1920 (specially selected) Italian Imported Queen. Limited number only for disposal, therefore delivery must be strictly in rotation. Price (per nuclei) £3, carriage paid, plus 7s. 6d. for box, which is returnable. Cash with order. Apply—

**G. REYNOLDS.**

1, THE GROVE, BARIHAM, NEAR CANTERBURY

### BEE FLOWER SEEDS.

Collection of six best Varieties, 1s., post free. Beautifully Illustrated Instructions Up-to-date. Garden Guide, 64 pages, Free.

**KNIGHTS,**  
SEED SPECIALISTS,  
WOLVERHAMPTON



THE  
KEY TO  
YOUR SUCCESS.

# The Metal Foundation

(Protected.)

Earlier than our expectation, we have pleasure in announcing that we are now booking orders for Metal Foundation (framed and otherwise) for the 1920 season. Special frames for its accommodation are supplied only by ourselves.

As the particular aluminium sheets needed for its production have to be specially manufactured at a notice of no less than 3 months, bee-keepers are advised to give their order *at once*, so that all orders may be executed before the season begins.

The Trade is recommended to order without delay the *maximum* quantity which is needed or is likely to be required. Judging by the numerous inquiries that are being received, we respectfully suggest to every large Bee Appliances Establishment placing an order of 10,000 framed sheets, to

begin with. No order, however, is too small and none is too big, provided it is immediately given. All orders, whether large or small, will be executed in strict rotation.

## RETAIL PRICES.

	Single.	For Two Dozens.	For Four Dozens and over.
(1) British Standard Frame fully fitted with worker Metal Foundation.	2/4	2/3	2/2 <small>Per fitted frame.</small>
(2) Standard Sheets of worker Metal Foundation.	2/-	1/11	1/10 <small>Per sheet.</small>

Subject to a five per cent discount to all members of the Apis Club.

Cash with Order.

Carriage forward.

**A FINAL REMINDER!** To avoid disappointment give your order **NOW.**

# JAMES LEE & SON,

UXBRIDGE, MIDDLESEX.

(Telegrams : Graphically, Uxbridge.)

**Don't Order "W.S." Queens until you have seen the "Queenland" Revised List for 1920. 3½d. post free**

## NUCLEUS STOCKS—Same Price as 1919.

The only Pedigree Bee-Stock Registered in direct line for more than 25 years.

**"AMALGA" is the name of our Queen breeding mother for 1920**

**"ALTA" is the name of our Drone parent for 1920.**

### PRODUCE OF ONE NUCLEUS REALISES OVER £40 IN CASH.

"The three-frame nucleus I purchased from you had increased last autumn to two strong stocks. I supered one on April 23rd of this year, and the other a few days later. I sold two swarms, and made up the others to five stocks. Of these I also sold three stocks. The original lot gave 198 lbs. of honey, and in all I have taken 365 lbs. My sales amounted to over £41 in actual cash."

(Miss) H. G. MOYSEY.

Somerset, Oct. 9th, 1918.

### EXCEEDS 500 PER CENT. INTEREST.

"We have now 12 stocks to winter, besides selling one, out of the two three-frame nuclei supplied June 20th last year." (August 15th, 1917). Miss B. D. Quinton, Bucks.

### THREE TO SEVENTEEN.

"It may interest you to know that the three stocks to which I introduced your queens (the only stocks saved in the apiary) in 1916, produced in all 17 stocks, and a good surplus in honey in 1917; this under the care of my wife who knew nothing about bees. I simply directed her as to management from there (France)." OLIVER G. PIKE.

April 9th, 1918.

### FIRST AND BEST.

"Your White Star strain was the first to enter the sections, and all the honey I got was from them." G. H. S. Heddon House Dairy.

### APRIL 19TH.—BOILING OVER.

"The hive is simply boiling over with W. S. bees. They are at work when my other stocks are idling, and they are stronger than any of my other stocks." Aberdare, Wales. E. T. W.

### ARE THE W.S. PROLIFIC?

"In 1904 I got a W.S. queen from you, and last year (1905) by the first week in June she had brood in *twenty-five* standard frames." J. H.

Higher Kinnerton, Chester.

### NUCLEUS DELIVERED IN JUNE; 40 FRAMES BY AUGUST.

"The three-frame nucleus of bees now occupy 40 Standard Frames. They have exceeded beyond anything I believed possible. I have never had anything like them before, and if the other queens on order turn out the same I consider my fortune made." JOHN JONES.

Llancarfan, Aug. 21st, 1918.

### SEVERAL STOCKS FROM ONE NUCLEUS.

"It seems almost ridiculous that this nucleus of the previous season (Aug.), before I was prepared for it, swarmed in April, and I now have several stocks from that investment." J. W. MCKAY. Croydon.

### EIGHT STOCKS FROM ONE W.S. NUCLEUS.

"I now have eight stocks from the one nucleus you supplied last year."

J. JONES.

Llancarfan, May, 1919.

### BEST IN THE COUNTY—NEVER SAW THE LIKE!

"May 26th.—The two queens you sent me have exceeded anything that I ever thought of. The stock chambers are full and crammed with brood, and all three supers crowded with bees; but even with this the bees are boiling over. I have not fed them at all, and have removed several frames of brood for another lot. The County Expert called yesterday, and said he had never seen such bees, and they were certainly the best in Hampshire."

D. D. P.

### NO SPRING-FEEDING, BUT AGAIN FIRST.

"The W.S. bees on eleven 16 x 10 frames were full and boiling over at the middle of May, and were the first to enter supers out of 23 stocks; and last, but not least, they required no spring feeding."

U. W.

Arnold, Notts.

SAFE DELIVERY of Nuclei and Queens GUARANTEED

Revised 1920 "White Star" List, 3½d., of S. SIMMINS, Queenland, Heathfield, Sussex.

A large quantity for Sale at carriage paid prices, either Plain or Glazed, **IRISH RUN HONEY.** Several cwts. for Sale in quantities to suit customers, at carriage paid prices in free tins and cases.

**GORDON ROWE,**  
Honey and Beeswax Packer,  
28a, Moy Road, Cardiff.

**THE  
British Bee-Keepers' Association.**

The recognised centre of practical and scientific bee-keeping in Great Britain. Particulars and conditions of membership may be obtained from the Secretary,  
**W. HERROD-HEMPSALL, 23, Bedford Street, Strand, London, W.C.2.**

The products of the Apiary, of Poultry and Farm Stock, of the Fruit and Vegetable Garden can be Advertised and Sold through

**THE  
BAZAAR, EXCHANGE & MART**  
Newspaper.

Get a Copy—Thursday and Saturday 3d. The "Bazaar" publishes also practical handbooks by experts. Send for full catalogue, post free from—**WINDSOR HOUSE, Breems Buildings, LONDON, E.C.2.**

**Books for Bee-keepers  
NOW IN STOCK.**

A Modern Bee Farm ... ..	7/6	... 6d.
Bee-keeping (DR. E. F. PHILLIPS)	10/6	... 6d.
<b>BEE-KEEPING SIMPLIFIED FOR THE COTTAGER AND SMALLHOLDER</b> (W. HERROD-HEMPSALL, F.R.S.) ... ..	1/-	... 1½d.
<b>BEE-KEEPERS' PRACTICAL NOTE BOOK</b> (T. W. COWAN)	1/-	... 1½d.
<b>BRITISH BEE - KEEPERS' GUIDE BOOK</b> (T. W. COWAN) (paper covers only)	2/6	... 3d.
Dissectible Model of Queen Bee	4/6	... 3d.
<b>FERTILISATION OF FRUIT BLOSSOMS BY BEES</b> (T. W. COWAN)	-/3	... 1d.
Honey and Health (A. HOPKINS)	-/6	... 1d.
Honey Vinegar (REV. G. BANCKS)	-/2	... 1d.
How to Keep Bees (ANNA B. COMSTOCK)	5/-	... 6d.
<b>PRODUCING, PREPARING, EXHIBITING AND JUDGING BEE PRODUCE</b> (W. HERROD-HEMPSALL, F.R.S.) ... ..	2/-	... 3d.
Queen Rearing in England (F. W. L. SLADEN)	1/6	... 2d.
Snelgrove's Method of Re-queening	-/6	... 1d.
The "Townsend" Bee Book	2/6	... 3d.
<b>WAX CRAFT</b> (T. W. COWAN)	2/-	... 2½d.
Wilke's Book on Swarming	1/-	... 1½d.
<b>MISCELLANEOUS.</b>		
Maeterlinck's Life of the Bee	3/6	... 3d.
The Lore of the Honey Bee (TICKNER EDWARDS)	2/-	... 2d.
The Humble Bee (F. W. L. SLADEN)	12/6	... 6d.

**British Bee Journal & Record Office,**  
23, BEDFORD STREET, STRAND, LONDON, W.C.2.

- - THE - -  
**BRITISH BEE JOURNAL.**  
ESTABLISHED 1873.

**THE NEW VOLUME COMMENCED JANUARY 1st.**

THE BRITISH BEE JOURNAL is supplied direct from the Office every week, post free for One Year, 10s. 10d.; Half Year, 5s. 5d.; Three Months, 2s. 9d. (payable in advance). Posted on Wednesday evening in time for delivery on Thursday.

Money Orders and Cheques should be made payable to W. Herrod-Hempsall and crossed "London County and Westminster Bank."

**SUBSCRIPTION FORM.**

(To be filled up by intending Subscribers, cut out, and returned to the Office.)

Please send me "THE BRITISH BEE JOURNAL" for \_\_\_\_\_

Commencing \_\_\_\_\_ 192 \_\_\_\_\_, for which I enclose

\_\_\_\_\_ \*Name \_\_\_\_\_

Date \_\_\_\_\_ Address \_\_\_\_\_

\*Please state whether Mr., Mrs., or Miss, etc.

*It will considerably facilitate our publishing arrangements if subscriptions are dated from the beginning of each year; the proprietor will therefore be obliged if subscribers will fill up and return the above form as early as possible.*

**COVERS FOR BINDING**

"BRITISH BEE JOURNAL" or "BEE-KEEPERS' RECORD," 1/8 post free.

**British Bee Journal Office, 23 Bedford St., Strand, London, W.C.2**

## QUALITY.

The difference between a good bargain and a bad bargain is not so much a matter of money as of quality.

All our goods have the "Hallmark of Quality" resulting in a large clientele of SATISFIED customers. Does this mean anything to you? If so, send for our large Illustrated Catalogue for 1920, free on application.

R. STEELE & BRODIE,  
Bee Appliance Works, WORMIT, FIFE, SCOTLAND.

## THE UXBRIDGE W.B.C. HIVE.



We originally introduced this type of W.B.C. Hive over twenty years ago, and offered it for several years as "Lee's Waterproof Cover." Beekeepers of those days did not care for it. Hence it was withdrawn from our list. We now offer it as illustrated. Lifts and covers are square and dovetailed.

Price, including stock box, ten frames with ends and dummy, two shallow frame boxes with eight frames in each, 48/6. We will also supply this hive without inside fittings, to enable beekeepers to transfer existing stocks to the new covers, for 30/-. Carriage paid, 2/6 extra.

**PROMPT DELIVERY.**

**JAMES LEE & SON, LTD.,**  
UXBRIDGE, MIDDLESEX.

## The 'Kent' Standard Model Hives & Appliances

### TESTIMONIAL.

May 12.

DEAR SIR,—I have had an opportunity of comparing the material and workmanship of your hives with others on the market, and in my opinion there is no sort of comparison between the two, yours being altogether superior in every particular.—Yours faithfully,—

S. J. BALDWIN, *Stanley Road, Bromley, Kent.*

**BURTT, Gloucester, FOR BEE APPLIANCES.**

*New Illustrated Catalogue Free on application.*

FEB 24 1920



No. 1960. Vol. XLVIII JANUARY 15, 1920. [Published every Thursday, Price 2d.]

**CONTENTS.**

	PAGE		PAGE
OBITUARY NOTICE .....	25	NORTHUMBERLAND B.K.A. ....	30
LARVAE OF DRAGON FLY .....	25	CORRESPONDENCE—	
A DORSET YARN .....	25	“Isle of Wight” Disease. Where are We? .....	31
JOTTINGS FROM HUNTINGDONSHIRE .....	26	Letter from a “Demobbed” Soldier .....	31
WINTERING TWO QUEENS IN ONE HIVE .....	27	How I Commenced Bee-keeping .....	32
BARNSTAPLE AND DISTRICT: PROPOSED B.K.A. ....	28	Re Notes on Bee Dysentery .....	32
BLITHE BRIDGE LOCAL B.K.A. ....	28	Bee Legislation .....	33
CORNWALL BEE-KEEPERS' ASSOCIATION .....	29	Remedy for Ants .....	35
MONMOUTHSHIRE B.K.A. ....	30	Utilising Partly-built Sections .....	35
TRING B.K.A. ....	30	NOTICES TO CORRESPONDENTS .....	35

**DO NOT LET YOUR BEES STARVE.**

# Use Taylor's Soft Candy

1-lb. 1/6, post free; 6-lbs. 6/-, post free;  
12-lbs. 10/6 (11/6 carriage paid, 12/- post free.)

SYRUP—7-lbs. 7/6; 14-lbs. 10/6; 28-lbs. 20/- SUGAR VOUCHER must be sent with order.

## BEESWAX BOUGHT,

2/- lb. Cash, or 2/1 lb. allowed if taken out in goods.

Also Cleaned and Sterilised and made into Foundation.

No. 77. Compressed  
**NAPHTHAFORMA TABLETS,**  
The Germ-killing Remedy for Foul Brood  
1/9 Bottle, Post Free.

**TAYLOR'S NEW REGISTERED  
ZINC EXCLUDER**  
giving 50% freer access to supers  
16 x 16 squares 3/-, post 6d.  
8-ft sheets 15/-, post 1/-.

**BACTEROL & YADIL,**  
For “Isle of Wight” Disease,  
Bacterol, 2/6 per bottle, post 6d.  
Yadil, 3/6 per bottle, post 6d.

Syrup should be fed medicated with above in  
**Taylor's Registered Feeder,**  
Specially designed for above cures,  
Post free, 3/10  
or Bottle of Bacterol and Feeder, 6/- post free

**TAYLOR'S No. 12 HIVE, Dovetailed, at 29/- Carriage Paid. In the Flat, 28/-  
BEST VALUE IN HIVES EVER OFFERED.  
NEW CATALOGUE FOR 1919 POST FREE.**

**E. H. TAYLOR, WELWYN, HERTS.**

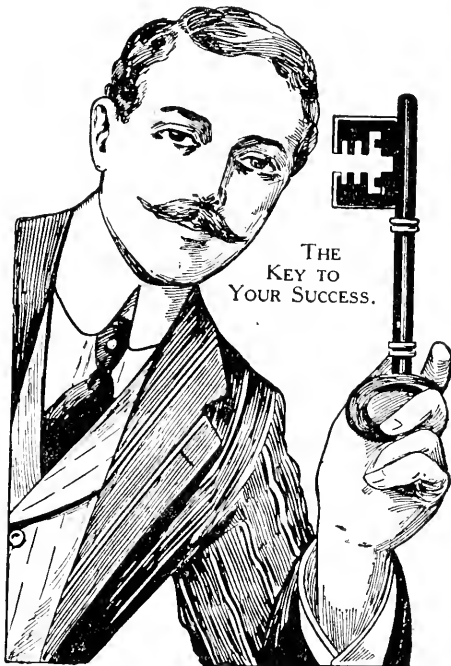

# The Metal Foundation

(Protected.)

¶ The triumph of the Metal Foundation is due to the following significant advantages:—(1) Indefinite durability with reasonable care; (2) Greater safety of bees in transit on new combs; (3) Capability of bearing the weight of a heavy swarm in hot weather; (4) Greater comb stability in quick extracting; (5) Control of drone cells; (6) The production of even combs; (7) Easy removal of queen cells without the slightest injury to the foundation; (8) Cleanliness and adaptability to sterilisation by boiling; (9) Economy of labour and time in fitting and detaching; (10) An ideal compromise between the metal comb and the wax foundation.

¶ The invention has created a world-wide interest. Its value will be the more appreciated by studying the fol-

lowing original literature:—"The British Bee Journal," November 13; "Bee Craft," December; and "The Bee World," September, October, and November, 1919.

## RETAIL PRICES.

¶ The Metal Foundation ("worker" type) can now be produced in any size required, whether for the brood chamber or the super, e.g., for the British Standard Frame (14 in. x 8½ in.), Deep Standard (14 in. x 12 in.), Simmins' (16 in. x 10 in.), Langstroth (17½ in. x 9⅞ in.), etc., and for their corresponding super frames. Despite the heavy cost of machinery, metal, etc., it is offered at a price *well within the purchasing power of the average bee-keeper*. All orders, whether large or small, receive *prompt attention*, and are executed in *strict rotation*, and in *good time for the season*. We have further decided—for the benefit of bee-keepers who are not yet in a position to place their orders—on taking the risk of a liberal margin of production to meet unavoidably delayed orders. *If you have not yet made up your mind as to your requirement, you are still in time to do so.*

## The Uxbridge W.B.C. Hive.

¶ This popular hive, which we originally introduced over twenty years ago, is admirable for its *water-proof* features, since it eliminates the plinth. It stands supreme amongst all W.B.C. patterns. You will never regret trying it with your metal foundation.

\* \* We allow a Five per cent. discount on all our goods (including the Metal Foundation) to members of the Apis Club, who are respectfully requested to forward their membership cards when placing orders.

A FINAL REMINDER! To avoid disappointment apply now for the Metal Foundation Price List, and for our 1920 Catalogue.

# JAMES LEE & SON,

## UXBRIDGE, MIDDLESEX.

(Telegrams: Graphically, Uxbridge.)

Telephone: Uxbridge 181.)





## Obituary Notice.

We regret to announce the death of Mr. J. Smallwood at the Cottage Hospital, Hendon. Mr. Smallwood had an operation several weeks ago, and though it was successful and he appeared to be going on all right for a time, he was unable to gain strength, and passed peacefully away on Wednesday, January 7. We hope to give further particulars of Mr. Smallwood's career in our next issue.

## Larvæ of Dragon Fly.

One of our readers is anxious to secure some larvæ of the dragon fly, preferably from Wales, where he is told they are very beautiful. No particular variety is mentioned. We shall be pleased to hear from anyone who can supply some.

## A Dorset Yarn.

The last flower in the old and the first in the new year on which bees were seen on our farm was the Christmas rose. Very pretty they look just now, and close to the lives, so whenever the weather is warm for an hour the bees have only to fly over the wall and revel in the wealth of pollen that is to be found in these white blossoms. These are like the large flowers in St. John's wort, producing an abundance of male organs. Nature seems to be very lavish of pollen organs in some units of the floral kingdom; this is one of them. Bees seem to know the flowers that have these polliniferous parts. I presume this is why they like all single flowers in preference to double ones. All young scholars know that double flowers have the male, or pollen, parts of these perfect flowers converted into extra petals; most botanists consider the double flowers only monstrosities, the single the only perfect ones. Bees are rarely seen in summer on double roses, but on the beautiful single varieties in great numbers. So with the Christmas rose (which does not belong to the rose family at all), a large

single flower, with abundance of pollen, is one that bees visit in great numbers. These plants will always be dear, as they do not grow everywhere well; there seems to be something special in the soil that they must have. A very small piece dibbled in the soil in March will carry 20 to 30 flowers the third and fourth year. Even the first year after planting they will bloom; they will bloom on for 20 years. In 10 years they will be 2 ft. across, with 50 to 100 flowers, from Christmas to end of March. Bee-keepers who plant them for their bees must try them in different positions, as they seem to do better in some places than others. Never be weary of trying them, as they are worth doing well for the bees. On our farm they seem to do well everywhere; it is only to dibble in a small piece, and it soon does well.

This changeable weather is not so well for the bees, though I like to see them out and about. The rise from 10 deg. of frost and north winds, to 48 deg. and south-west winds, soft and moist, then the sun bright for an hour or two, brought bees out of every hive. They will soon begin breeding when they can get pollen; it is early for them to keep up the heat for the young brood, as we shall have some cold weather yet. When writing this (early Sunday morning) it is blowing a gale from the S.W., and rain in abundance, so we shall not see them to-day.

It is up to us to try the aluminium combs this next season, as it is being written up by the bee press of America. Some of our British bee-keepers are writing of its good qualities. They would not praise it only because they are agents to sell, because they have their own good name to keep up, or our bee fraternity would not deal with them again. They must, of course, be expensive to begin with. We shall always value more what costs us more; at least, that is as I have found it through life. If this saves so much honey that would have to be consumed to build the combs we shall soon be the gainers, especially now honey is 2s. 6d. wholesale.

Mr. Rosser, one of our soldier bee-keepers, of Queensland, writes me that he is home on his farm again. He made a tour of the South and West of England after finishing in France. He spent some months in America before going back. He finds 70 stocks to his credit, which he left in charge of a lady when he left to follow the flag and the lure of the army for the motherland. I hope he will write the JOURNAL, and keep us posted up with the honey harvests of Queensland. He was at the last annual meeting of the B.B.K.A. at the Central Hall, Westminster.—J. J. KETTLE.

## Jottings from Huntingdonshire

Bobby was a pony, a dapple-grey gee owned by two single ladies. They were not old maids, for they were open and free and lovable. In fact, most people in the village would do anything for either of them for the sheer joy of receiving their genuine thanks, with sweet, honest smiles. Withal, Cupid did not come their way, and, being of loving dispositions and fond of animals, small wonder that Bobby came in for an unusual amount of affection. The elder sister performed the duties of groom and gardener, the younger the household duties, with bee-keeping as a hobby. The oats that Bobby was allowed would have made many a Shire horse frisky; small wonder that when Bobby took his mistresses for a drive he covered the ground at a great pace. His speed, with his reliability (he was never known to shy), brought him many admirers, and would-be buyers offered large sums in their vain endeavours to purchase him. This popularity made Bobby all the dearer to his owners, and much fussing and petting went on. When the elder sister went to groom him each morning, Bobby was released from his stall in order to go and put his head through the opened kitchen window for a lump of sugar or a crust of bread, and even (don't tell the Food Controller) a piece of cake. One day Bobby found the kitchen window closed; a sash-rod had broken and let it down. Not to be done, he found his way to the door, which, being opened, he entered, and standing in the hall neighed for his tit-bit. This deed of Bobby's was taken as a sign of superior wisdom, and so he became a more cherished pet than ever, and every visitor to The Hollies was invited to see Bobby pay his morning call. It came to pass one day that the younger sister fell sick; a bad attack of the "flu" laid her low for some weeks. When the disease had left her, she was so weak that the doctor ordered a month's change, and so it came about that arrangements were made for the two sisters to go for four weeks to the sea. What could be done with Bobby? It was July, so they looked around for a small field wherein their pet pony might graze away to his heart's content during his mistresses' absence. A field was offered quite near home. A local farmer had a small paddock of  $2\frac{1}{2}$  acres, which he offered to let for the month. "It's a grand bit of pasture, miss, and a stream runs along the bottom; and if that do run dry, as it does betimes in the summer, there's a good pond which I've 'eard say old monks made long whiles back, when an abbey were 'ere. The pond never is dry, miss; you see, miss, they believed in making 'em deep in those days."

It was therefore arranged that Bobby spend a month in this field. The first day he was turned into it he kicked up his heels and galloped around, and showed by other manifest signs that he was delighted to have such a place to romp and graze in. His mistresses, seeing this, went away happy in the thought that Bobby would be as happy as they.

Now, it happened that, growing near the edge of the field was an ash-tree, hollow with years. Near the top was a hole some 3 ins. in diameter, from which could be seen issuing forth some very busy bees. A swarm from one of the younger Miss R.'s hives had taken possession some two months previously, and by this time were fairly well established. The first week passed pleasantly for Bobby, for the grass was luscious, the weather warm, with a nice sprinkling of showers and plenty of shade. Towards the middle of the second week, however, Bobby was beginning to feel the effects of grazing out. Itching in the region of the shoulders, he sought a convenient object against which he might rub himself with some vigour. He selected the old ash-tree. As he rubbed away, the tree began to shake; a creak, and Bobbie shot off at a gallop; a crack, and it fell crash, just as Bobbie had rushed once round the field. The bees within the tree came out, anger buzzing in their wings, to look for the cause of their violent disturbance. Unfortunately, they considered Bobby to be the transgressor, and so a large number attacked him, and to some purpose, as he was seen to rear, then fall down and roll. This crushed several bees, and thus those living became the angrier. Bobby was smothered with furious bees, many succeeding in getting their stings home. Poor gee, he danced, rushed and groaned, and as the pain increased went mad. Rushing about hither and thither, he made for the pond, and with a mighty plunge jumped right into the middle. A shepherd, witnessing this, raised an alarm, and as quickly as possible got assistance and ropes, but reached the pond too late. Bobby was dead. Methinks he did not wish to live, for there were no signs of any attempts to scramble to the banks and so save himself. Near that pond is now a mound; not infrequently two maidens are seen standing near with saddened faces; sometimes a stray tear has to be wiped from an eye. They have another pony; she is a happy, sprightly mare, but in the corner of those good ladies' hearts there will always be a place for their faithful Bobby. As for the bees, they forsook their shattered home, and their nectar was taken by robber bees and wasps.

I have tried to relate the above as I heard it. We say such pleasant things of

bees that it's just as well that one should hear something not so pleasant concerning them; but, after all, in sacrificing their lives—every bee that loses its sting sacrifices its life—they do so to protect their unborn progeny and their queen.

It will be worth while for those who have old trees wherein bees have made their home to examine such trees occasionally, if they are where stock can reach them, lest other hearts be made sad by the loss of a choice or favourite beast.—E. F. HEMMING.

## Wintering Two Queens in One Hive.

The method of wintering described below is novel, so far as I am concerned, and is in the nature of an experiment, but with promise of great success. Mr. F. W. L. Sladen has wintered two queens in one hive in Canada. He arranged his stocks in a different way, but I am indebted to him for the encouragement his experiment gave. I packed up two queens in one hive last winter on a different principle, but with no practical results, for both were swept under by disease.

The stocks are placed on ten frames of comb each, five over five, side by side, in two brood chambers, one on the top of the other, with close fitting division boards separating the stocks. The brood chambers are placed on the top of a shallow super, also with a division board closely fitted down on the floor board, so that there is no communication whatever down to the entrance. This has the double advantage of giving room when crowding the bees when packing up for winter, and good clearance under the cluster during winter. The bees are allowed to fly from opposite sides of the alighting board.

There are one or two points to be considered when placing the stocks in position. After putting the two hives side by side for at least a week before uniting in one hive, the bees should be made to fly from the same position on their own alighting board as they will respectively use in the united hive, so that they become thoroughly accustomed to the position of the entrance.

When ready, the prepared floor board is placed in the position of one or other hive, and the bees from it are crowded on to five combs that contain all the brood, and that are best filled with stores. These are pushed to that side of the brood chamber where their entrance is, and a division board put in. The other five combs, for the most part filled with stores, are placed in another brood chamber, and

another division board put in. After this lot has settled down the same treatment is applied to the other stock. This can be done without uncovering the first stock treated. This time, of course, the combs have to be taken out and placed by the side of the first stock. Subsequently the other brood chamber, now filled with ten combs containing most of the stores, is placed on the top, and the operation is complete. In short, we have left the brood nest intact below in each case, and placed the stores overhead.

I find that it is best to keep the entrances separated by a pronounced division on the alighting board. On November 23, when my bees were flying freely after nearly a month of confinement, they got rather mixed, and there was some slight amount of fighting. It was at the same time evident that this was much less than it would ordinarily have been had the bees entered the wrong hive. During that month I had removed the division that I had originally made on the alighting board.

This method of wintering has obvious advantages. There will be greater warmth from two stocks than from one. In the hard weather I found them clustered close on each side of the division board, where, of course, they could feel each other's heat. There will be less consumption of stores. All the stores are overhead, as they should be, and the bees therefore need not move laterally, even if the stocks are large. If it be objected that the extra space overhead will make the brood chamber colder, I may say I think the stock over the wall will more than compensate for this. Moreover, there is little or no heat anywhere outside the cluster in winter. The bees will reach the top of the hive in early spring, when breeding is under way and they want the most heat, and we will probably have crowded them automatically on to as many combs as they can cover. If not, as they will be clustering close to the division board, it will be easy to remove an outer comb and contract the brood nest. Then again, according to Mr. Atkinson, of Fakenham, who winters two stocks in separate brood chambers in his attractive "Double-Six," the bees commence breeding earlier. Small colonies would be more safely wintered, three in a ten-frame brood chamber could easily be done. And last, but not least, only half the number of hives are exposed to winter weather, and there is more opportunity for painting and repairs.

I may add that for those who work on the principle of "doubling and uniting" this makes the management simplicity itself. But of this I may perhaps write later.—C. S. MORRIS.

### Barnstaple & District (Proposed) Bee-Keepers' Association.

All bee-keepers in North Devon should try to be present at the meeting to be held at the Y.M.C.A., High Street, Barnstaple, on Tuesday, 27th inst., at 3 o'clock, to pass rules and elect officers, etc.

### Blythe Bridge Local Bee-Keepers' Association.

A important meeting of bee-keepers was held on Monday, December 15, 1919, in the Forsbrook Church Schools, amongst whom were present: Messrs. W. Higgins, N. Tompkinson, F. Devereux, J. Keene, T. Bourne, W. Hampson, V. Bowden, V. Pickering, and Bertram T. Abell (District representative). Mr. W. Hampson was the chairman. Three schemes were brought forward for discussion, viz., "A scheme for instruction to beginners," "A re-stocking scheme," and a "Co-operation scheme."

The programme for the scheme for instruction to beginners was as follows:—

1st Year.—Approximately six beginners who are members of the local bee-keepers' association subscribe 10s. each. With the money a nucleus is purchased by the local committee in spring, 1920, and placed in a borrowed W.B.C. pattern hive in some central place (school garden). At stated times the six beginners and an instructor chosen by the committee meet at the hive, examine, and carry out necessary operations to build up into a stock, instructor to give impromptu lessons and lectures as occasion arises. If conditions are favourable the hive will be supered, and any honey obtained divided amongst the six beginners, after provision for winter feeding. The local secretary (Mr. Bertram T. Abell) to approach the Education Committee as to facilities during winter, 1920, for classes, or assistance in forming classes, for woodwork in connection with bee-keeping, i.e., making hives, nucleus boxes, frames, etc., and appliances, the local association providing material, the instructor, and lecturers, if necessary.

2nd Year.—During the spring and early summer, 1921, nuclei to be formed, as many as conditions permit, and to be drawn for as they are formed by the six novices, until each one has a nucleus.

The first year's work provides the beginner with a chance of thoroughly understanding the working of a hive, and a chance to recoup part of his subscription in the form of honey. Possibly the second part of the first year will provide a second hobby for the winter, and a chance to make a hive cheaply. The second and following years offer a chance to begin an apiary.

The class of beginners should be limited to six, and should more desire instruction, a separate class under a separate instructor should be formed. During the third year, either the six or the whole local association to purchase extractor and ripeners, and members (or the six, as the case may be) to draw for the dates on which they may use the same. Such appliances to be returned by users in as clean a condition as possible.

Suggestions:—

1. Members putting in most attendances at demonstrations to have the first nucleus.

2. The stock to become the property of the local association when last nucleus is given, and such stock or stocks to form apiary under control of local committee for purpose of:—

(a) Demonstrations and lectures.

(b) Funds for local association.

(c) Re-stocking or re-queening for members at a moderate charge.

(d) Not to provide instruction for later classes.

The next scheme, the re-stocking scheme, was brought forward. Owing to the losses brought about by the "Isle of Wight" disease, and also through lack of attention brought about by a large number of bee-keepers serving in the Army and Navy during the war, it was suggested that arrangements be made for a re-stocking scheme to assist those who desire to re-stock their apiary at a minimum cost with bees that are largely immune from disease. The objects of the scheme are:—

1. To supply subscribing members with bees as cheaply and as quickly as possible.

2. To maintain and to increase active interest in the bee-keeping world.

3. To give lectures and demonstrations in practical and theoretical bee-keeping.

4. To bring together bee-keepers with a view of forming a third scheme, known as a "Co-operation scheme," which will enable them to purchase their appliances at a reduced rate.

5. To attain these objects, it is suggested that an apiary be established in a central position and to be devoted entirely to the production of bees in the form of nuclei. These nuclei will each consist of four combs, with bees, brood, and stores, headed by a fertile queen.

6. Bee-keepers who are desirous of availing themselves of the benefits of this scheme are invited to apply for shares, value 10s. each, payable on application.

7. The capital raised by the issue of these shares will be devoted entirely to the establishment and working of the re-stocking apiary or apiaries. The distribution of the nuclei will commence as early as possible in the season (as soon as the young queens are safely mated and

laying), so as to enable recipients to build them up in time to take advantage of a possible late honey flow. Members putting in most attendances at demonstrations to have the first nuclei.

A co-operation scheme was discussed with a view to enabling the bee-keepers of the local association purchasing their appliances at a reduced rate by placing their orders with a firm of bee-keeping appliance manufacturers (in a quantity) at the beginning of the season, and do away with the agent's profits.

After these schemes had been thoroughly discussed, a large number of members decided to take up shares with a view of their participating in them.

The local expert, Mr. Abell, was asked to write for several quotations for Dutch bees and Italian queens, etc.

A vote of thanks to the chairman concluded the meeting.

This local association is worked under the auspices of the Staffordshire Bee-keepers' Association, and meets at least once a month to discuss various items that may arise.—*Communicated.*

### Cornwall Bee-Keepers' Association. ANNUAL MEETING.

The first annual meeting of Cornwall Bee-keepers' Association was held at Truro. In the absence of the President of the Association, Sir Arthur May, K.C.B., the meeting was presided over by Mr. Wilson L. Fox, of Carmino, Falmouth, who stated that the Association had made splendid progress, which reflected great credit on the officers responsible.

The Hon. Secretary (Mr. W. E. Bunny) reported that in Cornwall in recent years the bee-keeping industry had shown ominous signs of decay, on account of the ravages of disease, more particularly of the "Isle of Wight" disease. An opportunity to reconstruct the industry arose in February last at a conference of bee-keepers, when a Provisional Committee decided to form a County Association; to this Association the Cornwall Agricultural Executive Committee subsequently handed over the working of the Government restocking scheme. During the year 11 stocks of foreign bees had arrived and 34 nuclei had been distributed. It had not been possible to supply all nuclei ordered, on account of the necessity of replacing the first Italian queens forwarded by the Government. The thanks of the Council were due to Messrs. Williams and Best, the officers in charge of the restocking apiaries; at a very considerable expense of time and labour they had developed the scheme, and the Government expert, Mr.

W. Herrod-Hempsall, was well pleased with the success attained.

A register of Cornish bee-keepers had been compiled. In the face of the ravages of disease the formation was rendered difficult in several districts, some of the most influential bee-keepers having lost the whole of their stocks. It had now spread over nearly the whole of the county—in some areas not a honey bee having been seen for years. Stocks in wooden hives looked after by experienced men, and those kept in skeps on the "let alone" principle had all suffered alike. Happily, so far, all reports of hybrid nuclei sent out by the restocking apiaries stated that they had been free from disease, and were establishing their reputation of being far more nearly immune than the black bees. Numerous remedies and so-called "certain" cures had been tried, but although temporary relief had been noticed, there was no evidence of permanent cure. The Board of Agriculture was still investigating the cause, prevention and cure, and it was hoped that success would soon crown its efforts. Cornwall had done pioneer work in trying to stamp out the disease; bills had been posted throughout the county and advice given as to disinfecting dirty hives, and information asked for concerning careless bee-keepers.

The season had been a very bad one for the production of honey, there having been, during the white clover season, almost a total absence of rain, and consequently of nectar. Prices obtained for honey were naturally very high, but even then the demand had been much greater than the supply, so a 1920 market was practically certain. During the year no financial provision had been made by the County Council for instruction in bee-keeping, and no expert had been employed. The matter of employment of an expert for the coming season was under consideration. It was intended to issue honey labels for the use of members during 1920, also to institute a scheme of co-operative buying and use of Association appliances. The county had been divided into districts on the basis of the education areas, and local branches had been formed at Penzance, Helston, Camborne, Blackwater, Truro, Falmouth, St. Austell, Bodmin, Bude, Launceston and Saltash.

It was decided to support the demand for legislation providing for compulsory powers for dealing with diseases of bees, for which the British Bee-keepers' Association had been fighting for years.

Col. Sir Courtney Vyvyan, C.B., consented to become president for 1920; Mr. A. F. Knight was elected hon. secretary of the restocking scheme, and Mr. W. E. Bunny was re-elected hon. secretary of the Association.

### Monmouthshire Bee-Keepers' Association.

The annual general meeting of the above will be held in the Town Hall, Newport, at 2.15 on Saturday, February 7. At 4.30 a lecture will be given by Mr. W. Herrod-Hempsall. At 6.30 the first annual dinner will be held at the King's Head Hotel, Newport, tickets 10s. 6d. each—morning dress. Light tea will be provided by a ladies' committee between the meeting and the lecture, during which interval an organ recital will be given. All bee-keepers and any others interested are invited to the meeting. The lecture will be a public one—admission one shilling. All bee-keepers and their friends can attend the dinner. The subject of the lecture will be announced shortly.

A resolution urging the Government to introduce legislation to protect the bee-keeping industry was passed unanimously at the general meeting held on February 8, 1919. A similar resolution was passed at a recent committee meeting, and will again be proposed at the general meeting on February 7 next.

### Tring.

On December 9, at the Victoria Hall, Tring, under the auspices of the Herts County Council (in conjunction with the Herts County Bee-keepers' Association), a lecture on bee-keeping was given by W. Herrod-Hempsall, Esq. Capt. G. M. Brown presided.

After the lecture Mr. P. E. Wagstaff, Secretary of the County Association, addressed the meeting on the question of forming a local Branch.

Mr. J. Clark, of Park Hill, was elected president and Mr. F. Bull was appointed secretary, and a committee was formed. Will local bee-keepers wishing to become members please communicate with Mr. F. Bull, Beaconsfield Road, Tring, as soon as possible?

### Northumberland Bee-Keepers' Association.

#### ANNUAL MEETING AT MORPETH.

The Northumberland Bee-keepers' Association held their annual meeting at Morpeth on Saturday, January 3, Mr. G. G. Baker Cresswell presiding. It was reported that the condition of the Association had decidedly improved, thanks to the revived interest taken in the craft. The Government re-stocking scheme, in spite of difficulties, had been a success.

During the season many good "takes" had been reported, the only bad report coming from the Chathill district. The most hopeful sign of future prosperity

was the diminution of disease. "Isle of Wight" disease seemed to be less virulent than formerly, and no reports of wholesale devastation of individual apiaries, let alone districts, had been received.

It was decided to engage an expert to take charge of the re-stocking scheme. The Duke of Northumberland was elected president; Major F. Sitwell, secretary; Mr. W. Smart, treasurer; and Mr. G. G. Baker Cresswell, chairman; and the committee as follows:—Mr. R. W. Davison, Rev. J. G. Shotton, Mr. N. Beveridge, Mr. W. Colville, Mr. R. Robson (Wooler), Mr. R. Robson (Riding Mill), Mr. J. Scott, Mr. W. Smart, Mr. T. Bruce, Mr. E. B. Atkinson, Mr. R. Matheson, Ald. J. Wilkinson, Mrs. Davison, Mr. L. Rutherford, and Rev. M. M. Piddocke.—*Communicated.*



*The Editors do not hold themselves responsible for the opinions expressed by correspondents. No notice will be taken of anonymous communications, and correspondents are requested to write on one side of the paper only and give their real names and addresses, not necessarily for publication, but as a guarantee of good faith. Illustrations should be drawn on separate pieces of paper. We do not undertake to return rejected communications.*

### "Isle of Wight" Disease. Where are We?

[10093] I really do not know where we bee-keepers stand. I should very much like to have some enlightenment on the subject. We really do not know definitely what "Isle of Wight" disease is caused by.

Mr. Cowan, in his Guide-book, quotes authorities who attribute it to *Nosema apis*. Scotch authorities (vide B.B.J., October 9 of last year) say it is *not* caused by *Nosema apis*.

Furthermore, Dr. Rennie and others declare "the infection is *not* carried by honey, frames, hives, or dead bees, but apparently only by direct contact with diseased or dying bees"; in fact, it is more "contagious" than "infectious." In the extracts given in B.B.J. for October 23 of last year, from the "Review of Applied Entomology," it is stated that *Nosema* disease "is not particularly malignant in character." (From what I have heard, and from the little experience I have had of it, I believe "Isle of Wight" disease can be very malignant.)

This authority states that transmission of the (*Nosema*) disease "need not be feared through the medium of flowers, or hives, or hands and clothing of the apiarist, or tools used in apiary." I am inclined to agree with this.

There seems to be agreement as to the means of infection between this American authority and the authorities quoted by Mr. Cowan, viz.: a sluggish or stagnant body of water near the hives, and the robbing of diseased colonies. With all these diverse opinions it is difficult for a mere layman to know precisely where he stands. Is it not possible that the malignant form of dysentery which we know as "Isle of Wight" disease is caused by *Nosema apis*, and *Mucor Melittophthorus* acting together in the organs of the bee, and the milder sorts by one or the other of these micro-organisms alone? Does not the fact that bees from the Continent (where *mal de mai* or "Maikrankheit," has had to be fought for generations) show a marked degree of resistance to "Isle of Wight" disease, indicate that the above-mentioned diseases and malignant dysentery have something in common, if not a common origin?

There is evidently plenty of opportunity for investigation, and intelligent bee-keepers would do well to make particular notes of any observations they are able to make during the coming season with a view to further elucidate the mystery.—D. J. HEMMING, Runcorn.

### Letter from a "Demobbed" Soldier.

[10094] A few weeks ago our worthy friend Mr. Kettle asked the question, "Why don't the demobilised bee-keepers write their experiences?"

I feel, like Mr. Clewlow, that I am no great scribe, and feel my experiences would be of little value to others. My military duties called me farther afield than France, for I went to Salonica. There one doesn't see any bee-keepers, so conclude the bees were wild. The colour varied in different hues of grey, brown and black, and the bees were much smaller than those found at home. On my journey home in February, 1918 (having been invalided home), the ship, after having been caught in a severe storm, and getting a bad battering, called at Suda Bay, Isle of Crete, for repairs. While here I had a bee alight on my hand, and, being interested, I had a good look at it, and decided it was an Italian. I suppose in that country they would work the orange groves.

While away in the army my bees, unfortunately, went under, but was able to

re-start again last year. Mr. W. Ion kindly presented me with a stock, and I was able to buy a 3-frame nucleus, and have now managed to build up to eight stocks.

It is a practice of mine to give a clean hive to each stock in the spring, as I believe cleanliness goes a long way to combat disease. To solve the problem of preventing hive roofs from being blown off, I use a gate hook and eye attached to the side and roof of the hives, and find this a lot less trouble than bricks and ropes. In concluding, I wish you, Messrs. Editors, and all the staff, and all fellow-bee-keepers a very happy and prosperous New Year.—P. J. NORTH.

### How I Commenced Bee-Keeping.

[10095] The year 1886 was a year of events to me, as it was in that year I took unto myself a wife, and the first year that I commenced to keep bees, my first swarm being one of my wedding presents. It was in a straw skep, and how to get them from that into a frame hive was, to me, a bit of a puzzle. However, coming across another would-be bee-man, who had read a book about the industry, he brought me a single frame and told me the dimensions a frame hive should be. So I set about it and made a double-walled hive, which I possess at this date, after so many years. I can tell you, Sirs, there was plenty of timber put into the construction of this very particular hive. In 1886 I obtained one swarm from the skep, but did not retain it, being away on duty the whole day when the swarm issued, and no one at home but my young wife, who knew next to nothing about bees. My wife asked a neighbour if he would take the swarm, which he tried to do, but was not successful; but I give him credit for doing his best. After shaking the swarm into a skep, the bees went back and clustered again in the same position. The neighbour said, "Have you any wood ashes, Mrs. D—?" She said, "Yes," and fetched about two gallons of ashes in a pail, which the neighbour dashed right in amongst the swarm, with the remark, "That will shift them"; and, true enough, it did, as the swarm decamped and flew a mile away from home, settling in a bedroom chimney, where they were for several years, as I was not up to the bee-keeping enough to know how to get them out. I guess they would not be allowed to stay there long now before I gave them notice to quit. This was in 1886, where I will leave it for the present, and at another time, with your permission, Messrs. Editors, go on into 1887, the first Jubilee of Queen Victoria's reign.—BEECROFT, Chichester.

### Re Notes on Bee Dysentery.

[10096] Noting the above article in January 1 issue, I found a way to prevent this dysentery being found in the spring after wintering, I put it down to too many quilts, also the wrong material and results in sweating.

I condemn American cloth to begin with.

If one places a wired honey board over the combs, with a feed hole that has a movable top, place two large calico quilts cut with flaps over the whole nest, well tucked round the brood box, another of unbleached calico, and then fine sort of sacking. Then place four flat sticks (tops of old clean frames), two each end, two at sides, and lay a cork folding quilt on this, filling up the feed hole of the quilt with a cork bung and a bit of sacking over this well tucked in. The entrance 8 in. wide, with a "Silver" non-dwinder 8 in. wide at the top. If one has a drawer under brood nest so much the better. By this way the bees get warm air, which passes eventually through the quilts; any moisture is taken up by cork quilt. Sealing bees down I found is fatal. If the space is left for queen to get over the combs, and not confine her to one comb, you will find a nice patch of brood, and lively bees in March.—C. TRECROFT.

### Bee Legislation.

[10097] I notice that the assertion is continually being made that it is the large bee-keepers who are opposed to legislation. I am the possessor of several large apiaries, but, contrary to the above statement, no one would welcome legislation more than myself. As a practical bee-keeper, and also one who has at various times had experience of Government control, I cannot understand the attitude of those who oppose protection for the very weak reasons given, *i.e.*, meddling inspectors, and that the British Bee-keepers' Association will have control of the administration of any Act which may be obtained.

My experience of Government officials is that, as public servants, they are invariably considerate and tactful, while those especially of the Board of Agriculture, are ever ready to render assistance in any form required.

If friction does arise, then as a rule it is not the fault of the officer, who for any deviation from his duty may lose his position, but is usually caused by the unreasonableness of the civilian. With regard to the latter. Can a single case be adduced where the Government have delegated their power and functions to an

outside body? With all their alleged faults, surely we must give Government officials the credit for having a certain amount of common sense. Neither do I take it that if inspectors were appointed would they have unlimited powers. I think it will be found that their operations are limited to very definite instructions, issued by the head of their particular department.

The opposition, which apparently is limited to a very few, should come out into the open and state their views, also give their reasons for objecting to the industry being protected, and state clearly how they would remedy what they consider the faults.

Bee-keeping has a very different standing now than when the last Bill was introduced in 1913. It is admitted by one Association, the Kent (which is the largest in England), without a single dissident, that the only remedy for the disastrous state of bee-keeping is the passing of a bill to deal with bee diseases, as is the case with every other country in the world (even Ireland).

We now have at the Board of Agriculture and Fisheries men with the very highest standard of efficiency in apiculture, and who have no selfish motive, or interest, other than the well-being of our country, and noble craft.

Cannot we then delegate to them the work of drafting a Bill, or such an Order as they may think expedient, to prevent the spreading of bee diseases in England and Wales? Something must be done if we in Kent survive much longer. Although progressive, we find some that require licking into shape, and compelling to be made less selfish and more careful. To conclude, I state two cases which came to my knowledge this autumn. The first was a lady with two stocks. She wished to dispose of them, so sent for the expert to go and arrange price, etc. On examining the stocks he found them full of foul brood, and at once informed the owner, who promised to destroy them. Instead of this, and within fourteen days, she sold them to a young beginner.

The second instance is of a gentleman living in a country residence and with a practical knowledge of bee-keeping, whose bees had not given him any surplus during the season 1919. My assistance was requested, and an examination of the two stocks was carried out, when I found one of them with six combs full of foul brood. I advised him what he ought to do, and which he promised would be carried out. But the opportunity arose for him to sell them, which he did to another gentleman within one month. He then politely informed me that he had done so, and that



he had got enough for them to purchase two Italian nuclei from me next year, 1920. Also would I supply him with them as early as possible in May, so that he could get some honey before the end of the season?

Our association would like to have a good practical bee-keeper and expert for the county, also an inspector with these qualifications, who would get about the county, and teach those who stand in need of knowledge respecting diseases, etc. Those who did not require his service would, I am sure, never hesitate to allow him to examine bees at a proper time. We must rid our county and country of the neglectful, unscrupulous, and selfish bee-keeper, by having what the majority demand, i.e., Legislation.—G. BRYDEN.

[10098] By all means let us have legislation. Surely it is possible to frame an Act that would be protective and helpful to bee-keepers, professional and amateur!

Let bee diseases be compulsorily notifiable the same as for cattle, etc., with a heavy fine in case of failure to comply with the Act.

I see no reason why a Government official should have power to inspect bees unless disease has been reported or is suspected.

I should like to offer a suggestion to Mr. Hemming, with reference to black roof covering mentioned in his "Jottings from Huntingdonshire," B.B.J., December 18.

If he will first paint the roofing felt with the preparation painters call "knotting" (shellac dissolved in methylated spirit), he can then paint the felt white or any colour. I have tried this, and find it quite successful. Roofs treated in this manner have withstood scorching sun and winter weather without showing the least sign of discolouration from the gas-tar in the felt.—W. H. COLLIN.

[10099] My time has been so fully occupied during the past few weeks that I have been unable to reply to a remark of Mr. A. J. Coates-Cook in his article (No. 10059) which appeared in the JOURNAL of December 11, 1919; but, I fear, he has failed to grasp the main object for which, I take it, county associations exist. It is *not* to increase the number of bee-keepers—or, shall I say, keepers of bees—or to find business for appliance makers, but, by means of lectures given by those qualified to speak, and by gatherings of bee-keepers at well-run apiaries, to promote the study and development of apiculture.

With the object of increasing the use-

fulness of the Association and widening its sphere, the local centres to which Mr. Coates-Cook refers, are being inaugurated, and it would surely be more consistent with his views on the necessity of legislation if he gave us the pleasure of welcoming him as a member and aided the cause by his valuable knowledge and co-operation rather than by appearing to throw cold water on the efforts of those who are doing what they can to foster the craft. I shall be very pleased if Mr. Coates-Cook will write to me as Hon. Secretary of the Gloucestershire Beekeepers' Association. I would have written to him, but do not know his address.—EDWARD J. BARTLETT, Quedgeley Rectory, Gloucester. (First Class Expert, B.B.K.A.).

### Remedy for Ants.

[10100] Messrs. Cairncross and Zillen (10076) might find one of the following specifics useful in warding off the attacks of the black ants from the hives. The borax I have found particularly good in preventing ants attacking ripe fruit, both out of doors and under glass, one application being usually sufficient:—

(1) Sprinkle powdered borax freely about their nests, which, after being watered in, or after the first rain, will cause the ants to decamp to pastures new.

(2) Paraffin oil, mixed with six times its bulk of water, sprinkled over their nests every few days will both kill and drive ants away.

(3) Carbolic acid, of a good strength, diluted with ten or twelve times its bulk of water, and well sprinkled about places free from vegetation, will also prove effective.

Trusting the above may be of some use.—J. NEIGHBOUR.

[10101] In reply to Messrs. Cairncross and Zillen's inquiry *re* "Wanted, Remedy for Ants" (10076), I have found that a band of cloth or flannel, three or four inches wide, soaked in kerosene and tied or sewn round each leg of the hive will prevent any ants from getting in.

L. P.

[10102] In reply to 10076, I would state that in the tea gardens in India, where they are troubled with ants, the legs of tables, meat safes, etc., are all studded in tin dishes or saucers about 4 to 5 in. diameter. These saucers being kept filled with either water with some permanganate of potash, or kerosene, the ants cannot cross either. If this cannot be carried out, some of Messrs. McDougall's "Ostico," painted round each leg will arrest every ant attempting to climb. This is what I use on grease bands for

apple trees, and the stickiness lasts for five or six months. The collection of moths, flies, etc., that are caught is wonderful. It is stocked by most seedsmen, but the address of Messrs. McDougall is 66-68, Port Street, Manchester.

Trusting one of these remedies may be suitable.—F. J. CRIBB.

[10103] I should suggest that Messrs. Cairncross and Zillen (10076) make a mixture of tar, pitch, and lard, in proportions to be ascertained by experiment, to suit their climate.

Such a mixture would never dry, and each successive coat on the hive legs would render it more sticky; in fact, the legs could be placed on boards and the whole surface coated.

I used this preparation years ago with my own hives, and the legs eventually lost their square edges and became round "blobs."

Although nearly dry in winter the warmth later soon softened the surface, and on hot days it would "run."—G. J. CLARKE.

[10104] When I first kept bees, one hive was threatened with extinction by these pests, but I cured complaint as follows:—In place of wooden legs to hives I had 6 in. bolts with square heads (making level with spanner a very easy job). Round the pillar of bolt I bound soft rag and kept this soaked with kerosine. In our climate this does not evaporate quickly, and is quite effective. But in Pretoria??

At the meeting when Dr. Abushady showed us the metal foundation, he also raised the question as to whether bees drew out the wax for cell making, or made their own. Has he tried the experiment of weighing a sheet before and after cells are made? (of course, before any honey has been deposited). I presume it could be done. I hope "Bee Legislation," as you promote, will come into force.—T. KNIGHT.

[10105] *Re* No. 10076, South Africa, and visions of ants as large as grasshoppers. Whoever would have thought of our little nigger going round there and giving so much trouble? If the nests are difficult to locate, spread jam, or other sweet substance, on paper or cardboard, and place upside down between, and behind for preference, each two hives. When ants find anything of this kind, they soon make a to and fro straight line to it from their nest, as they have under my own front door, when I have had supers of honey indoors. Mark the nests in the daytime, rise two hours before daylight, and have a good supply of

boiling water by dawn, in the chill of which hour most orderly colonists, such as ants, should be indoors. Apply *boiling* water liberally; water that is only hot is of little use. By having it at boiling point the ants are dead almost before they feel anything. It may be necessary to make a channel round the nest if the ground is very hard, or if the ground is fissured by drought it may be necessary to water several times to close the fissures before dealing with the nest. And each nest should be dealt with thoroughly.

The legs of hives may be made of creosoted wood, as are railway sleepers; the legs of hives may then stand in vessels of water permanently. Under the South African sun I think the vessels will need to be of half-gallon capacity, seven or eight inches wide, and there may be a tablespoonful of paraffin oil on the water. If the ants' nests are on open property and inaccessible, use jars one-third filled with something sweet, with a string attached, and when well filled with ants drop into boiling water.

I think the reddy-brown ant is on the whole the more troublesome in this country. It often causes a good deal of irritation, too, by biting. This one is particularly troublesome in some parts of Sussex, where I have known it to carry pellets of earth and other material up the outside of hives, through the ventilators, and make quite large nests above the quilts, sometimes on a rack of completed sections. A particularly vicious-looking ant of great size, and in colour half red and half black, is found in great numbers in the wooded and hilly light lands of East Essex, between Danbury and Maldon. This ant collects quite a large heap of little pieces of wood for use as a nest. But when I was a boy there, no bees were kept near these ants.

W. LOVEDAY.

Chiltern View Road, Uxbridge.

[10106] *Re* 10076 *Remedy for Ants*, I was troubled with this pest; I had the iron shoes for paraffin, which were filled frequently, as evaporation was quick. This was put in by a glass squirt. I found the ants' nest in a border of roses close by, and dug "vaporite" into it, and have not been troubled since. Every ant hill I found I put "vaporite" in; it kills all grubs, too, in the most wonderful way.—CYRIL TREDCROFT.

[10107] Last November I sent a small stock of Italian bees to Madeira. A Kent standard hive was also despatched. In a letter just received I find a sketch of the hive, with legs removed, standing on a very short and stout post like a tree trunk. Halfway up, and completely encircling the post, is tied a band of grease-

proof paper, and on this is a layer of some sticky substance, such as Sticktite. The arrangement is made to keep out ants, which would otherwise infest the hives.

The idea is new to me, and may be to others, so I pass it on to your readers. It might be advisable, if trying this plan, to enlarge the alighting board, otherwise many a returning forager, dropping on the ground and then trying to crawl home, would test the quality of the Sticktite.

JOHN W. PRICE.

**Utilising Partly-Built Sections.**

[10108] It is inevitable every autumn that sections are taken from the hives untouched, or almost untouched, by the bees. When trying to use them again the following summer they are so brittle that they always break while trying to fix the foundation. Can you or any of your readers show how these old sections, after being used once, can be made serviceable again? As their value is so much higher than it used to be, it would be a great advantage to bee-keepers if old sections could have foundations fixed in them for use a second time.—A. T. F.

[Damp the corners before unfolding.—Ebs.]



Correspondents desiring an answer in the next issue should send questions to reach this office NOT LATER than the FIRST POST on MONDAY MORNING. Only SPECIALLY URGENT questions will be replied to by post if a STAMPED addressed envelope is enclosed. All questions must be accompanied by the sender's name and address, not necessarily for publication, but as a guarantee of good faith. There is no fee for answering questions.

H. F. KEEP (Birmingham).—Feeding bees with sections.—Providing they are from healthy bees, you cannot use anything better. Put the section over the feed hole as it is.

A. W. SMITH (Edinburgh).—(1) Sorry, we can't. (2) Carniolans are gentle, very prolific, fairly good workers, and use little propolis, but are excessive swarmers. You would find pure Italians equally good. (3) Yes. There is no other book on the same lines.

"RHUN" (Wales).—We are unable to say cause of queen's death.

*Honey Samples.*

"NOVICE" (Maidstone).—No. 1 mainly fruit; appears to have been slightly over-heated. No. 2, clover and lime. No. 3, from mixed sources.

*Suspected Disease.*

H. F. (Dunstable).—"ULSTER READER" (Ireland), J. J. B. Young (Sheffield), MRS. GOTT (N. Wales).—The bees were affected with "I.O.W." disease.

CAPT. ELSTOB (Mon.).—The bees appear to be suffering from dysentery.

M. BAKER (Runcorn).—We do not find disease in the bees sent.

"ENQUIRER" (Caterham).—The bees died from "I.O.W." disease. We do not think it advisable to feed other bees on the stores they have left.

**Special Prepaid Advertisements.  
One Penny per Word.**

**PRIVATE ADVERTISEMENTS.**

**FOR SALE**, 1 cwt. guaranteed pure Light English Honey; price £10 10s.; sample 6d.—LAW, Cuckoo, Ashwell, Herts. a.17

**STRAW SKEPS**, new, made specially for extra large swarms, holds 6 to 7 galls., flat top, with feed hole, very thick, and strongly bound with cane; approval; deposit system; carriage paid 12s. 6d. each.—BROWN, 67, Spencers Road, Crawley, Sussex. a.18

**W.B.C. HIVE**, new; one Bristol Hive, good condition.—BRETTELL, Pedmore, Stourbridge, Worcestershire. r.a.19

**WANTED**, Single Conqueror Hive in good order.—Stoneyhurst, Broadbridge Heath, Horsham. a.21

**EXPERT**, wide practical experience all branches Apiculture, and Utility Poultry, open engagement shortly; hive maker.—Box 58, B.B.J. Office, 25, Bedford Street, W.C.2. a.20

**PURE** light Cambridgeshire Honey, 14-lb. tins, 22s. 6d.; 28-lb. tins, 42s.; tins free; sample 4d.—J. YOUNGER, 6, Maid's Causeway, Cambridge. r.a.5

**HONEY**, clover blend, highly commended Grocers' Exhibition; 28-lb. tins, free, 49s.—THOMAS, Causeway, Burwell, Cambs. a.6

**7 CWTs. LIGHT CAMBRIDGESHIRE HONEY**, £8 10s. cwt., on rail, 28-lb. tins; tins free; sample 6d.—GEORGE BARNES, Burwell, Cambs. a.1

**THE GRAMOPHONE RECORD EXCHANGE** will exchange Records 5s. dozen; return postage free.—Address, 6, Rood Lane, London. Particulars stamp. x.23

**WANTED**, new Cycle Chain, 1 in. pitch by 1/2 and 5 ft. 6 in. long, twin roller, or block.—Price to A. J., B.B.J. Office, 25, Bedford Street, Strand, W.C.2. x.32a

**WANTED**, portable Greenhouse.—Price and particulars to W. HERROD-HEMPSALL, Old Bedford Road, Luton, Beds.

**WANTED**, Austro Rear Wind Screen for motor car.—HERROD-HEMPSALL, as above.

**FOR SALE**, one Exhaust Whistle, 11s., post free; one Wood Milne Motor Foot Pump, 45s., carriage free; one 760 x 90 Cover, 15s., carriage free; one small Motor Horn, 6s., post free.—HERROD-HEMPSALL, as above.

**CORRESPONDENCE** Course in Bee-keeping.—MISS F. E. PALING, Golden Square, Henfield, Sussex. rw.51

**WILL** all those bee-keepers possessing 25 stocks of bees and upwards kindly send particulars to SECRETARY, B.B.K.A., 25, Bedford Street, Strand, London, W.C.2. v.42

**BUSINESS ADVERTISEMENTS.  
1 1/2d. per word.**

**STRONG** Stocks of Bees, guaranteed, on 7 frames with pure selected Italian Queens, 1920; orders booked in rotation for delivery from end of May; price £5, carriage paid; travelling box 10s. extra, which is returnable. Cash with order.—MISS F. E. PALING, Golden Square, Henfield, Sussex. a.23

**PURE** Light English Honey, granulated, 28-lb. tins, 69 cwt.; tins and case free; sample 6d.—WELLS, Bowers Lane, Isleham, Cambs. a.26

**WE** are reserving a few choice Italian Queens for the D.B.s for delivery in May June, July and August. Prices and particulars on application.—S. H. SMITH, 30, Maid's Causeway, Cambridge. a.27

**THE BEST IS CHEAPEST IN THE END.**—Buy our guaranteed Bees and Queens, and get good value for your money. Catalogue 3d., which is returned on first order.—PEARSON & GALE, Marlborough. a.24

**ITALIAN QUEENS** and 3-frame Nuclei.—Insure against disappointment by getting your Queens and Bees from a place where "I.O.W." has never existed. Orders now booked for June and July delivery.—S. CRAWFORD, Apiaries, Castlederg, Co. Tyrone. a.23

**HIVE MAKERS** Wanted.—Apply, letters only, stating age, experience, wages expected, to LEE, Beehive Works, Uxbridge, Middlesex. a.13

**QUANTITY** amber-coloured Granulated Honey in 1-lb. glass jars at 21s. dozen, 1/2-lbs. at 11s. 6d. dozen; also in tins, 7 lbs., 11s.; 14 lbs., 20s. 6d.; and 28 lbs., 37s. 6d.; carriage paid.—Apply, MEADOW BROS., Shirley Road, Shirley, Surrey. r.a.10

**HAVE YOU READ "THE BEE WORLD"?** If not, why not? Every number in itself is a useful literary work for practice and reference. Specimen copy free.—Offices: THE APIS CLUB, Port Hill House, Benson, Oxon.

**ITALIAN QUEENS** direct from Italy. Price list for 1920 on application.—Address, E. PENNA, Bologna, Italy. w.39

## The Metal Foundation.

(Protected.)

For the benefit of readers of the JOURNAL and the RECORD we have arranged with the manufacturers of the Metal Foundation to accept all orders received through our offices at a consideration in the shape of a 25 per cent. deposit to begin with, and the balance by mid-March, or prior to delivery, if earlier. All orders are guaranteed by them to be executed *not later* than April, 1920.

Prices:—(1) **BRITISH STANDARD FRAME**, fully fitted with "worker" Metal Foundation: Single, 2s. 4d.; per two dozens, 2s. 3d. each frame; per four dozens and over, 2s. 2d. each frame.  
(2) **STANDARD SHEET** of "worker" Metal Foundation: Single, 2s.; per two dozens, 1s. 11d. each sheet; per four dozens, 1s. 10d. each sheet.

Subject to a 5 per cent. discount to members of the Apis Club.

*Packing & Carriage Extra.*

\*\* Since the Metal Foundation will be produced only to order, no order will be subject to cancelling.

## THE British Bee-Keepers' Association.

The recognised centre of practical and scientific bee-keeping in Great Britain. Particulars and conditions of membership may be obtained from the Secretary, W. HERROD-HEMPSALL, 23, Bedford Street, Strand, London, W.C.2.

## Books for Bee-keepers NOW IN STOCK.

		Postage
A Modern Bee Farm ... ..	7/6	... 6d.
Bee-keeping (Dr. E. F. PHILLIPS)	10/6	... 6d.
<b>BEE-KEEPING SIMPLIFIED FOR THE COTTAGER AND SMALLHOLDER</b> (W. HERROD-HEMPSALL, F.E.S.) ... ..	1/-	... 1½d.
<b>BEE-KEEPERS' PRACTICAL NOTE BOOK</b> (T. W. COWAN)	1/-	... 1½d.
<b>BRITISH BEE - KEEPERS' GUIDE BOOK</b> (T. W. COWAN) (paper covers only)	2/6	... 3d.
Dissectible Model of Queen Bee ... ..	4/6	... 3d.
<b>FERTILISATION OF FRUIT BLOSSOMS BY BEES</b> (T. W. COWAN) ... ..	-/3	... 1d.
Honey and Health (A. HOPE) ...	-/6	... 1d.
Honey Vinegar (REV. G. BANCKS)	-/2	... 1d.
How to Keep Bees (ANNA B. COMSTOCK) ... ..	5/-	... 6d.
<b>PRODUCING, PREPARING, EXHIBITING AND JUDGING BEE PRODUCE</b> (W. HERROD-HEMPSALL, F.E.S.) ...	2/-	... 3d.
Queen Rearing in England (F. W. L. SLADEN) ... ..	1/6	... 2d.
Snelgrove's Method of Re-Queening ... ..	-/6	... 1d.
The "Townsend" Bee Book ...	2/6	... 2d.
<b>WAX CRAFT</b> (T. W. COWAN) ...	2/-	... 2½d.
Wilke's Book on Swarming ...	1/-	... 1½d.
<b>MISCELLANEOUS.</b>		
Maeterlinck's Life of the Bee	3/6	... 3d.
The Lore of the Honey Bee (TICKNER EDWARDES) ... ..	2/-	... 2d.
The Humble Bee (F. W. L. SLADEN) ... ..	12/6	... 6d.

### British Bee Journal & Record Office,

23, BEDFORD STREET, STRAND, LONDON, W.C.2.

#### FINEST SECTIONS OF HONEY.

A large quantity for Sale at carriage paid prices, either Plain or Glazed

#### IRISH RUN HONEY.

Several cwts. for Sale in quantities to suit customers, at carriage paid prices in free tins and cases.

#### GORDON ROWE,

Honey and Beeswax Packer,  
28a, Moy Road, Cardiff.

#### BEE FLOWER SEEDS.

Collection of six best Varieties, 1s., post free. Beautifully Illustrated Instructions Up-to-date. Garden Guide, 64 pages, Free.

KNIGHT'S,  
SEED SPECIALISTS,  
WOLVERHAMPTON

The products of the Apiary, of Poultry and Farm Stock, of the Fruit and Vegetable Garden can be Advertised and Sold through

## THE BAZAAR, EXCHANGE & MART Newspaper.

Get a Copy—Thursday and Saturday 3d. The "Bazaar" publishes also practical handbooks by experts. Send for full catalogue, post free from—WINDSOR HOUSE, Breams Buildings, LONDON, E.C.2.

The certain cure for and Preventative of "Isle of Wight" disease.

## 'BACTEROL'

Proved by Bee-keepers generally after testing on the most hopeless stocks.

Manufactured by "Bacterol" Limited, London, N.

MENLEY & JAMES, LTD., MENLEY HOUSE, "ARRINGTON ROAD, LONDON, E.C.

**Don't Order "W.S." Queens until you have seen the "Queenland" Revised List for 1920. 3½d. post free**

**NUCLEUS STOCKS—Same Price as 1919.**

The only Pedigree Bee-Stock Registered in direct line for more than 25 years.

**"AMALGA" is the name of our Queen breeding mother for 1920**

**"ALTA" is the name of our Drone parent for 1920.**

PRODUCE OF ONE NUCLEUS REALISES OVER £40 IN CASH.  
 "The three-frame nucleus I purchased from you had increased last autumn to two strong stocks. I supered one on April 23rd of this year, and the other a few days later. I sold two swarms, and made up the others to five stocks. Of these I also sold three stocks. The original lot gave 198 lbs. of honey, and in all I have taken 365 lbs. My sales amounted to over £41 in actual cash."  
 (Miss) H. G. MOYSEY.  
 Somerset, Oct. 9th, 1918.

EXCEEDS 500 PER CENT. INTEREST.  
 "We have now 12 stocks to winter, besides selling one, out of the two three-frame nuclei supplied June 20th last year."  
 (August 15th, 1917). Miss B. D.  
 Quainton, Bucks.

THREE TO SEVENTEEN.  
 "It may interest you to know that the three stocks to which I introduced your queens (the only stocks saved in the apiary) in 1916, produced in all 17 stocks, and a good surplus in honey in 1917; this under the care of my wife who knew nothing about bees. I simply directed her as to management from there (France)."  
 OLIVER G. PIKE.  
 April 9th, 1918.

FIRST AND BEST.  
 "Your White Star strain was the first to enter the sections, and all the honey I got was from them."  
 G. H. S.  
 Heddon House Dairy.

APRIL 19TH.—BOILING OVER.  
 "The hive is simply boiling over with W. S. bees. They are at work when my other stocks are idling, and they are stronger than any of my other stocks."  
 Aberdare, Wales. E. T. W.

ARE THE W.S. PROLIFIC?  
 "In 1904 I got a W.S. queen from you, and last year (1905) by the first week in June she had brood in *twenty-five* standard frames."  
 J. H.  
 Higher Kinnerton, Chester.

**SAFE DELIVERY of Nuclei and Queens GUARANTEED**

NUCLEUS DELIVERED IN JUNE; 40 FRAMES BY AUGUST.  
 "The three-frame nucleus of bees now occupy 40 Standard Frames. They have exceeded beyond anything I believed possible. I have never had anything like them before, and if the other queens on order turn out the same I consider my fortune made."  
 JOHN JONES.  
 Llancarfan, Aug. 21st, 1918.

SEVERAL STOCKS FROM ONE NUCLEUS.  
 "It seems almost ridiculous that this nucleus of the previous season (Aug.), before I was prepared for it, swarmed in April, and I now have several stocks from that investment."  
 J. W. MCKAY.  
 Croydon.

EIGHT STOCKS FROM ONE W.S. NUCLEUS.  
 "I now have eight stocks from the one nucleus you supplied last year."  
 J. JONES.  
 Llancarfan, May, 1919.

BEST IN THE COUNTY—NEVER SAW THE LIKE!  
 "May 26th.—The two queens you sent me have exceeded anything that I ever thought of. The stock chambers are full and crammed with brood, and all three supers crowded with bees; but even with this the bees are boiling over. I have not fed them at all, and have removed several frames of brood for another lot. The County Expert called yesterday, and said he had never seen such bees, and they were certainly the best in Hampshire."  
 D. D. P.

NO SPRING-FEEDING, BUT AGAIN FIRST.  
 "The W.S. bees on eleven 16 x 10 frames were full and boiling over at the middle of May, and were the first to enter supers out of 23 stocks; and last, but not least, they required no spring feeding."  
 U. W.  
 Arnold, Notts.

Revised 1920 "White Star" List, 3½d., of S. SIMMINS, Queenland, Heathfield, Sussex.

## QUALITY.

The difference between a good bargain and a bad bargain is not so much a matter of money as of quality.

All our goods have the "Hallmark of Quality" resulting in a large clientele of SATISFIED customers. Does this mean anything to you? If so, send for our large Illustrated Catalogue for 1920, free on application.

**R. STEELE & BRODIE,**  
Bee Appliance Works, WORMIT, FIFE, SCOTLAND.

## The 'Kent' Standard Model Hives & Appliances

### TESTIMONIAL.

May 12.

DEAR SIR,—I have had an opportunity of comparing the material and workmanship of your hives with others on the market, and in my opinion there is no sort of comparison between the two, yours being altogether superior in every particular.—Yours faithfully,—

*S. J. BALDWIN, Stanley Road, Bromley, Kent.*

# BURTT, Gloucester, FOR BEE APPLIANCES.

*New Illustrated Catalogue Free on application.*

- - THE - -

# BRITISH BEE JOURNAL.

ESTABLISHED 1873.

## THE NEW VOLUME COMMENCED JANUARY 1st.

THE BRITISH BEE JOURNAL is supplied direct from the Office every week, post free for One Year, 10s. 10d.; Half Year, 5s. 5d.; Three Months, 2s. 9d. (payable in advance). Posted on Wednesday evening in time for delivery on Thursday.

Money Orders and Cheques should be made payable to W. Herrod-Hempsall and crossed "London County and Westminster Bank."

### SUBSCRIPTION FORM.

(To be filled up by intending Subscribers, cut out, and returned to the Office.)

Please send me "THE BRITISH BEE JOURNAL" for \_\_\_\_\_

Commencing \_\_\_\_\_ 192\_\_\_\_, for which I enclose

\*Name \_\_\_\_\_

Address \_\_\_\_\_

Date \_\_\_\_\_

\*Please state whether Mr., Mrs., or Miss, etc.

*It will considerably facilitate our publishing arrangements if subscriptions are dated from the beginning of each year; the proprietor will therefore be obliged if subscribers will fill up and return the above form as early as possible.*

### COVERS FOR BINDING

"BRITISH BEE JOURNAL" or "BEE-KEEPERS' RECORD," 1/8 post free.

**British Bee Journal Office, 23 Bedford St., Strand, London, W.C.2**

LIBRARY OF  
 Massachusetts  
 FEB 24 1920  
 Agriculture  
 College



No. 1961. Vol. XLVIII JANUARY 22, 1920. [Published every Thursday, Price 2d.]

**CONTENTS.**

	PAGE		PAGE
OBITUARY NOTICE .....	37	COWAL B.K.A. ....	43
REVIEW .....	38	BEE-KEEPING LECTURE AT WOLVERHAMPTON .....	43
A DORSET YARN .....	38	HONEY IMPORTS .....	43
JOTTINGS FROM HUNTINGDONSHIRE .....	39	CORRESPONDENCE—	
“ ISLE OF WIGHT ” DISEASE .....	40	Remedy for Ants .....	44
QUESTIONS FOR BEE-KEEPERS .....	41	The Apis Club .....	44
STRAY NOTES, COMMENTS AND QUESTIONS .....	42	Bee Legislation .....	44
NATIVE BEES .....	42	WEATHER REPORT .....	46
		NOTICES TO CORRESPONDENTS .....	46

**DO NOT LET YOUR BEES STARVE.**

**Use Taylor's Soft Candy**

1-lb. 1/6, post free ; 6-lbs. 6/-, post free ;  
 12-lbs. 10/6 (11/6 carriage paid, 12/- post free.)

SYRUP—7-lbs. 7/6 ; 14-lbs. 10/6 ; 28-lbs. 20/- SUGAR VOUCHER must be sent with order.

**BEESWAX BOUGHT,**

2/- lb. Cash, or 2/1 lb. allowed if taken out in goods.

Also Cleaned and Sterilised and made into Foundation.

**No. 77. Compressed NAPHTHAFORMA TABLETS,**  
 The Germ-killing Remedy for Foul Brood  
 1/9 Bottle, Post Free.

**TAYLOR'S NEW REGISTERED ZINC EXCLUDER**  
 giving 50% freer access to supers  
 16 x 16 squares 3/-, post 6d.  
 8-ft sheets 15/-, post 1/-.

**BACTEROL & YADIL,**  
 For “ Isle of Wight ” Disease,  
 Bacterol, 2/6 per bottle, post 6d.  
 Yadil, 3/6 per bottle, post 6d.

Syrup should be fed medicated with above in  
**Taylor's Registered Feeder,**  
 Specially designed for above cures,  
 Post free, 3/10  
 or Bottle of Bacterol and Feeder, 6/- post free

**TAYLOR'S No. 12 HIVE, Dovetailed, at 29/- Carriage Paid. In the Flat, 28/-**  
**BEST VALUE IN HIVES EVER OFFERED.**  
**NEW CATALOGUE FOR 1919 POST FREE.**

**E. H. TAYLOR, WELWYN, HERTS.**



# The Metal Foundation

(Protected.)

☐ The triumph of the Metal Foundation is due to the following significant advantages:—(1) Indefinite durability with reasonable care; (2) Greater safety of bees in transit on new combs; (3) Capability of bearing the weight of a heavy swarm in hot weather; (4) Greater comb stability in quick extracting; (5) Control of drone cells; (6) The production of even combs; (7) Easy removal of queen cells without the slightest injury to the foundation; (8) Cleanliness and adaptability to sterilisation by boiling; (9) Economy of labour and time in fitting and detaching; (10) An ideal compromise between the metal comb and the wax foundation.

☐ The invention has created a world-wide interest. Its value will be more appreciated by studying the fol-

lowing original literature:—"The British Bee Journal," November 13; "Bee Craft," December; and "The Bee World," September, October, and November, 1919.

## RETAIL PRICES.

☐ The Metal Foundation ("worker" type) can now be produced in any size required, whether for the brood chamber or the super, e.g., for the British Standard Frame (14 in. x 8½ in.), Deep Standard (14 in. x 12 in.), Simmins' (16 in. x 10 in.), Langstroth (17½ in. x 9½ in.), etc., and for their corresponding super frames. Despite the heavy cost of machinery, metal, etc., it is offered at a price *well within the purchasing power of the average bee-keeper*. All orders, whether large or small, receive *prompt attention*, and are executed in *strict rotation, and in good time for the season*. We have further decided—for the benefit of bee-keepers who are not yet in a position to place their orders—on taking the risk of a liberal margin of production to meet unavoidably delayed orders. *If you have not yet made up your mind as to your requirement, you are still in time to do so.*

## The Uxbridge W.B.C. Five.

☐ This popular hive, which we originally introduced over twenty years ago, is admirable for its *water-proof* features, since it eliminates the plinth. It stands supreme amongst all W.B.C. patterns. You will never regret trying it with your metal foundation.

*\*\* We allow a Five per cent. discount on all our goods (including the Metal Foundation) to members of the Apis Club, who are respectfully requested to forward their membership cards when placing orders.*

*A FINAL REMINDER!* To avoid disappointment apply now for the Metal Foundation Price List, and for our 1920 Catalogue.

# JAMES LEE & SON, Ltd.

## UXBRIDGE, MIDDLESEX.

(Telegrams: Graphically, Uxbridge.)

Telephone: Uxbridge 181.)





## Obituary Notice.

THE LATE MR. J. N. SMALLWOOD.

As briefly stated in our last issue, it is with deep regret that we record the passing of our old friend and colleague. He had not been well for some time, and, becoming suddenly worse, he consulted a specialist, who advised an immediate serious operation. This was performed successfully at the Cottage Hospital, Hendon, on December 18. He had great hopes that he would get about again, but on January 7, the day he was due to leave the hospital, he passed peacefully away.

Widely read and travelled, his knowledge of men and things was unbounded, and his lucid and interesting expression exceeded by few.

A devoted Catholic, and a schoolmate of Father Bernard Vaughan, his integrity was never questioned, and he was beloved by all who came in contact with him. In 1913 the late Junior Editor gave him his heart's desire, which was to visit The Vatican at Rome, by taking him as companion on his European tour. His one regret was that he failed to obtain the personal audience with the Pope, which had been arranged, on account of His Holiness being prostrated by the extreme heat on the day of Mr. Smallwood's arrival in the city. Our readers will remember his interesting account of that trip, which appeared in our pages. It was good to see his enjoyment of the tour, and the sight of all the interesting places

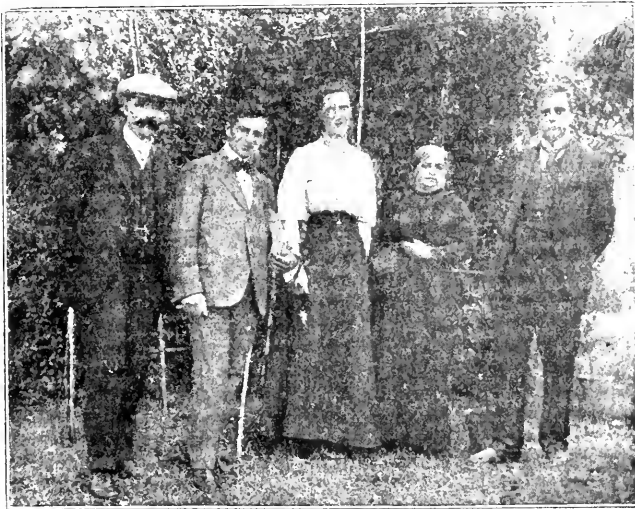

THE LATE MR. J. N. SMALLWOOD, ON THE EXTREME RIGHT.

Born at Handsworth, near Birmingham, in January, 1850, and educated at Stonehurst College, Blackburn, where he obtained premier honours in Latin and Greek, he was a very successful commercial traveller, both at home and abroad, where his command of foreign languages enabled him to succeed extremely well.

He commenced bee-keeping thirty-five years ago, when residing at Barnet, and from that time until his death he took a great and unflagging interest in the craft. He has been a constant contributor to THE BEE JOURNAL and THE RECORD for many years, and the contributions from his versatile pen were enjoyed and appreciated by our readers, as the many letters of thanks we have received testify,

and things of which he had long dreamed.

The photograph here given was taken during the tour at the home of Signor Piana.

As a member of the Council of the B.B.K.A. for many years, he did sterling work on the financial side. He very rarely missed a meeting, and was always ready and willing to do any task allotted to him.

He acted as expert to the Cumberland and Westmorland Association some years ago, and at that time wrote a series of articles, "Mid Pike and Fell," giving lucid pen pictures of the grand scenery of those counties and the typical North-country people with whom he came in contact; since then and up to the time of

his death he was expert for the Middlesex Association. He also undertook the work, single-handed, of the re-stocking apiary of the Middlesex Bee Committee, and there is no doubt that the work and anxiety of the latter at his age helped to shorten his days. He was indefatigable in his work for the members of the association, and none sought his advice and assistance in vain. Only the day before entering hospital, although in agonising pain, he made candy for some of the members.

His last words to the Secretary of the B.B.K.A. when he saw him into hospital was: "Give my love to the boys," meaning those he had worked with in both Associations.

As we look at his empty chair it seems impossible to realise that he will not return. But John Smallwood, a lover of bees, one of Nature's finest gentlemen, a loving husband and father, has passed to his reward, and we are sure that all bee-keepers who knew him, or have read his writings, will join with us in tendering to his widow and family our deepest sympathy.

\* \* \* \*

A very wide circle of bee-keepers will learn with great sorrow of the death of Mr. John Smallwood, who for many years has been an active member of the Council of the British Bee-keepers' Association, and has also acted as the expert of the Middlesex Bee-keepers' Association.

Those who knew him most intimately, and who consequently were aware of his poor state of health for some time past, will hardly be surprised at the sad news, more especially as the serious operation which he had to undergo recently would have been a severe tax upon the constitution of a young man, whereas Mr. Smallwood was advanced in years. The hope of his recovery entertained by his many friends was based upon the fact that his life had been a most healthy and regular one, and that for many years so much of his time had been spent in the open air.

Mr. Smallwood had many of the qualities essential for a successful bee-keeper. He was unassuming, and extremely kind hearted; he was always ready to give a helping hand to bee-keepers in need of assistance or advice; he could appreciate both the grandeur and the beauties of Nature, and he was blessed with a poetic disposition. The last two qualities were frequently apparent in his contributions to THE BRITISH BEE JOURNAL and THE RECORD.

It is customary to say that every one can be spared, and that when a person dies there is another ready and able to take on his duties; but it is difficult for the moment to say who will quite fill the gap in Middlesex caused by Mr. Smallwood's death. For many years he has

been the Bee-keeping Councillor and friend of a large number of persons in the districts of Mill Hill, Hendon, Hampstead, Golders Green and Finchley, to mention only a few of the districts where his services have been specially in request, and he had charge of the apiary established under the Government's re-stocking scheme at Finchley.

He was laid to rest on Monday, January 12, when the writer had the privilege of being present at this last ceremony, and among the floral tributes resting on his coffin was one: "In affectionate remembrance. From Mr. Smallwood's colleagues on the Council of the British Bee-keepers' Association. R.I.P."

His youngest daughter was too unwell to undertake the long journey to the cemetery, but whilst her mother and other relatives and friends were away she was doing just what her father would have wished her to do after the severe gale of Sunday—she was seeing that his bees, which he always looked after so carefully and loved so much, were safe.—  
J. B. LAMB.

---



---

## Review.

*Beginner's Bee Book*, by F. C. Pellett (J. B. Lippincott & Co.). Mr. Pellett's book, "Productive Bee-keeping," is well known. The present book is intended for those who do not intend to embark upon bee-keeping on an extended scale. Mr. Pellett has the happy knack of conveying a lot of information in a few words. His work as State Apiarist of Iowa, and as Associate Editor of the *American Bee Journal*, has made him conversant with the general difficulties of those making a start in bee-keeping, and readers of his book reap the advantage of the knowledge he has thus gained. The book is well printed, and there are some excellent illustrations. It will be found a very useful book for those commencing. The price is 5s., and may be obtained from this office, post free, 5s. 4d.

---



---

## A Dorset Yarn.

A spell of warm weather has brought out bees and flowers. On Thursday it was like the close of summer with our lot; in Wimborne it was the same; they were flying high and wide, quite a distance from the hives; they were on Christmas roses. Snowdrops have their white blossoms showing through the soil, but bees do not settle on them, though they are side by side with the Christmas rose. I see they only go to snowdrops when the male parts are well in evidence. In Covent Garden last week could not see any on sale; violets were very fine, the

warm spell of weather has opened them out in the open, as well as in the glass-houses. A grower from Cornwall whom I met at the R.H.S. meeting last week spoke of quantities out in the open, and bees were well and strong on the wing.

Our bees are still booming; so many write for them, so many about them. The Editor of the *Garden* told me last Tuesday that his paper was giving a column on bees by a noted bee-keeper, which all proves that bees will be much in evidence this year.

Growers of vegetables for market sales will be wise to get in early sowings of broad beans and peas, if not already done. Prices are very favourable to the grower everywhere. All winter crops also sell well; they are sought after at remunerative prices. I see in the markets that the bee-keepers bring in their honey as well, but all of them do not put it up in the best, or at least not the most attractive manner. Fine clear run honey in large pickle bottles, some in large jam bottles. Still, prices were high; the bee-keeper must be well pleased with the returns. One cannot but think it would be higher returns if in more attractive bottles, and less in each. It was all sold at per lb., starting at 1s. 6d., up to 2s. 6d.

The only things that hang are apples; some are cleared at 1½d. and 1¼d. per lb. I have a flat rate at 3d. for dessert and cooking, but with heavy crops it is all right for the farm. All trees look well for another season. We shall not sell our bees; there will be more flowers for them to fertilise as they open in spring. As the area increases, we shall want still more bees to go over the greater area.—  
J. J. KETTLE.

## Jottings from Huntingdonshire

Frequently in these "Jottings" I have remarked on the crude knowledge—I had almost said crass ignorance—shown by some rural bee-keepers as to the habits and economies of the honey-bee. This I generously put down to two reasons—one the desire on the part of some people to believe that what their fathers and grandfathers taught on the subject was the last word in bee-wisdom; and too, false deductions, made through imperfect observation, followed by a determination not to learn further wisdom from outside sources. The last thing that would have entered my head was that false bee-knowledge would be taught in our schools. Judge, then, of my surprise the other day in picking up a school book—one of the Royal Reader series—and coming across the following in

a chapter on bees:—"Bees gather not only honey, but also a kind of golden dust, from the inside of flowers. This dust they carry home on their hind legs. They use it to make bee-bread in the hive, as food for the young bees. *This dust they also use to make wax, and with the wax they build a great many little cells. . . .*" (The italics are mine.) Small wonder one hears the remark from children, as they see a pollen-laden bee enter a hive, "Look at the wax on its legs!" Earlier in the chapter we are told that bees suck juice from flowers and then carry it home to *make honey*. Further, we are told that when a snail enters a hive with a house on its back, they (the bees) seal up the edges of the shell with wax, and so the poor snail dies. Evidently the writer of the article had never heard of a bar-frame hive, as bees live in "little straw houses which have no windows and only a very small door." Our future citizens are also shown a picture of three straw skeps, snugly placed away in a thatched shelter. The book bears the date 1913. It may be argued that it is a print of an old edition. I so concluded at first, until a few pages further on I came across a chapter "About Kings and Queens," with a print of King George V. If the above is a fair sample of bee-wisdom taught in our schools it's about time the British Bee-keepers' Association called the Board of Education to account.

To-day (the 16th) has been an ideal day for cleansing flights, and where the queen is laying the bees have been busy searching for pollen. Christmas roses, jasmine, aconites, wall flowers, primroses and snowdrops are the sum-total of my garden flowers now in bloom, while coltsfoot, dandelions and dead nettles exhaust the wild flowers that are now out. Aconites are first favourite; one wishes there were more of them. It was rather pathetic to see the number of bees vainly trying to reach the pollen contained in the yellow jasmine. I purposely ripped open several of the flowers, and our little honey-flies were quick to discover what I had done for them.

I wonder is it possible to learn the language of the bee. Some of their actions are so expressive that they strike one as being accompanied with a definite tone or voice, which reminds me how, when I was learning Greek, I frequently came across allusions to "the voice of the bees." Did the ancients know more than we about the subject? However, actions speak louder than words, and it doesn't take long to learn what a bee is saying by her dramatic actions.

One day the bees of every hive but one were busy around the entrance, and I, wondering if anything were amiss in the silent hive, began tapping lightly on the

hive-roof, and stooped down to watch for signs of life. Presently I saw a scuttling backwards and forwards behind the entrance; then there was a squabble. Who was to go out and investigate? One said on this manner, and another on that, and like schoolgirls they began calling one another cowards. At last one was dared to go out. She made a short semi-circle and hurried back. I am sure I know what she said: "It's a blue tit, and why should I be food for its crop? Go yourselves if you want to be killed." Sitting well back, I got a long stick and continued tapping. Somewhat distressed, they held a council of war. (The blue-tit is the dragon of the bee-world.) Who should be sacrificed? Presently there was a rustling, which showed that relief was at hand. Several of the little ladies had found a fat, podgy drone, and were intent on pushing him out. His struggles were pathetic. He began to whimper and cry, and called his sisters names; but out he had to go. I was rather shocked at seeing him, and wondered where they had got him from; but I continued tapping away, and as their big fat brother was not consumed, they ultimately allowed him to squeeze his way back into the hive. Now what was to be done? One bee, braver than the rest, came forward, and with an indignant "Cowards all of you!" transcribed a semi-circle on the alighting board, then another, still another—each semi-circle larger than the last. In her third detour she was able to see that the dragon was no bird, but a stick. As quick as lightning she comprehended that the stick was being operated by me. She went in, and in a few hasty sentences reported the truth of things, and out came a score of bees, buzzing around me. I couldn't catch what they said, but gathered they were angry words. I think one or two did manage to say I ought to have known better, and but for the fact that I had tucked them up nice and warm for the winter would have punished me in the way I deserved. So I blushed and walked away. Two followed me quite a distance, saying very nasty things, and lest I shouldn't catch their remarks buzzed them into my ears. I was about to call them militant suffragettes, but checked myself in time, and began whistling to keep my courage up. They mistook the noise for a cry of distress, for, with a "Mind you don't do it again," they returned to their hive.

I have a mind to try it again on another hive, for I have an idea that bees keep a few drones through the winter as food for tits. If this can be proved, it will be another sign of the reasoning power of the little insects we love so well.—E. F. HEMMING.

## "Isle of Wight" Disease.

### ONE OF ITS CAUSES.

To all the writers who so kindly asked for the quick issue of this promised article I would respectfully ask them to accept my sincere thanks for their appreciation of my last article. To those who wrote in sympathy, after the accident which delayed this article, I can only say, "Thank you."

From England's outposts of bee-keeping to city gardens, all hopes are centred in the finding of a clue towards a solution of this all important question. We have available in the back issues of **THE BRITISH BEE JOURNAL** valuable data contributed by keen and careful observers, which is being sifted and tested by anxious investigators and students in pathology, in the hope of finding, "One of its causes." To every true lover of his bees the climax of a bitter tragedy, a shattered hope. The writer of this article has drunk from that cup, even to the dregs, and so towards a theory as to its cause, groping, as it were, in the dark, I have for three years waded with a sad heart through the litter of dead and dying stocks, prompted by hopeful research and the continuous desire of finding a true clue. Have I succeeded? My readers will answer, I hope, after an impartial study of my theory. I will answer, that my results obtained last summer, confirm without any trace of doubt, that we are in possession of the key factor, with which we shall in due season solve that important problem represented in the symbolical triangle of Cause, Effect, Result.

Having under close observation a ten-frame stock, in a hive so constructed that all four sides and floor board were of glass, gave me a unique opportunity of careful, continuous study. The stock was headed by one of Penna's 1919 queens, and was undoubtedly of a fine strain. As all ten combs were full of brood, the queen with two combs of uncapped brood was lifted up into the centre of the next lift of partly drawn-out comb. This was repeated three times, when what we know as "Isle of Wight" disease manifested itself by throwing out hundreds of crawlers. This text-book method of securing a stock, rich in brood, was done with a deliberate purpose, namely, that of creating under observation all the known symptoms of that dread malady which we know too well. And it succeeded so well that within 21 days a cluster of from 50-100 bees with a lovely queen, was left on 40 standard combs of decaying larvæ and dead, half-hatched bees. From such a conclusive and definite experiment there stands out this glaring fact, that a hive

so manipulated is held up as an example of successful bee-keeping—a triumph of modern methods. No greater fallacy was ever preached, and its accomplishment is a direct challenge to Nature's laws of reproduction. *For we must remember* that although the queen lays the egg, the bees nurse that speck of latent life into being. And knowing the exhaustive effects that abnormal reproduction in the animal world shows in the parent, we can imagine somewhat the condition of the nurse bees, who are the true parents of an abnormal stock created against their natural desire, but which they will continue to nurse until overtaken by that crawling death, the result of being true to that wonderful sense of responsible parenthood and loyalty to home. Here we arrive at a new, and hitherto unexamined, theory. That the nurse bees, and not the field bees, are the first victims, which is further proved by the abnormal amount of pollen found in the first crawlers when examined under the powerful microscope owned by Dr. Lowe, of Leicester, and especially mentioned by Dr. Rennie. Immediately we ask, "How, and for what reason should the nurse bee, be the first to show any signs of this scourge?" My experiments give this answer. Search the back numbers of THE BRITISH BEE JOURNAL, to the first report printed of loss through "Isle of Wight" disease, and note this remark which the writer emphasises: "My strongest stock was the first to throw out crawlers." When you are alone, and can review this statement calmly and unbiassed, let your thoughts couple it with the following.

Sifting all available evidence I would present to my readers for careful study and thought, an altogether new theory as to the cause, and leading up to the period when crawling begins. It may raise a storm of ridicule and opposition, and I may be denounced as prejudiced against the advancement of our craft. So be it. But time will prove that I am no skeptic advocate, neither an advance agent for some freak hive, but just a postman keeper of bees, the well-being of whose hobby is not sacrificed in trying to thwart Nature, nor its pleasures summed up in so many bottles of honey.

Brood changing, by Nature's wonderful laws, from the egg into the perfect bee, permits through the porous cap provided by the bees over the cell, a certain amount of air impregnated with gases evolved in the process of change. The air in a hive, with countless cells of brood beyond the inclination of the bees, becomes abnormally charged with a vapour of minute floating matter, at a temperature which makes it ideal for the incubation of that organism (call it what we like) which

blocks, by growth, the air passages of the bees. This favourable atmosphere, with the nurse bees' lowered vitality, soon develops into an advanced stage, with all its attendant symptoms. Many of my readers will remark, "Oh! that's a wonderful theory; but can you prove it?" I answer, that its proof can be found in the files of THE BRITISH BEE JOURNAL, where cures are reported by using Izal, Bacterol, Formalin, sulphur, etc. And how were those cures effected? Not by the washing of the bees, nor the administration of drugged honey, but by cleansing the air in the hive, and by a partial and small suffocating effect, causing the bees to inhale rapidly through the air passages, breaking down that state of "mucous membrane" growth, with air impregnated with a vapour of powerful disinfectant, which relieves for a period. As a concluding suggestion, is not this theory further strengthened by the repeatedly-noted fact, that "Isle of Wight" disease is increased in virulence during periods of damp weather, which, in my opinion, accounts for its rapid development in Great Britain, with its damp and ever-changing climate, as compared with the isolated cases reported in other countries. If this article results in advancing our knowledge towards finding a cure, I have achieved something, the knowledge of which will serve, to help the writing of the last article, which, with the editors' permission, shall be, "Isle of Wight" Disease, "One of its Cures."—RICH. L. EDWARDS.

### Questions, etc., for Bee-keepers for Self-Examination.

453. How may a swarm box be made, and how can it be used for queen-rearing?
454. Suggest a method by which old combs may be cleared of accumulations of cocoons.
455. Mention some of the methods used for fixing foundation in wired frames.
456. What is the minimum temperature of an ordinary colony of bees in winter?
457. How should a queen be taken up and held in the fingers?
458. What is the colour, in each case, of pollen obtained from gorse, poppy, gooseberry, hawthorn, and buttercup?
459. How is propolis conveyed by bees into the hive?
460. What work is due to be performed in an apiary in the month of January?
461. Who is required under the Bee Pest Prevention (Ireland) Act, 1908, to give notification of the presence of foul brood in an apiary, and to whom is the notification to be given?
462. Make notes for a 15-minute lecture on "Bee-keeping as a Pursuit or Occupation for Women."

J. L. E.

## Stray Notes, Comments and Questions.

*Bees recognising owners.*—*Re* Mr. Lythgoe's remarks on this point. I do not at present think that bees do recognise their keeper as some-one, or some object who is harmless, or otherwise. I have had instances in my experience in which bees which have been considered by their owners spiteful and cross, have behaved like lambs with me whom they had never seen before. I am inclined to think that they are largely influenced in their likes and dislikes of individual humans by their sense of smell. I know some people who dare not go near anybody's hives, or they would immediately be chased away by angry bees, such persons doubtless emitting an odour bees do not like. That some smells excite them is, I think, certain. Notably the smell of freshly-cut young grass, which gives a smell (especially in showery weather) very like the formic acid of their stings. The whole subject opens a wide field for speculation. Perhaps bees instinctively know a master when they see (or smell) him, as animals undoubtedly often do. Who can tell? We shall probably never know for certain until some super-bee writes his (or her) autobiography.—D. T. HEMMING, Run-corn.

## Native Bees.

I am glad to see from your columns that natives have still a few admirers, if not champions. Mr. Kettle even gives them a good word now and then. Is not one of your correspondents mistaken in thinking that the brown variety were introduced not so many years ago? Some may have been then introduced, but I think they must have been in force long before, for in our village—on the edge of Sherwood Forest—nigh on fifty years ago, they were all "browns," and there were a many of them; and some few years later, when I was doing expert work, and afterwards, they were all brown natives between Nottingham and Kiveton Park in Yorks. I believe I saw them in every parish between, and a good few each side, especially on the eastern side as far as the borders of Lincolnshire. The darker ones which we used to see at shows were mainly south-country bees, I believe. The darkest—almost blacks—came from Truro in Cornwall. These "browns" were as good in all points as could be wished for. The queens were very prolific, as they would keep ten standard frames of comb full of brood from top to bottom, and corner to corner for several months during the height of the season, and were practically non-swarmers if given room enough. In

1887, from thirty-three colonies I took over 33 cwt. honey, about half of it in sections. (See advt. same year, Queens, Fertile, 2s. 6d. each.) During several years previous to, and after 1887, I sent out several hundred queens. 1886 was a bad honey season, but a good breeding one. Had more than one swarm that season, biggest of which scaled just over 13 lbs. This lot left six racks of sections (12 sections), and ten combs of brood, even outside combs being brooded right up to top and down to bottom bars. This speaks for the prolificness of the queen. Most of the above-mentioned sections were not even drawn out, but all before swarming were simply packed with bees.

If "Isle of Wight" disease has not cleared them out there should still be some of these "browns" in the Dukeries, for many of the old oaks there were occupied by stray swarms of them. Now, as to the native bee being more susceptible to "Isle of Wight" disease than others, Is this really so? The Dutch were imported as being "Resisters," but are found on experience not to be so. The Italians—I scarce dare write it—are, in my opinion, doubtful, and I know I am not singular in that. With me for several seasons the first to show the disease were Italian hybrids. It appears to me that where a neighbourhood is fairly rotten with colonies which have died of disease, where a number of such disease centres are in roofs and hollow trees, to say nothing of hives in similar condition left open, no strain is more immune than another. Three years ago I had three lots of driven bees from Pickering, Yorks. I put them on combs containing honey from colonies which I had destroyed through showing unmistakably the "Isle of Wight" disease. In November these driven lots got at a pile of combs of similar quality and cleared them out. At the time there were within a few yards of them two twelve-frame hives which had for some little time shown the disease. I did not have time to attend to them for about a fortnight, and when I did go to them found both lots dwindled to a few hundred bees in each. Being just about "fed up," I said, "Here goes," and sweeping every bee off carefully I put two combs from each hive, which each contained a patch of hatching brood about the size of my hand, into centre of the hives of driven bees, two combs going into one, one into each of the others. The bees were hatching out before my eyes at the time. These three colonies came out healthy, and strong in the spring following, and did remarkably well that year.

Through having to move I sold all out. One of them was left in the village and gave a fair quantity of honey, and three or four swarms, and the year after it and

its swarms practically set the whole lot of bee-keepers in the village on their feet again. Unfortunately the "Isle of Wight" disease came round again last autumn, and cleared nearly all out once more. I am not grinding my axe in writing in favour of natives, for I have no bees now. One trait they had which nowadays many would consider a bad one, and that was as soon as the honey season was over, say, end of July, breeding would be curtailed, even if queen was a late young one. It was surprising the small quantity of stores which would carry a stock through. If a skep weighed anything like fourteen pounds in September it was considered safe for wintering. I have known many a one weigh pounds less than that even, and still live through and swarm early without feeding.

The Pickering bees were pure natives, of a rather darker strain. Good honey gatherers all. From one colony of same strain and an artificial swarm from them I, in 1916, extracted 280 lbs. honey (not so bad for the despised native), and left sufficient for winter and spring stores.—"ROBIN HOOD."

### Cowal Bee-Keepers' Association.

The usual monthly meeting of this Association, which was held in the hall of the U.F. Church, Sandbank, on Friday evening, December 26, took the form of a social. Notwithstanding the unfavourable weather, there was a good attendance of members and friends. Mr. John Thomson, President, occupied the chair. After tea,

The Chairman in his remarks, spoke of the aims of the Association and the many advantages of membership.

Mr. Donald Macdonald, Millhouse, expert for Argyll of the Scottish Bee-keepers' Association, in an interesting address, gave a number of seasonable hints to bee-keepers and prospective bee-keepers.

The Secretary (Rev. C. C. Stewart, Dron) moved a resolution, notice of which had been given at last meeting, urging the Government to legislate for the prevention and checking the spread of bee diseases.

The resolution was unanimously adopted, and the Secretary was instructed to forward copies to the Prime Minister, Sir William Sutherland, M.P., and the Secretary of the Ministry of Agriculture.

Mr. Macdonald was appointed official expert to the Association.

The Secretary submitted a report on the Association. At its institution on August 28 15 members were enrolled. At the first regular meeting in October the membership was 19, in November it

had increased to 30, and now it stood at 46. When the whole of Cowal had been overtaken he hoped to see it one of the strongest Associations in Scotland. Its progress had been remarkable, and new members were constantly being enrolled. The low annual subscription of one shilling made it possible for all to join, and the advantages of being members offered a strong inducement.

During the evening solos were rendered by Mr. John Thomson, jun., Mr. James Macdonald, Mr. Malcolm Wilkie, and Mr. George Gilmour; while Mr. Tom Thomson gave a recitation. Mrs. Dick and Miss Henderson accompanied on the American organ.

The meeting closed with the usual votes of thanks and the singing of a verse of "Auld Lang Syne."—*Communicated.*

### Report on Bee-Keeping Lecture at Wolverhampton.

On Tuesday, at 7 p.m., January 6, at the Woodfield Av. Schools, Mr. J. Price, the well-known bee expert of Stafford, gave a very interesting and instructive lecture on bee-keeping, aided by lantern slides. Although the audience was small, it was a very appreciative one. Mr. Price put his lecture to those present in a very clear and simple way, no doubt bearing in mind the number of schoolboys present, who learnt quite a lot of useful things. If all the fruit growers in the district had been there, the lecture would have proved as interesting to them as it did to the bee-keepers present, as Mr. Price proved how important a place the bee takes in the production of fruit. At the end of the meeting a vote of thanks to Mr. Price was passed on the proposition of Mrs. Bradley of Penn Fields, seconded by Mr. Walton, also of Penn Fields, for his very instructive lecture. I am sure when Mr. Price is this way again, those people who do not know anything about bees will be interested, as well as the bee-keepers, as there are many things in the life of a bee appertaining to our own lives in the way they manage the affairs of the hive. Bee-keeping is also a very paying concern, as proved by Mr. Price, when he stated that 50 bee-keepers within a five-mile radius of Dudley had, between them, in one season four tons of honey, which proves that if this can be done in a district like Dudley, those in the country should certainly do better.—W. M. ROE.

### Honey Imports.

The registered value of honey imported into the United Kingdom during the month of December, 1919, was £22,993.—From a return furnished by the Statistical Office, H.M. Customs.



### Remedy for Ants.

[10109] In the *BRITISH BEE JOURNAL* of January 1, page 7. No. 10076, one of your readers asked remedy for ants. A certain remedy is black, or white, pepper. White pepper, however, is best, as it is stronger. The pepper is to be strewed under and around the hives, and when the hives are like the W.B.C., it should also be strewed between the walls and upon the covers—which I know by own experience. This remedy may perhaps help your correspondent.

Please let me know the results after application.—G. H. TENWISSE, Oss, Holland.

### The Apis Club.

[10110] I was very pleased to see your editorial in *THE BEE JOURNAL* for December 25.

An institution such as the "Apis Club" and a paper such as the *Bee World* should have the willing support of all bee-keepers who have a sincere desire to see their craft developed to the utmost extent. The *Bee World* can hardly hope ever to be anything like self-supporting, and unless we bee-keepers support it, not only by writing for it and reading it, but by generous subscriptions to the Apis Club in order to help those who are producing this paper to carry it on, it cannot be a success. At present the whole deficit—which is a heavy one—is being borne by a few men who have the interests of bee-keeping in our country at heart, and it is now up to all those who appreciate the *Bee World* to help. No one can expect to have a paper such as this delivered to them for a few pence per copy. I therefore appeal to all associations to make some effort to help in this work, and also private individuals should do their bit. If all help, even a little, I feel sure the producers will be able to carry on this most valuable and interesting paper, which links the bee-keepers of all nations together. Unless bee-keepers are willing to put their hands in their pockets and help a bit, I feel that we cannot expect that it will be possible for the paper to continue for long.

Already the deficit is, I believe, heavy, and it cannot be expected that those responsible can go on piling deficit on deficit as each number is produced.

This paper is not, and was not intended to be, a commercial proposition. I appeal to all those who can help to do so.—  
ROBT. B. MANLEY.

### Bee Legislation.

[10111] I am very much surprised that the opponents to legislation have not given us something more satisfactory than what has already appeared in response to your invitation.

Evidently all the "Nots," so far, are quite satisfied with the present state of affairs. They are having a delightful time with their bees, and wishing for nothing better than to be allowed to go plodding on as before. Can any reasonably-minded bee-keeper, who has any knowledge whatever of disease and the extent to which the bee-keeping industry has been devastated the last few years, imagine for a moment that bee-keeping is in such a glorious condition as to be allowed to go on as before?

Not one single reply has contained an alternative to legislation that will remedy or revive the present state of bee-keeping. Personally, I am all for legislation, because I fail to see anything else which will rid us of the present nightmare to bee-keepers. By legislation we get—

(1) Control of bee diseases; not, as some seem to imagine, control of healthy bees.

(2) Protection from careless bee-keepers.

For the benefit of both sides I give my views on what I would like to see if diseases or bees were controlled.

(1) Compulsory registration of all bee-keepers.

(2) An order issued to make it a penal offence for allowing any infectious material, such as combs, etc., to be accessible to bees.

(3) An order issued at once making "Isle of Wight" disease notifiable.

(4) An order that no stocks of bees should be removed from their present locality without a permit.

Someone may ask, "How do I think this would work out?" And I herewith give my views, hoping if yours, Mr. Editor, are contrary you will give your reasons.

As to No. 1, there should be no difficulty. Simply make the present voluntary registration scheme (for bee food) compulsory, and the same authorities, the "Bee Committees," would deal with it. The same authorities could also deal with No. 2, and I believe this bugbear of present-day bee-keeping would soon disappear, probably without recourse to force, when it was known that such carelessness was liable to a penalty.

No. 3. An order issued making "Isle of Wight" disease notifiable does not neces-



sarily mean that every bee-keeper's premises would be invaded by an inspector immediately the law came in force. No. It means that when suspected cases were reported an inspection would be necessary, and precautions would be needed to prevent the disease from spreading to other stocks and apiaries.

This does not mean wholesale destruction of apparently healthy stocks in the same neighbourhood, or even apiary. Far from it. The district would be scheduled as an infected area, and a watch would be kept for any subsequent outbreaks.

On paper, No. 4 would, for a time, be hard on dealers, and heather men would probably feel it for a season, but in practice it would only affect those having had a recent outbreak of disease or those residing in infected areas.

Those possessing only healthy stocks would easily secure the necessary permit for removal.

These are my views and suggestions, as seen from a long experience in visiting apiaries, and I fancy all supporters of legislation will consider them fair.

At the same time I shall be interested to see if our friends in opposition can offer us something better as an alternative.—J. PRICE, Staffs.

[Our correspondent's long experience as a touring expert makes his remarks interesting and valuable. There is no doubt that "Joe" hits straight from the shoulder, and that he has the confidence and backing of every bee-keeper in each county in which he has toured. We think, however, it would be a mistake to specify "Isle of Wight" disease, or we would be in the same fix as Irish bee-keepers, who have an Act dealing with foul brood, but that does not apply to "Isle of Wight" disease.—Eds.]

[10112] As a constant reader of your valuable JOURNAL, I have been greatly interested in your readers' different views *re* "Bee Legislation," and for my own part I am with you every time in favour of it. I am by no means a learned bee-keeper, but I am a lover of bees. I kept a few stocks before the war, getting a swarm from a boss of mine as a present when only fifteen years of age, because I was always giving him a help amongst his bees, of which he had over twenty stocks. However, on being discharged from the Army as unfit three years ago, I found my bees were all dead, like the most of those around here, from "Isle of Wight" disease, so I got another swarm from a man who was fortunate to have his spared, and had very good luck with them until last summer, when a swarm came off, which my wife was able to fol-

low, when, to her joy but to my horror, they went into an open hive, the bees in which had been affected and died with the disease the previous year, and the hive had been left as it was. However, I took them off, and placed them by themselves in the garden, where they seemed to be doing all right until the early winter, when I saw signs of crawlers, which I understood was a sure proof that they were affected. Well, I left them as they were for some time, not knowing what to do for the simple reason, lack of knowledge, and you need not ask the result—they were soon all dead. Now, had there been any bee-keeper or inspector who knew his work, I could have reported to him for advice at the first signs, and might have saved them. I will say no more, but push on with "Bee Legislation," not only for the big man, but the small one, and also for the population in general.—GEO. ROGER GORDON.

P.S.—I may mention the man who first started me with bee-keeping is now making his living as a bee expert in Canada.—G. R. G.

[10113] In opening the columns of your paper for a frank discussion of the question of "Bee Legislation," you have given the bee community a revelation in drawing forth the letter from the "Sheffield Bee-Master," who states what he has *done*, and what he will *do again*, to hinder the progress of bee legislation. With this knowledge, the British bee-keepers should use every opportunity in fighting the individual monopolist. In the days gone by, the biggest bee-keeper was generally the biggest opponent, and often the greatest menace to a district.

Two of the greatest bee-keepers I have known in this district, I will give as an example of this menace. In a village not 20 miles from Salisbury an apiary was situated on the sunny side of the village, but was kept in a deplorable condition. About 80 stocks were kept, scattered over a plot of ground about 50 yards by 40 yards the bees were hived in every possible type of receptacle. It looked as if in the beginning a stand had been erected with a few bar-frame hives knocked up from any class of wood without any idea of shape or style. Bees don't wait, and evidently quick happenings had come about, and the bee-master had to resort to the general village store dealer (rather than the bee appliance dealer), and old skeps, tea chests, butter boxes, lard buckets, with sundry coverings of old bags, strips of corrugated iron, old biscuit tins knocked out flat, made up the general medley of this apiary of many years' standing. In the front of the

ground a shack was erected of wood of old boxes. The industrious bee-keeper had put his best work into this structure, but it was neither bee proof nor weather proof. This was the honey shed, where the process of squeezing honey was carried on, and destined for our busy centres by the hundredweight lot as pure honey. Disease was in this apiary in many types and stages, and could go on without check or hindrance. Small bee-keepers could be robbed out, and disease carried to their hives, but these 80 stocks could go on; even if he lost 40 during the winter, he could soon make up his loss in swarming. This "bee-master" I was informed was opposed to legislation, and I believe a letter was inserted from him in the B.B.J. I sent over several times to get a photo of the apiary, but was refused such a privilege. (The late Junior Editor will refresh his memory. He visited this bee dump with the writer in the year 1911.)

The other big bee-keeper was a farmer, who often had 200 stocks scattered in every part of his farm. It seemed wherever a swarm settled that was the place for them to be hived and stay; under trees, in rickyards, under hedges, in the ploughed fields, in gardens—anywhere and everywhere one would come across bees in old skeps and boxes covered with grass and weeds. The "Isle of Wight" disease finished this bee-keeper. When advised to get into the modern way of keeping bees, he would say, "My bees bring me honey, and costs little money, and I'm not going to have smart people to teach me anything about bee-keeping, and have hives that they could open and see what honey I'm getting." Now, sirs, if these types of men are going to decide the future of bee-keeping, what about the hundreds of others in a smaller way? The question is, ought one bee-keeper of 150 stocks to have the same consideration in pressing his views as 100 modern bee-keepers with one or two stocks each and working on modern and intelligent methods? Our country is ruled by the majority, not by money, or property values, but by individual votes; and each individual bee-keeper, be he either a small or large stocker, should be considered on equal terms.—Yours in the fight, J. E. PINDER, Salisbury.

[The late Junior Editor says he well remembers the visit referred to, and the long cycle ride in scorching hot sun. Yes, indeed, it was an ideal example of "A Not for Legislation." As the Irishman said, "The entrance out" of the hives was in every joint. As an example of an apiary demoralised by robbing it could not be beaten.]

## Weather Report.

WESTBOURNE, December, 1919.

Rainfall, 5.47 in.	Mean maximum, 47.9.
Heaviest fall, .97 in. on 15th.	Mean minimum, 36.3.
Rain fell on 27 days.	Mean temperature, 42.1.
Above average, 1.98 in.	Above average, 2.2.
Maximum temperature, 54 on 22nd.	Maximum barometer, 30.292 on 20th.
Minimum temperature, 25 on 1st.	Minimum barometer, 29.146 on 31st.
Minimum on grass, 21 on 9th and 10th.	
Frosty nights, 8.	

L. B. BIRKETT.

## Notices to Correspondents

### Suspected Disease.

- S. V. DOUGNEY (Folkingham), B. E. C. (Stratford).—We are unable to say cause of death.
- MISS L. G. (Shifnal).—Our opinion is "I.O.W." disease. Bees have been kept in London, and given a little surplus. We have taken filled sections from an observatory hive near the Marble Arch. The honey was from the lime trees.
- MISS PRATT (Renfrew).—We are sorry the bees were affected with "I.O.W." disease. We admire your pluck under such discouragement, and trust you may have success in the future. We shall be pleased to hear from you again as to progress.
- E. C. FAIRLOUGH (Lancs).—The cause of death was "I.O.W." disease. It would be an advantage to requeen. You might extract the honey from the combs, and disinfect them, but it is safer to burn them.
- F. STUBBS (Brecon).—"I.O.W." disease. The hives will be safe if disinfected as you suggest.
- W. K. (Wandsworth).—We think the bees are natives, but it is practically impossible to distinguish between natives and Dutch. We do not find any disease.
- J. J. DYKES (Kent).—(1) Dysentery. (2) Only keep them warm and dry for the present. Later, when it is safe to move combs, treat as suggested, pp. 183-4 of "Guide Book."
- "NOVICE" (Foxfield).—We do not find any "I.O.W." disease. Do not disturb bees at present.

## Special Prepaid Advertisements. One Penny per Word.

Advertisements must reach us NOT LATER than FIRST POST on TUESDAY MORNING for insertion in the "Journal" the same week.

Orders for three or more consecutive insertions in "The Bee Journal" entitle advertisers to one insertion in "The Bee-keepers' Record" free of charge.

### PRIVATE ADVERTISEMENTS.

WANTED, for scientific purposes, a few live Bees from diseased or dwindling stocks; cages sent and expenses paid.—SNELGROVE, Quadrant, Weston-super-Mare. a.11

EXPERT BEE-KEEPER required; experienced in forming nuclei, etc. State particulars and salary expected.—Box 59, B.B.J. Office, 23, Bedford Street, Strand, W.C.2. a.28

**21** CWTs. Pure Lincolnshire Honey, 14 and 28-lb. tins.—R. N. CHAPMAN, 24, Strait Bargate, Boston. a.29

**CHEAP APPLES.**—For one week I am offering 75-lb. lots of Bramley's, Graham's (sweet) and Lane's Prince Alberts at 22s. 6d. per lot, carriage paid England and Wales, in returnable boxes. All are crisp, and will keep well. Cash with order.—NELSON, West Farleigh, Maidstone. a.30

**FOR SALE,** 2 cwt. guaranteed pure Light English Honey, 2 cwt. Medium, good quality, 1 cwt. Dark. Will accept £8 cwt. to clear.—Pear Tree House, Wilburton, Cambs. a.31

**IN "INTENSIVE BEE-KEEPING"** we advocate a general post in the apiary in the spring. In an apiary of 12 stocks, and moving one stock per day, how many changes are possible? Use 12 playing cards, or a pencil and some paper.—SMITH, 30, Maid's Causeway, Cambridge. a.32

**FOR SALE,** a small quantity of nice flavoured Light Honey, granulated, quite solid, in 7, 14 and 28-lb. tins; prices, 13s., 22s. 6d. and 43s. respectively, free on rail, packed in returnable crate.—R. B. MANLEY, Brightwell, Wallingford. a.33

**FOR SALE,** about 30 Hives of Bees; inspection invited. Cause of sale, ill-health.—F. MARTIN, W. Wittering, Chichester. a.34

**FOR SALE,** Taylor's Observation Hive, with ten frames, sections, non-swarming chamber under brood nest, used one season, £2 2s.—MISS TONKS, Sutton Coldfield. r.a.35

**WANTED,** strong Stocks Italians, 1919 imported Queens; delivery April.—WALKER, Bryn-lithrig, St. Asaph. a.41

**WANTED,** 7- and 14-lb. syrup lever-lid Tins, empty, equal new.—BURGOYNE, Assistant Overseer, Lyonshall, Herefordshire. a.42

**WANTED,** to purchase, well-stocked Skeps.—HOPPER, JUNR., Fair View, Kidlington, Oxon. a.43

**"CLEANINGS,"** 1915, 12 copies, 2s.; 20 "American Journals," 3s.; Dadant's "Lessons in Bee-keeping," 3s. 6d.; Millar's "Thousand Questions Answered," 3s. 6d.; Simmins' Book, 5s. 9d., free.—BOWEN, Pittville Street, Cheltenham. a.44

**21 LBS. BEESWAX,** 8s.; 1-frame Observatory 3/2 Hive, polished walnut, 30s.; 3 dozen new Metal Dividers, 9s., carriage paid; 1 gross 1-lb. and 1/2-lb. Screw Honey Bottles, without caps, 36s., carriage forward.—MATTHEWS, 25, Cray Road, Crockenhill, Swanley, Kent. a.45

**CAVIES.**—Prize-bred Golden Agoutis. —Particulars from HODSON, Harley Lodge, Enfield. a.46

**ONE CWT.** Pure Cambridgeshire Honey, in 14-lb. tins, 1s. 6d. per lb.; 12 lbs. fine quality Beeswax.—R. WHITTING, Manea. a.47

**PURE** light Cambridgeshire Honey, 14-lb. tins, 22s. 6d.; 28-lb. tins, 42s.; tins free; sample 4d.—J. YOUNGER, 6, Maid's Causeway, Cambridge. r.a.5

**WANTED,** new Cycle Chain, 1 in. pitch by 1/2 and 5 ft. 6 in. long, twin roller, or block.—Price to A. J., B.B.J. Office, 23, Bedford Street, Strand, W.C.2. x.32a

**THE GRAMOPHONE RECORD EXCHANGE** will exchange Records 5s. dozen; return postage free.—Address, 6, Rood Lane, London. Particulars stamp. x.28

**W.B.C. HIVE,** new; one Bristol Hive, good condition.—BRETTELL, Pedmore, Stourbridge, Worcestershire. r.a.19

**CORRESPONDENCE** Course in Bee-keeping.—MISS F. E. PALING, Golden Square, Henfield, Sussex. rw.31

**WANTED,** portable Greenhouse.—Price and particulars to W. HERROD-HEMPSALL, Old Bedford Road, Luton, Beds.

**WANTED,** Anster Rear Wind Screen for motor car.—HERROD-HEMPSALL, as above.

**FOR SALE,** one Exhaust Whistle, 11s., post free; one Wood Milne Motor Foot Pump, 45s., carriage free; one 760 x 90 Cover, 15s., carriage free; one small Motor Horn, 5s., post free.—HERROD-HEMPSALL, as above.

**BUSINESS ADVERTISEMENTS.**  
1½d. per word.

**ITALIAN** and Hybrid 4-frame Nuclei, 1920 Queens, £3 3s.; Hybrid Swarms, 10s. 1b.; Fertile Queens, May-June 10s. 6d., July-August-September, 8s. Strongest and best honey gatherers in the country. All orders booked in rotation; £1 deposit, balance on delivery.—THOMAS CHITTY, Burligh Farm, Cassington, Oxon. a.36

**FEW ITALIAN NUCLEI** from 1919 Penna Queens, 5 frames, 50s.; delivery June-July; boxes 10s. extra, returnable.—LEWIS, J.P., Clarboston Road, Pem. r.a.37

**BEEs ON APPROVAL.**—We guarantee our Bees and Queens to give complete satisfaction. Special terms to disabled men. Catalogue 3d., which will be returned on first order.—PEARSON & GALE, Marlborough. a.38

**ITALIAN NUCLEI** (Adminton strain) now being booked, delivery end of May onwards, 1920 Queens, price 3 gs.; boxes 10s. 6d. extra if not returned.—MAYES, 79, Pembroke Road, Clifton, Bristol. a.39

**STRONG STOCKS** of Bees, guaranteed, on 7 frames, with pure selected Italian Queens, 1920; orders booked in rotation for delivery from beginning of June; price £5, carriage paid; travelling box 10s. extra, which is returned. Cash with order, or 25s. deposit and balance by May 25.—MISS F. E. PALING, Golden Square, Henfield, Sussex. a.40

**ITALIAN NUCLEI,** 3-frame, young Queens, £3; boxes 7s. 6d., returnable; Fertile Queens, 10s. 6d.; Virgins, 5s. 6d.; Simmins' and Penna's strain.—WATTS, Conway Cottage, Newtown, Parkstone, Dorset. r.a.48

**ITALIAN QUEENS** and 3-frame Nuclei.—Insure against disappointment by getting your Queens and Bees from a place where "I.O.W." has never existed. Orders now booked for June and July delivery.—S. CRAWFORD, Apiaries, Castlelderg, Co. Tyrone. r.a.25

**HIVE MAKERS** Wanted.—Apply, letters only, stating age, experience, wages expected, to LEE, Beehive Works, Uxbridge, Middlesex. a.13

**QUANTITY** amber-coloured Granulated Honey in 1-lb. glass jars at 21s. dozen, 1/2-lbs. at 11s. 6d. dozen; also in tins, 7 lbs., 11s.; 14 lbs., 20s. 6d.; and 28 lbs., 37s. 6d.; carriage paid.—Apply, MEADOW BROS., Shirley Road, Shirley, Surrey. r.a.10

**HAVE YOU READ "THE BEE WORLD"?** If not, why not? Every number in itself is a useful literary work for practice and reference. Specimen copy free.—Offices: THE APIS CLUB, Port Hill House, Benson, Oxon.

**FINEST SECTIONS OF HONEY.**  
A large quantity for Sale at carriage paid prices, either Plain or Glazed

**IRISH RUN HONEY.**  
Several cwt. for Sale in quantities to suit customers, at carriage paid prices in free tins and cases.

**GORDON ROWE,**  
Honey and Beeswax Packer,  
23a, Moy Road, Cardiff.

ITALIAN QUEENS direct from Italy. Price list for 1920 on application.—Address, E. PENNA, Bologna, Italy. w.39

## The Metal Foundation.

(Protected.)

For the benefit of readers of the JOURNAL and the RECORD we have arranged with the manufacturers of the Metal Foundation to accept all orders received through our offices at a consideration in the shape of a 25 per cent. deposit to begin with, and the balance by mid-March, or prior to delivery, if earlier. All orders are guaranteed by them to be executed not later than April, 1920.

Prices:—(1) BRITISH STANDARD FRAME, fully fitted with "worker" Metal Foundation: Single, 2s. 4d.; per two dozens, 2s. 3d. each frame; per four dozens and over, 2s. 2d. each frame.

(2) STANDARD SHEET of "worker" Metal Foundation: Single, 2s.; per two dozens, 1s. 11d. each sheet; per four dozens, 1s. 10d. each sheet.

Subject to a 5 per cent. discount to members of the Apis Club.

Packing & Carriage Extra.

\*\*\* Since the Metal Foundation will be produced only to order, no order will be subject to cancelling.

The products of the Apiary, of Poultry and Farm Stock, of the Fruit and Vegetable Garden can be Advertised and Sold through

THE  
**BAZAAR, EXCHANGE & MART**  
Newspaper.

Get a Copy—Thursday and Saturday 3d. The "Bazaar" publishes also practical handbooks by experts. Send for full catalogue, post free from—  
WINDSOR HOUSE, Breams Buildings, LONDON, E.C.2.

## Books for Bee-keepers NOW IN STOCK.

	Postage
A Modern Bee Farm ... ..	7/6 ... 6d.
Beginner's Bee Book (PELLETT)	5/- ... 4d.
Bee-keeping (DR. E. F. PHILLIPS)	10/6 ... 6d.
<b>BEE-KEEPING SIMPLIFIED FOR THE COTTAGER AND SMALLHOLDER</b> (W. HERROD-HEMPHALL, F.E.S.) ... ..	1/- ... 1½d.
<b>BEE-KEEPERS' PRACTICAL NOTE BOOK</b> (T. W. COWAN)	1/- ... 1½d.
<b>BRITISH BEE-KEEPERS' GUIDE BOOK</b> (T. W. COWAN) (paper covers only)	2/6 ... 3d.
Dissectible Model of Queen Bee ... ..	4/6 ... 3d.
<b>FERTILISATION OF FRUIT BLOSSOMS BY BEES</b> (T. W. COWAN) ... ..	-/3 ... 1d.
Honey and Health (A. HOPE) ...	-/6 ... 1d.
Honey Vinegar (REV. G. BANCKS)	-/2 ... 1d.
How to Keep Bees (ANNA B. COMSTOCK) ... ..	5/- ... 6d.
<b>PRODUCING, PREPARING, EXHIBITING AND JUDGING BEE PRODUCE</b> (W. HERROD-HEMPHALL, F.E.S.) ...	2/- ... 3d.
Queen Rearing in England (F. W. L. SLADEN) ... ..	1/6 ... 2d.
Snelgrove's Method of Re-Queening ... ..	-/6 ... 1d.
The "Townsend" Bee Book ...	2/6 ... 2d.
<b>WAX CRAFT</b> (T. W. COWAN) ...	2/- ... 2½d.
Wilke's Book on Swarming ...	1/- ... 1½d.
<b>MISCELLANEOUS.</b>	
Maeterlinck's Life of the Bee	3/6 ... 3d.
The Lore of the Honey Bee (TICKNER EDWARDS) ... ..	2/- ... 2d.
The Humble Bee (F. W. L. SLADEN) ... ..	12/6 ... 6d.

British Bee Journal & Record Office,  
23, BEDFORD STREET, STRAND, LONDON, W.C.2.

### BEE FLOWER SEEDS.

Collection of six best Varieties, 1s., post free.  
Beautifully Illustrated Instructions Up-to-date.  
Garden Guide, 64 pages, Free.

KNIGHT'S,  
SEED SPECIALISTS,  
WOLVERHAMPTON

## THE British Bee-keepers' Association.

The recognised centre of practical and scientific bee-keeping in Great Britain. Particulars and conditions of membership may be obtained from the Secretary, W. HERROD-HEMPHALL, 23, Bedford Street, Strand, London, W.C.2.

## INSURE YOUR STOCKS

### AGAINST "I.O.W." AND OTHER INFECTIONS.

Science has now placed within reach of every Apiarist a safe and certain preventative of infection in "Yadil" Antiseptic.

For **SPRING FEEDING** "Yadil" may be added freely to Syrup.

For **DISINFECTING** Bees and Combs a five-per-cent. solution in tepid water should be used with a fine spray.

ASK FOR GREEN LABEL.

Our Bee Brochure sent Free on Application.

**CLEMENT & JOHNSON, 19, Sicilian Avenue, W.C. 1.**

The certain cure for  
and Preventative of  
"Isle of Wight" disease.

## 'BACTEROL'

Proved by Bee-keepers  
generally after testing on  
the most hopeless stocks.

Manufactured by "Bacterol" Limited, London, N.  
**MENLEY & JAMES, LTD., MENLEY HOUSE, BARRINGTON ROAD, LONDON, E.C.**

**Don't Order "W.S." Queens until you have seen the "Queenland" Revised List for 1920. 3½d. post free**

**NUCLEUS STOCKS—Same Price as 1919.**

The only Pedigree Bee-Stock Registered in direct line for more than 25 years.

**"AMALGA" is the name of our Queen breeding mother for 1920**  
**"ALTA" is the name of our Drone parent for 1920.**

PRODUCE OF ONE NUCLEUS REALISES OVER £40 IN CASH.  
 "The three-frame nucleus I purchased from you had increased last autumn to two strong stocks. I supered one on April 23rd of this year, and the other a few days later. I sold two swarms, and made up the others to five stocks. Of these I also sold three stocks. The original lot gave 193 lbs. of honey, and in all I have taken 365 lbs. My sales amounted to over £41 in actual cash."  
 (Miss) H. G. MOXSEY.  
 Somerset, Oct. 9th, 1918.

EXCEEDS 500 PER CENT. INTEREST.  
 "We have now 12 stocks to winter, besides selling one, out of the two three-frame nuclei supplied June 20th last year."  
 (August 15th, 1917). Miss B. D.  
 Quainton, Bucks.

THREE TO SEVENTEEN.  
 "It may interest you to know that the three stocks to which I introduced your queens (the only stocks saved in the apiary) in 1916, produced in all 17 stocks, and a good surplus in honey in 1917; this under the care of my wife who knew nothing about bees. I simply directed her as to management from there (France)."  
 OLIVER G. PIKE.  
 April 9th, 1918.

FIRST AND BEST.  
 "Your White Star strain was the first to enter the sections, and all the honey I got was from them."  
 G. H. S.  
 Heddon House Dairy.

APRIL 19TH.—BOILING OVER.  
 "The hive is simply boiling over with W. S. bees. They are at work when my other stocks are idling, and they are stronger than any of my other stocks."  
 Aberdare, Wales. E. T. W.

ARE THE W.S. PROLIFIC?  
 "In 1904 I got a W.S. queen from you, and last year (1905) by the first week in June she had brood in *twenty-five* standard frames."  
 J. H.  
 Higher Kinnerton, Chester.

**SAFE DELIVERY of Nuclei and Queens GUARANTEED**

NUCLEUS DELIVERED IN JUNE; 40 FRAMES BY AUGUST.  
 "The three-frame nucleus of bees now occupy 40 Standard Frames. They have exceeded beyond anything I believed possible. I have never had anything like them before, and if the other queens on order turn out the same I consider my fortune made."  
 JOHN JONES.  
 Llancarfan, Aug. 21st, 1918.

SEVERAL STOCKS FROM ONE NUCLEUS.  
 "It seems almost ridiculous that this nucleus of the previous season (Aug.), before I was prepared for it, swarmed in April, and I now have several stocks from that investment."  
 J. W. MCKAY.  
 Croydon.

EIGHT STOCKS FROM ONE W.S. NUCLEUS.  
 "I now have eight stocks from the one nucleus you supplied last year."  
 J. JONES.  
 Llancarfan, May, 1919.

BEST IN THE COUNTY—NEVER SAW THE LIKE!  
 "May 26th.—The two queens you sent me have exceeded anything that I ever thought of. The stock chambers are full and crammed with brood, and all three supers crowded with bees; but even with this the bees are boiling over. I have not fed them at all, and have removed several frames of brood for another lot. The County Expert called yesterday, and said he had never seen such bees, and they were certainly the best in Hampshire."  
 D. D. P.

NO SPRING-FEEDING, BUT AGAIN FIRST.  
 "The W.S. bees on eleven 16 x 10 frames were full and boiling over at the middle of May, and were the first to enter supers out of 23 stocks; and last, but not least, they required no spring feeding."  
 U. W.  
 Arnold, Notts.

Revised 1920 "White Star" List, 3½d., of S. SIMMINS, Queenland, Heathfield, Sussex.

## QUALITY.

The difference between a good bargain and a bad bargain is not so much a matter of money as of quality.

All our goods have the "Hallmark of Quality" resulting in a large clientele of SATISFIED customers. Does this mean anything to you? If so, send for our large Illustrated Catalogue for 1920, free on application.

R. STEELE & BRODIE,

Bee Appliance Works, WORMIT, FIFE, SCOTLAND.

## THE UXBRIDGE W.B.C. HIVE.

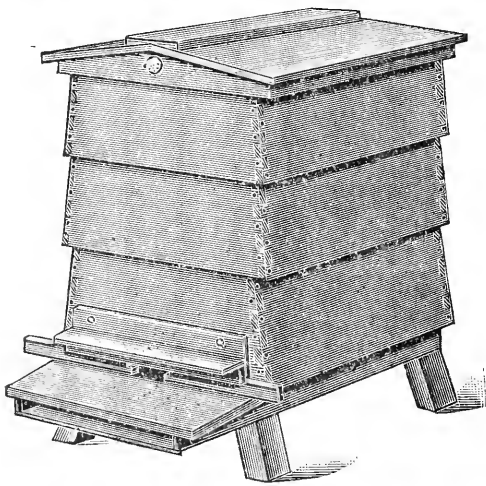

We originally introduced this type of W.B.C. Hive over twenty years ago, and offered it for several years as "Lee's Waterproof Cover." Beekeepers of those days did not care for it. Hence it was withdrawn from our list. We now offer it as illustrated. Lifts and covers are square and dovetailed.

Price, including stock box, ten frames with ends and dummy, two shallow frame boxes with eight frames in each, 48/6. We will also supply this hive without inside fittings, to enable beekeepers to transfer existing stocks to the new covers, for 30/-. Carriage paid, 2/6 extra.

**PROMPT DELIVERY.**

**JAMES LEE & SON, LTD.,**  
UXBRIDGE, MIDDLESEX.

## The 'Kent' Standard Model Hives & Appliances

### TESTIMONIAL.

May 12.

DEAR SIR,—I have had an opportunity of comparing the material and workmanship of your hives with others on the market, and in my opinion there is no sort of comparison between the two, yours being altogether superior in every particular.—Yours faithfully,—

S. J. BALDWIN, Stanley Road, Bromley, Kent.

**BURTT, Gloucester, FOR BEE APPLIANCES.**

*New Illustrated Catalogue Free on application.*



No. 1962. Vol. XLVIII JANUARY 29, 1920. [Published every Thursday, Price 2d.]

**CONTENTS.**

	PAGE		PAGE
SEASONABLE HINTS .....	49	MONMOUTHSHIRE BEE-KEEPERS' ASSOCIATION .....	52
BRITISH BEE-KEEPERS' ASSOCIATION .....	49	WICKHAM BISHOPS AND DISTRICT B.K.A. ....	52
JOTTINGS FROM HUNTINGDONSHIRE .....	50	CORRESPONDENCE—	
JOTTINGS .....	51	Bee Legislation .....	53
NOTES ON BEE-KEEPING .....	52	NOTICES TO CORRESPONDENTS .....	56

**DO NOT LET YOUR BEES STARVE.**

# Use Taylor's Soft Candy

1-lb. 1/6, post free ; 6-lbs. 6/-, post free ;  
12-lbs. 10/6 (12/- carriage paid, 12/- post free.)

SYRUP—7-lbs. 7/6 ; 14-lbs. 12/- ; 28-lbs. 23/- SUGAR VOUCHER must be sent with order.

## BEESWAX BOUGHT,

2/- lb. Cash, or 2/1 lb. allowed if taken out in goods.

Also Cleaned and Sterilised and made into Foundation.

No. 77. Compressed  
**NAPHTHAFORMA TABLETS,**  
The Germ-killing Remedy for Foul Brood  
1/9 Bottle, Post Free.

**TAYLOR'S NEW REGISTERED  
ZINC EXCLUDER**  
giving 50% freer access to supers  
16 x 16 squares 3/-, post 6d.  
8-ft sheets 15/-, post 1/-.

## BACTEROL & YADIL,

For "Isle of Wight" Disease,

Bacterol, 2/6 per bottle, post 6d.  
Yadil, 3/6 per bottle, post 6d.

Syrup should be fed medicated with above in  
**Taylor's Registered Feeder,**  
Specially designed for above cures,  
Post free, 3/10  
or Bottle of Bacterol and Feeder, 6/- post free

TAYLOR'S No. 12 HIVE, Dovetailed, at 29/- Carriage Paid. In the Flat, 28/-  
BEST VALUE IN HIVES EVER OFFERED.  
NEW CATALOGUE FOR 1920 POST FREE.

**E. H. TAYLOR, WELWYN, HERTS.**

THE  
**British Bee Journal**

ESTABLISHED 1875.

A Weekly Journal Devoted to the  
Interests of Bee-keepers.

Edited by T. W. COWAN, F.L.S., &c.,  
and J. HERROD-HEMPSELL, F.E.S.

**Correspondence: Whom to Address.**

All matters relating to the Literary Department, Associations, Shows, etc., should be addressed, "Editors, *British Bee Journal*," and all business communications and matters relating to subscriptions and advertisements to be addressed to the "Manager," *B.B.J.* Office.

**Subscriptions.**

Annual Subscription, 10s. 10d. post free in advance; single copies 2d., or 2½d. post free. If a receipt is required by post, a stamped and addressed envelope must be sent, otherwise a printed receipt will be enclosed along with the paper.

*Note.*—Cheques and Postal Orders should always be crossed, otherwise it is very difficult to trace them if they go astray.

**How to send Money.**—Remittances can be made payable to W. Herrod-Hempsall by crossed Cheques and Postal Orders. Stamps may be sent for small amounts up to 2s.

**Halfpenny stamps are preferred.**

Scottish or Irish cheques can only be taken in payment if 6d. is added for commission charged by banks for cashing them.

The Editors are not directly or indirectly interested in the manufacture or sale of bee-hives or appliances of any kind, and must refer correspondents wishing for prices or catalogues to advertisers in the paper.

## The Metal Foundation.

(Protected.)

For the benefit of readers of the JOURNAL and the RECORD we have arranged with the manufacturers of the Metal Foundation to accept all orders received through our offices at a consideration in the shape of a 25 per cent. deposit to begin with, and the balance by mid-March, or prior to delivery, if earlier. All orders are guaranteed by them to be executed not later than April, 1920.

Prices:—(1) BRITISH STANDARD FRAME, fully fitted with "worker" Metal Foundation: Single, 2s. 4d.; per two dozens, 2s. 3d. each frame; per four dozens and over, 2s. 2d. each frame.  
(2) STANDARD SHEET of "worker" Metal Foundation: Single, 2s.; per two dozens, 1s. 11d. each sheet; per four dozens, 1s. 10d. each sheet.

Subject to a 5 per cent. discount to members of the Apis Club.

Packing & Carriage Extra.

\*.\* Since the Metal Foundation will be produced only to order, no order will be subject to cancelling.

## Claridge's Famous 3-frame Nuclei of Pure Italian Bees,

still unsurpassed, bred from selected vigorous strains, are good tempered and easily handled, yet the sort that "Get the Goods."

Orders are now being booked, but please don't all speak at once.

**No Stocks or Swarms for Sale**

The well-known "Claridge Quality" nucleus has **all three frames** crowded with brood—(compare this with other offers of so-called 3-frame nuclei)—is **guaranteed** to be absolutely healthy, and to give satisfaction: headed by 1920 Pure Italian Queen.

### On three British Standard 14 x 8½ frames - £3 3 0

¶ Owing to the demand I had last season for nuclei on Commercial frames, I am offering a limited number on the 16 x 10 frames, same quality and condition as above.

### On three Commercial 16 x 10 frames - £4 4 0

All carriage paid.

Boxes to be returned.

¶ Customers are particularly requested to note, that in spite of the advance in cost of sugar necessary for feeding, and the probability of heavy increased railway charges, **I have not raised my prices.**

Full Price List, now in print, sent on request.

**F. M. CLARIDGE,**  
Copford Apiary, nr. Colchester.

THE HIGHEST TESTIMONIAL—90 % of my letters commence, "I have been recommended to you . . . ."





## Seasonable Hints.

So many colonies of bees die out during the first three months of the year, owing to a lack of food, that no apology is needed for again drawing attention to this matter. If there is any suspicion that any colony is likely to be short of stores they should be kept supplied with candy. We have noticed in several papers that give hints on bee-keeping it is recommended to give flour in the candy. This should not be done for at least three weeks. When honey, or pure sugar, is used as food by the bees during cold weather there is very little waste to incommode the intestines during the time the bees are confined to the hive by inclement weather and are unable to take a "cleansing flight." If they consume pollen, a very different state of affairs will result. There is a considerable amount of waste from the digestion of pollen, and unless frequent flights are possible the health of the bees will suffer. The same applies to flour in candy, only with more force, as the flour being mixed with the food the bees are obliged to take it, whereas they please themselves as to using the pollen stored in the combs. Although we have had mild weather in this part of the country the last few weeks, winter is by no means over. There is still time for several weeks of wintry weather, and a consequent long confinement of the bees to their hives, therefore do not mix flour with candy until there is at least a prospect of their being able to fly at frequent intervals.

From several inquiries we have received, it appears that a number of beginners have been very much concerned at their bees flying strongly on mild days. This need cause no alarm. As explained above, it enables the bees to rid themselves of accumulated faeces, and is beneficial to them, but one word of caution. If it is washing day when the bees are indulging in a cleansing flight, advise the "gude wife" not to hang clothes out to dry, even within 40 yards of the hives, during the time the bees are flying. Advantage will also be taken on a mild day of the opportunity of cleaning out the hive and ridding the floor of those bees that have died. A large or small number of these, and also bits of cappings and other *débris* will be found on the ground in front of the hives. The hives may also be plentifully spotted with excrement, and some old bees found chilled and crawling or dying near the hives. There is nothing

abnormal in this, and it should not cause undue alarm. Before the advent of "I.O.W." disease no notice used to be taken of these happenings; they were all a matter of course, but we can quite understand that now, when "soiling" and "crawling" are the best known symptoms of "I.O.W." disease these things may cause uneasiness.

## British Bee-Keepers' Association.

The Monthly Meeting of the Council was held at 23, Bedford Street, Strand, London, W.C.2, on Thursday, January 15, 1920.

Mr. W. F. Reid presided, and there were also present:—Miss M. D. Sillar, Messrs. G. Bryden, G. S. Faunch, G. J. Flashman, T. Bevan, G. R. Alder, G. W. Judge, J. Herrod-Hempsall. Association representatives: P. E. Wagstaff (Herts), R. R. Babbage (Middlesex), G. Thomas (Gloucester), E. Ff. Ball (Ducks), Major C. C. Lord (Kent).

Letters of regret at inability to attend were read from Messrs. T. W. Cowan, C. L. M. Eales, J. B. Lamb, W. H. Simms, F. W. Watts, F. W. Harper.

The Chairman referred to the sad loss the Council had sustained through the death of one of the members, Mr. J. N. Smallwood, who had rendered great service to the Association. A silent standing vote of sympathy to the widow and family was passed.

The minutes of the previous meeting were read and confirmed.

The following new members were elected:—Lady Katharine Meade, Miss M. Mack, Miss H. L. Beamond, Captain C. G. M. Hatfield, Captain R. F. Cuthbert, Messrs. R. B. Manley, H. Cleaver, F. W. Miles, W. A. Robinson, F. Richardson, C. D. Bartlett.

The following Associations nominated representatives, and all were accepted: Lady Katharine Bouverie (Salisbury and District), C. Harrison (Cornwall), W. Sanderson (Northumberland).

The report of the Finance Committee was presented by Mr. G. Bryden, who stated that the receipts for December were £32 8s. 4d., and the bank balance on January 1 was £45 16s. 8d.

The report for 1919 was read and adopted.

Arrangements were made for the annual meeting in March.

The report on the Intermediate Examination was presented, and it was resolved to grant certificates to the following:—Mrs. M. K. Hodgson, Mrs. Llewelyn Morgan, Misses D. Y. Knowles, A. D. Betts,

E. H. Darney, N. Meston, I. K. Berridge, Rev. W. P. Jones, Rev. G. Jones, Major E. B. Wilkinson, Rev. A. Callo, Rev. W. Murdoch, Dr. G. R. Strong, Messrs. A. T. Hedger, R. Lloyd Roberts, A. Preston, J. E. Pinder, J. G. Fletcher, D. E. Bonvonn, T. W. Cockerain, D. W. Walters, C. H. Brown, E. F. Ledger, E. D. Lowes, A. Fry, F. Tyler-Taylor, and E. J. George.

The Secretary reported progress with regard to labelling honey with the country of origin.

Letters were read from Mr. J. N. Kidd and Dr. Abushady, and the Secretary was instructed to deal with same.

Next meeting of Council, February 19, 1920, at 23, Bedford Street, Strand, London, W.C.2.

## Jottings from Huntingdonshire

People who live in the country, and not for it, miss much; in fact, three-fourths of the joys the countryside has to offer. One is continually witnessing scenes such as have set the poet singing and the painter and etcher busy with brush and pencil. And what wonderful hidden power and beauty can be discovered in a tree bud as it silently prepares itself for the resurrection of spring. Think of the fascination of keeping a diary, entering from day to day what one sees and hears. For instance, to begin on

Jan. 1st.—Bees all out; first primrose in bloom.

Jan. 2nd.—Colder; first wallflower opened.

Jan. 3rd.—Windy; many aconites in bloom.

Jan. 4th.—Sunny; snowdrops and violets open.

Jan. 5th.—Bees busy; arabis and dead nettles blooming.

Jan. 7th.—Sunny; heard a lark in full song.

Jan. 8th.—Sunny; saw first song thrush.

Jan. 9th.—Cool; saw dandelions out and partridges mating.

Jan. 10th.—Bees very lively; first colts-foot in bloom.

Jan. 11th.—More thrushes returning, and beginning their song.

I need not go on; enough has been said to show that the country in winter is only "deadly dull" to those who shut their eyes and ears. Again, what we miss by not getting in touch with bird and insect life! Many living things are misunderstood because we fail to try and understand their language. For instance, a little study of horsensense soon enables one to understand when a pony is greeting, or asking for food or water. Goats bleat

at times just to try their voice, at others they bleat a welcome, at others they ask for change of tether or to be brought in, and still again they bleat earnestly for their attendant. "Daddy, one of the goats is calling for you," announced one of my bairns to me one night last summer. I turned out and made for the field in which they were tethered, and found one had got loose, and had got so near to the other as to entangle chains, with the result one was so wound up as to be nigh choked; the other, seeing its distress, was calling to me to come and liberate it.

Last May I was busy one morning in the harness room, rubber-soleing some boots, when a blackbird flew in and made an unusually vigorous "Twit, twit." I at first concluded he was in the habit of stealing some of my fowl meal which I kept in a tub there, and was angry at my presence, but as he continued this for two or three minutes I went out to see if a cat was on the prowl. The bird then flew up to me and back to a fence, calling all the time; up to me again, and back to the fence. By this time I realised that the pretty creature wanted me to go to the fence. I went, and lo, there was a trap, which had been set for a rat or a rabbit, had caught a hen blackbird by one leg. I shall never forget the twittering of joy the cock bird uttered as I set his mate free. Fortunately, her leg was held between the teeth, so that cut skin was all the damage done. Later on in the summer a pair of thrushes came to me calling for my aid. Remembering the blackbird, I followed to where they led me. I may say that they first showed they needed my help by flying through an opened window to where I was sitting writing. On reaching the bush where the trouble was I found their nest on its side, and three young songsters in the hedge bottom; one was dead. I picked up the other two, and placed the nest in a secure place safe from the bullocks, which had evidently been responsible for the disaster, put the two fledglings in, and heard a pean of thanks. I have related all this to lead up to what I am going to say about some bees. Five days ago the sun set amidst the sweetest shades of pink and blue, with fringes of gold. It was a gorgeous sight, such as would rejoice the heart of a Leader. Darkness fell, and the gentle zephyrs gave way to a strong wind, which increased towards midnight, bringing with it a storm of rain. By morning light, however, both wind and rain had ceased, and the new day was bright and calm. A man was hedging near, and he came and said my bees were buzzing all about him. I couldn't quite understand this, so went out to investigate. No sooner had I got outside the

door than the insects were buzzing around me. The noise they were making was distinct to the hum of pleasure or the buzzing of anger, and as they continued circling around my head it struck me that, like the birds, they were endeavouring to attract my attention. It took me some time to discover which hive, these bees so busy making invisible halos around my head, were from. I got on the right track at last, and, thinking mice had got inside the hive, I took off the roof to see if I could see any traces of a mouse in the coverings. Judge of my surprise in finding the coverings—mostly paper—were soaked right through the middle. The woodwork is weather-proof, and the wet must have been forced by the wind through the ventilating cone. Anyhow, I got more newspapers, and gave them a warm, dry covering in return for the damp one. There was no buzzing around my head now, so I am convinced those bees were telling me in their own way that their hive coverings were not to their liking.

I should be glad if other bee-keepers would note anything unusual among their bees, and let me know. For some time past I have concluded that bees have more sense of reasoning than Lord Avebury thought them to have, and I wish to collect all the evidence I can to prove that bees are able to reason in a superior way, and are in this sense very little, if any, below the bird creation.

There is so much that is mysterious about a hive that one at times wonders whether the hive has a soul. The solemn, wonderful silence during wax making; the cleverness shown in distributing the work of the hive, scavenging, ventilating, guarding, varnishing, nursing, foraging—how mysterious it all is! Bees' ability to distinguish colours, their love of music, their quickness at detecting whether one is nervous in their presence, their sensing changes in the weather, days, weeks, months ahead; is it not awe-inspiring? Small wonder they have attracted the interest of civilised man for centuries. For fully 5,000 years man has watched the habits of the honey bees, and hived them and sang songs as they ate their honey. Studied so much and known so little, even Virgil hadn't fathomed the mystery of the swarm. To him, as to Orientals, bees were reigned over by a king, and young bees issued forth from carcasses of oxen. Eastern bees are carnivorous, and are not above swarming into a carcass of an animal.

The days are dashing by; soon breeding will be going apace. Some spring feeding will be needed, except where the stores were abundant. Every day this year my bees have been out and about, which means stores consumed. January has been

all too mild, but be prepared for a cold snap before the vernal equinoxial gales announce the bursting forth of hedgerow, tree and meadow.—E. F. HEMMING, Steeple Gidding.

## Jottings.

*Legislation, P. 529.*—10042 and 6.—How curious the only opponents to hand as yet adopt the title of "master." This "desirability," I see, does not wipe out the liability of disease inroads, however strenuous one's efforts, but it is most annoying when one is certain, as with foul brood, for instance, this might not have happened. Where the owner is qualified to do the necessary work, if trouble comes, surely this is no fair reason why those that are not should not have special assistance available, and where any doubt or disapproval of the expert actually handling exists, this can very easily be got over by doing it oneself, but he is a sorry "master" that can learn nothing, and see no good to the craft as a whole, in this reform.

This objection is, however, a live one, and seems to call for special choice and training, with regard to inspectors, as it is quite evident that tact for the human element will be almost as necessary as the "master hand."

My views are well known, so it is not necessary to repeat them, but I should like to see the B.B.K.A. get on with a conference to consider what steps bee-keepers wish, and how far it will be able to recommend compensation, and how. This seems advisable, if destruction is found necessary. Some remarks, "on the rounds," "What's it all about? Do they get another lot if we lose them." Owner of one skep. "I suppose it's to make bee diseases notifiable, like the cattle and other things." And there you have it, and why not?

10061.—I don't quite follow Mr. Fordham's line of argument, "I may be wilfully blind." Bee-keeping may be a small industry, but it is one of the most important, the art and philosophy of which is more or less hidden in the wheel of Nature, and really perpetuates and makes possible our "sylvan retreats."

I fail to see that an ordered state of affairs, as set up by Government with regard to bee-keeping and its products, should prove any more distasteful or arbitrary than the "interference" with other foods in a more developed state, fruit trees included. May trust and mutual help be advised, indulged, and provided for.

"*Tanqing*," p. 573.—G. D. C. has certainly started me thinking in a different

channel, and I will try and get some evidence, but up to the present I have leaned to the idea that this is done to establish a sort of "air" proprietorship. But my old father-in-law, who is 87, can certify that this is a sure settler, or preliminary, to safe hiving, as he assures me a swarm not only changed direction but chased him over a wall. He had a doorway to get through and over a yard, he eventually finding sanctuary in a dark harness room. The bees, however, found the key to a settlement.

*An Advertising Truism.*—I saw an appropriate honey label exhibited by a London vendor. As no rights appeared to be claimed, I venture to offer it:—

"To save the sugar, now's the cry,

So sweeten well with honey.

Get 'Maid of Honour,' and you get

Best sweetness for your money."

May all our readers have a prosperous season.

A. H. HAMSHAR.

### Notes on Bee-Keeping.

Many people would commence bee-keeping but for the constant dread of being stung in handling bees. Would-be bee-keepers should bear in mind that by a slight manipulation bees can be made as tame as flies. In order to accomplish this, the bees must be frightened. To frighten or intimidate a bee requires a different course of procedure to the ordinary method of subduing members of the animal kingdom. It was discovered that when smoke was blown into a hive the bees were thrown into a state of great commotion, and with evident trepidation commenced to gorge themselves with honey from the open cells. In this state of demoralisation bees were found to be comparatively harmless. Of course, there are other methods of subduing bees, such as the carbolic cloth, etc., but the best all-round appliance, to my mind, is the smoker. The most astonishing part of modern bee-keeping is the ease with which a bee-keeper handles his bees—removing combs covered with bees from the hives, taking up handfuls, causing them to perform an exodus from one hive to another, yet without a sting. Confidence, in a great measure is the bee-keeper's safeguard; skill, perhaps, ranks as second in importance; and while the appliances used in quieting the bees only take a third position, yet we cannot do without them. Various conditions have to be borne in mind when handling bees. A hive of bees in the middle of the day, when honey is coming in plentifully, is in its most amiable mood, and requires little, if any, subduing. The same hive on a cool evening will not per-

mit even a corner of the quilt to be turned up without resenting it. I have noticed bees in spring, after hibernating, are in a very amiable mood. In autumn the bee-keeper will find it the most difficult to handle his bees, as all stores are sealed up at this time. I have found out, if a little syrup is poured between the frames, this will have the desired effect. An incautious jarring of the hive by a sticking roof or super will raise a colony to extreme viciousness. In subduing bees the bee-keeper should raise the roof with as little sound as possible, place it somewhere near, then peel back the quilt with one hand, while the bees are driven down between the combs with the smoker. As soon as the bees are busily engaged filling themselves with honey—which can easily be noticed by them poking their heads in the cells, do what is required quickly and gently, make no sudden movements, and on no account allow your breath to enter the hive, as they seem to dislike the human breath. Always see there is plenty of room when lifting out a frame: the smell of poison when a bee is crushed seems to irritate others, and is quite discernible to the bee-keeper, even at a distance. Should a colony be raised to a pitch of stinging, it is far better to replace quilts, close up, and go to it again on a future occasion. One word of caution. When using a smoker, never smoke the bees so as to stupefy them: two or three puffs from the smoker are sufficient to cause the bees to gorge. I have known cases where bees have been killed by an overdose of smoke. The bee-keeper will soon learn from experience when and how to use the smoker, and if all his manipulating is done quickly and quietly then success is assured.—P. ЛУТНОВЕ, Padgate, Warrington.

### Of Monmouthshire Bee-keepers' Association.

The annual general meeting of the above Association and the lecture will take place in the Temperance Hall, Newport, not in the Town Hall, as previously announced. The subject of Mr. W. Herrod-Hempsall's lecture will be "Queen Rearing and Introduction." — G. R. STRONG.

### Wickham Bishops and District Bee-keepers' Co-Operative Association.

The above-named Association held its inaugural meeting on the 24th inst. Twenty-three local apiarists, representing about eighty stocks, promised their support, but we hope to double this number very soon. Our principal objects are mutual assistance in the management of bees, combating disease, buying plant, and

selling produce co-operatively, and encouraging exhibition at various shows. We are indebted to Mr. Hammond, our expert, for bringing us together and explaining the advantages we should enjoy by friendly co-operation, and are anticipating much pleasure and profit from the working of the scheme. Should any of your readers be able to send me the rules of a similar association the courtesy would be very much appreciated, and they would be a great assistance.—CHARLES W. COCKBURN, Wickham Bishops, Witham, Essex, Hon. Sec.



*The Editors do not hold themselves responsible for the opinions expressed by correspondents. No notice will be taken of anonymous communications, and correspondents are requested to write on one side of the paper only and give their real names and addresses, not necessarily for publication, but as a guarantee of good faith. Illustrations should be drawn on separate pieces of paper. We do not undertake to return rejected communications.*

### Bee Legislation.

[10114] I am not sure if a mere woman may express an opinion on the above subject, as I notice you ask that each correspondent should embody "his" views in one letter! But as a new member of the B.B.K.A. AND a voter who has already used "the power of the vote" to good effect with M.P.s. perhaps I may be allowed a space? On the face of it, one would think that legislation "to check the spread of infectious disease" would be a great advantage, but can the B.O.A. do this with regard to bees, considering that they do not even know the cause of, nor the remedy for, "I.O.W." disease? We might be compelled to make our bees (I have only one hive) the subjects for "a labyrinth of anti-serum experiments," as F. A. Charlton puts it. The B.O.A. are in the hands of the medical experts and bacteriologists. In 1912 the Board published a report by several M.D.'s and D.Sc.'s, which described "*Nosema apis*" as the agent of "I.O.W." disease, and cited numerous instances, although this report did not claim to be final. (They never are!)

Now this year Dr. Rennie (D.Sc.), of the University of Aberdeen, in a pamphlet he has sent me, opposes this idea, and writes: "We conclude that the causal organism—has yet to be found." (Why an organism at all?) Your correspondent (No. 10062), in issue for Dec. 11, 1919,

another D.Sc., considers: "The results of legislation upon the spread of infection in men and domestic animals is sufficient witness" in support of legislation; but Sir John MacFadyen, of the Royal Veterinary College, and a practical scientist of European reputation, commenting on the mistakes made by scientists in reference to the *swine fever* bacillus, says: "When one reflects on the nature of the evidence on which it has been held, and very generally accepted, that particular bacteria are the cause of contagious diseases, it becomes manifest that in some cases the proof is no more complete than it was in the case of swine fever; it is therefore not improbable that future investigations may bring on certain bacteria the discredit which has already fallen on the so-called bacilli of swine fever and canine distemper." The "B.M.J." for May, 1911, stated: "Remedies and modes of treatment, like fashions in dress, have their little day, and cease to be. Our back numbers are the graveyards of discarded theories."

Would it not be wiser, therefore, not to place ourselves in the hands of these "theorists"? Instead, I would suggest that every bee-keeper be compelled to join a bee association, and that every one who has a diseased hive be compelled to notify the expert of the association, who should go and inspect it and advise sanitary measures.

Sir Benjamin Ward Richardson tells us "Inoculation is bad sanitation"; also that it should be an offence, punishable with a fine, to leave a hive uncleaned and with dead bees in it.

If I have not exceeded my space I would like to point out to F. Charlton that "Mother Earth" is the best purifier we have. Is it not the Kaffirs or Zulus who purify their drinking water by carrying earth in their leather water bottles?—(Miss) A. PARKER, "Leigh," 24, Woodbury Grove, North Finchley, N.

[10115] In this discussion on legislation it appears to me that the main point is being missed altogether. It is idle to ask whether you are in favour of legislation, or to discuss such a vague term. How can any person say whether or not they are in favour of legislation, when no one has even the haziest notion as to what form that legislation is to take? One might equally well ask the foolish question of every M.P.—Are you in favour of "An Irish Bill."

May I say I am in favour of legislation if I know how, and by whom, that legislation is to be administered? but the whole question bristles with difficulties, and cannot be settled by loosely discussing "legislation." If we take the simplest form,

that of making it compulsory on the part of the bee-keeper to notify disease, under a penalty, who is to decide whether that stock has contracted "I.O.W." disease? I venture to make the assertion that there is not one man in England who could give a decision with certainty. One party of eminent bacteriologists state that *Nosema Apis* is the cause, and another equally eminent party are of the opinion that *Nosema* has nothing to do with it, hence the futility of the suggestion by "A Leicestershire Bee-keeper" (10060) that all inspectors should be B.B.K.A. experts. Another correspondent urges an extension of the Diseases of Animals Act, but, to take the case of swine fever, this is most easily diagnosed; the diagnosis of "I.O.W." disease is hopeless in a great number of cases. To take one example, simple dysentery is credited to it in almost every instance, and, incidentally, many "cures" of "I.O.W." disease have been attributed to the remedy employed, when no "I.O.W." disease has been present.

The real question to the thoughtful bee-keeper is, to whom are we to entrust our liberties? The Government would naturally place the power in the hands of their own people; but what sane bee-keeper would care to trust himself in the hands of the writer of the famous Government leaflets F.C.31 and 48, whoever he may be? If an inspection clause is embraced in the bill, who will be the inspectors? These are questions the thoughtful bee-keeper must ask himself before hastily committing himself and his liberties to legislation.

The uselessness of obtaining signatures, either for or against, is apparent when the signatory cannot possibly know what he is signing, and in the case of the ignorant bee-keeper the presenter of the petition carries no small measure of weight. I, for one, will sign no blank cheque for either party.

A better end would be served by the drafting of a bill by the JOURNAL; this could then be criticised to some good purpose, and eventually a statute evolved that could be presented as a model for the Government Bill, but until disease can be diagnosed with certainty legislation is premature, and would inevitably entail great hardships, and would result in much ill-feeling.

Until the time is ripe, let the B.B.K.A. take the lead, and introduce a scheme of education and research which would be a credit to its promoters and to apiculture generally.—GILBERT BARRATT, Sheffield.

[The petition for legislation is not a question of "signing a blank cheque." Its object is to find out whether bee-keepers want a "cheque" for the protection of careful bee-keepers, or if they are content

to put up with the "check" on the industry caused by the present state of affairs. We do not see that it is idle to discuss whether legislation is wanted or not, that appears to us to be the first question to be settled. If it is not wanted of what use would it be to draft and discuss a Bill? Decide that legislation is wanted by a considerable majority of bee-keepers, then discuss the form it is to take.—Eds.]

[10116] May I be allowed to use a few lines of your valuable space to state my convictions *re* legislation.

Although I grant that the principles of legislation—as applied to specific infectious diseases in the animal world—have been the means of checking the spread of disease, yet no rational form of legislation that could be applied to bee-keeping can have anything like the same effect, for the following reasons. Firstly, our races of bees are social insects living in colonies. When one or more bees in a hive become diseased it rapidly spreads until the whole are infected. They cannot be isolated like other animals under legislative interference; and *without legislation the spread of infectious disease cannot be checked*. Secondly, their latitude of flight cannot be controlled, and if we add to this the fact that they are by nature determined robbers, have we not, then, two of the most uncontrollable factors in the propagation of the disease?

Now observe, if we take it for granted that the cause of the "I.O.W." disease is of bacterial origin—at present "ultra-microscopic"—and highly contagious and infectious, then infected bees can spread the disease in two different ways: (1) They probably carry the micro-organisms on their feet, wings, proboscis, and especially in their alimentary canal. Thus contaminated they swab out the nectaries of flowers, leaving behind a film of these micro-organisms to be lapped up as a pure saccharine culture by the next healthy bee that visits these flowers. This bee returns to its healthy home and regurgitates the contaminated contents of its honey-sac into the nearest cell. The young grubs are fed with this food, and the disease spreads. (2) An infected colony of bees is in such a stuporous condition that strong relays of healthy robbers find no difficulty in storming the entrance and carrying off the microbial stores to their own healthy hives, only in turn to be seized with that lethargy which is shortly to become so prominent and distressing a feature of the disease.

I strongly object to any form of legislation that may be introduced, which will place the careful bee-keeper on the same footing as the careless keeper of bees. If

legislation should take the form of frequent visits from inspectors, then the careful bee-keeper will have to undergo the same amount of disturbance and inconvenience as his careless disease-spreading neighbour. If legislation is not required for the careful bee-keeper, he should neither be interfered with nor come under the law until disease breaks out in his apiary.

I do not advocate that nothing should be done, but what is to be done can be done by an Act which will make it—

- (1) Compulsory to notify infectious bee-diseases—attaching a heavy fine for non-notification.
- (2) An offence against the law to leave exposed any *focus* of infection whatever.
- (3) Every stock, swarm, nucleus and queen-bee to be certified by a trained expert in bee-diseases as healthy before being sold.
- (4) An offence against law to sell infected hives or appliances.

To Nos. (2), (3) and (4) a heavy fine to be attached for violating the law.

The best way to grapple successfully with any disease is to get rid of the ignorance concerning it.

A last word on the subject to bee-keepers. *The leadership of the battle against this devastating pestilence is in your hands. Your only hope lies in early diagnosis, with prompt systematic treatment of diseased colonies, and prophylactic measures rigidly carried out in every hive in the infected area.*—ANDREW WOOD SMITH (Final Medical Student), 5, West Castle Road, Edinburgh.

[10117] With regard to legislation, I cannot help thinking that most bee-keepers are too apt to think only of "I.O.W." disease. I should like to remind your readers that both "American" and "European" foul brood are still with us, and that even if hives in which stocks have died of "I.O.W." are not very dangerous (which I do not admit), it is quite certain that in the case of foul brood it is perfectly deadly to have hives left about in that way.

I am heartily in favour of any form of legislation which will be thoroughly effectual. I think that the Bill of 1912 a thoroughly bad one. Unless I am mistaken, under it an inspector of the B. of A. need not be a thoroughly qualified man, but could, "accompanied by an expert adviser, if he thinks fit," enter, etc. At the same time this Bill did not in any way provide for the prohibition of skeps and boxes as homes for bees, and without this I am very sure any legislation cannot be successful. For how can an inspector say whether a box hive is clean or not?

No one can say for certain that a stock is healthy without seeing the combs, and consequently an Act that does not provide for the prohibition of skeps is simply a measure of legislation for one branch of bee-keepers only—*i.e.*, the movable comb men.

Again, some method of appeal should be allowed before final destruction of stocks. Any stock that *can* be saved should at any cost *be* saved, since here is our best chance of overcoming disease.

Again, let me say that we should not lay too much stress on "I.O.W." disease. I feel sure "I.O.W." is an epidemic, and will in a year or two pass into oblivion for a considerable period. Already it is far less deadly. In other words, the surviving bees, as hosts of the "I.O.W." germs, are evolving a greater resistance to them, and I believe will become, to a great extent, fortified against their attack. This is why no diseased stock ("I.O.W.") should be destroyed if it can be saved by any means.

Foul brood seems to be on a different plane, but so little is known about it yet that it is hard to say much, except that there appear to be several diseases under this head which require different treatment. It does not appear to be epidemic, however, and should be either cured or destroyed within a very short time of discovery, and here, I think, inspectors would be useful.

Now, as to qualification of inspectors, I suggest that every inspector should be required to pass a severe test as to his knowledge of diseases and their treatment, and, further, that this test should have nothing whatever to do with the ordinary expert's certificates of the B.B.-K.A. I say this, not because I have anything against the B.B.-K.A., but because a minority of bee-keepers have and will oppose anything proceeding from it. As these are in many cases some of the largest bee-keepers in the country, their wishes must be consulted if the measure is to go through.

I think that we are beginning at the wrong end—putting the cart before the horse—over this question. You, Sir, say that the B. of A. is now taking an interest in bee-keeping. I question it. If they are, then they do not think legislation is required. If they did, they would very soon introduce it, with or without our leave. It is no use for the authorities to wait for bee-keepers to ask for legislation. If they think it is right for them to legislate they should bring in a Bill at once, and make it a Government Bill.

Did the Government, in the case of swine fever, wait for pig-keepers to ask for legislation? No. The same may be said of scab, mange, anthrax, etc. By all means let those who favour it petition for legislation, but, at the same time,

they must not find fault with those who are opposed to it because they strive against it. For one side to call their opponents "ignorant upstarts," and for the other to use the term "ignorance and cupidity," is quite beside the purpose.

In conclusion, let me assure your readers that Mr. Fordham's fears are quite groundless. Inspectors will, I am sure, not make themselves a nuisance, and where a man is taking proper measures to effect a cure he will be left to his own sweet will. It will not be a similar case to that of anthrax, where immediate destruction is compulsory.—Believe me, yours faithfully, R. B. MANLEY.

P.S.—Couldn't you print those other letters of Mr. Trowse for us just as they are? Judging by 10042, they must be priceless—and we get so few really funny articles in the B.B.J.

[10118] I am heartily in favour of legislation for control of bees. This district has suffered very much from "I.O.W." disease of late years, and my experience goes to show that we gamble, if we spend money on bees until we can secure compulsory notification of disease, followed by thorough dealing with the same.

I wonder if your readers have any knowledge of swarms being drowned. I am told of a case of it, in Esthwaite Lake, during the past season. Presumably the queen settled on the water, and was followed by the swarm. WM. MARTIN.

[10119] Our sympathies are with you, Messrs. Editors, in the task of deciding which of the numerous letters on the above subject are fit for publication. My opinion is that space should only be given to those who really deal with the matters under discussion, whether these be for or against, as so much already has been printed which is quite beside the point.

The crux of the question appears to be "Government inspection"—the probability of undue interference by Government novices. Surely the Bill, when introduced, would contain safeguards against incompetency of inspectors, and only experts would be appointed?

Would it not be better to obtain powers enabling county associations to take charge of this work of inspection in their own district, to give advice where such is needed? Should any stubborn or stupid member, who has the disease in his apiary, not be amenable to quiet and reasonable advice, then such cases should be reported to headquarters and force used where reason fails.

Let us stamp out the disease at all costs, even if it offends the susceptibilities of a few who are entirely out of joint with the times.—S. MILTON, Derby.

[10120] *Re* your advertisement in the B.B.J., I have 27 stocks of Italian and hybrid bees, but still slight traces of "Isle of Wight" disease. *Re* legislation, my newsagent failed to get me the B.B.J. for several weeks, so I did not know and have not been able to read all the aye's and no's of the problem of legislation; but I should like to say I have kept bees since 1892, when I had a bad attack of beeitis, have had up to 40 stocks and have handled a few of other people's bees, and it did not take me many years before I had very strong convictions for legislation. How can Smith, who is a clean bee-keeper, pride himself on his apiary, when Jones has a hive over the wall reeking with disease and Smith has no power to notify it? I take it we should not have inspectors to visit us unless there was a real reason, i.e., disease notified. Anyhow, I myself have no fear about inspectors visiting me. You may print this as you like or consign it to the W.P.B., but as it is an important issue I felt bound to give my opinion.—C. W. DYER.

## Notices to Correspondents

W. F. WILLMOT (London).—*Judging amount of stores.*—(1) You can only judge by examining the combs. Keep the bees supplied with candy until it is safe to look into the hive. On a mild day, when bees are flying, you might turn the quilt back, when you will be able to see if there are any sealed stores left. (2) You may use a little smoke to drive the bees down when giving candy. As the combs are not lifted out, it does not matter if the bees do not gorge themselves; it is only necessary to drive them out of the way so they are not crushed.

*Removing swarm in Brice swarm catcher.*—A little smoke, or a feather dipped in carbolic acid and water, will drive the bees away from the fasteners, so that they can be unscrewed. The swarm catcher and bees may then be carried to the hive, the frames of comb or foundation, with adhering bees, placed in it, and the rest of the bees shaken off in front.

G. F. STUBBS (Wednesbury).—*Price of sugar.*—Get the sugar from your ordinary retailer, and pay the same price you do for ordinary consumers' sugar—3d. per lb.

E. F. RALLI (Shalford).—*Bee gloves without fingers.*—Get a pair of bee gloves from any appliance dealer, and cut off the fingers to a length to suit yourself.

HEATHERWOOD (Surrey).—*Honey too thick to extract.*—The honey is too cold and stiff, or it is heather honey. The aroma and flavour will decide the latter point. If heather, it will not extract; if only too cold, keeping it in a temperature of about 100 deg. Fah. for a couple of hours should overcome the difficulty; extract while warm.

"BILLY" (Salop).—*Disinfecting hives and frames.*—The safest method of disinfecting hives is to scorch them out with a painter's lamp. Scrubbing out with scalding water and soap, and then



applying a strong solution of formalin or other disinfectant and water, would be effective. The frames could be boiled for 20 minutes, and then immersed in disinfectant and water for an hour or longer. The propolis can be cleaned off excluders with Fels Naphtha Soap or Scrubb's Cloudy Ammonia. They may then be treated the same as the frames, or, if too large to boil, treated with disinfectant only.

"A WORKER" (N. Wales).—*Destroying bees*.—The best and quickest method is to dissolve  $\frac{1}{2}$  oz. cyanide of potash in half a pint of warm water and pour it through the quilt between the combs. This is a deadly poison, and great care must be taken if it is used, the frames, quilt, combs and bees being burnt as soon as possible. If you wish to use any honey that may be in the combs, use about  $\frac{1}{2}$  oz. chloroform instead of the cyanide and water.

J. H. H. (Wales).—*Feeding with granulated honey*.—If the honey is so stiff it will not run, a bottle may be laid on its side, with the mouth over the feed hole. A feeder is not needed for candy; it is placed directly over the bees.

ANXIOUS ONE (Sussex).—*Moving bees*.—The hive may be moved a mile any time in February without danger of losing the bees.

J. LANGDON (Exeter).—*Salt for bees*.—Bees, like other living creatures, must have saline matter to keep them in health. They would probably use some if sprinkled on the alighting board.

A. L. H. (Easton).—The yellow substance under a thin layer of honey will be pollen.

T. H. MITCHELL (Greenock).—*Bee-keeping Simplified* and *The British Bee-keeper's Guide Book*. See list in this issue.

#### Suspected Disease.

A. S. BLACKETT (Surrey) and H. J. T. (Norwich).—Cause of death was "I.O.W." disease.

H. H. C. (Highgate).—So far as we can tell, there is no disease in either sample.

## Special Prepaid Advertisements One Penny per Word.

**Trade advertisements of Bees, Honey, Queens, and Bee goods are not permissible at above rate, but will be inserted at 1½d. per word as "Business" Announcements, immediately under the Private Advertisements. Advertisements of Hive-manufacturers can only be inserted at a minimum charge of 3s. per lin., or 5s. per inch.**

**PRIVATE ADVERTISEMENTS are only intended for readers having Surplus Stock to dispose of. Driven Bees, Nuclei, and Queens that are reared or imported for sale, are Trade Advertisements, and can only be accepted under trade terms. A charge of 6d. extra will be made if a box number is used.**

**Advertisements must reach us NOT LATER than FIRST POST on TUESDAY MORNING for insertion in the "Journal" the same week.**

**Orders for three or more consecutive insertions in "The Bee Journal" entitle advertisers to one insertion in "The Bee-keepers' Record" free of charge.**

### PRIVATE ADVERTISEMENTS.

**FOR SALE**, limited number of healthy stocks Bees, strong, 8 frames, or Hives and Bees complete; delivery early spring; deposit.—HEWETT, 5, Owens Road, Winchester. a.49

**FOR SALE**, strongly built Corrugated and Timber Span Roof Shed, 31 by 28 ft., easily converted two lean-to, each 31 by 14, put on rail in sections, or as stands; particulars given; also quantity Board and Felt Roofing, Doors, and Windows.—HEWETT, 5, Owens Road, Winchester. a.50

**12 P.M. STOP PRESS**.—Message from Mars arriving.—Smith, Cambridge. (Later) Four, seven, nine, nought, nought, one, six, nought, nought. Mars wins. (We don't know what this means. Do they keep bees in Mars?—Editors.) a.63

**FOR SALE**, two 10-frame stocks Hybrids, delivery April, £5 each, £2 deposit, balance in April; four Standard Frame Hives, clean and well painted, 18s. each; four Super Clearers, 2s. 6d. each; Geared Extractor (Taylor's), in good order, 35s.—F. HOOD, Hermitage, Horton, Slough. a.51

**EPICURE**, first early Seed Potatoes.—14 lbs., 3s. 6d.; 28 lbs., 6s. 6d.; 56 lbs., 12s.; carriage extra; splendid cropper.—W. WOODS, Normandy, near Guildford. a.52

**WANTED**, third-class Honey in bulk.—Box 60, B.B.J. Office, 23, Bedford Street, W.C.2. a.53

**2 CWT.** finest White Clover Honey; sample 4d.—NORTH, Cressing, Braintree, Essex. a.55

**ITALIAN BEES** on 6 frames, headed by Penna's 1920 imported direct Queen, delivery June, £4 10s.—ENNEVER, Oak Avenue, Ridgeway, Enfield. a.56

**A VACANCY** occurs for a Pupil on an old established bee farm. Opportunity will be given to learn bee-keeping on a big scale.—Apply, Box 61, B.B.J. Office, 23, Bedford Street, W.C.2. r.a.57

**70 SECTIONS**, 2 cwt. Extracted, 12 dozen screw tops; sample 6d.—A. W. SIMCOX, 17, Victoria Road, Follings Park, Wolverhampton. r.a.58

**CLERK** seeks situation in a bee appliance manufacturer's office; has had five years' experience. Full particulars by post.—Box 62, B.B.J. Office, 23, Bedford Street, W.C.2. a.59

**WANTED**, Extractor, either chain or cog driven, for cash.—FALSHAW, Avondale, Stocton Road, Guildford. a.60

**NUCLEUS HIVES**—Three beautifully made for three frames, price 50s. each. Full particulars on request. Wanted, straight Worker Comb; shape and age no object, but must be guaranteed free from foul brood spores. Quote price and quantity.—H. M. STICH, Riccartbar Avenue, Paisley. a.63

**PURE** light Cambridge Honey, 14-lb. tins, 22s. 6d.; 28-lb. tins, 42s., carriage paid; sample 4d.; tins free.—J. YOUNGER, 6, Maid's Causeway, Cambridge. a.66

**EXPERT BEE-KEEPER** required; experienced in forming nuclei, etc. State particulars and salary expected.—Box 59, B.B.J. Office, 23, Bedford Street, Strand, W.C.2. a.28

**WANTED**, 7- and 14-lb. syrup lever-lid Tins, empty, equal new.—BURGOYNE, Assistant Overseer, Lyonshall, Herefordshire. a.42

**THE GRAMOPHONE RECORD EXCHANGE** will exchange Records 5s. dozen; return postage free.—Address, 6, Rood Lane, London. Particulars stamp. x.28

**W.B.C. HIVE**, new; one Bristol Hive, good condition.—BRETTELL, Pedmore, Stourbridge, Worcestershire. r.a.19

**CORRESPONDENCE** Course in Bee-keeping.—MISS F. E. PALING, Golden Square, Henfield, Sussex. r.a.54

**WANTED**, portable Greenhouse.—Price and particulars to W. HERROD-HEMPSALL, Old Bedford Road, Luton, Beds.

**WANTED**, Auster Rear Wind Screen for motor car.—HERROD-HEMPSALL, as above.

**FOR SALE**, one Exhaust Whistle, 11s., post free; one Wood Milne Motor Foot Pump, 45s., carriage free.—HERROD-HEMPSALL, as above.

### BUSINESS ADVERTISEMENTS. 1½d. per word.

**WE** are reserving a few choice Italian Queens for the D.B.s for delivery in May, June, July and August. Prices and particulars on application.—S. H. SMITH, 30, Maid's Causeway, Cambridge. r.a.62

**BOOK NOW**—Italian Queens, pure Penna strain.—ASHWORTH, The Bungalow, Weymouth Street, Warminster (late of Heytesbury). r.a.61

**BOZZALLA, LIGURIAN, QUEENS.**—Write for Illustrated Catalogue at once, and secure the benefit of the reduction in price which is available until the end of February. No charge.—A post-card to H. M. STICH, Riccartbar Avenue, Paisley, will suffice. a.64

**ITALIAN NUCLEI**, 3-frame, Penna's 1920 Queens (guaranteed), 70s.; Hybrids, Penna's and Simmins' Special, May-June delivery, £3, carriage paid; box returnable. Orders (cash) strict rotation.—**MOORE**, 31, Monmouth Road, Dorchester. r.a.65

**FOR SALE**, Swarms, English strain. Book now for May and June.—**BRISTOW**, 47, Auckland Hill, West Norwood, Surrey. r.a.67

**ITALIAN** and Hybrid 4-frame Nuclei, 1920 Queens, £3 5s.; Hybrid Swarms, 10s. 1b.; Fertile Queens, May-June 10s. 6d., July-August-September, 8s. Strongest and best honey gatherers in the country. All orders booked in rotation; £1 deposit, balance on delivery.—**THOMAS CHITTY**, Burligh Farm, Cassington, Oxon. a.36

**NEW ITALIAN NUCLEI** from 1919 Penna Queens, 3 frames, 50s.; delivery June-July; boxes 10s. extra, returnable.—**LEWIS, J.P.**, Clarboston Road, Pem. r.a.37

**BEES ON APPROVAL.**—We guarantee our Bees and Queens to give complete satisfaction. Special terms to disabled men. Catalogue 3d., which will be returned on first order.—**PEARSON & GALE**, Marlborough. a.38

**STRONG STOCKS** of Bees, guaranteed, on 7 frames, with pure selected Italian Queens, 1920; orders booked in rotation for delivery from beginning of June; price £5, carriage paid; travelling box 10s. extra, which is returned. Cash with order, or 25s. deposit and balance by May 25.—**MISS F. E. PALING**, Golden Square, Henfield, Sussex. a.40

**ITALIAN NUCLEI**, 3-frame, young Queens, £3; boxes 7s. 6d., returnable; Fertile Queens, 10s. 6d.; Virgins, 5s. 6d.; Simmins' and Penna's strain.—**WATTS**, Conway Cottage, Newtown, Parkstone, Dorset. r.a.42

**ITALIAN QUEENS** and 3-frame Nuclei.—Insure against disappointment by getting your Queens and Bees from a place where "I.O.W." has never existed. Orders now booked for June and July delivery.—**S. CRAWFORD**, Apiaries, Castlederg, Co. Tyrone. r.a.25

**HIVE MAKERS** Wanted.—Apply, letters only, stating age, experience, wages expected, to **LEE**, Beehive Works, Uxbridge, Middlesex. a.13

**HAVE YOU READ "THE BEE WORLD"?** If not, why not? Every number in itself is a useful literary work for practice and reference. Specimen copy free.—Offices: **THE APIS CLUB**, Port Hill House, Benson, Oxon.

**ITALIAN QUEENS** direct from Italy. Price list for 1920 on application.—Address, **E. PENNA**, Bologna, Italy. w.39

#### FINEST SECTIONS OF HONEY.

A large quantity for Sale at carriage paid prices, either Plain or Glazed

#### IRISH RUN HONEY.

Several cwts. for Sale in quantities to suit customers, at carriage paid prices in free tins and cases.

#### GORDON ROWE,

Honey and Beeswax Packer,  
28a, Moy Road, Cardiff.

#### BEES. BEES. BEES.

First Quality Dutch (Imported) Stocks.  
£5 per skep.

Terms: Cash with order.  
Bees delivered in Spring.  
P. BENNETT.

437, CLARKSTON ROAD, GLASGOW.

#### BEES. BEES. BEES.

## Books for Bee-keepers NOW IN STOCK.

	Postage
A Modern Bee Farm ...	7/6 ... 6d.
Beginner's Bee Book (PELLETT) ...	5/- ... 4d.
Bee-keeping (DR. E. F. PHILLIPS) ...	10/6 ... 6d.
<b>BEE-KEEPING SIMPLIFIED FOR THE COTTAGER AND SMALLHOLDER</b> (W. HERROD-HEMPSALL, F.E.S.) ...	1/- ... 1½d.
<b>BEE-KEEPERS' PRACTICAL NOTE BOOK</b> (T. W. COWAN) ...	1/- ... 1½d.
<b>BRITISH BEE-KEEPERS' GUIDE BOOK</b> (T. W. COWAN) (paper covers only) ...	2/6 ... 3d.
Dissectible Model of Queen Bee ...	4/6 ... 3d.
<b>FERTILISATION OF FRUIT BLOSSOMS BY BEES</b> (T. W. COWAN) ...	-/3 ... 1d.
Honey and Health (A. HOPE) ...	-/6 ... 1d.
Honey Vinegar (REV. G. BANCKS) ...	-/2 ... 1d.
How to Keep Bees (ANNA B. COMSTOCK) ...	5/- ... 6d.
<b>PRODUCING, PREPARING, EXHIBITING AND JUDGING BEE PRODUCE</b> (W. HERROD-HEMPSALL, F.E.S.) ...	2/- ... 3d.
Queen Rearing in England (F. W. L. SLADEN) ...	1/6 ... 2d.
Snelgrove's Method of Re-queening ...	-/6 ... 1d.
The "Townsend" Bee Book ...	2/6 ... 2d.
<b>WAX CRAFT</b> (T. W. COWAN) ...	2/- ... 2½d.
<b>Wilke's Book on Swarming</b> ...	1/- ... 1½d.
<b>MISCELLANEOUS.</b>	
Maeterlinck's Life of the Bee	3/6 ... 3d.
The Lore of the Honey Bee (TICKNER EDWARDS) ...	2/- ... 2d.
The Humble Bee (F. W. L. SLADEN) ...	12/6 ... 6d.
<b>THE BEE WORLD</b> (supplied only to members of Associations interested in the control and development of the APIS CLUB, apart from ordinary members of the latter), per copy ...	-/8 ... 1d.

### British Bee Journal & Record Office,

23, BEDFORD STREET, STRAND, LONDON, W.C.2.

#### BEE FLOWER SEEDS.

Collection of six best Varieties, 1s., post free. Beautifully Illustrated Instructions Up-to-date. Garden Guide, 64 pages, Free.

KNIGHT'S,  
SEED SPECIALISTS,  
WOLVERHAMPTON.

The products of the Apiary, of Poultry and Farm Stock, of the Fruit and Vegetable Garden can be Advertised and Sold through

### THE BAZAAR, EXCHANGE & MART

Newspaper.

Get a Copy—Thursday and Saturday 3d. The "Bazaar" publishes also practical handbooks by experts. Send for full catalogue, post free from—**WINDSOR HOUSE**, Breams Buildings, LONDON, E.C.2.

#### THE

### British Bee-Keepers' Association.

The recognised centre of practical and scientific bee-keeping in Great Britain. Particulars and conditions of membership may be obtained from the Secretary, **W. HERROD-HEMPSALL**, 23, Bedford Street, Strand, London, W.C.2.

# The Apis Club.

(Founded 1919).

**An International Institute for the service of Modern Apiculture, and for fostering a genial spirit of scholarly brotherhood amongst bee-keepers of all countries, with the co-operative object of promoting their educational and material interests.**

**C** That research work in bee culture is something more than laboratory investigations and is by no means limited to the subject of I.W.D. is a fact that should be recognised. The difference between much of the present teaching of bee culture and the ideal that should be aimed at is as much as the difference between imitation and original investigation. Where one teacher uses so many words in disputing parthenogenesis, another, a believer in experimental work, succeeds in artificially fertilising drone eggs and thus cuts the time, uncertainty and trouble of selective queen rearing by half. Where one man wastes paper and ink in hypnotising the initiative of original bee-keepers by asserting that bees winter within empty cells, as such co-authority has stated, another takes the trouble to see for himself.

**C** Now such and greater experimental work cannot develop on the basis of a few scattered colonies, but in a decent apiary with ample material and good organisation, provided with a common research fund. The surplus from such an apiary will no doubt well serve to pay much of the expenses. Were organised beekeepers to contribute individually or through their Associations, in whatever possible degree, the status of the work would soon be enviable, and those who devotedly shape the success of the scheme should ultimately find the fruits of its success their own.

## Why Should You Join The Apis Club?

- (1) Because you contribute by your moral support to the realisation of the educational and co-operative aims for which it has been instituted;
- (2) Because you become a joint partner with a full voting power in shaping in addition the official organ of the Club, namely **THE BEE WORLD**, an international monthly journal devoted to the progressive interests of modern bee culture, and owned as a public bee magazine by bee-keepers everywhere, through membership of the Club.
- (3) Because you get in touch with different sections of bee-keepers by correspondence and association, and gain the consideration of your fellow members, whether manufacturers, breeders, or honey producers.

## Why Should You Support The Bee World Educational Fund?

Because such a periodical, which is disposed of at 400% below the cost of production, for the sake of serving its educational aims, cannot prosper without the unbiassed and unselfish support of the whole craft at home, and of international apiarists abroad.

**THE APIS CLUB, Port Hill House, Benson, Oxon.**



# The Metal Foundation

(Protected.)

**C.** The triumph of the Metal Foundation is due to the following significant advantages:—(1) Indefinite durability with reasonable care; (2) Greater safety of bees in transit on new combs; (3) Capability of bearing the weight of a heavy swarm in hot weather; (4) Greater comb stability in quick extracting; (5) Control of drone cells; (6) The production of even combs; (7) Easy removal of queen cells without the slightest injury to the foundation; (8) Cleanliness and adaptability to sterilisation by boiling; (9) Economy of labour and time in fitting and detaching; (10) An ideal compromise between the metal comb and the wax foundation.

**C.** The invention has created a world-wide interest. Its value will be the more appreciated by studying the fol-

lowing original literature:—"The British Bee Journal," November 13; "Bee Craft," December; and "The Bee World," September, October, and November, 1919.

## RETAIL PRICES.

**C.** The Metal Foundation ("worker" type) can now be produced in any size required, whether for the brood chamber or the super, e.g., for the British Standard Frame (14 in. x 8½ in.), Deep Standard (14 in. x 12 in.), Simmins' (16 in. x 10 in.), Langstroth (17⅔ in. x 9⅓ in.), etc., and for their corresponding super frames. Despite the heavy cost of machinery, metal, etc., it is offered at a price *well within the purchasing power of the average bee-keeper*. All orders, whether large or small, receive prompt attention, and are executed in *strict rotation, and in good time for the season*. We have further decided—for the benefit of bee-keepers who are not yet in a position to place their orders—on taking the risk of a liberal margin of production to meet unavoidably delayed orders. *If you have not yet made up your mind as to your requirement, you are still in time to do so.*

## The Uxbridge W.B.C. Hive.

**C.** This popular hive, which we originally introduced over twenty years ago, is admirable for its *water-proof* features, since it eliminates the plinth. It stands supreme amongst all W.B.C. patterns. You will never regret trying it with your metal foundation.

\* *We allow a Five per cent. discount on all our goods (including the Metal Foundation) to members of the Apis Club, who are respectfully requested to forward their membership cards when placing orders.*

A FINAL REMINDER! To avoid disappointment apply now for the Metal Foundation Price List, and for our 1920 Catalogue.

# JAMES LEE & SON, Ltd.

UXBRIDGE, MIDDLESEX.

(Telegrams: Graphicly, Uxbridge.)

Telephone: Uxbridge 181.)

**Don't Order "W.S." Queens until you have seen the "Queenland" Revised List for 1920. 3½d. post free**

**NUCLEUS STOCKS—Same Price as 1919.**

The only Pedigree Bee-Stock Registered in direct line for more than 25 years.

**"AMALGA" is the name of our Queen breeding mother for 1920**  
**"ALTA" is the name of our Drone parent for 1920.**

**PRODUCE OF ONE NUCLEUS REALISES OVER £40 IN CASH.**

"The three-frame nucleus I purchased from you had increased last autumn to two strong stocks. I supered one on April 23rd of this year, and the other a few days later. I sold two swarms, and made up the others to five stocks. Of these I also sold three stocks. The original lot gave 198 lbs. of honey, and in all I have taken 365 lbs. My sales amounted to over £41 in actual cash."

(Miss) H. G. MOYSEY.

Somerset, Oct. 9th, 1918.

**EXCEEDS 500 PER CENT. INTEREST.**

"We have now 12 stocks to winter, besides selling one, out of the two three-frame nuclei supplied June 20th last year." (August 15th, 1917).

Miss B. D.

Quinton, Bucks.

**THREE TO SEVENTEEN.**

"It may interest you to know that the three stocks to which I introduced your queens (the only stocks saved in the apiary) in 1916, produced in all 17 stocks, and a good surplus in honey in 1917; this under the care of my wife who knew nothing about bees. I simply directed her as to management from there (France)."

OLIVER G. PIKE.

April 9th, 1918.

**FIRST AND BEST.**

"Your White Star strain was the first to enter the sections, and all the honey I got was from them."

G. H. S.

Heddon House Dairy.

**APRIL 19TH.—BOILING OVER.**

"The hive is simply boiling over with W. S. bees. They are at work when my other stocks are idling, and they are stronger than any of my other stocks."

Aberdare, Wales.

E. T. W.

**ARE THE W.S. PROLIFIC?**

"In 1904 I got a W.S. queen from you, and last year (1905) by the first week in June she had brood in *twenty-five* standard frames."

J. H.

Higher Kinnerton, Chester.

**SAFE DELIVERY of Nuclei and Queens GUARANTEED**

**NUCLEUS DELIVERED IN JUNE; 40 FRAMES BY AUGUST.**

"The three-frame nucleus of bees now occupy 40 Standard Frames. They have exceeded beyond anything I believed possible. I have never had anything like them before, and if the other queens on order turn out the same I consider my fortune made."

JOHN JONES.

Llancafarn, Aug. 21st, 1918.

**SEVERAL STOCKS FROM ONE NUCLEUS.**

"It seems almost ridiculous that this nucleus of the previous season (Aug.), before I was prepared for it, swarmed in April, and I now have several stocks from that investment."

J. W. MCKAY.

Croydon.

**EIGHT STOCKS FROM ONE W.S. NUCLEUS.**

"I now have eight stocks from the one nucleus you supplied last year."

J. JONES.

Llancafarn, May, 1919.

**BEST IN THE COUNTY—NEVER SAW THE LIKE!**

"May 26th.—The two queens you sent me have exceeded anything that I ever thought of. The stock chambers are full and crammed with brood, and all three supers crowded with bees; but even with this the bees are boiling over. I have not fed them at all, and have removed several frames of brood for another lot. The County Expert called yesterday, and said he had never seen such bees, and they were certainly the best in Hampshire."

D. D. P.

**NO SPRING-FEEDING, BUT AGAIN FIRST.**

"The W.S. bees on eleven 16 x 10 frames were full and boiling over at the middle of May, and were the first to enter supers out of 23 stocks; and last, but not least, they required no spring feeding."

U. W.

Arnold, Notts.

Revised 1920 "White Star" List, 3½d., of S. SIMMINS, Queenland, Heathfield, Sussex.

## QUALITY.

The difference between a good bargain and a bad bargain is not so much a matter of money as of quality.

All our goods have the "Hallmark of Quality" resulting in a large clientele of SATISFIED customers. Does this mean anything to you? If so, send for our large Illustrated Catalogue for 1920, free on application.

**R. STEELE & BRODIE,**  
Bee Appliance Works, WORMIT, FIFE, SCOTLAND.

# Bee-keeping Simplified

FOR THE COTTAGER AND SMALLHOLDER,

By **W. HERROD-HEMPSALL, F.E.S.,**

*Author of "Producing, Preparing, Exhibiting and Judging Bee Produce."*

Price 1s. net. Post Free 1/1½

This little book supplies the need for a cheap up-to-date and well-illustrated handbook on bee-keeping, and gives in Mr. W. Herrod-Hempsall's well-known, clear, lucid style all that is necessary to enable anyone to commence bee-keeping successfully. From **THE BRITISH BEE JOURNAL OFFICE, 23, Bedford St., Strand, London, W.C.**

## "THE HERROD APICURE."

SIMPLE CLEAN! EFFICIENT!

For the Prevention and Cure of Foul Brood and other Diseases of Bees.

**DON'T DELAY—ORDER AND USE AT ONCE.**

PRICE, with full instructions, 1/8, 2/10 and 5/8, post free. From all the leading Appliance Dealers, and from

**THE BRITISH BEE JOURNAL & RECORD OFFICE, 23, Bedford Street, W.C.2.**

The certain cure for  
and Preventative of  
"Isle of Wight" disease.

## 'BACTEROL'

Proved by Bee-keepers  
generally after testing on  
the most hopeless stocks.

Manufactured by "Beatorol" Limited, London, N.

**MENLEY & JAMES, LTD., MENLEY HOUSE, WARRINGTON ROAD, LONDON, E.C.**

## The 'Kent' Standard Model Hives & Appliances

**TESTIMONIAL.**

May 12.

DEAR SIR,—I have had an opportunity of comparing the material and workmanship of your hives with others on the market, and in my opinion there is no sort of comparison between the two, yours being altogether superior in every particular.—Yours faithfully,—

*S. J. BALDWIN, Stanley Road, Bromley, Kent.*

Keep in touch with beekeeping methods in other countries, 4/- per year will bring you "L'Apiculture Francaise," a leading French monthly bee journal. Send a postal order to-day to

E. J. BURTT, Manufacturer, GLOUCESTER,  
agent also for "Gleanings in Bee-Culture" and "The American Bee-Journal," each 6/6 per year, post free. Ask for appliance list.



No. 1963. Vol. XLVIII FEBRUARY 5, 1920. [Published every Thursday, Price 2d.]

**CONTENTS.**

	PAGE		PAGE
"BEE CRAFT" .....	61	TO TALK OF MANY THINGS .....	66
A DORSET YARN .....	61	CORRESPONDENCE—	
JOTTINGS FROM HUNTINGDONSHIRE .....	61	Bee Legislation .....	66
THE METAL FOUNDATION .....	62	Empty Hives, the Larger Frame, and Legis-	68
THE ALTON DISTRICT B.K.A. ....	65	lation .....	
QUESTIONS FOR BEE-KEEPERS .....	65	QUERIES AND REPLIES—	
WEATHER REPORT FOR 1919 .....	65	Re-queening .....	69

**DO NOT LET YOUR BEES STARVE.**

# Use Taylor's Soft Candy

1-lb. 1/6, post free; 6-lbs. 6/-, post free;  
12-lbs. 10/6 (12/- carriage paid, 12/- post free.)

SYRUP—7-lbs. 7/6; 14-lbs. 12/-; 28-lbs. 23/- SUGAR VOUCHER must be sent with order.

## BEESWAX BOUGHT,

2/- lb. Cash, or 2/1 lb. allowed if taken out in goods.

Also Cleaned and Sterilised and made into Foundation.

**No. 77. Compressed  
NAPHTHAFORMA TABLETS,**  
The Germ-killing Remedy for Foul Brood  
1/9 Bottle, Post Free.

**TAYLOR'S NEW REGISTERED  
ZINC EXCLUDER**  
giving 50% freer access to supers  
16 x 16 squares 3/-, post 6d.  
8-ft sheets 15/-, post 1/-.

**BACTEROL & YADIL,**  
For "Isle of Wight" Disease,  
Bacterol, 2/6 per bottle, post 6d.  
Yadil, 3/6 per bottle, post 6d.

Syrup should be fed medicated with above in  
**Taylor's Registered Feeder,**  
Specially designed for above cures,  
Post free, 3/10  
or Bottle of Bacterol and Feeder, 6/- post free

**TAYLOR'S No. 12 HIVE, Dovetailed, at 29/- Carriage Paid. In the Flat, 28/-  
BEST VALUE IN HIVES EVER OFFERED.**

**NEW CATALOGUE FOR 1920 POST FREE.**

**E. H. TAYLOR, WELWYN, HERTS.**

## THE British Bee Journal

ESTABLISHED 1873.

A Weekly Journal Devoted to the  
Interests of Bee-keepers.

Edited by T. W. COWAN, F.L.S., &c.,  
and J. HERROD-HEMPSELL, F.E.S.

### Correspondence: Whom to Address.—

All matters relating to the Literary Department, Associations, Shows, etc., should be addressed, "Editors, *British Bee Journal*," and all business communications and matters relating to subscriptions and advertisements to be addressed to the "Manager," *B.B.J.* Office.

**Subscriptions.** — Annual Subscription, 10s. 10d. post free in advance; single copies 2d., or 2½d. post free. If a receipt is required by post, a stamped and addressed envelope must be sent, otherwise a printed receipt will be enclosed along with the paper.

*Note.*—Cheques and Postal Orders should always be crossed, otherwise it is very difficult to trace them if they go astray.

**How to send Money.**—Remittances can be made payable to W. Herrod-Hempsall by crossed Cheques and Postal Orders. Stamps may be sent for small amounts up to 2s.

**Halfpenny stamps are preferred.**

Scottish or Irish cheques can only be taken in payment if 6d. is added for commission charged by banks for cashing them.

The Editors are not directly or indirectly interested in the manufacture or sale of bee-hives or appliances of any kind, and must refer correspondents wishing for prices or catalogues to advertisers in the paper.

## The Metal Foundation.

(Protected.)

For the benefit of readers of the JOURNAL and the RECORD we have arranged with the manufacturers of the Metal Foundation to accept all orders received through our offices at a consideration in the shape of a 25 per cent. deposit to begin with, and the balance by mid-March, or prior to delivery, if earlier. All orders are guaranteed by them to be executed *not later than April, 1920.*

Prices:—(1) BRITISH STANDARD FRAME, fully fitted with "worker" Metal Foundation: Single, 2s. 4d.; per two dozens, 2s. 3d. each frame; per four dozens and over, 2s. 2d. each frame.

(2) STANDARD SHEET of "worker" Metal Foundation: Single, 2s.; per two dozens, 1s. 11d. each sheet; per four dozens, 1s. 10d. each sheet.

Subject to a 5 per cent. discount to members of the Apis Club.

*Packing & Carriage Extra.*

\* \* \* Since the Metal Foundation will be produced only to order, no order will be subject to cancelling.

## OUR DEPOSIT SYSTEM.

You are advised to insist on this being used when dealing with strangers.

### Rules and Conditions for Depositing

*In order to save trouble, it is requested that the Rules be carefully read over by persons using the Deposit System of trading.*

Goods should not be despatched until notice that the money has been deposited is received from this office.

**1. Method.**—When strangers are dealing together, the purchase-money of the articles is deposited at our office. We acknowledge receipt of the deposit to both parties, and hold the money until we are satisfied that the purchase is concluded. If a sale be effected, we remit to the seller the amount deposited, less a charge of 2½ per cent. in the £, with a minimum of 6d., and the expenses of Post Office Orders and postage, &c. Cash will be forwarded by Cheque, Post Office Order, or by Postal Order as preferred. If a sale or exchange be not completed, we return the amount deposited, after making the same deduction. By this means buyers and sellers are secured against fraud.

**2. Deposits.**—Postal Orders (drawn on General Post Office) and Cheques must be made payable to W. Herrod-Hempsall, and crossed "London County and Westminster Bank." The numbers of the Postal Orders should be kept by the sender. We cannot be responsible for any loss that may occur in transit.

**3. Honey on Approval.**—All honey will be sold by sample, which must be sent direct to buyer.

**4. Bee Appliances.**—In ordering, the time allowed for completing the order to be stated to us when sending cash. If maker accepts, we hold cash until transaction is satisfactorily completed, when the amount will be remitted, subject to conditions as in Clause 1.

**5. Bees and Queens.**—These will be dealt with entirely by the parties concerned, so far as price, &c., go, and when the purchase is satisfactorily completed cash will be remitted as per Clause 1.

**6. Goods in Transit.**—These are at the seller's risk, *i.e.*, any damage to or loss of an article on its journey is borne by the vendor; but a rejected article must be properly packed and returned by the same means as was used in sending it.

**7. Carriage.**—The carriage of all goods, *except such as are sent by post*, is payable by the buyer, unless otherwise agreed. If any article sent on approval be returned, each party to the transaction must pay carriage one way.

The products of the Apiary, of Poultry and Farm Stock, of the Fruit and Vegetable Garden can be Advertised and Sold through

THE  
**BAZAAR, EXCHANGE & MART**  
Newspaper.

Get a Copy—Thursday and Saturday 3d. The "Bazaar" publishes also practical handbooks by experts. Send for full catalogue, post free from—**WINDSOR HOUSE, Brems Buildings, LONDON, E.C.2.**

THE  
**British Bee-Keepers' Association.**

The recognised centre of practical and scientific bee-keeping in Great Britain.

Particulars and conditions of membership may be obtained from the Secretary, **W. HERROD-HEMPSELL, 23, Bedford Street, Strand, London, W.C.2.**





## “Bee Craft.”

We congratulate our contemporary on attaining its first birthday. No. 1 of Vol. I was issued in February, 1919, and the size of the paper has also been increased since the first issue. We take this opportunity of wishing it “many happy returns.”

## A Dorset Yarn.

To see the primroses at the R.H.S. meeting last week one would have thought it was April rather January. Our native flowers are yellow, but those exhibited by Mr. Miller, of Wisbech, were mostly shades of blue and mauve. Very beautiful they were to see. One could not but wish we had the same shades of blue at the Violet Farm. If they bloom so early in the Fen country they should be of service to our bees. This week they have been out in crowds on snowdrops and Christmas rose. They are clearing off all the pollen. These should produce plenty of seed with so many bees on them; they could not but be well fertilised. I notice that the light coloured Italians do not leave the hives so much as hybrids and blacks, but on lifting the quilt at the corner they were to be seen crowding the combs; one felt that they were covering brood to keep up the warmth. One gathers more of their habits and economics as the years go by.

We have had the fowls running among the hives since the autumn. They make their nests beneath the hives. Some of them have a dust bath beneath the floors. Having a fairly wide alighting board, the rain is carried away, leaving it dry beneath. There could not be much warmth from the bees, but the hens seem to think it a fine place to make their nests. We notice in summer if any fowls steal away to lay it is in the bee quarters, all carrying out the law of Nature, carry on the race. It all adds to the pleasure of the Nature lover to see all that he has doing well, all adds to the grand total of profits when the year is out. Increased production is the order of the day, and when one can have a certain amount of joy in doing this, then life is really worth living. Of course, I know city dwellers who get all the pleasures of life because their tastes are satiated in the libraries, where all the treasures of literature are to be had. They can hear the music of trained voices in opera and concerts. We who live in rural England have to be content with the songs of bees and birds; the good books are few

and far between, but our work is the most important; without it there is no increase. Production is the chief aim of the tiller of the soil. J. J. KETTLE.

## Jottings from Huntingdonshire

Seedsmen's catalogues will be in the hands of every professional and amateur gardener by this time. Bee-keepers naturally have a thought for their hive inhabitants as they pore over the list of flower seeds. Going off at a tangent, someone has said that faith is the belief of an amateur gardener that he will make his vegetables and flowers grow to look as beautiful as they appear in seedsmen's catalogues. In choosing flower seeds, do not pass over that excellent bee plant *Limnanthes*. It is a hardy annual, grows profusely, flowers early, and will flourish anywhere. An ounce of seed would produce a sufficient quantity of plants to provide an edging for a quarter of an acre of land. Far better to cover odd corners with *Limnanthes* than nasturtiums. The latter may be useful to the bumble bee, but it is not of much use to the hive bee. Borage, too, should be ordered by those who were unable to sow in autumn. Seed sown in March or April will produce some good flowering plants long before the summer closes. On mentioning Borage in my jottings last autumn, several readers wrote asking where they might get seed. Practically every seedsman can supply it. In looking for it in their catalogues, however, it will generally be found classed among the herb seeds.

The mild weather still continues, and the sun has shown himself so much of late that wood and coppice are speeding up apace. I notice some trees looking as forward as they were last year in March. Fruit trees, too, are much too forward. Tiny leaves on raspberry canes and gooseberry bushes in January may look springlike, but it's not good. All this precocity will receive a severe check, and the buds will suffer accordingly. There is one thing I am glad to see, and that is the wealth of catkins. The woods and gosses seem full of them, and well is it that the bees can get pollen in plenty from this source. I had, perforce, to trim up a box-tree last week. I hated doing it, for the bees' sake. The box-trees are loaded with flower-buds this year, and how the bees love them! A good-size box-tree will keep a whole hive of bees busy and put them in a most amiable temper; in fact, when working box they are all too happy to think of stinging.

One generally looks for the first crocus on the first of February, but from appear-

ances crocuses are going to be later than usual this year, while the daffs will be all too early for some of us. We parsons like the daffs to flower about Easter; they come in handy for church decorating.

What about the Holmewood bees? Have they practically vanished from our apiaries? There are a few stocks about, but all too few. I notice that one sees this strain in charge of trees however; they are undoubtedly an "Isle of Wight" disease resistant.

I think I shall have to preach one more sermon on the British native bee. So many people think the common brown bee a native bee, it is not. Its origin is Teutonic and it was introduced into England a century ago. The real British native bee is black, but larger than the Dutch. Fossil marks suggest that this bee originally had a longer thorax than any existent bee, its abdomen being flatter than is usually seen. I have come across stocks occasionally which are as truly native as is possible to conceive them. Gloucestershire, Derbyshire, Cornwall and parts of Somerset are where the black bee is commonest. The brown bee—she may justifiably be called after a century's colonisation, the English brown bee—is a useful insect; but she suffers more than some others from inbreeding. I expect this last paragraph will bring along not a few letters from one and another saying they do not agree with me and all the rest of it. My post-bag is very amusing at times. The same post which brings letters of appreciation, brings also letters of fury. A few bee masters are indignant that I should do anything to encourage the rank and file to keep bees. (Evidently they believe in monopoly.) In fact, the same post which brought a very kind letter from a schoolmistress, urging me to keep on with my jottings, brought also a letter urging me to keep to my own job, and if I was tired of that "to burst my shell of skin and hatch myself a cherubim," which, to say the least, was rather profane. Shortly before Christmas, I had some remarks about the planets—oh, dear! My astronomy was all wrong—out of date—irreverent. How could I, a "Sky Pilot," even insinuate that there was life in any other planet than this? One schoolmaster wrote to put me right. Mars was too cold to bear life, and if it were warmer there was no water, and no atmosphere, this was the conclusion of all scientists of to-day. I'm rather enjoying myself this week wondering how my critics feel as they read the views of Marconi and others. One suggestion of a quite young reader, however, appeals to me. He likes me to write as if bees talked. His "funny papers" tell him of Lions, Tiger Tims, Jumbos, and Teddy Bears being able to

speak, so why not bees? With the Editors' permission I will next week relate what I heard from a worker bee. It will appeal to the juvenile readers, and will not be profitless, I hope, to their parents.

It is pleasant to see the lambs appearing once again. One of my nannies kidded a week ago, and so increased our milk supply. I often wonder more people do not keep goats, especially in these days of milk scarcity and high prices. They cost so little to keep, and are an unfailing source of interest and profit. Of course, there are goats, and goats. A heavy yielder costs no more to keep than a poor milker. Such goats, for instance, as go dry during the winter are not worth much, but there are milk goats to be had, and giddy, happy creatures they are.

Congratulations to Mr. Manley on the evolution of the "Manley Hive." Steele and Brodie have placed it on the market. With locked corners and an asbestos concrete roof, and taking a 16" by 10" with 17½" top bar frame, this hive has without doubt come to stay; but is not, I think, likely to oust the "British Standard."—E. F. HEMMING, Steeple Gidding.

## The Metal Foundation.

By A. Z. ABUSHADY, F.R.M.S., Editor,  
*The Bee World.*

Mr. Ernest Root, the learned Editor of *Gleanings*, having most kindly drawn my attention to an editorial in the January number of his magazine (just to hand, with his communication dated January 3), in reply to my comments in the October *Bee World*, I think it would interest your readers to refer them to his notes, the essence of which is that "Mr. A. I. Root . . . away back in 1878, 1879, and 1880 experimented with metal foundations and was able to get combs built from them, and, as he now remembers, brood was raised and the bees stored honey in them. But the coldness of the metal base, and the expense of the product, caused him to drop it."

It seems absurd on my part to lecture to the worthy Editor of *Gleanings* on terminology. I have been asked, "Would it not improve metal foundation to 'wax' it? Also, would it not be more economical to stick ordinary wax foundation to a thin plain metal sheet? What is the difference in terminology between 'foundation,' 'midrib,' and 'support'?" The following replies appear in the November *Bee World*:—

"The first two queries have already been thoroughly treated in the *Bee World*. Suffice here to say that both theory and practice are against the artificial sticking

of wax to metal, wood, or the like, when a comb is built on the wax itself, since there is no safeguard against the separation of the wax coat from the solid support, which may buckle or split. It is a different case with wax cells elaborately built by the bees direct on the metal. The

has served to safeguard against the blistering of wax foundation, which when once begun is likely to spread, resulting in a disaster to the comb, especially in transit.

"The features of the metal foundation belong to the views which have led to its

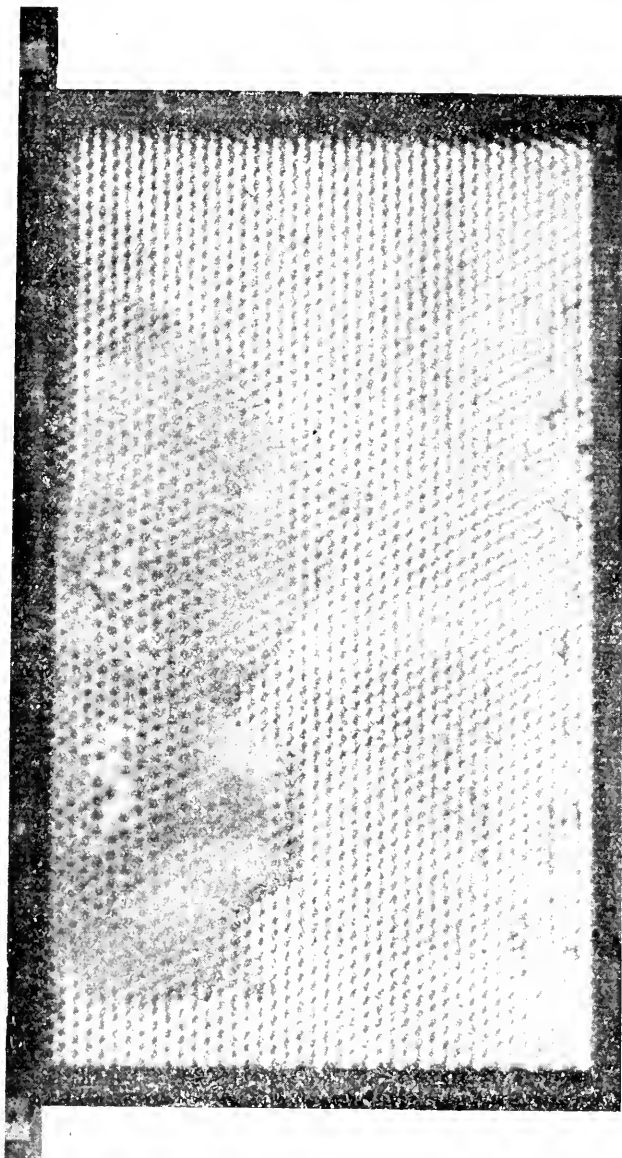

#### THE METAL FOUNDATION.

A British Standard frame fully fitted with a sheet of "round-ridged" metal foundation of the worker type, acting both as a true comb "foundation" as well as a self "support," thus serving a double purpose. The worker cells shown were built and partly stored with syrup four days after its insertion in a hive containing another frame which was receiving greater attention (apparently because it was nearer to the dummy feeder employed). Original combs of the hives were previously removed. Consider the extent of wax building within this time, at a temperature which has rarely exceeded a maximum of 40 deg. F. and which has often been below even 32 deg. F.

The frame was photographed at night (in artificial light) following a demonstration, and is partly out of focus. Bees fully established on a comb built on metal foundation were also exhibited in an observatory hive.

experiments which have been conducted in this country and abroad years ago, both with metal and wooden supports for wax foundation, have clearly shown again and again the failure of such supports, and that the method is non-economical. Neither a plain metal sheet nor the intelligent device of a corrugated metal core

development, and if these were not sufficiently appreciated it would be just as well to stick to wax foundation, since a real compromise between the two could not be effected, whilst coating metal foundation with wax would simply be a wasteful practice and would not serve a good purpose, but rather the contrary.

"Tastes may vary in preferring one type of metal foundation to the other, but both have good points, although, no doubt, 'sharp-ridged' metal foundation with a depth of, say, 3-16 in., would present facilities for immediate egg-laying, thus saving time and permitting breeding in conjunction with wax building. In this respect alone this type of foundation may be considered an improvement over the 'round-ridged' type, and may well rival a complete metal comb. The improvement would be due to the depth of the ridges and not to their sharpness. This is, however, purely a question of machinery. Wax coating can find no place in effecting any improvement. It can only help in defeating the objects of metal foundation.

"As for the correct definition of the words 'foundation,' 'midrib,' and 'support,' we may remark that the three words are interchangeably and loosely used in the same way as the terms 'division board' and 'dummy' are employed.

"The following may serve as rational definitions: (1) a Comb Foundation is a printed sheet of any material suitable as a comb basis, and is intended to *guide* the bees in their wax-building, direct on its substance; (2) a Comb Midrib is the central partition between its side sections; and (3) a Foundation Support is a staying device for enforcing the resistance of the comb foundation.

"From these definitions it will be seen that a central embossed wax sheet in a hive frame serves as comb foundation, and is naturally a midrib for the comb to be built on it finally, whilst the wire embedded in it acts as its support within the frame. Metal foundation, on the other hand, as we have repeatedly indicated, would act as foundation proper, a midrib, and a self-support within its frame.

"Another case of illustration is a frame wire. It serves at present as no more than a foundation support. But supposing a hexagonal meshwork of resistant and suitable wire correctly spaced could be adopted in place of embossed wax or stamped metal, then the wire would jump to the position of a comb foundation, a partial midrib, and a self-support. This is, of course, an extreme case of illustration."

Not even *Gleanings*, with its might, can convince an impartial observer that, however great is the service which A. I. Root has rendered to the bee-keeping world, it would be permissible to exaggerate what he has done and to ridicule what he has not achieved; nor will it mask the inaccuracy of its claim, when the following contradictory statement appeared in the same magazine for October 1, 1904:—

Mr. A. H. Frank, of Red House, N.Y.,

asked: "Cannot very thin tin be used for foundation instead of wax, and a coating of wax be put on it? It would be much stronger and not liable to break. I have to confess that I am not smart enough to extract the honey without breaking the comb. I used foundation the size of the frame and wired it, but before I get up speed enough to throw the honey out the comb is ruined by breaking." The Editor replied as follows: "About 35 years ago our Mr. A. I. Root tested tin as a base or midrib for foundation. He even went so far as to run a thin grade of metal called 'taggers tin' through an old foundation mill. He coated it with wax and gave it to the bees. He secured combs, but found the expense of the product was altogether prohibitive, and no better than ordinary foundation sustained by means of wire, at a mere fraction of the cost of the tin backing. It actually used more wax, and was colder for the bees. Then Moses Quinby, before A. I. R., had what might be called all-metal combs.

*"This field has been gone over thoroughly, not only by A. I. Root, but by hundreds of bee-keepers, and the general consensus of opinion has been that there is no better way to stay foundation than by the use of wire or wooden splints, as recommended by Dr. C. C. Miller."* (The italics are mine.)

The conclusion of the above remarks puts in a nutshell the real light in which metal was looked upon in the past in the construction of artificial foundation. It has never been utilised other than as a foundation *support*, in the same way as wire is used at present, and, strange to say, even the defects of buckling of this metal and of the blistering of wax, whether pressed or spread, did not suffice to open the eyes of researchers.

Having established and fostered the "wax-bait" theory for half a century, and having now revived an educational campaign relative to the wax aroma and the "preference" of bees to the wax foundation of one manufacturer over the others, our friends across the Atlantic prefer again to be silent over their past mistakes, or rather prefer to find an agreeable consolation in the discoveries of others. I do not mind saying that had metal foundation (and not metal support for wax foundation) been conceived before, despite traditional wrong teaching as to the "fancies" of bees, wax foundation would have been long ago a second grade frame equipment.

I was keenly looking forward to some able constructive criticism in *Gleanings*, but in this I have been greatly disappointed. Not even a word of reference to original literature is given. And as to the statement that "a recent talk with

Dr. Phillips, of the Bureau of Entomology, would indicate that he does not believe in the practicability of metal-comb foundation, as he thinks it will dissipate the heat of a cluster of bees more than the aluminium comb," it will suffice for me to say that no authority with a handle to his name can ever provide a satisfactory answer to the following question: "How is it possible that a comb totally composed of wax, except at its bases, dissipates the heat of the cluster more than a complete metal comb?"

In all my humble writings, I have done my best to cultivate a spirit of *constructive* criticism, which, in my opinion, is a valuable form of co-operation. One should have the courage to express his opinion, to think for himself without either fear or vanity, and to gauge any work by its merit and not by the name of the worker. For this reason I cannot help saying that despite my respect and admiration for Mr. Ernest Root and Dr. Phillips, I can neither applaud the hastiness in judgment of the former, nor the dogmatic criticism of the latter in relation to the subject of the metal foundation. George MacDonald, having safely endured his baptism, as did Cheshire and others endure before, I—a humble worker—take my turn confidently.

### The Alton District Bee-Keepers' Association.

(BRANCH OF THE HAMPSHIRE BEE-KEEPERS' ASSOCIATION.)

#### ANNUAL MEETING.

The annual general meeting of the above was held on Saturday, January 24, Mr. Hayden being in the chair. Amongst those present were Lady Bradford, the Revd. H. A. Wansbrough, Messrs. F. D. Hills, E. Stewart, W. Ranger, etc.

The secretary (Mr. H. P. Young) presented his report of the work of the branch, which disclosed a membership of 83. During the year lectures, demonstrations, and honey shows had been arranged and a re-stocking scheme had also been started, without any connection with the Government scheme, and this had proved a decided success. Nuclei had been made, and distributed to members at a very reasonable price. Although the scheme had an adverse cash balance, several stocks were being wintered, and it was thought this asset would well cover any liability to the treasurer.

The financial statement was read by Mr. F. D. Hills and considered very satisfactory.

Lady Bradford was again unanimously elected president, and her ladyship was thanked for the invitation extended to the members during the past season to visit her apiary and grounds.

After a very free discussion on the subject of legislation for bee diseases, the following resolution was carried unanimously:—"That this association are unable to support the Ministry of Agriculture for the drafting of a bill for legislation for bee diseases, in view of the methods adopted by the Ministry in regard to apiculture, as they do not appear to be a fit body, as now represented, to deal with the subject."

A vote of thanks to the chairman closed the business of the meeting.—H. P. YOUNG, hon. sec.

### Questions, etc., for Bee-keepers for Self-Examination.

(Students are recommended to write their answers, and check them afterwards by reference to books.)

463. Explain, as to a beginner in bee-keeping, the use of a nucleus hive.
464. What can be done to prevent a swarm deserting after hiving?
465. How is it shown that colonies sometimes gather pollen when it is not needed?
466. Give two reasons to show the desirability of preventing after-swarms.
467. When should swarms from colonies, the queens of which had been clipped, be encouraged to "settle," and be taken as usual instead of being left to return to the hives?
468. What is known of the differences in the food given to queen larvæ, drone larvæ, and worker larvæ?
469. Describe the formation and structure of a cluster in a hive in winter.
470. Criticise the statement that the "poison" of a bee-sting is formic acid.
471. Explain why the methods of a successful bee-keeper may fail if practised similarly in a different locality.
472. Set out, in the form of a concise summary, the arguments for and the arguments against legislation for bee diseases in this country.

J. L. B.

### Weather Report for 1919.

WESTBOURNE.

Rainfall, 32.08 in.	Minimum on grass, 18
Heaviest fall, 1.14 in.	on Feb. 8th.
on March 19th.	Frosty nights, 78 (av.
Rain fell on 177 days	73).
(av. 180).	Mean temperature,
Above average, .88 in.	48.3.
Maximum tempera-	Below average, .3
ture, 84 on August	Maximum barometer,
10th and 13th.	30.674 on Jan. 24th.
Minimum tempera-	Minimum barometer.
ture, 22 on Feb. 8th.	28.689 on Jan. 5th.
	J. B. BIRKETT.

## To Talk of Many Things.

For some long time I have been compelled, by ill-health, over-pressure of work, and a consequent disinclination to the effort of writing, to be merely a reader of THE BRITISH BEE JOURNAL, but an anticipatory quiver of waking spring leads me, like a certain type of poet, to break silence.

From my study of these columns during the last few months three things have most impressed me, and from them I take hope and courage for the future of our craft.

First, the general and insistent demand for legislation is one sign that bee-keepers do not mean to lie down in supine defeat by "I.O.W." disease.

From the correspondence to which this Journal has been open, there stands out a conviction generally, and tenaciously held, that the chief menace to bee-keeping lies in the risk of repeated re-infection incurred by the continued presence of derelict hives and of diseased stocks, whose owners are either too careless, too ignorant, or too short-sightedly selfish, and—*voilà le mot lâché*—too pig-headed, to take, or allow others to take, the steps necessary to restore cleanliness and health.

There are, doubtless, some objections to legislation that are worthy of respect.

These may arise either from a general feeling that we are already legislation-ridden. The hopeless muddles caused in almost every department of the national life by the intervention of inept officialdom, has created a bitterness in the heart of all sections of the community, and is doubtless responsible for the belief that any improvement, or alleviation of the present ills, is only to be found in sweeping away bureaucratic control rather than in extending it.

The efforts of bee-keepers who favoured legislative action in respect of bee diseases must, therefore, be directed to seeing to it that no new offence be created. This can be secured by the elimination of any wasteful or oppressive provisions, and the placing of the operation of the Act in the hands of competent persons.

The latter point is of the utmost importance. On the *personnel* of the inspectorate operating the measure will depend in the highest degree its success or failure.

Many bee-keepers who are careful, skilled, enthusiastic, intelligent bee lovers remain outside county associations, or, if members, decline or avoid the visits of the travelling experts, because they are apprehensive of the consequences to the health and temper of the bees, and to the success

of their own operations, of the rough, careless, and inexpert manipulations to which their stocks may be subjected during these visitations.

Such apprehensions are intensified in anticipation of compulsory examination of stocks at the arbitrary will of someone armed, in the absence of apiarian competence, with official powers, and clad in the terrifying garb of an inquisitor.

Our task must be to secure that no justification be afforded for such fears; that high qualifications, both in expertise and in tactful approach, be required and obtained of the staff to be appointed.

In general, bee-keepers, and especially those who in principle approve of and call for legislation, must hold a watching brief in the interests of economy, efficiency, and such remnant of liberty as we may be considered still to possess.—A. F. HARWOOD.



*The Editors do not hold themselves responsible for the opinions expressed by correspondents. No notice will be taken of anonymous communications, and correspondents are requested to write on one side of the paper only and give their real names and addresses, not necessarily for publication, but as a guarantee of good faith. Illustrations should be drawn on separate pieces of paper. We do not undertake to return rejected communications.*

## Bee Legislation.

[10121]. I hope I am not too late to express my opinion *re* legislation. I am not in favour of it for the following reasons.

"Isle of Wight" disease can be cured if taken in time, there is plenty of evidence, that hundreds of stocks have been cured this last two or three years; also, Government Inspectors *will not* stamp it out—like the poor, it will always be with us. Your correspondents that write in favour of legislation all appear to take it for granted that it will be a sure cure, and the only cure. They have legislation in America, as one of your correspondents a few weeks ago remarks, but I ask him, or any in favour, have they stamped out disease? (Foul brood.) In face of these facts, how is it that a small minority are so anxious for Government interference. Isn't the "careless neighbour" bogey a bit overdone; also is it fair always to blame your neighbour every time disease appears, and is it fair that if I have a stock showing signs of "Isle of Wight" disease I should have to submit to them being burnt, knowing that I can cure it

even though there are careless bee-keepers all around? If a hive in which bees have died is left exposed it would be cleared out in a week, and would then be no further source of danger.

If all bee-keepers in the country were canvassed, I am quite certain there would be a big majority against.—WM. SMITH.

[We should be very pleased if our correspondent would let us have his cure for "Isle of Wight" disease: by so doing, if effective, he would earn the eternal gratitude of all bee-keepers.

America, Australia, New Zealand, and Canada have all reduced the loss by F.B. our correspondent will find if he reads the reports from these countries.

We are sorry for the majority against legislation, if a comparison of our correspondence from both sides is any criterion, and we would also like to place our correspondent in the position of some who *have* "the careless neighbour bogey." He would soon have nightmare.

A canvass of all bee-keepers in Cumberland and Westmorland was taken for or against legislation some years ago. Out of over 800 postcards returned, FOUR single people only were against. THIS is fact, not surmise. *Verb sup.*—Eds.]

[10122] Having recently arrived from Canada, where legislation for bee diseases is practically general and its benefits appreciated, I am surprised that serious opposition should occur here, or that the severe epidemic of "Isle of Wight" should have left any room for argument. One might similarly object to any laws or restrictions to limit foot-and-mouth or any other infectious diseases.

My apiary in Nova Scotia was situated in a district that a few years ago was badly infected with American foul-brood, and bee-keepers, amateurs and professionals alike, were rapidly losing their stocks and facing extinction; but by dint of agitation and the passing of resolutions urging the Government to enact necessary legislation at all meetings of bee-keepers and also horticulturists—the fruit industry being an important one—and forwarding such resolutions to our Members of Parliament, we succeeded in securing an Act, so that at the time I left we were practically free of disease, to the great, and also future, benefit of all concerned, amateurs included. At present anyone may import bees into England without restriction, so that the door is wide open to further diseases besides "Isle of Wight." Jamaica, which has always been free of infectious bee diseases, recently had an outbreak around Kingston, brought overseas from Cuba, and only prompt action of their Government

in passing legislation and heroic measures, which necessitated destroying some 2,000 hives, freed the island.

I desire to invest of my capital and time in bee-keeping here, where increased production along all lines is so urgently needed, but I am faced with the fact that a neighbour may unintentionally, through lack of appreciation of what careless handling and exposure of infected hives and combs may mean, cause me a heavy or even total loss. The great majority of people desire progress, and are ready to do what an inspector may point out, and coercion need play no part except to those few who are always, like our friend Pat. "agin the Government." For myself, I may say that the necessity for treating and cleaning up disease in my apiary taught me bee-keeping, proving a blessing in disguise, and, instead of "me keeping bees," thereafter the "bees kept me."—C. HOGAN.

[10123] As a preliminary to any legislation granting plenary powers to any department or individuals to interfere in the management of apiaries, is it not essential that we should have some knowledge of our principal bee diseases? It is notorious that neither bee-keepers nor scientists have any certain knowledge of the origin of the various brood diseases of bees, or of what is known as "I.O.W." disease.

The situation, in all conscience, is bad enough. Let us see that it is not made worse by legislation. By all means, however, let us ask Parliament to vote the necessary funds for the investigation and study of bee diseases, their origin, and cure, but let us not legislate until we know more. Knowledge should surely precede action?

Legislation in America has not proved a success. I notice in recent issues of *Gleanings* that many of the states which clamoured for and obtained legislation are now asking for its withdrawal, and for educative rather than oppressive measures. In Ontario, Canada, after some ten years of legislation, F.B. was increasing rapidly, while instead of one inspector there were then sixteen. One of these, Jacob Alpaugh, said one thousand inspectors would be needed for that State alone. Does this not suggest that the inspectors spread rather than checked the disease?

With regard to a hive infected with F.B., and left accessible to foraging bees, I understand that under the present "Public Nuisances Act" the owner can be prosecuted. This is the opinion of a legal friend of mine of some professional standing. Could not the B.B.K.A. attempt a test case?

The recent suggestion of the Editor of the *Bee World* to hold a conference of leading bee-keepers and scientists is far more practical than the appointment of inspectors who know no more than the rest of us.—A. FISKEN, Westerton, Scotland.

[We refer our correspondent to the letter of a man from the spot in Canada, Mr. C. Hogan.

Bees cannot be dealt with under the "Public Nuisance Act": this has been tried and failed.—EDS.]

[10124] I have been very much amused at some of the letters in the *JOURNAL* on the above topic. Of course, according to some we do not require legislation any more than we require honey, and who requires honey in these days of such a surplus of sugar, and what good do the bees do—only harm? See the harm they have done to the orchards of Kent this year. Their handiwork can be seen in the fruit stores at the Kent farms: large apples, dessert ones, so big, give people too much trouble in eating; not like the nice little fellows that went 16 to the pound last year and sold at 1s. 6d. per lb. Of course, the bees interpollinated the flowers, and made the fruit grow out so big and plump that this year they go about two or three to the pound.

And what of the black-currants? The last few years, since disease cleared out the bees, what nice little ones we have had—all skin and (snuff) eye—not like the big juicy stuff we used to get. Now we get solids in the way of skins, not juice.

Then why do seed-growers want bees? Of course they get larger crops of seeds. Hence, since bees have been so short, seeds have been up in price. Take a trip through Romney Marsh and you will see scarcely a hive of bees on hundreds of acres of seeds. Oh, the pathetic inquiries—"Can you let me have a few hives of bees for my sanfoin, for my swedes, my white clover?"—and all or nearly all have to be refused because there are not enough to go round.

A sheep-breeder near here who grows white clover for his ram lambs, which fetch round about £1,000, is just delighted if he can see some bees in among his lambs. He knows the value of them, as they, so he says, improve his lambs' food.

I think I am taking up too much space, but we must have legislation; so say all the bee-keepers and keepers of bees. I have done about 200 miles on a push-bike with a petition. I have not had to solicit for a signature; I've got them all, every one. They all want bees, they all want honey, they all want fruit, and they all want seeds. So let our opponents get on with their piffle. They will in years to

come be thankful and even kiss the feet of those who to-day are carrying on this good work, when England, etc., are as free from bee diseases as they are from foot-and-mouth disease, swine fever, and rabies among animals, also smallpox, scarlet fever, etc., among human beings.

Let Parliament get on with the business, and the sooner it gets it on the Statute Book the sooner will they gain the applause of all the ignorant upstarts of bee-muddlers, if not of the bee-masters.—EDWARD GRISTWOOD.

### Empty Hives, the Larger Frame, and Legislation.

[10125] Under the above heading I propose giving to your readers as brief an account as possible of a few of my experiences, extending over 50 years, with the bees.

I first took an interest with the bees about 1870, my father obtaining some at that time, and soon after taking the B.B.J. he made his hives and all appliances, including the honey extractor.

Whilst watching the entrances I have seen the wasps seize bees and cut them in half with their mandibles as clean and quickly as one could do it with a sharp knife, flying away with one half; and yet, when looking inside a *small* observatory, these yellow corsairs walked about anywhere unmolested by the bees.

From 1875 to 1895 I was too much taken up with outdoor games to think anything about the bees, but, having to stand aside for younger and better players in the football field, I took up bee-keeping—an expert giving us such an interesting and instructive lecture here about bee-keeping (sent by the C.C.), it reawakened my old love for the bees. Taking it up with unsurpassed zeal, first of all I bought one of my father's observatory hives (Abbott's pattern, having the large frames, 16 in. by 10 in. or 10½ in. deep). Then I made 150 W.B.C. and combination hives in the winter evenings, and five bee-huts. Although working 11 hours a day at hardwood joinery, I generally made seven hives each winter, often working to 10 o'clock at night, and sometimes to 12 o'clock Saturday nights.

Now for my experience with the observatory hive having the large frames, standing side by side with the others having the standard frames. My honey-take year after year, for over 15 years, always *equalled the take from my best hive*, never requeening or doing anything but the annual spring cleaning, the same as the others.

My first experience with bee disease with *my own bees* was about 1909. Nearly



every cell was occupied with dead uncapped brood, six or seven combs in each hive, and in many hives, at one apiary only. I believe the correct reply was given of the cause in B.B.J., January 22, 1911, page 249, reply to J. E. S., North Finchley (the late Mr. J. Smallwood), but the wax moth was certainly not the cause. The bees never got up to full strength, and many died out the following winter.

My experience and loss by the "Isle of Wight" disease was a bitter one, and, considering the price of honey the last three years, if my bees had been alive, in one year alone, viz., 1918, I should have made from £500 to £700 clear profit. If it comes to voting for legislation, prohibiting the sale, or moving, or allowing diseased stocks to remain after July at the owner's apiary, I shall hold both hands up.

I had seven out-apiaries. Noticing crawlers at the first, I made inquiry, and ascertained there was another bee-keeper living near. He took me to his apiary, but he had already destroyed, or lost, most of his bees. I destroyed all mine, and scorched inside with petrol, starting again the next season by purchasing a stock in skep. These swarmed, the swarm taking possession of an old bar-frame hive where the bees had died from "Isle of Wight" disease, and it had not been cleaned; the owner being away in France. The swarm gave me 42 good sections and a rack of shallow frames, the shallow frames being already on. These bees eventually died in the winter from "Isle of Wight" disease, but I cannot say the old combs were the cause, because the stock that sent off the swarm died from the disease several months previously.

At the second out-apiary I sold, and sent away in April, several stocks, bar-frame and skeps, and never any complaint whatever; but a swarm from a quarter of a mile away went into a hive I had filled with frames of foundation at the extreme end of the garden, and soon showed signs of "Isle of Wight" disease, eventually dying, all the others following suit gradually from one end of the garden to the other.

At the third apiary the bees were infected all through a dealer buying a diseased stock and bringing them near. From this apiary I had sent away healthy stocks just previously.

At the fourth a bee-keeper bought a swarm from a distance away, which were the first to show signs of "Isle of Wight" disease.

At my other three out-apiaries the "Isle of Wight" disease was all round within  $1\frac{1}{2}$  miles. My bees were either infected by robbing, or diseased bees joined on to mine, and it is astonishing the

number of stranger bees that do join in with other hives than their own.

Am not sure how the home apiaries became infected, but a farmer bee-keeper living two miles away called and said I could have his bees and hives. I went and had a good look, but could not see any signs of disease, therefore risked it, as he was moving into Gloucestershire and would not take them. These were the first to show signs by crawlers, therefore I conclude they were the cause, although a bee-keeper living 200 yards away lost his bees at the same time.—DAVID HANCOX.



### Re-Queening.

[9901] Seeing you are so ready to give information about bees, I should like to know the best way and time to replace an old queen which I was not able to do in the autumn. I have three stocks. I made a fresh start last spring with a stock that swarmed twice, and would like the first swarm headed with a young queen at the first opportunity. I might say that about a week after the second swarm was hived I had a stray swarm come along, which I took and united with them, picking out the queen as they ran in, and the very next day found unmistakable signs of "I.O.W." disease, with bees crawling all over the place; but it was fine weather, and I got an Abol syringe and gave them a good syringing with "Bacterol," down between the combs and all in front of the hive. On the ground all round my hives I gave it a good doing with Izal, and kept it up twice a day for a week. By that time there was not a crawler left, and I have not seen one since, but don't know whether all the bees of that stray swarm would be lost before I stopped the disease. I always keep pieces of corrugated iron cut to fit the roofs of my hives, and well roped down all winter, have no trouble with dampness.—D. MASON.

REPLY.—You could, of course, buy a queen in, say, early May, and re-queen; but if you want a swarm, make one artificially as described in the Guide Book on page 93. Do it when queen cells are started, and instead of leaving the old queen with the comb of brood and bees, kill the queen, and see that the comb left has a queen cell. If you prefer having fresh blood, the old queen (and, of course, all queen cells) may be removed a day or two after the swarm is made and a new queen introduced.

## Special Prepaid Advertisements. One Penny per Word.

Will advertisers please read these Rules carefully in order to save trouble, as they will be strictly adhered to.

Trade advertisements of Bees, Honey, Queens, and Bee goods are not permissible at above rate, but will be inserted at 1½d. per word as "Business" Announcements, immediately under the Private Advertisements. Advertisements of Hive-manufacturers can only be inserted at a minimum charge of 3s. per ¼in., or 5s. per inch.

PRIVATE ADVERTISEMENTS are only intended for readers having Surplus Stock to dispose of. Driven Bees, Nuclei, and Queens that are reared or imported for sale, are Trade Advertisements, and can only be accepted under trade terms. A charge of 6d. extra will be made if a box number is used.

Advertisements must reach us NOT LATER than FIRST POST on TUESDAY MORNING for insertion in the "Journal" the same week.

Orders for three or more consecutive insertions in "The Bee Journal" entitle advertisers to one insertion in "The Bee-Keepers' Record" free of charge.

### PRIVATE ADVERTISEMENTS.

FOR SALE, Hand Foundation Mill complete; wanted, Geared Extractor and Ripener.—POLHILL, Monkwood, Chingford. b.1

WANTED, for delivery end March, healthy Stock headed by pure Italian Queen; box sent.—CLAXTON, Grammar School, Doncaster. r.b.2

FOR SALE, about 2 cwt. fine Extracted Welsh Honey; guaranteed pure.—JAMES, Adpar, Newcastle Emlyn. r.b.3

WANTED, Geared Honey Extractor and Ripener, in good condition, approval, deposit; also Simmins' Single Conqueror Hives.—BISHOP, Woodswater, Beaminster, Dorset. b.4

PURE Light Essex Honey, in 14- and 28-lb. tins, 1s. 6d. per lb., free tins, and on rail; boxes returnable.—TUNMER, The Apiary, Maldon, Essex. b.5

PLANT now for the bees, strong fruiting Raspberry Canes, 2s. 6d. per dozen, 8s. for 50; also Strawberry Runners, 1s. per dozen, 6s. per 100, best varieties, carriage paid; cash with order.—HALL, Highfield Lodge, Balderton, Newark. r.b.6

WE admit we were too hasty in interpreting that "wireless" as a cypher message from Mars. 479,001,600 is, of course, the answer to our query of January 22.—SMITH, Cambridge. b.7

WANTED, at once, six Stocks Italians; also 4-frame Extractor, Cowan's. Lowest prices for cash.—JACKSON, Hollins, Abergavenny. b.8

LADY wants post on Bee Farm; some experience. —Box 63, B.B.J. Office, 23, Bedford Street, W.C.2. b.9

PURE Light Shropshire Honey, 28-lb. tin, £2 12s., and 56-lb. tin, £5 2s.; tins free and carriage paid; sample 6d.—T. TUDOR, JUNR., 20, Spring Cottage, Little Drayton, Market Drayton, Salop. b.10

COTSWOLD HONEY, 60-lb. tin, granulated, 1s. 7½d. lb.; seven Volumes B.B.J., 1902 to 1912, home bound, 15s. 9d., separately 2s. 6d. each.—BOWEN, Pittville Street, Cheltenham.

PLANT "Willow Herb" for your bees; useful honey flower; 12 roots, 2s.—BOWEN, Pittville Street, Cheltenham. b.11

WANTED, Roots' "A.B.C.," latest edition, and Cowan's "Honey Bee."—WISDOM, 291, Coldharbour Lane, Brixton. b.12

FOR SALE, owner going abroad, Simmins' Single Conqueror Hive, 16in. by 10in. brood frames, and two Supers of standard frames, new 1918, containing strong, healthy Stock Italian Hybrid Bees, now wintering on abundant stores. What offers?—G. E. CLARK, Glanton, Northumberland. b.13

FOR SALE, Books by old authorities on bees.—H. WISDOM, 291, Coldharbour Lane, Brixton London. b.14

WANTED, W.B.C. or 12-frame ditto, Hives, Feeders and Appliances.—Apply, with lowest prices, MRS. INGLEBY, Pond Farm, Worcester Park, Surrey. b.15

150 BRITISH Butterflies and Moths, five Store Boxes, Net, Forceps, etc. What offers?—BRETTELL, Pedmore, Stourbridge. b.0

WANTED, Maid to assist with housework.—Apply, MRS. W. HERROD-HEMPSALL, The Apiary, Old Bedford Road, Luton, Beds.

ITALIAN BEES on 6 frames, headed by Penna's 1920 imported direct Queen, delivery June, £4 10s.—ENNEVER, Oak Avenue, Ridgeway, Enfield. a.56

70 SECTIONS, 2 cwt. Extracted, 12 dozen screw tops; sample 6d.—A. W. SIMCOX, 17, Victoria Road, Fallings Park, Wolverhampton. r.a.58

PURE light Cambridge Honey, 14-lb. tins, 22s. 6d.; 28-lb. tins, 42s., carriage paid; sample 4d.; tins free.—J. YOUNGER, 6, Maid's Causeway, Cambridge. a.66

CORRESPONDENCE Course in Bee-keeping.—MISS F. E. PALING, Golden Square, Henfield, Sussex. r.a.54

WANTED, portable Greenhouse.—Price and particulars to W. HERROD-HEMPSALL, Old Bedford Road, Luton, Beds.

WANTED, Anster Rear Wind Screen for motor car.—HERROD-HEMPSALL, as above.

FOR SALE, one Exhaust Whistle, 11s., post free; one Wood Milne Motor Foot Pump, 45s., carriage free.—HERROD-HEMPSALL, as above.

### BUSINESS ADVERTISEMENTS.

1½d. per word.

WATERPROOF RUBBER SHEETS for covering outhouses, etc., 72in. by 36in., brass eyelets, 12 for 20s.—SAGARS STORES, Ardwick, Manchester. b.16

A. H. BARTLETT, having established an Apiary where there are no bees within many miles, can supply pure mated Italian Queens and Nuclei. His stocks of Italians have been tested for five years for special qualities, and are second to none—hardy good disease resisters, extra prolific, the best of comb and honey producers, also mild tempered. Orders now booked for Nuclei, June-July, 3-frame, well covered with bees and brood, with 1920 pure mated Italian Queen, £2 15s.; 4-frame, £3 5s., carriage paid; box 5s., returnable. Pure mated 1920 Italian Queens, June-July, 9s. 6d.; August-September, 7s. 6d.; Virgins, 4s. 6d.; safe delivery; satisfaction guaranteed. Cash with orders. List ready shortly. All Queens reared by the best up-to-date method in full colonies. Thirty years' practical experience.—A. H. BARTLETT, Bee Specialist, High Street, Crowthorne, Berks. b.17

DUTCH BEES, and Dutch-Italian, 4-frame Nuclei May, June, delivery, orders taken in rotation, £3 3s., cash with orders, carriage paid. They are the Daily Mail strain I have had seven years, and Bee Mason's four years; never had disease; beautifully clean; healthy.—SEALE, Ashley Cottage, Oatlands Drive, Walton-on-Thames, Surrey. b.19

**CAN** book a few orders for Nuclei of disease-resisting strain of bees for early delivery.—**CHEESMUR**, Forest Apiary, Whiteley Hill, Worth, Sussex. b.18

**DONT** buy bees until you have seen our prices and guarantee. You risk nothing, as our bees are sent on approval. Catalogue 3d., which is refunded on first order.—**PEARSON & GALE**, Marlborough. b.20

**WE** are reserving a few choice Italian Queens for the D.B.s for delivery in May, June, July and August. Prices and particulars on application.—**S. H. SMITH**, 50, Maid's Causeway, Cambridge. r.a.62

**ITALIAN NUCLEI**, 3-frame, Penna's 1920 Queens (guaranteed), 70s.; Hybrids, Penna's and Simmins' Special, May-June delivery, £3, carriage paid; box returnable. Orders (cash) strict rotation.—**MOORE**, 31, Monmouth Road, Dorchester. r.a.65

**FOR SALE**, Swarms, English strain. Book now for May and June.—**BRISTOW**, 47, Auckland Hill, West Norwood, Surrey. r.a.67

**ITALIAN** and Hybrid 4-frame Nuclei, 1920 Queens, £3 3s.; Hybrid Swarms, 10s. 1b.; Fertile Queens, May-June 10s. 6d., July-August-September, 8s. Strongest and best honey gatherers in the country. All orders booked in rotation; £1 deposit, balance on delivery.—**THOMAS CHITTY**, Burleigh Farm, Cassington, Oxon. a.56

**FEW ITALIAN NUCLEI** from 1919 Penna Queens, 3 frames, 50s.; delivery June-July; boxes 10s. extra, returnable.—**LEWIS, J.P.**, Clarboston Road, Pem. r.a.37

**STRONG STOCKS** of Bees, guaranteed, on 7 frames, with pure selected Italian Queens, 1920: orders booked in rotation for delivery from beginning of June; price £5, carriage paid; traveling box 10s. extra, which is returned. Cash with order, or 25s. deposit and balance by May 25.—**MISS F. E. PALING**, Golden Square, Henfield, Sussex. a.40

**ITALIAN NUCLEI**, 3-frame, young Queens, £3; boxes 7s. 6d., returnable; Fertile Queens, 10s. 6d.; Virgins, 5s. 6d.; Simmins' and Penna's strain.—**WATTS**, Conway Cottage, Newtown, Parkstone, Dorset. r.a.48

**HIVE MAKERS** Wanted.—Apply, letters only, stating age, experience, wages expected, to **LEE**, Beehive Works, Uxbridge, Middlesex. a.13

**HAVE YOU READ "THE BEE WORLD"?** If not, why not? Every number in itself is a useful literary work for practice and reference. Specimen copy free.—Offices: **THE APIS CLUB**, Port Hill House, Benson, Oxon.

**ITALIAN QUEENS** direct from Italy. Price list for 1920 on application.—Address, **E. PENNA**, Bologna, Italy. w.39

**WANTED**, for scientific purposes, a few live Bees from diseased or dwindling stocks; cages sent and expenses paid.—**SNELGROVE**, Quadrant, Weston-super-Mare. a.11

**BEE FLOWER SEEDS.**

Collection of six best Varieties, 1s., post free. Beautifully Illustrated Instructions Up-to-date. Garden Guide, 64 pages, Free.

**KNIGHT'S,**  
SEED SPECIALISTS,  
WOLVERHAMPTON

BOOK NOW.

**ITALIAN QUEENS,**

Pure Penna Strain.

**ASHWORTH,**

THE BUNGLOW, WYEMOUTH STREET, WARMINSTER.  
(late of Heytesbury).

**Bee-Keepers  
Wake Up!**

You can make a Big Profit if you use right up-to-date Appliances, including the Manley Hive.  
**MEADOWS,**  
**SYSTON, LEICESTER.**



**BEES. BEES. BEES.**

First Quality Dutch (Imported) Stocks. £5 per skep.  
Terms: Cash with order.  
Bees delivered in Spring.  
**P. BENNETT**  
437, CLARKSTON ROAD, GLASGOW.

**BEES. BEES. BEES.**

**Books for Bee-keepers  
NOW IN STOCK.**

<b>A Modern Bee Farm</b> ... ..	7/6	... 6d.	Postage
<b>Beginner's Bee Book (PELLETT)</b>	5/-	... 4d.	
<b>BEE-KEEPING SIMPLIFIED FOR THE COTTAGE AND SMALLHOLDER (W. HERROD-HEMPSALL, F.E.S.)</b> ... ..	1/-	... 1½d.	
<b>BEE-KEEPERS' PRACTICAL NOTE BOOK (T. W. COWAN)</b>	1/-	... 1½d.	
<b>BRITISH BEE-KEEPERS' GUIDE BOOK (T. W. COWAN)</b> (paper covers only)	2/6	... 3d.	
<b>Dissectible Model of Queen Bee</b> ... ..	4/6	... 3d.	
<b>FERTILISATION OF FRUIT BLOSSOMS BY BEES (T. W. COWAN)</b> ... ..	-/3	... 1d.	
<b>Honey and Health (A. HOPE)</b> ... ..	-/6	... 1d.	
<b>Honey Vinegar (REV. G. BANCKS)</b>	-/2	... 1d.	
<b>How to Keep Bees (ANNA B. COMSTOCK)</b> ... ..	5/-	... 6d.	
<b>PRODUCING, PREPARING, EXHIBITING AND JUDGING BEE PRODUCE (W. HERROD-HEMPSALL, F.E.S.)</b> ... ..	2/-	... 3d.	
<b>Productive Bee-keeping (PELLETT)</b> ... ..	10/6	... 6d.	
<b>Queen Rearing in England (F. W. L. SLADEN)</b> ... ..	1/6	... 2d.	
<b>Snelgrove's Method of Re-queening</b> ... ..	-/6	... 1d.	
<b>The "Townsend" Bee Book</b> ... ..	2/6	... 2d.	
<b>WAX CRAFT (T. W. COWAN)</b> ... ..	2/-	... 2½d.	
<b>Wilke's Book on Swarming</b> ... ..	1/-	... 1½d.	

**MISCELLANEOUS.**

<b>Maeterlinck's Life of the Bee The Lore of the Honey Bee (TICKNER EDWARDS)</b> ... ..	3/6	... 3d.
<b>The Humble Bee (F. W. L. SLADEN)</b> ... ..	2/-	... 2d.
<b>THE BEE WORLD</b> (supplied only to members of Associations interested in the control and development of the APIS CLUB, apart from ordinary members of the latter), per copy ... ..	-/8	... 1d.

**British Bee Journal & Record Office,**  
23, BEDFORD STREET, STRAND, LONDON, W.C.1.

**FINEST SECTIONS OF HONEY.**

A large quantity for Sale at carriage paid prices, either Plain or Glazed

**IRISH RUN HONEY.**

Several cwts. for Sale in quantities to suit customers, at carriage paid prices in free tins and cases.

**GORDON ROWE,**

Honey and Beeswax Packer,  
28a, Moy Road, Cardiff.



# The Metal Foundation

(Protected.)

**¶** The triumph of the Metal Foundation is due to the following significant advantages:—(1) Indefinite durability with reasonable care; (2) Greater safety of bees in transit on new combs; (3) Capability of bearing the weight of a heavy swarm in hot weather; (4) Greater comb stability in quick extracting; (5) Control of drone cells; (6) The production of even combs; (7) Easy removal of queen cells without the slightest injury to the foundation; (8) Cleanliness and adaptability to sterilisation by boiling; (9) Economy of labour and time in fitting and detaching; (10) An ideal compromise between the metal comb and the wax foundation.

**¶** The invention has created a worldwide interest. Its value will be the more appreciated by studying the fol-

lowing original literature:—“The British Bee Journal,” November 13; “Bee Craft,” December; and “The Bee World,” September, October, and November, 1919.

## RETAIL PRICES.

**¶** The Metal Foundation (“worker” type) can now be produced in any size required, whether for the brood chamber or the super, e.g., for the British Standard Frame (14 in. x 8½ in.), Deep Standard (14 in. x 12 in.), Simmins’ (16 in. x 10 in.), Langstroth (17½ in. x 9½ in.), etc., and for their corresponding super frames. Despite the heavy cost of machinery, metal, etc., it is offered at a price *well within the purchasing power of the average bee-keeper*. All orders, whether large or small, receive *prompt attention*, and are executed *in strict rotation, and in good time for the season*. We have further decided—for the benefit of bee-keepers who are not yet in a position to place their orders—on taking the risk of a liberal margin of production to meet unavoidably delayed orders. *If you have not yet made up your mind as to your requirement, you are still in time to do so.*

## The Uxbridge W.B.C. Five.

**¶** This popular hive, which we originally introduced over twenty years ago, is admirable for its *water-proof* features, since it eliminates the plinth. It stands supreme amongst all W.B.C. patterns. You will never regret trying it with your metal foundation.

*\*\* We allow a Five per cent. discount on all our goods (including the Metal Foundation) to members of the Apis Club, who are respectfully requested to forward their membership cards when placing orders.*

*A FINAL REMINDER!* To avoid disappointment apply now for the Metal Foundation Price List, and for our 1920 Catalogue.

# JAMES LEE & SON, Ltd.

## UXBRIDGE, MIDLESEX.

(Telegrams: Graphicly, Uxbridge.)

Telephone: Uxbridge 181.)

# “QUEENLAND”

## SUPPLIES THE WORLD'S BEST QUEENS.

That's the Public Verdict. Do you doubt it? Then please refer to the spontaneous opinions of many clients, as given in the Revised 1920 "Queenland" List (3½d.) containing 20 pages of instructive reading which will start any unfortunate or hesitating beekeeper on the high road to success.

## “W.S.” BEES WON'T DIE OUT IN WINTER.

That's the General Verdict. You have only to glance through the Queenland 20-page List to find the proofs of this statement. Just give them ordinary care, with sufficient food to tide over the winter, and nothing can check their marvellously rapid progress.

## DON'T KNOW HOW TO DWINDLE IN SPRING.

That's because of their inherent VIM, as proved by the very frequent reports that established stocks of these bees are in swarming condition in APRIL. They have for more than 25 years been selected and bred for that very desirable trait—Longevity; hence the reason why the population of the hive is so rapidly piled up to massive proportions.

## READY FOR SUPERS IN APRIL.

That is—before other bees have barely started to build up, as confirmed in many instances; showing that “spring dwindling” is not in their line, under just reasonable treatment.

## THEY STORE HONEY WHILE OTHER BEES ARE IDLE.

That's because of their longer tongues and greater strength of wing, enabling them to visit flowers other kinds never reach. Established stocks of W.S. bees don't wait for the owner—they just push him along.

## THE “WHITE STARS” ARE MOST PROLIFIC AND WONDERFUL HONEY GATHERERS.

This is a rare combination, but is verified by many reports. Some queens have exceeded 350 lbs. in one season. In one case a nucleus increased to seven lots, five of which were sold while the remaining two gave 365 lbs., and the total sales amounted to over £40 in actual cash the second year. Another nucleus in Wales covered 40 frames of brood by August of the same year, and before the next season opened had made eight stocks. Then there is the case of a County Council delegate who reported that throughout his tour in EVERY CASE where an owner had done better than the average the results were attributed solely to the use of Simmins' Queens!

## MANY CLIENTS SAY “W.S.” BEES ARE IMMUNE FROM DISEASE.

That's because they have been bred by the most intense selection of both DRONE and Queen mothers for many generations, but S.S. gives no guarantee that they are absolutely immune, although it is known they have saved numerous apiaries, and collected tons of Honey that would otherwise have been wholly lost. In many cases “W.S.” queens have been given to hopelessly weak and diseased remnants of colonies, and have forthwith raised them to become the strongest stocks in the apiary; in one case storing (the same season) 100 lbs. after thus building up a small diseased lot—some cases reported of diseased remnants having been renovated by the introduction of W.S. queens have been so remarkable that S.S. himself has been astounded at the almost mysterious results.

## THE “W.S.” ARE NOT IMPORTED ITALIANS.

That is a great point to remember; we have no use for the soft imported Italians, and could not use the best queen selected from a thousand imported without causing a serious deterioration in our pedigree stock. The “W.S.” have gone miles beyond anything that can be imported from Italy.

**20 Page Revised List, 3½d., of S. SIMMINS, Queenland, Heathfield, Sussex.**

## QUALITY.

The difference between a good bargain and a bad bargain is not so much a matter of money as of quality.

All our goods have the "Hallmark of Quality" resulting in a large clientele of SATISFIED customers. Does this mean anything to you? If so, send for our large Illustrated Catalogue for 1920, free on application.

**R. STEELE & BRODIE,**  
Bee Appliance Works, WORMIT, FIFE, SCOTLAND.

# Bee-keeping Simplified

FOR THE COTTAGER AND SMALLHOLDER,

By **W. HERROD-HEMPSALL, F.E.S.,**

*Author of "Producing, Preparing, Exhibiting and Judging Bee Produce."*

Price 1s. net. Post Free 1/1½

This little book supplies the need for a cheap up-to-date and well-illustrated handbook on bee-keeping, and gives in Mr. W. Herrod-Hempsall's well-known, clear, lucid style all that is necessary to enable anyone to commence bee-keeping successfully. From **THE BRITISH BEE JOURNAL OFFICE, 23, Bedford St., Strand, London, W.C.**

## "THE HERROD APICURE."

SIMPLE CLEAN! EFFICIENT!

For the Prevention and Cure of Foul Brood and other Diseases of Bees.

**DON'T DELAY—ORDER AND USE AT ONCE.**

PRICE, with full instructions, 1/8, 2/10 and 5/8, post free. From all the leading Appliance Dealers, and from

**THE BRITISH BEE JOURNAL & RECORD OFFICE, 23, Bedford Street, W.C.2.**

The certain cure for  
and Preventative of  
"Isle of Wight" disease.

## 'BACTEROL'

Proved by Bee-keepers  
generally after testing on  
the most hopeless stocks.

Manufactured by "Bacterol" Limited, London, N.  
**MENLEY & JAMES, LTD., MENLEY HOUSE, WARRINGTON ROAD, LONDON, E.C.**

## The 'Kent' Standard Model Hives & Appliances

**TESTIMONIAL.**

*May 12.*

DEAR SIR,—I have had an opportunity of comparing the material and workmanship of your hives with others on the market, and in my opinion there is no sort of comparison between the two, yours being altogether superior in every particular.—Yours faithfully,—

*S. J. BALDWIN, Stanley Road, Bromley, Kent.*

Keep in touch with beekeeping methods in other countries, 4/- per year will bring you "L'Apiculture Francaise," a leading French monthly bee journal. Send a postal order to-day to

**E. J. BURTT, Manufacturer, GLOUCESTER,**

agent also for "Gleanings in Bee-Culture" and "The American Bee-Journal," each 6/6 per year, post free. Ask for appliance list.



No. 1964. Vol. XLVIII

FEBRUARY 12, 1920.

[Published every Thursday, Price 2d.

**CONTENTS.**

	PAGE		PAGE
BEE LEGISLATION .....	73	QUESTIONS FOR BEE-KEEPERS .....	76
JOTTINGS FROM HUNTINGDONSHIRE .....	73	CORRESPONDENCE—	
BEE NOTES FROM DERBYSHIRE .....	74	Bee Legislation .....	77
TRADE CATALOGUES RECEIVED .....	76	Re Hives .....	80
ASSOCIATION NEWS—		NOTICES TO CORRESPONDENTS .....	81
Somerset B.K.A. ....	76	WEATHER REPORT .....	81

**ALUMINIUM DRAWN OUT COMBS.**

**“MONEYCOMB”**

*The greatest invention in the Bee World for 40 years.*

This is a drawn out Comb of Hexagon Cells exactly as bees build in their natural state. It is slightly coated with wax, has been thoroughly tested, and is not an experiment. Bees readily take to it for rearing brood and storing honey. Strong and durable, will last 50 years with care. Big consumption of honey saved to produce wax for comb building. Control of bee diseases. No more burning of combs. Each comb easily sterilised and used over again.

Send for Catalogue and descriptive Leaflet.

1920 Catalogue post free.

Patented by ALUMINIUM HONEY COMB CO., of U.S.A.

SOLE MANUFACTURER AND LICENSEE:

**E. H. TAYLOR, WELWYN, HERTS.**

## THE British Bee Journal

ESTABLISHED 1873.

A Weekly Journal Devoted to the  
Interests of Bee-keepers.

Edited by T. W. COWAN, F.L.S., &c.,  
and J. HERROD-HEMPSALL, F.E.S.

**Correspondence: Whom to Address.**—All matters relating to the Literary Department, Associations, Shows, etc., should be addressed, "Editors, *British Bee Journal*," and all business communications and matters relating to subscriptions and advertisements to be addressed to the "Manager," *B.B.J.* Office.

**Subscriptions.**—Annual Subscription, 10s. 10d. post free in advance; single copies 2d., or 2½d. post free. If a receipt is required by post, a stamped and addressed envelope must be sent, otherwise a printed receipt will be enclosed along with the paper.

*Note.*—Cheques and Postal Orders should always be crossed, otherwise it is very difficult to trace them if they go astray.

**How to send Money.**—Remittances can be made payable to W. Herrod-Hempsall by crossed Cheques and Postal Orders. Stamps may be sent for small amounts up to 2s.

**Halfpenny stamps are preferred.**

Scottish or Irish cheques can only be taken in payment if 6d. is added for commission charged by banks for cashing them.

The Editors are not directly or indirectly interested in the manufacture or sale of beehives or appliances of any kind, and must refer correspondents wishing for prices or catalogues to advertisers in the paper.

## The Metal Foundation.

(Protected.)

For the benefit of readers of the JOURNAL and the RECORD we have arranged with the manufacturers of the Metal Foundation to accept all orders received through our offices at a consideration in the shape of a 25 per cent. deposit to begin with, and the balance by mid-March, or prior to delivery, if earlier. All orders are guaranteed by them to be executed *not later* than April, 1920.

Prices:—(1) BRITISH STANDARD FRAME, fully fitted with "worker" Metal Foundation: Single, 2s. 4d.; per two dozens, 2s. 3d. each frame; per four dozens and over, 2s. 2d. each frame.

(2) STANDARD SHEET of "worker" Metal Foundation: Single, 2s.; per two dozens, 1s. 11d. each sheet; per four dozens, 1s. 10d. each sheet.

Subject to a 5 per cent. discount to members of the Apis Club.

*Packing & Carriage Extra.*

\* \* \* Since the Metal Foundation will be produced only to order, no order will be subject to cancelling.

## OUR DEPOSIT SYSTEM.

You are advised to insist on this being used when dealing with strangers.

### Rules and Conditions for Depositing

*In order to save trouble, it is requested that the Rules be carefully read over by persons using the Deposit System of trading.*

Goods should not be despatched until notice that the money has been deposited is received from this office.

**1. Method.**—When strangers are dealing together, the purchase-money of the articles is deposited at our office. We acknowledge receipt of the deposit to *both* parties, and hold the money until we are satisfied that the purchase is concluded. If a sale be effected, we remit to the seller the amount deposited, less a charge of 2½ per cent. in the £, with a minimum of 6d., and the expenses of Post Office Orders and postage, &c. Cash will be forwarded by Cheque, Post Office Order, or by Postal Order as preferred. If a sale or exchange be not completed, we return the amount deposited, after making the same deduction. By this means buyers and sellers are secured against fraud.

**2. Deposits.**—Postal Orders (drawn on General Post Office) and Cheques must be made payable to W. Herrod-Hempsall, and crossed "London County and Westminster Bank." The numbers of the Postal Orders should be kept by the sender. We cannot be responsible for any loss that may occur in transit.

**3. Honey on Approval.**—All honey will be sold by sample, which must be sent direct to buyer.

**4. Bee Appliances.**—In ordering, the time allowed for completing the order to be stated to us when sending cash. If maker accepts, we hold cash until transaction is satisfactorily completed, when the amount will be remitted, subject to conditions as in Clause 1.

**5. Bees and Queens.**—These will be dealt with entirely by the parties concerned, so far as price, &c., go, and when the purchase is satisfactorily completed cash will be remitted as per Clause 1.

**6. Goods in Transit.**—These are at the seller's risk, i.e., any damage to or loss of an article on its journey is borne by the vendor; but a rejected article must be properly packed and returned by the same means as was used in sending it.

**7. Carriage.**—The carriage of all goods, *except such as are sent by post*, is payable by the buyer, unless otherwise agreed. If any article sent on approval be returned, each party to the transaction must pay carriage one way.

The products of the Apiary, of  
Poultry and Farm Stock, of  
the Fruit and Vegetable  
Garden can be Advertised  
and Sold through

THE  
**BAZAAR, EXCHANGE & MART**  
*Newspaper.*

Get a Copy—Thursday and Saturday 3d. The "Bazaar" publishes also practical handbooks by experts. Send for full catalogue, post free from—**WINDSOR HOUSE, Breams Buildings, LONDON, E.C.2.**

THE  
**British Bee-Keepers' Association.**

The recognised centre of practical and scientific bee-keeping in Great Britain. Particulars and conditions of membership may be obtained from the Secretary, **W. HERROD-HEMPSALL, 23, Bedford Street, Strand, London, W.C.2.**





## Bee Legislation.

A meeting of representative bee-keepers, and others, called by the Ministry of Agriculture, was held in the Surveyors' Institute on the afternoon of Friday, Feb. 6. Its purpose was to consider the draft of a Bill dealing with bee diseases, which is to be presented in the House of Commons at as early a date as possible. The Ministry of Agriculture promised some time ago that bee-keepers should be consulted before another Bill was presented, and the meeting was called in redemption of that promise. Dr. F. Keeble was in the chair, and was supported by Capt. Wellington, Major Garnsey, and Mr. W. Herrod-Hempsall. The meeting was an unqualified success, and we will give as full a report as possible in a later issue, also the Bill as soon as it is available for publication.

Dr. Keeble opened the proceedings with a very able address, and then called on Capt. Wellington to explain the draft Bill. This is, at present, practically the same as the one before Parliament in 1913, but, of course, some alterations may be made when it is before Parliament. Many bee-keepers will no doubt be disappointed that it is not proposed to make bee diseases "notifiable," but the reasons given for the omission were, we think, sound. The reasons given were, it would take too much clerical work, and would involve the appointment of a large number of inspectors in order to deal with the very numerous cases that would be reported; this, as a consequence, would entail the expenditure of a large amount of money, making it doubtful if Parliament would accept the Bill in the interests of national economy.

This statement should allay the fears of those who were under the impression that legislation for bee diseases meant letting loose a horde of badly qualified inspectors (at big salaries), who would harry all bee-keepers, good, bad, or indifferent, by calling to compusorily examine stocks of bees whenever they thought fit—mid-day or mid-night, at mid-summer, when supers were on, or at mid-winter, when bees were taking their winter rest. We believe these fears to have been groundless in any case, but the statement made should now wipe them out altogether.

For our own part, we think the Bill as good as it is possible to get now, and that it does not err on the side of harshness. The main idea is to make it more "educative" than "legislative."

## Jottings from Huntingdonshire

FOR JUVENILE READERS.

It was one day last August that, in plucking a monthly rose, I caught sight of a worker bee secreted between the petals, looking sad and desolate. "Holloa," I said, "what are you doing here?"

"Please leave me alone," said the bee. "I have come here to die."

"To die! Why such despair, you are only young?"

"I am truly quite young, as you say, but being no longer able to gather nectar and pollen for the hive, owing to my worn-out wings, I have no desire to live."

"But," I said, "surely you may go to your hive and help to tidy up, guard your queen, and let the stronger bees feed you?"

"I cannot do that; it is a law in the bee world that when a worker bee is no longer able to go and gather riches she must not consume the stores already laid by, but sacrifice herself for the sake of her successors; and even if they would allow me back, I have been taught that as soon as I am too weak to forage I must hide myself in a flower and sleep into death. So I beg of you to leave me quietly alone for my few remaining hours."

I was quite distressed, not knowing whether to grant her request, or take her in the house and make her comfortable in a nice cosy box, and thus lengthen her days. I decided to do the latter. "Come with me," I said: "as I have plucked your flower, I will take you in the house, and give you honey and a snug little home." And so saying I took her to my study, and, getting a spoonful of honey, placed her a plate and put her near it. She flew at once to the window, which was, fortunately, closed, and buzzed up and down the glass. I caught her again, and asked her, sharply, what she was trying to do, and why she refused my honey. "I mustn't eat any myself," she said, "but I must just struggle to my hive door and tell my younger sisters to come and clear it up." I seized her gently, and placed her again on the plate, and said quite firmly: "I have put this honey here for you, and not for your sisters, so take your fill, and then, when you're quite satisfied, I want you to tell me all you can about yourself, your mother and sisters and brothers, and your home." "Thank you," she said, and saluted me like a well-trained girl scout. "You seem kind; I'll do my best to tell you what I know." "That's right. Now have your meal, and then we'll talk." She sucked

away at the honey, and enjoyed it, and after wiping her mouth she began walking around the edge of the plate with a "what do you want to know" look as she passed by me. "Won't you sit down," I said, "and rest yourself?" "In a minute," she said, and made another attempt to fly, but fell to the floor. I picked her up, and placed her in my hand. "So sorry," said she. "I forgot the window was closed. I was going to empty my honey bag, but I couldn't do it were the window open, for the weight is too much for my frayed wings. Your hand is nice and warm, but don't squeeze me; I might forget and sting you. Please let me walk about; I can't sit still and talk." "Very well, then; you can walk up and down my arm if you wish. Tell me when were you born?" "Last May; and how I wondered where I had come to, but my elder sisters soon told me, and I had to go to school for a few hours. There the teachers told me that I should have to nurse the baby grubs, learn to fly, go out and visit flowers for nectar and pollen, and trees for propolis, and to love and guard my queen, and, when necessary, to stand at the doorway and keep away robbers, or ventilate the hive with my wings, tidy up the hive, and, above all, learn how to build comb and make cells, for without these the queen could not lay eggs, and we could not store honey and pollen."

"What a lot to learn in so short a time; you are clever little insects. Now tell me why you make your cells six-sided, and not round."

"Well, you see," said she, "if we made them round there would be a lot of waste space between each cell, and we are taught that all waste is a sin. Sometimes, when we are working a cell on the outer edge of a comb, we do make one side round, because there are no other cells to fit against it."

"I understand, little bee; but you could make them square, and they would still fit one against the other."

"O, you funny man. Don't you understand that if our cells were *square* they wouldn't fit our bodies, and the sharp angles of the corners would be such a nuisance to us, and how would the grubs curl up in a square cell?"

"Thanks for explaining it so nicely. Now let me go back a bit. You said you were born in May, and in three months you are worn out. Do no bees live longer?"

"Oh, yes; teacher told me she was born last September, and had lived all through the winter, but then she had not much to do until a few weeks before I was born.

She died two months ago, and the reason I am worn out so soon is because I was born when the hive was working overtime. We had so little rest; in fact, I should have collapsed before this had not July been so cold, which cold kept us close home, and gave us a chance of rest. Yet we weren't a bit happy that month; we got quite cross sometimes because we couldn't go out and forage. Of course, you know, our queens live three or four years sometimes?"

"Yes, I did know that. Now tell me, since your usefulness is ended because of your injured wings, why you have two pairs instead of one. With one large pair of wings you could carry more than with two smaller pairs."

"Of course we could, but how could we enter a cell had we one broad wing on each side? By having smaller wings we can fold them over each other close against our body, but when we fly they become one pair of wings. You look surprised; but it's quite true. We have hooks on our lower wings, which fasten into a long ridge on our upper wings when flying, so that's how they become one wing."

"How interesting; but you are looking tired; let me put you in this cosy box; you'll find two drops of honey in the corner. When you've rested I'll have another long talk with you, for I've heaps and heaps to ask you.—Bye-bye."—E. F. HEMMING.

P.S.—The elm trees are fully six weeks more forward than they were last year. If this means anything at all, it forbodes a very early honey flow, with a possible check in May. I shall uncap sealed comb and commence spring feeding by the end of this month. There is already plenty of pollen and propolis available, while daffs, crocuses, apricot blossom, hazels, willows, osiers, snowdrops, aconites, poplars, and the like, are ready to furnish pabulum for the bees.

## Bee Notes from Derbyshire.

As a great lover of bees, I am naturally a great lover of Nature. I do come across beemen at times who don't bother to study Nature; so long as honey comes into the hives they neither know nor care how or where it comes from. Well, I should say they are not the real beemen, for I think to follow a bee in all its wanderings after food one has to study Nature very closely, and, after being down the mine all night at work, I find it a pleasant recreation to follow the bee in a few of its ramblings.

Before I kept bees I was engaged in

pursuits agricultural. I never could see half the beauty of the countryside that I was compelled to live in at that time. I used to think "What good are all those trees, only to block out the view? but to go back to that part of Notts again, after being a bee-keeper for 20 years, how different.

Watching the first bees I had bringing in their loads of yellow pollen gave me a great desire to see where they were gathering it from, and as it was Easter Sunday I naturally thought of the "palm," or "pussy" willow, as a likely source for such pollen, so I started out (on my first Nature study) to find a "palm" tree; and how interested I was to see the bees running over the flower to collect the pollen. But what a lot of different colour they brought in on that first April day! It fairly bewildered me to see bees worked on so many colours of flowers; here was one bee coming in with the light orange from the dandelion, there another one with the dark orange of the furse, or gorse, then the light colour from the gooseberry. What a world of interest those few bees had opened up to me; and as the season advanced the more interested I got (especially when the honey began to come in). Every tree as it came into leaf or bloom gave me a greater interest in Nature to watch it, and see what kind of pollen bees got off it. In time I got to know practically every kind of bloom a bee would work on. Then, as one visits different parts, and at various seasons, one comes across trees that one little thinks bees visit. Thus I came upon a bee on a maple tree one day not so long ago. As there were not many maple trees about where I lived I had not noticed them at work on them, but as I travelled about on my bike this autumn, when the leaves on the trees were all colours imaginable, how one could spot the different bee trees from a distance that one little thought were so near to one and the bees, and how the maple was a predominating colour in some parts. It must give the honey a fine flavour, as I tasted some in one of those parts, and it was excellent.

But to come back to the pollen. I can about always tell what bees are working on now by the pollen they carry in; but the stock that I have among the heather now—and it was there all last summer—it beat me hollow one day in July to know what kind of a flower they were working on; they were bringing a pollen home that I had never seen before, and it was plentiful, too, for six out of every ten bees were loaded with it. I looked high and low that day for that pollen plant, or tree, but I could not find a bee working

on a flower anywhere that gave that colour of pollen—a kind of a blue-black.

As Mr. Henry Smith, of Darley Dale, has some large nurseries close to there, where practically every kind of tree and shrub are grown, I thought they might be going there for it, but as the nurseries are taboo to strangers, I could not get in to see if bees were finding it in there, so it is still a mystery to me.

I have never been able to catch the bees working on rhododendrons. Do they? Perhaps Mr. Kettle could clear that up for me; if they do, then those bees have a fine feast in store for them next June, for they are close to the home of the "rhodos." There are thousands, all sizes, from 6 in. high to 10 ft. The soil is a kind of black, loamy, peaty soil, and part fine white sand. In one part, all bog moss on here, the rhododendrons grow to perfection. The bog is grown over with birch, black firs and "pussy" willow, and in among these the rhododendrons grow to 10 ft. high, 15 ft. through the bushes, and once when I saw them they were solid masses of bloom. Really a sight to behold, and yet I don't think half a dozen people saw them, for they are far from the beaten track; but they are there—two or three acres of them. I should never have been wandering in that out-of-the-way place to have seen them if it had not been for the bees. One can get very close to Nature about there, and I visit it often when the heather is in bloom. It grows to four or five feet in length among those rhododendrons. The population is very scanty about there, and it does seem quiet on a summer evening; not a sound, save the call of a grouse or a curlew, and how rarefied the air is. As I sat among the heather one night last summer I could hear a brass band playing quite well five miles away. In London one would scarcely hear it in the next street.

We will leave those quiet scenes of purple heather in bloom, with here and there a patch of white heather. I call it my flower garden, as I scarcely ever see anyone else enjoying it but myself.

I take a bike ride across country 40 miles. The harvest is cut in places, and one can begin to see in the stubble the clover plant for the next year's clover honey season. Anyone not interested in bees would pass by those fields, and never see them, but the real beeman and lover of Nature sees them, and wonders and thinks what a happy time somebody's bees will have next June and July (if the all-important thing—the weather—is favourable) gathering honey from those same fields.

—TOM SLIGHT, Clay Cross, Derbyshire.

### Trade Catalogues Received.

*Mr. E. J. Burt, Stroud Road, Gloucester.*—Mr. Burt prefaces his catalogue with a word of advice to beginners as to the appliances needed, which will be of great assistance to anyone starting to keep bees. Those who know nothing of what is actually required are bewildered when they look through a catalogue, and this little advice will be appreciated. We notice that to all hives having legs these are specified as oak. The catalogue is well illustrated.

*Messrs. Steel & Brodie, Wormit, Fife.*—A very comprehensive catalogue containing a number of novelties. Being situated in the land of heather, this firm naturally caters more for the producer of heather honey than other appliance dealers. The catalogue concludes with a couple of pages of hints to beginners. We congratulate Messrs. Steel & Brodie on what we think the best catalogue they have yet issued.

*Mr. E. H. Taylor, Welwyn, Herts.*—This catalogue is also replete with everything necessary for the bee-keeper. Mr. Taylor also caters for the poultry-keeper, and a short list of poultry-keeping requisites is given. Several novelties are listed, including the Bryden wasp trap, a very ingenious appliance, which, judging from what we have seen of it, should prove very useful in wasp infested areas. Six pages are given to "Hints on Successful Bee Management." Mr. Taylor has been appointed sole manufacturer and licensee by the Aluminium Honeycomb Co., of U.S.A., which will be made in the British standard size, and is listed in his catalogue.

### Somerset Bee-Keepers' Association.

FROME AND DISTRICT.

The second and third lectures were given in the Council Schools at Frome on January 8 and 15. The Rev. Arnold Cook presided.

The lecturer was Mr. J. Bigg-Wither, 1st class expert and secretary to the Somerset Bee-Keepers' Association. He showed some excellent lantern slides, including one of the Dutch skeps at the restocking apiary; also the method of swarm control and the correct method of working bar frame hives. He specially dealt with bee diseases, including "I.O.W." disease, and Foul Brood, etc. All present were agreed that the time was over-ripe for such legislative action as may be necessary to protect those loyal bee-keepers who do all in their power to keep down disease, whilst often a neighbour who is a big possessor is affecting the whole district by exposing diseased stocks. Legislative powers are essential, and it is hoped the time is not far distant when

the Government will pass a Bill, and protect those who are trying to stamp out this dreaded disease.

He advised all those with any old hives to scorch out the interiors and wash out with strong disinfectant, burn old combs and quilts, and paint exteriors.

The method of re-queening yearly was necessary, as stocks that were strong and headed by a vigorous queen were more likely to keep free from disease. He recommended Hybrid or Italian (preferably Italian) bees.

He stated that they had received fifteen Dutch skeps and thirty imported Italian queens; they had previously four stocks. From these they supplied sixty-two nuclei, and were wintering forty-eight stocks at their apiaries. Each nuclei sent out was headed by a pure Italian queen, or a hybrid, and he was pleased to say that, up to the present, they had not received a complaint of disease affecting any of the nuclei sent out.

He stated that many of our experts were experimenting with diseased bees, but up to the present no real cure had been reported by them, although many people claimed cures from certain drugs, etc. Replying to several persons who required bees, he stated that they hoped to be in a position to supply 200 nuclei this season. The prices would be about 35s. to 40s. each. He urged them to make an early application, as 70 were already booked, and they would be supplied in strict rotation. He showed the method of re-queening, making candy, wiring and fixing foundations in standard frames, etc. Questions were asked, and all appreciated the lecturer's replies.

A very hearty vote of thanks was passed to the lecturer at the close of each lecture.—E. G. HAWKINS, Hon. Sec.

### Questions, etc., for Bee-keepers for Self-Examination.

(Students are recommended to write their answers, and check them afterwards by reference to books.)

473. Describe the Alexander feeder.

474. How may propolis be cleansed from the hands?

475. Compare the use of full sheets of foundation in shallow frames with that of starters.

476. Suggest an outfit for a beginner who wishes to commence with a swarm and to work for sections.

477. State fully how wax should be prepared for exhibition purposes.

478. To what portion or portions of the year is it advised that the operation known as spreading the brood should be restricted, and why?

479. If a hive be kept without a queen for, say, 12 days during a nectar flow what effect might be expected on (1) honey production and (2) the swarming fever?

480. Give a full explanation of spring dwindling.

481. Describe the heart of a bee and state where it is located.

482. Make notes for a 15-minute lecture on "How to make the best use of an inferior location for an apiary."

J. L. B.



*The Editors do not hold themselves responsible for the opinions expressed by correspondents. No notice will be taken of anonymous communications, and correspondents are requested to write on one side of the paper only and give their real names and addresses, not necessarily for publication, but as a guarantee of good faith. Illustrations should be drawn on separate pieces of paper. We do not undertake to return rejected communications.*

### Bee Legislation.

[10126] There seems to me to be only one real objection to asking for legislation; that is, that a Bill may be introduced which insists on the destruction of "parasite carriers" which show slight signs of "I.O.W." This would be a disaster, as it would mean the elimination of many partially immune strains of bees. Provided we are given an assurance that this will not be done, I, for one, am heartily in favour of legislation.

May I, in conclusion, suggest that Miss A. Parker (and anyone else who is disposed to agree with her) should spend a little time meditating on *what we owe* to research. Scientists, like other people, sometimes make mistakes; but, as Huxley said, the only people who do not are those who do nothing.—ANNIE D. BETTS, Camberley.

[10127] I have with particular interest read the various letters on legislation which have resulted from your generous invitation. I regret, however, that I have learned nothing practical from them. Surely there must be some sound arguments for or against; or the matter could hardly have developed such strong feeling.

If bee-keeping is to become an established industry in this country, we have a right to expect from the Government the same encouragement and protection as other live stock industries, together with whatever little worries, if any, such encouragement and protection bring in their train.

Since the call for legislation originated and has been maintained on the disease question, bee-keepers must expect apiculture to fall in line with other branches of farming where diseases may cause losses which legislation can at least limit—from experience in other directions, almost obliterate.

Legislation without education would, of course, be folly, and it would be useless to order notification of bee diseases unless by publicity, in freely distributed pamphlets, bee-keepers are given the symptoms which it is necessary to notify. Publicity must also be given to proper treatment, and evidence of proper treatment must be a protection against undue interference.

The Diseases of Bees Notification Act should give such educational facilities through the county educational authorities that bee-keepers quickly learn to take those precautions which will be a safeguard against the consequences which the opponents of the Act so much dread.

If there are not to be found men with sufficient knowledge of bee-culture to draft a Bill which will help the industry we are indeed in a poor way. I am optimistic enough to believe that the intention of those who will be responsible for the Bill is to benefit the industry, and not to wreck it. I cannot believe that a sufficient lack of intelligence exists for that intentioned benefit to result in detriment.—A. JARMAN.

[10128] I have read with great interest the arguments for and against legislation. I think that to any broad-minded bee-keeper it must be plain that in every case where they are against they are either bee-breeders, or know very little about bees. I started bee-keeping in 1896 as a means of livelihood, and went into it thoroughly, sparing neither labour nor expense, and to-day I have no bees, but hundreds of pounds' worth of bee hives and appliances standing out of use through no fault of my own.

Had there been legislation twenty years ago to compel careless and dirty bee-keepers to destroy hopelessly diseased bees and to remove all disease-infested matter, I should to-day have had 100 stocks of my own, which would have been as many as my wife and myself could manage, in addition to supervising all the bees in this district. My trouble has been brought about by one man, who refused my advice and assistance. This man brought twenty lots in October, 1900, all badly affected with foul brood. He placed them in his garden, which is about 200 yards from my home apiary, and about 300 yards from my Crease Drove apiary, thus making it necessary for me to hire standing room for the swarms from another small apiary four miles from home, where I was allowed

to keep only a limited number of stocks on account of its proximity to grazing cattle.

Previous to "I.O.W." disease reaching this district, I acted as expert to the Lincolnshire B.-K.A., and in my rounds I found that my case was not an isolated one.

I found in all cases where they were against legislation the bees were affected with disease.

I have seen stocks of bees on station platforms, sent out from *Bee Masters*, in such a dirty condition that had they been sent to me I would not have allowed them to enter my apiary. I could make no mistake as to where they came from, as the *Bee Master's* name was printed on the label. I have seen others returned from Scotland with "Full of Foul Brood" written across the label. I think there is ample proof that legislation is necessary if bee-keeping is to prosper. One thing is certain, the honest honey-producing bee-keeper has nothing to fear from legislation. For many years my apiaries were inspected by experts of the Lincolnshire B.-K.A., and I have yet to meet the first one either unreasonable in their inspection or careless with disease. In fact, I found them at all times courteous and considerate, and derived much benefit from their advice and help.

Re "I.O.W." disease. All the time I was fighting foul brood in *my home apiary* only this terrible plague was surrounding the district, until in July, 1915, the disease made its appearance in one of my out apiaries, and in a few weeks the whole lot, consisting of twenty-two stocks, were wiped out. I shall never forget the sight. The garden was literally covered with crawling bees; and I had been so proud of the fact that no disease had ever reached any of my out apiaries. This apiary was on the Peterborough side of Crowland. By 1914 the disease had reached Eye Green and Thorney, and did desperate work with the bees. I had bees in the neighbourhood of both these places.

At Eye Green there was an apiary in which all the bees died of "I.O.W." disease in 1914. The hives with the combs on which the bees died were left with the entrances open, and were robbed by the live bees in the neighbourhood. They contracted the disease and died, until not a single stock remained alive.

In the spring of 1915 I called several times upon the owner of this infected apiary, and asked him if he would clear the hives of the infected combs, so that the disease might be checked, as our bees were not then infected; but all my appeals were in vain, with the above result.

I still hoped to save my Whaplode Drove apiary, as it was eight miles from

the one at Eye Green, but in 1917 it reached there. In the intervening eight miles there were over 200 stocks of bees which were all wiped out.

I maintain this is a *national* as well as a personal loss. Before disease came I produced an average of one ton of honey per season, every pound of which was fit to go on the show bench. I have exhibited honey, and won prizes, in every part of the United Kingdom, and maintain that the loss of the stock of the honey-producing bee-keeper is a national one, which can, and ought to be, protected by legislation.—F. W. FRUSHER, Swiss Apiary, New Road, Crowland, Peterborough.

[We visited our friend in the time of his trouble, and can vouch for all he says. He has not told half the story of his gallant fight against disease, or the nights and days spent by one of the best of wives in boiling, scraping, and burning appliances, quilts, etc. A cleaner apiary it would be impossible to find. To such an extent was this carried out that in the bedroom in which we slept stood the honey extractor, so brightly polished that we used it as a shaving mirror.—Eds.]

[10129] I most certainly do not agree with the suggestion put forward by Mr. Bryden. What I should like to see is free, frank and open discussion by extensive and other bee-keepers BEFORE ANY BILL IS DRAFTED. Those who have had any experience with legislation know how exceedingly difficult it is to have changes made in the wording of a Bill once it has been drafted. I also know, being in touch as I am with those who last opposed legislation, what a large amount of assistance could be given to the Ministry of Agriculture by such a meeting before the Bill is drafted, thereby saving time, which is money.

I also know that there are many of us who would like to know and decide upon the means to be used to eliminate disease. I should like to hear which opinion held by scientists is to be followed as to the cause of "I.O.W." Is it spread by contact of bees? Is it spread by a diseased adult bee feeding another, either in larvæ form or matured life? Is it spread by a SOURCE QUITE OUTSIDE OF THE STOCKS? If every bee in Great Britain were killed to-day, everything likely to come in contact with the bee in the apiary disinfected, would we overcome "I.O.W."?

I have given at a meeting in Cambridge a discovery I made years ago in connection with foul brood (when investigating "I.O.W."), which proves that our present treatment for eradicating foul brood is not likely in every case to produce the definite elimination of this disease unless we re-

move the queen. Bee-keepers certainly should, in all honesty, pay towards the cost of their own protection, and for the benefits they would receive under SOUND LEGISLATION; and I have laid before this county a scheme by which they would be put to a minimum of expense, be independent of political changes and bureaucracy. I will not enlarge upon it here, as you will, no doubt, have a copy of minutes.—G. THOMAS, The Causeway, Burwell, Cambs.

[10130] As a bee-keeper for over fifteen years, having seen the ravages of foul brood and "I.O.W." in several districts, I am most decidedly in favour of legislation. Many opponents seem to have created a "bogey" in their minds—of a Government official who they seem very much afraid of! What would have been England's bill of health to-day without the care and solicitude displayed by the various health officers—sanitary and milkshop inspectors, etc., together with notification of diseases (infectious), including that scourge, tuberculosis? In one district I saw a bee-keeper of the "old school" who professed to know more than his fellows of the "I.O.W." scourge, and contended it was due to lack of pollen, but his apiaries dwindled, notwithstanding frequent purchases, and at the end some of the stocks were unmistakably affected with "I.O.W.," and on a sale were scattered far and wide. I daresay many of the stocks are now dead. Yet such a man was held up in the local Press as an "expert." Had the Board of Agriculture the necessary power, drastic action (to the common good of all bee-keepers in the locality) would doubtless have been taken. Let the majority of apiarists decide. I have over thirty stocks (in some of which I had sealed brood on the 16th ult.), and am thoroughly convinced that apiculture should no longer be allowed to drift as heretofore. Associations can do useful persuasive work sometimes, but it, after all, is very limited, and of no use with "stiff-necked" people.—G. M.

[10131] I have been interested in the various letters against legislation that have been appearing in your journal. With all the beneficent results of legislation in the case of infectious diseases among humans and animals before our eyes, I cannot understand the objection to it in principle. I can understand the objection that people might have to their stocks being examined by inspectors not properly cognisant of what I might call surgical cleanliness; I can also understand the fear of their abuse of their powers. But, then, the law might provide against

these by proper education of its officers, and by protecting the property rights of bee-keepers. It seems to me that many correspondents do not approach the question from the right angle. The point to ask ourselves is this: Are we likely to advance bee-keeping by a good law, properly administered, or not? I say most emphatically that we are.

At St. Just, here is a case for legislation: foul brood 200 yards from where I am, another apiary at my elbow—so far free—and no redress and nothing done. An apiary of 30 stocks a quarter of a mile away, well run and always fighting it. No "I.O.W."—which is a blessing—west of Penzance.—C. S. MORRIS, M.R.C.S., L.R.C.P.

[10132] As you invite readers of THE BRITISH BEE JOURNAL to give their opinion *re* legislation for bee disease, I must at once say I am against it, and the only ones that I can see who wish for it are those who have been unfortunate enough to lose all their bees, so they have nothing to lose. I have been a bee-keeper for a number of years, and am glad to say all my bees are strong and healthy. I take every precaution to keep disease away from them, although I believe them to be quite immune from "Isle of Wight" disease. But, at the same time, if inspectors are to go round from one apiary to another, it is a very certain thing they are going to spread the disease instead of preventing it; and then, again, these inspectors are to visit one's apiary at any time and in any weather, of course. That would be one of the greatest mistakes. Perhaps it would be wet and cold, or when one had three or four supers on each hive or when queen-raising, and any bee-keeper knows what that would mean. Then, in the last Bee Disease Bill it stated: "5 (1) An inspector of the Board, or of the local authority, may at any time, accompanied, if he thinks fit, by an expert adviser and, . . ." etc. That shows that each inspector would not be a bee expert, and should certainly not be allowed to pull anyone's hives to pieces to examine the bees, for only an expert would be able to tell if bees were diseased or not, and there are few of them who could tell in its early stage. No, sir, this certainly will never do. Now for the other side of the question. It certainly is not right for anyone to leave hives standing about in which bees have died of any disease, and anyone committing such an offence should be severely dealt with, for it is a menace to the whole district; and I think if something could be done on the same lines as Mr. D. J. Hemming suggests (10,043) in *B.B.J.*, November 27, 1919, it would be successful

all round. And if bee-keepers look this number up and read it carefully they will understand it better than by just glancing at it, and I don't think any good bee-keeper would object to it.—H. CHEESMAN.

[10133] You are undoubtedly doing bee-keepers a favour in allowing them to use the JOURNAL to ventilate their views concerning legislation for bee diseases. The real question at issue is: Would legislation free our bees from disease? Upon that question we are divided. We have quoted to us that legislation has proved effectual in combating diseases in cattle. But cattle are not in the habit of flying. It is different with bees. One cannot isolate them so easily. We should also have to stop the free import of honey, or get a guarantee that it is free from disease, or every exposed unwashed honey-jar would be a source of danger (if disease is spread by infection). Is it not a case of "Physician! heal thyself?" Have we yet found the cause of disease ("I.O.W.") or discovered the remedy? If the advocates of legislation, instead of trying to rule the roost and seeking Government posts, were first to put their own houses in order, and spend their energies in seeking to find the cause of the disease and then discover a remedy, they would be doing something commendable, and ultimately win the praise of all. Or will the Government give a guarantee that there *will not be any* inspectors appointed with their salaries in the aggregate running into thousands of pounds if we have legislation? Because, although the Government pay, we have to find the money; a fact ofttimes forgotten. My convictions are that legislation will stamp out more bee-keepers than bee diseases, and the situation will only be saved by research work and individual effort, with the free import of bees until we have such a virile race of bees that they are immune from disease, and instead of being bound hand and foot, with red tape and officialism and a burden of expenses around our necks, we shall be a free people, following a profitable and pleasure-giving industry.—JOSHUA B. CREWES.

[We have a number of other letters on legislation, all but one of which are in favour. As will be seen from our "Editorial," Bee Legislation is now well on the way, and we do not, therefore, propose to publish any further letters. Those given this week were already in type. We shall, of course, give facilities for discussing the provisions of the proposed Bill as soon as we are able to print the draft.—Eds.]

## Re Hives.

[10134] At the fall of the honey season, 1919, I complained regarding the narrowness of the present-day hive, which gets to bursting heat, and simply becomes a swarm box. I don't complain regarding the make, as I have now a hive that has stood a gale a man could not walk against, and the roof and hive were water-tight, and roof needed no stone or rope to keep it on. What my trouble developed into was this. Bees come from the mountains of Austria, Italy and Cyprus, some little way up the mountains, shaded from cold winds, but enjoying a warm air, not the hot stifle of the plains. Swarming is not known. Years back, when a boy, we used wide hives, and the bees enjoyed warm air, and plenty of room to winter down without being airtight, with that stuff called "American cloth," and we enjoyed the honey flow without swarming, unless forced. Shallow frames had only just come in, and the extractor was little known. The honey was sold in bars, cut out and put on dishes at the tea shops by the lump. Sections were used in quantity. Very thin foundation was used. As I stated above, I saw the trouble, and I determined to go back to the wider hive, with frames across the brood box, for easier manipulation. I wrote a well-known manufacturer, and put my trouble before him. He asked me to choose a hive, and he would build to my requirements. I chose the well-known C.D.B. hive, with patent floor vent for hot days, fixed up.

This, which arrived in the flat, I erected (dovetailed), which, if time is taken and it is not slammed together, just gentle taps with a mallet, the fit is perfect.

The hive consists of a large body brood nest, that fits on the floor board, and can be taken bodily off to clean. The middle board slips out. The brood nest takes eleven frames, which is a boon to rear a queen at the back of the hive, or to add another comb the right time before a swarm. The large 9-in. lift allows  $2\frac{1}{2}$  ins. between super and outer cases, so one can get one's arm down to tuck in quilts, and also see the supers are on straight, which does away with endless stripping of lifts, which the bees get to know, and are ready to play the deuce with the unfortunate owner.

The hive is warm in winter, allowing warm air without draught, with a wired honey board over the combs, or a Rymer board, so the queen is not confined to one comb, which means a small lot of bees in the spring. There still remains the dear old "Cowan" hive that gives these advantages.

I find wire excluders a great advantage,



as one does not see bees all fanning at the entrance, which is hateful to watch. I have heard they bend, and allow the queen up, which is all rubbish. A careful man need never bend a wire; heavy-handed men, who throw things about, deserve to get their honey spoilt.

The only alteration I have made is to add two board cheeks to the porch, to protect the bees from the wind. Some hives have an apology for a porch; wind and rain play havoc with the bees not protected. Watch a new brood come out for the first time, with no proper porch, and see them blown on to the grass, in many cases never to rise again.

I also use a Swiss entrance, which is a boon against robbing and wasps; but if a zig-zag entrance, this is removed in the winter, and an 8-in. "Silver" entrance put in its place to stop dwindling from sunlight, and it is removed in May. I hope to send photos of this hive working at a future date. I am in favour of small apiaries keeping one hive for feeding bees in autumn.—CYRIL TREDCROFT.

## Notices to Correspondents

Correspondents desiring an answer in the next issue should send questions to reach this office NOT LATER than the FIRST POST on MONDAY MORNING. Only SPECIALLY URGENT questions will be replied to by post if a STAMPED addressed envelope is enclosed. All questions must be accompanied by the sender's name and address, not necessarily for publication, but as a guarantee of good faith. There is no fee for answering questions.

### PRICE OF SUGAR.

In answer to numerous inquiries as to the price of sugar, we are at present unable to give any information. We are making inquiries, and will reply soon as we hear anything.

A. L. JACKSON (Walsall).—Feeding with golden syrup.—Neither this or treacle are suitable for bee food.

"SWARM" (Wores).—Treatment of skeps.—Let the bees stay as they are until the skeps are almost full of bees, which will probably be from early April to middle of May, then transfer to a movable comb hive, as directed on page 149 of "The British Bee-keepers' Guide Book," using 10 frames of foundation. The treatment for foul brood would not avail for "I.O.W." disease. Get the skep home early in March. If the queen appears to be failing, re-queen as soon as the bees have been transferred to the new hive, otherwise do it as soon as the honey flow is over, say, about end of July. If you buy a stock that has wintered it should have a "spring cleaning" early in April, and the hive be washed out with disinfectant, or transfer the bees to a clean hive.

"INQUIRER" (Aberdeen).—Moving stocks.—(1) and (2). We should say the best time for moving them in your part of the country would be early April. (3) A spring cart would be the most suitable conveyance. (4) Yes. (5) It would take up too much space to answer this. Full instructions

on "Packing Bees for Transit" were given in the RECORD for November and December, 1916. We can send them post free for 6d. (6) We do not care for clipping the queen's wings. Give extra room a little in advance of the bees' requirements.

## Weather Report.

WESTBOURNE, January, 1920.

Rainfall, 3.77 in.	Minimum on grass, 16 on 7th.
Heaviest fall, .75 in. on 10th.	Frosty nights, 11.
Rain fell on 23 days.	Mean maximum, 46.8.
Above average, 1.07 in.	Mean minimum, 34.9.
Maximum temperature, 53 on 11th and 31st.	Mean temperature, 40.8
Minimum temperature, 20 on 7th and 8th.	Above average, 2.5
	Maximum barometer, 30.544 on 16th.
	Minimum barometer, 29.136 on 11th.
	L. B. BIRKETT.

## Special Prepaid Advertisements. One Penny per Word.

Trade advertisements of Bees, Honey, Queens, and Bee goods are not permissible at above rate, but will be inserted at 1½d. per word as "Business" Announcements, immediately under the Private Advertisements. Advertisements of Hive-manufacturers can only be inserted at a minimum charge of 3s. per  $\frac{1}{2}$  in., or 5s. per inch.

PRIVATE ADVERTISEMENTS are only intended for readers having Surplus Stock to dispose of. Driven Bees, Nuclei, and Queens that are reared or imported for sale, are Trade Advertisements, and can only be accepted under trade terms. A charge of 6d. extra will be made if a box number is used.

Orders for three or more consecutive insertions in "The Bee Journal" entitle advertisers to one insertion in "The Bee-keepers' Record" free of charge.

Advertisements must reach us NOT LATER than FIRST POST on TUESDAY MORNING for insertion in the "Journal" the same week.

### PRIVATE ADVERTISEMENTS.

BEES FOR SALE.—Several small Stocks, on six combs, of honey fed, healthy Bees, £3 10s. each; travelling box 10s., refunded if box returned in sound condition within seven days. Stamp for reply.—REED, Primrose House, Heacham, King's Lynn. b.50

OFFERS WANTED.—Cwt. Honey, sample 6d.; also 50 Sections.—NEWMAN, Farmadine Grove, Saffron Walden, Essex. b.51

THIRTY Loganberry Plants, 10s. 6d. dozen; carriage extra.—GARNER, Plainwood, Wymondham, Norfolk. b.52

SECTIONS, first grade, two dozen heather, six dozen clover; season's best; sell reasonable.—PHILLIPS, Kirkbride, Carlisle. b.53

PURE Light English Honey, good quality, in 1-lb. Mono pots. 1s. 9d. per lb.—MISS E. JOHNSON, Ripple Hall, Tewkesbury. b.54

PURE English Honey, mainly white clover, in 14- and 23-lb. tins, £9 per cwt., carriage paid. Reduced price for larger quantity.—WELLS, Claudius Road, Colchester. b.55

COMPLETE set of new Appliances, never used; also Hives, used one season; no disease.—GREEN, Winterley, Sandbach. b.56

**400** ROOTS' extra polished plain Sections, 28s., carriage paid. Wanted. Geared Extractor and large Ripener.—VIDLER, Pevensey, Sussex. b.21

**PURE LIGHT BERKSHIRE HONEY.**—56-lb. tins, 105s.; 28-lb. tins, 54s.; 1-lb. screw-cap bottles, 32s. dozen; 1-lb. hygienic pots, 30s. dozen; tins free; sample 6d.—STIMSON, "Sunnyside" Apiary, Bradfield, Berks. b.22

**MICROSCOPE** for Sale, Beck's "Star," nickel-plated, 3 and 2½ objectives, two eyepieces, condensers, and other accessories, 84s.—GEARY, Florist, Barwell, Hinckley. b.23

**WANTED,** Geared Extractor, with reversible cages; deposit.—Box 64, B.B.J. Office, 23, Bedford Street, W.C.2. b.24

**WANTED,** Cheshire's "Bees and Bee-keeping," Vols. 1., II.—CHARLES HANSELL, 56, Birkendale, Sheffield. b.25

**PURE** Light English Honey, granulated, in 28-lb. tins, £9 cwt.; sample 6d.; tins and case free.—WELLS, Bowers Lane, Isleham, Cambs. d.26

**JOHN RUMBALL** will sell 15 Stocks, five Penna's Italians, £5 each; 10 Hybrid-Italian, £4 10s. each, 1919 Queens; also 2 cwt. Herts Clover Honey, ½ cwt., ⅓ cwt. tins, free, £10 cwt., f.o.r.—Ayot St. Lawrence Apiary, Welwyn, Herts. b.27

**BEEES.**—Three healthy Stocks for Sale, Italians, good disease-resisting strain, £4, £5, and £6 each.—WALKER, Portway, Street, Somerset. b.28

**FOR SALE,** owing to removal, four healthy Stocks of Bees and Hives in good condition, £5 10s. each, £20 the lot, Geared Extractor, good condition, 35s.; sundry Section Racks, Frames, etc., cheap; all carriage forward.—H. V. BAKES, Bradsby, Easingwold. b.29

**WEEK-END BEE-KEEPING.**—Chapter II., "When the Cuckoo Calls," will be out March 1. Subscriptions now due; 2s. 6d.—SMITH, Cambridge. b.37

**FOR SALE,** 4 cwt. Pure Cambridgeshire Honey, £8 10s. cwt., in 56-lb. tins. Will accept £8 cwt. to clear.—SULMAN, Tithe House, Wilburton, Cambs. b.44

**FOR SALE,** about 2 cwt. fine Extracted Welsh Honey; guaranteed pure.—JAMES, Adpar, Newcastle Emlyn. r.b.3

**PURE** Light Essex Honey, in 14- and 28-lb. tins, 1s. 6d. per lb., free tins, and on rail; boxes returnable.—TUNMER, The Apiary, Maldon, Essex. b.5

**PLANT** now for the bees, strong fruiting Raspberry Canes, 2s. 6d. per dozen, 8s. for 50; also Strawberry Runners, 1s. per dozen, 6s. per 100, best varieties, carriage paid; cash with order.—HALL, Highfield Lodge, Balderton, Newark. r.b.6

**WANTED,** at once, six Stocks Italians; also 4-frame Extractor, Cowan's. Lowest prices for cash.—JACKSON, Hollins, Abergavenny. b.8

**A VACANCY** occurs for a Pupil on an old established bee farm. Opportunity will be given to learn bee-keeping on a big scale.—Apply, Box 61, B.B.J. Office, 23, Bedford Street, W.C.2. r.a.57

**WANTED,** Maid to assist with housework.—Apply, MRS. W. HERROD-HEMPSALL, The Apiary, Old Bedford Road, Luton, Beds.

**ITALIAN BEES** on 6 frames, headed by Penna's 1920 imported direct Queen, delivery June, £4 10s.—ENNEVER, Oak Avenue, Ridgeway, Enfield. a.56

**70 SECTIONS,** 2 cwt. Extracted, 12 dozen screw tops; sample 6d.—A. W. SIMCOX, 12, Victoria Road, Fabling's Park, Walsingham. r.a.62

**PURE** light Cambridge Honey, 14-lb. tins, 22s. 6d.; 28-lb. tins, 42s., carriage paid; sample 4d.; tins free.—J. YOUNGER, 6, Maid's Causeway, Cambridge. a.66

**CORRESPONDENCE** Course in Bee-keeping.—MISS F. E. PALING, Golden Square, Henfield, Sussex. r.a.54

**WANTED,** portable Greenhouse—Price and particulars to W. HERROD-HEMPSALL, Old Bedford Road, Luton, Beds.

**WANTED,** Auster Rear Wind Screen for motor car.—HERROD-HEMPSALL, as above.

**OR SALE,** one Exhaust Whistle, 11s., post free; one Wood Millie Motor Foot Pump, 45s., carriage free.—HERROD-HEMPSALL, as above.

### BUSINESS ADVERTISEMENTS.

1½d. per word.

**TWO** CONTINENTS and seven world-known breeders sent queens to produce Outlook Bees. Four-frame Nucleus, despatched in May, 3 gs.—JOHN WM. PRICE, The Outlook, Maidstone. b.39

**WENSUM VIEW** APIARY.—A limited number of 4-frame Nuclei of healthy bees for Sale, with newly-imported Italian Queens, May, June delivery, 50s., plus 10s. on box, refunded on return in sound condition.—C. R. DENNINGTON, 121, Nelson Street, Norwich. b.40

**FOR SALE,** Nuclei, 1919 Queens, three frames, £ 47s. 6d.; four, 52s. 6d., May; Hybrids, young Queens, ready June; returnable cases 7s. 6d. JOURNAL deposit.—A. H. HAMSHAR, Wonerah, near Guildford. b.41

**5-FRAME** NUCLEI, 1919 Queens, Italians and Blacks, £3. Book early for April and May delivery. Also Appliances for Sale.—MISS BURDER, Chiltonington, Lewes. b.42

**A LADY** WRITES:—"They are so gentle that I can do almost anything with them, although I have never yet used a smoker." 3-comb Nuclei (on approval) from 35s. Order now. Catalogue 3d., returned on first order.—PEARSON & GALE, Marlborough. b.43

**STRICTLY BUSINESS.**—Flavine Candy, in 6-lb. lots, 7s. 6d., post paid, cash and sugar certificates; Japanned Sprayers, 5s.; Wire Clearer Boards, 6s. 6d.; "Intensive Bee-keeping," 6d.; "Let the Bees Tell You!" 2s.—S. H. SMITH, 30, Maid's Causeway, Cambridge. b.38

**WATERPROOF RUBBER SHEETS** for covering outhouses, etc., 72in. by 36in., brass eyelets, 12 for 20s.—SAGARS STORES, Ardwick, Manchester. b.16

**A. H. BARTLETT,** having established an Apiary where there are no bees within many miles, can supply pure mated Italian Queens and Nuclei. His stocks of Italians have been tested for five years for special qualities, and are second to none—hardy good disease resisters, extra prolific, the best of comb and honey producers, also mild tempered. Orders now booked for Nuclei, June-July, 3-frame, well covered with bees and brood, with 1920 pure mated Italian Queen, £2 15s.; 4-frame, £3 5s., carriage paid; box 5s., returnable. Pure mated 1920 Italian Queens, June-July, 9s. 6d., August-September, 7s. 6d.; Virgins, 4s. 6d.; safe delivery; satisfaction guaranteed. Cash with orders. List ready shortly. All Queens reared by the best up-to-date method in full colonies. Thirty years' practical experience.—A. H. BARTLETT, Bee Specialist, High Street, Crowthorne, Berks. b.17

**FOR SALE,** Swarms, English strain. Book now for May and June.—BRINTON, 49, Auckland Hill, West Norwood, Surrey. r.a.67

**ITALIAN NUCLEI**, 3-frame, Penna's 1920 Queens (guaranteed), 70s.; Hybrids, Penna's and Simmins' Special, May-June delivery, £3, carriage paid; box returnable. Orders (cash) strict rotation.—**MOORE**, 31, Monmouth Road, Dorchester. r.a.65

**WE** are reserving a few choice Italian Queens for the D.B.s for delivery in May, June, July and August. Prices and particulars on application.—**S. H. SMITH**, 30, Maid's Causeway, Cambridge. r.a.62

**ITALIAN** and Hybrid 4-frame Nuclei, 1920 Queens, £3 3s.; Hybrid Swarms, 10s. 1b.; Fertile Queens, May-June 10s. 6d., July-August-September, 8s. Strongest and best honey gatherers in the country. All orders booked in rotation; £1 deposit, balance on delivery.—**THOMAS CHITTY**, Burleigh Farm, Cassington, Oxon. a.36

**HIVE MAKERS** Wanted.—Apply, letters only, stating age, experience, wages expected, to **LEE**, Beehive Works, Uxbridge, Middlesex. a.13

**HAVE YOU READ "THE BEE WORLD"?** If not, why not? Every number in itself is a useful literary work for practice and reference. Specimen copy free.—**Offices: THE APIS CLUB**, Port Hill House, Benson, Oxon.

**ITALIAN QUEENS** direct from Italy. Price list for 1920 on application.—**Address, E. PENNA**, Bologna, Italy. w.39

**WANTED**, for scientific purposes, a few live Bees from diseased or dwindling stocks; cages sent and expenses paid.—**SNELGROVE**, Quadrant, Weston-super-Mare. a.11

**BEE FLOWER SEEDS.**

Collection of six best Varieties, 1s., post free. Beautifully Illustrated Instructions Up-to-date. Garden Guide, 64 pages, Free.

**KNIGHT'S,**  
SEED SPECIALISTS,  
WOLVERHAMPTON.

# Dutch Bees.

I have been appointed **Sole Agent** for Hans Matthes, the Dutch Bee Farmer who supplied the British Government last season with Skeps for their County Re-stocking Scheme. Hans Matthes also supplied me with what Skeps I required last year.

Last autumn I got a large consignment over from Holland, and am presently wintering these at my Apiary here.

To those desirous of testing these Dutch Bees, I will be pleased to send on my Illustrated Catalogue, containing much information regarding the hardiness, prolificacy, disease-resisting, and honey-gathering characteristics of this race of bee.

Address—

**R. WHYTE,**

The Bee Farm,  
Cumbernauld, Dumbartonshire.

BOOK NOW.

## ITALIAN QUEENS,

Pure Penna Strain.

**ASHWORTH,**  
THE BUNGALOW, WEYMOUTH STREET, WARMINSTER.  
(late of Heytesbury).

### Bee-Keepers Wake Up!

You can make a Big Profit if you use right up-to-date Appliances, including the Manley Hive.  
**MEADOWS,**  
SYSTON, LEICESTER.



### BEES. BEES. BEES.

First Quality Dutch (Imported) Stocks. £5 per skep.

Terms: Cash with order.  
Bees delivered in Spring.  
**P. BENNETT,**

437, CLARKSTON ROAD, GLASGOW.

### BEES. BEES. BEES.

## Books for Bee-keepers NOW IN STOCK.

<b>A Modern Bee Farm</b> ... ..	7/6	... 6d.	Postage
<b>Beginner's Bee Book (PELLET)</b>	5/-	... 4d.	
<b>BEE-KEEPING SIMPLIFIED FOR THE COTTAGER AND SMALLHOLDER (W. HERROD-HEMPSELL, F.E.S.)</b> ... ..	1/-	... 1½d.	
<b>BEE-KEEPERS' PRACTICAL NOTE BOOK (T. W. COWAN)</b>	1/-	... 1½d.	
<b>BRITISH BEE-KEEPERS' GUIDE BOOK (T. W. COWAN)</b> (paper covers only)	2/6	... 3d.	
<b>Dissectible Model of Queen Bee</b> ... ..	4/6	... 3d.	
<b>FERTILISATION OF FRUIT BLOSSOMS BY BEES (T. W. COWAN)</b> ... ..	-/3	... 1d.	
<b>Honey and Health (A. HOPE)</b> ... ..	-/6	... 1d.	
<b>Honey Vinegar (REV. G. BANCES)</b>	-/2	... 1d.	
<b>How to Keep Bees (ANNA B. COMSTOCK)</b> ... ..	5/-	... 6d.	
<b>Management of Out Apiaries, PRODUCING, PREPARING, EXHIBITING AND JUDGING BEE PRODUCE (W. HERROD-HEMPSELL, F.E.S.)</b> ... ..	3/-	... 3d.	
<b>Productive Bee-keeping (PELLET)</b> ... ..	10/6	... 6d.	
<b>Queen Rearing in England (F. W. L. SLADEN)</b> ... ..	1/6	... 2d.	
<b>Snelgrove's Method of Re-Queening</b> ... ..	-/6	... 1d.	
<b>The "Townsend" Bee Book</b> ... ..	2/6	... 2d.	
<b>WAX CRAFT (T. W. COWAN)</b> ... ..	2/-	... 2½d.	
<b>Wilke's Book on Swarming</b> ... ..	1/-	... 1½d.	
<b>MISCELLANEOUS.</b>			
<b>Maeterlinck's Life of the Bee</b>	3/6	... 3d.	
<b>The Lore of the Honey Bee (TICKNER EDWARDES)</b> ... ..	2/-	... 2d.	
<b>The Humble Bee (F. W. L. SLADEN)</b> ... ..	12/6	... 6d.	
<b>THE BEE WORLD</b> (supplied only to members of Associations interested in the control and development of the APIS CLUB, apart from ordinary members of the latter), per copy ... ..	-/8	... 1d.	

**British Bee Journal & Record Office,**  
23, BEDFORD STREET, STRAND, LONDON, W.C.1.

### FINEST SECTIONS OF HONEY.

A large quantity for Sale at carriage paid prices, either Plain or Glazed.

### IRISH RUN HONEY.

Several cwts. for Sale in quantities to suit customers, at carriage paid prices in free tins and cases.

**GORDON ROWE,**  
Honey and Beeswax Packer,  
28a, Moy Road, Cardiff.



# The Metal Foundation

(Protected.)

☐ The triumph of the Metal Foundation is due to the following significant advantages:—(1) Indefinite durability with reasonable care; (2) Greater safety of bees in transit on new combs; (3) Capability of bearing the weight of a heavy swarm in hot weather; (4) Greater comb stability in quick extracting; (5) Control of drone cells; (6) The production of even combs; (7) Easy removal of queen cells without the slightest injury to the foundation; (8) Cleanliness and adaptability to sterilisation by boiling; (9) Economy of labour and time in fitting and detaching; (10) An ideal compromise between the metal comb and the wax foundation.

☐ The invention has created a world-wide interest. Its value will be the more appreciated by studying the following original literature:—"The British Bee Journal," November 13; "Bee Craft," December; and "The Bee World," September, October, and November, 1919.

## RETAIL PRICES.

☐ The Metal Foundation ("worker" type) can now be produced in any size required, whether for the brood chamber or the super, e.g., for the British Standard Frame (14 in. x 8½ in.), Deep Standard (14 in. x 12 in.), Simmins' (16 in. x 10 in.), Langstroth (17⅝ in. x 9⅞ in.), etc., and for their corresponding super frames. Despite the heavy cost of machinery, metal, etc., it is offered at a price well within the purchasing power of the average bee-keeper. All orders, whether large or small, receive prompt attention, and are executed in strict rotation, and in good time for the season. We have further decided—for the benefit of bee-keepers who are not yet in a position to place their orders—on taking the risk of a liberal margin of production to meet unavoidably delayed orders. *If you have not yet made up your mind as to your requirement, you are still in time to do so.*

## The Uxbridge W.B.C. Five.

☐ This popular hive, which we originally introduced over twenty years ago, is admirable for its water-proof features, since it eliminates the plinth. It stands supreme amongst all W.B.C. patterns. You will never regret trying it with your metal foundation.

*\*\* We allow a Five per cent. discount on all our goods (including the Metal Foundation) to members of the Apis Club, who are respectfully requested to forward their membership cards when placing orders.*

*A FINAL REMINDER!* To avoid disappointment apply now for the Metal Foundation Price List, and for our 1920 Catalogue.

# JAMES LEE & SON, Ltd.

## UXBRIDGE, MIDDLESEX.

(Telegrams: Graphicly, Uxbridge.)

Telephone: Uxbridge 181.)

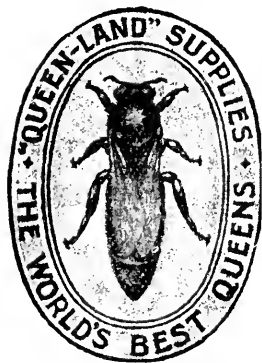

## We Save you 50 to 100 per Cent. by Taking Over your usual Serious Risks.

As evidence of our advanced methods of doing business in absolutely ensuring the interests of our clients, it may be stated :—

- (1) For more than Thirty years we have **Guaranteed** safe introduction of our queens at a small extra fee for such Insurance.
- (2) For some Twenty-five years every "White Star" queen sent out has been **Warranted** for Six Weeks.
- (3) In respect of nuclei, we have always made it a point to **Guarantee** to replace any queen lost therefrom up to 10 days from delivery, even if the purchaser himself accidentally loses the queen.
- (4) Every nucleus by rail, and every queen by post, we have always **Warranted** to arrive in good condition.

### Can you get the same Terms elsewhere?

## "W.S." Pedigree Bees and Queens at Nominal Prices.

It is well known that Pedigree Farm Stock, Horses, &c., realise prices *Ten to Twenty times higher* than those obtained for common stock.

Nevertheless for our Pedigree Queens and Bees which have been established as a Fixed Type by persistent care and intensive selection for over Twenty-five years, the charges are but little more than the prices asked for cheaper varieties, none of which have a fixed character.

The "W.S." stand by repute far ahead of others, and are prolific and industrious beyond the highest anticipations of purchasers.

## With all the above Risks absolutely excluded from your purchase, can you make a better Investment?

Revised "Queenland List," 3½d., of S. SIMMINS, Queenland, Heathfield. Sussex.

## QUALITY.

The difference between a good bargain and a bad bargain is not so much a matter of money as of quality.

All our goods have the "Hallmark of Quality" resulting in a large clientele of SATISFIED customers. Does this mean anything to you? If so, send for our large Illustrated Catalogue for 1920, free on application.

**R. STEELE & BRODIE,**  
Bee Appliance Works, **WORMIT, FIFE, SCOTLAND.**

# Bee-keeping Simplified

FOR THE COTTAGER AND SMALLHOLDER,

By **W. HERROD-HEMPSALL, F.E.S.,**

*Author of "Producing, Preparing, Exhibiting and Judging Bee Produce."*

Price 1s. net. Post Free 1/1½

This little book supplies the need for a cheap up-to-date and well-illustrated handbook on bee-keeping, and gives in Mr. W. Herrod-Hempsall's well-known, clear, lucid style all that is necessary to enable anyone to commence bee-keeping successfully. From **THE BRITISH BEE JOURNAL OFFICE, 23, Bedford St., Strand, London, W.C.**

## The "HERROD APICURE."

**SIMPLE CLEAN! EFFICIENT!**

For the Prevention and Cure of Foul Brood and other Diseases of Bees.

**DON'T DELAY—ORDER AND USE AT ONCE.**

PRICE, with full instructions, 1/8, 2/10 and 5/8, post free. From all the leading Appliance Dealers, and from

**THE BRITISH BEE JOURNAL & RECORD OFFICE, 23, Bedford Street, W.C.2.**

The certain cure for and Preventative of "Isle of Wight" disease.

### 'BACTEROL'

Proved by Bee-keepers generally after testing on the most hopeless stocks.

Manufactured by "Bacterol" Limited, London, N.

**MENLEY & JAMES, LTD., MENLEY HOUSE, FARRINGDON ROAD, LONDON, E.C.**

## The 'Kent' Standard Model Hives & Appliances

**TESTIMONIAL.**

*May 12.*

DEAR SIR,—I have had an opportunity of comparing the material and workmanship of your hives with others on the market, and in my opinion there is no sort of comparison between the two, yours being altogether superior in every particular.—Yours faithfully,—

*S. J. BALDWIN, Stanley Road, Bromley, Kent.*

Look after your profits by buying hives and appliances which are easy to work. I endeavour also to give good value by care over the workmanship. Send for catalogue.

**EDWARD J. BURTT, Manufacturer, GLOUCESTER.**

*Commercial (16" × 10") frames and brood boxes stocked.*

MAR 29 1920  
Agricultural

No. 1965. Vol. XLVIII FEBRUARY 19, 1920. [Published every Thursday, Price 2d.]

**CONTENTS.**

	PAGE		PAGE
CONFERENCE OF BEE-KEEPERS RE LEGISLATION	85	Twickenham and Thames Valley B.K.A.	89
POLLINATION OF FRUIT	85	Worcestershire B.K.A.	90
A DORSET YARN	86	Herts County B.K.A.	91
JOTTINGS FROM HUNTINGDONSHIRE	86	Eccleshall B.K.A.	91
ERRATUM	87	Somerset B.K.A.	91
ASSOCIATION NEWS—		BEE LEGISLATION	92
Sheffield B.K.A.	88	CORRESPONDENCE—	
Kent B.K.A.	88	Early Pollen	93
Cambridge B.K.A.	88	Larger Frames	93
		NOTICES TO CORRESPONDENTS	95

# ALUMINIUM DRAWN OUT COMBS.

# “MONEYCOMB”

*The greatest invention in the Bee World for 40 years.*

This is a drawn out Comb of Hexagon Cells exactly as bees build in their natural state. It is slightly coated with wax, has been thoroughly tested, and is not an experiment. Bees readily take to it for rearing brood and storing honey. Strong and durable, will last 50 years with care. Big consumption of honey saved to produce wax for comb building. Control of bee diseases. No more burning of combs. Each comb easily sterilised and used over again.

Send for Catalogue and descriptive Leaflet.

1920 Catalogue post free.

Patented by ALUMINIUM HONEY COMB CO., of U.S.A.

SOLE MANUFACTURER AND LICENSEE:

## E. H. TAYLOR, WELWYN, HERTS.

# THE British Bee Journal

ESTABLISHED 1873.

A Weekly Journal Devoted to the  
Interests of Bee-keepers.

Edited by T. W. COWAN, F.L.S., &c.,  
and J. HERROD-HEMPSALL, F.E.S.

## Correspondence: Whom to Address.—

All matters relating to the Literary Department, Associations, Shows, etc., should be addressed, "Editors, *British Bee Journal*," and all business communications and matters relating to subscriptions and advertisements to be addressed to the "Manager," *B.B.J.* Office.

**Subscriptions.** — Annual Subscription, 10s. 10d. post free in advance; single copies 2d. or 2½d. post free. If a receipt is required by post, a stamped and addressed envelope must be sent, otherwise a printed receipt will be enclosed along with the paper.

*Note.*—Cheques and Postal Orders should always be crossed, otherwise it is very difficult to trace them if they go astray.

**How to send Money.**—Remittances can be made payable to W. Herrod-Hempsall by crossed Cheques and Postal Orders. Stamps may be sent for small amounts up to 2s.

**Halfpenny stamps are preferred.**

Scottish or Irish cheques can only be taken in payment if 6d. is added for commission charged by banks for cashing them.

The Editors are not directly or indirectly interested in the manufacture or sale of beehives or appliances of any kind, and must refer correspondents wishing for prices or catalogues to advertisers in the paper.

## The Metal Foundation.

(Protected.)

For the benefit of readers of the JOURNAL and the RECORD we have arranged with the manufacturers of the Metal Foundation to accept all orders received through our offices at a consideration in the shape of a 25 per cent. deposit to begin with, and the balance by mid-March, or prior to delivery, if earlier. All orders are guaranteed by them to be executed *not later than April, 1920.*

**Prices:**—(1) BRITISH STANDARD FRAME, fully fitted with "worker" Metal Foundation: Single, 2s. 4d.; per two dozens, 2s. 3d. each frame; per four dozens and over, 2s. 2d. each frame.  
(2) STANDARD SHEET of "worker" Metal Foundation: Single, 2s.; per two dozens, 1s. 11d. each sheet; per four dozens, 1s. 10d. each sheet.

Subject to a 5 per cent. discount to members of the Apis Club.

*Packing & Carriage Extra.*

\* \* \* Since the Metal Foundation will be produced only to order, no order will be subject to cancelling.

## OUR DEPOSIT SYSTEM.

You are advised to insist on this being used when dealing with strangers.

### Rules and Conditions for Depositing

*In order to save trouble, it is requested that the Rules be carefully read over by persons using the Deposit System of trading.*

Goods should not be despatched until notice that the money has been deposited is received from this office.

**1. Method.**—When strangers are dealing together, the purchase-money of the articles is deposited at our office. We acknowledge receipt of the deposit to both parties, and hold the money until we are satisfied that the purchase is concluded. If a sale be effected, we remit to the seller the amount deposited, less a charge of 2½ per cent. in the £, with a minimum of 6d., and the expenses of Post Office Orders and postage, &c. Cash will be forwarded by Cheque, Post Office Order, or by Postal Order as preferred. If a sale or exchange be not completed, we return the amount deposited, after making the same deduction. By this means buyers and sellers are secured against fraud.

**2. Deposits.**—Postal Orders (drawn on General Post Office) and Cheques must be made payable to W. Herrod-Hempsall, and crossed "London County and Westminster Bank." The numbers of the Postal Orders should be kept by the sender. We cannot be responsible for any loss that may occur in transit.

**3. Money on Approval.**—All honey will be sold by sample, which must be sent direct to buyer.

**4. Bee Appliances.**—In ordering, the time allowed for completing the order to be stated to us when sending cash. If maker accepts, we hold cash until transaction is satisfactorily completed, when the amount will be remitted, subject to conditions as in Clause 1.

**5. Bees and Queens.**—These will be dealt with entirely by the parties concerned, so far as price, &c., go, and when the purchase is satisfactorily completed cash will be remitted as per Clause 1.

**6. Goods in Transit.**—These are at the seller's risk, *i.e.*, any damage to or loss of an article on its journey is borne by the vendor; but a rejected article must be properly packed and returned by the same means as was used in sending it.

**7. Carriage.**—The carriage of all goods, *except such as are sent by post*, is payable by the buyer, unless otherwise agreed. If any article sent on approval be returned, each party to the transaction must pay carriage one way.

The products of the Apiary, of Poultry and Farm Stock, of the Fruit and Vegetable Garden can be Advertised and Sold through

THE  
**BAZAAR, EXCHANGE & MART**  
*Newspaper.*

Get a Copy—Thursday and Saturday 3d. The "Bazaar" publishes also practical handbooks by experts. Send for full catalogue, post free from—WINDSOR HOUSE, Breams Buildings, LONDON, E.C.2.

THE  
**British Bee-Keepers' Association.**

The recognised centre of practical and scientific bee-keeping in Great Britain. Particulars and conditions of membership may be obtained from the Secretary, W. HERROD-HEMPSALL, 23, Bedford Street, Strand, London, W.C.2.



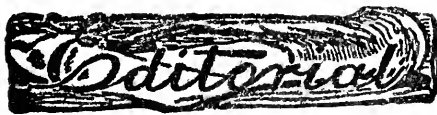

## Conference of Bee-Keepers re Legislation.

We are enabled by the permission of the Ministry of Agriculture to publish the report of the above as follows:—

Report of proceedings of a conference, convened by the Ministry of Agriculture and Fisheries, of bee-keepers and Associations interested on the subject of proposed legislation for the control of bee diseases, held on Friday, February 6, 1920, at 3 p.m., at the Surveyors' Institution, Great George Street, Westminster, London, S.W.

Professor Frederick Keeble, M.A., D.Sc., C.B.E., F.R.S., occupied the chair, and, opening the meeting, said:—Ladies and Gentlemen,—Both the Minister and Sir Arthur Griffith-Boscawen are deeply interested in the subject which has called us together this afternoon, and I can remember very well the active interest which Lord Lee took in the question of bees when, during the war, we had under consideration a scheme which was subsequently adopted for the introduction of bees of better behaviour with respect to disease than those which are native to this country. He was enthusiastically in favour of the scheme, and it was largely due to his energy that we were able, as a Government Department, to put it into action with a reasonable amount of celerity.

Our main business this afternoon is to confer constructively on the subject of proposed legislation. I take it that we shall keep that object in the forefront of our minds; we shall not allow this important Conference to spend time in discussing details or in offering criticisms, which in proper time and place may very well be offered, against one another or against absent ones. I take it that we shall devote our attention to an instructive consideration of the question of legislation and the form which that legislation should take.

But before we proceed to that business, I feel it my duty to trace in broad outline the ultimate reasons we are brought together here now. I think it will serve a useful purpose, and it may remove some misconception. It was not infrequently my experience, when I had the privilege of being an officer in the Ministry of Agri-

culture, to find that men—not necessarily bee-keepers, but men engaged in one industry or another—were under a very active impression that the chief occupation of the officers of the Ministry who were concerned with that industry was to interfere with their liberties or with the conduct of their business. It may be, gentlemen, that that impression lingers still in the minds of some; but I can assure you that, were it the case with the Ministry, there would be no reason for calling this Conference this afternoon. The exact opposite is the case, because what has been done with respect to a good many other industries may, I feel certain, be done with respect to yours. With respect to the fruit-growing industry and the market-gardening industry and others, we have this understanding: That it is with the growers themselves who are interested in introducing and in fashioning any control of one another which may be expedient. We do not take the view that it is the business of a Government Department to descend from the height of its position to impose restrictions on others, and therefore we do not start out with the intention of introducing legislation of this kind or another; but when the men concerned with that industry recognise that, for their own protection, it is necessary to have some ordered control, then it is our business to endeavour to introduce that control and to ensure that it shall be used, but with English justice, that it shall be rigorously and impartially applied. So that, if we have legislation, we must all agree that whatever penalties attach to it those penalties will be, and must be, enforced, because I am sure I am not alone in thinking that that Government which first of all imposes penalties, and then does not enforce them, is not worthy of the respect of the citizens. (Cheers.)

*(To be continued.)*

---

## The Question of Pollination of Fruit in Relation to Commercial Fruit Growing.

Since the articles written by Mr. C. H. Hooper, F.R.H.S., on the above subject, appeared in the B.B.J. during 1918, we have had so many inquiries for them that we have decided to issue a reprint. This is now ready, and may be obtained from this office for 6d. post free. Those who intend planting fruit trees will find the information it contains very useful, as it tells of the best varieties to plant together in order to get the beneficial results of cross fertilisation, a matter that in the past has not received the consideration from fruit growers that it should do.

## A Dorset Yarn.

"What a beautiful world we live in," so a visitor greeted me last week. There were plenty of flowers on the road sides, willows, hazels, and gorse. Then on the high hills by the farm the bright green of the fertile meadows, with the silent river winding between, gave to his artistic tastes, just the balance of beauty to open the floodgates of his artistic soul. "No wonder you are happy and contented," he said. "So we are, and we would that all other Nature lovers were the same; even the bees are flying far and wide this warm weather; they were very largely on the laurustinus, on the large trees they were to be seen on the south side (scarcely any on the north), their legs were thickly padded with pollen, of a cloudy white and yellow; all augurs well for an early season at the farm. This week was the first time that the light-coloured Italians were out in large numbers, they have stripped the Christmas rose of pollen, are away on the male blossoms of the salix family, and are flying over the violet fields as the staff are harvesting the flowers. All are in a hurry during just the few hours of sun and warmth as they hasten after the sweets of the floral kingdom; it is this same hurry, when the sun shines, that has given them the name of "busy" bees. So it is with all who get on in tilling the soil; "get busy" is an American phrase. Every one on the land must be busy now, work must be hurried on, weeds beneath gooseberry rows must all be cleared off or lightly forked in, to do them late will spoil the flowers, as the fruit grower knows that the roots are drawing on the reserves of food in the soil to develop the flower buds, each day they can be seen expanding; to loosen the roots now would be a loss to the bees, as we find they get so much from the gooseberry fields. It all means toil, but with the assurance of abundant harvest the toil becomes a pleasure. We try to show the staff how much better everything grows with the careful tillage, we get them to take a pride in the fact that their lot does a few more dozen lb. of fruit than the one who skips all he can. To me, that is the only way to get the villagers to be satisfied with their surroundings; it takes all to make a world, what seems to please one is of no interest to another, but all who take to bees, seem to be impatient to excel, they never mind the queries they make in order to get them to do well, at least that is as I find them. A tall, fine specimen of an Englishman (with a handle to his name) came to me at the last meeting of the R.H.S. at Westminster, and wished me every success with bees. He had always, since boyhood,

taken a great interest in them. He had started again last year, having been cleared out twice in five years. Queries for honey greeted me on the same day (we have taken some to many of the meetings, to show that we have other things besides flowers and fruit); one lady has taken three boxes of eighteen sections, and, like *Oliver Twist*, wants more. I suppose this is why so many want to come for a term to work up a knowledge of bees and flowers.

Every bee-keeper who sells nuclei seems to be making great provision for distributing large stocks of Italians, they know the wonderful workers they are and are convinced that they are good, and are prepared to back up their convictions as distributors of good stocks by selling only Italians.

J. J. KETTLE.

---



---

## Jottings from Huntingdonshire

FOR JUVENILE READERS

"Well, little bee, have you had a good night's rest?" I said as I opened the box in which I had placed her.

"Yes, thank you; and I am quite ready to answer some of those lots and lots of questions you spoke about yesterday," she replied.

"That's good," said I. "Shall I begin?"

"Yes—fire away."

"Holloa, though, you haven't touched the honey I put in the box for you. Surely you're not a hunger striker!"

"I should be sorry to be so foolish, when you've been so kind," said she; "but don't you remember that I gorged myself with honey yesterday? I shan't need any food now for two or three days. Bees can do that, you know. If we couldn't we shouldn't be able to travel miles and miles in a swarm-box when we get sent away."

"I see. Well, since you mentioned 'swarm,' please tell me how you arrange things with regard to swarms. How do you decide who is to go out with the swarm and who is to remain behind?"

"Well, it's not so difficult at times; at others it is. Sometimes we swarm because our home is crowded out by the young bees which are being born by hundreds a day, and the queen goes on laying eggs and eggs till at last we have to be cross with her and tell her not to lay any more. She gets angry and says that she's queen, therefore she will do what she likes; consequently we have to build queen cells with the hope of getting another queen, and some of us going off with her. But the old queen gets more cross than ever, and tries to kill the young queens before they are born, or rip their cells to pieces. So we just have to guard the royal cells, and then her

majesty begins to call for help, is indignant, and decides to go out herself. She stops laying—thank goodness!—and runs all over the hive collecting as many as she can to follow her. It is generally those who are on duty wax-making and scavenging at the time who follow her first, and nurses and foragers join her later, with a few drones. (Sometimes she'll get more than half the hive to follow her, when only some nurse-bees and a few foragers will be left to look after the brood.) Then on a warm day she says, 'I'm off!' and out she goes with those who want to go with her. And what a relief when they're gone! The hive seems roomy and cool once more. But a lot of swarms wouldn't happen if only you'd give more room and more ventilation to our hives."

"That's a lot for you to say at once; but I want to know more about swarming. How is it that a few days after sending out a swarm you send forth another, or a cast?"

"Do you call a small swarm and a cast the same thing? Because we bees don't."

"Really! Then what is the difference?"

"Well, sir, a small swarm might be sent out a week after the first with a young fertile queen. A cast is a few bees that are sent off with a virgin queen. Before the old queen-mother goes out a young princess is ready to come forth, but we dare not let her do so, or the old queen would kill her, so we pile on the wax over the queen-cell to keep her in; but as soon as the old queen has gone we let her come forth and reign. The extra confinement in her cell makes her big and strong, and so she bustles about for room to lay her eggs, and when there isn't enough room for her energies she begins shouting to us to build more cells, and we have to say there isn't room. So she just says, 'Anybody following me? I'm off to a fresh place, where new cells can be built and I can lay eggs by the thousand'; and off she goes with a lot of young bees, and my! when they're settled in a new house don't they work? A cast, however, happens like this. We generally build two or three queen cells at the same time, so that we shall be more than doubly sure of getting a good queen. If the first princess that comes out is to our liking we help her in destroying the unborn princesses; but if she does not meet with our approval we don't allow her to touch the other cells, so she goes off in a huff, and of course there are sure to be some bees that will go with her. Oftentimes these casts fly straight away and are lost, but swarms, as you know, settle first in the vicinity of the old hive."

"Well done! You're quite communicative," I replied. "So please tell me why

you sometimes build as many as a dozen queen cells?"

"Oh, that's due to the prophets."

"Prophets?"

"Yes. We have prophets in the hive—some wise, some foolish. Some tell us that the next year is going to be a grand year for honey, and so we ought to keep on sending out swarms, so that there may be plenty of colonies to gather the honey harvest that is to be, and we get the swarm fever. Other prophets say, if the honey flow is not good, 'Get rid of as many bees as you can, or there won't be enough food to keep us going through the winter'; and we, silly-like, obey, and repent afterwards, because we get so weak that we cannot spare a sufficient number of sentinels to guard the entrance, and other bees come and rob us wholesale. We try to right matters by bundling out six or seven queens with the last swarm, and killing all those unborn, but sometimes it's too late, for wasps and hornets come along and seize our home, and we're lost."

"That's sad news."

"Yes, very sad. If only we listened to reason at these times we shouldn't be so foolish; but, you see, when we get the swarming fever, all the old bees go, and those remaining are young and silly. Of course, I haven't been through all this. I have learnt it from my teachers, and it's just as well for you to know, because you could stop a lot of this folly by just cutting out the queen cells. We shouldn't dare to go off for good without a queen, so we'd therefore settle down to work."

"Thank you. That will do as regards swarms for the moment. No! Wait a minute. How do you all manage to hold on to one another when a swarm settles?"

"Simply enough. On our legs we have hook-like claws. We just hook them on to our neighbours', and there you are. It's rather fun."

"Is it really? Then how do you walk up a smooth hive with those hooks?"

"We don't! We have pads on our feet like a fly, and when our claws are not needed we use our pads, so that we could walk upside down if we wished. Shall I show you how?"

"Not now; I must be going. Help yourself to the honey and make yourself at home. Have a rest; later on we'll have another chat."

E. F. HEMMING.

---

### Erratum.

In your issue for January 29, on page 54, under "Correspondence" [10116], the word "legislation" should read "isolation," in line 17.—ANDREW WOOD SMITH, 5, West Castle Road, Edinburgh.

## Sheffield and District Bee-Keepers' Association.

ANNUAL MEETING.

The seventh annual general meeting of this Association was held on Thursday, January 15, at the Tontine Café, Sheffield, and, in the absence of the President, the chair was occupied by Wm. Bashforth, Esq. The Hon. Sec., Mr. W. Garwell, presented the report and balance-sheet, which showed that there had been a very satisfactory increase in the membership, four lantern lectures and four open-air lectures had been given during the year, books have been purchased to form an Association library, and there was a very substantial balance at the bank in the Association's favour.

The Chairman, in moving the adoption of the report and balance-sheet, commented on the amount of work that had been done during the year, and also the very satisfactory balance-sheet. Mr. Warburton seconded the motion, and the report and statement of accounts were adopted. W. J. Garnett, Esq., was re-elected President. The Vice-Presidents were re-elected *en bloc*, with the addition of F. Scott, Esq. Messrs. Wm. Bashforth and C. M. Hansell were elected Auditors, and Mr. W. Garwell was re-elected Hon. Secretary, Treasurer and Librarian. The following were elected for a committee:—Messrs. S. Livsey, J. Palmer, P. Ridge, T. Nelson, W. Bashforth, R. G. Walstenholme, E. W. Hodgson, and Mrs. Turner. The meeting closed with a vote of thanks to the Chairman, proposed by Mr. Hansell.—(*Communicated.*)

## Kent Bee-Keepers' Association.

The annual general meeting of the Northern Division of the Association was held at the Guildhall, Rochester, on January 24.

The Secretary (Mr. G. Bryden), in presenting his report, said the division continued to increase and flourish steadily. While the Council meetings had been well attended, the lecture and demonstrations were not all that could be desired, and he thought that if these were advertised in the local Press there would probably be better attendances.

Nine lectures and demonstrations were given during the season, with a honey show at the end of August, and the Kent Education Committee provided five lectures, which were held in Gillingham Park.

The division commenced the year with 112 members, and had elected 33 new ones, including the Earl of Darley; 24 had been transferred or had withdrawn, leaving an increase of nine, with a total of 121 to date.

The honey show was judged by Mr. W. Herrod-Hempshall, F.E.S., who said it was the best show in England that he had attended.

One of the members again carried off all the premier awards from the Royal Show at Cardiff, and from the Grocers' International Exhibition in London, and was congratulated by the British Bee-Keepers' Association on his phenomenal success.

"Isle of Wight" disease had not been much in evidence during the year, and there was no record of any of the nuclei supplied by the Association having "gone west" with it.

The following awards from the B.B.K.A. had been made during the year:—Dr. C. C. Lord (chairman), 1st class certificate; Mr. A. Fry, "Glenrosa," Gillingham, intermediate certificate; Rev. J. Butler, Borstal, preliminary certificate.

The officers elected for the year were:—Mr. W. Wilson, Swanley, chairman; Mr. W. H. Cook, Gillingham, vice-chairman; Mr. G. Bryden, Rochester, secretary and treasurer. Three names were added to the Council, and all members who had passed the preliminary examination were elected on the Visiting Committee.

It was decided to run an experimental apiary at Bleak House, Gillingham, with various-sized frames, to test their efficiency.

## Cambridge and District Bee-Keepers' Association.

A well-attended meeting of bee-keepers was held at the Zoological Lecture Room, Cambridge, on Saturday, January 24, 1920, to discuss "Legislation for Bee-keepers," Dr. C. G. L. Wolf being in the chair. Amongst those present were Sir Douglas Newton (President of the Cambs. and District B.K.A.), Messrs. Albon (a commercial bee-keeper from a neighbouring county), Barnes, Ford, Halford, G. Thomas (Cambs. Association expert), G. E. Rogers, E. H. Smith, J. Lee, G. W. Bullamore, Warboys, North, Richardson, and Holloway (secretary, Cambs. B.K.A.).

Dr. Wolf explained that owing to rumours that the Ministry of Agriculture were preparing a Bill to deal with diseases of bees, etc., Mr. Holloway wrote to the Ministry for a copy of the proposed Bill, and was informed that the draft was not yet completed, and as soon as it was a conference of representative bee-keepers would be called together to explain exactly how the Ministry proposed to make effective the administration of the powers contained in the Bill. It was therefore thought advisable to call a meeting of all known bee-keepers in the county to discuss the whole question. Dr. Wolf went on to describe the results of

legislation in connection with bees in America, and then called for open and free discussion of the subject. Mr. G. W. Bullamore stated that he was one of those who opposed the Bill of 1913, and gave his reasons for so doing.

Mr. Gauntlett Thomas mentioned his research work in connection with "Isle of Wight" disease, and emphasised one discovery he had made in regard to Foul Brood, namely, that the intestines of the queen contained F.B. bacteria. He was not at the moment investigating Foul Brood bacteria, but mentioned it so as to make quite clear that the treatment given in all text-books for eliminating F.B. did not go far enough. He therefore pointed out that there was insufficient knowledge of the bacteria of F.B. at the present moment to permit legislators to consider that they could lay down laws which would definitely remove brood diseases. He also brought out other points in F.B. and "I.O.W.," and emphasised the point that scientists were not in agreement as to the bacteria causing "I.O.W.," and that further research work was required, which he trusted the Ministry of Agriculture were proceeding with. He stated that it was known that in many parts of the country "I.O.W." was not so virulent as it was, and that there had been no facts published as to the source of contagion, as experimentalists in some cases stated they could re-infect and in others stated frankly that they had failed to do so. Although his criticism was destructive, he was in sympathy with legislation, but powers should be in the hands of bee-keepers, chiefly extensive ones. He therefore suggested that an un-alaried committee be formed, with executive powers under the proposed Act, composed chiefly of practical bee-keepers—that was those whose living was solely or mainly derived from agriculture—such committee to have one representative from the Ministry of Agriculture, whose sole duty should be to consider points in connection with administrative work; the administration of the Act to be in the hands of county organisations, whose formation should be a matter of consideration for the Ministry. Under this scheme the cost of administration would be very small—a vital point at the present period. (Applause.)

Mr. G. E. Rogers proposed "That this meeting of bee-keepers in the county of Cambridgeshire recommend legislation to deal with bee diseases, but before any Bill is drafted the Ministry of Agriculture should have the assistance of those whose living solely or in the main is derived from bee-keeping and the production of honey." This was seconded by Mr. Thomas.

Sir Douglas Newton, in supporting the resolution, added that the meeting should ask the Ministry of Agriculture to call a conference of bee-keepers, at which the views of this county could be given before the Bill is drafted and circulated. This was seconded by Mr. Ford, and supported by Mr. Thomas, who desired that emphatic prominence should be given to the words "before the Bill is drafted and circulated."

Mr. Allbon and Mr. Smith also took part in the discussion.

On the resolution being put to the meeting and a show of hands taken, there were four dissentients, and the resolution was therefore declared carried.

It was then unanimously agreed that a small committee be elected to draft a constructive scheme for submission to the Ministry by a deputation. The following were elected:—Sir Douglas Newton, Dr. C. G. L. Wolf, Mr. E. C. R. Holloway (president, chairman and secretary of the Camb. Bee-keepers' Association respectively), Messrs. Bullamore, Mapey, North, Rogers, Smith, Thomas and Young.

The usual votes of thanks concluded the meeting.

## Twickenham and Thames Valley Bee-keepers' Association.

### ANNUAL MEETING.

The first annual general meeting of the Association was held on Feb. 7 at Twickenham Library Lecture Room. The Rev. R. Dixon Box presided.

The reports of the Committee and Treasurer were submitted and adopted, the latter showing a balance in favour of the Association. The salient features of the Committee's report were as follows:—Membership for 1919, 43—satisfactory for a beginning, but much below the number which might reasonably be hoped for in the near future. Lectures, five in number, had been given by Messrs. W. and J. Herrod-Hempsall, A. G. Gambrill, and J. Curtis; five committee meetings had been held, with an average attendance of six. By the courtesy of the Twickenham Horticultural Society, an exhibition of honey, etc., was held at the Society's Show at Orleans Park. The question of a restocking scheme had received careful consideration, but the committee had been unable, up to the present, to formulate any definite proposals. They had, however, accepted an offer made by Mr. F. A. Secrett, of Twickenham, of a piece of ground on which it was hoped to start an Association Apiary during the coming season. By an arrangement made with Messrs. J. Lee & Son, Ltd., of Uxbridge, members would be able to obtain bee appliances, etc., from the various depôts

of Messrs. Platts' Stores, Ltd., throughout the district. The committee would welcome suggestions for increasing the usefulness of the Association.

Mr. Burnet, in referring to the proposed Association Apiary, said that, although the Committee had not thought it possible to carry out a full re-stocking scheme this year, they proposed to establish an apiary which would be used to form the foundation colonies; so that if necessary a start could be made next year. Members who had not sufficient room for bees in their own gardens could keep them at the Association Apiary; and it was hoped that many would avail themselves of the excellent accommodation offered. Situated in the midst of 40 to 50 acres of fruit trees, the site was particularly suited for bee-keeping, and was easily reached by tram, tram or motor-bus. It was also proposed to hold meetings for the instruction of members at the apiary.

The officers for 1920 were then elected. The President, Sir William Joynton-Hicks, M.P., Vice-President, Mr. Cyril Routh, Hon. Treasurer, Rev. R. Dixon Box, and Hon. Sec., Miss M. Byatt, were all re-elected. Mr. C. D. Burnet was elected a Vice-President. The executive of seven were then voted for, and the following were appointed:—Messrs. C. D. Burnet, J. Curtis, T. P. Grisdale, T. M. Nelson, H. A. T. Packford, C. Parks and Miss Shaw.

The meeting closed with a few remarks made by the Chairman on the subject of legislation with regard to bee diseases.

It is hoped that bee-keepers throughout the Thames Valley will do all they can to support the Association during the coming season; for there never was a time when it was so important to develop the resources of the country. There must be in Middlesex alone many acres of fruit and other blossom, never visited by a single bee, and consequently a vast amount of honey lost to the nation. The Hon. Secretary, Miss M. Byatt, "Hawthorn," Hanworth, Middlesex, will be glad to answer any inquiries from bee-keepers who may be desirous of becoming members of the Association.—(*Communicated.*)

### Worcestershire Bee-Keepers' Association.

#### ANNUAL MEETING.

The annual meeting of members of the Worcestershire Bee-Keepers' Association was held at the Central Hotel, Worcester, on Saturday, Major C. Knight-Coutts in the chair, 45 members present. The Hon. Secretary (Mr. John P. Phillips) read the Committee's report, which stated:

"The grievous losses of stocks from

disease during the last two or three years threatened at one time to bring an end to bee-keeping in this part of the country and to this Association. At their last meeting they were able to say that the crisis appeared to have passed, and that better times were within sight. The improvement had been continuous; losses by disease were much less frequent, and stocks had increased rapidly. Never were there so many people anxious to keep bees. Novices had been flocking to join the Association as fast as they could get stocks, but still many were waiting. The roll of new members, which had become alarmingly short, was now lengthening satisfactorily, and over forty new members had been admitted this season. In order to provide as many stocks as possible, the County Horticultural Sub-Committee invited several members of the committee to join them in carrying out the Food Production Department's re-stocking scheme. A Re-Stocking Society was formed, and Mr. Lecdham was good enough to undertake the management of the apiary at Lower Bentley, where the imported foreign stocks were placed. Forty-three nuclei were raised. Sixty-six persons took shares, but as fifteen of these withdrew their subscriptions rather than wait, most of the members would have received a nucleus by the spring. The honey season was distinctly less productive than the last one. The early weeks were very promising ones, and many bee-keepers had capital returns in May and early June. Following this came east winds and other unfavourable weather, and the season as a whole was decidedly unsatisfactory, although there were a few fortunate apiaries."

The report was adopted.

The Treasurer (Mr. A. R. Moreton) stated that last year they began with a balance of £10 4s. 11d. This year the balance was £15 19s. 7d. The number of members was now 92, as against 76 last year.

A letter was read from Canon Coventry expressing his great interest in the Association, and regretting that he was not able to attend the meetings as regularly as he would like to. He was unanimously re-elected President.

The following Vice-Presidents were re-elected *en bloc*: Earl of Dudley, the Dean of Worcester (Dr. W. E. Moore Ede), Miss E. Johnson, Miss H. H. Turner, Mrs. John Walker, Messrs. B. Evres Monsell, M.P., Stanley Baldwin, M.P., A. H. Martin, C. H. Havnes, G. Cadbury, G. E. Wilson, Geoffrey F. Hooper, and E. Corbett. Mr. Moreton was re-elected Treasurer, Mr. J. P. Phillips, Spetchley (for instruction and general business), Mr.

Percy Leigh, Stoke Prior (for expert work), and Messrs. G. Richings and S. Leedham (for shows) were unanimously re-elected Secretaries. The auditors (Messrs. E. Corbett and E. A. Millward) were re-appointed.

The following committee was appointed: Messrs. G. Bracken, C. C. Duncan, C. H. Haynes, S. Leedham, Percy Leigh, C. A. Lloyd, E. A. Millward, J. Price, G. Richings, W. H. Sisman, H. Smith, Canon Coventry, the Dean, Major C. Knight-Coutts, Captain Turner, Mrs. Painter, Mrs. Walker, Mrs. Joshua, and Miss H. H. Turner. Messrs. C. H. Haynes and A. R. Moreton were re-elected representatives to the British Bee-Keepers' Association.

An address on the Re-Stocking Scheme and Bee Diseases Bill was given by Mr. W. Herrod-Hempsall. In the course of his remarks, he mentioned that England, Scotland and Wales were the only countries in the world where there was no legislation as regards bee diseases. He strongly advocated legislation in stamping out these obnoxious diseases, and the meeting passed a resolution to this effect.

(Communicated.)

### Herts County Bee-Keepers' Association.

BARNET AND DISTRICT BRANCH.

This branch is enjoying a series of lantern lectures, etc., which have been arranged for the winter and early spring, covering the whole district. Up to the present the attendances have been very satisfactory, and great interest is being shown. It is hoped to follow these lectures during the season with demonstrations in bee-keeping and experiments with metal combs and metal foundation at the Association's Apiary in Barnet. The following is the list of lectures arranged:—

December 5, 1919.—"Bee Diseases and Enemies," at Barnet, by Mr. W. Herrod-Hempsall, F.E.S.

January 23, 1920.—"Fertilisation of Fruit and Flowers by Bees," at Barnet, by Mr. W. Herrod-Hempsall, F.E.S.

January 28.—"The Honey Bee and Honey Production," at North Finchley, by Mr. Norris S. Toms.

February 13.—"Demonstration of Wiring Frames, Embedding, etc.," at Barnet, by Mr. W. D. Ridley, followed by a Social.

February 26.—"Bee-Keeping," at Totteridge, by Mr. Norris S. Toms.

February 27.—"Spring Management and Swarm Control," at South Mymms, by Mr. Norris S. Toms.

March 4.—Social and General Meeting, followed by exhibition and explanation of

several of the latest bee-keeping appliances, at Barnet.

March 15.—"Production of Honey and Preparation of Honey and Wax for the Show Bench," at New Barnet, by Mr. W. Herrod-Hempsall, F.E.S.

Should this report come under the notice of any bee-keeper in these districts not a member or any intending bee-keeper, it is hoped they will communicate with the Hon. Secretary, Mr. Norris S. Toms, 60, Fitzjohn Avenue, Barnet, Herts.

### Eccleshall.

MEETING OF BEE-KEEPERS.

A meeting of Eccleshall bee-keepers was held in the Church Rooms on January 30 to consider the best means to be adopted to increase the number of bee-keepers in the district, and the better management of the bee industry. A committee was appointed to carry out the scheme, and to arrange for lectures and demonstrations to be held. Mr. T. H. Dean, Eccleshall, was appointed to be the representative of the Association on the committee of the Staffordshire Bee-Keepers' Association. Mr. J. Price, county expert, gave an interesting lecture on re-queening and other matters appertaining to bee-keepers.

### Somerset Bee-Keepers' Association.

ANNUAL MEETING.

Many experts in the business of bee-keeping gathered in the Assembly Hall, Yatton, on Saturday afternoon, when Mr. T. W. Cowan (Clevedon) presided at the annual meeting of the Somerset Bee-Keepers' Association. Those present included Lieut.-Colonel H. F. Jolly (chairman), Dr. Wallace (Weston-super-Mare), Messrs. L. Bigg-Wither (hon. secretary and treasurer), S. Jordan, H. J. Grist, J. W. Heard, A. G. Smith, R. Pritchett, A. W. House, E. G. Hawkins, A. Fox, F. C. B. Jefferies, L. E. Snelgrove, A. Goodrington, F. S. Hawkins, J. Brackley, E. L. Story, and others.

Mr. L. Bigg-Wither (Wells) in presenting the secretarial report, said the principal work of the association during the past year had been done in connection with the re-stocking scheme. Sixty-two nuclei were distributed, and 48 colonies were now being wintered in the different restocking apiaries which had been formed at Shepton Mallet, Yeovil, Wells, Bridgewater, and Weston-super-Mare. At the present time the association had orders for nearly 80 nuclei, which would be dealt with in strict rotation. He was glad to be in a position to report that the "Isle of Wight" disease, although not entirely stamped out, appeared to be on the decrease. The association consulting

expert (Mr. E. L. Snelgrove) had done during the past year a considerable amount of research work in connection with the disease, and hoped to publish his report later, when results of his experiments had been verified. The membership of the Association had more than doubled during the twelve months. (Applause.) They had now 257 members, compared with 115 in 1918.

The financial statement showed receipts £103, and expenditure £59 15s. 7½d., leaving a balance in hand of £43 4s. 4½d.

The Chairman congratulated the secretary and the meeting on the satisfactory report. Referring to the credit balance he suggested that a fair portion of it should be expended during the current year, which would be considerably to the benefit of the Association. Alluding to the comparative absence of disease among the bees in the country, he warned them not to be surprised if cases occurred occasionally, in which event he advised prompt and careful isolation.

The election of officers was then proceeded with. Mr. T. W. Cowan was unanimously re-elected president; Lieut.-Colonel H. F. Jolly, chairman; and Mr. L. Bigg-Wither, hon. secretary and treasurer. All were cordially thanked for past services, special reference being made to the work accomplished by Mr. Bigg-Wither in connection with the re-stocking scheme.

Mr. E. L. Snelgrove (Weston-super-Mare), said they were most fortunate in having Mr. Cowan—who was such an eminent authority on bees—permanently connected with the Association. (Applause.) He took a great interest in the work, and it was a privilege to have him among them. His advice was always so sound, and he was able to tell them the "secrets first hand" before they were made public. Most of them knew that Mr. Cowan was the leading authority on bees in the world.

Mr. Cowan, in returning thanks, said he had been interested in bees since the year 1862. At first the interest was directed to the scientific aspect, but he very soon discovered the possibilities of making the pursuit a commercial enterprise and of service to the country. In bee-keeping there was always something new to learn.

Mr. E. L. Snelgrove then moved the following resolution: "That this meeting instructs the Council to consider the present constitution of the Association, and draw up a set of rules so as to place the Association on a more representative and efficient footing." He considered the existing organisation was very "antiquated and inefficient." They in Somerset prided themselves on being in advance of other

counties in the business of bee-keeping, but it was about time they reviewed their organisation and made it more effective. They had twenty branches scattered throughout the county. Instead of electing the delegates haphazardly they should have a sane system. The local delegates should be elected by the branches.

A brief discussion followed on the resolution, which was eventually carried unanimously.

The meeting adjourned for tea, and subsequently Mr. Snelgrove gave an interesting address on "Various Methods of Increase."—(Communicated.)

## Bee Legislation.

As intimated in our last issue, we did not intend publishing further letters on this matter until the Bill can be printed. The following letter, however, defines the situation so aptly that we think we need make no apology for publishing it:—

You are to be commended on throwing open your columns to both advocates of legislation and opponents alike, and it is somewhat difficult to decide which side furnishes the stronger argument in favour of legislative action. It is curious to notice the fallacies into which so many of our opponents fall—fallacies which, if carried to a logical conclusion, would lead to all sorts of absurdities. Take, for instance, the letter of Mr. Fiskén (10123) in your issue of Feb. 5, 1920, who propounds the axiom that "knowledge should surely precede action." If this is Mr. Fiskén's rule of life, some fine morning, on opening our newspaper, we may come across something of this sort:—

### ALARMING FIRE IN WESTERTON.

#### WHOLE TOWNSHIP DESTROYED.

Exciting Scenes, etc., etc.

About 1 a.m. this morning smoke was observed issuing from a house in \_\_\_\_\_ Street in the occupation of Mr. F\_\_\_\_\_ and family. An alarm was raised, and the local fire brigade was quickly on the spot (beg pardon—scene of the conflagration). In the meantime Mr. F\_\_\_\_\_ and family had with difficulty been rescued from the now furiously burning building.

The origin of the fire being a complete mystery, and Mr. F\_\_\_\_\_ having no knowledge of its origin, refused to allow the fire brigade to take any action until the cause of the conflagration could be ascertained, with the result, owing to the high wind prevailing at the time, the fire rapidly spread from house to house until the whole township was involved.

Is this so very far-fetched?

C. HARRISON.

Hayle, Cornwall.





The Editors do not hold themselves responsible for the opinions expressed by correspondents. No notice will be taken of anonymous communications, and correspondents are requested to write on one side of the paper only and give their real names and addresses, not necessarily for publication, but as a guarantee of good faith. Illustrations should be drawn on separate pieces of paper. We do not undertake to return rejected communications.

### Early Pollen.

[10135] I was very much surprised to see my bees carrying pollen in to-day. Have other readers of the B.B.J. any record of pollen being gathered at so early a date as this (January 18)? Perhaps a line in the JOURNAL would bring to you records from other parts. I would not be surprised if friend Kettle could give us an earlier date.—H. F. SWANN.

### — Experimenting with Larger Frames.

[10136] *Re* your article on experimenting with larger frames. It appears to me that if we wish to obtain exact data something more than placing bees on a set of larger frames will be necessary. We all know that bees are very susceptible to position for one thing, so that it seems to be requisite that very careful thought should be given to this trial if we are to reap any definite results from it.

It is worth the attention of our council (the B.B.K.A.), and I suggest that they draw up a few simple rules that may be followed by those of us who propose testing the theory advanced.

The first essential is an unbiassed mind. For my own part, if I find the larger frame the best then my support will be given; if not, shall most strenuously oppose it. We have no place for sentiment in this matter, and we must, if we wish to hold our own in the market, stick to hard facts. Bee-keeping seems to have been looked on as a hobby; it should be conducted as a business. In my experience the best members of the craft, and they who take the keenest interest in their bees, are those who run their apiaries for profit.

I offer a few suggestions as to the method of testing the frames, and no doubt others will do the same, so that it should be possible to draw up some plan that will be applicable before the season opens.

Two stocks of about the same strength to be used. Queens of equal age, and of same strain. Hives of the same pattern, to stand in line facing S.E., if possible, about 4 ft. apart. A careful record of all

feeding and attention to be kept, with, say, a monthly report as to state of the stocks. If surplus is worked for, racks in both cases to be identical (*i.e.*, no bait combs to be employed unless both can be served the same). Special attention to be given as to tendency to swarm. Exact record of (1st) surplus, (2nd) amount of stores on closing down, (3rd) amount of food given, and, lastly, a statement as to how the stocks have wintered.

I think by this means we shall be able to decide if an alteration is desirable. Should it prove so, a start could be made in 1921, and the new standard begin to find its way into the apiary.—G. JAMES FLASHMAN.



Correspondents desiring an answer in the next issue should send questions to reach this office NOT LATER than the FIRST POST on MONDAY MORNING. Only SPECIALLY URGENT questions will be replied to by post if a STAMPED addressed envelope is enclosed. All questions must be accompanied by the sender's name and address, not necessarily for publication, but as a guarantee of good faith. There is no fee for answering questions.

#### Suspected Disease.

- R. A. HOLDEN (Herts), J. D. (Eythorne), "BURNELL" (Wilts), B. J. F. (Essex).—The bees were affected with "I.O.W." disease.
- MISS WELDON (Surrey).—Both samples were affected with "I.O.W." disease.
- J. PRYDE (East Lothian).—The bees were smashed in post. It is useless sending bees in an envelope. They should be sent in a small box. From what we could see we think the bees had "I.O.W." disease.
- J. BROWN (Sussex).—We are unable to say cause of death.

### Special Prepaid Advertisements. One Penny per Word.

Trade advertisements of Bees, Honey, Queens, and Bee goods are not permissible at above rate, but will be inserted at 1½d. per word as "Business" Announcements, immediately under the Private Advertisements. Advertisements of Hire-manufacturers can only be inserted at a minimum charge of 3s. per <sup>line</sup>lin., or 5s. per inch.

PRIVATE ADVERTISEMENTS are only intended for readers having Surplus Stock to dispose of. Driven Bees, Nuclei, and Queens that are reared or imported for sale, are Trade Advertisements, and can only be accepted under trade terms. A charge of 6d. extra will be made if a box number is used.

Orders for three or more consecutive insertions in "The Bee Journal" entitle advertisers to one insertion in "The Bee-Keepers' Record" free of charge.

#### PRIVATE ADVERTISEMENTS.

**B**EEES FOR SALE.—Several small Stocks, on six combs, of honey fed, healthy Bees, £3 10s. each; travelling box 10s., refunded if box returned in sound condition within seven days. Stamp for reply.—REED, Primrose House, Heacham, King's Lynn. r.b.30

**PURE** English Honey, mainly white clover, in 14- and 28-lb. tins, £9 per cwt., carriage paid. Reduced price for larger quantity.—WELLS, Claudius Road, Colchester. r.b.35

**17 HEALTHY** Italian Stocks, headed by Penna Queens, £5 5s. each.—J. YOUNGER, 6, Maid's Causeway, Cambridge. r.b.45

**PLANT** "Willow Herb" for your bees; useful honey flower; 12 roots, 2s.—BOWEN, Pittville Street, Cheltenham. b.46

**TWO** healthy Stocks of Hybrid Italian Bees, and nearly new Taylor Hives, complete with four Section Racks, two Excluders, Double Escape Board (new), Smoker, and about 100 Sections, £12 the lot; also two Stocks in new strong skeps, £6. Would divide.—CLUBB, "Cranston," Sudbury, Suffolk. b.47

**EARLY SEED POTATOES**—14 lbs., 3s. 6d.; 56 lbs., 12s.; carriage extra; supply limited.—W. A. WOODS, Normandy, Guildford. r.b.43

**SIX** good Hives for Sale, zinc roofs, floor section, double walled body box, eke, and roof, take standard frames; or exchange for bees.—STRATFORD, 37, Belle Vue Street, York. b.49

"**BRITISH BEE JOURNAL**." Vols. 5, 6, 7 and 8, bound, two vols. cloth; Roots' "A B C Bee Culture," 1882; 25s. the lot.—BROWN, 87, Alexander Road, Acocks Green, Birmingham. b.50

**ITALIAN HYBRIDS**—Surplus stocks, guaranteed strong, no disease, on 10 frames, April delivery, £7 per stock, carriage forward.—Box 65, B.B.J. Office, 23, Bedford Street, W.C.2. b.51

**FOR SALE**, Guinea Extractor, sound condition, 30s.; also four Queen Excluders, 9s., carriage paid.—MEAD, 27, Godson Road, Croydon. b.52

**NINE MATING HIVES**, twin standard frames, side wall feeders, calico-covered roofs, painted, complete, 7s. 6d. each, £3 5s. the lot.—MOSS, London Road, Hinckley b.53

**WANTED**, completely equipped small Apiary, with lease of comfortable House with Orchard and Fields, suitable for poultry, in district offering facilities for learning general farming; near sea preferred; or would buy Hives and Appliances separately.—SACK, 22, St. Mark's Hill, Surbiton. b.54

**BEEES**—Healthy Stock in W.B.C. Hive, complete, with fitted supers, £4; also Hives, Section Racks, Frames, and other Appliances for Sale. Owner giving up.—Apply for particulars, PARTIDGE, Harvey House, Watton, Norfolk. b.55

**FOR SALE**, six good Hives, some suitable for Italians, 15 frames, shallow frame boxes. Stamp for particulars.—CROWE, Merriott, Crewkerne. b.56

**HOLLYHOCKS**, strong plants, 6 for 1s. 9d., 3s. dozen, post free.—TICKELL, below. b.57

**DRAWN** Shallow Combs, wired, 36 drone, 36 worker, 7s. dozen; six home-made Bottle Feeders, 1s. 9d. each.—TICKELL, St. Mark's, Cheltenham. b.57

**HONEY** for Sale, four tins, about 28 lbs. each; very best quality. Best offer to clear.—HIXE, Fourways House, Hemycok, Devon. b.58

**HONEY**—25 dozen finest clover, clean, well-filled Sections, 30s. per dozen, carriage forward; expert packing free.—GIBSON, Apiaries, Ballygowan, Belfast. r.b.59

**WANTED**, in March, strong Stock pure Italian Bees, 1920 Queens; must be guaranteed free from disease.—WORTHINGTON, World's End, Solihull, Warwickshire. r.b.60

**FOR SALE**, about 3 cwt. fine Extracted Welsh Honey; guaranteed pure.—JAMES, Adpar, Newcastle Emlyn. r.b.3

**PLANT** now for the bees, strong fruiting Raspberry Canes, 2s. 6d. per dozen, 8s. for 50; also Strawberry Runners, 1s. per dozen, 6s. per 100, best varieties, carriage paid; cash with order.—HALL, Highfield Lodge, Balderton, Newark. r.b.6

**ITALIAN BEEES** on 6 frames, headed by Penna's 1920 imported direct Queen, delivery June, £4 10s.—ENNEVER, Oak Avenue, Ridgeway, Enfield. a.56

**PURE** light Cambridge Honey, 14-lb. tins, 22s. 6d.; 28-lb. tins, 42s., carriage paid; sample 4d.; tins free.—J. YOUNGER, 6, Maid's Causeway, Cambridge. a.66

**CORRESPONDENCE** Course in Bee-keeping.—MISS F. E. PALING, Golden Square, Henfield, Sussex. r.a.54

**WANTED**, portable Greenhouse.—Price and particulars to W. HERROD-HEMPSALL, Old Bedford Road, Luton, Beds.

**ANTED**, Auster Rear Wind Screen for motor car.—HERROD-HEMPSALL, as above.

**FOR SALE**, one Exhaust Whistle, 11s., 45s., free; one Wood Millie Motor Foot Pump, 45s., carriage free.—HERROD-HEMPSALL, as above.

#### BUSINESS ADVERTISEMENTS.

1½d. per word.

**DUTCH BEEES**, Skeps (as imported from Hans Matthes), Nuclei, Queens. Illustrated Catalogue on request, containing points on management.—Buy direct from Sole Agent, WHYTE, Bee Farmer, Cumbernauld, Dumbartonshire. b.61

**BOOK ORDERS FOR MAY**—Dutch-Golden 4-frame Nuclei, £3; strong; no disease; Stocks, £5.—GREEN, Bee-keeper, Laindon, Essex. b.62

**TWO** 28-lb. tins Granulated Honey, taken 1st prize, £2 each; 3-frame Nuclei, with Queens, from mid-June. 55s., carriage paid.—VINCENT, 132, Croydon Road, Anerley. b.63

**ITALIAN** 4-frame Nuclei, 50s.; box 10s., returnable. All orders strict rotation, May-June delivery. £1 deposit, balance prior to delivery.—LEE, "Little Bowden Apiary," Burgess Hill, Sussex. b.64

**FOR SALE**, Stocks, £5; Swarms, £2; Queens, 7s. 6d.; Nuclei, £3. Orders booked now.—THE HEATHERLANDS BEE FARM, Thursley, Godalming. b.65

**RE-SELECTED** Italian and Norvic Queens, 10s. 6d. to 21s.; Bees, 13s. and 14s. 6d. per frame, from perfected hygienic stocks; May onwards; carriage paid; boxes returnable.—ARTHUR TROWSE, 51, Eade Road, Norwich. b.66

**BEEES**—Healthy Stocks, Swarms, Nuclei, early delivery. Chickens, hatching weekly; best strains. Particulars, stamp.—J. MOORE, Bleasby, Notts. b.67

**THREE-FRAME NUCLEI**, £2 2s.; Queens, 10s. 6d. Hardy, prolific hybrids, disease resistant strain. I have not had any "I.O.W." in my hives at any time.—O. W. H. OVENS, 151, Fishponds Road, Eastville, Bristol. rb.68

**IT'S NO USE TO DRUG YOUR BEEES**—You can only keep "I.O.W." in check by having bees of disease-resisting strain. The safest and best way is to buy our guaranteed 3-comb Italian Nuclei in June or July. Each nucleus contains two combs of brood and one of store, and is headed by a 1920 Penna or home-bred Italian Queen, according to preference. Money refunded in full if on arrival bees fail to give complete satisfaction. Price: June, £3 5s.; July, £2 12s. 6d., carriage paid, plus 10s. box, returnable. 123 per cent. discount to disabled men. Cash with order, or by April 1. Book now to secure early delivery.—PEARSON & GALE, Marlborough. b.69

**FOR SALE**, Nuclei, 1919 Queens, three frames, 47s. 6d.; four, 52s. 6d.; May; Hybrids, young Queens, ready June; returnable cases 7s. 6d. JOURNAL deposit.—A. H. HAMSHAR, Womersley, near Guildford. b.41

**5-FRAME NUCLEI**, 1919 Queens, Italians and Blacks, £5. Book early for April and May delivery. Also Appliances for Sale.—MISS BURDER, Chittington, Lewes. r.b.42

**WATERPROOF RUBBER SHEETS** for covering outhouses, etc., 72in. by 36in., brass eyelets, 12 for 20s.—SAGARS STORES, Ardwick, Manchester. b.16

**A. H. BARTLETT**, having established an Apiary where there are no bees within many miles, can supply pure mated Italian Queens and Nuclei. His stocks of Italians have been tested for five years for special qualities, and are second to none—hardy, good disease resisters, extra prolific, the best of comb and honey producers, also mild tempered. Orders now booked for Nuclei, June-July, 3-frame, well covered with bees and brood, with 1920 pure mated Italian Queen, £2 15s.; 4-frame, £3 5s., carriage paid; box 5s., returnable. Pure mated 1920 Italian Queens, June-July, 9s. 6d., August-September, 7s. 6d.; Virgins, 4s. 6d.; safe delivery; satisfaction guaranteed. Cash with orders. List ready shortly. All Queens reared by the best up-to-date method in full colonies. Thirty years' practical experience.—A. H. BARTLETT, Bee Specialist, High Street, Crowthorne, Berks. b.17

**WE** are reserving a few choice Italian Queens for the D.B.s for delivery in May, June, July and August. Prices and particulars on application.—S. H. SMITH, 30, Maid's Causeway, Cambridge. r.a.62

**HAVE YOU READ "THE BEE WORLD"?** If not, why not? Every number in itself is a useful literary work for practice and reference. Specimen copy free.—Offices: THE APIS CLUB, Port Hill House, Benson, Oxon.

**ITALIAN QUEENS** direct from Italy. Price list for 1920 on application.—Address, E. PENNA, Bologna, Italy. w.39

**BEE FLOWER SEEDS.**

Collection of six best Varieties, 1s., post free. Beautifully Illustrated Instructions Up-to-date. Garden Guide, 64 pages, Free.

KNIGHT'S,  
SEED SPECIALISTS,  
WOLVERHAMPTON.

**BOOK NOW.**

**ITALIAN QUEENS,**

Pure Penna Strain.  
ASHWORTH,  
THE BUNGALOW, WEYMOUTH STREET, WARMINSTER.  
(late of Heytesbury).

**Pure Golden Italian Bees and Queens.**

Their superior honey-gathering qualities, prolificacy, beauty, and gentleness are well recognised by

**THE WORLD'S PROMINENT APIARISTS.**

A limited number of Colonies raised from my Stock of Imported Pure Golden, also Three-Band Italians, for disposal.

Three Standard Frames, £3 10s. and £2 10s. respectively, carriage paid; Golden Virgins, 10s. each; Three-Band Fertiles, 8s. 6d.; Virgins, 4s. each.

Bookings executed in rotation from mid-May, depending upon weather conditions. Descriptive Circular, stamp.

E. COOMBER,  
64, RONALD PARK AVENUE,  
WESTCLIFF, ESSEX.

Send for

**Bee-Keepers Wake Up!**

You can make a Big Profit if you use right up-to-date Appliances, including the Manley Hive. MEADOWS, SYSTON, LEICESTER.

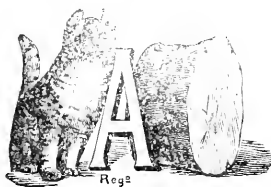

**Queens that will fight "Isle of Wight" Disease.**

Send 3d. for **'The Secret of Immunity'**

and Price List.  
T. F. COBB, 33, Bevan Road, Plumstead.

**Books for Bee-keepers NOW IN STOCK.**

A Modern Bee Farm ... ..	7/6	... 6d.
Beginner's Bee Book (PELLETT)	5/-	... 4d.
BEE-KEEPING SIMPLIFIED FOR THE COTTAGER AND SMALLHOLDER (W. HERROD-HEMPALL, F.E.S.) ... ..	1/-	... 1½d.
BEE-KEEPERS' PRACTICAL NOTE BOOK (T. W. COWAN)	1/-	... 1½d.
BRITISH BEE - KEEPERS' GUIDE BOOK (T. W. COWAN) (paper covers only)	2/6	... 3d.
Dissectible Model of Queen Bee	4/6	... 3d.
FERTILISATION OF FRUIT BLOSSOMS BY BEES (T. W. COWAN) ... ..	-/3	... 1d.
Honey and Health (A. HOPE) ...	-/6	... 1.1.
Honey Vinegar (REV. G. BANKS)	-/2	... 1d.
How to Keep Bees (ANNA B. COMSTOCK) ... ..	5/-	... 3d.
Management of Out Apiaries	3/-	... 2d.
Pollination of Fruit in relation to Commercial Fruit Growing ... ..	-/6	... ½d.
PRODUCING, PREPARING, EXHIBITING AND JUDGING BEE PRODUCE (W. HERROD-HEMPALL, F.E.S.) ...	2/-	... 3d.
Productive Bee-keeping (PELLETT) ... ..	10/6	... 6d.
Queen Rearing in England (F. W. L. SLADEN) ... ..	1/6	... 2d.
Snelgrove's Method of Re-queening ... ..	-/6	... 1d.
The "Townsend" Bee Book ...	2/6	... 2d.
WAX CRAFT (T. W. COWAN) ...	2/-	... 2½d.
Wilke's Book on Swarming ...	1/-	... 1½d.
<b>MISCELLANEOUS.</b>		
Maeterlinck's Life of the Bee	3/6	... 3d.
The Lore of the Honey Bee (TICKNER EDWARDS) ... ..	2/-	... 2d.
The Humble Bee (F. W. L. SLADEN) ... ..	12/6	... 6d.
THE BEE WORLD (supplied only to members of Associations interested in the control and development of the APIS CLUB, apart from ordinary members of the latter), per copy ... ..	-/8	... 1d.

**British Bee Journal & Record Office,**  
23, BEDFORD STREET, STRAND, LONDON, W.C.2.

**FINEST SECTIONS OF HONEY.**

A large quantity for Sale at carriage paid prices, either Plain or Glazed

**IRISH RUN HONEY.**

Several cwts. for Sale in quantities to suit customers, at carriage paid prices in free tins and cases.

**GORDON ROWE,**  
Honey and Beeswax Packer,  
28a, Moy Road, Cardiff.



# The Metal Foundation

(Protected.)

☐ The triumph of the Metal Foundation is due to the following significant advantages:—(1) Indefinite durability with reasonable care; (2) Greater safety of bees in transit on new combs; (3) Capability of bearing the weight of a heavy swarm in hot weather; (4) Greater comb stability in quick extracting; (5) Control of drone cells; (6) The production of even combs; (7) Easy removal of queen cells without the slightest injury to the foundation; (8) Cleanliness and adaptability to sterilisation by boiling; (9) Economy of labour and time in fitting and detaching; (10) An ideal compromise between the metal comb and the wax foundation.

☐ The invention has created a world-wide interest. Its value will be more appreciated by studying the following original literature:—"The British Bee Journal," November 13; "Bee Craft," December; and "The Bee World," September, October, and November, 1919.

Following original literature:—"The British Bee Journal," November 13; "Bee Craft," December; and "The Bee World," September, October, and November, 1919.

## RETAIL PRICES.

☐ The Metal Foundation ("worker" type) can now be produced in any size required, whether for the brood chamber or the super, e.g., for the British Standard Frame (14 in. x 8½ in.), Deep Standard (14 in. x 12 in.), Simmins' (16 in. x 10 in.), Langstroth (17½ in. x 9½ in.), etc., and for their corresponding super frames. Despite the heavy cost of machinery, metal, etc., it is offered at a price *well within the purchasing power of the average bee-keeper*. All orders, whether large or small, receive *prompt attention*, and are executed in *strict rotation, and in good time for the season*. We have further decided—for the benefit of bee-keepers who are not yet in a position to place their orders—on taking the risk of a liberal margin of production to meet unavoidably delayed orders. *If you have not yet made up your mind as to your requirement, you are still in time to do so.*

## The Uxbridge W.B.C. Hive.

☐ This popular hive, which we originally introduced over twenty years ago, is admirable for its *water-proof* features, since it eliminates the plinth. It stands supreme amongst all W.B.C. patterns. You will never regret trying it with your metal foundation.

\* \* We allow a Five per cent. discount on all our goods (including the Metal Foundation) to members of the Apis Club, who are respectfully requested to forward their membership cards when placing orders.

A FINAL REMINDER! To avoid disappointment apply now for the Metal Foundation Price List, and for our 1920 Catalogue.

# JAMES LEE & SON, Ltd.

## UXBRIDGE, MIDDLESEX.

(Telegrams: Graphicly, Uxbridge.)

Telephone: Uxbridge 181.)

**Don't Order "W.S." Queens until you have seen the "Queenland" Revised List for 1920. 3½d. post free**

**NUCLEUS STOCKS—Same Price as 1919.**

The only Pedigree Bee-Stock Registered in direct line for more than 25 years.

**"AMALGA" is the name of our Queen breeding mother for 1920**  
**'ALTA' is the name of our Drone parent for 1920.**

**SAFE DELIVERY of Nuclei and Queens GUARANTEED**

PRODUCE OF ONE NUCLEUS REALISES OVER £40 IN CASH.  
 "The three-frame nucleus I purchased from you had increased last autumn to two strong stocks. I supered one on April 23rd of this year, and the other a few days later. I sold two swarms, and made up the others to five stocks. Of these I also sold three stocks. The original lot gave 198 lbs. of honey, and in all I have taken 365 lbs. My sales amounted to over £41 in actual cash."  
 (Miss) H. G. MOYSEY.  
 Somerset, Oct. 9th, 1918.

EXCEEDS 500 PER CENT. INTEREST.  
 "We have now 12 stocks to winter, besides selling one, out of the two three-frame nuclei supplied June 20th last year."  
 (August 15th, 1917). Miss B. D.  
 Quinton, Bucks.

THREE TO SEVENTEEN.  
 "It may interest you to know that the three stocks to which I introduced your queens (the only stocks saved in the apiary) in 1916, produced in all 17 stocks, and a good surplus in honey in 1917; this under the care of my wife who knew nothing about bees. I simply directed her as to management from there (France)."  
 OLIVER G. PIKE.  
 April 9th, 1918.

FIRST AND BEST.  
 "Your White Star strain was the first to enter the sections, and all the honey I got was from them."  
 G. H. S.  
 Heddon House Dairy.

APRIL 19TH.—BOILING OVER.  
 "The hive is simply boiling over with W. S. bees. They are at work when my other stocks are idling, and they are stronger than any of my other stocks."  
 Aberdare, Wales. E. T. W.

ARE THE W.S. PROLIFIC?  
 "In 1904 I got a W.S. queen from you, and last year (1905) by the first week in June she had brood in *twenty-five* standard frames."  
 J. H.  
 Higher Kinnerton, Chester.

NUCLEUS DELIVERED IN JUNE; 40 FRAMES BY AUGUST.  
 "The three-frame nucleus of bees now occupy 40 Standard Frames. They have exceeded beyond anything I believed possible. I have never had anything like them before, and if the other queens on order turn out the same I consider my fortune made."  
 JOHN JONES.  
 Llancarfan, Aug. 21st, 1918.

SEVERAL STOCKS FROM ONE NUCLEUS.  
 "It seems almost ridiculous that this nucleus of the previous season (Aug.), before I was prepared for it, swarmed in April, and I now have several stocks from that investment."  
 J. W. MCKAY.  
 Croydon.

EIGHT STOCKS FROM ONE W.S. NUCLEUS.  
 "I now have eight stocks from the one nucleus you supplied last year."  
 J. JONES.  
 Llancarfan, May, 1919.

BEST IN THE COUNTY—NEVER SAW THE LIKE!  
 "May 26th.—The two queens you sent me have exceeded anything that I ever thought of. The stock chambers are full and crammed with brood, and all three supers crowded with bees; but even with this the bees are boiling over. I have not fed them at all, and have removed several frames of brood for another lot. The County Expert called yesterday, and said he had never seen such bees, and they were certainly the best in Hampshire."  
 D. D. P.

NO SPRING-FEEDING, BUT AGAIN FIRST.  
 "The W.S. bees on eleven 16 x 10 frames were full and boiling over at the middle of May, and were the first to enter supers out of 23 stocks; and last, but not least, they required no spring feeding."  
 U. W.  
 Arnold, Notts.

Revised 1920 "White Star" List, 3½d., of S. SIMMINS, Queenland, Heathfield, Sussex.

# HIVES.

Compare the WORKMANSHIP and FINISH of our Hives.

All made by practical Men who know what a good hive should be.

In various designs to suit all tastes and requirements.

Season's speciality—THE MANLEY HIVE for 16 in. x 10 in. Frames.

Full descriptions and illustrations in our 1920 Catalogue:

*"Everything for an Apiary."*

If you have not received your copy, send a P.C. at once.

OUR MOTTO—SERVICE & QUALITY.

**R. STEELE & BRODIE, Wormit Works, Wormit, Scotland.**

## Bee-keeping Simplified

FOR THE COTTAGER AND SMALLHOLDER,

By **W. HERROD-HEMPSALL, F.E.S.,**

*Author of "Producing, Preparing, Exhibiting and Judging Bee Produce."*

Price 1s. net. Post Free 1/1½

This little book supplies the need for a cheap up-to-date and well-illustrated handbook on bee-keeping, and gives in Mr. W. Herrod-Hempsall's well-known, clear, lucid style all that is necessary to enable anyone to commence bee-keeping successfully. From **THE BRITISH BEE JOURNAL OFFICE, 23, Bedford St., Strand, London, W.C.**

## The "HERROD APICURE."

**SIMPLE CLEAN! EFFICIENT!**

For the Prevention and Cure of Foul Brood and other Diseases of Bees.

**DON'T DELAY—ORDER AND USE AT ONCE.**

PRICE, with full instructions, 1/8, 2/10 and 5/8, post free. From all the leading Appliance Dealers, and from

**THE BRITISH BEE JOURNAL & RECORD OFFICE, 23, Bedford Street, W.C.2.**



## "BACTEROL" FOR BEES

2/6 per Pottle.

Post Free.

The cure for, and preventive of, "Isle of Wight" Disease. Non-poisonous—free from stain or unpleasant odour.

**MENLEY & JAMES, LTD.,**  
39, Farringdon Road, London, E.C.1.

## The 'Kent' Standard Model Hives & Appliances

**TESTIMONIAL.**

May 12.

DEAR SIR,—I have had an opportunity of comparing the material and workmanship of your hives with others on the market, and in my opinion there is no sort of comparison between the two, yours being altogether superior in every particular.—Yours faithfully,—

*S. J. BALDWIN, Stanley Road, Bromley, Kent.*

Look after your profits by buying hives and appliances which are easy to work. I endeavour also to give good value by care over the workmanship. Send for catalogue.

**EDWARD J. BURTT, Manufacturer, GLOUCESTER.**

*Commercial (16" x 10") frames and brood boxes stocked.*



No. 1966. Vol. XLVIII FEBRUARY 26, 1920. [Published every Thursday, Price 2d.]

**CONTENTS.**

	PAGE		PAGE
CONFERENCE OF BEE-KEEPERS .....	97	CRIEFF AND DISTRICT B.K.A. ....	102
NOTICE .....	101	MONMOUTHSHIRE B.K.A. ....	103
EAST OF SCOTLAND B.K.A. ....	101	MONTGOMERYSHIRE B.K.A. ....	104
STAFFORDSHIRE B.K.A. ....	102	NOTICES TO CORRESPONDENTS .....	104

**ALUMINIUM DRAWN OUT COMBS.**

**“MONEYCOMB”**

*The greatest invention in the Bee World for 40 years.*

This is a drawn out Comb of Hexagon Cells exactly as bees build in their natural state. It is slightly coated with wax, has been thoroughly tested, and is not an experiment. Bees readily take to it for rearing brood and storing honey. Strong and durable, will last 50 years with care. Big consumption of honey saved to produce wax for comb building.

Control of bee diseases. No more burning of combs. Each comb easily sterilised and used over again.

Send for Catalogue and descriptive Leaflet.

1920 Catalogue post free.

Patented by ALUMINIUM HONEY COMB CO., of U.S.A.

SOLE MANUFACTURER AND LICENSEE:

**E. H. TAYLOR, WELWYN, HERTS.**

## THE British Bee Journal

ESTABLISHED 1873.

A Weekly Journal Devoted to the  
Interests of Bee-keepers.

Edited by T. W. COWAN, F.L.S., &c.,  
and J. HERROD-HEMPSALL, F.E.S.

**Correspondence: Whom to Address.**—All matters relating to the Literary Department, Associations, Shows, etc., should be addressed, "Editors, *British Bee Journal*," and all business communications and matters relating to subscriptions and advertisements to be addressed to the "Manager," *B.B.J.* Office.

**Subscriptions.**—Annual Subscription, 10s. 10d. post free in advance; single copies 2d., or 2½d. post free. If a receipt is required by post, a stamped and addressed envelope must be sent, otherwise a printed receipt will be enclosed along with the paper.

*Note.*—Cheques and Postal Orders should always be crossed, otherwise it is very difficult to trace them if they go astray.

**How to send Money.**—Remittances can be made payable to W. Herrod-Hempsall by crossed Cheques and Postal Orders. Stamps may be sent for small amounts up to 2s.

**Halfpenny stamps are preferred.**

Scottish or Irish cheques can only be taken in payment if 6d. is added for commission charged by banks for cashing them.

The Editors are not directly or indirectly interested in the manufacture or sale of beehives or appliances of any kind, and must refer correspondents wishing for prices or catalogues to advertisers in the paper.

## The Metal Foundation.

(Protected.)

For the benefit of readers of the JOURNAL and the RECORD we have arranged with the manufacturers of the Metal Foundation to accept all orders received through our offices at a consideration in the shape of a 25 per cent. deposit to begin with, and the balance by mid-March, or prior to delivery, if earlier. All orders are guaranteed by them to be executed *not later* than April, 1920.

Prices:—(1) BRITISH STANDARD FRAME, fully fitted with "worker" Metal Foundation: Single, 2s. 4d.; per two dozens, 2s. 3d. each frame; per four dozens and over, 2s. 2d. each frame.  
(2) STANDARD SHEET of "worker" Metal Foundation: Single, 2s.; per two dozens, 1s. 11d. each sheet; per four dozens, 1s. 10d. each sheet.

Subject to a 5 per cent. discount to members of the Apis Club.

*Packing & Carriage Extra.*

\* \* \* Since the Metal Foundation will be produced only to order, no order will be subject to cancelling.

## OUR DEPOSIT SYSTEM.

You are advised to insist on this being used when dealing with strangers.

### Rules and Conditions for Depositing

*In order to save trouble, it is requested that the Rules be carefully read over by persons using the Deposit System of trading.*

Goods should not be despatched until notice that the money has been deposited is received from this office.

**1. Method.**—When strangers are dealing together, the purchase-money of the articles is deposited at our office. We acknowledge receipt of the deposit to both parties, and hold the money until we are satisfied that the purchase is concluded. If a sale be effected, we remit to the seller the amount deposited, less a charge of 2½ per cent. in the £, with a minimum of 6d., and the expenses of Post Office Orders and postage, &c. Cash will be forwarded by Cheque, Post Office Order, or by Postal Order as preferred. If a sale or exchange be not completed, we return the amount deposited, after making the same deduction. By this means buyers and sellers are secured against fraud.

**2. Deposits.**—Postal Orders (drawn on General Post Office) and Cheques must be made payable to W. Herrod-Hempsall, and crossed "London County and Westminster Bank." The numbers of the Postal Orders should be kept by the sender. We cannot be responsible for any loss that may occur in transit.

**3. Money on Approval.**—All honey will be sold by sample, which must be sent direct to buyer.

**4. Bee Appliances.**—In ordering, the time allowed for completing the order to be stated to us when sending cash. If maker accepts, we hold cash until transaction is satisfactorily completed, when the amount will be remitted, subject to conditions as in Clause 1.

**5. Bees and Queens.**—These will be dealt with entirely by the parties concerned, so far as price, &c. go, and when the purchase is satisfactorily completed cash will be remitted as per Clause 1.

**6. Goods in Transit.**—These are at the seller's risk, *i.e.*, any damage to or loss of an article on its journey is borne by the vendor; but a rejected article must be properly packed and returned by the same means as was used in sending it.

**7. Carriage.**—The carriage of all goods, *except such as are sent by post*, is payable by the buyer, unless otherwise agreed. If any article sent on approval be returned, each party to the transaction must pay carriage one way.

The products of the Apiary, of  
Poultry and Farm Stock, of  
the Fruit and Vegetable  
Garden can be Advertised  
and Sold through

THE  
**BAZAAR, EXCHANGE & MART**  
*Newspaper.*

Get a Copy—Thursday and Saturday 3d. The "Bazaar" publishes also practical handbooks by experts. Send for full catalogue, post free from—  
WINDSOR HOUSE, Brems Buildings, LONDON, E.C.2.

THE  
**British Bee-Keepers' Association.**

The recognised centre of practical and scientific bee-keeping in Great Britain. Particulars and conditions of membership may be obtained from the Secretary,  
W. HERROD-HEMPSALL, 23, Bedford Street, Strand, London, W.C.2.



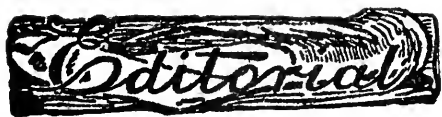

## Conference of Bee-Keepers re Legislation.

(Continued from page 85.)

PRESENT AT MEETING OF BEE-KEEPERS, ETC., TO  
DISCUSS BEE DISEASES BILL, AT SURVEYORS'  
INSTITUTION—FRIDAY, FEBRUARY 6, 1920:—

Edwd. Hodson; Jas. Hill, Hertford and Ware B.K.A.; G. S. Peren, M. of A.; A. Whiting, M. of A.; R. Hedger Wallace, Glamorganshire A. Ed. C.; C. D. Thompson, Glamorganshire A. Ed. C.; H. Harmer, Durham B.K.A.; Edgar T. Gardiner, Durham B.K.A.; Austin Keen, Cambridgeshire A. Ed. C.; Major S. G. Cook, Huntingdonshire A. Ed. C.; Wynn Thomas, Ministry of A. and F.; W. E. Richardson, Yorkshire B.K.A. and A. Ed. Council; J. Geo. Bothamley, Lincolnshire (Kesteven) A. Ed. C.; E. C. R. Holloway, Cambridgeshire B.K.A.; G. E. Rogers, Cambridgeshire B.K.A.; Geo. Hayes, Notts. B.K.A.; C. Taborn, Notts. A. Ed. C.; T. W. White, Walthamstow; Norris S. Toms, Herts. B.K.A.; P. E. Wagstaff, Herts. B.K.A.; A. H. Cobbett, M. of A.; Miss G. M. Hay, Bucks. B.K.A.; J. Pearman, Derby B.K.A.; A. Briers, Leicester B.K.A.; H. M. Riley, Leicester B.K.A.; H. E. Warren, Eastbourne B.K.A.; W. S. Gornall, Eastbourne B.K.A.; G. W. Bullamore, School of Agriculture, Cambs.; T. W. Cockeram, Wilts. Bee Expert and A. Ed. C.; G. S. Bedford, Berks. A. Ed. C.; A. D. Woodley, Berks. A. Ed. C.; E. C. Middleton, South Staffs. B.K.A.; Alfred Dewey, Kent B.K.A.; Geo. W. Judge, Kent B.K.A.; L. E. Snelgrove, Somerset B.K.A.; L. Bigg-Wither, Somerset B.K.A.; Dr. T. Turner O'Callaghan, Wembly B.K.A.; W. Broadhurst, Wembly B.K.A.; P. C. H. Jay, Sutton; Arthur F. Hardy, Hants. and I. of Wight B.K.A.; L. Illingworth, Hants. and I. of Wight B.K.A.; E. Ff. Ball, Bucks. B.K.A.; J. A. Hebbes, Bedfordshire A. Ed. C.; W. Wallace, Bedfordshire A. Ed. C.; Major H. F. B. Archer, Suffolk B.K.A.; W. J. Walton, S. Staffs. B.K.A.; W. A. Stewart, Northampton A. Ed. C.; G. H. Garrod, Kent A. Ed. C.; Mrs. Edward Fielding, Chairman Hortl. Committee, Shropshire County Council; T. P. P. MacPhail, Hortl. and Bee Instructor, Dorset A. Ed. C.; Rev. G. E. H. Pratt, Expert and Lecturer, Salop County Council, A. Ed. C.; J. W. Stephens, Herefordshire B.K.A.; J. Arnfield, Herefordshire B.K.A.; Thomas W. Cowan, Chairman of the British B.K.A.; J. B. Lamb, Chairman Middlesex B.K.A.; W. J. Pearce, Chesham B.K.A.; H. F. Swann, Hon. Sec. Northamptonshire B.K.A.; A. F. Harwood, Middlesex B.K.A. and Bee Committee; George Bryden, B.B.K.A.; J. Herrod-Hempsall, Junior Editor BRITISH BEE JOURNAL and BEE-KEEPERS' RECORD; John Rennie, Aberdeen; H. E. Scrope Viner, Worcestershire B.K.A.; J. H. Jones, M. of A.; Samuel Leadham, Worcestershire B.K.A. and Sec. Bee Committee; J. H. Roper, Lincs. (Kesteven) A. Ed. C.; F. W. Dowdey, M. of A.; Rev. H. Morgan, Lecturer on Bees, Aberystwyth College of Agriculture, and Pembroke A. Ed. C.; James Ritchie, Fleet B.K.A.; Robert Lee, Uxbridge B.K.A.; G. R. Alder, Essex B.K.A.; F. M. Claridge, Essex B.K.A.; J. Steel, Cumberland and West-

morland B.K.A.; G. Chatham, Cumberland and Westmorland B.K.A.; Joseph Price, Stafford County Council Bee Expert and A. Ed. C.; W. Griffiths, Staffs. B.K.A.; A. G. Burgess, Sec. of Surrey Bee Restocking Committee; A. D. Turner, Hortl. Supt. Somerset; John Rowlands, Madryn Farm School Bee Instructor for Carnarvonshire; Rev. R. Dixon Box, Chairman Twickenham and Thames Valley B.K.A.; Miss Byatt, Hon. Sec. Twickenham and Thames Valley B.K.A.; Jas. Allbon, Hitchin; C. B. Bartlett, Oxford B.K.A. and A. Ed. C.; R. T. Cuthbert, Oxford B.K.A.; Gauntlett Thomas, Gloucester B.K.A.; John Silver, Croydon; F. Kenward, Sec. Sussex B.K.A.; C. H. Woodford, B.K. Sec. to Hunts. C. Council; F. W. Frusher, Lincolnshire B.K.A.; James N. Bold, Lancs. B.K.A.; Frederick H. Taylor, Lancs. B.K.A.; Fred. Richardson, Ely, Cambs.; G. Barratt, Sheffield B.K.A.; G. R. Peart, Sheffield B.K.A.; J. E. Pinder, Chairman Salisbury Bee Assn., Member of Wilts. County Bee Committee; Mrs. J. E. Pinder, Salisbury B.K.A.; W. Herrod-Hempsall, M. of A.; Archibald Seth-Smith, Surrey B.K.A.; Walter Reid, Vice-Chairman B.B.K.A.; Thos. Cox, Norfolk A. Ed. C.; C. J. Glead, Hants. A. Ed. C.; A. Willmott, Hertford and Ware District B.K.A.; G. H. Hollingworth, Gloucestershire A. Ed. C.; W. E. Hamlin, Surrey B.K.A.; G. J. Flashman, Middlesex Ed. C.

[The foregoing list should have preceded the report, but we only had it just as we were going to press last week, and judged a part of Dr. Keeble's address would be of more interest than the list of those present.—Eds.]

### CONTINUATION OF DR. KEEBLE'S ADDRESS.

We have then to assume that it is not a case of two opposing parties of representatives of a Department and representatives of an industry meeting here to-day, but rather a group of people all of whom are interested in securing, if possible, an extension of this small but very important industry. We are all agreed that the present state of this industry leaves very much to be desired, and it is an extraordinary thing that, although bee-keepers as a class, thanks largely to their power of co-operation with one another—which does not always preclude disagreement with one another—have, I venture to say, a very high standard of skill, they have found their skill baffled and their bees destroyed by a series of acts of God which have taken the form of sundry pestilences. As a consequence of the recurrence of diseases to which various names have been given—more names than certain cures—the bee stocks of the country have been seriously depleted.

In the happy days before the War nobody had any statistics about anything, and therefore it is not possible to say exactly how many bee-keepers there were before the War, and exactly how many were lost during the War or gave up the work during the War. But, by a lucky circumstance, we were asked to undertake

the alms-giving of sugar, and we used that opportunity—I hope we shall have your assent to that course—as a means of getting some statistics with regard to bee-keepers. The figures which we obtained—I daresay they are common knowledge to you; of course, they are by no means complete, because Englishmen generally object to giving you information about anything—but the figures we obtained as to the number of people who really wanted sugar, and who, we ascertained, really had stocks of bees up to December, 1919, was a little over 18,000, and the number of stocks which they possessed was, with respect to movable comb hives, some 64,000; in skeps, boxes and other receptacles, which we will have something to say about later on—there were some 14,000, making a total of something like 78,000 stocks of bees in that year.

How big a decline there has been it is impossible to say, but it is within the knowledge of many experts here that that decline during the last four years has been great and rapid. For example, a year or two ago—in 1916—the Essex bee-keepers made a census, a repetition of a previous census, and they were able to show that, in place of some 2,629 stocks kept by members of their Association in the year 1908, that number of upwards of two and a half thousand had dwindled to a paltry 205 in the latter year, 1916; there had been a fall of 90 per cent., and in other counties, Middlesex, for instance, a similar fall is known to have occurred. I do not suggest for one moment that the fall throughout the country has been anything like so great; in fact, I will not suggest what it has been. We may take the present figures as somewhere about 78,000, and leave it to those with more knowledge than I have to suggest whether the decline has been of the order of 20 per cent., or 50 per cent., or so great as it has been in certain localities. It does not greatly matter now to say how great that decline has been, except to show us how much we have to do to make good.

We know that there is plenty of room for more bees in this country. You would have to walk, on the average, in England along a line or over an area of about three acres of a fruit plantation before you would see a single hive, were all the 78,000 stocks kept in fruit plantations and orchards. That is to say, if we take the total area of this country under fruit, leaving out the small gardens and ground under one acre, then we find, speaking in averages, there is one hive or stock for every three acres of plantation of fruit trees. There is plenty of room for more.

I do not propose to go into the question of the value of bees as fertilising agents at the present moment. I think probably

a good deal of exaggeration has found its way into the Press on that subject, for how otherwise should we account for the extraordinarily bountiful harvest of last year? But I think the truth probably lies in this—that hive bees do play a very valuable part in the pollination of fruit trees, and that part is most marked in seasons when fruit is most wanted. In years of great plenty, when all the conditions are favourable, and all the insect life of the earth comes tumbling out and searching for pollen, the hive bee may not be so important, but in those years when the conditions are uncertain, it is pretty certain—and investigations in America confirm it—that the hive bee does play an important part, by effecting fertilisation, in supplying us with fruit.

But apart from that accessory advantage, we know that we want the honey. We know that sugar is scarce—or, rather, dear, and therefore scarce. (Laughter.) We know that the imports of honey reached the extraordinarily high figure of £2,750,000 in 1918. Of course, money has depreciated, but even so it is a very large amount to import. If we try to make a computation of the amount of honey produced at home as compared with the amount imported, I think we shall find we can estimate the value of the honey produced at home at something between £500,000 and £1,000,000. I asked Mr. Herrod-Hempsall, whose expert knowledge on these subjects is unrivalled, to give me an estimate, but I have also myself some experience in dealing with averages, and I know that averages can be made to prove anything. Therefore I prefer to be very cautious, and so I say that the probable value of the home crop of honey lies between £500,000 and £1,000,000. Let us say that about three times as much is imported as is produced at home. I should think that is probably somewhere near the truth. It is rather a pity when you think that for every four pots of honey that are eaten, three of them have been raised by foreign bees on foreign soil, and the money which has gone to pay for them has also gone to the people who live on the foreign soil. There is, then, good ground for first realising that we have had a bad set-back in this business, and secondly in realising that there is a good opening if only we can recover the lost ground.

We now come to the more difficult question—that is, the question of the cause of this loss of ground. Everybody is aware nowadays—nobody knows anything with certainty, but many people are quite certain that the chief cause is "Isle of Wight" disease. Not many people are quite certain what the "Isle of Wight" disease is. Each new researcher—I will not say gives it a new name, but is apt to

rather under-rate the conclusions reached by his predecessor. A little while ago we were quite sure it was due to the bacillus *Nosema apis*; now we are not quite certain that it is. But, after all, gentlemen, that is a matter for these research people; we know that, whatever the cause, the bees die. The problem then becomes a twofold one. In the first place, we want more investigation. (Hear, hear.) The practical men and the scientific men—if one can use those two terms, which ought to be synonymous, but which are usually taken to be in opposition to one another—the practical men and the scientific men must co-operate in the research.

The Ministry has done what it can. It has founded a Research Institute; it has encouraged work at Cambridge and at Oxford; there are practical bee-keepers associated with that work, and we have hopes that in the course of time good results will follow. But anybody who thinks that research work produces results quickly knows nothing about it. I have been engaged on such a work all my life, and although I can not claim to be a conspicuous ornament thereof, I have sufficient experience to know that no good research work is ever done quickly; it is slow work. Therefore, we cannot wait while these gentlemen in laboratories spend their years over their microscopes finding out some remedy for this or that disease; we have to get on in the meantime in more rough-and-ready ways.

There are two ways, I think, by which we can get it. There is the way which has been followed in the past, but which, I think, can be followed with more assiduity, and that is by seeing that ignorance is dissipated. There are many people who keep bees who ought not to. (Hear, hear.) They do not know how to keep them; in fact, they are so ignorant that they do not know anything about the first principles of cleanliness. (Hear, hear.) Those people must, by some means or other, be encouraged to be clean, not in their own interests, but in the interests of their neighbours, because there is nothing so contagious as dirt, and the reason why the modern world insists on cleanliness is not so much because it is a virtue of itself, but because dirt is the means of the dissemination of pestilence. And what is true of human affairs is true even more acutely of the bees, and therefore, partly by persuasion, this habit of dirtiness as applied to the keeping of bees must be discouraged.

Then, of course, there is in every class of society, even amongst the most austere and upright, always a residuum of people who are dishonest, and those dishonest people are often the ones who leave their

dirty hives about in the hope that they will pick up clean bees. That sharp practice must, if possible, be stopped. Then there are even people who, from ignorance or worse, will sell stocks of diseased bees. Such cases have come under the notice, I believe, of expert bee-keepers. That also must be stopped. There is not any room in the modern world for wicked people! Much in those directions can be secured, and is being secured, by the public-spirited action of bee-keepers in different parts of the country. More, I think, can be secured presently when the bee-keepers have the encouragement which, I hope, this afternoon we will give them, or which they will give themselves.

In the second place, and in the case of this disease which is known as "Isle of Wight" disease, there does appear to be good ground for believing that certain hybrid races of bees stand up against this disease better than the pure races. I am aware I am getting now into the domain of controversy; I do not propose to go into that domain. I will merely state that when this question of disease came up I had that open mind which accompanies ignorance on the subject, and I caused an inquiry to be made by many practical bee-keepers in different parts of the country where hybrid bees, Dutch and Italian, had been tried. The inquiry was made by expert bee-keepers, and I read the results with care and attention and pondered them very closely. The results were perfectly convincing—not convincing that for always and for ever the hybrid stock of bees was going to resist all sorts of diseases—but they were quite convincing that it was worth while putting one's money on that horse, that it was worth while trying on a large scale the introduction of Dutch stocks and Italian queens and producing hybrids, and, as you all know, we did introduce on a moderate scale Dutch and Italian, and—thanks again to the generous help which we had from bee-keepers in the different counties, we have been able to distribute some 200 or 300 stocks of Dutch bees and something like 700 queens, and I am informed that up to the present some 1,500 nucleus of stocks have been raised. So that in the course of a few years there will be, for better or for worse—I hope for better—a considerable number of these little strangers within our gates. It is quite probable that they will have to be strengthened up by the occasional introduction of Italian queens. We are making preparations for such introduction. But we are none of us satisfied that that expedient is going to solve our problem, and we believe, the more we look into the matter, the greatest thing—that which is going to help the bee industry most—is

the introduction of legislation which will impose the minimum measure of cleanliness and decent bee-keeping upon those who take part in this industry. (Hear, hear.)

We do not wish, and I am sure none of us Englishmen at all events, wish to have a whole penal code applying to every possible industry whereby any man who does anything gets himself fined. We do not wish, I think, to introduce that system of State "bossing" which was so characteristic of Germany before the War. I for my part am most anxious to keep all legislation within the narrowest bounds possible; but in the face of the declared views of bee-keepers—we have had representations from 37 Bee-keepers' Associations, from 39 counties, and other public bodies declaring in favour of legislation—in the face, then, of the declared view of people of experience, we feel that we cannot any longer resist, in the interest of the general community, the introduction of a reasonable measure of legislation.

But we want that legislation to be as kindly and as instructive as possible. We want it to be used side by side with the most careful and active propaganda—propaganda undertaken by people who really know what they are propagating—although ignorance is no excuse for breaking the law—so that there shall be no reason why even the smallest bee-keeper should not be aware that by practising bad customs he is not only condemning his own stocks to death, but is acting as a focus of infection of his neighbours. I believe when that is really known we shall find the same practices applied by bee-keepers as we find now by all the better fruit-growers. They also know that unless they adopt certain precautions their trees act as centres for the distribution of disease, and all, except a small minority whom we are hoping to weed out by legislation, now adopt precautionary measures. Similarly, as and when we know what measures to prescribe, I am quite certain that bee-keepers will do the like.

Well, gentlemen, that is the present state of affairs. We have done what we could to lay the foundation for research; but I warn you, I have warned you, that with these foundations the building which is to rest on those foundations and the results which are to come out of that building must perforce be slow. In the meantime, we do not propose in our legislation to be too precise as to the disease we want to exterminate; we want to adopt, in this case at all events, a famous admiral's advice, and, referring it to all the diseases, we want to "sack the lot!" (Cheers and laughter.)

It is therefore for you to consider, and

both now and always to regard ourselves, not as somebody being legislated for, but as co-partners, as we all are, in the State, and as requested to contribute from long experience and from your creativeness of mind to the introduction into this country of legislation which shall be liberal in spirit and yet which shall not be futile in operation, so that at long last, although we may be the latest of all the chief countries in the world to introduce this form of legislation, perhaps in some respects we may introduce the best. (Hear, hear.) In any case, I hope the deliberations which are to take place this afternoon will result in some such success as that.

As I sit down, I would like to call upon Captain Wellington to outline to you the essential points of the proposal, a draft of which is before you, and, as you will notice, is marked "Confidential."

Captain Wellington: Dr. Keeble, ladies and gentlemen, I am sorry, on behalf of the Ministry, that this draft has not been circulated previous to the meeting, but owing to the fact that it has only recently been prepared, and also to the fact that it had to be sent for printing and had to be forwarded to the Legal Branch for final drafting, it was not possible to obtain the copies prior to the meeting, as otherwise there was a fear that the Bill might not be presented this next Session should it be decided to proceed with it. That point has not been cleared up yet, and it is still not certain whether it will be proceeded with this next Session, although we have every hope, if the general consensus of opinion is agreed that this course is desirable, that it will.

In dealing with the points in the Bill, I want to be as frank and as free as possible, so that you may understand exactly what is in our minds with regard to what the Bill contains and to how it will be worked in practice, so that there may be no mistaking what our attitude of mind is with regard to this measure, and also so that later on this afternoon you may express your opinions, and may no doubt make suggestions as to how the Bill can be most effectually put into force.

If you will take your copies, I will just run through, in the first instance, the various clauses and tell you exactly what each clause confers on the Ministry.

The first clause refers to the importation of stocks or queens. The second clause refers to the making of general Orders for controlling disease, and I should like under this heading that you should understand that in any Order which may be made the Ministry hope that it will be with the assent, and only after consultation, with the bee-keeping industry; that they shall be fully aware of what is proposed in the Order and what the Order

proposes to do, so that they may understand exactly how it will be carried out.

In the second part of Clause 2 the Ministry is authorised to direct the destruction of the infected hives or stocks; and also the Minister or the Local Authority may in respect of such stocks which are destroyed pay such compensation as the Minister or Local Authority may think fit. I shall come back to that point of compensation later on.

The second part of Clause 2 also refers to the destruction of stocks which, though not diseased, may be suspected of being diseased, or it may appear in the opinion of the Ministry that the destruction of such stocks will prevent the spread of disease, and in that case compensation has to be paid to the value of the stocks and material so destroyed.

Clause 3 refers to the enforcement of the Bill and of Orders under the Bill. There is no necessity to deal with the second and third sections of Clause 3.

Clause 4 refers to the sale or the offering for sale of infected bees, and also covers the sale of infected appliances.

Clause 5, unfortunately, through an error, it is the second Clause 4 in this draft copy of the Bill, refers to Local Authorities and the delegation of powers to Local Authorities, and for the payment of the expenses incurred by them. I shall come back to this also.

Clause 5 (You will notice there are two Clauses 4, Clause 5 should therefore read Clause 6) refers to the inspection of apiaries. We shall come back to this also. And Clause 8, which is the only other important clause, refers to the application of the Bill to Scotland; and I should say here that that is subject, of course, to the Board of Agriculture for Scotland concurring in this measure. At present they have not been approached, and the Bill would therefore only relate to England and Wales.

Now, if you will run through the Bill once more I can refer to the various clauses in detail.

Clause 1, with regard to the importation, either prohibits importation or, if thought desirable, regulates the importation under certain restrictions.

Clause 2, as I have said, refers to the making of general Orders, and as I read through the various proposals which we should like to see conferred, you will see that a number of points have to be dealt with by general Order rather than by the powers conferred actually by the Bill. The various proposals for which it would appear desirable to obtain legislative enforcement, besides prohibiting or regulating importation of bees, are these:—

(i.) The destruction or treatment of bees affected with disease; that is covered

by Clause 2 in the Bill. (iii.) Directing the destruction or disinfection of infected appliances; that is also covered by Clause 2. (iv.) Which is, by an Order under Clause 2, the exposure of (1) honeycomb or bee appliances where bees can have access to them, except in occupied hives, would be prohibited. I think that is one of the most important points which would have to be dealt with in any Bill. And the second proposal under this heading is to prohibit the exposure of unoccupied hives in such a manner that bees can gain access to them. These two proposals would be dealt with together under an Order issued under Clause 2. (v.) The inspection of apiaries, that is covered by Clause 5 of the Bill, Section 1. (vi.) Prohibiting the sale and movement of diseased bees. Clause 4 of the Bill prohibits the sale, and an Order issued under Clause 2 would prohibit the movement. (vii.) The inspection and, if desirable, the certification of queen-rearing apiaries could be done by an Order under Clause 2. And (viii.) The imposition of penalties for non-compliance either with the Bill or with an Order issued under the Bill, is covered by Clause 3 (Section 1).

Under these headings I have run through the chief measures which it would probably be thought desirable to bring into force, and I have shown how each could be brought into force. We should like very much to hear the views of the meeting on those various points.

(To be continued.)

---



---

## Notice.

The Council of the British Bee-keepers' Association are anxious to take their usual part at the Royal Show to be held at Darlington this year, so that their unbroken record of representation at this show may not be spoilt. In order to defray the expenses in connection therewith the Council ask that all bee-keepers assist in this work by giving donations, which should be sent as early as possible to the Secretary, 23, Bedford Street, Strand, London, W.C.2. No sum will be too small—or too large.

---



---

## East of Scotland Bee-keepers' Association.

The annual general meeting of the East of Scotland Bee-keepers' Association takes place on March 6, in Dundee. We have been successful in securing Mr. J. Tinsley, Lecturer for the West of Scotland College of Agriculture, to give a lecture on the "Isle of Wight" disease.—C. M. FULTON, Sec.

## Staffordshire Bee-Keepers' Association.

### ANNUAL MEETING.

One of the most interesting of the annual gatherings in connection with the Association took place on Saturday, February 7, in the Technical Buildings, Stafford, when about 100 members were present. Colonel A. H. Heath, the President, who was the founder, and for nearly 40 years has been the mainstay of the Association, was in the chair. The Rev. A. R. Alsop, the Vice-President, was unavoidably absent through illness.

The Secretary (Mr. W. Griffiths, of Silkmore) read the annual report, which showed a total membership of 327, the largest number for over 25 years. The library was now in successful working order, and two members—Mr. W. Sproston and Mr. Wm. Valon—were thanked for gifts of books. The district committees had now been put on a business footing. Their representatives would form two-thirds of the new committee, local government being greatly to the advantage of the members and of interest to the Association. The financial statement showed a total income of £113 8s. 9d. Including subscriptions, £55 15s., there was a credit balance of £31 3s. 10½d., against £51 3s. 11d. brought forward from the previous year. The statement of assets and liabilities showed a balance in favour of the Association of £97 16s. 4½d.

Mr. J. Price gave a very interesting account of the progress of bee-keeping in the county. Considerable progress had been made. They had not yet got rid of disease amongst bees, but they had put their house in as good order as any county in England. He was afraid that disease would always exist as long as bee-keepers were allowed to do things they ought not to do. The Government were recognising the necessity of assisting bee-keepers, and good work was being done in connection with the re-stocking apiary at Penkridge. He reported having attended a meeting in London, along with the Secretary, at which it was unanimously agreed that legislation was necessary in the national interests. Three of the four points he had advocated as essential were accepted by the Conference.

The Secretary gave a detailed report of the Conference, and proposed the following resolution:—"That this meeting approves of the Government's action in introducing legislation to deal with diseases of bees, and on account of the urgency hopes every facility will be given for the passing into law of this beneficent measure." This was seconded by the President and carried unanimously.

The following were elected Vice-Presidents of the Association:—Rev. A. R.

Alsop, Messrs. J. Kendrick, J. T. Homer, and H. J. Bostock. The Secretary was re-elected, as was also Mr. W. M. Valon as delegate to the B.B.K.A. The following were elected on the Committee:—Messrs. F. Amies, W. Jackson, E. W. H. Knight, G. H. Mytton, J. Stoney, J. Swanwick, W. M. Valon, G. H. Hope, and Dr. Mackenzie. Colonel Heath being compelled to leave, Rev. B. R. Hibbert was elected to the chair, and Mr. G. W. Buttery opened a discussion on "Frames." He said the consensus of opinion was in favour of a frame larger than the British standard. Personally he favoured the 16 by 10, because very little alteration was required in a hive, and it was made and sold extensively in this country.

The general opinion was not adverse to a larger frame, but various speakers advocated different sizes. Replying to a suggestion to use a 14 by 12 frame, he said it was very difficult to obtain timber 12 in. wide, and he did not know of frames being stocked in that size, so bee-keepers would be compelled to make their own.

Mr. Middleton, of the South Staffs B.K.A., gave an interesting account of a visit he paid to Italian bee-keepers a few months ago. The system of keeping bees, except with the queen-rearers, was very crude. The frame hive was very little used. They had a disease similar to "Isle of Wight" disease, and a reputed cure given to him was made up of a kilo of honey, a litre of red wine, two grammes of salicylic acid, and a couple of sprigs of rosemary. This was boiled and filtered and given to the bees. Two feeds of it were said to cure the disease. Several questions were answered by Mr. Middleton, and he and Mr. Buttery were thanked for their addresses.

Light refreshments were served by five of the lady members, and the usual prize-drawing for members present took place.—(Communicated.)

## Crieff and District Bee-Keepers' Association.

### VISIT TO KILMARNOCK APIARY.

The annual general meeting of the above Association was held in the Strathearn Institute, Crieff, Perthshire, on January 12. There was an unusually large attendance, owing to a scheme being under consideration for re-stocking the district with Dutch bees from the West of Scotland Agricultural College Apiary at Kilmarnock. Mr. Joseph Tinsley, B.B.K.A., the well-known Bee Expert of the College, was present, and after the local secretary, Mr. Clement A. Harris, had read a report showing an increased membership and satisfactory financial balance, he, Mr. Tinsley, gave an interest-

ing account of his visit to Holland to purchase a large consignment of bees; the special treatment required, and the method adopted by the College for distribution. Orders for a dozen skeps were booked, and the Chairman, Mr. John McInnie, and the secretary were appointed delegates to visit the Kilmarnock apiary and select them. This visit was paid on Saturday, January 24, and proved most interesting and profitable.

Most of the time was, of course, spent in carefully inspecting a number of skeps and choosing those to be sent, for which Mr. Tinsley offered every facility. He also proved tireless in answering the many questions, both on beekeeping in general and on the treatment of Dutch bees in particular, with which his visitors plied him. The chief business over, a visit was paid to the workshops connected with the apiary, where much explanation and discussion of various appliances and processes connected with bee-keeping took place, and where the secretary had the pleasure of writing out by far the largest cheque he has yet drawn as treasurer of the Association! Mr. Tinsley then showed his visitors over the College Dairy, and what must perhaps be called cow-houses, though with their electric lights and what-not, cattle-palaces would seem a more suitable name; and over the horticultural gardens. The delegates had been joined at Kilmarnock by Mr. Robert Allan, a member of the Crieff Association, who entertained them and Mr. Tinsley to lunch, during which the conversation was such as is common among bee-men, though, the Paisley election being so near in point of both time and place, it, alas! eventually degenerated into politics.

The bees have since arrived safely at Crieff, in excellent condition: the skeps weighing from 11½ up to 19 lbs. The first result of a careful inspection was a prompt wire for more stock, and hope once more inspires lovers of the *apis mellifica* in Upper Strathearn.—CLEMENT A. HARRIS, Ellangowan, Crieff, Hon. Sec. Crieff and District B.K.A.

## Monmouthshire Bee-Keepers' Association.

### ANNUAL MEETING.

The annual meeting of the Monmouthshire Bee-Keepers' Association was held on Saturday, February 7, at the Temperance Hall, Newport. Alderman Graham White took the chair at the outset, but upon the arrival of the Rev. M. G. Stanley, he vacated the chair in this gentleman's favour. Supporting the chairman were:—Dr. Strong (hon. sec.), Mr. Ll. Morgan (hon. treasurer), Mr. R. Hancock (assistant hon. secretary), the Rev. W. H. Wil-

liams (Llangstone), Mr. F. Tyler Taylor (Monmouth), Mrs. Farr, Mrs. Tom Jones, Miss Evelyn Smith, Mr. H. Price, Mr. W. Parker, Mr. G. R. Lusty, Mr. H. G. Heighton, Mr. H. George, Mr. B. Nicholas, Mr. A. T. Young, Mr. A. Jackson, Mr. E. M. Hughes and others. The minutes of the last annual meeting were read and adopted, and the report and treasurer's statement passed.

At this stage, Mr. Herrod-Hempsall, F.E.S., secretary to the British Bee-Keepers' Association, arrived and met with an enthusiastic reception, and the meeting then proceeded with the election of officers. Mr. L. Forestier-Walker, M.P., was re-elected president, the chairman, the Rev. H. G. Stanley, was also re-elected, as was also Alderman Graham White, as vice-chairman. Mr. A. T. Young was elected hon. treasurer in place of Mr. Llewelyn Morgan, who did not offer himself for re-election, and was thanked for his past services on the motion of the Rev. H. G. Stanley, seconded by Alderman Graham White.

Dr. G. R. Strong did not offer himself for re-election as hon. secretary, a fact which was much regretted by the whole assembly, the chairman referring in eulogistic terms to the great service which Dr. Strong had rendered to bee-keepers in general, being, in fact, the founder of the Association. In his place, the meeting unanimously elected Mrs. Llewelyn Morgan, it being remarked that for a lady to hold this position was somewhat unique. Mr. R. Hancock found himself unable to continue his duties as hon. assistant secretary, and he was heartily thanked for his painstaking services during the past season on the motion of Mr. Ll. Morgan, seconded by Alderman Graham White. With some few exceptions, the committee were re-elected. The local hon. secretaries were all re-elected with the addition of Mrs. Farr, for Cwmbran district, Mr. Hughes for Western Valleys, and Mr. Jackson for Abergavenny. As representatives on the council of the British Bee-Keepers' Association, the meeting elected Mrs. Ll. Morgan and Mr. L. Forestier-Walker, M.P.

The resolution, as outlined in the report regarding bee legislation, with the addition of "Compulsory registration of all bee-keepers," was put to the meeting and carried with acclamation.

In the course of other business a letter was read from the Rev. E. J. Bartleet, of the Gloucestershire Bee-keepers' Association, suggesting a three days' convention of bee-keepers to be held in Gloucester, in which he invites the Monmouthshire Association to participate. This project was favourably received, and was left in the hands of the committee. It was decided to

accept an invitation received from the Newport Allotment Holders' Association to form a honey section in their show in August next. It was decided to subscribe to the "Apis" Club with a view to assisting in agricultural research. Hopes were expressed that the application to the Monmouthshire County Council for a financial grant would be acceded to during the year.

An adjournment was now made for tea, which was kindly provided by a committee of ladies.

Whilst tea was in progress Mr. J. A. Gaccon, F.R.C.O., gave a most enjoyable organ recital, appropriately opening his programme with Mendelssohn's "Bees' Wedding."

The *pièce de résistance* was now announced, and took the form of a lantern lecture from Mr. Herrod-Hempsall, who kept his audience spell-bound for over one hour and a half. The subject of the lecture was "Queen Rearing and Introduction," and was dealt with in a most lucid manner. At the close Mr. Herrod-Hempsall showed some remarkable slides depicting the beneficial action of bees upon fruit blossom and clover, and after answering a number of questions, he was heartily thanked on the motion of the Rev. H. G. Stanley, seconded by the Rev. W. H. Williams.

Mr. L. Forestier-Walker presided at the first annual dinner, which was held at the King's Head Hotel, in the evening. There was a very good attendance. A number of toasts were proposed, and responded to, and a most enjoyable meeting and dinner was closed with the singing of the National Anthem.—(Communicated.)

## Montgomeryshire Bee-Keepers.

ASSOCIATION TO BE FORMED.

Mr. T. Simpson Jones presided over a conference at the Town Hall, Welshpool, on Saturday, February 14, convened by Mr. D. L. John, the agricultural organiser for Montgomeryshire, to consider proposals emanating from the Ministry of Agriculture that a Bee-Keepers' Association should be formed for the county to carry into effect the Ministry's scheme for combating "Isle of Wight" disease among bees and making good the havoc which the disease has wrought among the stock of bees in the country.

There was a fairly representative attendance of bee-keepers, to whom Mr. John read correspondence forwarded by the Ministry to the County Agricultural Education Committee. In substance the Ministry's scheme provides for educational lectures on bee-keeping; steps for disinfecting or preferably destroying skeps where the disease has been preva-

lent, and for arranging for the reception of imported Italian queen bees and their hybridisation with British bees to form the nuclei of new stocks of bees. The Ministry were prepared to bear two-thirds of the expense of carrying out the scheme.

Mr. Alfred Jones, Hall Street, Welshpool, moved that an association be formed. The Education Committee, he said, were convinced that the formation of an association was the only way of carrying out the scheme, which was certainly a matter of much importance. No doubt many smallholders would desire to take up bee-keeping, and, apart from the profitable nature of the work, it would be very prejudicial to fruit-growing and other branches of agriculture if no steps were taken to make good the ravages to the stocks of bees in the country.

Mr. Holmes, Powis Castle Nursery, seconded the motion, which was unanimously carried.

The following were appointed the committee of the Association, with Mr. Rees Pryce, Welshpool, as secretary:—Messrs. Simpson Jones, Alfred Jones, C. Ridding, Holmes, Spence, W. Stourton, Roberts (Pool Quay), Keeling, John Pugh, the Rev. T. D. James, Major Beadnell, Mrs. Salter, Mrs. J. H. Davies, and the Rev. E. M. Davies.

## Notices to Correspondents

### PRICE OF SUGAR FOR BEE FOOD.

We are still receiving queries on this matter. We understand that retailers have instructions from the Sugar Commission to charge manufacturers' prices to bee-keepers. These prices are upwards of 1s. Sugar for household purposes is subsidised by the Government, and sold under cost price. Efforts are being made to get sugar for bee food at the same price as for household purposes, and our readers may trust us to let them know what once if they are successful.

E. L. DOWNER (Windsor).—*Tom Tit eating bees.*—Your best plan will be to give the marauder a dose of small shot. If you do not want to kill it, try the effect of half a cocoanut shell, containing mutton, or other hard fat, hung near the hive.

H. M. L. (Chilwell).—*Testing sugar.*—(1) Lump, or loaf, sugar is not all pure cane. (2) It requires special apparatus, and analytical skill to determine if sugar is beet or cane. (3) A rough and ready test is to partly fill a bottle with a syrup of sugar and water, stand in a warm place for about 48 hours, keeping the bottle tightly corked. If the cork is removed at the end of that time pure cane sugar will have a sweet wholesome smell; that of beet sugar will be foul.

H. POOLE (Salop).—*Bees pollinating tomatoes.*—We have not noticed bees working these. We believe they are wind fertilised. Tapping the stems with the fist is the method of distributing the pollen usually adopted for tomatoes grown under glass.



"LEIGH-ON-SEA" (Essex).—*Starting sections under brood box.*—(1 and 2) If the section rack is put in a shallow comb box, pack it up until the top is within  $\frac{1}{2}$  in. of the bottom bars of frames. A better plan would be to use "The Lee" section rack. The brood box would stand on this, or make a box similar to a shallow comb box, only the same depth as the section rack. (3) No excluder is needed, as the rack of sections is transferred to the top of brood nest, preferably over an excluder, soon as the bees commence to work in it, another empty one taking its place. The method is not often followed now, but it was much used a few years ago.

E. W. L. (Northwich).—*Using wooden lid instead of quilt.*—These have been used satisfactorily, and are strongly recommended by some of the best bee-keepers. The main disadvantage is that they are not easily adaptable to any required number of frames. A better plan than a hinged board is to have several loose boards of varying width, with slats  $\frac{3}{8}$  in. thick nailed under each end. Two of them would each need a slat along one side as well.

S. M. M. (Dorking).—*Making compound nuclei hives.*—Use an ordinary well-fitting division board to divide the nuclei, not queen excluder. To clean excluders boil them, or scrub with a fairly stiff brush, dipped in hot water and Fels naptha soap, or Scrubbs' cloudy ammonia.

"B—" (Inverness).—*Dealing with Dutch bees in skeps.*—If you have failed to get the bees to work down on to frames of foundation, try artificial swarming. As soon as a colony is fairly strong remove it to a new stand on a warm day, placing a movable comb hive fitted with frames of foundation in its place. In the late afternoon drive the skep until the queen is secured and hive her and the bees in the new hive. The skep may be allowed to rear a new queen and work up again, or it may be driven again later, if no queen cells were started in about three weeks time, and the bees united to those in the new hive. Any young queens may be killed, or the old queen may be killed, and one of the young ones retained. If queen cells were started drive 10 or 12 days after moving the hive. Better requeen with Italians. You will then have no difficulty in disposing of surplus stocks at a reasonable price.

H. GORDON (Birmingham).—If the colony is strong try one of the remedies soon as the weather is suitable for application. If the bees are destroyed,  $\frac{1}{2}$  oz. cyanide of potash dissolved in water and poured between top bars is the most effectual method, but needs great care, as cyanide is a deadly poison. Bisulphide of carbon—which should be kept away from fire, as it is very inflammable—or chloroform will also prove effective. The quilts may be boiled 15 minutes, and then soaked for at least an hour in disinfectant and water. If the hives are scorched they will be all right.

C. M. HASLAM (Ripley).—It is evident the last queen in the hive was a drone breeder.

A. E. STEPHENS (Somerset).—There is only one standard frame, 14 in. by  $8\frac{1}{2}$  in. Possibly you mean a suggested larger frame, 14 in. by 12 in. or 16 in. by 10 in.

W. HUNT (Somerset).—Your plan for introducing should succeed, but in queen introduction the best laid plans "gang aint agley." We do not know of any bees for sale except those advertised in the JOURNAL.

R. N. BROWN (Kington).—(1) Most of them are good. (2 and 3) Yes. We cannot say that one is better than another. (4) We would prefer them to imported queens. (5) We do not think so, though they would probably do as well. It is largely a question of management.

B. WRIGHT (Devon).—It is better to wire the frames. Use fine round wire nails of a suitable length to go through the wood and form a small hook. Start the nail about  $\frac{1}{4}$  in. from the groove, and drive it obliquely so that it comes out about the centre on the inside.

#### Suspected Disease.

J. BORCH (Birtley).—The trouble is "I.O.W." disease. Thanks for letter, which we hope to make use of soon as space is available.

J. S. P. (Flints), G. G. (Hampstead).—All samples had "I.O.W." disease.

M. G. BRETT (Woking), H. C. R. N. (Glam.), T. AXFORD (Salisbury), G. WILLOUGHBY (Grantham), "CONSTANCE" (Marlborough), "KIDNOR" (Kidderminster).—The bees were affected with "I.O.W." disease.

H. WARD (Birkenhead).—Nos. 1, 2, 3, and 5 are natives, or possibly Dutch. No. 4 Italians, and all are healthy so far as we can tell. We advise you to stick to the "British Bee-keepers' Guide Book."

C. B. LINDSAY (Horley).—We do not find disease in the bees, and think they died from starvation.

\* \* \* \* \*

We shall be obliged if readers will not send bees to this office for diagnosis. We have so much other work, and the samples are so numerous that we are unable to afford the time to make a satisfactory examination, neither is the Junior Editor, on whom this work falls, by any means a skilled bacteriologist. Those desiring bees examined should send them to Dr. Helen Goodrich, The Department of Comparative Anatomy Museum, Oxford, who is working on the diseases of bees, for the Ministry of Agriculture, and these examinations may provide useful information for the Government bacteriologists. A brief description of any symptoms noticed should also be given. A stamped, addressed envelope should accompany inquiries.

## Special Prepaid Advertisements. One Penny per Word.

Trade advertisements of Bees, Honey, Queens, and Bee goods are not permissible at above rate, but will be inserted at 1½d. per word as "Business" Announcements, immediately under the Private Advertisements. Advertisements of Hive-manufacturers can only be inserted at a minimum charge of 3s. per lin., or 5s. per inch.

PRIVATE ADVERTISEMENTS are only intended for readers having Surplus Stock to dispose of. Driven Bees, Nuclei, and Queens that are reared or imported for sale, are Trade Advertisements, and can only be accepted under trade terms. A charge of 6d. extra will be made if a box number is used.

Advertisements must reach us NOT LATER than FIRST POST on TUESDAY MORNING for insertion in the "Journal" the same week.

Orders for three or more consecutive insertions in "The Bee Journal" entitle advertisers to one insertion in "The Bee-keepers' Record" free of charge.

### PRIVATE ADVERTISEMENTS.

QUEEN, 1919, fertile, wanted at once.—HORN, 80, Wharfedale Gardens, Thornton Heath. b.69

PURE Light English Honey, good quality, in 1-lb. Mono pots, 1s. 9d. per lb.—MISS E. JOHNSON, Ripple Hall, Tewkesbury. b.71

THE SECRET OF IMMUNITY.—Fresh supply ready in a few days.—COBB, 33, Bevan Road, Plumstead. b.72

LADY BEE-KEEPER wanted to take charge of Apiary at Billingshurst.—State salary required and full particulars to GORDON, 24, Lewes Crescent, Brighton. b.73

SEVERAL STOCKS of Italian Bees (guaranteed healthy) for Sale, also Hives and Bee Appliances.—PHELPS, Pippbrook, Mill House, Dorking. b.74

WHAT offers for Observatory Hive? Bees preferred.—Particulars, F. HOPKIN, Eastwood, Notts. b.76

ONE DOZEN well-filled Sections, glazed, clover and heather. What offers?—THOS. LLOYD, Cilmery, Blith Wells, Breconshire. b.78

**FOR SALE**, two Stocks of Dutch Hybrid Bees in Taylor's No. 6 Bee Hives.—MISS H. LANGTON, 7, Calverley Park Crescent, Tunbridge Wells, b.75

**FOR SALE**, two strong Stocks Hybrid Italians, one Stock British Blacks, all on ten frames, no disease, £5 each.—WOOD, Manor House, Neston, Cheshire. r.b.77

**FIVE** Lee's Holborn Hives complete, good condition, zinc roofs, £2 5s.—TAYLOR, 137, Keldgate, Beverley. b.79

**FOR SALE**, two Stocks Bees on 10 frames in W.B.C. Hives (1918 and 1919), two empty Hives, complete, also quantity Appliances, frames, sections, etc.; reason for selling, overstocked; full hive, £7; empty hive, fitted, £3 3s. Can be seen by appointment.—MRS. ANTHONY, Buckland, Betchworth. b.81.a

**WANTED**, for scientific purposes, a few live Bees, from diseased or dwindling stocks; cages sent and expenses paid.—SNELGROVE, Quadrant, Weston-super-Mare. a.11

**BEE PLANTS** for early forage, Limnanthes, strong, autumn sown, 100 2s. 4d., free.—WM. COLLINS, Castlebellingham, Ireland. b.80

**WANTED**, Books on Bees and Bee-keeping, scientific, historical, or practical, including Cowan's "The Honey Bee, Its Natural History, etc.," and Cheshire's "Bees and Bee-keeping." State full title, date of publication, number of pages, and lowest price.—Box 66, B.B.J. Office, 23, Bedford Street, W.C.2. b.81

**WANTED**, Extractor, gear driven, good condition, for cash.—TYLER, Wrangle, Boston, Lines. b.82

**CAN** spare a few Dutch Stocks of Bees on six standard frames, 1919 Queen, 60s., carriage paid; April delivery.—W. CHANNELL, Grove Apiary, Histon, Cambs. b.83

**TWO** W.B.C. Hives for Sale, quite new, super T and section rack included, 35s. each; a bargain.—H. STRIDE, 248, Wimborne Road, Bourne-mouth. b.84

**WANTED**, healthy Stock of Bees, 6 or 8 frames, April delivery.—WATERHOUSE, Rossett Green, Harrogate. r.b.85

**BEE SWAX** for Sale, good quality yellow, 10 cwt.s., in 1 or 2 cwt. bags, at £9 16s. per cwt., f.o.r. London.—Apply, Box 67, B.B.J. Office, 23, Bedford Street, W.C.2. r.b.86

**FOR SALE**, several good, strong, healthy Stocks of Bees (on 8 frames), £5; travelling box 10s., returnable; April delivery or earlier if weather suitable.—ROSE, Wellington House, Ten Mile Bank, Downham Market, Norfolk. b.87

**FOR SALE**, four Hives, Extractor, Skep, quantity of Accessories, £4; no disease. View by appointment.—PICKERING, 6, Heathfield Gardens, Chiswick, W.4. b.88

**1,000 SECTIONS**, grooved and split top, 10 lbs. foundation squares, 95s., carriage paid.—HULL, Bee-keeper, Barrow-on-Soar, Leicester. b.90

**COMPLETE APIARY** for Sale, comprising eight Stocks of Bees on 10 frames, six Hives, W.B.C. pattern, two old Hives, Shallow Frame Boxes with drawn-out combs, Section Racks and Sections, Queen Excluders, three Feeders, Smoker, Super Clearer, two Uncapping Knives, Section Block, and Extractor; estimated value £80; would accept £70 or near offer; would sell separately; no "I.O.W." or any other disease.—SNOW, "Bundoran," Hartley, Longfield, Kent. b.91

**A VACANCY** occurs for a Pupil on an old established bee farm. Opportunity will be given to learn bee-keeping on a big scale.—Apply, Box 61, B.B.J. Office, 23, Bedford Street, W.C.2. r.a.87

**WILL** it be worth waiting for? You may well wonder what is coming next. More later.—SMITH, Cambridge. b.95

**BEEES FOR SALE**.—Several small Stocks, on six combs, of honey fed, healthy Bees, £3 10s. each; travelling box 10s., refunded if box returned in sound condition within seven days. Stamp for reply.—REED, Primrose House, Heacham, King's Lynn. r.b.30

**PURE** English Honey, mainly white clover, in 14 and 28-lb. tins, £9 per cwt., carriage paid. Reduced price for larger quantity.—WELLS, Claudius Road, Colchester. r.b.35

**WANTED**, in March, strong Stock pure Italian Bees, 1919 Queen; must be guaranteed free from disease.—WORTHINGTON, World's End, Solihull, Warwickshire. r.b.60

**HONEY**.—25 dozen finest clover, clean, well-filled Sections, 30s. per dozen, carriage forward; expert packing free.—GIBSON, Apiaries, Ballygowan, Belfast. r.b.59

**PLANT** "Willow Herb" for your bees; useful honey flower; 12 roots, 2s.—BOWEN, Pittville Street, Cheltenham. b.46

**17 HEALTHY** Italian Stocks, headed by Penna Queens, £5 5s. each.—J. YOUNGER, 6, Maid's Causeway, Cambridge. r.b.45

**ITALIAN BEEES** on 6 frames, headed by Penna's 1920 Queen, delivery June, £4 10s., carriage paid.—ENNEVER, Oak Avenue, Ridgeway, Enfield. r.b.70

**CORRESPONDENCE** Course in Bee-keeping.—MISS F. E. PALING, Golden Square, Henfield, Sussex. r.a.54

**WANTED**, portable Greenhouse.—Price and particulars to W. HERROD-HEMPSALL, Old Bedford Road, Luton, Beds.

**WANTED**, Auster Rear Wind Screen for motor car.—HERROD-HEMPSALL, as above.

**FOR SALE**, one Exhaust Whistle, 11s., post free; one Wood Milne Motor Foot Pump, 45s., carriage free.—HERROD-HEMPSALL, as above.

#### BUSINESS ADVERTISEMENTS. (1½d. per word.)

**DUTCH AND DUTCH-ITALIANS**.—Four-frame Nuclei, May and June delivery, orders taken in rotation, £3 3s.; cash with order; carriage paid. They are the *Daily Mail* strain I have had seven years, and Bee-Mason's four years. Never had disease; beautifully clean and healthy. You want good disease resisters, prolific, and heavy honey producers. HERE YOU HAVE THEM.—SEALE, Ashley Cottage, Oatlands Drive, Walton-on-Thames, Surrey. b.92

**ITALIAN NUCLEI** from 30s., Fertile Queen from 7s. 6d., Virgins from 3s. 6d., 8-frame Stocks £4. Warranted healthy. Particulars stamp.—WATTS, Conway Cottage, Newtown, Parkstone, Dorset. b.93

**DON'T BUY BEES** until you have seen our prices and guarantee. You risk nothing, as we return money in full if bees fail to give satisfaction. Special terms to disabled men. Catalogue 3d., which is refunded on first order.—PEARSON & GALE, Marlborough. b.94

**STRICTLY BUSINESS**.—Wire Clearer Boards, 6s. 6d., post paid; Japanned Sprayers, 5s., post paid; six 1-lb. cakes Flavine Candy, 10s., post paid. No sugar certificates needed. Free sugar! At a price!—S. H. SMITH, 30, Maid's Causeway, Cambridge. b.96

**NUCLEI** from pure imported Italian Stock, 4 frames, May £2 12s. 6d., June £2 7s. 6d., July, £2 2s. 6d.; 3 frames, May £2 5s., June £2 2s. 6d., July £1 15s., carriage paid; also Virgin and Fertile Queens and Stocks for Sale.—DAVIDSON, Forest Road, Burton-on-Trent. b.97

**LIGURIANS.**—My strain combines all the good qualities you desire. They are beautiful, gentle and hardy, capital foragers, and disinclined to swarm. Queens, end of May, 10s.; June, 8s.; July, 7s., post free. Limited number of spare Nuclei in June and July; three frames and Queen, £2 5s., carriage paid. Inquiries stamp.—**HOUSTON, Ellen Villa, Sidcup.** b.39

**FOR SALE, Stocks, £5; Swarms, £2; Queens, 7s. 6d.; Nuclei, £3.** Orders booked now.—**THE HEATHERLANDS BEE FARM, Thursley, Godalming.** b.65

**THREE-FRAME NUCLEI, £2 2s.;** Queens, 10s. 6d. Hardy, prolific hybrids, disease resistant strain. I have not had any "I.O.W." in my hives at any time.—**O. W. H. OVENS, 151, Fishponds Road, Eastville, Bristol.** rb.68

**FOR SALE, Nuclei, 1919 Queens, three frames, 47s. 6d.; four, 52s. 6d., May; Hybrids, young Queens, ready June; returnable cases 7s. 6d.** JOURNAL deposit.—**A. H. HAMSHAR, Womersh, near Guildford.** b.41

**5-FRAME NUCLEI, 1919 Queens, Italians and Blacks, £3.** Book early for April and May delivery. Also Appliances for Sale.—**MISS BURDER, Chiltoning, Lewes.** r.b.42

**WATERPROOF RUBBER SHEETS** for covering outhouses, etc., 72in. by 36in., brass eyelets, 12 for 20s.—**SAGARS STORES, Ardwick, Manchester.** b.16

**HAVE YOU READ "THE BEE WORLD"?** If not, why not? Every number in itself is a useful literary work for practice and reference. Specimen copy free.—**Offices: THE APIS CLUB, Port Hill House, Benson, Oxon.**

**ITALIAN QUEENS** direct from Italy. Price list for 1920 on application.—**Address, E. PENNA, Bologna, Italy.** w.39

**COUNTY OF SOUTHAMPTON.**

**AGRICULTURAL EDUCATION COMMITTEE.**

**HORTICULTURAL SUB-COMMITTEE.**

Wanted, **TRAVELLING STAFF TEACHER OF BEE-KEEPING**, to take up duties shortly. Conditions of appointment and Application Form sent on receipt of stamped, addressed foolscap envelope, to be returned by March 15, to **D. T. COWAN, Director of Education, The Castle, Winchester.**

# Dutch Bees.

I have been appointed **Sole Agent** for Hans Matthes, the Dutch Bee Farmer who supplied the British Government last season with Skeps for their County Re-stocking Scheme. Hans Matthes also supplied me with what Skeps I required last year.

Last autumn I got a large consignment over from Holland, and am presently wintering these at my Apiary here.

To those desirous of testing these Dutch Bees, I will be pleased to send on my Illustrated Catalogue, containing much information regarding the hardness, prolificacy, disease-resisting, and honey-gathering characteristics of this race of bee.

Address—

**R. WHYTE,**  
The Bee Farm,  
Cumbernauld, Dumbartonshire.

Send for

## Bee-Keepers Wake Up!

You can make a Big Profit if you use right up-to-date Appliances, including the Manley Hive. **MEADOWS, SYSTEM, LEICESTER.**

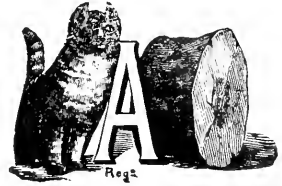

## Books for Bee-keepers NOW IN STOCK.

<b>A Modern Bee Farm</b> ... ..	7/6	... 6d.
<b>Beginner's Bee Book (PELLETT)</b>	5/-	... 4d.
<b>BEE-KEEPING SIMPLIFIED FOR THE COTTAGER AND SMALLHOLDER (W. HERROD-HEMPSELL, F.E.S.)</b> ... ..	1/-	... 1½d.
<b>BEE-KEEPERS' PRACTICAL NOTE BOOK (T. W. COWAN)</b>	1/-	... 1½d.
<b>BRITISH BEE - KEEPERS' GUIDE BOOK (T. W. COWAN)</b> (paper covers only)	2/6	... 3d.
<b>Dissectible Model of Queen Bee</b> ... ..	4/6	... 3d.
<b>FERTILISATION OF FRUIT BLOSSOMS BY BEES (T. W. COWAN)</b> ... ..	-/3	... 1d.
<b>Honey and Health (A. HOPE)</b> ...	-/6	... 1d.
<b>Honey Vinegar (REV. G. BANCKS)</b>	-/2	... 1d.
<b>How to Keep Bees (ANNA B. COMSTOCK)</b> ... ..	5/-	... 1d.
<b>Management of Out Apiaries</b>	3/-	... 2d.
<b>Pollination of Fruit in relation to Commercial Fruit Growing</b> ... ..	-/6	... ½d.
<b>PRODUCING, PREPARING, EXHIBITING AND JUDGING BEE PRODUCE (W. HERROD-HEMPSELL, F.E.S.)</b> ...	2/-	... 3d.
<b>Productive Bee-keeping (PELLETT)</b> ... ..	10/6	... 6d.
<b>Queen Rearing in England (F. W. L. SLADEN)</b> ... ..	1/6	... 2d.
<b>Snelgrove's Method of Re-queening</b> ... ..	-/6	... 1d.
<b>The "Townsend" Bee Book</b> ...	2/6	... 2d.
<b>WAX CRAFT (T. W. COWAN)</b> ...	2/-	... 2½d.
<b>Wilke's Book on Swarming</b> ...	1/-	... 1½d.
<b>MISCELLANEOUS.</b>		
<b>Maeterlinck's Life of the Bee</b>	3/6	... 3d.
<b>The Lore of the Honey Bee (TICKNER EDWARDS)</b> ... ..	2/-	... 2d.
<b>The Humble Bee (F. W. L. SLADEN)</b> ... ..	12/6	... 6d.
<b>THE BEE WORLD</b> (supplied only to members of Associations interested in the control and development of the APIS CLUB, apart from ordinary members of the latter), per copy ... ..	-/8	... 1d.

**British Bee Journal & Record Office,**  
23, BEDFORD STREET, STRAND, LONDON, W.C.1.

**FINEST SECTIONS OF HONEY.**

A large quantity for sale at carriage paid prices, either Plain or Glazed.

**IRISH RUN HONEY.**

Several cwt. for sale in quantities to suit customers, at carriage paid prices in free tins and cases.

**GORDON ROWE,**

Honey and Beeswax Packer,  
23a, Moy Road, Cardiff.

**BEE FLOWER SEEDS.**

Collection of six best Varieties, 1s., post free. Beautifully Illustrated Instructions Up-to-date. Garden Guide, 64 pages, Free.

**KNIGHT'S,**  
SEED SPECIALISTS,  
WOLVERHAMPTON.



# The Metal Foundation

(Protected.)

**Q.** The triumph of the Metal Foundation is due to the following significant advantages:—(1) Indefinite durability with reasonable care; (2) Greater safety of bees in transit on new combs; (3) Capability of bearing the weight of a heavy swarm in hot weather; (4) Greater comb stability in quick extracting; (5) Control of drone cells; (6) The production of even combs; (7) Easy removal of queen cells without the slightest injury to the foundation; (8) Cleanliness and adaptability to sterilisation by boiling; (9) Economy of labour and time in fitting and detaching; (10) An ideal compromise between the metal comb and the wax foundation.

**Q.** The invention has created a world-wide interest. Its value will be the more appreciated by studying the fol-

lowing original literature:—"The British Bee Journal," November 13; "Bee Craft," December; and "The Bee World," September, October, and November, 1919.

## RETAIL PRICES.

**Q.** The Metal Foundation ("worker" type) can now be produced in any size required, whether for the brood chamber or the super, e.g., for the British Standard Frame (14 in. x 8½ in.), Deep Standard (14 in. x 12 in.), Simmins' (16 in. x 10 in.), Langstroth (17⅞ in. x 9⅞ in.), etc., and for their corresponding super frames. Despite the heavy cost of machinery, metal, etc., it is offered at a price *well within the purchasing power of the average bee-keeper*. All orders, whether large or small, receive *prompt attention*, and are executed in *strict rotation*, and in *good time for the season*. We have further decided—for the benefit of bee-keepers who are not yet in a position to place their orders—on taking the risk of a liberal margin of production to meet unavoidably delayed orders. *If you have not yet made up your mind as to your requirement, you are still in time to do so.*

## The Uxbridge W.B.C. Hive.

**Q.** This popular hive, which we originally introduced over twenty years ago, is admirable for its *water-proof* features, since it eliminates the plinth. It stands supreme amongst all W.B.C. patterns. You will never regret trying it with your metal foundation.

**\*\*** We allow a Five per cent. discount on all our goods (including the Metal Foundation) to members of the Apis Club, who are respectfully requested to forward their membership cards when placing orders.

**A FINAL REMINDER!** To avoid disappointment apply now for the Metal Foundation Price List, and for our 1920 Catalogue.

# JAMES LEE & SON, Ltd.

UXBRIDGE, MIDDLESEX.

(Telegrams: Graphicly, Uxbridge.)

Telephone: Uxbridge 181.)

**Don't Order "W.S." Queens until you have seen the "Queenland" Revised List for 1920. 3½d. post free**

**NUCLEUS STOCKS—Same Price as 1919.**

The only Pedigree Bee-Stock Registered in direct line for more than 25 years.

**"AMALGA" is the name of our Queen breeding mother for 1920**

**"ALTA" is the name of our Drone parent for 1920.**

PRODUCE OF ONE NUCLEUS REALISES OVER £40 IN CASH.

"The three-frame nucleus I purchased from you had increased last autumn to two strong stocks. I supered one on April 23rd of this year, and the other a few days later. I sold two swarms, and made up the others to five stocks. Of these I also sold three stocks. The original lot gave 198 lbs. of honey, and in all I have taken 365 lbs. My sales amounted to over £41 in actual cash."

(Miss) H. G. MORSEY.

Somerset, Oct. 9th, 1918.

EXCEEDS 500 PER CENT. INTEREST.

"We have now 12 stocks to winter, besides selling one, out of the two three-frame nuclei supplied June 20th last year." (August 15th, 1917).

Miss B. D.

Quainton, Bucks.

THREE TO SEVENTEEN.

"It may interest you to know that the three stocks to which I introduced your queens (the only stocks saved in the apiary) in 1916, produced in all 17 stocks, and a good surplus in honey in 1917; this under the care of my wife who knew nothing about bees. I simply directed her as to management from there (France)."

OLIVER G. PIKE.

April 9th, 1918.

FIRST AND BEST.

"Your White Star strain was the first to enter the sections, and all the honey I got was from them."

G. H. S.

Heddon House Dairy.

APRIL 19TH.—BOILING OVER.

"The hive is simply boiling over with W. S. bees. They are at work when my other stocks are idling, and they are stronger than any of my other stocks."

Aberdare, Wales.

E. T. W.

ARE THE W.S. PROLIFIC?

"In 1904 I got a W.S. queen from you, and last year (1905) by the first week in June she had brood in twenty-five standard frames."

J. H.

Higher Kinnerton, Chester.

SAFE DELIVERY OF Nuclei and Queens GUARANTEED

NUCLEUS DELIVERED IN JUNE; 40 FRAMES BY AUGUST.

"The three-frame nucleus of bees now occupy 40 Standard Frames. They have exceeded beyond anything I believed possible. I have never had anything like them before, and if the other queens on order turn out the same I consider my fortune made."

JOHN JONES.

Llancarfan, Aug. 21st, 1918.

SEVERAL STOCKS FROM ONE NUCLEUS.

"It seems almost ridiculous that this nucleus of the previous season (Aug.), before I was prepared for it, swarmed in April, and I now have several stocks from that investment."

J. W. MCKAY.

Croydon.

EIGHT STOCKS FROM ONE W.S. NUCLEUS.

"I now have eight stocks from the one nucleus you supplied last year."

J. JONES.

Llancarfan, May, 1919.

BEST IN THE COUNTY—NEVER SAW THE LIKE!

"May 26th.—The two queens you sent me have exceeded anything that I ever thought of. The stock chambers are full and crammed with brood, and all three supers crowded with bees; but even with this the bees are boiling over. I have not fed them at all, and have removed several frames of brood for another lot. The County Expert called yesterday, and said he had never seen such bees, and they were certainly the best in Hampshire."

D. D. P.

NO SPRING-FEEDING, BUT AGAIN FIRST.

"The W.S. bees on eleven 16 x 10 frames were full and boiling over at the middle of May, and were the first to enter supers out of 23 stocks; and last, but not least, they required no spring feeding."

U. W.

Arnold, Notts.

Revised 1920 "White Star" List, 3½d., of S. SIMMINS, Queenland, Heathfield, Sussex.

# HIVES.

Compare the WORKMANSHIP and FINISH of our Hives.

All made by practical Men who know what a good hive should be.

In various designs to suit all tastes and requirements, Season's speciality—THE MANLEY HIVE for 16 in. x 10 in. Frames.

Full descriptions and illustrations in our 1920 Catalogue:

*"Everything for an Apiary."*

If you have not received your copy, send a P.C. at once.

OUR MOTTO—SERVICE & QUALITY.

**R. STEELE & BRODIE, Wormit Works, Wormit, Scotland.**

## Bee-keeping Simplified

FOR THE COTTAGER AND SMALLHOLDER,

By **W. HERROD-HEMPSALL, F.E.S.,**

Author of "Producing, Preparing, Exhibiting and Judging Bee Produce."

Price 1s. net. Post Free 1/1½

This little book supplies the need for a cheap up-to-date and well-illustrated handbook on bee-keeping, and gives in Mr. W. Herrod-Hempsall's well-known, clear, lucid style all that is necessary to enable anyone to commence bee-keeping successfully. From THE BRITISH BEE JOURNAL OFFICE, 23, Bedford St., Strand, London, W.C.

## The "HERROD APICURE."

**SIMPLE CLEAN! EFFICIENT!**

For the Prevention and Cure of Foul Brood and other Diseases of Bees.

**DON'T DELAY—ORDER AND USE AT ONCE.**

PRICE, with full instructions, 1/8, 2/10 and 5/8, post free. From all the leading Appliance Dealers, and from

**THE BRITISH BEE JOURNAL & RECORD OFFICE, 23, Bedford Street, W.C.2.**



## "BACTEROL"

FOR BEES

per Bottle.

Post Free.

The cure for, and preventive of, "Isle of Wight" Disease. Non-poisonous—free from stain or unpleasant odour.

**MENLEY & JAMES, LTD.,**  
39, Farringdon Road, London, E.C.1.

## S. J. BALDWIN.

I beg to inform that the No. 1 Kent Hive is not manufactured by me, only the No. 2 "Bromley Kent."

(New deep frame 17 x 14 x 12. Sample by post 6d.)

**THE APIARY, BROMLEY, KENT.**

Look after your profits by buying hives and appliances which are easy to work. I endeavour also to give good value by care over the workmanship. Send for catalogue.

**EDWARD J. BURTT, Manufacturer, GLOUCESTER.**

Commercial (16" x 10") frames and brood boxes stocked.

MAR 29 1920

Cultural  
lege



No. 1967. Vol. XLVIII

MARCH 4, 1920.

[Published every Thursday, Price 2d.

**CONTENTS.**

	PAGE		PAGE
CONFERENCE OF BEE-KEEPERS RE LEGISLATION	109	CORRESPONDENCE—	
ASSOCIATION NEWS—		Winter Pollen	116
Glamorganshire B.K.A.	114	Feeding Bees	116
Derbyshire B.K.A.	115	Labelling Honey	116
HONEY IMPORTS	115	Mr. Manley's Letter—September 25, 1919	116
NOTICES TO CORRESPONDENTS	117	Experiments with Frames	117
		Remedy for Ants	117

# ALUMINIUM DRAWN OUT COMBS.

## “MONEYCOMB”

*The greatest invention in the Bee World for 40 years.*

This is a drawn out Comb of Hexagon Cells exactly as bees build in their natural state. It is slightly coated with wax, has been thoroughly tested, and is not an experiment. Bees readily take to it for rearing brood and storing honey. Strong and durable, will last 50 years with care. Big consumption of honey saved to produce wax for comb building.

Control of bee diseases. No more burning of combs. Each comb easily sterilised and used over again.

Send for Catalogue and descriptive Leaflet. 1920 Catalogue post free.

Patented by ALUMINIUM HONEY COMB CO., of U.S.A.

SOLE MANUFACTURER AND LICENSEE:

### E. H. TAYLOR, WELWYN, HERTS.

## THE British Bee Journal

ESTABLISHED 1873.

A Weekly Journal Devoted to the  
Interests of Bee-keepers.

Edited by T. W. COWAN, F.L.S., &c.,  
and J. HERROD-HEMPSELL, F.E.S.

**Correspondence: Whom to Address.**—All matters relating to the Literary Department, Associations, Shows, etc., should be addressed, "Editors, *British Bee Journal*," and all business communications and matters relating to subscriptions and advertisements to be addressed to the "Manager," *B.B.J.* Office.

**Subscriptions.**—Annual Subscription, 10s. 10d. post free in advance; single copies 2d., or 2½d. post free. If a receipt is required by post, a stamped and addressed envelope must be sent, otherwise a printed receipt will be enclosed along with the paper.

**Note.**—Cheques and Postal Orders should always be crossed, otherwise it is very difficult to trace them if they go astray.

**How to send Money.**—Remittances can be made payable to W. Herrod-Hempshall by crossed Cheques and Postal Orders. Stamps may be sent for small amounts up to 2s. **Halfpenny stamps are preferred.**

Scottish or Irish cheques can only be taken in payment if 6d. is added for commission charged by banks for cashing them.

The Editors are not directly or indirectly interested in the manufacture or sale of beehives or appliances of any kind, and must refer correspondents wishing for prices or catalogues to advertisers in the paper.

## The Metal Foundation.

(Protected.)

For the benefit of readers of the JOURNAL and the RECORD we have arranged with the manufacturers of the Metal Foundation to accept all orders received through our offices at a consideration in the shape of a 25 per cent. deposit to begin with, and the balance by mid-March, or prior to delivery, if earlier. All orders are guaranteed by them to be executed *not later* than April, 1920.

**Prices:**—(1) BRITISH STANDARD FRAME, fully fitted with "worker" Metal Foundation: Single, 2s. 4d.; per two dozens, 2s. 3d. each frame; per four dozens and over, 2s. 2d. each frame.  
(2) STANDARD SHEET of "worker" Metal Foundation: Single, 2s.; per two dozens, 1s. 11d. each sheet; per four dozens, 1s. 10d. each sheet.

Subject to a 5 per cent. discount to members of the Apis Club.

*Packing & Carriage Extra.*

\*\* Since the Metal Foundation will be produced only to order, no order will be subject to cancelling.

## OUR DEPOSIT SYSTEM.

You are advised to insist on this being used when dealing with strangers.

### Rules and Conditions for Depositing

*In order to save trouble, it is requested that the Rules be carefully read over by persons using the Deposit System of trading.*

Goods should not be despatched until notice that the money has been deposited is received from this office.

**1. Method.**—When strangers are dealing together, the purchase-money of the articles is deposited at our office. We acknowledge receipt of the deposit to both parties, and hold the money until we are satisfied that the purchase is concluded. If a sale be effected, we remit to the seller the amount deposited, less a charge of 2½ per cent. in the £, with a minimum of 6d., and the expenses of Post Office Orders and postage, &c. Cash will be forwarded by Cheque, Post Office Order, or by Postal Order as preferred. If a sale or exchange be not completed, we return the amount deposited, after making the same deduction. By this means buyers and sellers are secured against fraud.

**2. Deposits.**—Postal Orders (drawn on General Post Office) and Cheques must be made payable to W. Herrod-Hempshall, and crossed "London County and Westminster Bank." The numbers of the Postal Orders should be kept by the sender. We cannot be responsible for any loss that may occur in transit.

**3. Honey on Approval.**—All honey will be sold by sample, which must be sent direct to buyer.

**4. Bee Appliances.**—In ordering, the time allowed for completing the order to be stated to us when sending cash. If maker accepts, we hold cash until transaction is satisfactorily completed, when the amount will be remitted, subject to conditions as in Clause 1.

**5. Bees and Queens.**—These will be dealt with entirely by the parties concerned, so far as price, &c., go, and when the purchase is satisfactorily completed cash will be remitted as per Clause 1.

**6. Goods in Transit.**—These are at the seller's risk, i.e., any damage to or loss of an article on its journey is borne by the vendor; but a rejected article must be properly packed and returned by the same means as was used in sending it.

**7. Carriage.**—The carriage of all goods, *except such as are sent by post*, is payable by the buyer, unless otherwise agreed. If any article sent on approval be returned, each party to the transaction must pay carriage one way.

The products of the Apiary, of Poultry and Farm Stock, of the Fruit and Vegetable Garden can be Advertised and Sold through

THE  
**BAZAAR, EXCHANGE & MART**  
Newspaper.

Get a Copy—Thursday and Saturday 3d. The "Bazaar" publishes also practical handbooks by experts. Send for full catalogue, post free from—**WINDSOR HOUSE, Breams Buildings, LONDON, E.C.2.**

## THE British Bee-Keepers' Association.

The recognised centre of practical and scientific bee-keeping in Great Britain. Particulars and conditions of membership may be obtained from the Secretary, **W. HERROD-HEMPSELL, 23, Bedford Street, Strand, London, W.C.2.**





## Conference of Bee-Keepers re Legislation.

(Continued from page 101.)

Now, with regard to matters of general interest contained in the draft of the Bill, I said I would refer to compensation, which is mentioned in Clause 2, and I want you to be quite clear with regard to this question of compensation. I shall deal later with the general application and working of the Bill, but at this stage I should like to make it quite clear that in the event of the enforced destruction of diseased bees and appliances no compensation will, in practice, be paid, as the materials, if ordered to be destroyed, will be considered valueless. I think it is most desirable that you here to-day should know exactly what would be the policy on that point, because otherwise serious misunderstanding might arise. The important point, remember, is that the destruction of stocks or appliances will not be ordered except on inspection by a bee expert, and only when they are considered valueless.

Secondly, you will probably notice that various minor amendments will have to be made in the draft, and that the drafting is not textually quite complete.

The third general detail I want to raise is this: it would be possible to do this by an Order of the Ministry after the Bill is passed, and that is the registration of bee-keepers throughout the country. (Hear, hear.) I am very glad to hear the sense of the meeting on that point. It was a question which the Ministry thought desirable to refer to this meeting here to-day. It seems it would be a very good plan for several reasons, and, except from the point of view that it is an enforcement, I can see nothing undesirable in it. It would supply very valuable information for educational work in the counties, both with regard to Bee-keepers' Associations and also the statutory authority which is responsible for educational work in bee-keeping, viz., the County Agricultural Education Committee or its sub-committee, the Horticultural Committee. It would assist very much the working of any Bill or Order made by the Ministry. And thirdly, what is more important than either of the two I have mentioned, it would provide statistical information indicating the prosperity or otherwise of the industry in this country. I mentioned at the beginning of my remarks that it would probably be desirable for a Standing Committee to be set up with reference to bee-

keeping, and I should like to make a suggestion here that it might be possible to arrange for a Bee Committee to be constituted to form part of the Horticultural Advisory Committee which is already attached to the Ministry. This committee is of an advisory character only; it has not executive powers, but all important questions relating to those sections of the horticultural industry which are represented on the Committee are referred for advice and discussion to the Committee by the Ministry before they are dealt with. The Committee is a means of obtaining that co-operation between the Ministry on the one hand and the horticultural industry on the other, and of preventing measures being carried by the Ministry in the face of the industry. I want to make this aspect of the Committee quite clear. Dr. Keeble also referred to it in his remarks. If this Bee Committee is set up, the statistical information obtained from the Registry of Bee-keepers would be extremely valuable, and the Committee would always be able to feel the pulse of the bee-keeping industry of the country.

Now with regard to the general administration of the Bill. As I said, any Order which was issued under the Bill would only be issued after a consultation with the Standing Committee. The Ministry regard the effectiveness of the Bill to depend entirely on the co-operation between bee-keepers and the Ministry, not only with regard to working the Bill, but also with regard to the educational work, which will do much to cause the removal of the sources of disease. It seems to the Ministry that probably more can be done on the educational side than on the legislative side. (Hear, hear.)

The two go together, however, and it is most desirable—in fact, it is the crux of the whole matter—that Bee-keepers' Associations in each county, the responsible authority for education in the county—i.e., the Agricultural or the Horticultural Committee—and the Ministry should work together in unison and have a common plan of action with regard to bee-keeping matters on the educational side, and it would then only be for the Ministry to invoke the powers conferred on them under this Bill or under any Orders made under this Bill in any flagrant cases of neglect. It would not be a question of enforcing Orders in every case of disease throughout the country. An Order under the Bill would only be enforced when every other means had failed.

Now, you will notice that there is nothing in the Bill, and I have not said anything so far, with regard to general notification of disease, and it appears to the Ministry impracticable and unnecessary, in view of the wide distribution of

disease at the present time. Notification—and I should like you to understand exactly what notification would mean—would mean, firstly, an enormous amount of clerical work; secondly, it would mean innumerable inspectors, especially if action had to be taken in every case of notification—in fact, it would be practically impossible to carry out effectively the measures which would be necessary after notification. Consequently, the expenditure resulting from notification which would be incurred would probably mean that Parliament would throw out the Bill as one of doubtful national economy. It would be much better to have a more reasonable method of operating the Bill, and to exclude general notification, somewhat on these lines: First, by educational work to show the necessity of removing the sources of infection, carried out by Bee-keepers' Associations, bee-keepers themselves, the county authorities, and the Ministry, working in co-operation. Cases of neglect to maintain hygienic conditions in the apiary would be dealt with by persuasion first, and the Orders of the Bill would only be enforced when these persuasive powers failed. That is to say, in the event of a centre of infection remaining in a district, and the owner will not be persuaded to clear it away, then the Ministry would expect to be informed of this centre by either the county authority or the Bee-keepers' Associations, and they would then take up the case and deal with it. The enforcement of the Bill and its Orders by the Ministry will be carried through by a small staff of inspectors who will be trained in bee-keeping, and this small staff will work under the general direction of the technical bee staff at the Ministry.

It is not suggested to delegate the powers of the Bill—at any rate, at first—to local authorities. You will no doubt be aware that in the case of the Destructive Insects and Pests Acts the administration of Orders under these Acts were at first delegated by the Ministry to local authorities, but it was found after some years' enforcement that nearly every local authority administered the Orders in a different way. It has recently been found desirable for the Ministry to take back the powers they delegated and to carry out the work themselves, and, acting on experience obtained in working these Acts, it is proposed with regard to bee diseases that the work should be carried out directly from the Ministry, who would not delegate their powers to local authorities.

I think I have covered all the points which are contained in the Bill and in the Orders which it would probably be found necessary to issue under the Bill, but I should like to again draw your attention

to the necessity for close co-operation, so far as the eradication of bee diseases is concerned, between all the parties connected with the bee-keeping industry; and also to this point, and it is a very important point, that any Order which the Ministry might propose to issue would only be issued after consultation with and acquiescence of the representatives of the bee-keeping industry, probably with a Standing Bee Committee of the Horticultural Advisory Committee.

The Chairman: I have now to invite discussion, and it will, I think, conduce to the harmony of the meeting if speakers will come to the platform, and will preface their remarks by announcing their names, so that they can be reported. The meeting is now open for discussion.

Mr. Walter F. Reid: Would it not be as well, sir, to take the clauses one by one? If we do not, I do not quite see how we are to arrive at the sense of the meeting on each point.

The Chairman: I am perfectly prepared. I am entirely in the hands of the meeting, but I purposely refrained at this stage from doing that, because I thought the meeting would probably prefer to discuss and clear out of the way the questions of principle—first of all, do you want legislation or do you not; secondly, should registration be included in legislation or not—(cries of "Yes")—and thirdly, should the administration be conferred on local authorities—if that were argued, I should have something to say about it—or should it be carried out by headquarters? I submit, if you take the principle first, we can, in conclusion, go through the details. But I know what it is when once we start reading this legal phraseology; half the audience will fail quickly to understand what it really means, whereas we have all got the principles in our minds.

Mr. Reid: May I suggest that Mr. Cowan, the chairman of the British Bee-keepers' Association, who has had this matter before him for a great number of years, and knows perhaps the views of all the bee-keepers better than anyone else in this room, gives us his views?

The Chairman: I hope he will.

Mr. T. W. Cowan: I have only had this paper put into my hands as I came into the room, so I have not had an opportunity of thoroughly studying it, but I think, taking it altogether, I am in favour of the scheme, as it is proposed that the Ministry should undertake the whole management of this thing. I should like to suggest, as our Chairman has suggested, that there should be a registry of bee-keepers. I know how important it is. In our County of Somerset we started last year, and have now got a register of every

bee-keeper in the county. We did it through the police, and we got a complete register in that way. We were able to get the number of stocks the bee-keepers kept, and the number of stocks they had lost, and we found, on the whole, that about 90 per cent. of the bees had perished in the county.

Now with regard to compensation; that is a question, I think, to be discussed. I myself am not in favour of compensation. I think bees that are diseased are not worth anything, and the sooner they are got rid of the better. It is for the benefit of bee-keepers and for the neighbourhood. I do not think any compensation should be given. But if you are going to destroy hives and appliances that can be disinfected, of course, in that case, I should certainly say that you ought to have compensation, but not otherwise.

I think, with regard to the way of working that it would be much better, as has been suggested, to work it through the Ministry, and with the Agricultural Education Committees of the different counties. We are doing that in Somerset. The Agricultural Education Committee is in thorough sympathy with the Somerset Bee-keepers' Association, and we have formed, from the Horticultural Sub-Committee, an Advisory Bee Committee.

The County Agricultural Education Committee have funds that Bee-keepers' Associations have not, so in that way they are able to help us considerably. As I say, we have formed what we call an Advisory Sub-Committee, which consists of certain members of the Somerset Bee-keepers' Association and certain members of the Horticultural Committee. That, so far, has been working very well indeed, and through that channel we have been able to re-stock a great many apiaries in the county.

Why we want legislation is this. I can give you an instance in our own county of what has been done quite recently, this last year. We supplied nuclei with queens to several of those who had applied for them, and we issued leaflets, larger leaflets than these, with very full and detailed instructions on how to manage bees and how to disinfect hives, and what they were to do. Notwithstanding that, one of our experts went round and found one of the nuclei was being put into a hive that had not been disinfected, after giving them these pamphlets. Now, what are you to do with a person like that?

The Chairman: Disinfect him.

Mr. Cowan: The Chairman says, disinfect him. We should like to do so, but we have no compulsory power. We cannot go and tell him, "You must disinfect," so there we are in a difficulty, and in that way, of course, it will be some time

before we can really say we have got rid of the disease in the county.

I do not think I need say much more about it, except that I quite approve of the step that has been taken. I think all these clauses, after they have been thoroughly considered, will be approved, and I think we are very fortunate in getting the Ministry to undertake the matter at last. I have been agitating this for years, so has the British Bee-keepers' Association, and for years we have been pointing out the danger of these ignorant bee-keepers, and asking for powers to do something towards stopping the spread of disease, and I congratulate the Ministry on having taken the matter up seriously. I am very glad to see such a large meeting of bee-keepers and other representatives here to-day.

An Hon. Delegate: May I ask if it is your intention to take any resolutions on the various points raised?

The Chairman: It is my intention to take resolutions on the larger issues.

The Hon. Delegate: On the three principles you have just referred to?

The Chairman: Yes. If I omit any principle, and anybody else thinks it worth while, I shall be prepared to accept a proposal from him. We want to get a perfectly clear, explicit view on the part of those present.

The Hon. Delegate: The first question would be, is legislation desirable?

The Chairman: That is the large thing; I think we might turn that out of the way. (Cries of "Agreed.") Is there anybody here who would like to speak against the proposal that legislation should be introduced?

Mr. John Silver (Croydon): Mr. Chairman, ladies and gentlemen, it is seven years ago now—that is, in February, 1913—when the last attempt to legislate was brought forward—that is to say, it was brought forward in the autumn of 1912 and reappeared in 1913. Then, sir, there was throughout the country, a very determined and active opposition to the principle of legislation. I was one of the moving spirits in that active opposition, which went on until July of 1913, when Mr. Asquith, in the House of Commons, after promising a Second Reading on a certain day, when that day arrived said that the whole thing would be dropped. He and the Government were astonished at the opposition to legislation throughout the country.

Rev. H. Morgan: We do not want history.

Mr. Silver: Exactly; I will come to it. I do not care what opposition you make. I am prepared for any opposition; I am used to heckling.

The Chairman: I must appeal for a quiet hearing for Mr. Silver.

Mr. Silver: That day Mr. Asquith said he was surprised at the opposition. The Ministry, the Government, then, in 1913, were given to understand that there was no opposition to the principle of legislation in the country, so you see the Government were deceived. They found they had been deceived, and they dropped the whole thing. That is seven years ago.

Now, the Bill that was brought forward then is child's play to the measure that we have in our hands here to-day—child's play. Here, in these proposals, the bee-keepers of the country are asked to open their mouths and shut their eyes and take whatever the Ministry would like to order them to do. (Cries of "No, no.")

The Chairman: In the interest of accuracy I must intervene to say the Bill which is being introduced to-day is the same Bill which was introduced before, exactly.

Mr. Silver: I say no, sir. I have a copy of the Bill at home; I have thoroughly studied it. There are one or two persons present here who worked with me in that campaign six years ago, and they agree with me that this is far worse than it was then.

Let us come to one or two points. First of all the argument is that the diseases of bees in this country have so overwhelmed the industry that legislation is called for in order to preserve it. Now, which is the disease that has done this? What is known as "Isle of Wight" disease. After ten years of investigation by the Government, by their experts—after ten years, mind you—they are unable at the present moment, your Chairman has told you, either to define what "Isle of Wight" disease really is or to give us a remedy, to give us a cure, and tell us how to deal with it. (Hear, hear.) And yet, after ten years of investigation, with all the resources of a Government, with all the powers of calling in the scientists of the world, they are unable to tell you what it is, and yet we are asked here, as practical bee-keepers, who have, many of us, overcome this difficulty ourselves without the aid of science—overcome it by practical common-sense and observation. What is that? That is science, is it not? It is a science of overcoming a difficulty. And now we are asked to give powers to a Ministry to compel us to deal with a disease that they do not understand themselves, and they cannot tell us what to do.

Now, sir, what I say is this, that the time has not yet arrived for a measure of bee legislation to be imposed upon the bee-keepers of this country that will meet with general acceptance. That is my first suggestion. For this reason, that

the investigations of scientists have not reached that point to declare with any definite certainty what "Isle of Wight" disease is.

Now let me give you an instance; I will confine it to this one thing. Take an instance that occurred at Walton Heath, in Surrey. At Walton Heath, in Surrey, in 1918, there was a hive with what is known as "Isle of Wight" disease. Several experts from the Surrey Association were called in to see this hive. They sent up samples of these bees to THE BRITISH BEE JOURNAL; they declared it to be "Isle of Wight" disease. These two ladies came down to visit me—an eleven or twelve miles journey on a bicycle. I went and saw those bees that were certified by the Surrey experts, by THE BRITISH BEE JOURNAL, as suffering from "Isle of Wight" disease. Directly I got there I laughed at it. I am not afraid of "Isle of Wight" disease; I have cured heaps of it. What is the matter with these bees is that it is a race of bees that is deteriorating; that is to say, the race is worn out, they are subject to disease. All you want is a better type of queen and a better type of bee put in there. We did so, and the following spring (last year), it was the best hive in the whole of Walton Heath. I can refer you to the two ladies—Lady Hawkins, of Walton Heath, and Miss Reid, at The Oaks, Walton Heath. You can refer to these two for corroboration of what I say.

Now I say this, that "Isle of Wight" disease, as defined by THE BRITISH BEE JOURNAL and as defined by the bee-keepers of this country, is largely due to two causes—one a race of bees that ought to be exterminated—that is to say, they were worn out, the race had deteriorated—the other, want of air.

Rev. H. Morgan: Mr. Chairman, I must appeal to you. I have come from next door to New York, and I want to get home. I think I am voicing the opinion of a large majority of the gentlemen present when I say that this speaker is not speaking to the point.

The Chairman: I have already arranged with the present speaker to conclude his remarks.

Rev. H. Morgan: Thank you very much.

Mr. Silver: I will confine my remarks to one point, and the one point is this—that with regard to the most destructive disease that has been destructive in this country, that has depleted the apiaries of this country, the scientists and the Government are not in a position to declare definitely what that disease is, and I say that the bee-keepers of this country are not justified in giving power to a Ministry who do not know this and cannot tell us. (Hear, hear.)

An Hon. Delegate : May I ask one question before we go on? Perhaps it will clear the air a little? Can bacteriological knowledge at present say definitely what is the bacillus or bacteria which causes "Isle of Wight" disease?

The Chairman : I ought to say, in answer to Mr. Silver, although it is difficult to distinguish—I am informed by experts, extremely difficult to distinguish—by the naked eye examination, it is a matter of certainty, as in other bacterial diseases, to distinguish the presence of *Nosema apis*, and the research people have got that technique worked out quite satisfactorily.

Mr. P. E. Wagstaff : May I ask a question arising out of that, sir? Is the judgment of the expert bee-keeper, who knows how to handle bees, to be relied on in giving a definite answer as to whether bees have or have not "Isle of Wight" disease? Of course, in the later stage, anyone can tell.

The Chairman : I think the answer is, there would be no decision—obviously, there can be no decision in the case of "Isle of Wight" disease at present—on a naked-eye examination; but my previous answer meets your point, namely, that it is quite easy, just as one does in the case of influenza or other similar diseases, to diagnose the disease microscopically, and that would have to be done in any case where prosecution was intended.

Mr. P. E. Wagstaff : Have these people, the naked-eye experts, any value whatever?

The Chairman : I should say they had very great value, to know whether the thing is clean or unclean. Obviously, one of the chief causes of disease is insanitary conditions, and an experienced bee-keeper ought to be able to tell—like Mr. Herrod-Hempsall can tell—whether they are getting the right amount of air, and so forth.

Mr. P. E. Wagstaff : I have the report of an Association which proposes to issue a certificate when bees are unhealthy and are sold. Is such a thing as that to be of any value whatever?

The Chairman : I should be very doubtful about accepting the certificate of any private society as being of value.

Mr. E. C. Middleton : May I take it, Mr. Chairman, as a definite statement by you that bees with "Isle of Wight" disease must have *Nosema apis*?

The Chairman : No; I did not make that remark.

Mr. E. C. Middleton : Is that a definite statement of yours?

The Chairman : No.

Mr. E. C. Middleton : Very well, then; the statement that you make is that the bacteriologist knows all about it.

The Chairman : I do not want to go into the whole question of bacteriology. I thought I was talking to people who had informed themselves of the latest work and knew more about it than I do, which I am certain is the case. You are aware of the fact that all the experts are disagreed with respect to detail. The present experts, those who are now working at the disease, are all agreed in this, that where *Nosema apis* is present there is a diseased state. Whether that microbe produces all the symptoms of "Isle of Wight" disease is a matter which, I believe, is engaging your attention.

Mr. E. C. Middleton : Quite so; it is not understood.

The Chairman : But I really do not think, ladies and gentlemen, it would serve any useful purpose if you were to ask me, who have only a general knowledge of the subject, though a trained investigator, but having no specific knowledge of this problem, a lot of technical questions which I am certain you can answer much better than I can.

Mr. C. B. Bartlett : May I suggest that we have an account of legislation in other countries?

Rev. H. Morgan : I think the question before the meeting is as to whether legislation is desirable or not. I think we should confine our attention at the present time to one or two points. Is bee disease in the country? Not what Tom, Dick and Harry think about this, that and the other in connection with it, but is there disease? And is this disease, which is in the country, decimating the bees of the country, doing harm to the bees of the country? Now, let us decide once and for all, brother bee-keepers, as to whether there is disease in the country, and, if there is, whether we are going to have legislation to stamp it out or not. (Cheers.)

Mr. Reid : I do not know what procedure you wish to adopt—whether it will be necessary to move a resolution, have it seconded and put to the meeting—but I presume some stage in these proceedings will come when the opinion of the meeting will be taken.

The Chairman : Not every member would wish to speak on the subject. As soon as there is a lull in the flow of speakers I will ask for a resolution. I think, however, it would conduce to the more rapid conduct of business if somebody would move a resolution, and then speakers who wished to oppose it or support it could do so. But I shall have now to ask that all speakers shall, in the first instance, and on a specific topic, confine their remarks to not more than three minutes; otherwise, I am afraid the meeting will go on indefinitely. Would anyone, to help the

meeting on, propose that legislation is desirable?

Mr. Reid: If I may be allowed, I will not take up more than one minute, and my resolution would be—"That this meeting approves of the principle that legislation for the prevention of disease is desirable and should be asked for."

Mr. Hayes: I beg very heartily to second that proposition.

Mr. E. C. Middleton: To me, you are putting the cart before the horse. Before you know whether legislation is desirable it is just as well to know what the nature of the legislation is to be. What on earth is the good of saying we want something when we know not what it is? There is no doubt there is a great deal of disease, but it is certain, as that gentleman said on the platform, the disease is not understood. Is there anyone here present who would go to a doctor to have a prescription made up if he did not understand their disease? Not for a moment. You want to go to a man who understands the case. The case is not understood, and you ought to commence that investigation instead of legislation. Settle what it is, and when you have settled what it is give us legislation as strong as ever you like.

The Chairman: I do not wish to take any part in an argument; I am here in an impartial capacity; but I have some historical knowledge of diseases other than bee diseases, and the statement that legislation is to wait for an understanding of the nature of the disease is inaccurate. I say that on my own knowledge.

Mr. E. C. Middleton: I cannot understand that you should express the opinion that we should have legislation to deal with a matter that the Government does not understand.

The Chairman: It is not a question of understanding the disease; it is a question of understanding the cause, which is a very different thing. You may know that you are ill, you may not know the cause of your illness; you may know you are infectious; you may not know the source of the infection.

Mr. E. C. Middleton: The source of the "Isle of Wight" disease is not known, and that was why I asked you the pointed question whether you were quite satisfied that with the presence of *Nosema apis* you had "Isle of Wight" disease, and to that the reply was "No."

An Hon. Delegate: I beg to move the resolution be put.

Another Hon. Delegate: Crime is not understood very often, but it is punished.

The Chairman: Gentlemen, I am most anxious that all views should be heard. There is only one truth, whether it please

or displease. We are all anxious to get at the truth of this matter, though we may not be able to come to an agreement. If any other speaker who cannot defer his remarks until we come to some other subject desires now to address the meeting, will he do so? Mr. Bartlett, I believe, has the first call. Would your remarks come equally well later?

Mr. Bartlett: I think not. It would be of great interest to us to know what has happened to other countries in regard to legislation.

(To be continued.)

### Glamorganshire Bee-Keepers' Association.

The annual meeting was held at Bridgend on February 14, 1920. Mr. W. H. C. Llewellyn, J.P., Court Coleman, presided over a good attendance, which included Rev. Gower Jones (Treforest), Messrs. H. Skelding, D. Davies, B.A., and Mrs. Davies (Bargoed), Mr. and Mrs. Gunter, Wm. Morgan, D. W. Walters, B.Sc., and C. B. Pardo (Barry), Ivor Williams, C. Spiller, R. Thomas (Cowbridge), W. H. Yeo (Court Coleman), J. Whitehead, F. Gravil, Wm. Morgan, Hy. Butt, Mrs. Watkins, and Mrs. Squire.

The Secretary read letters apologising for absence from Messrs. W. Dyche, B.A. (Cardiff), R. James (Penarth), and E. Boobier (Swansea).

A vote of sympathy and condolence with the widow and family of Mr. E. Church (Cardiff), who was a most successful beekeeper and exhibitor, was passed.

The Chairman, in proposing the adoption of the annual report and statement of accounts, referred to the advantages of having so strong an Association in existence in the county. He considered that it was of the utmost importance that beekeeping should be carried out on scientific methods, as also the replacing of stocks carried on under the re-stocking scheme, thereby improving the stamina of the bees and providing members with stocks after the ravages of the "Isle of Wight" disease. He was particularly grateful for the assistance rendered by the visits of the local expert to his apiary; also he congratulated those members who had succeeded in obtaining certificates of the B.B.K.A. Mr. F. Gravil seconded the adoption of the report, and said he hoped the visit of the Royal Horticultural Society to Cardiff on July 6, 7 and 8, 1920, would be a great success. The R.H.S. had kindly granted them a tent and a site for lectures, etc., and arrangements would be made for a good schedule of prizes and opportunities afforded for examinations of candidates for B.B.K.A. certificates. The Right Hon. the Earl of Plymouth was re-elected President, and Mr. C. B. Pardo a Vice-Presi-

dent. The Secretary (Mr. W. I. Wiltshire), Treasurer (Mr. F. Gravil), and Auditor (Mr. John Jenkins) were re-elected. A new Committee was elected as follows:—Messrs. D. W. Walters, B.Sc., D. Davies, B.A., W. Dyche, B.A., R. Thomas, Fred Thomas (Briton Ferry), H. Skelding, Red. Gower Jones, C. Spiller, D. Hardcastle, W. H. Yeo, A. Roberts, and E. Gibbon (Clydach).

Mr. F. Gravil and Mr. C. Spiller were elected representatives to B.B.K.A. Mr. C. Spiller was elected to represent the Association on the Glamorgan Chamber of Agriculture.

Mr. C. B. Pardo raised the question of payment of the expenses of representatives attending meetings, and the following resolution was passed:—"That this meeting authorises the Executive Committee to pay the claims of representatives for their expenses when they deem it desirable."

Mr. F. Gravil proposed and the Secretary seconded that Rule VII. be altered for the annual meeting to be held any day in February; but on the proposition of Mr. W. T. Gunter and seconded by Mr. Wm. Morgan it was resolved that the annual meeting should be held in April.

Mr. C. Spiller explained the position in reference to bee legislation, and the terms of the Bill that was proposed for introduction to Parliament. A proposition in favour of bee legislation on these lines was passed unanimously.

Mr. Walters, B.Sc., announced that at the Welsh National Eisteddfod to be held at Barry, 1920, a prize of £5 was offered for the best essay on "How to Combat 'Isle of Wight' Disease."

A vote of thanks to the Chairman, proposed by Mr. R. Thomas, brought the meeting to a close, after which many members remained to tea generously provided by the Chairman.

### Derbyshire Bee-Keepers' Association.

The annual meeting of this Association was held in the Guildhall, Derby, on Saturday, February 14, at 2.30 p.m., a good number of members being present. In the absence of the Chairman (Mr. R. Giles, Etwall), Mr. G. T. Pallett (Makeney) presided.

A statement of accounts was submitted, which showed a debit balance of £5 13s. 7d., which, in view of the work done under the restocking scheme, was considered highly satisfactory.

An interesting report of the year's working was read by the Secretary, which showed that much valuable work had been done by the distribution of a large number of nucleus stocks among members, raised from Dutch bees imported under

the Government Re-stocking scheme. Mr. H. Hill (Ockbrook—to whom had been entrusted the Dutch stocks purchased by the Association) gave an interesting account of his experiences, which showed him to be eminently the man to deal with the problem of BEE-REARING. Largely through his success in this direction, material increase in membership had to be recorded. Mr. Hill stated his willingness to continue the re-stocking scheme for 1920. A hearty vote of thanks was accorded to Mr. Hill for his valued assistance to the Association.

Messrs. Bannister and Durose (experts) gave an account of the work done in visiting the members' apiaries. The Chairman expressed the thanks of the meeting for the work undertaken by these gentlemen.

The Rev. R. H. N. Ellison and Dr. St. John made several valuable suggestions for the improvement of the Association and education of its members in the art of BEE-KEEPING, which was heartily appreciated by the members.

An interesting discussion followed on "Bee Diseases and their Cure." A draft Parliamentary Bill was read by the Chairman, which provided protection and assistance to bee-keepers anxious for the welfare of their valued stocks.

The Duke of Devonshire, K.G., was elected Patron, and A. Preston Jones, Esq., Mickleover House, was unanimously elected President for the forthcoming year. The following appointments were also made:—Committee: Chairman, Mr. R. Giles (Etwall); Vice-chairman, Mr. G. T. Pallett (Makeney), Rev. R. H. N. Ellison, Messrs. G. Bannister, J. R. Bond, W. Davidson, S. T. Durose, A. Eaton, H. Hill, J. Hinton, J. Kirkland, C. Meakin, S. Milton, E. J. Swain, J. Speed, Dr. St. John, J. Turton, H. J. Morris, G. H. Strutt, Esq., J.P. (Makeney), representing Derbyshire County Council). Hon. Treasurer: Mr. E. J. Swain, Mickleover. Hon Auditor: Mr. S. Milton, Derby. Experts: Messrs. Bannister, Durose and Pearman. Hon. Secretary: Mr. F. Meakin, Derby. Representative to B.B.K.A. Council: Mr. Pearman.

The meeting closed, all present feeling that bee-keeping had at last taken a new lease of life in Derbyshire.—S. MILTON, Derby.

### Honey Imports.

The registered value of honey imported into the United Kingdom during the month of January, 1920, was £38,099.—From a return furnished by the Statistical Office, H.M. Customs.



### Winter Pollen.

[10137] I have often wondered, like a good many others, where bees get pollen from in dead of winter. To-day, January 19, I picked up some catkins which had fallen from a deodara (an Indian fir tree). I enclose specimen, and should be glad to know if you, or any bee-keeper, have noticed bees gathering pollen from these catkins.

[We have not seen bees working these catkins, but no doubt they would do so.—Eds.]

Re Mr. Sladen's article, page 4 of January 1, 1920, I use the W.B.C. type of hive, the stand of which I board on the underside, and well paint. This leaves a 2-in. space between these boards and the floorboard, but the underside of frame of floorboard must be perfectly level, to make a dead air space, which gives the same protection to the bottom as any other part of hive.

Re remedy for Ants.—I have been troubled with this pest, and I find a small lump of cyanide of potassium placed in their nest does the trick, or use in liquid form, if not too close to the hive.—T. F. J.

[This would be effective in killing the ants, but, as we have frequently pointed out, cyanide of potash is a deadly poison, nearly as deadly as prussic acid, and it should be used with great caution. We do not think it would be advisable, or safe, to use it for ants' nests.—Eds.]

### Feeding Bees.

[10138] Just a line to thank you for your excellent tip in "Seasonable Hints," some little way back, about feeding bees this mild weather. I have been feeding since the middle of December on candy, and it is delightful to see, through the glass of the candy-box, how lively my bees are. I have just put some more with pea meal, nice and soft, for the young bees hatching. I hear a great deal of bees dying near here, and am visiting two stocks on Sunday. They are either starved or the hooked wire has not been used to clear the entrance, and they are smothered, I fancy.

I use a very little smoke, only at certain times—always a carbolic cloth, not too strong, just enough to make the bees hum, and I am certain this is what keeps them healthy. As a disinfectant I am not very much in love with a smoker; I hate to think I am choking them. I use a wired

honey board with feed hole, and covered with porous quilts, with a cork quilt, raised slightly, on top of all. Putting one's hand under, a nice, warm, dry feeling, which is very pleasing, has seemed to agree well with my two stocks.—CYRIL TREDCROFT.

### Labelling Honey.

[10139] I have enclosed a honey label of mine, designed for the protection of myself and customer. To my mind, the reason for some persons being against honey is because, some time or other, they have had some very questionable stuff, which oft-times, upon investigation, proved to be some imported variety.

If we could get all imported honey so labelled it would give a good stimulus to

## PURE NORFOLK HONEY

From the Apiaries of A. TROWSE,  
Norwich.

*I hereby guarantee this golden honey is produced solely from the nectar of flowers by golden bees. Extracted and rendered by modern methods untouched by hand, free from any adulteration whatever. Therefore this honey is genuine and pure. When honey granulates, to make liquid, heat slowly.*

"Eat thou honey, Nature's purest confection, because it's good!"

our home product. Few, if any, among the craft would object to this form of protection.

Personally, I have a strong objection to any article of food bearing no label as to origin, or known source of supply, especially in these days of substitutes. Trusting you will push this matter *re* labelling honey right now, and thanking you for the same.—A Trowse, Norwich.

### Mr. Manley's Letter—September 25, 1919.

[10140] I certainly take very strong objection to Mr. Manley's assumption in above communication that I "think because the Englishman is a fool, that there is little commercial bee-keeping here" [in England]. I consider that remark tantamount to accusing me of insulting my fellow countrymen, for I must inform Mr. Manley that I am an Englishman, born in London. My frequent communications to your JOURNAL a few years ago, as you were made aware at the time,



and was plainly shown in my letters, were solely to assist in bringing about a better state of things in bee-keeping in Britain, chiefly through legislation, giving as example the result of legislation controlling bee-keeping in New Zealand. All Mr. Manley's remarks about the difference in climate between England and New Zealand are beside the mark. I never hinted that the industry of commercial bee-keeping in England would be carried out on so extensive a scale as in this country; but what I have said, and still maintain, is, that you are not getting as much out of bee-keeping as you would were the like energy and push exercised by British bee-keepers in taking action to bring about improvements as has been and is still the case with New Zealand bee-keepers.

Mr. Manley's condemnatory remarks on British bee-keeping in same letter are, so far as they go, a repetition of mine on different occasions. Untravelling Englishmen are, as a rule, too conservative to readily adopt new ideas, hence many purely British industries in the past have been lost to foreign nations. The same applies to bee-keeping, so, Mr. Manley, don't blame the climate altogether for any shortcomings until you have done your best to improve the existing conditions.—I am, etc., J. HOPKINS, Auckland, N.Z.

### Experiments with Frames.

[10141] Referring to No. 10136, "Experimenting with Frames," surely Mr. Flashman would not be satisfied with a test that only embraced two stocks. Let him take at least ten stocks of each size and test for three years, and then his results will be worth consideration. A test of two stocks for one season would be quite insufficient.—R. B. MANLEY.

### Remedy for Ants.

[10142] At one time I was troubled very much with ants. I found a perfect remedy by screwing 3-in. galvanised screws into the legs of hive and letting the heads stand in small tins of creosote (crude). Of course, there must be no long grass round the hive. The vacuum lids of fruit bottles, etc., answer well, or small patty pans—they used to be cheap then.—T. F. NEWMAN.

"A Dorset Yarn." "Jottings from Huntingdonshire," and a number of other articles and letters that are in type are held over, as we wish to get the whole of the somewhat lengthy report of the Conference on Legislation published as quickly as possible.—Eds.

## Notices to Correspondents

### PRICE OF SUGAR FOR BEE FOOD.

We are still receiving queries on this matter. We understand that retailers have instructions from the Sugar Commission to charge manufacturers' prices to bee-keepers. These prices are upwards of 1s. Sugar for household purposes is subsidised by the Government, and sold under cost price. Efforts are being made to get sugar for bee food at the same price as for household purposes, and our readers may trust us to let them know at once if they are successful.

### Suspected Disease.

- MISS HERON (Hants); E. A. REYNOLDS (Sussex), MRS. CHAMBERS (Walton), P. B. H. DESMOND (Hants), "WALTON" (Surrey), W. ELOBER (Portsmouth), S. C. CAVELL (Yorks).—The bees were affected with "I.O.W." disease.
- D. W. J. (S. Wales) and J. H. B. (Norwich).—(1) "I.O.W." disease. (2) Native.
- E. J. F. (Glos).—The trouble is "I.O.W." disease. If the food in comb is used for bee food, it should be extracted and boiled for 10 to 15 minutes, first adding a little water to it. It will be safe to give syrup now in your part of the country. After cutting out the combs, the frames may be boiled, but the safest thing is to burn frames and combs and get new ones. The hive can be disinfected. The best plan is to scorch it out with a painter's lamp, failing that apply a strong solution of some disinfectant by means of a brush.
- T. WILHELMINA (Bournemouth).—The colony had been robbed out.
- C. INGLE (Cardiff).—We are unable to say cause of death.
- R. SMITH (Aberdeen), A. LAW (W. Melton), J. BRAWN (Horsham).—We do not find disease.
- In reference to our note last week, Dr. Helen Goodrich asks us to say that any bees sent for examination should be *live* ones, as dead bees are useless for microscopical examination. The notices given above were crowded out last week.

## Special Prepaid Advertisements. One Penny per Word.

Trade advertisements of Bees, Honey, Queens, and Bee goods are not permissible at above rate, but will be inserted at 1½d. per word as "Business" Announcements, immediately under the Private Advertisements. Advertisements of Hive-manufacturers can only be inserted at a minimum charge of 3s. per 3in., or 5s. per inch.

PRIVATE ADVERTISEMENTS are only intended for readers having Surplus Stock to dispose of. Driven Bees, Nuclei, and Queens that are reared or imported for sale, are Trade Advertisements, and can only be accepted under trade terms. A charge of 6d. extra will be made if a box number is used.

Orders for three or more consecutive insertions in "The Bee Journal" entitle advertisers to one insertion in "The Bee-keepers' Record" free of charge.

### PRIVATE ADVERTISEMENTS.

FINEST English Honey. £3 per cwt.; sample 3d.  
—DUTTON, Terling, Witham, Essex. c.5

FOR SALE, two fine, healthy Stocks of Hybrid Bees, 10 frames each, £4 10s.; box extra.—  
TOOVEY, Grove Road, Hazlemere, Bucks. c.4

50 LANTERN SLIDES ON BEES, new, only shown twice, also Lecturer's Lantern, £7.—  
W. THOMPSON, Lieut., R.F.A., 290, Well Hall Road, Eltham, Kent, S.E.9. c.5

**PLANT** "Willow Herb" for your bees; useful and ornamental; 12 roots, 2s.—**BOWEN**, Pittville Street, Cheltenham. r.c.6

**WELL-FILLED** Sections of delicious Honey, 3s. 6d. each,  $\frac{1}{2}$  dozen £1, post free.—**WHITE**, Park Villas, Maryborough. c.7

**FOR SALE**, strong 10-frame Stock Italian Hybrids, 1919 Queen, from apiary never known disease, £5 5s., carriage paid; delivery first week in May.—**HOWLETT**, 138, Seaforth Avenue, New Malden. c.8

**PURE** Light Cambridge Honey, 14-lb. tins, 22s. 6d.; 28-lb. tins, 42s., carriage paid; sample 4d.; tins free.—**J. YOUNGER**, 6, Maid's Causeway, Cambridge. r.c.9

**BARGAIN**.—Eight Perfection Bottle Feeders, good as new, 2s. each.—**HERRING**, Blackthorn, Bicester. c.10

**FOR SALE**, two Stocks of Bees on 10 frames each, in hives; good strain of hybrids; no disease; owner has to move, only reason for selling; price £5 each.—**WILLIAMS**, Winslade, Kenley, Surrey. c.11

**TWO** Hives of Bees, strong and healthy. What offers?—**MRS. CRAGGS**, Brough, East Yorks. c.12

**EXPERT** required for King's Lynn and District Bee-keepers' Association.—Applications to **GEO. A. KNOWLES**, Hon. Sec., Tennyson Avenue, King's Lynn. c.13

**FOR SALE**, large quantity of Appliances, including 6-frame reversible Geared Extractor in good condition, nearly new Dadant New Wax Press, Honey Ripeners, Nucleus Hives, Travelling Boxes, both swarms and frames, large number of Section Racks, including single walled, Lee's pattern, Burgess double walled, and W.B.C. hanging frames, Shallow Frame Boxes, etc., quantity new Frames, Sections, Metal Ends, Honey Jars, Glass for glazing, Smokers, etc.—May be viewed by appointment or particulars from "S," Avenue House, Finchley Lane, Hendon. Stamp for reply. c.14

**SELL** Cowan Extractor, geared, and reversible cages; price £4 10s; approval; deposit.—**Box 68, B.B.J. Office**, 23, Bedford Street, W.C.2. c.15

**FOR SALE**, two strong Stocks Hybrid Italians, one Stock British Blacks, all on ten frames, no disease, £5 each.—**WOOD**, Manor House, Neston, Cheshire. r.b.77

**FOR SALE**, two Stocks Bees on 10 frames in W.B.C. Hives (1918 and 1919), two empty Hives, complete, also quantity Appliances, frames, sections, etc.; reason for selling, overstocked; full hive, £7; empty hive, fitted, £3 5s. Can be seen by appointment.—**MRS. ANTHONY**, Buckland, Betchworth. b.81.a

**BEE PLANTS** for early forage, Limnanthes, strong, autumn sown, 100 2s. 4d., free.—**WM. COLLINS**, Castlebellingham, Ireland. b.80

**CAN** spare a few Dutch Stocks of Bees on six standard frames, 1919 Queen, 60s., carriage paid; April delivery.—**W. CHANNELL**, Grove Apiary, Histon, Cambs. b.83

**BEE SWAX** for Sale, good quality yellow, 10 cwt., in 1 or 2 cwt. bags, at £9 16s. per cwt., f.o.r. London.—Apply, **Box 67, B.B.J. Office**, 23, Bedford Street, W.C.2. r.b.86

**1,000** SECTIONS, grooved and split top, 10 lbs. foundation squares, 95s., carriage paid.—**HULL**, Bee-keeper, Barrow-on-Soar, Leicester. b.90

**WANTED**, in March, strong Stock pure Italian Bees, 1919 Queen; must be guaranteed free from disease.—**WORTHINGTON**, World's End, Solihull, Warwickshire. r.b.60

**WANTED**, healthy Stock of Bees, 6 or 8 frames, April delivery.—**WATERHOUSE**, Rossett Green, Harrogate. r.b.85

**HONEY**.—25 dozen finest clover, clean, well-filled Sections, 30s. per dozen, carriage forward; expert packing free.—**GIBSON**, Apiaries, Ballygowan, Belfast. r.b.59

**17** HEALTHY Italian Stocks, headed by Penna Queens, £5 5s. each.—**J. YOUNGER**, 6, Maid's Causeway, Cambridge. r.b.45

**ITALIAN BEES** on 6 frames, headed by Penna's 1920 Queen, delivery June, £4 10s., carriage paid.—**ENNEVER**, Oak Avenue, Ridgeway, Enfield. r.b.70

**CORRESPONDENCE** Course in Bee-keeping.—**MISS F. E. PALING**, Golden Square, Henfield, Sussex. r.a.54

**WANTED**, portable Greenhouse.—Price and particulars to **W. HERROD-HEMPSALL**, Old Bedford Road, Luton, Beds.

**WANTED**, Auster Rear Wind Screen for motor car.—**HERROD-HEMPSALL**, as above.

**FOR SALE**, one Exhaust Whistle, 11s., post free; one Wood Millie Motor Foot Pump, 46s., carriage free.—**HERROD-HEMPSALL**, as above.

#### BUSINESS ADVERTISEMENTS.

1½d. per word.

**STOCKS**, native and hybrid Bees, £4 each; Swarms, £2; Nuclei, £1 18s.; Hybrid, £2 2s.; pure Italian, £3; Queens, 10s. 6d. each, carriage paid.—**S. CRAWFORD**, Apiaries, Castledegr, Co. Tyrone. r.c.17

**COMING!**—The "Smith-Burgess" Skyscraper Hive, standard size and 16 in. x 10 in. frames; the "Smith-Burgess" combined Super Clearer and Uniting Board; also Glass Quilts, Wooden Quilts, the Floorboard Feeder, Wire and Zinc Excluders on frames. No prices yet, but coming—and well worth waiting for.—**SMITH**, Cambridge. c.18

**SIX** packages Flavine, S. Powders, circulars. S. testimonials, etc., 6d., post paid; Japanned Sprayers, 5s., post paid; Wire Clearer Boards, 6s. 6d., post paid; "Week-end Bee-keeping," Chapter II, "When the Cuckoo Calls," now ready.—**S. H. SMITH**, 30, Maid's Causeway, Cambridge. c.19

**2-FRAME NUCLEI**, 50s.; Simmins' strain; particulars upon request.—**ERIC WATERHOUSE**, Watford Field House, Watford, Herts. c.20

**PURE ITALIAN QUEENS AND NUCLEI**.—Can accept few more orders. This strain is second to none, hardy, good disease resisters, very prolific, splendid honey gatherers, comb builders, little given to swarming, quiet to handle. June 3-frame Nuclei, £2 15s.; 4-frame, £3 5s.; well covered with bees and brood; 1920 pure fertile Italian Queens, June-July 9s. 6d., August-September 7s. 6d.; Virgins, 4s. 6d.; few hybrid natural Swarms, £2 5s.; safe delivery; carriage paid; cash with order; satisfaction guaranteed.—**BARTLETT**, Bee Specialist, Crowthorne, Berks. c.21

[The above advertiser and advertisement are not in any way connected with Mr. C. B. Bartlett, Witney, Oxon.]

**FLAVINE CANDY**.—6 lbs. for 10s., post paid. We managed to obtain some free sugar—at a price—and we have turned it into candy.—**S. H. SMITH**, 30, Maid's Causeway, Cambridge. c.22

**STRONG ITALIAN STOCKS** on 7 frames with 1920 Penna Queens, ready June, £5; travelling box 10s. extra, returnable; strong 3-frame Nuclei with 1920 Queens, £3; boxes 7s. 6d. extra, returnable. Cash with order, or quarter amount deposit. Italian Queens, home mated, 12s.; Virgins, 5s. 6d.; booked; ready May onwards. Pupils taken.—**MISS PALING**, Golden Square, Henfield, Sussex. c.23

**NEW-ENGLAND-BRED ITALIAN QUEENS.**—Untested laying Queens, ready June 1, 10s., delivery guaranteed; 6s. at purchaser's risk. English money accepted by registered mail.—ALLEN LATHAM, Norwichtown, Conn., U.S.

**ITALIAN NUCLEI,** 3-frame, Penna's 1920 Queens (guaranteed), 65s.; Hybrids, Penna's and Simmins' Special, early delivery, 50s., carriage paid; box returnable. Orders (cash) strict rotation.—MOORE, 31, Monmouth Road, Dorchester. r.c.1

**STOCKS and Nuclei,** headed by 1920 Queens. Guaranteed pure mated Italians, good gatherers, prolific, and gentle; ten frames, £5; six, £3 10s.; three, £2 10s.; June onwards; cases 10s., returnable.—H. NEVILLE, Mount Pleasant, Fieldgate, Walsall. r.c.2

**DUTCH AND DUTCH-ITALIANS.**—Four-frame Nuclei, May and June delivery, orders taken in rotation, £3 3s.; cash with order; carriage paid. They are the *Daily Mail* strain I have had seven years, and Bee-Mason's four years. Never had disease; beautifully clean and healthy. You want good disease resisters, prolific, and heavy honey producers. HERE YOU HAVE THEM.—SEALE, Ashley Cottage, Oatlands Drive, Walton-on-Thames, Surrey. b.92

**DON'T BUY BEES** until you have seen our prices and guarantee. You risk nothing, as we return money in full if bees fail to give satisfaction. Special terms to disabled men. Catalogue 3d., which is refunded on first order.—PEARSON & GALE, Marlborough. b.94

**ITALIAN 4-frame Nuclei,** 50s.; box 10s., returnable. All orders strict rotation. May-June delivery. £1 deposit, balance prior to delivery.—LEE, "Little Bowden Apiary," Burgess Hill, Sussex. b.64

**FOR SALE,** Stocks, £5; Swarms, £2; Queens, 7s. 6d.; Nuclei, £5. Orders booked now.—THE HEATHERLANDS BEE FARM, Thursley, Godalming. b.65

**THREE-FRAME NUCLEI,** £2 2s.; Queens, 10s. 6d. Hardy, prolific hybrids, disease resistant strain. I have not had any "I.O.W." in my hives at any time.—O. W. H. OVENS, 151, Fishponds Road, Eastville, Bristol. rb.68

**FOR SALE,** Nuclei, 1919 Queens, three frames, 47s. 6d.; four, 52s. 6d.; May; Hybrids, young Queens, ready June; returnable cases 7s. 6d. JOURNAL deposit.—A. H. HAMSHAR, Womersley, near Guildford. b.41

**WATERPROOF RUBBER SHEETS** for covering outhouses, etc., 72in. by 36in., brass eyelets, 12 for 20s.—SAGARS STORES, Ardwick, Manchester. b.16

**HAVE YOU READ "THE BEE WORLD"?** If not, why not? Every number in itself is a useful literary work for practice and reference. Specimen copy free.—OFFICES: THE APIS CLUB, Port Hill House, Benson, Oxon.

**ITALIAN QUEENS** direct from Italy. Price list for 1920 on application.—Address, E. PENNA, Bologna, Italy. w.39

**DUTCH BEES,** Skeps (as imported from Hans Matthes), Nuclei, Queens. Illustrated Catalogue on request, containing points on management.—Buy direct from Sole Agent, WHYTE, Bee Farmer, Cumbernauld, Dumbartonshire. b.61

COUNTY OF SOUTHAMPTON.

AGRICULTURAL EDUCATION COMMITTEE.

HORTICULTURAL SUB-COMMITTEE.

Wanted, TRAVELLING STAFF TEACHER OF BEE-KEEPING, to take up duties shortly. Conditions of appointment and Application Form sent on receipt of stamped, addressed foolscap envelope, to be returned by March 15, to D. T. COWAN, Director of Education, The Castle, Winchester.

Send for

**Bee-Keepers Wake Up!**

You can make a Big Profit if you use right up-to-date Appliances, including the Manley Hive.

**MEADOWS,**  
SYSTON, LEICESTER.



**Books for Bee-keepers NOW IN STOCK.**

	Postage	
A Modern Bee Farm ... ..	7/6	... 6d.
Beginner's Bee Book (PELLETT)	5/-	... 4d.
<b>BEE-KEEPING SIMPLIFIED FOR THE COTTAGER AND SMALLHOLDER</b> (W. HERROD-HEMPSELL, F.E.S.) ... ..	1/-	... 1½d.
<b>BEE-KEEPERS' PRACTICAL NOTE BOOK</b> (T. W. COWAN)	1/-	... 1½d.
<b>BRITISH BEE - KEEPERS' GUIDE BOOK</b> (T. W. COWAN) (paper covers only)	2/6	... 3d.
Dissectible Model of Queen Bee	4/6	... 3d.
<b>FERTILISATION OF FRUIT BLOSSOMS BY BEES</b> (T. W. COWAN) ... ..	-/3	... 1d.
Honey and Health (A. HOPE) ...	-/6	... 1l.
Honey Vinegar (REV. G. BANKS)	-/2	... 1d.
How to Keep Bees (ANNA B. COMSTOCK) ... ..	5/-	... 1d.
Management of Out Apiaries	3/-	... 3d.
Pollination of Fruit in relation to Commercial Fruit Growing ... ..	-/6	... ½d.
<b>PRODUCING, PREPARING, EXHIBITING AND JUDGING BEE PRODUCE</b> (W. HERROD-HEMPSELL, F.E.S.) ...	2/-	... 3d.
Productive Bee-keeping (PELLETT) ... ..	10/6	... 6d.
Queen Rearing in England (F. W. L. SLADEN) ... ..	1/6	... 2d.
Snelgrove's Method of Re-Queening ... ..	-/6	... 1d.
The "Townsend" Bee Book ...	2/6	... 2d.
WAX CRAFT (T. W. COWAN) ...	2/-	... 2½d.
Wilke's Book on Swarming ...	1/-	... 1½d.
<b>MISCELLANEOUS.</b>		
Maeterlinck's Life of the Bee	3/6	... 3d.
The Lore of the Honey Bee (TICKNER EDWARDS) ... ..	2/-	... 2d.
The Humble Bee (F. W. L. SLADEN) ... ..	12/6	... 6d.
<b>THE BEE WORLD</b> (supplied only to members of Associations interested in the control and development of the Apis Club, apart from ordinary members of the latter), per copy ... ..	-/8	... 1d.

**British Bee Journal & Record Office,**  
23, BEDFORD STREET, STRAND, LONDON, W.C.2.

**FINEST SECTIONS OF HONEY.**

A large quantity for Sale at carriage paid prices, either Plain or Glazed.

**IRISH RUN HONEY.**

Several cwt. for Sale in quantities to suit customers, at carriage paid prices in free tins and cases.

**GORDON ROWE,**  
Honey and Beeswax Packer,  
28a, Moy Road, Cardiff.

Queens that will fight "Isle of Wight" Disease.

Send 3d. for

**'The Secret of Immunity'**

and Price List.

T. F. COBB, 33, Bevan Road, Plumstead.

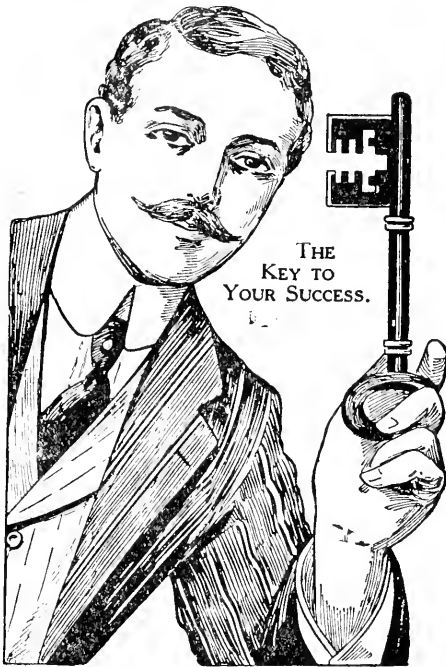

# The Metal Foundation

(Protected.)

¶ The triumph of the Metal Foundation is due to the following significant advantages:—(1) Indefinite durability with reasonable care; (2) Greater safety of bees in transit on new combs; (3) Capability of bearing the weight of a heavy swarm in hot weather; (4) Greater comb stability in quick extracting; (5) Control of drone cells; (6) The production of even combs; (7) Easy removal of queen cells without the slightest injury to the foundation; (8) Cleanliness and adaptability to sterilisation by boiling; (9) Economy of labour and time in fitting and detaching; (10) An ideal compromise between the metal comb and the wax foundation.

¶ The invention has created a world-wide interest. Its value will be the more appreciated by studying the fol-

lowing original literature:—"The British Bee Journal," November 13; "Bee Craft," December; and "The Bee World," September, October, and November, 1919.

## RETAIL PRICES.

¶ The Metal Foundation ("worker" type) can now be produced in any size required, whether for the brood chamber or the super, e.g., for the British Standard Frame (14 in. x 8½ in.), Deep Standard (14 in. x 12 in.), Simmins' (16 in. x 10 in.), Langstroth (17⅞ in. x 9⅞ in.), etc., and for their corresponding super frames. Despite the heavy cost of machinery, metal, etc., it is offered at a price *well within the purchasing power of the average bee-keeper*. All orders, whether large or small, receive *prompt attention*, and are executed in *strict rotation*, and in *good time for the season*. We have further decided—for the benefit of bee-keepers who are not yet in a position to place their orders—on taking the risk of a liberal margin of production to meet unavoidably delayed orders. *If you have not yet made up your mind as to your requirement, you are still in time to do so.*

## The Uxbridge W.B.C. Five.

¶ This popular hive, which we originally introduced over twenty years ago, is admirable for its *water-proof* features, since it eliminates the plinth. It stands supreme amongst all W.B.C. patterns. You will never regret trying it with your metal foundation.

\*\* We allow a Five per cent. discount on all our goods (including the Metal Foundation) to members of the Apis Club, who are respectfully requested to forward their membership cards when placing orders.

A FINAL REMINDER! To avoid disappointment apply now for the Metal Foundation Price List, and for our 1920 Catalogue.

# JAMES LEE & SON, Ltd.

## UXBRIDGE, MIDDLESEX.

(Telegrams: Graphicly, Uxbridge.)

Telephone: Uxbridge 181.)

# “QUEENLAND”

## SUPPLIES THE WORLD'S BEST QUEENS.

That's the Public Verdict. Do you doubt it? Then please refer to the spontaneous opinions of many clients, as given in the Revised 1920 "Queenland" List (3½d.) containing 20 pages of instructive reading which will start any unfortunate or hesitating beekeeper on the high road to success.

## “W.S.” BEES WON'T DIE OUT IN WINTER.

That's the General Verdict. You have only to glance through the Queenland 20-page List to find the proofs of this statement. Just give them ordinary care, with sufficient food to tide over the winter, and nothing can check their marvellously rapid progress.

## DON'T KNOW HOW TO DWINDLE IN SPRING.

That's because of their inherent VIM, as proved by the very frequent reports that established stocks of these bees are in swarming condition in APRIL. They have for more than 25 years been selected and bred for that very desirable trait—Longevity; hence the reason why the population of the hive is so rapidly piled up to massive proportions.

## READY FOR SUPERS IN APRIL.

That is—before other bees have barely started to build up, as confirmed in many instances; showing that “spring dwindling” is not in their line, under just reasonable treatment.

## THEY STORE HONEY WHILE OTHER BEES ARE IDLE.

That's because of their longer tongues and greater strength of wing, enabling them to visit flowers other kinds never reach. Established stocks of W.S. bees don't wait for the owner—they just push him along.

## THE “WHITE STARS” ARE MOST PROLIFIC AND WONDERFUL HONEY GATHERERS.

This is a rare combination, but is verified by many reports. Some queens have exceeded 350 lbs. in one season. In one case a nucleus increased to seven lots, five of which were sold while the remaining two gave 365 lbs., and the total sales amounted to over £40 in actual cash the second year. Another nucleus in Wales covered 40 frames of brood by August of the same year, and before the next season opened had made eight stocks. Then there is the case of a County Council delegate who reported that throughout his tour in EVERY CASE where an owner had done better than the average the results were attributed solely to the use of Simmins' Queens!

## MANY CLIENTS SAY “W.S.” BEES ARE IMMUNE FROM DISEASE.

That's because they have been bred by the most intense selection of both DRONE and Queen mothers for many generations, but S.S. gives no guarantee that they are absolutely immune, although it is known they have saved numerous apiaries, and collected tons of Honey that would otherwise have been wholly lost. In many cases “W.S.” queens have been given to hopelessly weak and diseased remnants of colonies, and have forthwith raised them to become the strongest stocks in the apiary; in one case storing (the same season) 100 lbs. after thus building up a small diseased lot. Some cases reported of diseased remnants having been renovated by the introduction of W.S. queens have been so remarkable that S.S. himself has been astounded at the almost mysterious results.

## THE “W.S.” ARE NOT IMPORTED ITALIANS.

That is a great point to remember; we have no use for the soft imported Italians, and could not use the best queen selected from a thousand imported without causing a serious deterioration in our pedigree stock. The “W.S.” have gone miles beyond anything that can be imported.

20 Page Revised List, 3½d., of S. SIMMINS, Queenland, Heathfield, Sussex.

# HIVES.

Compare the WORKMANSHIP and FINISH of our Hives.

All made by practical Men who know what a good hive should be.

In various designs to suit all tastes and requirements. Season's speciality—THE MANLEY HIVE for 16 in. x 10 in. Frames.

Full descriptions and illustrations in our 1920 Catalogue:

*"Everything for an Apiary."*

If you have not received your copy, send a P.C. at once.

OUR MOTTO — SERVICE & QUALITY.

**R. STEELE & BRODIE, Wormit Works, Wormit, Scotland.**

## INSURE YOUR STOCKS

### AGAINST "I.O.W." AND OTHER INFECTIONS.

Science has now placed within reach of every Apiarist a safe and certain preventive of infection in "Yadil" Antiseptic.

For **SPRING FEEDING** "Yadil" may be added freely to Syrup.

For **DISINFECTING** Bees and Combs a five-per-cent. solution in tepid water should be used with a fine spray.

ASK FOR GREEN LABEL.

Our Bee Brochure sent Free on Application.

**CLEMENT & JOHNSON, 19, Sicilian Avenue, W.C. 1.**



## "BACTEROL"

FOR BEES

2/6 per Bottle.

Post Free.

The cure for, and preventive of, "Isle of Wight" Disease. Non-poisonous—free from stain or unpleasant odour.

**MENLEY & JAMES, LTD.,**  
39, Farringdon Road, London, E.C. 1.

## Bee-Keeping Simplified

FOR THE COTTAGER AND SMALLHOLDER,

By **W. HERROD-HEMPSALL, F.E.S.**, Author of "Producing, Preparing, Exhibiting & Judging Bee Produce.

Price 1/- net.

Post free 1/1½

This little book supplies the need for a cheap up-to-date and well-illustrated handbook on bee-keeping, and gives in Mr. W. Herrod-Hempsall's well-known, clear, lucid style all that is necessary to enable anyone to commence bee-keeping successfully. From

**THE BRITISH BEE JOURNAL OFFICE, 23, Bedford St., Strand, W.C.2.**

## S. J. BALDWIN.

I beg to inform that the No. 1 Kent Hive is not manufactured by me, only the No. 2 "Bromley Kent."

(New deep frame 17 × 14 × 12. Sample by post 6d.)

**THE APIARY, BROMLEY, KENT.**

Look after your profits by buying hives and appliances which are easy to work. I endeavour also to give good value by care over the workmanship. Send for catalogue.

**EDWARD J. BURTT, Manufacturer, GLOUCESTER.**

Commercial (16" × 10") frames and brood boxes stocked.



No. 1968. Vol. XLVIII

MARCH 11, 1920.

[Published every Thursday, Price 2d.]

**CONTENTS.**

	PAGE		PAGE
CONFERENCE OF BEE-KEEPERS .....	121	ASSOCIATION NEWS—	
AN APOLOGY .....	126	British B.K.A. ....	128
A DORSET YARN .....	126	Herefordshire B.K.A. ....	129
NOTINGS FROM HUNTINGDONSHIRE .....	127	NOTICES TO CORRESPONDENTS .....	130

**ALUMINIUM DRAWN OUT COMBS.**

**“MONEYCOMB”**

*The greatest invention in the Bee World for 40 years.*

This is a drawn out Comb of Hexagon Cells exactly as bees build in their natural state. It is slightly coated with wax, has been thoroughly tested, and is not an experiment. Bees readily take to it for rearing brood and storing honey. Strong and durable, will last 50 years with care. Big consumption of honey saved to produce wax for comb building. Control of bee diseases. No more burning of combs. Each comb easily sterilised and used over again.

Send for Catalogue and descriptive Leaflet.

1920 Catalogue post free.

Patented by ALUMINIUM HONEY COMB CO. of U.S.A.

SOLE MANUFACTURER AND LICENSEE:

**E. H. TAYLOR, WELWYN, HERTS.**



# The Metal Foundation

(Protected.)

¶ The triumph of the Metal foundation is due to the following significant advantages:—(1) Indefinite durability with reasonable care; (2) Greater safety of bees in transit on new combs; (3) Capability of bearing the weight of a heavy swarm in hot weather; (4) Greater comb stability in quick extracting; (5) Control of drone cells; (6) The production of even combs; (7) Easy removal of queen cells without the slightest injury to the foundation; (8) Cleanliness and adaptability to sterilisation by boiling; (9) Economy of labour and time in fitting and detaching; (10) An ideal compromise between the metal comb and the wax foundation.

¶ The invention has created a worldwide interest. Its value will be the more appreciated by studying the following original literature:—“The British Bee Journal,” November 13; “Bee Craft,” December; and “The Bee World,” September, October, and November, 1919.

lowing original literature:—“The British Bee Journal,” November 13; “Bee Craft,” December; and “The Bee World,” September, October, and November, 1919.

## RETAIL PRICES.

¶ The Metal Foundation (“worker” type) can now be produced in any size required, whether for the brood chamber or the super, e.g., for the British Standard Frame (14 in. x 8½ in.), Deep Standard (14 in. x 12 in.), Simmins’ (16 in. x 10 in.), Langstroth (17½ in. x 9½ in.), etc., and for their corresponding super frames. Despite the heavy cost of machinery, metal, etc., it is offered at a price well within the purchasing power of the average bee-keeper. All orders, whether large or small, receive prompt attention, and are executed in strict rotation, and in good time for the season. We have further decided—for the benefit of bee-keepers who are not yet in a position to place their orders—on taking the risk of a liberal margin of production to meet unavoidably delayed orders. If you have not yet made up your mind as to your requirement, you are still in time to do so.

## The Uxbridge W.B.C. Hive.

¶ This popular hive, which we originally introduced over twenty years ago, is admirable for its water-proof features, since it eliminates the plinth. It stands supreme amongst all W.B.C. patterns. You will never regret trying it with your metal foundation.

\*\*\* We allow a Five per cent. discount on all our goods (including the Metal Foundation) to members of the Apis Club, who are respectfully requested to forward their membership cards when placing orders.

A FINAL REMINDER! To avoid disappointment apply now for the Metal Foundation Price List, and for our 1920 Catalogue.

# JAMES LEE & SON, Ltd.

UXBRIDGE, MIDDLESEX.

(Telegrams: Graphicly, Uxbridge.)

Telephone: Uxbridge 181.)





## Conference of Bee-Keepers re Legislation.

(Continued from page 114.)

The Rev. H. Morgan: I crave your indulgence, Mr. Chairman, ladies and gentlemen, just for a few minutes with regard to this matter we are discussing this afternoon, as to whether we are going to have legislation. Not as to whether the Government understands the disease or not, we none of us understand it, but we know the effects of it. We have got the disease, and we have to stop it in the best way we possibly can, naturally. As the Chairman has so kindly and ably put it this afternoon, the investigators will find some means of curing it. We are not here to cure it this afternoon. What we are here for this afternoon is to legislate to help the matter, and it is the only way, I think, that we can prevent it spreading even more than it is at the present time.

I will give you some of the instances that I have come across, and I will tell you why I am a great advocate of legislation. I have been a bee-keeper for five years; I have acted as a county expert for two counties, and at the present time I am under another authority as well, but that does not matter; it proves to you that I know something, and have had something to do with bees for the last 25 years. What we want to stop is the spreading of disease. Some years ago those of you who read your BEE JOURNAL and followed the advertisement columns saw in these columns an advertisement for 300 or 400 swarms of bees in the spring-time. I know the history of some of these swarms. The only interest that the man who advertised had in these bees was the profit he made out of them. I have had to investigate the outbreak of disease in various counties, and I can tell you this, that in every case of outbreak, the outbreak was traceable to the bees that were sold by that individual. The first case I ever came across was in Pembrokeshire, and I asked the man, "Where did you get these bees from?" He said, "From so and so"—the very same person again. I do not blame the man so much as the system. That system must not be allowed, and I firmly believe this, and I can prove it, that if we had had legislation, say, for the last 10 years, we should never have known in South Wales what the "Isle

of Wight" disease was. You may laugh, but I can tell you that every case is traceable to importation.

Facts are hard things to controvert. We are wide awake down there as well as yourselves, and we know what we are about. We know where these bees came from, and "Isle of Wight" disease was never known there until the bees and the "Isle of Wight" disease were imported. I guarantee that wherever you investigate that disease in West Wales you will find it traceable to bees that have been imported.

Well, now, we are here this afternoon, and let us confine ourselves; do not let us ramble all over the shop; let us come to the point. We have got the disease among our bees, we do know that; the Chairman has told us we cannot cure it, what is the next best thing we can do? I say legislate, to prevent it spreading, and to remove the sources of infection. The Chairman has put it very fairly and as clearly as he possible could put it. They do not wish to be hard; they took the bee-keepers into their confidence; they will not move without the bee-keepers as a whole; what more do we want? I have never known of anything so fair. They are not going to play the top dog or anything of that sort; they are not to move without us. They want us to legislate or combine—if you like to put it in that way—to get some means of stopping the spread of this disease.

Our friend, Mr. Cowan, said he did not believe in compensation. Now there are many stocks of bees, especially those of foul brood, that are worth compensating. Some of them are not worth anything at all except for fire purposes. Leave that alone, but let us come to the point. We know we have the disease, let us make up our minds what we are going to do. Let us recognise whether we have the disease or not, and then let us decide what we are to do, legislate or not.

Mr. Pearman: A certain publication about eight years ago contained an advertisement offering a number of swarms. I was one of the first to bring disease into our county, Derbyshire, and I did it by purchasing swarms. I also hold a post card here coming from Lincolnshire, which speaks of the very same thing with regard to the swarms they had sent into Lincolnshire being affected with disease. It is quite true that none of us know really what this "Isle of Wight" disease is, but we know it is there, and we want the power to stop spreading it broadcast into our counties. We want more power given to our County Association. We do not care so much about

working through these Educational Committees.

The Chairman: If you would mind not bothering about that now; there will be an opportunity of talking about that later. We are on the main argument now.

An Hon. Delegate: How many British Colonies have legislation, and how many Foreign States?

The Chairman: The number of countries and Colonies is 14. There are 14 foreign countries, including our Colonies that have legislation.

Mr. J. B. Lamb: Mr. Chairman, ladies and gentlemen, may I express the hope that the time of this meeting will not be taken up by arguments in favour of legislation, because they are so numerous and so convincing that I feel sure it is simply waste of time to talk thus. I do hope that everyone who objects to legislation will have the opportunity of placing his views before the meeting, because I trust this is the last time that we shall have these—shall I call them—flimsy objections placed before bee-keepers.

I have heard many objections during the last 10 or 15 years, but the only objection that seems to be popular is that the Ministry of Agriculture is to send about the country numbers of bee-keepers or inspectors to go through apiaries during the brief period of the honey flow, in order to inspect the bees and stop the efficiency of the hive. That is the only objection I have heard worth mentioning. I leave it to you, ladies and gentlemen, to decide whether that is a real fundamental objection. I have heard many complaints against the Ministry of Agriculture in recent years; I am hearing complaints now, but I have never heard a complaint that the Ministry has been prodigal in expending money on the bee-keeping industry. I venture to say, as we have a representative of the Ministry here today, that for every £1,000 spent on the bee-keeping industry, there will be a good return of interest to the country, fifty times beyond the 5½ per cent. now returned on the latest gilt-edged security. But what I hope, Mr. Chairman, is this, that no-one will speak in favour of legislation. We all know it is necessary; but those who deliberately think that there are grave objections to legislation shall lay their objections briefly before you this afternoon.

Dr. Rennie: I should like just to ask a question which I hope will reconcile the contending parties of the meeting. The question is this: Will it not be the case that associated with the Ministry in all the important decisions which arise in connection with the proposed legislation,

particularly with regard to the question of whether disease is present or not in particular cases, will be certain of the investigators on the Advisory Committee?

The Chairman: The answer is, "Yes, undoubtedly." Of course, it is very difficult. I do not think you would like the Chairman to get up and answer himself some of the objections that have been raised, because it would mean his making another speech after each speech, but it is evident that the object of the Ministry in proposing legislation is to assist the bee-keeping industry. You can only assist that industry if you know what the industry wants. You can only know what the industry wants if you associate with the actual bee-keepers the investigators and apply administratively the results of investigation; and the answer, therefore, to your question is undoubtedly there would be associated in the body which would determine whether an order was to be introduced, there would be associated with those bureaucratic people the practical bee-keeper and the investigator. That is what we do in every other department.

Well, Gentlemen, I really think, in spite of the very liberal-minded suggestion, that we should ask all conscientious objectors—(laughter)—to speak. We must now take the vote on this subject; on the question of the resolution, whether this meeting is in favour of legislation, and I will ask first of all for a general vote, and then as you go away, since I attach the greatest importance to this, I hope all those who have voted will put down their names and official designations. I think we ought to analyse this objection, and find out what it does amount to. We have heard it said that it amounts to a very considerable volume. The right of minorities is a most respected one, and the Ministry ought to ascertain and give consideration not only to the feeling of whatever the majority is, but also that of the minority. But, in doing that, it ought to know who the minority is; what title they have to speak authoritatively, because they would increase our respect for their voices very much. I therefore ask you to vote, those in favour of the resolution.

Mr. Barrett (Sheffield): In the first place, Mr. Chairman, ladies and gentlemen, we listened very attentively to the clerical gentleman there for six minutes—(Several voices: three minutes)—Six minutes, if you will pardon me.

The Chairman: Do not waste time on that kind of thing.

Mr. Barrett: I must have the courtesy of a hearing.

The Chairman: will secure that.

Mr. Barrett: He did not confine his remarks to the point. I must first protest very strongly against the shortness of the time which elapsed between the receipt of the notice of this meeting and the date of holding it. Captain Wellington has explained to us about the delay in the time of getting the notices out, but he has not explained to us any reason —

The Chairman: I must ask you to speak on the question. The question is whether legislation should be introduced or not.

Mr. Barrett: I protest, Sir.

The Chairman: You can speak on that motion. Other complaints, if you have any to make, we will be happy to hear afterwards. We wish you now to speak on whether legislation is desirable or not.

Mr. Barrett: Yes, quite.

An Hon. Delegate: Would it not be better that he proposed an amendment against?

Mr. Barrett: I will propose a resolution: certainly. I would draw attention to the impossible position in which the Ministry find themselves with regard to legislation. On the one hand, they have drafted this Bill for checking disease. On the other hand, they are breeding, fostering and spreading disease the whole length and breadth of the country—(A Voice: Explain)—countenancing the issue of the Food Protection Leaflet, No. 48.

The Chairman: I must again ask you, Sir, to speak on the subject, to give arguments in favour or against legislation. Any criticisms of the Ministry of Agriculture can be dealt with at your leisure later.

Mr. Barrett: Very good, Sir, I will withdraw.

Mr. Price (Staffordshire): I am not here to-day to put forward my own views. I have had a little experience of bee-keeping, and I can guarantee at the back of me the bulk of the bee-keepers in the four northern counties and also the bee-keepers of Staffordshire. I have visited these bee-keepers; I have heard their views, and they have not been represented to-day. Of all those bee-keepers that I have visited there has not been one person that has objected to legislation. (Hear, hear.) My impression is that we may carry on here for a long time and dwindle away the time and not know where we are at the finish. So, therefore, those are my views. I have told you that I have found the same views amongst the bee-keepers that I have come in contact with for the last 13 or 14 years, and I also have given you the number of objectors I have found in those areas.

Mr. Broadhurst (Wembley): I do not

agree with legislation from a general point of view, but how you are to deal with the dirty bee-keeper without legislation and registration I do not know. That is what we would all like to find out to-day. The man who keeps bees in the corner, there; you know he has got the "Isle of Wight" disease, or at any rate he has got *Nosema apis*; you have no power over him whatever. How are you to deal with him unless you have some power from the Government, and then if he is not registered how are you to have power over him? I agree with legislation to include registration. (Cheers.)

Mrs. Fielding (Shropshire): As Shropshire is considered rather a naughty county we have sat outside waiting for the Ministry to bring this legislation forward for months, and I may say years; might I ask the Chairman not to delay any longer? As Shropshire is a very long way off I shall have to go soon, so I would ask you to bring forward the resolution now without any more delay.

The Chairman: I am glad there is a representative of Shropshire at this meeting to-day because she will be able to go back and report to her committee the reasons why the Ministry did not bring in legislation at an earlier stage. The resolution is before the meeting; I now propose to put it. It has been proposed and seconded: the proposer will be good enough to repeat the felicitous words that he used so that we may have the exact form.

Mr. Reid: There were very few words, but I am not quite sure that I remember each one of them. It was to the effect that legislation is desirable for the prevention of disease in bees. It was quite general.

The Chairman: The resolution before me is that legislation is desirable for the prevention of disease in bees.

An Hon. Delegate: I think you had better be in order and ask for an amendment.

The Chairman: Does anyone propose an amendment?

Mr. Lamb: I think, Mr. Chairman, we ought to be very careful in the exact wording of the resolution. I think it ought to be a little more comprehensive. To prevent disease in bees is ridiculous; what we want is to prevent the spreading of disease. "That in the interests of apiculture it is necessary that legislation should be introduced to check bee diseases." It is quite simple: legislation is necessary to check bee diseases. We must be careful because this resolution may get into the Press to-morrow; we do not want people about the country to read some ridiculous

resolution such as this passed by some bee-keepers.

The Chairman: Does the mover accept these words?

Mr. Reid: I do, Sir. My friend, Mr. Lamb, is a past master in putting his and other people's views into shape. I think it is very desirable indeed that we should have a wording that should be accurate in every respect. May I ask him to leave out the words "in the interests of apiculture"? It is the interest of Great Britain, the bee-keepers, and everybody else.

Mr. Lamb: With pleasure. "That it is desirable to introduce legislation to check bee diseases or to check the spread of bee diseases."

The Chairman: The words that I have written down are "That it is desirable in the National interest to introduce legislation to control the spread of diseases in bees." That is the substantive resolution which has been proposed and seconded, and no amendment has yet been offered to it.

Mr. Bartlett: May I just be allowed to say that neither my friends nor myself are in any way opposed to the principle of legislation. I think there is an impression that we are, but that is not so. We simply desire that legislation should be very carefully introduced. People who now openly say they are not aware of any means of fighting disease should not be given very wide powers of handling bees throughout the country. It is much more necessary that research work should go on now. But the principle of legislation we approve.

The Chairman: I put the resolution to the meeting.

On a show of hands:

The Chairman: The motion is carried with one dissentient. There is a certain symbolism in the figures. The numbers are 99 to 1. (Cheers.) Gentlemen, I think, with your permission, I will ask for an expression of opinion on the question of registration next. That seems to be a clear-cut issue. Is that agreed; is there any dissentient?

An Hon. Delegate: It is desirable in the framing of the Bill to make it quite clear that legislation is wanted more for educational purposes than for anything else.

The Chairman: It is very difficult to put any explanation in the form of the Bill.

The Hon. Delegate: I think every person who keeps bees or has bees should be registered. In my opinion that is the only way in which you can get in touch with them; insist on registration.

The Chairman: Then there is no disagreement on that?

Mr. Silver: Might I make a suggestion that, coupled with registration, every person that keeps bees should make a return of the number of hives and the condition of those hives, indicating whether he has disease, say, twice a year, on the 1st to the 15th April, and the 1st to the 15th October. If a return were made by every bee-keeper twice a year the authority would know exactly the position of the bee-keeping industry throughout the country, and the condition of those bees.

The Chairman: A note will be taken of your suggestion.

Mr. Frusher: I represent Lincolnshire, and we favour registration.

Mr. Thomas: I suggest that no person be allowed to keep bees without a certificate.

Major Archer: May I move that this meeting approves of the principle of registration?

Mr. Frusher: I will second that.

An Hon. Delegate: I will support that.

Mr. Alder: I want to put a clause in the Bill to the effect that anyone who knows of any bees on his property should notify the same; there might be stray swarms.

Mr. Price: I think that would not work out in practice very well. I am quite agreeable to registration.

The Chairman: I think, if I may say so, what Captain Wellington said about notification is very true, and I think one ought to save you from yourselves. After all, notification would become a statutory obligation. We have many such obligations already; I for one do not want any more. I think registration would give you what you want, because it would give you means of ascertaining the general condition of the bees in the neighbourhood.

Mr. Riley (Leicester): Will that amount to compulsory registration?

The Chairman: If it goes into the Bill it must be.

An Hon. Delegate: May we vote, Mr. Chairman?

The Chairman: Gentlemen, I presume it is scarcely necessary to put it to the vote, but will you indicate?

On a show of hands:

The Chairman: That is carried without the one dissentient. (Laughter.) Ladies and gentlemen, Mr. Bartlett, who most magnanimously refrained from addressing us at the more crowded part of the afternoon, would like to say a few words to express his views on the subject of legislation. It is not re-opening the question at all, but I have agreed on your behalf

that he should make these remarks, and he has promised to be very brief.

Mr. Ritchie: I want to ask a question about that registration business, which has now been passed: Is that to be notified to the County Councils the same as we do about the sugar at the present moment?

The Chairman: Probably. I think in that work what we would do would be this. The Ministry would empower the County Committee, which would be probably a joint Committee of bee-keepers and a Horticultural Committee; that would serve as the model. I cannot commit myself, but I feel pretty certain that would be done.

Mr. Bartlett: Mr. Chairman, ladies and gentlemen, My friends who have been associated with me in opposing legislation in the past have always desired to say that we did not oppose the principle of legislation, but we are extremely anxious that whatever measures are taken should be taken with caution and deliberation, because I think bee-keepers who read the foreign journals and know what is happening in other parts of the world, where legislation has already been given, are at one with me in realising that in no such country has legislation been able to prevent the spread of disease. Legislation is designed to stop the spread of disease, but it has not yet succeeded in doing so, and at this present moment the two chief writers in the American journals, Mr. Doolittle and Mr. Pellet, are writing against legislation. That I think is remarkable because they, like yourselves, are not yet aware how to deal with disease. The unhappy part of the thing is that we may keep bees, and keep them carefully, but yet not be able to check disease. I have had long experience of bees, and if I am unable to prevent disease, where are you to get inspectors with the best will in the world who can stop it? I suggest that, as our knowledge of the checking of disease is so elementary, if it is in existence at all, it would be far better for us to go very slowly with our active measures; that we had better find out how to do things first and then do them.

In the meantime there is one thing that might be done. If you will get bees that are absolutely free from diseases, and then introduce those to areas that are completely free from any other bees, you will meet with success, but as long as you import bees, from any country, good or bad, and pour them into areas where there are already in existence bees with disease, you will have trouble. It is quite impossible to talk about re-stocking counties as long as you leave any bees there at all, because it is quite impossible to tell for some

months whether they are suffering from disease or not. Bees that appear to be quite sound may go under any time.

Speaking from a very large experience, I can say it is almost, if not quite, a hopeless job trying to bring sound bees, immune bees, resistant bees, or anything else into a district that is already infected. You want to clear things out first, and, if the first use the Ministry would put their powers to would be to take some small area and absolutely clear out all bee life before they tried to restock it at all, I think they would meet with such success that they would have no trouble at all in getting people to agree to having the whole of the existent bees cleared out.

An Hon. Delegate: What about the bumble-bee?

Mr. Bartlett: I do not think they are of the same character, nor do I think they are communicable to the hive bee. So little is known I do not think you can say anything is proved.

The Chairman: We have got over two of our points. The third point we want your opinion on is one which is not of great importance, to which Captain Wellington has referred, namely that, as we proposed, the administration of legislative measures shall remain in the hands of the Ministry. Perhaps you would allow me to give reasons why we were led to make that recommendation.

It is fashionable now to delegate all powers, and it is desirable that all powers that can be delegated should be delegated. But in my experience, whenever you are dealing with a general proposition such as disease, and I have had to administer quite other sorts of disease, as, for example, Wart Disease of Potatoes, whenever you are dealing with a matter of disease, you cannot delegate your functions at all, because when you have delegated them into 60 departments, corresponding to 60 odd counties, you have not got rid of the problem. It is a case of the whole being very much greater than even the sum of its parts. You have to keep an eye, in other words, on the relations of one part of the country with another if you delegate to several counties serving different parts of the country; there is nobody to keep that eye; you have given away the powers which you might want to exercise and, therefore, although I have no use for bureaucracy myself, I see no way in which effective administration of legislation of this kind can be carried out except through a central body. I am, frankly, against devolution in that respect, but I am entirely in favour of that central body doing its administration work only in

consultation with the expert as I have already described, and in close relation with the County Authorities which we have set up for this purpose.

Those are my views, which may carry some weight with some of you because they are entirely disinterested. It will not be I to administer this Order if and when it comes in, but I think it is a very great point administratively which this meeting should be aware of, and for that reason I think it is wise to put in the Bill that the Ministry should retain the administrative power in the legislative enactment.

An Hon. Delegate: I think we may take it from that that you mean to say our bees would not be handled only by experts?

The Chairman: Quite.

The Hon. Delegate: If the powers are delegated to a local authority they may appoint anybody.

The Chairman: I do not think they ever would, but they do sometimes. A policeman had to determine what potatoes had wart disease.

The Hon. Delegate: I have no objection to an expert, provided he is a proper expert, but I certainly object to any and every individual who thinks he knows something about it coming and inspecting them.

The Chairman: May I take it that that is the general view of the meeting?

An Hon. Delegate: May I ask this question: Whether this process of leaving it to the Ministry will not be a very slow process, and evil will be done before it reaches the Ministry, and they can take action?

The Chairman: It is not so bad as you might think. There is a certain delay in information getting to the notice of a Ministry, but the thing is rather more organised now. There are representatives of the Ministry in every division of the country, so that it is not the case of having to send right up to Whitehall; there is always a local representative. I do not think there will be more delay than necessarily attaches to any work of Government.

Another Hon. Delegate: I should like to ask a question for the purpose of obtaining information. It has been suggested that notification is not practicable; I am not meaning to suggest that it should be done, but that the Ministry should tell us what can be done and how far it is practicable. How is the Ministry to get the information to know when to act? What could be the means taking place to know when there is disease about, short of notification?

(To be concluded next week.)

## An Apology.

In the BRITISH BEE JOURNAL for December 4, 1919, we published an article translated from *L'Apicoltore Moderno*. Though we gave that paper the credit of the article, by an oversight we omitted to say the translation was from the *American Bee Journal*. We do not have time to be constantly looking up articles in back numbers, and therefore did not notice the omission until a few days ago we saw the following paragraph in the *A.B.J.*:—

### PLAGIARISM.

The BRITISH BEE JOURNAL, in its December 4 number, copies *verbatim* our translation of *L'Apicoltore Moderno's* article on "Cryptograms" published in our September number, page 305. This translation cost us some effort. Since it was easier to borrow it from us than to translate it from the Italian, we believe the BRITISH BEE JOURNAL should have given us credit for the translation.

We offer our apologies to the *A.B.J.*, at the same time we cannot commend the method of bringing the matter to our notice adopted by our contemporary. Our own procedure would have been to first send a short note by post, drawing attention to the omission. Had the *A.B.J.* done this it would have secured the proper acknowledgment, an apology, and thanks for the letter. Failure on our part to so respond to a courteous note would then have fully justified a charge of "plagiarism."

We do not know what the custom is in America, but here, if anyone accidentally treads on our best Sunday corn we do not retaliate with a punch in the face without giving the defaulter the opportunity to apologise.—J. H. H.

---

## A Dorset Yarn.

Our bees are flying away after the salix flowers—"pussy willow" it is called in American books. Ours are quite a distance from the farm after these separate sexual flowers. In the same woods are trees of alder; these have the pistilliferous and polleniferous flowers on the same tree. It is not quite clear to me if bees get anything from the alders; they are flying round them after visiting the willow flowers. The flowers of willows are quite sticky with nectar. The alder flowers are mostly pollinated by wind; the pollen, when ready for distribution, drops off the catkins into a small cup, so arranged that it shall be kept dry from the rain until the female flowers are ready for pollination. They are not always developed sufficiently when the male flowers are at their best.

I notice that bees open the *Trollius*, or

globe flower, as it is called. These flowers never really open; Nature has so arranged the petals to entirely cover the sexual parts that are in the same calyx, so that they should not be injured by wet, or eaten out by big bumble bees. The bees have to get in between the petals to get at the pollen. They have to open the crocus when the sun does not shine, but these flowers are easy to enter compared with the *Trollius* flowers. The same thing happens with the *Eranthis hiemalis*, one of the earliest to bloom in the New Year. The petals entirely cover the seed organs the shelter them from wet. The Ornithogalum, or Star of Bethlehem, which follows later, never opens only when the sun shines, and it is safe for the seed organs to be exposed. All close up at approach of rain or night.

Those readers of THE BEE-KEEPERS' JOURNAL who have magnolias in their grounds will notice the same evolutions; many bees will be round them, even though the petals are all closed over the seed organs, yet bees know that food is there, and they will get in somehow. Some flowers are pollinated both by wind and insects. Take the common plantain. Bees get a great deal of pollen from them in the months of June and July, yet I have seen both the common sorts produce seed that have never had a bee near them. The flowers of the tall one, *lanceolata*, that is found in the hay fields, smells very sweet, and has nectar as well as pollen, yet it will produce seed without the aid of bees. After the hay harvest there are many of these seeds in the wagons, and they lie quite thick round the rick where the hay was pitched off the loads on to the rick. In our fields bees are to be found more on this plant than the white clover. The red clover, "*Icarnatum*," has always a lot of bees, but it's blossoming time is so short—for hay purposes it must be cut as soon as it opens, or it loses a deal of its feeding value. Just now all the laurels have their flower spikes growing perfectly upright on the tops of the branches, but when the flowers open the racemes all become inverted, they hang down like the black and red currants—a wonderful provision of Nature that the flowers should not hold water in the centres, and thus spoil their chances of fertilisation. Several kinds of bees visit these flowers beside the honey bee. The same evolutions can be seen with the bird-cherry and others. Many of our wild plums are in full blossom, so if weather keep warm our bees will have plenty of flowers to look over. The beautiful cydonias, with their many shades of rose and red, are delightful; the wild daffs are in every hedgerow. One sees the school children

with large bunches of them; all tell us "spring has come."

Since writing this our Editor writes he has so much matter to crowd into JOURNAL for that issue, this was not sent on. At the R.H.S. great library I borrowed a book called "*The Flower and the Bee*," published in America in 1919. It gives alder as a source of pollen for Italian bees in the Northern States, with a fine drawing of both staminate and fertile flowers.—J. J. KETTLE.

## Jottings from Huntingdonshire

FOR JUVENILE READERS.

"Well, little bee, are you ready for another gossip?"

"Gossip, sir! Indeed not! Bees—at least female bees—never gossip; it's only the lazy, fat male bees who do the gossiping."

"Sorry, but don't get cross. I'll put it nicer: Are you ready for another interesting chat?"

"Quite ready."

"Good; then may I put you through a personal examination?"

"I've no objection; but don't be too personal, will you?"

"I'll try not. May I first of all ask your name? What are you laughing at?"

"Ah, I was thinking 'that's just like a man'; if you'd been a woman you'd asked me that first, before you began talking of swarms and other things."

"Well, dear Miss Bee," I, a puny man, confess that I'm an inferior mortal, but don't be too hard on me—please tell me your name?"

"Apis Mellifica."

"Where were you born?"

"You asked me that the other day; have you forgotten already? We never forget anything we've been told."

"No? But then I'm a mere man, so you must excuse my dulness. Tell me how many bees were there in the hive you came from?"

"45,000."

"45,000! Oh, Apis, what a number! However do you all know what to do—does your queen instruct you all?"

"No, sir, she does not; she has many ministers to wait upon her, and to advise the hive as to what each bee must do. We take our orders from them, and we dare not disobey—in fact, we have no wish to, we're always loyal to our leaders, although we sometimes have to take sides against our queen."

"Now, that is news; and are these ministers elected for life, and do you have general elections, like we do?"

"They are elected daily during the

honey flow; not so frequently when the hive is at a standstill."

"Daily, did you say? Fresh ones every day, may I ask?"

"Yes, fresh ones every time we change our government; no bee is allowed to remain in the same office two sessions in succession. Our government is arranged as follows:—Royal body guards, ministers, sentinels, ventilators, scouts, waxmakers, architects, varnishers, scavengers, nurses and outside workers, such as honey gatherers, pollen gatherers, and propolisers."

"Really, how wonderful; but tell me where your ministers and rulers place themselves?"

"Oh, you dense man havn't you noticed that yourself? What do you come poking around our hives for if you don't learn anything? Why we know quite a lot about you."

"I daresay you do; but, Apis, dear, just remember when I come to visit you it's two eyes watching 40,000 or more insects, whereas, from your point of view, it's thousands to one."

"Well, yes, you've scored there; you've more sense than I thought you had, so I'll tell you all about our ministers. So many are on each comb, and always some at the bottom, and now you humans have given us such respectable dwellings as movable comb hives we can govern much easier, or at least our ministers can. You will always see some at the bottom of the comb; they know who goes out and who comes in, and if any sentinel allows a robber to pass she gets punished, and sometimes thrown out of the hive, and is kept out until she has learnt better. Do you remember how that the other day you came and took our queen away? Well, some of the ministers saw you, and they signalled the news to the next comb, and those on the next comb to another, and in no time we all knew our queen was gone, so we just went into a panic, our ministers all resigned, and we all stopped working. For a little time we didn't know what to do, and we searched all over the hive to see if we could find a worker bee whom we could make queen. We didn't succeed, so decided we must raise a new queen as quickly as possible, so we set to work and built another queen cell and prepared royal jelly for feeding the grub we selected should be our queen, when, lo and behold, somebody came and said there was a queen in a cage on the top of one of the frames. We were so excited, we elected a new government to greet her, and the ministers decided that if she were ready to come and mother us we would have her, but if she showed fight or no inclination to lay eggs she must be treated as a usurper and con-

demned to death. When we let her down she looked a bit dazed, but in a few minutes began walking about in a friendly way, so we let her stay, and when she began laying we sung our bee doxology, and went on working again as merry as larks, and—I'm out of breath."

"Small wonder, after all that; but I still want to know what you did with the young princess you were rearing?"

"Well, we hadn't been given orders to stop, so we proceeded to make her cell suitable shape and all that, and sealed her over after she had spun her cocoon; but a few days after our ministers said the new queen was even better than the old one, so we won't have any rivals, and they brought her majesty to the royal cell; she put her sting into the unborn princess, and that was the end of it."

"And what of the royal bodyguards?" I asked; "are they always in attendance on their queen?"

"They are always within call," she replied, "but they do not bore her to death by dancing needless attention upon her; like all royal beings, she hates being 'fussed,' and when she wishes she goes out of the hive alone for a constitutional, and although our ministers order some of us not to lose sight of her, we keep far enough away not to be a nuisance in her incognito flight."

"But I've read in books that queens, after mating, never leave their hives until they go out with a swarm."

"Well, that's all wrong; they do."

"Right. I'll write that down."

"Do what?"

"Write it down. I am going to write all this later on for the children's benefit; we've been using rather big words for children to understand, don't you know?"

Oh, you horrid man. Why didn't you tell me. I'm a grown-up bee, not a babe. I'm quite offended." She pouted, and, what was more, refused to speak to me again for a whole week, but she came round at last, and told me a lot about drones and other things, which can wait until next week.—E. F. HEMMING, Steeple Gidding.

---

### British Bee-Keepers' Association.

The annual meeting for passing the report and balance-sheet, election of officers, etc., will be held at the Central Hall, Westminster, on April 1, 3.30 p.m. A conversation will be held after the annual meeting, at which lectures, followed by discussion, will be given by Dr. C. C. Lord and Mr. W. Herrod-Hemp-sall. Further particulars will be given in a later issue.



## Herefordshire Bee-keepers' Association.

### ANNUAL MEETING.

The ninth annual meeting of the Herefordshire Bee-keepers' Association, held at the Y.M.C.A., Hereford, was of unusual interest. Mr. C. T. Pulley, M.P., presided.

The report for the year 1919, as presented by the hon. secretary, indicated that the "Isle of Wight" disease, so much dreaded by apiarists, was passing away. During the last two years 90 nuclei had been sent out from the re-stocking apiary; the vigour of the hybrids showing that they are more resistant of disease than the native black bee, now practically extinct in Herefordshire. The membership of the society now stands at 127, a considerable increase in the last five years. An honorarium of practically 11 guineas, donated by shareholders, was presented to Mr. Arnfield as some small recognition of his services in connection with the re-stocking scheme of 1918. The County Council again granted £35 towards the funds of the Association.

Mr. Mynors, in presenting the accounts, explained the £35 County Council grant referred to in the secretary's report. What the County Council had done was to offer their customary £15, to which they were prepared to add a special £20 conditionally that the Association should furnish them with certain nuclei. This the Association thought was too much to ask from them, and they declined. Later, however, after negotiations had been reopened, the County Council conceded the £20 unconditionally.

The reports were passed, and the election of officers proceeded with.

The Rev. K. O'Neill proposed that Mr. C. T. Pulley be re-elected president. Mr. Pulley, he said, represented in Parliament part of Herefordshire. He was quite willing to represent the Association, not only for the whole of Herefordshire, but also in a portion of Radnorshire, to which their operations extended. Anything which Mr. Pulley took up would be carried through, and as they anticipated Parliamentary legislation in connection with apiculture, they would find it valuable again to have Mr. Pulley as their president. (Applause.)

Mr. Pulley expressed thanks. He was quite willing to act as president for another year, as he felt that he might be of some assistance in the House of Commons. In ordinary circumstances he thought it quite wrong to retain the presidency of any society for a number of years; they ought to get new blood. He therefore hoped that at the end of the

present year they would find themselves another president. After a few years' interval, he (Mr. Pulley) would perhaps again take office. (Applause.)

The vice-presidents (12), with the addition of two more names, were, on the proposition of the Chairman, re-elected *en bloc*. The hon. treasurer and hon. secretary were also re-elected; so, too, was the committee, with the addition of Mr. Norman Helme. Mrs. Clowes and Mrs. Mynors were re-appointed delegates to the British Bee-keepers' Association, and the local secretaries in various parts of the county were also re-elected.

Mr. Arnfield submitted a gratifying report on the 1919 re-stocking scheme, the season having commenced with 14 stocks. Pleasing progress was made; some stocks had done wonderfully well.

The Chairman read a very full reply from the Ministry of Agriculture, which had been sent by that Department in reply to a resolution forwarded to them by the Herefordshire Bee-keepers' Association, urging the necessity for legislation dealing with bee disease. The Ministry wrote sympathetically, recognising the severe loss suffered by British apiarists through the "Isle of Wight" disease, stating that at the present time causes were being investigated, and giving details of ameliorative measures taken, notably by the introduction of Dutch stock and Italian queen bees.

Mr. Pulley then explained the action which was being taken jointly by the Ministry of Agriculture and the County Council. The Government would give two-thirds in addition to such amount as the County Council would be prepared to give. The Association thus hoped to get an advance of £160. Of this, £106 13s. 4d. would be granted by the Government; £53 6s. 8d. by the County Council. He informed them how the Association would apply its £160.

He had before him some figures prepared by an enthusiast, and for that reason he would not do more than submit them, which would interest them. Mr. Alexander in 1905 invested £1,000 in 700 stocks of bees, in one apiary. The average production in the three years was 60,000 lbs. of honey, and that worked out, and all expenses paid, meant that the honey was produced at a cost of a halfpenny a pound.

The Rev. K. O'Neill referred to the amount, now about £70, which Mr. Arnfield had advanced for the Association in connection with his re-stocking work and the rearing of nuclei or colonies. It was important that it should be disbursed. Of course they had not taken into consideration in their balance-sheet a profitable asset in their stock. He alluded with satisfaction to the sympathetic attitude of

the Government and the value of the £160 grant. The importance of apiculture could not be over-estimated, especially in such a county as Hereford, one of the finest fruit-growing areas in England. As for the production of honey, he thought, when they were told that butter might yet rise to 5s. or 6s. per lb., and when they remembered that 1 lb. of honey was equal in food value to 3 lbs. of butter, they might well foster the bee industry.

The hive, which was drawn for, fell to Mrs. Chambers, Hatfield Court.—(Communicated.)

## Notices to Correspondents

**MAJOR SAVILL-ONLEY** (Norfolk).—*Clipped queen and swarming*.—If a colony having a queen with clipped wings swarms, one of several things may happen. The queen may refuse to leave the hive at all, and the bees will return. The queen may attempt to fly, but will fall to the ground. In that case she may be lost, or the bees may cluster with her on the ground, or on anything up which she may be able to crawl.

**"Anxious"** (Stockport).—*Candy made with icing sugar*.—This will not be suitable, as other ingredients are mixed with the sugar.

**H. W. DALTRY** (Crewe).—*Price of beeswax*.—This varies in different localities. We have seen it ticketed at 4d. per oz., but we should say about 3d. would be a fair price for an odd ounce, and larger quantities cheaper in proportion to the weight, 2s. 6d. to 3s. per lb., if well cleaned.

**E. LOOMS** (Stratford).—*Cleaning honey from shallow combs*.—Soak the combs in clean water for about 24 hours, then shake out the water. A gentle syringing with a garden syringe would make a better job of it.

**F. HADFIELD** (Milsbridge).—*Working bees on shores*.—This is a matter for arrangement. If one partner provides all the stock and appliances, and the other does all the work, probably equal shares in the profits would be a fair division. You may divide the stock when the bees are covering eight combs, but do not do it until there is a certainty of drones flying to mate with the young queen. We should say early May would be quite early enough for your district. Bees gather very little nectar from wild hyacinth. If the observatory hive has an abundance of ventilation it might stand in the window for a couple of days. The window and hive must be shaded from the sun. Better allow the bees to fly every evening.

**D. CARPENTERS** (King's Lynn).—*Dianosis for "I.O.W." disease*.—You can only judge by the general symptoms, i.e., a large number of bees crawling, soiling of hive interior and alighting board, excrement thick, and often deposited in strings, abdomen swollen and wings out of place. Dysentery and "I.O.W." disease are closely related, the latter being sometimes called "malignant dysentery."

**"Bys"** (Harrigate).—*Metal foundation*.—You are confounding the foundation with the comb. There are no cells on the former except those built by the bees. The cells of metal comb do not slope, but it does not appear to be any the worse for that. The metal foundation is not coated with wax, and is used in the same manner as wax foundation. We have not yet tried either ourselves.

**L. ARSTIN** (Osborne).—*Bee wine*.—The "bees" referred to are not bees at all, but a kind of yeast. We published a cutting from *The Western Honey Bee* on the subject in the B.B.J. of December 11 last. We cannot say where you can get the material.

### Honey Sample.

**O. E. (Llandwrog)**.—It is from very mixed sources, including lime, chestnut, fruit, clover, etc., quality fair. Dark colour is due to the sources from which it is gathered; the strong smell we cannot account for. It is quite wholesome for human consumption or for bees if it came from healthy bees. It will granulate in time, as it is commencing now. No reason can be given for some honeys not candying.

### Suspected Disease.

**E. CRATTERTON** (Brighton).—"CHESHAM" (Bucks).  
**C. V. PRYSE RICE** (S. Wales).  
**J. G. ADAMS** (Bristol).—The bees died from "I.O.W." disease.  
**R. BROWN** (Gavan).—Cause of death was "I.O.W." disease. The candy was too hard through over-boiling.

**A. E. MCKINTOSH** (Lichfield).—Starvation caused death of bees.

**"Novice"** (Doncaster).—Cause of death was "I.O.W." disease. Better destroy contents of hive, and disinfect it soon as possible. Give the ground round it and the other hives a dressing of ordinary builders' quicklime, and, if possible, dig it in, clean out and disinfect the other hives soon as possible, and see that bees have access to plenty of clean water.

## Special Prepaid Advertisements. One Penny per Word.

### PRIVATE ADVERTISEMENTS.

**FOR SALE**, finest Devonshire Flower Honey, in bulk. What offers?—**D. HUNTER**, Lifton, Devon. c.24

**PURE** Light English Honey, £8 cwt.; sample 3d. —**BUTTON**, Castle Camps, Cambridge. r.c.25

**FOUR** fine, healthy Stocks on 8 frames, 1919 Queens; booked now for April delivery; fourth season without disease; £4 each; box 10s., returnable.—**BROWN**, "Beechwood," Wantage. c.26

**FINE HONEY GATHERERS**.—Being over-stocked, I can supply by middle of May six healthy 8-frame Stocks at £4 each; £1 deposit with order. Honey in bulk, 28-lb. tins, £2.—**VINCENT**, 132, Croydon Road, Anerley, S.E. c.27

**FOUR** 20 lbs. splendid Light English Honey, screw cap bottles, 1s. 9d. per lb., carriage paid.—**A. WILLMOTT**, Apiarist, Higham Ferrers. c.28

**FOR SALE**, two 12-frame Hives, new, three 10-frame Hives, new, and one old 12-frame Hive, Taylor's new 6-frame Swarm Catcher, Honey Press, 40 Standard Frames; lot £12, or best offer. Overstocked.—**T. GREEN**, New Dale, Wellington, Salop. c.29

**WANTED**, Extractor, gear driven, in good condition.—State make, frame capacity, etc., to **BASSETT**, Earley Hill Road, Reading. c.30

**FOR SALE**, Stock of Italian Hybrids, packed down on 10 frames in new hive, complete, £5.—**RADCLIFFE**, Frederick Street, Crosland Moor, Huddersfield. c.31

**SHALLOW COMBS** for Sale, wide frames, perfect; also Excluders.—Apply, Box 69, B.B.J. Office, 25, Bedford Street, W.C.2. c.32

**EIGHT** frames Hybrids, 1919 Queen, 84s.: 5s. returnable box: April delivery.—**DR. SMITH**, Firbank, Burghill, Hereford. c.33

**PURE ENGLISH HONEY**, in 28-lb. tins, £2 each, or nearest offer.—**S. PREECE**, No. 9, Cross Street, Kidderminster. c.35

**ITALIAN BEES**, 12 lots, headed by Penna's imported Queens: 4 frames, 63s.; 6 frames, 90s.; delivery June; carriage paid.—**ENNEVER**, Oak Avenue, Enfield. c.36

**BEES FOR SALE**, strong and healthy, five bar hives, and three straw skeps.—**HIRD**, Church Terrace, Inverurie, Aberdeenshire. c.37

**12 GUARANTEED** healthy Hybrid Italian Stocks, Penna strain, £5 each.—**J. YOUNGER**, 6, Maid's Causeway, Cambridge. c.38

**F**OR SALE, 2-frame Observatory Hive, good condition, 7s. 6d.—SEWARD, Cherington, Aveing. c.40

**W**ANTED, by the Northumberland B.K.A., Expert, April-August, 1920, to work one re-stocking scheme.—State qualifications and salary required to MAJOR SUTWELL, Ord Hill, Berwick-on-Tweed. c.39

**F**OR SALE, 1 cwt. good Essex Honey, in four 28-lb. tins; sample 4d; tins free; price 28.—L. DELSHAM, Heybridge, Essex. c.41

**I**TALIAN HYBRIDS, 1919 Queens, 10 frames; guaranteed strong, healthy, no disease; April delivery; surplus stock. Stamp.—Box 70, B.B.J. Office, 23, Bedford St., W.C.2. c.42

**S**EVERAL healthy Stocks of Bees for Sale with 5 hive, £6, or without hive £5, on 10 frames. raised by bee expert.—MRS. HENNEL, Ash Rectory, Wrotham, Kent. c.43

**F**OR SALE, about 1 cwt. of good Extracted Honey, 2s. per lb., in 14-lb. tins.—ARTHUR ADCOCK, Meldreth, Cambs. c.44

**F**OR SALE, Rymer Heather Honey Press, good condition, £5, or near offer; deposit.—MISS BETTS, Hill House, Camberley. c.45

**F**OR SALE, three colonies Bees (crossed Italian) with Hives, two new Hives, three Section Racks and other equipments. What offers?—"Bee," c/o WALKER, Stationer, Ballard's Lane, Finchley, N.3. c.46

**I**ST CLASS EXPERT (Lady), having large experience, seeks post of establishing or running an Apiary.—Box 71, B.B.J. Office, 23, Bedford Street, W.C.2. c.47

**F**OR SALE, two Stocks of Italian Hybrid Bees, hives and bees included, £6 each.—WHITE, 16, Pulteney Road, South Woodford, Essex. c.48

**T**HE CAMBS BEE BAROMETER.—Send 6d. for the new bee mascot. This sum will be refunded on any 5s. order.—S. H. SMITH, 30, Maid's Causeway, Cambridge. c.49

**P**LANT "Willow Herb" for your bees; useful and ornamental; 12 roots, 2s.—BOWEN, Pittville Street, Cheltenham. r.c.6

**P**URE Light Cambridge Honey, 14-lb. tins, 22s. 6d.; 28-lb. tins, 42s., carriage paid; sample 4d.; tins free.—J. YOUNGER, 6, Maid's Causeway, Cambridge. r.c.9

**E**XPERT required for King's Lynn and District Bee-keepers' Association.—Applications to GEO. A. KNOWLES, Hon. Sec., Tennyson Avenue, King's Lynn. c.13

**F**OR SALE, large quantity of Appliances, including 6-frame reversible Geared Extractor in good condition, nearly new Dadant New Wax Press, Honey Ripeners, Nucleus Hives, Travelling Boxes, both swarms and frames, large number of Section Racks, including single walled, Lee's pattern, Burgess double walled, and W.B.C. hanging frames, Shallow Frame Boxes, etc., quantity new Frames, Sections, Metal Ends, Honey Jars, Glass for glazing, Smokers, etc.—May be viewed by appointment, or particulars from "S," Avenue House, Finchley Lane, Hendon. Stamp for reply. c.14

**B**EESWAX for Sale, good quality yellow, 10 cwt., in 1 or 2 cwt. bags, at 29 16s. per cwt., f.o.r. London.—Apply, Box 67, B.B.J. Office, 23, Bedford Street, W.C.2. r.b.86

**W**ANTED, healthy Stock of Bees, 6 or 8 frames, April delivery.—WATERHOUSE, Rossett Green, Harrogate. r.b.85

**B**EE-KEEPER wanted to take charge of Apiary at Billingshurst, Sussex.—GORDON, 24, Lewes Crescent, Brighton. c.34

**C**ORRESPONDENCE Course in Bee-keeping.—MISS F. E. PALING, Golden Square, Henfield, Sussex. r.a.54

**W**ANTED, portable Greenhouse.—Price and particulars to W. HERROD-HEMPSALL, Old Bedford Road, Luton, Beds.

**W**ANTED, Auster Rear Wind Screen for motor car.—HERROD-HEMPSALL, as above.

**F**OR SALE, one Exhaust Whistle, 11s., post free; one Wood Maim Motor Foot Pump, 45s., carriage free.—HERROD-HEMPSALL, as above.

**W**ANTED, for scientific purposes, a few live Bees, from diseased or dwindling stocks; cages sent and expenses paid.—SNELGROVE, Quadrant, Weston-super-Mare. a.11

**A** VACANCY occurs for a Pupil on an old established bee farm. Opportunity will be given to learn bee-keeping on a big scale.—Apply, Box 61, B.B.J. Office, 23, Bedford Street, W.C.2. r.a.57

**BUSINESS ADVERTISEMENTS.**

1½d. per word.

**M**RS. ARTHUR BREE is booking orders for Swarms of pure Dutch Bees, excellent working strain, at following prices:—May, 40s.; June, 35s. (returnable boxes); also a few Dutch Stocks, £5. Stamp for reply.—Lutton Rectory, Oundle, Hants. c.16

**S**IX packages Flavine, S. Powders, circulars, testimonials, etc., 6d., post paid; Japanned Sprayers, 5s., post paid; Wire Clearer Boards, 6s. 6d., post paid; "Week-end Bee-keeping," Chapter II., "When the Cuckoo Calls," now ready.—S. H. SMITH, 30, Maid's Causeway, Cambridge. c.50

**5-FRAME NUCLEI**, Italian Hybrids, May-June delivery, £3; box 10s., returnable. Orders with deposit booked in rotation.—ERNEST GRIFFITHS, Helsby, Cheshire. c.51

**P**ENNA strain Italian Queens, from June 7.—ASHWORTH, The Bungalow, Weymouth Street, Winchester. c.52

**R**EV. HEWISON (1st Class Expert, B.B.K.A.) makes to order Photo-micrographic Lantern Slides, Anatomy of the Honey Bee, etc.; also Nosema Apis. Particulars on application.—Marr Vicarage, Doncaster. c.55

**A** LIMITED number of 3-frame Italian Nuclei end of May and beginning of June, bred from high-class stock; no disease, and all frames crowded with sealed brood and covered with bees; not as sent by some apiaries—one frame brood and two of stores; £3 3s., cash with order; box 10s., returnable. My guarantee: "Money returned if not completely satisfied."—E. H. TUNMER, "Chalfonts," Leiston, Suffolk. c.54

**3-FRAME NUCLEI**, 45s.; 4-frame, 55s.; boxes 7s. 6d., returnable. Queens, June 10s., August 7s. 6d. Cash with order. All guaranteed healthy. Over 30 years' experience.—G. SAWYER, Marlow, Bucks. c.55

**S**TRONG, healthy Bees, 10-frame Stock in W.B.C. hive, now; 6-frame Stocks, April; Swarms to order.—SMITH, 5, Florence Terrace, Ramsgate. r.c.56

**P**URE ITALIAN QUEENS AND NUCLEI.—Can accept few more orders. This strain is second to none, hardy, good disease resisters, very prolific, splendid honey gatherers, comb builders, little given to swarming, quiet to handle. June 3-frame Nuclei, £2 15s.; 4-frame, £3 5s.; well covered with bees and brood; 1920 pure fertile Italian Queens, June-July 9s. 6d., August-September 7s. 6d.; Virgins, 4s. 6d.; few hybrid natural Swarms, £2 5s.; safe delivery; carriage paid; cash with order; satisfaction guaranteed.—BARTLETT, Bee Specialist, Crowthorne, Berks. c.21

[The above advertiser and advertisement are not in any way connected with Mr. C. B. Bartlett, Witney, Oxon.]

**STOCKS**, native and hybrid Bees, £4 each; S Swarms, £2; Nuclei, £1 18s.; Hybrid, £2 2s.; pure Italian, £3; Queens 10s. 6d. each, carriage paid.—S. CRAWFORD, Apiaries, Castlederg, Co. Tyrone. r.c.17

**STRONG ITALIAN STOCKS** on 7 frames with S 1920 Penna Queens, ready June, £5; travelling box 10s. extra, returnable; strong 3-frame Nuclei with 1920 Queens, £3; boxes 7s. 6d. extra, returnable. Cash with order, or quarter amount deposit. Italian Queens, home mated, 12s.; Virgins, 5s. 6d.; booked; ready May onwards. Pupils taken.—MISS PALING, Golden Square, Henfield, Sussex. r.c.23

**ITALIAN NUCLEI** from 30s., Fertile Queen from 7s. 6d., Virgins from 3s. 6d., 3-frame Stocks £4. Warranted healthy. Particulars stamp.—WATTS, Conway Cottage, Newtown, Parkstone, Dorset. r.b.93

**ITALIAN NUCLEI**, 3-frame, Penna's 1920 Queens (guaranteed), 65s.; Hybrids, Penna's and Simmins' Special, early delivery, 50s., carriage paid; box returnable. Orders (cash) strict rotation.—MOORE, 31, Monmouth Road, Dorchester. r.c.1

**STOCKS** and Nuclei, headed by 1920 Queens, guaranteed pure mated Italians, good gatherers, prolific, and gentle; ten frames, £5; six, £3 10s.; three, £2 10s.; June onwards; cases 10s. returnable.—H. NEVILLE, Mount Pleasant, Fieldgate, Walsall. r.c.2

**DUTCH AND DUTCH-ITALIANS**.—Four-frame Nuclei, May and June delivery, orders taken in rotation, £3 3s.; cash with order; carriage paid. They are the *Daily Mail* strain I have had seven years, and Bee-Mason's four years. Never had disease; beautifully clean and healthy. You want good disease resisters, prolific, and heavy honey producers. **HERE YOU HAVE THEM**.—SEALE, Ashley Cottage, Oatlands Drive, Walton-on-Thames, Surrey. b.92

**DON'T BUY BEES** until you have seen our prices and guarantee. You risk nothing, as we return money in full if bees fail to give satisfaction. Special terms to disabled men. Catalogue 3d., which is refunded on first order.—PEARSON & GALE, Marlborough. b.94

**WATERPROOF RUBBER SHEETS** for covering outhouses, etc., 72in. by 36in., brass eyelets, 12 for 20s.—SAGARS STORES, Ardwick, Manchester. b.16

**HAVE YOU READ "THE BEE WORLD"?** If not, why not? Every number in itself is a useful literary work for practice and reference. Specimen copy free.—Offices: THE APIS CLUB, Port Hill House, Benson, Oxon.

**ITALIAN QUEENS** direct from Italy. Price list for 1920 on application.—Address, E. PENNA, Bologna, Italy. w.39

## THE "CLARIDGE QUALITY NUCLEI."

From this week's letter bag—

" . . . I wished to write and tell you "how very pleased I have been with the 3-frame "nucleus which you sent me in 1918 . . . they "wintered well (having built up a very strong "colony) . . . and from your original stock "I now have THREE well developed strong "hives ready for full work."

*This nucleus was supplied on July 29th.*

No fear of failure with the "Claridge Quality Nuclei."

Every frame is FILLED WITH BROOD!!!  
Only pure Italians supplied.

List post free from

Claridge, Copford Apiary, Colchester

Send for

## Bee-Keepers Wake Up!

You can make a Big Profit if you use right up-to-date Appliances, including the Manley Hive. MEADOWS, SYSTON, LEICESTER.

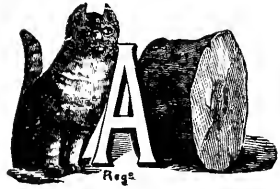

Queens that will fight "Isle of Wight" Disease.

Send 3d. for

## 'The Secret of Immunity'

and Price List.

T. F. COBB, 33, Bevan Road, Plumstead.

# Dutch Bees.

I have been appointed Sole Agent for Hans Matthes, the Dutch Bee Farmer who supplied the British Government last season with Skeps for their County Re-stocking Scheme. Hans Matthes also supplied me with what Skeps I required last year.

Last autumn I got a large consignment over from Holland, and am presently wintering these at my Apiary here.

To those desirous of testing these Dutch Bees, I will be pleased to send on my Illustrated Catalogue, containing much information regarding the hardiness, prolificacy, disease-resisting, and honey-gathering characteristics of this race of bee.

Address—

R. WHYTE,

The Bee Farm,

Cumbernauld, Dumbartonshire.

The products of the Apiary, of Poultry and Farm Stock, of the Fruit and Vegetable Garden can be Advertised and Sold through

THE BAZAAR, EXCHANGE & MART  
Newspaper.

Get a Copy—Thursday and Saturday 3d. The "Bazaar" publishes also practical handbooks by experts. Send for full catalogue, post free from—WINDSOR HOUSE, Brems Buildings, LONDON, E.C.2.

THE British Bee-Keepers' Association.

The recognised centre of practical and scientific bee-keeping in Great Britain.

Particulars and conditions of membership may be obtained from the Secretary,

W. HERROD-HEMPSELL, 23, Bedford Street, Strand, London, W.C.2.

**Don't Order "W.S." Queens until you have seen the "Queenland" Revised List for 1920. 3½d. post free**

**NUCLEUS STOCKS—Same Price as 1919.**

The only Pedigree Bee-Stock Registered in direct line for more than 25 years.

**"AMALGA" is the name of our Queen breeding mother for 1920**

**"ALTA" is the name of our Drone parent for 1920.**

**PRODUCE OF ONE NUCLEUS REALISES OVER £40 IN CASH.**

"The three-frame nucleus I purchased from you had increased last autumn to two strong stocks. I supered one on April 23rd of this year, and the other a few days later. I sold two swarms, and made up the others to five stocks. Of these I also sold three stocks. The original lot gave 198 lbs. of honey, and in all I have taken 365 lbs. My sales amounted to over £41 in actual cash."

(Miss) H. G. MOYSEY.

Somerset, Oct. 9th, 1918.

**EXCEEDS 500 PER CENT INTEREST.**

"We have now 12 stocks to winter, besides selling one, out of the two three-frame nuclei supplied June 20th last year." (August 15th, 1917).

Miss B. D.

Quainton, Bucks.

**THREE TO SEVENTEEN.**

"It may interest you to know that the three stocks to which I introduced your queens (the only stocks saved in the apiary) in 1916, produced in all 17 stocks, and a good surplus in honey in 1917; this under the care of my wife who knew nothing about bees. I simply directed her as to management from there (France)."

OLIVER G. PIKE.

April 9th, 1918.

**FIRST AND BEST.**

"Your White Star strain was the first to enter the sections, and all the honey I got was from them."

G. H. S.

Heddon House Dairy.

**APRIL 19TH.—BOILING OVER.**

"The hive is simply boiling over with W. S. bees. They are at work when my other stocks are idling, and they are stronger than any of my other stocks."

Aberdare, Wales. E. T. W.

**ARE THE W.S. PROLIFIC?**

"In 1904 I got a W.S. queen from you, and last year (1905) by the first week in June she had brood in twenty-five standard frames."

J. H.

Higher Kinnerton, Chester.

**SAFE DELIVERY of Nuclei and Queens GUARANTEED**

**NUCLEUS DELIVERED IN JUNE; 40 FRAMES BY AUGUST.**

"The three-frame nucleus of bees now occupy 40 Standard Frames. They have exceeded beyond anything I believed possible. I have never had anything like them before, and if the other queens on order turn out the same I consider my fortune made."

JOHN JONES.

Llancarfan, Aug. 21st, 1918.

**SEVERAL STOCKS FROM ONE NUCLEUS.**

"It seems almost ridiculous that this nucleus of the previous season (Aug.), before I was prepared for it, swarmed in April, and I now have several stocks from that investment."

J. W. MCKAY.

Croydon.

**EIGHT STOCKS FROM ONE W.S. NUCLEUS.**

"I now have eight stocks from the one nucleus you supplied last year."

J. JONES.

Llancarfan, May, 1919.

**BEST IN THE COUNTY—NEVER SAW THE LIKE!**

"May 26th.—The two queens you sent me have exceeded anything that I ever thought of. The stock chambers are full and crammed with brood, and all three supers crowded with bees; but even with this the bees are boiling over. I have not fed them at all, and have removed several frames of brood for another lot. The County Expert called yesterday, and said he had never seen such bees, and they were certainly the best in Hampshire."

D. D. P.

**NO SPRING-FEEDING, BUT AGAIN FIRST.**

"The W.S. bees on eleven 16 x 10 frames were full and boiling over at the middle of May, and were the first to enter supers out of 23 stocks; and last, but not least, they required no spring feeding."

U. W.

Arnold, Notts.

Revised 1920 "White Star" List, 3½d., of S. SIMMINS, Queenland, Heathfield, Sussex.

# HIVES.

Compare the WORKMANSHIP and FINISH of our Hives.

All made by practical Men who know what a good hive should be.

In various designs to suit all tastes and requirements.

Season's speciality—THE MANLEY HIVE for 16 in. x 10 in. Frames.

Full descriptions and illustrations in our 1920 Catalogue:

*"Everything for an Apiary."*

If you have not received your copy, send a P.C. at once.

OUR MOTTO—SERVICE & QUALITY.

**R. STEELE & BRODIE, Wormit Works, Wormit, Scotland.**

## 'Order Early and secure the Best'

THE FOLLOWING UNSOLICITED TESTIMONIALS PROVE THE ABOVE :

Dear Sir.—The bees arrived all right this afternoon. Both my wife and I are very pleased with them. They are a splendid lot and should we at any time require more we shall know where to write.—Yours faithfully,  
A. J. B.—Chesterfield.

Dear Sir,—I received the bees on Saturday. I am highly satisfied with them, they are a fine lot and I think they will soon be a full stock.  
Yours truly,  
A. M. GOOLE.

## The best of Satisfaction given.

These Nuclei consist of 3 frames of Mature Brood (not merely eggs and honey) but in advanced stages and well crowded with Bees. Queens exceptionally fine bred from selected stocks under the most ideal method of Queen-Rearing. They are sent Carriage Paid to anywhere in Britain for the following price:—

3 Frame Pure Italian Nuclei **£3 3 0**. Terms Cash with order or £1 deposit, balance Mid May.

**J. H. ROPER, The Bee Farm, Thorpe-on-the-Hill, Lincoln.**



## "BACTEROL" FOR BEES

2/6 per Pottle.

Post Free.

The cure for, and preventive of, "Fist of Wight" Disease. Non-poisonous—free from stain or unpleasant odour.

**MENLEY & JAMES, LTD.,**  
39, Farringdon Road, London, E.C.1.

## INSTRUCTION in BEEKEEPING PRACTICAL AND THEORETICAL

My Apiary will be open for a limited number of pupils during this season. Terms and particulars from

**W. HERROD-HEMPSALL,**

**The W.B.C. Apiary, Old Bedford Road, Luton, Bedfordshire.**

## S. J. BALDWIN.

I beg to inform that the No. 1 Kent Hive is not manufactured by me, only the No. 2 "Bromley Kent."

(New deep frame 17 x 14 x 12. Sample by post 6d.)

## THE APIARY, BROMLEY, KENT.

Look after your profits by buying hives and appliances which are easy to work. I endeavour also to give good value by care over the workmanship. Send for catalogue.

**EDWARD J. BURTT, Manufacturer, GLOUCESTER.**

*Commercial (16" x 10") frames and brood boxes stocked.*

PRINTED BY THE AVENUE PRESS (L. UPCOTT GILL & SON, LTD.) 55-57, DRURY LANE, LONDON, W.C., AND PUBLISHED FOR THE PROPRIETOR (W. HERROD-HEMPSALL), BY SIMPKIN, MARSHALL, HAMILTON, KENT & CO., LTD., 31 & 32, PATERNOSTER ROW, E.C.



No. 1969. Vol. XLVIII MARCH 18, 1920. [Published every Thursday, Price 2d.

**CONTENTS.**

	PAGE		PAGE
CONFERENCE OF BEE-KEEPERS .....	135	Pembrokeshire B.K.A. ....	140
A DORSET YARN .....	136	Guildford B.K.A. ....	141
JOTTINGS FROM HUNTINGDONSHIRE .....	137	Notts B.K.A. ....	141
TO TALK OF MANY THINGS .....	138	South Staffordshire B.K.A. ....	141
HONEY IMPORTS .....	138	CORRESPONDENCE—	
ASSOCIATION NEWS—		A Young Bee-keeper's Letter .....	142
Montgomeryshire B.K.A. ....	139	Early Pollen .....	142
Derbyshire B.K.A. ....	139	QUERIES AND REPLIES—	
Kent B.K.A. ....	139	Various Queries .....	142
		The "Acid Test" of Honey .....	143

**ALUMINIUM DRAWN OUT COMBS.**

**“MONEYCOMB”**

*The greatest invention in the Bee World for 40 years.*

This is a drawn out Comb of Hexagon Cells exactly as bees build in their natural state. It is slightly coated with wax, has been thoroughly tested, and is not an experiment. Bees readily take to it for rearing brood and storing honey. Strong and durable, will last 50 years with care. Big consumption of honey saved to produce wax for comb building. Control of bee diseases. No more burning of combs. Each comb easily sterilised and used over again.

Send for Catalogue and descriptive Leaflet. 1920 Catalogue post free.

Patented by ALUMINIUM HONEY COMB CO., of U.S.A.

SOLE MANUFACTURER AND LICENSEE:

**E. H. TAYLOR, WELWYN, HERTS.**

**Don't Order "W.S." Queens until you have seen the "Queenland" Revised List for 1920. 3½d. post free**

## NUCLEUS STOCKS—Same Price as 1919.

The only Pedigree Bee-Stock Registered in direct line for more than 25 years.

**"AMALGA" is the name of our Queen breeding mother for 1920**

**"ALTA" is the name of our Drone parent for 1920.**

### PRODUCE OF ONE NUCLEUS REALISES OVER £40 IN CASH.

"The three-frame nucleus I purchased from you had increased last autumn to two strong stocks. I supered one on April 23rd of this year, and the other a few days later. I sold two swarms, and made up the others to five stocks. Of these I also sold three stocks. The original lot gave 198 lbs. of honey, and in all I have taken 365 lbs. My sales amounted to over £41 in actual cash."

(Miss) H. G. MOYSEY.

Somerset, Oct. 9th, 1918.

### EXCEEDS 500 PER CENT. INTEREST.

"We have now 12 stocks to winter, besides selling one, out of the two three-frame nuclei supplied June 20th last year." (August 15th, 1917).

Miss B. D.

Quainton, Bucks.

### THREE TO SEVENTEEN.

"It may interest you to know that the three stocks to which I introduced your queens (the only stocks saved in the apiary) in 1916, produced in all 17 stocks, and a good surplus in honey in 1917; this under the care of my wife who knew nothing about bees. I simply directed her as to management from there (France)."

OLIVER G. PIKE.

April 9th, 1918.

### FIRST AND BEST.

"Your White Star strain was the first to enter the sections, and all the honey I got was from them."

G. H. S.

Heddon House Dairy.

### APRIL 19TH.—BOILING OVER.

"The hive is simply boiling over with W. S. bees. They are at work when my other stocks are idling, and they are stronger than any of my other stocks."

Aberdare, Wales.

E. T. W.

### ARE THE W.S. PROLIFIC?

"In 1904 I got a W.S. queen from you, and last year (1905) by the first week in June she had brood in *twenty-five* standard frames."

J. H.

Higher Kinnerton, Chester.

SAFE DELIVERY of Nuclei and Queens GUARANTEED

### NUCLEUS DELIVERED IN JUNE; 40 FRAMES BY AUGUST.

"The three-frame nucleus of bees now occupy 40 Standard Frames. They have exceeded beyond anything I believed possible. I have never had anything like them before, and if the other queens on order turn out the same I consider my fortune made."

JOHN JONES.

Llancarfan, Aug. 21st, 1918.

### SEVERAL STOCKS FROM ONE NUCLEUS.

"It seems almost ridiculous that this nucleus of the previous season (Aug.), before I was prepared for it, swarmed in April, and I now have several stocks from that investment."

J. W. MCKAY.

Croydon.

### EIGHT STOCKS FROM ONE W.S. NUCLEUS.

"I now have eight stocks from the one nucleus you supplied last year."

J. JONES.

Llancarfan, May, 1919.

### BEST IN THE COUNTY—NEVER SAW THE LIKE!

"May 26th.—The two queens you sent me have exceeded anything that I ever thought of. The stock chambers are full and crammed with brood, and all three supers crowded with bees; but even with this the bees are boiling over. I have not fed them at all, and have removed several frames of brood for another lot. The County Expert called yesterday, and said he had never seen such bees, and they were certainly the best in Hampshire."

D. D. P.

### NO SPRING-FEEDING, BUT AGAIN FIRST.

"The W.S. bees on eleven 16 x 10 frames were full and boiling over at the middle of May, and were the first to enter supers out of 23 stocks; and last, but not least, they required no spring feeding."

U. W.

Arnold, Notts.

Revised 1920 "White Star" List, 3½d., of S. SIMMINS, Queenland, Heathfield, Sussex.





## Conference of Bee-Keepers re Legislation.

(Continued from page 126.)

The Chairman: Each county has, or will have; most of them have already—I have, I hope expressed my thanks to the Bee-Keepers' Associations—most counties have a committee containing representatives of bee-keepers, and all others interested in general cultivation. Each county committee has a horticulturalist interested in a whole lot of small cultivation. He has assistants, and on that staff there is, let us say, a part-time bee-keeper who will make it his business to visit all parts of the country, not as an inspector, not as a policeman, but as an adviser. In the course of his duties he may encounter cases of gross neglect. He will try and persuade, and ascertain whether the persuasion has been efficacious, but when it is not he will probably get some other member of the committee to come down and report it, and then it will be dealt with. But you cannot mix up your policeman and your teacher; it is a very dangerous thing; we have often tried it at the Ministry, and we have always failed, because the one is always mistaken for the other.

An Hon. Delegate: I would like to say one more word. You will find that this question of inspection of hives for disease is the sorest point of all in the question of legislation, and I would ask you all, on behalf of every bee-keeper here present, to do everything you possibly can to see that inspection is carried out properly by proper expert bee-keepers.

The Chairman: I have had such a lot to do with this inspection, and it was such a terrible thing for me when I started on it, but I find, as a matter of fact, we have to do a good deal of inspection of nurseries and fruit plantations, and in point of fact, provided it is done by men who have two qualities, one is knowledge and the other is tact, there is no difficulty; but you have to find men with both qualities.

The Hon. Delegate: The proceedings are nearly finished, but I should like to draw the attention of the Government to one particular point which hits the bee-keeping industry, and especially the future of the bee-keeping industry. In your address you referred to the value of the

home-produced honey as between £500,000 and £1,000,000, and the value of the honey imported into this country from abroad as between £2,500,000 and £2,750,000. What some of us want to know is this: What is the attitude of the Government with regard to this, and how would they propose to deal with this question in the future? Do they propose to encourage the importation of honey from abroad, or do they wish to encourage the production of honey at home?

The Chairman: I am sorry to interrupt, but this is a matter which concerns the Cabinet, and not a single Ministry. I enjoy it, because it comes up so often, but as a matter of fact it is a matter of high policy, and therefore can only be discussed at a Cabinet meeting.

The Hon. Delegate: Can nothing be said?

The Chairman: I do not think it is worth our while discussing it; really I do not.

The Hon. Delegate: What I want to draw attention to is this: That within three-quarters of a mile of where I live tons of honey are bottled up with the name of some paltry firm, and sold as English honey. What are you to do with that?

The Chairman: That is another story, which British bee-keepers will, I am sure, in proper time and place, take up, but it is not particularly relevant to our meeting this afternoon. I would ask, therefore, if any gentleman has any other point of principle that he wishes to bring forward, that he should do so now.

Mr. Reid: There is one item here which says, "Every local authority shall appoint such inspectors and other officers as may be necessary for the execution and enforcement by the local authority of Orders under this Act." Well, now, Sir, that does leave the door open very wide.

The Chairman: No. I think I may interpret that. Of course, there is a certain common form of drafting in these Bills, but that does not contract us out of our responsibility. This is common form. Though the powers can be delegated, it is the intention of the Ministry to retain these powers. I think you may accept it. You can have it in writing in the "Report of the Conference," if you like, that it is the intention of the Ministry to retain those powers; but it will not do to take a draft to your legal adviser and ask him to make a brand new Bill; he will always put it in the form in which that type of Bill goes.

Mr. Reid: I would not venture to dispute the legal position of matters, but I am

quite sure that every bee-keeper in this room would wish you to insert in paragraph (2)—“Every local authority shall appoint such *qualified* inspectors and other officers as may be necessary.” If you put in the word “qualified,” or “properly qualified,” then I think the objection would be met. Any legal questions I do not wish to introduce. I would not, in one of the remaining clauses, call a Minister a Ministry; I would call a Ministry a Ministry; I think to call a Minister a Ministry —

The Chairman: We will have that point at the end; that we need not discuss. You will see, in line 5 of Clause 2, you have got a governing phrase—“the ‘Ministry or the local authority,’”—that applies throughout. I do assure you—I am speaking about that with a lot of experience—I would rather remove the Ark of the Covenant than try to alter a legal term. You cannot get your men who are responsible for drafting Bills to put a thing in a simple and straightforward way that a common person like myself would like.

Mr. Reid: May I remind you that the Ark of the Covenant was ultimately destroyed absolutely?

Mr. Bold (Lancashire): I should have said the very same words as the last speaker, but I was relying on paragraph (3) “The appointment of an inspector shall be subject to the approval of the Ministry.”

The Chairman: I think you may take it that the Ministry, after all, under this Bill will have the powers; the Local Authority will only be its delegate, and the Ministry will only appoint a delegate when it decides to. At present it does not intend to delegate its powers.

Mr. Bold: Of course, the Ministry would not sanction the appointment of anyone who was not a bee-keeper to come and inspect our hives. That is the point. If the Ministry gave that assurance there would be very little objection.

The Chairman: We have given that assurance.

Mr. Harwood (Middlesex): May I ask you to overcome your diffidence and give me and the meeting generally an interpretation of this part of the Bill? Section (3) reads: “In any proceedings under this Act, no proof shall be required of the appointment or handwriting of an inspector or other officer of the Ministry or of the clerk or an inspector or other officer of a local authority.” Is it a question of the meaning of the word “proceedings,” because later on I see, “An inspector of the Ministry or of the local authority may for the purposes of

any Order under this Act at any reasonable time, enter any building or place wherein he has reasonable ground for supposing that there are or have recently been bees affected by any pest or disease, or that any Order under this Act has not been or is not being complied with, and may examine or cause to be examined any bees, honey, or comb on such premises and anything thereon used for or in connection with bees”? Is the point “for inspection”?

The Chairman: “Proceedings” under (3) simply means legal proceedings, police court proceedings, or whatever it may be. That again is common form, to obviate having to prove in court you wrote something which you wrote.

An Hon. Delegate: In regard to paragraph 2. “Orders for preventing spread of bee disease”: I am an expert at Cambridge, and in going round one has had a few expert’s experiences this year. There was a case in point bearing on the paragraph: “The Minister may make such orders as he thinks expedient for preventing the spread in England and Wales of any pest or disease affecting bees, and any such Order may direct or authorise the destruction by the Ministry, or the local authority, of any colony of bees so affected, and any receptacle (other than a serviceable movable comb hive) in which there are or have been bees so affected, and the contents of any receptacle which is being used or has recently been used for bees so affected. The Minister or Local Authority may in respect of anything so destroyed pay such compensation as the Minister or Local Authority may think fit.” One would think a stock of bees very bad with disease would gather no honey. I saw a stock diseased with the worst form of foul brood: a strong stock. I decided to leave it alone, rightly or wrongly. That stock gathered 185 lbs. of honey. If that had been destroyed, what compensation should have been given? I suggest to you that you should consider it, because it would have been a loss to the country had that stock been destroyed. I may say from my own experience—we destroyed a stock in the autumn—it is a thing the Ministry should consider, this question of compensation.

An Hon. Delegate: On behalf of the Cambridge Bee-Keepers’ Association, may I ask what are the proposed qualifications for an expert?

The Chairman: Really, that is worth a written question; if you will put it in writing and send it up to the Ministry, they will be able to consider it. I suppose a competent knowledge of his work. A

man must have been a practical bee-keeper, he must have kept bees, and he must have a working knowledge of the conditions under which bees live. He can have any other knowledge you like. I do not think I could answer it more than that.

The Hon. Delegate: The reason I asked the question was because a few years ago a practical bee-keeper, well known throughout the country, with first-class and other certificates, a producer of a large quantity of honey, took a quantity of diseased bees in hives on to a piece of ground about half a mile from a very large bee-keeper. That rendered bee-keeping absolutely impossible in that district. The point arises: If a man with all these qualifications can go and condemn another man's bees, and is incapable of managing his own, his qualifications are not much use.

The Chairman: Surely it is not uncommon that a high degree of skill goes together with an extraordinary amount of stupidity. One might hope that does not occur regularly. Many of us are extraordinarily stupid sometimes, but we might rely on the Advisory Council or Committee of Practical Bee-keepers to petition the Ministry not to renew the appointment of that gentleman, if he did these things.

I think the time is getting late. I would ask if there are any other suggestions in relation to the considerations before us that any member of this Conference desires to put.

Mr. Snelgrove: If this Bill ever becomes an Act, and the Ministry have to administer it, I for one, and I think I am voicing the opinions of the meeting, hope that they will not do it in a half-hearted sort of way. (Hear, hear.) A remark of Captain Wellington's rather alarmed me. He spoke of trying to do all this by persuasion first. Well, we have all experienced the effects of persuasion, and we have been waiting so long for this Bill that I am sure we all hope, Sir, that whenever the Ministry do it, they will do it with the greatest possible vigour. (Hear, hear.)

The Rev. Mr. Morgan: I think it was understood, at least I understood it in that way, that it was persuasion first: compulsion afterwards. In the past we have had persuasion: now we need compulsion. Compulsion comes if persuasion fails.

Mr. Frusher: I can give you an instance of some hives standing from 1914 till last March, in a neighbourhood where they cleared all the bees off, and they

would not remove them by persuasion, nor yet sell them.

The Chairman: Well, that is a case for compulsion. Well, Gentlemen, there is no more business before the meeting.

An Hon. Delegate: I should just like to remark that, so far as I know, there is nothing in this Bill to hint that skeps are not advisable. I do not know how you would deal with those. An inspector comes across a lot of skeps he cannot inspect; what is he to do? There is no guidance, so far as I know, in this Bill. What compels me to speak, more than anything else, is an assurance from Captain Wellington that this Bill is going to be carried out in rather an easy manner, at any rate to start with, and we really shall have something going forward. I do want to know what is to happen about the skeps.

Mr. Reid: May I make one remark, Sir, before we part? We have had a very interesting meeting here to-day, we have had a chairman who has conducted our business with very great ability and courtesy—(cheers)—and I would ask you, if the chairman will permit me, to give a hearty vote of thanks, from this conference, to our chairman, Dr. Keeble.

Mr. J. B. Lamb: Mr. Chairman, ladies and gentlemen, Mr. Reid rose to do what I was going to do one minute ago—I second it—to ask this meeting to thank you very sincerely for your able conduct in the chair to-day. I assure you I have attended hundreds of meetings, but I do not think I have come across one chairman who possesses such a super-abundance of tact and patience, and combines so admirably the *suaviter in modo* with the *fortiter in re*. Although I came half expecting ructions, I think the fact that we have not had ructions is due entirely to your tact. May I also associate with you Captain Wellington, who, so very clearly explained to the meeting what is comprised in about four pages of foolscap? (Hear, hear.) I will now second the resolution, and put it to the meeting: is it your pleasure?

The resolution was carried by acclamation.

The Chairman: Ladies and gentlemen, the fact that I came to this meeting at a very great personal inconvenience, and from a long distance, makes it all the more agreeable to find, that, in spite of the journey, the conduct of the meeting has met with your approval. The reason why Captain Wellington asked me to represent the Minister and preside at this meeting was a very simple one. During the years of the war, when I was at the Ministry of Agriculture, I set myself one

task, which I believe is a real task, and that that was to smash altogether the idea that a Ministry represents a governing body issuing edicts, to be obeyed by those persons to whom they were addressed. Instead of that we have now got, in all matters relating to horticulture and to intensive cultivation, a concordat between the industry and the Ministry, which is enabling us to do rapidly what we could not do, even with great delay, before, and I hope that, as the result of this meeting, you and I may now look forward to the time when bee-keepers will not disagree with one another, there will be found a common measure of agreement, and that you will all help to make this industry what it deserves to be, a very general and a very successful one. (Cheers.)

(The Conference then terminated.)

#### CONFERENCE OF BEE-KEEPERS—A CORRECTION.

I notice you say in your issue of the 11th I was the first to bring disease into our county—Derbyshire. That is an error on your part. I have never bought a swarm. I said a certain gentleman (giving the name) was the first, by buying a swarm from a certain dealer.—J. PEARMAN, Derby.

[We are sorry Mr. Pearman was not reported correctly, but the error was not ours, as the report is printed exactly as received. The mistake was made by the reporter in transcribing his shorthand notes.—EDS.]

### A Dorset Yarn.

Bees have wonderful eyes that they may see the flowers that they search over for nectar, yet it is scent that they depend on most for the searching. Some flowers smell like honey; this is very noticeable in clover and peas. Notice the coriander flowers when open in summer; they smell very strong of honey, but the foliage has a very nasty smell indeed. The hemlock flowers have the sweet smell of honey, but the foliage, if rubbed with the hands, smells like mice. There is so much that the nature lover can learn if he but takes notice as the bees search over flowers. Take the flowers of hawthorn, the wild sloe, apricot, almond, cherry, sea buckthorn, and bird cherry. These smell like beeswax. Bees work them all in their season. Take, again, the strong-smelling garlic; all the growth has the strong smell of onions, yet the blossoms (unless you rub the stems) smell very strong of honey.

I have a friend, a manufacturing chemist, who says that ethereal oils are distilled from the flowers of oranges, gardenias, yuccas and magnolias, from the

citron and thyme. All this proves that the honey scent must be very prominent in these flowers. But some of the Daphnes, sweet as they all are, are very variable; one of them fills a room with the smell of violets (I presume that is the source of the strong perfume that is labelled violets), another of them smells like lilac. When a grower of flowers in the gardens of the wealthy, and when different flowers were used on the dinner tables, the odours given off these Daphnes were very noticeable. Scent must be the chief guide to these nectariferous flowers. Bees must smell them from a long distance; see how they work the Virginia creeper; the flowers are exceptionally small and have no colour. It is the same with vines in the open; these have a very sweet honey odour, though they have no colour to guide the bees to them; when grown under glass the perfume is very pleasing. We have no bees to fertilise them; the grower always raps the rods in order to jerk the pollen off the stamens on to the pistil, so as to ensure perfect fertilisation.

In some flowers the nectar can be seen to glisten when the sun shines directly on them; this is seen on the ivy in autumn, on the spindletree and saxifrages. Those that have a wealth of stamens, like almonds and peaches, have the calyx tube lined with nectar, but it is hidden by the wealth of stamens carrying pollen. Bees have to force their way to it by pressing aside the stamens. Kerner states that Linums, Dianthus, Lychnis, and most papilionaceous flowers have nectar in the stamens. What is so singular with them is that nine of them only have nectar, the tenth has none; the nine are fused into the floral tube in which the nectary is closed. The same writer states that the snowdrop secretes nectar in parallel grooves on the inner side of the floral leaves; this is the same with many of the fly family. Kerner also states that the Hellebore, or Christmas rose, has abundant honey at the base of stamens.

On the farm now there are flowers of plums, Jargonelle and Louise Bon of Jersey pears. Raspberries and gooseberries are showing the buds, but the last few days have been cold. Our bees have not gone further than the peaches, which are all round and among the hives; but these have so many thousands of flowers there is plenty for them to do without going far away. So very beautiful they are, particularly the large-flowering ones—as beautiful as almonds, and much more useful, as they furnish us with delicious fruits from July to October. Most of them are grown as standard trees, growing and spreading naturally, with the branches all radiating outwards, covered with their beautiful flesh-coloured flowers. In Holy

Writ we have it noted of a tree that man was not to eat the fruit; so, in ancient Chinese, traditions of the peach-tree of life and a peach-tree of knowledge, which grew on a mountain, guarded by 100 demons. It brought death to all mortals that ate it. Modern growers bud the peach on plum stocks, but they will fruit from seed in a few years if the soil is not over-rich, and very fine fruits will come on some of the seedlings. Many Americans believe that a fruit diet in the hot season is the best for health; they eat a lot of peaches.—J. J. KETTLE.

## Jottings from Huntingdonshire

FOR JUVENILE READERS.

First I must ask my young readers to recall that, as stated a few weeks back, this conversation took place last summer. Some of them seem to think I am alluding to the present time. Not so: it wouldn't do to try introducing queens in March, would it? A little girl would like to know if "its all true or make-believe." Will she wait until I'm finished and then ask me again? A young laddie thinks it's awfully clever to be able to talk to a bee and understand the bees' language, and wishes to know if it's as hard to learn as Latin. Not quite; and now shall we get on. Apis, after a week's ponting, became quite amiable again, and apologised for her rudeness of the week before; and, after assuring me that bees are really fond of boys and girls, providing they don't get playing hide and seek around and leap-frog over, the hives, and poking sticks in the entrance after dark with the hope that said sticks will come out coated with honey, I asked her why bees reared such a lot of drones. "One reason," she said, "is they help keep the hive warm at certain times of the year, and another reason is that our young queens like to have plenty of lovers to choose from."

"But Apis, dear," I replied, "do drones ever help? To me they seem to hinder and be generally in the way."

"They're not all alike, sir," said she: "some of them do at least come and watch us as we empty our honey into the cells and say flattering words to us. Of course they ask for some of our honey which we can't resist giving after they have talked to us so nicely. Just a few—the gentlemen—will help to make a way for us when we are in a great hurry. On the other hand, a lot of them go in a corner to sleep till about midday, when they wake up and go blundering out of the hive, knocking everybody down. I must say they have shocking manners at times. These are no good at all, for when the queen goes to

select a lover she never chooses one of the sleepy, lazy sort."

"How can she tell one from the other when there are so many?"

"Oh, she goes out of the hive and flies about to be sure she will know the spot when she comes back, then she flies up and up, and the very lazy drones haven't the inclination to fly so far; therefore, its just the best drones who go up and up with the young princess, or virgin queen, as she is sometimes called, then she chooses the very best of those to be her lover."

"Then to give the young queen a large choice is one reason why you rear so many drones?"

"Yes. If we had only one or two drones our young queen would not go out on a lover's flight for perhaps a month instead of about four days after her birth."

"Why should she stay a month?"

"Because she could lay drone eggs which would hatch into drones in 34 days; and they would wait 10 days or more before going out for a flight, so it might be even five or six weeks before the young queen went for her courtship flight."

"Really! Then if I were to catch all the drones in a hive but one or two, and destroy all the drone cells and put in a virgin queen she would w —"

"She would be killed."

"Killed?"

"Yes, and quickly. You won't ever do it, will you?"

"I mustn't after that. But supposing, Apis, that a hive had sent out a swarm, and after the swarm had gone I killed all the remaining drones and destroyed all drone cells, would the young queen, when born, wait a month before going out?"

"Yes, if there were no other hives about."

"What if there were?"

"Why some scouts would be sent out to see if there were any drones on the wing, and if they returned and said 'yes,' we should make the queen go out and choose a lover from drones of other hives."

"But, dear Apis, I've often been told that young queens will choose sweethearts from other hives, even when there are scores of would-be lovers in her own; is that true?"

"Yes; if a drone from a strange hive can fly higher and better than one from her own city, the young queen will be sure to make love to that one. I wonder you don't try and prevent it."

"Prevent it, Apis! How?"

"Easily; if you want drones of one hive to be sweethearts to all your queens, you should trap the drones in all the hives except that one."

"I know; but I've done that, dear; but what about hives in a neighbour's garden,

if there happen to be any, and worse, that hive may be diseased."

"You are insulting me again, you horrid man."

"Insulting you, Apis; how do you mean?"

"I'm an Italian bee"

"You are, dear; but what have I said against Italians?"

"Italian queens don't choose lovers from diseased drones, so there!"

"Sorry to hurt your feelings; forgive me, and just tell me if drones are of any other use than what you have described."

Not much; you see, like all men, they don't like work."

"Ah, that's too bad; why do you say so?"

"Because I think you're all alike. Drones go out for a few hours a day and come back, and begin asking if the meals are ready, and we lady bees have to work, work, work, and I've heard say you men kick up ever such a fuss if you have to work more than eight hours a day. Yet you expect your wives to be at work morning, noon and night. We don't stand too much of it: your women have more patience than we have."

"How do you right matters?"

Easily enough: when honey is getting scarce we say to them, 'No food for you unless you can work! They try and fight for it, but we close round them, tear their wings, bite their legs, and drive them forth out of the hive, and don't allow them back."

"But I've seen one or two drones in winter, Apis; how's that?"

"Well, just one or two hide themselves in some corner and wait till our anger has cooled, and then come crying for mercy, and pretend to be anxious to do anything we want them to do, so we let them stop. They make good meals for Tits in winter when they come tapping the hive—I'm getting tired; may I go to my box?"

"Yes, run along, and have a good rest, and we'll conclude our talks next week."

—E. F. HEMMING.

## To Talk of Many Things.

The general body of readers of this JOURNAL must, I think, owe a debt of gratitude to him who suggested a reprint of the articles formerly contributed by the choice spirit that expressed itself over the pseudonym of "Lordswood."

To many, I am one of the number, who have become readers since the dates of original publication, the re-print has all the charm of novelty. The exquisite Nature lover who, condemned by one of life's little

ironies to dwell in a suburb of that monstrous accretion that nauseated the soul of Cobbett, yet contrived occasional excursions, suggests the parallel of the lark, caught in its native meadow by a prowling ruffian and imprisoned in a cage in some squalid slum, whence, taking advantage of its gaoler's drunken clumsiness, it escapes, and regaining its natal air pours out its thanks in a flood of melody. Oh the pity of it that it should be fated to be again emmeshed in the fowler's net so soon as it drops to earth once more.

The inevitable regret that so gifted a writer is no longer with us is tempered by the consciousness that his mantle, or at any rate a generous fold of it, has fallen upon the Rev. E. F. Hemming, of Steeple Gidding, Hunts.

This gentleman, from his enviable seclusion in his little Huntingdonshire parish, is giving us articles which, while reminiscent in their spirit, of the lamented author of "The Drone Fly," are *individual in style, fresh in matter*. Mr. Hemming's personality so informs his writings that one seems no more willing to criticise them than one would be to beard him in the pulpit. There is no disputing the fact that occupants of country parsonages have embellished perhaps more than any other class—the bye-paths of literature. Parochial histories, so rich in varied lore, natural histories—every parish differs from others in its fauna and flora—these form a conspectus of the lives of that population which is the essential and enduring element of a sane commonwealth, together with a mirror of the setting in which those lives begin and end.

Not the least important function of this school of literature is the keeping in touch with the All-Mother those who, as "Lordswood" phrases it, "but for a diabolical combination of untoward circumstances" would still crowd round her instead of being herded into the exile which is best described by an inversion of the first line of Shelley's "Comus."

The entry into apicultural journalism of so competent and scholarly an observer as the rector of St. Andrew's—to say nothing of the pleasing contributions of his brother and daughter—is an auspicious event in the history of our craft, and welcomed by no one more than the present writer.—A. F. HARWOOD.

## Honey Imports.

The registered value of honey imported into the United Kingdom during the month of February, 1920, was £15,543.—From a return furnished by the Statistical Office, H.M. Customs.

### Montgomeryshire Bee-keepers' Association.

The Montgomeryshire Bee-keepers' Association has now become an accomplished fact, and the first meeting of the body proper met at Welshpool, under the presidency of the Vicar of Llanerfyl (Rev. T. D. James).

On the motion of Mr. Salter, Mr. Johnson Pugh was elected Chairman of the Committee. It was unanimously resolved to form a Bee-keepers' Association, to be called the Montgomeryshire Bee-keepers' Association, at an annual subscription of 5s., which would meet—said Mr. Holmes—the needs of rich and poor alike. The objects of the Society being to combine in an Association all bee-keepers within the county, and enable them to take united action for their mutual benefit.

In reply to Mrs. J. H. Davies, Mr. J. L. John stated that the County Education Committee had allocated £30 to the Bee Committee to assist towards the re-stocking scheme and in disinfecting the hives.

The general rules of the Association were drafted and passed.

Mr. John stated that under the scheme of the Ministry of Agriculture one paid-up share in the Association would entitle a bee-keeper to a nucleus. If a bee-keeper required more than one nucleus he could procure more by the purchase of fresh shares.

In arriving at a price of a share Mr. Spence reminded the Committee that the prices of nuclei had very greatly advanced since November, 1918, when the scheme was first mooted.

Mr. Holmes said they wanted bee-keepers in Montgomeryshire, and he was fighting for those poor bee-keepers who could not afford to pay £3 or £4 for a nucleus.

Mr. John thought the Committee might make special arrangements for bee-keepers who were in poor circumstances.

Mr. Holmes was deputed to visit the apiary of Rev. E. M. Davies, of Taliesin, and procure immune stocks from him.

It was agreed to open an account at the Welshpool Branch of the National Provincial Bank.

Mr. Rees Price having signified his intention of resigning from the post of Secretary, Mr. J. L. John congratulated him on securing a new and better appointment, although they greatly deplored his departure from Welshpool.

Mrs. J. H. Davies also spoke of the great loss the Association would suffer by the resignation of Mr. Price.

It was decided to ask Mr. Gordon Stuart to undertake the secretarial duties. —S. C. HOLMES.

### Derbyshire Bee-keepers' Association.

Amidst feelings of regret, Mr. R. Giles, for many years chairman, informed a meeting of the Derbyshire Bee-keepers' Association that owing to impaired hearing it was with reluctance that he felt compelled to resign that position. An ideal chairman, and with unremitting devotion to his duties, Mr. Giles had won the respect and confidence of all. He still remains an active member, and it is hoped the affliction may only be of a temporary character.

Mr. Pallett, another pillar of long standing, was unanimously elected Chairman, and he referred in sympathetic terms to the unfortunate circumstances which caused his election. He then welcomed the new members, remarking that bee-keeping, after a period of adversity, had completely revived, membership was increasing, and there never was a keener desire to commence. It was for them to stimulate that desire more and more, and he urged the importance of encouraging the art more extensively at schools, and the Association rendering any educational assistance in its power.

Mr. Morris (expert and schoolmaster, Alvaston) said he had already established an apiary there, and bee-keeping was being taught. Both he and his assistant were thoroughly interested in the work.

Mr. Eaton (schoolmaster, Hatton), an experienced bee-keeper, thought the object was an excellent one, although his impression was that many scholars were not so fond of bees, as they were apt to think the sting was no plaything. However, they had a number of bee-keepers who were schoolmasters, and there lay the foundation for the future expansion of the industry.

It was decided to hold a honey show this year in conjunction with the Agricultural Show, and arrangements were being made to hold examinations of members for expert certificates. Candidates should forward their names early. There will also be demonstrations on both days.

A resolution was passed protesting against the increased price charged for bee sugar, and that steps should be taken to eliminate the hardship imposed, contending that the price should not be in excess of that for domestic use.—(Communicated.)

### Kent Bee-keepers' Association.

#### A SUCCESSFUL LECTURE AT BEXLEY.

An extremely instructive lecture was given at the Freemantle Hall, Bexley, on Thursday last (March 4) by Dr. C. Courtenay Lord, of Orpington. The subject of the lecture was "Some Wonders of Bee Life," and was illustrated by a number of

excellent lantern slides. In the unavoidable absence of Colonel Knowles-Stansfield, C.B.E., of Baldwyns Park, Dr. J. Brander presided. The Chairman was supported by Dr. Jackson Wolfe, chairman of the district, under whose direction the details had been arranged, also Mr. A. Dewey and Mr. G. W. Judge, chairman and secretary respectively of the Kent Bee-keepers' Association.

The meeting was arranged with a view of further encouraging the culture of bees in the neighbourhood, and, judging from the enthusiasm exhibited, there bids fair to be a revival of interest taken in this fascinating pursuit. The district is a good one for bee-keeping, and it is no uncommon occurrence for individual hives to yield upwards of 100 lbs. of honey in a good season when properly managed.

The lecturer, after dealing with the life history of the honey bee, briefly described some of the most important organs of the queen, worker and drone.

Illustrations were shown of the details of the mouth and tongue parts, the eyes and wings, revealing marvellous structures highly specialised and beautifully adapted to perform their respective functions.

Bee-keeping in Kent was well organised, yet only the fringe of its resources had been touched. At present there was only one colony of bees to every 183 acres. It had been computed that for every pound of honey produced in this country 3 lbs. were purchased abroad. The Association was doing its best to remedy this state of affairs.

At the conclusion of the lecture a number of questions were asked and answered, after which Dr. Jackson Wolfe proposed a hearty vote of thanks to the lecturer, which was accorded with acclamation.

Mr. A. Dewey moved a vote of thanks to the Chairman of the meeting (Dr. Brander). He also explained the aims and objects of the Association and the remarkable growth which had been attained during the last few years. Bexley is within the area of the Eltham Branch, of which Mr. W. H. J. Prior, Main Road, New Eltham, is the secretary. Dr. Jackson Wolfe, of Claremont, Bexley, had very kindly offered to give anyone who needed information or advice the benefit of his experience.

The Secretary of the Association, Mr. G. W. Judge, stated for the benefit of those who wished to commence bee-keeping that nucleus colonies of bees could be obtained during June and July at two guineas each through the Restocking Scheme being carried out by the Kent Bee Development Committee. Full particulars could be obtained from him at Barrowdene, Shepherd's Lane, Dartford,

or direct from the Agricultural Organiser, Sessions House, Maidstone. In regard to the supply of hives and other equipment, these could be obtained from any of the advertisers in "Bee Craft," the Association's official journal. The Bee Supplies Association was constituted by the Kent Bee-keepers' Association some years ago to supply bee-keepers with their requirements. Their address is 36, High Street, Dartford.

The rendering of the National Anthem brought the meeting to a close.—(Communicated.)

## Pembrokeshire Bee-keepers' Association.

### FIRST ANNUAL MEETING.

The first annual meeting of the Pembrokeshire Bee-keepers' Association was held at the Agricultural Executive Committee's Offices, Haverfordwest. Mr. Frank Hayman, Uzmaston, was voted to the chair, and was supported by Mr. T. G. Lewis, J.P., Councillor F. D. Phillips, Mr. Thomas Mends, Rev. Henry Morgan, B.A., Mrs. Annie James (Little Milford), Mr. W. H. Owen, and others.

The Hon. Secretary (Mr. D. Evans Bonvouni, Barham School, Trecwn) read the following report on the progress of the Association during the past year:—

"This report is unique as being the first of a regularly constituted Bee-keepers' Association in the County of Pembrokeshire. For some years the idea of forming such an association was current, and the matter crystallised into a 'live' meeting of bee-keepers early in February. An executive council was elected, while in March the rules and privileges were drawn up. The Government Re-stocking Scheme was discussed, and it was felt that as the County Council Bee Sub-Committee had the matter in its hands, we had no option but to agree with its decisions. The Rev. H. Morgan, St. Brides, undertook the working thereof, and sent out nuclei. Prizes were offered for honey exhibits at Fishguard and Haverfordwest Horticultural Shows with good results. 'Isle of Wight' disease, which has played havoc with the stocks of late years, is still prevalent in many districts, but we have strong hopes of eradicating this disease in the very near future. Legislation is expected in this session of Parliament. Local experts have been appointed for the county, and are giving their services free. An application has been made to the County Council for a grant to enable the Association to carry forward the good work by lectures, pamphlets, and other means."

The Chairman paid a high tribute to



the services rendered by Mr. Bonvouini in connection with the formation of the Association, and congratulated him on the splendid progress that had been made. Mr. Bonvouini had taken up the work with real enthusiasm, and had given a valuable impetus to bee-keeping in the county.

Mr. Bonvouini was unanimously re-appointed as hon. secretary, and the other officials were also re-appointed.

An interesting feature of the meeting was the exhibition of the Uxbridge W.B.C. bee-hive, which was given by the Rev. Henry Morgan, and as a result several new users of this hive were secured.

A vote of thanks to the Chairman and officials brought a successful meeting to a close.—(Communicated.)

### Guildford and District Bee-Keepers' Association.

The preliminary meeting of the above was held at the Guildhall, Guildford, on February 21. The Mayor (Mr. W. S. Tavener) presided, and it was decided to form the association, a provisional committee being elected to draw up rules for submission to a meeting of members. This committee has duly met and the first meeting of members will be held on Saturday, March 20, at 3.15 p.m., at the Guildford Institute and Library, to elect officers, receive the rules suggested by the committee, and discuss future work and meetings. Bee-keepers in the district, and also those interested in bee-keeping, will be heartily welcomed.—(Rev.) E. C. PITT-JOHNSON, hon. secretary.

### Notts Bee-Keepers' Association.

ANNUAL MEETING.

The 35th annual meeting of this Association was held in the Wesley Hall, Nottingham, on Saturday, February 28, Mr. Wm. S. Ellis, of Hawksworth, presiding, there being a large attendance of members and friends, amongst whom were representatives from the adjoining counties of Leicestershire and Derbyshire, also Mr. C. Taborn, the horticultural organiser for Notts, Mr. W. Herrod-Hempsall, Mr. J. Herrod-Hempsall, and others.

A satisfactory record of progress came under review, it being reported as follows :—

During this period we have enrolled 48 new members, and at the present time the number of members who have paid their subscription is higher than for the two previous years, viz., 240. We are also pleased to note that some few have increased their subscription, to enable us to meet the present high cost of everything.

We welcome back those of our members who have returned from the Forces, and

trust we shall see them active in the more peaceful pursuit of bee-keeping, and lively members of our Association.

The balance-sheet, when carefully examined, will show that we have been able to carry our finances through in a way which we hope will prove satisfactory. The cash balance is small owing to the grant made at the last annual meeting to the Re-stocking Committee, which we think all will agree was money well expended, as it has been of great value to the cause of bee-keeping in this county.

The price of sugar came under review, and it was stated that negotiations were in progress between the Ministry of Food and the Royal Commission on Sugar Supplies, with a view to its reduction in price for the purpose of feeding bees.

Mr. Taborn stated that they wanted to see four or five times as many bee-keepers in Notts, for getting four or five times as much fruit, etc., and that the County Council had in mind the starting of another re-stocking apiary for the production of bees to this end. (Hear, hear.)

The Duchess of Portland was re-elected president. The committee were re-elected, with the addition of Messrs. W. Trinder, Edwin-stowe, and A. E. Goodlad, Mansfield. Mr. G. Hayes was again appointed secretary and treasurer, and he mentioned that at next annual meeting he will have completed a quarter of a century in office, and that he would then have to ask to be allowed to retire. Mr. A. Riley was re-elected auditor.

Mr. Riley reported that Mr. Pugh was unable to be present owing to illness, and it was requested that a letter be sent him stating the meeting's regret at the cause of his absence, and wishing him a speedy recovery.

An adjournment was made for tea, to which a large company sat down.

A conference of bee-keepers and others was held in the evening, when a very lucid, instructive address on "The best methods of increase" was given by Mr. W. Herrod-Hempsall. It was listened to with rapt attention, and at its conclusion a most enthusiastic vote of thanks was accorded him.—(Communicated.)

### South Staffordshire and District Bee-Keepers' Association.

ANNUAL MEETING.

The annual meeting of the above took place on the 6th inst. at Jesson's School, Dudley, and was well attended. The agenda, which provided for the passing of the report and balance-sheet, election of president, vice-presidents, officers and committee, was carried through under the chairmanship of Mr. E. H. Hipkins, J.P. The following were unanimously elected

by the members:—President, Mr. R. Talbot Clayton; vice-presidents, Messrs. Ed. Davis, J. T. Horner, General Hickman, M.P., W. E. Pearson, E. H. Kipkins, and Jos. Price; secretary, Mr. J. W. Walton, vice Mr. A. E. Taylor, resigned; treasurer, Mr. C. C. Thompson; committee, Messrs. A. Cheshire, W. Hildreth, E. C. Middleton, G. F. Stubbs, A. E. Griffiths, C. Robinson, Thos. Taylor, A. E. Taylor, Walton (Wolverhampton), Mrs. Thompson, Mrs. Sheldon, and Miss Manley.

On conclusion of business the members adjourned to the Temple Café, where they partook of tea nicely arranged for them in the newly decorated dining-room. After tea an interesting address was given by Mr. J. Price, county expert, who reported upon the progress of the bee re-stocking scheme, etc. He was followed by Mr. Middleton, who related what passed at the recent conference of beekeepers in London relative to proposed legislation for the prevention and spread of bee diseases. The usual votes of thanks ended a pleasant evening.—(Communicated.)



### A Young Bee-Keeper's Letter.

[10143] Will you kindly send me the book called "Bee-keeping Simplified," as I'm anxious to learn all about bees and their ways? My daddy gave me a small hive last year, and I want them to have plenty of honey this year, so I can sell it and have the money to give my mother to buy some new teeth. I hope you will not laugh, but she wants them very bad. To-day I found a new-born drone bee outside my hive on the alighting board. Don't you think they are early? I would like this little letter put in the BRITISH BEE JOURNAL if you think it's nice enough. My daddy has it every week, and I do enjoy reading about "The Little Bee," by E. F. Hemming. I know you will be sorry to hear I'm a little cripple. I've been under two operations, but I shall never be like other little boys; but I don't mind much, for I'm very fond of woodwork, drawing, and making ships and other things, and I mean to look well after my bees, and hope to be a help to my mother and father later on.—CYRIL T. W. TOMS, Devonport (age 12 years)

[It gives us great pleasure to print the above letter, and we are sure that, far from laughing at it, everyone will wish our young friend a most successful sea-

son, with a bountiful harvest of honey. It is early in the year to find a drone, but as the weather has been so mild the last few weeks bees will be very forward, especially in the south-west of the country.—Eds.]

### Early Pollen.

[10144] In reply to H. F. Swann (10135), February 19, *re* early pollen, I think I can beat his bees easily. On December 15 the bees in two of my hives were carrying in pollen; had I watched longer it is possible that pollen would have been noticed on the legs of bees entering my other hives.

I would like to say, in passing, what very interesting reading friend Kettle's articles make; but they are not always altogether bee articles. I think I also read an enthusiastic once-upon-a-time gardener, and one can forgive him for allowing his enthusiasm for gardening, to lead his thoughts away from bees occasionally.—H. WARD.

[Mr. Kettle is not by any means a once-upon-a-timer, but an enthusiastic present-time gardener.—Eds.]



### Various Queries.

[9902] As long ago as 1894 I wrote to THE BRITISH BEE JOURNAL, and asked to be informed of the name of the inventor of the honey-extractor. The reply was: "The honey-extractor, as the machine is now known to bee-keepers in this country, is described in THE BRITISH BEE JOURNAL of May 1, 1874. The original invention was, however, due to Major von Hruschka, an officer in the Italian army." The Rev. Mr. Digges, in his *Guide*, says the name was *de* Hruschka, an Italian, and the A.B.C. says it was Major D. Hruschka, of Venice.

As I am writing something about bees, I should be greatly obliged if you would reply (in next week's issue, if convenient) to the following queries:—

1. The name of the original inventor of the honey-extractor, with date?
2. If the humming and other sounds of bees are caused solely by their wings? (Is the buzz that bees make on a hive being jarred the result of wing-movement?)
3. Is the sting of a wasp barbed, or is it able to withdraw it easily?—A. CANNING WILLIAMS, Hon. Sec., Edinburgh Beekeepers' Association.

REPLY.—1. The correct designation is Major von Hruschka, a retired Austrian

officer, who was residing at Dolo, near Venice. He invented the extractor in 1865, and introduced and described his invention at the Conference of Beekeepers held at Brünn in that year. 2. The buzzing is produced by the wings, and the humming by the spiracles as described in "The Honey Bee," by T. W. Cowan, page 85. 3. The sting of the wasp is barbed, but the barbs are so fine that, unlike those of the honey bee, they do not prevent the withdrawal of the sting.

### The "Acid Test" of Honey.

[9903] In Section 10 of his classic work M. Maeterlinck says that the bees inject a drop of formic acid into each cell of honey before sealing it over. Some editions of the book have a note "proving" this to be incorrect; but the fifty-ninth thousand edition, the latest, omits the note. Is it because there has been evidence to corroborate the author?

It is a point of intense interest, and it appears to me that the only conclusive proof lies in the comparative analysis of honey unsealed and sealed. The latter contains the minute quantity of .1 per cent. of acids.

Can you tell me (a) what other acids, besides formic acid, honey contains? and (b) whether any experiments have been made to preserve foods with formic acid? and (c) what is the percentage of acid in unsealed and sealed honey?—EDGAR W. DEMPSTER.

REPLY.—It was formerly suggested that as formic acid was found in honey, a drop was injected into the cell before sealing, but it has been demonstrated by A. Caillas that through secretions produced from the blood the indispensable formic acid is incorporated in the honey. The quantity of formic acid in honey, sealed or unsealed, is 0.14 per cent. A minute quantity of phosphoric acid is also found in honey, and M. Caillas gives it as an average of 125 mmg. per cent. We do not know what experiments have been made to preserve foods with formic acid.

## Special Prepaid Advertisements. One Penny per Word.

Advertisements must reach us NOT LATER than FIRST POST on TUESDAY MORNING for insertion in the "Journal" the same week.

### PRIVATE ADVERTISEMENTS.

**SELL COWAN EXTRACTOR**, geared and reversible cages, price £4 10s.; approval; deposit.—Box 68, B.B.J. Office, 23, Bedford Street, W.C.2. c.15

**WANTED**, Honey Ripener with strainer and tap, perfect condition, for small apiary.—SCOTT, Temple House, Kennington, Ashford Kent. c.57

**OWING** to considerable reduction in my stocks I have a large variety of healthy bee goods for disposal, mostly for W.B.C. hives. Send for list.—DELL'S, County Apiaries, Leigh, Lancs. r.c.58

**FINE** Light Honey, granulated, 23-lb. tins, £2 per tin; tins and case free; sample 6d.; carriage forward.—WELLS, Bowers Lane, Isleham, Cambs. c.59

**TWO STOCKS** Hybrids, healthy, strong, one Frame Hive with roof and legs, one without, one Swarm Box, one Excluder, two Crates, 50 Sections, eight Frames, ½ lb. Brood, 1 lb. Super Foundation; £11 to clear.—JOYCE, Park View, Farnborough, Hants. c.60

**FOR SALE**, three strong Stocks of Hybrid Italians, in bar frame hives, and in splendid condition, £15 the lot.—MANAGER, King's Arms Hotel, Hemel Hempstead, Herts. c.61

**PURCHASERS** may select Colonies from an apiary which has never known disease. Wintered chiefly on honey. Now very strong. Must be called for. Four colonies for disposal at £4 each, including combs. Appointment.—Ivy Bridge, Chislehurst. c.62

**WANTED**, Extractor, geared; also Ripener, good condition.—"BEES," Mill Cottage, Bell Hill, Billericay. c.63

**FOR SALE**, W.B.C. Hives, large and small, rapid feeders, excluders, new unused honey boxes to hold 5 doz.—Particulars, GEORGE, Oak Drive, Oswestry. c.64

**FOUR HIVES** for Sale, no disease; 50s. the lot.—5, Strafford Road, Twickenham. c.65

**FOR SALE**, two good Stocks Italian Hybrids, ten frames each, two 1919 Queens; two Taylor hives, four-section racks, two wire Queen excluders, Porter's escape board, smoker, 50 sections; everything in good condition; £12.—PINDER, Barnsdale, Kings Road, Walton-on-Thames. c.66

**WANTED**, Beekeeper, with practical working experience of nuclei and general bee work, as Assistant, lady preferred. Also vacancy for Pupil. Easy terms.—Write C. H., c/o J. W. VICKERS & CO., LTD., 5, Nicholas Lane, E.C.4. c.67

**AR** Werth Gwenyn Italiad Cymraeg, Haidau, Nuclei, Breihinesau, Mai a Mehefin Gwarediad: Cymhwysiadau a Cwchiau.—BOOBIER, Valley Bee Farm, Bishopston, Swansea. c.68

**FOR SALE**, one strong Stock of Bees, in skep, £4 10s.; also stock on six frames, £4.—NEAME, Popley, Hants. c.69

**GUN**, 12 bore, hammer, by Stephen Grant; will exchange for five stocks of bees, must be on six frames.—Box 72, B.B.J. Office, 23, Bedford Street, W.C.2. c.70

**SEVEN** strong Stocks of Bees, on eight to ten standard frames; price £5.—H. CRAFER, Gisleham, Lowestoft. c.71

**SEVERAL** splendid Stocks, on ten frames, 1919 Penna Queens, April delivery. Stamp reply.—NEWELL, 93, Reginald Street, Luton, Beds. c.72

**WANTED**, Extractor, not geared, for brood and super frames.—POWELL, Drellingore, Folkestone. c.73

**A** STAMPED addressed envelope will bring you a free sample of Flavine, Testimonials, Circular, etc.—S. H. SMITH, 30, Maid's Causeway, Cambridge. c.74

**CAUCASIANS**, Carniolans, Queens, three of each wanted, pure imported, in June. Deposit B.J.—H. CLEAVER, 8, Northcote Street, Leamington Spa.

**PURE** Light English Honey, £8 cwt.; sample 3d.  
—**BUTTON**, Castle Camps, Cambridge. r.c.25

**FOR SALE**, two 12-frame Hives, new, three 10-frame Hives, new, and one old 12-frame Hive, Taylor's new 6-frame Swarm Catcher, Honey Press, 40 Standard Frames; lot £12, or best offer. Overstocked.—**T. GREEN**, New Date, Wellington, Salop. c.29

**ITALIAN BEES**, 12 lots, headed by Penna's imported Queens; 4 frames, 63s.; 6 frames, 90s.; delivery June; carriage paid.—**ENNEVER**, Oak Avenue, Enfield. c.36

**BEEES FOR SALE**, strong and healthy, five bar hives, and three straw skeps.—**HIRD**, Church Terrace, Inverurie, Aberdeenshire. c.37

**12 GUARANTEED** healthy Hybrid Italian Stocks, Penna strain, £5 each.—**J. YOUNGER**, 6, Maid's Causeway, Cambridge. c.38

**WANTED**, by the Northumberland B.K.A., Expert, April-August, 1920, to work the restocking scheme.—State qualifications and salary required to **MAJOR SITWELL**, Ord Hill, Berwick-on-Tweed. c.39

**1ST CLASS EXPERT** (Lady), having large experience, seeks post of establishing or running an Apiary.—Box 71, B.B.J. Office, 25, Bedford Street, W.C.2. c.47

**PLANT** "Willow Herb" for your bees; useful and ornamental; 12 roots, 2s.—**BOWEN**, Pittville Street, Cheltenham. r.c.6

**PURE** Light Cambridge Honey, 14-lb. tins, 22s. 6d.; 23-lb. tins, 42s., carriage paid; sample 4d.; tins free.—**J. YOUNGER**, 6, Maid's Causeway, Cambridge. r.c.9

**FOR SALE**, large quantity of Appliances, including 6-frame reversible Geared Extractor in good condition, nearly new Dadant New Wax Press, Honey Ripeners, Nucleus Hives, Travelling Boxes, both swarms and frames, large number of Section Racks, including single walled, Lee's pattern, Burgess double walled, and W.B.C. hanging frames, Shallow Frame Boxes, etc., quantity new Frames, Sections, Metal Ends, Honey Jars, Glass for glazing, Smokers, etc.—May be viewed by appointment, or particulars from "S," Avenue House, Finchley Lane, Hendon. Stamp for reply. c.14

**BEE-KEEPER** wanted to take charge of Apiary at Billingshurst, Sussex.—**GORDON**, 24, Lewes Crescent, Brighton. c.54

**CORRESPONDENCE** Course in Bee-keeping.—**MISS F. E. PALING**, Golden Square, Henfield, Sussex. r.a.54

**WANTED**, portable Greenhouse.—Price and particulars to **W. HERROD-HEMPSALL**, Old Bedford Road, Luton, Beds.

**WANTED**, Auster Rear Wind Screen for motor car.—**HERROD-HEMPSALL**, as above.

**FOR SALE**, one Exhaust Whistle, 11s., post free; one Wood Milne Motor Foot Pump, 45s., carriage free.—**HERROD-HEMPSALL**, as above.

#### BUSINESS ADVERTISEMENTS. 1½d. per word.

**FLAVINE CANDY**.—6 lbs. for 10s., post paid. No certificates needed.—**S. H. SMITH**, 30, Maid's Causeway, Cambridge. c.75

**ALBERT HOPKINS**, Specialist Breeder and Importer of best strains of Italian Bees, is booking orders for his guaranteed perfectly healthy and reliable Stocks and Nuclei, which, being well established, quickly become profitable colonies. Prices strictly moderate. List on application. Many testimonials and repeat orders. 25 years' practical apicultural experience.—**Woodland Valley Apiary**, Lyninge, Folkestone. c.76

**ITALIANS**.—Queens, 5s. Book now. Stamp.—**HOUSTON**, Ellen Villa, Sidcup. r.c.77

**NEW** more Nuclei, also Swarms, from disease-resisting strain. Orders now booked for early delivery.—**CHEESMUR**, Forest Apiary, Worth, Sussex. c.78

**FOR SALE**, Swarms, Hybrid Italians. Orders executed in strict rotation.—**KAYE**, Kilderry, Hatfield Peverel, Essex. c.79

**HAVE YOU WINTERED 100 PER CENT.?** If not, your strain must be wrong. Booking orders now for delivery June onwards. Hardy, disease-resisting, home-reared Italians; splendid honey gatherers. Three-frame Nuclei, 1920 Queen, price £3 5s., carriage paid; 7s. 6d. refunded on box if returned carriage paid, Saxilby Station. Terms: Cash with order.—**HERBERT VALLEY**, Apiarist, Saxilby, Lincoln. r.c.80

**ITALIAN NUCLEI**, 3 frames crowded with sealed brood, 1920 Queen, early delivery, £3 3s., carriage paid; box 10s., returnable. Cash with order. Complete satisfaction guaranteed or money returned.—**E. H. TUNMER**, "Chalfonts," Leiston, Suffolk. r.c.81

**FOR SALE**, W.B.C. Hives, standard size, made of American pine, complete without erection, painted three coats, 50s. each.—**L. FULLER**, 218, Brighton Road, Croydon. c.82

**THREE-BANDED ITALIANS**.—Real Producers. We can still book orders for 3-frame Nuclei, Bees, Brood, and 1920 Queens, delivery May, 50s. Safe delivery guaranteed, or money returned. We have received numerous letters from our customers expressing their satisfaction with nuclei and queens sent them during 1919. Lists sent on receipt of stamped, addressed envelope.—**FREE-MAN & BROS.**, Hillside Apiaries, Ipswich. c.83

**DON'T BUY BEES** until you have seen our prices and guarantee. You risk nothing, as we return money in full if bees fail to give complete satisfaction. Catalogue 3d., which is refunded on first order.—**PEARSON & GALE**, Marlborough. c.84

**NUCLEI** from pure imported Italian Stock.—1 Four frames, May £2 12s. 6d., June £2 7s. 6d., July £2 2s. 6d.; 3 frames, May £2 5s., June £2, July £1 15s., carriage paid; also Virgin and fertile Queens and Stocks for Sale.—**DAVIDSON**, Forest Road, Burton-on-Trent. c.85

**BEEES FOR SALE**.—Several small Stocks, on six combs, of honey fed, healthy Bees, £3 10s. each; travelling box 10s., refunded if box returned in sound condition within seven days. Stamp for reply.—**REED**, Primrose House, Heacham, King's Lynn. r.b.30

**DUTCH BEES**, Skeps (as imported from Hans Matthes), Nuclei, Queens. Illustrated Catalogue on request, containing points on management.—Buy direct from Sole Agent, **WHYTE**, Bee Farmer, Cumberland, Dumbartonshire. b.61

**PENNA** strain Italian Queens, from June 7.—**ASHWORTH**, The Bungalow, Weymouth Street, Warminster. c.52

**PURE ITALIAN QUEENS AND NUCLEI**.—Can accept few more orders. This strain is second to none, hardy, good disease resisters, very prolific, splendid honey gatherers, comb builders, little given to swarming, quiet to handle. June 3-frame Nuclei, £2 15s.; 4-frame, £3 5s.; well covered with bees and brood; 1920 pure fertile Italian Queens, June-July 9s. 6d., August-September 7s. 6d.; Virgins, 4s. 6d.; few hybrid natural Swarms, £2 5s.; safe delivery; carriage paid; cash with order; satisfaction guaranteed.—**BARTLETT**, Bee Specialist, Crowthorne, Berks. c.21

[The above advertiser and advertisement are not in any way connected with Mr. C. B. Bartlett, Witney, Oxon.]

**3-FRAME NUCLEI**, 45s.; 4-frame, 55s.; boxes 7s. 6d., returnable. Queens, June 10s., August 7s. 6d. Cash with order. All guaranteed healthy. Over 50 years' experience.—G. SAWYER, Marlow, Bucks. c.55

**NEW-ENGLAND-BRED ITALIAN QUEENS.**—Untested laying Queens, ready June 1, 10s., delivery guaranteed; 6s. at purchaser's risk. English money accepted by registered mail.—ALLEN LATHAM, Norwichtown, Conn., U.S.

**STOCKS**, native and hybrid Bees, £4 each; Swarms, £2; Nuclei, £1 13s.; Hybrid, £2 2s.; pure Italian, £3; Queens 10s. 6d. each, carriage paid.—S. CRAWFORD, Apiaries, Castledegr, Co. Tyrone. r.c.17

**STRONG ITALIAN STOCKS** on 7 frames with 1920 Penna Queens, ready June, £5; travelling box 10s. extra, returnable; strong 3-frame Nuclei with 1920 Queens, £5; boxes 7s. 6d. extra, returnable. Cash with order, or quarter amount deposit. Italian Queens, home mated, 12s.; Virgins, 5s. 6d.; booked; ready May onwards. Pupils taken.—MISS PALING, Golden Square, Henfield, Sussex. r.c.23

**ITALIAN NUCLEI** from 30s., Fertile Queen from 7s. 6d., Virgins from 3s. 6d., 8-frame Stocks £4. Warranted healthy. Particulars stamp.—WATTS, Conway Cottage, Newtown, Parkstone, Dorset. r.b.93

**ITALIAN NUCLEI**, 3-frame, Penna's 1920 Queens (guaranteed), 63s.; Hybrids, Penna's and Simmins' Special, early delivery, 50s., carriage paid; box returnable. Orders (cash) strict rotation.—MOORE, 31, Monmouth Road, Dorchester. r.c.1

**WATERPROOF RUBBER SHEETS** for covering outhouses, etc., 72in. by 36in., brass eyelets, 12 for 20s.—SAGARS STORES, Ardwick, Manchester. b.16

**HAVE YOU READ "THE BEE WORLD"?** If not, why not? Every number in itself is a useful literary work for practice and reference. Specimen copy free.—Offices: THE APIS CLUB, Port Hill House, Benson, Oxon.

**ITALIAN QUEENS** direct from Italy. Price list for 1920 on application.—Address, E. PENNA, Bologna, Italy. w.39

**THE British Bee-Keepers' Association.**

The recognised centre of practical and scientific bee-keeping in Great Britain. Particulars and conditions of membership may be obtained from the Secretary,

W. HERROD-HEMPSALL, 23, Bedford Street, Strand, London, W.C.2.

**Pure Italian Nuclei**

Owing to the extra demand, I beg to announce that I have made arrangements to extend my apiary, and hope to be able to meet all orders for 1920 in good time. The Queen to be mother of my 1920 Queens is the daughter (raised in August, 1919) of a three-year-old Queen who filled 30 shallow frames **solid with brood** (besides several standards) when in **her third year**, giving over 200 lbs. surplus, and has never swarmed!!

My drone parent is Queen of a stock which has never swarmed in her three years, and to which I never use a smoker.

Price List post free from

**Claridge, Copford Apiary, Colchester**

Send for

**Bee-Keepers Wake Up!**

You can make a Big Profit if you use right up-to-date Appliances, including the Manley Hive. MEADOWS, SYSTON, LEICESTER.

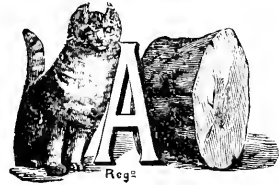

The products of the Apiary, of Poultry and Farm Stock, of the Fruit and Vegetable Garden can be Advertised and Sold through

**THE BAZAAR, EXCHANGE & MART**  
Newspaper.

Get a Copy—Thursday and Saturday 3d. The 'Bazaar' publishes also practical handbooks by experts. Send for full catalogue, post free from—WINDSOR HOUSE, Breams Buildings, LONDON, E.C.2.

**"BACTEROL" FOR BEES**

2 6 per "ottle.

Post Free.

The cure for, and preventive of, "Iste of Wight" Disease. Non-poisonous—free from stain or unpleasant odour.

MANLEY & JAMES, LTD. 33, Farringdon Road, London, E.C.1.

**INSTRUCTION in BEEKEEPING PRACTICAL AND THEORETICAL**

My Apiary will be open for a limited number of pupils during this season. Terms and particulars from

W. HERROD-HEMPSALL,

The W.B.C. Apiary, Old Bedford Road, Luton, Bedfordshire

# HIVES.

Compare the WORKMANSHIP and FINISH of our Hives.

All made by practical Men who know what a good hive should be.

In various designs to suit all tastes and requirements. Season's speciality—THE MANLEY HIVE for 16 in. x 10 in. Frames.

Full descriptions and illustrations in our 1920 Catalogue: "*Everything for an Apiary.*"

If you have not received your copy, send a P.C. at once.

OUR MOTTO—SERVICE & QUALITY.

**R. STEELE & BRODIE, Wormit Works, Wormit, Scotland.**



THE  
KEY TO  
YOUR SUCCESS.

## The Metal Foundation

(Protected)

The latest invention in Scientific hive equipment.



Durable ♦ Economic ♦ Sterillisable



An Ideal compromise between the Metal Comb and the Wax Foundation.



¶ For further details and prices, send for our 1920 ILLUSTRATED CATALOGUE, post free on application. It contains detailed information on the most up-to-date hives and appliances for which the House of Lee is famous.

\*\* Five per cent discount to Members of THE APIS CLUB.

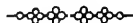

**JAMES LEE & SON,**  
LTD.,

Uxbridge, Middlesex,

(Telegrams : Graphicly, Uxbridge.)

Telephone : Uxbridge 181.)

## S. J. BALDWIN.

I beg to inform that the No. 1 Kent Hive is not manufactured by me, only the No. 2 "Bromley Kent."

(New deep frame 17 x 14 x 12. Sample by post 6d.)

**THE APIARY, BROMLEY, KENT.**

Look after your profits by buying hives and appliances which are easy to work. I endeavour also to give good value by care over the workmanship. Send for catalogue.

**EDWARD J. BURTT, Manufacturer, GLOUCESTER.**

Commercial (16" x 10") frames and brood boxes stocked.

PRINTED BY THE AVENUE PRESS (L. UPCOTT GILL & SON, LTD.) 55-57, DRURY LANE, LONDON, W.C., AND PUBLISHED FOR THE PROPRIETOR (W. HERROD-HEMPBALL), BY SIMPKIN, M<sup>rs</sup>SHALL, HAMILTON, KENT & Co., LTD., 31 & 32, PATERNOSTER ROW, E.C.

LIBRARY  
APR 20 1920



No. 1970. Vol. XLVIII

MARCH 25, 1920.

[Published every Thursday, Price 2d.]

**CONTENTS.**

BRITISH BEE-KEEPERS' ASSOCIATION .....	145	WEATHER REPORT .....	152
A DORSET YARN .....	145	CORRESPONDENCE—	
JOTTINGS FROM HUNTINGDONSHIRE .....	146	An Aged Bee-keeper's Request .....	152
A DAY'S TOUR WITH A BEE EXPERT .....	147	Snake Eating Bees .....	152
RUNCORN NOTES .....	148	Flowers Visited by Bees .....	153
NOTES FROM GREINA GREEN .....	148	Early Pollen .....	153
PETERSFIELD BOYS' SCHOOL BEE CLUB .....	148	Bee Skeps and How to Make Them .....	153
BEE DISEASE LEGISLATION IN CANADA .....	150	The Hive Bees Working on Rhododendrons .....	154
ASSOCIATION NEWS—		Starting Bee-keeping .....	154
Monmouthshire B.K.A. ....	151	New Use for Bee's Sting .....	154
Salisbury B.K.A. ....	151	Price of Hives of Bees .....	154
Leicestershire and Rutland B.K.A. ....	151	Killing of Ants .....	154
Guildford B.K.A. ....	152	NOTICES TO CORRESPONDENTS .....	155

**ALUMINIUM DRAWN OUT COMBS.**

**“MONEYCOMB”**

*The greatest invention in the Bee World for 40 years.*

This is a drawn out Comb of Hexagon Cells exactly as bees build in their natural state. It is slightly coated with wax, has been thoroughly tested, and is not an experiment. Bees readily take to it for rearing brood and storing honey. Strong and durable, will last 50 years with care. Big consumption of honey saved to produce wax for comb building. Control of bee diseases. No more burning of combs. Each comb easily sterilised and used over again.

Send for Catalogue and descriptive Leaflet.

1920 Catalogue post free.

Patented by ALUMINIUM HONEY COMB CO., of U.S.A.

SOLE MANUFACTURER AND LICENSEE:

**E. H. TAYLOR, WELWYN, HERTS.**

**Don't Order "W.S." Queens until you have seen the "Queenland" Revised List for 1920. 3½d. post free**

## NUCLEUS STOCKS—Same Price as 1919.

The only Pedigree Bee-Stock Registered in direct line for more than 25 years.

**"AMALGA" is the name of our Queen breeding mother for 1920**

**"ALTA" is the name of our Drone parent for 1920.**

PRODUCE OF ONE NUCLEUS  
REALISES OVER £40 IN CASH.

"The three-frame nucleus I purchased from you had increased last autumn to two strong stocks. I supered one on April 23rd of this year, and the other a few days later. I sold two swarms, and made up the others to five stocks. Of these I also sold three stocks. The original lot gave 198 lbs. of honey, and in all I have taken 365 lbs. My sales amounted to over £41 in actual cash."

(Miss) H. G. MOYSZY.

Somerset, Oct. 9th, 1918.

EXCEEDS 500 PER CENT. INTEREST.

"We have now 12 stocks to winter, besides selling one, out of the two three-frame nuclei supplied June 20th last year." (August 15th, 1917).

Miss B. D.

Quainton, Bucks.

THREE TO SEVENTEEN.

"It may interest you to know that the three stocks to which I introduced your queens (the only stocks saved in the apiary) in 1916, produced in all 17 stocks, and a good surplus in honey in 1917; this under the care of my wife who knew nothing about bees. I simply directed her as to management from there (France)."

OLIVER G. PIKE.

April 9th, 1918.

FIRST AND BEST.

"Your White Star strain was the first to enter the sections, and all the honey I got was from them."

G. H. S.

Heddon House Dairy.

APRIL 19TH.—BOILING OVER.

"The hive is simply boiling over with W. S. bees. They are at work when my other stocks are idling, and they are stronger than any of my other stocks."

Aberdare, Wales. E. T. W.

ARE THE W.S. PROLIFIC?

"In 1904 I got a W.S. queen from you, and last year (1905) by the first week in June she had brood in twenty-five standard frames."

J. H.

Higher Kinnerton, Chester.

NUCLEUS DELIVERED IN JUNE;  
40 FRAMES BY AUGUST.

"The three-frame nucleus of bees now occupy 40 Standard Frames. They have exceeded beyond anything I believed possible. I have never had anything like them before, and if the other queens on order turn out the same I consider my fortune made."

JOHN JONES.

Llancarfan, Aug. 21st, 1918.

SEVERAL STOCKS FROM ONE  
NUCLEUS.

"It seems almost ridiculous that this nucleus of the previous season (Aug.), before I was prepared for it, swarmed in April, and I now have several stocks from that investment."

J. W. MCKAY.

Croydon.

EIGHT STOCKS FROM ONE W.S.  
NUCLEUS.

"I now have eight stocks from the one nucleus you supplied last year."

J. JONES.

Llancarfan, May, 1919.

BEST IN THE COUNTY—NEVER  
SAW THE LIKE!

"May 26th.—The two queens you sent me have exceeded anything that I ever thought of. The stock chambers are full and crammed with brood, and all three supers crowded with bees; but even with this the bees are boiling over. I have not fed them at all, and have removed several frames of brood for another lot. The County Expert called yesterday, and said he had never seen such bees, and they were certainly the best in Hampshire."

D. D. P.

NO SPRING-FEEDING, BUT AGAIN  
FIRST.

"The W.S. bees on eleven 16 x 10 frames were full and boiling over at the middle of May, and were the first to enter supers out of 23 stocks; and last, but not least, they required no spring feeding."

U. W.

Arnold, Notts.

Revised 1920 "White Star" List, 3½d., of S. SIMMINS, Queenland, Keathfield, Sussex.

SAFE DELIVERY of Nuclei and Queens GUARANTEED





## British Bee-Keepers' Association.

May we remind our readers that the Annual General Meeting will be held next Thursday, April 1, at the Central Hall, Westminster, to commence at 2 p.m., when the minutes of the last annual general meeting will be read, the report and balance sheet for 1919 received, and council and officers elected for the ensuing year.

A conversazione will follow, when a lecture on "Bee Diseases" is to be given by Major O. C. Lord, at 3 p.m. A lecture on "Queen Rearing, and Introduction, and Increase," will be given by Mr. W. Herrod-Hempsall at 4.30, followed by a discussion. The secretary will be pleased to receive objects of interest for exhibition, and it is hoped that members will bring as many friends as possible to the conversazione. Ladies are specially invited.

Tea will be provided for members and friends at 4 p.m. A collection to defray expenses will be taken at the table. This is a new departure, but the cost of a free tea is rather more than the funds of the Association can bear, the Council therefore decided to adopt this plan rather than drop the tea, which is such an enjoyable social function.

The nearest station to the Central Hall is Westminster, District Railway.

## A Dorset Yarn.

After several days of cold winds, it changes to soft, southerly breezes and warm days. Our bees were out in the fields by 7 a.m. on the 17th. The willows in the hedgerows were teeming with them. What a wealth of nectar there is in them just now—all of them sticky with it. Charlock in flower among the turnips and swedes, plants that have not been killed by frost, all well up above the tops, as high as the sheep hurdles. Bees are having a wonderful time. When the warm days are with us the cells are being repaired and lengthened; the new honey can be seen to shine in those that are being built on the tops of bars (between the shallow strips that cover the bars beneath the quilts). Yesterday (the 20th) they had a real field day among the pears, plums and peaches. Plums have so many flowers, even if the food from each is small the many thousands of flowers

must yield a lot from each tree. *Ribes sanguinea*, the red-flowering currant of North America, has a lot of them, but there are more to be seen on the laurustinus, which are growing side by side, making hedgerows by the side of cottage gardens. Bees may well hum their loudest, for the time of flowers is come; plenty abounds everywhere. Very few of them are on our wild flowers. The "wee red-tipped daisies" are open in thousands. Only a few go to them, though speedwell blooms on the sunny banks and the small celandine opens its golden flowers, very few bees are near them; but overhead is a charm of them among the wild plums and willows. A meadow of wild daffodils close to our bees has but a few bees on them, though the field looks real yellow from a distance. All proves to me that scent is the greatest allurements for bees. The male flowers of willows are the gayest, but just as many bees are on the female trees. On the plums and pears they seem to be searching for nectar, as they treat the anthers very roughly, and the movements of the abdomen are as is seen in drinking. The smell of plum-blossom is something like the hawthorn, an aminoid scent which, according to Kerner, is composed of "hydrogen, atoms of ammonia, and alcohol." The odour of pears is very pleasing; if one could only get some of the honey from these blossoms I should assume it would be very nice tasting, but all of it seems to be used for feeding brood.

Some of the very dry pollen has to be moistened with nectar before it is in a fit state to be moulded on the pollen-baskets; that is why I have often thought that there was nectar on stamiferous flowers of willow, but I have never seen it authentically stated. They could easily moisten it with nectar already stored in the honey-sac as they go from the female flowers; but in perfect flowers, like the plum and pear, where both male and female organs are in one calyx, the bee can easily moisten the pollen with nectar from the same flower. In newly open flowers of pears the pollen is quite moist of itself, but it soon dries as the flower ages, and if not gathered by bees it is blown away by wind. This is easily seen these bright, sunny days as they go. As one tills the soil year by year one sees so many little things one cannot help but state some of them, as they seem to show the wondrous works of God. Milton wrote: "The light we have gained was given us, not to be for ever staring on, but by it to discover onward things more remote from our own knowledge." "Every man's business, whatever it is, becomes a liberal education to him just as soon and just as fast as he lives, not

in its methods, but in its principles." So through life we live our simple lives, just observing and storing in our minds things that we see around us.—J. J. KETTLE.

## Jottings from Huntingdonshire

FOR JUVENILE READERS.

"Rested, little bee?" I asked next morning as I opened her box.

"I'm not so tired, sir, thank you; but I'm not feeling very well," she replied.

"How is that?"

"Well, I'm afraid that I cannot stay much longer. I should really like to sleep right away before the winter comes."

"My dear Apis, don't be so despondent," I said. "Come, let's play at confidences."

She brightened up and said, "Confidences; what be they?"

"They're simple enough, dear. You just answer a number of questions that are printed down. Shall I start? I see the first question is, *What is your name?*"

Apis Mellifica.

*What is your favourite colour?*—Blue.

*Your favourite flowers?*—Fruit blossoms, borage, sainfoin, clover, anchusa, box blossom, willow herb, Limnanthes, blackberry, mustard, and heather.

*Your favourite holiday resort?*—Anywhere south.

*Your favourite painters?*—Italian painters, of course.

"Hush! Don't be rude."

*Your favourite authors?*—Wood, White, and Nutt (because they first taught men a better way than stuffing us into skeps), Ellison, Hawks, Cowan, Herrod-Hempsall, and Sladen.

*Your favourite names?*—Apis, Melvis, Queenie, Nectaria, and Poll.

*Your pet aversions?*—Careless men, disease, and cold summers.

*Your favourite winter pastime?*—Fox and hounds.

*Your favourite summer pastime?*—Chasing larks and goats.

*Your favourite instruments of music?*—Church bells.

*Your favourite composers?*—Those who compose themselves when examining hives.

*If not yourself, who would you like to be?*—A Dutch queen; she gets plenty of change.

"Now for the last question: Any remarks you would like to make with reference to any of the above?"

"Yes, sir; I should like to say more about question three."

"Fire away."

"Well, although we bees have favourite flowers, there are lots we like besides. In early spring, crocuses, broom, arabis, laurustinus, ozier, and hazel flowers, to say nothing of flowering enrrants, blackthorn,

willows, coltsfoot, dandelions, elm blossom, and box. Later on we love the sycamore, the chestnut, the gooseberry, and almost every flower growing in meadows—with beans, peas, tares, and flax in the fields. Summer, we look for lime, mustard, and white clover. Late summer and early autumn, hardheads, red clover, and blackberry blossom; while still later we look to autumn raspberries, heather, and ivy flowers. In winter, jasmine, Christmas rose, acouite, and snowdrops."

"Goodness, Apis, what a list!"

"Yes; but it's not exhausted, for we peep at your garden flowers. But I won't name all those."

"No, don't. Now answer me a lot of questions quickly. How do you make wax?"

"It's rather a wonderful process. We hang ourselves in festoons, and under our abdomen there are eight wax pockets. As we hang in solemn silence, tiny scales are pushed forth from these wax pockets, and with the pincers on our hind legs we take hold of these scales of wax and pass them to our front legs and on to our mouths. In our mouths we have to chew the wax and soften it and make it quite pliable, and then it is placed in its required position. We leave it to the architects to shape it and hollow it, you know."

"How wonderful! You mentioned legs; I see you have six. What do you call that part of the body your legs are fastened to, also your wings?"

"The thorax, sir."

"Thanks. And what are those things by the side of your mouth, or I should say above your mouth?"

"Oh, those are the antennæ, or feelers. We talk to each other, we smell, we hear, we feel with those; and what is more, by their use we are able to work in the dark."

"How surprising! Then, don't you use your tongue when you want to talk?"

"No; we need that to suck up and spoon up the nectar from flowers. You see, our tongue is covered with hairs, so that we clean up all the nectar in a flower. Then we have jaws which can bite through a flower which hides its honey out of reach of our tongue."

"Wonderful again! Now tell me, does the nectar you collect pass through any changes before you store it in combs?"

"Yes. When we have our honey-sac full, the nectar, as we are flying home, is strained to separate it from the pollen. Then we add some juices to it. If we didn't do that it wouldn't be fit for you to eat."

"How interesting! But, Apis dear, I've seen bees settle on flowers, quite close to their hive and fill their sacs. Have they time to strain and prepare the honey in so short a flight?"

"No, simple man. Next time you watch what we do, just notice that if a bee fills up with nectar close home she flies about for a few seconds, and even if she landed on the alighting board and tried to enter with unstrained honey, she would be stopped at the door and would have to crawl about for a little time, or take another short flight, to give time for the straining and mixing to take place. Haven't you noticed that?"

"Yes."

"Then why did you ask me?"

"To make sure. Now don't be cross. You know, when a little lady says a thing we know it's right. Now one more question: How do you breathe?"

"Through our spiracles."

"Through what?"

"Spiracles—little holes or tiny tubes distributed over our bodies. We sing through them, too."

"Thanks. I thought to have finished this time, but I fear I shall have to trouble you once more, Apis darling. Then I will let you sleep. Bye-bye!"

E. F. HEMMING.

P.S.—Owing to a slip of the pen or printer's error, last week, drones' eggs were said to be 34 days developing into drones. The figure should be 24. Three people have already called my attention to this. I am glad our readers are so well informed.—E. F. H.

## A Day's Tour with a Bee Expert.

The object of this article is to describe the impressions gathered by a novice when seeing for the first time the various ways in which bees are kept.

On a hot day in July we started up the valley to visit a number of the subscribers to the local Association. A motor bicycle and a sidecar was our means of transport, and we had a round of nearly 100 miles and some 15 bee-keepers to visit before evening.

Our first visit was most interesting, not because of the bees, but because of our reception. This member was a lady having only one hive. We were received by her stern parent, who informed us that his daughter was in, and would be with us shortly, but that in the meantime we were, on no account, to go near the hive. After waiting impatiently for nearly 20 minutes, the lady, having put on her garden party frock, hailed us with delight, and said how glad she was we had come, as she was so interested in bees.

She explained at tedious length how so-and-so advised her to do this, and so-and-so to do that, but that she had quite made

up her mind that they were all wrong, and that the right thing to do was to leave the bees to Nature. The expert's query as to whether she thought the same idea should be applied to all domesticated stock only drew the reply that she had been advised that the new-fangled ideas must be wrong, because they interfered with the bee's nature. She did not want her hive examined; she assumed it was all right except that the bees had not yielded her any surplus. After wasting nearly an hour of precious time we escaped from this dreadful example of wilful ignorance.

The next visit was to a small farm where a number of hives were kept by one of the sons, a soldier invalided from the war. Again hailed with delight, but with a request for definite information on certain points. The owner of the hives opened two of his hives, and it was pointed out to him that the bees were storing candy in the supers, and other ways in which he was making mistakes, though generally the hives were models of how bees should be kept. Here was real gratitude, and we left feeling it was a pleasure to visit such a man.

We had our lunch by the riverside, and then left the valley for the hills. To reach some of the crofts we had to leave our machine at the roadside and walk over the moor, and each visit was full of interest. In one case a number of queen cells, with queens just on the point of emerging, were cut out; in another a queenless hive was pointed out. At one place, the bee-keeper, whose hives were placed in the edge of a fir wood, had put up low artificial bushes for his bees to settle on when swarming, because of the trouble he had had with swarms taking to the tree tops. In another case the owner was using slate as a quilt, because he thought it would be cool for the bees. His bees were all clustered outside the hives; the slate was so hot, because of the sun, that you could hardly hold your hand on it. In another case a grizzled old man, smoking a big pipe, seemed very anxious to make his bees angry for our particular benefit, but in nearly every case the expert was able to be of real assistance to the bee-keeper visited.

Our last visit was nearly as interesting as the first one, and again the bee-keeper was a lady. She took us to her hives—five standing so close together that you could not get between them, and scarcely behind them because of a thick edge. The roofs were held down with rocks too heavy for anyone but a strong man to lift. The ground was covered with remains of smoker fuel. The lady said she would fetch the gardener who looked after the

bees, and she then retired to the house. Presently she re-appeared clad in the most wonderful bee-proof costume, and shortly afterwards the gardener came, wearing a meat safe over his head and thick woollen gauntlets. Evidently they were both scared stiff at the sight of a bee, and judging by the amount of debris from their smokers, the bees had good cause to be scared stiff at the way their keepers treated them.

It was dark when we got home, and we were very tired, but it was a most interesting and instructive day, particularly for the writer, who learnt much both about how to keep, and how not to keep, bees.—W. C. B.

### Runcorn Notes.

I have been thinking over what is the proper or rather the best situation for hives. We are told in the text books that they should have a clear flight-way, and face either S.E. or S.W. My own preference as to aspect is S.E. As to situation I have not yet made up my mind. I once asked a bee-keeper who kept hives by the thousand, and had them in almost every conceivable location, these questions:—"Where do you find bees do best, on hillsides or in valleys?" His answer was: "On hillsides, decidedly." I next asked: "What position do you find best, a clear flight-way, or near hedges or trees?" He answered: "The more hugger-muggered up they are the better." This rather coincides with my own experience. Years ago I was asked to take charge of an apiary of four hives, situated about two miles from my own apiary. I found them with some difficulty in a small, neglected orchard, where I had to get a scythe to cut down the old grass and weeds which practically buried them. This was in April. I found them ready for supers—a fortnight in advance of my own. They did better than my best. The bees had to thread their way through a veritable thicket of undergrowth and tree branches whichever direction they wanted to fly. The following summer the same thing happened. I took honey from them a fortnight before I took any from my own only two miles away. The following autumn I bought these stocks and transferred them to my own apiary. There they did no better than my others. As the country thereabouts is nearly as flat as the proverbial pancake, it must have been their situation, rather than location that made so much difference. Another case I remember. An old man who lived in a wood and kept bees in skeps. His bees had often to get a great deal of

manœuvring to get away from their hives, but he nearly always had swarms in April, whereas his neighbours had to wait till nearly June. I have a mind to plant a hive in a rhododendron thicket, and see what happens, this summer (if I can get permission, the rhododendrons are not mine). Has any other reader had similar experience.—D. J. HEMMING, Runcorn.

### Notes from Gretna Green.

All my stocks are alive so far, and, judging by the great warmth under the quilts, brood-rearing is well under way.

I have no occasion to feel any doubt as to the food supply, for all are warmly packed in heavily-stored doubled hives, à la Smith, of "Flavine" fame.

The "Adminson" bees were the first on the wing this year. The Penna Italians followed, and all appeared healthy in flight.

No matter what doubters may say, disease can be mastered during the active working season. But a winter outbreak is quite another matter; any form of treatment then simply hastens the end by inducing dysentery. Stocks found slightly affected now should be left undisturbed until March, and then united, if necessary, before being sprayed and fed with medicated syrup.—J. M. ELLIS, Gretna, Carlisle.

### Petersfield Boys' School Bee Club.

#### SECOND ANNUAL REPORT.

The past season has been a very poor one—in fact, in some localities it is mentioned as the worst on record. From early spring to the end of that season, warm, dry weather prevailed. The climatic conditions were most favourable to breeding for the bees. Nectar was running in plenty in fruit blossom and wild flower, and the bees worked unceasingly from early morn to dusk. But the continuation of these conditions proved "too much of a good thing" for the flowers and bees. Absence of moisture in the soil caused failure of nectar to rise into the blossom "treasure bags," and the bees were hard put to find sufficient food for daily needs, especially as breeding had been carried on so rapidly. Then the weather changed; rain came—too much for the limes, worse luck—washing the nectar from the blossoms each day, though not enough for general needs. Then, sad to relate, the wind chopped to the north, and continued from that quarter for a considerable time.

Result: Very cold nights, non-secretion of nectar by the flowers.

In many districts the fields were white with Dutch clover, but the bees practically ignored the blossoms; there was no reward for their visits, and they knew it. Thus the two main sources of honey production for our district—limes and clover—were, this year, worthless from the bees' point of view. However, as the summer ad-

the swarm had clustered. But the bees were, as usual, very particular little creatures, and were dissatisfied with their new home. Whilst at dinner a boy breathlessly informed me that "the school bees are going over the gasworks!" I cycled to the gasworks, sent scouts in every direction, but our bees were never traced. We could ill afford the loss, but—just another lesson from the bees



A LESSON AT THE PETERSFIELD SCHOOL APIARY.

vanced the flow of nectar improved, but all too late for obtaining a real surplus. Our hive worked well under adverse conditions. In May it threw a good swarm (about 3½ lbs.), which I left well hived in a box obtained for the purpose, and attached to the apple branch on which

Two racks of sections, with starters, were placed on the stock, which yielded 16 sections—12 of grade one! I felt that it was worth while showing a sample of our surplus in the Petersfield Autumn Show—result, third prize for three sections. Very encouraging, too. We may

be proud as a young club of our exhibit doing so well.

Our surplus this year was easily disposed of. The three prize sections sold for 4s. each (a general price this year in the South for grade one sections), and the others from 3s. 6d. downwards, according to quality and finish. The total realised was £2 13s. 9d., plus 2s. prize-money; our income for the year, £2 15s. 9d! Our expenditure for feeding, etc., was 10s. 5d., giving us a profit on the year's working of £2 5s. 4d. (balance-sheet attached). This allows of a dividend to shareholders of 66 $\frac{2}{3}$  per cent.—8d. on each 1s. share! I think this result speaks volumes.

Early in October I took a peep at the bees' winter stores, and found that they will need candy feeding later on. They appeared to be healthy, and we hope they may continue so, to merrily buzz around our fruit blossoms in the coming spring and give us a good surplus next season—a surplus which will put our previous reports in the shade. May the Weather Clerk for 1920 have something good mapped out for us all!

#### BEE CLUB BALANCE-SHEET, 1919.

Dr.			
To Cash in hand	...	£0 16	8 $\frac{1}{2}$
„ 10-frame stock	...	2 10	0
„ Hive, £1 12s. 3d.; less 5 per cent. depreciat'n, 1s. 7d.	...	1 10	8
„ Sale of surplus	...	2 13	9
„ Prize-money	...	0 2	0
		£7 13	1 $\frac{1}{2}$
Cr.			
By Paint for hive	...	£0 1	0
„ Spring feeding	...	0 3	2
„ Autumn feeding	...	0 6	3
„ Dividend to shareholders, 66 $\frac{2}{3}$ per cent.	...	2 0	0
		2 10	5
„ Balance	...	5 2	8 $\frac{1}{2}$
		£7 13	1 $\frac{1}{2}$

W. BENNETTS,

Hortiel, and Bee Instructor.

[The head teacher of Petersfield boys' school (Mr. W. Gates) is to be congratulated on being in charge of a school that is, we believe, a pioneer in establishing bee clubs among the scholars. If other head masters would follow the excellent lead set, the future of bee-keeping would be rosy indeed, for in the coming years the industry would be in the hands of bee-keepers having a sound knowledge of the craft. Unfortunately, all schools have not an enthusiast like Mr. Bennetts to take charge of the work. Both he and the members of the club are deserving of their continued success.—EDS.]

## Bee Diseases Legislation in Canada.

Having been attending the annual convention of the Nova Scotia Fruit Growers' Association, I did not get an opportunity to see my article on "The Forward Movement in Bee-keeping" in the BRITISH BEE JOURNAL until to-day. May I call your attention to a printer's error of one letter which reverses the meaning I intended to convey:—"In Canada we have quite a number of sizes of frames, and so great confusion is caused," should read, "no great confusion is caused."

May I also take this opportunity to say a word in favour of bee disease legislation, which I am pleased to see has again become a live issue in Britain. While the Dominion Government has no Bee Disease Act this Division is entirely in favour of, and co-operates where possible with, the work of the Provincial Governments, no less than five of which have Bee Disease Acts. About one hundred bee inspectors are employed annually under these Acts, and the good work they do is incalculable, not so much in bringing offenders to justice, which is seldom done except as a last resort, but in educating the bee-keepers how to control these diseases, and in general helping them to become better bee-keepers. The system that seems to work best is to have one good administrative officer, usually the provincial apiarist, permanently employed, and he is responsible for hiring men in the summer, each to cover a certain territory and paid by the day. These men are experienced bee-keepers, who are selected because they have knowledge, tact, and reasonableness. The pay they get, although good, scarcely compensates them for loss of valuable time in their own apiaries, but they are attracted to do this work from a sense of public service, and the work gives them a fine and varied experience outside of the sphere of their regular activities.

In the rare event of an inspector having acted carelessly or arbitrarily, a complaint may be lodged by the bee-keeper with the provincial apiarist, and if he finds it is substantiated, that man is not engaged the next year. In this way practically nothing but good comes out of our bee legislation, and a great deal of it. The present trouble is that the appropriations for this work are all too little to cover the work to be done, and American foul-brood (we are less afraid of European foul-brood) is not getting stamped out at the rate it would be if we had more money to employ more inspectors.—F. W. L. SLADEN, Apiarist.

January 31, 1920.

### Meeting of Monmouthshire Association.

A meeting of the Monmouthshire Bee-keepers' Association was held at the County Hall (through the good offices of Mr. T. G. James) on Saturday last. Arrangements were made to put the re-stocking scheme on a working basis.

Instructions were received from the Ministry of Agriculture respecting the supply of Italian queens, regarding which advertisements will appear in the *Weekly Post*.

Two delegates were appointed to confer with the Hon. Secretary of the Gloucestershire Bee-keepers' Association regarding a suggested Bee-keepers' Convention to be held at Gloucester in July or August.

A deputation was chosen to make arrangements with the Hon. Secretary to the Newport Allotment Holders' Association respecting the honey section in their forthcoming show.

Prizes were conditionally authorised for the honey sections at the St. Mellons and Risca shows. Some few members have kindly offered to lend their grounds for the purpose of bee demonstrations during the summer.—*Communicated*.

### Salisbury and District Bee-keepers' Association.

#### ANNUAL MEETING.

The first annual meeting of the Salisbury and District Bee-keepers' Association was held on Wednesday, March 3, 1920. The President (the Hon. Louis Greville) presided. There was a good attendance.

The Secretary (Miss E. J. Hardy) presented the report of the committee, which related that the Association was inaugurated on April 29, 1919. A feature of the year was a visit to the apiary of Lady Katharine Bouverie, in Longford Park, where about 50 bee-keepers attended, and greatly enjoyed the demonstrations given by Mr. Pinder and Mr. White.

The Association had obtained about 150 signatures to the petition for legislation respecting bee diseases. The membership of the Association stands at 72, drawn from a radius of 12 miles of Salisbury. Miss E. J. Hardy also gave the financial report, which showed a balance in hand of £2 10s.

On the proposition of Mr. Pinder the Hon. Louis Greville, who expressed his willingness to help the Association to his utmost, was re-elected president.

The vice-presidents were re-elected, the Rev. H. M. Livens being added to the number.

The Secretary (Miss E. J. Hardy) and Chairman of Committee (Mr. J. E. Pinder) were re-appointed for the ensuing

year. The committee were re-elected *en bloc*, with the addition of three—Miss Fussell (Salisbury), Mr. F. W. Miles (Shrewton), and Mrs. Wrottesley (Down-ton). A treasurer has yet to be appointed.

Major Francis put forward a resolution, which was carried, asking the Board of Agriculture to deal expeditiously with the preparation of the Bee Diseases Bill, also for the prevention of substitutes for honey, being sold as honey.

The proposal was adopted that this Association, in connection with the Wilts County Bee Committee, should have an Exhibition at the great show given by the Bath and West Agricultural Society, May 20 to 25, at Salisbury.

The Hon. Louis Greville was cordially thanked for his efforts on behalf of the Society.

The Rev. H. M. Livens then gave a most interesting lecture, entitled "The Place of the Honey Bee in Nature," illustrating his remarks by excellent lantern slides, which were shown by Mr. Bernard Pinder.—(*Communicated*).

### Leicestershire and Rutland Bee-keepers' Association.

#### ANNUAL MEETING.

The annual general meeting of the above Association was held at the Museum Buildings, Leicester, on Saturday, March 13, 1920. Mr. G. W. Dunn presided over a very good attendance, which included Messrs. E. E. Lowe, B.Sc., H. M. Riley, W. P. Meadows, H. Clark, J. Waterfield, A. J. Marriott, J. Hunt, A. G. Pugh (Notts), J. Pearman (Derby), and many others.

The Chairman, at the outset, remarked that not only was bee-keeping a source of profit, but it was also an interesting and healthy hobby: What proved very discouraging to the newer members was the very high price of hives and other necessaries.

The report showed that the membership had increased from 245 to 287 during the year under review, and the Association was sound financially, there being a balance in hand of £14 9s. 1d.

Lady Levy was re-elected president, the vice-presidents were elected *en bloc*, the auditor (Mr. W. K. Bedingfield), the treasurer (Mr. H. M. Riley) and the secretary (Mr. A. Briers) were re-elected.

A new committee was elected as follows:—Chairman, Mr. H. Clark; vice-chairman, Mr. H. M. Riley; Messrs J. J. Abell, A. E. Biggs, S. Clark, W. G. Dunn, T. H. Geary, J. Thompson, J. Hayward, E. Hall, A. J. Marriott, W. P. Meadows, A. H. Ridgway, Councillor E. J. Underwood, and J. Waterfield. Messrs. H. M. Riley

and W. E. Moss were elected representatives to B.B.K.A.

The rules, which had been revised by the Council, were submitted to the meeting for approval, and after a short discussion were passed as read.

In the evening the usual drawings for prizes took place, and Mr. H. Clark, the newly-elected chairman of the Association, gave a lecture on "The Lure of the Hive, with Bits for Beginners," which proved highly interesting and instructive.

Several objects of interest were brought, explained and discussed, and a very successful meeting was brought to a close with a vote of thanks to the lecturer and the chairman.—A. BRIERS, Hon. Sec.

### Guildford and District Bee-Keepers' Association.

The first members' meeting of the above was held on March 20 at the Guildford Library and Institute. Alderman W. J. Patrick presided, and 32 members were present. The rules drawn up by the Provisional Committee were confirmed and names for the offices of President and Vice-Presidents suggested. Alderman Patrick was elected Hon. Treasurer, and Major E. B. Wilkinson Chairman of the Committee, on which the members appointed Miss M. D. Higgins (Worplesdon), Miss D. T. Knowles (Thursley), Rev. E. Newill (Witley), Messrs. F. A. Brown (Guildford), H. Butcher (Merrow), J. J. Chatfield (Chobham), F. M. Falshaw (Guildford), J. A. H. Hamshar (Womersh), J. W. Savage (Guildford), E. G. Waldock (Guildford), and W. A. Woods (Normandy). The future work of the Association was discussed, and the details were left to the Committee. It is hoped the Association will be able to organise a honey exhibition at one of the local shows, and to arrange during the summer months garden meetings in some centres of the district. Local bee-keepers will be warmly welcomed as members, and a post-card to the Hon. Secretary (Heatherwood, Pirbright) will bring particulars and a form of application for membership.—E. C. PITT-JOHNSON (Rev.), Hon. Secretary.

### Weather Report.

WESTBOURNE, February, 1920.

Rainfall, '65 in.	Minimum on grass, 24
Heaviest fall, '24 in.	on 22nd.
on 10th.	Frosty nights, 3.
Rain fell on 13 days.	Mean maximum, 49.3.
Below average, 1.54 in.	Mean minimum, 37.1.
Maximum temperature, 55 on 18th and 19th.	Mean temperature, 43.2
Minimum temperature, 29 on 9th.	Above average, 4.1
	Maximum barometer, 30.648 on 5th.
	Minimum barometer, 29.837 on 20th.
	L. H. BIRKETT.



### An Aged Bee-Keeper's Request.

[10145] Could you kindly put me in communication with a brother bee-keeper who might be able to sell me a hive or a nuclei or an early swarm? I have kept bees for 64 years continuously up to five years ago, when they went with "I.O.W." disease, but I would like to get in amongst them again, although I am in my 89th year.

Trusting you can do something for me, and oblige.—ROBERT BROWNLEE, 54, Waverley Place, Galashiels.

[We do not know any bee-keeper near our correspondent, but possibly someone near may be able to assist him. We admire his pluck in wishing to start again at his age.—Eds.]

### Snake Eating Bees.

[10146] One of our stocks last season did not seem to make any progress at all; there were always plenty of young bees and hatching brood, but the proportion of flying bees always small. We could not trace any disease, and we knew the queen was young. Thinking the bees lacked stamina, we re-queened with a young B. of A. Italian queen. The superseded queen was given to a four-frame nucleus, and she rapidly built this to a strong stock. The new queen was a good one, but still no improvement took place. We were quite at a loss to discover the cause until one hot day in August we were strolling quietly among the hives and saw coiled up in front of the hive a large snake. As we watched we noticed that every bee that dropped in front was quickly snapped up, and twice we saw the reptile rear its head and calmly pick a bee from the alighting board. We ought to have crushed its head under heel; but, ugh! We dashed for a spade, but on return it had vanished. We searched long and carefully without success. After this for weeks we never went near the hive without a spade ready to strike, and at last, towards the end of September, we saw the snake disappearing under the hive. A quick run, and we fixed the spade firmly across its back, and, in spite of much hissing, we squared the account by halving it. Then a wonderful thing happened, for the head half went on as though nothing had happened, and we lost sight of it in the long grass. Two days after we found it about 30 yards from the hive. The snake measured over 3 feet long, and nearly 2 inches thick. I



wonder sometimes how many bees it takes to make such a reptile. Why did the snake choose this hive out of nearly 40 others? It might have surely taken a few from each, instead of bringing ruin to one stock.

When we united the bees for the winter we gave extra good treatment to this stock, and am pleased to say it seems to be going on well at present, and we trust it will not be favoured during the coming season with such an unpleasant visitor.—WALTER SARGANT.

### Flowers Visited by Bees.

[10147] I should be glad if you will please give me the exact inside and outside dimensions, etc., of the new Standard frame (one-third greater area than the old standard), as I am thinking of making a hive to take same, and greatly oblige.

I enclose list of flowers visited by my Hybrid Italians since May last. They are working yew, wallflower, etc., now. I thought you might like to publish the list in THE BRITISH BEE JOURNAL and THE BEE-KEEPERS' RECORD.—A. E. STEPHENS.

[There is no "new" Standard frame; possibly you mean one of the larger frames that have been advertised—16 in. by 10 in. or 14 in. by 12 in.—Eds.]

#### BEE PLANTS.

Limnanthes.	Travellers' Joy.**
May (pollen).**	White clover.
Mignonette.***	Rambler roses.
Broad beans.***	Buddlea.
Anchusa.*	Dwarf sunflower.
Lime.***	Veronica.
Cotoneaster.	Bindweed.
Borage.	Marrow.
Raspberries.***	Burdock.
Blackberries.***	Ivy.*
Privet.	Michaelmas daisy.*
Dewberries.	Charlock.*
Gaillardias.**	Christmas roses.*
Mimulus.	Red dead nettle.
Solidago.	Yew.***
Wallflower.	Sedum.
Greater centaurea.***	
Large St. John's Wort.	

\* Well worked by bees.

### Early Pollen.

[10148] I can furnish the parallel which H. F. Swann (10135) calls for.

Late in August last year I had two stocks of dark bees sent me, which I immediately re-queened with True Golden queens. It was then apparently too late for the "darkies" to breed, though the Ligurians were still going strong, and the eggs were cleared out as fast as the new queens laid them.

At the end of the second week in

January this year I noticed the bees of these stocks darting from the hives in numbers, and questing about for something which they could not find.

I filled the water-fountain and set it out, but they would not look at it. I then tried them with a box of artificial pollen, and this they fastened on at once, carrying it in in quantities and rolling in it till they looked like little ghosts.

To-day, February 18, I saw numbers of the young Golden out taking their first flight in the bright sunshine. Opening one of the hives, I found nearly as many newly-hatched Golden as there were of dark bees.

This record of young Golden flying as early as February 18 demonstrates, I think, that the True Golden of the Western and Southern States are not nearly so "tender" as some writers would have us believe.

I may mention that I found some of the Ligurians nearly as far advanced, though they had been breeding late last year, and I never saw them at the *ersatz* pollen.—HUGH HOUSTON, Sidcup, Kent.

[10149] My bees were out on 18th: early crocus and some fruit trees in bloom.

Mostly yellow pollen, very large pellets being carried into hives.—C. TRECROFT.

### Bee Skeps and How to Make Them.

[10150] I am writing to ask whether you, or some one of the many readers of your valuable B.B.J., will be good enough to give full directions for making bee skeps, what tools are required, the best materials for making them with, and what size the skeps should be for stocks for supering. I think it would be a good thing for small bee-keepers with a small income, such as cottagers, to know how to make their own bee skeps, which they could easily do if they only knew how to go to work about it, and bee skeps are and will always be useful to all who keep bees.

I have been told that blackberry brambles one year old make the best binding for skeps, but do not know what is the best time of the year to cut the brambles, nor yet how to prepare them for the binding of the straw in making the skeps. Are the brambles put into water to soak before they are split into halves or quarters, and the pith removed or scraped out, and the bark taken off with some sort of tool. I have also heard that some use a piece of cow or bullock horn of the right size to draw the straw through to keep the band the proper size all round the skep, but do not know what size the horn should be, or whether it

should be straight, or curved to give the straw a slight bend to make the shape of the skep. I have never seen any skeps made, so have no idea how to proceed to make some, and would be grateful for instructions, which may be useful for other small bee-keepers like myself. There are many poor people who would keep bees, but cannot afford to buy bar-frame hives, and the cheap skeps that hawkers sell to bee-keepers are too small, and cause the bees to swarm so often that they do not get so much profit from their bees as they might if they had proper-sized hives. I have seen in some cottage gardens skeps so small that the bees have built the comb under the stool that the skep stood on.

I have seen instructions in the B.B.J. for making home-made bar-frame hives, but not one for making a skep. I enclose name and address, and sign—A COTTAGER.

### “The Hive Bees Working on Rhododendrons.”

[10151] Doubtless our good friend, J. J. Kettle, can answer Mr. Sleight's query *re* the above (B.B.J., February 12, p. 75), as there are a considerable number of the common variety, *R. Ponticum*, grown in the New Forest, but I think few have had the unique opportunity that fell to my lot from 40 to 70 years ago. During a portion of those 30 years I was residing close to the two of those most famous American nurseries, “Knaphill” and “Bagshot,” in Surrey, where in each many thousands of hybrid seedlings were raised annually, in addition to thousands of established bush and standard named varieties.

From frequent observations I can say the hive bees do not work on rhododendrons: one may be seen at rare intervals hovering over a blossom, and hovering only. And yet nectar is secreted in abundance, which the hive bee could obtain if it so desired. Why not? Can it be that our little pets are more temperate than the larger species, “Bombus”? It is a fact that these latter throw all their energies in collecting the nectar from rhododendrons with this curious and interesting result: they get intoxicated, I can give it no other name. I have seen them many hundreds of times, after collecting this nectar, drop on the ground, and in endeavouring to take a flight they would fall back and roll about in a most comical fashion.—JAMES LEE, Fulbourne.

### Starting Bee-Keeping.

[10152] I want to start keeping bees on a gradually increasing scale. Can any of your readers kindly say how I should begin, and what the initial cost of making a start would be?—SUBSCRIBER.

### New Use for the Bee's Sting.

[10153] The enclosed may be of interest to bee-keepers. I have not seen the “fact” mentioned before!—STING.

#### THE BEE'S TROWEL.

It is not generally known that the bee's sting is a trowel, not a rapier. It is an exquisitely delicate little trowel with which the bee finishes off the honey cell; injects a little preservative inside, and seals it up. With its trowel-like sting the bee puts the final touches on the dainty and wonderful work. With the sting it pats and shapes the honey cell as a mason pats and shapes a row of bricks. Before sealing up the cell it drops a little bit of poison into the honey. This is formic acid. Without it the honey would spoil. Most of us think the bee's sting, with its poison, is a weapon only. It is a weapon secondarily, but primarily it is a magic trowel from whose end, as the honey cells are built up, a wonderful preserving fluid drips.—From the *Shooting Times*, November 29, 1919.

### Price of Hives of Bees.

[10154] The following may be interesting to your readers:—At a sale of bees in Yorkshire just lately the following prices were realised: Straw skeps, 52s. 6d., 75s., 20s.; modern wood hives, 62s. 6d., 70s., 77s. 6d. The same strain of bees had been in the owner's possession for over forty years, and were strong, healthy stocks, the wood hives modern bar frames. A few years ago the same kind of skeps could be bought from 7s. 6d. to 10s. each, and the present prices go to prove how anxious people are to again commence bee-keeping and have their own “Nature sugar factory.” The Re-stocking scheme and propaganda work to educate keeping bees on proper lines, cleanliness and folly of having dirty combs and hives standing out, should go far to bring the industry to the fore in every village again.—W. E. RICHARDSON.

### Killing of Ants.

[10155] Put a heaped teaspoonful of camomile in half a pint of boiling water, stir up, and when cold, strain it, sweeten it with sugar, making it into a thin syrup. Put in shallow pans, protected by perforated zinc, so that bees cannot get at it. Ants will take this readily and die by thousands soon afterwards.

Have found both the above very effectual. If saucers are used with the legs to stand in, containing water, turps, paraffin, or carbolic, ants will carry small particles which float, so that they can bridge across. The four named liquids were used, but in each instance found by observation how they managed to bridge from edge of saucers to legs.

# Notices to Correspondents

W. J. PALMER (Staffs.).—Price of sugar. Your grocer is not profiteering. The price is fixed by the Sugar Commission. See our note in this column on March 4.

N. A. SQUIER (London, N.).—Making an extractor.—Instructions were given in B.B.J. of April 24 and May 8, 1913. You can cut the comb out of the frames, break it up and strain, or with care you might be able to cut the comb and honey away from the foundation, and strain. Either plan would be better than trying to squeeze the comb in a potato masher, unless it contained heather honey.

"BLANDFORD" (Stratford).—Ventilated clearer board.—(1) This is a super clearer with the pail made of wire cloth instead of wood. (2) Better use calico, summer and winter. (3) You may give extra frames of foundation as soon as the bees cover ten combs, the weather is warm, and there is plenty of forage. Early May will probably be soon enough. (4) A queen excluder is not used with a Rymer honey board.

F. H. B. (Devon).—Transferring from skep.—Allow the skep to stay over the frames, and as soon as the bottom combs contain brood get the queen on them and place a queen excluder over them, and under the skep. If the queen cannot be found on the bottom combs, she will be in the skep, which will have to be "driven" until she is secured and placed below. Three weeks later the skep may be cleared of bees and taken away, as all the worker brood will have emerged from the cells by that time.

W. CRICHTON (Forfar).—"I.O.W." disease and black currant mite.—There is no connection between the two. "Big Bud" is not a disease, but is caused by the presence within the bud of a tiny beetle-like insect, which may be seen by the aid of a strong pocket magnifying glass.

E. CHATBERTON (Brighton).—We take it that by "cones" you mean skeps. There is no satisfactory method of disinfecting them. You might try soaking in disinfectant and water for about 24 hours, but better burn them.

*Suspected Disease.*

MISS HARDY (Salisbury), MRS. KILBURN (Dorset).—The bees sent were affected with "I.O.W." disease.

H. W. T. P. (Winchester).—The trouble appears to be dysentery.

D. SEAMER (Lincs.).—No. 1: We cannot say. No. 2: "I.O.W." disease.

K. JORDAN (Surrey), MISS HUNT (Winchester).—We did not find disease in the bees sent.

## Special Prepaid Advertisements. One Penny per Word.

Trade advertisements of Bees, Honey, Queens, and Bee goods are not permissible at above rate, but will be inserted at 1½d. per word as "Business" Announcements, immediately under the Private Advertisements. Advertisements of Hive-manufacturers can only be inserted at a minimum charge of 3s. per *lin.*, or 6s. per *inch.*

PRIVATE ADVERTISEMENTS are only intended for readers having Surplus Stock to dispose of. Driven Bees, Nuclei, and Queens that are reared or imported for sale, are Trade Advertisements, and can only be accepted under trade terms. A charge of 6d. extra will be made if a box number is used.

Advertisements must reach us NOT LATER than FIRST POST on TUESDAY MORNING for insertion in the "Journal" the same week.

### PRIVATE ADVERTISEMENTS.

SMALL APIARY for Sale, seven strong Stocks, 19 Hives and Fittings; owner moving; must clear at once.—Particulars of SMALLBONE, Lodge, Woodsgate Place, Bexhill-on-Sea. c.87

FINE HONEY GATHERERS.—Five healthy 10-frame Stocks, 1919 Queens, ample stores, April delivery, £4 10s. each; £1 deposit each stock with order. Pure English Honey, 23-lb. tins, 35s. each.—VINCENT, 132, Croydon Road, Anerley. c.88

STRONG, healthy Stock Dutch Bees, 10 frames, £4 10s.—CHAPMAN, 15, Heming Road, Edgware. c.89

AN APIARY FOR SALE.—Six strong Stocks, Hives, Supers, Geared Extractor, Ripener, and Appliances, £40. Purchaser to remove.—W. FAY, Bee-keeper, Havant. c.90

PAIR of W.B.C. Hives, splendidly made, canary-wood, zinc-covered roofs, brood sections drawn, super crates with section frames, quantity new Frames, Sheet Wax, Excluder, Smoker, etc.; whole outfit new July, 1919; £5 complete.—Box 73, B.B.J., 23, Bedford Street, Strand, W.C.2. c.91

ELEVEN CWTS. pure Irish Honey in 56-lb. tins at £8 per cwt.—PETER LENNON, Cornanure, Ballyhaly, Co. Monaghan, Ireland. c.92

FOR SALE, strong cast, new Skep, 1919, wintered own stores, Penna strain, very strong, £4 10s.—MEAD, 27, Godson Road, Croydon. c.93

WANTED, Queen (Italian). State price.—STEWART, Panshauger, Hertford. c.94

GOOD STANDARD HIVE, full of healthy (Italian hybrid) Bees, £5 10s.; also one £4 10s.; hives included.—WHITE, 16, Pultney Road, South Woodford, Essex. r.c.95

FOR SALE, three full Stocks of splendidly hardy Bees, never have had disease, £4 each.—MISS DAYRELL, The Hale, Chiddingly, Sussex. c.96

HAVING bought another Apiary, can offer the following bargains: Three pure Italian Stocks, £5 each; seven ordinary Stocks for £28, or single Stock for £4 2s. 6d.; three Dutch Stocks, £11 15s.; all bar frame.—THOMAS, The Causeway, Burwell, Cambs. c.97

ITALIAN HYBRIDS, 1919 Queens, 10 frames, guaranteed strong, healthy; no disease; April delivery; overstocked; stamp.—Box 74, B.B.J. Office, 23, Bedford Street, Strand, W.C.2. c.98

WANTED, experienced Man to take charge of our Bee-keeping Department.—Apply, stating wages required, experience, etc., to THE ALLOTMENT AND SMALL HOLDERS' SUPPLY ASSOCIATION, LTD., Hare Hatch, Twyford, Berks. c.99

ITALIAN HYBRIDS.—Ten-frame Stock, £5 5s.; 8-frame, £4 4s.; 1919 Queens; carriage paid. Apiary never known disease.—HOWLETT, 138, Seaforth Avenue, New Malden. c.100

TWO 28-lb. Honey Tins in crate, 6s. 6d.; 56-lb. Tin in crate, 4s.; 28-lb. Pail with honey gate, 6s. 6d.; box Shallow Bars, 4s.; one Excluder Zinc, 1s. 6d.; 1 lb. Brood Foundation, 2s. 6d.; five Swarm Boxes, 5s. each; one Nucleus Travelling Hive, 10s.; 75 12-hole Cartridges; or offer for lot.—CEILEY, Higheroft, Muswell Hill Road, N.10. c.101

FOR SALE, eight 10-frame Hives, one glass-sided Hive, Crates, Sections, Feeders, two Swarm Boxes, Skep, Smoker, etc., etc., all in good condition, £14, or would separate.—BAKER, 6, Walsingham Road, Clapton, London. c.102

WANTED, "The Honey Bee," by Cowan; second-hand copy.—Write, E. J. HARDY, Bouverie Avenue, Salisbury. c.103

APIARY FOR SALE.—26 Colonies, all requeened last autumn, 11 with fertile imported Italians from Signor Piana, Bologna; 26 Hives, 24 of standard pattern, 12-frame size and interchangeable; also general equipment of frames, drawn-out combs, supers, excluders, reversible extractor, ripeners, honey tins, and feeders; the whole practically new. Purchaser to remove.—Viewing, and offers to P. H. SCOTT, Fairley Grange, Hartley, Longfield, Kent. c.104

**WANTED**, "Bees and Bee-keeping" (Cheshire), Vol. 1 (Scientific), or both volumes.—HEWISON, Marr Vicarage, Doncaster. c.107

**FOR SALE**, several Hives of Bees, dozen or so empty Hives, Frames, Extractor, Separator, Feeders, Glass Jars, Exhibition Cases, etc.—Further particulars, EXORS., late J. Connop, 33, Hubert Road, Selly Oak, Birmingham. c.105

**A FEW** first-class Stocks for Sale, on 6 frames, 1919 Queens, delivery about end of April or early May, £4 each. Inspection invited. Orders treated in rotation.—LARMUTH, Hillside, Monahan Avenue, Purley. c.115

**BEEs**.—Several Stocks for Sale, 6 frames, 6 gs.; also Swarms, May and June.—MISS NEALE, Highfield, Littlehampton. r.c.117

**OWING** to considerable reduction in my stocks I have a large variety of healthy bee goods for disposal, mostly for W.B.C. hives. Send for list.—DELLS, County Apiaries, Leigh, Lancs. r.c.58

**FOR SALE**, W.B.C. Hives, large and small, rapid feeders, excluders, new unused honey boxes to Lold 3 doz.—Particulars, GEORGE, Oak Drive, Oswestry. c.64

**WANTED**, Extractor, not geared, for brood and super frames.—POWELL, Drellingore, Folkestone. c.73

**A STAMPED** addressed envelope will bring you a free sample of Flavine, Testimonials, Circular, etc.—S. H. SMITH, 30, Maid's Causeway, Cambridge. c.74

**ITALIAN BEES**, 12 lots, headed by Penna's imported Queens; 4 frames, 63s.; 6 frames, 90s.; delivery June; carriage paid.—ENNEVER, Oak Avenue, Enfield. c.36

**12 GUARANTEED** healthy Hybrid Italian Stocks, Penna strain, £5 each.—J. YOUNGER, 6, Maid's Causeway, Cambridge. r.c.38

**WANTED**, by the Northumberland B.K.A., Expert, April-August, 1920, to work the re-stocking scheme.—State qualifications and salary required to MAJOR SITWELL, Ord Hill, Berwick-on-Tweed. c.39

**PLANT** "Willow Herb" for your bees; useful and ornamental; 12 roots, 2s.—BOWEN, Pittville Street, Cheltenham. r.c.6

**FOR SALE**, large quantity of Appliances, including 6-frame reversible Geared Extractor in good condition, nearly new Dadant New Wax Press, Honey Ripeners, Nucleus Hives, Travelling Boxes, both swarms and frames, large number of Section Racks, including single walled, Lee's pattern, Burgess double walled, and W.B.C. hanging frames, Shallow Frame Boxes, etc., quantity new Frames, Sections, Metal Ends, Honey Jars, Glass for glazing, Smokers, etc.—May be viewed by appointment, or particulars from "S," Avenue House, Finchley Lane, Hendon. Stamp for reply. c.14

**A VACANCY** occurs for a Pupil on an old established bee farm. Opportunity will be given to learn bee-keeping on a big scale.—Apply, Box 61, B.B.J. Office, 23, Bedford Street, W.C.2. r.a.57

**WANTED**, for scientific purposes, a few live Bees, from diseased or dwindling stocks; cages sent and expenses paid.—SNELGROVE, Quadrant, Weston-super-Mare. a.11

**WANTED**, portable Greenhouse.—Price and particulars to W. HERROD-HEMPSALL, Old Bedford Road, Luton, Beds.

**WANTED**, Auster Rear Wind Screen for motor car.—HERROD-HEMPSALL, as above.

**FOR SALE**, one Exhaust Whistle, 11s., post free; one Wood Milne Motor Foot Pump, 45s., carriage free.—HERROD-HEMPSALL, as above.

**CORRESPONDENCE** Course in Bee-keeping.—MISS F. E. PALING, Golden Square, Henfield, Sussex. r.a.54

**PURE** Light English Honey, £8 cwt.; sample 3d.—BUTTON, Castle Camps, Cambridge. r.c.25

### BUSINESS ADVERTISEMENTS.

1½d. per word.

**BOOK** now for July, August and September.—Penna Queens, direct from Italy. All May and June queens sold.—S. H. SMITH, 50, Maid's Causeway, Cambridge. c.106

**THE REV. G. H. HEWISON**, M.A. (First Class Expert, B.B.K.A.), is open to give Lectures on Bee-keeping and Demonstrations. Unique photo-micrographic Lantern Slides of any part of the Honey Bee made to order; also Nosema Apis (spores). Prints sent on approval.—Marr Vicarage, Doncaster. c.108

**CAN** accept more orders, June and July delivery, of 3-frame Italian Nuclei, with all three combs packed with brood; June, £3 3s.; July, £2 12s. 6d.; carriage paid; boxes returnable. Terms: Cash with order.—ROPER, Thorpe-on-the-Hill, Lincoln. c.109

**STOCKS OF BEES** of Dutch descent in perfect health on from 9 to 10 frames in hives with supers and empty section crates, price £6; also a limited number of Swarms at 30s. Stamped envelope for reply.—MAJOR HENDRIKS, Littlewick Meadow, Knaphill, near Woking. c.110

**ITALIAN NUCLEI**, with 1920 Queens, 40s.—FOALE, Wolverton, Bucks. c.111

**DUTCH AND DUTCH-ITALIAN**.—Four-frame Nuclei, May-June delivery, orders in rotation, £3 3s.; cash with order; carriage paid. I strongly recommend my Dutch-Italians. See B.B.J., February 26, page 99, conference of British Beekeepers re legislation. Dutch and Italian had been tried; they were quite convinced that it was worth while putting one's money on this strain—Dutch-Italian Hybrids.—SEALE, Ashley Cottage, Oatlands Drive, Walton-on-Thames, Surrey. r.c.112

**ITALIAN** 4-frame Nuclei, 50s.; box 10s., returnable; all orders strict rotation; May-June delivery; £1 deposit, balance prior to delivery.—LEE, "Little Bowden Apiary," Burgess Hill, Sussex. c.113

**ITALIAN BEES**.—A few 10-frame Stocks, headed by Penna's imported Queens, £5 each; Dutch Hybrid, 10-frame stocks, £4. I am booking orders for Swarms, headed by Penna's imported Queens, May £2 10s. each, June £2; Hybrids, May £2, June £1 15s.—J. WHITE, Fairstead Hall, near Witham, Essex. c.114

**THE "CLARIDGE QUALITY NUCLEI"** have all combs packed with brood, and are the best value for money offered to bee-keepers for the 1920 season. Book your order now.—Price list post free from CLARIDGE, Copford Apiary, Colchester. No Government queens used or supplied from my Apiary.

**BOZZALLA** tested Queens are sold at the price usually charged for untested queens.—Catalogue from H. STICH, Riccartars Avenue, Paisley. c.116

**ITALIANS**—Queens, 5s. Book now. Stamp.—HOUSTON, Ellen Villa, Sideup. r.c.77

**FOR SALE**, Swarms, Hybrid Italians. Orders executed in strict rotation.—KAYE, Kilderry, Hatfield Peverel, Essex. r.c.79

**HAVE YOU WINTERED 100 PER CENT.?** If not, your strain must be wrong. Booking orders now for delivery June onwards. Hardy, disease-resisting, home-reared Italians; splendid honey gatherers. Three-frame Nuclei, 1920 Queen, price £3 3s., carriage paid; 7s. 6d. refunded on box if returned carriage paid, Saxilby Station. Terms: Cash with order.—HERBERT VALLEY, Apiarist, Saxilby, Lincoln. r.c.80

**ITALIAN NUCLEI**, 3 frames crowded with sealed brood, 1920 Queen, early delivery, £3 3s., carriage paid; box 10s., returnable. Cash with order. Complete satisfaction guaranteed or money refunded.—E. H. TUNMER, "Chalfonts," Leiston, Suffolk. r.c.81

**DON'T BUY BEES** until you have seen our prices and guarantee. You risk nothing, as we return money in full if bees fail to give complete satisfaction. Catalogue 3d., which is refunded on first order.—PEARSON & GALE, Marlborough. r.c.84

**BEES FOR SALE**.—Several small Stocks, on six combs, of honey fed, healthy Bees, £3 10s. each; travelling box 10s., refunded if box returned in sound condition within seven days. Stamp for reply.—REED, Primrose House, Heacham, King's Lynn. r.b.50

**PENNA strain Italian Queens**, from June 7.—ASHWORTH, The Bungalow, Weymouth Street, Warminster. r.c.52

**STRONG, healthy Bees**, 10-frame Stock in W.B.C. hive, now; 6-frame Stocks, April; Swarms to order.—SMITH, 5, Florence Terrace, Ramsgate. r.c.56

**ITALIAN NUCLEI** from 50s., Fertile Queen from 7s. 6d., Virgins from 3s. 6d., 8-frame Stocks £4. Warranted healthy. Particulars stamp.—WATTS, Conway Cottage, Newtown, Parkstone, Dorset. r.b.93

**WATERPROOF RUBBER SHEETS** for covering outhouses, etc., 72in. by 36in., brass eyelets, 12 for 20s.—SAGARS STORES, Ardwick, Manchester. b.16

**HAVE YOU READ "THE BEE WORLD"?** If not, why not? Every number in itself is a useful literary work for practice and reference. Specimen copy free.—Offices: THE APIS CLUB, Port Hill House, Benson, Oxon.

Send for

**Bee-Keepers Wake Up!**

You can make a Big Profit if you use right up-to-date Appliances, including the Manley Hive, MEADOWS, SYSTON, LEICESTER.

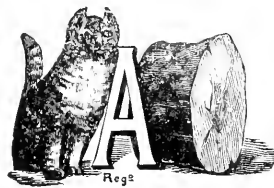

The products of the Apiary, of Poultry and Farm Stock, of the Fruit and Vegetable Garden can be Advertised and Sold through

THE **BAZAAR, EXCHANGE & MART** Newspaper.

Get a Copy—Thursday and Saturday 3d. The "Bazaar" publishes also practical handbooks by experts. Send for full catalogue, post free from—WINDSOR HOUSE, Breams Buildings, LONDON, E.C.2.

THE **British Bee-Keepers' Association.**

The recognised centre of practical and scientific bee-keeping in Great Britain. Particulars and conditions of membership may be obtained from the Secretary, W. HERROD-HEMPSALL, 23, Bedford Street, Strand, London, W.C.2.



**"BACTEROL" FOR BEES**

2/6 per Bottle.

Post Free.

The cure for, and preventive of, "Isle of Wight" Disease. Non-poisonous—free from stain or unpleasant odour.

MENLEY & JAMES, LTD., 39, Farringdon Road, London, E.C.1.

**INSTRUCTION in BEEKEEPING**  
*PRACTICAL AND THEORETICAL*

My Apiary will be open for a limited number of pupils during this season. Terms and particulars from

**W. HERROD-HEMPSALL,**  
The W.B.C. Apiary, Old Bedford Road, Luton, Bedfordshire

**INSURE YOUR STOCKS**  
**AGAINST "I.O.W." AND OTHER INFECTIONS.**

Science has now placed within reach of every Apianist a safe and certain preventive of infection in "Yadil" Antiseptic. For **SPRING FEEDING** "Yadil" may be added freely to Syrup. For **DISINFECTING** Bees and Combs a five-per-cent. solution in tepid water should be used with a fine spray.

ASK FOR GREEN LABEL.

Our Bee Brochure sent Free on Application.

**CLEMENT & JOHNSON, 19, Sicilian Avenue, W.C.1.**

# HIVES.

Compare the WORKMANSHIP and FINISH of our Hives.

All made by practical Men who know what a good hive should be.

In various designs to suit all tastes and requirements, Season's speciality—THE MANLEY HIVE for 16 in. x 10 in Frames

Full descriptions and illustrations in our 1920 Catalogue:

*"Everything for an Apiary."*

If you have not received your copy, send a P.C. at once.

OUR MOTTO—SERVICE & QUALITY.

**R. STEELE & BRODIE, Wormit Works, Wormit, Scotland.**



THE  
KEY TO  
YOUR SUCCESS.

## The Metal Foundation

(Protected)

The latest invention in Scientific hive equipment.

♦ ♦ ♦

Durable ♦ Economic ♦ Sterilisable

♦ ♦ ♦

An Ideal compromise between the Metal Comb and the Wax Foundation.

♦ ♦ ♦

¶ For further details and prices, send for our 1920 ILLUSTRATED CATALOGUE, post free on application. It contains detailed information on the most up-to-date hives and appliances for which the House of Lee is famous.

\* \* \* Five per cent discount to Members of THE APIS CLUB.



**JAMES LEE & SON,**  
LTD.,

Uxbridge, Middlesex,

(Telegrams: Graphicly, Uxbridge.)

Telephone: Uxbridge 181.)

## S. J. BALDWIN.

I beg to inform that the No. 1 Kent Hive is not manufactured by me, only the No. 2 "Bromley Kent."

(New deep frame 17 x 14 x 12. Sample by post 6d.)

**THE APIARY, BROMLEY, KENT.**

Look after your profits by buying hives and appliances which are easy to work. I endeavour also to give good value by care over the workmanship. Send for catalogue.

**EDWARD J. BURTT, Manufacturer, GLOUCESTER.**

Commercial (16" x 10") frames and brood boxes stocked.

PRINTED BY THE AVENUE PRESS (L. UPCOTT GILL & SON, LTD.) 55-57, DRURY LANE, LONDON, W.C., AND PUBLISHED FOR THE PROPRIETOR (W. HERROD-HEMPBALL), BY SIMPKIN, MARSHALL, HAMILTON, KENT & CO., LTD., 31 & 32, PATERNOSTER ROW, E.C.



No. 1971. Vol. XLVIII

APRIL 1, 1920.

[Published every Thursday, Price 2d.]

**CONTENTS.**

	PAGE		PAGE
SEASONABLE HINTS .....	157	THE BRITISH ISLES HONEY PRODUCERS' ASSO-	
A DORSET YARN .....	157	CIATION .....	163
JOTTINGS FROM HUNTINGDONSHIRE .....	158	ECHOES FROM THE HIVES .....	164
THE PRICE OF SUGAR .....	159	JERSEY BEE-KEEPERS' ASSOCIATION .....	164
BRITISH BEE-KEEPERS' ASSOCIATION—		DONCASTER AND DISTRICT B.K.A. ....	164
Royal Show Fund .....	159	SCOTTISH BEE-KEEPERS' ASSOCIATION .....	165
Lectures at Golder's Hill Park .....	159	GINGER CAKE .....	165
BEE NOTES FROM DERBYSHIRE .....	159	CORRESPONDENCE—	
THE HONEY BIRD .....	160	What is Wrong with the Craft? .....	166
"ICHABOD," OR THE BEE-KEEPER'S LAMENT (poem) .....	162	To Keep Ants from Having Nests in Hives .....	166
STINGING .....	162	NOTICES TO CORRESPONDENTS .....	166

## ALUMINIUM DRAWN OUT COMBS.

# "MONEYCOMB"

*The greatest invention in the Bee World for 40 years.*

This is a drawn out Comb of Hexagon Cells exactly as bees build in their natural state. It is slightly coated with wax, has been thoroughly tested, and is not an experiment. Bees readily take to it for rearing brood and storing honey. Strong and durable, will last 50 years with care. Big consumption of honey saved to produce wax for comb building.

Control of bee diseases. No more burning of combs. Each comb easily sterilised and used over again.

Send for Catalogue and descriptive Leaflet.

1920 Catalogue post free.

Patented by ALUMINIUM HONEY COMB CO., of U.S.A.

SOLE MANUFACTURER AND LICENSEE:

**E. H. TAYLOR, WELWYN, HERTS.**

# “QUEENLAND”

## SUPPLIES THE WORLD'S BEST QUEENS.

That's the Public Verdict. Do you doubt it? Then please refer to the spontaneous opinions of many clients, as given in the Revised 1920 "Queenland" List (3½d) containing 20 pages of instructive reading which will start any unfortunate or hesitating beekeeper on the high road to success.

## “W.S.” BEES WON'T DIE OUT IN WINTER.

That's the General Verdict. You have only to glance through the Queenland 20-page List to find the proofs of this statement. Just give them ordinary care, with sufficient food to tide over the winter, and nothing can check their marvellously rapid progress.

## DON'T KNOW HOW TO DWINDLE IN SPRING.

That's because of their inherent VIM, as proved by the very frequent reports that established stocks of these bees are in swarming condition in APRIL. They have for more than 25 years been selected and bred for that very desirable trait—Longevity; hence the reason why the population of the hive is so rapidly piled up to massive proportions.

## READY FOR SUPERS IN APRIL.

That is—before other bees have barely started to build up, as confirmed in many instances; showing that “spring dwindling” is not in their line, under just reasonable treatment.

## THEY STORE HONEY WHILE OTHER BEES ARE IDLE.

That's because of their longer tongues and greater strength of wing, enabling them to visit flowers other kinds never reach. Established stocks of W.S. bees don't wait for the owner—they just push him along.

## THE “WHITE STARS” ARE MOST PROLIFIC AND WONDERFUL HONEY GATHERERS.

This is a rare combination, but is verified by many reports. Some queens have exceeded 350 lbs. in one season. In one case a nucleus increased to seven lots, five of which were sold while the remaining two gave 365 lbs., and the total sales amounted to over £40 in actual cash the second year. Another nucleus in Wales covered 40 frames of brood by August of the same year, and before the next season opened had made eight stocks. Then there is the case of a County Council delegate who reported that throughout his tour in EVERY CASE where an owner had done better than the average the results were attributed solely to the use of Simmins' Queens!

## MANY CLIENTS SAY “W.S.” BEES ARE IMMUNE FROM DISEASE.

That's because they have been bred by the most intense selection of both DRONE and Queen mothers for many generations, but S.S. gives no guarantee that they are absolutely immune, although it is known they have saved numerous apiaries, and collected tons of Honey that would otherwise have been wholly lost. In many cases “W.S.” queens have been given to hopelessly weak and diseased remnants of colonies, and have forthwith raised them to become the strongest stocks in the apiary; in one case storing (the same season) 100 lbs. after thus building up a small diseased lot. Some cases reported of diseased remnants having been renovated by the introduction of W.S. queens have been so remarkable that S.S. himself has been astounded at the almost mysterious results.

## THE “W.S.” ARE NOT IMPORTED ITALIANS.

That is a great point to remember; we have no use for the soft imported Italians, and could not use the best queen selected from a thousand imported without causing a serious deterioration in our pedigree stock. The “W.S.” have gone miles beyond anything that can be imported.

20 Page Revised List, 3½d., of S. SIMMINS, Queenland, Heathfield, Sussex.





### Seasonable Hints.

The abnormally warm weather has brought all vegetation on with a rush. This out-of-season weather brings home to bee-keepers the fact that no hard-and-fast dates can ever be given for certain work, but they must use their brains, and adapt their bee work to circumstances. As a rule, it is not wise to give syrup for spring food until the end of this month at the earliest, but it has been quite in order to feed with syrup during almost the whole of this month, at any rate in the southern part of the country. At the present time one hears of bees revelling in orchards where the plum trees are white with bloom, fully a month before the usual time. If the present open weather continues—and we see no reason why it should not—all will be well, but should a spell of cold inclement weather come, feeding must be the order of the day. There are large quantities of brood in most hives, and as we have frequently pointed out, the hundreds of larvæ make a heavy drain on the bees' larder. A growing youth of 17 or 18 will require far more food than an adult, as bone and tissue have to be built up. The same rule holds good with bees. Very often the strongest colonies are in the most danger, by reason of the multitude of larvæ in the combs. A supply of water and artificial pollen should not be neglected; both water and pollen are necessary for feeding the larvæ. It must not be forgotten that contaminated water is a fruitful source for the spread of "Isle of Wight" disease, hence the importance of a supply that is beyond suspicion.

Preparations for increase, if desired, and queen rearing should be completed. Swarming will probably be early this year, and the making of artificial swarms or nuclei may follow suit, and be done earlier than usual. A safe plan to follow when making increase artificially, is not to do it before the bees swarm naturally. The one point that amateurs are likely to overlook when making early nuclei is that there will most likely be a scarcity of flying drones to mate the young queen. If a fertile queen is available the case is altered. The early breeding of drones should be encouraged in the colony from which they are desired for mating purposes, and in all others they should be limited as much as possible.

### A Dorset Yarn.

"Bees are bringing in blue pollen; could you tell me the plant from which it is collected?" This was a query last week. Had to answer, "Cannot tell." But going out to see some bees (a bee-keeper wanted to sell, as he was going back to Scotland from Dorset) in a vicarage garden, the bees were carrying in pollen of a blue colour. All round the hives were the loveliest blue anemones—not only the ray petals, but the centres blue as well. Some old-time parson had planted the garden with some of the choicest flowers from all parts of the world. It was a perfect paradise of flowers, including large tulip trees (*Liriodendron*)—a small Dorset village between the hills close to the sea, with 100 inhabitants, a little church, and about 20 worshippers, "far from the haunts of men," but a lovely place to live in, a perfect home for bees. On the tops of the bars there was plenty of new honey; no sign of disease, and very strong in numbers. They are big blacks; should not think they are Dutch, as they do not worry themselves with swarming (as another bee-keeper had them in Lytchall; from two hives he had 17 before last season was over). To see them was an incentive to buy them, so they will go to the Violet Farm. This old-world parson's house and glebe is to be sold, in order that the parson should have "a living wage." May some bee-keeper buy it and finish his life in one of the most delightful counties in England!

Colour of pollen is wonderful. Just now the swedes, turnips and cabbage are in full bloom, many acres of them, much higher than the sheep hurdles that are confining the sheep. All these pollens are shades of yellow, but pears have purple-red stamens of pollen; the horse chestnut has a scarlet colour; gooseberries, which are now out in bloom, have greeny-coloured stamens—if you see the flower under a strong lens it has a green calyx, tinged with dull red mostly, though some varieties are much more golden. This calyx is divided into sepals. At the base of these rise five small petals in a cup-shaped form, with scarcely any colour at all; between these are the five stamens with the pollen on the tips, the pistillate part connected with the ovary standing up in the centre of the small cup of five petals. The great Swedish naturalist divided up the flora of the world by the numbers of stamens: this one, you will notice, has five sepals, five petals and five stamens. Bees seem to like this flower more than any other variety of fruit. It is not the gay colour that is the incentive, as they are not at all a showy flower; but it must be the strong smell of the nectar that is within that attracts them in thou-

sands. The flowers must of necessity be perfectly fertilised, with so many bees on them; but, the male and female organs being so close together, they can be wind-pollinated as well, unless heavy, driving rains wash off the pollen. But the flowers are so formed that they do not stand up for the rains to go into the flower, as they hang outwards and downwards,

"Lest the sun be too glaring,  
Or the wind too daring."

All seem to be arranged that the fertilising organs should not be injured. No wonder the poet Cowley should write in wender and praise of the wonders of Nature's flowers:—

"If we would open and extend our eye,  
We all, like Moses, should espy,  
Ev'n in a bush, the radiant Deity;  
But we despise these, his inferior ways,  
Though no less full of miracle and  
praise." J. J. KETTLE.

### Jottings from Huntingdonshire

"Oh! to be in England, now that April's  
there,  
And whoever wakes in England sees  
some morning unaware  
That the lowest bow and the brushwood  
sheaf  
Round the elm tree hole are in tiny  
leaf,  
While the chaffinch sings in the orchard  
bough  
In England now!"

So sang Browning, and what poet could resist the call of spring? What a time it is! And how the countryside, with its insistent yet still, small voice, speaks its message of new birth, of peace and love. The very air is charged with something that gives us joy; the earth is full of scents, the hedgerows and trees encompass one around with their influence of growth, and all the birds are making merry with their mates, while the bees are in never such a hurry to find the pollen and the nectar, the propolis and the honeydew. More of Robert Browning's words come to mind:—

"The year's at the spring, and day's at the morn,  
Morning's at seven, the hillside dew-pearled;  
The lark's on the wing, the snail's on the thorn—  
God's in His Heaven, all's right with the world!"

Those of us who have been wise and fed their bees will begin to think seriously of supering. One stock I have already supered. I did it some week or two back—more, I think, to give room than anything else and I now find one shallow frame nigh full. Hard and fast rules are

unwise in the bee world. When spring comes so early we must work in harmony, and not wait till a given date. As soon as the brood chamber is covered from frame to frame, super; and if your bees are Dutch give them plenty of supers and heaps of room. In most districts south of the Trent there will be abundance of nectar ready for gathering. We went a stroll yesterday afternoon, my daughter and I, and oh the joy of it! The hedges white with blackthorn and wild plum and cherry; the plum orchards almost singing with their wealth of blossom white as milk; the pear blooms coming on to provide pabulum for the bees when the plum petals come snowing down with every wind. O'er the springy turf, carpeted with the "wee, modest, crimson-tipped flower," the celandine, the cowslip and the violet, the bees are busy. Here and there we came across osier and willow catkins alive with our insect friends. How happy they are! The thrush and chaffinch sing in tree and bush, wrens come hopping up, inquisitively asking what we're doing. We enter a coppice. The daffs. are over, but the violets and primroses are flowering side by side—one with a modesty that is of itself a charm, the other staring up and about as if to say, "I'm here." We cross a stream, and are glad to note that near the edge, where grass is growing into the water, the bees rest a while and take a drink. We return through an avenue of chestnuts bursting with buds. Later on we shall walk down here at six in the evening and hear the ceaseless hum of the honey-flies as they sip the nectar from the opening flowers. As we ascend up rising ground, we pause to note the various hues of green. How Nature conjures with her colours and her shades! She makes seemingly impossible shades blend, by some bewitching trickery impossible of emulation. The oaks and elms are silent. A week ago the blossoms of the latter were the meeting-places of the Italians and the Dutch. We are back home now, and note the box blossom is attracting our golden friends, but Holland's darkies have other choices; they will be where the flowers are white when April's here. Within one box bush a thrush has made her nest and deposited five black-spotted sea-green eggs. A mallard and a duck fly overhead, the que, que, que of the wryneck comes float-o'er the meads, a cuckoo flits from tree to tree, too shy as yet to open up in song. No doubt about it all, spring is here; and no one loves it more than he or she who also loves the bees.—E. F. HEMMING, Steeple Gidding.

P.S.—I ask my young friends to forgive my keeping them waiting. I hope to complete my confidential talks with Apis next week.

### The Price of Sugar for Bee-Feeding Purposes.

We have received the following circular letter from the Ministry of Agriculture:—

I am directed to inform you that the Ministry have been in frequent communication with the Royal Commission on the Sugar Supply on behalf of bee-keepers, and have been informed that the Commission are unable to reduce the price of sugar for bee feeding below the economic price, or below that at which it is sold for purposes other than grocery and the manufacture of jam, as this would, in effect, be equivalent to paying a subsidy to the bee-keeping industry. The Commission add that the price of sugar for all purposes will probably be raised in the near future to a figure more closely approximating to the economic price.

The Ministry regret this decision, but they would like to point out that in view of the proposed general increase in price, bee-keepers cannot expect to receive preferential treatment.

### British Bee-Keepers' Association.

ROYAL SHOW FUND.

The Council of the British Bee-keepers' Association are anxious to take their usual part at the Royal Show to be held at Darlington this year, so that their unbroken record of representation at this show may not be spoilt. In order to defray the expenses in connection therewith the Council ask that all bee-keepers assist in this work by giving donations, which should be sent as early as possible to the Secretary, 23, Bedford Street, Strand, London, W.C.2.

DONATIONS RECEIVED.

	s.	d.
I. Price ... ..	5	0
W. H. Teed ... ..	10	0
<hr/>		
Total ... ..	15	0

LECTURES AT GOLDERS HILL PARK.

A special course of six lectures on bee-keeping will be given in the British Bee-keepers' Association's apiary, London County Council Park, Golders Hill, London, N.W., on Fridays, April 23 and 30, May 7, 14, 21, and 28 at 6 o'clock each evening.

Those desiring to attend these lectures must make application at once for enrolment and particulars to—W. HERROD-HEMPSELL, Secretary, 23, Bedford Street, Strand, London, W.C.2.

A simple "chat" on bees will be given free, at 3.30 each afternoon before the lectures.

### Bee Notes from Derbyshire.

I well remember the first time I ever saw bees working on clover. I should be about twelve years old. It was in a field between Ossington and Woodhouse, and I had to cross this field. It was literally covered with bees. I was positively frightened to death, for fear I should get stung on my bare legs, as they were about one on every "nob." I well remember standing watching them, and wondering whatever in the world they could be after, so many of them on that one field. There must have been a good flow on that day. I little thought then I should ever get so interested in bees as I am to-day. That appears to be about the second time I can ever recollect noticing bees in my young days; but I do recollect seeing two lots in straw skeps on the railway side, between South Leverton and Cottam, when I was a lot younger than that, and how they were working on a patch of white arabis. And I have also a faint recollection that the woman who owned them gave my father a swarm, but where he stood them the remaining part of that summer I have not the least idea, as we had no garden there; but I do remember seeing the skeps on a pantry shelf in an empty house next door when the snow was on the ground, and him saying they would be warmer in there; but they must have died, for I never remember anything more about them. I could not have been above six or seven years old, and we lived at South Leverton then.

At the time I saw those bees in the clover field there used to be four or five lots under the tiles of the first house going into Woodhouse from Norwell; they must have had quite a store of honey there. I noticed them there for a year or two at that time, but as I went away from that part again in 1884 I could not say much about them. Perhaps Mr. G. Marshall, at Norwell, could tell more about them. The next time I noticed any bees was at Sutton in the Vale, near Belvoir, in 1889. They were swarming, and an old woman was tanging the old dust-pan and door key; but I was frightened of bees then, and I soon "hopped it." Another ten years passed before I ever noticed any more bees, nor do I ever remember tasting any honey much till then. I do remember tasting a bit that came from those two hives beside the railway, and I have only once since tasted any that compared with it for flavour, with forty years between the two tastes. Having eaten and tasted of pounds this last twenty years. I have only once come across that first flavour again.

But to come back to that house with the bees under the tiles. I wonder if

"I.O.W." disease cleared them out. I was within a mile of the same house on October 11. I was going by on my bike when it came on to rain, so I turned round to go back, and as I turned round I looked on the same trees that, between thirty and forty years since, I thought were good for nothing, only to hide, or block, the view. I thought what a lovely country for bees. Just near to me was an acre of "pussy" willow, that in my boyhood days were perhaps five feet high, now they are very large trees. What a feast there for bees in the spring! Away in the distance were large trees, such as horse chestnut, sycamore, limes, and other varieties that I could not name, but all going toward making an ideal place for the bees.

What a many bee trees have been cut down these last two or three years for pit timber nobody knows, but I have noticed a large amount of sycamore and bass wood, or lime. I use a lot of timber when I am at work, and one night we had been using a lot of what I at first sight took for elm, judging by the bark. When later on I had to chop a large slice out, my mate picked it up, and says: "What white wood, as white as snow." As I examined it more closely by the light of our lamps I said: "By Jove, its section wood: what a shame such wood has to come down a pit, for that one piece would have cut hundreds of sections." I have seen a great lot of it lately: trees that would be from 7 to 9 in. in diameter. I have thought somebody's bees would miss them next year: perhaps some beeman will be wondering where they have gone to. Well, I can say it will stand a lot of punishment, same as larch, before it breaks; not like beech, it snaps in two with a bang, and down comes the roof very often. But still I think it's a shame the poor bees should be robbed of their favourite trees like that, the same as they have been robbed of their favourite pasture fields round here, with dandelions and clover in them. But so the world rolls on.

I have been busy lately collecting all my BEE JOURNALS together, and tying each year's lot in a bunch, and reading them over again. I have just perused 1899. I see a lot about Lordswood among that year's. He was really a very interesting writer; and what a lot of names one sees that are seldom mentioned to-day. I expect a few have joined the "great majority," but I am real glad to see Mr. Loveday has come to life again, for I used to be very fond of reading his bits in THE BEE JOURNAL, but real sorry that he got cleared out with foul brood. A Bee Disease Act would do such like as them good, for I came across a case this year where bees had died of "I.O.W." disease

last winter. A swarm this year had taken possession of old combs, and died again, and when I proposed burning the lot, as the hives were all to bits, the owner said: "Oh, the frost will clear the disease out." So there they are, open to all comers. No wonder "I.O.W." disease dies so slowly. —TOM SLEIGHT, Clay Cross, Derbyshire.

## The Honey Bird.

The following interesting translation from an old book has been sent to us by the Rev. E. H. Oldnam, Stanford Rectory, Worcester. The translation was made by his son, who is an enthusiastic bee-keeper in Rhodesia. In a letter sent with the article he says: "I picked up this book by accident, it is *extremely* old, and probably by one of the earliest settlers in the country. THE BRITISH BEE JOURNAL may be glad to print it. It rambles at times, but is true to life, and gives some idea of how the niggers think in a way."

The "Insehlu" is a bird which by its cry calls men to places where there are honey bees. Among black men it is said to be a chief. If a man throws a stone at it when he does not follow it, he is regarded as a man of naught. For if a man does not find bees, he should not say, "Let me throw a stone at it, it is a liar." It is not so. The bees are there; or if they are not there, there is something else. If he does not see it, he must not blame the bird; for if it is struck it is afraid to call men to the place where there are honey bees.

It happens when a man is walking, unconscious of anything, or perhaps he is very hungry, and is unable to walk fast, being a burden to himself; then may come a bird, its name is Insehlu. As he is walking along, perhaps it appears in front of him, and he hears it loudly chirping, and he begins to gain strength through faith, saying: "My hunger is already appeased, because I am called for a reality." So he says in answer: "Eh!" or "Chirp!" He first praises it, saying: "Thou honey bird, who calls the women when they are digging! Yes! Yes! Speak, that I hear what you may say." Then it cries with a very great crying, and makes a great noise in the bushes; and the man, too, is very glad. The bird goes in front, for it is, in fact, a guide. The man does not ask where he is going. He follows it continually; it goes and waits for him; for it flies, and he passes with difficulty through the underwood. If it goes a great distance in front, it returns and meets him. When he does not hear even its cry, and it is quite silent, he says again and again: "Where

are you gone?" If there is no sound he begins to shout very loud, saying, "O-o-oyi!" telling it to understand that he is looking for it. And then he stands near the place where the bird left him; for when it comes back, it comes back to the place where it left him; and he hears it coming and making a great noise, and he cheers it very much, shouting "E-ha." At length it comes to him. If it does not see him and sits on a tree, he at length stands forth, and sees it, and it sees him, and so it departs and pitches in front: at length it comes near the place where the bees are, and begins to cry less loudly. And he says: "Let me make haste, for it has now pitched," when he hears it gently crying; but it has not yet settled; but when he approaches, it begins to go towards the ground; and he thereby knows that the bees are near at hand.

If the place is exposed, it goes and settles in front; it chirps and is silent; he again and again responds to it, it chirps and is silent, and points in the direction of the bees. When it sees him it flies off, and he catches sight of it and begins to mark down the bees; again and again he says: "Ah! there they are entering the foot of the tree." And when he sees them going in in crowds he draws near; and the bird is still. When he reaches the very place, the bird comes over and waits over against him, and looks on; and he sees that it is quiet; he digs out the bees and takes out the honey; he places the young bees for the bird, and sticks a piece of comb on a stick, that it may eat. And then it will call him again on another day.

But it does not eat the comb; it eats the young bees that can fly. So the man sets out; for it is said if a man places honey for it, it will lose its voice. Perhaps if it is a country which abounds in honey, as he is carrying it off looking for a place where he can eat it, it comes again, and he hears it crying, and he responds to it gladly; but since it has given him abundance he will not follow it again; for he has enough, so he goes home.

And in the thorn country bees are found by it. A woman follows it; if it comes to her when she is digging, she calls another woman, and they follow it, and the husband sees his wife returning with honey. When there is a snake in the hole, we know that people are frequently bitten when they are taking out the honey; for we do not like to destroy the hole; and a wise man when he digs does not injure the hole by which the bees enter; he digs at the side, and makes a hole by which he can take out the comb; we do not destroy the hole by digging; for if we destroy it, that swarm of bees

will not repair it; we measure the hole we have made, that we may find a stone and close it up nicely.

If there is a snake in the hole, when the man takes out the honey, perhaps he sees there are holes in the comb; perhaps he says it is roots which have occasioned the holes; but if it is roots, the combs are broken. At the last where the snake is coiled up, when he thinks to grasp the last comb (the eyes cannot see inside, he is searching about with his hand only), he feels himself wounded; he draws his hand out rapidly, and sees it bleeding; he has been bitten. If it is a mambu, he will die there and then. If it is another snake, perhaps he will live to have remedies applied.

Now, before we dig, we begin by putting a stick into the mouth of the hole, that we may see if there is a snake with the bees or not. If there is, as soon as the man puts the stick in, the bees will walk on it. So he says, "There is a snake," and will leave that hole if he is a timid man; but if he is brave, he will break down the whole, that he may see what he is about, when he is taking out the honey. That is how it is. When it calls a person to a place where there is a leopard, it is heard striking its sides with its wings; and then a man will turn back. But at first it was not so; it was not understood what it was doing, until the place was seen where the leopard was; and he said: "O, it calls me to where there is a leopard forsooth." Or it may call to a place where there is a dead goat, or a bullock devoured by wild beasts, or a great snake coiled up. As it happened to us, when we were living on the Mtshingwe River. Our father having killed a buffalo, we awoke early in the morning to go and fetch the flesh; when the sun was now hot, there came a honey bird, and called us urgently; as we were many, we chose some of us to follow it; some set out for the place where we were going; and others followed it. As it was winter, the whole country had been burnt, and nothing was concealed by long grass; when it arrived at the site of an old village, it stopped and pitched in an open space; we proceeded gently, saying: "Why, what kind of bees are those which are in an open situation?" When we came up it flew away, and pitched again near at hand over against us, and was silent. We looked and looked, but found nothing. We went away, going along and talking. But it came back again, and took us back to the same place. We searched and searched for we were looking for honey; but it, forsooth, was not calling us for honey; it was calling us for something else. As we were searching, bent on itself under a tree, it had an

opening, and was large. I shouted: "Behold my piece of metal. We all ran hurrying together to the place. I took it up; it was heavy. I said: "What metal is this?" The others said: "It is really metal." But we disagreed. We found a stone and struck it, and said: "Ah! so it is a collar of red brass." So we walked away; it was silent; and that was the end of it.

### "Ichabod"; or,

"THE BEE-KEEPER'S LAMENT.

Twelve empty hives with fast-closed door,  
The glory from the scene now fled.  
Silence where all was life before—

The gloom and silence of the dead!

My ban upon the fell disease  
That sprang from yonder luckless Isle,\*  
And slew my poor defenceless bees

With baffling art, o'er-mastering guile!  
Shame on the high-placed, faithless  
"crew,"

Who watched the plague spread far and wide—

Like fire before the wind it flew—  
Yet no preventive measures tried!

Companions of my leisure hours,  
My little friends, for you I mourn,  
I miss your songs among the flowers  
That everywhere the earth adorn.

I miss th' excitement of the swarm,  
That pours like torrent from the hive.  
Your circling as in wild alarm,  
The air with myriad wings alive.

I miss the cheerful, drowsy hum  
That with soft music fills the air,  
As hurrying past in bands you come,  
And home your precious treasures bear.

While I, as seated on a throne, z  
Observe you do my sovereign will,  
Me as your rightful master own,  
And with rich stores my garners fill.

You flowers, that daily open wide,  
And draw the busy, wandering bee,  
In vain you strive your grief to hide—  
I know you grieve along with me;

For now your sweets go all to waste,  
None now the fragrant nectar sips,  
And you must miss the kisses chaste  
The bees imprinted on your lips!

And you, ye fair, fruit-bearing trees,  
Now void of all fertility,  
You, too, bewail my vanished bees—  
The cause of your sterility!

Alas, those hives with fast-closed door,  
The glory from the scene now fled,  
Silence where all was life before,  
The gloom and silence of the dead!

A. E. McINNES.

Roberton Manse, Hawick.

\* Isle of Wight.

### Stinging.

I am not an orthodox bee-keeper.

Heterodoxy has advantages, and disadvantages. One of the advantages is that it brings one into contact with out-of-the-way facts of bee life not apprehended of the many. A serious disadvantage is that it will effectually prevent me ever taking the expert certificate of the B.B.K.A. For I perform my manipulations in gloves, and this, I am assured, is one of the cardinal sins which no board of examiners will ever overlook.

Of course, gloves are a nuisance. So is something else. And when a wise man has to choose between two nuisances, he is morally bound to prefer the less to the greater. Otherwise, he will cease to merit the adjective.

The other nuisance is that indispensable weapon of every hefty bee-man, the smoker. At least, a nuisance I have found it, and so, I think, have others, if they would but make that open confession which we are told is so good for the soul. At the first bee meeting that I ever attended it took the united, and sometimes desperate, efforts of two leading members of the committee to maintain the smoker in usable condition for the lecturer. And they were not always successful. Indeed, as the lecture proceeded the manipulation of the bees took a gradually decreasing position of importance, and the attention of everybody, including the lecturer, was concentrated upon the greater problem of keeping the smoker alight.

I confess that I could never manage it—the smoker, I mean. It roared like a furnace what time I stood it on end, and when I laid it in a reclining position it incontinently yielded up the ghost. If I reached for it as it stood in the perpendicular position, in a mechanical sort of way, having my attention riveted upon some problem of the stock-chamber, I was almost certain to grab it by a part that had become red-hot, which casualty impelled me to "tell the bees" certain facts in terms which it was well for me the wise and discerning little creatures kept closely to themselves and never repeated to anybody. At other times I would find the smoker about as much use to me as a raw potato might have been, and would fling it away in disgust. Finally I put my foot through the bellows of the treacherous appliance and relegated it to the dust-heap.

Thereafter, with a certain savage determination, setting at naught the open jeers and the secret pity of the elect, I pulled on a pair of stout gloves, with gauntlets attached, and went through my manipulations without smoke, letting the

bees do just what they liked. And, strange to say, nothing very catastrophic happened. The bees were good sportsmen, and declined to take any undue advantage.

My first gloves were of stout leather, strong enough to turn the rapier of anything but a very malignant "black." The points of the digits I cut off, sufficient to bare my fingers and thumbs as far as the first joint. Thus provided, I could perform the most intricate operations of the hive without feeling the least clumsy. Picking queens off the comb, and caging them, became quite easy; not so easy, though, what I had always found a far more difficult operation—picking up workers by the wings and pushing them head foremost through the little hole in the end of the travelling cage, after their mistress. Even using the grafting tool, and transferring tiny larvæ from the depths of unshorn worker-cells to the spacious accommodation of queen-cups, was successfully accomplished in gloves with bared finger-tips. . . . No, certainly gloves do not make one clumsy. And the saving of time, by discarding the smoker, is immense.

(To be continued.)

### "The British Isles Honey Producers' Association."

Since November last I have been thinking over a scheme which will materially help every bee-keeper in the British Isles to dispose of his honey crop in the best possible market and at the same time stimulate the demand for the "home-produced" article.

Like most other plans which aim at large things its success will be entirely dependent upon the amount of financial backing, and it will depend upon the way in which the funds are spent.

To put it as briefly as possible, what I suggest is this:—

All bee-keepers should amalgamate (co-operate is another word) to form what I should like to call "The British Isles Honey Producers' Association," and asked to subscribe a reasonable sum each to a "central fund." It will be useless to stint the amount of such a subscription, and I would suggest a minimum of £1 1s. per annum (if a "sliding scale" rate could be adopted for the larger owners, so much the better), and it would be advisable to operate each county separately and through the county association. This fund should be used primarily for extensive propaganda work, chiefly by means of the newspapers, in educating the public to the higher value of British (home produced)

honey over that of imported foreign honeys; and also for expenses in seeking contracts and sales of the crops. I would suggest that every county association sets up centres for the receiving, grading and packing of the honey, which should be graded and packed in uniform standard packages, bearing the mark and guarantee of the local association. All returns should be liable to a small commission to defray working expenses.

As every bee-keeper who had honey to sell would benefit by the undoubted increased demand, it would be "up to him" to support such an association, whether he sent any of his crop in or not. Such an increased demand will be still further assured if every reader of the BRITISH BEE JOURNAL will add his vote to the motion I made to the Board of Trade that all foreign honey be compelled to be labelled with its "country of origin" and the nett weight of contents stated on the label.

I wish every reader of the JOURNAL to seriously think over these proposals, for in view of the possibilities of the future it is hopeless, madness, indeed, to think of going on in the same old easy way. Sugar is threatened to be 1s. or over per pound. Jam will, therefore, be dear; sweets and confectionery will likewise suffer, "and honey will maintain a high price?" Oh, dear no! Not by any means! Read the current American bee papers, and see what they consider *their* prospects are for 1920!

I venture to predict we shall have hundreds of tons of foreign honey dumped upon us next autumn, and those of us who already are finding it difficult to dispose of first-class (and even extra fancy) honey at moderate prices, will then find we shall have to sell our crops at prices lower than sugar.

By a curious coincidence I see in the February numbers of the *American Bee Journal* and *Gleanings* a report that the old "National Bee-keepers' Association" (of U.S.A.) is re-forming along lines similar to those outlined in my suggestions. Now it behoves us "to be up and doing," and I sincerely trust this appeal will meet with all the support such a movement will require. Get busy with your local association secretary and don't forget the "Bradburys" and "Fishers." The whole thing will depend upon the commercial spirit which must permeate every idea and movement in its connection.

The most important point to my mind, in the operations to be undertaken, will be to *make certain of the market first!*

I know someone will say, "counting your chickens"—but I ask which is the worse, to have heaps more orders than you can execute, or tons more supplies than you

can sell? And, incidentally, which state of affairs maintains the best returns?

If correct propaganda (advertising if you like, only "propaganda" includes more than mere advertising), is carried out from the start, each succeeding year will see less need for so much of it, unless the encouragement received brings many more recruits to our calling.

Don't forget 1918!—when nearly £3,000,000 went "west." Yes, literally west, on imported honey, and all of it could have been produced in this country. May it never happen again—but if will if we don't "amalgamate." — F. M. CLARIDGE, Copford, March 6, 1920.

### Echoes from the Hives.

Have just been through the bees, and it may be of interest to some of your readers to know the result.

All but one are safely through. Unfortunately, one very strong lot has gone under. It died about five weeks ago (through my carelessness) of starvation. It was on 10 or 11 standard frames, and much pollen was stored under honey which gave the impression last autumn that it had plenty of stores.

Most of my stocks are, as you know, on 16 by 10 frames, and all these are strong—indeed, five or six of them have six or seven combs almost completely full of brood. The standards are not so forward (they never are) except in one case where there are seven combs of brood. This does not amount to the same thing as 7 16-by-10, or even six of the latter.

The most striking experiment of all this winter was with a rather weak stock in a very old hive, which I bought from a neighbour who sold his farm and had it left about. When I bought these they had practically no food. I gave them two combs of sealed stores—one hanging and one lying flat on top of combs. The roof did not fit the hive, and it was impossible to pack them properly.

Indeed, throughout the winter, there has been direct draught right over the tops of frames. This stock has wintered well, and had four combs of brood on March 21.

Of all the stocks wintered the one with most brood has been left all winter with a 2-in. deep entrance left open the full width of the hive. I mean that there was a 2-in. space under the combs right to the back given by means of cleats nailed on the bottom and thus giving 2-in. entrances. This is a 16 by 10 stock, and has seven combs covered with brood almost to the top bar.

I also have wintered 10 stocks pur-

chased in butter and other boxes last autumn. These have no protection whatever, except at top, and are unpainted, and the wood is half-inch stuff. The top is just covered with a bit of linoleum tacked on. These are all very strong, forward, and appear to be breeding fast. Some have not got the combs more than half-built down.

I know it has been an exceptional winter, but I think the above goes to prove that my contention, that expensive double-walled hives are quite unnecessary, is justified.—ROB. B. MANLEY, Brightwell, Wallingford, March 25.

### Jersey (Channel Islands) Bee-keepers' Association.

#### ANNUAL MEETING.

The annual meeting of the above was held at the Agricultural Society's office, St. Helier, on March 5, and was well attended.

The President, Mr. P. N. Richardson, took the chair, but announced that owing to pressure of business he was unable, much to his regret, to accept nomination for another year, and the Vice-President, Mr. J. D. Arthur, wrote to the same effect.

The following were then elected:—President, Major Falle; vice-president, the Rev. Van der Beken; hon. secretary and hon. treasurer, Mr. P. A. Gore. The Council for the current year elected were:—Mr. P. N. Richardson, the Rev. J. G. Balleine, the Rev. R. Le Sueur, Mr. J. D. Arthur, Mr. J. A. Grew, Miss Hind and Miss Luce.

A number of members exhibited samples of honey. During the subsequent discussion members were reminded that owing to the efforts of the Rev. R. Le Sueur, the States of Jersey passed a law prohibiting the importation of bees into the island from England, owing to the prevalence of "Isle of Wight" disease in the latter country, which is non-existent in Jersey.—P. A. GORE.

### Doncaster & District Bee-keepers' Association.

#### ANNUAL MEETING.

The annual general meeting was held at the Grammar School, Doncaster, on Saturday, March 20, General Sir Bewicke-Copley, C.B., presiding.

The Rev. G. H. Hewison, hon. secretary, read the report of the Committee. The membership showed a slight increase in numbers, there being now 63 members. The season was started with a balance in hand of £2 15s. 8d., and the present balance in hand was £7 12s. 8d., mainly



due to the generous financial help given by the President and the Vice-presidents.

Locally the season was an exceptionally bad one for honey-gathering. Disease is still rampant, and many stocks have been lost during the winter. We hope that legislation will soon be an established fact, and feel confident that good results would thereby ensue.

The Committee wished to congratulate the Hon. Secretary on his having obtained a first-class expert certificate from the British B.K.A.

The Committee regretted that they were not nearly so successful with the Government re-stocking scheme as they had hoped to be. The long drought, followed by cold, windy weather, prevented the secretion, or gathering of nectar, so that breeding was spasmodic. Moreover, the queens available from Italy were much fewer in number, and arrived later in the season than had been expected. Another difficulty, and this was common throughout the country, was the apparent antipathy of the Dutch bees to Italian queens, making it a difficult matter to introduce the latter. Instead of twelve queens expected, four only were received, and of these one arrived dead, and another was killed on introduction, and a third was "balled" by one stock before being safely introduced to another.

Throughout the season, and particularly towards the end, it was found that the Dutch bees made little attempt to ward off attacks of wasps, which were numerous, and any weak stocks soon fell victims.

Finally twenty nuclei were distributed, but most of these went to the Sheffield people whose applications preceded those of our own members.

During the season Mr. W. Herrod-Hempsall, F.E.S., paid a visit to our re-stocking apiaries and expressed himself as fully satisfied with the progress made.

General Sir Bewicke-Copley, C.B., was elected president; J. A. Claxton, Esq., M.A., chairman of the Committee; the Rev. G. H. Hewison, hon. secretary and expert of the Association; and the following were elected members of the Committee:—Rev. M. Yate Allen, M.A., Mr. R. W. Merriman, Mr. W. T. Chafer, Mr. W. Clark, Mrs. Claxton, Mrs. Wynne Davies and Mrs. Jennings.

At the conclusion of the meeting an interesting lecture and demonstration on wax-rendering was given by Mr. W. Garwell, hon. secretary and expert of the Sheffield B.K.A. Mr. Garwell is the winner of many prizes at various shows throughout the country, and he demonstrated how wax should be prepared for the show-bench. His demonstration was much appreciated by all present, and a

hearty vote of thanks was proposed by Mr. Claxton and accorded by those present.—G. H. HEWISON, hon. secretary.

### Scottish Bee-Keepers' Association.

The Association reports most encouraging progress during the past year. The federated associations have increased from 25 to 34, and now cover practically the whole country. The decrease in virulence of the dreaded "Isle of Wight" disease, and the demand for honey at a remunerative price have led to a great demand for bees and to increased interest in the study of the subject of practical modern methods. This has been shown by the number of candidates seeking to gain certificates in practical bee-keeping. During the year 60 candidates gained the Bee-master certificate, and the Expert Diploma (E.B.:S.B.A.) was gained by 25. Of the successful candidates no fewer than 13 were ladies. The financial grant made by the Scottish Board of Agriculture to the Scottish Bee-keepers' Association is being used for propaganda work, and for the taking of a census of bee-keepers and bee-hives in Scotland. This will be useful in the interests of the bee-keeping industry, and may facilitate the securing and distribution of sugar for feeding bees. The financial abstract for the year shows a favourable balance, which will admit of considerable aggressive work being undertaken, and proposals are being considered for making grants to any federated branch or association which engages a qualified expert to visit and advise its members. The contractor for the supply of bee goods and appliances to members is Messrs. Steele & Brodie, Wormit-on-Tay. Depôts for the disposal of the surplus produce of members have been arranged at Edinburgh, Dundee and Perth. The annual exhibition will be held as usual in connection with the Highland and Agricultural Show at Aberdeen in July. The new hon. secretary is the Rev. John Beveridge, B.D., Gartmore. The new president, Mr. J. H. Langlands, C.E., E.B., S.B.A., Dundee, will succeed the retiring President, Mr. John Anderson, M.A., B.Sc., Aberdeen at the next meeting of the Council which falls to be held at Perth in April.

### Ginger Cake.

One cup honey, half cup sour milk, half cup butter or dripping. Warm these ingredients together and add one tablespoonful ginger and 1 teaspoonful soda, sifted in with flour enough to make a soft batter. Bake in flat pan.—*The Western Honey Bee.*



## What is Wrong with the Craft?

[10156] "What is wrong with the craft" is very largely that so many of those who call themselves experts are in the unenviable state of being entirely satisfied with themselves and their methods. These men are hopelessly reactionary, hating all progress and deprecating all discussion. They appear to hold ideal a kind of millennium of smug complacency and stagnation which would lead nowhere, and incidentally save them the trouble of learning anything new.—R. B. MANLEY.

## To Keep Ants from Having Nests in Hives.

[10157] It is often found that ants enter hives and make their nests and deposit eggs, and make an unusual mess. To prevent this take 1 lb. of hyposulphite of soda (the fixing agent for negatives) to one gallon of water. Dissolve and apply to parts of hive (not where bees are) either hot or cold, to all crevices and corners frequented by ants. Use it by means of a fine sprayer. Will quickly destroy them. One need not drench the parts.—THE BEE MASTER OF WARRILOW.



- C. V. BLACKHAM (Tunbridge).—Using *mildewed combs*.—Spray the combs with a 10 per cent. solution of Formalin and water.
- S. MARFLEET (I.O.W.).—*Sugar sample*.—The sugar is not suitable for bee food. We understand that retailers have instructions that only *white cane sugar* is to be supplied for the purpose. Brown sugar, even if pure cane, is not suitable for bee food. Make a complaint to the Ministry of Agriculture, and enclose sample of sugar.
- C. E. GOULD (Guernsey).—"Java Crystals" will be cane sugar. See reply to S. Marfleet.
- E. G. BALLARD (Bucks).—Get a swarm of bees locally if possible. You will find bees advertised in our prepaid advt. columns. Better join the Bucks B.K.A. The Secretary is Mr. E. Ff. Ball, Nockhill, Denham, Bucks.
- G. HAMILTON (Hford).—Try Jas. Lee & Son, Uxbridge.
- F. J. BEWKERT (Sydenham).—(1) It will be quite safe to use the combs now. (2) Place them between the other combs, next to the outside comb of brood.
- C. F. C. (Clare). (a) The queen was not an Italian, but she may have mated with an Italian drone. In that case most of the workers will be more or less banded with yellow. (b) Yes.
- C. F. (Grimsby). Dr. Helen Goodrich, Department of Comparative Anatomy, The University, Oxford. Dead bees are of no use; only live bees should be sent.

### Suspected Disease.

- Miss E. T. MARRIAGE (Essex).—The trouble is "I.O.W." disease. The Secretary of the Essex B.K.A. is Mr. G. R. Alder, 7, Bulwer Road, Leytonstone.
- E. DALZIEL (Dellburn).—Cause of death was "I.O.W." disease. See reply to C. V. Blackham.
- W. T. (Farmers).—The trouble is "I.O.W." disease.
- W. MASON (Barton-on-Humber).—We do not find disease. It is probably the old bees dying off.

## Special Prepaid Advertisements. One Penny per Word.

Trade advertisements of Bees, Honey, Queens, and Bee goods are not permissible at above rate, but will be inserted at 1½d. per word as "Business" Announcements, immediately under the Private Advertisements. Advertisements of Hive-manufacturers can only be inserted at a minimum charge of 3s. per *lin.*, or 5s. per *inch.*

PRIVATE ADVERTISEMENTS are only intended for readers having Surplus Stock to dispose of. Driven Bees, Nuclei, and Queens that are reared or imported for sale, are Trade Advertisements, and can only be accepted under trade terms. A charge of 6d. extra will be made if a box number is used.

Advertisements must reach us NOT LATER than FIRST POST on TUESDAY MORNING for insertion in the "Journal" the same week.

Orders for three or more consecutive insertions in "The Bee Journal" entitle advertisers to one insertion in "The Bee-Keepers' Record" free of charge.

### PRIVATE ADVERTISEMENTS.

ASSISTANT wanted in Apiary; must have good practical experience.—Box No. 75, B.B.J. Office, 23, Bedford Street, W.C.2. d.2

FOUR healthy Stocks of Hybrids and Hives complete, also empty Hives for Sale.—THOS. E. PILGRIM, St. John's Cross, Great Chesterford, Essex. d.3

FOUR strong Stocks of Bees, new Hives, £4 10s. each, and spare lifts, etc. Must be sold, owner going away.—Martin, 75, Southview Road, Southwick, Sussex. d.4

FOR SALE, Apiary, consisting of two healthy Stocks Bees (hybrids) on W.B.C. Hives, on 10 and 11 standard frames; also five other Hives (one new), with lifts, racks, sections, and most appliances wanted for bee-keeping; price £15.—Apply, Homefield, Ganwick, Barnet. d.5

SWARMS for Sale, May and June, from healthy Stocks.—CHRISTIE, Hill View, Oxted Road, Godstone, Surrey. d.6

PRIME healthy Stocks of Bees on 10 frames, 75s., April delivery, £1 deposit; English Honey, granulated solid, 28-lb. tins, 35s. each.—VINCENT, 132, Croydon Road, Anerley, S.E. d.7

VACANCY for Pupil to learn honey production, either sex; cycle rider; men must be ex-Service; five apiaries; genuine workers, no premium.—THOMAS, Causeway, Burwell, Cambs. d.8

FOR SALE, about 5 cwt. pure English Honey. No reasonable offer refused to clear.—Box 76, B.B.J. Office, 23, Bedford Street, Strand, W.C.2. d.9

WANTED, 10/15 first-class Stocks of Bees, guaranteed free from disease.—Box 77, B.B.J. Office, 23, Bedford Street, Strand, W.C.2. d.10

IMMEDIATE DELIVERY.—Four strong Stocks of Hybrids on 8 frames each, will all swarm early, £4 10s. each.—C. PRESSEY, St. Elmo, Coulsdon, Surrey. d.11

**S**HOULD any D.B. wish to try the 8s. 6d. Government Queens instead of the 12s. May and June Penna's we are supplying, we will gladly return any money deposited. We have run out of Cambs Bee Barometers, temporarily, but a Cambs Cuckoo Card will be sent to any address on receipt of a 1d. stamp.—S. H. SMITH, 30, Maid's Causeway, Cambridge. d.12

**F**OR SALE, Hives, Extractor, Supers, and all necessary Bee Appliances. Giving up owing to lack of time. Full particulars on application. All in good condition.—MISS CHILD, White Lodge, Woodside Road, Woodford Green. d.13

**I**TALIAN HYBRIDS, 1919 Queens; six strong Stocks ready for supering, guaranteed healthy, April delivery, £4 10s.; case, returnable, 10s. extra.—TURNER, Schoolmaster, West Drayton, Middlesex. d.14

**S**IX STOCKS Hybrid Italians, Claridge's strain, 9 and 10 frames, guaranteed healthy, 1919 Queens, all in good, sound hives; also four empty Hives, splendid condition; large Solar Wax Extractor, as new; eight Supers, Shallow Combs, four Section Racks, five Excluders, 11 3-frame Nuclei Hives; all healthy, in good condition; lot £30. Purchaser must remove.—DOWNS, Hardwycke Lodge, near Wellingborough, Northants. d.15

**W**ANTED, by disabled soldier, in exchange for mahogany brass dial Grandfather (sound condition, value £20) offers in Stocks of Hybrids, hived.—Communicate, ALEXANDER, Whinnie House, Carlisle. d.16

**P**ROFITABLE modern and complete Apiary for Sale (removal) owing ill-health; £400 quick sale.—Write, "N. C.," c/o J. W. VICKERS & CO., LTD., 5, Nicholas Lane, E.C.4. d.17

**W**ANTED, immediately, Essex district, two strong Stocks pure Italian, or Italian Hybrids, with 1919 Queens.—State price, and where can be inspected, Box 78, B.B.J. Office, 23, Bedford Street, W.C.2. d.18

**F**OR SALE, 1 cwt. English Honey, candied, in 28-lb. tins, £9 per cwt.—C. CLARK, 37, Locket Road, Wealdstone, Middlesex. d.19

**F**OR SALE, W.B.C. Hives, Section Racks, two cases new Sections, and other sundries.—For particulars apply W. H. SIMS, The Summit, Rednal Road, King's Norton, Birmingham. d.20

**C**OWAN GEARED REVERSIBLE EXTRACTOR. been used twice, not a scratch, £4 10s.; large Ripener, Taylor's, good order, 25s.; Cottage Extractor, painted green, wants cleaning, only £1; new Clearer Boards, with escapes, 3s. 6d. and 5s. each; several good W.B.C. pattern Hives, double walled throughout, two racks for shallow frames, 30s. each; Rapid Feeders, used, 1s. 6d.; several racks of drawn-out Shallow Combs, clean, 6s. each. Cash returned if not approved; carriage extra.—CURTIS, The Limes, Holbeach. d.21

**F**OUR STOCKS OF BEES, six Hives, quantity extra fittings, Veil, Bellows, Glass Honey Jars, etc.—VILLAROSA, Hartley, Longfield, Kent. d.22

**E**LEVEN CWTs. pure Irish Honey in 56-lb. tins at £8 per cwt.—PETER LENNON, Cornaunre, Ballyhay, Co. Monaghan, Ireland. c.92

**F**OR SALE, strong cast, new Skep, 1919, wintered own stores, Penna strain, very strong, £4 10s.—MEAD, 27, Godson Road, Croydon. c.93

**G**OOD STANDARD HIVE, full of healthy (Italian hybrid) Bees, £5 10s.; also one £4 10s.; hives included.—WHITE, 16, Pulteney Road, South Woodford, Essex. r.c.95

**H**AVING bought another Apiary, can offer the following bargains: Three pure Italian Stocks, £5 each; seven ordinary Stocks for £28, or single Stock for £4 2s. 6d.; three Dutch Stocks, £11 15s.; all bar frame.—THOMAS, The Causeway, Burwell, Cambs. c.97

**B**EES.—Several Stocks for Sale, 6 frames, 3 gs.; also Swarms, May and June.—MISS NEALE, Highfield, Littlehampton. r.c.117

**O**WING to considerable reduction in my stocks I have a large variety of healthy bee goods for disposal, mostly for W.B.C. hives. Send for list.—DELL'S, County Apiaries, Leigh, Lancs. r.c.53

**P**LANT "Willow Herb" for your bees; useful and ornamental; 12 roots, 2s.—BOWEN, Pittville Street, Cheltenham. r.c.6

**F**OR SALE, large quantity of Appliances, including 6-frame reversible Geared Extractor in good condition, nearly new Dadant New Wax Press, Honey Ripeners, Nucleus Hives, Travelling Boxes, both swarms and frames, large number of Section Racks, including single walled, Lee's pattern, Burgess double walled, and W.B.C. hanging frames, Shallow Frame Boxes, etc., quantity new Frames, Sections, Metal Ends, Honey Jars, Glass for glazing, Smokers, etc.—May be viewed by appointment, or particulars from "S." Avenue House, Finchley Lane, Hendon. Stamp for reply. c.14

**W**ANTED, portable Greenhouse.—Price and particulars to W. HERROD-HEMPSALL, Old Bedford Road, Luton, Beds.

**W**ANTED, Auster Rear Wind Screen for motor car.—HERROD-HEMPSALL, as above.

**F**OR SALE, one Exhaust Whistle, 11s., post free; one Wood Milne Motor Foot Pump, 45s., carriage free.—HERROD-HEMPSALL, as above.

**C**ORRESPONDENCE Course in Bee-keeping.—MISS F. E. PALING, Golden Square, Henfield, Sussex. r.a.54

**BUSINESS ADVERTISEMENTS.**  
1d. per word.

**A** LIMITED NUMBER of six-comb Nuclei for disposal, end of May or early June, 3 gs. each; guaranteed healthy.—Communicate with FRANK HOLLOWAY, Windmill House, Croxley Green, Herts. d.1

**T**HREE-BANDED ITALIANS.—Real Producers. We can still book orders for 3-frame Nuclei, Bees, Brood, and 1920 Queens, delivery May, 60s. Safe delivery guaranteed, or money returned. We have received numerous letters from our customers expressing their satisfaction with nuclei and queens sent them during 1919. Lists sent on receipt of stamped, addressed envelope.—FREE-MAN & BROS., Hillside Apiaries, Ipswich. c.83

**3**-FRAME NUCLEI, 45s.; 4-frame, 55s.; boxes 7s. 6d., returnable. Queens, June 10s., August 7s. 6d. Cash with order. All guaranteed healthy. Over 30 years' experience.—G. SAWYER, Marlow, Bucks. c.55

**N**EW-ENGLAND-BRED ITALIAN QUEENS.—Untested laying Queens, ready June 1, 10s., delivery guaranteed; 6s. at purchaser's risk. English money accepted by registered mail.—ALLEN LATHAM, Norwichtown, Conn., U.S.

**Q**UANTITY of drawn-out Shallow Combs, excellent condition, 1s. 6d. each.—E. H. TAYLOR, Welwyn, Herts. d.23

**N**UCLEI for honey production. Nuclei for restocking purposes. Vigorous strains of worldwide reputation.—STURGES, Shenstone, Hartford, Cheshire. d.24

**I**N response to numerous and grateful inquiries from careful apiarists, I am now able to offer my Bee Disease Remedy in a very effectual form; you are courting trouble in not using same; 3s., post free. My hygienic methods are original, and unique, ensuring the best in bees. Nuclei from 50s.—ARTHUR TROWSE, Eade Road, Norwich. d.25

**ORDERS** booked for 3-frame Nuclei, Fertile Queens, Virgin Queens, etc. List for stamped, addressed envelope.—**H. CRACKNELL**, Mount Road, Thundersley, Essex. d.27

**"PRUNES AND PRISMS,"** Chapter III., "Week-end Bee-keeping," will be out April 1; "Paralipomena," Chapter IV., on May 1.—**S. H. SMITH**, 30, Maid's Causeway, Cambridge. d.28

**PURE GOLDEN ITALIAN** and Three-band Bees and Queens combine all qualities desirable; deliveries guaranteed by booking; list, stamp.—**COOMBER**, 64, Ronald Park Avenue, Westcliff-on-Sea. d.29

**INVICTA KENT BEES.**—Nuclei for Sale. Write for particulars, then, if satisfied, send 2s. 6d deposit with order, balance June 1.—**EDWARD GRISTWOOD**, Cheriton, Folkestone. Same address 17 years. d.30

**ITALIAN NUCLEI**, with 1920 Queens, 40s.—**FOALE**, Wolverton, Bucks. c.111

**DUTCH AND DUTCH-ITALIAN.**—Four-frame Nuclei, May-June delivery, orders in rotation, £3 3s.; cash with order; carriage paid. I strongly recommend my Dutch-Italians. See **B.B.J.**, February 26, page 99, conference of British Beekeepers re legislation. Dutch and Italian had been tried; they were quite convinced that it was worth while putting one's money on this strain—Dutch-Italian Hybrids.—**SEALE**, Ashley Cottage, Oatlands Drive, Walton-on-Thames, Surrey. r.c.112

**BOZZALLA** tested Queens are sold at the price usually charged for untested queens.—Catalogue from **H. STICH**, Riccartbar Avenue, Paisley. c.116

**ITALIANS.**—Queens, 5s. Book now. Stamp.—**HOUSTON**, Ellen Villa, Sidcup. r.c.77

**FOR SALE**, Swarms, Hybrid Italians. Orders executed in strict rotation.—**KAYE**, Kilderry, Hatfield Peverel, Essex. r.c.79

**HAVE YOU WINTERED 100 PER CENT.?** If not, your strain must be wrong. Booking orders now for delivery June onwards. Hardy, disease-resisting, home-reared Italians; splendid honey gatherers. Three-frame Nuclei, 1920 Queen, price £3 5s., carriage paid; 7s. 6d. refunded on box if returned carriage paid, Saxilby Station. Terms: Cash with order.—**HERBERT VALLEY**, Apiarist, Saxilby, Lincoln. r.c.80

**ITALIAN NUCLEI**, 3 frames crowded with sealed brood, 1920 Queen, early delivery, £3 3s., carriage paid; box 10s., returnable. Cash with order. Complete satisfaction guaranteed or money returned.—**E. H. TUNMER**, "Chalfonts," Leiston, Suffolk. r.c.81

**DON'T BUY BEES** until you have seen our prices and guarantee. You risk nothing, as we return money in full if bees fail to give complete satisfaction. Catalogue 3d., which is refunded on first order.—**PEARSON & GALE**, Marlborough. r.c.84

**BEES FOR SALE.**—Several small Stocks, on six combs, of honey fed, healthy Bees, £3 10s. each; travelling box 10s., refunded if box returned in sound condition within seven days. Stamp for reply.—**REED**, Primrose House, Heacham, King's Lynn. r.b.30

**PENNA** strain Italian Queens, from June 7.—**ASHWORTH**, The Bungalow, Weymouth Street, Warminster. r.c.52

**STRONG**, healthy Bees, 10-frame Stock in W.B.C. hive, now; 6-frame Stocks, April; Swarms to order.—**SMITH**, 5, Florence Terrace, Ramsgate. r.c.56

**WATERPROOF RUBBER SHEETS** for covering outhouses, etc., 72in. by 36in., brass eyelets, 12 for 20s.—**SAGARS STORES**, Ardwick, Manchester. b.16

**ITALIAN NUCLEI** from 30s., Fertile Queen from 7s. 6d., Virgins from 3s. 6d., 8-frame Stocks £4. Warranted healthy. Particulars stamp.—**WATTS**, Conway Cottage, Newtown, Parkstone, Dorset. r.b.93

**HAVE YOU READ "THE BEE WORLD"?** If not, why not? Every number in itself is a useful literary work for practice and reference. Specimen copy free.—**Offices: THE APIS CLUB**, Port Hill House, Benson, Oxon.

## "PLAGIARISM"— and Other Things.

While the *American Bee Journal* objects to being copied, however innocently, we have always held that "Imitation is the sincerest form of flattery."

Thus, we feel proud to see present-day advertisers following the example set in 1916, when we started a new "STANDARD" in the sale of NUCLEI—previous to which date it was considered correct to always send the two outside combs containing no brood, and often there was little enough in the other.

At this date we commenced advertising our famous 3-frame Nuclei, having "ALL FRAMES CROWDED WITH BROOD," and the success of the idea was so enormous that it has taxed all our capabilities to keep pace with the demand ever since, and even then often failing to supply all orders.

While we feel proud at seeing other breeders follow our example—in some cases, even copying our adverts., we must remind our customers that THE "CLARIDGE QUALITY" NUCLEI AND QUEENS are obtainable only from the Originator:—

**F. M. CLARIDGE, Copford Apiary,  
near Colchester.**

*Price List Free on Request.*

**SPECIAL NOTE.**—"NO GOVERNMENT QUEENS USED OR SUPPLIED FROM MY APIARY!"

Send for

**Bee-Keepers  
Wake Up!**

You can make a Big Profit if you use right up-to-date Appliances, including the Manley Hive. MEADOWS, SYSTON, LEICESTER.

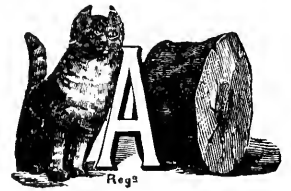

The products of the Apiary, of Poultry and Farm Stock, of the Fruit and Vegetable Garden can be Advertised and Sold through

THE  
**BAZAAR, EXCHANGE & MART**  
Newspaper.

Get a Copy—Thursday and Saturday 3d. The "Bazaar" publishes also practical handbooks by experts. Send for full catalogue, post free from—**WINDSOR HOUSE**, Breams Buildings, LONDON, E.C.2.

# HONEY JARS.

1 & 2 lbs., white glass, metal screw caps, any quantity.

**COLLINSON & CO.,**  
East Street, Dovercourt. Essex.

THE  
**British Bee-Keepers' Association.**

Insure *now* against loss by damage done through bee stings. All particulars from  
**W. HERROD-HEMPSALL, 23, Bedford Street, Strand, London, W.C.2.**

# Dutch Bees.

I have been appointed Sole Agent for Hans Matthes, the Dutch Bee Farmer who supplied the British Government last season with Skeps for their County Re-stocking Scheme. Hans Matthes also supplied me with what Skeps I required last year.

Last autumn I got a large consignment over from Holland, and am presently wintering these at my Apiary here.

To those desirous of testing these Dutch Bees, I will be pleased to send on my Illustrated Catalogue, containing much information regarding the hardiness, prolificacy, disease-resisting, and honey-gathering characteristics of this race of bee.

Address—

**R. WHYTE,**

The Bee Farm,  
Cumbernauld, Dumbartonshire.

# 'The Secret of Immunity'

price threepence, conveys a message you cannot afford to neglect.

**T. F. COBE, 33, Bevan Road, Plumstead.**

## Books for Bee-keepers NOW IN STOCK.

A Modern Bee Farm ... ..	7/6	Postage ... 6d.
Beginner's Bee Book (PELLETT)	5/-	... 4d.
<b>BEE-KEEPING SIMPLIFIED FOR THE COTTAGE AND SMALLHOLDER</b> (W. HERROD-HEMPSALL, F.E.S.) ... ..	1/-	... 1½d.
<b>BEE-KEEPERS' PRACTICAL NOTE BOOK</b> (T. W. COWAN)	1/-	... 1½d.
<b>BRITISH BEE-KEEPERS' GUIDE BOOK</b> (T. W. COWAN) (paper covers only)	2/6	... 3d.
Dissectible Model of Queen Bee ... ..	4/6	... 3d.
<b>FERTILISATION OF FRUIT BLOSSOMS BY BEES</b> (T. W. COWAN) ... ..	-/3	... 1d.
Honey and Health (A. HOPE) ...	-/6	... 1d.
Honey Vinegar (REV. G. BANKS)	-/2	... 1d.
How to Keep Bees (ANNA B. CONSTOCK) ... ..	5/-	... 3d.
Management of Out Apiaries	3/-	... 3d.
Pollination of Fruit in relation to Commercial Fruit Growing (C. H. HOOPER, F.R.H.S.)	-/6	... ½d.
<b>PRODUCING, PREPARING, EXHIBITING AND JUDGING BEE PRODUCE</b> (W. HERROD-HEMPSALL, F.E.S.) ...	2/-	... 3d.
Productive Bee-keeping (PELLETT) ... ..	10/6	... 6d.
Queen Rearing in England (F. W. L. SLADEN) ... ..	1/6	... 2d.
Snelgrove's Method of Re-Queening ... ..	-/6	... 1d.
The "Townsend" Bee Book ...	2/6	... 2d.
WAX CRAFT (T. W. COWAN) ...	2/-	... 2½d.
Wilke's Book on Swarming ...	1/-	... 1½d.
<b>MISCELLANEOUS.</b>		
Maeterlinck's Life of the Bee	3/6	... 3d.
The Lore of the Honey Bee (TICKNER EDWARDS) ... ..	2/-	... 2d.
<b>THE BEE WORLD</b> (supplied only to members of Associations interested in the control and development of the APIS CLUB, apart from ordinary members of the latter), per copy ... ..	-/8	... 1d.

**British Bee Journal & Record Office,**  
23, BEDFORD STREET, STRAND, LONDON, W.C.2.



# "BACTEROL" FOR BEES

2/6 per Bottle.

Post Free.

The cure for, and preventive of, "Iste of Wight" Disease. Non-poisonous—free from stain or unpleasant odour.

**MENLEY & JAMES, LTD.,**  
39, FARRINGTON ROAD, LONDON, E.C.1.

## INSTRUCTION in BEEKEEPING PRACTICAL AND THEORETICAL

My Apiary will be open for a limited number of pupils during this season. Terms and particulars from

**W. HERROD-HEMPSALL,**  
The W.B.C. Apiary, Old Bedford Road, Luton, Bedfordshire

# HIVES.

Compare the WORKMANSHIP and FINISH of our Hives.

All made by practical Men who know what a good hive should be.

In various designs to suit all tastes and requirements.  
Season's speciality—THE MANLEY HIVE for 16 in. x 10 in. Frames.  
Full descriptions and illustrations in our 1920 Catalogue:  
"Everything for an Apiary."

If you have not received your copy, send a P.C. at once.

OUR MOTTO—SERVICE & QUALITY.

**R. STEELE & BRODIE, Wormit Works, Wormit, Scotland.**



THE  
KEY TO  
YOUR SUCCESS.

## The Metal Foundation

(Protected)

The latest invention in Scientific hive equipment.

Durable \* Economic \* Sterilisable

An Ideal compromise between the Metal Comb and the Wax Foundation.

¶ For further details and prices, send for our 1920 ILLUSTRATED CATALOGUE, post free on application. It contains detailed information on the most up-to-date hives and appliances for which the House of Lee is famous.

\*\* Five per cent discount to Members of THE APIS CLUB.

**JAMES LEE & SON,**  
LTD.,

Uxbridge, Middlesex,

(Telegrams: Graphicly, Uxbridge.)

Telephone: Uxbridge 181.)

## S. J. BALDWIN.

I beg to inform that the No. 1 Kent Hive is not manufactured by me, only the No. 2 "Bromley Kent."

(New deep frame 17 x 14 x 12. Sample by post 6d.)

**THE APIARY, BROMLEY, KENT.**

Look after your profits by buying hives and appliances which are easy to work. I endeavour also to give good value by care over the workmanship. Send for catalogue.

**EDWARD J. BURTT, Manufacturer, GLOUCESTER.**

Commercial (16" x 10") frames and brood boxes stocked.

PRINTED BY THE AVENUE PRESS (L. UPCOTT GILL & SON, LTD), 55-57, DRURY LANE, LONDON, W.C., AND PUBLISHED FOR THE PROPRIETOR (W. HEROD-HEMPHALL), BY SIMPSON, M<sup>rs</sup>SHALL, HAMILTON, KENT & Co., LTD., 31 & 32, PATERNOSTER ROW, E.C.

LIBRARY of the  
 Massachusetts  
 MAY 7 1920



No. 1972. Vol. XLVIII APRIL 8, 1920. [Published every Thursday. Price 2d.]

**CONTENTS.**

	PAGE		PAGE
REVIEW .....	169	Winter Feeding .....	175
A DORSET YARN .....	169	Bees Building Comb Upwards .....	176
JOTTINGS FROM HUNTINGDONSHIRE .....	170	"Isle of Wight" Disease; One of its Causes .....	176
STINGING .....	171	The Origin of Tanging .....	177
NOTES FROM SOUTH WALES .....	172	A Lucky Gale .....	178
ECHOES FROM CORNWALL .....	173	Remedy for Ants .....	178
TO TALK OF MANY THINGS .....	173	TO THE LOVER OF BEES (poem) .....	178
WARM OR COLD WAY .....	174	BEES AND ALCOHOL .....	179
CORRESPONDENCE—		QUERIES AND REPLIES—	
Bee Hives in Palestine .....	174	Making Frames .....	179
Tanging .....	174		

**ALUMINIUM DRAWN OUT COMBS.**

**“MONEYCOMB”**

*The greatest invention in the Bee World for 40 years.*

This is a drawn out Comb of Hexagon Cells exactly as bees build in their natural state. It is slightly coated with wax, has been thoroughly tested, and is not an experiment. Bees readily take to it for rearing brood and storing honey. Strong and durable, will last 50 years with care. Big consumption of honey saved to produce wax for comb building. Control of bee diseases. No more burning of combs. Each comb easily sterilised and used over again.

Send for Catalogue and descriptive Leaflet. 1920 Catalogue post free.

Patented by ALUMINIUM HONEY COMB CO., of U.S.A.

SOLE MANUFACTURER AND LICENSEE:

**E. H. TAYLOR, WELWYN, HERTS.**

# ROYAL AGRICULTURAL SOCIETY OF ENGLAND. Seventy-Ninth Annual Exhibition

To be held at DARLINGTON.

Commencing Tuesday, June 29th, and Closing Saturday, July 3rd, 1920.

SCHEDULES for BEE DEPARTMENT from THE SECRETARY, 23, Bedford Street, Strand, W.C.2.

ENTRIES CLOSE MONDAY, MAY 31.

## PRIZE LIST FOR HIVES, HONEY, ETC.

### APPLIANCES.

A price must be affixed to each exhibit in Classes 1 to 4, the price named to include every portion of the Exhibit staged.

CLASS 1.—Collection of Hives and Appliances, to include, among other articles, the following:—Three Frame Hives complete, fitted with arrangements for Supering; a Suitable Outfit for a Beginner in Bee-keeping (the Entries for which are to be grouped together and separate from the main exhibit); 1 pair of Section Racks fitted with Sections; 1 Extractor; 1 Stimulative Feeder; 1 Rapid Feeder; 1 Smoker or other Instrument for Subduing Bees; 1 Super Clearer; 1 Vell; 1 Swarm Box for travelling; 1 Nucleus Box for travelling; 1 Travelling Crate for Comb Honey. Class 1 is open only to Manufacturers of Bee Appliances, being articles sold in their usual way of trade, and as far as possible of the Exhibitor's own manufacture. Staged by the Exhibitor or his representatives on 50 superficial feet. Price to be affixed to each article. No articles must be added to the collection, nor any portion of the Exhibit removed, during the Show.

CLASS 2.—Best and most complete Frame Hive for general use, unpainted.

CLASS 3.—Most complete and inexpensive Frame Hive for Cottager's use, unpainted, price not to exceed 10s. 6d.

CLASS 4.—Honey Extractor. Price not to be taken into account.

CLASS 5.—Any Appliance connected with Bee-keeping, to which no Prize has been awarded at a Show of the Royal Agricultural Society of England. First Prize, 5s.; Second Prize, Certificate of Merit; Third Prize, Certificate of Merit.

Owing to the exceptional circumstances caused by the war, the exhibitors of previous years have consented to exhibit in Classes 1 to 4 not for competition.

### HONEY.

All Exhibits to which no price is attached will be entered in the Catalogue as "Not for sale."

#### SPECIAL CLASSES.

Entries in Classes 6 to 9 can only be made by Members of the Durham County Bee-keepers' Association, and must be sent to Mr. J. Watson Egglestone, "Firbeck" House, Hutton Avenue, Cockton Hill, Bishop Auckland.

ENTRY FEES: Classes 6, 7, 8, 1s. 6d.; Class 9, 2s. 6d.

CLASS 6.—Four Sections of Comb Honey of any year, approximate weight, 4lb. First Prize, 12s. 6d.; Second Prize, 10s.; Third Prize, 6s.

CLASS 7.—Four Jars of Extracted Light-coloured Honey of any year, gross weight to approximate 4lb. (See Regulation 6.) First Prize, 12s. 6d.; Second Prize, 10s.; Third Prize, 6s.

CLASS 8.—Four Jars of Extracted Medium-coloured Honey of any year, gross weight to approximate 4lb. (See Regulation 6.) First Prize, 12s. 6d.; Second Prize, 10s.; Third Prize, 6s.

CLASS 9.—The best made Moveable Comb Hive suitable for Cottagers' use, unpainted. (Joiners, etc., debarred.) First Prize, 20s.; Second Prize, 15s.; Third Prize, 10s.

Entries in Classes 10 to 13 can only be made by residents in Cheshire, Cumberland, Derbyshire, Durham, Herefordshire, Lancashire, Leicestershire, Lincolnshire, Monmouthshire, Northumberland, Nottinghamshire, Rutland, Shropshire, Staffordshire, Warwickshire, Westmorland, Worcestershire, Yorkshire, the Isle of Man, Ireland, Scotland, or Wales.

CLASS 10.—Twelve Sections of Comb Honey, excluding Heather Honey, of any year—approximate weight, 12lb. First Prize, 15s.; Second Prize, 10s.; Third Prize, 5s.

CLASS 11.—Twelve Jars of Extracted Light-coloured Honey of any year, gross weight to approximate 12lb. (See Regulation 6.) First Prize, 15s.; Second Prize, 10s.; Third Prize, 5s.

CLASS 12.—Twelve Jars of Extracted Medium or Dark-coloured Honey of any year, excluding Heather Honey, gross weight to approximate 12lb. (See Regulation 6.) First Prize, 15s.; Second Prize, 10s.; Third Prize, 5s.

CLASS 13.—Six Jars of Granulated Honey, excluding Heather Honey, of any year, gross weight to approximate 12lb. First Prize, 15s.; Second Prize, 10s.; Third Prize, 5s.

Duplicate Prizes corresponding to, the foregoing will be offered in the group of counties named below, and numbered 14 to 17.

Open to residents in Bedfordshire, Berkshire, Bucks, Cambridgeshire, Cornwall, Devon, Dorset, Essex, Gloucestershire, Hampshire, Herts, Hunts, Isle of Wight, Kent, Middlesex, Norfolk, Northamptonshire, Oxfordshire, Somerset, Suffolk, Surrey, Sussex, or Wiltshire.

### MISCELLANEOUS, OPEN CLASSES.

CLASS 18.—Three Shallow Frames of Comb Honey, for extracting, gathered during 1919. First Prize, 15s.; Second Prize, 10s.; Third Prize, 5s.

CLASS 19.—Six Jars of Heather Honey, of any year, gross weight to approximate 6lb. (See Regulation 6.) First Prize, 15s.; Second Prize, 10s.; Third Prize, 5s.

CLASS 20.—Six Jars of Heather-mixture Extracted Honey, of any year, gross weight to approximate 6lb. First Prize, 15s.; Second Prize, 10s.; Third Prize, 5s.

CLASS 21.—Best and most attractive Display of Honey in any form, and of any year, staged on space 3ft. by 3ft., maximum height to be about 4ft. above the table. The gross weight to be stated. [The Exhibits in this class to be staged and repacked by the Exhibitors or their representatives.] First Prize, 25s.; Second Prize, 15s.; Third Prize, 5s.

\* Regulation 6, with regard to the size of the jars, does not apply to this class, but Regulation 5, re lace edging, does apply.

CLASS 22.—Exhibit of not less than 2lb. of Bees' Wax, in two cakes only, the produce of the Exhibitor's Apiary; extracted and cleaned by the Exhibitor or his assistants. First Prize, 7s. 6d.; Second Prize, 5s.; Third Prize, 2s. 6d.

CLASS 23.—Exhibit of not less than 3lb. of Bees' Wax, the produce of the Exhibitor's Apiary; extracted and cleaned by the Exhibitor or his assistants. To be shown in shape, quality and package suitable for the retail trade. First Prize, 7s. 6d.; Second Prize, 5s.; Third Prize, 2s. 6d.

CLASS 24.—Honey Vinegar, 1 quart, in clear glass bottles. First Prize, 5s.; Second Prize, 2s. 6d.; Third Prize, Certificate of Merit.

CLASS 25.—Mead, 1 quart, in clear glass bottles. First Prize, 5s.; Second Prize, 2s. 6d.; Third Prize, Certificate of Merit.

CLASS 26.—Exhibit of an interesting nature connected with Bee Culture, not mentioned in the foregoing Classes, including Candy for Bee Feeding, Articles of Food, or Medicine in which Honey is an ingredient (offered by Mr. T. W. COWAN). First Prize, 5s.; Second Prize, 2s. 6d.; Third Prize, Certificate of Merit.

CLASS 27.—Exhibit of a Scientific Nature not mentioned in the foregoing Classes, to which no Prize has been awarded at a Show of the Royal Agricultural Society of England (offered by Mr. T. W. COWAN). First Prize, 5s.; Second Prize, 2s. 6d.; Third Prize, Certificate of Merit.

The **W. Broughton Carr Memorial Gold Medal** will be awarded to the Exhibitor obtaining the most points under the following conditions:—First Prize to count 3 points, Second 2 points, Third 1 point. In case of a tie the competitor having the largest number of highest awards shall obtain the medal. No exhibitor shall take the medal for two consecutive years. The points to be awarded in all classes except Appliances and Classes 6 to 9.





## Review.

*The Bee Master of Warrilow*, by Tickner Edwards.—Our readers will be pleased to hear that a new edition of this popular book has been issued. "Good wine needs no bush," and those who have read the first edition of this book and other works by the same author need not to be told of the charming manner in which they are written. The present edition has been revised and enlarged, and is more than three times the length of the former edition. A new feature is the introduction of a dozen full-page illustrations, which are not merely illustrations but possess much pictorial merit. The publishers are Messrs. Methuen, and the price 7s. 6d. net.

## A Dorset Yarn.

Just now on the farm all is full of promise. Never were there more flowers on the fruit trees than this season. All the long lines of pears seem to vie with each other in beauty; the different varieties have a beauty of their own, though the flowers are all white, yet they vary in size, also in whiteness, and the coloured stamens of pollen add to their beauty. But the bees seem not to care for any particular variety—all crowd over the flowers in that wild freedom, singing all the time of sweets in plenty all waiting for the harvest. They are now working like summer, so many away in the fields, yet, if one looks at the hives, all the bars are covered with bees: this mild time since Christmas they have added largely to the population. Bees seem to be singing of freedom, free to go a distance after the nectar that is welling up in the nectaries of flowers. Besides pears, plums, and peaches, they are crowding over the laurel blossoms. These give so many flowers, they smell very strong as one walks under them; the nectar must have a high flavour. Monday, March 29, our bees were away over the fields, even when there was a fine rain. The pear flowers under a lens showed fine drops of rain inside among the stamiferous organs; the bees must of necessity gather some of the moisture with the nectar. It was just the same with the plums. Under a lens these flowers are very beautiful, though to the naked eye only white is seen. The lens shows up the stamens, with the tips of them covered with pollen, the pistiliferous organ standing up in the midst. This

fruit being a drupe with one stone, it has only a solitary point, but with pears the female organ is divided into the number of ovaries in the embryo fruits. If each of these are fertilised with pollen from the stamens, then each ovary swells in a regular manner and the fruit is perfect in shape. If only part of the ovaries are fertilised then the pear swells irregularly. Nature's aim is to perpetuate the race by seed. This gives a far greater covering of the luscious pulp which is so delightful to eat when quite ripe. Each grower can see how bees help toward this perfect union of the sexual organs. The small treatise by Mr. Cowan, showing how much heavier each fruit becomes when perfectly fertilised by the pollen from other varieties, should be in the hands of every fruit grower. It can be had from the JOURNAL office for 3d. and postage. If the bee-keeper has a lens he will be able to watch the pollination of the flowers and the result of cross-pollination. To the horticulturist all this has been known for generations, but many who keep bees have other walks in life, perhaps more remunerative than he who tills the soil. If they take notice in spare time of these evolutions they will get greater pleasure in life. As I have written before, "Life is real, life is earnest." Life is not an empty dream when once the bee-keeper looks deeper into the sources from which bees get nectar. He will soon want to know more about the structural parts of flowers, and it is not all growers that give the time to the crossing of flowers. It was the weavers round Leeds that raised the beautiful Leedsii narcissus, the Lancashire cotton-spinners the large gooseberries for show purposes. They all got the greatest pleasures of life by these entrancing pursuits. So with us who keep bees; it is not alone for the profit they give us, but that they help us to the pleasures of life; they teach us more and more of Nature's truths, and "Truth is the element of life" (I think this is Emerson). Ruskin wrote: "You are never to sell truth, but guard it, and to give." The Dorset Yarn has tried to give some of his knowledge that he has gathered in his life's work on the soil.

In one of the long lines of gooseberries there is a large plant of charlock, but so great is the hurry of bees to sip the nectar in the small flowers of gooseberries, with no colour to guide them, only scent, they miss entirely the rich yellow blossom of charlock. I have been working quite close on two warm days, but have not seen a bee on it at all, yet have seen them in crowds on the same plant in summer. Each day we can see that they are adding to the store of honey and are building new comb on the tops of bars up to the

glass. They are filling cells with honey of a deep amber colour. One lot of Italians to-day, Saturday, April 3, seemed to be having an assembly, as if they were wanting the queen to come out to swarm. It shows how they appreciate the warm sunshine after rain; it tells the bee-keeper that the time of natural swarming is come. I have not seen a drone in this lot, but there must be some in the cells or these would not be going through the preliminaries for swarming. Business compels me to see to the tilling and planting of the land, so that bees have not yet been overhauled; but to see them strong and hear them chanting the glad psalm of content is very dear to the heart of the bee-keeper, because they are getting on with production without having to set out the work for them, as we have to do with the acres of soil to plant by hand. The horse can draw the marker, but man must do the planting in the rows. With labour at high rates, the tiller of the soil must keep busy during the brief hours of hired help. Still, the bees are ever with us as we get the planting done in the spaces between the long lines of pears and bush fruits; no day but what we have them at some time or other. Now that we have an association floated for Dorset we anticipate a good year's working, as each bee-keeper states that the stocks have come through well, excepting in a small area in North Dorset.—J. J. KETTLE.

## Jottings from Huntingdonshire

FOR JUVENILE READERS.

"How's Apis this morning?" I said, when I had finished my breakfast.

"Feeling the effects of old age, sir. I really do begin to long for death," she replied.

"Oh, you sad, sad bee, is it that bad? Does that mean you are too tired to talk to me?"

"No, sir; I can talk a little. But I fear this must be the last of our conversations. My strength is going, and I really should like to go where all good bees go to. I have been a good bee, haven't I?"

"I'm sure you have, Apis dear. Now let me continue my questions. Do bees sleep in winter?"

"Ah! that depends on what you call winter, sir. If it's very, very cold we pass the days in a semi-stupor, but we don't hibernate, as we eat honey, and we cluster and snuggle up close together, as you know. Those who happen to be on the outside of the cluster get cold, so they move up to where it's warmer, and so this movement goes on. When a few warm days come along the bees use the opportunity for taking cleansing flights,

and do a little tidying up. If the winter season happens to be very mild bees work most days, and, of course, need a lot of food; that is why we are so anxious to store up plenty of surplus honey when the flowers are here. As soon as early flowers appear, then the hive wakes up in earnest, and the queen begins to lay—plenty of eggs if nectar and pollen is in plenty—few if these are scarce."

"Thanks for all that. Now a different question altogether. What about your sting?"

"Yes. What about it?"

"Well, Apis dear, you know how frightened many people are of bees because of their stings, especially young people."

"Well, sir, we can't help it."

"Can't help what?"

"Having our stings, of course. I don't wish to be rude, but I do think you men are silly when you blame us for using our stings. What are they there for but to be used when we feel we ought?"

"That's all right, Apis. But when *should* you use them?"

"Well, sir, we need them when guarding the entrances to our home, to help keep at bay robbers, wasps, mice, snails and other things; in fact, our ministers are so strict that if a worker bee loses her sting she is not considered fit to return to the hive. If she did return she'd be killed, and if she doesn't she dies, so that should prove we do not sting for the fun of the thing."

"Then, Apis, does that mean that every sting I have had left in my hands at various times has meant the death of the bees who have left them?"

"It does. So why not learn wisdom, and do without getting stung?"

"Tell me how."

"Listen, then. First of all, don't go poking around the hives as if you were intent upon making us as angry as possible, and don't stand shaking and shivering as if you lived in mortal dread of being stung. We hate silly, nervous, fussy people. Don't, when we are all busily engaged in our hives, come and upset us without any warning. Fancy the madness of some people who rip off our coverings, exposing us all at once, and when we fly up in alarm start fencing. It rouses our ire so much that we lose our self-control, and lose our stings and our life in consequence."

"I see, Apis dear. Then what you wish is that we assist you in controlling yourselves such times as we wish to look in at your homes?"

"Exactly, sir; and if some of our young bees should be silly enough to sting you, help them to extract their stings. It is

better both for the stingers and the stung."

"How is that?"

"I'll explain. Inside our stings are needle-like darts, but our sting itself is barbed so as to hold on to the flesh while the darts do their work. Our darts, too, are barbed, which means that if a bee is knocked away the sting is pulled away by the roots. If you exercise self-control you might allow the bee to extract the sting; this she can do by working round and round, corkscrew fashion."

"Thanks, dear, for all that. Now tell me—"

"I'm afraid I'm exhausted; I can't say any more."

"Dear me; I'm so sorry. There is a lot more I want to know."

"Is there? Then you must ask another bee to tell you. Good-bye! Let me sleep on now."

So, dear children, little Apis is no more. Perhaps some day I may find another bee that is willing to tell me lots about bees and their ways. If so, I will let you know all about it.—E. F. HEMMING.

## Stinging.

(Continued from page 163.)

"Give a stock of bees a black roof and they will never forgive you," quoth that careful observer and entertaining writer the Rev. E. F. Hemming, in a recent number of the B.B.J. Whether the dictum be veracious or the reverse I am not prepared to say. I have myself given several stocks a black roof in the stress of war-time scarcity, but have not noticed them cherish any special animosity against me on that account. Certainly they never presented anything in the nature of a "grand remonstrance." It may be that they forgave the insult in recognition of my having left off attempting to stifle them with noisome vapour every time I went among them. As I said, my bees are sportsmen, and, as such, do not often let the sun go down upon their wrath. Indeed, judged by their spirit of forbearance under the tortures inflicted upon them by some bee-keepers I wot of, many bees are better Christians than the bipeds who control them.

Nevertheless, I am emphatically of the opinion of Mr. Hemming, that some colours are provocative in bees of what I should hardly call bad temper, but rather the instinct of self-defence. *Apropos de gants*: one day I mislaid one of my hand-coverings, and could not find it anywhere. As a makeshift I donned another nearly similar, but with a roughish surface, while the other was smooth. Both were brown. On returning to the hives I was dismayed to find that the bees were mak-

ing a dead-set against the rough glove, and in less time than it takes to tell it a round half-dozen had put their stings through it.

It may be that I am squeamish, but I have an utter horror of seeing such kindly little creatures, as I know bees are, running about minus part of their intestines, so as quickly as possible I got rid of the offending glove and sought another in its place. Alas! the only substitute I could find was of the very thinnest white kid—absolutely no protection at all. However, I donned it and plunged into the work again. There was not another sting! The next time I went through the stocks I wore it with the same result, and the time after that. I thought it singular. I would experiment.

With a pair of rough dark gloves upon my hands I went among the bees again, and at once they fastened upon the gloves, stinging viciously. Thereupon I returned to the house and performed a most unheard-of action. I took a pot of white enamel and a brush, and painted those gloves a glossy white. Next day they were dry, and wearing them I plunged my hands into one of my biggest Ligurian stocks. Not a sting! One after another the stocks were overhauled, but not a bee attempted to sting those enamelled gloves. Yet they were the very ones that had provoked them so before.

From this experience I deduced that bees have a traditional antipathy towards anything with a rough dark coat, a feeling which has probably descended to them from their wild forefathers of ancient days, whose experiences with bears, badgers, *et hoc genus omne*, taught them to regard such a covering as that of an enemy.

On a later occasion I witnessed another manifestation of the same spirit, though in a different medium, as painters would say.

I had made one of my "pilgrimes" to my queen-mating apiary down in the wilds of Kent—a beautiful spot. Miles and miles of billowing plantations of the choicest fruit—pear, apple, plum, raspberry, curiant—a perfect paradise for the enthusiastic bee-keeper, with but one vile element in it—man's arseniate spray.

On riding up to the farm I encountered the farmer's little maid, a pretty child, by the wicket gate, who on seeing me ran into the garden and returned with a half-burst blossom of that prince of hybrid roses, Hugh Dickson. This she presented to me, partly, perhaps, in payment for sundry chunks of comb honey which had fallen to her share in the past, and partly, perhaps, in anticipated payment of sundry expected favours still to come.

Wearing the favour of the gracious

little lady in my button-hole, I began to examine my nuclei. It was not long before I perceived that something was amiss. The usually sweet-tempered Ligurians were up in arms, and there was a continual angry hiss about my head. At last my attention was attracted to the red rose in my coat. It was the centre of an irate cloud of bees, and though not one attempted to sting my fortunate self, the flower was the recipient of a perfectly murderous display of fury. No matter where I went, it was the same all through that morning's work.

From this further experience I drew another deduction—*videlicet*, that our domestic bees have not only inherited from their wild forebears of ancient days an instinctive dislike of objects with rough dark coverings, but also the intuition that a glowing red orifice is at once the focus of danger and the most vulnerable spot in which to attack the would-be desolator of their hearths and homes.

Whether I be right or wrong in these my deductions, I leave it to the scientific readers of the B.B.J. to determine. The rigid utilitarian, who cares no fig for scientific deductions as such, may peradventure take a hint from the bald *précis* of my own observations and those of Mr. Hemming, namely, that objects of a certain texture and hue will provoke to perfect fury bees of even the most advanced pacifist views, while an opposite texture and a different range of colours will maintain an atmosphere of complete tranquillity. The practical man may find it profitable to arrange his equipment accordingly.—HUGH HOUSTON, Sidcup.

---

### Notes from South Wales.

The health of the bees, up to now, has been better this winter than I have known for the last ten years. It is a pleasure to go out and around, and not see any crawlers, or stocks dwindling away, such as in other winters. One could almost make sure of losing two-thirds of the lot that went into winter quarters, and one thought it a bit of luck if he had one or two left. I know for the last nine years it has been a hard struggle to keep the bee flag flying, for if one managed to get enough to buy a stock or two, one could make sure that one would have to buy some more in the spring, as they would be wiped out with "Isle of Wight" disease, which was very disheartening, especially if it was the whole of one's savings. I have often thought that I would give up until the disease was cleared off, and then in came the JOURNAL, and off I went again with some more, and as full as ever with the fever, hoping for better luck next

time. That is how I have held on to bee-keeping during the last ten dark years. I somehow think that the storm is getting over, and the bees themselves have far more vigour in them than they have had other winters, for I believe that it takes a very long time for a stock to show signs of "Isle of Wight" disease, and therefore the bees would be gradually losing vigour, for notice a stock that is hanging about in front of the hive when others are working, and no real cause for it, such as swarming or lack of room. It will be found that there is the first outside symptom of the disease, namely, the weakness. The bees are languid, and their flying energy is being eaten up, and the bees are satisfied to be crawling about the alighting board until the next stage, when they come out with a determination to try and fly, and drop off to the ground, and either run or walk themselves to death.

I was asked to have a look at some bees in skeps about two years ago, as the owner could not make out why at three of them they were lurking about at the entrance when the others were in full working order. I thought I should have found crawlers when I went; but no, I did not see one, but only, as he said, the bees hanging about, so I had a feather and brushed them off. They all managed to fly up again and take up their old position at the entrance. I thought it rather strange, so I lifted the skeps and found them rather light, for I thought that they might be preparing to swarm, and if that had been the case they would have been full of brood, etc.; but, as I say, they were very light, so I came to the conclusion that they were doomed. I informed the owner as to what I thought would happen, and I believe to this day that at the time he thought I was strange in my manner; but they were all dead by the autumn, and it was then that he believed what I said.

A case came to my notice of a young gentleman buying a stock of bees that was showing signs of crawling sickness. He asked me if I would have a look at them, to see their strength. I did, and told him that they would not go through the winter by themselves, and as they were sick I advised him to let them alone as they were; but he said that if I had a nucleus to spare he would risk it with them. I happened to have one, with a nice young queen, and he had it. I undertook to do the uniting, which came off all right. Next morning he went to a friend in a terrible plight, saying that the Italian bees were carrying out all the black ones and dropping them over the alighting board. I was called on the scene again, and I did not expect to find any black bees left in the hive: but, to my surprise, half of them were there, and the others

were outside, dead and dying, but those inside were quite able to fly, for I jerked the frame and they all fell off and flew away. It was very strange to me about the carrying-out business, but in the "British Bee-keepers' Guide Book," in the part devoted to disease (Bee Paralysis), it states that if a healthy lot of bees are put in with bees suffering with bee paralysis they will carry out the paralytic ones—which those bees did, proving Mr. Cowan to be quite right in that respect.—E. BOOBIER, Valley Apiary, Bishopston, Swansea.

### Echoes from Cornwall.

Being one of the "Roll of Honour," and having safely returned from the "fiery furnace" over across, I wonder if you will give space in the JOURNAL for a few remarks, etc., of mine?

Of bees in the devastated areas I saw very little, and of those I did see the "Jerries" had taken full toll; but I did notice that practically all the little apiaries were of the old-fashioned type, i.e., straw skeps and boxes of all descriptions, and had apparently been in a very flourishing state prior to the outbreak of war. Further south, towards Marseilles, where I had occasion to go on escort duties, I saw that there was a more modern look about things, and several apiaries had all bar frame hives, and some were on the point of swarming. I should judge from the surrounding country that quite an enjoyable and profitable time could be had by the bee-men of that place. But, having had quite enough of the "bitters" of the battlefield around Ypres and Paschendaele, etc., I was glad to quit "fair" Belgium and France for some of the "sweets" (?) of dear old England. Returning home to Bonny Devon, I soon had "bee fever" again, but found my old district scoured out with "Isle of Wight" disease, so I thought I was doomed to disappointment. However, my pre-war employers offered me a better position in Cornwall, and so I migrated still further west. Before long my duties brought me in touch with several bee-keepers, two of whom kindly gave me a couple of stocks for a little help, which my 10 years' experience with bees enabled me to give them, and now I hope I have "got a move on" again. I am now hoping to get into touch with the county association and become a member.

Unfortunately I was, in company with the chairman-to-be, unable, through a train mishap, to attend a meeting when a branch was being formed. If this should catch the eye of the secretary of that

branch, will he please communicate with me?

Reading the various bits on legislation, several rather amused me. Having had experience of Government control in more ways than one, I certainly am not in favour of creating more Government officials at a high salary. Far from it, but at the same time, how are we going to get anything drastic enough unless it goes through in the form of a Bill and becomes law? If we could only get a protective measure through, and at the same time obtain a fully qualified body of experts of the B.B.K.A. as inspectors, I, for one, would at once welcome such a man to inspect my stocks. But if the Government appointed men not recognised by the B.B.K.A., then I should be one of the foremost to object, as their journeyings from one apiary to another would only make matters a hundred times more serious.

For my part I should welcome a law which gave power to an association to prosecute any case, member or not, which the association's special inspector or expert discovered in his travels, and who refused to destroy his diseased stock or stocks after having been duly reported and interviewed. At the same time, I feel some recompense should be allowed from some source agreed upon to any unfortunate bee-keeper who readily destroys his affected stock or stocks, as the destruction may be an untold blessing to brother bee-men in the district, and any recompense in the shape of cash, bees, or honey to the unfortunate one gratefully received. This is what I think Mr. D. Davies (10,084), para. 5, really means, and in that way would do away with any incompetent men, which, in the event of a Bill being got through, the Government might plant on us.

Wishing all the greatest success the coming season.—A. D. BENNETT (late L.-Cpl., R.F.'s), 8, Higher Rose Row, Redruth, and late of Laira, Plymouth.

### To Talk of Many Things.

The second of three tendencies which may be regarded as hopeful for the future of bee-keeping in these Isles is that towards experiment with types of frames other than the standard size so long dominant.

Much of the credit for bringing this to actuality is due to Mr. Manley, whose enthusiastic advocacy of the 16-in. x 10-in. frame, introduced and used by Mr. Simmins, seems well on the road to success.

So long as native bees were the general occupants of our hives, so long the standard frame might well be considered adequate, but now that more prolific races have practically ousted the blacks in

many districts, a new set of conditions has arisen, calling for new methods of management.

Hybrids of Italo-Dutch, Italo-Carniolan, or any permutation of these, together with the three pure races, if there be such a thing as a pure Dutch race, require considerably more space for breeding and winter stores.

The provision of this space in the form of the 16-in. x 10-in. frame, with winter passageway through a thick top bar, would, I am convinced, go far to obviate the heavy losses now experienced through decamping swarms and winter starvation.

—A. F. HARWOOD.

### Warm or Cold Way?

Somehow, when correspondents write about the combs being parallel or at right angles to the entrance I am never certain that I have rightly understood. The Germans hit off the difference by calling the respective arrangement "Warmbau" and "Kaltbau." The cold way of the combs, of course, is the arrangement that provides a draught from the entrance straight through the central street, whereas in the warm construction the frames stand across the draught.

I have been running my hives on the "warm-way" principle, because it is easier to work new frames in from the back, because a back frame can be taken out in autumn full of honey, whereas in the "cold-way," honey and pollen get mixed up in all the combs, and probably for other reasons I can't think of just now.

It is said that when bees build in the hollow branch of a tree they build "cold-way," and when they build in a hollow trunk they build "warm-way." From this it seems to follow that "cold-way" is the proper construction with the English frame, which is longer than it is deep. The bees store the honey at the back of the combs, and begin the winter sitting at the front, where the last brood was raised. As they eat they work easily back, whereas if the frames ran across the hive they might fail to find new stores when the old were gone. With the deep frame they store the honey overhead and can work upward as well on the "warm-way" as on the "cold."

Undoubtedly the "cold-way" gives better and quicker entry to all parts of the hive in summer, when the doorway is extended all along the alighting board, and I should think keeps the hive from swarming, that might soon boil out if the frames ran across, spoiling the ventilation and the traffic.—G. G. DESMOND, Sheepscote, Stroud, Glos.



### Beehives in Palestine.

[10158.] Being a reader of your BEE JOURNAL, I thought other readers might be interested in the enclosed photo of a beehive which I took while in Palestine, in the little village called Tulkeram.

You will notice it is made of clay, with small holes for bees to work from. This is the largest I saw, although there were



BEE HIVE IN PALESTINE.

quite a number of them in the village. The others are round, and mostly to be seen on the top of the houses. The bees are very small and black.

I am sorry I cannot send a better photo, but unfortunately I lost the films.—J. E. BEANS.

### "Tanging."

[10159.] The article on the above subject, by G. D. C., opens up a very interesting subject, and the long-felt want of a decisive opinion as to whether bees possess auditory organs.

"Tanging" or "Ringing" is an ancient practice, prior to the days of Aristotle, the reason for which, as given, is no other than the rousing of the neighbourhood, when a swarm has issued, and assistance is solicited to follow it closely, as directed by law for rightful claim; do we not adapt the same method in the ringing of the fire-bell in the case of a fire, to rouse the neighbourhood for assistance?

It is admitted by such scientists as Huber, Bevan, Huish, Lubbock, etc., that bees possess the powers of discerning sound, still information is very vague as to where the auditory organs are placed, or what effect it has on them, and though making this assertion, give no fundamental proofs in support; in fact, the re-

sults of experiments carried out by them are quite contrary, for instance, Lubbock, on page 222, says—"I have over and over again tested them with the loudest and shrillest noises I could make, etc.—but all without effect—I carefully avoid inferring from this they are really deaf—but, probably the range of hearing is very different from ours." This last passage gives us something to work on, and must be transferred to other hands than that of entomological scientists.

It is very evident the human ear does not perceive all sounds, and is aided by delicate instruments, such as the microphone, for instance, to improve its powers beyond certain limits. Also let us take wireless telegraphy, which is transmitted and received many hundreds of miles by structures called "antenna," which, for a perfect installation, must be "in tune." Cannot we then, assert the cause of failure in experiments so far carried out. I will instance one. A musical box, on which was placed a plate of honey, was set going near a hive, the bees came out and greedily devoured the honey, after which the plate was removed and the musical box, still going, placed a few yards further away in the opposite direction. One would have expected the bees to follow the sound, but such was not the case, they simply flew round and round the spot where they had feasted. This is insufficient proof they have no sense of hearing, for probably the vibrations set up by the various sounds of the musical box had no effect on the chitinous hairs of the antennæ, or where such sound-receiving organs may be placed.

G. D. C. says he drew the bees towards him by imitating the note given by the queen, but I was always under the impression the bees followed the queen, therefore to be successful he must draw the queen, when the bees will follow, otherwise without the queen they will not settle.

I apologise for the length of space I have taken up, and my only excuse is, the subject is too interesting.—A. P.

### Winter Feeding.

[1916.] It really began during the Great War. A newspaper paragraph announced that one Maurice Maeterlinck was an ardent friend of England, and so drew my attention to his writings. From reading "The Life of a Bee" to becoming a keeper of bees was a short step, though the interval between was over a year.

They arrived in July—a six-frame stock of alleged Dutchmen. As they have brass bands on their backs there is some doubt as to their nationality, but my own opinion—based on their actions—is that they are

German. The local expert says Dutch bees are of little use for anything except swarming, but I am prepared to match my little lot against any other breed for the virulence of their stings. (N.B.—Anyone accepting this challenge must provide the umpire, all available parts of my person being already used up.)

Now, before the bees arrived I procured a collection of text-books and assimilated bee-knowledge as greedily as ever bee sipped nectar. It was no doubt due to this, or perhaps to that good fortune which is the prerogative of fools and novices, that by the end of August I had a strong stock crowding ten combs, most of which contained brood and honey.

Then came the question of wintering. I applied myself industriously to the text-books, and learned that, like the Dutchman with his beer, "too much is shust enough," and that "eight combs well filled is the necessary quantity." It looks simple enough to an old hand, no doubt, but when I read, "The bees cluster on the empty parts of the combs, just below the honey," I began to wonder exactly what was meant by "well filled."

A further application to the founts of knowledge revealed the fact that "a little over four square inches of comb contains about one pound of food." At last I had something definite, and set to work with a foot-rule and a sheet of foolscap, my erstwhile idle moments being occupied with abstruse mental calculations in which the figures 14 and 8 loomed large.

By this time I had discarded veil and gloves, having acquired that "firmness without aggression" which renders them an incubus. But those Dutch bees did not appear to understand my English ways, and by the end of September I had the finest collection of bumps which has been seen in this district for many years. But I glowed with the satisfaction which comes of good work well and truly done. My beloved pets (I have called them other names) were as safe as man could make them; they had empty combs, full combs, piles of quilts and a waterproof roof. And even, as an extra precaution, a cake of candy in a glass-topped box.

My satisfaction lasted until Christmas, when I found the candy, the emergency ration, was all gone! Then it occurred to me that perhaps four square inches of comb represented one pound of food only when both sides were filled. Horrors!

In an evil moment I bought still another book. Herein I found the other experts were mere blunderers. The correct procedure was to "feed solid" in September; "it should be distinctly understood that no feeding should take place in winter." And if so, it should not be candy; give 'em

hot, thick syrup! By this time I had secured a document entitling me to six pounds of sugar—"for the manufacture of bees"—and decided to follow the advice of my latest mentor.

But before the bottle was fairly at work a bee periodical gave several incontestable reasons why only candy should be used for winter feeding, so I put the remainder of my sugar into the syrup and boiled it up for candy. But, alas! it steadily refused to "candy."

I boiled it each evening for a week—on the gas stove, the kitchen range and the dining-room fire—but the only results were a week's notice from the cook and a bill for repairs to the gas-cooker. It may be that the three pounds of honey which I added to help out the sugar had something to do with it.

I thought it *had* set the last time, and placed the candy-box full over the feed-hole, but as soon as the bees warmed it up I fancy it must have uncandied, because next day the floor of the hive was covered by a thick brown carpet plentifully studded with bees.

It looked the right time to do a little "charing," so I began to scrape out the mess with a poker; but evidently my bees have great respect for the dead (perhaps they are Chinese bees, after all!), and resented my attentions. One in particular flew like a stone from a sling right into my face, imprisoned herself behind one of my "blinkers," and then, doubtless feeling tired, sat down on my eyelid—hard.

The books tell me there are special bees for nursing, scavenging, door-keeping, ventilating and other odd jobs. This one had been specially trained for stinging! At the present moment one of my eyes is on holiday, and that side of my face resembles a ripe pomegranate, though normally I am a lantern-jawed, lugubrious-looking individual. Bee-keeping is a splendid hobby! It has caused more gaiety among my so-called friends than any other I have taken up.

This morning I looked into the hive, and found several of the inner combs still capped over. Pollen, thought I, and to make sure cut off some of the capping. How long will four combs, "fed solid," last, I wonder?—CIRES.

### Bee Building Comb Upwards.

[10161.] In the chapter on comb building in the "Lore of the Honey Bee," Mr. Tickner Edwards writes to the effect that—"Rarely—so rarely that in many years spent among bees, the writer has only seen three examples of it—combs are built upwards."

On March 13 I placed a glass-bottomed

box containing candy in one of my hives. By the 20th the candy was consumed, and on removing the box I found about 1½ in. of comb built upwards from the top of the centre frame.

It might be of interest to hear if other bee-keepers have had any similar experience. I do not think the occurrence is so exceedingly rare.—A. C. GRIMSHAW.

### "Isle of Wight" Disease: One of Its Causes.

[10162.] Readers of THE BRITISH BEE JOURNAL ought to be grateful to Mr. Edwards for his interesting article under the above heading. Many who *can* contribute to our knowledge are unfortunately unwilling to share their information and experience, and for this reason alone our thanks are due to Mr. Edwards.

I think we are making progress towards a solution of the problem of "Isle of Wight" disease. On April 3 an article of mine appeared in the B.B.J., followed by another in the issue of June 5, in which I endeavoured to formulate a theory which would explain the many apparently conflicting experiences as recorded from time to time by bee-keepers whose apiaries have suffered from the disease. In the latter article (page 230) I formulated definite experiments for the confirmation or disproving of my theory, which is now put forward by Mr. Edwards with slight modification, and I am glad that one, at least, capable apiarist has not only undertaken one of the experiments I suggested, but has been good enough to make the results thereof public.

There is a ring of confidence in Mr. Edwards's words which infuses courage. Compare the following:—"And it succeeded so well that within twenty-one days a cluster of from 50 to 100 bees, with a lovely queen, was left on 40 standard combs of decaying larvæ and dead half-hatched bees." These are Mr. Edwards's words. I wrote on June 5, 1919:—"All the same, if any person, out of academic interest, wishes to secure all the symptoms of 'Isle of Wight' disease, let him take a natural swarm and hive it on as many frames of foundation as it will cover, and do not feed. As quickly as they are drawn out insert fresh foundation in the centre of the cluster until the brood chamber is full (of eggs sterile for lack of heat), and 'Isle of Wight' will be rampant before he is finished extending. Essential conditions: Good bee weather and plenty of forage." *Verb. sap.*

Now, it may be objected that we do not want to find out how to *produce* "Isle of Wight" disease; it comes uninvited.



That is so; but I was not satisfied to wait for it to attack my stocks. I, too, have deliberately caused its incidence, but I confess to a deficiency of the necessary altruism (excusable, perhaps, in that I possessed but two stocks). I gained control of and stamped out the disease I provoked, but, as I cannot say definitely that my curative methods were the means of saving the colony, or, rather, that the colony would have succumbed but for my treatment, I did not, and cannot yet, put it forward as a cure. I am quite willing and anxious that the discovery be accredited to Mr. Edwards when he can see his way to publish his third article. All I can say with confidence is that the disease, if disease it really be, is brought about by defective nutrition, and that it can be cured by proper and adequate feeding. But my main point is that no colony of bees—English, Dutch or Italian—need be attacked by “Isle of Wight” disease, and if so attacked the cause is a reflection on the owner of the bees. I am aware of the gravity of this statement, and I have been waiting for six months for the confirmation now supplied by Mr. Edwards.

So far so good; but I, and no doubt many other apiarists, will not be satisfied until we know exactly what “Isle of Wight” disease is. I am not content to know that I need not anticipate an attack, or that if I do provoke one I can deal with it before it is *too late*. For let it be understood that a queen and a few hundred workers is a foundation of a new colony only on condition that these workers *are capable of living for at least one month*. Any help from other colonies is not a cure in the proper sense of the word. Mr. Edwards modifies my theory, and says the nurse bees, and not the field bees, are the victims. This may be true, and in any case there is as much evidence in favour of the one as of the other. But he goes farther and ventures a prophecy that “Isle of Wight” disease is a growth of some fungus which interferes with respiration. This is going beyond my knowledge, and I leave to more capable minds this portion of the new theory. I do not agree with your contributor that it is proved; far from it. I can arrest “Isle of Wight” disease, but I am aware that this is not synonymous with effecting a cure. Those bees already affected may conceivably continue to die off despite the treatment, but the latter stops the incidence of the disease in hitherto healthy bees, and the stock recuperates. So that whilst defective nutrition properly corrected does effect a cure, the trouble *may* after all be a disease of a specific and definite character. But, as I have already said, I have grave—very grave—doubts. I cannot forget the mal de Mai, Maikrank-

heit, and frenezia di Maggio of France, Germany, and Italy respectively. Better weather, less intensive and more rational methods, coupled with the restrictions imposed on the bee-keeper's powers of production in bees and honey by the absence of a surrogate for honey, keep May madness, or May disease, from assuming the proportions attained in Great Britain, and glorified with the name “Isle of Wight” disease. This is a bold assertion, to the proof of which I have nothing but circumstantial evidence to offer. I proffer it all, however, and if every other apiarist would follow Mr. Edwards and me, and not sit on the fence with criticism on his lips and the sneering smile of the superior being on his face, we should soon be out of our difficulties.—H. M. STICH, Paisley.

### The Origin of “Tanging.”

[10163.] It is, I believe, generally the case that when the original reason for a superstitious belief or practice is forgotten, the people who used to hold it invent a new explanation of their actions. Possibly this is so in the case of “tanging.” The reasons usually given for it are: (1) That it makes the swarm settle; and (2) that it announces the “tanger's” ownership of the swarm to his neighbours. It is however possible that neither of these is the original idea underlying the practice of “tanging,” even if—as seems possible—it really does serve both these purposes.

Some little while ago, when glancing through Frazer's “Folk-Lore in the Old Testament,” I was struck by several facts which, taken together with what we know of bee folk-lore, seem to promise an explanation of the origin of “tanging.”

There is a widespread belief that the clang of metal drives away evil spirits, and a somewhat less common belief that it attracts good ones. Also, in many parts of the world there is a practice, derived from this belief, of making a noise with metal at a birth, to keep evil spirits away from the child. Sir James Frazer considers that this was the original meaning of the story of the Curetes, who clashed cymbals (or, some say, their spears and shields) while guarding the infant Jupiter. According to the legend, the noise attracted a swarm of bees, and Jupiter was fed on the honey: but another version states that this last story grew out of the name of one of the two nymphs who acted as nurses—Melissa, meaning “a bee” in Greek. (See BRITISH BEE JOURNAL, 1911, p. 301; and “Folk-Lore in the O.T.,” vol. III, p. 472.)

Now let us turn to the beliefs relating to bees. There is plenty of evidence that

bees were sacred animals in olden times. I may mention the heavy penalties attached to stealing them (which proves that a man's bees were something more than mere property, and that to steal them was to do him a very great injury); the belief that one must not sell bees; that the bee-keeper must be chaste, temperate and peaceable (must have the qualifications of a priest, in fact); that their swarming points out the lucky days (China; see BRITISH BEE JOURNAL, 1909, p. 470); and, lastly, the important fact that they must be told of all domestic events, and the frequent Oriental custom of keeping them in hives built into the house-wall.

The suggestion is, therefore, that bees were originally held to be in some way connected with the house-gods or ancestral spirits. This explains why the house-key should be used to "tang" with, or to rap on the hive when "telling the bees." It is associated with the *threshold*, which is the especial haunt of the spirits of the dead relatives of the inmates of the house. (See "Folk-Lore in the O.T.," vol. III., p. 13.)

The action of "tanging" was therefore originally intended to prevent these spirits leaving the family; later, this belief was forgotten, or fell into bad repute owing to the people having adopted a different religion, and the more materialistic explanation was then advanced, that a swarm was "tanged" to prevent it from decamping. Still later, people who prided themselves on being free from superstition suggested that "tanging" was merely an assertion of ownership.

As regards the practical question whether "tanging" makes a swarm settle, may I suggest that perhaps the settling is often due to the reflection of sunlight into the swarm from the polished pan used for "tanging." Bees while swarming are under an uncontrollable impulse to rush towards the brightest visible light; and may well be confused and made to settle by suddenly finding a sun underneath them as well as above. Langstroth, in fact, somewhere suggests the use of a mirror for this purpose.—ANNIE D. BETTS, Camberley

### A Lucky Gale.

[10164.] It's an ill wind that blows nobody good, for even a gale has brought good luck to me. The gale that swept the country some weeks ago wrought havoc to some wonderful old trees in the district, one near by being split in halves, exposing to the weather and public a scene of intense interest to any bee-keeper, for in the hollow of the tree a complete nest of bees could be seen.

Arriving early upon the scene, I rescued the bees from their then exposed home, and after tying the straight and clean combs into frames with tapes, I placed them with the bees in an empty hive, where they are now happily settled.—THOS. BLIGH, Holme Nurseries, Downham Market.

### Remedy for Ants.

[10165.] Having suffered from the above pests in my hives I tried this:—Coat each leg of hive with lithographic varnish, see that the alighting boards do not touch the ground, keep the weeds and grass down close. Have seen the legs perfectly black with ants.

### To the Lover of Bees.

Hail to the spring that comes in with a rush!  
Hail to the birds, and the song of the thrush!  
Oh for the bees, and the boom of the drone!  
It makes one feel happy; reminds one of home.  
From the side of the mountains bees to us come,  
Sheltered from winds, with a glorious sun.  
On leaving these glories they in England arrive,  
To be transferred to a ten-frame hive.  
A beekeeper man, who is pleasant and kind  
Says, "Larger home, my wee beastie, for you I must find;  
"Here's a nice, roomy, twelve-framer  
hive for your home,  
"It's airy, and warmer, and chock full  
of comb."  
"Here's Dadant's foundation, with a  
good queen at stake,  
And twelve Standard frames," and see  
what she'll make:  
A hive full of bees, all ready to work,  
Supers all crowded, and wax looking pert.  
Now for the "Zip" of those bees off the  
board,  
Away on a flight through the sunshine  
abroad;  
Returning with honey back to the hive  
door,  
Off again quickly for more, and for more.  
"And now, Little Beastie, do you like  
your new home?"  
"We bless you, we're happy, just pulling  
out comb,  
"When God sends the sunshine how  
thankful are we  
"Remember, kind owner, my work is for  
thee."

C. TREDGROTT.

### Bees and Alcohol.

A curious argument against the use of alcohol, which I daresay Mr. Pussyfoot Johnson might find useful, is afforded by bees. Herr Buchner, a German scientist, who tried the effect of feeding bees on alcoholised honey, found that they soon acquire a liking for it, and rapidly lose their best qualities, giving up work and adopting a career of brigandage, robbing the hives of other bees instead of gathering their own honey.—From the *Sheffield Independent*.



### Making Frames.

[9902] I think I am a convert to the larger brood frames for my bees, and I propose to adapt my four hives to the new ideas. I do not want to scrap my present hives, but to make deeper brood chambers to take frames 10 in. or 12 in. deep, but not any longer than the ordinary standard frames.

This last season (my first in the craft) I have had considerable trouble by finding brood frames fastened to the floor of the hives, and have in several cases pulled the frames to pieces in trying to get them out for inspection. I think the frames are made too flimsy, and so I propose to make frames for the new chambers much stronger—bottom bar as strong as top bar, and side pieces square, so that they will take a good nail to hold bottom bar more firmly. I also propose to utilise present brood chambers and frames for supers.

Will some kind friend with more knowledge and experience than myself kindly say if in the above innovations I shall be going on safe lines.—A CONVERT.

REPLY.—There is no necessity to make the frames of such strength. The trouble appears to have been caused by the bottom bars being too near, or actually touching, the floor board. There should be from  $\frac{1}{2}$  in. to  $\frac{5}{8}$  in. between the bottom bars of frames and the floorboard and  $\frac{1}{4}$  in. between the ends and hive sides. There will then be no trouble from the frames being fastened.

### Bee Shows to Come.

July 6, 7 and 8, at Cardiff.—Royal Horticultural Society's Show. The Glamorgan B.K.A., in conjunction with R.H.S., offer prizes for Honey, Wax, Bees, and Appliances. Members, Novices, and Open Classes. Schedules, Mr. Wiltshire, Maindy School, Cardiff. Entries close June 22.

### Special Prepaid Advertisements. One Penny per Word.

Trade advertisements of Bees, Honey, Queens, and Bee goods are not permissible at above rate, but will be inserted at 1½d. per word as "Business" Announcements, immediately under the Private Advertisements. Advertisements of Hive-manufacturers can only be inserted at a minimum charge of 3s. per lin., or 5s. per inch.

PRIVATE ADVERTISEMENTS are only intended for readers having Surplus Stock to dispose of. Driven Bees, Nuclei, and Queens that are reared or imported for sale, are Trade Advertisements, and can only be accepted under trade terms. A charge of 6d. extra will be made if a box number is used.

Advertisements must reach us NOT LATER than FIRST POST on TUESDAY MORNING for insertion in the "Journal" the same week.

#### PRIVATE ADVERTISEMENTS.

A VACANCY occurs for a Pupil on an old-established bee farm. Opportunity will be given to learn bee-keeping on a big scale.—Apply, Box 61, B.B.J. Office, 23, Bedford Street, W.C.2. r.a.57

WANTED, for scientific purposes, a few live Bees, from diseased or unwinding stocks; cages sent and expenses paid.—SNELGROVE, Quadrant, Weston-super-Mare. a.11

FOR SALE, Bee Smoker, Queen Excluder, Feeder, Skep, 16 Sections and Dividers.—WHITE, 16, Pulteney Road, South Woodford, Essex. c.95

FOR SALE, cheap, second-hand, six Hives with sections, and other Appliances, in good condition.—MRS. M. BURTON, Holmleigh, Panual, Harrogate. d.31

FOR SALE, Stock Dutch Hybrid on 10 combs, 1919 Queen, £3, or nearest offer.—STAYGLE, 26, Ashburham Road, Tonbridge. d.32

FOR SALE, three strong Stocks of healthy Bees of Dutch descent on 10 frames in excellent W.B.C. Hives, with lifts and one section crate, price £6 each; immediate delivery; also a few early Swarms can be booked at 30s. each. Stamped envelope for reply.—MAJOR HENDRIKS, Littlewick Meadow, Knaphill, near Woking. d.33

FOR SALE, 1919 W.B.C. Hive with two racks of partly drawn-out sections and excluder, £2 10s.; several racks sections with full sheets foundation, 5s.; empty racks, 2s. 6d.—VEASEY, Holmwood, North Park, Eltham. d.34

STOCKS Bees for Sale in skeps.—HUGHES, Hill Farm, Beechwood, Dunstable, Beds. d.35

WANTED, at once, young fertile Queen, Italian preferred.—HEWITT, Baine Avenue, Wakefield. d.37

GUARANTEED strong, healthy Stocks of BEES (leaving Combs). What offers?—WHITTING, Eastwoods, Wimblington, March. d.38

FOR SALE, four Hives, new, used once, guaranteed free from disease, all standard size, two on W.B.C. principle (two on Simmins' principle; also two Stocks Bees.—"H. J.," 72, Greyhound Road, Tottenham. N.17. d.39

HYBRID ITALIAN BEES.—Strong, healthy stock on 10 standard frames, guaranteed free from disease, 1919 Queen, £5, free on rail Attleborough; box 10s., returnable. Stamp reply.—"Clewlow," Codsall, Wolverhampton. d.40

ITALIAN. Healthy Swarms, 35s.; second swarms, 25s.; package returnable. Stamp for reply. CADMAN, Codsall Wood, Wolverhampton. d.41

FOR SALE.—Can offer one or two selected Hybrid Stocks, 1919 Queens, 70s.—BALE, 1, Hodford Road, Golder's Green, N.W. r.d.42

**STOCKS.**—Few for Sale, Italian strain, 10 frames, quiet, breeding fast, £4 10s.—**DR. COMPTON**, Harehild, Middlesex. d.45

**12 GUARANTEED** healthy Hybrid Italian Stocks, Penna strain, £5 each.—**J. YOUNGER**, 6, Maid's Causeway, Cambridge. r.c.44

**A FEW** hundredweights of excellent White Clover Honey for Sale. Best offers will get it.—**JONES**, Sunny Bank, Llanfihangel-Ar-Arth, Carmarthenshire. d.45

**FOR SALE**, three or four Swarms Dutch Hybrids. Stamp for particulars.—**F. W. COOPER**, Couchmore Farm, Esher. d.46

**WANTED**, with immediate delivery, two strong, healthy Stocks of good strain, 1919 Queens; pure Italians preferred, otherwise Italian Hybrids; also Geared Extractor in good condition; also well-made Observatory Hive.—**Box 79, B.B.J. Office**, 23, Bedford Street, Strand, W.C.2. d.50

**FINE** Light English Honey, granulated, in 28-lb. tins, £8 per cwt., carriage forward; sample 6d.—**WELLS**, Bowers Lane, Isicham, Cambs. d.51

**FOUR** strong Stocks of Bees, new Hives, £4 10s. each, and spare lifts, etc. Must be sold, owner going away.—**Martin**, 75, Southview Road, Southwick, Sussex. d.4

**VACANCY** for Pupil to learn honey production, either sex; cycle rider; men must be ex-Service; five apiaries; genuine workers, no premium.—**THOMAS**, Causeway, Burwell, Cambs. d.8

**FOR SALE**, about 5 cwt. pure English Honey. No reasonable offer refused to clear.—**Box 76, B.B.J. Office**, 23, Bedford Street, Strand, W.C.2. d.9

**WANTED**, 10/15 first-class Stocks of Bees, guaranteed free from disease.—**Box 77, B.B.J. Office**, 23, Bedford Street, Strand, W.C.2. d.10

**FOR SALE**, W.B.C. Hives, Section Racks, two cases new Sections, and other sundries.—For particulars apply **W. H. SIMS**, The Summit, Rednal Road, King's Norton, Birmingham. d.20

**HAVING** bought another Apiary, can offer the following bargains: Three pure Italian Stocks, £5 each; seven ordinary Stocks for £28, or single Stock for £4 2s. 6d.; three Dutch Stocks, £11 15s.; all bar frame.—**THOMAS**, The Causeway, Burwell, Cambs. c.97

**BEES**—Several Stocks for Sale, 6 frames, 3 gs.; also Swarms, May and June.—**MISS NEALE**, Highfield, Littlehampton. r.c.117

**WANTED**, portable Greenhouse.—Price and particulars to **W. HERROD-HEMPSELL**, Old Bedford Road, Luton, Beds.

**WANTED**, Auster Rear Wind Screen for motor car.—**HERROD-HEMPSELL**, as above.

**FOR SALE**, one Exhaust Whistle, 11s., post free; one Wood Milne Motor Foot Pump, 45s., carriage free.—**HERROD-HEMPSELL**, as above.

**CORRESPONDENCE** Course in Bee-keeping.—**MISS F. E. PALING**, Golden Square, Henfield, Sussex. r.a.54

#### BUSINESS ADVERTISEMENTS.

1½d. per word.

**PURE** Carniolan Queens, imported, for Sale, May-June delivery. Stamped, addressed envelope. **B. WOODLEY**, Thorne, near Doncaster. d.48

**4-FRAME NUCLEUS**, 1920 Penna Italian Queen, May-June delivery, 55s.; box 10s., returnable.—**Durrington**, 202, Grangehill Road, Eltham, S.E.9. d.36

**STRICTLY BUSINESS.**—Free samples Flavine, six packages for 6d.; Wire Clearer Boards, 6s. 6d., postage 6d.; Japanned Sprayers, 5s., postage 6d.; six cakes Flavine Candy, 10s., post paid.—**S. H. SMITH**, 30, Maid's Causeway, Cambridge. d.47

**6-FRAME** Dutch Stocks, splendid workers, one stock of this strain gathered me 18 suppers of honey, total 360 lbs., in 1917, 65s., carriage paid; boxes to be returned. Light Honey, £7 cwt., tins and cases free, carriage forward.—**F. BUTLER**, West Road, Histon, Cambs. d.49

**BEES ON APPROVAL!**—We guarantee our Bees and Queens to give complete satisfaction. Special terms to disabled men. Supply very limited, so order now. Catalogue 3d., which is refunded on first order.—**PEARSON & GALE**, Marlborough.

**DUTCH BEES**, Skeps (as imported from Hans Matthes), Nuclei, Queens. Illustrated Catalogue on request, containing points on management.—Buy direct from Sole Agent, **WHYTE**, Bee Farmer, Cumbernauld, Dumbartonshire. b.61

**A LIMITED NUMBER** of six-comb Nuclei for disposal, end of May or early June, 3 gs. each; guaranteed healthy.—Communicate with **FRANK HOLLOWAY**, Windmill House, Croxley Green, Herts. d.1

**2-FRAME NUCLEI**, 45s.; 4-frame, 55s.; boxes 7s. 6d., returnable. Queens, June 10s., August 7s. 6d. Cash with order. All guaranteed healthy. Over 30 years' experience.—**G. SAWYER**, Marlow, Bucks. c.55

**QUANTITY** of drawn-out Shallow Combs, excellent condition, 1s. 6d. each.—**E. H. TAYLOR**, Welwyn, Herts. d.23

**ORDERS** booked for 3-frame Nuclei, Fertile Queens, Virgin Queens, etc. List for stamped, addressed envelope.—**H. CRACKNELL**, Mount Road, Thundersley, Essex. d.27

**ITALIAN NUCLEI**, with 1920 Queens, 40s.—**FOALE**, Wolverton, Bucks. c.111

**DUTCH AND DUTCH-ITALIAN.**—Four-frame Nuclei, May-June delivery, orders in rotation, £3 3s.; cash with order; carriage paid. I strongly recommend my Dutch-Italians. See B.B.J., February 26, page 99, conference of British Beekeepers re legislation. Dutch and Italian had been tried; they were quite convinced that it was worth while putting one's money on this strain.—**Dutch-Italian Hybrids**.—**SEALE**, Ashley Cottage, Otlands Drive, Walton-on-Thames, Surrey. r.c.112

**BOZZALLA** tested Queens are sold at the price usually charged for untested queens.—Catalogue from **H. STICH**, Riccartbar Avenue, Paisley. c.116

**ITALIANS.**—Queens, 5s. Book now. Stamp.—**HOUSTON**, Ellen Villa, Sidcup. r.c.77

**BEES FOR SALE.**—Several small Stocks, on six combs, of honey fed, healthy Bees, £3 10s. each; travelling box 10s., refunded if box returned in sound condition within seven days. Stamp for reply.—**REED**, Primrose House, Heacham, King's Lynn. r.b.30

**PENNA** strain Italian Queens, from June 7.—**ASHWORTH**, The Bungalow, Weymouth Street, Warminster. r.c.52

**WATERPROOF RUBBER SHEETS** for covering outhouses, etc. 72in. by 36in., brass eyelets, 12 for 20s.—**SAGARS STORES**, Ardwick, Manchester. b.16

**ITALIAN NUCLEI** from 3's, Fertile Queen from 7s. 6d., Virgins from 3s. 6d., 8-frame Stocks £4. Warranted healthy. Particulars stamp.—**WATTS**, Conway Cottage, Newtown, Markstone, Dorset. r.b.93

**HAVE YOU READ "THE BEE WORLD"?**  
If not, why not? Every number in itself is a useful literary work for practice and reference. Specimen copy free.—Offices: THE APIS CLUB, Port Hill House, Benson, Oxon.

**Bee-Keepers  
Wake Up!**

You can make a Big Profit if you use right up-to-date Appliances, including the Manley Hive. MEADOWS, SYSTON, LEICESTER.

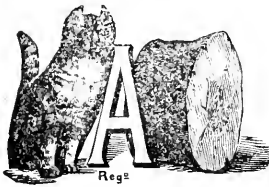

Send for

The products of the Apiary, of Poultry and Farm Stock, of the Fruit and Vegetable Garden can be Advertised and Sold through

THE  
**BAZAAR, EXCHANGE & MART**  
*Newspaper.*

Get a Copy—Thursday and Saturday 3d. The "Bazaar" publishes also practical handbooks by experts. Send for full catalogue, post free from—WINDSOR HOUSE, Breams Buildings, LONDON, E.C.2.

THE  
**British Bee-Keepers' Association.**

Insure *now* against loss by damage done through bee stings. All particulars from W. HERROD-HEMPSALL, 23, Bedford Street, Strand, London, W.C.2.

**Books for Bee-keepers  
NOW IN STOCK.**

A Modern Bee Farm ...	7/6	6d.
Beginner's Bee Book (PELLETT)	5/-	4d.
<b>BEE-KEEPING SIMPLIFIED FOR THE COTTAGER AND SMALLHOLDER</b> (W. HERROD-HEMPSALL, F.E.S.) ...	1/-	1½d.
<b>BEE-KEEPERS' PRACTICAL NOTE BOOK</b> (T. W. COWAN)	1/-	1½d.
<b>BRITISH BEE-KEEPERS' GUIDE BOOK</b> (T. W. COWAN) (paper covers only)	2/6	3d.
Dissectible Model of Queen Bee ...	4/6	3d.
<b>FERTILISATION OF FRUIT BLOSSOMS BY BEES</b> (T. W. COWAN) ...	-/3	1d.
Honey and Health (A. HOPE) ...	-/6	1d.
Honey Vinegar (REV. G. BANCKS)	-/2	1d.
How to Keep Bees (ANNA B. COMSTOCK) ...	5/-	3d.
Management of Out Apiaries	3/-	2d.
Pollination of Fruit in relation to Commercial Fruit Growing (C. H. HOOPER, F.R.H.S.)	-/6	½d.
<b>PRODUCING, PREPARING, EXHIBITING AND JUDGING BEE PRODUCE</b> (W. HERROD-HEMPSALL, F.E.S.) ...	2/-	3d.
Productive Bee-keeping (PELLETT) ...	10/6	6d.
Queen Rearing in England (F. W. L. SLADEN) ...	1/6	2d.
Snelgrove's Method of Re-queening ...	-/6	1d.
The "Townsend" Bee Book ...	2/6	2d.
<b>WAX CRAFT</b> (T. W. COWAN) ...	2/-	2½d.
Wilke's Book on Swarming ...	1/-	1½d.
<b>MISCELLANEOUS.</b>		
Maeterlinck's Life of the Bee The Lore of the Honey Bee. (TICKNER EDWARDS) ...	3/6	3d.
<b>THE BEE WORLD</b> (supplied only to members of Associations interested in the control and development of the APIS CLUB, apart from ordinary members of the latter), per copy ...	-/8	1d.
<b>British Bee Journal &amp; Record Office,</b> 23, BEDFORD STREET, STRAND, LONDON, W.C.2.		

**"BACTEROL"**

**FOR BEES**

The cure for, and preventive of, "Iste of Wight" Disease. Non-poisonous—free from stain or unpleasant odour.

2/6 per Bottle.

Post Free.

**MENLEY & JAMES, LTD.,**  
39, FARRINGTON ROAD, LONDON, E.C.1.

**INSTRUCTION in BEEKEEPING**

**PRACTICAL AND THEORETICAL**

My Apiary will be open for a limited number of pupils during this season. Terms and particulars from

W. HERROD-HEMPSALL,

The W.B.C. Apiary, Old Bedford Road, Luton, Bedfordshire.

**S. J. BALDWIN.**

I beg to inform that the No. 1 Kent Hive is not manufactured by me, only the No. 2 "Bromley Kent."

(New deep frame 17 x 14 x 12. Sample by post 6d.)

**THE APIARY, BROMLEY, KENT.**

# HIVES.

Compare the WORKMANSHIP and FINISH of our Hives.

All made by practical Men who know what a good hive should be.

In various designs to suit all tastes and requirements. Season's speciality—THE MANLEY HIVE for 16 in. x 10 in. Frames.

Full descriptions and illustrations in our 1920 Catalogue: "*Everything for an Apiary.*"

If you have not received your copy, send a P.C. at once.

OUR MOTTO—SERVICE & QUALITY.

**R. STEELE & BRODIE, Wormit Works, Wormit, Scotland.**



THE  
KEY TO  
YOUR SUCCESS.

## The Metal Foundation

(Protected)

The latest invention in Scientific hive equipment.

♦ ♦ ♦

Durable ♦ Economic ♦ Sterilisable

♦ ♦ ♦

An Ideal compromise between the Metal Comb and the Wax Foundation.

♦ ♦ ♦

For further details and prices, send for our 1920 ILLUSTRATED CATALOGUE, post free on application. It contains detailed information on the most up-to-date hives and appliances for which the House of Lee is famous.

\*\* Five per cent discount to Members of THE APIS CLUB.

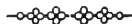

**JAMES LEE & SON,**

LTD.,

Uxbridge, Middlesex,

(Telegrams: Graphicly, Uxbridge.)

Telephone: Uxbridge 181.)

## 20-Page 1920 "WHITE STAR" List,

3d. POST FREE.

S. SIMMINS, QUEENLAND, HEATHFIELD, SUSSEX.

Look after your profits by buying hives and appliances which are easy to work. I endeavour also to give good value by care over the workmanship. Send for catalogue.

**EDWARD J. BURTT, Manufacturer, GLOUCESTER.**

*Commercial (16" x 10") frames and brood boxes stocked.*

PRINTED BY THE AVENUE PRESS (L. UPCOTT GILL & SON, LTD.) 55-57, DRURY LANE, LONDON, W.C., AND PUBLISHED FOR THE PROPRIETOR (W. HERROD-HEMPBALL), BY SIMPKIN, M<sup>rs</sup>SHALL, HAMILTON, KENT & CO., LTD., 31 & 32, PATERNOSTER ROW, E.C.



No. 1973. Vol. XLVIII

APRIL 15, 1920.

[Published every Thursday, Price 2d.]

**CONTENTS.**

	PAGE		PAGE
A FORWARD MOVEMENT .....	181	BUCKS BEE-KEEPERS' ASSOCIATION .....	187
REVIEW .....	181	CHESHIRE BEE-KEEPERS' ASSOCIATION .....	187
ROYAL SHOW FUND .....	182	BEE-KEEPERS' ASSOCIATION IN BRITISH COLUMBIA .....	188
A DORSET YARN .....	182	CORRESPONDENCE—	
JOTTINGS FROM HUNTINGDONSHIRE .....	183	Natural Stores & Sugar Feeding .....	188
BEEES IN MACEDONIA .....	184	" I.O.W." Disease: One of its Causes .....	188
NOTES OF A NOVICE .....	185	Wake Up England .....	189
A NOVEL METHOD OF RE-QUEENING .....	186	Information Required .....	189
BRITISH BEE-KEEPERS' ASSOCIATION—		Another Remedy for " I.O.W." Disease .....	189
Monthly Meeting of Council .....	186	British Honey Producers' Association .....	189
Lectures at Golders Hill Park .....	187	NOTICES TO CORRESPONDENTS .....	190

**ALUMINIUM DRAWN OUT COMBS.**

**“MONEYCOMB”**

*The greatest invention in the Bee World for 40 years.*

This is a drawn out Comb of Hexagon Cells exactly as bees build in their natural state. It is slightly coated with wax, has been thoroughly tested, and is not an experiment. Bees readily take to it for rearing brood and storing honey. Strong and durable, will last 50 years with care. Big consumption of honey saved to produce wax for comb building. Control of bee diseases. No more burning of combs. Each comb easily sterilised and used over again.

Send for Catalogue and descriptive Leaflet.

1920 Catalogue post free.

Patented by ALUMINIUM HONEY COMB CO., of U.S.A.

SOLE MANUFACTURER AND LICENSEE:

**E. H. TAYLOR, WELWYN, HERTS.**

# THE British Bee Journal

ESTABLISHED 1873.

A Weekly Journal Devoted to the  
Interests of Bee-keepers.Edited by T. W. COWAN, F.L.S., &c.,  
and J. HERROD-HEMPSALL, F.E.S.**Correspondence: Whom to Address.—**

All matters relating to the Literary Department, Associations, Shows, etc., should be addressed, "Editors, *British Bee Journal*," and all business communications and matters relating to subscriptions and advertisements to be addressed to the "Manager," *B.B.J.* Office.

**Subscriptions.** — Annual Subscription,

10s. 10d. post free in advance; single copies 2d., or 2½d. post free. If a receipt is required by post, a stamped and addressed envelope must be sent, otherwise a printed receipt will be enclosed along with the paper.

*Note.*—Cheques and Postal Orders should always be crossed, otherwise it is very difficult to trace them if they go astray.

**How to send Money.**—Remittances can be made payable to W. Herrod-Hempsall by crossed Cheques and Postal Orders. Stamps may be sent for small amounts up to 2s.

**Halfpenny stamps are preferred.**

Scottish or Irish cheques can only be taken in payment if 6d. is added for commission charged by banks for cashing them.

The Editors are not directly or indirectly interested in the manufacture or sale of beehives or appliances of any kind, and must refer correspondents wishing for prices or catalogues to advertisers in the paper.

## OUR DEPOSIT SYSTEM.

You are advised to insist on this being used when dealing with strangers.

### Rules and Conditions for Depositing

*In order to save trouble, it is requested that the Rules be carefully read over by persons using the Deposit System of trading.*

Goods should not be despatched until notice that the money has been deposited is received from this office.

1. **Method.**—When strangers are dealing together, the purchase-money of the articles is deposited at our office. We acknowledge receipt of the deposit to *both* parties, and hold the money until we are satisfied that the purchase is concluded. If a sale be effected, we remit to the seller the amount deposited, less a charge of 2½ per cent. in the £, with a minimum of 6d., and the expenses of **Post Office Orders** and postage, &c. Cash will be forwarded by Cheque, Post Office Order, or by Postal Order as preferred. If a sale or exchange be not completed, we return the amount deposited, after making the same deduction. By this means buyers and sellers are secured against fraud.

2. **Deposits.**—Postal Orders (drawn on General Post Office) and Cheques must be made payable to W. Herrod-Hempsall, and crossed "London County and Westminster Bank." The numbers of the Postal Orders should be kept by the sender. We cannot be responsible for any loss that may occur in transit.

3. **Honey on Approval.**—All honey will be sold by sample, which must be sent direct to buyer.

4. **Bee Appliances.**—In ordering, the time allowed for completing the order to be stated to us when sending cash. If maker accepts, we hold cash until transaction is satisfactorily completed, when the amount will be remitted, subject to conditions as in Clause 1.

5. **Bees and Queens.**—These will be dealt with entirely by the parties concerned, so far as price, &c., go, and when the purchase is satisfactorily completed cash will be remitted as per Clause 1.

6. **Goods in Transit.**—These are at the seller's risk, i.e., any damage to or loss of an article on its journey is borne by the vendor; but a rejected article must be properly packed and returned by the same means as was used in sending it.

7. **Carriage.**—The carriage of all goods, *except such as are sent by post*, is payable by the buyer, unless otherwise agreed. If any article sent on approval be returned, each party to the transaction must pay carriage one way.

## Books for Bee-keepers NOW IN STOCK.

Cash in full must be sent with order.

		Postage
A Modern Bee Farm ... ..	7/6	... 6d.
Beginner's Bee Book (PELLETT)	5/-	... 4d.
<b>BEE-KEEPING SIMPLIFIED FOR THE COTTAGER AND SMALLHOLDER</b> (W. HERROD-HEMPSALL, F.E.S.) ... ..	1/-	... 1½d.
<b>BEE-KEEPERS' PRACTICAL NOTE BOOK</b> (T. W. COWAN)	1/-	... 1½d.
<b>BRITISH BEE-KEEPERS' GUIDE BOOK</b> (T. W. COWAN) (paper covers only)	2/6	... 3d.
Dissectible Model of Queen Bee ... ..	4/6	... 3d.
<b>FERTILISATION OF FRUIT BLOSSOMS BY BEES</b> (T. W. COWAN) ... ..	-/3	... 1d.
Honey and Health (A. HOPE) ...	-/6	... 1d.
Honey Vinegar (REV. G. BANCES)	-/2	... 1d.
How to Keep Bees (ANNA B. COMSTOCK) ... ..	5/-	... 0d.
Management of Out Apiaries	3/-	... 3d.
Pollination of Fruit in relation to Commercial Fruit Growing (C. H. HOOPER, F.R.H.S.)	-/6	... ½d.
<b>PRODUCING, PREPARING, EXHIBITING AND JUDGING BEE PRODUCE</b> (W. HERROD-HEMPSALL, F.E.S.) ...	2/-	... 3d.
Productive Bee-keeping (PELLETT) ... ..	10/6	... 6d.
Queen Rearing in England (F. W. L. SLADEN) ... ..	1/6	... 2d.
Snelgrove's Method of Re-Queening ... ..	-/6	... 1d.
The "Townsend" Bee Book ...	2/6	... 2d.
<b>WAX CRAFT</b> (T. W. COWAN) ...	2/-	... 2½d.
Wilke's Book on Swarming ...	1/-	... 1½d.
<b>MISCELLANEOUS.</b>		
Maeterlinck's Life of the Bee	3/6	... 3d.
The Lore of the Honey Bee (TICKNER EDWARDS) ... ..	2/-	... 2d.
<b>THE BEE WORLD</b> (supplied only to members of Associations interested in the control and development of the APIS CLUB, apart from ordinary members of the latter), per copy ... ..	-/8	... 1d.

British Bee Journal & Record Office,  
23, BEDFORD STREET, STRAND, LONDON, W.C.2.

## THE British Bee-keepers' Association.

Insure *now* against loss by damage done through bee stings. All particulars from

W. HERROD-HEMPSALL, 23, Bedford Street, Strand, London, W.C.2.





## A Forward Movement.

Very shortly the anniversary of the institution of The Apis Club will be due. A general conference of members in the United Kingdom will be held at the Central Hall, Westminster, on Saturday, May 29, to decide on the future constitution of the club (the draft of which is well thought out, and is most embracing),\* the election of its Council, the selection of its offices, and on other important matters relative to the scope and conduct of the work, including the future of *The Bee World*, its official organ, which will soon be completing its first volume.

It is gratifying to find the membership of the club, despite all obstacles, is growing at a steady and sure rate, already embracing several hundred members, the rate of increase per month alone accounting in itself for the membership of a respectable society.

In view of the non-party, the national, as well as the international, character of the work, it is to be hoped that members of all associations are well to the front in its enthusiastic support, so that it will be truly representative and impartial. The advantages of the membership of this research, educational and co-operative institute far exceed the comparatively small membership fee. This in itself, apart from the lofty spirit of public duty, should win for the club a still greater measure of support, which cannot be better shaped than by a more rapid increase of its membership, by the liberal patronage of the whole trade to the publicity section of its official organ, and by a greater education of the public as to its objects and activities.

The scheme has entailed during its organisation phase a heavy sacrifice and a full sense of responsibility, both endured with an admirable spirit, as every member who has visited its offices and inspected its books and files must have verified for himself or herself. On the basis of this exceptional self-denial and tenacious perseverance in the service of such an ideal, the British bee community should be capable of worthy construction for a big forward movement.

Seeing that international apiarists everywhere are appealing for the whole-hearted support of the work, we make no apology, as the leading bee journal in this country, which has given it sincere help from the beginning, in repeating our appeal.

## Review.

*Determination of the Age in Honey-Bees*, by Helen L. M. Pixell-Goodrich, D.Sc. *The Quarterly Journal of Microscopical Science*, Vol. 64, Part 2, January, 1920. The writer of this paper says it is of the utmost importance in the study of certain bee diseases to be able to separate definitely bees dying of a specific disease from those which are merely dying of old age. As during the summer months worker bees seldom live more than from six to eight weeks, the normal daily mortality is very high. Old bees as a rule die away from home, and it may be that the last load is too much for them, but sometimes they appear to return, especially to a weak colony, and are then turned out by the younger members. It is difficult to recognise an old bee by her worn appearance, because young bees under exceptional circumstances, may become hairless and have their wings frayed. That such a diagnosis for scientific purposes was useless was apparent to the writer, and as bees have so few ways of showing their symptoms there is much difficulty in recognising disease from old age. If a bee is ill or very old she will first be unable to fly, and later hardly able to crawl. In "Isle of Wight" disease one of the characteristic symptoms is crawling, and it is important to know if bees that are found crawling are really diseased or only old. So far in this disease, a specific organism has not yet been separated. Although *Nosema apis* is frequently found in cases of "Isle of Wight" disease, it is not the cause, for it is found in many cases where the characteristic symptoms do not appear at all, and on the other hand is not found in unmistakable cases of the disease. The alimentary canal contains so many different bacteria that with ordinary media it is difficult to separate them for identification. The uncertainty as to whether a crawling bee was merely senescent or really diseased caused the problem of finding whether any special bacterium was associated with the disease practically impossible to solve.

As Dr. Goodrich was satisfied that from an examination of the external parts of the body of the bee it was not possible to determine the age, she turned her attention to the study of the brain and head parts. The work of O. S. Minot, "The Problem of Age, Growth and Death," and others, suggested to her that the nerve-cells would give a good indication of age, and the results showed that much could be learnt from their study. Serial sections of the brain and subesophageal ganglion were made, and in these cells of different

\* "The Bee World," February, 1920.

sizes were found. The large cells show great constancy in appearance, and are very similar to those from other bees of the same age, but exhibit constant differences from those of bees of other ages. A reference to the excellent illustrations accompanying the paper will show the difference in the cells at different ages.

This work, which was carried out for the Ministry of Agriculture, was required for their pathological work to find out whether a crawling bee sent for examination was aged or not. Consequently, if nerve-cells were found to be in sufficiently good condition, old age can be eliminated, and it would then be worth while to spend time on the complete investigation of the numerous bacteria of the bee, which may take some weeks, on the chance of finding some organism which may be pathogenic.

Dr. Goodrich's work is an important addition to our previous knowledge of the subject, and she sums up by saying, "For the study of those diseases with which no specific organisms have so far been identified, it is important to be able to eliminate bees dying of old age, and this cannot be done with certainty by observing outward symptoms. However, the age of bees, which normally work almost incessantly for about six weeks and then die, may be determined with some accuracy from a study of the brain-cells. With advancing age the cytoplasm of these cells undergoes gradual reduction peripherally, until in senescence only a vestige is left surrounding the nucleus."

### Royal Show Fund.

The Council of the British Bee-keepers' Association are anxious to take their usual part at the Royal Show to be held at Darlington this year, so that their unbroken record of representation at this show may not be spoilt. In order to defray the expenses in connection therewith the Council ask that all bee-keepers assist in this work by giving donations, which should be sent as early as possible to the Secretary, 23, Bedford Street, Strand, London, W.C.2.

#### DONATIONS RECEIVED.

	s.	d.
Amount received ...	15	0
Mr. A. H. Breach...	5	0
Mr. A. Donkin ...	4	0
Total ...	£1	4 0

#### ROYAL SHOW.

Will exhibitors please note a printer's error in the schedule. In Class 18 "gathered during 1919" should be "gathered during 1920."

### A Dorset Yarn.

It was good to read in this week's JOURNAL that supers were on and partly fitted. Fortune always favours those that take a risk. "Nothing venture, nothing have," and to get new honey it is worth risking something. We have plenty of sections for sale in May, but never in March; bees never take to sections so soon as bars. This season is early, but we have always been afraid to give space above too soon, as bees must of necessity keep the brood warm, and when they are breeding on 13 frames of comb they have a lot of brood to cover. The earliest sections we have had have been with a reduced brood chamber, but with a small brood chamber they make such early arrangements for swarming. Then one has to unload the racks to take out the queen cells. One likes to do this before placing on racks of sections or bars, as it is not all bee-keepers that have the time to give to them.

One college boy assured me last summer, in his holidays he makes a new lot by division, takes out the queen cells, leaving but one, puts on one rack of sections, one box of bars, and goes back to college for the next term; then at the August holidays he harvests his stores. It seems like an American story, but his people said he did not lose his swarms. So he did what he could when home, and left the bees to do the work while he was away. He was making arrangements for a farm when his college term was at an end; one could but think he would be successful on the farm, as he was so methodical with his bees.

We find that honey is still being stored above and extra comb is being built, but we do not see any drones above the bars, though in a small skep drones can be seen on the front. But these are blacks; the drone is very black. Yet not any are to be seen with the Italians, but they have so many bars in the hives they do not have the same necessity to hurry swarming. The pollen that is brought in has so many shades of colour it is difficult to determine the source; the clouded green and bright yellow predominate. By far the greater number of bees are pollen-bearers this week, yet nectar is being stored away in abundance and capped over. As one looks down on the glass they sweep their tongues from side to side, and the honey appears to stay in the cells on the upper side close to the glass, and does not run to a level as most other liquids do. Should assume it is mostly from gooseberry flowers, as they are so close to the hives. American books tell us that bees get a lot of nectar

from wild gooseberries (Langstroth, page 398), but American books on horticulture consider this a very poor fruit, especially the British race, but the native species of America, which they call *Ribes oxycanthoides*, stands the extreme variations of climate better, and gives a great deal of nectar in some States. F. W. Chard, in his exhaustive book on small fruits of America, quotes one called *Ribes gracile*, that grows over the dry plains of the States. Many of the seedlings that come up wild from the excrement of birds produce very few fruits, so cannot be of much use to bees.

We have now some of the cherries in flower. These, like pears, open at different times, some varieties later than others. It is computed that they only bloom 21 days, and are in full bloom only 12 days; that is about the time each variety is in flower. If the bees do not carry the pollen from different varieties, the sorts that are sterile in themselves cannot possibly give fruit.

The wild cherries in the woods give us now a lot of blossom, but as they are not near our cherries the bees cannot give us any help with that pollen. By having some that are good for pollination planted with those that are sterile, we get the good results with our bees.

We get a good many letters still about buying land and houses. Many of our bee-keepers want to come South. There are many farms being split up for our soldier heroes, who will not want the large farmhouses for their modest house-keeping. Many of them will be sold by the owners, so there will be room for some of our Northern bee-keepers after this season is passed. Many of the newcomers are taking up bees with their stock, and are enthusiastic about the results. They are taking up shares in the County Re-stocking Association. Some are tired of waiting, and are buying up stocks at £3 and £4 each, as they want to see good results this year. I always advise them to buy clean established stocks on eight and ten bars, even if they have to pay double for them. One bee-keeper assured me that he sold three hybrid stocks for £18, each of them on ten bars, only last week. This was at a local sale. No less than five bee-keepers were there; some wanted to buy glasshouses, some fowls. While waiting for the lots we wanted we talked of bees. Mr. Watts, of Parkstone, has a very fine lot of Italians, which he has managed to keep true to colour: Mr. Tite is eager for a local association to be formed, that bee-keepers may meet and assist each other: Mr. Giles, who keeps bees with great success, is a man of many parts—a fine carver of wood, beside being a local preacher for the

Methodists. It was good to listen to them; each of them knew the good bees were for profit to themselves, beside the pleasure of possessing them. It seems that enthusiasm is the greatest lever to help on all associations; without it all seems cold and commonplace. But these men love the least of the great Creator's creatures. In spare time they take pleasure with their bees. Some of them are growers like myself. They are producers of food under glass and in the open field, have invested their money in production, and know that bees help them. Some of our bee-keepers have retired from business and have taken up bees as a hobby. One close to me who bought a swarm in a soap box two years ago now has six bar hives full and six new ones all ready for increase this year. He has his new bars all fitted and wired, foundation all fixed, racks of sections ready. All shows fine business method. He must succeed; nothing is left to chance.—J. J. KETTLE.

### Jottings from Huntingdonshire

The past week has been one of cloudy skies, many showers, and occasional down-pours. The bees have been rather impatient, and are longing for the sun to shine forth in all his strength. There are buds everywhere, which only need the genial warmth Old Sol can give to bring them forth in all their beauty. After such refreshing rain there should be nectar in plenty as the weather improves, which it is shortly going to do. As one watches the swallows and hears their merry twit-twit, one realises how near summer must be. Queen wasps are out in all too great numbers, and it is some satisfaction to know that every one killed means one nest less. And what a number of flies one sees! The mild winter has allowed all too many to live, and unless drastic measures are taken they will be a plague as the season advances. It is worth while looking into every room and killing every fly there may be crawling about; every fly killed is a million less later on in the year.

One notes with pleasure that some 1,300 queen bees have been ordered under the Ministry of Agriculture's scheme, but what an oversight that the price should be a flat rate of 8s. 6d. Surely any bee-keeper would gladly pay 10s. 6d. for those delivered in May, and, say 9s. for June, while 6s. 6d. might be considered a reasonable price in July. It is some satisfac-

tion to know that at least 1,000 of these queens will come from Piana's apiary. This effort of the Government ought to do much to stamp out "Isle of Wight" and other diseases that bees are prone to suffer from, and, with the Bee Diseases Bill, coupled with investigations that are going on in many laboratories on both sides of the "herring pond," should ultimately result in *Nosema apis*, "Isle of Wight" and other bee sicknesses being things of the past. What then? Apiculture in the British Isles will be a stimulating and profitable business. We shall not only be able to supply our home markets with the "delectable sweet," but shall be in a position to consider exportation of our surplus honey. There is already a delightful feeling of fellowship in the apiculture world. Occasionally, and only occasionally, one comes across a bee-keeper who shuts up like a trap when he is questioned on his craft, but these close and uncommunicative individuals are enemies to themselves. Their refusal to impart any knowledge gained by practical experience results in others refusing to impart information to them. I have met one of this breed quite recently. Friendly questions as to how his bees are faring are not welcomed. He draws himself up, and looks, or tries to look, the personification of wisdom, and mutters in a superior sort of voice, "Oh, I don't keep bees; they keep me. I have nothing to do with now-fangled notions.—I've a method of my own which I follow, and always get good results." On my suggesting that he might be doing good service to his brother bee-keepers if he handed on his wisdom, he curtly replied, "Let 'em find it out, same as I've had to do." Personally, I am always suspicious of these superiorly wise type of bee-keepers. When they get a fair result in honey and stocks they never cease to talk. If disaster overtakes them, they keep silent, or talk only of their success. They remind me of amateur poultry-keepers who when their nests are empty say nothing, but let them pick up a few eggs per day now and again and they advertise it abroad, with the hope of impressing their neighbours. Ask one of them, "How do you manage it?" The reply comes, "Oh, there's ways of doing it." With that you have to be satisfied—say little and think more. To go back to what I was saying. Brotherly co-operation in the bee world is an essential if success against foreign competition is to be commanded. Every apiary should be an observatory, and knowledge gained should be passed on. What matters it whether we be dukes, marquesses, earls, barons, baronets, knights, or just members of the common herd, we should be all comrades in apiculture.—E. F. HEMMING, Steeple Gidding.

## Bees in Macedonia.

The letter from a fellow-member of the British Salonica Force reminds me that I have not redeemed the promise I made to tell what I know of bees in that wild land.

Except for an occasional forager, I did not see any bees worth mentioning till the end of May, 1917, when I saw a small swarm clustered on the ground by the roadside. In the middle of June I was exploring a ravine in the same neighbourhood (near the town of Kilkich) when I came across a little cave in the cliff. It was quite open, and not more than four feet from front to back, and two or three feet high. In this cave, quite exposed and visible, was a small colony, a swarm of the current year, for the five combs were all quite new and had only a small patch of brood. I took the honey, as such luxuries did not often come our way, but the flavour was very poor indeed, and had a bitter twang which I did not appreciate.

Although working more or less normally, this colony did not in the least resent my interference, and both these and others which I found later were the tamest bees I ever handled. As Mr. North says, they are distinctly smaller than our black bees, but I did not notice much variation in colour. There was no trace of yellow, and they might be described as a small black, with, perhaps, rather more grey hair about them. So little different did they seem, in fact, that I did not go out of my way to preserve any specimens.

I saw a swarm of about 2 lbs. on a bush about two months after this, and, in fact, hived it in a ration box; but, as I had no means of feeding it, and the flowers were practically all dried up, it did not make much headway, and as we moved shortly afterwards I was obliged to abandon it.

In September I went on duty one day to a Greek camp, where, to my delight, I found a flourishing little apiary, some stocks in the native hives and some in ration boxes of sorts. There were ten or twelve altogether, ranged on a stand about three feet high, no doubt to keep out ants. That the bee-keeper knew something about the craft was evident from the presence of a shallow pan filled with stones as a drinking place. One would have to fill the pan several times a day, I imagine, and it was quite dry then. I could not see the owner, he being away, and I did not visit the place again.

The following winter I was quartered in an abandoned village, and in my wanderings came across several native bee-hives, all empty. They were of wicker work, plastered with a mixture of mud and cowdung, inside and out; dome-

shaped, but much higher than wide, being about 18 in. high, and not more than nine to 12 wide at the base.

In the spring I noticed a colony in an elm tree not far from the village. The bees were entering a small hole about ten feet up, and I intended watching it in the hope of getting a swarm. As usual, I was shifted just before I might reasonably have expected one.

It needs little knowledge of bee craft to understand why bees are scarce in the country, and why it is extremely unlikely that apiculture would ever be very profitable in Macedonia.

The winter is very severe, and the coldest portion comes in February or March. Perhaps a little explanation may be desirable for those who have never been so unfortunate as to spend a year or two in the Balkans. The dominant factor in the weather is the "Vardar," a wind which blows at intervals throughout the year. It comes from the north-west, passing over the snow-covered Carpathians, which take all the heat out of it. It occurs at least once a month, and more frequently in the winter, blowing steadily for two days or longer. I have known it to blow continuously for five days. When this wind is not, the climate is delightfully mild, and one can lounge about in shirt-sleeves in January in perfect comfort. But if a "Vardar" springs up in the night one will need greatcoats, fur coats and any old thing one can get hold of the next day.

As I said, the worst of this came late, and then, about the beginning of April, a sudden change came. Light winds from the south, bringing soft, warm rain, prevail for a month or more. The herbage shoots up, and the flowers blossom almost as by magic. There is a riot of blossom, particularly clovers of all sorts of familiar and unfamiliar species, so long as these rains last. But early in May they cease, and except local storms, which in the plains occur rarely or not at all, there is no rain till autumn.

It is obvious that no known methods of stimulation could get a stock from zero to full honey-gathering strength in time for the blossom, which, when I found the swarms, was well on the wane. There are, of course, various species which bloom through the dry weather, but even the majority of thistles have passed their best by the end of June. The *Echinops vitro*, known to bee-keepers as the Chapman honey-plant, is certainly common in places and blooms late, but, curiously enough, I never saw a bee at it the whole time.

I fear this is all much ado about nothing for I do not suppose there is anyone mad enough to contemplate going out there to start bee-keeping.

The young lady who so charmingly deputised for the "Jottings from Hunts" some weeks back expressed a fervent desire to capture a "Marbled White." Does she know Monkswood in her county? It is not more than ten miles from her home, lying hard by Wood Walton. If she will visit it on a suitable day about the middle of July, she may hope easily to realise her ambition. I have taken, not only that, but the dark green fritillary and several other very local species of butterfly there. She might even hope to see the wonderful *Apatura iris*, though I was not so fortunate.—HERBERT MACE.

## Notes of a Novice.

The experience of a novice in his first season of bee-keeping may be of interest to other novices who are readers of your admirable journal, and may possibly create a smile of amusement to older bee-keepers by recalling to their minds their own early days in the craft.

My interest in bees was aroused by the desire to improve the fertility of the fruit-trees in the garden, and, settling down again after war work in the early spring of 1919, I was anxious to get the bees going in time to benefit the trees for the current season. A hive was duly purchased and painted ready for use, and a stock of English bees on eight frames ordered. The bees arrived on the evening of April 22, too late for transference that day, and I must confess that, having had no previous experience whatever with bees, some sleepless hours were spent occupied with thoughts, mingled with trepidation, of the operation of transferring them on the morrow.

Armed with smoker and gloves, however, the operation was successfully carried out the next day, and my first hive satisfactorily established.

Thus encouraged, another stock of 10 frames in a hive was ordered from a well-known bee-keeper, and this arrived on April 25. On my first examination of these a serious difficulty presented itself, for the brood box contained eight frames only, no dummy, and the remaining space a mass of comb. Advice was sought from our district expert, but, being a very busy man, three weeks elapsed before he was able to pay a visit of inspection and put matters right.

The report on my stocks on May 17, the date of his visit was:—No. 1: A good lot, with young queen, going strong, and almost ready for swarming. No. 2: A poor lot, with very old queen which needed superseding.

Anxiety now arose lest No. 1 should swarm in my absence—I am away from

home all day—so, acting on advice, preparation was made to make an artificial swarm from this stock. This operation was carried out successfully by myself, without gloves and with only two stings, stock No. 3 being started on June 7 in a hive made at home in spare hours.

Attention was now turned to No. 2, and having purchased a fertile Italian queen, I attempted to re-queen by Simmin's method of running in at night. The old queen was found with difficulty and killed, and the new queen run in some hours later. This was on June 14, but the queen was evidently rejected, as queens were subsequently reared in the hive.

On Sunday, June 22, returning from church in the morning, my young son, greatly excited, met me with the news that the bees had swarmed and had settled on a young apple-tree. I was caught unprepared, but with haste improvised a hive, and, securing the swarm in a small dress basket, ran them in during the evening. My first swarm taken successfully!—though the operation was carried out with considerable anxiety—and No. 4 hive set up. So far so good, but the pace was getting too hot for me. On June 27 a strong swarm issued during my absence. Fortunately they were secured for me by a neighbour, but, being in ignorance as to which hive they came from, and having no other accommodation ready, they were run into No. 4 and the queens left to fight it out.

On July 2 a swarm from No. 2 issued. These were secured and returned to the hive. I noticed at least two young queens go in with this lot. On July 30 a swarm issued from No. 3: these were returned to the hive after cutting out eight queen cells. This swarm was also a surprise to me, as the hive was supered with sections and had not been examined for some time. This finished my days of excitement for the first season.

From June 24 to July 24 much perplexity was experienced owing to no signs of a laying queen in either No. 1 or No. 2. All well in both hives, however, on the latter date.

Owing to bad weather, and probable mismanagement, only 20 lbs. of honey was secured. Two stocks were sold in September and a stock of pure Italians purchased. I wintered down with three strong stocks with full stores.

Commencing with the idea of increasing the fruit crop only, I have become enamoured with our little friends, have discovered the *bon camaraderie* of bee-keepers, and am looking forward with great hope to a successful season in 1920, my zeal being stimulated each week by reading your excellent journal.—B. J. F.

## A Novel Method of Re-Queening.

In the German bee-paper *Bienenzucht* is told how a queenless colony got itself a new queen. "Last autumn," says the correspondent, "a bee-keeper de-queened a colony in a framé hive. The queen was killed, the colony remained in the hive. Then he stifled a skep on a stand ten metres away, took the stifled bees and threw them under a skep, bumped the skep of the stifled lot on the earth, so that the queen and some bees fell out and then went to his tea. When at the end of half an hour he returned, he found the de-queened lot very uneasy. Then he saw a small swarm, now greater, now less, where the stifled queen and bees were. The bees of this little swarm were from the de-queened lot. Shortly all the bees, together with the queen, rose up, returned to the frame hive and entered it. Now the queen walks sound and jolly round her new kingdom." Comments, please!

I find this in a German bee-book:—Drone cells are used by the bees for brood and very unwillingly for honey-storing; therefore, we seldom find pollen in them, and they are only used for honey when all other available cells have been used. It is not good then to put drone combs in the super, for they act on the queen as a magnet (and are distasteful to the honey-storers). When I think back over some scattered experience I find this true enough, remembering some supers of drone-comb that were very reluctantly taken to. In fact, I have bought no drone foundation for many years, though the few well-tried old combs I have generally come in useful. The greed of the queen for drone-cells, of course, plays into our hands very nicely when the time comes for raising an early batch of selected drones for fertilising our young queens.—G. G. DESMOND, Sheepscomb, Glos.

---



---

## British Bee-Keepers' Association.

The monthly meeting of the Council was held on April 1, 1920, at the Central Hall, Westminster. Mr. T. W. Cowan presided, and there were also present Miss M. D. Sillar, Messrs. W. F. Reid, W. H. Simms, G. J. Flashman, J. Herrod-Hemp-sall, G. Thomas, G. Bryden, G. W. Judge, A. Richards, C. L. M. Eales, T. Bevan, Association representative, J. Pearman (Derby), and the secretary, W. Herrod-Hemp-sall.

Letters of regret at inability to attend were read from Sir Ernest Spencer and Mr. G. R. Alder.

The minutes of the previous meeting were read and confirmed.

Mr. T. W. Cowan was re-elected chairman and Mr. W. F. Reid vice-chairman. The various committees were re-elected with the following additions:—(Finance), Messrs. G. W. Judge and W. H. Simms, vice Messrs. J. Smallwood and E. Walker. (Exhibition), Mr. J. Pearman vice Mr. E. Walker. (Publication), Mr. G. Thomas vice Mr. J. Smallwood. (Board of Examiners), as before. (For Lecture Test, Miss M. D. Sillar and Mr. W. H. Simms vice Mr. Smallwood and Mr. E. Walker. (Emergency), as before.

The following new members were elected:—Mrs. G. J. Flashman, Mrs. Macrory, Mrs. E. C. Seymour, Miss A. M. Holland, Miss Hinton, Dr. H. French, C.B.E., F.R.C.P., Dr. W. St. Andrew St. John, Messrs. D. Owen, F. Holland, H. T. Thornbery, C. G. Traill, T. H. Hayes, J. C. Wood, M. C. Gibb, E. F. Jones and F. L. J. Wilson.

The following Associations nominated representatives, and all were accepted:—A. H. E. Wood (Aberdeenshire and Kincardineshire), H. Stroud (Essex), D. E. Bonvouni (Pembrokeshire), W. E. Moss (Leicestershire), J. N. Kidd (Durham County), E. Ff. Ball (Bucks), W. M. Valon (Staffordshire).

Payments amounting to £57 17s. were passed.

Applications for Preliminary Examinations from Salisbury, Glamorganshire, Derbyshire, and Leicestershire Associations were granted.

A resolution *re* price of sugar was read from the Derbyshire Association, and it was explained that everything possible had been done to obtain a reasonable price.

Next meeting of Council, April 15, at 23, Bedford Street, Strand, London, W.C.2.

#### LECTURES AT GOLDERS HILL PARK.

A special course of six lectures on bee-keeping will be given in the British Beekeepers' Association's apiary, London County Council Park, Golders Hill, London, N.W., on Fridays, April 23 and 30, May 7, 14, 21, and 28 at 6 o'clock each evening.

Those desiring to attend these lectures must make application at once for enrolment and particulars to—W. HERROD-HEMPSELL, Secretary, 23, Bedford Street, Strand, London, W.C.2.

A simple "chat" on bees will be given free, at 3.30 each afternoon before the lectures.

#### Bucks. Bee-Keepers' Association.

The annual meeting of the Association took place on Saturday, March 27, at 2.15 p.m., at the Congregational Schools, Aylesbury.

In the unavoidable absence of Mr. Winterton and Mr. Watkins, Mrs. Bass was voted to the chair.

Mr. Winterton, who has so kindly lent his apiary every year for the examination of candidates for third-class certificates, was elected president for 1920. He is the only person in the county with a first-class certificate. The present members of the committee other than Mr. Phillips and the Rev. T. E. Peters were re-elected, and Miss Hay and Mr. A. E. Warren were elected in the place of the latter two, who, to our regret, retire. The vice-presidents and other officers were duly elected. Mr. P. Ryall, who has returned to the county, was, together with the Hon. Secretary, elected a delegate to the B.B.K.A.

#### Cheshire Bee-Keepers' Association.

The annual meeting of the Cheshire Bee-keepers' Association was held at Chester on March 6. The Rev. Canon T. J. Evans presided over a record gathering of members. The Secretary gave a report of last year's work, stating that the membership had increased by 100. The county re-stocking scheme had been most successful, all the nuclei applied for being supplied. It was announced that the work would be continued another year.

The Duke of Westminster was re-elected president; Col. Sir G. Dixon, J.P., Major H. Barnston, M.P., Major G. H. Garratt, Miss L. Brooks, Mrs. F. Roby, Dr. F. Paul and Messrs. A. B. Earle, J. W. P. Laird, T. N. C. Nevill, Jesse Haworth, Geo. Malcolm, A. M. Sturges and Capt. Leicester Warren were elected vice-presidents.

Mr. E. W. Franklin was re-elected hon. secretary and treasurer.

Major G. H. Garratt and Mr. A. J. Blakeman were elected delegates to the B.B.K.A.

It was resolved to hold the annual show at Chester this year, in connection with the Cheshire Agricultural Society, and to support the Altrincham and Knutsford Shows.

This being the twenty-first anniversary of the birth of the Association, the members felt pleased that in spite of the vicissitude of war and pestilence they had been able to bring it through to mature age. They now look forward to many years of increased activity and usefulness.—*Communicated.*

## Bee-Keepers' Association of British Columbia.

### KOOTENAY DIVISION.

The second annual meeting of the Kootenay Division, Bee-keepers' Association of British Columbia, was held at the Board of Trade Rooms, Nelson, on Saturday, January 17, 1920. The President, Major-General Lord Aylmer, presided, and there was a good attendance. The annual report stated that the past season had been about an average one for honey production in the Kootenays. The total crop is estimated to have been 23½ tons, and the average per hive 50 lbs., against 21 tons for 1918. The general average for the whole Province is estimated at 38 lbs. per hive. The weather on the whole was too dry for realising a larger quantity. In favoured localities where the rainfall was more abundant, record yields were obtained. One of the members in the Slocan Valley reported 2,100 lbs. surplus from three hives, spring count, the largest yield yet recorded in the Province. In Creston and Castlegar honey dew was gathered by the bees owing to the dry weather. Three colonies in two apiaries were found to be affected with American foul-brood, and it was proved, beyond a doubt, that the disease had been brought in with package bees imported from the United States. These were all destroyed. There were good exhibits of honey shown at the Nelson Fair last September. The "Aylmer Trophy," consisting of a handsome clock, donated by the President, for the exhibitor scoring the highest number of points, viz., three for a first, two for a second, and one for a third prize, was won by Mr. R. V. Ramsden, Nelson. The silver medal, donated by the Canadian Bank of Commerce, for the best twelve jars of extracted honey, went to Mr. H. E. Sainsbury, Cranbrook; and the bronze medal, similarly donated, to Mr. R. V. Ramsden for the best twelve sections of comb honey. 22,385 Association honey labels were taken by the members during the season. The bulletin on "Bee-keeping in the Kootenays," issued by the Division, has had a wide circulation, having been sent to all parts of British Columbia, several of the other Provinces, the United States and the Old Country.

The following resolution was passed at the meeting:—Resolved that the bee-keepers here assembled form an Association entitled the "British Columbia Honey Producers' Association, Kootenay Division," and that the Kootenay Division, Bee-keepers' Association of British Columbia, be dissolved, and all funds remaining and incoming be handed over to the new Association.

W. J. SHEPPARD.



## Natural Stores v. Sugar Feeding.

[10166] It may be of interest to your readers to know the experiences of bee-keepers in this district with regard to "Isle of Wight" disease. There have been several apiaries, but all with one exception have been destroyed by this disease. This apiary belongs to a man who has been a bee-keeper for 30 years. He is not up to date in his methods, his hives, which are mostly made of old boxes, are poor, unpainted, and certainly not waterproof; yet, notwithstanding the fact that he has been surrounded by disease, his own bees have remained perfectly healthy. He attributes his immunity to the fact that his bees have always been fed during the winter on natural stores, whereas all other bee-keepers around him have fed their bees on sugar. I myself am certainly drawn to the conclusion that in sugar feeding we are so weakening the stamina of our bees, that when disease comes, they have no power of resistance, and fall easy victims.—CHARLES S. GREENHOUGH.

## "Isle of Wight" Disease: One of Its Causes.

[10167] The article appearing in your issue of January 22 by Mr. R. L. Edwards provides much food for thought, and his theory regarding "Isle of Wight" disease has the merit of being distinctly intersecting.

To the lay mind there are several factors regarding which some more information is desirable before one would feel justified in ruling out other considerations, and accepting the theory advanced.

To those who have made a close study of the subject, and all that has appeared in the "B.B.J." and elsewhere pertaining thereto, my inquiries may appear somewhat elementary. Nevertheless, to the great mass of bee-keepers, I think it would be of assistance for future observation to confirm or refute the experience recorded by your correspondent, if more information were forthcoming on the following points:—

1. Partly drawn out combs given: Were these above suspicion from being a source of infection?
2. On what date was experiment commenced, and was any artificial stimulating adopted?



3. . . . " Within 21 days a lovely queen was left on 40 combs of decaying larvæ, etc." Does this mean within 21 days from the time queen was transferred to second chamber?
4. Were any steps taken to ensure that ample food supplies (both honey and pollen) were available all the time, or were the bees left to provide for themselves?
5. If the latter, was there any cessation of honey flow during the course of the experiment?
6. Is there any conclusive evidence that vitality of nurse bees is materially lowered by having a large quantity of larvæ to feed, provided that food is available in sufficient quantity?
7. Is it not rather that, having insufficient food to go round, the nurse bees themselves suffer from partial starvation?
8. Mr. Edwards says that the nurses, and not the field bees, are the first victims. This may be perfectly true, but do not the decaying larvæ, and half-hatched bees, indicate that they are the first victims?

It is easily conceivable that the conditions of atmosphere indicated by your correspondent would quickly be brought about by the decomposition of the dead larvæ in a warm hive. That, to my mind, is a *result*. What we really require to know is the *cause*.

In the case under review one or other of two causes seems probable—

- (1) Starvation.
- (2) Overwork of nurse bees.

Until the first is absolutely ruled out, it seems a waste of time to consider the second. I, therefore, suggest that, if Mr. Edwards can give an emphatic declaration regarding the former, a big step forward will have been made.

My intention, during the coming season, is to experiment on a small scale with intensive brood rearing, and any further light which can be thrown on this question will be much appreciated.

JAY BEE.

### Wake Up England.

[10168] England has at present the honour of possessing a journal, the *Bee World*, which is primarily devoted to the encouragement of bee-keeping research. It provides a means of publication for any bee-keeper who has a discovery or idea to impart to his fellows, and is deserving of much more support than it has hitherto received. Research is—or should be—neutral ground, on which no private political or other controversial views should intrude, but all should work together for

the advancement of knowledge. It is to be hoped that British bee-keepers will awake to a sense of their opportunity, and support the *Bee World* and the Apis Club liberally. The past years should have taught us all the value of scientific knowledge and the danger of neglecting it; let us show that we have learnt our lesson.

As my name appears on the list of the editorial staff of the *Bee World*, it may be well to state that I have no financial interest whatever in the success of that journal, and make this appeal solely from a wish to see wiped out (as far as bee-keepers are concerned), the reproach of a contempt for science under which our nation labours.—ANNIE D. BETTS.

### Information Required.

[10169] Knowing that members of the craft are always ready to assist each other, may I trespass on your valuable space with the following:—

Will any bee-keeper living near London be good enough to recommend bee districts, within 12 miles of the City, where there is likely to be housing accommodation in the near future? Any information will be much appreciated, and postage refunded.—L. C. F., 37, Archers Road, Eastleigh, Hants.

### Another Remedy for "Isle of Wight" Discase.

[10170] I am writing to ask you if you will insert in the BRITISH BEE JOURNAL:—

I have found a cure for "Isle of Wight" disease: my fellow bee-keepers can have the recipe on payment of 2s. 6d. (which will be given to our local hospital).

This is a sure cure, and very little trouble, costing only about 3d. per hive. I will guarantee this will cure any case of "Isle of Wight" disease. Crawlers sprayed with it are flying the next day.—A. BARTHOLOMEW, The Homestead, Beccles.

### British 'Honey Producers' Association.

[10171] I was pleased to see in your issue of April 1 a proposal to form a "British Isles Honey Producers' Association." As I was one of the prime movers in establishing the "New Zealand Co-operative Honey Producers' Association," which has now become an unqualified success, probably over two-thirds of New Zealand bee-keepers are shareholders, and over 600 tons of honey are handled annually, my offering a few remarks may not be out of place.

The weak point in the suggestions put forward to my mind, is that the honey

is to be sold on commission; those, therefore, who happen to send in their honey first would reap the chief advantage, especially if the season has been a good one, and more or less of a glut has occurred for the time being. Those whose honey arrived later would consequently be left out in the cold, and things would remain much the same as they are at present. Why not pool the whole of the honey and pay out a percentage to all suppliers in proportion to the amount they have sent in, at certain intervals, until the whole of the crop has been disposed of?

This would mean real co-operation; on this principle, all would share and share alike, and no charge of favouritism could be brought against the management.

I quite agree that propaganda must precede any scheme being put into operation, but before this takes place it will be necessary to have a Board of Trade Order issued that all imported honey shall have its country of origin specified on the label, otherwise the general public will not be able to tell whether they are buying British honey or not.

If the Association is formed it should be run on strictly commercial lines, on a share basis; that is, the number of hives kept should determine the number of, say, £1, shares to be taken up, reckoning, say, at the rate of 5s. per hive.

I will not suggest any further details at present, but trust these few remarks may be of use.—W. HOOPER TEED.

## Notices to Correspondents

H. K. SPRINGETT (Cheshm). *Mouldy pollen in combs.*—Spray them with a 10 per cent. solution of formalin, "Bacterol," or "Yadil" and water. If the pellets are dry much of the pollen may be shaken out of the cells, or you might soak the combs in water for a day or two and then wash out with a garden syringe.

H. J. STRIDE (Winton).—*Spring feeding.*—Do not feed up to a certain amount in the spring, but use a slow feeder. The object of spring feeding is not to get a lot of syrup stored in the combs. If this happens the egg-laying activities of the queen are curtailed, and as a result the colony does not build up so rapidly as it should. Stop feeding as soon as the bees are able to obtain sufficient food from fruit and other blooms.

J. ECKFORD (Surrey).—*Disinfecting combs, etc., with formalin.*—The method you propose would be effective. We cannot tell you how many of the formalin tablets would be needed, as we do not know their size. No doubt instructions are given with them as to how many are needed for a given area. Your room contains nearly 2,000 cubic feet.

"CYMRO" (Mont.).—The simple fact of excreta on the alighting board does not of itself indicate dysentery. It has quite likely been evacuated by the bees when taking a cleansing flight.

M. T. (Enfield).—Your plan should be successful. When dividing remove the standard combs to a new site, and leave the queen on the old one. If you fail to find her and accidentally take her to the new location, the bees left on the old stand will rear a queen if there are worker eggs in the combs.

R. N. AVELINE (Coventry).—(1) For a registration form for sugar for bee food apply to The Secretary, Warwickshire Agricultural Executive Committee, Horticultural Branch, 12, Northgate Street, Warwick. (2) You cannot do better than continue your present method. Place the box over the standard frames when it is nearly full of bees and comb. (3) Yes.

## Bee Shows to Come.

*A nominal charge of 2s. 6d. is made for notices (not exceeding 7 lines) in this column, 10 lines charged 3s. 6d., up to 15 lines 5s., which covers cost of insertion from order till date of show. Cash should accompany orders for insertion.*

**June 16 and 17.**—Hanley Park Meeting of the Staffordshire Agricultural Society. The Staffordshire B.K.A. offer valuable prizes and six silver medals and nine bronze medals. Twelve Classes for members only, and five Open Classes. (Honey Classes are for four or three jars or sections). Schedules, W. Griffiths Silkmore, Stafford. **Entries close May 29.**

**June 29 to July 3, at Darlington.**—Royal Agricultural Society's Show, Bee and Honey Section, under the direction of the B.B.K.A. Prizes arranged in groups of counties for Associations affiliated to the B.B.K.A. Schedules from The Secretary, 25, Bedford Street, Strand, W.C.2. **Entries close May 31.**

**July 6, 7 and 8, at Cardiff.**—Royal Horticultural Society's Show. The Glamorgan B.K.A., in conjunction with R.H.S., offer prizes for Honey, Wax, Bees, and Appliances. Members, Novices, and Open Classes. Schedules, Mr. Wiltshire, Maindy School, Cardiff. **Entries close June 22.**

## Special Prepaid Advertisements. One Penny per Word.

*Advertisements must reach us NOT LATER than FIRST POST on TUESDAY MORNING for insertion in the "Journal" the same week.*

*Orders for three or more consecutive insertions in "The Bee Journal" entitle advertisers to one insertion in "The Bee-Keepers' Record" free of charge.*

### PRIVATE ADVERTISEMENTS.

**WANTED,** from August 22 to September 4, in Cornwall or Devon, within 12 miles or so of sea, Bedroom and Sitting Room, with shed for motor car; farmhouse preferred. Can any bee-keeper oblige me?—W. HERROD-HEMPSALL, Old Bedford Road, Luton, Beds.

**FOR SALE,** two "Rotax Roadlight 267" self-contained Acetylene Motor Headlights, very powerful, £6 the pair; one Exhaust Whistle, 10s.; one Wood-Milne Motor Foot Pump, 40s.—HERROD-HEMPSALL, as above.

**TWO** good Stocks of Italian Bees, Penna strain, third year from Claridge, £4 10s. each; 5s. refunded if box returned carriage paid.—HANSON, 24, Triangle, Ilkeston. d.53

**THREE** Stocks of Hybrids on 10 frames, £3 each, guaranteed healthy; box 10s., returnable.—MILLER, Wood Road, Shepperton. d.54

**4-FRAME NUCLEI,** headed by 1920 Italian Queen, 50s.; box charged 10s., returnable; May-June delivery; £1 deposit with order.—LEE, "Little Bowden Apiary," Burgess Hill, Sussex. d.26

**L**ARGE 2 cwt. Ripener, fine condition, strainer, lid and tap, 50s.; 3-frame Observation Hive, walnut and plate glass, takes four sections, £2, boxes eight drawn-out drone combs, shallow frames, 8s. each.—VINCENT, 132, Croyson Road, Anerley. d.55

**F**OR SALE, four strong Stocks of healthy Italian Hybrid Bees, 1919 Queens, on 8 and 10 frames, £4 10s. each.—HOBBS, Camlet Cottages, Barnet, Herts. d.56

**F**INEST Virgini Clover Honey, 20 lbs. 40s., 15 lbs. 31s. Swarms booked. Particulars stamp.—NORTH, Crossing, Braintree, Essex. d.57

**E**XCHANGE, five good Bee Hives for two stocks of bees, or sell.—GREEN, New Dale, Wellington, Salop. d.58

**F**OR SALE, four Stocks Italian cross, guaranteed healthy, good disease resisters, £4 each.—GRIFFIN, Brook Farm, Colnbrook, Slough. d.59

**W**ANT OFFER.—Two joiner-made Hives, 7-in. boards, W.B.C. pattern; 19 Standard Frames with foundation; never been used.—R. MORRIS, 80, Church Road, St. Annes-on-Sea. d.60

**F**OR SALE, Geraniums, Scarlet Crampel, 6s.; summer flowering Chrysanthemums, 2s. 6d.; Tomato Plants, strong, 3s. per dozen; early sown Leeks, 3s.; Celery, 4s. per 100; 50 same rate; carriage paid.—HALL, Highfield Lodge, Balderton, Newark, Notts. r.d.61

**F**OR SALE, six 10-frame Hives, Sections, Racks, Smoker, etc.—BAKER, 6, Walsingham Road, Clapton, London. d.62

**F**OR SALE, three new W.B.C. Hives with inner chamber, super, and section rack; never been used; £2 each; bargain.—H. STRIDE, 37, Ridley Road, Winton, Bournemouth. d.63

**I**TALIAN HYBRIDS. — Surplus 1919 fertile Queen, 10s.; Nucleus (1919), wintered with 1919 fertile Queen, 50s.—WEBSTER, Tretawn Park, Mill Hill, N.W.7. d.64

**P**URE Light Cambridge Honey, 14-lb. tins, 22s. 6d.; 28-lb. tins, 42s., carriage paid; sample 4d.; tins free.—J. YOUNGER, 6, Maid's Causeway, Cambridge. r.d.66

**F**OR SALE, four Stocks of Bees, no disease, £4 10s. each, or offer.—R. H. BOTT, Bennington, Stevenage, Herts. d.67

**C**ONQUEROR HIVES, one single, one double, for sale, complete; no disease; in excellent condition.—RECTOR, Quedgeley, Gloucester. d.65

**F**OR SALE, 12 strong Stocks Italian Bees, absolutely free of disease, mostly 1919 Queens, £5 each, on 10 standard frames (can have some hives if desired).—THOS. G. WALKER, Symonds Hyde, Hatfield, Herts. r.d.68

**P**LANT "Willow-Herb," splendid honey flower, 12 2s.—BOWEN, Coronation Road, Cheltenham. d.69

**G**OOD Glazier's Diamond, perfect, 8s. 9d.—HUBBARDE, North Kilworth, Rugby. d.70

**F**OR SALE, two Hives and Sundries.—29, Clundi Road, Blackheath. d.71

**F**OR SALE, cheap to clear, well-preserved B.B.J.'s, 1903 to 1914, complete, quantity illustrated Dutch Bee Journals, Swarthmore System Queen-rearing Appliances.—ARCHER, 64, Kingston Road, Oxford. d.72

**P**RACTICAL INSTRUCTION in Bee-keeping wanted by lady; Manchester.—Box 60, B.B.J. Office, 23, Bedford Street, W.C.2. d.73

**F**OR SALE, Swarms, English strain. Book now for May and June.—BRISTOW, 47, Auckland Hill, West Norwood, Surrey. r.d.74

**F**OR SALE, May and June Swarms, £2.—KNOWLES, Thursley, Godalming. r.d.75

**12** GUARANTEED healthy Hybrid Italian Stocks, Penna strain, £5 each.—J. YOUNGER, 6, Maid's Causeway, Cambridge. r.c.38

**S**WARMS for Sale, May and June, from healthy stocks. Stamp.—CHRISTIE, Hill View, Oxted Road, Godstone, Surrey. d.76

**1919** QUEENS for Sale, 8s. 6d. each.—MRS. BRUCE CULVER, Broomfield Hall, Swanley, Kent. d.77

**I**TALIAN.—Healthy early Swarms, price 35s.—Apply, MRS. A. M. WADMAN, Sompting, Worthing. d.78

**H**EALTHY Stock Hybrids, 10 frames, ready for supers, £4 4s. or with nearly new "Doncaster" Hive, zinc, and two racks sections, £5 15s.—CLUBB, Sudbury, Suffolk. d.79

**S**WARMS.—Orders taken for a few Hybrid Italians, May-June, 50s. upwards. Book now.—CLUBB, Sudbury, Suffolk. d.80

**F**OR SALE.—Can offer one or two selected Hybrid Stocks, 1919 Queens, 70s.—BALE, 1, Hodford Road, Golder's Green, N.W. r.d.42

**12** GUARANTEED healthy Hybrid Italian Stocks, Penna strain, £5 each.—J. YOUNGER, 6, Maid's Causeway, Cambridge. r.c.44

**F**OR SALE, three or four Swarms Dutch Hybrids. Stamp for particulars.—F. W. COOPER, Couchmore Farm, Esher. d.46

**F**OUR strong Stocks of Bees, new Hives, £4 10s each, and spare lifts, etc. Must be sold, owner going away.—Martin, 75, Southview Road, Southwick, Sussex. d.4

**F**OR SALE, about 5 cwt. pure English Honey. No reasonable offer refused to clear.—Box 76, B.B.J. Office, 23, Bedford Street, Strand, W.C.2. d.9

**F**OR SALE, W.B.C. Hives, Section Racks, two cases new Sections, and other sundries.—For particulars apply W. H. SIMS, The Summit, Rednal Road, King's Norton, Birmingham. d.20

**W**ANTED, portable Greenhouse.—Price and particulars to W. HERROD-HEMPSELL, Old Bedford Road, Luton, Beds.

**W**ANTED, Auster Rear Wind Screen for motor car.—HERROD-HEMPSELL, as above.

**BUSINESS ADVERTISEMENTS.**

1½d. per word.

**D**UTCH AND DUTCH-ITALIAN 4-FRAME NUCLEI, May-June delivery, orders in rotation, £5 3s.; cash with order; carriage paid. See B.B.J., February 26, page 99, Conference of British Bee-keepers re Legislation. Read what the greatest experts say: Dutch-Italian Hybrids had been tried. The result was they were quite convinced they stand up against disease better than pure races. They hoped in a few years that a number of these little strangers will be within our gates. Also, it was worth while putting one's money on this strain—Dutch-Italian Hybrids.—SEALE, Ashley Cottage, Oatlands Drive, Walton-on-Thames, Surrey. r.d.81

**I**TALIAN HYBRIDS.—Limited number 3-frame Nuclei, 1919 Queens, May-June delivery, packing and carriage paid, 50s.—HUTCHINGS, Stopsley, Beds. d.82

**3-FRAME** ITALIAN NUCLEI, frames crowded with sealed brood, 1920 Queen, no disease, £5 3s.; box 10s., returnable; carriage paid; cash with order. Initial cost slightly more than for some nuclei, but worth it. Satisfaction guaranteed or money returned. Full particulars free.—E. H. TUNMER, "Chalfonts," Leiston, Suffolk. r.d.83

**W**E ARE NOT a restocking scheme, but we supply the bees. No Government queens used. Send 3d. for Catalogue (money refunded on first order), and see what our satisfied customers say.—PEARSON & GALE, Marlborough. r.d.93

**MISSES PALING AND PILLANS** having 14 combined and enlarged their Apiaries, are now prepared to book orders for strong 3-frame Italian Nuclei, massed with brood and bees, headed with 1920 Penna Queens or 1920 Queens of their own rearing from best selected Italian strains, £3, carriage paid. Speciality made in rearing choice Italian fertile Queens, 12s.; Virgins, 6s. Reduction on quantities. Pupils taken.—Golden Square, Henfield, Sussex. r.d.84

**INVICTA KENT BEES.**—Nuclei for Sale. Write for particulars, then, if satisfied, send 2s. 6d. deposit with order, balance June 1.—**EDWARD GRISTWOOD**, Cheriton, Folkestone. Same address 17 years. r.d.85

**50-75 3-FRAME Nuclei Italian Hybrids**, 1920 Queens, proved disease-resisting strain and excellent honey gatherers. Delivery early June onwards; orders executed in rotation. Price 45s. each, carriage paid; travelling boxes to be returned.—Further particulars, **HOSEGOOD**, 26, Purley Park Road, Purley, Surrey. d.86

**PURE GOLDEN ITALIANS** combine all qualities desirable. Nuclei and Queens are being booked rapidly. Particulars stamp.—**COOMBER**, 64, Ronald Park Avenue, Westcliff, Essex. d.87

**BEES FOR SALE.**—Fine pure-bred Italian Stocks on 6, 8, or 10 frames, also Hybrids and Blacks. All guaranteed to be free from any disease whatsoever, and to be bred at apiaries situated in the beautiful Avon Valley fruit district. These apiaries have never yet shown any signs of "I.O.W." disease at any time since they were established four years ago.—Apply, stating requirements, to 7, Gravelly Hill North, Birmingham. d.88

**EXTRA SPECIAL.**—We can now offer 100 more June Pennas, delivery latter part of month from Bologna, 15s. each. Orders in strict rotation.—**S. H. SMITH**, 30, Maid's Causeway, Cambridge.

**I CAN SUPPLY** in May and June a few very fine Nuclei of Hybrid Bees of Simmins' strain on standard frames, also a few on 16 by 10 frames to anyone who is in difficulty as to procuring the latter. I do not want to sell the large frame lots particularly, but will do my best to supply a few if wanted.—**R. B. MANLEY**, Brightwell, Wallingford. d.91

**HAVE YOU WINTERED 100 PER CENT.?** If not, your strain must be wrong. Booking orders now for delivery June onwards. Hardy disease-resisting, home-reared Italians; splendid honey gatherers. Three-frame Nuclei, 1920 Queen, price £3 3s., carriage paid; 7s. 6d. refunded on box if returned carriage paid Saxilby Station. Terms: Cash with order. I will refund 10s. on all orders not despatched before July 1.—**HERBERT VALLEY**, Apiarist, Saxilby, Lincoln. r.d.92

**PURE Carniolan Queens**, imported, for Sale, May-June delivery. Stamped, addressed envelope.—**B. WOODLEY**, Thorne, near Doncaster. d.48

**A LIMITED NUMBER** of six-comb Nuclei for disposal, end of May or early June, 3 gs. each; guaranteed healthy.—Communicate with **FRANK HOLLOWAY**, Windmill House, Croxley Green, Herts. d.1

**3-FRAME NUCLEI**, 45s.; 4-frame, 55s.; boxes 7s. 6d., returnable. Queens, June 10s., August 7s. 6d. Cash with order. All guaranteed healthy. Over 30 years' experience.—**G. SAWYER**, Marlow, Bucks. r.c.55

**NUCLEI** for honey production. Nuclei for re-stocking purposes. Vigorous strains of world-wide reputation.—**STURGES**, Shenstone, Hartford, Cheshire. d.24

**HAVE YOU READ "THE BEE WORLD"?** If not, why not? Every number in itself is a useful literary work for practice and reference. Specimen copy free.—Office: **THE APIS CLUB**, Port Hill House, Benson, Oxon.

**QUANTITY** of drawn-out Shallow Combs, excellent condition, 1s. 6d. each.—**E. H. TAYLOR**, Welwyn, Herts. r.d.55

**ORDERS** booked for 3-frame Nuclei, Fertile Queens, Virgin Queens, etc. List for stamped, addressed envelope.—**H. CRACKNELL**, Mount Road, Thundersley, Essex. r.d.27

**ITALIAN NUCLEI**, with 1920 Queens, 40s.—**FOALE**, Wolverton, Bucks. r.c.111

**BOZZALLA** tested Queens are sold at the price usually charged for untested queens.—Catalogue from **H. STICH**, Riccartbar Avenue, Paisley. r.c.116

**ITALIANS.**—Queens, 5s. Book now. Stamp.—**HOUSTON**, Ellen Villa, Sidecup. r.d.90

**BEES FOR SALE.**—Several small Stocks, on six combs, of honey fed, healthy Bees, £3 10s. each; travelling box 10s., refunded if box returned in sound condition within seven days. Stamp for reply.—**REED**, Primrose House, Heacham, King's Lynn. r.b.30

**PENNA** strain Italian Queens, from June 7.—**ASHWORTH**, The Bungalow, Weymouth Street, Warminster. r.c.52

**WATERPROOF RUBBER SHEETS** for covering outhouses, etc., 72in. by 36in., brass eyelets, 12 for 20s.—**SAGARS STORES**, Ardwick, Manchester. r.b.16

## Dutch Bees.

I have been appointed **Sole Agent** for **Hans Matthes**, the Dutch Bee Farmer who supplied the British Government last season with Sleps for their County Re-stocking Scheme. **Hans Matthes** also supplied me with what Sleps I required last year.

Last autumn I got a large consignment over from Holland, and am presently wintering these at my Apiary here.

To those desirous of testing these Dutch Bees, I will be pleased to send on my Illustrated Catalogue, containing much information regarding the hardiness, prolificacy, disease-resisting, and honey-gathering characteristics of this race of bee.

Address—

**R. WHYTE,**  
The Bee Farm,  
**Cumbernauld, Dumbartonshire.**

The products of the Apiary, of Poultry and Farm Stock, of the Fruit and Vegetable Garden can be Advertised and Sold through

THE  
**BAZAAR, EXCHANGE & MART**  
Newspaper.

Get a Copy—Thursday and Saturday 3d. The "Bazaar" publishes also practical handbooks by experts. Send for full catalogue, post free from—**WINDSOR HOUSE**, Breams Buildings, LONDON, E.C.2.



**“BACTEROL”**  
FOR BEES

The cure for, and preventive of, “Isle of Wight” Disease. Non-poisonous—free from stain or unpleasant odour.

2/6 per Bottle. Post Free.

**MENLEY & JAMES, LTD.,**  
39, Farringdon Road, London, E.C.1.

**INSTRUCTION in BEEKEEPING**  
*PRACTICAL AND THEORETICAL*

My Apiary will be open for a limited number of pupils during this season. Terms and particulars from

**W. HERROD-HEMPSALL,**  
The W.B.C. Apiary, Old Bedford Road, Luton, Bedfordshire.

**INSURE YOUR STOCKS**  
AGAINST “I.O.W.” AND OTHER INFECTIONS.

Science has now placed within reach of every Apiarist a safe and certain preventive of infection in “Yadil” Antiseptic.

For **SPRING FEEDING** “Yadil” may be added freely to Syrup.  
For **DISINFECTING** Bees and Combs a five-per-cent. solution in tepid water should be used with a fine spray.

*ASK FOR GREEN LABEL.*

Our Bee Brochure sent Free on Application.

**CLEMENT & JOHNSON, 19, Sicilian Avenue, W.C. 1.**

**The Apis Club.**  
(FOUNDED 1919.)

An International Institute for the service of Modern Apiculture and for fostering a genial spirit of scholarly brotherhood amongst bee-keepers of all countries with the co-operative object of promoting their educational and material interests.

If you have a live interest in bee culture as a science and a craft you should join **The Apis Club.**

For particulars write to:

The Secretary, **The Apis Club,** Benson, Oxon, England.

**S. J. BALDWIN.**

I beg to inform that the No. 1 Kent Hive is not manufactured by me, only the No. 2 “Bromley Kent.”

(New deep frame 17×14×12. Sample by post 6d.)

**THE APIARY, BROMLEY, KENT.**

**The “HERROD APICURE.”**  
SIMPLE CLEAN! EFFICIENT!

For the Prevention and Cure of Foul Brood and other Diseases of Bees.

**DON'T DELAY—ORDER AND USE AT ONCE.**

PRICE, with full instructions, 1/8, 2/10 and 5/8, post free. From all the leading Appliance Dealers, and from

**THE BRITISH BEE JOURNAL & RECORD OFFICE, 23, Bedford Street, W.C.2.**

# HIVES.

Compare the WORKMANSHIP and FINISH of our Hives. All made by practical Men who know what a good hive should be.

In various designs to suit all tastes and requirements. Season's speciality—THE MANLEY HIVE for 16 in. x 10 in. Frames.

Full descriptions and illustrations in our 1920 Catalogue: *"Everything for an Apiary."*

If you have not received your copy, send a P.C. at once.

OUR MOTTO — SERVICE & QUALITY.

**R. STEELE & BRODIE, Wormit Works, Wormit, Scotland.**



THE  
KEY TO  
YOUR SUCCESS.

## The Metal Foundation

(Protected)

The latest invention in Scientific hive equipment.

Durable \* Economic \* Sterilisable

An Ideal compromise between the Metal Comb and the Wax Foundation.

¶ For further details and prices, send for our 1920 ILLUSTRATED CATALOGUE, post free on application. It contains detailed information on the most up-to-date hives and appliances for which the House of Lee is famous.

\*\* Five per cent discount to Members of THE APIS CLUB.

**JAMES LEE & SON,**  
LTD.,

Uxbridge, Middlesex,

(Telegrams: Graphicly, Uxbridge.)

Telephone: Uxbridge 181.)

## 20-Page 1920 "WHITE STAR" List,

3½d. POST FREE.

S. SIMMINS, QUEENLAND, HEATHFIELD, SUSSEX.

Look after your profits by buying hives and appliances which are easy to work. I endeavour also to give good value by care over the workmanship. Send for catalogue.

**EDWARD J. BURTT, Manufacturer, GLOUCESTER.**

Commercial (16" x 10") frames and brood boxes stocked.

PRINTED BY THE AVENUE PRESS (L. UPGOTT GILL & SON, LTD) 55-57, DRURY LANE, LONDON, W.C., AND PUBLISHED FOR THE PROPRIETOR (W. HERBOD-HEMPSELL), BY SIMPKIN, MASHALL, HAMILTON, KENT & CO., LTD., 31 & 32, PATERNOSTER BOW, E.C.



No. 1974. Vol. XLVIII

APRIL 22, 1920.

[Published every Thursday, Price 2d.]

**CONTENTS.**

	PAGE		PAGE
REVIEW .....	193	WARWICKSHIRE B.K.A. ....	200
BRITISH BEE-KEEPERS' ASSOCIATION .....	193	SHEFFIELD AND DISTRICT B.K.A. ....	201
ROYAL SHOW FUND .....	195	BEVERLEY AND DISTRICT B.K.A. ....	201
A DORSET YARN .....	195	CORRESPONDENCE—	
JOTTINGS FROM HUNTINGDONSHIRE .....	196	" Isle of Wight " Disease : One of Its Causes .....	201
TO TALK OF MANY THINGS .....	197	Bees on the Seashore .....	202
A BEGINNER'S DIFFICULTIES WITH " ISLE OF WIGHT " DISEASE .....	198	NOTICES TO CORRESPONDENTS .....	202
SUSSEX B.K.A. ....	199	BEE SHOWS TO COME .....	202

**ALUMINIUM DRAWN OUT COMBS.**

**"MONEYCOMB"**

*The greatest invention in the Bee World for 40 years.*

This is a drawn out Comb of Hexagon Cells exactly as bees build in their natural state. It is slightly coated with wax, has been thoroughly tested, and is not an experiment. Bees readily take to it for rearing brood and storing honey. Strong and durable, will last 50 years with care. Big consumption of honey saved to produce wax for comb building. Control of bee diseases. No more burning of combs. Each comb easily sterilised and used over again.

Send for Catalogue and descriptive Leaflet.

1920 Catalogue post free.

Patented by ALUMINIUM HONEY COMB CO., of U.S.A.

SOLE MANUFACTURER AND LICENSEE:

**E. H. TAYLOR, WELWYN, HERTS.**

THE  
**British Bee Journal**

ESTABLISHED 1873.

A Weekly Journal Devoted to the  
Interests of Bee-keepers.

Edited by T. W. COWAN, F.L.S., &c.,  
and J. HERROD-HEMPSALL, F.E.S.

**Correspondence: Whom to Address.—**

All matters relating to the Literary Department, Associations, Shows, etc., should be addressed, "Editors, *British Bee Journal*," and all business communications and matters relating to subscriptions and advertisements to be addressed to the "Manager," *B.B.J.* Office.

**Subscriptions.** — Annual Subscription, 10s. 10d. post free in advance; single copies 2d., or 2½d. post free. If a receipt is required by post, a stamped and addressed envelope must be sent, otherwise a printed receipt will be enclosed along with the paper.

*Note.*—Cheques and Postal Orders should always be crossed, otherwise it is very difficult to trace them if they go astray.

**How to send Money.**—Remittances can be made payable to W. Herrod-Hempsall by crossed Cheques and Postal Orders. Stamps may be sent for small amounts up to 2s. **Halfpenny stamps are preferred.**

Scottish or Irish cheques can only be taken in payment if 6d. is added for commission charged by banks for cashing them.

The Editors are not directly or indirectly interested in the manufacture or sale of beehives or appliances of any kind, and must refer correspondents wishing for prices or catalogues to advertisers in the paper.

**OUR DEPOSIT SYSTEM.**

**You are advised to insist on this being used when dealing with strangers.**

**Rules and Conditions for Depositing**

*In order to save trouble, it is requested that the Rules be carefully read over by persons using the Deposit System of trading.*

Goods should not be despatched until notice that the money has been deposited is received from this office.

**1. Method.**—When strangers are dealing together, the purchase-money of the articles is deposited at our office. We acknowledge receipt of the deposit to both parties, and hold the money until we are satisfied that the purchase is concluded. If a sale be effected, we remit to the seller the amount deposited, less a charge of 2½ per cent. in the £, with a minimum of 6d., and the expenses of Post Office Orders and postage, &c. Cash will be forwarded by Cheque, Post Office Order, or by Postal Order as preferred. If a sale or exchange be not completed, we return the amount deposited, after making the same deduction. By this means buyers and sellers are secured against fraud.

**2. Deposits.**—Postal Orders (drawn on General Post Office) and Cheques must be made payable to W. Herrod-Hempsall, and crossed "London County and Westminster Bank." The numbers of the Postal Orders should be kept by the sender. We cannot be responsible for any loss that may occur in transit.

**3. Honey on Approval.**—All honey will be sold by sample, which must be sent direct to buyer.

**4. Bee Appliances.**—In ordering, the time allowed for completing the order to be stated to us when sending cash. If maker accepts, we hold cash until transaction is satisfactorily completed, when the amount will be remitted, subject to conditions as in Clause 1.

**5. Bees and Queens.**—These will be dealt with entirely by the parties concerned, so far as price, &c., go, and when the purchase is satisfactorily completed cash will be remitted as per Clause 1.

**6. Goods in Transit.**—These are at the seller's risk, i.e., any damage to or loss of an article on its journey is borne by the vendor; but a rejected article must be properly packed and returned by the same means as was used in sending it.

**7. Carriage.**—The carriage of all goods, *except such as are sent by post*, is payable by the buyer, unless otherwise agreed. If any article sent on approval be returned, each party to the transaction must pay carriage one way.

THE  
**British Bee-Keepers' Association.**

Insure *now* against loss by  
damage done through bee  
stings. All particulars from

W. HERROD-HEMPSALL, 23, Bedford  
Street, Strand, London, W.C.2.

The products of the Apiary, of  
Poultry and Farm Stock, of  
the Fruit and Vegetable  
Garden can be Advertised  
and Sold through

THE  
**BAZAAR, EXCHANGE & MART**

*Newspaper.*

Get a Copy—Thursday and Saturday 3d. The "Bazaar" publishes also practical handbooks by experts. Send for full catalogue, post free from—**WINDSOR HOUSE, Breams Buildings, LONDON, E.C.2.**

**The Metal Foundation.**

(Protected.)

For the benefit of readers of the JOURNAL and the RECORD we have arranged with the manufacturers of the Metal Foundation to accept all orders received through our offices at a consideration in the shape of a 25 per cent. deposit to begin with, and the balance by mid-March, or prior to delivery, if earlier.\* All orders are guaranteed by them to be executed *not later* than April, 1920.

**Prices:—**(1) **BRITISH STANDARD FRAME;** fully fitted with "worker" Metal Foundation: Single, 2s. 4d.; per two dozens, 2s. 3d. each frame; per four dozens and over, 2s. 2d. each frame.  
(2) **STANDARD SHEET** of "worker" Metal Foundation: Single, 2s.; per two dozens, 1s. 11d. each sheet; per four dozens, 1s. 10d. each sheet.

Subject to a 5 per cent. discount to members of the Apis Club.

*Packing & Carriage Extra.*

\* \* \* Since the Metal Foundation will be produced only to order, no order will be subject to cancelling.





**Review.**

*Jahresbericht über die Faulbrutversicherung des Vereins Schweizer Bienenzüchter pro, 1919*, by F. Leuenberger, Bern. This is the 12th annual report of the results obtained in German-Switzerland as the result of legislation and insurance. There was a large increase in the number of bee-keepers insuring amounting to 1,024, with 16,684 colonies. Thus they have reached the record number of 14,684 compulsorily insured apiaries containing 162,346 colonies.

During the year foul brood was found in 89 apiaries, 70 of which belonged to members of the Association and 19 to non-members. The percentage of foul brood cases is 0.5 per cent., or one colony in every 200. The highest percentage of disease is found in the following cantons:—Valais, 6 per cent.; Glarus, 2.9 per cent.; Bale, 1.1 per cent.; Lucerne, 0.8 per cent. It is satisfactory to find that in six cantons, namely those of Uri, Zug, Soleure, Schaffhausen, Appenzell and Thurgovie, not a single case of foul brood was found. The results show the value of inspectors and the advantages that resulted from legislation. Valais still shows the highest percentage of cases, as it was the worst-infected canton in Switzerland, but even here we find the percentage of infected colonies reduced from 10 per cent. in 1913 to 6 per cent. The high percentage is accounted for by the fact that foul brood had for years become endemic in this canton, owing to no measures having been taken to combat it previous to legislation. In the 89 apiaries consisting of 620 colonies, foul brood was found in 199. Of these artificial swarms were made from 61 and 138 were destroyed and appliances disinfected. In accordance with recent investigations, it is possible to free honey of the disease germs by adding 50 per cent. of water and boiling until it is reduced to the original consistency of the honey. It is, however, not suitable for commerce.

We would remind our readers that the Swiss Cantons have delegated their powers to the Swiss Bee-keepers' Society, who is authorised to administer the law. By this everyone is required to notify the presence of disease in his apiary, but only members of the Society are entitled to compensation. No purchase of bees can take place without a health certificate, and the purchaser who does not conform to this condition forfeits all right to com-

pensation in the event of foul brood being found in his apiary.

The finances in connection with the scheme, which is administered by M. F. Leuenberger, are in a flourishing condition, for although the insurance is only 5 centimes per colony, and no call has been made on the Government for financial help, it has been amply sufficient to pay all expenses including compensation. The insurance premiums amounted to 8310.35 francs, and compensation cost 4530.90 francs. We congratulate our Swiss friends on what the Society, under the able direction of M. Leuenberger, has been able to accomplish with the powers that legislation has given them.

**British Bee-Keepers' Association.**

The annual general meeting and *conversazione* were held at the Central Hall, Westminster, on April 1. There was a fair attendance at the annual meeting, at which the chair was taken by Mr. T. W. Cowan. The minutes of the last annual general meeting were read and confirmed. The balance-sheet was then considered, and was passed as satisfactory. In considering the report for the year, the Chairman made the following remarks:—

**AFFILIATED ASSOCIATIONS.**

The number of Associations affiliated to us was 41; not quite as many as a few years ago, when there were 45 or 46, but many of these were small ones which have amalgamated, so actually none have been lost.

**LEGISLATION.**

You know that for some years bees have been dying owing to "I.O.W." disease, and we were not able to do very much. It has been found that the only way to tackle this is to have legislation. In 1895 I had the pleasure of introducing a deputation to the Board of Agriculture, but at that time we were not ready to go in for legislation. We are now all agreed to have legislation. You will be glad to know that the Ministry of Agriculture a few weeks ago convened a large conference of bee-keepers, inviting two delegates from each Association and other organisations interested. The meeting was held at the Survcyors' Institute in London, and a resolution was passed in favour of legislation with but one dissentient.

The registration of all bee-keepers will be a great help. In the case of an outbreak of disease we shall be able to send our instructors to examine the bees and advise as to what is best to be done. The

Bill will shortly be presented to Parliament, and there is every probability of it being passed.

#### MR. SMALLWOOD.

In referring to the death of Mr. Smallwood, he was on the Council for many years, and we were all very sorry to lose him. He had done a large amount of good work for the Association, especially in regard to the accounts.

#### FINANCE.

Financial position was satisfactory. Income has been greater than last year, but expenses have also increased. Membership is still very small, and the subscription is only 5s. He appealed to those who could do so to give more than the ordinary subscription.

#### SHOWS.

As one of the judges of the Royal I was very pleased to see such a good show. The total cost of the exhibition was £49, of which £44 was subscribed, and as the Council has decided to again undertake the work, it is hoped that bee-keepers will again subscribe liberally to the fund opened for this purpose.

#### EXAMINATION.

The interest is still kept up, and a large number of country members have passed the examinations.

#### INSURANCE.

There has been a satisfactory increase in the number of stocks insured, which indicates that we have got over the difficulties experienced for some years.

On the whole the report is very favourable. We are a society which always wants more money, and we are only restricted by the amount of our income.

Mr. Sanders proposed and Mr. Claridge seconded that the Report and Balance Sheet for 1919 be adopted and issued. Carried unanimously.

Mr. Kenward proposed a vote of thanks to retiring officers. Seconded by Mr. Breach, who stated that the affairs were conducted in a very satisfactory manner. Carried unanimously.

Mr. Pearman moved the re-election of existing members of Council, with the addition of two new members nominated. Seconded by Mr. Burt and carried unanimously.

The Secretary proposed a very hearty vote of thanks to Mr. Paulin for engrossing the examination certificates, and this was carried unanimously.

#### W.B.C. GOLD MEDAL.

Mr. Cowan: I am very pleased to be able to present this to Mr. Bryden, who was the winner last year. It is the first memorial medal awarded since the war. I have much pleasure in congratulating Mr. Bryden and of presenting the medal to him.

Mr. Bryden suitably replied, stating that he had succeeded in winning the medal by following the lines laid down by the Association, and so well indicated in that admirable book on the subject written by Mr. W. Herrod-Hempsall. He hoped the medal would be in the family for many years by being handed down as a heirloom.

This concluded the business of the meeting.

A number of appliances were staged for examination by members, the model W.B.C. hives of Mr. Kenward coming in for a large amount of attention. An asbestos roof covering by Mr. Pinder, of Salisbury, queen rearing outfits by Mr. Meadows, and a patent super clearer by Messrs. Burgess, of Exeter, were also most interesting.

The *Conversazione*, at which there was a good attendance, was presided over by Mr. T. W. Cowan, and was opened by a very able lecture by Major C. C. Lord on "Diseases of Bees," which was listened to with marked attention, and several questions were put to the lecturer.

There was then an interval for a most welcome and refreshing tea, and advantage was taken of renewing acquaintances and examining the various exhibits. After tea the *Conversazione* was resumed, Mr. W. Herrod-Hempsall giving a lecture on "Queen Rearing and Methods of Increase." A number of questions were asked and answered, which brought a most interesting meeting to a close.

#### MONTHLY MEETING OF COUNCIL.

The monthly meeting of the Council was held at 23, Bedford Street, Strand, London, W.C.2, on Thursday, April 15, 1920.

Sir Ernest Spencer presided, and there were also present Miss M. D. Sillar, Messrs. G. J. Flashman, G. S. Faunch, F. W. Harper, G. Bryden, J. B. Lamb, F. W. Watts, J. Herrod-Hempsall. Association representatives: J. Pearman (Derby), R. R. Babbage (Middlesex), H. Stroud (Essex), and the Secretary, W. Herrod-Hempsall.

Letters of regret at inability to attend were read from Messrs. T. W. Cowan, C. L. M. Eales, A. G. Pugh, W. F. Reid, and G. R. Alden.

The minutes of the previous meeting were read and confirmed.

The following new members were elected:—H. Stroud and A. F. Birch.

South Staffordshire Association nominated Mr. J. Price, and Cheshire Mr. A. J. Blakeman, as their representatives, and both were accepted.

The financial report was presented by the Secretary, who stated that the receipts for February were £43 15s. 4d.,

and for March £39 9s. 5d. The bank balance on April 1 was £164 8s. 6d.

Payments amounting to £13 17s. 6d. were passed.

It was proposed by Mr. Bryden and seconded by Mr. Babbage that the Council meetings be held on the third Thursday in each month, except August, when no meeting will be held, and that the Council meeting at the Royal Show be discontinued, as the representatives of the Association, for whose benefit it was fixed, failed to take advantage of the opportunity afforded. After a lengthy discussion Mr. Bryden agreed to withdraw his motion, and it was resolved that the Council meeting at the Royal be continued as a trial for one more year.

A letter was read from Mr. R. Mossop accepting the appointment as hon. solicitor for 1920.

Correspondence was read from the Isle of Wight B.K.A. and Chesham B.K.A., and the Secretary was instructed to deal with it.

Next meeting of Council on May 20, 1920, at 23, Bedford Street, Strand, London, W.C.2.

LECTURES AT GOLDERS HILL PARK.

A special course of six lectures on bee-keeping will be given in the British Bee-keepers' Association's apiary, London County Council Park, Golders Hill, London, N.W., on Fridays, April 23 and 30, May 7, 14, 21, and 28 at 6 o'clock each evening.

Those desiring to attend these lectures must make application at once for enrolment and particulars to—W. HERROD-HEMPSALL, Secretary, 23, Bedford Street, Strand, London, W.C.2.

A simple "chat" on bees will be given free, at 3.30 each afternoon before the lectures.

Royal Show Fund.

The Council of the British Bee-keepers' Association are anxious to take their usual part at the Royal Show to be held at Darlington this year, so that their unbroken record of representation at this show may not be spoilt. In order to defray the expenses in connection therewith the Council ask that all bee-keepers assist in this work by giving donations, which should be sent as early as possible to the Secretary, 23, Bedford Street, Strand, London, W.C.2.

DONATIONS RECEIVED.

	£	s.	d.
Amount received	...	1	4
Wembley B.K.A.	...	1	0
Total	...	£2	5
		0	0

A Dorset Yarn.

In Dorset we have had one of the worst weeks this season. Wet every day, and then two days of gale. To-day (Saturday, April 17) bees were out by 7 a.m., modern time; they seemed to know it was going to be fine. All day, even up to 6 p.m., they were going over the bush fruits. They are most interesting, now that you can see them over the tops of bars and sections; anyone who has visited us before always wants to see the bees. I notice in the roughest weather the blacks were the most active; there were more out (between the storms) on the gooseberry lines; there was a greater crowd round the entrance than with the Italians. One Italian lot had begun to build between the brood box and the front. The brood box was put well back from the front in the autumn, so they were in long chains building comb. These have plenty of room up on the top, but when the top was left off for an hour they soon found it too cold; they went off inside to work.

In these strong stocks of Italians there has not been one drone on the front, neither have I seen one inside under the glass; yet the blacks, a late migrant swarm in a small box, we saw them in the front two weeks since. These Italians are immensely strong; when the racks were put on we had to clear off a good bit of comb between the strips on the top of bars. Though but little smoke was used, they poured out of the front, covering it all, yet they did not show any fighting instincts; all were back within 15 minutes. These should give me a good many dozen sections in May; they are in large brood boxes—the racks do not cover it all; we have to lay a piece of covering on one side. There is one hybrid lot which has by far the greater number of workers still taking in pollen, yet honey is being stored; quite a lot was cleared off this one to-day, delicious-tasting honey from willows and gooseberries.

The apples are now opening. Some few varieties have been out a week, but the greater part of them do not seem to be in a hurry to open—well, they were not open during the two days' gale.

Plums look to be a heavy set, Jargonelle pears are hanging well, and the Louis Bon of Jersey is showing colour, though the fruit is very small. The pollination of these pears was almost wholly by bees; but the plums, I should say, were partly wind-pollinated, as there were not so many bees on them at any time as there were on the pears. Large trees of laurés, which had thousands of bees on them, seem not to have any fruit set at all; they must have suffered with frosts.

I am pleased to see many of the bees on the late flowers of violets, because it

is the late flowers that come very small in April and May that seem to give us the seed. Am hoping that bees will cross some of our large ones, so that we may get new varieties. Our native varieties, like all the species of violets that grow over all the temperate parts of the world, all seed freely, but the very large flowering ones but rarely, and when we sow them they come the same as the parent flower. The new large one that is going strong towards buying this farm was crossed by ants going from flower to flower, taking the pollen with them; but why bees should just now go to them so much more than they did a month ago puzzles me somewhat. The deduction I make is that the warmth is adding to the scent of each flower. The wild borage is open in the hedgerow close to them, but not a bee has been seen on it yet; the flowers as they mature must increase the scent of honey.

Going back to the violet, if any of your readers should have Hall's "Plant Life," it gives a very fine par. on the fertilisation of violets. The honey is to be found on two of the stamens; he writes that "the lower petal constitutes an alighting platform, prolonged into a spur in which honey is secreted, with fine lines, or honey guides, pointing to the refectory. The visiting bee touches first the stigma, pushing it upwards; its head is dusted with pollen by the stamens. When it visits another flower the pollen on the insect's head is brushed on to the stigma, and cross fertilisation is complete."

In this same work (which has not a very alluring title, but is nevertheless an interesting work) it distinctly states, on page 309 in the 1912 edition, that "the common willow (*Salix Caprea*) has sticky pollen, and is much sought by bees on that account, but there is the additional attraction of honey secreted by small scales at the base of each flower." One can see why the male flowers of willows are so alluring to bees. I notice that other willows are now in flower, but have not been near them in fine weather, so cannot state of what value it is to our hives. Any bee-keepers who are Fellows of the R.H.S. will be able to get this delightful book from their extensive library ("Plant Life," by Chas. A. Hall), and probably from the large municipal libraries.

If memory does not fail me, I think it has been stated in B.B.J. that nectar comes from the female flower, and pollen from the male; but that nectar and pollen are both to be found in the male flowers of the common willow is a new feature, proving "not half has ever yet been told," and we bee-keepers should still "drink deep."

As an English writer puts it:

"A little learning is a dangerous thing,  
Drink deep, or touch not the Pierian  
spring."  
J. J. KETTLE.

## Jottings from Huntingdonshire

The shallow frames placed on one of my stocks a week or two back were this morning covered with bees anxious to use the bright spell after many showers for storing purposes. Mr. Kettle is quite right when he says bee-keepers to be successful must take risks. I took a double risk last autumn (may Mr. Bryden forgive me), and left two nuclei to winter out of doors, and they have come through and now are working with the best. Had the winter been long and severe it is possible a different tale would have to be told. My greatest difficulty was preventing robbing, but by contracting the entrance to one bee space each nucleus was able generally to hold its own. Now this risk of early supering—why run the risk? I happen to be one of those who believe that bees are able to sense the weather weeks, even months, ahead, even more cleverly than birds, which is saying much. When, last autumn, I wrote in my "Jottings" that the bees were prognosticating an early spring I had some correspondence from various ladies and gentlemen asking how I was able to read the intelligence of the bees in this manner. I have since explained something of this nature in my "Jottings for Juvenile Readers." The point is, the honey flies were right, and now let me say that our insect friends are anticipating a check in the honey flow, possibly in May or June, and they are about to make desperate efforts to be prepared. So my advice to everybody is to super every stock which is strong in numbers without delay—of course, I except those stocks which may be in exposed and cold positions. My nuclei I am still feeding, and shall continue to do so until April is out.

The other day I took a goat to the station—it was going to a bee-keeper down South Wales way. I did not know goats were such objects of interest. Men stopped work in the fields to stare, other men busy hedging gazed at the inoffensive creature as if she were a rare animal from the Zoo. Meeting a caravan. The man sitting in the front entrance driving turned his head, and said something to the occupants within, and in a moment six swarthy children appeared, the mother holding the youngest up to have a good view of the animal. Passing by a village school—it was playtime—the youngsters ceased their games to race alongside us, so as to see as much of Nanny as possible. Arrived at the station, a train came in, and every window appeared to have a face against it, all gazing at the goat. Perhaps it was the fact that Nanny was all white that aroused so much wonderment. All

this, however, was nothing compared with my return journey. I was expecting a few hives from my kinsman of Runcorn, and hoped they might be at the station, so that I might be saved a journey. They were there in various portions. Although every care had been taken in cording them securely together, they were badly knocked about, one roof being completely smashed. I do not know why it should be so, but it is a fact that things are handled less carefully by railway companies than ever. Higher wages do not always mean better work. However, I got them loaded up and started on my return journey. I was stopped before I had gone a mile. "D'you mind telling me what you're going to do with them hives, master?" asked a happy-faced farm hand. On my replying that I was hoping to have them filled with bees some day, he looked puzzled, and then said: "No bees about, master; I count you won't get them filled yet awhile." "Why not?" I asked. "'Aint you never heard of the 'Isle of Wight' disease?" said he. I smiled, and told him that I had an impression that there was such a disease. My facetiousness was lost, for I had to listen to a long story of Thomas this, and David that, and Henry somebody else, who lost all their stocks. I proceeded on my way; stopped again. "You got bee-hives in your trap, mister," said a very wise-looking youth. I surveyed my load, and sarcastically said: "Ah, so I have." "Well, I wouldn't give a shilling for the lot; bar frame hives, ugh! the man who invented them ought to be shot if he's still alive. I had a dozen once, full of bees, and they all died: wish now I'd followed my father's advice, and stuck to the old skep. I reckon there'd be no disease among bees if all hives were burnt," and so he rattled on. He was young, but as pigheaded as any I've met for some time. My arguments in favour of bar frames were all lost, I fear. I drove on, and was getting along quite nicely when a boy called me, and said: "Please farver wants yer." Father came up, and breathlessly said: "Got a stock to sell, sir?" "Sorry," I said, "but all my spare stocks and swarms were booked up long ago." He looked anxious, and then went on: "I wish you could manage me just one swarm; I've got a hive or two which I bought of a neighbour, and want to make another start." I asked him about those hives, and soon learnt his neighbour's bees died from "I.O.W." disease; but when I suggested the hives should be scorched over with a painter's blow lamp, and old frames, etc., burnt, he boastfully said he wasn't going to that trouble with them. "Then," said I, "I shall not let

you have one of my swarms." He thought me hard, and I'm sure he anxiously wishes to restart keeping bees. How is it people so keen will not go to any trouble to keep disease down?

My next interrogator was a small tradesman, who asked if bees paid; was it worth while bothering with them. I frankly told him if he used the word "bother" he'd be well advised to leave bees alone.

The climax came when I was taken for an inspector, who had gone and destroyed an apiary and was carting off the hives, presumably for a bonfire. It is evident we have much prejudice to live down. I'll close my jottings with a conundrum: "What bird do bees dislike most?" This, by the way, is not, in strict English, a conundrum; shall we call it a riddle? No, it's just a query.—E. F. HEMMING, Steeple Gidding.

---

## To Talk of Many Things.

An article by Mr. F. M. Claridge recently appeared in these columns, which should be productive of much useful discussion, and, let us hope, lead to effective action on behalf of British commercial honey producers.

Many points of pressing importance are touched upon therein, and I would like to call further attention to some of them.

At present the marketing, like the producing, of home-gathered honey is unsystematic and unsatisfactory. There are individuals, it is true, who put up both extracted and comb honey well-graded and pleasing in appearance, but these are exceptions rather than the rule, and even were it otherwise the need for standardisation would still persist.

A definite classification of British honeys of varying origin would not only be more satisfactory commercially, but would be educative in permitting more exact comparison with the honeys imported.

In honey, as in athletics, our best can hold its own and have a bit in hand against the best that can be brought from elsewhere, but here again the analogy holds good—only the best must be pitted against the best, and under the best conditions.

Personally, I would exclude nothing that came honestly and in its true colours, but it is necessary, in the interest of fair play, that the consumer should know, within a little, what he is getting for his money.

Diseases in bees are not the only thing for which legislation is needed in the interests of bee-keepers. Mr. Claridge

rightly singles out for mention the question of weight. His contention that the nett should be clearly marked on each package, together with the name of the country of origin, surely marks the minimum that honesty would dictate.

Some of our colonies, notably New Zealand, market a good article in a businesslike way, and I am confident that none of these would raise any objection to the imposition of the above requirements.

One highly desirable effect of such a measure would be to eliminate the indescribable mixture which many dairies and multiple shops foist on the public as English honey, while, as a fact, it is a vile mas of lowest-grade honey, with larval and membral *débris*, the whole of sickening odour, in receptacles of unknown weight.

Where I have to part company from Mr. Claridge is the point at which he proposes the formation of a new *ad hoc* association. In my opinion, there already exist means to hand quite ready and adaptable to his main purpose. Either the B.B.K.A. or the Apis Club could handle the matter; the former acting through and in conjunction with County Associations, the latter through local committees.

I would earnestly suggest that the two bodies mentioned be approached and the result of this step published before any other move be made.

Favourable consideration would, I am already assured, be accorded in at least one of these quarters, and any help I may be allowed to give will be most willingly directed to securing the necessary financial backing and to perfecting the organisation of a widely ramifying scheme.—A. F. HARWOOD.

## A Beginner's Difficulties with "Isle of Wight" Disease.

So much good ink and paper have been expended, to so little purpose, on the subject of "Isle of Wight" disease that I feel very chary about adding to the heap. However, as a comparatively newcomer to the craft, and a voracious reader of all available literature on bees, I cannot but observe the contradictory nature of the evidence given on practically every point that might have any bearing on the subject; while matter is frequently introduced which serves no purpose but to confuse the issue and rake up old questions which have already been thrashed out.

The first question which confronts the beginner in the craft is that of selection of a strain most likely to resist disease,

and much evidence is to be found which shows that, as a rule, Italians are less liable to infection than is the native variety. In fact, few cases of loss of stock through "Isle of Wight" disease appear to have been reported where the owner could vouch that bees and queen were of pure Italian strain. Nevertheless, much so-called evidence is still published which appears to prove that natives are preferable.

To take three of the favourite arguments as examples: How often do we see some variation of the following in the correspondence columns of the daily papers?

"We hear a lot nowadays about the ravages of the 'Isle of Wight' disease among the native bees of this country and the superiority of foreign bees in resisting it. If these statements are true, how can the fact be explained that an old tree in our back garden has had a nest of bees in it ever since my great-grandmother was a girl, and they are still going strong? There were no foreign bees in this country then, and . . .," and so on to the limit of words allowed.

Or—

"We seem nowadays to prefer anything foreign to the home-grown article which has served us so well for so many years. A few years ago the 'Isle of Wight' disease was unknown in this country, but a number of bee-keepers commenced to introduce foreign bees, and very soon after we heard of the awful disease spreading all over England. Now these same bee-keepers would have us believe that the disease originated with the natives, and that the foreign bees are more able to resist it, when it is clearly the foreign bees who brought it to England in the first place. How is it that, in an old tree . . ." etc., etc.

Or again—

"Having heard that Italian bees were more immune from 'Isle of Wight' disease than were natives, I bought two stocks of them last year. I paid more for these than I should have had to pay for natives, but the money was wasted just the same, as not a single bee survived the winter. This 'Isle of Wight' disease is an awful thing, and I do not believe that any kind is immune," etc., etc.

If these reports are carefully gone into, much information can be gained, and a full investigation quite frequently proves that the original conclusions drawn were erroneous.

Take the yarn about the old tree. Further inquiries will generally elucidate the fact that the bees have had several periods of inaction, and have several times appeared to be dying off, but they have always recovered, and a few months later

been as strong as ever again. As it is well known that a swarm of bees is very prone to take possession of an old nest, especially if the previous occupants left any honey behind, the remarkable recovery of the bees in the old tree is easily explained. Proof that the present occupants are not the descendants of those who lived in the old tree when great-grandmother was a girl is frequently obtainable from an examination of one of them, as many such bees have been found to be full-blooded Italians, which have only been introduced to this country within the last few years.

The second letter requires no further inquiries to render its conclusions invalid. Previous to the outbreak of "Isle of Wight" disease very few foreign bees appear to have been imported, and stocks in this country were so rare as to render it extremely improbable that they were responsible for the trouble. Moreover, the introduction of foreign bees into America, where the natives are of the same strain as ours, although on a much larger scale, has not been followed by a similar outbreak.

Large numbers were only imported into this country when bee-keepers had satisfied themselves that they were less liable to the disease than the native variety, and it appears to have been established beyond question that Italian bees, when the strain has been kept pure without inbreeding, are more nearly immune.

Assuming, however, for the moment that the statement that Italian bees are responsible for the starting of the disease in this country, the fact that they are more liable to loss by the disease does not then follow. Consideration of the effect of various diseases on human beings is sufficient to prove this. One of the most deadly infectious diseases to which our prisoners of war in Germany were subject was typhus. The Russian soldiers, who originally infected our men, were practically unaffected by it, coming, as they did, from a country where it was common, but our men, to whom the disease was new, contracted it with fatal ease, very few of those affected recovering. In the same way, measles, which, in this country, is a trivial disease, when contracted for the first time by natives of Africa, resulted in the loss of thousands of lives, the percentage of deaths being greater than in the case of similar outbreaks of small-pox. If this is the case with men, why should it not be so with bees? Clearly, the question of responsibility for the outbreak has nothing to do with that of immunity.

Very often, questioning the writers of such letters as the third will establish the fact that his bees died as a result of mis-

management, and that none of the symptoms of "Isle of Wight" disease were observed.

In the same way, letters and articles appear from time to time endeavouring to disprove facts which have been established beforehand, and knowledge of which would greatly assist bee-keepers in preventing infection from the disease. Only a week or so ago a statement appeared in the BEE JOURNAL to the effect that "Isle of Wight" disease is not always spread by infection, as the writer knew of a stock which was wiped out by the disease when there were no other diseased bees within reach to infect them.

When the writer of that statement furnishes a certificate to the effect that he examined every hive of bees and every old roof, hollow tree, crevice in a wall or other place which might afford shelter to a stock of bees, within a radius of four miles of the stock in question, at the time when the stock was first observed to be infected, and that he found no trace of diseased bees, then, and not until then, can his statement be accepted as evidence. Even if the statement were so corroborated, the stock may have been infected by bees who, although themselves unaffected, carried the germs with them, just as carriers of dysentery and other human diseases have been discovered by our medical men.

Many more examples of erroneous conclusions could be brought forward, but sufficient has been said to prove that hasty conclusions are too frequently drawn, and that much information likely to mislead poor beginners, like myself, is extant. In short, my appeal to all bee-keepers is that they shall not confuse the issue by making statements which they cannot prove. Let them, by all means, publish any information which they may have discovered, but give all the facts, and not just those which suit their preconceived ideas. Then they will be able to make their conclusions fit the facts, and not the facts fit the conclusions. Let them remember the old saying, which quite possibly applies to the writer of this letter, "Fools will rush in," etc.—E. C. HIPKINS, B.Sc., Birmingham.

---

### Sussex Bee-Keepers' Association.

Members of the Sussex Bee-keepers' Association visited Haywards Heath on Wednesday afternoon for their annual meeting, the gathering taking place in the Church Lads' Brigade Hall (by kind permission of the Rev. E. Cresswell, Gee). Mr. G. Hilton, J.P., occupied the chair, supported by Mr. W. T. Cowell, Mr. H.

W. Anderson, Mr. B. J. Burtenshaw, Mr. F. Kenward (hon. secretary and expert) and an attendance of about fifty members.

The Chairman extended to all present a hearty welcome to Haywards Heath. He was glad they had come there for their annual meeting, and hoped that at some future time they would visit the town again. It was fifty years since he had taken any interest in bees, and then he remembered his mother kept them and extracted honey in the old-fashioned way. Since that time vast improvements had taken place in regard to the industry, and it had become very profitable from a commercial point of view. The little bees that worked so hard during the summer-time to provide them with so much of that useful commodity—honey—might be taken by them as an example to-day. If all people worked as industriously as the bees, conditions would be brighter than they are. (Applause.)

The balance sheet showed expenditure totalling £63 7s. 1d. Subscriptions for 1919 amounted to £64 15s. 6d., and there remained a balance in favour of the Association of £20 12s. 10d.

On the proposition of the Chairman, seconded by Mr. Cowell, the report and balance sheet were adopted. The last-named referred to the increased membership, and said the object of holding their annual meetings in different parts of the county was with a view to promoting the culture of bees. It was hoped to embrace the whole of the bee-keepers in Sussex in the Association. The increased membership during the past year was mainly due to the interest displayed by their Hon. Secretary, and it was to be hoped that the present year would see a repetition of that success. The people of Sussex should recognise the value of bee-keeping, and as a first step should join the Association.

Mr. W. Herrod-Hempsall, F.E.S., moved a vote of thanks to the retiring officers. The life of the Association depended on the Hon. Secretary, and they in Sussex were fortunate in having Mr. F. Kenward. (Applause.)

The election of officers was the next business. His Grace the Duke of Devonshire was elected President. The retiring Vice-Presidents were re-elected, with the addition of the Right Hon. Austen Chamberlain, M.P., and Mr. G. Randall Davidson. The old Committee was re-appointed, with the exception of the Rev. A. C. Atkins, of Haywards Heath, who had left the county. Miss D. Sillar, of Buxted, was elected representative to the British Bee-keepers Association. Mr. F. Kenward was re-elected hon. secretary and expert, and Mr. W. Hill Hunter, A.C.A., hon. auditor.

In accordance with notice a discussion was held as to the advisability of raising the annual subscription or discontinuing the monthly journal.

Mr. Cowell, who explained the necessity for one of these steps, said some time ago the Committee unanimously decided to advance the expert's fee for visiting apiaries from 2s. 6d. to 4s. a member, owing to increased railway fares, etc. This necessitated extra funds, or they would have a deficit of £14 at the end of the year. The proposals, therefore, were that they should either raise members' subscriptions from 6s. to 7s. 6d., or discontinue the monthly journal, which cost them £27 last year. He spoke purely from a personal point of view, and not as from the Committee. His own idea was that the journal should be discontinued, as if they raised the subscription their membership might be adversely affected at a time when they wished to increase it. At present the journal was sent out free to members, but if this was discontinued they would still be able to obtain it from newsagents at twopence per month. He moved a resolution to this effect.

Mr. W. L. Watton seconded.

Mr. C. T. Overton moved an amendment that the subscription be raised to 7s. 6d.

Mr. Anderson seconded.

A further amendment that the subscription be raised to 7s. was moved by Mr. W. H. Killick and seconded by the Rev. J. L. Brack, and after an interesting discussion, in which, besides those already mentioned, Mr. G. Randall Davidson, Mr. J. C. Peache, Mr. J. H. Lee, and Mr. F. Kenward joined, Mr. Cowell's proposition and Mr. Killick's amendment were withdrawn, and Mr. Overton's amendment was put as a substantive motion and carried.

It was pointed out that cottagers' subscriptions, which were raised last year, would remain at 4s. 6d.

A hearty vote of thanks to the Chairman for presiding was initiated by Mr. Cowell and seconded by Mr. Burtenshaw.—*Communicated.*

## Warwickshire Bee-keepers' Association.

### ANNUAL MEETING.

The 40th annual meeting of this Association was held at 13, Bennett's Hill, Birmingham, on Thursday, April 15, Mr. A. H. Foster presiding.

The report stated that the season had been a very good one, notwithstanding the prevalence of "Isle of Wight" disease, and that large quantities of honey had been secured by bee-keepers generally, as was evidenced by the fine display



of exhibits at the Leamington Show held in September.

With regard to the financial statement, the income from all sources amounted to £63 7s. 10d., and the expenditure to £95 14s. 7d., leaving an adverse balance on the year's working of £32 6s. 9d., which is attributable to the heavy expenses in connection with the Show.

The officers and committee were duly elected for the ensuing year, with the Earl of Craven as president.

At the close of the business of the meeting a discussion took place on general bee-keeping matters, in which much interest was taken.—(Communicated.)

### Sheffield and District Bee-Keepers' Association.

There was a pleasant gathering of the members of this Association last Tuesday evening when a capital musical programme was arranged by one of the members, Mr. Percy Lawson. The meeting was primarily for the presentation of a microscope to the hon. secretary, Mr. H. W. Garwell, who has been secretary since 1913. The gift was made by the President, Mr. W. T. Garnett, and was from the members as a mark of appreciation for services rendered and Mr. Garwell's unflinching kindness and assistance during a number of years. In his reply, the Hon. Secretary spoke of the thriving state of the Association, and showed how for the future there were very bright prospects.—C. M. H.

### Beverley and District Bee-Keepers' Association.

The second annual meeting of this Association was held in Beverley on April 15 under the presidency of Mr. W. J. Algar, of Lockington. The President, Secretary, Treasurer and committee were re-elected, with the addition of another member, Mr. J. E. Saunders, Willerby, to the committee to represent the southern part of the district. The other members of the committee are:—Mrs. G. Scott, Brandesburton, Mr. A. Gray, Cherry Burton, and Messrs. T. Richardson, H. Chapman and J. H. Walgate, Beverley.

It was decided to ask those members who possess bees to work them for increase more than usual this year, and supply swarms and nuclei at moderate prices to those members who have lost all through disease. The membership is now 53.—T. T. TAYLOR, hon. sec., 137, Keldgate, Beverley.



### "Isle of Wight" Disease: One of Its Causes.

[10172] I would like to draw attention to the interesting article in the B.B.J. for January 22 on "Isle of Wight" disease, by Mr. Edwards. The theory that overwork is primarily responsible for "Isle of Wight" disease has frequently been advanced in the B.B.J. and elsewhere, and while a few here and there may be adherents, what we might call the official element has either neglected to comment or has ridiculed the suggestion. So far as I know, the solitary exception was "The Western Honey Bee." Perhaps it will be remembered (and perhaps it will not) that during last summer Mr. Stich, of Paisley wrote to the JOURNAL on this subject, and among much interesting matter he advocated the trial of an experiment, namely, the forcing of a colony, and assured us that before we had finished "Isle of Wight" disease would develop. Now we get the report of just such an experiment with a ten-frame stock from Mr. Edwards. After filling up the brood chamber, the queen was lifted into a new chamber above, and when that was full into a third. It was unnecessary to go further. "Isle of Wight" disease developed and practically destroyed them.

What, then, are we to learn from the foregoing? Mr. Edwards comes to the conclusion that the usual text-book methods of securing a populous colony are utterly opposed to Nature's laws, and so far I am in hearty agreement with him; but when he goes on to speak of the gases generated from the larvæ I am not in a position to express an opinion.

It appears to me that a much simpler explanation is available. If we consider for a moment the laying of an overworked queen, it is not difficult to imagine the large number of eggs passing through her body during the twenty-four hours have not had sufficient time to be truly formed or gather the necessary constituents, the result being the germ of life lacks vitality. In a large, populous colony this might well be the only source of error; but how can one account for overwork in a small hive or nucleus?

The bad effects of overwork can and do occur just as easily in the smallest hive in which bees will stay. It is brought about in these cases by overwork of the workers, transmitted by them to the queen and larvæ. A hive with little or no honey

in it is a direct incentive to overwork, without further aid; but when the bee-keeper, true to his English text-book teaching, commences slow feeding, and spreading the brood, the bees are thrown into the wildest excitement, eagerly developing a brood-nest out of proportion to the number of mature bees. In their endeavour to supply the too large amount of food to larvæ and queen, the bees are rapidly worked to death, and it is only reasonable to suppose the food prepared is not up to the standard quality, perhaps badly digested, or not of the correct ingredients—or even not enough of it—finally resulting in a mature bee without strength to withstand disease.

Whether the above explanation is correct or not is only of secondary importance; the really vital point is that overwork on text-book lines does result in "Isle of Wight" disease, and this Mr. Edwards's experiment almost conclusively proves. He deserves the heartiest congratulations of us all, and has certainly made a step in the right direction. Let us hope his final article will have no accident to delay it.—THOS. F. COBB.

### Bees on the Seashore.

[10173] Am sending you an account of a lot of bees I took on the 12th of January. They were right on the shore. A box had been washed in by the tide and left upside down in the hedge right on the ground, which was very wet. The bees had an entrance where a part of the end was broken away; they had evidently been there all the summer, as they are very strong, and heavy with stores. The box was very wet, and the bottom boards only one eighth of an inch thick. At spring tides the sea was only five feet away. They appear to be natives.—S. MARFLEET, Freshwater, Isle of Wight.

## Notices to Correspondents

MRS. M. L. CHAMEN (Essex).—*Price of swarms.*—A fair price for early swarms is about 7s. to 7s. 6d. per lb.

MISS E. TILT (Essex).—*Using observatory hive.*—A two-frame observatory hive is of no practical use, and an attempt to use it would only end in disappointment. Better wait until you can get a 20-frame hive. Watch our advertisement columns for a second-hand hive at a reasonable price.

M. CONNELL (Islington).—The bee you sent is quite common in the country. It is one of the humble bees, *Bombus Terrestris*.

#### Honey Samples.

T. P. (Ipswich).—The honey is foreign, or at the best a mixture of foreign and English. The reason it does not granulate is that it has been heated.

H. BRIGHT (Hants).—The honey is foreign, and is not clover honey.

## Bee Shows to Come.

A nominal charge of 2s. 6d. is made for notices (not exceeding 7 lines) in this column, 10 lines charged 3s. 6d., up to 15 lines 5s., which covers cost of insertion from order till date of show. Cash should accompany orders for insertion.

**June 16 and 17.**—Hanley Park Meeting of the Staffordshire Agricultural Society. The Staffordshire B.K.A. offer valuable prizes and six silver medals and nine bronze medals. Twelve Classes for members only, and five Open Classes. (Honey Classes are for four or three jars or sections). Schedules, W. Griffiths Silkmore, Stafford.

**Entries close May 29.**

**June 29 to July 3, at Darlington.**—Royal Agricultural Society's Show, Bee and Honey Section, under the direction of the B.B.K.A. Prizes arranged in groups of counties for Associations affiliated to the B.B.K.A. Schedules from The Secretary, 23, Bedford Street, Strand, W.C.2.

**Entries close May 31.**

**July 6, 7 and 8, at Cardiff.**—Royal Horticultural Society's Show. The Glamorgan B.K.A., in conjunction with R.H.S., offer prizes for Honey, Wax, Bees, and Appliances. Members, Novices, and Open Classes. Schedules, Mr. Wiltshire, Mandy School, Cardiff. **Entries close June 22.**

## Special Prepaid Advertisements. One Penny per Word.

Trade advertisements of Bees, Honey, Queens, and Bee goods are not permissible at above rate, but will be inserted at 1½d. per word as "Business" Announcements, immediately under the Private Advertisements. Advertisements of Hive-manufacturers can only be inserted at a minimum charge of 3s. per lin., or 5s. per inch.

PRIVATE ADVERTISEMENTS are only intended for readers having Surplus Stock to dispose of. Driven Bees, Nuclei, and Queens that are reared or imported for sale, are Trade Advertisements, and can only be accepted under trade terms. A charge of 6d. extra will be made if a box number is used.

Advertisements must reach us NOT LATER than FIRST POST on TUESDAY MORNING for insertion in the "Journal" the same week.

### PRIVATE ADVERTISEMENTS.

**WANTED,** a Lecturer on Bees to accompany a Demonstration Train for seven weeks, commencing May 17. Sleeping accommodation and food found.—Applications, with salary required, to W. HERROD-HEMPSELL, W.B.C. Apiary, Old Bedford Road, Luton.

**SWARMS FOR SALE.**—A few healthy Hybrids, or would exchange for a Clumber Spaniel Bitch, not under six months old.—A. W. DENNY, High Street, Godstone, Surrey. d.94

**HEALTHY STOCK** of Italian Bees, £4 10s.—15, Kelvin Avenue, Bowes Park, London. d.95

**TWO** strong Stocks and Hives, £5 each; eight Section Racks, 2s. 6d. each; Hive, 15s.—THOMPSON, 14, Frederick Road, Cheam, Surrey. d.96

**FOR SALE,** three strong and healthy 10-frame Stocks (Italians) in good hives, with miscellaneous apparatus, including four section racks with sections, super, excluders, spare frames, sections, foundation, smoker, etc. (list sent); price £22 the lot. Purchaser must undertake removal. Can be seen by appointment any Monday, Wednesday, or Saturday. Giving up bee-keeping owing to want of time.—MRS. MCKERROW, Enderley, Great Missenden, Bucks. d.97

**SWARMS** for Sale, May and June, very healthy stocks, price 30s.—MRS. BARRY, Home Place, Limpsfield. r.4.98

**TWO W.B.C. HIVES**, no disease, fitted Claustal chamber, each with two 6-in. lifts, brood box with 10 standard frames, two shallow boxes with 8 frames, well painted, and roofs covered with zinc, 45s. each.—**MOSS**, 54, London Road, Hinckley. d.99

**FOR SALE**, four 5-frame Swarms British Bees, 57s. 6d. each; box 7s. 6d., returnable. Ready second week in May.—**S. COCKS**, Napton, Rugby. d.100

**FOR SALE**, 14 Straw Skeps, good condition, 35s. to clear, carriage paid.—**F. BROWN**, Hermitage, Newbury, Berks. d.101

**GIVING UP BEE-KEEPING**.—I am offering three Stocks of Bees, six Queens, six Queen Excluders, a quantity of drawn-out Shallow Combs, and all Appliances for bee-keeping.—**A. S. STORTON**, 105, Preston Road, Coppull, near Chorley, Lancs. d.102

**WANTED**, for four weeks from about end of August, Board and Residence for family of four at a farm near South or South-East Coast; bee-keeper and fruit grower preferred.—State terms to Box 81, B.B.J. Office, 23, Bedford Street, W.C.2. d.103

**FOR SALE**, Italian Hybrids on 6 frames, 1919 Queens, £4, carriage paid; early Swarms, 35s.—**LARMUTH**, Hillside, Monahan Avenue, Purley. d.104

**FOR SALE**, 4 cwt. of pure light English Honey, £2 per 28-lb. tin, or best offer to clear, carriage forward.—**WELLS**, Bowers Lane, Isleham, Cambs. d.105

**FOR SALE**, four W.B.C. Hives, with inner chambers, supers, and section racks, Cottage Ripener, Skep and sundries; £5 the lot.—**COWLEY**, Lechlade, Glos. d.106

**SALE**, good Stock healthy Bees, Italian Hybrids, 1919 Queen, on 10 frames in brand new hive, rack, drawn-out shallows, £5 5s.—**B. Balne Avenue**, Wakefield. d.107

**NEW HIVE and Outfit**, 10 frames, W.B.C. ends, super clearer, excluder, extra rack of sections, smoker, feeder, brood and super foundation, £3 10s., or offer.—**MacIVER**, Highfield, Helsby. d.108

**SHALLOW COMBS**, new, clean, perfect, sale or exchange; dozen Excluders 13s. 6d., paid.—Box 82, B.B.J. Office, 23, Bedford Street, W.C.2. d.109

**FOR SALE**, Apiary, consisting of eight Stocks of Bees in W.B.C. Hives, two Geared Extractors, two extra Hives, Nuclei Hives, Traveling Boxes and sundries. Owner going abroad.—25, Sutton Court Road, Chiswick, W.4. d.110

**STOCK of Bees on 6 frames for Sale**, 1919 Queen.—**C. PARKS**, Ivy Cottage, Whittton Road, Twickenham. d.111

**300 SHALLOW wired Combs for Sale**; no disease.—**CRAWFORD**, Apiaries, Castleberg, Co. Tyrone. r.d.112

**WHAT offer in Bees for B.B.J.**, 1901-7 inclusive? Well bound, unopened.—**SPENCER**, Sussex Road, Gorleston-on-Sea. d.113

**TWO W.B.C. HIVES**, each fitted inner brood chamber, two 6-in. lifts, with two racks shallow frames and wax foundations, metal queen excluder, and quilt, painted three coats, new April, 1919, 42s. each; one Holborn Hive, one 10-in. lift and section rack, painted three coats, new April, 1918, 22s. 6d.; two Rapid Tin Feeders, 1s. 6d. each; Copper Smoker, 4s.; W.B.C. Knife, 3s.; Porter Bee Escape on board (two escapes), 3s.; Rosamond Sprayer, 2s. 6d.; all as new.—**SPENCE**, Alexandra Road, Peterborough. d.114

**LARGE HONEY PRESS**, in new condition; will exchange for a healthy stock of bees.—**IBBOTSON**, Green Lane, Glusburn, near Kelfley, Yorks. d.115

**EXCEPTIONAL OFFER**.—Four W.B.C. Hives, standard size, heavy casing (one doubled); also five Nucleus Hives and sundries.—Full particulars from **A. G. NEWBY**, Spennithorne Road, Urmston, Manchester. d.128

**REMOVAL SALE**.—Six Stocks Italian Hybrids, Penna's strain, 8 and 10 frames, £3 10s. and £4 10s.—**HUNT**, Bordon, Hants. d.129

**WANTED**, from August 22 to September 4, in Cornwall or Devon, within 12 miles or so of sea, Bedroom and Sitting Room, with shed for motor car; farmhouse preferred. Can any bee-keeper oblige me?—**W. HERROD-HEMPSALL**, Old Bedford Road, Luton, Beds.

**FOR SALE**, two "Rotax Roadlight 267" self-contained Acetylene Motor Headlights, very powerful, £6 the pair; one Exhaust Whistle, 10s.; one Wood-Milne Motor Foot Pump, 40s.—**HERROD-HEMPSALL**, as above.

**WANT OFFER**.—Two joiner-made Hives, 3-in. boards, W.B.C. pattern; 19 Standard Frames with foundation; never been used.—**R. MORRIS**, 80, Church Road, St. Annes-on-Sea. d.160

**FOR SALE**, Geraniums, Scarlet Crampel, 6s.; summer flowering Chrysanthemums, 2s. 6d.; Tomato Plants, strong, 3s. per dozen; early sown Leeks, 5s.; Celery, 4s. per 100; 50 same rate; carriage paid.—**HALL**, Highfield Lodge, Balderton, Newark, Notts. r.d.61

**PURE Light Cambridge Honey**, 14-lb. tins, 22s. 6d.; 28-lb. tins, 42s., carriage paid; sample 4d.; tins free.—**J. YOUNGER**, 6, Maid's Causeway, Cambridge. r.d.66

**FOR SALE**, 12 strong Stocks Italian Bees, absolutely free of disease, mostly 1919 Queens, £5 each, on 10 standard frames (can have some hives if desired).—**THOS. G. WALKER**, Symonds Hyde, Hatfield, Herts. r.d.68

**PLANT "Willow-Herb"**, splendid honey flower, 12 2s.—**BOWEN**, Coronation Road, Cheltenham. d.69

**GOOD Glazier's Diamond**, perfect, 8s. 9d.—**HUBBARDE**, North Kilworth, Rugby. d.70

**FOR SALE**, Swarms, English strain. Book now for May and June.—**BRISTOW**, 47, Auckland Hill, West Norwood, Surrey. r.d.74

**FOR SALE**, May and June Swarms, £2.—**R. KNOWLES**, Thursley, Godalming. r.d.75

**ITALIAN**.—Healthy early Swarms, price 35s.—Apply, **MRS. A. M. WADMAN**, Sompting, Worthing. d.78

**FOR SALE**.—Can offer one or two selected Hybrid Stocks, 1919 Queens, 70s.—**BALE**, 1, Hodford Road, Golder's Green, N.W. r.d.42

**12 GUARANTEED** healthy Hybrid Italian Stocks, Penna strain, £5 each.—**J. YOUNGER**, 6, Maid's Causeway, Cambridge. r.c.44

**WANTED**, portable Greenhouse.—Price and particulars to **W. HERROD-HEMPSALL**, Old Bedford Road, Luton, Beds.

**WANTED**, Auster Rear Wind Screen for motor car.—**HERROD-HEMPSALL**, as above.

**BUSINESS ADVERTISEMENTS.**  
1½d. per word.

**HOW TO KEEP YOUR BEES HEALTHY!** Valuable advice, 5s.—**ALFRED RYALL**, Kenwood Apiary, Elcombe, near Stroud. d.116

**ALBERT HOPKINS**, Specialist Breeder and Importer Italian Bees; 23 years' practical apicultural experience. Guaranteed strong, healthy Stocks and Nuclei. Prices strictly moderate. List on application.—Woodland Valley Apiary Lyvinge, Folkestone. r.d.117

**NUCLEI**, 3-frame, Penna's 1920 Queen, 55.; best Hybrids, 45s.; carriage paid; early delivery; Penna's Queen, 14s. Cash with order.—**MOORE**, 31, Monmouth Road, Dorchester. r.d.118

**PURE Carniolan Queens**, imported. May delivery all booked up.—**B. WOODLEY**, Thorne, near Doncaster. d.119

**FOR SALE**, May and June Swarms.—**DEAR**, Funtington, Chichester, Sussex. d.120

**BEEES** from reliable disease-resisting strain; 3- and 4-frame Nuclei and Swarms, also Queens, for early delivery.—**CANDY**, Worth Park Apiary, Crawley, Sussex. r.d.121

**BEEES ON APPROVAL**.—We guarantee our Bees and Queens to give complete satisfaction. Special terms to disabled men. Supply nearly exhausted, so order now. Catalogue 3d., which is refunded on first order.—**PEARSON & GALE**, Marlborough. d.122

**3-FRAME NUCLEI**, 45s.; 4-frame, 55s.; Penna Italian 1920 Queens; May-June delivery; boxes 10s., returnable; warranted perfectly healthy. "W.B.C." Hives and Apiary Supplies for Sale.—**C. HOGAN**, Boxford, Suffolk. d.124

**"CAST NO CLOUT TILL MAY IS OUT!"**—But that is no reason for postponing the purchase of a good Bee Stock. We offer from well-known Combs. Apiaries: 200 Black Bee Stocks on 3 frames, 100 Hybrid Bee Stocks on 3 frames, 10 Italian Bee Stocks on 3 frames. All for delivery in the month of May. Terms on application.—**S. H. SMITH**, 30, Maid's Causeway, Cambridge. d.125

**PUPILS** received by life-long whole-time Bee Farmer.—Terms on application to **C. B. BARTLETT**, Sandford, Mount Charlbury, Oxon. d.127

**DUTCH AND DUTCH-ITALIAN 4-FRAME NUCLEI**, May-June delivery, orders in rotation, £3 3s.; cash with order; carriage paid. See B.B.J., February 26, page 99, Conference of British Bee-keepers re Legislation. Read what the greatest experts say: Dutch-Italian Hybrids had been tried. The result was they were quite convinced they stand up against disease better than pure races. They hoped in a few years that a number of these little strangers will be within our gates. Also, it was worth while putting one's money on this strain—Dutch-Italian Hybrids.—**SEALE**, Ashley Cottage, Oatlands Drive, Walton-on-Thames, Surrey. r.d.81

**ITALIAN HYBRIDS**.—Limited number 3-frame Nuclei, 1919 Queens, May-June delivery, packing and carriage paid, 50s.—**HUTCHINGS**, Stopsley, Beds. d.82

**WE ARE NOT** a restocking scheme, but we supply the bees. No Government queens used. Send 3d. for Catalogue (money refunded on first order), and see what our satisfied customers say.—**PEARSON & GALE**, Marlborough. d.93

**INVICTA KENT BEES**.—Nuclei for Sale. Write for particulars, then, if satisfied, send 2s. 6d. deposit with order, balance June 1.—**EDWARD GRISTWOOD**, Cheriton, Folkestone. Same address 17 years. r.d.85

**MISSES PALING AND PILLANS** having combined and enlarged their Apiaries, are now prepared to book orders for strong 3-frame Italian Nuclei, massed with brood and bees, headed with 1920 Penna Queens or 1920 Queens of their own rearing from best selected Italian strains, £3, carriage paid. Speciality made in rearing choice Italian fertile Queens, 12s.; Virgins, 6s. Reduction on quantities. Pupils taken.—**Golden Square, Henfield, Sussex.** r.d.84

**PURE GOLDEN ITALIANS** combine all qualities desirable. Nuclei and Queens are being booked rapidly. Particulars stamp.—**COOMBER**, 64, Ronald Park Avenue, Westcliff, Essex. d.87

**3-FRAME ITALIAN NUCLEI**, frames crowded with sealed brood, 1920 Queen, no disease, £3 3s.; box 10s., returnable; carriage paid; cash with order. Initial cost slightly more than for some nuclei, but worth it. Satisfaction guaranteed or money returned. Full particulars free.—**E. H. TUNMER**, "Chalfonts," Leiston, Suffolk. r.d.85

**HAVE YOU WINTERED 100 PER CENT?** If not, your strain must be wrong. Booking orders now for delivery June onwards. Hardy disease-resisting, home-reared Italians; splendid honey gatherers. Three-frame Nuclei, 1920 Queen, price £3 3s., carriage paid; 7s. 6d. refunded on box if returned carriage paid Saxilby Station. Terms: Cash with order. I will refund 10s. on all orders not despatched before July 1.—**HERBERT VALLEY**, Apiarist, Saxilby, Lincoln. r.d.92

**HAVE YOU READ "THE BEE WORLD"?** If not, why not? Every number in itself is a useful literary work for practice and reference. Specimen copy free.—Offices: **THE APIS CLUB**, Port Hill House, Benson, Oxon.

**QUANTITY** of drawn-out Shallow Combs, excellent condition, 1s. 6d. each.—**E. H. TAYLOR**, Welwyn, Herts. r.d.23

**ORDERS** booked for 3-frame Nuclei, Fertile Queens, Virgin Queens, etc. List for stamped, addressed envelope.—**H. CRACKNELL**, Mount Road, Thundersley, Essex. r.d.27

**BOZZALLA** tested Queens are sold at the price usually charged for untested queens.—Catalogue from **H. STICH**, Riccartbar Avenue, Paisley. r.c.116

**ITALIANS**.—Queens, 5s. Book now. Stamp.—**HOUSTON**, Ellen Villa, Sidcup. r.d.90

**PENNA** strain Italian Queens, from June 7.—**ASHWORTH**, The Bungalow, Weymouth Street, Warminster. r.c.52

**WATERPROOF RUBBER SHEETS** for covering onhouses, etc., 72in. by 36in., brass eyelets, 12 for 20s.—**SAGARS STORES**, Ardwick, Manchester. r.b.16

**DUTCH BEES**, Skeps (as imported from Hans Matthes), Nuclei, Queens. Illustrated Catalogue on request, containing points on management.—Buy direct from Sole Agent, **WHYTE**, Bee Farmer, Cumbernauld, Dumbartonshire. b.61

**NEW-ENGLAND-BRED ITALIAN QUEENS**.—Untested laying Queens, ready June 1, 10s., delivery guaranteed; 6s. at purchaser's risk. English money accepted by registered mail.—**ALLEN LATHAM**, Norwichtown, Conn., U.S.

## Italian Stocks.

**OUR** 10-bar Italian Stocks are now ready for delivery. Free from disease. Cash with order. Carriage paid.—**D. ALLBON & CO.**, Sunnyside, Hitchin. d.123

### BEE FLOWER SEEDS.

Collection of six best Varieties, 1s., post free.

Beautifully Illustrated, Instructive, Up-to-date Garden Guide, 64 pages, Free.

### KNIGHT'S.

Seed Specialists, WOLVERHAMPTON.

### HIVES AND ALL YOUR REQUIREMENTS.

Quality A. Quick delivery.

Write for prices to—

**L. ANDREWS & CO.**,  
Joinery and Carving Works,  
78a, WESTGATE, PETERBOROUGH.

d.126

**BOWENS**  
**BEES and**  
**EE GOOD**

**EARLY ORDERS MEAN**  
**EARLY DELIVERIES.**  
Lt. A. H. BOWEN, Coronation Rd., Cheltenham.

*Artistic  
Booklet  
Free ::*



**“BACTEROL”**  
**FOR BEES**

2/6 per Bottle.

Post Free.

The cure for, and preventive of,  
“Isle of Wight” Disease.  
Non-poisonous—free from stain  
or unpleasant odour.

**MENLEY & JAMES, LTD.,**  
39, Farringdon Road, London, E.C.1.

**INSTRUCTION in BEEKEEPING**  
**PRACTICAL AND THEORETICAL**

My Apiary will be open for a limited number of pupils  
during this season. Terms and particulars from

**W. HERROD-HEMPSALL,**  
The W.B.C. Apiary, Old Bedford Road, Luton, Bedfordshire.

**THE SERVICE COMPANY, LTD.,**  
289/293, HIGH HOLBORN, LONDON, W.C.

Phone: HOLBORN 6430.

Telegrams: “ADMITTEDLY,” LONDON

**CALL WRITE or 'PHONE**  
*for*

**BEST BRITISH AND AMERICAN MADE**  
**BEE HIVES AND APPLIANCES**

We carry extensive Stocks for immediate use.

The **Latest** and **Best** at the **LOWEST POSSIBLE PRICES.**

**WE SAVE YOU TIME, TROUBLE AND EXPENSE.**

**S. J. BALDWIN.**

I beg to inform that the No. 1 Kent Hive is not manufactured  
by me, only the No. 2 “Bromley Kent.”

(New deep frame 17 x 14 x 12. Sample by post 6d.)

**THE APIARY, BROMLEY, KENT.**

# HIVES.

Compare the WORKMANSHIP and FINISH of our Hives.

All made by practical Men who know what a good hive should be.

In various designs to suit all tastes and requirements. Season's speciality—THE MANLEY HIVE for 16 in. x 10 in. Frames.

Full descriptions and illustrations in our 1920 Catalogue:

*"Everything for an Apiary."*

If you have not received your copy, send a P.C. at once.

OUR MOTTO—SERVICE & QUALITY.

**R. STEELE & BRODIE, Wormit Works, Wormit, Scotland.**



THE  
KEY TO  
YOUR SUCCESS.

## The Metal Foundation

(Protected)

The latest invention in Scientific hive equipment.

**Durable \* Economic \* Sterilisable**

An Ideal compromise between the Metal Comb and the Wax Foundation.

¶ For further details and prices, send for our 1920 ILLUSTRATED CATALOGUE, post free on application. It contains detailed information on the most up-to-date hives and appliances for which the House of Lee is famous.

\*\* Five per cent discount to Members of THE APIS CLUB.

**JAMES LEE & SON,**

LTD.,

Uxbridge, Middlesex,

(Telegrams: Graphicly, Uxbridge.)

Telephone: Uxbridge 181.)

## 20-Page 1920 "WHITE STAR" List,

3½d. POST FREE.

S. SIMMINS, QUEENLAND, HEATHFIELD, SUSSEX.

Look after your profits by buying hives and appliances which are easy to work. I endeavour also to give good value by care over the workmanship. Send for catalogue.

**EDWARD J. BURTT, Manufacturer, GLOUCESTER.**

*Commercial (16" x 10") frames and brood boxes stocked.*

PRINTED BY THE AVENUE PRESS (L. UPOOTY GILL & SON, LTD), 65-67, DRURY LANE, LONDON, W.C., AND PUBLISHED FOR THE PROPRIETOR (W. HERROD-HEMPHILL), BY SIMPKIN, MARSHALL, HAMILTON, KENT & Co., LTD., 31 & 32, PATERNOSTER ROW, E.C.

LIBRARY of  
Massachusetts  
18 1920  
Cultural



No. 1975. Vol. XLVIII

APRIL 29, 1920.

[Published every Thursday, Price 2d.]

**CONTENTS.**

	PAGE		PAGE
THE BUDGET AND THE B.B.J. ....	205	DUNDEE CONFERENCE .....	212
OBITUARY NOTICE .....	205	AYR BEE-KEEPERS AT KILMARNOCK .....	212
LEGISLATION .....	206	QUESTIONS FOR BEE-KEEPERS .....	212
BRITISH BEE-KEEPERS' ASSOCIATION—		TOTAL HONEY IMPORTS FOR 1919 .....	212
Lectures at Golders Hill Park .....	208	CORRESPONDENCE—	
ROYAL SHOW FUND .....	208	Size of Frames .....	213
A DORSET YARN .....	209	Natural Stores v. Sugar Feeding .....	214
JOTTINGS FROM HUNTINGDONSHIRE .....	209	An Early Swarm .....	214
ECHOES FROM THE HIVES .....	210	WEATHER REPORT .....	214
SHAKESPEARE, BEES AND OTHER THINGS .....	211	BEE SHOWS TO COME .....	214
TO TALK OF MANY THINGS .....	211		

**ALUMINIUM DRAWN OUT COMBS.**

**“MONEY COMB”**

*The greatest invention in the Bee World for 40 years.*

This is a drawn out Comb of Hexagon Cells exactly as bees build in their natural state. It is slightly coated with wax, has been thoroughly tested, and is not an experiment. Bees readily take to it for rearing brood and storing honey. Strong and durable, will last 50 years with care. Big consumption of honey saved to produce wax for comb building. Control of bee diseases. No more burning of combs. Each comb easily sterilised and used over again.

Send for Catalogue and descriptive Leaflet.

1920 Catalogue post free.

Patented by ALUMINIUM HONEY COMB CO., of U.S.A.

SOLE MANUFACTURER AND LICENSEE:

**E. H. TAYLOR, WELWYN, HERTS.**

THE  
**British Bee Journal**

ESTABLISHED 1873.

A Weekly Journal Devoted to the  
Interests of Bee-keepers.

Edited by T. W. COWAN, F.L.S., &c.,  
and J. HERROD-HEMPSALL, F.E.S.

**Correspondence: Whom to Address.**—

All matters relating to the Literary Department, Associations, Shows, etc., should be addressed, "Editors, *British Bee Journal*," and all business communications and matters relating to subscriptions and advertisements to be addressed to the "Manager," *B.B.J.* Office.

**Subscriptions.**—Annual Subscription, 10s. 10d. post free in advance; single copies 2d., or 2½d. post free. If a receipt is required by post, a stamped and addressed envelope must be sent, otherwise a printed receipt will be enclosed along with the paper.

*Note.*—Cheques and Postal Orders should always be crossed, otherwise it is very difficult to trace them if they go astray.

**How to send Money.**—Remittances can be made payable to W. Herrod-Hempsall by crossed Cheques and Postal Orders. Stamps may be sent for small amounts up to 2s.

**Halfpenny stamps are preferred.**

Scottish or Irish cheques can only be taken in payment if 6d. is added for commission charged by banks for cashing them.

The Editors are not directly or indirectly interested in the manufacture or sale of beehives or appliances of any kind, and must refer correspondents wishing for prices or catalogues to advertisers in the paper.

The products of the Apiary, of  
Poultry and Farm Stock, of  
the Fruit and Vegetable  
Garden can be Advertised  
and Sold through

THE  
**BAZAAR, EXCHANGE & MART**

*Newspaper.*

Get a Copy—Thursday and Saturday 3d. The "Bazaar" publishes also practical handbooks by experts. Send for full catalogue, post free from—WINDSOR HOUSE, Breams Buildings, LONDON, E.C.2.

**OUR DEPOSIT SYSTEM.**

You are advised to insist on this being used when dealing with strangers.

**Rules and Conditions for Depositing**

*In order to save trouble, it is requested that the Rules be carefully read over by persons using the Deposit System of trading.*

Goods should not be despatched until notice that the money has been deposited is received from this office.

**1. Method.**—When strangers are dealing together, the purchase-money of the articles is deposited at our office. We acknowledge receipt of the deposit to both parties, and hold the money until we are satisfied that the purchase is concluded. If a sale be effected, we remit to the seller the amount deposited, less a charge of 2½ per cent. in the £, with a minimum of 6d., and the expenses of Post Office Orders and postage, &c. Cash will be forwarded by Cheque, Post Office Order, or by Postal Order as preferred. If a sale or exchange be not completed, we return the amount deposited, after making the same deduction. By this means buyers and sellers are secured against fraud.

**2. Deposits.**—Postal Orders (drawn on General Post Office) and Cheques must be made payable to W. Herrod-Hempsall, and crossed "London County and Westminster Bank." The numbers of the Postal Orders should be kept by the sender. We cannot be responsible for any loss that may occur in transit.

**3. Honey on Approval.**—All honey will be sold by sample, which must be sent direct to buyer.

**4. Bee Appliances.**—In ordering, the time allowed for completing the order to be stated to us when sending cash. If maker accepts, we hold cash until transaction is satisfactorily completed, when the amount will be remitted, subject to conditions as in Clause 1.

**5. Bees and Queens.**—These will be dealt with entirely by the parties concerned, so far as price, &c., go, and when the purchase is satisfactorily completed cash will be remitted as per Clause 1.

**6. Goods in Transit.**—These are at the seller's risk, i.e., any damage to or loss of an article on its journey is borne by the vendor; but a rejected article must be properly packed and returned by the same means as was used in sending it.

**7. Carriage.**—The carriage of all goods, *except such as are sent by post*, is payable by the buyer, unless otherwise agreed. If any article sent on approval be returned, each party to the transaction must pay carriage one way.

THE  
**British Bee-Keepers' Association.**

Insure now against loss by  
damage done through bee  
stings. All particulars from

W. HERROD-HEMPSALL, 23, Bedford  
Street, Strand, London, W.C.2.

**Bee-keeping Simplified**

FOR THE COTTAGER AND SMALLHOLDER,

By W. HERROD-HEMPSALL, F.E.S.,

*Author of "Producing, Preparing, Exhibiting and Judging Bee Produce."*

Price 1s. net. Post Free 1/1½

THE BRITISH BEE JOURNAL OFFICE, 23, Bedford St., Strand, London, W.C



*Editorial*

**The Budget and the B.B.J.**

As time goes on, the effects of the war are felt more and more, and the financial burden it has entailed presses even more heavily on everyone. As all our readers will be painfully aware, the Chancellor of the Exchequer has to find an enormous sum of money to enable the nation to carry

have already sent in their subscriptions to forward a further sum to cover the extra postage on the papers from the date it comes into operation, and increase the yearly subscription for the JOURNAL to 13s. and the Record to 3s.

**Obituary Notice.**

THE LATE CANON COVENTRY.

By the death of Canon Coventry, Rector of Severn Stone, Worcestershire loses one of its best known clergymen. A type of the true, old English gentleman, who



THE LATE CANON COVENTRY.

on, and in his latest Budget has had to try and find fresh sources of revenue, and make increased demands on those already tapped. The increased charge of postal rates will be felt by everyone in more or less degree, and the effect of one of these increases, if passed, will be to increase the subscription rates to all papers sent by post. It will add a further 2s. 2d. to the BRITISH BEE JOURNAL and 6d. to the Record per annum, and we shall, very reluctantly, be compelled to ask those who

was held in high esteem and affection by all classes and creeds, Canon Coventry, who reached the advanced age of 90 last Christmas Eve, had been a keen bee-keeper for nearly 70 years, and has been President of the Worcestershire Bee-keepers' Association since 1908. He has been no mere figure-head, but has consistently attended the meetings of members and committee, devoting his influence and a considerable amount of time for the benefit of the craft. He was educated at

Winchester and Pombroke College, Oxford. He was a fine oarsman, and was captain of the College eight which won the Ladies' Plate at Henley, and also won many other prizes at Worcester, Tewkesbury, and other regattas. He was one of the Oxford crew when Cambridge were defeated at Henley in a contest for the Grand Challenge Cup in 1852. He took Holy Orders in 1853, was ordained priest in 1854, and first held an incumbency at Worlstone, in Gloucestershire. Then he was the perpetual curate of Orenton, Glos., 1855-59. He had travelled extensively, and was at Naples at the time of Garibaldi's arrival there at the head of his troops in 1860. He witnessed the Battle of Volturno and the triumphant entry of King Victor Emmanuel. He was at Warsaw when a number of people were shot down by the Russians, and at Kiel when the Prussians descended upon Denmark. In Moscow he saw prisoners off to Siberia.

He began his life at Severn Stoke in 1869, and from that day until the present he had been in the very truest and broadest sense an ideal rector. He established himself as an authority on the culture of fruit and of bees, and he was unflinching in interest and sympathy with agriculturists. Those who were fortunate enough to attend the Severn Stoke Harvest Home—which was celebrated last October for the 49th time—were able to realise how intimately he identified himself with the people and the life of the parish. These annual assemblies breathed the atmosphere of an earlier England when life was sweetened by such neighbourly rejoicings. Canon Coventry always invited the parishioners to lunch at the Rectory, and the children to tea in the afternoon following a service in the church. Severn Stoke's parochial life owed much of its unity and agreeableness to his inspiration and example. In times of agricultural depression and of bad harvests he summoned the parishioners together to cheer them to another effort in the succeeding year; and in times of plenty and of relative prosperity, he invoked expressions of satisfaction and gratitude. His fatherly concern in the farmers' interests, his sympathy with them in their trials and disappointments, and his congratulations in more favourable circumstances, were highly valued.

He was appointed an Hon. Canon of Worcester Cathedral in 1885, and Rural Dean of Bredon in 1878. He took a wide and keen interest in county affairs. He was elected an Alderman of the County Council when that body was first formed, was a Justice of the Peace for the Upton-Severn Division (he sat regularly at the Upton Police Court until recently),

and was on the Visiting Committee of the Powick Asylum.

Canon Coventry married in 1868, Lulia Louisa, daughter of Charles Goodwin Colquitt, of Craven, Shropshire. She died in 1899. There were four children of the marriage, three daughters and one son. The son is Mr. Fulwar Cecil Ashton Coventry, who holds a responsible position in the Motor Department of the G.W. Railway. One of his daughters is Lady Dudley, who for many years assisted him in entertaining at the Rectory.

## Legislation.

A friend in Jamaica, who is interested in the endeavour to obtain legislation in England, sends us a copy of "The Diseases of Bees Law" in force in Jamaica, and also an extract from the Annual Report of the Department of Agriculture for Jamaica, 1918-19. Comment on our part is needless, beyond pointing out the drastic nature of the penalties, which include imprisonment, showing the importance attached to the industry there; the report shows how legislative powers prevented a catastrophe in the Island.

### JAMAICA.

A law to prevent the introduction and Spread of Dangerous Diseases amongst Bees.

(10th May, 1918.)

Be it enacted by the Governor and Legislative Council of Jamaica, as follows:—

1. This law may be cited as the Protection from Disease (Bees) Law, 1918.
2. In this law the expression "Disease" means the diseases known as "Foul Brood," and "Isle of Wight Disease of Bees," and any other disease which the Governor in Privy Council, by notice published in *The Jamaica Gazette*, may declare to be a disease for the purposes of this law.
3. It shall be lawful for the Governor from time to time by Orders to be published in *The Jamaica Gazette*, to:—
  - (a) Prescribe the measures to be taken for the treatment of any disease by the owner or person having the charge or management of any apiary.
  - (b) Regulate the duty of persons appointed to carry out the provisions of any Orders issued under this law.
  - (c) Direct the destruction of any apiary infected or suspected of being infected with disease.
  - (d) Generally make provision for the purpose of preventing the introduction and spread of disease or of any particular disease named in the Order.
4. It shall be lawful for the Governor

to appoint persons to carry out the provisions of this law, and of any Orders issued thereunder, and the Governor may by warrant direct payment out of the Public Treasury of the remuneration and expenses of all such persons and of any other expenditure that the Governor may deem necessary for the purposes of this law, including such compensation to the owner of any apiary destroyed under the provisions of this law, as the Governor may, in his absolute discretion, approve.

5. Any person appointed under the provisions of the next preceding section may with such assistance as may be necessary, enter upon any land, and there examine any apiary in order to ascertain whether the said apiary is infected with disease.

6. (1) Every owner or person having the charge or management of an apiary who knows of or suspects the existence of any disease in such apiary shall, with all practicable speed, give notice in writing to the Director of Agriculture of the fact of the apiary being so infected or suspected, and shall in such notice give all information in his power as to the extent and nature of such disease. The said notice shall be served personally on the Director of Agriculture, or shall be addressed to him by registered post.

(2) Where the owner or person having the charge or management of an apiary is charged with an offence under this law, he shall be presumed to have known of the existence of the disease, unless and until he shows to the satisfaction of the Court that he had not knowledge thereof, and could not with reasonable diligence have obtained that knowledge.

7. If any person without lawful authority or excuse, proof whereof shall lie on him, does any of the following things, he shall be guilty of an offence against this law:

(1) If he does anything in contravention of this law or of any Order issued under this law, or of any rule made under this law or fails to carry out any measures required to be carried out by him under any such Order or rule.

(2) If he fails to give any notice which by this law he is required to give.

(3) If he refuses to any person acting in execution of this law or of any Order issued thereunder, admission to any land, or place which the said person is entitled to enter or obstructs or impedes such person in so entering or in examining any apiary or otherwise in any respect obstructs or impedes any person in the execution of his duty under this law or assists in any such obstructing or impeding,

and he shall on summary conviction before a Resident Magistrate be liable to a fine

not exceeding £50, and in default of payment to imprisonment with or without hard labour for any period not exceeding three months, and on a further conviction within a period of twelve months, for a second or subsequent offence against this law he shall be liable in the discretion of the Court to be imprisoned for any term not exceeding six months with or without hard labour in lieu of a fine to which he is liable.

8. No prosecution for an offence against this law shall be instituted except by or with the consent of the Director of Agriculture.

9. Any person charged with an offence against this law may, if he thinks fit, tender himself to be examined on his own behalf, and thereupon he may give evidence in the same manner and with the like effect and consequences as any other witness.

10. (1) The Governor may make rules for the purpose of more effectually carrying out the provisions and objects of this law.

(2) Rules made under this section shall have the same effect as if they were contained in this law, and shall be judicially noticed.

(3) Rules made under this section shall come into operation on publication in *The Jamaica Gazette* or at such other time as may be named in such rules.

11. For the purposes of this law the decision of the Director of Agriculture as to the presence of any disease shall be final.

EXTRACT FROM ANNUAL REPORT, DEPARTMENT OF AGRICULTURE, 1918-1919.

Honey has been one of the surprises of the year. Owing to the lack of sugar and jam in England, and the permission given by the Imperial Authorities for the shipment of honey, the bee-keepers of Jamaica have reaped a most gratifying harvest. The Collector-General records the export of 188,000 gallons or 1,175 tons of Jamaica honey to the United Kingdom, at a value of £154,700. This is greater than that of either of two of our major products, cacao and coconuts. Unfortunately, honey in transit from Cuba where foul brood is prevalent, was permitted to enter the port of Kingston, and owing to the ineffective powers of the law this infected honey was exposed to the local bees with the result that American foul brood was discovered in the Kingston area in December last.

Fortunately, the possibility of the entry of foul brood through foreign honey in transit had been recognised, and a special law (Law 9, of 1918) was passed in April, 1918 which gave powers for dealing with dangerous diseases of bees.

In May an area of approximately three miles in radius from the Parish Church, Kingston, was declared under the law, and all bees in this area were required to be notified, and were inspected quarterly by the Inspector of Apiaries. Rules as to the movement of bees in and out of the declared area were also made.

The first case of American foul brood was reported by the owner on December 14. By January 7, 13 cases, extending over a frontage of about a mile on the sea-front of Kingston had been discovered and the hives destroyed by fire. Owing to the apparent migration of the bees from two diseased hives at the extremities of the infected area, before the hives had been destroyed, the Department, with the concurrence of the Bee-keepers' Union, advised that all hives within the declared area should be destroyed at once.

His Excellency acted with promptitude, and as the Legislative Council was fortunately in session, a credit of £3,800 was voted to enable the whole of the declared area to be treated forthwith, and for a maximum compensation of £2 per hive to be paid to the owners of the bees destroyed.

With the assistance of the Bee-keepers' Union, who enrolled eleven of their members as special inspectors appointed by the Governor under the law, and under the general direction of the Chief Inspector, Mr. C. N. Eddowes, 1,719 hives of bees were destroyed by fire on the nights of January 16 and 17.

The Acting Inspector-General organised effective police supervision of all the apiaries in the declared area pending their destruction. His Worship the Mayor of Kingston, assisted us by permitting the hives from the city area to be burnt on the race-course. The hives were treated with carbon bisulphide by Mr. H. G. Coofe, Inspector of Plant Diseases before being moved.

I am glad to be able to report that there is every reason to believe that foul brood has been effectively stamped out, and that this prompt and drastic action has freed the honey industry of the Colony from the inroads of a most destructive disease. The Legislative Council is to be congratulated on its action in authorising this large expenditure at a time when general revenue was not in an easy condition for meeting extra demands for money.

On the advice of the Bureau of Entomology at Washington, the prohibition against the importation of queen bees from U.S.A., that had been effected two years ago so as to guard against the introduction of the "Isle of Wight" disease, of which some suspicion existed as

to its presence in American, was withdrawn by His Excellency in April, 1919.

It is now possible for bee-keepers to import queen bees under special regulations previously in force under the law, and apiarists are now advised that it would be well to introduce some fresh blood by the importation of good Italian queens from the United States.

Although it may never again record such a year of prosperity as that experienced in 1918, there is every reason to believe that the merits of Jamaica honey are now better recognised in the English market, and that there are good prospects for the future of our honey industry.

It has been urged on the Department that a travelling inspector in apiculture would be very helpful to the industry, and I hope with the advent of more prosperous times that such an officer may be added to our staff who will devote himself to the promotion of the success of the honey industry in all sections of the island.

## British Bee-Keepers' Association.

LECTURES AT GOLDERS HILL PARK.

A special course of six lectures on bee-keeping will be given in the British Bee-keepers' Association's apiary, London County Council Park, Golders Hill, London, N.W., on Fridays, April 30, May 7, 14, 21, 28, and June 4 at 6 o'clock each evening.

Those desiring to attend these lectures must make application at once for enrolment and particulars to—W. HEROD-HEMPSELL, Secretary, 23, Bedford Street, Strand, London, W.C.2.

A simple "chat" on bees will be given free, at 3.30 each afternoon before the lectures.

## Royal Show Fund.

The Council of the British Bee-keepers' Association are anxious to take their usual part at the Royal Show to be held at Darlington this year, so that their unbroken record of representation at this show may not be spoilt. In order to defray the expenses in connection therewith the Council ask that all bee-keepers assist in this work by giving donations, which should be sent as early as possible to the Secretary, 23, Bedford Street, Strand, London, W.C.2.

DONATIONS RECEIVED.

	£	s.	d.
Amount received	...	2	5 0

### A Dorset Yarn.

In the Rectory garden at Durweston, near Blandford, where the rock gardens had their gayest mantle, like Jacob's "coat of many colours," bees could revel in masses of flowers. Many of them the bees had worked assiduously until the small flowers of gooseberries were open. Now they have transferred their affections from the rock gardens with their masses to the small and inconspicuous ones; large breadths of hyacinths, all shades of colour, cannot lure them away; they know these flowers are rich in sweetness, and one would imagine that they knew the flowers were of short duration, as they stay with them so much.

In a pasture field close to the farm there are thousands of dandelion, which is figured in Root's "A. B. C. and X. Y. Z. of Bee-keeping," as a fine bee plant. Here there is not a bee to be seen on them, yet before the fruit blossom opened they were on the early flowers on warm banks. This flower is singular in its habits—it only opens when the sun shines and rain is not coming. A field may be quite yellow for an hour or so, and then they close up; they open that the ligulate flowers, which are crowded together in one calyx, should be fertilised when pollen is quite dry and the pistillate organ is ripe for inoculation.

A lot of these ligulate flowers, like the thistle, hawkweeds, etc., all go through the same evolutions. The salsify family always close up at 12 o'clock, and is called "John go bed at noon," but it will only open when the climatic conditions are favourable; they go to sleep at night, and many of them bend over the flower heads, as men do in prayer—but this is digressing. Bees seem to have the "Get-rich-quick" fever, and leave the flowers where stores are short for the flowers where abundance reigns. If it is so at our farm and in other gardens of Dorset, we may assume it is general everywhere.

We are interested in all flowers that are visited by bees. The composites, to which the dandelion, thistles, and daisies belong, have hundreds of flowers in one calyx. The small daisy has about 250 florets in the one calyx, yet they are so arranged that they form a perfect flower. Up to fifty are ray flowers forming the outside circle; these have a pistil but no stamens or pollen parts; the centre is filled up with five cleft yellow flowers, with both stamens and pistil. In the large double daisies the whole of the flowers are ligulate.

All our hives now seem to have an assembly; all seem to be rushing out in a hurry, enticing out the young bees—and what is more, the drones. I saw these

for the first time in the Italian stocks on Sunday, the 18th. All seem to be telling us how good it is to be alive when the sun shines and food is so plentiful, or letting the world see how important each colony is to the Violet Farm. It is the workers that sing so continuously—not like the birds; with them it is the male that sings all springtime. But the worker-bee does not sing because she wants the males to notice her; it must be overflowing exuberance, and she must let off the safety-valve with an extra effort of song. 'Tis said the thrush sings that the female should notice him; the glowworm gives her lamp that the male should find her; but the worker-bee sings her loudest when the most work is to be done. To-day, Saturday, April 24, it seemed like swarming time with so much extra song. With the song of the workers this week, there is the song of Italian drones. Such beautiful creatures they are; they seem very shy when they look out on the front; they hesitate a good deal before they set off with their loud song. But there will not be many queens for them to follow on the wedding trip this year at the Violet Farm; most of the royal cells are destroyed, and sections and bars on top of the brood box.

Our bees to-day are on a breadth of turnips (most of the pollen is yellow that is carried in). All lines of red and black currants are in bloom, as well as most of the apple trees. The white broom is opening; this is a fine plant for bees. They work them very much; there are so many flowers on them, though they are very small. Bees are on them twelve hours in the day. They are revelling in wall-flowers and are still looking over the gooseberries, but the lilacs are not attractive to them.—J. J. KETTLE.

---

### Jottings from Huntingdonshire

The outstanding feature during the past week has been a slaughter of drones; before most hives one has seen a little pile of dead or dying drones. Why this premature slaughter? Truly the bees have been forced to do it, then why bring so many into existence? The answer is, bees, like humans, are liable to err. While they can and do sense the weather well ahead they do not seem able to reason out to the end. A check in the honey flow they can anticipate, but are not always correct in the question of storage. In March many drones were brought into existence; not alone to be prospective royal lovers, but also to help maintain the temperature of the hive and so allow an unusual number of foragers to be abroad. April brought a spell of wet and some chilly winds, and

all the time young bees were being born by the thousand each day, and all surplus stores were being drawn upon. The ministers of the hives had to make a decision for economy's sake, and the decision was, turn out the majority of drones, so out they had to go. What beauties they are! Rarely have I seen such fine timbered male bees. We need not despair. A cursory glance will reveal that a few drones are left, sufficient if a swarm should be deemed necessary in the course of a few weeks. Two hives I have visited this week would, without doubt, have swarmed had March's warmth continued into April. From the bee-keeper's point of view, this check is all to the good, providing he has guarded against the possibility of starvation. Many nectar-bearing flowers were being brought out before their time, and but for this check would have been blossoming—half developed. There is little beauty in a half-developed flower, and less nectar and pollen. Personally, I am sorry to see the chestnuts so soon in bloom. I would prefer to see their charming candles of pink and white in May. May blossom, again, will soon be opening. It is said that not more than three times in a century does hawthorn blossom on or before May Day. This year is evidently one of those unusual years, and we must work accordingly. Mad though it may sound to some, I say super all strong stocks, but keep cakes of candy handy for slipping under the quilt should necessity arise. The bees have increased at such a rate since the year came in that all but the weakest stocks need more room than a single brood chamber gives them. Refuse them this, and what is the result? A sultry day comes along, such as we had on the 23rd, and the poor little insects are unable to stand the temperature of the hive and are found listlessly crowded around the entrance "spiriting" for air.

The oaks are in good leaf, the elms covered with feathery green, but the majority of ashes are only just bursting bud, so "If the oak is out before the ash, etc., etc." It is well to take note of these things. There is some wisdom in many of these old sayings. "A swarm of bees in May is worth a load of hay"; "A swarm of bees in June is worth a silver spoon"; "A swarm in July is hardly worth a fly." Someone asked me the other day if a May swarm was worth a load of hay, what was the worth of an April swarm? That depends on what part of the month the swarm appears. If in the earlier fortnight, I should say its worth was very little, for it would not be strong; it would need very liberal feeding, be pestered with robbers, and during a cold snap would suffer considerably. I have

known of only one early April swarm, it was taken and duly hived or skepped, no artificial feeding was done; a cold, wet week came along, and every single bee died from starvation.

The answer to my last week's query is "The Lark." No, there is no catch or pun lingering. It is just that bees do dislike larks. I have never seen a lark eat bees—maybe their song annoys them, or it maybe that they fear for their virgin queen, as she soars into space for her mating flight, reaching heights the singing lark only attains to. Blackbirds, thrushes, finches, robins, wrens, and even swallows may build their nest quite close to the hives, but if a poor lark does so she soon repents of her folly. She is allowed very little peace. A lady in Buckinghamshire writes me to say that she once saw a lark enclosed in a ring of bees from which she was frantically endeavouring to free herself to get to her nest. Poor little larks, I am sorry you and apis cannot agree, but I hope you will go on singing none the less.—E. F. HEMMING, Steeple Gidding.

### Echoes from the Hives.

Bees are steadily forging ahead in this locality, and most colonies still possess a small reserve of natural stores. On the whole, reports show, that bees have wintered quite normally, and no unusual losses have occurred yet; although starvation has still time to claim a few victims, where the owners are of the happy-go-lucky type.

In the Cheltenham Vale—which abounds with gardens and orchards for market growing—everything in the way of blossom, is fully three weeks ahead of its normal date, but this cannot be said of the Cotswold uplands, where the bigger apiaries are, for here there is very little fresh vegetation to be seen. Indeed, in the Sainfoin district, a late spring is better than an early one, because of the cooler temperature and lack of early blossom before May comes in. Then the dandelion is an excellent asset. So that there is nothing so essential as a good reserve of stores, and then the bees can be left quite undisturbed.

Given a burst of genial sunny weather, swarms would be frequent in the early blossom districts, and will be greatly valued by those having empty hives to fill.

All things considered, I think we are in for a fair season, provided the spring rainfall is ample.—A. H. BOWEN, Cotswold Apiaries, Cheltenham.

April 2, 1920.

## Shakespeare, Bees, and Other Things.

I cannot dignify my words by the title of "Jottings from Huntingdonshire," as this week they are appearing also, although I was able to hide my light under that bushel the first time I wrote. Some people might put a different interpretation to this "light," or say I have got muddled up with the English language. I should not be the first, so they can.

I might have written before when there was something to write about, namely, to put it in hackneyed language, "The signs of an early spring," but I was making the acquaintance of another form of "bee," the hospital nurse, and I found them very interesting. The beautiful days in February made me only irritable, for I had to lay in a furnace of a ward with the temperature at 75. That was all the benefit I derived from those remarkably early spring days (I am quite aware that February belongs to winter by the calendar); fancy appendicitis in spring! I said that at Easter I should have something worth writing about; alas! at the moment my father is melting down bee sugar and putting it out on pieces of paper, looking as if he kept a sweet shop for the convenience of those who like "a apeth o' them white sweets."

I have often wondered what acquaintance Shakespeare had with bees when he wrote "Henry V." Was he enthusiastic over his first swarms, for he is supposed to have written it in the earlier part of the year 1599, or was some book-friend continually filling him with romantic tales of their wonderful ways. I am inclined to think the latter, and also that the friend was anxious to strike a bargain. About half-way through the very first scene comes a phrase, "To steal his sweet and honey'd sentences." Perhaps he had had honey for the last meal. Be that as it may, anyone who is interested in bees, even if they are not in Shakespeare (if they are interested in both, all the better) should read the long speech of Canterbury's dealing with bees in Act I., Sc. II., of Henry V. Was Shakespeare true to history in giving Archbishop Canterbury such an accurate and intellectual knowledge of bees?

I should like to thank those who have so kindly offered help and suggestions with regard to my pet collection. Mr. Mace mentioned Monkswood as a most hopeful place for certain species of "lepidoptera," but I am sorry to say that it is fast being levelled to the ground. Nevertheless, I shall try my luck there next summer.—  
LOIS E. HEMMING.

## To Talk of Many Things.

Whenever there is a prospect of my visiting a certain town or village or of tramping over a particular stretch of country, it is my custom, with a view to deepening my knowledge of the locality and thus getting the utmost enjoyment from my stay or passage, to procure whatever books may be obtainable that deal with the places I hope to explore.

So, too, when an unpremeditated visit leaves an impression of interest and charm, the bibliography of the neighbourhood is drawn upon to deepen and strengthen that impression.

It happens sometimes that one visit creates the desire for another, when the lore studied as a reviver of the first may be drawn upon.

Thus it has been with the sister counties, Surrey and Sussex, and, actuated by a hope of renewing acquaintance with Holmwood Common in particular, and the country in general, of which Dorking may be taken as the centre. I have been reading a book\* whose every chapter is calculated to stimulate understanding enjoyment of the changing scene. When I add that its author is a modernised and localised Cobbett, keenly observant alike of natural beauties and of socio-economic conditions, acquainted with many of the celebrities of the artistic and literary world who have illustrated the stretch from Hindhead to the sea, no further commendation of the volume should be needed.

The fact that our author is a bee-keeper is soon revealed, as in this little reminiscence:—

"Bucolic humour of a practical kind was once displayed towards me when I was looking at some beehives at a farm sale. A keen bee-keeper, looking upon me as a dangerous competitor, clumsily bumped up against the hives, hoping thereby the enraged bees would come out and sting me, and so cool my ardour as a bidder. Unfortunately for him, he got the stings, and had to fly, pursued by angry bees, whilst I remained scathless."

Even without this direct evidence, one would know "beyond a peradventure" that only a bee-man instinctively observant of any least sign of the pursuit of the craft, would write, as in the chapter on Bletchingley.

"It was pleasant, on the occasion of my last visit there, to observe a number of newly made straw bee-skeps outside a shop close to the old 'White Hart Inn.' They made you feel that you would like to find life's anchorage on the heather-clad slopes of Tilburstow Hill and to keep bees close

\* "The Surrey Hills." F. E. Green. Chatto and Windus. 7s. 6d. net.

to a venerable village where the tide of life drifted so leisurely."

One may be pardoned for envying the lot of, say, the county expert on tour, when one reads, in the section devoted to Merrow Downs—

"This is not the Pilgrims' Way, which is lower down and obliterated by the plough near Netley House, where you may wish to descend into Shere and bathe your hot limbs in the cooling stream at the parochial cost of a glass of beer. Or you may wish to stand in the shadow of the noble avenue of limes, especially at blossoming time, when every tree is alive with murmurous wings. And surely no one could resist the appeal of the cottage gardens in July; for even the wheelwright's by the river bank, instead of exhibiting mournful, derelict timber, is aflame with flowers.

"This is the true valley home of bees, which, issuing from golden-domed hives behind regiments of hollyhocks and masses of Michaelmas daisies, suck nectar from the sweet, white clover of the chalk downs and win yet another golden harvest of honey from the purple heather of the sandstone heath."

I must have my boots clumped.—A. F. HARWOOD.

### Dundee Conference.

An important conference of bee-keepers was held at the Dundee Training College. An audience of more than 200 attended to hear a lecture by Mr. Joseph Tinsley, of the West of Scotland College of Agriculture, on the "Isle of Wight" disease. Mr. Tinsley outlined the history, spread, and cause of the disease. The experiments conducted by him in producing immunity were explained. Methods of selection in breeding were given for the prevention of diseases. At the close the chairman, Mr. Langlands, in proposing a vote of thanks, remarked that the lecture had been interesting and instructive, and it was hoped the lecturer would give them another lecture on an early date. In the discussion which followed, the general body of bee-keepers favoured legislation in regard to bee diseases

### Ayr Bee-Keepers at Kilmarnock Apiary.

The Ayr Bee-keepers' Association and a number of the Glasgow bee-keepers recently paid a visit to the West of Scotland Agricultural College, Kilmarnock, in connection with the bee re-stocking scheme authorised by the Board of Agriculture for Scotland. The party, numbering over 70, was met by Mr. Joseph Tinsley, who is in charge of the scheme, and conducted them over

the apiary. The modern appliances, together with the various races of bees, were a source of great interest to the bee-keepers. Mr. Dixon, in proposing a vote of thanks to Mr. Tinsley, remarked that they were extremely fortunate in having one of the foremost expert bee-keepers in Great Britain attached to the College, and he was convinced that so long as Mr. Tinsley stayed in the West that institution would always occupy the leading place in apiculture.

### Questions, etc., for Bee-Keepers for Self-Examination.

(Students are recommended to write their answers, and check them afterwards by reference to books.)

483. What is the colour of healthy brood?

484. Design a label for affixing to honey bottles and jars.

485. What is done to prevent the re-crystallisation of sugar prepared for feeding?

486. Suggest methods of providing shade for hives in the heat of mid-day in summer.

487. Explain why some colonies get strong in the spring sooner than others.

488. Whether is it better, in the spring, to unite two weak colonies or to let each strengthen separately? And why?

489. Describe a bee's foot, and explain why the bee is able to walk up a vertical surface whether quite rough or quite smooth.

490. What points are considered in granulated honey exhibited at a honey show?

491. Amplify the statement that it is advisable to manipulate bees as little as possible.

492. On what evidence is it concluded that each hive has its own special odour recognisable by its bees? J. L. B.

### Total Honey Imports for 1919.

	£
January ... ..	53,803
February ... ..	277,691
March ... ..	200,781
April ... ..	45,811
May ... ..	94,001
June ... ..	26,013
July ... ..	42,883
August ... ..	46,683
September ... ..	22,098
October ... ..	41,437
November ... ..	18,694
December ... ..	22,993
<b>Total ... ..</b>	<b>892,888</b>





### Size of Frames.

[10174] I do not wish to stir up a correspondence over the question of the size of frames, but ever since your editorial in THE BRITISH BEE JOURNAL of September 11 I have wanted to make some reply. You say there, sir, that you "do not attach the slightest importance to the theory that the space between the top and bottom set of combs would hinder either queen or bees," and then you argue that the space would be filled with bees, and the queen would spend only a few seconds in traversing it. The facts recorded would seem to show that there is a good deal more in the theory than you have allowed.

In the *American Bee Journal* for April, 1919, Mr. C. P. Dadant, in his editorial notes, touches upon this very point—for they have their controversies, too, over the size of frames, only they would appear to be about 30 years ahead of us. The whole discussion in that *Journal* of that month under "Shallow brood frames" would well bear being reprinted complete.

He is quite ready to argue that it is possible that different apiarists may have different experiences, "but," he adds, "that the separation of the brood chamber into two or more storeys should make no difference whatever in the laying of the queen is an untenable proposition."

He then brings forward the various facts upon which his conviction is based. Langstroth at one time used frames with a perpendicular bar or partition in the middle. The Dadants, who tried nearly everything Langstroth described, used these, and found that the "queens would often breed on one side of them only."

"The senior Dadant, who estimated the value of pieces of worker comb very highly, was in the habit of making horizontal partitions in brood frames" to fasten the pieces in. "Often queens would lay on the upper or lower side of such partitions to the exclusion of the other side." He also used divisible frames for queen rearing, and found the same thing, which, he says, anyone can confirm. "Not in every case, but in many cases—perhaps one-quarter of the time—the queens would find such divisions an obstacle sufficient to cause them to turn away for the time being, though they usually came back to them afterwards. He concludes this paragraph by adding: "What, then, must it be when they have not only a bar, but two bars

and a bee's space to pass over before changing from one storey to another? It is true they finally do it. But how much time is lost in hesitating and hunting can hardly be guessed." This, too, I may add, would be taking place more frequently in spring, when bees are fewer, and we want our queens to be laying to their fullest extent. It is, no doubt, the reason why bees build up more rapidly in spring in large frames than in shallow ones.

This contention is confirmed by an experience I had when wintering two stocks for a friend in Hampshire last September. The stocks stood side by side, and were on two sets of combs, and had had the same management, for I had done most of it. When I examined them I was particularly struck by the way in which both queens were laying. The arrangement of their stores was identical. The two outside combs on each side were solid—having a brood nest on six combs—the middle ones being about half-full, and the outside ones having only a narrow strip left at the bottom for brood. Both queens were June bred. Now, though there were some stores below, there was no brood. The queens had laid narrow strips of eggs along the outside combs, filling up all available space, but had stopped there, in spite of the fact that they were both big stocks. It is difficult to imagine that with larger frames the queens would not have had larger circles of brood instead of the half-moon shapes that they had. Both queens had Italian blood in them. I notice that Mr. A. C. Miller has had a similar experience when examining an apiary where double Langstroth and Jumbo hives were used.

I am writing this a few miles from Land's End, and far from my old BRITISH BEE JOURNALS, but I think it was Mr. Atkinson, of Fakenham, who said that we had a new factor in England since our standard was decided on—the Italian bee. This is, in fact, the deciding factor in determining the size of frames. The Italian blood in the country is increasing now at an enormous pace, and it will do so in an increasing ratio if this country goes the way of every other country nearly that has introduced these bees. I have run them side by side with blacks for the last two seasons, and we must all agree that they want larger hives—and considerably larger.

Mr. Charlton has advocated a deeper frame of the same length as the present standard—making the frame more nearly square. This shape was given up in America, and we should probably give it up, and for the same reason. The 16 x 10 is going to come in, whether we like the change or not. This discussion

will have started many more to use it. It is not large enough to my mind, but twelve frames like the "Langstroth twelve" would make a good, ample hive. This could be used by all who work for run honey, for there the large frame is at its best. But for working for comb honey the double standard could be used, for it possesses advantages, when so used, that, in my opinion, more than outweigh those of the larger frame.—Yours truly, C. S. MORRIS.

[We will endeavour to write a few notes on the foregoing letter next week. Eds.]

### Natural Stores v. Sugar Feeding.

[10175] I was much interested at Mr. C. Greenhough's letter regarding the above, and can say he is right about the old man feeding his bees on honey.

In years gone by, as a lad, I was taught management of bees by an old expert, a R.N. sea captain, who, for one thing, made me wash my hands before I touched the hive. They *were* hives in those days. (Nuff said on that point, perhaps.)

Sugar feeding was looked upon as poison; honey only was given. Vinegar, salt and chemicals were laughed at, and his bees stood through the first onslaught of "Isle of Wight" disease, and were with him till his death.

I took up bee-keeping last year in order to rub my memory up again, and two large stocks had my entire time and care in management of their comfort and health I was astounded at the present-day ideas, and let them pass by and carried on in the way I learnt, trying experiments which were a success. I kept one hive for honey to feed bees, resulting in seven combs, nice and dry, of bees, brood, and abundance of capped honey to start feeding on, which lasted some considerable time. To make a long story short, I winter my bees in a way they get proper air, and my quilts are as clean as the day I put them on. This year my colonies are already in large, wide hives I had built, on twelve combs, with one extra quilt during breeding. If only bee-keepers would study ventilation and not extract honey from the brood-nest, to be replaced by sugar, which is quite unnatural, bees will withstand anything that comes along. Great hot quilts allowed to be stuck down, so that bees live in an atmosphere of fermenting sugar, is cruelty in my estimation. Why rob them of their natural food for selfish aims, and wonder why your stocks are weak? If you want honey in abundance be humane and use common sense.

A bee is not a machine, but the most wonderful little insect of the whole Uni-

verse, who needs as much care and looking after as a human being. What is nicer than to get them to know you by being gentle, and not using endless manipulation? Many a time I had a tired bee alight on my bare arms with a load of pollen without attempting to sting. How can one not get to like them, and see to their comfort? I was always taught to treat them with affection, which I do. My hives are kept wide apart, so I get no robbing, and they are much quieter in the autumn. Each has its full amount of stores, and a bit over. I advise those who would spare honey to let their bees be the first little customers; they will pay it back tenfold in the spring of the following year. They have done it for me, so try it! I guarantee you will never regret it.—C. TREDCROFT.

### An Early Swarm.

[10176] It may be of interest to readers of the B.B.J. to know that one strong stock of mine sent out a swarm on April 17; I think this possibly might almost be a record for earliness? This stock was a cast when I obtained it last summer, and came from the roof of a house just outside this town; there appear to have been bees in this roof for the last six years or more. The bees are not natives, but have foreign blood in them; the queen certainly is prolific.—F. TYLER-TAYLOR.

### Weather Report.

WESTBOURNE, March, 1920.

Rainfall, 2.15 in.	Minimum on grass, 20 on 9th.
Heaviest fall, .44 in. on 14th.	Frosty nights, 8.
Rain fell on 19 days.	Mean maximum, 51.9.
Below average, .27 in.	Mean minimum, 40.4.
Maximum temperature, 62 on 22nd and 30th.	Mean temperature, 46.1
Minimum temperature, 25 on 4th.	Above average, 4.7
	Maximum barometer, 30.710 on 3rd.
	Minimum barometer, 28.842 on 15th.
	L. B. BIRKETT.

### Bee Shows to Come.

June 2-5, at Reading.—Royal Counties' Agricultural Society's Show. Hon Sec., 131, King's Road, Reading. Honey entries close May 15.

June 9 and 10, at Colchester.—Essex Agricultural Society. Classes for Extracted and Comb Honey, etc. Schedules from Secretary, Essex Beekeepers' Association, 7, Bulwer Road, Leytonstone. Entries close May 31.

June 16 and 17.—Hanley Park Meeting of the Staffordshire Agricultural Society. The Staffordshire B.K.A. offer valuable prizes and six silver medals and nine bronze medals. Twelve Classes for members only, and five Open Classes. (Honey Classes are for four or three jars or sections). Schedules, W. Griffiths, Silkmore, Stafford. Entries close May 29.

June 29 to July 3, at Darlington.—Royal Agricultural Society's Show, Bee and Honey Section, under the direction of the B.B.K.A. Prizes

arranged in groups of counties for Associations affiliated to the B.B.K.A. Schedules from The Secretary, 23, Bedford Street, Strand, W.C.2. Entries close May 31.

**July 6, 7 and 8, at Cardiff.**—Royal Horticultural Society's Show. The Glamorgan B.K.A., in conjunction with R.H.S., offer prizes for Honey, Wax, Bees, and Appliances. Members, Novices, and Open Classes. Schedules, Mr. Wiltshire, Maindy School, Cardiff. Entries close June 22.

**Special Prepaid Advertisements.  
One Penny per Word.**

*Will advertisers please read these Rules carefully in order to save trouble, as they will be strictly adhered to.*

**Trade advertisements of Bees, Honey, Queens, and Bee goods are not permissible at above rate, but will be inserted at 1½d. per word as "Business" Announcements, immediately under the Private Advertisements. Advertisements of Hive-manufacturers can only be inserted at a minimum charge of 3s. per lin., or 5s. per inch.**

**PRIVATE ADVERTISEMENTS are only intended for readers having Surplus Stock to dispose of. Driven Bees, Nuclei, and Queens that are reared or imported for sale, are Trade Advertisements, and can only be accepted under trade terms. A charge of 6d. extra will be made if a box number is used.**

**Advertisements must reach us NOT LATER than FIRST POST on TUESDAY MORNING for insertion in the "Journal" the same week.**

**Orders for three or more consecutive insertions in "The Bee Journal" entitle advertisers to one insertion in "The Bee-keepers' Record" free of charge.**

**PRIVATE ADVERTISEMENTS.**

**HONEY EXTRACTOR**, rotary, 2-cage, in good condition, 50s. in crate on rail.—A. MARSHALL, Lagham, Ashtead, Surrey. d.130

**COMMENCE** with early Swarms of healthy Hybrid Bees; 30s. during May, June 25s.; on rail; box returnable; orders in strict rotation.—DELF, Great Yeldham, Essex. d.131

**FOR SALE**, four Stocks of Bees on eight frames, 1919 Queens, at 10s. per frame; box 10s. returnable.—DOUBLE, Orchard House, Walton-on-Naze, Essex. d.132

**FINEST CLOVER HONEY**, 15 lbs., 30s. Swarms booked from stocks that have marked immunity from disease.—NORTH, Cressing, Braintree, Essex. d.133

**SIX** double-walled Hives, painted this season, £1 each.—H. CRACKNELL, Mount Road, Thundersley, Essex. d.135

**BEEES FOR SALE.**—Strong Stock, 10 frames W.B.C. Hive, £6.—BATTERSHELL, Staunton, Gloucester. d.136

**GEARED EXTRACTOR**, no cover, 30s.; 250 two beeway Sections, 17s. 6d.; 4 doz. 1-lb. Honey Bottles, square white glass, 14s.; "A B C Bee-keeping," 1901 edition, 4s.—73, St. John's Park, Blackheath, S.E.3. d.137

**SIX STOCKS ITALIAN BEES** on 7-8 frames, 84s. each; guaranteed.—Ennever, Oak Avenue, Enfield. d.138

**FOR SALE**, two very strong Stocks Hybrid Italians in clean, newly-painted Hives, with two racks of sections, £7 each. Can be seen by appointment.—DR. CUFF, Woodside, Bookham. d.139

**STRONG** healthy Stock of Italian Bees, £4.—15, Kelvin Avenue, Bowes Park, London. d.140

**THREE** surplus 10-frame Stocks for Sale, 70s. each.—PENTNEY, Harleston, Norfolk. d.143

**EXCHANGE**, four Bee Hives, 40 Standard Frames, and Swarm, for a good stock of Bees on 10 frames, or sell £5.—T. GREEN, New Dale, Wellington, Salop. d.141

**50 LBS.** Light Hampshire Down Honey, of first-class quality. What offers for part or whole?—S. G. LEIGH, Broughton, Hants. d.142

**12 GUARANTEED** healthy Hybrid Italian Stocks, Penna strain, £5 each.—J. YOUNGER, 6, Maid's Causeway, Cambridge. r.d.145

**ITALIAN HYBRID**, healthy swarms, May and June, 30s.—H. ROBINS, 290, Priory Road, St. Denys, Southampton. r.d.146

**NATURAL MAY SWARMS**, packed in straw skep, free on rail, £2 each.—E. PRESSEY, St. Elmo, Coulsdon. r.d.147

**SEVEN** 6-frame lots of Italian Bees, Penna's 1920 Queens, 63s.; five 4-frame lots, 45s. each; carriage paid; delivery early June.—"Earldoms", Ridgeway, Enfield. r.d.148

**CORRESPONDENCE COURSES** in Bee-keeping.—H. E. NEWTON, Brown House, Barton-on-Sea, Hants. r.d.157

**ITALIAN QUEENS**, 7s. 6d., and 3-frame Italian Nucleus, 30s., booked for early delivery.—YOUNG, 29, Central Road, Sudbury, Middlesex. r.d.158

**WANTED**, a Lecturer on Bees to accompany a Demonstration Train for seven weeks, commencing May 17. Sleep.ing accommodation and food found.—Applications, with salary required, to W. HERROD-HEMPSELL, W.B.C. Apiary, Old Bedford Road, Luton.

**SWARMS** for Sale, May and June, very healthy Stocks, price 30s.—MRS. BARRY, Home Place, Limpfield. r.d.98

**GIVING UP BEE-KEEPING.**—I am offering three Stocks of Bees, six Hives, six Queen Excluders, a quantity of drawn-out Shallow Combs, and all Appliances for bee-keeping.—A. S. STORTON, 105, Preston Road, Coppull, near Chorley, Lancs. d.102

**WANTED**, for four weeks from about end of August, Board and Residence for family of four at a farm near South or South-East Coast; bee-keeper and fruit grower preferred.—State terms to Box 81, B.B.J. Office, 23, Bedford Street, W.C.2. d.103

**FOR SALE**, Italian Hybrids on 6 frames, 1919 Queens, £4, carriage paid; early Swarms, 35s.—LARMUTH, Hillside, Monahan Avenue, Purley. d.104

**300 SHALLOW** wired Combs for Sale; no disease.—CRAWFORD, Apiaries, Castleberg, Co. Tyrone. r.d.112

**WANTED**, from August 22 to September 4, in Cornwall or Devon, within 12 miles or so of sea, Bedroom and Sitting Room, with shed for motor car; farmhouse preferred. Can any bee-keeper oblige me?—W. HERROD-HEMPSELL, Old Bedford Road, Luton, Beds.

**FOR SALE**, two "Rotax Roadlight 267" self-contained Acetylene Motor Headlights, very powerful, £6 the pair; one Exhaust Whistle, 10s.; one Wood-Milne Motor Foot Pump, 40s.—HERROD-HEMPSELL, as above.

**FOR SALE**, Geraniums, Scarlet Crampel, 6s.; summer flowering Chrysanthemums, 2s. 6d.; Tomato Plants, strong, 3s. per dozen; early sown Leeks, 3s.; Celery, 4s. per 100; 50 same rate; carriage paid.—HALL, Highfield Lodge, Balderton, Newark, Notts. r.d.61

**PURE** Light Cambridge Honey, 14-lb. tins, 22s. 6d.; 28-lb. tins, 42s., carriage paid; sample 4d.; tins free.—J. YOUNGER, 6, Maid's Causeway, Cambridge. r.d.66

**FOR SALE, 12 strong Stocks Italian Bees, absolutely free of disease, mostly 1919 Queens, £5 each, on 10 standard frames (can have some hives if desired).—THOS. G. WALKER, Symonds Hyde, Hatfield, Herts. r.d.68**

**FOR SALE, Swarms, English strain. Book now for May and June.—BRISTOW, 47, Auckland Hill, West Norwood, Surrey. r.d.74**

**FOR SALE, May and June Swarms, £2.—KNOWLES, Thursley, Godalming. r.d.75**

**WANTED, portable Greenhouse.—Price and particulars to W. HERBOD-HEMPSELL, Old Bedford Road, Linton, Beds.**

**WANTED, Auster Rear Wind Screen for motor car.—HERBOD-HEMPSELL, as above.**

**BUSINESS ADVERTISEMENTS.**  
1½d. per word.

**WANT any Queens, Nuclei, or Swarms, home-raised Italians? Prices on application.—BOOBIER, Bishopston, Swansea. d.134**

**PURE Golden and three-band Italian Bees and Queens; prolific and gentle; the ideal bee for pleasure and profit.—COOMBER, 64, Ronald Park Avenue, Westcliff, Essex. d.144**

**"ISLE OF WHITE" DISEASE.—Don't worry; use the solution that cures; 2s. per bottle.—E. PRESSEY, St. Elmo, Coulsdon.**

**1920 PURE Fertile Italian Golden Queens, guaranteed imported direct from Italy; regular supplies throughout the season from second week in May; 14s. each; specially selected, 17s. 6d.—GOODARE, Italian Queen Specialist, New Cross, Wednesfield. r.d.150**

**PURE Italian Queens, fertile. Now booking orders for my selected Queens, bred for quality and hardiness. Orders executed in rotation. Price 10s. 6d. each. Book now.—SHERRY, Queen Rearing Apiary, Wallflat, Tarbolton, Ayrshire. d.151**

**PENNA has sent me two specially selected 1919 Breeding Queens. Spare Virgins from these mothers, 4s.; spare Fertiles, crossed with Bozzalla (Ligurian) drones, 8s.; best only; real 4-frame Nuclei with I.Q., ready July, £2 10s.; in rotation; 25 per cent. cash with order.—PATRICIA, Grammar School, Doncaster. r.d.152**

**PENNA ITALIAN QUEENS, direct from Bologna. We have bought all the June, July, August, and September Penna Queens not already booked, and will distribute them at Penna's advertised prices.—S. H. SMITH, 30, Maid's Causeway, Cambridge. d.153**

**NUCLEI during summer from apiaries run on modern lines; never had any disease; isolated apiaries for mating Italians, imported 1919; Natives bred by selection; 3-frame, £2 10s.; 4-frame, £3; carriage paid; boxes free; quantity limited; cash before despatch.—R. DOUPE, Maam, Co. Galway. d.154**

**BEEES ON APPROVAL.—We guarantee our Bees and Queens to give complete satisfaction. Catalogue 3d., which is returned on first order.—PEARSON & GALE, Marlborough. d.156**

**HOW TO KEEP YOUR BEES HEALTHY! Valuable advice, 5s.—ALFD. RYALL, Kenwood Apiary, Elcombe, near Stroud. d.116**

**ALBERT HOPKINS, Specialist Breeder and Importer Italian Bees; 23 years' practical apicultural experience. Guaranteed strong, healthy Stocks and Nuclei. Prices strictly moderate. List on application.—Woodland Valley Apiary Lyminge, Folkestone. r.d.117**

**NUCLEI, 3-frame, Penna's 1920 Queen, 55s.; best Hybrids, 45s.; carriage paid; early delivery; Penna's Queen, 14s. Cash with order.—MOORE, 31, Monmouth Road, Dorchester. r.d.118**

**BEEES from reliable disease-resisting strain; 3- and 4-frame Nuclei and Swarms, also Queens, for early delivery.—CANDY, Worth Park Apiary, Crawley, Sussex. r.d.121**

**FOR SALE, May and June Swarms.—DEAR, Funtington, Chichester, Sussex. d.120**

**2-FRAME NUCLEI, 45s.; 4-frame, 55s.; Penna's Italian 1920 Queens; May-June delivery; boxes 10s., returnable; warranted perfectly healthy. "W.B.C." Hives and Apiary Supplies for Sale.—C. HOGAN, Boxford, Suffolk. d.124**

**PUPILS received by life-long whole-time Bee Farmer.—Terms on application to C. B. BARTLETT, Sandford, Mount Charlbury, Oxon. d.127**

**DUTCH AND DUTCH-ITALIAN 4-FRAME NUCLEI, May-June delivery, orders in rotation, £3 3s.; cash with order; carriage paid. See B.B.J., February 26, page 99, Conference of British Bee-keepers re Legislation. Read what the greatest experts say: Dutch-Italian Hybrids had been tried. The result was they were quite convinced they stand up against disease better than pure races. They hoped in a few years that a number of these little strangers will be within our gates. Also, it was worth while putting one's money on this strain—Dutch-Italian Hybrids.—SEALE, Ashley Cottage, Oatlands Drive, Walton-on-Thames, Surrey. r.d.81**

**INVICTA KENT BEEES.—Nuclei for Sale. Write for particulars, then, if satisfied, send 2s. 6d. deposit with order, balance June 1.—EDWARD GRISTWOOD, Cheriton, Folkestone. Same address 17 years. r.d.85**

**MISSES PALING AND PILLANS having combined and enlarged their Apiaries, are now prepared to book orders for strong 3-frame Italian Nuclei, massed with brood and bees, headed with 1920 Penna Queens or 1920 Queens of their own rearing from best selected Italian strains, £3, carriage paid. Speciality made in rearing choice Italian fertile Queens, 12s.; Virgins, 6s. Reduction on quantities. Pupils taken.—Golden Square, Henfield, Sussex. r.d.84**

**3-FRAME ITALIAN NUCLEI, frames crowded with sealed brood, 1920 Queen, no disease, £3 3s.; box 10s., returnable; carriage paid; cash with order. Initial cost slightly more than for some nuclei, but worth it. Satisfaction guaranteed or money returned. Full particulars free.—E. H. TUNMER, "Chalfonts," Leiston, Suffolk. r.d.83**

**HAVE YOU WINTERED 100 PER CENT.? If not, your strain must be wrong. Booking orders now for delivery June onwards. Hardy disease-resisting, home-reared Italians; splendid honey gatherers. Three-frame Nuclei, 1920 Queen, price £3 3s., carriage paid; 7s. 6d. refunded on box if returned carriage paid Saxilby Station. Terms: Cash with order. I will refund 10s. on all orders not despatched before July 1.—HERBERT VALLEY, Apiarist, Saxilby, Lincoln. r.d.92**

**HAVE YOU READ "THE BEE WORLD"? If not, why not? Every number in itself is a useful literary work for practice and reference. Specimen copy free.—Offices: THE APIS CLUB, Port Hill House, Benson, Oxon.**

**ORDERS booked, for 3-frame Nuclei, Fertile Queens, Virgin Queens, etc. List for stamped, addressed envelope.—H. CRACKNELL, Mount Road, Thundersley, Essex. r.d.27**

**BOZZALLA tested Queens are sold at the price usually charged for untested queens.—Catalogue from H. STICH, Riccartbar Avenue, Paisley. r.c.116**

**ITALIANS.—Queens, 6s. Book now. Stamp.—HOUSTON, Ellen Villa, Sidcup. r.d.90**

**PENNA strain Italian Queens, from June 7.—ASHWORTH, The Bungalow, Weymouth Street, Warminster. r.c.82**

**WATERPROOF RUBBER SHEETS** for covering outhouses, etc., 72in. by 36in., brass eyelets, 12 for 20s.—**SAGARS STORES**, Ardwick, Manchester. r.b.16

## Italian Stocks.

OUR 10-bar Italian Stocks are now ready for delivery. Free from disease. Cash with order. Carriage paid.—**D. ALLBON & CO.**, Sunny-side, Hitchin. d.123

### BEE FLOWER SEEDS.

Collection of six best Varieties, 1s., post free.

Beautifully Illustrated, Instructive, Up-to-date Garden Guide, 64 pages, Free.

### KNIGHT'S,

Seed Specialists, WOLVERHAMPTON.

### HIVES AND ALL YOUR REQUIREMENTS.

Quality A. Quick delivery.

Write for prices to—

L. ANDREWS & CO.,  
Joinery and Carving Works,  
7&A, WESTGATE, PETERBOROUGH.

d.126

## Dutch Bees.

I have been appointed **Sole Agent** for Hans Matthes, the Dutch Bee Farmer who supplied the British Government last season with Skeps for their County Re-stocking Scheme. Hans Matthes also supplied me with what Skeps I required last year.

Last autumn I got a large consignment over from Holland, and am presently wintering these at my Apiary here.

To those desirous of testing these Dutch Bees, I will be pleased to send on my Illustrated Catalogue, containing much information regarding the hardiness, prolificacy, disease-resisting, and honey-gathering characteristics of this race of bee.

Address—

**R. WHYTE,**

The Bee Farm,

**Cumbernauld, Dumbartonshire.**

## BOWEN ITALIANS HYBRIDS

BOOK NOW FOR MAY DELIVER.

8 Comb Colonies	...	...	93/-	<i>Artistic Booklet Free ::</i>
6 " "	...	...	71/-	
3 " Nuclei	...	...	45/-	

Lt. A. H. Bowen, Bee & Queen Specialist, Coronation Rd., Cheltenham.

## BRADBURY, TAUNTON,

FOR QUALITY BEE GOODS.

*Illustrated Bee Guide free.*

Telephone: TAUNTON 176.



## "BACTEROL" FOR BEES

2/6 per Bottle.

Post Free.

The cure for, and preventive of, "Isle of Wight" Disease. Non-poisonous—free from stain or unpleasant odour.

**MENLEY & JAMES, LTD.,**  
39, Farringdon Road, London, E.C.1.

## INSTRUCTION in BEEKEEPING PRACTICAL AND THEORETICAL

My Apiary will be open for a limited number of pupils during this season. Terms and particulars from

**W. HERROD-HEMPSALL,**

The W.B.C. Apiary, Old Bedford Road, Luton, Bedfordshire.

## S. J. BALDWIN.

I beg to inform that the No. 1 Kent Hive is not manufactured by me, only the No. 2 "Bromley Kent."

(New deep frame 17×14×12. Sample by post 6d.)

**THE APIARY, BROMLEY, KENT.**

# HIVES.

Compare the WORKMANSHIP and FINISH of our Hives.

All made by practical Men who know what a good hive should be.

In various designs to suit all tastes and requirements. Season's speciality—THE MANLEY HIVE for 16 in. x 10 in. Frames.

Full descriptions and illustrations in our 1920 Catalogue:

*"Everything for an Apiary."*

If you have not received your copy, send a P.C. at once.

OUR MOTTO — SERVICE & QUALITY.

**R. STEELE & BRODIE, Wormit Works, Wormit, Scotland.**



THE  
KEY TO  
YOUR SUCCESS.

## The Metal Foundation

(Protected)

The latest invention in Scientific hive equipment.

♦ ♦ ♦

Durable ♦ Economic ♦ Sterilisable

♦ ♦ ♦

An Ideal compromise between the Metal Comb and the Wax Foundation.

♦ ♦ ♦

¶ For further details and prices, send for our 1920 ILLUSTRATED CATALOGUE, post free on application. It contains detailed information on the most up-to-date hives and appliances for which the House of Lee is famous.

\*\* Five per cent discount to Members of THE APIS CLUB.

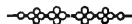

## JAMES LEE & SON,

LTD.,

Uxbridge, Middlesex,

(Telegrams : Graphicly, Uxbridge.)

Telephone : Uxbridge 181.)

## 20-Page 1920 "WHITE STAR" List,

3½d. POST FREE.

S. SIMMINS, QUEENLAND, HEATHFIELD, SUSSEX.

Look after your profits by buying hives and appliances which are easy to work. I endeavour also to give good value by care over the workmanship. Send for catalogue.

**EDWARD J. BURTT, Manufacturer, GLOUCESTER.**

*Commercial (16" x 10") frames and brood boxes stocked.*

PRINTED BY THE AVENUE PRESS (L. UPCOTT GILL & SON, LTD), 55-57, DRURY LANE, LONDON, W.C., AND PUBLISHED FOR THE PROPRIETOR (W. HERROD-HEMPHALL), BY SIMPKIN, MARSHALL, HAMILTON, KENT & Co., LTD., 31 & 32, PATERNOSTER ROW, E.O.



No. 1976. Vol. XLVIII

MAY 6, 1920.

[Published every Thursday, Price 2d.

**CONTENTS.**

	PAGE		PAGE
THE USE OF TWO BROOD CHAMBERS .....	217	PONTEFRAC T AND DISTRICT BEE-KEEPERS .....	224
" FARM LIFE " AND THE ISLE OF WIGHT BEE-KEEPERS' ASSOCIATION .....	217	GUILDFORD AND DISTRICT B.K.A. ....	224
A DORSET YARN .....	218	KENT B.K.A. ....	224
JOTTINGS FROM HUNTINGDONSHIRE .....	219	ROYAL SHOW FUND .....	224
RUNCORN NOTES .....	220	CORRESPONDENCE—	
SUSSEX SCRAPS .....	220	Natural Stores r. Sugar Feeding .....	225
QUESTIONS FOR BEE-KEEPERS .....	221	School Bee Clubs .....	225
NOTES ON BEE-KEEPING .....	222	Wiring Frames .....	225
SUPPLY OF ITALIAN QUEENS, 1920 .....	223	Co-operative Bee Clubs .....	226
TO WILTSHIRE BEE-KEEPERS .....	224	NOTICES TO CORRESPONDENTS .....	226
		BEE SHOWS TO COME .....	226

## ALUMINIUM DRAWN OUT COMBS.

# " MONEY COMB "

*The greatest invention in the Bee World for 40 years.*

This is a drawn out Comb of Hexagon Cells exactly as bees build in their natural state. It is slightly coated with wax, has been thoroughly tested, and is not an experiment. Bees readily take to it for rearing brood and storing honey. Strong and durable, will last 50 years with care. Big consumption of honey saved to produce wax for comb building.

Control of bee diseases. No more burning of combs. Each comb easily sterilised and used over again.

Send for Catalogue and descriptive Leaflet.

1920 Catalogue post free

Patented by ALUMINIUM HONEY COMB CO., of U.S.A.

SOLE MANUFACTURER AND LICENSEE:

**E. H. TAYLOR, WELWYN, HERTS.**

# THE British Bee Journal

ESTABLISHED 1873.

A Weekly Journal Devoted to the  
Interests of Bee-keepers.

Edited by T. W. COWAN, F.L.S., &c.,  
and J. HERROD-HEMPSELL, F.E.S.

**Correspondence: Whom to Address.**—All matters relating to the Literary Department, Associations, Shows, etc., should be addressed, "Editors, *British Bee Journal*," and all business communications and matters relating to subscriptions and advertisements to be addressed to the "Manager," *B.B.J.* Office.

**Subscriptions.**—Annual Subscription, 10s. 10d. post free in advance; single copies 2d., or 2½d. post free. If a receipt is required by post, a stamped and addressed envelope must be sent, otherwise a printed receipt will be enclosed along with the paper.

*Note.*—Cheques and Postal Orders should always be crossed, otherwise it is very difficult to trace them if they go astray.

**How to send Money.**—Remittances can be made payable to W. Herrod-Hempshall by crossed Cheques and Postal Orders. Stamps may be sent for small amounts up to 2s.

*Halfpenny stamps are preferred.*

Scottish or Irish cheques can only be taken in payment if 6d. is added for commission charged by banks for cashing them.

The Editors are not directly or indirectly interested in the manufacture or sale of beehives or appliances of any kind, and must refer correspondents wishing for prices or catalogues to advertisers in the paper.

## OUR DEPOSIT SYSTEM.

You are advised to insist on this being used when dealing with strangers.

### Rules and Conditions for Depositing

*In order to save trouble, it is requested that the Rules be carefully read over by persons using the Deposit System of trading.*

Goods should not be despatched until notice that the money has been deposited is received from this office.

**1. Method.**—When strangers are dealing together, the purchase-money of the articles is deposited at our office. We acknowledge receipt of the deposit to both parties, and hold the money until we are satisfied that the purchase is concluded. If a sale be effected, we remit to the seller the amount deposited, less a charge of 2½ per cent. in the £, with a minimum of 6d., and the expenses of Post Office Orders and postage, &c. Cash will be forwarded by Cheque, Post Office Order, or by Postal Order as preferred. If a sale or exchange be not completed, we return the amount deposited, after making the same deduction. By this means buyers and sellers are secured against fraud.

**2. Deposits.**—Postal Orders (drawn on General Post Office) and Cheques must be made payable to W. Herrod-Hempshall, and crossed "London County and Westminster Bank." The numbers of the Postal Orders should be kept by the sender. We cannot be responsible for any loss that may occur in transit.

**3. Honey on Approval.**—All honey will be sold by sample, which must be sent direct to buyer.

**4. Bee Appliances.**—In ordering, the time allowed for completing the order to be stated to us when sending cash. If maker accepts, we hold cash until transaction is satisfactorily completed, when the amount will be remitted, subject to conditions as in Clause 1.

**5. Bees and Queens.**—These will be dealt with entirely by the parties concerned, so far as price, &c., go, and when the purchase is satisfactorily completed cash will be remitted as per Clause 1.

**6. Goods in Transit.**—These are at the seller's risk, i.e., any damage to or loss of an article on its journey is borne by the vendor; but a rejected article must be properly packed and returned by the same means as was used in sending it.

**7. Carriage.**—The carriage of all goods, *except such as are sent by post*, is payable by the buyer, unless otherwise agreed. If any article sent on approval be returned, each party to the transaction must pay carriage one way.

## Books for Bee-keepers

NOW IN STOCK.

Cash in full must be sent with order.

	Postage	
A Modern Bee Farm ... ..	7/6	6d.
A B C & X Y Z of Bee Culture (ROOT) ... ..	15/6	9d.
Advanced Bee Culture (HUTCHINSON) ... ..	6/-	6d.
Beginner's Bee Book (PELLETT) ... ..	5/-	4d.
<b>BEE-KEEPING SIMPLIFIED FOR THE COTTAGER AND SMALLHOLDER</b> (W. HERROD-HEMPSELL, F.E.S.) ... ..	1/-	1½d.
<b>BEE-KEEPERS' PRACTICAL NOTE BOOK</b> (T. W. COWAN) ... ..	1/-	1½d.
<b>BRITISH BEE - KEEPERS' GUIDE BOOK</b> (T. W. COWAN) (paper covers only) ... ..	2/6	3d.
<b>Dissectible Model of Queen Bee</b> ... ..	4/6	3d.
<b>FERTILISATION OF FRUIT BLOSSOMS BY BEES</b> (T. W. COWAN) ... ..	-/3	1d.
<b>Fifty Years Among the Bees</b> (MILLER) ... ..	6/-	5d.
<b>Honey and Health</b> (A. HOPE) ... ..	-/6	1d.
<b>Honey Vinegar</b> (REV. G. BANCKS) ... ..	-/2	1d.
<b>How to Keep Bees</b> (ANNA B. COMSTOCK) ... ..	5/-	1d.
<b>Management of Out Apiaries</b> ... ..	3/-	2d.
<b>Pollination of Fruit in relation to Commercial Fruit Growing</b> (C. H. HOOPER, F.R.H.S.) ... ..	-/6	½d.
<b>PRODUCING, PREPARING, EXHIBITING AND JUDGING BEE PRODUCE</b> (W. HERROD-HEMPSELL, F.E.S.) ... ..	2/-	3d.
<b>Productive Bee-keeping</b> (PELLETT) ... ..	10/6	6d.
<b>Queen Rearing in England</b> (F. W. L. SLADEN) ... ..	1/6	2d.
<b>Scientific Queen Rearing</b> (DOOLITTLE) ... ..	4/-	3d.
<b>Snelgrove's Method of Re-queening</b> ... ..	-/6	1d.
<b>The "Townsend" Bee Book</b> ... ..	2/6	2d.
<b>WAX CRAFT</b> (T. W. COWAN) ... ..	2/-	2½d.
<b>Wilke's Book on Swarming</b> ... ..	1/-	1½d.

### MISCELLANEOUS.

<b>Maeterlinck's Life of the Bee</b> ... ..	3/6	3d.
<b>The Lore of the Honey Bee</b> (TICKNER EDWARDS) ... ..	2/-	2d.
<b>THE BEE WORLD</b> (supplied only to members of Associations interested in the control and development of the APIS CLUB, apart from ordinary members of the latter), per copy ... ..	-/8	1d.

British Bee Journal & Record Office,

23, BEDFORD STREET, STRAND, LONDON, W.C.1.





## The Use of Two Brood Chambers.

We promised last week to make a few notes on the letter on size of frames (10174, p. 213) by Mr. Morris. We have not yet read any argument to cause us to alter our statement with regard to the space between two sets of brood combs hindering the queen. We have not, and do not now say the space will make *no* difference. How much it hinders will depend partly on the queen. We have more than once known queens penetrate and spoil two racks of sections, and we venture to think any queen that will do this, or even go up into one rack of sections, would not allow the space between two sets of frames to hinder her activities in the slightest degree. The matter is easily tested. Let any bee-keeper put on a super of shallow combs without a queen excluder, and see how long it will be before the queen goes up. To carry the argument a little further, let us consider the expansion of the brood nest from the time breeding commences in the early weeks of the year. The queen will be somewhere in the centre of the cluster of bees, and will there commence to lay. The area of comb containing eggs and brood gradually expands, the cells on one side of the two combs facing each other being utilised. After a time the patches of brood extend to the limit covered by the cluster of bees. Normally this cluster is spherical, and may extend over three or four combs, but will not cover them to the ends. As the brood area increases, bees from the outer combs must come towards the centre, so that the cluster becomes elongated parallel with the combs, but eventually a limit to this form of expansion is reached, and it becomes necessary for the queen to transfer her activities to the other side of one of the combs. How is this to be done? It is very seldom there is a bee-way through the comb, so the queen must either go over the top bar—if there is a bee space—or under the bottom, or round the end of the comb. To quote Dadant, from top of second column of Mr. Morris's letter: "It is true they finally do it, but how much time is lost in hesitating and hunting can hardly be guessed." The logical conclusion would appear to be that an ideal home for the bees would consist of two combs only, the inner portion to be used for brood rearing, and the outsides for honey. The same thing goes on all summer, but the queen is prevented from going over the frames, first by a close-

fitting quilt, and later by a queen excluder, unless the latter is in a frame. Which is the greater impediment—to travel up or down a distance at the very utmost of  $1\frac{1}{2}$  in., or over a stretch of comb, possibly containing honey, round an end, or bottom bar of the frame, and back an even further distance on the other side of the comb? "It is true they finally do it," but we are not in the least convinced that the space between top and bottom bars is the hindrance it is sometimes claimed to be. Our greatest objection to two brood chambers is still the difficulty of manipulation, especially when it is necessary to find the queen.

J. H. H.

## "Farm Life" and the Isle of Wight Bee-keepers' Association.

It is not often that contemporary publications take the trouble to rap the knuckles, of those who show their ignorance of bee-keeping, and also fail to appreciate the Government's endeavour to foster the industry. The following is the copy of a resolution proposed by Mr. J. W. Gillespy, at the annual meeting of the Isle of Wight Bee-keepers' Association:—

Following the announcement by the hon. secretary that the Education Committee would receive orders for pure Italian queen bees imported by the Board of Agriculture with the object of securing a healthy stock of bees, Mr. J. W. Gillespy moved that a resolution be sent to the Bee-keepers' Association in London and the Board of Agriculture absolutely condemning such importations. He said the idea of putting Italian queen bees with Dutch varieties to form a useful and healthy stock was sheer humbug. They wanted no foreign bees at all. They had the best bees in the world, and if they were properly looked after there was no great danger from the disease. The crossing of Italian and Dutch bees would produce the most vicious and useless stock possible (hear, hear).—Mr. Lewis seconded, and the proposition was carried.

He is taken to task in *Farm Life*, the *John Bull* of agricultural journals in "The Epistles of Giles" in the following amusing and candid letter, to which, we say, "serves him right."

To Mr. J. W. Gillespy, Bee Expert, Isle of Wight.

Dear Mr. Gillespy.—If people who live in glass houses shouldn't throw stones, neither should people who live in the Isle of Wight make sweeping remarks about bee disease and its treatment.

Although I fancy that the Isle of Wight

disease was first discovered in modern times in Buckinghamshire and not in the island at all.

They say it was known a long time before that, however.

A learned friend once told me that a bald-headed old gentleman with whiskers, called Homer, was very much upset by the condition of his apiary some thousands of years ago.

He wrote verse on it, I believe.

They say that the people round about Hymettus were nearly as worried about it then as they are to-day at 4, Whitehall Place and 72, Victoria Street.

And they had no Herrod-Hempsall to get them out of their difficulties.

Nor (still worse luck) had they anyone so wise as Mr. J. W. Gillespy to tell them what not to do.

Some folks collect butterflies; some algae; I have made a hobby of collecting bee-keepers.

They are the most amusing little creatures imaginable—especially when they perform at flower shows inside those large gauze nets.

Ultra-patriotic bee-keepers are even funnier than the other sort.

I am not quite clear whether you are merely an Isle of Wight sort of patriot or a moralist.

Nor do I understand the exact sense in which you use the word "vicious" as applied to Italian and Dutch bees.

I have kept both kinds myself and found them thoroughly respectable.

Naturally, I agree with you that our native black or brown bees are the best in the world—or rather they were, before they were dead.

But when you say "we want no foreign bees at all," will you kindly in future speak only for yourself. Most of us have foreign bees or none.

The Ministry of Agriculture has been more than justified in its bee policy.

This policy judged merely as a part of the fruit production programme of the country must have returned thousands of times its own cost.

A year ago a few silly old gentlemen might have taken some notice of what you say on the subject.

Nobody who knows anything about bees will do so to-day.

The Ministry, if it has not actually saved the honey industry here from extinction, has taken a worthy part in stimulating it to renewed activity.

In short, I disagree with you entirely.

This will not astonish you, perhaps.

Did you ever know any bee-keeper to agree with any other bee-keeper on any point except the entire ignorance of a third bee-keeper.

But then in the North Country, I understand, they have a theory that nobody ever keeps bees unless he has "a little bit off the top."

Your fellow bee-keeper,

GILES.

## A Dorset Yarn.

Flowers for bees at the farm are still at their best. Lane's Prince Albert apples are opening, early flowering ones are losing their petals, the need of the alluring colouring has passed; Northern Spy, another late apple, has not showed a coloured petal yet, but they are always late in opening. Bees are on fruit trees and bushes all the time. A 200-yards line of *Limanthus Douglassi* (sent me by Mr. Harwood), plants 15 in. across, full of flower, but not a bee on it; raspberries and currants have the bees all the time. As soon as the flowers open bees are with them, but why they should not go to the *Limanthus* as soon as the flowers are open is a problem too difficult for me. Last year in May it seemed to have a bee in every flower. A breadth of turnip the other side of the hedgerow has thousands of them on the flowers; they all seem to go with the greatest number. They have not left the gooseberries; they seem to want to get all the nectar from every late flower.

We took out two bars of fresh-gathered honey. It was not entirely finished, but the greater part was capped; the flavour was excellent, but it would have been difficult to extract, it was so very thick. When cut out and still warm, it did not readily run out of the cells; it must be from willow and gooseberries, as that is the most early bloom they could get. Under a powerful glass the shiny nectar can be seen in both currant and gooseberry; each has the five petals, the small sepals, and five stamens, with the one pistil; the shiny substance cannot be fine rain or dew, as the flowers are pendulous; could not see any in the *Limanthus*—it may want age in the blossom to develop the nectar. It is so with fruit blossom: many of the stamens that carry the pollen have passed their best before the pistiliferous organ is perfect for fertilisation. The *Limanthus* open upright to the heavens; they would have the fine rains in the blossoms. Bees know their business of food hunting better than the Dorset yarker. Cows always go to the best pasture first. Horses will eat very close some parts of the fields, and leave large patches severely alone. Bees go to the flowers where they know there is abundance of nectar; when the best is over they will go to what is next best. Still, it is most

interesting to see the plants that bees like at different seasons.

The deduction I make is that certain flowers have nectar as soon as they open, and that others want age, or sunshine, to develop the nectar in the blossoms. We have no real warm sunshine this season, and the bees have not had so many fine days to get stores. Those of us who have fruit blossom close to the hives are fortunate. A bee-keeper in Parkstone writes that his bees are short of food, his first lot in a skep, and he is afraid that they will go under. He has just bought a bar hive for £3. He naturally does not want to lose his bees, but in the heather districts there is not the early food for bees, and they will not go far from the hives when the weather is not fair. He must feed them, if there is a lot of brood to cover and weather is against them searching, and the queen will not lay a great number of eggs.

Bees are building up; we have only one lot working in sections, but freely on bars, yet all the racks had some sections with honey in them, and many partly drawn out, that were left from last year. One lot which is very strong (a late swarm) has had a rack on all the winter; there were only a few in the centre that were capped, the others only partly filled. The capped ones were not emptied, but the others were emptied and the honey carried below. The only covering this lot had was a Porter escape board on top of the rack; it now has a glass cover, so that the bees may be seen. It shows that great quantities of nectar are used for the brood in the month of April.

One lot of Italians are covering a rack of standard bars above the brood chamber, but a very small belt of honey on the tops of brood bars; they seem to fill every available space with brood. I am anticipating a fine lot of surplus from these.—  
J. J. KETTLE.

---

## Jottings from Huntingdonshire

Not all the cold winds and occasional night frosts have succeeded in holding the bean blossoms in check. They are flowering apace, their pungent perfume fills the air, and the bees are unable to resist visiting them. Every opportunity is seized by our insect friends to go forth and gather food for themselves and their young. Warm spells come along now and again, giving the bees time to take their fill and carry a little home. Very strong stocks are even able to continue storing in the supers. Those of us who want a swarm or two will not have to wait long as soon as the weather improves, which it will do soon. In this

part of the country we are hoping that the change in the weather will be gradual. A sudden change to hot, sunny days will bake the crust of the ground, crack the pasture lands, and cripple growth in field and meadow.

I've met with Maypest this year for the first time in my experience. It was quite pathetic to watch the afflicted insects in their struggles to take flight. They climb blades of grass, and attempt to take wing, but they fail and fall to the ground. After repeating the process two or three times they give it up, and crawl aimlessly about. Poor things—night comes on, they cluster together and die. This is a disease that will yield to treatment; it will even pass from a hive without special attention; but it should not be treated too lightly. Many people, I find, have been distressed by this same complaint this year. To see bees crawling about is enough to make a bee-lover's heart sink; at once one dreads the worst, and fears "I.O.W." disease, and what a relief it is when one can assure them that it is something not quite so serious.

Some months back I mentioned the Holmewood strain of bees. May I once more ask all who have any stocks of this interesting bee to be so good as to communicate with me. Exchanging of queens, or swarms, might be arranged, which should benefit all parties concerned.

"Where ignorance is bliss, 'tis folly to be wise." How true! The latest type of ignorance is a man who claims to know something of bees, having ordered an Italian queen through the Ministry of Agriculture, and is declaring that the queen and her attendant bees only need to be placed in a small hive or box and they will build up a stock. I hope no other person will be foolish enough to attempt this; it passes comprehension that the most uninitiated person should think such a thing possible. It is most surprising the ignorance one comes across now and again. A man asked a little while ago which was the best day to go to London. He had never been to London, and he was hoping to go soon; could I tell him which was London's busiest day. Evidently his idea of the great city is that it is a glorified market town. We can smile at this, but when ignorance enters the bee world one feels sad. Hasten the day when our County Councils or Education Committees will take steps to give at least elementary instruction in bee craft.

I see in one of our daily papers some one writes to say that the "Isle of Wight" disease is described in Virgil's "Georgics." To what does he allude? Virgil was a great writer and a fair ob-

server, but one would not feel inclined to follow a man who had not discovered the origin of a swarm. Granting bees in Virgil's day were carnivorous, it is quite certain that he hadn't discovered that the bee and the drone fly were distinct species of insects. Fancy bringing a fat young ox to get a swarm of bees! Oxen must have been cheap in Virgil's day!

Silly letters to the Press do not help bee craft; they only bring ridicule upon the writer, unless, indeed, which may be not unlikely, such writers delight in pulling the Editor's leg.

At the moment of writing a strong south-westerly gale is blowing, yet the bees seem happy enough. The wind, though strong, is warm. One feels sorry for those bee-keepers farther north, where south-westerly winds invariably mean rain. I would say cheer up! there is a good time coming, and with sugar prices soaring honey should be in great demand this year.—E. F. HEMMING, Steeple Gidding.

### Runcorn Notes.

Bees working in shallow frames in Huntingdonshire, Mr. Kettle anticipating plenty of sections in May, and *The Times* trotting out the announcement of a swarm from a hive in South Bucks last week are enough to make one break the tenth commandment, especially as one's own bees have only had four days in five weeks in which they could be really busy, and are still closely acquainted with a feeder. Perhaps our time will come later on; at any rate, I hope so. I wonder how friend Lythgoe of Padgate, is faring? He is not more than ten miles distant, but he is not so near the chemical factories of Widnes. What difference does that make? Why, just this: One's bees are busy on some particular blossoms. The wind shifts to N.N.W. (a favourite quarter for it to blow from here), and the biting, acid-laden fumes from a hundred-and-one tall chimneys smite the tender blossoms like a curse. They shrivel up and die almost in a night, and that source of honey-supply is gone, and the tender leaves in the beautiful green dress of spring look as if one had been throwing scalding water over them. Some trees withstand this better than others. Pear-trees resist it much better than apple or plum. Sycamore are great sufferers, so are the beautiful horse-chestnuts. One has to bear these things and keep on smiling, draw what comfort one can from being told "it's not nearly so bad as it used to be," and fervently wish that the wind keeps south of west and east.

*Re* Mr. Kettle on the honey-yielding

quality of the common willow. I remember, when I lived in a "land of rivers of water," and the "willows by the water-courses" were a distinctive feature of the landscape, my bees fairly loved them, forsaking plums and pears to gather the salicylic-acid impregnated nectar from the genus *Salix*. I have noticed the peculiar odour of this drug in hives where this honey has been stored in quantity. Has anyone else?

Mr. Hipkins' observations and remarks are worth noting. Most people, bee-keepers included, are very apt to form conclusions from incomplete observations. It is always wise to make sure of all apparent facts before drawing conclusions. We have all heard the yarns he quotes, and have, some of us, gone to the trouble of disproving them; but the average reader of the daily Press would not.

That it is time some decisive steps were taken to have all honey exposed for sale labelled with the country of origin, and, in the case of British honey, probable source from which gathered. I offered some honey to a greengrocer lately, who readily bought it, and told me he had some while since bought £20 worth of "Antwerp honey" in kegs. He showed me a sample. It was beastly stuff. I doubt whether my bees would have had it if fed to them. Yet it was retailed at 2s. per lb. Definite weight of package ought also to be insisted on.—D. J. HEMMING, Runcorn.

### Sussex Scraps.

The bee-keepers in that corner of Sussex which is the part of Tunbridge Wells known as Broadwater Down (the rest of the town being in the county of Kent) number six, and muster a total of twenty-three hives. Some of us, myself being one, are only beginners, but we are all tremendously keen. We are very well favoured in the matter of "honey-country," as there are many large gardens around, with plenty of fruit-trees and flowers, many fields containing white clover, a glorious avenue of lime-trees, and a mile and a half away there is a tract of heather-land, known as Broadwater Forest. Last year the drought in early summer, and a rather rainy fortnight when the lime blossom was out, somewhat militated against a good crop of honey, but some hives gave us a return of from 30 to 40 lbs. We did our best to keep our bees as Italian as possible, but our young queens seem to have found drones of another colour on their mating flights, as most of the stocks now show very little sign of Italian blood. We know of three lots of "wild" bees in a house roof and hollow trees not far away, so

perhaps they were responsible for this change. I learnt one or two lessons by sad experience last year. One was this—when removing a super at the end of the season from a hive well crowded with bees always put another super in its place to provide room for the bees. Omitting to do this to two hives which I had Porter-boarded the same Saturday, I found on my return home the following Monday morning that, obviously owing to the congestion in the hives, large swarms had departed. It was rather late to rear queens, so I purchased two, but they had laid no eggs by the closing-down time for the winter, so the stocks are none too strong at the present time.

In order to get full advantage of the heather on Broadwater Forest I took a hive over there in August, but my method of transit—viz., a hand-cart—proved so shaky and jolty that I think the bees in alarm must have balled the queen, as there was no sign of her presence from that day forward, so this hive had to be re-queened, and as a result it also was not up to such full strength as one would like to see for wintering. Next time I shall adopt the more restful method of transit for the bees which I used in bringing them home, viz., slinging the hive between two bicycles, one of which a friend pushed along.

I had a great adventure one bitterly freezing, cold day. I was moving a single-walled hive, with the help of a lad, to another part of my garden, when, unfortunately, he dropped his end, and the hive fell to the ground on its side, the roof came off, and all the frames of comb fell out. Luckily, I had a new vacant W.B.C. hive which I speedily brought to the scene of the disaster, and transferred to it all the tumbled combs except one, which had broken away from the frame in the fall. After packing it up, I brought the hive indoors, and stood it in front of a fire for an hour, in order to get the temperature up, having placed perforated zinc over the entrance, and then with a hot-water bottle on top of them, I put the bees back into the garden. Many of them came out for a flight on a warm day since, so I conclude that all is well. The number of casualties at the time was very small, so I came off better than I deserved!

By the way, having read that after a fortnight's incarceration bees can be safely moved to a new stand, I tried moving three hives to another part of the garden after the inmates had had three weeks of incarceration owing to the cold and wet weather. I put laurel boughs near the entrances to warn the bees that "something was up," but when they came out one warm day back they went to the old positions, so I had to hastily replace

the hives to where they were before.  
*Moral*—Don't believe everything you read about bees.

One of my most exciting mornings last year was when I made the discovery, in examining a hive from which a swarm had just issued, that there were no fewer than fourteen young queens just out, or just about to come out, of their cells! It was very sad not having kingdoms (or queen-doms) for them to go to, but, anyway, I was able to make use of two of them.

Well, we are hoping for great things this year. Some of us are keen on the idea of larger frames and metal foundation, but the need of having to get new hives in order to use the larger frames seems to be inevitable, so I fear we can't do anything in that direction yet awhile. I have read that *deeper* frames are not considered satisfactory, as the combs are likely to sag and break with the extra weight, or else one might use ekes under the brood boxes. We should much value your opinion on this subject.—J. F. A. WICKSTEED, 43, Broadwater Down, Tunbridge Wells.

[The combs in deeper frames are no more likely to sag or break than those in the longer frames.—EDS.]

### Questions, etc., for Bee-Keepers for Self-Examination.

(Students are recommended to write their answers, and check them afterwards by reference to books.)

493.—State the object and describe exactly the method of fitting foundation in sections, whether full sheets or otherwise.

494.—How are combs uncapped for extracting? Explain as to a beginner.

495.—Describe a division board, and state the circumstances in which it is used.

496.—What sources of pollen and of nectar are the earliest in the year in your locality?

497.—Mention the conditions which must be present when an artificial swarm is made.

498.—What may be expected to happen to a colony should it lose its queen in winter?

499.—Compare the different kinds of bees from the point of view of the bee-keeper who works for sections only.

500.—Why is it considered preferable when giving an additional super to a hive to place it next to the brood chamber?

501.—What are the sources of honeydew?

502.—Make notes for a 15-minute lecture to beginners on "The Choice of Form of Hive."  
J. L. B.

## Notes on Bee Keeping.

When one wants to examine a stock of bees, it is quite a perplexity sometimes to know where to temporarily rest a frame of comb and bees after removal from a hive; especially is this so when the hives are not made large enough to allow a space outside the division board. Should a comb and bees be rested on the grass by the side of the hive quite a number of the younger members of the stock are left on the ground—possibly the queen. There is a comb-stand on the market to hang on the side of the hive, but this has the same disadvantage as resting on the grass—the queen is apt to drop on the ground. It will, therefore, be found handy to have a frame-stand to span the top of brood

very serious accident; in fact, it is so at any time.

A colony of bees that have lost their queen can be detected from outside as easily as from inside appearance, except when the season is late; it is then rather difficult. When a queen is lost or removed from a hive almost immediately the bees become restless, running up and down in all directions on the alighting board, flying a short distance from their hive and returning again at once; they seem to be in search of something they cannot find. Should there be any young larvæ or eggs in the hive, the bees will not carry on this search for any considerable time, but will commence making queen-cells with a view to rearing young queens, and when they have no chance of rearing a queen owing

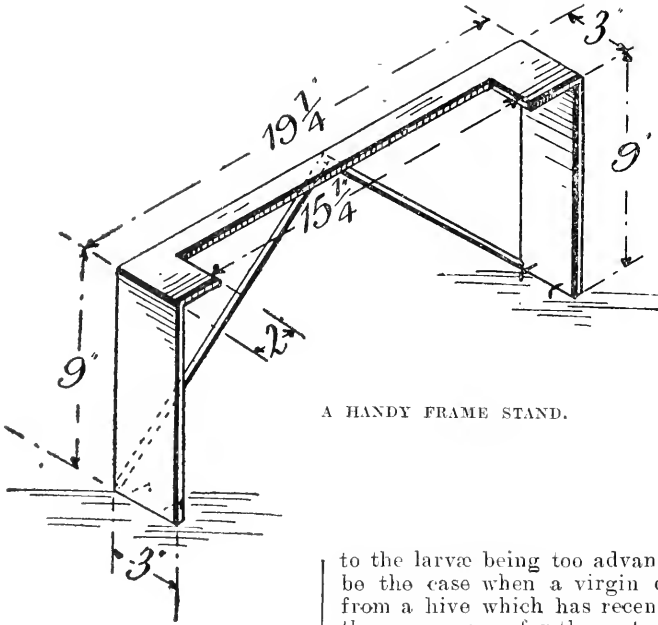

A HANDY FRAME STAND.

chamber. Should the bees, or queen, drop off, they then fall back into the hive again. Owing to the unfavourableness of the above-mentioned stand, I designed a home-made comb-stand, made of  $\frac{1}{2}$ -in. wood, to grip the top of brood chamber by four screw hooks, two on each side of the stand, 1 in. from the bottom, inside, and 2 in. apart. By kind permission of the Editor, I enclose a rough sketch of the stand, with all dimensions, should any reader care to make one. Any novice in carpentering can easily make one at very little expense. This home-made appliance enables the bee-keeper to spray both sides of the comb and bees without removing, and makes an examination of comb, bees, and brood quite easy, with both hands free. The loss of a queen from a hive before the honey-flow takes place is a

to the larvæ being too advanced, as would be the case when a virgin queen is lost from a hive which has recently swarmed, they are uneasy for the rest of their existence. They simply hang around the entrance, no work is done, a fit of laziness seems to pervade the whole hive, pollen is rarely carried in, or, if it is, in very small quantities, the pellets being about quarter the size. The bees instead of leaving the hive with a quick dart, listlessly crawl out, just take a little turn round, and make back again, no rushing or tumbling over each other as with a colony in a normal state, but a drowsy, sleepy look seems to possess the whole community. Of course, queens sometimes die naturally in winter, but upon the hive being opened in spring, the absence of eggs, or brood, is a sure sign that the bees are without their queen, and is easily noticeable even by the most casual observer.—P. LYTHGOE, Padgate, Warrington, Lancs.

## The Apis Club.

I was very pleased to read in the *BRITISH BEE JOURNAL* of April 15, the Editorial which spoke so strongly in favour of the "research, educational and co-operative institute" known as the Apis Club. There is always a great deal of thankless spade work to be done in promoting a new organisation, and curiously enough there are many persons who either damn such a proposal with faint praise, or who endeavour to strangle it in its infancy by callous aloofness. Consequently the help and encouragement given to the promoters of the Apis Club by your *Journal* must prove gratifying in the extreme to them.

It is probable that most of those who have attended the conversaziones of the British Bee-keepers' Association, will agree with me that the great attraction of these gatherings is not so much the paper read, or the discussion which ensues thereon, but rather the opportunity which is provided for having a chat with old bee-keeping friends, and for meeting from time to time those with whom we are only familiar by name as a result of seeing their articles in bee-keeping journals. Personally I find the time available for friendly chats at these pleasant reunions is always far too short, and I think it would be an excellent arrangement if the Apis Club could provide a suitable place in or near London at which members might frequently meet and discuss matters connected with bee-keeping.

There is one proposal in the suggested constitution of the Apis Club which some persons might be inclined to criticise, namely, that "Associates of the Club are members who secure its diploma in Bee Culture." One could imagine from this rule that there was to be set up a new examining Body; but I understand on inquiry that this is not to be the case. This diploma apparently will not be an alternative certificate to existing ones, but an additional qualification based principally upon original research work; in fact the candidature will probably be limited to those holding certificates from bee-keeping Associations. This very reasonable attitude is gratifying, because the British Bee-keepers' Association has conducted examinations in practical and scientific bee-keeping for many years, and it is generally recognised that their certificates are guarantees that the holders possess sound knowledge on the subject. Perhaps the Annual Conference of members may deem it wise to make the rule read "Associates of the Club are members who secure the diploma granted by the Club for original research work."

It is to be hoped that as many bee-

keepers as possible will respond to the invitation of the Editor of the *BRITISH BEE JOURNAL* to become members of the Apis Club, as the potentialities of such an organisation can hardly be visualised.

Enthusiastic co-operation will do wonders for any industry, and there is certainly ample scope for whole hearted combination in the bee-keeping industry, bearing in mind that at the recent conference of bee-keepers the Chairman, Dr. Keeble, stated that in 1918, the value of imported honey was about three times that of honey produced in our own country.

I hope the promoters of the Apis Club will forgive me for venturing to make a suggestion that bee-keepers who have not yet joined the Club will be invited to attend the Annual Conference of members which has been convened for May 29, at the Central Hall, Westminster, in order that they may learn about the objects and activities of the Club. They would not, of course, expect to take part in the voting, or even in the discussion unless invited to do so by the Chairman; but I am confident that a general invitation such as I suggest would be certain to enlist the support of many bee-keepers, more especially if a leaflet giving the objects of the Club were to be circulated at the meeting.

If this forward movement is to be a permanent success, as it certainly deserves to be, there must be enthusiasm on the part of bee-keepers generally, and more especially on the part of members of the British Bee-keepers' Association. May I hope, therefore, that many who are reading this brief communication from me will at once send an annual subscription of 10s. 6d. for membership to the Secretary of the Apis Club, Port Hill House, Benson, Oxon, which will entitle the contributor to a copy of the *Bee World*, the monthly official magazine which is issued by the Club.—J. B. LAMB, Chairman of the Middlesex Bee-keepers' Association.

---

## Supply of Italian Queens, 1920.

The Ministry of Agriculture has decided to endeavour to give bee-keepers a few days' notice of the despatch of their Italian queens. It is quite impossible to guarantee delivery on any specified date, as this depends entirely on the postal service between Italy and this country, and also on the number of queens that may arrive dead, or in such a condition that would not justify their being re-despatched.

Whether this preliminary notice is possible or not, however, bee-keepers will in all cases receive notice of the despatch of their queens from the Ministry of

Agriculture by telegram, sent at the actual time of despatch.

Printed instructions as to the best method of introducing these queens to stocks of bees will be sent with them.

### To Wiltshire Bee-Keepers.

In connection with the Bath and West, and Southern Counties Show, which is being held in Salisbury, May 20 to May 25, the Wilts County Council, and Salisbury and District Bee-keepers' Association, are holding an Exhibition of Bee-keeping Appliances, etc., and giving demonstrations.

On Saturday, May 22, Mr. W. Herrod-Hempsall is expected to be present and has promised to give a lecture to bee-keepers in the evening of that day at 6 p.m. in the lecture room of the Church House, Crane Street, Salisbury, on "How to make Bee-keeping a Success."

It is hoped bee-keepers of the county visiting the show, will do so on that date and attend the meeting, when matters of interest and importance relating to bee-keepers of this county will be discussed.

### To Bee-Keepers and Intending Bee-Keepers around Pontefract and District.

A semi-private lantern lecture on the Honey Bee, will be held in the Gospel Hall, Station Lane, Featherstone, on Saturday, May 8, at six o'clock, when any of the above are cordially invited. Copy of BRITISH BEE JOURNAL will admit two persons. Lecturer, Arthur Haigh, 1, Stanley Street, Featherstone.

### Guildford and District Bee-Keepers' Association.

A meeting was held on April 21 at the Guildford Institute, when about fifty were present. The chair was taken by Alderman W. T. Patriek. An interesting and helpful lecture on the elements of bee-keeping was given by Mr. J. W. Savage, who illustrated his remarks by a fully fitted hive. A hearty expression of thanks to the lecturer was proposed by Mr. H. G. Herbert, and seconded by the Rev. E. C. Pitt-Johnson, who urged those present who were not already members to join the Association, which has about fifty enrolled, but it is hoped that a large number of another eighty, with whom the Association has been in touch, will join. The Earl of Onslow has kindly consented to become the first President, and among the Vice-Presidents are Col. J. A. C. Younger, of Braboeury Manor, and Mr. Alwyn Parker, C.B., of Thursley. The Association are organising the Honey Show at the Guildford

Allotment Holders' Exhibition on July 17, with classes for members and also classes open to all. The next meeting will be on May 29, at 3.15, at the Guildford Institute, when the lecturer will be Mr. W. Herrod-Hempsall. A special appeal is made to each member to be present.—E. C. PITT-JOHNSON (hon. secretary).

### Kent Bee-Keepers' Association.

#### NORTHERN DIVISION.

A very successful meeting was held at the Apiary of Mr. S. Wakeley, Upchurch, on Saturday, April 24, by kind invitation of Mr. Bishop. The programme was Spring Management, and the Rev. J. Butler gave an instructive lecture on the subject, which led to a rather lengthy discussion on the advisability of strengthening stocks at this time of the year by taking brood from one or two others run for the purpose. Mr. Fry, of Gillingham, explained electric embedding, which proved very interesting, and after tea (which was provided by the Ladies' Social Committee) Mr. G. Bryden gave a demonstration on Manipulation in his usual able manner. The weather was favourable, and this, being the first outdoor meeting of the season, attracted quite a large gathering, which included Mrs. Leigh Pemberton, Capt. Tylden, Mr. S. Wilson, Mr. Cook, and other well-known bee-keepers.—(Communicated.)

### Royal Show Fund.

The Council of British Bee-keepers' Association are anxious to take their usual part at the Royal Show to be held at Darlington this year, so that their unbroken record of representation at this show may not be spoilt. In order to defray the expenses in connection therewith the Council ask that all bee-keepers assist in this work by giving donations, which should be sent as early as possible to the Secretary, 23, Bedford Street, Strand, London, W.C.2.

Subscriptions for this fund are coming in very slowly, and we would urge all those who can possibly do so to send a donation, however small. The sum needed is not, comparatively, large and if every one does a little should be easily forthcoming. "The Royal" is the show of the year, when the value of bee-keeping, and of the use of honey, to the community is brought to the notice of hundreds of people, and should the Bee and Honey Department have to be dropped for lack of funds, the loss to bee-keeping will be out of all proportion to the amount needed to carry on. May



we also urge all those who can do so to make an entry, and exhibit at the Darlington show. A good display will help both the show and the craft. We are sure our bee-keeping friends in the North are looking forward to a good display of honey, etc., at this year's Royal Show.

DONATIONS RECEIVED.

	£	s.	d.
Amount received	...	2	5 0



**Natural Stores v. Sugar Feeding.**

[10177.] I have read with interest Mr. Charles S. Greenhaugh's letter (10166), re "Natural Stores v. Sugar Feeding," in BRITISH BEE JOURNAL of April 15.

I thought it would interest readers to hear experiences of another advocate of the above.

When I started again last April in this district (Pershore Fruit District), there were very few bees about, as all had been wiped out with "Isle of Wight" disease during war. I was always convinced that if one took less honey away from the brood chamber, and avoided sugar feeding, the stocks would stand a better chance of wintering.

To take honey away and give sugar is like giving a baby milk and water instead of rich milk. There cannot be a substitute for their natural food—honey. Anyhow, I was determined to do this last autumn, and have wintered fourteen stocks, some of which I have not even fed up-to-date, on their own stores. Even the weakest are healthy, and have plenty of stores and brood.

We have had but one or two days when it has been safe to open a hive since Good Friday. Consequently when I went to examine them on Sunday, April 18, I found a splendid swarm on the grease band of an apple (bush) tree!!

It took me two hours or more to get them into a skep, and then as I hived them in the afternoon it rained and has done every day since, besides being cold.

They were a splendid lot, quite 3½ to 4½ lbs., though I did not have time to weigh them.

They are now in a small swarm hive I made, with two drawn out combs and three frames of foundation, all well covered with bees. I am feeding owing to bad weather, and they should be a

splendid lot soon, if weather will only clear up a bit.

I maintain (for what it is worth) that—  
1. Natural stores; 2. Warmth (good coverings); 3. avoidance of damp; 4. good "Bee Ways" over frames, go a long way towards successful wintering.—  
Geo. M. TURNER, Capt., Little Comberton, Pershore.

[Add to our correspondent's four points, a fifth, an abundance of young bees, and the conditions for successful wintering would be ideal.—Eds.]

**School Bee Clubs.**

[10178.] I have read with much interest the report of the Bee Club of Petersfield School, also your comments thereon. As a schoolmaster of a school with 415 on the roll, let me make two observations:—

I. There are many bee experts in this neighbourhood (my father among them), and I have a working knowledge of apiculture, too. My father visited our school and delivered a lecture to Standards VI. and VII. Prizes were offered for three best essays. Every encouragement was given by the staff, but no result occurred. Apathy exists in this as in many other directions, and it would appear a herculean task to form a bee club in face of this indifference. I have made attempts myself, and would do so again if I saw any chance of success.

II. Be that as it may, as a schoolmaster, I am inclined to wonder how many more things outsiders would like to see on our curriculum. To teach them all thoroughly is an almost impossible task as it is, but certainly some of the subjects could very well be dropped for practical instruction in apiculture. We are expecting a new headmaster shortly, then I will do my best to form a club.

This is not written in any spirit of criticism, but merely to point out the great difficulties that stand in the way.—  
ANOTHER HAMPSHIRE SCHOOLMASTER.

**Wiring Frames.**

[10179.] Now that so many bee-keepers are adopting the 16 by 10 frame, it would be useful to draw attention to an article by Mr. E. R. Root in February "Gleanings" on the subject of wiring frames. It is shown there that the ordinary four horizontal wires are not sufficient support for the foundation of a frame 9½ in. deep. It is shown that the cells near the top are slightly elongated, and that being neither worker nor drone cells the queen will not lay in them. He found that frames wired in the following manner had brood right up to the top bar, thus giving 20 per cent. extra space for brood

rearing, which tended to keep down swarming. The plan was to thread a wire through the hole at the end of the bottom wire, pass it over the centre of the top wire and out through the hole at the other end of the bottom wire. This extra wire is pulled tight drawing down the top wire a little and keeping it taut. This tightening of the top wire and the two diagonals formed by the extra wire give a very good support to the foundation and prevent any stretching.

It seems to me a mistake to put the horizontal wires at equal distances apart; they are needed closer together at the top than at the bottom. Suppose there are four horizontal wires 2 in. apart, and the lowest 2 in. from the bottom bar, then when the bees are evenly spread over the foundation there is four times as great a pull on the top wire as on the bottom one. I think the distance of the top wire from the top bar should only be one-quarter the distance of the bottom wire from the bottom bar, and the other wires spaced at increasing distances apart the further they are away from the top bar. --W. B. WALLACE, Lieut.-Colonel.

### Co-Operative Bee Clubs.

[10180.] I am pleased to report good progress, as the result of your kindness in publishing in the New Year number of THE BRITISH BEE JOURNAL, my co-operative bee scheme. It may surprise you and many other readers to know, that quite a large number have availed themselves of this co-operative scheme, all small bee-keepers, but all enthusiastic and keen for more knowledge on matters concerning how to manage their bees.

The difficulty with many is the need of demonstrative lectures. And no doubt the lack of sufficient knowledge is the cause of so many disasters among new beginners.—G. H. CLEWLOW.

## Notices to Correspondents

W. WILLMOTT (London).—*Larvæ turned out of the hive.*—We cannot say if the larvæ are drones without seeing them. The cause is usually shortage of food. Transfer the bees to another hive as soon as possible. If you want to try and get surplus from early bloom, put on a rack of sections. You may be able to make an artificial swarm later on when the colony is strong enough. It could be done when the bees need more room instead of giving them another rack of sections, but you must not expect much surplus honey if you work for increase.

"VERACITY" (Co. Wexford).—*Strength of Formalin solution for spraying.*—Only a weak solution must be used for spraying bees, a teaspoonful of a 40 per cent. solution to a pint of water. It may be syringed into entrance of hive. It would not hurt the honey at that strength.

F. W. ASTBURY (Birmingham).—The queen had not mated.

M. W. DROOP (Surrey).—See reply to M. S. Chamen, April 22.

F. T. T. (Monmouth).—(1) This would work all right. Payment should be for the weight of bees taken. Weigh your box before and after the operation, and the difference will give the weight of bees. (2) If the bees were only taken half a mile a number would return to the old location. The better plan would be to bring the combs and young bees to your apiary, and leave the artificial swarm on the old location. (3) We cannot say; probably only a few hours.

F. STRINGER (Plumstead).—Read "Bee-keeping Simplified" and "The British Bee-keepers' Guide Book," and, if possible, get in touch with a practical bee-keeper, who will give you a little instruction. Commence with a new hive, and either a nucleus or a swarm.

#### Honey Sample.

M. D. (N. Wales).—The honey is mainly from fruit. The flavour is fair, but the aroma is spoilt by a little ragwort.

#### Suspected Disease.

MRS. S. D. CARLISLE (Godalming).—We are unable to say cause of death. There does not appear to be any disease.

C. F. C. (Clare).—The bees have "I.O.W." disease. There is a little Italian blood in them.

MR. GILBERT (Cornwall), A. LINGHAM (Bexhill).—The bees showed symptoms of "I.O.W." disease.

W. GEORGE (Leeds).—The trouble is "I.O.W." disease.

"SWOLLEN BEES" (Northants).—The bees have "I.O.W." disease, and appear to be Dutch.

MISS BARKER (Ulverston), B. WRIGHT (Lyme).—The bees were too dry for diagnosis.

"ANXIOUS" (Bristol).—We think the trouble is paralysis.

## Bee Shows to Come.

*A nominal charge of 2s. 6d. is made for notices (not exceeding 7 lines) in this column, 10 lines charged 3s. 6d., up to 15 lines 5s., which covers cost of insertion from order till date of show. Cash should accompany orders for insertion.*

**June 2-5, at Reading.**—Royal Counties' Agricultural Society's Show. Hon Sec., 131, King's Road, Reading. **Honey entries close May 15.**

**June 9 and 10, at Colchester.**—Essex Agricultural Society. Classes for Extracted and Comb Honey, etc. Schedules from Secretary, Essex Beekeepers' Association, 7, Bulwer Road, Leytonstone. **Entries close May 31.**

**June 16 and 17.**—Hanley Park Meeting of the Staffordshire Agricultural Society. The Staffordshire B.K.A. offer valuable prizes and six silver medals and nine bronze medals. Twelve Classes for members only, and five Open Classes. (Honey Classes are for four or three jars or sections). Schedules, W. Griffiths Silkmore, Stafford. **Entries close May 29.**

**June 29 to July 3, at Darlington.**—Royal Agricultural Society's Show. Bee and Honey Section, under the direction of the B.B.K.A. Prizes arranged in groups of counties for Associations affiliated to the B.B.K.A. Schedules from The Secretary, 23, Bedford Street, Strand, W.C.2. **Entries close May 31.**

**July 6, 7 and 8, at Cardiff.**—Royal Horticultural Society's Show. The Glamorgan B.K.A., in conjunction with R.H.S., offer prizes for Honey, Wax, Bees, and Appliances. Members, Novices, and Open Classes. Schedules, Mr. Wiltshire, Malndy School, Cardiff. **Entries close June 22.**

## Special Prepaid Advertisements. One Penny per Word.

Trade advertisements of Bees, Honey, Queens, and Bee goods are not permissible at above rate, but will be inserted at 1½d. per word as "Business" Announcements, immediately under the Private Advertisements. Advertisements of Hive-manufacturers can only be inserted at a minimum charge of 3s. per lin., or 6s. per inch.

PRIVATE ADVERTISEMENTS are only intended for readers having Surplus Stock to dispose of. Driven Bees, Nuclei, and Queens that are reared or imported for sale, are Trade Advertisements, and can only be accepted under trade terms. A charge of 6d. extra will be made if a box number is used.

Advertisements must reach us NOT LATER than FIRST POST on TUESDAY MORNING for insertion in the "Journal" the same week.

Orders for three or more consecutive insertions in "The Bee Journal" entitle advertisers to one insertion in "The Bee-keepers' Record" free of charge.

### PRIVATE ADVERTISEMENTS.

**B**EEES FOR SALE.—A few Stocks of Penna's Italians and Hybrids from £5 5s. a stock, including hive; guaranteed healthy. Also about 150 BEE JOURNALS. What offers?—WIGGINS, 1, Swinderby Road, Wembley. e.1

**F**OR SALE, six Stocks of healthy Bees on 6 and 8 frames at 10s. per frame.—MAYES, Bennington, Stevenage, Herts. e.2

**F**OR SALE, two well-made W.B.C. Hives, with inner chamber, super and section rack, painted three coats, never been used, 45s. each; bargain.—W. F. ARNOLD, 242, Wimborne Road, Winton, Bournemouth. e.3

**150** LBS. pure Lincolnshire Honey for Sale, also Swarms. Wanted, Oil Engine, about 4 H.P.—WILCOX, Dyke, Bourne. e.5

**V**IRGINS from swarmed stock, black, prolific, 5s. 6d. each.—HILDRETH, 41, Three Shires Oak Road, Smethwick. e.6

**A** FEW Stocks of Bees, in well-made Hives, £5 each; empty hives, 20s. each, on rail Burgess Hill Station.—S. F. EDGE, Ditchling, Sussex. e.7

**E**XTRACTOR for Sale, barrel form, for two frames, without gearing, perfect condition, 40s.—PELLY, Witham, Essex. e.8

**M**AY SWARMS of Bees wanted, Italian or Italian Hybrids.—Offers to F. B. CHARLTON, Starkey Street, Stockton-on-Tees. e.9

**W**ANTED, Books on South African Bee-keeping, including Roots' "A B C and X Y Z of Bee-keeping."—W. THOMPSON, Lieut., R.F.A., 119, Parkdale Road, Plumstead, Kent. e.10

**S**COTTISH Congested District Board Hive, No. 3, like new, with all equipment, painted; cost 48s.; offers; room wanted.—POWELL, Selbourne Street, Walsall, Staffordshire. e.11

**O**FFERS requested for five healthy Swarms. Disease never seen here.—A. BUTLER, Tunnel Cottages, Pirbright, Surrey. e.12

**O**BSERVATORY HIVE, plate glass, three frames and super sections, solid walnut, with doors, £4.—FOUNTAIN, Lavender Road, Leicester. e.13

**F**OR SALE, 3½ cwt. pure English Honey. No reasonable offer refused to clear; must sell.—Box 83, B.B.J. Office, 25, Bedford Street, Strand, W.C.2. e.15

**T**WO complete W.B.C. Hives with frames, five other Hives and few Appliances, £7.—HASLER, Upper Downing, Holywell, Flintshire. e.16

**10**-FRAME Stock of Bees, Italian Hybrid, 84s.; carriage paid. Send your packing crate.—ROMER, 254, Kew Road, Kew Gardens. e.17

**F**OR SALE, two strong Stocks Hybrid Italians, 1919 Queens, £5 each.—EXLEY, Lamer, Wheathampstead, Herts. e.18

**F**OR Sale, six 10-frame Hives and Accessories.—BAKER, 6, Walsingham Road, Clapton, London. e.19

**F**OR SALE, six frames of healthy honey-fed Bees, never had any disease in apiary, £3 10s. and 10s. charged on travelling box, from which carriage of bees is deducted and balance returned to buyer.—REED, Primrose House, Heacham, Norfolk. e.20

**F**OR SALE, four nearly new Bee Hives, complete with body boxes and a lot of other Bee Appliances.—For particulars apply to H. E. PENNICK, Wellesley Road, Clacton-on-Sea. e.23

**F**OR SALE, two Colonies Italians, no disease, three Hives, Section Lifts, Frames, etc., 2-frame Extractor, side geared; owner going abroad; price £9 9s. Can be seen any Saturday, 3 to 7 p.m.—Apply, BEES, Dencliffe House, Church Road, Ashford, Middlesex. e.24

**12** GUARANTEED healthy Hybrid Italian Stocks, Penna strain, £5 each.—J. YOUNGER, 6, Maid's Causeway, Cambridge. r.d.145

**I**TALIAN HYBRID, healthy swarms, May and June, 30s.—H. ROBINS, 290, Priory Road, St. Denys, Southampton. r.d.146

**N**ATURAL MAY SWARMS, packed in straw skep, free on rail, £2 each.—E. PRESSEY, St. Elmo, Coulsdon. r.d.147

**S**EVEN 6-frame lots of Italian Bees, Penna's 1920 Queens, 63s.; five 4-frame lots, 45s. each; carriage paid; delivery early June.—"Earldoms", Ridgeway, Enfield. r.d.148

**C**ORRESPONDENCE COURSES in Bee-keeping.—H. E. NEWTON, Brown House, Barton-on-Sea, Hants. r.d.157

**I**TALIAN QUEEN, 7s. 6d., and 3-frame Italian Nucleus, 30s., booked for early delivery.—YOUNG, 29, Central Road, Sudbury, Middlesex. r.d.158

**W**ANTED, a Lecturer on Bees to accompany a Demonstration Train for seven weeks, commencing May 17. Sleeping accommodation and food found.—Applications, with salary required, to W. HERROD-HEMPSELL, W.B.C. Apiary, Old Bedford Road, Luton.

**S**WARMS for Sale, May and June, very healthy Stocks, price 30s.—MRS. BARRY, Home Place, Limpsfield. r.d.98

**300** SHALLOW wired Combs for Sale; no disease.—CRAWFORD, Apiaries, Castleberg, Co. Tyrone. r.d.112

**W**ANTED, from August 22 to September 4, in Cornwall or Devon, within 12 miles or so of sea, Bedroom and Sitting Room, with shed for motor car; farmhouse preferred. Can any bee-keeper oblige me?—W. HERROD-HEMPSELL, Old Bedford Road, Luton, Beds.

**F**OR SALE, two "Rotax Roadlight 267" self-contained Acetylene Motor Headlights, very powerful, £6 the pair; one Exhaust Whistle, 10s.; one Wood-Milne Motor Foot Pump, 40s.—HERROD-HEMPSELL, as above.

**W**ANTED, portable Greenhouse.—Price and particulars to W. HERROD-HEMPSELL, Old Bedford Road, Luton, Beds.

**W**ANTED, Auster Rear Wind Screen for motor car.—HERROD-HEMPSELL, as above.

**BUSINESS ADVERTISEMENTS.**

1½d. per word.

**4-FRAME NUCLEI**, 1920 Italian Queen, 50s.; box charged 10s., returnable; May-June delivery. £1 deposit with order. 6-frame Stocks, 70s.; 8-frame Stocks, 90s. Immediate delivery.—**L.EE**, "Little Bowden Apiary," Burgess Hill, Sussex. c.22

**PENNA QUEENS**, 1920.—There are always some cancellations of early orders for queen bees. We have bought all queens that thus may become available in 1920 at the queen-rearing apiaries of Enrico Penna, Bologna. We offer these queens at Penna's advertised prices, viz., May and June, 12s. each; July and August, 10s. each; September, 9s.—**S. H. SMITH**, 50, Maid's Causeway, Cambridge. c.21

**100 FOUR-FRAME NUCLEI**, of Dutch, Dutch-Italian, £3 3s., and Italian, £2 15s.; all beautifully clean and healthy; massed with brood and bees. I strongly recommend my Dutch-Italian Hybrids, a fine disease-resisting strain. May-June delivery; cash with orders; carriage paid. All orders for July are £2 5s.—**SEALE**, Ashley Cottage, Oatlands Drive, Walton-on-Thames, Surrey. r.e.4

**CAN BOOK** a few more Nuclei of perfectly healthy Hybrid Bees of the "White Star" (Simmins') strain; Nuclei of four combs of brood, well covered, price 60s.—**MAULEY**, Brightwell, Wallingford. c.14

**"ISLE OF WHITE" DISEASE**.—Don't worry; use the solution that cures; 2s. per bottle.—**E. PRESSEY**, St. Elmo, Coulsdon. r.d.149

**1920 PURE Fertile Italian Golden Queens**, guaranteed imported direct from Italy; regular supplies throughout the season from second week in May; 14s. each; specially selected, 17s. 6d.—**GOODARE**, Italian Queen Specialist, New Cross, Wednesfield. r.d.150

**PURE Italian Queens**, fertile. Now booking orders for my selected Queens, bred for quality and hardiness. Orders executed in rotation. Price 10s. 6d. each. Book now.—**SHERRY**, Queen Rearing Apiary, Wallflat, Tarbolton, Ayrshire. d.151

**PENNA** has sent me two specially selected 1919 Breeding Queens. Spare Virgins from these mothers, 4s.; spare Fertiles, crossed with Bozzalia (Ligurian) drones, 8s.; best only; real 4-frame Nuclei with I.Q., ready July, £2 10s.; in rotation; 25 per cent. cash with order.—**PATRICIA**, Grammar School, Doncaster. r.d.152

**BEES ON APPROVAL**.—We guarantee our Bees and Queens to give complete satisfaction. Catalogue 3d., which is returned on first order.—**PEARSON & GALE**, Marlborough. d.156

**HOW TO KEEP YOUR BEES HEALTHY!** Valuable advice, 5s.—**ALFRED RYALL**, Kenwood Apiary, Elcombe, near Stroud. d.116

**ALBERT HOPKINS**, Specialist Breeder and Importer Italian Bees; 23 years' practical apicultural experience. Guaranteed strong, healthy Stocks and Nuclei. Prices strictly moderate. List on application.—Woodland Valley Apiary Lylinge, Folkestone. r.d.117

**NUCLEI**, 3-frame, Penna's 1920 Queen, 55s.; best Hybrids, 45s.; carriage paid; early delivery; Penna's Queen, 14s. Cash with order.—**MOORE**, 51, Monmouth Road, Dorchester. r.d.118

**BEES** from reliable disease-resisting strain; 3- and 4-frame Nuclei and Swarms, also Queens, for early delivery.—**CANDY**, Worth Park Apiary, Crawley, Sussex. r.d.121

**FOR SALE**, May and June Swarms.—**DEAR**, Funtington, Chichester, Sussex. d.120

**3-FRAME NUCLEI**, 45s.; 4-frame, 55s.; Penna Italian 1920 Queens; May-June delivery; boxes 10s., returnable; warranted perfectly healthy. "W.B.C." Hives and Apiary Supplies for Sale.—**C HOGAN**, Boxford, Suffolk. d.124

**PUPILS** received by life-long whole-time Bee Farmer, Terms on application to **C. B. BARTLETT**, Sandford, Mount Charlbury, Oxon. d.127

**MISSES PALING AND PILLANS** having combined and enlarged their Apiaries, are now prepared to book orders for strong 3-frame Italian Nuclei, massed with brood and bees, headed with 1920 Penna Queens or 1920 Queens of their own rearing from best selected Italian strains, £3, carriage paid. Speciality made in rearing choice Italian fertile Queens, 12s.; Virgins, 6s. Reduction on quantities. Pupils taken.—**Golden Square, Henfield, Sussex.** r.d.84

**HAVE YOU READ "THE BEE WORLD"?** If not, why not? Every number in itself is a useful literary work for practice and reference. Specimen copy free.—**Offices: THE APIS CLUB**, Port Hill House, Benson, Oxon.

**ORDERS** booked for 3-frame Nuclei, Fertile Queens, Virgin Queens, etc. List for stamped, addressed envelope.—**H. CRACKNELL**, Mount Road, Thundersley, Essex. r.d.27

**BOZZALIA** tested Queens are sold at the price usually charged for untested queens.—**Catalogue** from **H. STICH**, Riccartbar Avenue, Paisley. r.c.116

**ITALIANS**.—Queens, 5s. Book now. Stamp.—**HOUSTON**, Ellen Villa, Sideup. r.d.90

**PENNA** strain Italian Queens, from June 7.—**ASHWORTH**, The Bungalow, Weymouth Street, Warminster. r.c.63

**NEW-ENGLAND-BRED ITALIAN QUEENS**.—Untested laying Queens, ready June 1, 10s., delivery guaranteed; 6s. at purchaser's risk. English money accepted by registered mail.—**ALLEN LATHAM**, Norwichtown, Conn., U.S.

**EDINBURGH AND EAST OF SCOTLAND COLLEGE OF AGRICULTURE.**

**APIARIST.**

The Governors invite applications for the post of Apiarist in the Bee-keeping Department; salary £150 per annum.

Letters of application, together with two copies of not more than three recent testimonials, should be lodged with the undersigned, from whom further particulars may be obtained, not later than May 17, 1920.

**THOMAS BLACKBURN**,

Secretary,

15, George Square, Edinburgh.

**HIVES AND ALL YOUR REQUIREMENTS.**

Quality A. Quick delivery.

Write for prices to—

**L. ANDREWS & CO.**,  
Joinery and Carving Works,  
78A, WESTGATE, PETERBOROUGH.

d.126

**Italian Stocks.**

**OUR** 10-bar Italian Stocks are now ready for delivery. Free from disease. Cash with order. Carriage paid.—**D. ALLBON & CO.**, Sunnyside, Hitchin. d.123

**Bee Flower Seeds.**

**Collection of Six best Varieties,**

1s., post free

Beautifully Illustrated, Instructive,  
Up-to-date Garden Guide, 64 pages, Free.

**KNIGHT'S**,  
Seed Specialists, WOLVERHAMPTON.

# ITALIAN QUEENS

Direct from Italy.

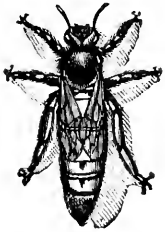

Address:  
Signor Gaetano Piana,  
Castel San Pietro,  
near Bologna, Italy.

All Queens are reared by the most up-to-date and scientific methods. Mr. W. Herrod-Hempsall has personally inspected the apiary and methods employed, with which he is perfectly satisfied.

PRICES FOR 1920.

For 1 Fertile Queen: May, 12/-; June, 11/-; July, August and September, 9/- each queen.

Carriage paid in Great Britain. Cash must accompany all orders, which will be executed in rotation. Guaranteed safe arrival of all Queens, but not the introduction. Bees dead upon arrival must be sent at once to "B.B.J." Office.

For the mutual convenience of all parties, Il Signor Piana has made arrangements that all communications, orders and remittances of the readers of "B.B.J." and "B.K.R." can be addressed to him, c/o British Bee Journal, 23, Bedford Street, Strand, London, W.C.2.

Cheques payable to "British Bee Journal."

The products of the Apiary, of Poultry and Farm Stock, of the Fruit and Vegetable Garden can be Advertised and Sold through

THE  
**BAZAAR, EXCHANGE & MART**  
*Newspaper.*

Get a Copy—Thursday and Saturday 3d. The "Bazaar" publishes also practical handbooks by experts. Send for full catalogue, post free from—  
WINDSOR HOUSE, Breems Buildings, LONDON, E.C.2.

THE  
**British Bee-Keepers' Association.**

Insure now against loss by damage done through bee stings. All particulars from

W. HERROD-HEMPSALL, 23, Bedford Street, Strand, London, W.C.2.

**BOWEN'S SECTION FOLDER.**

Send 2/- for Novel and Easy-to-use Folder. —Prevents Breakage—Lasts a Lifetime.—  
*ART BOOKLET INCLUDED.*  
Lt. A. H. BOWEN, Bee Goods Depot, CHELTENHAM.

**BRADBURY, TAUNTON,**  
FOR QUALITY BEE GOODS.



*Illustrated Bee Guide free.*

Telephone: TAUNTON 176.

**"BACTEROL"**  
FOR BEES



2/6 per Bottle.

Post Free.

The cure for, and preventive of, "Iste of Wight" Disease. Non-poisonous—free from stain or unpleasant odour.

MENLEY & JAMES, LTD.,  
39, Farringdon Road, London, E.C.1.

## INSTRUCTION in BEEKEEPING PRACTICAL AND THEORETICAL

My Apiary will be open for a limited number of pupils during this season. Terms and particulars from

W. HERROD-HEMPSALL,  
The W.B.C. Apiary, Old Bedford Road, Luton, Bedfordshire.

## S. J. BALDWIN.

I beg to inform that the No. 1 Kent Hive is not manufactured by me, only the No. 2 "Bromley Kent."

(New deep frame 17 x 14 x 12. Sample by post 6d.)

**THE APIARY, BROMLEY, KENT.**

# HIVES.

Compare the WORKMANSHIP and FINISH of our Hives.

All made by practical Men who know what a good hive should be.

In various designs to suit all tastes and requirements. Season's speciality—THE MANLEY HIVE for 16 in. x 10 in Frames.

Full descriptions and illustrations in our 1920 Catalogue:

*"Everything for an Apiary."*

If you have not received your copy, send a P.C. at once.

OUR MOTTO—SERVICE & QUALITY.

**R. STEELE & BRODIE, Wormit Works, Wormit, Scotland.**



THE  
KEY TO  
YOUR SUCCESS.

## The Metal Foundation

(Protected)

The latest invention in Scientific hive equipment.

♦ ♦ ♦

**Durable ♦ Economic ♦ Sterilisable**

♦ ♦ ♦

An Ideal compromise between the Metal Comb and the Wax Foundation.

♦ ♦ ♦

¶ For further details and prices, send for our 1920 ILLUSTRATED CATALOGUE, post free on application. It contains detailed information on the most up-to-date hives and appliances for which the House of Lee is famous.

\*\* Five per cent discount to Members of THE APIS CLUB.

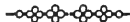

**JAMES LEE & SON,**

LTD.,

**Uxbridge, Middlesex,**

(Telegrams: Graphicly, Uxbridge.)

Telephone: Uxbridge 181.)

## 20-Page 1920 "WHITE STAR" List,

3½d. POST FREE.

S. SIMMINS, QUEENLAND, HEATHFIELD, SUSSEX.

Look after your profits by buying hives and appliances which are easy to work. I endeavour also to give good value by care over the workmanship. Send for catalogue.

**EDWARD J. BURTT, Manufacturer, GLOUCESTER.**

*Commercial (16" x 10") frames and brood boxes stocked.*



No. 1977. Vol. XLVIII

MAY 13, 1920.

[Published every Thursday, Price 2d.]

**CONTENTS.**

	PAGE		PAGE
REVIEW .....	229	LINCOLNSHIRE B.K.A. ....	235
DORSET YARN .....	229	DERBYSHIRE BEE-KEEPING .....	235
JOTTINGS FROM HUNTINGDONSHIRE .....	230	QUESTIONS FOR BEE-KEEPERS .....	236
THE FUTURE OF THE APIS CLUB .....	231	CORRESPONDENCE—	
NOTES FROM SOUTH WALES .....	232	The British Isles Honey Producers' Association .....	236
NOTES FROM GREINA GREEN .....	233	Early Swarms .....	237
SPRING FEEDING .....	235	Bees Building Comb Upwards .....	237
JOTTINGS .....	234	Natural Stores v. Sugar Feeding .....	237
BRITISH BEE-KEEPERS' ASSOCIATION .....	235	BEE SHOWS TO COME .....	238
ROYAL SHOW FUND .....	235		

# ALUMINIUM DRAWN OUT COMBS.

# “MONEY COMB”

*The greatest invention in the Bee World for 40 years.*

This is a drawn out Comb of Hexagon Cells exactly as bees build in their natural state. It is slightly coated with wax, has been thoroughly tested, and is not an experiment. Bees readily take to it for rearing brood and storing honey. Strong and durable, will last 50 years with care. Big consumption of honey saved to produce wax for comb building.

Control of bee diseases. No more burning of combs. Each comb easily sterilised and used over again.

Send for Catalogue and descriptive Leaflet.

1920 Catalogue post free

Patented by ALUMINIUM HONEY COMB CO., of U.S.A.

SOLE MANUFACTURER AND LICENSEE:

## E. H. TAYLOR, WELWYN, HERTS.

# THE British Bee Journal

ESTABLISHED 1873.

A Weekly Journal Devoted to the  
Interests of Bee-keepers.

Edited by T. W. COWAN, F.L.S., &c.,  
and J. HERROD-HEMPSELL, F.E.S.

**Correspondence: Whom to Address.**—All matters relating to the Literary Department, Associations, Shows, etc., should be addressed, "Editors, *British Bee Journal*," and all business communications and matters relating to subscriptions and advertisements to be addressed to the "Manager," *B.B.J.* Office.

**Subscriptions.**—Annual Subscription, 10s. 10d. post free in advance; single copies 2d., or 2½d. post free. If a receipt is required by post, a stamped and addressed envelope must be sent, otherwise a printed receipt will be enclosed along with the paper.

*Note.*—Cheques and Postal Orders should always be crossed, otherwise it is very difficult to trace them if they go astray.

**How to send Money.**—Remittances can be made payable to W. Herrod-Hempshall by crossed Cheques and Postal Orders. Stamps may be sent for small amounts up to 2s.

**Halfpenny stamps are preferred.**

Scottish or Irish cheques can only be taken in payment if 6d. is added for commission charged by banks for cashing them.

The Editors are not directly or indirectly interested in the manufacture or sale of beehives or appliances of any kind, and must refer correspondents wishing for prices or catalogues to advertisers in the paper.

## OUR DEPOSIT SYSTEM.

You are advised to insist on this being used when dealing with strangers.

### Rules and Conditions for Depositing

*In order to save trouble, it is requested that the Rules be carefully read over by persons using the Deposit System of trading.*

Goods should not be despatched until notice that the money has been deposited is received from this office.

**1. Method.**—When strangers are dealing together, the purchase-money of the articles is deposited at our office. We acknowledge receipt of the deposit to both parties, and hold the money until we are satisfied that the purchase is concluded. If a sale be effected we remit to the seller the amount deposited, less a charge of 2½ per cent. in the £, with a minimum of 6d., and the expenses of Post Office Orders and postage, &c. Cash will be forwarded by Cheque, Post Office Order, or by Postal Order as preferred. If a sale or exchange be not completed, we return the amount deposited, after making the same deduction. By this means buyers and sellers are secured against fraud.

**2. Deposits.**—Postal Orders (drawn on General Post Office) and Cheques must be made payable to W. Herrod-Hempshall, and crossed "London County and Westminster Bank." The numbers of the Postal Orders should be kept by the sender. We cannot be responsible for any loss that may occur in transit.

**3. Honey on Approval.**—All honey will be sold by sample, which must be sent direct to buyer.

**4. Bee Appliances.**—In ordering, the time allowed for completing the order to be stated to us when sending cash. If maker accepts, we hold cash until transaction is satisfactorily completed, when the amount will be remitted, subject to conditions as in Clause 1.

**5. Bees and Queens.**—These will be dealt with entirely by the parties concerned, so far as price, &c., go, and when the purchase is satisfactorily completed cash will be remitted as per Clause 1.

**6. Goods in Transit.**—These are at the seller's risk, i.e., any damage to or loss of an article on its journey is borne by the vendor; but a rejected article must be properly packed and returned by the same means as was used in sending it.

**7. Carriage.**—The carriage of all goods, *except such as are sent by post*, is payable by the buyer, unless otherwise agreed. If any article sent on approval be returned, each party to the transaction must pay carriage one way.

## Books for Bee-keepers NOW IN STOCK.

Cash in full must be sent with order.

		Postage
A Modern Bee Farm	7/6	6d.
A B C & X Y Z of Bee Culture (Root). 1919 Edition	15/6	9d.
Advanced Bee Culture (HUTCHINSON)	6/-	6d.
Beginner's Bee Book (PELLETT)	5/-	4d.
BEE-KEEPING SIMPLIFIED FOR THE COTTAGER AND SMALLHOLDER (W. HERROD- HEMPSELL, F.E.S.)	1/-	1½d.
BEE-KEEPERS' PRACTICAL NOTE BOOK (T. W. COWAN)	1/-	1½d.
BRITISH BEE - KEEPERS' GUIDE BOOK (T. W. COWAN) (paper covers only)	2/6	3d.
Dissectible Model of Queen Bee	4/6	3d.
FERTILISATION OF FRUIT BLOSSOMS BY BEES (T. W. COWAN)	-/3	1d.
Fifty Years Among the Bees (MILLER)	6/-	5d.
Honey and Health (A. HOPE)	-/6	1d.
Honey Vinegar (REV. G. BANCKS)	-/2	1d.
How to Keep Bees (ANNA B. COMSTOCK)	5/-	6d.
Management of Out Apiaries	3/-	3d.
Pollination of Fruit in rela- tion to Commercial Fruit Growing (C. H. HOOPER, F.R.H.S.)	-/6	½d.
PRODUCING, PREPARING, EXHIBITING AND JUDG- ING BEE PRODUCE (W. HERROD-HEMPSELL, F.E.S.)	2/-	3d.
Productive Bee-keeping (PEL- LETT)	10/6	6d.
Queen Rearing in England (F. W. L. SLADEN)	1/6	2d.
Scientific Queen Rearing (DOOLITTLE)	4/-	3d.
Snelgrove's Method of Re- queening	-/6	1d.
The "Townsend" Bee Book	2/6	2d.
WAX CRAFT (T. W. COWAN)	2/-	2½d.
Wilke's Book on Swarming	1/-	1½d.

### MISCELLANEOUS.

Maeterlinck's Life of the Bee	3/6	3d.
The Lore of the Honey Bee (TICKNER EDWARDS)	2/-	2d.
THE BEE WORLD (supplied only to members of Associations interested in the control and development of the APIS CLUB, apart from ordinary members of the latter), per copy	-/8	1d.

British Bee Journal & Record Office,  
23, BEDFORD STREET, STRAND, LONDON, W.C.2.





## Review.

*Outapiaries and their Management*, by M. G. Dadant, published by the *American Bee Journal*, Hamilton, Illinois, U.S.A., price \$1. This book will be of interest to the advanced bee-keeper, especially one who has gone in for honey production on a large scale, and has outgrown bee-keeping in his home apiary, and decides to take up outapiary work, with a view to increasing his income. The development of commercial bee-keeping in America is intimately connected with the extension of outapiaries, and as Mr. M. G. Dadant has been brought up in the midst of commercial honey production, he writes with authority on the subject. The Dadant family has kept bees on a large scale for three generations, the author's father, C. P. Dadant, being the talented editor of the *American Bee Journal*, and the author the business manager of this periodical, and his grandfather, C. Dadant, the founder of the business. From such a quarter one expects sound advice, and in reading this book we have not been disappointed, for it is abundantly evident that it is written with a thorough knowledge of the subject. Good advice is given, such as, for instance, that on the choice of a location, which, he says, should be where there is the greatest profusion of honey plants capable of guaranteeing the largest surplus of yield, and to insure at least one main flow during the year. Although the up-to-date bee-keeper knows how to combat disease, and with care rid his apiaries of foul brood, the author says it would be a great relief if it was possible to locate the apiary in a district free from disease, the labour in such a place would be greatly reduced were it not necessary to be always on the alert for foul brood. Sound advice this, even for those who are commencing on a small scale.

The work not only deals with the business of bee-keeping on a large scale as carried on by the Dadant family, but also describes the methods and practice of the most successful bee-men. It is well illustrated, and we have much pleasure in recommending it not only to our readers who are contemplating bee-keeping for profit, but to those also who desire to learn how the industry is carried on by our brethren in the United States of America.

## A Dorset Yarn.

In Dorset now we have the oaks in bloom: these are peculiar in that they have such a quantity of male blossom. The pollen flowers are produced at the base of the young growths (the female flowers are well up above them and are not so easily seen). Nature seems so lavish with pollen flowers, nothing must be left to chance. The bees seem to make the same mistake with so many drones: they want to be sure that the queen is perfectly mated, they raise so many of them (just now, when the working days are few, it must take a lot to feed them). The seed blossom of the oak has bright colours, and under a glass shows the embryo acorns: the male flowers are a dirty yellow. It is termed a wind-fertilised flower, but old bee-keepers state that bees get a lot of food from oaks. In my opinion, it is not from the flower, but from the growths punctured by the small *cinips*, which causes a sweet sap to flow from the wound, which ants, as well as bees, collect to feed their young. Wind-fertilised flowers are termed "anemophilous" (from *anemos*, wind; *phileo*, I love).

There are thousands of plants that are wind-pollinated, from many of which bees get some stores, mostly pollen. The male flowers have very dry pollen: it must be so, or it could not be carried by wind. Plants that have catkins, like birch, hazel, and alders, etc., are among those that are "anemophilous," as are sedges, rushes, reeds, hemsps, etc. The willows have adhesive pollen; this is one of the exceptions, but as the sexual flowers are on different trees, it must be adhesive, or it could not be carried to other trees other than by bees and other insects.

The plants that are pollinated by bees are called "entomophilous" (*entomon*, insect), pollinated by insect agency. Bees that enter the flowers of gorse are covered with adhesive pollen: where the pollen is not adhesive enough to be moulded on the pollen baskets, the bees seem to moisten it with honey from the honey sac. These are the flowers that interest the bee-keeper most, there are so many of them; in these "yarns" I have covered all of them, but they seem to be part of the bee-keeper's stock-in-trade. It is well that we should be conversant with them all.

Many are rich in honey, but the tongues of bees are not long enough to reach the nectar. Honey-suckles are visited by butterflies and moths; they unroll their long, spiral tongue and get the honey that wells up in the flowers. Some flowers open in the day, others at night. There is an instance of the "champions," *Lychnis Dioica* bees fertilise, as it opens

in sunlight; but *Lychuis Vesperlina* does not open till night. Night moths sip the nectar, and in doing so the seeds are made perfect by their agency. Those bee-keepers who at one time collected insects will know that this plant, being open in the evening, will always attract the night moths.

Our bees just now seem to be still largely on rasps and turnip. Adjoining our farm are the village allotments: one plot is all turnips, it is only 200 yards from our bees. When it is favourable this patch is one loud hum of thousands of bees; they must get a lot of stores from this plant, as it blooms a long time, fresh flowers opening each day. They must get a lot of moisture with the nectar from them this showery time, there is so much they could get were it at all fine. The horse chestnuts are very beautiful: these are mostly gone over by bumble bees; they seem to be able to put up with more hardships than the hive bees, as these cannot get far from home when the weather is unsuitable. The ends of the rows that are nearest the hives have the most bees.

Bees are sure weather guides, they will not go far when the weather is unsettled: they are on the strawberries that are close to the hives, but not one on the distant plants, even though they are only 300 yards away. They care very little for these flowers at any time, but in catchy weather they go to the nearest. This long line in full bloom shows up half a mile from the farm, so it must be scent that lures the bees to the sources of nectar, not sight, though most writers on natural history assume that the bright-coloured petals and sepals are an attribute to the flowers to allure the bees to them for pollination. A few are on the *Limanthes Douglasi*. They like the turnip most.

In Dorset many others are joining our ranks. Bees are changing hands at good prices. One farmer at Bere Regis sold two stocks at £4 10s. each—a fine lot they were. I saw them at the Durweston Rectory, and transferred them to their hives from the travelling boxes. They looked like Dutch, but what was remarkable among the drones were some very handsome Italians (the queen in one of them was not Italian). I mentioned last year how some drones went from our light-coloured bees to the black ones. The owner of these must have had some Italian stocks; not any of this lot had workers with a mark on them. The Rev. Baldwin Pinney has a most delightful place for bees, there are some of the finest forest trees to be found in this country in the woods of Bryanstone (the home of the wealthy Portmans). Wealth has had planted all the flowering trees from every

part of the world—many of them are just now magnificent. The Rev. Pinney's garden was full of Darwin and cottage tulips, huge patches of hyacinths, and some glorious lilacs. This must be one of the places of which the great writers of literature have given their word-pictures, for here is the valley of the Stour, with high forest land and rolling downs; here are great paddocks of deer, and miles of drives through the most beautiful woods I have ever seen.—J. J. KETTLE.

## Jottings from Huntingdonshire

As I write the sun is sinking in the west and the whole countryside is filled with peace. The many fragrant blossoms are giving out of their best, the trees are all looking never so lovely in their various sheens of green. I have just recently returned from helping a brother cleric who lives some five miles distance. I had just half-an-hour to cycle back here for a service in my own church fixed at half-past seven, but that half-an-hour was not too short to take in the beauties of the field and hedgerow. One passed hedges and hawthorn bushes massed with blossom, so white that a stranger from Mars would surely describe them as white hedges and lusher tinged with green. And what a lot of nightingales were tuning up for their evening song! Their sweet, beautiful, inimitable voice is lovely in the day, but outclassed by the full-throated warbling of the thrush; at night, when all is quiet, it is more lovely still. Other songsters had not yet gone to sleep, for summer time is naught to them; many a copse was a choir of birds, while on the telegraph wires were chaffinches trying their hardest not to be outdone. Swifts were, with amazing energy, shrieking here and there, swallows and martins overtook one, and with a twit, twit, wheeled round and did it all over again. I knew what they meant. Following me were myriads of winged insects of various kinds: what swallow could resist such a meal? A cuckoo finds amusement in flying ahead and settling only to rise and wing ahead again as one draws near. Who can express that joyous feeling, who describe the subtle light of a May evening? Truly

“This is the season now to go

About the country high and low;

Among the lilacs hand in hand,

And two by two in fairyland”

At midday I had a swarm which chose to settle on a hedge overhanging the pathway leading to church. I skipped them quite easily, but had perforce to leave them there until the evening. I fear their presence filled many of the evening

church-goers with misgiving; some turned back and found their way to church another way—one man jocularly remarking that he liked bees, but thought them a little too warm about the tail. However, as soon as service was over, they were successfully hived; and, being able to give them drawn-out combs, they will doubtless go ahead. Their happy foraging ground—or shall I say trees?—are the chestnuts. A chestnut avenue of some 100 trees, covered with bloom, should provide all the bees' wants for a while, despite the many premature blooms. Bean blossom, too, is not neglected, while a few bees stick religiously to the dandelions.

This past week I have had shoals of letters asking how to treat May pest. Some scores of bee-keepers, like myself, having their first experience of it this year. The warm weather of March and the chilly days of April is the primary cause. Pollen and nectar of prematurely opened flowers the secondary. Not till I had hunted up a book written nearly a century ago did I discover how to treat it. I give the method for the benefit of many who may be glad to render, as one of my correspondents puts it, "First aid to the bees":—

Make your hives warmer, especially at evening, than they have hitherto been. Feed with a syrup, about half a pint in the evening, medicated (I prefer Yodil), about three times in the week—note this—to which, if the disease be bad, a little bismuth or carbonate of soda has been added. Disinfect a little warm water—here Izal comes in handy—and throw a few cupfuls into the entrance of the hive. Sweep up all crawlers and throw into warm, medicated water, strain through a cloth and take to a warm place; those bees able to clean themselves and take flight should be allowed to do so, those not able should be burnt. If the syrup is made with pure honey, the soda or bismuth need not be used. As an extra precaution sprinkle chloride of lime around the hives and if possible dig in.

May pest is one of those diseases that needs studying. While my bees have yielded to the above treatment, one would like to know a great deal more about the disease. Beware lest you mistake it—"Isle of Wight" disease is still about. An infallible sign I find with May pest is a straining at the abdomen and the evacuation of half-digested pollen. Prevention is better than cure, extra warmth and any aid to digestion that can be given would appear the best means of keeping this distressing complaint at bay. I should say, in conclusion, that often the abdomen of the bees so afflicted is covered with a grey dust, but this does not always appear.—E. F. HEMMING, Steeple Gidding.

## The Future of the Apis Club.

By A. Z. ABUSHADY, F.R.M.S.,  
Editor, "The Bee World."

Now that the preliminary phase of organisation in the development of *The Apis Club* will be brought to a close at the coming general conference of members to be held at the Central Hall, Westminster, on May 29, it is my foremost duty to thank you, Mr. Editor, for the spontaneous, steady, and liberal encouragement which you have given to this movement. It is certainly to your credit that you based your support on general principles, and that differences in opinion have never caused you to alter your faith and support. For this genial attitude the movement owes you an everlasting gratitude, especially as I feel sure that you must have been repeatedly taken to task by those who are more "loyal" to THE BRITISH BEE JOURNAL than you are. . . .

As many readers of THE JOURNAL are also readers of *The Bee World*, and considering the repeated publicity which has been given to *The Apis Club* in your columns, I shall not trespass on your valuable space by repeating details of principles or policy. But in view of the enthusiastic appeals for the development of this co-ordinating and educational institute, and especially in the light of the remarks from the pen of Mr. Lamb, which appeared recently, I feel that I should emphasise the main issue which is at stake. It is this: After a year of arduous labour and exceptional sacrifice for demonstrating the public motive of the work, is the craft in this country now able to shoulder what a few have carried for so long, or otherwise? Unless the bee-keeping organisations in the country, great and small, are prepared to patronise the work, and not only to pay it a lip service, it is impossible to carry out the proposed programme; and as an alternative to the transference of the work to another country, a different constitution has to be evolved.

The publicity sections of the home Bee Press, apart from the literary sections, have repeatedly shown that an institute called "The Apis Club" exists, that any bee-keeper can have on request a free specimen copy of its official organ for enlightenment regarding its objects and activities, that there is no liability beyond the membership fee and any spontaneous donations to its funds, and that the whole work will be handed over to the craft, free from any liability, if they care to avail themselves of the offer. Even at present nothing prevents any of your readers from asking for a free specimen copy of *The Bee World* and deciding for

himself or herself whether the movement is worthy of support or otherwise. The first general conference is of a *private* character, and any bee-keeper who cares to be identified with the movement is provisionally entitled to join it. Thanks to the co-operation of many able writers both at home and abroad, the January, February, and spring numbers of the magazine are alone worth more than the membership fee. *So there is no excuse whatever for any bee-keeper for not joining the Club prior to the coming conference.*

If organised bee-keepers and public benefactors can advance between them one thousand pounds per annum—a very small sum indeed for a professional community, however small this may be, then the unfettered development of this public medium of education and co-ordination will continue, and as our good friend, Mr. Lamb, says, "enthusiastic co-operation will do wonders for any industry." On the other hand, if the timidity of our leaders is beyond all expectations; if no association or a combination of associations in the country are prepared to arouse the conscience of the public and to take the lead; if no constructive proposals are coming forward, then probably the conference will limit itself to discussing an alternative policy and appointing a select committee to advise, and this in itself will be a reflection on the craft here.

The writer will only be too pleased to answer any queries and to supply any possible information to those desirous of joining the Club within the days remaining before the coming conference. But with all respect to Mr. Lamb's suggestion, I feel sure that on re-consideration he will feel that neither those bee-keepers who cannot appreciate that what they are paying does *not* even cover what they are getting back, nor those who prefer to enjoy a belief in the callous misrepresentations of our professional intriguers, should be given any serious thought. My appeal is limited to *thinking* men and women who might not have sufficiently realised the extent of difference which every passing day of inertia is making to the prospects of the movement.

---

### Notes from South Wales.

Judging from the strength of some of the stocks here, I should think we are going to have some early swarms this year, and nearly everybody is saying they don't know when their bees have been so strong as they are this spring. I suppose it must be the very fine weather that we have had, and also early flowers that have helped the stocks to build up so well.

There is a wealth of flowers everywhere for them, and stocks of any strength at all are bound to make great headway, but whether we shall get a set-back later on I don't know, but it will behove the bee-keeper to bear that in mind and keep them snug and warm, also to see that they are not short of food, as when they are so strong it takes a good deal to keep them going. Apart from that, if they do run short, it will stop brood rearing, which is very valuable now, and cause a general upset of the stock which will take a deal of getting over. I remember having such a stock on one occasion; as soon as I discovered it I put on a feeder, and I found that for days the bees were still bringing out young grubs, although they had plenty of food on top of them and must have had plenty to go on with in the brood chamber. It appears to me when the bees are in such a plight, they get so used to carrying out the grubs, that they cannot stop at once, but the habit has to wear out, irrespective of whether there is food in the hive or not. A young beginner called on me about a month ago—it was on a Sunday—and we had a lovely morning. He wanted to know how the bees were doing, so I told him so far as I knew everything was quite all right with them. I asked him as to his stocks, and he said that he had examined one stock that morning and found that they had got four combs of brood and eggs. "But," I said, "you never took them out, did you?" "Oh yes," he said, "for the sun was lovely and warm, and it could not harm them." "Well," he said, "haven't you overhauled yours yet." I told him no, and apart from that I should not think of such a thing in winter, that he had done very wrong in doing so and that if I was not mistaken, he would find that out later on. He called again Easter Monday, for advice as to what he had better do, as that same stock was dwindling fast, and no signs of brood whatever in the hive. By the description he gave me, I should think that he must have got the queen chilled, and of course all the brood, eggs, etc., must have been chilled as well, and perhaps when he put the queen back in the hive she might have dropped off on to the floor board and crawled out and perished. All these things are lessons for us all to remember, especially the beginner, who is anxious to know how the stock has fared during the winter, for there was a stock of bees that was doing well, and just that incident has ruined it.

I was on a visit to the beautiful Caswell Bay, which is about half an hour's walk from here, when the housekeeper of Herbert's Lodge, informed me that every year regularly a swarm of bees has come there and settled in the window, and

if they come this year, would I come and take them away as they cannot go near the window, until winter comes to keep the bees in. I thought it was strange, and asked her to show me the window, which she did, and I found that it was a window projecting out from the roof, which afforded a good shelter for the bees. There were stains on the slates. I asked what they were, and she told me that was where the honey had been running out from them. I did not see any bees working there then, so I concluded that they must have died out, but I should think there must be plenty of honey under the slates, which, I hope to see if they come this summer. Would honey stain the slates, such as I have mentioned above? There is no other part of the roof stained, so it must come from the bees.—E. BOOBIER, Bishopston, Swansea.

[We should not expect honey to stain the slates. If honey had run out, it would most likely be caused by the sun's rays, making the slates so hot, that the comb was melted, so that both wax and honey ran down the slates, and the wax would leave its mark. Eds.]

### Notes from Gretna Green.

In these days of fantastic prices for all sugar products, it seems strange that home honey is difficult to sell. But while dealers can buy any amount of imported honey for 8d. per lb., and retail it at anything up to 2s., they naturally have no use for the higher-priced home product. Bee-keepers in general, and new beginners in particular, should work mainly for sections this season, as comb honey has no foreign competition to meet. The outlay for extractor, ripener and bottles is very heavy, while section racks can be made up for a few pence apiece, and, of course, sections sell more readily and at a much higher price than extracted honey.

Swarming should be anticipated by dividing strong colonies previous to the honey flow, but natural swarming, if allowed, need not be ruinous, providing after swarms are checked by destroying all queen cells, and inserting a young fertile Italian. The supers are then divided between the swarm and its parent colony, and at end of season the old queen is removed, and both lots united by doubling.

This method gives a colony possessed of a young queen, plenty of young bees, and abundant stores—the three essentials for safe wintering.

Our friend "Flavine" Smith asserts that colonies so prepared are proof against "Isle of Wight" disease, and

my personal experience proves that he is absolutely right. Disease is rampant here, and every apiary in the locality has been completely wiped out since autumn, *yet with affected bees only a few yards away I haven't lost a single colony.* I don't pretend that mine are immune, for occasional "crawlers" were seen at all times. But the fact remains that after giving an average of over £6 each for sections actually sold last year, every one of my stocks is still alive and exceptionally strong. I discarded the smoker entirely during last season, using instead the sprayer, with "Flavine" solution, in all manipulations of the brood chamber, and a cigarette for the supers.

Another important feature is the use of wide entrances, and brood boxes raised on  $\frac{3}{4}$ -in. strips all year round, so that the bees have abundant fresh air at all times.

In my opinion, our colonies, if kept in a state of high vitality by suitable methods, will live and flourish, even although surrounded by diseased apiaries.—J. M. ELLIS, Gretna, Carlisle.

### Spring Feeding.

Seasonable hints are always welcome to bee-keepers, as they always come just at the time one is not quite certain whether to feed on syrup or not. We hear that sugar is going up in price this year.

I hope it will mean bee-keepers will spare a bottle or two of honey in the autumn to make up the full stores on all combs. This means healthy stocks in the spring. I quote stocks, as I found them in early March by this idea, seven combs of baby bees, a large area of brood, and quantity of honey. By not sealing down my bees with thick quilts, placing a Rymer board across the frames, fine light quilts, and a cork folding quilt on top, bees were given warm air, which passed through the cluster, moisture being taken up by the cork quilt. Queen and bees had the whole run of combs, entrance 8 in., with a "Silver" non-dwindler over entrance, and a drawer (or eke will do) under brood, so air is warm before it reaches the cluster. The honey can be used by uncapping every three days, which quickens breeding, and is enough to last some weeks. These are on Standard frames. We hear so much about 16 x 10 crammed with brood and remarks about Standard frames that are quite unnecessary. Letting bees have honey in the autumn means dry combs, and bees are not living in an atmosphere of fermenting sugar, and either little air, or too much, which proves so fatal even to the bees of the careful bee-keeper.

I have two stocks that (owing to illness caused by the war) I use for study of management and health of bees, so I can devote my whole time to this study, and have made experiments regarding air for bees, which are important and, glad to say, have proved successful. I have been able to re-hive my bees into large wide new hives, with combs parallel to entrance, giving plenty of combs, which is the same thing as the larger in a way, and very snug to winter down. One has for the lower portion a large body box, which, with two winter divisions, makes an excellent four-sided, 2-in. thick body all round. A large Cowan hive also, that has an excellent brood box, with arrangements for chaff cushions at the sides, between the box and outer casing, which is a boon. One need not use larger supers. These two hives are the best medicine for regaining my shattered health I ever had, I am glad to say. So my bees are my little pals, whom I repay by great comfort and attention.—CYRIL TREDCROFT.

### Jottings.

I see the Ministry of Agriculture are appointing inspectors to "compel" the cleaning and destruction of thistles from the land, also for the cutting of dead and diseased wood from fruit-trees, with a view to preventing the attack of a disease called "silver leaf." This, to my mind, is quite as it should be, and forms yet more precedents, if necessary, to strengthen our own cause, in the endeavour to clear away the stubble of opposition with reference to our own overdue, but we may hope early success in this direction. It only remains to apply all available pressure, individually and collectively. This, too, will rob our little friends of many a flowery visit, but most of us will suffer no pang on this account, as we can make up to them with something useful or beautiful. I hope the inspector will be an educated one "thistlewards," as the question arises, shall we need protection for the "Chapman Honey plant," or shall we let the "druggists" have it, and style them also a danger? I have no worry, as my last patch didn't grow.

Truly, we pay for neglect by the sweat of our brow!

*Frames.* Although I have written on behalf of the "Standard" frame, I am not prejudiced against a larger, if found an advantage; but I think the "Standard" lends itself to a greater addition by an extra chamber, or by its interchangeability for any purpose in the swarming, or hot season, and a larger will not always be found adequate, although

it would have wintering advantages. I shall experiment with a 14½ x 12, as I consider this will make the stronger and most compact mass for a brood chamber, and will interfere very little with my present sizes. It is to be hoped that experiments will be conducted with, if I may style them so, twin colonies, or no definite result would be proved otherwise. Mr. Sladen's idea of two standards seems to meet the whole situation. I have, however, had yellow bees for a dozen years, and while I had the management found no trouble in finding the necessary breeding room for these bees on the old standard. Mr. Sladen might be interested to hear that the colour is still passed on from a virgin I purchased from him about that time, and fine gentle bees they are, too, and withstand disease splendidly. I have, of course, had other Italians.

*Bee Clubs.*—This shows what can be done in a district centre. We have a far greater opportunity to improve our craft and usefulness if these are worked in conjunction with the present county Associations. The machinery is there, if the executives will only turn the handle and invite co-operation in a guiding manner.

*Remedy for Ants (10076).*—If your correspondent had placed paraffin in the leg-stand, I think this would have settled them. A thin tin covering should be made above to keep out rain, but that does not bother very much there.

I have read alum will assist, but I should think only among the quilts, I have not tried it yet. I have only the little brown nuisances to deal with, but they are pretty persevering, and will seize an egg and run everywhere but out of the hive when disturbed.

*Nucleus Boxes.*—An easy way to confine bees, if necessary, is to cut a small perforated zinc door, hinge it on one nail, and cover with a small rebated covering to darken. It should be somewhat longer than the opening, and the ends left open for ventilation. A screw will hold this in position, and can readily be adjusted.

*Brood-Hatching Chamber.*—It is hardly curious that these young bees were so docile, as they were unable, most likely, to fly, and it is the flying bee that becomes aggressive.

We owe thanks, rather than criticism, to these experiments, and it is difficult to discriminate between "appreciation" and "destruction," with condemnation that is not intended.

I feel quite sure to the less observant bee-keeper a queen and bee accessible double chamber is safer, or the former can be confined to bottom if one can judge, or spare the time to find her, if lifting up frames, whatever the atmospheric conditions.—A. H. HAMSHAR.

### British Bee-Keepers' Association.

The Secretary is obliged to go abroad for a short period, and for the time will be unable to attend to any correspondence.

#### Royal Show Fund.

The Council of British Bee-keepers' Association are anxious to take their usual part at the Royal Show to be held at Darlington this year, so that their unbroken record of representation at this show may not be spoilt. In order to defray the expenses in connection therewith the Council ask that all bee-keepers assist in this work by giving donations, which should be sent as early as possible to the Secretary, 23, Bedford Street, Strand, London, W.C.2.

Subscriptions for this fund are coming in very slowly, and we would urge all those who can possibly do so to send a donation, however small. The sum needed is not, comparatively, large and if every one does a little should be easily forthcoming. "The Royal" is the show of the year, when the value of bee-keeping, and of the use of honey, to the community is brought to the notice of hundreds of people, and should the Bee and Honey Department have to be dropped for lack of funds, the loss to bee-keeping will be out of all proportion to the amount needed to carry on. May we also urge all those who can do so to make an entry, and exhibit at the Darlington show. A good display will help both the show and the craft. We are sure our bee-keeping friends in the North are looking forward to a good display of honey, etc., at this year's Royal Show.

#### DONATIONS RECEIVED.

	£	s.	d.
Amount received ... ..	2	5	0
Mrs. Bruce Culver ... ..	0	10	0
Miss E. G. Lamb ... ..	0	5	0
N. H. Lamb ... ..	0	5	0
R. H. Manley ... ..	0	16	6
H. E. C. Carter ... ..	0	4	0
F. Hammond ... ..	0	2	6
	4	8	0

### Lincolnshire Bee-Keepers' Association.

The annual general meeting of the Association was held on Saturday, May 1, in the Council Chamber of the Lincolnshire Agricultural Society, and there was a good attendance of members. Dr. W. A. Carline presided.

In his annual report, the Hon. Sec.

referred to the terrible havoc that "Isle of Wight" disease had made in the county. This had led to a large decrease in the membership, as most bee-keepers, with the loss of their bees, had ceased membership. Under these circumstances the balance in the bank of £35 19s. 7d. was considered very satisfactory.

It was reported that under the County Horticultural restocking scheme 24 nuclei were sent out last year, and it is hoped that over 120 will be sent out during the coming season.

The Earl of Ancaster was re-elected President of the Association, Dr. Percy Sharp, of Swallowbeck, Chairman of the Committee, and Mr. J. Emerson Vice-Chairman. All the other officials were re-elected.

Dr. Carline, who has acted in an official capacity in the Association for over 40 years, has been reluctantly compelled to give up the chairmanship of the Association on account of ill-health. A most hearty vote of thanks was accorded to him for his splendid work on behalf of bee-keeping in the county.

Mr. F. W. Frusher, of Crowland, was appointed delegate to the B.B.K.A. meetings.

The next general meeting has been fixed to take place in Grimsby.

After the business part of the meeting a visit was paid to the restocking apiary at Thorpe-on-the-Hill. This apiary is under the charge of Mr. H. Roper, and he is to be congratulated on its excellent and flourishing condition.

The members spent a most interesting and instructive visit.

The members were kindly entertained to tea by Mrs. Roper.—*Communicated.*

### Derbyshire Bee-Keeping.

Another successful gathering of bee-keepers was held on Saturday afternoon, May 1, at the well-known apiary of Mr. H. Hill, Ockbrook, about fifty members and friends presenting themselves for instruction in the art of bee-keeping.

Under delightful conditions Mr. Hill opened his discourse by sketching the life of the honey bee, stating with what affection bee-keepers regarded their bees. So much was this the case that he had never known, or met, a drunken bee-keeper, probably owing to the fact that bees resent unsteady or careless handling, giving as his opinion that was one reason which made women such excellent bee-keepers, being more gentle in their handling of the stock.

The lecturer then contrasted the old skep, or straw hive of our forefathers, with the bar frame, or movable comb hive now in use. There were still to be

found in remote country places prejudice among the older generation for the "owd skip," who cared little for the new fangled notions of to-day. The straw skep, Mr. Hill stated, was a sealed book. To find "the queen" under those conditions was possible only by driving the whole colony out of the hive, whereas with the modern frame hive one was able to witness the movements, and in a large measure control the activities of these wonderful creatures.

The method of "driving" bees was watched with great interest; as were also various devices for the economical management of an apiary.

The bees on this occasion were living models of a well ordered apiary, and although they were flying freely, no one present came in for special attention. Appreciations are due to Mrs. Hill for the excellent tea provided.

This series of lectures and demonstrations, planned by the Derbyshire Bee-keepers' Association, was continued on Saturday, May 8, 7.30 p.m., at the Agricultural Education Offices, No. 12, St. Peter's Churchyard, with an address by the Rev. R. H. N. Ellison (Aston Rectory), and the next demonstration will take place on the afternoon of May 15 at the Council Schools, Hatton, to which members and non-members are cordially invited.—S. MILTON, "Hazeldene," Fairfax Road, Derby.

### Questions, etc., for Bee-keepers for Self-Examination.

503.—In what circumstances is spring feeding requisite, and how is it done?

504.—How should skeps containing (1) a colony and (2) a swarm be packed for transit?

505.—Compare the hiving of a swarm on a fresh site in an apiary with hiving it in a fresh hive on the old or parent stand.

506.—Describe exactly the make of a board for use when fixing foundation in frames, and state how it is used and how the foundation is prevented from adhering to it.

507.—In normal circumstances how early in the year may eggs in drone cells be found in a colony?

508.—What is an "old" queen? Comment on the retention of an old queen in a colony.

509. Mention some advantages in the marketing of granulated honey as compared with liquid honey.

510.—What does an excess of drones in a colony indicate?

511.—Why is it inadvisable to fit frames with foundation in a cold atmosphere?

512.—In what liquids is propolis soluble?

J. L. B.



### The British Isles Honey Producers' Association.

[10181] I was very pleased to see a letter following up my proposal for the formation of a co-operative association under some such title as above, especially from such an experienced organiser as Mr. Teed, whose assistance and mature advice in the administration of any movement along the lines suggested will be very heartily appreciated by all interested parties.

While thanking all those who have written me upon this subject, I must ask their kind consideration in expecting replies, as my ordinary correspondence completely takes up my time.

In addition to my previous remarks, may I draw particular attention to the possibilities of the Apis Club successfully carrying out some such organised scheme, working to the mutual benefit of all concerned. I have received an assurance from Dr. Abushâdy, the secretary of the Club, of the sympathetic attitude of this organisation, and that the marketing of honey is one of the items on its programme. This matter can be more conveniently discussed in conjunction with the Council of the Club, which is holding its first Annual Conference on May 29, at the Central Hall, Westminster.

While thanking the Editor of the BRITISH BEE JOURNAL for the broad-mindedness shown in giving full publicity to any projected scheme intended to further the interests of British Bee-keepers' I should like, with his permission, to enumerate a few points which will show how the Apis Club can fulfil the aspirations of an amalgamated union of producing bee-keepers.

(1). The Apis Club, being a very rapidly developing and powerful federation of bee-keepers of all sections, will soon have at its command a large number of potential organisers, whose whole-hearted co-operation will ensure the smooth working of the scheme.

(2). The pioneers of this Club, having worked unselfishly and at great personal sacrifice, have obtained the ever growing confidence of all parties in the bee-keeping world, at home and abroad, and now merit the full support of all sections of the fraternity, from the humblest cottager to the man with his thousands; and seeing that they do not intend, or desire to retain the government of the Club in their hands alone, but invite the members to take their share in framing the con-



stitution and general working plans, such an attitude should give the assurance of success to any scheme which the Club decided to undertake.

The moral contained in the above remarks is to the effect that all bee-keepers interested in the progress of the craft should give their whole hearted support to the Apis Club, for one day soon, we shall find an accomplished fact what many scoffers said was impossible, i.e., a fully developed amalgamation of all the bee-keeping fraternity, irrespective of party differences, having their interests merged into one united whole. Then the man who "sat on the fence," waiting to see if it was going to be a success or not, will wish he had helped to attain this position, and I hope his conscience will give him no peace until he has made amends.

It will be a matter of great interest to see how the Council will regard the possibilities of successfully working out a commercial scheme, which will bring together the consumer and producer to their mutual benefit.

We can all hasten that day by supporting the federation known as "The Apis Club."—F. M. CLARIDGE.

### Early Swarms.

[10182] Is this the first swarm this season? On April 23 at 3 p.m. Swarm weighed 6 lbs., and was in a laurel hedge. Strange to say, a bird's nest was in the centre of the swarm.—I. DRAPER.

[There appear to have been a number of swarms on April 23 and 24. Mr. Draper sent us the nest, which was a new one, and, we judge, was a robin's.—EDS.]

### Bees Building Comb Upwards.

[10183] *Re* the article on the above subject which appeared in the Journal April 8 (10,161). I was very interested while reading it, as I had a similar experience which happened practically the same date. I may state that this is a very rare occurrence in this district, but am anxious to know why they built upwards, whereas they had plenty of space on the frames below.—MATH. ROBERTS, Harlech, N. Wales.

### Natural Stores v. Sugar Feeding.

[10184] I was much interested in your correspondent's (10177) letter *re* Sugar Feeding.

I cannot understand any bee-keeper taking honey from the brood chamber and replacing with sugar. I myself was quite content with the surplus obtained from the shallow frames and sections, and always left any honey stored in the

brood chamber for the bees, and if on examination in the autumn, I found they had not sufficient supplies to carry them over the winter I always supplemented it with one or two combs of good sealed honey, as the occasion required.

I do not agree that there cannot be a substitute for the natural food, honey; my experience leads me to believe that much depends on the condition of the honey or the substitute which the bees are wintered on. There is bad honey, there are also bad substitutes, and I generally found that if I put up the bees for winter with sufficient good sealed honey, or cane sugar syrup, I never had much to fear from starvation or dysentery.

Some years ago when residing in North Wales, in the district where I lived were a number of old-time bee-keepers. My first skep I obtained from an old man well over 70 years of age, who had kept bees as long as he could remember, and the custom of taking the honey in the autumn was to sulphur the bees. One autumn an old lady asked if me if I would take the honey for her, so with her permission I drove the bees from the skeps and took the bees home. In addition to the stocks that I had in wood hives, I had a bee-house which had accommodation for ten hives; these hives were fitted with a glazed movable board at the back, which could be extended to the requirements of the brood chamber. Into these hives I put the driven bees on a drawn-out comb well supplied with pollen (if possible) together with five or six frames with full sheets of foundation according to the number of bees.

The whole of these stocks I built up on cane sugar syrup which I fed to them in a Canadian feeder, holding 1½ to 2 pints; and as near as I can remember, it took about two weeks to get them fixed up with their allowance of about 20 lbs. to carry them over the winter. As before-mentioned, having glazed backs to the hives I could observe the bees working without disturbing them; and, being enclosed in the house, they would work much later on the syrup than if they had been outside.

In the spring I always had strong stocks to transfer to the hives in the garden. In the usual course of events these bees would have been sacrificed to the sulphur, but thanks to the substitute I was enabled to produce strong stocks for the coming spring; and what I considered more valuable to the beecraft, I eventually persuaded many to take to the wood hives by pointing out the folly of killing the bees.

We are told that from experiments carried out by Huber and corroborated by

other observers, bees fed on sugar syrup yielded more wax than those fed on honey. I consider this alone is in favour of the sugar feeding at a time when every day is valuable in getting the stores capped for the winter.—**GEO. M. TUNE**, Charlton.

## Bee Shows to Come.

*A nominal charge of 2s. 6d. is made for notices (not exceeding 7 lines) in this column, 10 lines charged 3s. 6d., up to 15 lines 5s., which covers cost of insertion from order till date of show. Cash should accompany orders for insertion.*

**June 2-5, at Reading.**—Royal Counties' Agricultural Society's Show. Hon Sec., 131, King's Road, Reading. **Honey entries close May 15.**

**June 9 and 10, at Colchester.**—Essex Agricultural Society. Classes for Extracted and Comb Honey, etc. Schedules from Secretary, Essex Beekeepers' Association, 7, Bulwer Road, Leytonstone. **Entries close May 31.**

**June 16 and 17.**—Hanley Park Meeting of the Staffordshire Agricultural Society. The Staffordshire B.K.A. offer valuable prizes and six silver medals and nine bronze medals. Twelve Classes for members only, and five Open Classes. (Honey Classes are for four or three jars or sections). Schedules, W. Griffins Silkmore, Stafford. **Entries close May 29.**

**June 29 to July 3, at Darlington.**—Royal Agricultural Society's Show, Bee and Honey Section, under the direction of the B.B.K.A. Prizes arranged in groups of counties for Associations affiliated to the B.B.K.A. Schedules from The Secretary, 23, Bedford Street, Strand, W.C.2. **Entries close May 31.**

**July 6, 7 and 8, at Cardiff.**—Royal Horticultural Society's Show. The Glamorgan B.K.A., in conjunction with R.H.S., offer prizes for Honey, Wax, Bees, and Appliances. Members, Novices, and Open Classes. Schedules, Mr. Wiltshire, Maindy School, Cardiff. **Entries close June 22.**

## Special Prepaid Advertisements.

**One Penny per Word.**

*Will advertisers please read these Rules carefully in order to save trouble, as they will be strictly adhered to.*

**Trade advertisements of Bees, Honey, Queens, and Bee goods are not permissible at above rate, but will be inserted at 1½d. per word as "Business" Announcements, immediately under the Private Advertisements. Advertisements of Hive-manufacturers can only be inserted at a minimum charge of 3s. per lin., or 5s. per inch.**

**PRIVATE ADVERTISEMENTS are only intended for readers having Surplus Stock to dispose of. Driven Bees, Nuclei, and Queens that are reared or imported for sale, are Trade Advertisements, and can only be accepted under trade terms. A charge of 6d. extra will be made if a box number is used.**

**Advertisements must reach us NOT LATER than FIRST POST on TUESDAY MORNING for insertion in the "Journal" the same week.**

**Orders for three or more consecutive insertions in "The Bee Journal" entitle advertisers to one insertion in "The Bee-Keepers' Record" free of charge.**

### PRIVATE ADVERTISEMENTS.

**WANTED**, to exchange Hornless Nanny Goat, kidded last month, good milker, for Bee Hives in good condition. **POLDEN**, The Beeches, Dinton, Salisbury. e.25

**SWARMS**, healthy, splendid strain, 40s.; Clover Honey, 15 lbs., 50s.—**NORTH**, Crissing, Braintree, Essex. r.e.26

**SIX** new standard Hives, unused, all inch material, double walled, movable bottom, 55s. each.—**MARTIN**, 66, Stratford Road, Wolverton, Bucks. e.27

**STRONG** healthy Stock of Dutch Bees, 10 frames, £4 15s.—**GLYNN**, 15, Kelvin Avenue, Bowes Park, London. e.28

**A FEW** more Swarms for Sale on 5 frames, 57s. 6d. each; ready now; box, returnable, 7s. 6d.—**S. COCKS**, Napton, Rugby. e.29

**FOR SALE**, two new Hives, W.B.C., complete with brood box, shallow crate and section rack, painted three coats, calico covered roof, 21 in. square, ¾ in. materials, price 50s.—**Apply, SYD. BARNWELL**, 44, Western Road, Strood. e.30

**SALE**, BRITISH BEE JOURNAL, 1917-April, 1920. What offer?—**MRS. NORRIS-ELYE**, Utterby Rectory, Louth, Lincolnshire. e.32

**SWARMS** for Sale. Orders booked now.—**COLE**, Hornsey High School, Weston Park, N.8. r.e.33

**SIX STOCKS ITALIAN BEES** on 7-8 frames, 84s. each; guaranteed.—**ENNEVER**, Oak Avenue, Enfield. e.40

**PURE** Golden and three-band Italian Bees and Queens; prolific and gentle; the ideal bee for pleasure and profit.—**COOMBER**, 64, Ronald Park Avenue, Westcliff, Essex. e.38

**SWARMS**—May, £3; June, 50s.—**SAUNDERS**, Waverley, Farnham, Surrey. r.e.39

**FOR SALE**, six frames of healthy honey-fed Bees, never had any disease in apiary, £3 10s. and 10s. charged on travelling box, from which carriage of bees is deducted and balance returned to buyer.—**REED**, Primrose House, Heacham, Norfolk. r.e.20

**FOR SALE**, two Colonies Italians, no disease, three Hives, Section Lifts, Frames, etc., 2-frame Extractor, side geared; owner going abroad; price £9 9s. Can be seen any Saturday, 5 to 7 p.m.—**Apply, BEES**, Dencliffe House, Church Road, Ashford, Middlesex. e.24

**12 GUARANTEED** healthy Hybrid Italian Stocks, Penna strain, £5 each.—**J. YOUNGER**, 6, Maid's Causeway, Cambridge. r.d.145

**NATURAL MAY SWARMS**, packed in straw skep, free on rail, £2 each.—**E. PRESSEY**, St. Elmo, Coudson. r.d.147

**THREE** 6-frame lots of Italian Bees, Penna's 1920 Queens, 63s.; five 4-frame lots, 45s. each; carriage paid; delivery early June.—"Earldoms," Ridgeway, Enfield. r.d.148

**ITALIAN QUEEN**, 7s. 6d., and 3-frame Italian Nucleus, 50s., booked for early delivery.—**YOUNG**, 29, Central Road, Sudbury, Middlesex. r.d.158

**CORRESPONDENCE COURSES** in Bee-keeping.—**H. E. NEWTON**, Brown House, Barton-on-Sea, Hants. r.d.157

**SWARMS** for Sale, May and June, very healthy stocks, price 30s.—**MRS. BARRY**, Home Place, Limpsfield. r.d.98

**WANTED**, from August 22 to September 4, in Cornwall or Devon, within 12 miles or so of sea, Bedroom and Sitting Room, with shed for motor car; farmhouse preferred. Can any bee-keeper oblige me?—**W. HERROD-HEMPSELL**, Old Bedford Road, Luton, Beds.

**300** SHALLOW wired Combs for Sale; no disease.—CRAWFORD, Apiaries, Castle-berg, Co. Tyrone. r.d.112

**FOR SALE**, two "Rotax Roadlight 267" self-contained Acetylene Motor Headlights, very powerful, £6 the pair; one Exhaust Whistle, 10s.; one Wood-Milne Motor Foot Pump, 40s.—HERROD-HEMPSELL, as above.

**WANTED**, portable Greenhouse.—Price and particulars to W. HERROD-HEMPSELL, Old Bedford Road, Luton, Beds.

**WANTED**, Auster Rear Wind Screen for motor car.—HERROD-HEMPSELL, as above.

**SIX** pure 1919 American 3-banded Italian imported Queens for Sale, following dividing stocks for nuclei, healthy, 8s. each. Just "it" for crossing to improve strain of apiary.—DAVIDSON, Forest Road, Burton-on-Trent e.34

**BUSINESS ADVERTISEMENTS.**  
1½d. per word.

**FOR SALE**, new W.B.C. dovetailed Hives, including inner chamber, shallow super and section crate, £2 each; painted, 5s. 6d. extra; also cheaper makes.—H. STRIDE, 37, Ridley Road, Winton, Bournemouth. e.35

**STRICTLY BUSINESS.**—Free samples of Flamine with testimonials and circular. A Japanned Sprayer, 5s. 6d., post free. A Cambs "Bee Barometer" with every order.—S. H. SMITH, 30, Maid's Causeway, Cambridge. e.37

**A FEW SWARMS** of Dutch strain Bees can now be booked for present season, price 35s. per swarm, carriage paid.—Apply, D. MANNINGTON, Brooklands, Rippe, Sussex. e.41

**BEES**, swarmed May 1 on 10 frames, wired, ditto 10th, for sale, £5 each.—OXBORROW, Kirby Cross, Essex. e.42

**MR. BEE-KEEPER**,—If you wish to succeed with your bees you must have the best. Three-frame Nuclei, hardy, disease-resisting, home-reared Italians, 1920 Queen; price, June £3 3s., July £2 13s., carriage paid; 7s. 6d. refunded on box if returned carriage paid Saxilby Station. Terms: Cash with order.—HERBERT VALLEY, Apiarist, Saxilby, Lincoln. r.e.31

**FOR SALE**, May Swarms 30s., June 25s.; good Nuclei, 1920 Queens, four frames 52s. 6d., three 45s., two 37s. 6d.; ready mid-May; cases 7s. 6d., returnable; JOURNAL deposit.—A. H. HAMSHER, Womersh, Guildford. e.41

**PENNA QUEENS, 1920.**—There are always some cancellations of early orders for queen bees. We have bought all queens that thus may become available in 1920 at the queen-rearing apiaries of Enrico Penna, Bologna. We offer these queens at Penna's advertised prices, viz., May and June, 12s. each; July and August, 10s. each; September, 9s.—S. H. SMITH, 30, Maid's Causeway, Cambridge. e.21

**100 FOUR-FRAME NUCLEI**, of Dutch, Dutch-Italian, £3 3s., and Italian, £2 15s.; all beautifully clean and healthy; massed with brood and bees. I strongly recommend my Dutch-Italian Hybrids, a fine disease-resisting strain. May-June delivery; cash with orders; carriage paid. All orders for July are £2 5s.—SEALE, Ashley Cottage, Otlands Drive, Walton-on-Thames, Surrey. r.e.4

**"ISLE OF WIGHT" DISEASE.**—Don't worry; use the solution that cures; 2s. per bottle.—E. PRESSEY, St. Elmo, Coulsdon. r.d.149

**BEES ON APPROVAL.**—We guarantee our Bees and Queens to give complete satisfaction. Catalogue 3d., which is returned on first order.—PEARSON & GALE, Marlborough. d.156

**PENNA** has sent me two specially selected 1919 Breeding Queens. Spare Virgins from these mothers, 4s.; spare Fertiles, crossed with Bozzalla (Ligurian) drones, 8s.; best only; real 4-frame Nuclei with I.Q., ready July, £2 10s.; in rotation; 25 per cent. cash with order.—PATRICIA, Grammar School, Doncaster. r.d.152

**1920 PURE Fertile Italian Golden Queens**, guaranteed imported direct from Italy; regular supplies throughout the season from second week in May; 14s. each; specially selected, 17s. 6d.—GOODARE, Italian Queen Specialist, New Cross, Weymouth. r.d.150

**PUPILS** received by life-long whole-time Bee Farmer.—Terms on application to C. B. BARTLETT, Sandford Mount, Charlbury, Oxon. d.127

**MISSES PALING AND PILLANS** having combined and enlarged their Apiaries, are now prepared to book orders for strong 3-frame Italian Nuclei, massed with brood and bees, headed with 1920 Penna Queens or 1920 Queens of their own rearing from best selected Italian strains, £3, carriage paid. Speciality made in rearing choice Italian fertile Queens, 12s.; Virgins, 6s. Reduction on quantities. Pupils taken.—Golden Square, Henfield, Sussex. r.d.84

**HAVE YOU READ "THE BEE WORLD"?** If not, why not? Every number in itself is a useful literary work for practice and reference. Specimen copy free.—Offices: THE APIS CLUB, Port Hill House, Benson, Oxon.

**ORDERS** booked for 3-frame Nuclei, Fertile Queens, Virgin Queens, etc. List for stamped, addressed envelope.—H. CRACKNELL, Mount Road, Thundersley, Essex. r.d.27

**BOZZALLA** tested Queens are sold at the price usually charged for untested queens.—Catalogue from H. STICH, Riccartbar Avenue, Paisley. r.e.116

**PENNA** strain Italian Queens, from June 7.—PASHWORTH, The Bungalow, Weymouth Street, Warminster. r.e.62

**EDINBURGH AND EAST OF SCOTLAND COLLEGE OF AGRICULTURE.**

**APIARIST.**

The Governors invite applications for the post of Apiarist in the Bee-keeping Department; salary £150 per annum.

Letters of application, together with two copies of not more than three recent testimonials, should be lodged with the undersigned, from whom further particulars may be obtained, not later than May 17, 1920.

THOMAS BLACKBURN,  
Secretary,

13, George Square, Edinburgh.

**HIVES AND ALL YOUR REQUIREMENTS.**

Quality A. Quick delivery.

Write for prices to—

L. ANDREWS & CO.,  
Joinery and Carving Works,  
78A, WESTGATE, PETERBOROUGH.

d.126

**HIGHLAND AND AGRICULTURAL SOCIETY.**

**Aberdeen Show, 20th, 21st, 22nd and 23rd July, 1920.**

Classes for Bee Appliances and Honey. Premiums, £53 10s. Half of Prize Money and Silver and Bronze Medals contributed by Scottish Beekeepers' Association.

Entry Forms from JOHN STIRTON, Secretary, 3, George IV. Bridge, Edinburgh.

## Italian Stocks.

We can deliver immediately strong 10-bar Italian stocks free from disease, carriage paid, 1919 Queens.

## Nuclei.

We are booking orders for 3-frame nuclei with plenty of bees and brood. 1920 Italian Queens. Start delivery first week in June.

## Italian Queens.

We can supply pure fertile Italian queens (1920) commencing first week in June, 10/6 each. Guarantee safe arrival.

## Goldens.

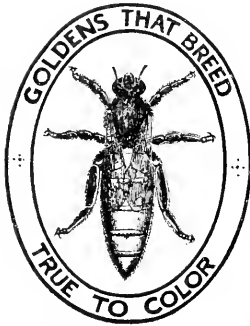

Our Guinea Gold Queens are bred in England. They are quiet, healthy, hardy, splendid workers and a lovely colour. They are bred from stock that has never had I.O.W. disease. We can supply fertile queens, 12/6 each. Delivery in June.

D. ALLBON & CO., Sunnyside Apiaries, Hitchin.

## Dutch Bees.

I have been appointed Sole Agent for Hans Matthes, the Dutch Bee Farmer who supplied the British Government last season with Skeps for their County Re-stocking Scheme. Hans Matthes also supplied me with what Skeps I required last year.

Last autumn I got a large consignment over from Holland, and am presently wintering these at my Apiary here.

To those desirous of testing these Dutch Bees, I will be pleased to send on my Illustrated Catalogue, containing much information regarding the hardiness, prolificacy, disease-resisting, and honey-gathering characteristics of this race of bee.

Address—

**R. WHYTE,**

The Bee Farm,  
Cumbernauld, Dumbartonshire.

5 per cent. discount allowed to members of the Apis Club.

## Bee Flower Seeds.

Collection of Six best Varieties,  
1s., post free

Beautifully Illustrated, Instructive,  
Up-to-date Garden Guide, 64 pages, Free.

**KNIGHT'S,**  
Seed Specialists, WOLVERHAMPTON.

## ITALIAN QUEENS

Direct from Italy.

Address:  
**Signor Gaetano Piana,**  
Castel San Pietro,  
near Bologna, Italy.

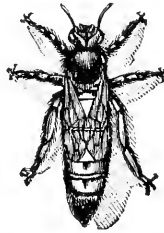

All Queens are reared by the most up-to-date and scientific methods. Mr. W. Herrod-Hempsall has personally inspected the apiary and methods employed, with which he is perfectly satisfied.

PRICES FOR 1920.

For 1 Fertile Queen: May, 12/-; June, 11/-;  
July, August and September, 9/- each queen.

Carriage paid in Great Britain. Cash must accompany all orders, which will be executed in rotation. Guaranteed safe arrival of all Queens, but not the introduction. Bees dead upon arrival must be sent at once to "B.B.J." Office.

For the mutual convenience of all parties, Signor Piana has made arrangements that all communications, orders and remittances of the readers of "B.B.J." and "B.K.R." can be addressed to him, c/o British Bee Journal, 23, Bedford Street, Strand, London, W.C.2.

Cheques payable to 'British Bee Journal.'

The products of the Apiary, of Poultry and Farm Stock, of the Fruit and Vegetable Garden can be Advertised and Sold through

THE  
**BAZAAR, EXCHANGE & MART**  
Newspaper.

Get a Copy—Thursday and Saturday 3d. The "Bazaar" publishes also practical handbooks by experts. Send for full catalogue, post free from—  
WINDSOR HOUSE, Breams Buildings, LONDON, E.C.2.

THE  
**British Bee-Keepers' Association.**

Insure now against loss by damage done through bee stings. All particulars from

W. HERROD-HEMPSALL, 23, Bedford Street, Strand, London, W.C.2.

# BEE CANDY FOR SPRING FEEDING

(In 1 lb. Cakes, medicated with Bacterol),

can be supplied by

**JAMES PASCALL, LIMITED,**  
BLACKFRIARS ROAD, S.E.1.

In lots of 6lbs., 12lbs., 18lbs., 24lbs., etc.

The necessary voucher must accompany order.  
Prices on application.

**BRADBURY, TAUNTON,**  
FOR QUALITY BEE GOODS.



*Illustrated Bee  
Guide free.*

Telephone: TAUNTON 176.



“**BACTEROL**”  
FOR BEES

2/6 per Bottle.

Post Free.

The cure for, and preventive of,  
“Isle of Wight” Disease.  
Non-poisonous—free from stain  
or unpleasant odour.

**MENLEY & JAMES, LTD.,**  
39, Farringdon Road, London, E.C.1.

## INSTRUCTION in BEEKEEPING *PRACTICAL AND THEORETICAL*

My Apiary will be open for a limited number of pupils  
during this season. Terms and particulars from

**W. HERROD-HEMPSALL,**

The W.B.C. Apiary, Old Bedford Road, Luton, Bedfordshire.

## **S. J. BALDWIN.**

I beg to inform that the No. 1 Kent Hive is not manufactured  
by me, only the No. 2 “Bromley Kent.”

(New deep frame 17×14×12. Sample by post 6d.)

**THE APIARY, BROMLEY, KENT.**

# HIVES.

Compare the WORKMANSHIP and FINISH of our Hives.

All made by practical Men who know what a good hive should be.

In various designs to suit all tastes and requirements. Season's speciality—THE MANLEY HIVE for 16 in. x 10 in. Frames.

Full descriptions and illustrations in our 1920 Catalogue: "*Everything for an Apiary.*"

If you have not received your copy, send a P.C. at once.

OUR MOTTO—SERVICE & QUALITY.

**R. STEELE & BRODIE, Wormit Works, Wormit, Scotland.**



(Telegrams: Graphicly, Uxbridge.)

## The Metal Foundation

(Protected)

The latest invention in Scientific hive equipment.

♦ ♦ ♦

**Durable ♦ Economic ♦ Sterillisable**

♦ ♦ ♦

An Ideal compromise between the Metal Comb and the Wax Foundation.

♦ ♦ ♦

¶ For further details and prices, send for our 1920 ILLUSTRATED CATALOGUE, post free on application. It contains detailed information on the most up-to-date hives and appliances for which the House of Lee is famous.

\*\* Five per cent discount to Members of THE APIS CLUB.

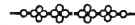

**JAMES LEE & SON,**  
LTD.,

Uxbridge, Middlesex,

Telephone: Uxbridge 181.)

## 20-Page 1920 "WHITE STAR" List,

3½d. POST FREE.

S. SIMMINS, QUEENSLAND, HEATHFIELD, SUSSEX.

**Bees and Beekeeping Appliances. Catalogue free. EDWARD J. BURTT. MANUFACTURER. GLOUCESTER.**

*I very much regret that there has been a large increase in the cost of the manufacture of bee-appliances, and therefore my prices will be advanced 10% from May 10th. Books excepted.*

PRINTED BY THE AVENUE PRESS (L. UPCOTT GILL & SON, LTD), 55-57, DRURY LANE, LONDON, W.C., AND PUBLISHED FOR THE PROPRIETOR (W. HERROD-HEMPBALL), BY SIMPKIN, MARSHALL, HAMILTON, KENT & CO., LTD., 31 & 32, PATERNOSTER ROW, E.C.



No. 1978. Vol. XLVIII

MAY 20, 1920.

[Published every Thursday, Price 2d.]

CONTENTS.

	PAGE		PAGE
REVIEW .....	241	EASTBOURNE AND DISTRICT B.K.A. ....	248
A DORSET YARN .....	241	CORRESPONDENCE—	
JOTTINGS FROM HUNTINGDONSHIRE .....	242	The Origin of "Tanging" .....	248
WHY BEES SWARM .....	243	Bees Building Comb Upwards .....	248
RE-STOCKING SCHEMES .....	244	QUERIES AND REPLIES—	
FIXING FOUNDATION .....	245	Bee-keeping in California .....	249
NOTES ON BEE-KEEPING .....	246	NOTICES TO CORRESPONDENTS .....	249
ECHOES FROM CORNWALL .....	247	BEE SHOWS TO COME .....	249
ROYAL SHOW FUND .....	247	WEATHER REPORT .....	250

# ALUMINIUM DRAWN OUT COMBS.

## “MONEY COMB”

*The greatest invention in the Bee World for 40 years.*

This is a drawn out Comb of Hexagon Cells exactly as bees build in their natural state. It is slightly coated with wax, has been thoroughly tested, and is not an experiment. Bees readily take to it for rearing brood and storing honey. Strong and durable, will last 50 years with care. Big consumption of honey saved to produce wax for comb building.

Control of bee diseases. No more burning of combs. Each comb easily sterilised and used over again.

Send for Catalogue and descriptive Leaflet.

1920 Catalogue post free

Patented by ALUMINIUM HONEY COMB CO., of U.S.A.

SOLE MANUFACTURER AND LICENSEE:

### E. H. TAYLOR, WELWYN, HERTS.

# THE British Bee Journal

ESTABLISHED 1873.

A Weekly Journal Devoted to the  
Interests of Bee-keepers.

Edited by T. W. COWAN, F.L.S., &c.,  
and J. HERROD-HEMPSELL, F.E.S.

## Correspondence: Whom to Address.—

All matters relating to the Literary Department, Associations, Shows, etc., should be addressed, "Editors, *British Bee Journal*," and all business communications and matters relating to subscriptions and advertisements to be addressed to the "Manager," *B.B.J.* Office.

**Subscriptions.**—Annual Subscription, 10s. 10d. post free in advance; single copies 2d., or 2½d. post free. If a receipt is required by post, a stamped and addressed envelope must be sent, otherwise a printed receipt will be enclosed along with the paper.

*Note.*—Cheques and Postal Orders should always be crossed, otherwise it is very difficult to trace them if they go astray.

**How to send Money.**—Remittances can be made payable to W. Herrod-Hempshall by crossed Cheques and Postal Orders. Stamps may be sent for small amounts up to 2s.

*Halfpenny stamps are preferred.*

Scottish or Irish cheques can only be taken in payment if 6d. is added for commission charged by banks for cashing them.

The Editors are not directly or indirectly interested in the manufacture or sale of beehives or appliances of any kind, and must refer correspondents wishing for prices or catalogues to advertisers in the paper.

## OUR DEPOSIT SYSTEM.

You are advised to insist on this being used when dealing with strangers.

## Rules and Conditions for Depositing

In order to save trouble, it is requested that the Rules be carefully read over by persons using the Deposit System of trading.

Goods should not be despatched until notice that the money has been deposited is received from this office.

**1. Method.**—When strangers are dealing together, the purchase-money of the articles is deposited at our office. We acknowledge receipt of the deposit to both parties, and hold the money until we are satisfied that the purchase is concluded. If a sale be effected, we remit to the seller the amount deposited, less a charge of 2½ per cent in the £, with a minimum of 6d., and the expenses of Post Office Orders and postage, &c. Cash will be forwarded by Cheque, Post Office Order, or by Postal Order as preferred. If a sale or exchange be not completed, we return the amount deposited, after making the same deduction. By this means buyers and sellers are secured against fraud.

**2. Deposits.**—Postal Orders (drawn on General Post Office) and Cheques must be made payable to W. Herrod-Hempshall, and crossed "London County and Westminster Bank." The numbers of the Postal Orders should be kept by the sender. We cannot be responsible for any loss that may occur in transit.

**3. Honey on Approval.**—All honey will be sold by sample, which must be sent direct to buyer.

**4. Bee Appliances.**—In ordering, the time allowed for completing the order to be stated to us when sending cash. If maker accepts, we hold cash until transaction is satisfactorily completed, when the amount will be remitted, subject to conditions as in Clause 1.

**5. Bees and Queens.**—These will be dealt with entirely by the parties concerned, so far as price, &c., go, and when the purchase is satisfactorily completed cash will be remitted as per Clause 1.

**6. Goods in Transit.**—These are at the seller's risk, i.e., any damage to or loss of an article on its journey is borne by the vendor; but a rejected article must be properly packed and returned by the same means as was used in sending it.

**7. Carriage.**—The carriage of all goods, *except such as are sent by post*, is payable by the buyer, unless otherwise agreed. If any article sent on approval be returned, each party to the transaction must pay carriage one way.

## Books for Bee-keepers NOW IN STOCK.

Cash in full must be sent with order.

		Postage
A Modern Bee Farm	7/6	6d.
A B C & X Y Z of Bee Culture (Root). 1919 Edition	15/6	9d.
Advanced Bee Culture (HUTCHINSON)	6/-	6d.
Beginner's Bee Book (PELLETT)	5/-	4d.
BEE-KEEPING SIMPLIFIED FOR THE COTTAGER AND SMALLHOLDER (W. HERROD-HEMPSELL, F.E.S.)	1/-	1½d.
BEE-KEEPERS' PRACTICAL NOTE BOOK (T. W. COWAN)	1/-	1½d.
BRITISH BEE-KEEPERS' GUIDE BOOK (T. W. COWAN) (paper covers only)	2/6	3d.
Dissectible Model of Queen Bee	4/6	3d.
FERTILISATION OF FRUIT BLOSSOMS BY BEES (T. W. COWAN)	-/3	1d.
Fifty Years Among the Bees (MILLER)	6/-	5d.
Honey and Health (A. HOPE)	-/6	1d.
Honey Vinegar (REV. G. BANCKS)	-/2	1d.
How to Keep Bees (ANNA B. COMSTOCK)	5/-	6d.
Management of Out Apiaries (DOOLITTLE)	3/-	3d.
Pollination of Fruit in relation to Commercial Fruit Growing (C. H. HOOPER, F.R.H.S.)	-/6	½d.
PRODUCING, PREPARING, EXHIBITING AND JUDGING BEE PRODUCE (W. HERROD-HEMPSELL, F.E.S.)	2/-	3d.
Productive Bee-keeping (PELLETT)	10/6	6d.
Queen Rearing in England (F. W. L. SLADEN)	1/6	2d.
Scientific Queen Rearing (DOOLITTLE)	4/-	3d.
Snelgrove's Method of Requeening	-/6	1d.
The Bee-keepers' Vade Mecum (GEARY)	2/6	1½d.
The "Townsend" Bee Book	2/6	2d.
WAX CRAFT (T. W. COWAN)	2/-	2½d.
Wilke's Book on Swarming	1/-	1½d.

## MISCELLANEOUS.

Maeterlinck's Life of the Bee The Lore of the Honey Bee (TICKNER EDWARDS)	3/6	3d.
THE BEE WORLD (supplied only to members of Associations interested in the control and development of the APIS CLUB, apart from ordinary members of the latter), per copy	-/8	1d.

British Bee Journal & Record Office,

23, BEDFORD STREET, STRAND, LONDON, W.C.2.





## Review.

*The Bee-keeper's Vade Mecum*, by Henry Geary. A very handy illustrated book of a convenient size for carrying in the pocket. It is exceedingly well written, and will prove interesting reading, even to those who do not keep bees. The chapters are well arranged, the advice given is sound, and is useful to both the new beginner and the old hand. Mr. Geary's style is simple and lucid; his meaning is clear, though given in a comparatively few well-chosen words, which are to the point. He says in Chapter I, "No effort has been made to deal with the scientific side of the subject over and above what it is incumbent upon every earnest bee-keeper to know. The aim in view is practical bee-keeping on safe lines for the beginner and for others more advanced." This result has been well achieved. We give a few short quotations: "There is no royal road to success in the craft; what is required is perseverance and a commencement at the bottom of the ladder—not an initial fall from the top rung."

"The possible profits connected with apiculture is usually one of the first considerations of intending bee-keepers, and unfortunately it is not altogether easy to be very definite. Many good apiarists place it at one pound (£1) per stock per annum, taking a series of years, and probably they are not far wrong. . . . Of one thing we may assure the beginner, and that is the fact that with reasonable care his percentage of profits will be very much greater on the whole than is derived from most small live stock. This profit is usually strictly commensurate with the attention given to the bees, and the close study of their requirements." The above are from Chapter I. The opening paragraph of Chapter II. on "The Life History of Bees" says, "Before embarking upon practical apiculture it is absolutely essential for the student to have a thorough understanding of the life history and habits of the honey bee. This is not a chapter to lightly pass over, for without this knowledge he will be as a ship without a rudder, much success in practical work being dependent upon accurate theoretical knowledge."

One more quotation from the chapter on "Varieties of Bees." "In summarising this chapter it must be said that strain is of far more importance than race. And in the opinion of the writer, the pure im-

ported bees are much inferior as a whole to a good strain of our common bees, or to good crosses."

A chapter is devoted to "The Food Value of Honey," and several recipes are given. The book is one we can heartily commend to our readers. It is published by Stanley Paul, bound in cloth, price 2s. 6d. We can supply it post free for 2s. 7½d.

## A Dorset Yarn.

Bees this week are on a wide range of subjects; the hollies claim quite a lot of attention, and the limnanthes are covered all day with them. Broad beans and peas are in flower, but not many go to them. The rasps are, however, a continual feast, and as we are at work beside them bees are with us all the time; the honey stored must be largely from this source just now, as we have such a lot of them. We are cutting the crimson clover for the stock, and the bees are with the lines as the scythe lays it down; the horse chestnut is still good, but it is bumble bees that make the most of the hum on these trees. The loads of pollen brought in are shades of yellow, and three parts of the home-comers are carrying it in; some have a crimson pollen, others a dirty-looking white.

Our bees are taking a lot of water just now; we have always given them a lot in May. They will go to all sorts of places for water—some of them into the ditches where mud was more in evidence, but they seemed to get some moisture out of it.

We are still learning a lot from the bees at the farm, how they will act differently when we try to prevent swarming. One stock of Italians had a brood box of drawn-out combs placed on top; another lot had one placed below. In the latter the queen has already entered, but in the former she has not presumed above; yet the workers rule the hive—they are the governing body, they have already filled the tops and sides with honey, the corner angles quite deep, leaving the centre and bottom in the crescent shape of brood-nest. All cells are made perfect by these workers, yet the queen has not entered them, at least there were no eggs.

This lot is very strong; in working upward the queen comes to the band of honey near the top bars, then goes down again looking for empty cells in which to lay her eggs. The workers are building a lot of drone cells, even on last year's new bars; this is against the honey surplus. But why should it be so this season, when in April they could not get out above five or six hours each week? I have known a wet May when they have pulled out the

white larvæ of the drones and carried them outside between evening and morning, and I have seen the sparrows after them quite early on the alighting board; but when looking over this week, now nice weather has come, they are building patches of drone comb. I am inclined to think it is because of destroying the queen cells, the workers are raising other queens; and knowing the drones take the longest to develop they are raising another lot of these handsome, though lazy, creatures.

What a lot of trade is being done in new stuff this year! One trader in Wimborne is clearing made-up bars in great numbers; there is a great spread of bees in Dorset now our County Association has started propaganda. Work on the farm takes up so much time that I have to get the bars made up for me, and have advised others to do the same, because so many amateurs in wiring the frames pull them out of square. To my mind, when handling bars, if not square they crush bees when taking out and returning them; the wood is cut true, but it is the wiring that pulls them out of square. If the brood box is too big the bees will build by the sides of bars. There should be only enough space at the ends of bars for bees to get by, but if the bar is pulled with wire it makes the bottom of one side touch the sides of brood box. When the beginner starts moving bars he will soon find those that hang well.—J. J. KETTLE.

## Jottings from Huntingdonshire

Many S.O.S.'signals have reached me from neighbouring apiarists, and many letters from away. It would appear that every bee-keeper is, or has been, in trouble over May Pest. Although in my own home apiary everything has gone merrily along, for which one is profoundly thankful, I have met with this trouble in neighbouring apiaries which I supervise. It has in each case passed away, and now there are no signs of trouble with the improved weather. With regard to the hives I've been asked to inspect, and also letters I have received, two things have been noticeable—one that the symptoms in some cases have been unmistakably those of "Isle of Wight" disease, the other that there was not even May Pest about, but simply an overcrowding, which caused many bees to seek relief outside, only to be troubled with the cold winds. One stock I went to see I asked and received permission to destroy. "Isle of Wight" symptoms were all too evident. Please, gentle reader, don't write asking me how I can tell whether crawlers are afflicted with

May Pest or "Isle of Wight" disease. To the observant mind the distinction in appearance is unmistakable, but it is rather difficult to define in words. Expert poultry-keepers can distinguish pullets from cockerels as soon as they emerge from the shell, but I've not yet come across anyone who could explain *how*. By the time these words appear in print, no doubt all signs of May Pest will have disappeared, and the owners of bees will be happy. This spring has been so unusual that one looks for unusual things. We shall not forget another year to put extra coverings on our hives at night during such time the days are warm and the nights are cold. The swarm I took on Sunday last being hived on drawn-out combs are establishing themselves well, and will soon be ready to go off to the lady who wants them.

Orders still come, and I have, reluctantly to say, all available swarms and nuclei are booked up. The price and scarcity of sugar is turning the attention of thousands to bees, and one gets panic orders—one lady offering £5 for a swarm. Visitors come a wheel and think by personal persuasion to wheedle a nucleus or swarm out of one, and look glum when told that all orders were booked many months ago.

I have been busy making every hive look in some way unlike the others. This may sound a fad, but there's sanity in it. Last year I happened to see a virgin queen go off on her mating flight. She returned and hovered awhile in doubt as to which hive she should return, and ultimately alighted at the wrong home. After performing her *apotheka* she was about to enter when half-a-dozen sentinel bees sent her forth; she again took wing, and returned in about 30 seconds, alighting on the same board only to be attacked again. Fortunately, I was able to catch her this time, and introduce her to her rightful home, where she was, of course, being anxiously awaited. I haven't forgotten the incident. Quite possibly many newly-mated queens lose their lives in this way: and when there are several hives as much alike as two peas, small wonder that their majesties get puzzled at times. Some one will be asking: How is it the worker bees do not get puzzled, too? They do. I have watched young bees pushed off by their nurses for their first flight return to the wrong hive, and what is more, enter without meeting any resistance. I had two hives—and still have them—two yards apart, one stock being Dutch and the other Italian. The queen in each case was pure, but one could always see Dutch bees in the Italian hives, and vice versa. Sentinels will let bees loaded with pollen

or honey pass in, but robbers and drones are kept at bay. How can I keep the two stocks pure if each sends forth a swarm? By introducing pure fertile queens. I have a method of my own in introducing queens. It has so far proved satisfactory, but before I give it to the world I want to experiment a little further.

There should be a good time ahead for apiculturists. Never have I seen stocks so strong. Last year I took off my first section rack by the end of May; I don't think I shall be so fortunate this year. The continual cold of April, while not preventing breeding, resulted in only the very strongest stocks taking freely to the supers; but there is another fortnight to run before June appears, and a good stock can do wonders in fourteen days.—E. F. HEMMING, Steeple Gidding.

## Why Bees Swarm.

### THE FUTTERSALT THEORY.

Miss Betts reminds me in the *Bee World* of my promise to the B.B.J. of a translation of Gerstung's "Futtersaltlehre"—that is, of his theory that the charging of the milk glands of the nurse bees in excess of brood requirements automatically causes swarming. The full translation would take up too much room, so I shall do my best to summarise his argument.

From the bloodstream of any organism the various parts each take out the ingredients it requires. By the subtraction of one ingredient some other comes into greater predominance, and if the proper organ does not ease that superfluity a catastrophe threatens. In the bee this circulation is not confined to the individual insect, but carries on through the whole hive, one bee giving to another its excess of food, especially its glandular secretion. Now for a few of Gerstung's own words:—

"As long as the hive consumes its stores and no superfluity of raw foodstuff streams in from outside, the activities of each age-class of the hive members are able to use up all the blood-content. But as soon as, through higher temperature and other favourable conditions, increased activity and therewith greater eating takes place, bees of all ages produce more futtersaft or bee blood (say, chyle food) than is necessary for the upkeep of their own organs. The hive passes from the state of regeneration to the state of over-production of tissue material, therefore to a higher phase of life.

"Let us now observe the result of this superfluity of life material on individual bees. Generally it brings into activity some gland which seeks to give away the superfluity; for example, the salivary

gland of the chyle stomach (vomiting of futtersaft and food broth), the wax glands, production of warmth by breathing, etc. It matters not by what organ the superfluity is got rid of; it goes from one bee to another through the blood stream of the whole hive. All members of the community produce nourishment and building-up material in excess of their own requirements, that must somehow be given away. . . . We must see that the whole chain of hive life represents a great mill, a unified digestion machine in which, from the oldest bee to the youngest, bee-blood is produced from honey and pollen. What older bees of the chain do not want, and perhaps cannot use because their glands have atrophied, streams to the younger, and *vice versa*. No keen observer can fail to note an uninterrupted exchange of nourishment among all members of the hive, which can well be called a futtersaftstrom (stream of chyle food).

. . . . The stream of superfluity that flows from the young bees to the old is apparently of carbo-hydrates, or warmth-producing, and the stream from older to younger consists of albumen, or fat. Now what happens when the young bee receives the stream? We see the first result in the distended abdomen that makes a worker bee seem almost a queen. The bloated body can take no more; the brooding glands come into activity and a giving-up of superfluity becomes imperatively necessary. At first these young bees and those standing next to them in the chain of exchange produce warmth. By giving up sugar and fat for warmth production, the albumen becomes predominant in the blood. All the glands come to bursting-point with albuminous excess.

"Whither shall gush this finest extract of the bee-blood, the finest extract of the whole nourishment production of the whole hive? At first there are no grubs. Elder sisters get the excess, and then the queen."

Let me now summarise a little. The queen takes pure royal jelly, which she converts into eggs, the grubs from which require during the first four days 53 per cent. of albumen in their food. In three weeks' time these grubs appear again as still more numerous brood-bees demanding outlet for their superfluous albumen.

"We may assume that a young bee requires from 5 to 10 grubs to take her chyle. A simple sum shows that the bee community cannot endure on this basis. Suppose that the queen easily supplies 1,000 eggs for the 100 young bees of the first brood batch. In three weeks' time these thousand nurse bees require 10,000 eggs. That also is child's play for a good queen. But these 10,000, still more charged with chyle by reason of still more

favourable weather conditions, will be let loose on the queen in three weeks' time. They demand within three weeks 100,000 eggs. The very best queen cannot supply them, for her limit is 3,500 to 4,000 per day. At first follows a general enriching of the organism of the young bee, a storing of growth material in young bee bodies, the well-known overfeeding of brood bees. The young bees require the expenditure of sugar for warmth production, and that still more brings the albumen into excess. The wax glands come into play, and cells are built that shall contain still greater devourers of albumen—that is, drones, whose food averages 55 per cent. of albumen in the first four days. So by comb production and drone raising the stress of the glands is relieved. . . . But the drones are fourteen days in the cells (after spinning up), during which time they cannot relieve the nurses of the food they are bursting with, and every day emerge fresh nurses also bursting to feed something." Gerstung then shows how inevitable it has become that queen cells shall be built, whose tenants can take a great deal of royal jelly, and, in fact, never consume all that is poured upon them. That seems to be the pith of a long chapter in which the theory is set forth. It shows us clearly enough a theory of swarming that seems to have a great deal in it, and the lines on which we must work in order to stave it off.—G. G. DESMOND, Shepscombe, Glos.

## Re-Stocking Schemes.

By J. PRICE.

Since the destruction of so many stocks of bees by "Isle of Wight" disease a great deal of interest has been taken in restocking devastated areas. Associations have given serious attention to this in order to restock their members' apiaries and so retain their subscriptions.

Private individual bee-keepers have been more cautious in getting fresh stock, many anxiously awaiting the discovery of some cure, others have plunged, having placed confidence in the many reported cures, only to find disappointment in the end. At the present time we are still waiting anxiously for the arrival of this something that will relieve us of this plague; at the same time restocking is going along on a large scale.

Therefore, my remarks on the above subject are for the purpose of assisting those that intend to restock, whether they are individual bee-keepers, bee-keepers' associations, or county restocking committees.

To me there appear to be three vital points that are absolutely necessary

before we can hope for success in this venture, and I am afraid that these three things have not always been taken into account; at the same time, I admit it is very difficult in some cases to secure them.

I will enumerate them as follows:—First, clean, untainted bees; second, a stock of clean appliances; and third, a clean district for the apiary. I remember that in 1908, when this disease was still playing havoc on the apiaries in the Isle of Wight, the bee-keepers of the mainland attempted to help their unfortunate brother bee-keepers by sending them gifts of fresh stock from England. Unfortunately, this generosity but added fresh fuel to the fire, and it would have been a wonder if they had remained healthy.

In those days we knew so little about the disease that it was excusable, and so I pass on.

Since then I know of at least one association that attempted to restock their members' apiaries on a plan very excellent in theory, but not at all practical.

It was as follows:—Bees were purchased by the association, split up into nuclei, and sent out to any members that were prepared to give a nucleus from this stock to some other member the next year. This would have been an excellent plan had the three points I have mentioned been taken into account, and had they been possible.

Unfortunately, the whole thing was a failure because the nuclei sent out into the various districts went into infected areas, and so, in course of time, they fell victims to the disease. This is now the most serious matter in restocking, but has been relieved somewhat by the selection of resistant bees. Nevertheless, I am afraid, in the near future those restocking committees that have not taken this into account will probably have difficulties to face. I admit it is a most difficult matter without legislation, but every endeavour should be made by the person expecting bees from the apiaries to see to it that his district is clean. If it is not so, the least he can do then will be to report it before receiving the bees, and then hope for the best. The committee of the restocking apiaries will then be able to make investigations, and I believe the county bee committees could do a great work in this way, as a letter from them would carry such a great weight, and thus help in getting infection removed.

The Kent restocking scheme has proved a success, mainly because resistant bees of a hybrid strain have been sent out. This is undoubtedly a great point, and no doubt the Government restocking

scheme has its main value in resistant bees.

There is still another restocking scheme which has been an unbounded success, which readers of THE BEE JOURNAL have heard very little about, and in which the English bee only was used. It is a well-known fact that the north countryman is not the person accustomed to crack of his good things before everybody; hence, I presume, this is the explanation for silence on the above scheme.

In reciting this case, I do so to show that it is possible to make a restocking scheme a success if the three points mentioned above are attainable. From 1911 to 1916 the Keswick district in Cumberland was reeking with "Isle of Wight" disease, and very few bees were left for miles around.

In the latter year, whilst I was touring expert for that county, a restocking scheme was suggested, and a local committee, consisting of the most active beekeepers in the district, was formed. It was arranged for this committee to go in pairs, each pair to visit every place in their appointed districts where bees had been known to have been kept. They were instructed by the Association that, if persuasion failed in removing infected appliances and bees, to buy them, and burn them on the spot. Happily, with the aid of the local Press calling attention to this matter, not one objector was found and no purchase-money was needed.

In the meantime my portion of work consisted of appealing to more fortunate members residing in districts where disease was unknown at that time for offers of swarms and nuclei, the result being that I received four lots from Kendal district and two others from South-West Cumberland.

An excellent site for the apiary was offered, free of charge, by Mr. R. Slack, Derwent Hill, Keswick, and a quantity of hives were loaned by another individual, so that in the summer of 1916 this restocking apiary was established, having those three essentials, *clean bees and appliances and a clean district.*

Under the able management of Mr. R. Just, of Portinscale, this apiary has been a decided success, the whole district has been restocked with bees, and now it is intended to use this apiary as the county restocking apiary for Cumberland, at the same time removing a portion of the stocks to Kendal to establish a restocking apiary for Westmorland.

It was a great pleasure to me to visit this apiary and also the district during the railway strike last September. I met many old friends who were jubilant over their bees and the success that had attended their scheme, and yet had re-

tained the native bee, with all its good qualities. It will be observed that no control could be used against infected bees being again imported into the district; therefore the Fell district beekeepers are anxiously awaiting the protective measure called "legislation" to make them safe.

(To be continued.)

---

## Fixing Foundation.

Perhaps a few remarks on the above may not be out of place at the present time.

I want first of all to say that no one should for a moment tolerate frames with saw cuts through the top bars. These, as has often been pointed out, form the finest harbours imaginable for wax caterpillars. By the use of plain top bars these pests are reduced to a minimum, even in neglected hives. The cut also greatly weakens the top bar, and disposes it to twist sideways, and it will be found a very common occurrence for split top bars to be in the shape more or less of a bow.

The wedge and groove principle is better, and not much can be said against it except for extra expense and the extra time which it takes to fix foundation by it. At least to me it is a most awkward and inconvenient plan. Another plan which I use is simply a shallow groove in the top bar in which to insert the foundation, running a little wax along each side.

But I have for some years now used a perfectly plain top bar. It saves foundation, and I find that with a little practice I can fix my foundation more quickly in this way than in any other. The method is this:—

First wire your frame, next take the sheet of foundation, and with a rule and a knife shave a very narrow strip from the top edge, so that the top edge is perfectly straight, and will touch the top bar evenly all along. Then lay the sheet on the wiring board, and place the wired frame over it, so that the top bar touches the foundation. Then lift board, foundation and frame up on end at such an angle that a little hot wax (not too hot) can be run down where the wax and the frame meet. If desired to wax both sides turn board and frame over, and lift off the board, when the foundation will be found to lie on the wires with its top edge fixed. Then run a little wax down the other side. Then with embedder you can embed the wires. If the wires are parallel from end to end of the frame it is easy with the little finger to pull their

centres down a little while embedding, so that there is less likelihood of the foundation sagging.

By this method I have wired a very large number of frames, and have hardly ever had a breakdown.

Of course, I need not say that each process should be done on the number of frames required at once, and not as detailed above, each frame completed separately. First wire, say, 50 frames, then shave the foundation, then wax them to the top bar, etc.

I should say that in handling frames in which the foundation is waxed to the top bar and in which the wire is not embedded, they must always be held with the wires under, so that the foundation lies on them.

This takes long to describe, but is in practice a quick way, and by it good combs are produced, with no weak and unsightly top bars, which spoil the appearance of so many hives.

One special tool is necessary—a wax smelter, with a water jacket.

Much has lately been said in the U.S. bee Press about the wiring of frames. I think there is no way equal to wires placed parallel and lengthways. Two for shallow frames, four for standard, five for 16 x 10, and I should think six or seven for 14 x 12. The top wire  $\frac{3}{4}$  in. from the top bar, the next about 1 in. below, and so on, wider as you get further from the top. If the wires are stretched a little down in the middle when embedding, no sagging will ever occur with good foundation. If people could fairly generally adopt this method it would be easy, I expect, to get frames with end bars neatly pierced ready for wiring, which would be a great saving of labour. Hooks I abhor, because it is so difficult to cut out old combs.

One other point. Foundation is rarely made *wide* enough to fill up to within  $\frac{1}{4}$  in. of the bottom bar. In many cases, when fixed in a saw cut or groove, it leaves a considerable space between the comb and the bottom bar, which the bees rarely fill. This weakens the comb, besides restricting the breeding space.—R. B. MANLEY.

[We can thoroughly recommend this method of fixing foundation, as we have used it for a number of years now. The only difference between Mr. Manley's procedure and our own is that we prefer to embed the wire before waxing the foundation. There is one other advantage of a plain top bar. It is easier to clean than the split bar, as in the latter there is not only the groove to contend with, but very often one-half of the bar is lower than the other.—Ems.]

## Notes on Bee Keeping.

The cold, wet weather we have experienced of late up here in the North is serious for our bees. Strong stocks kept active indoors brood-rearing, and unable to take a cleansing flight owing to climatic conditions, will prove disastrous to our bees should it continue. Have had to give a spare comb of honey to each stock to keep them in a prosperous condition ready to take advantage of an early honey flow, which seems likely if the weather will only take up. There is a possibility of plenty of stocks going under this spring if not fed, because of the unusually mild winter we have passed through. Stores must be used up, and if a stock finds itself in a starving condition the bees are almost sure to destroy the maturing brood. In addition to bee life, fruit trees have suffered heavily. I was noticing the young shoots on the gooseberry and black currant trees twisted and broken off with the recent gales, while the apple trees appear to be changing colour from green to brown. The next two or three weeks might bring a change for the better. I usually super at the end of May. Placing supers on a hive is a very important manipulation. There may be, perhaps, with many bee-keepers very little importance attached to the manner in which supers are placed on a hive; in fact, in many cases they are simply "clapt" on, the cover replaced, and then left to their (or rather the bees') fate. No notice of season is taken; they may be put on in March, if there are a few fine days, or in July, when most of the harvest is over, as would be the case here. What is required is observation. When colonies are strong—which means that they must be thickly packed with bees on nine or ten frames—it will be time then to think of supers. How often do we find the question asked: "When does the honey flow commence?" An observant bee-keeper will know at a glance when this takes place. If there are few flowers blossoming it will not be necessary to examine the bees, but as soon as the meadows and hedgerows begin to be well sprinkled with the advance guard of the army of wild flowers to follow, then remove the quilts from off the frames, and note whether the cells on top of the combs are beginning to be elongated. This can easily be seen by the new (white) wax with which the bees are adding to the walls, that they may accommodate the precious nectar that is then commencing to be produced by the flowers; if this is so, the supers must be put on at once. The super must now be wrapped up as warm as possible, to prevent any sudden change in the outside temperature being felt

within. If a super is ill-protected, the bees will on a cold night descend into the brood-chamber for warmth. And all work is suspended in the super during this time, and it will be quite late in the morning before it will be again filled with bees, perhaps a loss of twelve hours out of twenty-four being the result. For bees work almost as energetically between sunset and sunrise as they do during the day, but this work is confined to the hive, such as comb-building, feeding larvæ, evaporating and sealing over honey, etc. Some bee-keepers are in the habit of only using one shallow frame super, and removing combs as fast as they are filled and sealed over. This is a bad practice, for nothing discourages the bees more than this; in fact, some bee-keepers have often found them discontinue work in the super for the rest of the season when treated in this manner. A good motto is handle *supers*, not *frames and sections*.—P. LYTHGOE, Padgate, Warrington, Lancs.

### Echoes from Cornwall.

Heavy S.W. winds and gales for nearly six weeks have worked havoc with the fruit trees, etc. If fire had gone through, it could not have blasted worse. Most stocks hereabouts are rather weak, so that prospects up to now are not too rosy. Many brother bee-keepers have lost all their stocks; others have only two or three left out of a dozen or so. The bees have been out, but, strange to say, the fruit trees seem to have been left severely alone.

Yesterday and to-day (May 8 and 9) have been glorious, and all stocks were exceedingly busy carrying in pollen in huge yellow and white pellets, and there is that peculiar odour of brood rearing about the apiary. If this weather holds up I hope the weak stocks will rapidly improve in time for the clover, which usually appears about the end of June here. I notice, like Rev. E. F. Hemming, that there is May Pest about, and I have a slight bit of it in my own apiary, but hope this lovely weather will soon make it disappear.

It is really pathetic to see the bees with swollen abdomens, vainly trying to fly, but they drop down and run wildly hither and thither; some manage to relieve themselves and fly off with a hum of joy, others fall and die. What a fright I had at first on seeing them unable to fly, but what a relief to notice that the wings were not apparently disjointed, and no combs at all spoiled by excreta, as in "I.O.W." disease.

All the bees are very sprightly, in spite of their malady, so I have great hopes

yet. We do not expect to obtain sections, or extracted honey, in these parts for at least another month or six weeks. The horse chestnuts and sycamores are not in bloom yet, but "the best is yet to be."

The plums they absolutely ignored, and only a few on the gooseberries, but they are working the currants just now I see, yet we are still associated with the feeder, and seem likely to be for a while.

I have a friend in York who has lost his stocks and cannot obtain any in his vicinity. Can any brother bee-keeper oblige him thereabouts at a moderate price? He is a jolly good fellow, and not returned long from France.

It is now time for me to be seeing to my feeders, so will bring this to a close, with best wishes to all.—A. D. BENNETT.

### Royal Show Fund.

The Council of British Bee-keepers' Association are anxious to take their usual part at the Royal Show to be held at Darlington this year, so that their unbroken record of representation at this show may not be spoilt. In order to defray the expenses in connection therewith the Council ask that all bee-keepers assist in this work by giving donations, which should be sent as early as possible to the Secretary, 23, Bedford Street, Strand, London, W.C.2.

Subscriptions for this fund are coming in very slowly, and we would urge all those who can possibly do so to send a donation, however small. The sum needed is not, comparatively, large and if every one does a little should be easily forthcoming. "The Royal" is the show of the year, when the value of bee-keeping, and of the use of honey, to the community is brought to the notice of hundreds of people, and should the Bee and Honey Department have to be dropped for lack of funds, the loss to bee-keeping will be out of all proportion to the amount needed to carry on. May we also urge all those who can do so to make an entry, and exhibit at the Darlington show. A good display will help both the show and the craft. We are sure our bee-keeping friends in the North are looking forward to a good display of honey, etc., at this year's Royal Show.

#### DONATIONS RECEIVED.

	£	s.	d.
Amount received ... ..	4	8	0
C. S. M. Eales ... ..	1	1	0
Dr. J. Loane ... ..	0	10	0
G. Bryden ... ..	0	10	0
	£6	9	0

## Eastbourne & District Bee-Keepers Association.

This Society completed its first year of existence in March last, and celebrated its birthday by giving an open, free lecture in the Lecture Room of the Technical Institute, Eastbourne, where an audience, which quite filled the room, listened with unusual interest to an excellent lantern lecture by Mr. Judge, the well known and popular secretary of the Kent B.K.A. From very small beginnings this new Association is steadily spreading its influence, and the "district" it covers continues to increase. To obtain about 80 subscribing members in its first year shows that its aims are appreciated. During the year the members met one evening every month, when addresses were given on seasonable subjects and general discussions followed.

During the summer five outdoor demonstrations were given at the apiaries of members, and at one of these Mr. Pryor, of the Kent B.K.A., was good enough to spend several hours going through a season's work, demonstrating his methods as he went along. Thanks to the generosity of one or two members, it has been possible to supply monthly a copy of *Bee Craft* to all members, and still end the year with a creditable balance in hand. The enclosed notice on diseases will show, Mr. Editor, that in some respects at least this Society is being conducted on right lines:—

### EASTBOURNE AND DISTRICT BEE-KEEPERS' ASSOCIATION.

As there have been a number of cases of "Isle of Wight" disease in this district, the Committee are anxious that all members should realise the importance of taking *immediate* measures to deal with this and other diseases.

In doubtful cases, or where members do not feel themselves competent to take the necessary steps, help will be available at once upon application to the Hon. Secretary. The early employment of the proper remedies will generally result in the saving of a stock, and will certainly help to prevent the spread of disease.

It is not fair to neighbours to leave stocks alone when their appearance shows that disease is present. One of the chief objects of the Association is to free the district from disease and keep it clean.

Should members unfortunately lose their stocks by disease, the Association will endeavour to start them again with a healthy nucleus the following year.

W. P. GORNALL,

Chairman.

By co-operative buying, by free assistance willingly given to members in need

of it, and by many other small acts of mutual kindness, this Society is growing weekly, and hopes to make itself known as a real live Society.

Requests for membership come from places further and further afield, and with the hope that this may meet the eyes of some of these outlying bee-keepers, with your permission, Mr. Editor, the writer will end by giving the address of the energetic Hon. Secretary—Mr. W. H. Nurse, 7, Ocklynge Avenue, Eastbourne.—(Communicated.)



### The Origin of "Tangling."

[10185] The very interesting suggestion as to the origin of "tangling" made by your correspondent, Miss Annie D. Betts appears to be worthy of very careful consideration and investigation.

The two reasons usually given for the custom are mutually destructive, and whatever may be the value of "tangling" for giving notice of ownership, I can find not the slightest proof that "tangling" causes bees to settle.

In answer to the letter I sent you, which you inserted in the Journal a short time since, I have received a good many replies informing me that swarms did settle when "tanged," but no single instance of anything like proof that the settlement was the *result* of the "tangling."

If Miss Betts' suggestion is the correct one—as I think most probable—that the clanging of metal was believed to be effectual in driving away evil spirits, this course would naturally be adopted to prevent evil spirits from driving away the bees.

Hence, if they settled near home, the magic was successful.

From this it was a short step to believe, as the old faith grew dim, that the noise of clashing metal caused bees to settle.

I hope Miss Betts will pursue the investigation, for which all lovers of bee lore should be most grateful.—N. F. ROBERTS.

### Bees Building Comb Upwards.

[10186] In reply to your correspondent, A. C. Grimshaw (10.161), I do not think it at all an uncommon occurrence for bees to build combs upwards, as some of my bees do this nearly every spring. Only yesterday, April 8, I found three of my stocks had built about 1½ in.



of comb upwards from the tops of frames into the empty glass-covered candy boxes. It appears that as they consume the candy the comb is built to fill up the empty space, it being well known that bees will very rarely tolerate an empty space above the combs.—W. T. HOWLETT.

## QUERIES AND REPLIES.

### Bee-Keeping in California.

[9903] Do you consider California a good place to start bee-farming? I understand there is very little rain in summer. Would there be a succession of crops, and what would be a fair average of comb honey per hive and price? I am 50 years of age, with experience in bee-keeping. I would work and keep a number of hives at first, and increase as I could. I would go slowly at first. A reply in next week's Journal would oblige yours, etc., ANXIOUS.

*Reply.*—Some districts of California are very good for bee-keeping, especially the canyons in the mountains, where sage is plentiful. California sage produces some of the finest white honey, and in some seasons very abundantly. An apiary situated on a level spot, if such can be found, well protected by the sides of the mountain covered with sage, is a good locality, as the bee-pasturage is at close range and within easy reach of the bees. There is about one good yield of sage honey in five years. During the months of May and June, when the sage is in bloom, it is a very busy time for the bee-keeper. There are other flowers, but of minor importance, but honey is obtained from alfalfa, where it is cultivated, and also from orange blossoms where orange trees are grown in any quantity. There is no great succession of crops, as there is no rain during the summer months. The present price of Californian honey by the car-load free on board is from 14 to 18 cents. The rainfall is uncertain, and when there is a lack of it at the proper time the outlook, like that of this year, is very unpromising. The honey market this year is rather dull owing, it is said, to high prices. At your age we would not recommend you to start bee-farming in California, as the life in some of these lonely mountain canyons is extremely lonely and arduous, and for the short honey season the work is very hard. If you could find a suitable place in the plains where alfalfa is grown and irrigation carried on it would not be so hard.

## Notices to Correspondents

- Will Miss E. Tilt, Essex, whose query we answered in B.B.J. for April 22, kindly send her address. We have mislaid it, and have a letter to forward.
- C. M. P. (I.O.W.).—*Preventing propolis.*—We do not know of any other method than applying vaseline.
- "Novice" (Yateley).—*Transferring bees from box to frame hive.*—Fit up a movable comb hive with frames fitted with foundation. Take the bottom off the box and stand it on the top of the frames, making all secure so that bees can only get in and out through the legitimate entrance. When there is brood in the new combs see that the queen is on them, and place a queen excluder under the box. It may be necessary to "drive" the box in order to find the queen. Three weeks later all the brood in the box will have emerged from the cells, and the box and combs may be removed.
- "Novice" (Tunbridge Wells).—*Alighting board spotted with excreta.*—The excreta from diseased bees is generally a dark brown, but varies from that to yellow. The colour of excreta cannot be taken as indicating disease.
- E. W. (Dellburn).—*Feeding with honey from diseased bees.*—It is much better not to use such honey for this purpose. If you do so, add about  $\frac{1}{2}$  pint of water to each pound, boil for 15 to 20 minutes, and when cool medicate it. The hives and frames will be safe after your treatment. The wires will not be affected by formalin.
- J. W. WHITE (Gloucester).—*Making artificial swarm.*—(1) Yes, the old flying bees will return to the original stand. These will form the "swarm." The young bees will stay at the new location. (2) Cut the projecting cells down. (3) Yes, but do not stuff the entrance so tightly as he says. (4) Yes.
- Suspected Disease.*
- "GOFALUS," P. C. (Grantown-on-Spey), J. TURNBULL (Haydon Bridge), M. E. W.—The bees are affected with "I.O.W." disease.
- E. V. (Brackley).—(1) Chilled brood. (2) A couple of the dead larvae.
- F. M. (Eastbourne), D. P. (Dingwell), X. Y. Z. (Middlesex).—We do not find any disease.

## Bee Shows to Come.

*A nominal charge of 2s. 6d. is made for notices (not exceeding 7 lines) in this column, 10 lines charged 3s. 6d., up to 15 lines 5s., which covers cost of insertion from order till date of show. Cash should accompany orders for insertion.*

**June 2-5, at Reading.**—Royal Counties' Agricultural Society's Show. Hon Sec., 131, King's Road, Reading. Honey entries closed.

**June 9 and 10, at Colchester.**—Essex Agricultural Society. Classes for Extracted and Comb Honey, etc. Schedules from Secretary, Essex Beekeepers' Association, 7, Bulwer Road, Leytonstone. Entries close May 31.

**June 16 and 17.**—Hanley Park Meeting of the Staffordshire Agricultural Society. The Staffordshire B.K.A. offer valuable prizes and six silver medals and nine bronze medals. Twelve Classes for members only, and five Open Classes. (Honey Classes are for four or three jars or sections). Schedules, W. Griffiths Silkmere, Stafford. Entries close May 29.

**June 29 to July 3, at Darlington.**—Royal Agricultural Society's Show, Bee and Honey Section, under the direction of the B.B.K.A. Prizes arranged in groups of counties for Associations affiliated to the B.B.K.A. Schedules from The Secretary, 23, Bedford Street, Strand, W.C.2. Entries close May 31.

**July 6, 7 and 8, at Cardiff.**—Royal Horticultural Society's Show. The Glamorgan B.K.A.

in conjunction with R.H.S., offer prizes for Honey, Wax, Bees, and Appliances. Members, Novices, and Open Classes. Schedules, Mr. Wiltshire, Maindy School, Cardiff. **Entries close June 22.**  
**July 15 and 16, at Grimsby.**—Lincolnshire Agricultural Society. Show of Bee Appliances, Honey, Sections, Wax, etc., under the management of the Lines B.K.A. Open and County Classes. Valuable prizes.—Schedules from Major Hadfield, Alford, Lincs. **Entries close June 12.**  
**July 20 to 23, at Aberdeen.**—Highland and Agricultural Society. Classes for Bee Appliances and Honey. Premiums £53 10s. Half of Prize Money and Silver and Bronze Medals contributed by the Scottish Bee-keepers' Association.—Entry forms from John Stirton, Secretary, 3, George IV. Bridge, Edinburgh.

**Monday and Tuesday, August 2 and 3, at Newport.**—Monmouthshire Bee-keepers' Association Annual Show (in connection with the Newport Allotment Holders' Association). Members and Open Classes.—Schedules (post free 3d.) from Hon. Sec., "Underwood," Portskewett, near Chepstow, Monmouthshire. **Entries close July 26.**

**August 12, at Taunton.**—Somerset Bee-keepers' Association Show of Honey, Wax, and Appliances. Seven Open Classes. Liberal prizes.—Schedules from Mr. F. J. J. Stacey, 3, Hammet Street, Taunton. **Entries close August 6.**

## Weather Report.

WESTBOURNE, April, 1920.

Rainfall, 2.59 in.	Minimum on grass, 27 on 22nd.
Heaviest fall, .50 in. on 11th.	Frosty nights, 0.
Rain fell on 22 days.	Mean maximum, 54.2.
Above average, .83 in.	Mean minimum, 43.1.
Maximum temperature, 60 on 10th and 23rd.	Mean temperature, 48.6
Minimum temperature, 33 on 22nd and 30th.	Above average, 2.5
	Maximum barometer, 30.249 on 24th.
	Minimum barometer, 29.136 on 13th.
	L. B. BIRKETT.

## Special Prepaid Advertisements.

One Penny per Word.

### PRIVATE ADVERTISEMENTS.

**TWO** strong Colonies, perfectly healthy, supered up in double-walled bar-framed hives, in good condition; removing reason for selling; price £10 the lot.—JONES, The Elms, Ashford, Middlesex. e.43

**WILL** exchange two Hives, disease free, in good condition, for two Swarms, or one 10-frame Stock, English Bees.—DYSON, Chemist, Alfreton, Derby. e.44

**PURE** Light Cambridgeshire Honey for Sale in 28-b. tins, £1 15s. per tin.—WELLS, Bowers Lane, Isleham, Cambs. e.45

**SEVERAL** HIVES, in good condition, for sale, cheap.—Particulars free, AVERY, Deverill, Warminster. e.46

**FIVE** FRAMES, capped brood, well covered with bees, good frames (not old), 1919 Queen; Dutch hybrids, 60s. MONEY returned if not up to specification. H. WILCOX, 46, Lyndon Road, Olton, Warwick. e.47

**ITALIANS.**—Choice strain (Penna's extra selected). Spare nuclei, 33s., delivered. Inquiries stamp.—Box 669, B.B.J. Office, 23, Bedford Street, Strand, W.C.2. e.48

**TWO** New Hives, painted, £1 2s. and £1 5s. each.—GREEN, Woodville, Landon. e.52

**STRONG**, natural Swarms, 40s.—NORTH, Cressing, Braintree, Essex. e.87

**FOR SALE**, Honey Extractor; will take two Standard frames or shallows, complete, with covers and in good condition; price 60s.—MOSES, 743, Holderness Road, Hull. e.50

**WANTED**, Swarms of Bees, Italians, Dutch-Italian hybrids. State price.—REV. EVANS, The Rectory, Llangammarch Wells. e.51

**WANTED**, a few 1919 Queens of good strain. Cages sent if desired.—J. MOORE, Bleasby, Notts. e.54

**PURE** light Cambridge Honey (guaranteed), 28lb. tins 42s., carriage paid; sample 4d.—J. YOUNGER, 6, Maid's Causeway, Cambridge. e.56

**TWO** excellent 1919 Queens for sale, 10s. 6d. each.—MR. LAMB, 7, Redbourne Avenue, Church End, Finchley, N.3. e.58

**ITALIAN BEES.**—Five stocks on 10 frames, £4 10s. each; one stock in skep, £2 10s.; one strong swarm on 10 combs, £3; all carriage paid. Travelling boxes 10s. extra, refunded on return. No disease in apiary. W.B.C. hives if required, 30s. each.—BRISCOE, "Ashmore," Fairview Road, Sutton, Surrey. e.60

**FOR SALE**, two Hives, large brood chamber, 15 frames, condition as new, exceptionally well made; 30s. each, or nearest offer; sundries included.—CROSSLEY, Consall, Stoke-on-Trent. e.61

**TWO** strong Stocks of Bees for sale; also a Hive.—CHALEEL, Teignmouth. e.62

**HEN** and 19 Chicks, hatched May 10, pure Leg-horns and Wyandottes, 75s.; ditto, and 11 chicks, 38s. 6d.—W. WOODS, Normandy, near Guildford. e.63

**FOR SALE**, a few 1919 Hybrid Queens, from this year's purchased stocks; price 7s. 6d. each.—ASHWORTH, The Bungalow, Weymouth Street, Warminster. e.64

**TWO** 8-frame Stocks of guaranteed healthy golden Italians, £4 10s. each, cash. Box returnable.—COX, 116, Addison Road, King's Heath, Birmingham. e.65

**ITALIAN BEES**, very strong stock, on ten Standard frames, guaranteed free from disease, £5. Box 10s. allowed for returned, carriage paid Attleborough. Stamp reply.—CLEWLOW, Codsall, Wolverhampton. e.66

**FOR SALE**, strong 10-frame Stock Black Bees, re-Queened August, 1919; £3. Immediate delivery.—WALLACE, Hedenham Lodge, Bungay. e.67

**STRONG** Stocks for sale, 1919 Queens, 7 frames; £3 10s.—JAMES, Alexandra Park, Penarth. e.68

**STRONG** healthy Swarms booked for delivery in May and June £2 each.—MRS. LUSCOMBE, The Cottage, South Darloth. e.71

**100** New Standard Frames, wired, fitted Taylor's weed foundation, 12s. doz., carriage paid; crate of 60, carriage paid, 57s.—W. G. BRANDISH, Ettington, Stratford-on-Avon. e.70

**FOR SALE**, two 10-frame Stocks, ready for supers, £6 each; 6-frame Nucleus, £3; Swarm, on four frames, £2.—Box 84, B.B.J. Office, 23, Bedford Street, Strand, W.C.2. e.83

**FOR SALE**, eight hives and strong stocks of bees, Italian and Carniolan, with young Queens, separately 28 each hive lot £60. With appliances and geared extractor, £10 extra.—Apply A. J. RAYMENT, 50 Chandos Avenue, Whetstone, N.20. e.82

**SALE**, two Hives (Taylor's), Smoker, and Tin Dividers, all new last year.—Box 85, B.B.J. Office, 23, Bedford Street, W.C.2. e.85

**SURPLUS QUEENS.**—Dutch and Hybrid Virgins from County Re-stocking Apiary, 4s. 6d. each.—ANDREWS, Expert, 78a, Westgate, Peterboro'. e.81

**SWARMS**, healthy, splendid strain, 40s.; Clover Honey, 15 lbs., 30s.—NORTH, Cressing, Braintree, Essex. r.e.26

**SIX** new standard Hives, unused, all inch material, double walled, movable bottom, 35s. each.—MARTIN, 66, Stratford Road, Wolverton, Bucks. e.27

**SALE, BRITISH BEE JOURNAL, 1917-April, 1920.** What offer?—MRS. NORRIS-ELYE, Utterby Rectory, Louth, Lincolnshire. e.32

**SWARMS for Sale.** Orders booked now.—COLE, Hornsey High School, Weston Park, N.8. r.e.33

**SWARMS.**—May, £3; June, 50s.—SAUNDERS, Waverley, Farnham, Surrey. e.39

**FOR SALE**, six frames of healthy honey-fed Bees, never had any disease in apiary, £3 10s. and 10s. charged on travelling box, from which carriage of bees is deducted and balance returned to buyer.—REED, Primrose House, Heacham, Norfolk. r.e.20

**CORRESPONDENCE COURSES** in Bee-keeping.—H. E. NEWTON, Brown House, Barton-on-Sea, Hants. r.d.157

**WANTED**, from August 22 to September 4, in Cornwall or Devon, within 12 miles or so of sea, Bedroom and Sitting Room, with shed for motor car; farmhouse preferred. Can any bee-keeper oblige me?—W. HERROD-HEMPSALL, Old Bedford Road, Luton, Beds.

**FOR SALE**, two "Rotax Roadlight 267" self-contained Acetylene Motor Headlights, very powerful, £6 the pair; one Exhaust Whistle, 10s.; one Wood-Milne Motor Foot Pump, 40s.—HERROD-HEMPSALL, as above.

**WANTED**, portable Greenhouse.—Price and particulars to W. HERROD-HEMPSALL, Old Bedford Road, Luton, Beds.

**WANTED**, Auster Rear Wind Screen for motor car.—HERROD-HEMPSALL, as above.

**BUSINESS ADVERTISEMENTS.**  
1½d. per word.

**DUTCH BEES**, Skeps (as imported from Hans Matthes), Nuclei, Queens. Illustrated Catalogue on request, containing points on management.—Buy direct from Sole Agent, WHYTE, Bee Farmer, Cumbernauld, Dumbartonshire. b.61

**500** Virgin Italian Queens for sale during the season, from now onwards, 5s. each. Fertile Queens, June, onwards, 10s. Orders in rotation.—JACK TICKELL, Westbourne Apiary, Cheltenham. e.55

**3-FRAME** Italian Nuclei, crowded, quickly build up full strength, May delivery 55s., June 45s. Box returnable. Satisfaction guaranteed.—H. BOWREY, Swallowfield, Berks. e.57

**IF** it is Italian Queens, Nuclei, or swarms you require, try my Welsh bred ones, equal to any better than many.—BOOBIER, Bishopston, Swansea. e.59

**STRONG**, healthy stocks Bees for sale, from £3 3s. Orders now being booked for delivery in June.—MISS PELLY, Lodge, Witham, Essex. e.69

**PURE** Golden and three-band Italian Bees and Queens; prolific and gentle; the ideal bee for pleasure and profit.—COOMBER, 64, Ronald Park Avenue, Westcliff, Essex. e.38

**ITALIAN 4-FRAME NUCLEI**, Penna Queen, covered bees and brood, 55s.; boxes 10s., returnable. 1920 Penna imported Queens, 11s. each. Large stock "W.B.C." Hives and Apiary Supplies; bargain.—C. HOGAN, Boxford, Suffolk. r.e.80

**50-75 3-FRAME** Nuclei Italian Hybrids, 1920 Queens, proved disease-resisting strain and excellent honey gatherers. Delivery early June onwards; orders executed in rotation. Price 45s. each, carriage paid; travelling boxes to be returned.—Further particulars, HOSEGOOD, 26, Purley Park Road, Purley, Surrey. r.e.86

**4-FRAME NUCLEI**, headed by 1920 Italian Queen, 50s., June delivery; 6-frame Stocks, 70s.; 8-frame Stocks, 90s.; immediate delivery; box charged 10s., returnable; Italian Fertile Queens, 10s. 6d. All orders in strict rotation. Cash with order.—LEE, "Little Bowden Apiary," Burgess Hill, Sussex. e.78

**3-FRAME NUCLEI**, with Fertile Queen, 37s. 6d.; 3 case 5s., returnable; cash with order.—W. WOODS, Normandy, near Guildford. e.78

**NUCLEI**, 5 frames, 1920 Queen, immediate delivery, £3 3s.; June delivery, £2 2s.—LARMUTH, Hillside, Monahan Avenue, Purley. e.77

**MY CHAMPION STRAIN OF HYBRIDS.**—1920 3-frame Nuclei, immediate delivery, 45s.; box and carriage free; Fertiles, 8s.; Virgins, 4s. Guaranteed healthy.—LOWE, Park Road Apiary, Chilwell, Notts. e.76

**ITALIAN COLONIES.**—Simmins and Penna strains; 8 frames, £4 15s.; Nuclei, 3 frames, 45s. Five per cent. discount to members of Middlesex Bee-keepers' Association.—BABBAGE, 33, Whitestile Rd., Brentford. r.e.75

**CAMBS MAY STOCKS!** CAMBS MAY SWARMS!—All our Black and Hybrid Stocks must be moved out by June 1. Send for price list. May Swarms, as they come, not less than 4 lbs., 8s. per lb.; travelling boxes 10s. extra, returnable. Some time in June we will supply 8-b. Swarms to fill those American or 16-in. x 10 in. frame hives.—S. H. SMITH, 30, Maid's Causeway, Cambridge. e.73

**PENNA QUEENS, 1920, DIRECT FROM BOLOGNA.**—We have bought all queens that may become available through cancellations of orders at the queen-rearing apiaries of Enrico Penna, Bologna. We offer these queens at Penna's advertised prices, viz., May and June, 12s. each; July and August, 10s. each; September, 9s.—SMITH, 30, Maid's Causeway, Cambridge. e.74

**ORDERS** booked for Swarms, all guaranteed healthy, also Nuclei.—STANLEY, 56, Montague Road, Cambridge. r.e.72

**FOR SALE**, good Nuclei, 1920 Queens, four frames 52s. 6d., three 45s., two 37s. 6d.; ready mid-May; cash 7s. 6d., returnable; JOURNAL deposit.—A. H. HAMSHAR, Womersley, Guildford. e.41

**MR. BEE-KEEPER,**—If you wish to succeed with your bees you must have the best. Three-frame Nuclei, hardy, disease-resisting, home-reared Italians, 1920 Queen; price, June £3 3s., July £2 13s., carriage paid; 7s. 6d. refunded on box if returned carriage paid Saxilby Station. Terms: Cash with order.—HERBERT VALLEY, Apiarist, Saxilby, Lincoln. r.e.31

**100 FOUR-FRAME NUCLEI**, of Dutch, Dutch-Italian, £3 3s., and Italian, £2 15s.; all beautifully clean and healthy; massed with brood and bees. I strongly recommend my Dutch-Italian Hybrids, a fine disease-resisting strain. May-June delivery; cash with orders; carriage paid. All orders for July are £2 5s.—SEALE, Ashley Cottage, Oatlands Drive, Walton-on-Thames, Surrey. r.e.4

"ISLE OF WIGHT" DISEASE.—Don't worry; use the solution that cures; 2s. per bottle.—  
E. PRESSEY, St. Elmo, Coulsdon. r.d.149

**BEEES ON APPROVAL.**—We guarantee our Bees and Queens to give complete satisfaction. Catalogue 3d., which is returned on first order.—  
PEARSON & GALE, Marlborough. d.156

**1920 PURE Fertile Italian Golden Queens,** guaranteed imported direct from Italy; regular supplies throughout the season from second week in May; 14s. each; specially selected, 17s. 6d.—  
GOODARE, Italian Queen Specialist, New Cross, Wednesday. r.d.150

**PUPILS** received by life-long whole-time Bee Farmer.—Terms on application to C. B. BARTLETT, Sandford Mount, Charlbury, Oxon. d.127

**MISSES PALING AND PILLANS** having combined and enlarged their Apiaries, are now prepared to book orders for strong 3-frame Italian Nuclei, massed with brood and bees, headed with 1920 Penna Queens or 1920 Queens of their own rearing from best selected Italian strains, £3, carriage paid. Speciality made in rearing choice Italian fertile Queens, 12s.; Virgins, 6s. Reduction on quantities. Pupils taken.—Golden Square, Henfield, Sussex. r.d.84

**HAVE YOU READ "THE BEE WORLD"?** If not, why not? Every number in itself is a useful literary work for practice and reference. Specimen copy free.—Offices: THE APIS CLUB, Port Hill House, Benson, Oxon.

HOLLAND COUNTY COUNCIL.  
AGRICULTURAL EDUCATION COMMITTEE.

**APPLICATIONS** are invited for the post of Instructor in the combined subjects of Poultry and Bee-keeping.—Applications, stating salary required, should be sent in by May 31, 1920, to THE PRINCIPAL, Kirton Agricultural College, near Boston, Lincs, from whom further particulars may be obtained. e.84

## SCIENTIFIC QUEEN REARING.

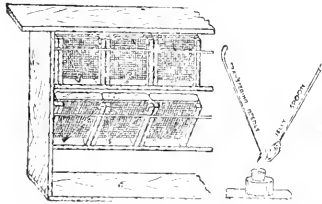

**BEST**  
in the world.  
Every  
appliance and  
instructions.  
Send for  
**KAT-A-LOG**  
**MEADOWS**  
**SYSTEM.**  
Near LEICESTER.

## HIVES AND APPLIANCES.

Immediate dispatch. Quality O.K.  
Write for prices.

### ANDREWS & CO.

Joinery and Carving Works,  
78a, WESTGATE, PETERBOROUGH.

**ORDERS** booked for 3-frame Nuclei, Fertile Queens, Virgin Queens, etc. List for stamped, addressed envelope.—H. CRACKNELL, Mount Road, Thundersley, Essex. r.d.27

**BOZZALLA** tested Queens are sold at the price usually charged for untested queens.—Catalogue from H. STICH, Riccarton Avenue, Paisley. r.c.116

## ITALIAN QUEENS

Direct from Italy.

Address:  
Signor Gaetano Piana,  
Castel San Pietro,  
near Bologna, Italy.

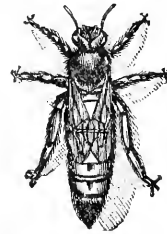

All Queens are reared by the most up-to-date and scientific methods. Mr. W. Herrod-Hempsall has personally inspected the apiary and methods employed, with which he is perfectly satisfied.

PRICES FOR 1920.

For 1 Fertile Queen: May, 12/-; June, 11/-;  
July, August and September, 9/- each queen.

Carriage paid in Great Britain. Cash must accompany all orders, which will be executed in rotation. Guaranteed safe arrival of all Queens, but not the introduction. Bees dead upon arrival must be sent at once to "B.B.J." Office.

For the mutual convenience of all parties, Il Signor Piana has made arrangements that all communications, orders and remittances of the readers of "B.B.J." and "B.K.R." can be addressed to him, c/o British Bee Journal, 23, Bedford Street, Strand, London, W.C.2.  
Cheques payable to "British Bee Journal."

The products of the Apiary, of  
Poultry and Farm Stock, of  
the Fruit and Vegetable  
Garden can be Advertised  
and Sold through

THE  
**BAZAAR, EXCHANGE & MART**  
Newspaper.

Get a Copy—Thursday and Saturday 3d. The "Bazaar" publishes also practical handbooks by experts. Send for full catalogue, post free from—  
WINDSOR HOUSE, Brems Buildings, LONDON, E.C.2.

THE  
**British Bee-Keepers' Association.**

Insure now against loss by  
damage done through bee  
stings. All particulars from

W. HERROD-HEMPSALL, 23, Bedford  
Street, Strand, London, W.C.2.

## PREPARE FOR EXTRACTING.

The quickest, cleanest and most efficient on the market is the "BAIRD" EXTRACTOR, which extracts from BOTH SIDES of the COMB simultaneously.

Particulars from G. S. BAIRD, 1, HURST ROAD, ERITH, KENT.

# BEE CANDY FOR SPRING FEEDING

(In 1 lb. Cakes, medicated with Bacterol),

can be supplied by

**JAMES PASCALL, LIMITED,**  
BLACKFRIARS ROAD, S.E.1.

In lots of 6lbs., 12lbs., 18lbs., 24lbs., etc.

The necessary voucher must accompany order.

Prices on application.

**BRADBURY, TAUNTON,**  
FOR QUALITY BEE GOODS.



*Illustrated Bee  
Guide free.*

Telephone: TAUNTON 176.



**“BACTEROL”**  
FOR BEES

2/6 per Bottle.

Post Free.

The cure for, and preventive of,  
“Iste of Wight” Disease.  
Non-poisonous—free from stain  
or unpleasant odour.

**MENLEY & JAMES, LTD.,**  
39, Farringdon Road, London, E.C.1.

## INSTRUCTION in BEEKEEPING PRACTICAL AND THEORETICAL

My Apiary will be open for a limited number of pupils  
during this season. Terms and particulars from

**W. HERROD-HEMPSELL,**  
The W.B.C. Apiary, Old Bedford Road, Luton, Bedfordshire.

## S. J. BALDWIN.

I beg to inform that the No. 1 Kent Hive is not manufactured  
by me, only the No. 2 “Bromley Kent.”

(New deep frame 17 × 14 × 12. Sample by post 6d.)

**THE APIARY, BROMLEY, KENT.**

# HIVES.

Compare the WORKMANSHIP and FINISH of our Hives.

All made by practical Men who know what a good hive should be.

In various designs to suit all tastes and requirements. Season's speciality—THE MANLEY HIVE for 16 in. x 10 in Frames.

Full descriptions and illustrations in our 1920 Catalogue:

*"Everything for an Apiary."*

If you have not received your copy, send a P.C. at once.

OUR MOTTO—SERVICE & QUALITY.

**R. STEELE & BRODIE, Wormit Works, Wormit, Scotland.**



(Telegrams: Graphicly, Uxbridge.)

## The Metal Foundation

(Protected)

The latest invention in Scientific hive equipment.

♦ ♦ ♦

Durable ♦ Economic ♦ Sterilisable

♦ ♦ ♦

An Ideal compromise between the Metal Comb and the Wax Foundation.

♦ ♦ ♦

¶ For further details and prices, send for our 1920 ILLUSTRATED CATALOGUE, post free on application. It contains detailed information on the most up-to-date hives and appliances for which the House of Lee is famous.

\*\*\* Five per cent discount to Members of THE APIS CLUB.

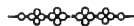

**JAMES LEE & SON,**  
LTD.,  
Uxbridge, Middlesex,

Telephone: Uxbridge 181.)

## 20-Page 1920 "WHITE STAR" List,

3½d. POST FREE.

S. SIMMINS, QUEENLAND, HEATHFIELD, SUSSEX.

**Bees and Beekeeping Appliances. Catalogue free.**  
**EDWARD J. BURTT. MANUFACTURER. GLOUCESTER.**

*I very much regret that there has been a large increase in the cost of the manufacture of bee-appliances, and therefore my prices will be advanced 10% from May 10th. Books excepted.*

PRINTED BY THE AVENUE PRESS (L. UPCOTT GILL & SON, LTD), 65-67, DRURY LANE, LONDON, W.C. AND PUBLISHED FOR THE PROPRIETOR (W. HERBOD-HEMPBALL), BY SIMPKIN, MARSHALL, HAMILTON, KENT & Co., LTD., 31 & 32, PATERNOSTER ROW, E.C.



No. 1979. Vol. XLVIII      MAY 27, 1920.      [Published every Thursday, Price 2d.]

**CONTENTS.**

	PAGE		PAGE
SEASONABLE HINTS .....	253	JOTTINGS .....	259
JOTTINGS FROM HUNTINGDONSHIRE .....	253	ROYAL SHOW FUND .....	260
THE APIS CLUB .....	254	CORRESPONDENCE—	
RE-STOCKING SCHEMES .....	255	Queens and Space Between Two Brood	
NATIVE BEES .....	256	Chambers .....	260
COMMENTS ON VARIOUS ARTICLES .....	257	The British Honey Producers' Association .....	261
NOTES ON BEE-KEEPING .....	258	Bees Disappearing .....	261
HOW TO MAKE A SKEP .....	258	Keeping Quilts clear from Propolis .....	262
NOTES OF ANOTHER NOVICE .....	259	BEE SHOWS TO COME .....	262

QUARTER OF COST.

# VEILS

1/10 POST FREE.

We have just taken over from the Government all their surplus unused VEILS (750) made for protecting the faces of soldiers in Mesopotamia from Mosquitos and Flies. These are perfect as Bee Veils and we are able to offer them at the above exceedingly small figure. Once these are sold it will not be possible to replace at anything approaching this price. The Veils fit over any hat and are fitted with one adjustable cane which keeps the veil well clear of the face.

**SOMETHING NEW IN  
WAX EXTRACTORS.**

**“THE WILLIS” 33/-  
NO WASTE—NO TROUBLE—NO SMELL.**

**E. H. TAYLOR, WELWYN, HERTS.**

# June PENNA QUEENS

## 12s. each.

---

**Italian Queen Bees direct from Italy.**

From the queen-rearing apiaries of  
**ENRICO PENNA, BOLOGNA, ITALY.**

---

Although we bought a fair supply of May and June Penna queen bees we miscalculated the demand of the D.B.s and we have now bought *all the surplus* queen bees Mr. Penna has still for sale this year.

We offer these queens at Mr. Penna's advertised prices, and all queen bees will come direct from him to customers.

To simplify matters: If you will send us your name, address and the money, Mr. Penna will do the rest.

As these June queens will be arriving every other day please don't delay your orders.

**SAFE DELIVERY GUARANTEED.**

**S. H. Smith, 30, Maid's Causeway, Cambridge**





### Seasonable Hints.

At the time of writing these notes we are having another spell of hot weather, of which the bees are taking advantage to swarm, and a number have come off during the last few days of brilliant sunshine. Do not neglect the oft-repeated advice to feed a swarm for a week, longer if the weather should turn unfavourable, and no one knows better than a bee-keeper how untrustworthy our climate is, but many do not realise in how short a time a prosperous colony may be at the point of starvation, their very prosperity helping towards the catastrophe. The fine weather of February and March induced breeding, and by the end of the latter month many colonies were so strong that they were ready for supers and looked likely to swarm. The combs contained a fair amount of stores, old and new, some even had an over-abundance, but April was cold and wet, stores were rapidly used up owing to the large number of larvæ that needed feeding. From the middle to the end of the month drones were being killed off and larvæ turned out of the hive, both signs that food was scarce and the bees were on the verge of starvation, some actually starved to death, not a cell of honey in many hives. The moral is that bee-keepers must always be on the alert. The present fine weather may not last, and the honey stored will quickly disappear during a short spell of unfavourable weather, the swarms are especially liable to come to grief, as the honey taken into the honey sac by the bees before leaving the parent hive has to be used for wax making as well as food.

A long continued period of hot, dry weather is also unfavourable for bees, and may result in a food shortage, vegetation is parched and stunted, and the few flowers that do come out contain no nectar. It is possible that this type of weather may prove more dangerous, especially to the novice, than cold and wet. The bees are seen to be flying every day, but their owner does not look or think deeply enough; bees cannot collect nectar from dry and withered flowers, but they will try and collect honey from their weaker neighbours.

One of the worries now is how to prevent swarming when it is not desired. The main cause of swarming is overcrowding. There is no room for the ordinary work of the hive to be carried on. The queen has no room for egg-laying,

the workers have no room to build more comb or to deposit honey, all available space is utilised, and the cell walls of the old combs are elongated. We are told in most text books that when this elongation of the cells is noticed supers should be put on at once. Our own opinion, often expressed, is that by the time this stage is reached preparations for swarming have already begun, drones have been reared, and queen cells started, and it is then difficult, if not impossible, to stop the swarm. The bees must have room *in advance of their requirements*, and we therefore advise supering when bees are seen working between the outer combs and the hive sides, on both sides of the hive. The plan for swarm prevention given in "Gleanings in Bee Culture," by Miss Iona Fowls, and printed in the *B.B.J.* for May 8 last year, has been tried by many of our correspondents and ourselves with success, and can be recommended. Always use a queen excluder under supers, even sections. Some bee-keepers do not use one under sections, but if it is not used there is always the danger of the queen going up. We have already seen half-a-dozen spoilt in one rack this year through the absence of a queen excluder.

### Jottings from Huntingdonshire

My bees, I fancy, have been reading *THE BRITISH BEE JOURNAL*, for no sooner did my remarks that I could hardly expect filled sections by the end of May appear in print, than they set to work to fill up sections in earnest, and by the time these jottings appear I shall, I hope, take off my first 1920 honey. Forsooth, what an opportunity the insects of the hive have! As they come forth and seek pollen and nectar before them stretches some 200 acres of meadow land rich in buttercups, hop, white and crimson clover. But walk through field after field and one sees no Italians there. The Dutch are keen on the hop clover, but the yellow backs, where are they? Turn aside into a field of winter beans, full of bloom, and you'll see my ladies busy. Farmers who have acres of winter beans must feel singularly happy this year. Did ever one see such fine sturdy plants with so much promise of fruit! Hop clover flower is very tiny yet, the Dutch bees delight in sipping its sweets. Indeed, when the first few heads opened I witnessed many a fight. In one instance I noticed no less than twelve bees struggling to take possession of one small plant.

The endless masses of May blossom are now passing—that is, the white variety; "Blossom that hangs in the tremulous

air, blossom with tips of snow." The red and pink varieties are now at their best, but there are no fields surrounded with this. Here and there a bush, and its scarcity is half its beauty. The hawthorn bloom passes, and the dog roses come, followed by the elder and then the black-berry; thus does Nature keep our hedges painted for us from month to month. At the time of writing the scent of honey-suckle fills the air, alive with bees, but not the tiny insects we love. Bumble and mason bees are there, so, too, are the miner and tapestry queens. How hard they work! Yet how happy they are. What care they that they have to make their own nest, lay the eggs and prepare food for the grubs, and often without a mate to help them. The world is young to them, and they are gay and full of the spirit of spring.

Not for many years have such myriads of cowslips appeared in the mead and roadside as this year. They are over now, and their delicate beauty passed; and yet, sweet though they are, did ever one see bees upon them? Ye town lovers, with your murky atmosphere, your hot pavements, your dusty streets, what a lot ye miss! "Can't stick the country!" Ah; you've never seen it, tasted it, felt it, peeped into its soul. Know ye aught of the number of flowers, the varieties of grasses which can be seen in a single meadow? Do you know how many species of trees may be found in a given square mile? How many birds nest in field, hedgerow and tree, the colour of their eggs, the character of their song? You know not; small wonder when you love your bricks and mortar so. Tell me, can't thou show me anything in all your cities half as beautiful as a valley bathed in liquid moonlight in the month of May? Can your concert halls give us anything approaching a calm, June evening, when choirs of birds are singing their lullaby while the nightingale stirs the very atmosphere with his thrilling song, harmonised by the hum of home-coming bees. In the meadows are oxen feeding, horses grazing, and sprightly foals come timidly up to ask you something, yet are too shy at first to stay to hear the answer. When a little older they will ask to be patted and stroked; their mothers, jealous, will demand a share of the attention. Ah, me, my pen will ne'er run dry when I compare country with town—I must shake myself and talk of bees, or bee-keepers, or both.

Bee-keepers! How funny some of them can unwittingly be! Quite a number out to get honey get their first stock or swarm, and ask everybody what they know of bees. They gather knowledge here,

and knowledge there—so far so good—but hopelessly mix it up. "If you're passing my way would you be so kind as to have a look at my bees; I can't get them to enter the supers," writes a lady. I go to see if I can help; what do I find? The dear, good lady has heard of the use of carbolic cloths when supering, and calmly concluded that said cloths were meant to cover the section racks as a first quilt. Poor bees. Another lady arrived at a friend's, keen on bees, in her motor car, ordered a stock, and wished to take it away there and then, hive and all, which reminded me of a man who two years ago asked if I could let him have a swarm. I promised I would. He arrived two days after to take the bees away, and gazed dumbfoundly when I told him I hadn't one yet. When he found his tongue he explained that he thought all that was necessary was to shake a few hundred bees into a skep and transfer into a hive more than two miles away from parent home; the queen would do about September. He wanted *workers* not *brooders*. He was quite of the opinion that the same bees would work from April to September without a queen and the continued hatching of brood. He is wiser now.

Orders for honey are already beginning to come in. They are wise who look ahead, wiser than a brother cleric who asked me this last week to let him have my earliest swarm. "Booked and dispatched," I replied. "Your next swarm then." "Sorry," I replied, "all booked up before last October." "Can't you let me have one somehow?" "Yes, if all be well, I'll let you have my first swarm in 1921." What a shock it gave him—he quite thought I should jump at the chance of an order coming along. He, too, is wiser, and wisdom so gained is not soon forgotten.—E. F. HEMMING, Steeple Gidding.

### The Apis Club.

The General Conference of members of THE APIS CLUB will take place at the Central Hall, Westminster, London, on Saturday, May 29, at 2 p.m. The subjects under consideration are, however, of great importance, and concern the whole craft rather than a federation of bee-keepers. It is much to be hoped that some constructive proposals will be put forward for the greater development which the scheme aims at.

The meeting will be limited to the members and to representatives of Associations who have an official membership in the Club.

The nearest station to the Hall is the Westminster District Railway Station.

## Re-Stocking Schemes.

By J. PRICE.

(Continued from page 245.)

When the Staffordshire Bee Committee received particulars of the Government restocking scheme, they, fortunately, all sensible bee-keepers, having decided to accept, seriously considered the possibility of this excellent scheme being made a channel for propagating disease, and they took measures, as far as possible, to avoid it. It was taken for granted that untainted bees were coming from Holland, and it would be very unfair to use any other bees, or any second-hand appliances, even although the shareholders had to wait a little longer until such time as the apiary was established and fully equipped.

The selection of the site was left to me, and we were fortunate in securing a place near to the main railway and close to a station, and also in a district where no other bees were near. We therefore started with those three most valuable assets I have mentioned before, and so far all has gone well at this apiary.

The committee also took precautions, as far as possible, to prevent their bees going into infected apiaries, and an agreement had to be signed by the shareholder before his share was retained, and it is interesting to know that only two refused to sign and had their shares refunded. It may be of interest to give particulars of this agreement:—

STAFFORDSHIRE AGRICULTURAL EXECUTIVE COMMITTEE.

HORTICULTURAL SUB-COMMITTEE.

County Buildings, Stafford,

February 14, 1919.

Dear Sir or Madam,—

BEES.

The Bee Committee beg to acknowledge the receipt of your share in their restocking scheme, and to say that you will be duly notified when your nucleus or queens are ready.

The price of a four-frame nucleus for this season has now been fixed at 30s., the balance of 10s. to be paid on the receipt of bees.

The Committee are anxious, as far as possible, to avoid sending their bees into infected apiaries or districts, and they will be pleased to hear on the accompanying form (which please return to me) that you are willing to abide by the following conditions for the prevention of disease, otherwise the value of your shares can be refunded to you, namely:—

(1) That you will endeavour to ascertain and report in confidence to the County Expert (Mr. J. Price, County Education Offices, Stafford) any possible existing sources of contamination in your neighbourhood or any future outbreaks,

and will assist in removing all infection from your own apiary.

(2) Should disease at any time be found in your apiary you will at once report to the County Expert, and you will follow the instructions given for its suppression.

(3) That you will not sell or send any bees out of your neighbourhood without the consent of the Bee Committee.

(4) That all imported Italian queens received from them shall be used primarily for the purpose of increasing your healthy stocks, and not for sale or introduction to already diseased lots.

Yours faithfully,

EUSTACE JOY,

Hon. Secretary of Committee.

A belated report of a meeting held at this apiary in July appeared in *THE BEE JOURNAL* for September. On this occasion the apiary was open to inspection, and all bee-keepers in the county were notified, the result being a most excellent gathering. Over 300 visited the apiary, and included pedestrians, cyclists, motorists and others that came by train, all of whom enjoyed a very pleasant and interesting day, and it was very gratifying to the Bee Committee to know that such interest was being taken in this subject.

Since the report of the above gathering was inserted in the *B.B.J.* several inquiries have been made as to the number of nuclei produced, and I trust this report I give will not be confused with accounts of other restocking apiaries where other bees were used in conjunction with the imported ones.

Staffordshire received eight Dutch skeps, six of the tall pattern, about 3 ft. high, and two very similar to the English pattern skep. Thirteen Italian queens were received, and we have been able to produce 32 extra lots from the original eight, twenty of which were sent out as nuclei, and twelve retained at the apiary as stock for this year. Altogether, 160 sheets of foundation were drawn out, the greatest difficulty being to get the first dozen or so, for except in the case of the two English-pattern skeps, which were placed on to the top of frames and transferred, we had to depend on swarms from the tall skeps to work out the combs.

A great deal of criticism has been made about the queens imported by the Government, and supplied to the restocking apiaries. Personally, I have no complaint to make about the queens, and I think it is wrong to put the blame on the breeder. It is quite an easy matter to shelve the responsibility on to the queen-breeder, and not seek for a solution of the difficulty in other ways.

Some have suggested that the difficulty has been with the Dutch bees—that they know and will not accept a queen of

another colour. I don't think this is right, either. I believe the main reason so many failures have occurred in introducing these imported queens is the extraordinary difficulty under which the scheme has had to be worked. For instance, if one is compelled to drive bees from a skep, or make an artificial swarm by removing the old stock and catching the flying bees on their old stand, then one has the worst element possible to contend with, namely, the oldest bees. Again, I admit that the Dutch bee is an "Artful Dodger," being able to locate its old hive a long way off, so that in a little time one has nothing left of the artificial swarm, or driven lot, to receive the new queen.

My practice has been to drive the bees

## Native Bees.

I like my native bees even more than the beautiful Italian, which latter I am testing against them. Now it is laid against the natives that they are not so prolific as foreign races. This I venture to state is a mistake, mine are able to fill two boxes, that is twenty-two or twenty-four standard frames, with brood, and what is more, keep them filled in the honey flow; how much more they could do is not easy to say, but I remove two, four, or six combs of brood, replace with foundation and find these full of brood in a few days. If I did not do this they would swarm, but I have been able to prevent swarming this way. Last season was not good, yet they averaged 102 lbs.

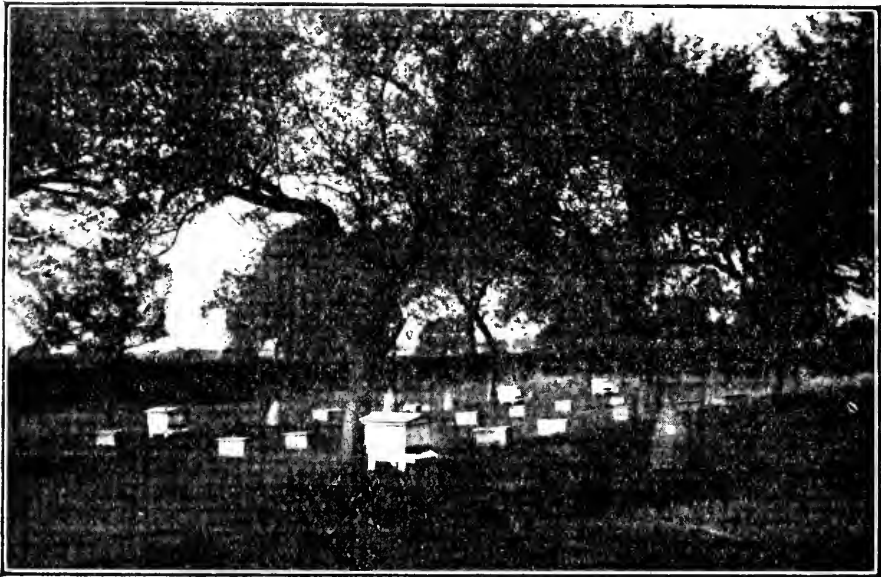

A STAFFORDSHIRE RE-STOCKING APIARY.

from the skeps minus the queen (a difficult job with the tall skep), dump them immediately into a well ventilated box containing frames of foundation, with a queen caged on the top. These bees are imprisoned for a couple of days, and even then some would return to their old home. However, these difficulties will not be met with now, seeing that we have bees established on frames of comb. The best method of introducing imported queens is undoubtedly the nucleus plan, where there are only young bees left to receive the new mother.

The price for nuclei last year was 30s. each, and this year nuclei headed with home-raised Italian queens are the same price, whilst a limited number headed with imported Italians are available at 35s.

honey per hive, and gave two to three nuclei each, and they supplied stores for these nuclei also, as I could not get sugar. They are very gentle. I only breed from best queen, and gentleness is a qualification, but as a rule they do not see the necessity of rearing more than two or three queens, and if I rear in a strong nucleus, sometimes only one. Yet if I bred queens for sale, and used only strongest stocks, they would possibly rear a larger number. But natives, being in their own land, are able to give surplus every year, which is undoubtedly a good quality. This is not a good district for honey, I have seen better localities, and often wonder where they get their forage, just now they are getting pollen from furze which is scarce here, but as they only got out two days

this year I could observe fairly accurately.

Bees are adaptable to whatever forage there may be, and natives possibly second to none in this respect.

I had no disease here of any kind, but no bees are within miles of my locations, also they are in dry hives, warm, yet ventilated, with zinc covered roofs and no draught of cold frosty air can get through.

Now I gather from remarks in the bee press that no race of bees is exempt from disease, why therefore is it more or less suggested that natives are more prone to maladies than other races? Echo answers "cows far off wear long horns."

My belief is, that if those who keep bees for sale charged more for natives than others, natives would stand first in favour, because what costs us most we value most, as a general rule.

If natives were moderate in price a generation or so ago, was it not due to their easy propagation, for natives were not slandered in my father's days.

Please observe, natives means just that—pure natives. I abhor all crossbred, hybrid, or mongrel bees, for one very good reason, that when a boy my father got some "Ligurian" queens, they came by post, in pill boxes, and his bees became mixed. I had reason to remember these things, as I used to help him with about twenty stocks. Hardy bee-man as he was, and a reader of the *B.B.J.* he found those bees a tough proposition. However, he carried on with them, and possibly—every cloud has a silver lining—that was why he never had rheumatism. I made a resolution never to keep bees, but years bring discretion, also possibly there is something in heredity, my forefathers kept bees since the dim ages, and I got a present of a swarm. Perhaps these things were the "circumstances that were too strong for me." After a season I bought the "British Bee-Keepers' Guide Book," then things began to happen, queen rearing by selection, honey extracting, more bee books and papers, but also note more honey and bees, sowing of white clover which did not grow and other plants which did.

Well, to finish the above "Ligurians," it took about ten years, but foul brood did it, and it happened gradually, swarms brought up losses. I was out in the wide world by that time, but finally an expert or inspector, I am not sure at this date what he was, said it was brood disease, and that summer they went under.

I do not understand, when I read that natives run into a corner like frightened sheep, what is meant unless too much smoke is given. A friend got a swarm last summer, and on arrival they buzzed in what he thought was a dangerous

manner. Well, he "subdued" them with smoke, as per directions, until the buzzing stopped, thereafter they did not sting—dead.

I use little smoke, and none this time of year, generally a veil, often none, and can say I only got three stings last season from my own bees, and they were when I pressed a bee by accident.

Finally *vide* "Bee World" for September, page 67 quotes from conversation B.B.K.A., 1906.—R. DOUPE.

## Comments on Various Articles.

*Bees in a Bell.*—Some weeks ago Rev. E. F. Hemming said he would like to hear if anyone had known of bees using a bell as a hive. For many years the tower of North Benfleet church (near here) was so cracked that the largest bell of four could not be used. When the tower was rebuilt about 20 years ago, the large bell was found to be full of very good honey. The combs were all dark—but not the honey. I did not see it myself, but the gardener at the rectory told me about it.

*Stinging.*—In the BRITISH BEE JOURNAL for April 8, Mr. Houston quotes Rev. E. F. Hemming *re* a black roof. I have none except dark roofs—most of them tarred—but I always work my bees with my sleeves rolled up and no veil on. I often go a month without a sting. Mr. Houston tells us his bees sting his brown gloves, but not after he painted them white. It was not because his gloves were brown, but the scent of the stuff they were dressed with at the tanyard. I once had a stock that would sting everything that went within 50 yards of their hive. I was about to re-queen them when "Isle of Wight" disease ended them. That was the only stock I ever had I could not work without a veil. There are times when I have to put on a veil for a short time, but if I find the bees are so cross I close up the hive as soon as I can and try another day. I find if I give all hives a puff or two of smoke and lay just a small bunch of grass in front of all hives before I start to move a roof, and use a damp cloth with two or three drops of Calvert's No. 5 carbolic, I can do just as I like with the bees. I always have three or four such cloths with me.

With regard to the rose, Hugh Dickson. I think if Mr. Houston had washed his hands and face in plenty of cold, soft water and scented soap (such as his mother washed the baby with, would do!) the bees would not have cared a rap about Hugh Dickson!

Lord Avebury tells us the bees like blue flowers, but I know of very few blue flowers

hereabouts that are visited by bees. Could friend Kettle tell us the names of all the blue flowers he knows his bees to visit?

*Warm Way—Cold Way.*—I like what Mr. Desmond calls the "warm way." It is so much nicer to work a hive from the back than the side. I have charge of three hives, which belong to Sir Bertram H. Jones, all of the frames hanging the cold way. Each hive holds just 10 frames and a very thin following board, and I find the bees do no better in such hives than they do in my own home-made 12-frame hives—in fact, they swarm more from such hives than from my own, and I often get the most honey.

I never knew the bees so forward as they are this year. If the weather keeps warm I must put some sections and shallow bars on this week.

On Sunday (April 11) it was raining steadily, but the bees were at work just as freely as if the sun was shining.

I saw the first drone on the alighting board yesterday (April 12), but the rain had been too much for him, for he had come home to die.—C. REED, Wickford.

## Notes on Bee Keeping.

Bees are like every other stock, if well attended to they will amply repay their keeper. If a bee-keeper means to be successful, fear of his labours must be banished from his mind. Mr. Cowan, in his general management remarks, as per "Guide Book," hits the nail on the head when advising a bee-keeper to exercise his intelligence in applying instructions afforded, and inform himself, or herself, by thinking out what is best to be done in all varying circumstances in bee-life. I may say here in passing I have found this book of valuable assistance in my early bee-keeping career. Every new beginner should make himself, or herself, conversant with the theory of bee-keeping by reading up some good bee-book before commencing in practice. A friend bee-keeper of mine destroyed his first lot of bees by an overdose of smoke through lack of this knowledge.

The action of the Council of the B.B.K.A. in trying for all honey to be labelled with country of origin is very timely. Entering a certain shop in Warrington I noticed some 1 lb. tins labelled "Pure Honey" on the counter, minus country's origin. After making inquiries as to price, etc., I was informed that honey was selling at 1s. 9d. to 2s. per lb., and this was offered as a sample. Inside the lever lid was filled with honey, a look of messiness, and the colour resembled golden syrup. With regard to

taste, there was no comparison with our own English honey. After a short discussion I found this to be Australian honey. There is no doubt about it, that the words "Pure Honey" were held up for the public to swallow, simply because a vast majority of the public have never tasted the real pure English honey, and it is due to the lack of this knowledge that they (the public) cry down the price of English honey, hence the reduction in market value.

I see the Rev. E. F. Hemming and I are agreed on the sentimentiveness of the honey bee. In the autumn of 1915 I remember on one occasion refilling the feeders with syrup for brood-raising. After a short time the bees came out with a joyful hum, and seemed to form a kind of halo around me, alighting on my face and neck; they seemed to realise my good intent. In this condition I was accompanied to the house. When bees are crawling backward and forward over the face, the titillation produced is not at all conducive to a calm demeanour, for, as a rule, bees prove to be more vicious in autumn than at any other time of the year.—P. LYTHGOE, Padgate, Warrington.

## How to Make a Skep.

I was rather surprised and pleased to read your request in the BEE JOURNAL for hints on how to make a straw skep, and if paper can convey the necessary instructions I will endeavour to put them here and now. I am not a professional skep maker (who would not perhaps take the trouble) as I have only made a few to satisfy a whim, and used blackberry canes to bind with. The one who showed me how to do it was a labouring man. To make the cane for binding, go to a tall hedge, get down low and look upwards—the best canes grow in the darkest part—and cut a likely-looking cane about  $\frac{3}{4}$  in. to  $\frac{5}{8}$  in. diameter, 4 ft. to 8 ft. long, and not too old and hard (about one to three years old will do), and 4 ft. will be long enough for an amateur to handle, cutting right down in the bank to have a hard end to stab with. The canes must be split the same day or they will not split, or kept under water till you can do so, the sooner the better. Use a blunt, strong, clasp knife, start at the butt end, and whichever way the split seems to be running prise hard against the opposite side. That is, if one half is getting weak, bend the stout half while cleaving, and the split will then run towards the centre again. Repeat the process to make the half into quarters, trim any splinters off, and scrape out the pith on a leather pad on the knee. Like French polishing

you will find there is a lot of "knack" required, and, as my instructor told me, you have to be your own teacher. For a first start I should advise anyone to start making the skep round a piece of board, with holes bored for the binding, as it is a difficult job to start a top of all straw with a hole for supering. I don't advise skeps for supering, but should think about 15 in. diameter by 10 in. deep (inside measures) would be useful, and ought to do well for the bees, and think that the skep is a very healthy home for breeding up stock. Look at the picture of W. Gordon, the old skep maker, in the "Guide Book," and you will see how to hold the straw. I advise you not to bother with any cow's horn, but let clever fingers and strong thumb push the straw into shape. Squeeze and bend the straw tightly with your fingers, and do not rely on the canes to pull it in; you will, I expect, have to stab holes with a smooth round spike, as briar is not so sharp as cane, and the rolls will have to be slightly inclined outwards as they tend to pull in as the briar is pulled tight. You must decide for yourself how to fasten the briar to start and finish, which is a simple matter. The briars need not be used as soon as split, but if not must be soaked in cold water before use. If allowed to get dry they will break. I do not advise wetting the straw, as it shrinks after, and the work is not so good. I have a good lot of tools, and could make a bar frame hive quicker than a skep, but have sense enough not to waste £5 worth of brain and body, to earn 5s., or I should not be able to send these few hints, which I hope may be of use. When you have made four or more skeps you will understand what I mean, that knowledge is bought at a price, and that you will have to put more than 5s. worth of brain and time to make your first 5s. worth of skeps. A man I know, a Scot, who knew W. Gordon, said that was the only man who ever made a skep. When I told him I could do it, he said he could stand on his skep without damaging it—and he is 13 stone weight. But don't be upset if your first one is not quite so strong as that.—C. CAMERY.

### Notes of Another Novice.

Being a regular reader of THE BRITISH BEE JOURNAL, and seeing the experience of a fellow bee-keeper in your issue of April 15, this may also interest some of your readers, if you can find room for it.

What first aroused my interest in bees was seeing swarm after swarm leave the house of my neighbour, where they had made a home for the last 20 years.

In 1918 I made my first attempt to take a large swarm, in which I was successful, and hived them in a cheese tub. They did well, and I wintered them down on their own stores. On May 14, 1919, I had my first swarm, on the 23rd a cast, and on the 25th another; these two I placed together. On the 26th I took another swarm from the house. On July 3 my first swarm of May 14 threw another swarm, making four stocks, which I ran till the end of the season. In September I had the misfortune to lose a queen. A fertile worker caused a lot of trouble. Failing to get another queen, we decided to drive those in the cheese tub, and place them with the queenless stock. We were successful in doing so, and wintered them down on own stores in all hives, besides taking a surplus of 47 lb. of honey. Not so bad for my first year. My bees have all wintered well, and doing fine up to the present. I had my first swarm on April 24, and I am expecting another in a few days from No. 2 hive. Is it not early for them to swarm? I am looking forward to the season's work, as I am very much interested in my bees.—F. J. L.

### Jottings.

*An Early Turn Out.*—I took part in what may be described as an early turn out, from either the individual or insect point of view. During some repairs, March 19, I was requested to "take" some bees that had been in possession five or six years, but the combs seemed to resemble those of a single season, and were built to the rafters of a bay window. The conditions were somewhat close, and as soon as I diverted the entrance by removing the tiles, etc., the bees were very curious as to the object of this untimely visit, but were in a decidedly amiable frame of mind.

I managed to pass a nucleus box in by taking off the lid, after placing in a couple of empty frames, and cutting out four slabs of fine brood combs, which were tied in, later, and then the fun commenced. The bees ran everywhere but into the box; there was a cavity between the ceiling of the room and the floor above. The major part seemed to be bolting that way. The whole wall in the roof was a mass of bees, while a nice little bunch defied attack in the apex of the hip and rafter. I made a little platform, tilted the lid against the wall, and brushed and smoked about, when all at once there was a decided and pleasing musical hum, with a general stampede toward the box. The little bunch of bees

under the joists refused to be drawn, so I left them until the evening. I had only one sting up to this time. On returning I, of course, thought I had a soft job, so didn't take smoker, but forgot that as it was necessary to take off the lid to get the box in, the same rule applied for its removal. My word! didn't they pay my hands for remembrance. However, I continued to lift the lid by inches and turn the box to the opening, and so left them until morning, when only about a dozen remained out. About 10 lb. of honey was found, and the bees are now working away very happy and tractably, and are amenable to law and order, as we modern bee-keepers define it.

*An Emergency Feeder.*—A splendid feeder is quickly made by puncturing four holes that the thumb can cover, as small as possible, into the lid of a syrup tin. This can be inverted full, or part full, without trouble.

*Requeening.*—It is to be hoped that wholesale slaughter of queens will not take place when the "Government" queens arrive. Some of these may prove the finest stock for crossing, and this wholesale influx of queens from one District (?) to my mind may not altogether do all we desire in an efficient manner, to say nothing of the waste of stock. I have a three-year-old queen from the only stock that gave much surplus last season, artificially swarmed early in August, still going strong, which compares very favourably with others. I hope to secure several youngsters from her this season. Curiously, I was unable to discover her successor last year. She failed to lay by mid-October, but she is much in evidence now, as the bees cover ten frames of comb, and a change in the weather will see them supered with a rack of sections.—A. H. HAMSHAR.

### Royal Show Fund.

The Council of British Bee-keepers' Association are anxious to take their usual part at the Royal Show to be held at Darlington this year, so that their unbroken record of representation at this show may not be spoilt. In order to defray the expenses in connection therewith the Council ask that all bee-keepers assist in this work by giving donations, which should be sent as early as possible to the Secretary, 23, Bedford Street, Strand, London, W.C.2.

Subscriptions for this fund are coming in very slowly, and we would urge all those who can possibly do so to send a donation, however small. The sum needed is not, comparatively, large and if every one does a little should be easily forthcoming. "The Royal" is the show

of the year, when the value of bee-keeping, and of the use of honey, to the community is brought to the notice of hundreds of people, and should the Bee and Honey Department have to be dropped for lack of funds, the loss to bee-keeping will be out of all proportion to the amount needed to carry on. May we also urge all those who can do so to make an entry, and exhibit at the Darlington show. A good display will help both the show and the craft. We are sure our bee-keeping friends in the North are looking forward to a good display of honey, etc., at this year's Royal Show.

#### DONATIONS RECEIVED.

	£	s.	d.
Amount received .....	6	9	0
Mrs. H. E. Brown .....		10	0
J. Birkett .....		2	6
Messrs. Adminson .....	1	1	0
	8	2	6



### Queens and Space Between Two Brood Chambers.

[10187] *Re* "Editorial," May 6.—It is hardly a question for argument or theory. It is a hard fact that queens more often than not refuse to pass the space.

I say nothing of shallow frames placed over deep ones because the small size of the former practically forces the queen past the gap; but where two brood chambers are used, although the queen will always go up past the space, she will return only with great reluctance. And this is one of the difficulties with this method, as everyone knows who has used it extensively.

*Re* the queen passing over or under frames when spreading in the spring. Do you really suggest that the queen walks out of the cluster by herself on a cold winter day, and over or under frames to change sides? Of course she does not, as a moment's thought would convince you or anyone else. When bees are clustered in winter, the cluster almost always either hangs below the frames (when a space is given under them) or extends above the frames when possible. Either under or over, the cluster *does* extend, and it is by this means that the queen shifts.

At the same time, your argument is one of the strongest of those in favour of larger combs because the queen will, no



doubt, extend on two combs before changing over.

Again, I have often met with cases where eggs are first laid on both sides of one comb.

The greatest objection to two brood chambers is that while one is too small two are often too big, and, as you say, the almost utter impossibility of proper manipulation.

One word *re* Col. Wallace's letter. Why not use five wires? I always do in 16 by 10 frames. First one close to top bar, and the others at slightly increasing distances.—R. B. MANLEY.

[We did not suggest how or when the queen passed from one side of a comb to the other. All we said was that "eventually" she does it, but the idea of the queen leaving the cluster to perambulate alone round the end of a frame on a cold winter day never entered our head; it is too absurd. If, as Mr. Manley says, the cluster of bees extends above or below the combs we should say it is an argument for two sets of shallow combs, which would give the queen opportunity for passing from one comb to another in the thick of the cluster, and thus preserve its spherical shape, which is the best for conserving heat. The bees will only cluster over the combs and the queen will be able to pass in that direction while the winter passages are in position. One advantage of the present two sizes of standard frames is that a brood nest of several sizes may be made to suit requirements of queen, season, or locality by a judicious combination of deep or shallow frames.—Eds.]

### The British Honey Producers' Association.

[19188] I have read with great interest and pleasure the letter by Mr. F. M. Claridge in the April 1st issue of your Journal. I think the first great help we could give our craft is to educate our would-be customers to the value of honey—*pure, good, unadulterated English honey as given by our bees*. I am not sure if anyone really understands the difficulty the ordinary public have in buying honey *pure* as we bee-keepers understand it. To illustrate my statement. Last year I spent my holidays in Wales, and out of curiosity I wanted to buy some Welsh heather honey. Strange as it may seem, I tried first to buy a 1 lb. pot in Denbigh, but after looking in all the provision and fruiterers' shops, I tried the market, where I found a plentiful supply of Welsh honey, so *labelled*; but honey and it were nearly strangers, as it was a dark brown liquid of a strong nauseous smell. Needless to say, I did not buy, but, to my amusement, the

seller said: "But surely it's beautiful Welsh honey; look at it's rich dark colour." After that I tried Chester, but still no honey, as we understand it, could be found, but some labelled Pure Australian, or Welsh Heather Honey. At Colwyn Bay I purchased a pot for 2s. 10½d., labelled in large letters—

#### PURE WELSH HEATHER HONEY.

It was in appearance a little better than the rest I had seen, so in desperation I took it to our table. Oh! the disgust of my friends, who only tried it. I brought it home to show my family at Betley, where it remained in its pot until at last a judge of honey called to help in a difficulty I had with my bees. Of course, I showed the honey (so-called) to him, and he said: "You have set me some work; but this I can tell you, very little real honey is in that mixture." This incident brought to my notice the difficulty the public in general have in purchasing honey (that a lover of bees would like to acknowledge as honey). My best honey customer very willingly pays me 3s. a lb., and 3s. 6d. for section honey, and says she is delighted to buy the genuine honey, which, to my knowledge, is proved to be a very valuable food. She told me before she bought honey from me that she too found the same difficulty I had in buying a so-called pound of honey, which really only weighed out 13 ozs., and cost me 2s. 10½d. The difficulty, I think, is this: Can't we be honest, and label our honey, and so prove our pride in our British production. I think, like Mr. Claridge, if we don't this year we shall find ourselves having our honey unsold and much foreign honey dumped in our country, and our money "gone West." I had a lovely label sent to me this morning. I shall proudly label all my honey this year with like labels. Won't you all help push out the foreign honey, and show the public how fine our honey really is?—F. WRENCH.

### Bees Disappearing.

[19189] In October last, I put six *strong* stocks into winter quarters, each in clean hive and on twenty standard frames of comb.

No. 1. In a hive built to specification supplied by Mr. Simmins, Conqueror type, but with standard frames, this is the only one of the kind I have. It gave no surplus last year, but I left over 50 lbs. of honey for wintering. These bees are alive and flying but I have not examined.

No. 3. Very strong stock, gave over 200 lbs. surplus, left over 60 lbs. honey for winter, second season queen, the best I ever had, was full of brood when closed

down. Bees dead, about two to three hundred only in the hive (dead).

No. 5. Strong stock, with 1919 queen, painters working on house, closed doors and suffocated bees, put on a new base, clearing out dead bees about four inches deep on floor, a few bees still alive, but have not examined. Wintered on Bacterol syrup.

No. 6. Wintered on Bacterol syrup, 1919 queen, plenty of brood when closed down, about two to three hundred dead bees, none alive.

No. 8. Same condition as No. 6, Bacterol syrup.

No. 9. Same as No. 6 and 8. Wintered on Flavine syrup and candv. Now what has become of the bees? I have a clean board in front of each hive and have seen no more than the average number of dead bees, inside of hives not soiled, ample sealed stores. I will make a thorough examination when I have time, at present I have simply closed the doors. I want to see if I can find dead queens.

Two years ago a friend of mine, lost a lot under exactly similar conditions, but in his case, I do not think there were a dozen dead bees to be found. As the other lots were healthy, I suggested that the queen was unfertile, and that they had all come out with her on a warm day and got lost.

The dead bees in my hives are not abnormal in any way, wings, abdomens, etc., as usual, no soiling of inside hives. By examination under microscope, can I find cause of death; that is, can you give me any instructions of what to look for, or is there a book where I can obtain this information?

All my hives are disinfected twice a year, with bees sprayed either with Bacterol or Flavine; I have been testing both.—GEO. M. ROSLING.

[We are unable to give cause of death. It would not be possible to find the cause by a microscopical examination. Perhaps some of our readers may be able to advance a theory.—Eds.]

### Keeping Quilts Clear from Propolis

[101901] I hope Mr. C. Tredcroft (No. 10175) will enlighten us further as to the way he winters his bees, so that his "quilts are as clean as the day he puts them on."

I put a quilt of unbleached calico next the frames, and on that for the winter several thicknesses of felt, carpet or sack- ing, quite clean and regularly disinfected with Izal before using each year.

My bees invariably fasten down the calico quilt, and when spring cleaning (I give each lot a clean hive) I give a fresh quilt if the old one has much propolis.

Does Mr. Tredcroft only use *one* quilt,

and an extra one in the spring when breeding commences?

My first experience of I.O.W. disease was in 1914, and my bees had never been sugar-fed, but always wintered on abundance of their own stores.—RICHARD H. AMIES.

## Bee Shows to Come.

*A nominal charge of 2s. 6d. is made for notices (not exceeding 7 lines) in this column, 10 lines charged 3s. 6d., up to 15 lines 5s., which covers cost of insertion from order till date of show. Cash should accompany orders for insertion.*

**June 2-5, at Reading.**—Royal Counties' Agricultural Society's Show. Hon. Sec., 131, King's Road, Reading. Honey entries closed.

**June 9 and 10, at Colchester.**—Essex Agricultural Society. Classes for Extracted and Comb Honey, etc. Schedules from Secretary, Essex Beekeepers' Association, 7, Bulwer Road, Leytonstone. Entries close May 31.

**June 16 and 17.**—Hantley Park Meeting of the Staffordshire Agricultural Society. The Staffordshire B.K.A. offer valuable prizes and six silver medals and nine bronze medals. Twelve Classes for members only, and five Open Classes. (Honey Classes are for four or three jars or sections). Schedules, W. Griffiths Silkmere, Stafford. Entries close May 29.

**June 29 to July 3, at Darlington.**—Royal Agricultural Society's Show, Bee and Honey Section, under the direction of the B.B.K.A. Prizes arranged in groups of counties for Associations affiliated to the B.B.K.A. Schedules from The Secretary, 23, Bedford Street, Strand, W.C.2. Entries close May 31.

**July 6, 7 and 8, at Cardiff.**—Royal Horticultural Society's Show. The Glamorgan B.K.A., in conjunction with R.H.S., offer prizes for Honey, Wax, Bees, and Appliances. Members, Novices, and Open Classes. Schedules, Mr. Wiltshire, Maundy School, Cardiff. Entries close June 22.

**July 15 and 16, at Grimsby.**—Lincolnshire Agricultural Society. Show of Bee Appliances, Honey, Sections, Wax, etc., under the management of the Lincs B.K.A. Open and County Classes. Valuable prizes.—Schedules from Major Hadfield, Alford, Lincs. Entries close June 12.

**July 20 to 23, at Aberdeen.**—Highland and Agricultural Society. Classes for Bee Appliances and Honey. Premiums £53 10s. Half of Prize Money and Silver and Bronze Medals contributed by the Scottish Beekeepers' Association.—Entry forms from John Stirton, Secretary, 3, George IV. Bridge, Edinburgh.

**Monday and Tuesday, August 2 and 3, at Newport.**—Monmouthshire Beekeepers' Association Annual Show (in connection with the Newport Allotment Holders' Association). Members and Open Classes.—Schedules (post free 3d.) from Hon. Sec., "Underwood," Portskewett, near Chepstow, Monmouthshire. Entries close July 26.

**August 12, at Taunton.**—Somerset Beekeepers' Association Show of Honey, Wax, and Appliances. Seven Open Classes. Liberal prizes.—Schedules from Mr. F. J. J. Stacey, 3, Hammet Street, Taunton. Entries close August 6.

## Special Prepaid Advertisements. One Penny per Word.

### PRIVATE ADVERTISEMENTS.

SWARMS for Sale, 21s.; on frames, 28s.; box 10s. 6d., refunded on return.—CULLEN, Bull Hill, Great Clacton. e.88

SWARMS.—Hybrid Itallans, established on six frames, very gentle and quiet, 1919 Queens, £3. Apiary absolutely free from disease.—REDDIE, Cliff Cottage, Leigh, Essex. e.89

**FOR SALE**, new Conqueror Hive, containing strong Stock Hybrid Italians, 1919 Queen, three shallow racks drawn-out combs, £7 10s.; Hive with stock working in super, complete, £6; Hive, small stock, rack drawn-out shallows, £3 10s.; Swarm, £2; Nuclei, 30s. Nearest offers accepted.—**EXLEY**, Lamer, Wheathampstead, Herts. e.90

**JUNE SWARMS** for Sale on 6 frames, new, with full sheets foundation, £2 7s. 6d., carriage paid; 3 dozen new Metal Dividers, 7s.; boxes 7s. 6d., returnable.—**MATTHEWS**, 25, Cray Road, Crockenhill, Swanley, Kent. e.91

**NEW Light Lincolnshire Honey**, fine quality, £10 cwt.—**TAYLOR**, Schoolmaster, New Leake, Boston. e.92

**SWARMS**, 360-lb. strain, 35s., carriage paid; boxes to be returned.—**BUTLER**, West Road, Histon, Cambs. e.93

**12 SECOND-HAND** healthy Section Racks, no separators, lino for veils, two part reels wire for frames, 30s. and carriage.—**JOYCE**, 1, Park View, Farnborough, Hants. e.94

**SELLING**, through illness, about 20 crowded Stocks of Bees, £3 and £4 each; hives extra if wanted.—**GREEN**, Basildon Road, Laindon, Essex e.95

**VIRGIN Italian Queens**, 5s. each; immediate delivery.—**JACK TICKELL**, Westbourne Apiary, Cheltenham. e.96

**FOR Sale**, two Extractors, take standard or shallows, in good condition, one side geared, one centre geared, 50s. each on rail.—**LOXLEY**, Northfield, Birmingham. e.97

**WANTED**, immediately, Swarms or Nuclei, Italians. Brothers help. All bees dead.—Address, **CROSS**, Dent, Sedbergh. e.98

**FOR SALE**, several stocks healthy Bees, supered, £5 per stock.—**GIDDINGS**, South Mimms, Barnet. e.105

**FOR SALE**, Apiary, consisting of seven well-stocked hives.—25, Sutton Court Road, Chiswick, W.4. e.106

**SWARMS**, 30s. to 40s.; finest quality Sections, new, 32s. dozen.—**NORTH**, Cressing, Braintree, Essex. r.e.25

**EXCHANGE**, 5 x 4 Folding Camera, three double slides, case, etc., for pound packages of Italians or Hybrids.—**McCATHIE**, Rosebank, Victoria Road, Kirkcaldy. e.108

**QUANTITY** of drawn-out Shallow Frames, excellent condition, 14 frames with drone comb, 1s. 6d. each; one gross 7-lb. lever-lid Honey Tins, with handles, 14s. per dozen, packed, on rail; one gross 28-lb. lever-lid Tins, 20s. dozen.—**J. ARNFIELD**, Breinton, Hereford. e.107

**ITALIANS**.—Choice strain (Penna's extra selected). Spare nuclei, 35s., delivered. Inquiries stamp.—Box 600, B.B.J. Office, 23, Bedford Street, Strand, W.C.2. e.48

**WANTED**, Swarms of Bees, Italians, Dutch-Italian hybrids. State price.—**REV. EVANS**, The Rectory, Llangammarch Wells. e.51

**PURE light Cambridge Honey** (guaranteed), 28lb. tins 42s., carriage paid; sample 4d.—**J. YOUNGER**, 6, Maid's Causeway, Cambridge. e.56

**FOR SALE**, a few 1919 Hybrid Queens, from this year's purchased stocks; price 7s. 6d. each.—**ASHWORTH**, The Bungalow, Weymouth Street, Warminster. e.64

**SURPLUS QUEENS**.—Dutch and Hybrid Virgins from County Re-stocking Apiary, 4s. 6d. each.—**ANDREWS**, Expert, 78a, Westgate, Peterboro'. e.81

**SWARMS** for Sale. Orders booked now.—**COLE**, Hornsey High School, Weston Park, N.8. r.e.33

**SWARMS**.—May, £3; June, 50s.—**SAUNDERS**, Waverley, Farnham, Surrey. e.39

**FOR SALE**, six frames of healthy honey-fed Bees, never had any disease in apiary, £3 10s. and 10s. charged on travelling box, from which carriage of bees is deducted and balance returned to buyer.—**REED**, Primrose House, Heacham, Norfolk. r.e.20

**CORRESPONDENCE COURSES** in Bee-keeping.—**H. E. NEWTON**, Brown House, Barton-on-Sea, Hants. r.d.157

**WANTED**, from August 22 to September 4, in Cornwall or Devon, within 12 miles or so of sea, Bedroom and Sitting Room, with shed for motor car; farmhouse preferred. Can any beekeeper oblige me?—**W. HERROD-HEMPSELL**, Old Bedford Road, Luton, Beds.

**FOR SALE**, two "Rotax Roadlight 267" self-contained Acetylene Motor Headlights, very powerful, £6 the pair; one Exhaust Whistle, 10s.; one Wood-Milne Motor Foot Pump, 40s.—**HERROD-HEMPSELL**, as above.

**WANTED**, portable Greenhouse.—Price and particulars to **W. HERROD-HEMPSELL**, Old Bedford Road, Luton, Beds.

**WANTED**, Angster Rear Wind Screen for motor car.—**HERROD-HEMPSELL**, as above.

**BUSINESS ADVERTISEMENTS.**  
1½d. per word.

**ITALIAN QUEENS DIRECT FROM ITALY**.—E. Penna, Bologna, Italy.—Mr. S. H. Smith, 30, Maid's Causeway, Cambridge, has bought all the Queens I have still for sale in this year. As agreed with him, all these queens will be sent by me direct to customers.

**MISSES PALING & PILLANS**.—Orders booked for strong three-frame Nuclei with pure Italian Penna Queens or home-reared Queens from best selected Italian strains, £3; choice home-bred Italian Queens, 12s.; Virgins, 6s., four for 20s.—Golden Square, Henfield, Sussex. e.101

**47 4-FRAME** Dutch, Dutch-Italian Nuclei for the first and second week in June, £3 5s., carriage paid. I strongly recommend my Dutch-Italian, a fine disease-resisting strain. 50 Nuclei for July, £2 5s. Cash with order.—**W. SEALE**, Ashley Cottage, Oatlands Drive, Walton-on-Thames, Surrey. e.99

**NATURAL SWARMS**, 25s.; Stocks, 7s. per frame, carriage paid.—**R. TINSON**, Sutton Courtenay, Abingdon, Berks. e.102

**1920 PURE Fertile Italian Queens**, direct from the well-known French breeder, Abbé Warre, 7s. 6d. each.—Orders, for execution in rotation, to **ELLIOTT**, Kelvin Road, Ipswich. r.e.104

**PURE Golden** and three-band Italian Bees and Queens; prolific and gentle; the ideal bee for pleasure and profit.—**COOMBER**, 64, Ronald Park Avenue, Westcliff, Essex. e.38

**NEW-ENGLAND-BRED ITALIAN QUEENS**.—Untested laying Queens, ready June 1, 10s., delivery guaranteed; 6s. at purchaser's risk. English money accepted by registered mail.—**ALLEN LATHAM**, Norwichtown, Conn., U.S.

**ITALIAN 4-FRAME NUCLEI**, Penna Queen, covered bees and brood, 55s.; boxes 10s., returnable. 1920 Penna imported Queens, 11s. each. Large stock "W.B.C." Hives and Apiary Supplies; bargain.—**C. HOGAN**, Boxford, Suffolk. r.e.63

**50-75 3-FRAME** Nuclei Italian Hybrids, 1920 Queens, proved disease-resisting strain and excellent honey gatherers. Delivery early June onwards; orders executed in rotation. Price 45s. each, carriage paid; travelling boxes to be returned.—Further particulars, HOSEGOOD, 26, Purley Park Road, Purley, Surrey. r.e.86

**4-FRAME NUCLEI**, headed by 1920 Italian Queen, 50s., June delivery; 6-frame Stocks, 70s.; 8-frame Stocks, 90s.; immediate delivery; box charged 10s., returnable; Italian Fertile Queens, 10s. 6d. All orders in strict rotation Cash with order.—LEE, "Little Bowden Apiary," Burgess Hill, Sussex. e.79

**ITALIAN COLONIES**.—Simmins and Penna 8 strains; 8 frames, £4 15s.; Nuclei, 3 frames, 45s. Five per cent. discount to members of Middlesex Bee-keepers' Association.—BABBAGE, 33, Whitestile Rd., Brentford. r.e.75

**ORDERS** booked for Swarms, all guaranteed healthy, also Nuclei.—STANLEY, 56, Montague Road, Cambridge. r.e.72

**FOR SALE**, good Nuclei, 1920 Queens, four frames 52s. 6d., three 45s., two 37s. 6d.; ready mid-May; cases 7s. 6d., returnable; JOURNAL deposit.—A. H. HAMSHAR, Womersley, Guildford. e.41

**MR. BEE-KEEPER**.—If you wish to succeed with your bees you must have the best. Three-frame Nuclei, hardy, disease-resisting, home-reared Italians, 1920 Queen; price, June £3 5s., July £2 15s., carriage paid; 7s. 6d. refunded on box if returned carriage paid Saxilby Station. Terms: Cash with order.—HERBERT VALLEY, Apiarist, Saxilby, Lincoln. r.e.31

**"ISLE OF WIGHT" DISEASE**.—Don't worry; use the solution that cures; 2s. per bottle.—E. PRESSEY, St. Elmo, Coulsdon. r.d.149

**1920 PURE Fertile Italian Golden Queens**, guaranteed imported direct from Italy; regular supplies throughout the season from second week in May; 14s. each; specially selected, 17s. 6d.—GOODARE, Italian Queen Specialist, New Cross, Wednesfield. r.d.150

**PUPILS** received by life-long whole-time Bee Farmer.—Terms on application to C. B. BARTLETT, Sandford Mount, Charlbury, Oxon. d.127

**HAVE YOU READ "THE BEE WORLD"?** If not, why not? Every number in itself is a useful literary work for practice and reference. Specimen copy free.—Offices: THE APIS CLUB, Port Hill House, Benson, Oxon.

**HIGHLAND & AGRICULTURAL SOCIETY'S SHOW** at ABERDEEN, July 20-23. Entries close for STOCK, etc., on June 10.—Entry Forms from JOHN STIRTON, 3, George IV. Bridge, Edinburgh.

**NOTE**.—The Minister of Transport has now decided that Live Stock returning from the Show *unsold*, be conveyed at half rate, and that Attendants accompanying Live Stock to the Show, and necessary provender for the journey, be carried free.

HOLLAND COUNTY COUNCIL.  
AGRICULTURAL EDUCATION COMMITTEE.

**APPLICATIONS** are invited for the post of Instructor in the combined subjects of Poultry and Bee-keeping.—Applications, stating salary required, should be sent in by May 31, 1920, to THE PRINCIPAL, Kirtton Agricultural College, near Boston, Lincs, from whom further particulars may be obtained. e.84

**ORDERS** booked for 3-frame Nuclei, Fertile Queens, Virgin Queens, etc. List for stamped, addressed envelope.—H. CRACKNELL, Mount Road, Thundersley, Essex. r.d.27

## Dutch Bees.

I am Sole Agent for Hans Matthes, the Dutch Bee Farmer who supplied the British Government last season with Skep stocks for their County Restocking Scheme.

These bees are hardy, prolific, healthy.

Send for Illustrated Catalogue giving methods of management, characteristics, honey-gathering and disease-resisting powers of this race of bee.

Address—

**R. WHYTE,**

The Bee Farm,

**Cumbernauld, Dumbartonshire.**

5 per cent. discount allowed to members of the Apis Club.

## ITALIAN QUEENS

Direct from Italy.

Address:  
**Signor Gaetano Piana,**  
Castel San Pietro,  
near Bologna, Italy.

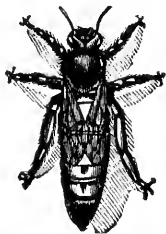

All Queens are reared by the most up-to-date and scientific methods. Mr. W. Herrod-Hempshall has personally inspected the apiary and methods employed, with which he is perfectly satisfied.

**PRICES FOR 1920.**

**For 1 Fertile Queen:** May, 12/-; June, 11/-; July, August and September, 9/- each queen.

Carriage paid in Great Britain. Cash must accompany all orders, which will be executed in rotation. Guaranteed safe arrival of all Queens, but not the introduction. Bees dead upon arrival must be sent at once to "B.B.J." Office.

For the mutual convenience of all parties, Il Signor Piana has made arrangements that all communications, orders and remittances of the readers of "B.B.J." and "B.K.R." can be addressed to him, c/o British Bee Journal, 23, Bedford Street, Strand, London, W.C.2.

Cheques payable to 'British Bee Journal.'

THE  
**British Bee-Keepers' Association.**

Insure *now* against loss by damage done through bee stings. All particulars from

**W. HERROD-HEMPSHALL, 23, Bedford Street, Strand, London, W.C.2.**

**SCIENTIFIC QUEEN REARING.**

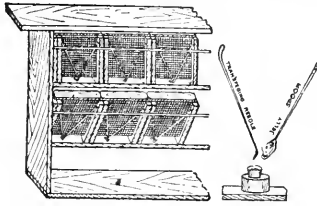

**BEST**  
In the world.  
Every  
appliance and  
instructions.  
Send for  
**KAT-A-LOG**  
**MEADOWS**  
SYSTON,  
Near LEICESTER.

**HIVES AND APPLIANCES.**

Immediate dispatch. Quality O.K.  
Write for prices.

**ANDREWS & CO.**

Joinery and Carving Works,  
78a, WESTGATE, PETERBOROUGH.

**BOZZALLA** tested Queens are sold at the price usually charged for untested queens.—Catalogue from H. STIOH, Riccartbar Avenue, Paisley. r.c.116

The products of the Apiary, of Poultry and Farm Stock, of the Fruit and Vegetable Garden can be Advertised and Sold through

THE  
**BAZAAR, EXCHANGE & MART**  
Newspaper.

Get a Copy—Thursday and Saturday 3d. The "Bazaar" publishes also practical handbooks by experts. Send for full catalogue, post free from—WINDSOR HOUSE, Breams Buildings, LONDON, E.C.2.

**BRADBURY, TAUNTON,**  
FOR QUALITY BEE GOODS.



*Illustrated Bee Guide free.*

Telephone: TAUNTON 176.



**"BACTEROL"**  
FOR BEES

2/6 per Bottle.

Post Free.

The cure for, and preventive of, "Isle of Wight" Disease. Non-poisonous—free from stain or unpleasant odour.

**MENLEY & JAMES, LTD.,**  
39, Farringdon Road, London, E.C.1.

**PREPARE FOR EXTRACTING.**

The quickest, cleanest and most efficient on the market is the "BAIRD" EXTRACTOR, which extracts from BOTH SIDES of the COMB simultaneously.

Particulars from G. S. BAIRD, 1, HURST ROAD, ERITH, KENT.

**HIGH-GRADE ITALIAN BEES FROM THE COTSWOLD HILLS.**

6 COMB COLONIES	...	...	...	71/-	PROLIFIC QUEENS	...	...	...	9/6
3 " NUCLEI	...	...	...	45/-	VIRGIN QUEENS	...	...	...	5/-

BOOK NOW FOR IMMEDIATE DELIVERY.  
LT. A. H. BOWEN—QUEEN BREEDER—CHELTENHAM.

**INSTRUCTION in BEEKEEPING**  
*PRACTICAL AND THEORETICAL*

My Apiary will be open for a limited number of pupils during this season. Terms and particulars from

**W. HERROD-HEMPSALL,**

The W.B.C. Apiary, Old Bedford Road, Luton, Bedfordshire.

**S. J. BALDWIN.**

I beg to inform that the No. 1 Kent Hive is not manufactured by me, only the No. 2 "Bromley Kent."

(New deep frame 17x14x12. Sample by post 6d.)

**THE APIARY, BROMLEY, KENT.**

# HIVES.

Compare the WORKMANSHIP and FINISH of our Hives.

All made by practical Men who know what a good hive should be.

In various designs to suit all tastes and requirements. Season's speciality—THE MANLEY HIVE for 16 in. x 10 in. Frames.

Full descriptions and illustrations in our 1920 Catalogue: *"Everything for an Apiary."*

If you have not received your copy, send a P.C. at once.

OUR MOTTO—SERVICE & QUALITY.

**R. STEELE & BRODIE, Wormit Works, Wormit, Scotland.**



THE  
KEY TO  
YOUR SUCCESS.

## Lee's Bee Supplies.

¶ In design, material and workmanship, Lee's Bee Supplies still retain the reputation of being your best and safest investment.

¶ Our 1920 ILLUSTRATED CATALOGUE is yours for the asking. It contains detailed information on the most up-to-date hives and appliances for which the House of Lee is famous.

¶ We regret the necessity of having to advise our Customers that owing to the increased cost of production, all prices in 1920 price list are subject to 10% increase. The increase will not apply to orders received before May 10.

\* \* Five per cent discount to Members of THE APIS CLUB.

**JAMES LEE & SON,**  
LTD.,

Uxbridge, Middlesex.

(Telegrams: Graphicly, Uxbridge.)

Telephone: Uxbridge 181.)

## 20-Page 1920 "WHITE STAR" List,

3½d. POST FREE.

S. SIMMINS, QUEENLAND, HEATHFIELD, SUSSEX.

Bees and Beekeeping Appliances. Catalogue free.  
**EDWARD J. BURTT. MANUFACTURER. GLOUCESTER.**

*I very much regret that there has been a large increase in the cost of the manufacture of bee-appliances, and therefore my prices will be advanced 10% from May 10th. Books exceptd.*

PRINTED BY THE AVENUE PRESS (L. UPOOTT GILL & SON, LTD), 65-67, DRURY LANE, LONDON, W.C.. AND PUBLISHED FOR THE PROPRIETOR (W. HERROD-HEMPBALL), BY SIMPKIN, MARSHALL, HAMILTON, KENT & CO., LTD., 31 & 32, PATERNOSTER ROW, E.C.

LIBRARY of the  
Horticultural Society  
188 1920  
Agriculture  
Library



No. 1980. Vol. XLVIII

JUNE 3, 1920.

[Published every Thursday, Price 2d.]

**CONTENTS.**

	PAGE		PAGE
REVIEW .....	265	CORRESPONDENCE—	
ROYAL SHOW FUND .....	265	Queens and Space Between Brood Chambers ..	271
A DORSET YARN .....	266	Saving Bee Life .....	272
NOTES FROM GREYNA GREEN .....	267	The British Honey Producers' Association ..	272
SUGAR FEEDING .....	267	QUERIES AND REPLIES—	
THE EXAMPLE OF THE BEES (poem) .....	268	Various Queries .....	273
NOTES ON BEE-KEEPING .....	268	A BEE STORY .....	273
HEREFORDSHIRE BEE-KEEPERS' ASSOCIATION ....	269	BEE SHOWS TO COME .....	273

QUARTER OF COST.

# VEILS

1/10 POST FREE.

We have just taken over from the Government all their surplus unused VEILS (750) made for protecting the faces of soldiers in Mesopotamia from Mosquitos and Flies. These are perfect as Bee Veils and we are able to offer them at the above exceedingly small figure. Once these are sold it will not be possible to replace at anything approaching this price. The Veils fit over any hat and are fitted with one adjustable cane which keeps the veil well clear of the face.

---

**SOMETHING NEW IN "THE WILLIS" 33/-**  
**WAX EXTRACTORS. NO WASTE—NO TROUBLE—NO SMELL.**

---

**E. H. TAYLOR, WELWYN, HERTS.**

# The Canadian Bee Supply & Honey Co.,

(TORONTO)

Limited

Manufacturers of, and Dealers in, Beekeepers' Supplies, Hives, Bees, Queens, Honey, and Wax.

SOLE AGENT FOR EUROPE AND THE COLONIES:—

**C. S. J. CRUTCHFIELD,**

25, BARTLETT'S BUILDINGS, HOLBORN CIRCUS,  
LONDON, E.C.4.

(Telephone Holborn 824).

## DON'T KEEP BEES! Let the Bees Keep you! WE'LL TELL YOU HOW!

You are cordially invited to pay a visit to the

### CANADIAN INDUSTRIES EXHIBITION,

Agricultural Hall, Islington,  
London,

June 3rd to 17th, 1920,  
and to inspect our exhibit of Hives and Appliances on Stand 45, Row D.

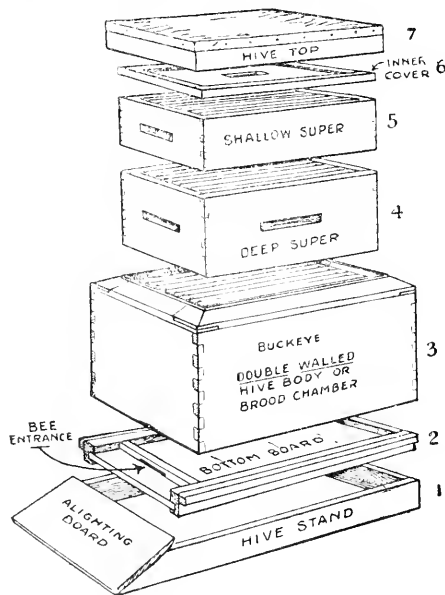

Keep Bees to make Honey. Produce Honey and make Money. If you merely wish to "Keep Bees" any old Hive will do. But if you want to produce Honey in bulk, try "Canada's way." With Sugar at  $1/3$  per lb. HONEY FOR NOTHING is worth while.

The "BUCKEYE" Double-walled Hive.

Makers of the celebrated Canadian "STANDARD" Single-walled Hive and "BUCKEYE" Double-walled Hive, upon which models a tremendous Honey producing industry has been built up in Canada and the States. Thoroughness has characterised the methods employed by Apiarists in the above-named Countries, and everything in the form of useless ornamentation has been rigorously cut out. "UTILITY" is their keynote.

Good, stout, well-seasoned wood, and practical utility appliances, which will assist the Bees to make and man to take, with the least possible amount of effort, the greatest possible quantity of Honey, go to the making of these splendid Hives. Nothing is done in Canada to hamper, but everything IS done to encourage, the Bees to do their best; AND THEY DO IT!

As much as 300 lbs. of Honey has been taken in one season from one "BUCKEYE" Double-walled Hive, and still sufficient has been left in for Winter feeding.





Review.

*American Foulbrood and European Foulbrood*, by G. F. White (Bulletins Nos. 809 and 810, Bureau of Entomology) Department of Agriculture, Washington, D.C. U.S.A.

These are two professional papers dealing with the further investigations carried on by the author on these diseases. He says respecting American foulbrood that it is an infectious disease caused by *Bacillus larvæ* and is characterised by a decided ropiness of the decaying brood and a peculiar foul odour. It is very widely distributed, is easily recognised, and is of much economic importance. The present studies refer to the resistance of *Bacillus larvæ* to heat, drying, sunlight, fermentation and disinfectants, etc., and the discussions are based upon observations made in the laboratory and experimental apiary. Discussing the name of the disease he points out, as has been generally recognised in Europe, that there are two diseases that have gone by the name of foulbrood, a strong smelling and an odourless form. This latter form the author calls European foulbrood, which is also an infectious disease caused by *Bacillus pluton*. It is characterised by the death of brood during the uncapped stage and by the absence of any marked odour. While *Bacillus alvei* is not as has been supposed the cause of any bee disease, it occurs very frequently with European foulbrood and is found seldom in the ropy disease. Other bacteria are frequently encountered but by demonstrating *Bacillus pluton* to be the cause of the disease, and other species such as *B. alvei*, *Streptococcus apis* and *Bacterium euridice* were thereby proven to be secondary invaders. It is evident that there is some difference between these diseases as they occur in Europe and America, because what is called American foulbrood (*B. larvæ*) as we find it in Europe has no strong odour, and in fact goes by the name of "odourless foulbrood" (*nichtstinkende Faulbrut*.) It has also been called "bosartige Faulbrut," or virulent foulbrood. The strong smelling (*stinkende Faulbrut*) as it is called in Europe is now stated to be caused by *Bacillus pluton* and that *Bacillus alvei* and *Streptococcus apis* (Maassen) or sour brood, although present

are only secondary invaders and not the prime cause of the disease.

While we recognise the value of Dr. White's researches we think it a pity that continental names should have been given to two diseases which occur not only in Europe and America but also in other countries. The two names "odourless or virulent" and "strong smelling or mild" sufficiently well defined and characterised the two diseases, and we think better than those adopted by the author.

In these two bulletins the author gives full details of the work carried out and a comprehensive summary of his conclusions, and the large number of illustrations showing the changes which take place in the larvæ at various periods during the progress of the disease, add considerably to the value of the work.

Royal Show Fund.

The Council of British Bee-keepers' Association are anxious to take their usual part at the Royal Show to be held at Darlington this year, so that their unbroken record of representation at this show may not be spoilt. In order to defray the expenses in connection therewith the Council ask that all bee-keepers assist in this work by giving donations, which should be sent as early as possible to the Secretary, 23, Bedford Street, Strand, London, W.C.2.

Subscriptions for this fund are coming in very slowly, and we would urge all those who can possibly do so to send a donation, however small. The sum needed is not, comparatively, large and if every one does a little should be easily forthcoming. "The Royal" is the show of the year, when the value of bee-keeping, and of the use of honey, to the community is brought to the notice of hundreds of people, and should the Bee and Honey Department have to be dropped for lack of funds, the loss to bee-keeping will be out of all proportion to the amount needed to carry on. May we also urge all those who can do so to make an entry, and exhibit at the Darlington show. A good display will help both the show and the craft. We are sure our bee-keeping friends in the North are looking forward to a good display of honey, etc., at this year's Royal Show.

DONATIONS RECEIVED.

	£	s.	d.
Amount received .....	8	2	6
R. Amies .....	0	10	6
	<hr/>		
	£8	13	0

## A Dorset Yarn.

Each season one sees more of the flowers for which bees have a preference; they like rasps more than logans, though the latter have the larger flowers. There evidently is not so much nectar in the logan as in the rasp. It is the same with white broom, quite five times more bees are on these small flowers than on the showy and larger flowers of *Andreana*, a brown and yellow flower growing side by side with the white. Numbers are on the crimson clover as it is cut each day for the stock, huge fields of corn with wild charlock giving them a yellow covering, bad for the farmer but good for the bees.

Our bees now have the larger part without pollen. We assume they are storing nectar; it is to be seen in the sections, not any are capped over, but now a few real, warm days have come they will do more. It is possible, with so much wet, they leave honey longer to ripen before closing over entirely. One lot has swarmed (while the bee-keeper was at church); it seemed such a pity with a rack of sections not finished, they must be put on top of the swarm for them to finish off.

Where an extra brood chamber was placed over the top of a strong stock, and the bees had stored a lot of honey in the cells, leaving the part for the brood nest empty, the queen had been up and filled a comb or two with eggs. The under-brood box we moved to another place, leaving the upper brood box to take the place of the old. This was a lot of Italians, a part of one huge swarm where several queens came out together, last season. There was only a very small following with this one, and what was better for the bee-keeper, they never showed a drone last season; being only a small lot they knew that they would not swarm, so never built up any drone cells. There were but very few this season, and these were beautifully marked; am hoping that this division (made by themselves) will save the necessity of them swarming at all. I have never tried this method of increase before; but having the drawn-out standard bars of comb one is able to build up strong increase quickly, as the queen has not to stop her egg-laying for one day. We have arranged a brood box of ten bars for the big swarm that has come out to-day (May 23). Three of the bars are all drawn out; the queen will not have to wait as she would do if all were bars with foundation only.

I was transferring some bees a week or two since, where the bars had all the lower half filled with drone comb; all full of drone brood, the bars could only

have had a part of a sheet of brood foundation. It is a pity that those who raise bees for sale should do this, as the bees will always have this extra lot of drone cells, and so many of those who feed but do not work. The bars were all new, and must have been started with shallow bar foundation, as the cells were so regular on the lower part of each bar. I have found that bees will build drone cells even in new bars in some seasons. The greater the population the earlier the workers seem to decide that they must have queen cells, and as a "necessary evil," males to make quite sure the queens are perfect mothers, so that they can emigrate and found another colony. A very small lot do not see the necessity of queens and males, as they will not become too crowded the first season.

Since writing this I have had one stock that showed some crawlers going over the front of the hive; and knowing that it is easy to stop this by spraying with Flavine, I sent in for Squire Tomlinson (of Wimbourne), who came and helped me with a spray of sugar and Flavine. Each comb as it was taken out was sprayed on both sides. He has been up another day with me since, and all the stocks have been gone over, even those that had two racks of sections and a brood box of bars (that were full of honey) on top; these are "skyscraper" hives.

After the third day the crawling seems to have finished; they had all gone from the hives, or had the kink taken out of their wings so that they could fly. I hope every bee-keeper has such a good neighbour as the Dorset varner; the desire to help each other in times of need is the right spirit. Bee-keepers send after him with their motors; the cottager (even seven miles away) comes to him for advice. So great is the lure of bees with him that he is always helping some one; he finds that it is easy in summer, when it is warm, to clear out this crawling with Flavine, and not to let it spoil the honey season for the bee-keeper.

We are building up a new lot of bars for all the stocks this year, and each stock has had one lot on the top or beneath the brood chamber. As soon as the queen has taken to the new combs the old ones are transferred to another place, and the new lot left in the place of them; even one that was in a skep, a box of bars was placed on top (we had a board the length of a section box). The queen was some time deciding to go up; she did eventually, but those placed beneath the old stock were the first that the queen took possession of. During the war we have not had new bars; they have been on the same all the time, and we have

only taken out those that had so many drone cells built on them. Some of the stocks have already filled the large standard bars with honey, have drawn out the foundation in one week, and started storing them with the shiny liquid.

The deduction we have made by these trials is that it is better to place the new lot of standard bars beneath the old; but, of course, for honey surplus the standard bars that are filled with honey before the end of May are best for income. These are on top of the brood box, yet in some the queen went up and took possession; but, as I described last week, the workers left the part for the brood empty; in these others they have filled the combs with honey, and in one instance are hanging round the entrance waiting for a nice day to swarm. It shows that the workers rule the hive, the lot that swarmed on the 23rd had on Friday (when Squire Tomlinson sprayed them with Flavine) queen cells on six of the combs. The workers had decided to swarm out again, and found another colony. It was interesting to see where these cells were placed, some on the side of the top bar, some in the centre of comb, some with bolt holes to the other side of comb, and queen cells on both sides.—J. J. KETTLE.

---

## Notes from Gretna Green.

### SUPERING.

May has been a honey-less month here, but reserve stores are still abundant and feeding unnecessary. When working for sections every effort should be made to keep the brood nest compact, as ten frames really full are preferable to having the same amount of brood spread over twelve. Before supering I looked over all the brood boxes, removing drone combs and those with too much pollen, contracting each stock to ten of comb.

The combs with sealed stores over brood had the honey cappings bruised, and were placed in the centre, a rack of combed sections put on and all wrapped up warmly. The bees went up strongly at once, and will carry all their stores above, giving the queen a monopoly of the cell room below, the result being frames full of brood from side to side, and right up to top bars.

### QUEEN INTRODUCTION.

I find no difficulty in getting any queen accepted by the confined nucleus method. The two outer pollen combs and adhering bees are taken from a colony, making certain about no queen or eggs being present.

These hopelessly queenless and broodless bees are confined in a nucleus box and

allowed to release the new queen by eating away the candy from her travelling cage. This method is almost infallible.

### RESERVE STORES.

I have already suggested in the B.B.J. and now repeat that one colony should be set aside each season solely to store up solid combs of honey for distribution over the other colonies according to their needs. Consistently practised this would eliminate the now formidable sugar bill, besides being an insurance against loss of stocks through starvation during winter and spring.

Many otherwise good bee-keepers are guilty of this form of dreadful cruelty to their little workers, and these careless ones should bear in mind that this evil is wrought by want of thought—and forethought.—J. M. ELLIS, Gretna, Carlisle.

---

## Sugar Feeding.

We ought to be very grateful for our allowance of sugar this spring, as there was a difficulty regarding shortage, I believe.

In the autumn those who have many hives would profit by reserving one hive with shallow frames during the season, to feed bees at the end of the honey harvest.

The reason I quote is this. I have seen a good deal of dysentery about owing to sugar fermenting from being left uncapped after a mild season with cold snaps.

Sugar feeding in the autumn (late) means endless manipulation to see if it is capped, which disturbs bees very much at this time of year.

I am sorry to see some sell every scrap of honey, even from the brood box, and its place is taken by sugar, which in itself is unnatural to bees. By feeding with honey they cap it easier and quicker. By being fed early autumn they raise a large brood, and therefore don't eat so much. In the spring one finds plenty of capped honey to begin breeding, which is the finest thing to start on at the end of March. Let them have all their combs during winter.

I have seen them all huddled in a comatose state along the top of the frames through the passages of a Rymer Board, where it is warm, looking the picture of health. Gently putting a candy box with glass top over the feed hole, a week later a lot of little black heads are seen busy feeding, and so on till syrup time arrives.

If the bees are put up snug with well capped honey (which is uncapped slowly as needed), and the hive is opened on a warm day at the end of March, there is a nice dry hive, with a good start of bees: no shake of the head, "Dysentery"; small

patch of brood. Take my tip and try it.

Let your bees be your *first* customers. They will repay you tenfold. This applies only to those who really can afford it, of course.—CYRIL TREDCROFT.

### The Example of the Bees.

[As is well known, bees play an important part in the fertilisation of flowers.]

I threw me down in a clover field

Beneath a cloudless sky.

"My life is nothing but endless toil!"

I cried, with a weary sigh.

The bees were flitting from flower to flower,

Working with all their might.

"Why rest you not, little bees?" I said.

"Why labour from morn till night?"

"Ah, no!" hummed one, as she lit quite near

To my throbbing and aching head.

"There are thousands of helpless babes at home

Who'll die if they are not fed."

And under the sky I lay for awhile

On my bed 'mong the clover bloom.

"They fancy they drudge for the babes,"

I mused,

"And bear with joy their doom.

"But Nature impels their ceaseless search

For nectar the livelong day,

Because she would brighten the dull old earth

With countless blossoms gay."

I rose from the ground with a new-found zest,

With a stronger and braver heart.

"I'll not be shamed by the bees," I cried,

"But will play a manly part!

"My tasks are lowly, my duties dull,

But I'll never again repine;

Who knows but my humble toil may serve  
Some hidden end divine?"

CANNING WILLIAMS.

### Notes on Bee Keeping.

Strong, healthy hives of bees will be found to contain brood in various stages during February. It is then but a small patch, right in the centre of the cluster, and as the season advances this increases until nearly all combs in the brood-chamber are one mass of brood. A hive at the commencement of spring is in a very depopulated condition; especially is this the case if, through excess of stores the previous autumn, the queen has been restricted in her breeding space. Under these circumstances there will be

very few bees left in the hive when spring arrives. The oldest bees of a community die first; as a consequence, the young ones are the most likely to live through the rigours of winter, and come out in spring in the best of condition. If the number of these can be replaced by young ones reared early in spring a great gain will be made. Not only is this done, but a hive can, by gentle feeding, be brought into such a condition before the honey flow as it would be *after* such had commenced if left unattended. It is a well-known fact that bees left entirely to their own inclinations are not in so flourishing condition when the honey flow sets in as they are a short time after, when honey is the bee-keepers' first consideration. If we can, by a certain system of management, get our hives in as strong a condition just before this event takes place, then, of course, much early honey is gathered for the bee-keeper. Bee-keepers may be tempted, owing to the high price of sugar, to leave their bees to their own inclination, but I venture to suggest if they will take the trouble and expense to spring-feed, they will be amply repaid when the honey harvest comes round. The best time to spring-feed is in autumn, and use the uncapping knife in spring. This is my experience, and, in my opinion, beats the bottle-feeding. It can be easily done without removing the combs—which is inadvisable in early spring—by simply inserting an ordinary table knife between the combs and raising the cappings of a few cells every two or three days. This will increase breeding very much, and is considered by others far superior to bottle-feeding. Sometimes we find colonies at spring-time—about March or beginning of April—to be short of stores, especially when the winter has been mild, like the one we have just passed through, causing the bees to move about, and in consequence to feed more freely. It is at this time syrup is needed, about six weeks before the expected honey flow. As a cheap kind of feeder, take a lever-lid tin (a Lyle's golden syrup tin answers well) and bore two small holes in the bottom with an awl or darning needle, not more, or else the bees will get too much syrup, and the queen would be "crowded out," the meaning of which is that the cells would be filled with syrup until there were none, or very few, empty ones left for her to lay eggs in. The colony must then gradually dwindle away. But, on the contrary, if the amount of syrup fed to the bees is restricted to suit the ideas of the advanced bee-keeper a great advantage will be gained; therefore,

unless the colony is in a starving condition, the bees must only be allowed to obtain syrup through not more than two holes, and if they take down more than half a pint of syrup per day this must be reduced to one hole. The manner in which this so favourably affects the colony is easily explained. Unless a certain amount of stores is being collected by the bees, sufficient for their own consumption as well as for the larvæ, the queen will not lay eggs beyond the number that can be supported upon that quantity. If no stores are coming in, but there is sufficiency in the hive to support the colony, the queen will lay a moderate number of eggs; in fact, will breed in a half-hearted sort of manner, but the instant stores begin to come in her laying is greatly increased, hence, by practising deception on the queen, causing her to suppose that natural stores are being collected, she increases the number of eggs laid, and the colony increases proportionately in strength, ready to take advantage of an early honey flow.—P. LYTHGOE, Padgate, Warrington, Lancs.

## Herefordshire Bee-Keepers' Association.

### RE-STOCKING SCHEME.

The Ministry of Agriculture's bee re-stocking scheme has placed the Herefordshire Bee-Keepers' Association in a dilemma. It had been hoped that the scheme would be worked through the Association, but a condition was imposed that those taking advantage of the scheme should become members of the Association.

To this the Ministry refused to agree, and the matter was referred to a special general meeting of members of the Association, held at the Y.M.C.A., Hereford, on Saturday afternoon.

The meeting was faced with something in the nature of an ultimatum, by reason of the fact that Mrs. Mynors, the hon. secretary, a lady who has rendered great service to the Association, had stated her intention of resigning if the amendments suggested by the Ministry were accepted.

The Rev. G. W. Turner, of Madley, presided, and, explaining the position, said that at a previous meeting an agreement was practically come to that the Association should act as a sub-committee of the County Council for the purpose of carrying out the Government's bee re-stocking scheme in the county, for which purpose they would receive grants amounting to about £150. One of the conditions the Association imposed was that everyone benefiting by the scheme, if not already a member, should become a

member of the Association. Their reason for that was to ensure that the money spent should not be wasted, but that they should have a guarantee that the bees supplied were being properly looked after, the Association having an expert who went round at intervals and examined the hives. They thought the matter was settled until they received an intimation that the Ministry would not agree to the condition imposed.

Mr. Porter, the agricultural organiser, had written the following letter:—

"I am directed by my committee to inform you that the Ministry of Agriculture is not prepared to approve, without amendment, of the arrangement arrived at between the County Council and your Association, and, as the Ministry are providing two-thirds of the expenditure, my committee feel there is no alternative but to accept the amendments which the Ministry of Agriculture suggest. The points to which the Ministry raises objection are as follows:—

(1) The Ministry are unable to give their sanction to the bee re-stocking scheme being confined to members to your Association, and as the scheme is a national one it should be open to residents in the county, however desirable it may be for all bee-keepers to be united in an association.

(2) The Ministry objects to any differentiation being made between cottagers and smallholders, and suggests that their subscriptions for each stock of bees should be from 35s. to 40s. as a flat rate.

(3) The Ministry suggest that spring and autumn visits should not be confined solely to members of the Association, but for all bee-keepers in the county who wish to receive a visit from the expert carrying out this work. The remuneration the committee suggest for the expert carrying out this work for non-members should be an inclusive fee of 2s. per visit made, although this might be worked in along with the ordinary work of the expert.

The only point that really affects your Association is No. 1 as given above, and as non-members will not be able to secure any of the advantages offered by your Association, with the exception of a visit when requested—for which your expert would receive separate remuneration as suggested in No. 3 above—my committee do not think that these amendments will in practice be found to adversely affect the work of your Association. In any case, they will be bound to conform to them, or lose the grant, which would be fatal to the development of bee-keeping in the county.

With regard to No. 2, the fixing of a

flat rate to cottagers and smallholders does not affect your Association at all, as the County Council has to pay the difference between the 35s. and the 60s. in each case.

With respect to No. 3, it is a matter which affects the bee expert only, and as he can work his visits to non-members in with the visits to members, I do not think there will be any difficulty in this case, as there are likely to be very few non-members who wish to have a visit.

My committee will be glad to have your early reply, stating whether your Association are willing to agree to the amendments which are imposed by the Ministry of Agriculture if the joint arrangement is to be carried into operation."

The chairman said the feeling appeared to be that if they accepted the amendments they would be practically committing suicide, because everyone could have the same advantages as if they were members of the Association. He spoke with warm appreciation of the services rendered by Mrs. Mynors to the Association, and said that to accept the amendments would be to lose those services.

Mr. Arnfield said his opinion was that the Association would commit suicide whichever way it acted.

The chairman suggested that they might follow the example of Kent, and leave the bee re-stocking scheme entirely in the hands of the County Council.

Mrs. Mynors explained that for once in a way Herefordshire had been in advance of the times. Kent started a bee re-stocking scheme some few years ago, and Herefordshire started about two years later. The result was that they were about two years in advance of the Government scheme which had now been brought forward.

Considerable pressure was brought to bear upon Mrs. Mynors to agree to continue the secretaryship if the amendments were accepted, but, while regretting that she might be thought obstinate, she explained that her decision was the result of very serious and careful thought, and was final.

With regard to the financial position of the Association, it was stated that about £60 was owing to Mr. Arnfield, but that they had stocks which were sufficient to meet the deficit. Mrs. Mynors said they had spent their little all on their own re-stocking scheme, to which she had always been opposed. One member expressed the view that they should go on as they did before the Isle of Wight disease came, and that if members lost their bees they should buy again in the open markets, as he had done.

Mr. Arnfield's opinion was that the work of the Association would eventually

cease whether they accepted the amendments or not, and that it would be carried on through the County Council.

A motion was proposed that they should not accept the amendments of the Ministry, but this was not seconded.

Mrs. Mynors said she would be willing to continue as secretary if the Association would drop the re-stocking scheme.

Mr. Wood said that while it was most unfortunate that they should lose their secretary at such a juncture, he was in favour of accepting the amendments, and suggested that clerical assistance might be rendered by the County Council in regard to the re-stocking scheme.

To reach a decision, the chairman put the question to the meeting, whether they should accept the amendments, involving the resignation of the secretary, or whether they should refuse to accept them and retain Mrs. Mynors' assistance. By thirteen votes to 8 the meeting decided in favour of acceptance, a final effort to induce Mrs. Mynors to continue having failed.

Mr. Wood proposed, and Mr. Watkins seconded, that the amendments should be accepted, and this was agreed to by a majority of five.

Mrs. Tuke was then elected secretary and treasurer, in place of Mr. and Mrs. Mynors.

[We learn that Mrs. Tuke, since the meeting, has reconsidered her decision, and does not see her way to accept the position of secretary.]

Mr. Stephens proposed that the heartiest thanks of the Association be accorded to Mrs. Mynors for the great work she has done for them, and this was seconded by Mr. Arnfield. He said that while he was in favour of accepting the amendments, he much regretted the loss of the services of Mrs. Mynors.

The chairman also expressed his warm appreciation of Mrs. Mynors' work, energy, and judgment, and the resolution was unanimously carried.

The result of the deliberations is that the Association will carry out the scheme of the Ministry of Agriculture for bee re-stocking in the county, and that there will be no compulsion upon those receiving stocks to join the Association.

[Mrs. Mynors is strongly in favour of the re-stocking scheme which was originally started in Herefordshire at her suggestion, but she was opposed to carrying it on at increasing expense to the Association, and feels that the above mentioned deficit of £60 justifies her in her views. She reluctantly resigns the hon. secretaryship for the same reason, feeling convinced that the present scheme is detrimental to the interests of the Association, though she is, of the opinion

that, with certain re-arrangements, a thoroughly workable scheme could be set on foot, to the advantage of all bee-keepers in the county, members of the H.B.K.A. and others alike.]

(Communicated.)



The Editors do not hold themselves responsible for the opinions expressed by correspondents. No notice will be taken of anonymous communications, and correspondents are requested to write on one side of the paper only and give their real name and address, not necessarily for publication, but as a guarantee of good faith. Illustrations should be drawn on separate pieces of paper. We do not undertake to return rejected communications.

### Queens and Space Between the Brood Chambers.

[10191] I note you are quite determined (10187) that a division through the brood chamber is no detriment—indeed, rather an advantage—and that you rather favour the Heddon type. But why then do you advocate a frame 14 by 12. There is, in fact, no difficulty about the queen passing from one frame to another.

The cluster protects her, and she passes freely about. There is no question of any difficulty whatever. I do not in any way follow you when you say the fact of the cluster extending below or above is an argument in favour of division. I have read the remark several times, and can make nothing of it. Do you imply that the bees should not extend below? If so, you are quite wrong. Just experiment a bit. A conqueror hive is very little use, but it is excellent for studying the habits of bees in winter.

In Mr. Simmins's original frames bee-passages were made through the top bars. Even when no other passage was given the bees mostly blocked these passages up, but they are almost always found to hang below the frames in winter. In fact, I have seen them hanging so that nearly half the cluster was suspended like a swarm below the frames, and this in the depth of winter. I want to give you to understand that I do not write about things till I have tried them out. In the matter of frames, for instance, I tried a frame 14 by 11½ for two or three seasons in two stocks, but I found it to be an utterly worthless frame for every purpose except wintering. I have never tried the Langstroth frame, so I cannot speak so clearly. Its great length seems to cause our United States friends some bother in wiring, and all sorts of weird plans have been described in the United States bee press lately. Its length also seems to preclude its use in

square hives. I doubt very much if one can exceed 10½ in. in depth to still work for comb honey, while at the same time it is as well to have as much depth as possible. I hope some people will try out the Langstroth frame soon and let us know how they get on—someone with no axe to grind—but I know enough about the 14 by 12 to advise all to leave it alone except for a hive or two for experimental purposes.

(10175) *Re* Mr. Tedcroft's notes. Let me assure Mr. Amies that where a quilt is taken off a hive at the end of the season "as clean as the day they were put on," there is precious little under them. Give me a sight of a well-plastered quilt.—R. B. MANLEY.

[May we once again say that we have never stated that a division through the brood chamber is "no detriment," but we are still unconvinced that it is the detriment Mr. Manley and others would have us believe. Mr. Manley seems unable to resist the temptation to read more into a statement we make, or anything we use by way of illustration, than is intended, simply for the sake of trying to demolish an argument he himself has set up—like playing skittles. We endeavour to look at matters from both sides, and for our readers' guidance point out what we consider either faults or advantages. It does not follow that if we point out a fault in a method of working or some appliance we condemn it utterly, or that if we draw attention to an advantage we are advocating its general adoption. We leave our readers to judge for themselves as to what will be best under their special conditions. Mr. Manley appears unable to see any fault in anything that suits him, or any virtue in what does not. To make our position as clear as possible, we still prefer the British standard frame for the brood chamber. For those who think it too small we recommend the 14 by 12 in preference to 16 by 10, as brood chambers and hives in use now can easily be adapted to tone it—a W.B.C. brood box by having a 3-in. exe under it and single-walled hives by a rim on the top 3 in. high. The adoption of the 16 by 10 would mean the scrapping of all W.B.C. brood chambers and single-walled hives unless they are made to take 11 standard frames. To work in comfort new supers would also be needed. We do not condemn the 16 by 10 as a frame, but in our opinion the drawbacks mentioned would more than counterbalance any advantage it may possess. It is now nearly 20 years since the "Commercial" frame (16 by 10) was introduced, and it strikes us as rather remarkable that if the standard frame

has been such a drag and handicap on the industry, and the 16 by 10 is so far superior to it as its champions assert, it has not in that time ousted the standard.

We trust this disposes of the idea that we favour a brood chamber composed of two sets of shallow combs. As to the queen passing from one comb to another under the comb we will grant the cluster generally extends below the frames, but the deeper the comb the more elongated will the cluster be, and the longer will it be before the queen moves. When she does so, she will have to travel from the lowest point at which eggs have been deposited on one side to a point much higher up on the other. In this the 14 by 12 is at a disadvantage, but two sets of shallow combs would have a much larger cluster of bees and more warmth at the division of the two lots, and the queen therefore would be able to travel more freely from one comb to another. If one set only of standard combs are used the cluster under the comb will be larger than under the deeper combs, and the distance for the queen to travel will not be so great. If more breeding room is needed later on, another set of combs—shallow or standard, as thought desirable—may be placed *under* the first lot, and the cluster that hung under the combs will now extend down into those beneath.—Eds.]

### Saving Bee Life.

[10192] May I suggest in the interests of bee-keeping, and especially of the bees themselves, that attention should be drawn to a great fault with very many bee-keepers, and that you will see your way to use your influential journal to point it out.

I refer to the cruelty, unintentional certainly, of starving bees to death in the galleries of the hives, and smothering them between the quilts.

As a bee-keeper myself, I have had the opportunity of inspecting the hives of others, and have noticed a large number of dead bees between the quilts, and in the galleries, under the frame ends. What has happened in the former case is, of course, that when the hive has been opened, the bees have settled on the quilts, and the bee-keeper, without taking thought or trouble to clear them off, has simply laid the quilts back again with the unfortunate creatures between them.

In the second case, what happens is this. The bee-keeper is instructed in the best handbooks to use spacers for dividing the frames, and does so, filling every space between the frames from side to side of the hive and leaving no

loophole for the bees, numbers of which enter the galleries when the hive is opened, to get back again. They are thus excluded from all further food or warmth, and die of starvation. I have seen galleries with lots of these unfortunates, simply because the bee-keeper has not the sense to see that he is deliberately starving his workers to death by confining them in the galleries. The remedy in this case is, of course, quite simple. Leave, at any rate, one bee way open (if necessary omit one spacer) in each gallery, to permit the bees to re-enter the brood chamber. This cannot possibly do any harm, and does good by saving the lives of many bees.

This is my practice, and, being very careful to see that all bees are removed from the quilts before replacing them. I have the satisfaction of opening my hive without finding a single dead bee.

I think to avoid the cruelty, to say nothing of the waste, these points should be emphasised, as, I am certain that very many of your readers only want their attention drawn to this, to see that they are overlooking a very simple but necessary precaution.—C. C. WILLIAMS.

P.S.—This trouble with the galleries could not happen if a bee way were cut in the metal runners when the hive is made. The ventilation into the galleries would, I think, be rather an advantage than otherwise. But this is only a suggestion.

[Our correspondent is quite right, Many bees are sacrificed in the manner indicated through thoughtlessness, or carelessness, or both.—Eds.]

### The British Honey Producers' Association.

[10193] May I put a few paragraphs in your valuable journal referring to Mr. Claridge's article on April 1? I should like to draw the attention of bee-keepers, especially those that are working on commercial lines, to the suggestion put forward by Mr. Claridge, who points out the advantages of a "British Isles Honey Producers' Association." He urges us to get busy with our local Association's secretary to push the thing forward. I sincerely hope that Mr. Claridge's suggestion will meet with all county Associations' support.

I am intending to keep bees on a large commercial basis myself, but at present I cannot see any guarantee of a good market for the produce; neither is there a fixed price for it, and, as all know, honey is being sold at all prices at the present time. I look in the JOURNAL, and see a certain amount of honey for sale, "What offers?" This is nothing more



or less than cutting one another's throats.

Now, the formation of a "British Isles Honey Producers' Association" would put an end to that, and again it would encourage the industry and protect it from foreign competition. All the chief fruit-growing districts of the world have an Association of their own, and those who take in *The Fruit Grower* cannot help but see the advantages of them.

So let us have a "British Isles Honey Producers' Association," as Mr. Claridge suggests, and profit by the experience of others. I congratulate Mr. Claridge for his grand suggestion, viz., B.I.H.P.A. and "the labelling of origin of foreign honey," hoping these will be supported by the bee-keepers of the British Isles.

"Isle of Wight" Disease: *One of Its Causes*.—I am extremely grateful to Mr. Edwards and Mr. Boobier for their interesting articles under the above heading, and hope they will meet with still further success. EDWARD GRIFFITHS.



### Various Queries.

[9904] May I ask you to answer in one of your issues the following three questions:—

1. If a queen is taken out of a hive and another substituted in a cage, if the latter is found to be dead 36 or 40 hours after, can the original queen be given back uncaged without risk?

2. Can anything be done to prevent an undue proportion of drones being raised without taking away drone comb and substituting worker comb (which I am not in a position to do)? A short time back one of my three hives had for days a very large cluster hanging outside. On looking close I found a great number of drones, so I swept the lot into a box and then put a sheet of queen-excluding wire on top. The next day, the workers having escaped, I scalded the drones, and counted 6,200! I then took away one comb filled from top to bottom with drone cells (honey therein), and another partly filled, substituting a frame of worker comb and one with a strip ( $\frac{3}{4}$ -inch) of foundation. The queen was not solely a drone breeder, for the hive is fairly strong and threw out a swarm six weeks after the killing of the drones. Within the last six days (five weeks after the swarm was thrown out) I have again killed 3,100 drones, so I suppose that drone comb has been built in the frame with strip of foundation.

3. Can anything be done to prevent

pollen being put in a super? On taking honey a short time ago from one of my hives I found nearly half the sections spoilt through a good many of the cells having bee bread in them! There was a sheet of excluder wire below the super, and not a sign of eggs or brood in the sections, so the queen could not have got up. I had the excluder on all the winter. Could that fact have anything to do with the trouble?

H. J. BOVELL, St. Helena.

REPLY.—(1) It will be advisable to cage the queen after so long an absence. (2) Cut out the drone comb and close the combs to  $1\frac{1}{2}$  ins. from centre to centre. If you use the W.B.C. ends, pull every other one back, so that the shoulders slip one behind the other. When the combs are built, space  $1\frac{1}{2}$  ins. as usual. (3) A queen excluder generally prevents it to a great extent. We do not know that you can do anything else. Leaving the excluder on all winter will make no difference.

### A Bee Story.

"THE TRUTH, THE WHOLE TRUTH—AND—"

A rather interesting instance of the sagacity of bees occurred in County Tipperary recently. Mr. Patrick Dalton, Cloughaleigh, Golden, had been an extensive bee-keeper until three years ago, when he gave up, and his servant maid then took charge of them. Some short time ago the maid left and went to reside at her home 6 miles away. After she had left Mr. Dalton missed four or five swarms of the bees, and he subsequently discovered that they had flown off and lodged at the servant maid's.—From the *Cork Constitution*.

[The above is the type of story one expects from America.—Eds.]

## Bee Shows to Come.

*A nominal charge of 2s. 6d. is made for notices (not exceeding 7 lines) in this column, 10 lines charged 3s. 6d., up to 15 lines 6s., which covers cost of insertion from order till date of show. Cash should accompany orders for insertion.*

**June 9 and 10, at Colchester.**—Essex Agricultural Society. Classes for Extracted and Comb Honey, etc. Schedules from Secretary, Essex Beekeepers' Association, 7, Bulwer Road, Leytonstone. Entries closed.

**June 16 and 17.**—Hanley Park Meeting of the Staffordshire Agricultural Society. The Staffordshire B.K.A. offer valuable prizes and six silver medals and nine bronze medals. Twelve Classes for members only, and five Open Classes. (Honey Classes are for four or three jars or sections). Schedules, W. Griffiths Silkmore, Stafford. Entries closed.

**June 29 to July 3, at Darlington.**—Royal Agricultural Society's Show, Bee and Honey Section, under the direction of the B.B.K.A. Prizes arranged in groups of counties for Associations affiliated to the B.B.K.A. Schedules from The Secretary, 33, Bedford Street, Strand, W.C.2. Entries closed.

**July 6, 7 and 8, at Cardiff.**—Royal Horticultural Society's Show. The Glamorgan B.K.A., in conjunction with R.H.S., offer prizes for Honey, Wax, Bees, and Appliances. Members, Novices, and Open Classes. Schedules, Mr. Wiltshire, Mandy School, Cardiff. Entries close **June 22.**

**July 15 and 16, at Grimsby.**—Lincolnshire Agricultural Society. Show of Bee Appliances, Honey, Sections, Wax, etc., under the management of the Lincs B.K.A. Open and County Classes. Valuable prizes.—Schedules from Major Hadfield, Alford, Lincs. Entries close **June 12.**

**July 17, at Guildford.**—Guildford and District Bee-keepers' Association. Members and Open Classes.—Schedules and prize list from Rev. E. C. Pitt-Johnson (Hon. Sec.), Heatherwood, Pirbright, Surrey. Entries close **July 3.**

**July 20 to 23, at Aberdeen.**—Highland and Agricultural Society. Classes for Bee Appliances and Honey. Premiums £53 10s. Half of Prize Money and Silver and Bronze Medals contributed by the Scottish Bee-keepers' Association.—Entry forms from John Stirton, Secretary, 3, George IV. Bridge, Edinburgh.

**Monday and Tuesday, August 2, 3 and 4, at Newport.**—Monmouthshire Bee-keepers' Association Annual Show (in connection with the Newport Allotment Holders' Association). Members and Open Classes.—Schedules (post free 3d.) from Hon. Sec., "Underwood," Portskewett, near Chepstow, Monmouthshire. Entries close **July 26.**

**August 12, at Taunton.**—Somerset Bee-keepers' Association Show of Honey, Wax, and Appliances. Seven Open Classes. Liberal prizes.—Schedules from Mr. F. J. J. Stacey, 3, Hammet Street, Taunton. Entries close **August 6.**

**Wyke and Normandy Horticultural Society.**—Honey Classes (Open). Best three sections, 5s., 3s., 2s.; Run Honey, light, 3 1-lb. glass jars, 5s., 3s., 2s.; Run Honey, dark, 3 1-lb. glass jars, 5s., 3s., 2s. Entrance fee, 6d.—Particulars, H. L. Mumford, Hon. Sec., Heatherside, Normandy, Guildford.

## Special Prepaid Advertisements. One Penny per Word.

Will advertisers please read these Rules carefully in order to save trouble, as they will be strictly adhered to.

Trade advertisements of Bees, Honey, Queens, and Bee goods are not permissible at above rate, but will be inserted at 1½d. per word as "Business" Announcements, immediately under the Private Advertisements. Advertisements of Hive-manufacturers can only be inserted at a minimum charge of 3s. per lin., or 5s. per inch.

PRIVATE ADVERTISEMENTS are only intended for readers having Surplus Stock to dispose of. Driven Bees, Nuclei, and Queens that are reared or imported for sale, are Trade Advertisements, and can only be accepted under trade terms. A charge of 6d. extra will be made if a box number is used.

Advertisements must reach us NOT LATER than FIRST POST on TUESDAY MORNING for insertion in the "Journal" the same week.

Orders for three or more consecutive insertions in "The Bee Journal" entitle advertisers to one insertion in "The Bee-keepers' Record" free of charge.

### PRIVATE ADVERTISEMENTS.

**TWO HIVES** of healthy Italian Bees, also a few empty Hives and Fittings; no disease.—GREEN, Winterley, Sandbach. f.1

**NEW Light Lincolnshire Honey**, fine quality, £10 cwt.—TAYLOR, Schoolmaster, New Leake, Boston. f.2

**EXTRACTOR**, with Cowan cog gearing, perfect working order, good condition, 50s.; packed.—C. E. GOULD, 38, Fountain Street, Guernsey. f.3

**FOR SALE**, six 10-frame Hives and Accessories.—BAKKE, 6, Walsingham Road, Clapton, London. f.4

**SWARMS.**—Two for Sale on 4 and 5 frames, 35s. and 40s. respectively, Hybrid Italian 1919 Queens, box returnable; also carpenter's Steel Grip Vice, 12-in. draw, 27s. 6d.—WISDOM, 291, Coldharbour Lane, Brixton. f.5

**SHALLOW FRAME BOXES** (eight drawn-out combs), 15s. 6d. each; 1s. extra on rail.—51, Lower Mortlake Road, Richmond, Surrey. f.6

**PRIME SWARMS**, 30s. to 40s.; marked immunity from disease.—NORTH, Cressing, Braintree, Essex. f.7

**THREE good 10-frame Stocks Italian Hybrids**, 1919 Queens, June delivery, £5 each.—NICHOLSON, 176, Thorpe Road, Norwich. f.8

**SMALL APIARY** for Sale with spare hives, drawn-out combs, etc.; 30 miles from London. Could remain in present position till autumn if desired.—Box 86, BEE JOURNAL Office, 23, Bedford Street, W.C.2. f.10

**FOR SALE**, pure, new Light Cambridgeshire Honey, finest quality, extracted last week, May 26; accept £10 for 1 cwt.—SULMAN, Tithe House, Wilburton, Ely. f.11

**EIGHT clean Brood Boxes**, £1; 200 Metal Ends, 6s.—CHAURIER, Desford, Leicester. f.12

**SWARMS**, 20s., on frames, 27s., buyer paying carriage; box 10s. 6d., refunded on return.—CULLEN, Bull Hill, Great Clacton. f.13

**FOR SALE**, 4 cwt. genuine Welsh Honey, all extracted, quality good, mainly clover, 1s. 7d. lb., carriage forward; sample 6d.—JAMES, Brynafon, Newcastle Emlyn. f.14

**A FEW strong Stocks** of guaranteed healthy Bees, in hives complete, 5 gs.—WIGGINS, 1, Windermere Road, Wembley. f.15

**TWO good lots Hybrid Italians**, each 4 frames, 42s. each, carriage paid.—AYERS, 7, Chesterfield Grove, Dulwich. f.16

**SWARMS, ITALIAN HYBRIDS.**—Several for Sale. What offers?—Particulars apply SMITH (Gardener), Hook Farm, Aldingbourne, Chichester. f.17

**TWO W.B.C. Hives**, complete, supers with comb; five other Hives, several Appliances; cheap.—HASLER, Upper Downing, Holywell, Flintshire. f.18

**FOR SALE**, several healthy Swarms of Hybrid Italians in skeps or frames. Can be inspected by appointment.—BANKS & ROBINSON, The Elms, Pertenhall, St. Neots. f.19

**FOR SALE**, Hives, Drawn-out Shallow Frames, Queen Excluders, and Dividers. Would exchange for swarms.—17, Beverley Road, Canterbury. f.20

**EXCHANGE.** Swarm from healthy stock for W.B.C. Hive in good condition.—Write particulars, BREWER, Bontddu, Dolgelly. f.21

**TWO 10-frame Hives** of Bees, Simmins' strain, 5gs., including hives; also two empty Hives, £1 each; purchaser to pay carriage.—T. GREEN, New Dale, Wellington, Salop. f.22

**FOR SALE**, five W.B.C. Hives and several other standard patterns, complete, second-hand, £1 each.—MISS GORDON, Wettersfield Place, near Braintree, Essex. f.24

**DUTCH.**—Seven Stocks healthy (four nearly swarming, three weak) to near buyer who can personally fetch same. 7s. 6d. a frame.—MATRON, Croydon Borough Sanatorium, North Cheam, Sutton, Surrey. f.25

**LARGE EXTRACTOR.** Strainer and Blower; lot £2 10s.—GRAHAM, Woodlands, Brookville, Stoke Ferry, S.O. f.23

**APIARY FOR SALE.**—Two strong Stocks of Bees, six good Hives, and other Appliances. Stamp for particulars.—C., The Elms, Leyton Road, Harpenden, Herts. f.26

**SWARMS.**—A few strong ones for delivery during June, £2 each.—J. MOORE, Bleasby, Notts. f.27

**A FEW LOTS** of good, healthy Bees on from 6 to 8 standard frames, 8s. per frame; travelling box to be returned.—WRIGHT, Waterworks, Sutton Poyntz, near Weymouth. r.f.28

**BEEES.**—Good Stocks May Swarms in skeps, hives, extractors, and all appliances to be cleared at once. Stamp for list. No disease.—STEEL, West Ashling, Chichester. r.f.29

**WANTED,** Swarm of Italian Bees at once.—Write, MRS. SAYERS, 24, Thornhill Road, Plymouth. f.39

**TWO PENNA QUEENS,** to be delivered shortly, 10s. 6d. each; overstocked.—BLENKARN, The Lodge, Burford, Dorset. f.40

**FOR SALE,** Nucleus Dutch Bees, Italian Queen.—Box 87, B.B.J. Office, 23, Bedford Street, W.C.2. f.44

**WANTED,** a 2-framed Nucleus with Fertile Queen (Italians)—D. SINCLAIR, Klondyke, Glenboig, Lanarkshire. f.46

**SWARMS,** 30s. to 40s.; finest quality Sections, new, 32s. dozen.—NORTH, Cressing, Braintree, Essex. r.e.25

**QUANTITY** of drawn-out Shallow Frames, excellent condition, 1½ frames with drone comb, 1s. 6d. each; one gross 7-lb. lever-lid Honey Tins, with handles, 14s. per dozen, packed, on rail; one gross 23-lb. lever-lid Tins, 20s. dozen.—J. ARNFIELD, Breinton, Hereford. e.107

**ITALIANS.**—Choice strain (Penna's extra selected). Spare nuclei, 35s., delivered. Inquiries stamp.—Box 000, B.B.J. Office, 23, Bedford Street, Strand, W.C.2. e.48

**SURPLUS QUEENS.**—Dutch and Hybrid Virgins from County Re-stocking Apiary, 4s. 6d. each.—ANDREWS, Expert, 78a, Westgate, Peterboro'. e.81

**FOR SALE,** eight hives and strong stocks of bees, Italian and Carniolan, with young Queens, separately £8 each hive, lot £60. With appliances and geared extractor, £10 extra.—Apply A. J. RAYMENT, 50 Chandos Avenue, Whetstone, N.20. e.82

**PURE** light Cambridge Honey (guaranteed), 28lb. tins 42s., carriage paid; sample 4d.—J. YOUNGER, 6, Maid's Causeway, Cambridge. e.56

**FOR SALE,** six frames of healthy honey-fed Bees, never had any disease in apiary, £3 10s. and 10s. charged on travelling box, from which carriage of bees is deducted and balance returned to buyer.—BEED, Primrose House, Heacham, Norfolk. r.e.20

**WANTED,** from August 22 to September 4, in Cornwall or Devon, within 12 miles or so of sea, Bedroom and Sitting Room, with shed for motor car; farmhouse preferred. Can any beekeeper oblige me?—W. HERROD-HEMPSALL, Old Bedford Road, Luton, Beds.

**FOR SALE,** two "Rotax Roadlight 267" self-contained Acetylene Motor Headlights, very powerful, £6 the pair; one Exhaust Whistle, 10s.; one Wood-Milne Motor Foot Pump, 40s.—HERROD-HEMPSALL, as above.

**WANTED,** Anster Rear Wind Screen for motor car.—HERROD-HEMPSALL, as above.

**CORRESPONDENCE COURSES** in Bee-keeping.—H. E. NEWTON, Brown House, Barton-on-Sea, Hants. r.d.157

### BUSINESS ADVERTISEMENTS.

1½d. per word.

**NUCLEI,** 3 frames, Bees and fertile 1920 Queen, £2 2s.—LARMUTH, Hillside, Monahan Avenue, Purley. f.9

**ITALIAN HYBRIDS.**—Four-frame Nuclei, June delivery, 50s.; box 10s., returnable.—ERNEST GRIFFITHS, Helsby, Cheshire. f.50

**4-FRAME NUCLEI,** with Italian or English Queen, 50s.; returnable box, 10s.; Queens, 10s.—HOLLINGSWORTH, Heanor. f.51

**NUCLEI,** 3-frame, £2 10s.; 4-frame, £3 5s.; Cross "White Star"; box, 5s. extra.—A. SKINNER, Oaks, Micklegate, Derby. f.32

**"LAZENBEE" PROLIFIC ITALIAN QUEENS** are selected and tested; fertile, 10s.; virgins, 5s. All available nuclei are sold.—YOUNG, 29, Central Road, Sudbury, Middlesex. f.33

**"LAZENBEE" PROLIFIC ITALIAN QUEENS** are selected and tested; fertile, 10s.; virgins, 5s.—YOUNG, One Hundred Elms Apiary, Central Road, Middlesex. f.34

**4-FRAME GOLDEN NUCLEI,** £3 5s.; Golden Queens, 10s. 6d.; Swarms, £2 2s. (travelling box 10s., returnable).—L. DAVEY, Mawneys, Romford. f.35

**DUTCH CROSS,** wonderful workers, Swarms, £2; 3-frame Nuclei, £2 5s.; 4-frame Nuclei, £2 10s.; carriage paid; box returnable.—ALBERT COE, Apiarist, Ridgewell, Halstead, Essex. f.36

**FOR SALE,** 3-frame Nuclei, Hybrid Italians, 45s. each; boxes 5s., returnable; June delivery for cash with order.—T. EVANS, Lattiford, Wincanton, Somerset. f.37

**NO MORE ORDERS** can be accepted for Swarms until we can catch up with those on hand. Instead of 4 lbs., our May Swarms this year average 2½ lbs., and these are being thrown back in hopes that subsequent issues will be larger. We still have a few Black and Hybrid Stocks for prompt shipment.—S. H. SMITH, 30, Maid's Causeway, Cambridge. f.41

**VIRGIN ITALIAN QUEENS,** immediate delivery, 5s.; Fertile Queens to order, 10s.—JACK TICKELL, Westbourne Apiary, Cheltenham. f.15

**PENNA** specially picked me a 1919 beauty, now laying nearly 3,000 eggs daily. Spare Virgins from this mother 4s. by return, or money back; fertiles, 8s., in rotation.—"PATRICIA," Grammar School, Doncaster. f.38

**STRICTLY BUSINESS.**—Last chance at old prices. Japanned Sprayers, 5s. 6d., post paid. Flavine, free samples on request. "Let the Bees Tell You," six chapters, 2s., post paid.—S. H. SMITH, 30, Maid's Causeway, Cambridge. f.42

**ITALIAN HYBRID BEES** (immediate delivery), disease-resisting strain, 1920 Queens. 4-frame Nuclei, 50s.; travelling box 10s., returnable. Also a few 10- and 15-frame Stocks at 10s. per frame. Above can be supplied in good sound Hives (freshly painted with three coats white) from £1 upwards.—STARKEY, 55, Stafford Road, Brighton. e.103

**ITALIAN QUEENS DIRECT FROM ITALY.**—E. Penna, Bologna, Italy.—Mr. S. H. Smith, 30, Maid's Causeway, Cambridge, has bought all the Queens I have still for sale in this year. As agreed with him, all these queens will be sent by me direct to customers. We do not hold ourselves responsible for the queens that are not sent by us direct to customers.

**NUCLEI** (good Hybrids), 1920 Queens, 3 frames, £4 5s.; 4 frames, 52s. 6d.; box charged 7s. 6d., returnable.—E. G. WALDOCK, Upwey, The Mount, Guildford. f.45

**MISSIS PALING & PILLANS.**—Orders booked for strong three-frame Nuclei with pure Italian Penna Queens or home-reared Queens from best selected Italian strains, £3; choice home-bred Italian Queens, 12s.; Virgins, 6s., four for 20s.—Golden Square, Henfield, Sussex. e.101

**47** 4-FRAME Dutch, Dutch-Italian Nuclei for the first and second week in June, £3 3s. carriage paid. I strongly recommend my Dutch-Italian, a fine disease-resisting strain. 50 Nuclei for July, £2 5s. Cash with order.—W. SEALE, Ashley Cottage, Oatlands Drive, Walton-on-Thames, Surrey. e.99

**1920** PURE Fertile Italian Queens, direct from the well-known French breeder, Abbé Warré, 7s. 6d. each.—Orders, for execution in rotation, to ELLIOTT, Kelvin Road, Ipswich. r.e.104

**PURE** Golden and three-band Italian Bees and Queens; prolific and gentle; the ideal bee for pleasure and profit.—COOMBER, 64, Ronald Park Avenue, Westcliff, Essex. e.38

**ITALIAN 4-FRAME NUCLEI**, Penna Queen, covered bees and brood, 55s.; boxes 10s., returnable. 1920 Penna imported Queens, 11s. each. Large stock "W.B.C." Hives and Apiary Supplies; bargain.—C. HOGAN, Boxford, Suffolk. r.e.60

**50-75** 3-FRAME Nuclei Italian Hybrids, 1920 Queens, proved disease-resisting strain and excellent honey gatherers. Delivery early June onwards; orders executed in rotation. Price 45s. each, carriage paid; travelling boxes to be returned.—Further particulars, HOSEGOOD, 26, Purley Park Road, Purley, Surrey. r.e.86

**4-FRAME NUCLEI**, headed by 1920 Italian Queen, 50s., June delivery; 6-frame Stocks, 70s.; 3-frame Stocks, 90s.; immediate delivery; box charged 10s., returnable; Italian Fertile Queens, 10s. 6d. All orders in strict rotation. Cash with order.—LEE, "Little Bowden Apiary," Burgess Hill, Sussex. e.79

**ITALIAN COLONIES.**—Simmins and Penna strains; 8 frames, £4 15s.; Nuclei, 3 frames, 45s. Five per cent. discount to members of Middlesex Bee-keepers' Association.—BABBAGE, 33, Whitestile Rd., Brentford. r.e.75

**FOR SALE**, good Nuclei, 1920 Queens, four frames 52s. 6d., three 45s., two 37s. 6d.; ready mid-May; cases 7s. 6d., returnable; JOURNAL deposit.—A. H. HAMSHAK, Wonerah, Guildford. e.41

**1920 PURE Fertile Italian Golden Queens**, guaranteed imported direct from Italy; regular supplies throughout the season from second week in May; 14s. each; specially selected, 17s. 6d.—GOODARE, Italian Queen Specialist, New Cross, Wednesfield. r.d.150

**PUPILS** received by life-long whole-time Bee Farmer.—Terms on application to C. B. BARTLETT, Sandford Mount, Charlbury, Oxon. d.127

**"ISLE OF WIGHT" DISEASE.**—Don't worry; use the solution that cures; 2s. per bottle.—E. PRESSEY, St. Elmo, Coulsdon. r.d.149

**HAVE YOU READ "THE BEE WORLD"?** If not, why not? Every number in itself is a useful literary work for practice and reference. Specimen copy free.—Offices: THE APIS CLUB, Port Hill House, Benson, Oxon.

**ORDERS** booked for 3-frame Nuclei, Fertile Queens, Virgin Queens, etc. List for stamped, addressed envelope.—H. CRACKNELL, Mount Road, Thundersley, Essex. r.d.27

**BOZZALLA** tested Queens are sold at the price usually charged for untested queens.—Catalogue from H. STICH, Riccarton Avenue, Paisley. r.c.116

**DUTCH BEES**, Skeps (as imported from Hans Matthes), Nuclei, Queens. Illustrated Catalogue on request, containing points on management.—Buy direct from Sole Agent, WHYTE, Bee Farmer, Cumbernauld, Dumbartonshire. b.61

## BEES FROM HOLLAND

The **BEST** Dutch Stocks offered in original skeps by

**H. J. VAN LANGEVELD,**

Gasthuisingel 42 Road, HAARLEM, HOLLAND

## ITALIAN QUEENS

Direct from Italy.

Address:

**Signor Gaetano Piana,**  
Castel San Pietro,  
near Bologna, Italy.

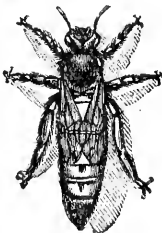

All Queens are reared by the most up-to-date and scientific methods. Mr. W. Herrod-Hempsall has personally inspected the apiary and methods employed, with which he is perfectly satisfied.

**PRICES FOR 1920.**

**For 1 Fertile Queen:** May, 12/-; June, 11/-; July, August and September, 9/- each queen.

Carriage paid in Great Britain. Cash must accompany all orders, which will be executed in rotation. Guaranteed safe arrival of all Queens, but not the introduction. Bees dead upon arrival must be sent at once to "B.B.J." Office.

For the mutual convenience of all parties, Il Signor Piana has made arrangements that all communications, orders and remittances of the readers of "B.B.J." and "B.K.R." can be addressed to him, c/o British Bee Journal, 23, Bedford Street, Strand, London, W.C.2. Cheques payable to "British Bee Journal."

## SCIENTIFIC QUEEN REARING.

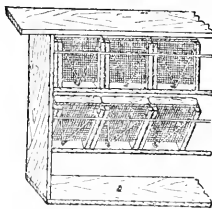

**BEST**  
in the world.  
Every  
appliance and  
instructions.  
Send for  
**KAT-A-LOG**  
**MEADOWS**  
SYSTON,  
Near LEICESTER.

The products of the Apiary, of Poultry and Farm Stock, of the Fruit and Vegetable Garden can be Advertised and Sold through

THE  
**BAZAAR, EXCHANGE & MART**  
Newspaper.

Get a Copy—Thursday and Saturday 3d. The "Bazaar" publishes also practical handbooks by experts. Send for full catalogue, post free from—WINDSOR HOUSE, Breams Buildings, LONDON, E.C.2.

**HIVES AND APPLIANCES.**

Immediate dispatch. Quality O.K.  
Write for prices.

**ANDREWS & CO.**

Joinery and Carving Works,  
78a, WESTGATE, PETERBOROUGH.

THE  
**British Bee-Keepers' Association.**

Insure *now* against loss by damage done through bee stings. All particulars from  
W. HERROD-HEMPSELL, 23, Bedford Street, Strand, London, W.C.2.

**INSURE YOUR STOCKS**

**AGAINST "I.O.W." AND OTHER INFECTIONS.**

Science has now placed within reach of every Apiarist a safe and certain preventive of infection in "Yadil" Antiseptic. For **SPRING FEEDING** "Yadil" may be added freely to Syrup. For **DISINFECTING** Bees and Combs a five-per-cent. solution in tepid water should be used with a fine spray.

ASK FOR GREEN LABEL.

Our Bee Brochure sent Free on Application.

**CLEMENT & JOHNSON, 19, Sicilian Avenue, W.C. 1.**

**BRADBURY, TAUNTON,**  
FOR QUALITY BEE GOODS.



*Illustrated Bee Guide free.*

Telephone: TAUNTON 176.



**"BACTEROL"**  
FOR BEES

2/6 per Bottle.

Post Free.

The cure for, and preventive of, "Isle of Wight" Disease. Non-poisonous—free from stain or unpleasant odour.

**MENLEY & JAMES, LTD.,**  
39, Farringdon Road, London, E.C.1.

**PREPARE FOR EXTRACTING.**

The quickest, cleanest and most efficient on the market is the "BAIRD" EXTRACTOR, which extracts from BOTH SIDES of the COMB simultaneously.

Particulars from **G. S. BAIRD, 1, HURST ROAD, ERITH, KENT.**

**BEAUTIFUL HYBRID QUEENS**

Scientifically bred on the Cotswold Hills, these queens are hardy and extremely prolific.

Price, 9/6 each Specially Selected, 10/6. VIRGINS, 5/-.  
**L.T. A. H. BOWEN—QUEEN BREEDER—CHELTENHAM.**

**INSTRUCTION in BEEKEEPING**  
*PRACTICAL AND THEORETICAL*

My Apiary will be open for a limited number of pupils during this season. Terms and particulars from

**W. HERROD-HEMPSELL,**

The W.B.C. Apiary, Old Bedford Road, Luton, Bedfordshire.

**S. J. BALDWIN.**

I beg to inform that the No. 1 Kent Hive is not manufactured by me, only the No. 2 "Bromley Kent."

(New deep frame 17 x 14 x 12. Sample by post 6d.)

**THE APIARY, BROMLEY, KENT.**

# HIVES.

Compare the WORKMANSHIP and FINISH of our Hives.

All made by practical Men who know what a good hive should be.

In various designs to suit all tastes and requirements. Season's speciality—THE MANLEY HIVE for 16 in. x 10 in. Frames. Full descriptions and illustrations in our 1920 Catalogue:

*"Everything for an Apiary."*

If you have not received your copy, send a P.C. at once.

OUR MOTTO — SERVICE & QUALITY.

**R. STEELE & BRODIE, Wormit Works, Wormit, Scotland.**



THE  
KEY TO  
YOUR SUCCESS.

## Lee's Bee Supplies.

¶ In design, material and workmanship, Lee's Bee Supplies still retain the reputation of being your best and safest investment.

¶ Our 1920 ILLUSTRATED CATALOGUE is yours for the asking. It contains detailed information on the most up-to-date hives and appliances for which the House of Lee is famous.

¶ We regret the necessity of having to advise our Customers that owing to the increased cost of production, all prices in 1920 price list are subject to 10% increase. The increase will not apply to orders received before May 10.

\* \* Five per cent discount to Members of THE APIS CLUB.

**JAMES LEE & SON,**  
LTD.,

Uxbridge, Middlesex.

(Telegrams: Graphicly, Uxbridge.)

Telephone: Uxbridge 181.)

## 20-Page 1920 "WHITE STAR" List,

3½d. POST FREE.

S. SIMMINS, QUEENLAND, HEATHFIELD, SUSSEX.

**Bees and Beekeeping Appliances. Catalogue free. EDWARD J. BURTT. MANUFACTURER. GLOUCESTER.**

*I very much regret that there has been a large increase in the cost of the manufacture of bee-appliances, and therefore my prices will be advanced 10% from May 10th. Books excepted.*



No. 1981. Vol. XLVIII

JUNE 10, 1920.

[Published every Thursday, Price 2d.]

**CONTENTS.**

	PAGE		PAGE
NOTICE TO ADVERTISERS .....	277	BRITISH BEE-KEEPERS' ASSOCIATION .....	283
THE ROYAL SHOW .....	277	DORSET BEE-KEEPERS' ASSOCIATION .....	284
ROYAL SHOW FUND .....	277	TRADE CATALOGUE RECEIVED .....	284
A DORSET YARN .....	277	CORRESPONDENCE—	
JOTTINGS FROM HUNTINGDONSHIRE .....	278	Standard Frames .....	284
QUEENS AND TIERED CHAMBER BEE SPACES .....	280	Italian-Dutch Bees .....	284
NOTES ON BEE-KEEPING .....	282	NOTICES TO CORRESPONDENTS .....	285
THE HONEY CUCKOO .....	282	BEE SHOWS TO COME .....	285

QUARTER OF COST.

# VEILS

1/10 POST FREE.

We have just taken over from the Government all their surplus unused VEILS (750) made for protecting the faces of soldiers in Mesopotamia from Mosquitos and Flies. These are perfect as Bee Veils and we are able to offer them at the above exceedingly small figure. Once these are sold it will not be possible to replace at anything approaching this price. The Veils fit over any hat and are fitted with one adjustable cane which keeps the veil well clear of the face.

**SOMETHING NEW IN WAX EXTRACTORS. "THE WILLIS" 33/- NO WASTE—NO TROUBLE—NO SMELL.**

**E. H. TAYLOR, WELWYN, HERTS.**

# The Canadian Bee Supply & Honey Co.,

(TORONTO) Limited

Manufacturers of, and Dealers in, Beekeepers' Supplies, Hives, Bees, Queens, Honey, and Wax.

SOLE AGENTS FOR EUROPE AND THE COLONIES:—

**C. S. J. CRUTCHFIELD,**

25, BARTLETT'S BUILDINGS, HOLBORN CIRCUS,  
LONDON, E.C.4. (Telephone Holborn 324).

## DON'T KEEP BEES! Let the Bees Keep you! WE'LL TELL YOU HOW!

You are cordially invited to pay a visit to the

### CANADIAN INDUSTRIES EXHIBITION;

Agricultural Hall, Islington, London,  
June 3rd to 17th, 1920,  
and to inspect our exhibit of Hives and Appliances on Stand 45, Row D.

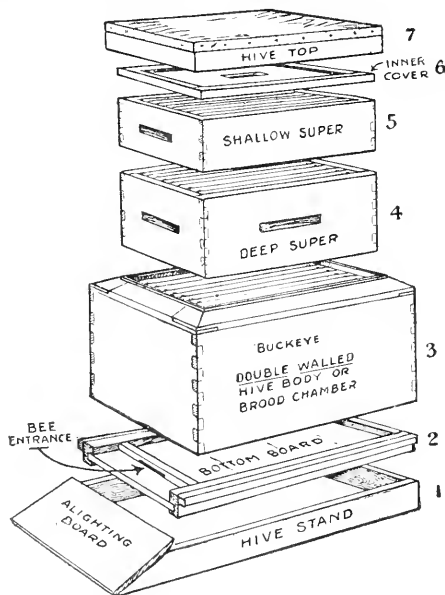

Keep Bees to make Honey. Produce Honey and make Money. If you merely wish to "Keep Bees" any old Hive will do. But if you want to produce Honey in bulk, try "Canada's way." With Sugar at 1/3 per lb. HONEY FOR NOTHING is worth while.

The "BUCKEYE" Double-walled Hive.

Makers of the celebrated Canadian "STANDARD" Single-walled Hive and "BUCKEYE" Double-walled Hive, upon which models a tremendous Honey producing industry has been built up in Canada and the States.

Thoroughness has characterised the methods employed by Apiarists in the above-named Countries, and everything in the form of useless ornamentation has been rigorously cut out. "UTILITY" is their keynote.

Good, stout, well-seasoned wood, and practical utility appliances, which will assist the Bees to make and man to take, with the least possible amount of effort, the greatest possible quantity of Honey, go to the making of these splendid Hives.

Nothing is done in Canada to hamper, but everything IS done to encourage, the Bees to do their best; AND THEY DO IT!

As much as 300 lbs. of Honey has been taken in one season from one "BUCKEYE" Double-walled Hive, and still sufficient has been left in for Winter feeding.



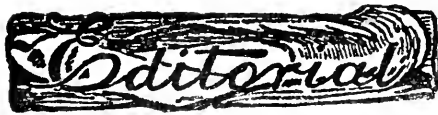

**Notice to Advertisers.**

Owing to the greatly advanced price of printing paper, and the increase of wages in the printing trade, we shall be obliged to raise the price for our "displayed" advertisements at the end of this month. We are sorry to have to do this, but if we are to carry on it is inevitable. We can only hope this will be the last increase we shall have to make, but this is by no means certain. The revised rates as given will come into force with the issue of the BRITISH BEE JOURNAL for July 1 and the July RECORD.

**DISPLAYED ADVERTISEMENT RATES.**

*British Bee Journal or Bee-keepers' Record.*

	£	s.	d.
Full page ... ..	4	0	0
Half page ... ..	2	10	0
One-third page ... ..	1	16	0
Quarter page ... ..	1	12	0
1½ in. across page ... ..	1	7	0
1 in. across page ... ..	0	18	0
¾ in. across page ... ..	0	10	0
1½ in. single column ... ..	0	15	0
1 in. single column ... ..	0	10	0
¾ in. single column ... ..	0	6	0

Discount for a series of consecutive displayed advertisements:—Six insertions 2½ per cent.; Twelve insertions 5 per cent.; Twenty-six 15 per cent.; Fifty-two 30 per cent.

**The Royal Show.**

Up to the present entries for the Royal Show at Darlington are very few; it has therefore been decided to extend the closing date to Wed. June 16th. It is desirable in the interests of bee-keepers that the honey exhibits at the premier show in the country should be worthy of the craft, and we trust that the bee-keepers of the country will rise to the occasion and send as many entries and exhibits as possible.

It is well known that many people do not know the difference between British and foreign honey, and honey shows are always an excellent opportunity for educating the general public, and showing how much better our home produced honey is than the bulk of that from abroad. A good display of the finest products of our apiaries at all shows big and little, will do much to foster the taste, and increase the market for British honey.

**Royal Show? Fund.**

The Council of British Bee-keepers' Association are anxious to take their usual part at the Royal Show to be held at Darlington this year, so that their unbroken record of representation at this show may not be spoilt. In order to defray the expenses in connection therewith the Council ask that all bee-keepers assist in this work by giving donations, which should be sent as early as possible to the Secretary, 23, Bedford Street, Strand, London, W.C.2.

Subscriptions for this fund are coming in very slowly, and we would urge all those who can possibly do so to send a donation, however small. The sum needed is not, comparatively, large and if every one does a little should be easily forthcoming. "The Royal" is the show of the year, when the value of bee-keeping, and of the use of honey, to the community is brought to the notice of hundreds of people, and should the Bee and Honey Department have to be dropped for lack of funds, the loss to bee-keeping will be out of all proportion to the amount needed to carry on. May we also urge all those who can do so to make an entry, and exhibit at the Darlington show. A good display will help both the show and the craft. We are sure our bee-keeping friends in the North are looking forward to a good display of honey, etc., at this year's Royal Show.

	£	s.	d.
Amount Received .....	8	13	0
The Apis Club .....	1	1	0
Major F. Sitwell .....		10	0
W. J. Goodrich .....		2	6
	<hr/>		
	10	6	6

**A Dorset Yarn.**

Peas and beans do not entice the bees on the farm; a very small proportion of them stay on these floriferous legumes. They are away on my neighbour's fields of charlock in the corn. In one field last week there were fifteen men pulling up the plants of this pernicious crucifer, bees all in front of them as they cleared off the flowers. The crimson clover still has a tremendous lot of them. I am leaving mine as long as possible for the bees to get all they can from it; other fields quite close are cut; but there is no question about the nectar that is being got in large quantities from somewhere just now, standard bars being filled in a very short time.

The amount of water taken up by the bees has materially lessened this week; being dry, one would have thought they would have used more, but the combs are

full of sealed brood. There is not so much feeding of young larvæ; very little pollen is being taken in. At some stocks there are always drones that have been torn from their cradles on the alighting board, perfect in shape, but not left long enough to get colour; it seems that bees are never still, as this is done in the night they are outside in the morning, to be cleared away when the sun is up. One lot has a double brood chamber with two section racks, yet a lot of them have hung outside each night for more than a week. There cannot be room inside for them all; if it was for swarming they would have stayed about in the day, but all seem to go about their collecting duties. Then it could not be for pleasure that they hung in bunches outside, as the nights have been very cold, Saturday morning 3 degrees of frost, and this morning (Sunday) it is very cold. We have to be about at daybreak, or the rooks would soon clear off all our early peas; one can hear them coming as they seem to be telling each other of new peas, and even new potatoes. Why big estates can tolerate these predacious birds is beyond me. They eat a lot of grubs that are prejudicial to the farmer, but they eat a lot of the beetles that are beneficial as well, and peas and beans in late May and early June they will soon clear off.

We keep them off our fields, but they punish the allotments where the fields are large; they do not care to get into small enclosures, and it is only a few dead ones hung up that will frighten them away.

It is in early morning that the coldest hour is felt; these bees must feel the cold at night, and the stock must be very crowded for them to stay outside.

Up to the first Sunday in June not one of the stocks that have had an extra brood chamber (above or below) have swarmed. This seems to be a gain in the right direction, for the larger the colonies the more honey can be harvested in early summer, which is always when the best prices can be got. One lot, the queen of which went up into the extra brood chamber, has already a second rack of sections; this was left in the same place, and the lower one that had stood the winter moved to another position. These are Italians. Another lot that had nine new bars with three drawn-out combs placed beneath the old brood chamber; when the queen went down into the new one, the old was moved to another stand. These are blacks, but having to draw out nine new bars of full sheets of foundation, they have not yet stored surplus; but where they are working the two brood chambers, the bees are so crowded, even in the daytime, it is as if there was not space for them to move

even, though the outer case is lifted at bottom, which gives them the whole front to come in and out. In one of them the upper did not quite fit the lower brood chamber; it was a bar smaller than the old one, a strip was placed on the part not covered by the upper brood chamber. This did not quite cover the bar, and it was fastened down by some old drone comb (which left in the sun is warm and plastic), but the bees have eaten away parts of it, and now they have an entrance into the upper brood chamber without going through the lower.

Almost all of these hives have a free way round the brood chamber; they climb up the lower to the upper, and these are the largest stocks we have ever had at the Violet Farm. I think this is from Simmins' book, I have had so many sent me, lent me, and given me, that I cannot be quite sure unless I look again, and time is short, even though it is Sunday morning. When strawberries are ripe, birds have to be kept away. In between writing this yarn, frequent journeys up to the strawberry quarters have been taken. I have not had time to open last week's JOURNAL yet—not even to see if they have had space for the yarn—so what I read in books, I try the methods advocated as a prevention of swarming, and when we find it adds to the surplus for sale in early summer, we feel that what others have done, others can do if they read the same things and try them as I have done.—  
J. J. KETTLE.

---

### Jottings from Huntingdonshire

The delightful rains have put the bees in a good humour, and all is going very merrily in the hives. Pabulum abounds—everywhere one looks one sees flowers of all descriptions, many simply asking to be relieved of their nectar. Alas! however, the Italians are deaf, or blind, to all the beauties save the bean fields, and, tell it not in Gath, publish it not in the streets of Askelon, the bean flowers are not the greater attraction, but the charlock which is flowering apace among the beans; consequently, our first honey is half candied. The borage is opening fast, and borage and charlock honey mixed is, as the Yanks would say, "some sweet." My eyes sparkled the other day when I chanced on a field of sainfoin, young, healthy looking plants that will soon be flowering, and these—clover, borage, charlock, orchids, dandelions, roses—may be bursting with nectar, yet all will be forsaken; sainfoin will hold the day. My Dutch bees are working as only the Dutch ladies can, and yet no swarm. Crowded to suffoca-

tion, they are sticking tight. Maybe they know I am sending the first Dutch swarm away, and want to outwit me. Someone described Dutch bees to me last year as "devils for swarming." I'm inclined to agree up to a point. In a properly-made W.B.C. hive—I purposely say "properly-made," as a number of hives are placed on the market as "W.B.C." without the ventilating shutter beneath the floor board—if the shutter is kept open whenever the shade temperature rises above 60 I don't think one need fear swarming fever. Moreover, just as broodiness can be bred out of fowls, proclivities for swarming can be bred out of bees.

The lack of bright sunshine in April was, I fear, disastrous for the apple blossom; not only was it improperly developed, but was little fertilised. Those who live in more northern situations, where apples blossom later than in this forward region, will have the pull of us. We do not begrudge them having more than their share of the fruit of the gods—we can score in other ways.

Truly, this has, so far, been a remarkable year for the bees. Never have I seen such lovely drones as can be seen in any hive to-day, and workers more than usually developed; so much so that some appear to be miniature queens. I am thankful that so far no fertile workers have appeared in my hives, and it's something to be spared this pest.

"Is there profiteering among the hive makers? I hope not, yet I "ha' ma doots." The prices of wood, nails and labour, one knows, have all advanced, but, allowing for all that, ought quite ordinary hives—i.e., legs, brood box, two lifts, and two empty racks, with, of course, roof and alighting board—to cost between three and four pounds? That is the price a neighbour of mine has paid for a hive. In looking through one or two catalogues I see the 1920 price for a W.B.C. hive, with all frames and rack of sections fitted with full sheets of foundation and wired, is only 67s. 6d. The moral would appear to be—get your hives from bee appliance makers with a reputation to maintain, and not from amateur hive makers, who are undoubtedly out literally to make.

The two nuclei which I wintered out of doors have established themselves well. Had the winter been cold and wet there might have been another tale to tell. Wintering nuclei has advantages, as Mr. Bryden has forcibly told us. I supered mine last week, and they are already storing. If I had united them to another stock last autumn with the hope of an early swarm I should have been at a loss. For no swarm of this year's taking could be expected to commence super storing before the end of May.

The eternal question of tanging keeps cropping up in this JOURNAL. Whatever its origin, tanging bees does have an effect, and one has only to try it to be convinced.

Judging by the number of queen wasps about, there will be a plague of wasps this year, and bee-keepers will do well to be prepared well ahead. Get ready your shield fronts to place before your hive entrances, and as soon as convenient purchase cyanide of potassium, which will finish a nest of wasps quicker than anything else. Paraffin and straw will do, but it takes more time and is a little more trouble.

Somewhere between here and York lives an old man who has kept bees in skeps for fifty years, and has never seen, and, until the other day, had never heard of driving bees. Nor had he heard of an extractor. I was reminded of an old fellow who, when I was staying in North Yorkshire some five years ago, said, in response to the question which I shouted in his ear as to what he thought of the war. "I don't think much about it, but I've heard there be one on." Perhaps my old friend, when the next person mentions an extractor, will say, "I don't know much of such things, but I've heard there be one about." What a lot they miss, and *what a lot they gain.*—E. F. HEMMING, Steeple Gidding.

JUNE 5, 1920.—The Editor writes me to say my last week's Jottings went astray, and have only just turned up, so they must perforce appear one week late. It will not be fair to take up much additional space, so I will confine my remarks to a few words.

The brambles are flowering—all too early, of course, but take heed and super liberally, for as things are moving the honey flow will end much earlier than usual. At the present time there is nectar everywhere. In one of my hives this last week I noticed some 30 lbs. of honey stored, and mostly capped, and others are following close in their anxiety to store. Some of this will have to be given back to them before autumn is here.—E. F. H.

[*Re* Rev. Hemmings' remark as to charlock honey granulating, we draw our readers' attention to this quality of charlock honey. We have known it to granulate in the combs before it was sealed over, and have seen sections filled with it granulated solid in less than a couple of weeks after taken off the hive. The moral is not to use sections where the fields are golden with this weed, and to extract shallow combs as soon as sealed. The capping of charlock honey is a very light lemon colour.—Eds.]

## Queens and Tiered Chamber Bee Spaces.

I have many shallow supers of worker comb, not for a honey harvest, but for the "bee harvest," which comes before any and every honey harvest. These combs, not of worker cells for nothing, are a provision by which I can get increased breeding at a period when a queen's laying would not spread laterally over the frames of a large brood chamber. But queens are ready and anxious to go up, if only there is something to go to. Why? Because the central part of any large brood chamber in spring has a far greater attraction for bees and queens than the sides.

The cluster will extend vertically more cheerfully than laterally, and I would suggest that beemen dismiss from their minds any idea, where it exists, that it is the queen which leads the way through tiered chamber spaces. The initiative throughout is with the bees, and as soon as they decide to extend the brood area upwards they will prepare the central comb area overhead, and, when ready, the tiered chamber space intervening *is no detriment to any good queen going up*, and at a time when the barn-like chill of all outer combs in a large chamber is truly a detriment of a decided character to both queen and bees.

The tiering bee-keeper will get more brood by giving his queens this chamber space to pass *and use* than by omitting it, and at a period when bees have treble value individually to a colony's development, compared to brood not brought on until they are able to extend the brood area laterally.

It should not be overlooked that lateral expansion means heat dissipation. The slice of space and material in only a single comb area laterally *adds nothing appreciably* for a good while to the cluster area heat, but must dissipate a lot for a good while also, i.e., whatever additional area is warmed by the lateral expansion of the cluster is at the expense of a great deal of warmth lost by elongated radiation into cold, unoccupied and partially occupied space.

Small wonder, then, that queens cross the overhead space and lay in an upper chamber. And that they do so, *and prefer to do it rather than go to the next frame*, I know, because my queens tell me so every spring. Any visitor here in winter can see shallow supers on top of dozens of the regular brood chambers.

But the bees' and queens' choice is for a six-frame half-super to be overhead, because it is more compact and heat-preserving than the full size ten-frame of the regular super. Also visitors in spring

can be shown brood in shallow upper chambers, when every freedom is still available for good, strong colonies to extend laterally in their deep standard frames, yet these deep outer frames are deserted, and bees and queens prefer to go up, and do so; and the intervening space is no detriment, I repeat.

It appears to me as common "horse sense" on a bee-keeper's part to adopt this obvious arrangement, if he will but study the all-important matter of cluster heat preservation. That the bees prefer the deep formation at all times when heat preservation is vital is an assurance I feel justified in recording, because I know from experience. And the higher from entrance draught the deep formation can be formed the better. The bees are independent of all entrance draught at the expansion areas of vertical brood extension upwards in a six-frame super, compared with being at the mercy of all such draught at any stage of lateral expansion in the big chamber.

However, tiered chamber spaces are also a detriment to queens passing, but in another respect altogether. It is only when they must go *down* to a cold area in spring, and that will deter any queen, good or bad. That is the only circumstance which makes these spaces detrimental to a queen for any serious purpose. Make a note of it.

There is no half-heartedness about the use of the space to an upper chamber by the bees and queen. It will be found that brood is solidly ensconced to the wood at these spaces; brood to top bars absolutely in the lower deep frames, and to the bottom bars in the upper shallow frames. The sight of that alone is quite enough to convince any bee-keeper of what the space means to a colony in spring. Who would ask for further evidence?

A note on the half-super (six frames, narrow ends). Such a super, without excluder, should be left on every colony of bees, black or yellow, **with shallow** frames full of well-sealed stores as a winter "cap." So arranged, any colony is in far better wintering trim than all and every other arrangement possible. No deep brood frames, 14 by 8½, 14 by 12, 16 by 10, or any other dimensioned frame you can think of for wintering purposes, used alone, can ever equal it. Let in some "horse sense" again, and remember the greater size your brood frames the greater detriment arises to lateral expansion in spring, and consequently the greater the need of the six-frame "cap" can be understood. It will be found when upward vertical expansion occurs the tiered chamber space becomes an integral

part of the cluster's heart, affording the freest passage way and interchange point to and from every part of the cluster and its brood rearing work. Make no mistake of that. It leads to a very handsome addition of brood and new bees, presently filling the "cap" chamber, and the sure overflow of that chamber is the only right way to expand the colony laterally over the big unoccupied and chiefly outer combs of the deep lower chamber.

Acceptance of the winter "cap" proposition involves the condemnation of the 14 by 12 in. frame, because it is too deep, unbroken by any passage way or universal interchange point from top to bottom. I would suggest those experimenting with 14 by 12 combs "cap" their colonies this coming winter with a six-frame shallow super of stored worker comb, and no excluder, and note if the bottom half of the deep combs is not entirely deserted, and the cluster and brood nest arranged in the upper half and the "cap" equally, the interchange space the heart of all there is until warm outer conditions prevail. I am not in agreement with the idea that for the queen to pass from comb to comb by the end bar space is congenial or attractive to her, nor are the Editors, nor that it, or the space created by wintering strips on top bars, is anywhere equal to the traffic centre of the tiered chamber space created by a "cap," as a means to aid a colony in getting into its stride in late winter and spring, as it will do, if given the chance.

Again, very deep combs must always become seriously mouldy, a great part of which will be torn away by the bees later on as worthless worker comb, and be rebuilt with drone cells, quite spoiling them as good breeding combs for the real work of the colony. There is quite enough of that in the present British standard frame, and the deeper we would go the worse will be the disadvantage and the damage.

Then again referring to the six-frame super, some will say, "Now that introduces another contraption to worry the bee-keeper." Well, what of it; and is it really a worry in fact? Is it not rather an application of the skep's dome top to the bar frame hive, whose whole value every bee-keeper can estimate accurately? Think again. When the cap is going well you can spread brood in it until it is packed tight with it, and lose no heat at all, neither from the cap area nor from the central cluster area underneath it in the large chamber; and as a mobile appliance it has greater utility than the skep's dome, because any part of the large chamber can be "capped" as suc-

ceeding circumstances may warrant. The "cap" super is indeed a valuable appliance.

Not only is a six-frame shallow super in use here, but also there are nearly as many six-frame standard deep chambers in use as of 10-frame size. And for what purpose? For none other than that "horse sense" demands the abolition of the ten- or twelve-frame brood chamber as a decent winter and spring home for bees. That with two six-frame chambers tiered, any good colony of bees is far better circumstanced to conserve cluster warmth from the very moment brood rearing commences in mid-winter, right along until increasing forces and outer conditions put it within their power to occupy a large brood chamber without detriment to their continued and unbroken progress. And on top of the two six-frame chambers is placed the "cap" of six full shallows, adding the chamber bee space which the queen will traverse immediately the bees decide on upward expansion.

Here, you will see, I give my queens two spaces between three chambers. The top space she will cross, and be glad of it; the bottom one she will not go near; and I don't blame her. It's a detriment as long as ever she finds it more congenial elsewhere. But, in effect, it gives the colony that central formation they themselves arrange, when housed in a ten-frame barn, only it is deeper by the depth of a 9 in. standard brood chamber of six-frame size, and so no cluster warmth is dissipated into cold side frames and spaces as in a large brood chamber, the colony's heat being contained and secured to them at the critical period by the upper six-frame deep chamber and its six-frame "cap" of shallows. Vertical expansion upwards the colony initiates and can take care of; vertical expansion downwards to the lower six-frame brood chamber I take care of, and begin before the colony would, but with due regard to several circumstances and conditions, which a breeding bee-keeper can easily understand and any intelligent bee-keeper quickly learn.

What I most of all desire to show is that this matter of "detrimental" space between chambers is a fallacy, and a great deal of confused and also irrelevant argument is being put forward which can easily be refuted by simple trial on the lines I have given, and which I practice myself, and which also confirms the Editor's remarks on similar tests for the purpose.

It is important that all bee-keepers should get as thorough a grasp of breeding problems as possible. Honey production depends on it as on nothing else.

To be merely acquainted with bee manuals is not enough. More or less ideal as they may be as guides, very necessary, too, to limit one's outlook and knowledge to a guide book is to remain in the A.B.C. class for all time. The bees left that class a long time ago.—M. ATKINSON, Fakenham.

### Notes on Bee Keeping.

Now that the swarming season is upon us, among bee-keepers of the old school there is bound to be the old style of beating a tom-tom on pans, pots, frying pans and kettles etc., which in my opinion has no effect whatever on the bees; it is but a little amusement to the beater. An explanation once given to me by an old timer, re tanging, was that queens had a peculiar kind of hum, and whatever direction she chose to take, the workers would certainly follow, allured on by this hum, and eventually were lost to the bee-keeper should she decamp. By this beating process, he contended that the queen's call was drowned by the noise, the result a discord in her ranks, causing the bees to settle in a compact mass while she got them in order again, and of course at this stage they were captured. I suppose the old bee-keeper attached great importance to tanging his bees when swarming, as it brought them to a sudden stop! It sounds something akin to the Irishman's remarks when he fell down the coal-pit. The old man's bees, like Paddy if he hadn't been brought to a sudden stop at the bottom, would be going yet.

We are living in a day when the vast majority of bee-keepers have passed beyond this kind of superstitious belief, thanks to our advanced apiarists and the movable comb hive. It is a well-known fact that long before the bees swarm scouts are sent out examining the neighbourhood with a view to finding a suitable home for founding another colony, and should they find one, when swarming, they are bound to leave for their new destination, in spite of all efforts to resist them. I have noticed these scouts looking out a home underneath the eaves of the house when swarming is in preparation, especially when the queen begins to pipe. We read and hear a lot how to prevent our bees from swarming; I have yet to learn of a reliable remedy re swarm prevention. Swarming is the bees' natural mode of procedure for the reproduction of colonies, and once the bees intend to swarm it is difficult to prevent, although we may give them plenty of room in advance of their requirements, such as extending the hive above and beneath the brood-chamber. Some of our local Dutch bees

swarmed before they had filled the hive, when only on eight frames. When once the bees have got the swarming fever, it is difficult to tackle, especially after they are supered up. It is a tedious job to be always lifting heavy supers of honey about and cutting out queen cells. I usually allow the bees to swarm, and return the swarm to the parent hive in the evening. The spare queens I generally find killed off and thrown outside next morning when I return to the hive. Directly a swarm is put in a hive, that is if we desire to extend our colonies, it should always be fed for a few days till all the foundation is drawn out. An early May swarm will give a good account of itself if fed. Feeding is of great importance. Keep the feeder continually replenished until all foundation is drawn out, and when these are finished feeding can then be stopped—if the honey flow is on—and the supers put on. If there is little honey coming in, or the bees are confined to the hive through inclement weather, keep feeding slowly—that is, allow about two holes of the feeder to be uncovered. Sometimes when placing a swarm in a new home, they will issue again; the reason of these movements is often a mystery. If we have other stocks at hand, a good plan is to place a frame of uncapped brood in the centre of the frames. This offers a good inducement for them to stay, as they have a considerable amount of affection for the nurselings of the hive.—P. LYTHGOE, Padgate, Warrington, Lancs.

### The Honey Cuckoo.

I see in your issue for the week ending April 1 you publish an interesting article about the honey bird of Africa. May I supplement the writer's remarks by giving a description of this very remarkable bird, which attracts men to the haunts of bees in order that it may appease its craving for honey and eggs, of both of which it is extremely fond, as instinct tells it that the men, in robbing the hive, are certain to break the combs in so doing, and upon this residuum it feeds, being quite content to let the larger portion of honey go to the person whom it directed to the hive. But people know its ways and generously apportion part of the honeycomb for the bird to feast upon.

Now to give a description of the bird. It belongs to the class of birds known as the pie kind—a class which seems to contribute least to man; in fact, with the exception of the pigeon, they serve rather to tease than to amuse or assist him. It is called the honey-guide cuckoo, and is

an inhabitant of the interior of Africa. In length it measures about six or seven inches, and its colour is a rusty grey, and white beneath. The eyelids are naked and black, a yellow patch is seen on the shoulders, while the tail is wedge-shaped and also rusty. Its bill, surrounded with bristles, is brown and yellow in colour. The feathers of the thighs are white, with a black streak running longitudinally. The quill feathers are brown above; beneath they are of a greyish hue, and the first tail feathers very narrow and rusty. Those following are black, and the rest brown at the tip on the inner web.

Professor Sparrmann gives the following account of the honey cuckoo, which he first saw at the Cape of Good Hope:—

"This bird has nothing striking either in his size or colour. On a superficial view he appears very like the common sparrow, though he is somewhat larger and has a more yellow tinge; he has a yellow spot on each shoulder and the feathers of his tail are streaked with white. Properly speaking, it is merely self-interest that induces him to solicit the aid of men to find and rob bee-nests for him.

"Honey and bees' eggs are his favourite food, and he knows that in plundering bees' nests a part is always lost which will then fall to his share, or that a portion will be expressly allotted him as a reward for his services. Nevertheless, the manner in which this bird executes his design is extremely remarkable.

"The morning and evening seem to be his principal meal times; at least, it is then that he chiefly endeavours to attract the attention of men with his shrill voice. They then approach the bird, who, continuing his cry, flies on towards the place where the swarm of bees is to be found. They follow him, taking care not to make him too shy either by much noise or a too numerous assemblage, but answer from time to time with a low whistle to give him to understand that they are following him.

"I have observed," says Mr. Sparrmann, "that when the bees' nests were still at a distance the bird never halted till after a long flight, and then stopped only in order to let the bee-hunters come up with him. As he came nearer the nest he flew shorter distances at a time, and repeated his cry with greater earnestness and frequency. When arrived at last at the nest, whether it be situated in the cleft of a rock, or in a hollow tree, or underground, he hovers for some moments over it and then takes his station in a neighbouring tree or bush out of sight of the men.

"They are always sure they are near the bees' nest when the bird is silent.

When they have discovered the nest and taken the honey therefrom, under the direction of the bird, they generally reward it for its services by leaving a considerable part of the bad combs which contain the eggs and grubs, and of which it is particularly fond."

The above quotation is taken from the pages of "The History of the Earth and Animated Nature."

I thought of sending this before, but I delayed doing so; but, in the hope that this description of the bird may interest your readers, I forward it for your consideration and to use as you may desire.—  
JOHN BOUCH.

## British Bee-Keepers' Association.

The monthly meeting of the Council was held at 23, Bedford Street, Strand, London, W.C.2, on Thursday, May 20. Mr. W. F. Reid presided, and there were also present:—Miss M. D. Sillar, Messrs. G. R. Alder, T. Bevan, W. E. Moss, G. S. Faunch, J. Herrod-Hempsall, F. W. Watts. Association representatives: Messrs. R. R. Babbage (Middlesex), and H. Stroud (Essex). In the absence of the Secretary, who was abroad, his duties were undertaken by Mr. J. Herrod-Hempsall.

The minutes of the previous meeting were read and confirmed.

Letters of regret at inability to attend were read from Messrs. T. W. Cowan, W. H. Sims, Major Sitwell, J. N. Kidd, and C. L. M. Eales. The following new members were elected:—Mr. I. Scott Dier, M.B.E., B.Sc., A.I.C., life member; Mesdames I. M. Thoyts, C. B. Crawshaw, F. Graham, Rev. C. Pepys, Messrs. H. S. Stevens, W. F. Longley, J. B. Gainer, W. E. Hamlin, A. T. Stephenson, E. A. Hayes, W. Hamilton, F. Hobbs, R. S. Wicks, and W. R. Lilly.

The Suffolk B.K.A. applied for affiliation, and were accepted.

The following Association delegates, as nominated, were accepted:—Surrey, Mr. E. G. Waldoek; Twickenham and Thames Valley, Mr. C. D. Burnet; Sussex, Miss M. D. Sillar; Hants, and Isle of Wight, Mr. A. F. Hardy; Notts, Mr. G. Hayes. The report of the Finance Committee was presented by Mr. G. S. Faunch, who stated that payments into the bank for April were £35 2s. 7d. Payments during April were £71 14s. 9d. The balance at the bank on May 1 was £127 16s. 4d. Payments amounting to £10 were recommended. It was agreed that Dr. Lord should be awarded the honours' certificate for lecturing.

The Somerset B.K.A. applied for pre-

liminary examination. This was agreed to.

The Secretary of the Somerset B.K.A., Mr. L. Bigg-Wither, wrote that the Ministry of Agriculture had informed him that it is unlikely that sugar will be available for private bee-keepers this summer, and asking the B.B.K.A. to put before the Ministry the unfortunate position in which those who were rearing nuclei would be placed if the weather was unfavourable. Mr. Flashman said he understood that there would be no grant of sugar after May 31, but that bee-keepers would probably be able to get "free" sugar, but the price would be about 1s. 7d. per lb. It was felt that the Council could do no more than they had already done, as the supply depended on the Sugar Commission and amount of sugar available for the country, and it was agreed that the Secretary deal with the letter on these lines.

At this stage, Mr. Reid was obliged to leave, and Mr. T. Bevan was elected to the chair.

The Essex B.K.A. applied for the silver and bronze medals for their show at Colchester on June 9. These were granted, subject to the usual condition.

Next meeting of the Council June 17, at 23, Bedford Street, W.C.2.

### Dorset Bee-Keepers' Association.

#### EAST DORSET BRANCH.

A most encouraging gathering took place in the Council Chamber at Wimborne, when the East Dorset branch was established. Bee-keepers came from all parts of the constituency. Mr. George Habgood, C.C., presided, and stated that this was a move for producing more food in the country, the more we produced the less we had to have from a foreign country, so the richer our own country was, as the money would be kept here for still further prosperity. Representatives from the different villages and towns were elected on the committee. Two guineas was voted for the Wimborne Show in August for prizes to members of the Association, also a prize to the Handley Village Show at the end of July. The fees are 5s. a member. Meetings will be held fortnightly through the summer, at different apiaries. The next one at Squire Tomlinson's, in Wimborne.—J. J. K.

### Trade Catalogue Received.

Mr. J. E. Pinder, Market Place, Salisbury. This catalogue, though small compared with others, contains a list and illustrations of all essential appliances. Mr. Pinder's speciality is the J.P. "W.B.C." hive, it is very strongly made with the roof of a durable water-proof material which does not need painting, and is impervious also to heat or cold.



*The Editors do not hold themselves responsible for the opinions expressed by correspondents. No notice will be taken of anonymous communications, and correspondents are requested to write on one side of the paper only and give their real name and addresses, not necessarily for publication, but as a guarantee of good faith. Illustrations should be drawn on separate pieces of paper. We do not undertake to return rejected communications.*

### Standard Frames.

[10194] Regarding larger frames, we have heard much. A photograph in the early Spring of a 16 by 10 frame filled top to bottom with capped brood would be interesting.

Those who still like the standard, which is so handy and gives half the exposure. By giving a queen 12 frames it comes almost to the same thing, and they are filled quicker to the brim.

The mistake was 10 frames in narrow hives, with no proper room and air. Also, these combs being at right angles to the entrance, which causes draught, bees in a mild winter cluster on many combs to get out of the cold, and wander about looking for food.

By experiment combs parallel to the entrance give better all round temperature in winter, providing a winter dummy is placed front and back, making the hive an even thickness all four sides.

Those who can afford it ought to feed on honey in the autumn, not rob the brood-nest of honey and give sugar to take its place; and the difference will be seen in the spring—nice, dry combs, healthy bees, and an excellent thing to start breeding on by uncapping the honey not touched.

I have two wide airy hives, one I keep for feeding by shallow frame, the other tiered with sections for which I get a ready market. That pays me back. I find people prefer sections to bottled honey, as there is such a quantity on the market they get tired of it before Christmas. Let your bees be your first little customers, it will pay you tenfold.—C. TREDGROFF.

### Italian-Dutch Bees.

[10195] After reading the letter in *Farm Life* to Mr. J. W. Gillespy, as reported in the BEE JOURNAL by "Giles," I cannot refrain from giving my experience of the Italian-Dutch cross. I thoroughly endorse what Mr. Gillespy says: the crossing of Italian and Dutch bees would, and *does* (my addition), "produce the most vicious and useless stocks possible." I write in the interest of bee-



keepers, and I say, Don't keep Dutch bees or Italian-Dutch.

I have been a bee-keeper for 30 years, with the exception of one year when my stocks, upwards of 30, went under through "Isle of Wight" disease. I started again with a swarm of Dutch bees which I had given me. I got little or no honey that year, but was able to increase my stocks. The following year I requened one stock with an Italian queen, and last year I had four stocks of Italian-Dutch bees. I gave two of these stocks an extra brood chamber to prevent swarming, but for all the good it did I might have saved myself the trouble. Both stocks swarmed, and one of them before the foundation in the lower brood chamber was fully drawn out. I defy anyone to control the swarming propensities of Dutch bees, and Italian-Dutch seem equally bad in this respect. There is no doubt about it that they are exceedingly vicious. Pure Dutch are as quiet as are pure Italians. For the future I intend to keep Italians only; to do this I shall have to clear out all my cross-breds. With my old strain of black bees I was always able to control swarming, and frequently had over half a ton of honey from 20 or more stocks. I never had more than 30. My work amongst the bees was then an unmixed pleasure; now it is sometimes accompanied by pain.—E. H., Oldham.

## Notices to Correspondents

"POLLEN" (Builth).—*Bees carrying pollen and honey.*—When out foraging a bee will collect both nectar and pollen. If flowers are plentiful they will visit only one kind of flower on each journey, and probably the amount of honey and pollen will vary in proportion to the nectar, or pollen yielding capacity of the particular flower visited.

"CORNISH NOVICE" (Liskeard).—*Queen on ground after swarming.*—The queen is unable to fly more than a few yards. This may be due to old age, or to some damage to her wings. She fell to the ground and the bees lost her.

D. A. (Ipswich).—*Repairing broken sections.*—(1) We have not tried to do this, as up to the present sections have been so cheap it was not worth while. Either Secotine, or other fish glue, or ordinary glue, would serve. The former would be most convenient, and it would not melt in the hive, unless it was damp. (2) No.

P. P. W. (Yorks).—The Association is not formed yet, nor is it certain that it will be.

Miss E. H. DARNEY (Notts) and J. COLVILLE (Belford).—The queens were virgins.

### Suspected Disease.

W. R. A. (Loughborough).—The trouble is "I.O.W." disease.

C. D. (Haslemere).—The bees you sent appear to be healthy. Judging from what you say, the trouble appears to be robbing.

## Bee Shows to Come.

*A nominal charge of 2s. 6d. is made for notices (not exceeding 7 lines) in this column, 10 lines charged 3s. 6d., up to 15 lines 5s., which covers cost of insertion from order till date of show. Cash should accompany orders for insertion.*

**June 16 and 17.**—Hanley Park Meeting of the Staffordshire Agricultural Society. The Staffordshire B.K.A. offer valuable prizes and six silver medals and nine bronze medals. Twelve Classes for members only, and five Open Classes. (Honey Classes are for four or three jars or sections). Schedules, W. Griffiths Silkmore, Stafford. **Entries closed.**

**June 29 to July 3,** at Darlington.—Royal Agricultural Society's Show, Bee and Honey Section, under the direction of the B.B.K.A. Prizes arranged in groups of counties for Associations affiliated to the B.B.K.A. Schedules from The Secretary, 23, Bedford Street, Strand, W.C.2. **Entries close June 16.**

**July 6, 7 and 8,** at Cardiff.—Royal Horticultural Society's Show. The Glamorgan B.K.A., in conjunction with R.H.S., offer prizes for Honey, Wax, Bees, and Appliances. Members, Novices, and Open Classes. Schedules, Mr. Wiltshire, Maindy School, Cardiff. **Entries close June 22.**

**July 14.**—Wickham Bishops and District Beekeepers' Co-operative Association. Group 2.—Open to bee-keepers resident in Essex. Class 79.—Four Sections; 1st prize, 7s. 6d.; 2nd, 5s. Class 80.—1 lb. Extracted Honey; 1st prize, 5s.; 2nd, 3s. Class 81.—1 lb. of Wax (in 2-oz. cakes), 1st prize, 5s.; 2nd, 3s. Group 3.—For bee-keepers' resident in the British Isles. Class 82.—1 lb. glass jar of 1920 Run or Extracted Honey; 1st prize, 20s.; 2nd prize, 10s. 6d. Exhibits in Class 82 to be the property of the Association, and to be given to hospitals in County of Essex. Entrance fee 6d. per class. Rules for exhibiting on back of entry form.—All entries to be sent to C. W. Cockburn, Hon. Sec., Meadow Bank, Wickham Bishops, Witham, Essex. **Entries close July 2.**

**July 15 and 16,** at Grimsby.—Lincolnshire Agricultural Society. Show of Bee Appliances, Honey, Sections, Wax, etc., under the management of the Lincs B.K.A. Open and County Classes. Valuable prizes.—Schedules from Major Hadfield, Alford, Lincs. **Entries close June 12.**

**July 17,** at Guildford.—Guildford and District Beekeepers' Association. Members and Open Classes.—Schedules and prize list from Rev. E. C. Pitt-Johnson (Hon. Sec.), Heatherwood, Pirbright, Surrey. **Entries close July 3.**

**July 20 to 23,** at Aberdeen.—Highland and Agricultural Society. Classes for Bee Appliances and Honey. Premiums £53 10s. Half of Prize Money and Silver and Bronze Medals contributed by the Scottish Beekeepers' Association.—Entry forms from John Stirton, Secretary, 3, George IV. Bridge, Edinburgh.

**July 21,** Wyke and Normandy Horticultural Society.—Honey Classes (Open). Best three sections, 5s., 3s., 2s.; Run Honey, light, 3 1-lb. glass jars, 5s., 3s., 2s.; Run Honey, dark, 3 1-lb. glass jars, 5s., 3s., 2s. Entrance fee, 6d.—Particulars, H. L. Mumford, Hon. Sec., Heatherside, Normandy, Guildford.

**July 28,** at Blandford.—The Blandford and District Horticultural Society are holding a Show of Fruit, Vegetables, Flowers, and Honey in the Park, adjoining the Crown Meadow, Blandford. Prizes for honey by the Dorset B.K.A. for members of the Association.—Schedules from C. G. Bone (Dorset Beekeepers' Association), County Education Office, High West Street, Dorchester.

**Monday and Tuesday, August 2 and 3,** at Newport.—Monmouthshire Beekeepers' Association Annual Show (in connection with the Newport Allotment Holders' Association). Members and Open Classes.—Schedules (post free 3d.) from Hon. Sec., "Underwood," Portskewett, near Chepstow, Monmouthshire. **Entries close July 26.**

**August 4,** at Shedfield, Hants, in conjunction with the Shedfield Horticultural Society's Show, Hants and Isle of Wight Beekeepers' Associations, Swanmore and Bitterne Branches.

Classes for Comb and Extracted Honey.—Schedules from the Hon. Sec., A. F. Hardy, Esq., The Palace House, Bishop's Waltham, Hants.

**August 12, at Taunton.**—Somerset Beekeepers' Association Show of Honey, Wax, and Appliances. Seven Open Classes. Liberal prizes.—Schedules from Mr. F. J. J. Stacey, 3, Hammet Street, Taunton. Entries close August 6.

**August 14, at Llanelly.**—Carmarthenshire B.K.A. Show, in connection with the Llanelly and District Horticultural Society's Show. Liberal prizes (nearly £15) offered for Honey, Wax, and Appliances. 15 Classes (7 Open).—Schedules from R. Lloyd Roberts, London Joint, City and Midland, Llanelly. Entries close August 6.

## Special Prepaid Advertisements. One Penny per Word.

*Will advertisers please read these Rules carefully in order to save trouble, as they will be strictly adhered to.*

*Trade advertisements of Bees, Honey, Queens, and Bee goods are not permissible at above rate, but will be inserted at 1½d. per word as "Business" Announcements, immediately under the Private Advertisements. Advertisements of Hive-manufacturers can only be inserted at a minimum charge of 3s. per lin., or 6s. per inch.*

*PRIVATE ADVERTISEMENTS are only intended for readers having Surplus Stock to dispose of. Driven Bees, Nuclei, and Queens that are reared or imported for sale, are Trade Advertisements, and can only be accepted under trade terms. A charge of 6d. extra will be made if a box number is used.*

*Advertisements must reach us NOT LATER than FIRST POST on the 27th of the month for insertion in the next month's RECORD.*

*Orders for three or more consecutive insertions in "The Bee Journal" entitle advertisers to one insertion in "The Bee-keepers' Record" free of charge.*

### PRIVATE ADVERTISEMENTS.

**FOR SALE,** strong 10-frame Stock Italian Hybrids, with 1920 Queen, £4 10s.—ASH-WORTH, "Redfern," Limpsfield, Surrey. f.47

**FOR SALE,** Bee Hives, Section Crates, Travelling Boxes (swarm and frame), Skep Supers and various articles. Would sell the whole or separate, cheap. Seen by appointment.—60, Finchley Lane, Hendon, N.W.4. f.48

**WANTED,** Old and New Books on Bees, Humble Bees, Wasps, etc.—HERD, 58, High Street, Egham. f.49

**NO SPARE** Penna Virgins (4s.) left. Booking for next week.—PATRICIA, Grammar School, Doncaster. f.50

**WELL-MADE BENCH,** 6 ft. 6 in. long, 2 ft. 10 high, 3 ft. wide, with good drawer, large shelf under, stained, varnished, excellent for potting, etc., 45s.; smaller one, unstained, 25s.—W. WOODS, Normandy, near Guildford. f.51

**FOR SALE,** strong Stock Dutch Bees (healthy) with Hive, also two W.B.C. and two Taylor Hives (one new). Geared Extractor (new), Shallow Supers with drawn-out comb, Section Racks, and other Bee Appliances, £20.—N. S., "Woodrising Barn," Merstham, Surrey. f.52

**WANTED,** at once, an Italian Swarm.—SHORT, St. Mellion, Cornwall. f.53

**FOR SALE,** four strong Stocks of Bees in new bar-frame hives, £5 each, or offer.—NEAME, Ropley, Hants. f.54

**IMMEDIATE DELIVERY.**—Twenty Stocks of Italian Bees, ready to super, £5.—BOOBIER, Bishopston, Swansea f.55

**EXTRACTOR** for Sale, take standards and shallows, not geared, £1, carriage forward.—WILSON, 33, Turney Road, Dulwich, S.E.21. f.58

**PER RETURN.**—Two beautiful new "Conqueror" Section Racks, 12s.; new Brood-hatching Chamber, 8s.—DYKES, Shortlands, Kent. f.60

**NEW Brass Blow Lamp,** 15s. 9d.; never used; carriage paid with directions; present price 25s.—FLOWER, Owslebury, Winchester. f.61

**FOR SALE,** large Stock in new Conqueror Hive, £7 10s., Italian Hybrids; Swarm, two 5-frame Nuclei, £2 each. Immediate delivery.—EXLEY, Lamer, Wheathampstead, Herts. f.62

**SALE,** immediate delivery, one Black, and one Hybrid, Nuclei, young Queens, very prolific and healthy, 3 frames, 37s. 6d.; 5s. returned for box.—1, Balne Avenue, Wakefield. f.63

**FOR SALE,** May and June Swarms, hived on full sheets of foundation, 3 frames, 30s.; 4 frames, 40s.; 5 frames, 50s.; 6 frames, 60s.; boxes 7s. 6d., returnable; carriage paid.—KNIGHT, Kenwyn, Truro. f.65

**SALE,** single-walled Hives, standard, 7s. 6d. upwards; approval.—HUNT, Bank Street, Somercotes, Alfreton. f.67

**SEVERAL** surplus Stocks of Italian and Hybrid Bees for Sale, 10 frames (Penna strain), £4 17s. 6d., carriage paid; 10s. on box, returned on receipt. Inspection invited.—H. OBORNE, 25, Guest Road, Bishopstoke, Hants. r.f.68

**STRONG STOCK** on 10 frames, 1919 Queen, £5 (10s. extra on box, returnable).—STANLEY, 56, Montague Road, Cambridge. f.69

**ONE STOCK** of Hybrids on eight combs, £3 10s.; one Stock of pure Italians on eight combs, £4; 10s. extra to be sent for traveling box, refunded on return of box in good condition within seven days.—ADAMS, Southfields, Newmarket. f.70

**FINE STOCK** pure Penna Bees, ten frame, packed bees and brood, Penna Queen, guaranteed healthy, £5; box and packing 10s., returnable.—FROST, 28, Chatfield Road, Sheffield. f.71

**FOR SALE,** two strong Stocks in hives, supers on, £4 and £4 10s.—DAY, 15, Park Lane, Southwick, Sussex. f.72

**SURPLUS STOCKS** of Bees, Hybrids, Golden, English, and Black; quite healthy; just examined by expert; 6 frames, 65s.; 8 frames, 80s.; box 10s., returnable.—TAYLOR, 3, Exeter Street, Birmingham. f.73

**NATIVE BEES.**—Strong Stock on 10 frames, ready for supering, £4 10s.; also Stock on 8 frames, £3 5s.; 5s. allowed on travelling boxes when returned.—HENRY, Smithfield, Egremont, Cumberland. f.74

**8-FRAME STOCK,** Hybrid Italians, 1920 Queen, wired combs, ample stores, £4 10s.—STRATTON, Barn Lane, Kings Heath, Birmingham. f.75

**WANTED,** for month's holiday on Bee Farm, two bedrooms and cooking.—Box 88, BRITISH BEE JOURNAL Office, 23, Bedford Street, Strand, London, W.C.2. f.88

**FINEST COMB HONEY,** also Swarms. Particulars, stamp.—NORTH, Cressing, Brain-tree, Essex. f.76a

**SWARMS,** 20s., on frames, 27s., buyer paying carriage; box 10s. 6d., refunded on return.—CULLEN, Ball Hill, Great Clacton. f.13

**A FEW** strong Stocks of guaranteed healthy Bees, in hives complete, 5 gs.—WIGGINS, 1, Swinderby Road, Wembley. f.43

**SWARMS, ITALIAN HYBRIDS.**—Several for Sale. What offers?—Particulars apply SMITH (Gardener), Hook Farm, Aldingbourne, Chichester. f.17

**APIARY FOR SALE.**—Two strong Stocks of Bees, six good Hives, and other Appliances. Stamp for particulars.—C., The Elms, Leyton Road, Harpenden, Herts. f.26

**A FEW LOTS** of good, healthy Bees on from 6 to 8 standard frames, 8s. per frame; traveling box to be returned.—WRIGHT, Waterworks, Sutton Poyntz, near Weymouth. r.f.28

**BEEES.**—Good Stocks May Swarms in skeps, hives, extractors, and all appliances to be cleared at once. Stamp for list. No disease.—STEEL, West Ashling, Chichester. r.f.29

**QUANTITY** of drawn-out Shallow Frames, excellent condition, 1½ frames with drone comb, 1s. 6d. each; one gross 7-lb. lever-lid Honey Tins, with handles, 14s. per dozen, packed, on rail; one gross 28-lb. lever-lid Tins, 20s. dozen.—J. ARNFIELD, Breinton, Hereford. e.107

**ITALIANS.**—Choice strain (Penna's extra selected). Spare nuclei, 33s., delivered. Inquiries stamp.—Box 000, B.B.J. Office, 23, Bedford Street, Strand, W.C.2. e.48

**SURPLUS QUEENS.**—Dutch and Hybrid Virgins from County Re-stocking Apiary, 4s. 6d. each.—ANDREWS, Expert, 78a, Westgate, Peterboro'. e.81

**FOR SALE**, eight hives and strong stocks of bees, Italian and Carniolan, with young Queens, separately £8 each hive, lot £60. With appliances and geared extractor, £10 extra.—Apply A. J. RAYMENT, 50 Chandos Avenue, Whetstone, N.20. e.82

**PURE** light Cambridge Honey (guaranteed), 28lb. tins 42s., carriage paid; sample 4d.—J. YOUNGER, 6, Maid's Causeway, Cambridge. e.56

**FOR SALE**, two "Rotax Roadlight 267" self-contained Acetylene Motor Headlights, very powerful, £6 the pair; one Exhaust Whistle, 10s.; one Wood-Milne Motor Foot Pump, 40s.—HERROD-HEMPSALL, as above.

**CORRESPONDENCE COURSES** in Bee-keeping.—H. E. NEWTON, Brown House, Barton-on-Sea, Hants. r.d.157

**NEW-ENGLAND-BRED ITALIAN QUEENS.**—Untested laying Queens, ready June 1, 10s., delivery guaranteed; 6s. at purchaser's risk. English money accepted by registered mail.—ALLEN LATHAM, Norwichtown, Conn., U.S.

**BUSINESS ADVERTISEMENTS.**

1½d. per word.

**BOUGHT ANOTHER APIARY.**—Offer Dutch or Hybrid Queens, clipped, 6s. each; eight Swarms, minimum 4 lbs. and upwards, 7s. 6d. per lb., delivery to-day if you send your boxes; Skeps, 30s. to 35s., according to strength; a few 5-frame Italian Hybrid Nuclei at £3 2s. 6d. each. Cash with order. Buy from where you can get immediate delivery.—THOMAS, Causeway, Burwell, Cambs. f.56

**3-FRAME NUCLEI**, with fertile Queen, 37s. 6d.; 3 case 5s., returnable, carriage deducted. Stocks on 8 frames, £3 10s., ditto.—The Firs, Normandy, near Guildford. f.57

**SALE OF BEE APPLIANCES.**—Ironmonger, retiring from business, has small stock of above which he will sell much below current prices. Stock comprises Sections, Bar Frames, Glasses for Sections, Bottles, Weed Foundation, etc., etc. All Lee & Sons' goods, and perfect as new. List sent on application.—HUNTER, Ironmonger, Cumnock, Ayrshire. r.66

**THREE STOCKS** of Italians on 10 frames, ready for supering, £4; Nuclei, 10s. per frame; boxes charged, returnable.—HENSLEY, 24, Queen's Road, Luton, Chatham. f.64

**1920 FERTILE** Golden Italian Queens, guaranteed imported direct from Italy, regular supplies every few days, 11s. each; specially selected, 15s.—GOODARE, New Cross, Wadnesfield. f.59

**VIRGIN ITALIAN QUEENS**, 4s.—I can book further orders for fertile Queens, 10s.—JACK TICKELL, Westbourne Apiary, Cheitenham. f.76

**4-FRAME NUCLEI**, headed by 1920 Italian Queen, 50s.; box charged 10s., returnable; 6-frame Stocks, 70s.; 8-frame Stocks, 90s. Immediate delivery. All guaranteed free from disease.—LEE, "Little Bowden Apiary," Burgess Hill, Sussex. r.f.77

**6-FRAME STOCKS** in bar-frame hives at £5 each, free on rail; Italian fertile Queens, 10s. 6d. each. Daily deliveries.—LEE, "Little Bowden Apiary," Burgess Hill, Sussex. r.f.78

**PURE** Carniolan Alpine Queens, imported direct, 13s. 6d. each. Orders in rotation.—J. MOORE, Bleasby, Notts. f.79

**SWARMS**, 30s. to 40s.; strong 3-frame Nuclei, 42s. (no disease); satisfaction guaranteed; travelling boxes 6s., returnable.—A. LONGLEY, 35, Tharp Road, Wallington, Surrey. f.80

**VIRGIN ITALIAN QUEEN**, Penna's (1920) strain, 4s. 6d.; fertile ditto, ditto, 10s.; Nuclei on 3 or 4 frames.—WARD, Decside Nursery, West Kirby.

**INCUBATOR** hatched Hybrid Italian Queens, from the best strains in the country; immediate delivery; fertile, 8s. 6d.; virgins, 5s.—T. CHITTY, Burleigh Farm, Cassington, Oxon.

**ITALIAN HYBRIDS**, 4 frame, 45s.; fertiles, 7s. 6d.—ASHE, Yatton Keynell, Chippenham, Wilts. f.83

**ITALIAN NUCLEI**, 3 frames, packed with brood and bees, carriage paid, £2 15s.; cash with order; box 10s., returnable. Satisfaction guaranteed, or money returned. Fertile Queens, 10s. 6d.; virgins, 5s.—E. H. TUNMER, "Chalfonts," Leiston, Suffolk. f.84

**FERTILE QUEENS**, Italian Hybrids, wonderful strain. Up to 25 can be sent by return of post. Prices: Selected, 10s. 6d.; others, 8s. 6d.—HOSEGOOD, 26, Purley Park Road, Purley, Surrey. f.85

**EGYPTIAN-ITALIAN** Virgin Queens, per return post, 5s.—BARLOW, Bee Expert, Newcastle, Staffs. f.86

**IMMEDIATE DELIVERY.**—3-frame Nuclei, Italian Hybrids, 1920 fertile Queens, 45s., carriage paid; box 5s., returnable.—EVANS, Lattiford, Wincanton, Somerset. f.87

**FOR SALE** now a few mated Hybrids, 1919 and 1920, 7s. 6d. each; virgins, 4s.; from June 16 mated Penna strain Italian, 10s. 6d.; postage extra.—ASHWORTH, The Bungalow, Weymouth Street, Warminster. f.88

**STRICTLY BUSINESS.**—Japanned Sprayers, 6s., post paid. Flavine—samples free, as usual. The Smith-Burgess Ventilated Clearer Board, 8s., post paid. Chapter V., "Week-end Bee-keeping," free with all orders this week.—S. H. SMITH, 50, Maid's Causeway, Cambridge. f.89

**A GENUINE PENNA QUEEN** in your hive during July, August and September means pounds in your pocket next spring. All Penna queens coming through me after June 31 delivery will arrive direct from Bologna.—SMITH, 50, Maid's Causeway, Cambridge. f.90

**NUCLEI**, 3 frames, Bees and fertile 1920 Queen, £2 2s.—**LARMUTH**, Hillside, Monahan Avenue, Purley. f.9

**4-FRAME NUCLEI**, with Italian or English Queen, 50s.; returnable box, 10s.; Queens, 10s.—**HOLLINGSWORTH**, Heanor. f.51

**NUCLEI**, 3-frame, £2 10s.; 4-frame, £3 5s.; Cross "White Star"; box, 5s. extra.—**A. SKINNER**, Oaks, Mickleover, Derby. f.32

**"LAZENBEE" PROLIFIC ITALIAN QUEENS** are selected and tested; fertile, 10s.; virgins, 5s.—**YOUNG**, One Hundred Elms Apiary, Central Road, Sudbury, Middlesex. f.34

**PENNA** specially picked me a 1919 beauty, now laying nearly 5,000 eggs daily. Spare Virgins from this mother 4s. by return, or money back; fertiles, 8s., in rotation.—**"PATRICIA"**, Grammar School, Doncaster. f.38

**ITALIAN QUEENS DIRECT FROM ITALY.**—**E. Penna**, Bologna, Italy.—**Mr. S. H. Smith**, 30, Maid's Causeway, Cambridge, has bought all the Queens I have still for sale in this year. As agreed with him, all these queens will be sent by me direct to customers. We do not hold ourselves responsible for the queens that are not sent by us direct to customers.

**MISSIS PALING & PILLANS.**—Orders booked for strong three-frame Nuclei with pure Italian Penna Queens or home-reared Queens from best selected Italian strains, £3; choice home-bred Italian Queens, 12s.; Virgins, 6s., four for 20s.—**Golden Square**, Henfield, Sussex. e.101

**1920 PURE Fertile Italian Queens**, direct from the well-known French breeder, **Abbé Warré**, 7s. 6d. each.—Orders, for execution in rotation, to **ELLIOTT**, Kelvin Road, Ipswich. r.e.104

**ITALIAN 4-FRAME NUCLEI**, Penna Queen, I covered bees and brood, 55s.; boxes 10s., returnable. 1920 Penna imported Queens, 11s. each. Large stock "W.B.C." Hives and Apiary Supplies; bargain.—**C. HOGAN**, Boxford, Suffolk. r.e.80

**50-75 3-FRAME Nuclei Italian Hybrids**, 1920 Queens, proved disease-resisting strain and excellent honey gatherers. Delivery early June onwards; orders executed in rotation. Price 45s. each, carriage paid; travelling boxes to be returned.—Further particulars, **HOSEGOOD**, 26, Purley Park Road, Purley, Surrey. r.e.86

**4-FRAME NUCLEI**, headed by 1920 Italian Queen, 50s., June delivery; 6-frame Stocks, 70s.; 8-frame Stocks, 90s.; immediate delivery; box charged 10s., returnable; Italian Fertile Queens, 10s. 6d. All orders in strict rotation. Cash with order.—**LEE**, "Little Bowden Apiary," Burgess Hill, Sussex. e.79

**ITALIAN COLONIES.**—**Simmins** and Penna strains; 8 frames, £4 15s.; Nuclei, 3 frames, 45s. Five per cent. discount to members of Middlesex Bee-keepers' Association.—**BABBAGE**, 33, Whitstile Rd., Brentford. r.e.75

**FOR SALE**, good Nuclei, 1920 Queens, four frames 52s. 6d., three 45s., two 37s. 6d.; ready mid-May; cases 7s. 6d., returnable; **JOURNAL** deposit.—**A. H. HAMSHAR**, Womersley, Guildford. e.41

**PUPILS** received by life-long whole-time Bee Farmer.—Terms on application to **C. B. BARTLETT**, Sandford Mount, Charlbury, Oxon. d.127

**HAVE YOU READ "THE BEE WORLD"?** If not, why not? Every number in itself is a useful literary work for practice and reference. Specimen copy free.—**Offices: THE APIS CLUB**, Port Hill House, Benson, Oxon.

**"ISLE OF WIGHT" DISEASE.**—Don't worry; use the solution that cures; 2s. per bottle.—**E. PRESSEY**, St. Elmo, Coulsdon. r.d.149

**ORDERS** booked for 3-frame Nuclei, Fertile Queens, Virgin Queens, etc. List for stamped, addressed envelope.—**H. CRACKNELL**, Mount Road, Thundersley, Essex. r.d.27

**BOZZALLA** tested Queens are sold at the price usually charged for untested queens.—Catalogue from **H. STICH**, Riccartebar Avenue, Paisley. r.e.116

## ITALIAN QUEENS

Direct from Italy.

Address:  
**Signor Gaetano Piana,**  
**Castel San Pietro,**  
near Bologna, Italy.

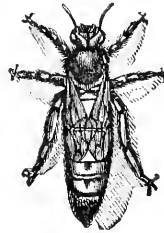

All Queens are reared by the most up-to-date and scientific methods. **Mr. W. Herrod-Hempshall** has personally inspected the apiary and methods employed, with which he is perfectly satisfied.

PRICES FOR 1920.

**For 1 Fertile Queen:** August and September, 9/- each queen.

Can take no more orders for June & July. Booked up.

Carriage paid in Great Britain. Cash must accompany all orders, which will be executed in rotation. Guaranteed safe arrival of all Queens, but not the introduction. Bees dead upon arrival must be sent at once to "**B.B.J.**" Office.

For the mutual convenience of all parties, **Il Signor Piana** has made arrangements that all communications, orders and remittances of the readers of "**B.B.J.**" and "**B.K.R.**" can be addressed to him, c/o **British Bee Journal**, 23, Bedford Street, Strand, London, W.C.2.

Cheques payable to "British Bee Journal."

## Dutch Bees.

I am Sole Agent for **Hans Matthes**, the Dutch Bee Farmer who supplied the British Government last season with Skep stocks for their County Restocking Scheme.

These bees are hardy, prolific, healthy.

Send for Illustrated Catalogue giving methods of management, characteristics, honey-gathering and disease-resisting powers of this race of bee.

Address—

**R. WHYTE,**

The Bee Farm,

**Cumbernauld, Dumbartonshire.**

5 per cent. discount allowed to members of the **Apis Club**.

**THE British Bee-Keepers' Association.**

Insure now against loss by damage done through bee stings. All particulars from **W. HERROD-HEMPSALL, 23, Bedford Street, Strand, London, W.C.2.**

**SCIENTIFIC QUEEN REARING.**

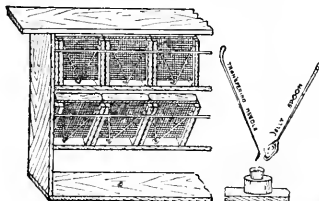

**BEST** in the world. Every appliance and instructions. Send for **KAT-A-LOG** **MEADOWS SYSTON, Near LEICESTER.**

The products of the Apiary, of Poultry and Farm Stock, of the Fruit and Vegetable Garden can be Advertised and Sold through

**THE BAZAAR, EXCHANGE & MART**  
*Newspaper.*

Get a Copy—Thursday and Saturday 3d. The "Bazaar" publishes also practical handbooks by experts. Send for full catalogue, post free from—**WINDSOR HOUSE, Breams Buildings, LONDON, E.C.2.**

**BRADBURY, TAUNTON,**  
FOR QUALITY BEE GOODS.



*Illustrated Bee Guide free.*

Telephone: TAUNTON 176.



**"BACTEROL"**  
FOR BEES

2/6 per Bottle.

Post Free.

The cure for, and preventive of, "Isle of Wight" Disease. Non-poisonous—free from stain or unpleasant odour.

**MENLEY & JAMES, LTD.,**  
39, Farringdon Road, London, E.C.1.

**PREPARE FOR EXTRACTING.**

The quickest, cleanest and most efficient on the market is the "BAIRD" EXTRACTOR, which extracts from BOTH SIDES of the COMB simultaneously.

Particulars from **G. S. BAIRD, 1, HURST ROAD, ERITH, KENT.**

**RUSH ORDERS**

WHEN YOU WANT GOODS QUICK SEND

TO **BOWEN—CHELTENHAM.**

You get them by return.

Booklet of Specialities Free.

**LT. A. H. BOWEN—BEE GOODS DEPOT—CHELTENHAM.**

**INSTRUCTION in BEEKEEPING**  
*PRACTICAL AND THEORETICAL*

My Apiary will be open for a limited number of pupils during this season. Terms and particulars from

**W. HERROD-HEMPSALL,**

The W.B.C. Apiary, Old Bedford Road, Luton, Bedfordshire.

**S. J. BALDWIN.**

I beg to inform that the No. 1 Kent Hive is not manufactured by me, only the No. 2 "Bromley Kent."

(New deep frame 17x14x12. Sample by post 6d.)

**THE APIARY, BROMLEY, KENT.**

# HIVES.

Compare the WORKMANSHIP and FINISH of our Hives.

All made by practical Men who know what a good hive should be.

In various designs to suit all tastes and requirements. Season's speciality—THE MANLEY HIVE for 16 in. x 10 in. Frames.

Full descriptions and illustrations in our 1920 Catalogue: *"Everything for an Apiary."*

If you have not received your copy, send a P.C. at once.

OUR MOTTO—SERVICE & QUALITY.

**R. STEELE & BRODIE, Wormit Works, Wormit, Scotland.**



THE  
KEY TO  
YOUR SUCCESS.

## Lee's Bee Supplies.

¶ In design, material and workmanship, Lee's Bee Supplies still retain the reputation of being your best and safest investment.

¶ Our 1920 ILLUSTRATED CATALOGUE is yours for the asking. It contains detailed information on the most up-to-date hives and appliances for which the House of Lee is famous.

¶ We regret the necessity of having to advise our Customers that owing to the increased cost of production, all prices in 1920 price list are subject to 10% increase. The increase will not apply to orders received before May 10.

\*\*\* Five per cent discount to Members of THE APIS CLUB.

**JAMES LEE & SON,**  
LTD.,

Uxbridge, Middlesex.

(Telegrams: Graphicly, Uxbridge.)

Telephone: Uxbridge 181.)

## 20-Page 1920 "WHITE STAR" List,

3½d. POST FREE.

S. SIMMINS, QUEENLAND, HEATHFIELD, SUSSEX

**Bees and Beekeeping Appliances. Catalogue free. EDWARD J. BURTT. MANUFACTURER. GLOUCESTER.**

*I very much regret that there has been a large increase in the cost of the manufacture of bee-appliances, and therefore my prices will be advanced 10% from May 10th. Books excepted.*

ESTD 1873

# BRITISH BEE JOURNAL

**& Bee-keepers Adviser.**  
 A Weekly Journal Devoted to the Interests of Bee-keepers.

Edited by  
 T.W. Cowan, F.L.S.  
 and J. Herrod-  
 Hempsall, F.E.S.

Office—  
 23a Bedford Street,  
 Strand,  
 London, W.C.

No. 1982. Vol. XLVIII

JUNE 17, 1920.

[Published every Thursday, Price 2d.]

### CONTENTS.

	PAGE		PAGE
NOTICE TO ADVERTISERS .....	289	Beetles as Enemies of Bees .....	295
ROYAL SHOW FUND .....	289	A Correction .....	295
A DORSET YARN .....	289	Dutch Bees and "I.O.W." Disease .....	295
JOTTINGS FROM HUNTINGDONSHIRE .....	290	Virgil and Bees .....	296
BEE NOTES FROM SOUTH AFRICA .....	291	Bees Building Comb Upwards .....	296
SOUTH STAFFORDSHIRE B.K.A. ....	293	Re Bees Disappearing .....	296
CORRESPONDENCE—		The Difficulties of Italian Queen Breeders .....	297
Difficulties with "I.O.W." Disease .....	294	Skep Making .....	297
		BEE SHOWS TO COME .....	297

WRITE FOR  
 FREE CATALOGUE  
 WITH  
 INSTRUCTIONS  
 FOR BEGINNERS.

AS MY

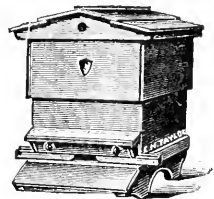

S

ARE THE  
**FOUNDATION OF SUCCESS**  
 SO IS SUCCESS

MADE CERTAIN  
 BY

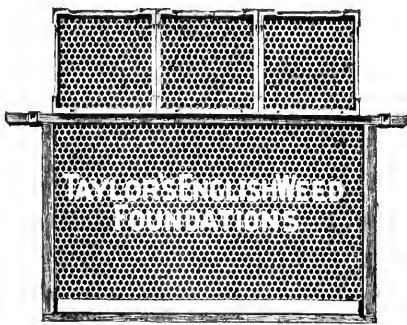

MY

**E. H. TAYLOR**  
 WELWYN,  
 HERTS.

Telephone: 13 WELWYN.

# THE British Bee Journal

ESTABLISHED 1873.

A Weekly Journal Devoted to the  
Interests of Bee-keepers.

Edited by T. W. COWAN, F.L.S., &c.,  
and J. HERROD-HEMPSELL, F.E.S.

**Correspondence: Whom to Address.**—All matters relating to the Literary Department, Associations, Shows, etc., should be addressed, "Editors, *British Bee Journal*," and all business communications and matters relating to subscriptions and advertisements to be addressed to the "Manager," *B.B.J.* Office.

**Subscriptions.**—Annual Subscription, 10s. 10d. post free in advance; single copies 2d., or 2½d. post free. If a receipt is required by post, a stamped and addressed envelope must be sent, otherwise a printed receipt will be enclosed along with the paper.

*Note.*—Cheques and Postal Orders should always be crossed, otherwise it is very difficult to trace them if they go astray.

**How to send Money.**—Remittances can be made payable to W. Herrod-Hempshall by crossed Cheques and Postal Orders. Stamps may be sent for small amounts up to 2s. *Halfpenny stamps are preferred.*

Scottish or Irish cheques can only be taken in payment if 6d. is added for commission charged by banks for cashing them.

The Editors are not directly or indirectly interested in the manufacture or sale of bee-hives or appliances of any kind, and must refer correspondents wishing for prices or catalogues to advertisers in the paper.

## OUR DEPOSIT SYSTEM.

You are advised to insist on this being used when dealing with strangers.

### Rules and Conditions for Depositing

*In order to save trouble, it is requested that the Rules be carefully read over by persons using the Deposit System of trading.*

Goods should not be despatched until notice that the money has been deposited is received from this office.

1. **Method.**—When strangers are dealing together, the purchase-money of the articles is deposited at our office. We acknowledge receipt of the deposit to both parties, and hold the money until we are satisfied that the purchase is concluded. If a sale is effected, we remit to the seller the amount deposited, less a charge of 2½ per cent. in the £, with a minimum of 6d., and the expenses of Post Office Orders and postage, &c. Cash will be forwarded by Cheque, Post Office Order, or by Postal Order as preferred. If a sale or exchange be not completed, we return the amount deposited, after making the same deduction. By this means buyers and sellers are secured against fraud.

2. **Deposits.**—Postal Orders (drawn on General Post Office) and Cheques must be made payable to W. Herrod-Hempshall, and crossed "London County and Westminster Bank." The numbers of the Postal Orders should be kept by the sender. We cannot be responsible for any loss that may occur in transit.

3. **Honey on Approval.**—All honey will be sold by sample, which must be sent direct to buyer.

4. **Bee Appliances.**—In ordering, the time allowed for completing the order to be stated to us when sending cash. If maker accepts, we hold cash until transaction is satisfactorily completed, when the amount will be remitted, subject to conditions as in Clause 1.

5. **Bees and Queens.**—These will be dealt with entirely by the parties concerned, so far as price, &c., go, and when the purchase is satisfactorily completed cash will be remitted as per Clause 1.

6. **Goods in Transit.**—These are at the seller's risk, i.e., any damage to or loss of an article on its journey is borne by the vendor; but a rejected article must be properly packed and returned by the same means as was used in sending it.

7. **Carriage.**—The carriage of all goods, *except such as are sent by post*, is payable by the buyer, unless otherwise agreed. If any article sent on approval be returned, each party to the transaction must pay carriage one way.

## Books for Bee-keepers NOW IN STOCK.

Cash in full must be sent with order.

		Postage
A Modern Bee Farm ... ..	7/6	... 8½d.
Advanced Bee Culture (HUTCHINSON) ... ..	6/-	... 6½d.
Beginner's Bee Book (PELLETT) BEE-KEEPING SIMPLIFIED FOR THE COTTAGER AND SMALLHOLDER (W. HERROD- HEMPSELL, F.E.S.) ... ..	5/-	... 4d.
BEE-KEEPERS' PRACTICAL NOTE BOOK (T. W. COWAN) ... ..	1/-	... 2d.
BRITISH BEE-KEEPERS' GUIDE BOOK (T. W. COWAN) (paper covers only) ... ..	1/-	... 2d.
Dissectible Model of Queen Bee ... ..	2/6	... 3d.
FERTILISATION OF FRUIT BLOSSOMS BY BEES (T. W. COWAN) ... ..	4/6	... 3d.
Fifty Years Among the Bees (MILLER) ... ..	-/3	... 1d.
Honey and Health (A. HOPE) ... ..	6/-	... 5½d.
Honey Vinegar (REV. G. BANCKS) How to Keep Bees (ANNA B. COMSTOCK) ... ..	-/6	... 1d.
Management of Out Apiaries Pollination of Fruit in relation to Commercial Fruit Growing (C. H. HOOVER, F.R.H.S.)	-/2	... 1d.
PRODUCING, PREPARING, EXHIBITING AND JUDG- ING BEE PRODUCE (W. HERROD-HEMPSELL, F.E.S.) ... ..	5/-	... 4½d.
Productive Bee-keeping (PEL- LETT) ... ..	3/-	... 2d.
Queen Rearing in England (F. W. L. SLADEN) ... ..	10/6	... 8½d.
Scientific Queen Rearing (DOOLITTLE) ... ..	1/6	... 2d.
Snelgrove's Method of Re- queening ... ..	4/-	... 3½d.
The "Townsend" Bee Book ... ..	-/6	... 1d.
WAX CRAFT (T. W. COWAN) ... ..	2/6	... 2d.
Wilke's Book on Swarming ... ..	2/-	... 2½d.
1/-	... 1d.	

### MISCELLANEOUS.

Maeterlinck's Life of the Bee The Lore of the Honey Bee (TICKNER EDWARDS) ... ..	3/6	... 3d.
THE BEE WORLD (supplied only to members of Associations interested in the control and development of the APIS CLUB, apart from ordinary members of the latter), per copy ... ..	2/-	... 2½d.
	-/8	... 1½d.

British Bee Journal & Record Office,  
23, BEDFORD STREET, STRAND, LONDON, W.C.1.





**Notice to Advertisers.**

Owing to the greatly advanced price of printing paper, and the increase of wages in the printing trade, we shall be obliged to raise the price for our "displayed" advertisements at the end of this month. We are sorry to have to do this, but if we are to carry on it is inevitable. We can only hope this will be the last increase we shall have to make, but this is by no means certain. The revised rates as given will come into force with the issue of the BRITISH BEE JOURNAL for July 1 and the July RECORD.

**DISPLAYED ADVERTISEMENT RATES.**

*British Bee Journal or Bee-keepers' Record.*

	£	s.	d.
Full page ... ..	4	0	0
Half page ... ..	2	10	0
One-third page ... ..	1	16	0
Quarter page ... ..	1	12	0
1½ in. across page ... ..	1	7	0
1 in. across page ... ..	0	18	0
¾ in. across page ... ..	0	10	0
1½ in. single column ... ..	0	15	0
1 in. single column ... ..	0	10	0
¾ in. single column ... ..	0	6	0

Discount for a series of consecutive displayed advertisements:—Six insertions 2½ per cent.; Twelve insertions 5 per cent.; Twenty-six 15 per cent.; Fifty-two 30 per cent.

**Royal Show Fund.**

The Council of British Bee-keepers' Association are anxious to take their usual part at the Royal Show to be held at Darlington this year, so that their unbroken record of representation at this show may not be spoilt. In order to defray the expenses in connection therewith the Council ask that all bee-keepers assist in this work by giving donations, which should be sent as early as possible to the Secretary, 23, Bedford Street, Strand, London, W.C.2.

Subscriptions for this fund are coming in very slowly, and we would urge all those who can possibly do so to send a donation, however small. The sum needed is not, comparatively, large and if every one does a little should be easily forthcoming. "The Royal" is the show of the year, when the value of bee-keeping, and of the use of honey, to the community is brought to the notice of

hundreds of people, and should the Bee and Honey Department have to be dropped for lack of funds, the loss to bee-keeping will be out of all proportion to the amount needed to carry on. May we also urge all those who can do so to make an entry, and exhibit at the Darlington show. A good display will help both the show and the craft. We are sure our bee-keeping friends in the North are looking forward to a good display of honey, etc., at this year's Royal Show.

	£	s.	d.
Amount received ... ..	10	8	6
Mrs. G. Scott ... ..	0	5	0
Mr. T. Walker ... ..	0	10	0
R. J. R. ... ..	0	10	0
W. A. Woods ... ..	0	6	8
C. F. Clay ... ..	0	5	0
J. Pearman ... ..	0	5	0
	<hr/>		
	£12	8	2

**A Dorset Yarn.**

Many of our upland fields are bare of grass and flowers. Very heavy crops of clover and rye grasses have been cut. The bees are on the permanent pastures; they get a lot of surplus from these fields, but they have left the red field clover alone. The white Dutch has but a few bees, but the yellow flowers of Hieraciums are crowded with Italian bees; they make themselves yellow all over with the pollen as they scramble over these ligulate composites. As last year, the white clover is not thought much of, as are other flowers, and they are storing surplus at a rapid rate. There are so many flowers for them just now, as the hedgerows have the first blackberry flowers open; but our bees are mostly on the uncut permanent grass fields and the corn-fields, where the charlock abounds. Sections are selling well; shops will take all we have as fast as filled. It looks a rosy season for bee-keepers.

The stocks with the extra brood chambers are best; they produce the goods in early summer, without having the swarming fever early, though at night they are hanging round the entrance. It rained heavily last night (Saturday), I rested an extra board against front of hive to keep them from getting wet. One of them had the rain-board over the entrance broken, this has been so for a fortnight; by their doing this nocturnal rest on the outside so long, one would think that it was the swarming fever, but they all go to work each day as usual. Another one of these double brood chambered stocks came out as if swarming; but I assume the queen would not come out

with them—they all went back again within five minutes. They have shown no desire to go through this mad round and round flight again, so we must assume that there was plenty of room for the queen to lay her eggs—she did not see the necessity of leaving; these do the best for the early harvest. One lot from which I took out four bars in May has now the second rack of sections on top, and no sign of swarming. The four bars with the queen from the parent hive have made a strong lot, and have just started sections.

A visitor from the Board of Agriculture is round Dorset inspecting the Government pupils, who have a grant for one year from the State. After seeing the crops he came last to the bees (he was not a bee-keeper), and was astonished to see them with tier upon tier. He looked in the top where the finished rack of sections with glass covering was seen, and saw the bees going in close to the ground, the finished rack up level with his chin. He had an object-lesson of what bees can do if given plenty of scope to do it. The poultry, the pigs, and cows all do well, but the bees give the greatest return for the smallest outlay. I am to have some more Government pupils, as they are extending the scheme to some who are returning from the distant lands where the war has been. These could never have known of the teaching scheme for men who have suffered the miseries of campaigning and exile from home.

Those bee-keepers who grow small vegetable crops for a quick return need not hesitate about planting largely lettuce for early spring and summer. We have had motor lorries after 60 and 80 dozen a day for lettuce at 1s. 3d. to 1s. 6d. per dozen. Strawberries began at 4s. per lb., and finished last Saturday, June 12, at 1s. 6d. per lb. This is only the first week of picking. The raspas have their first fruits ripe, and the currants, just showing colour, have been offered 1s. per lb. for the lot as they are; gooseberries are heavy crops, and all, as I have written before, can be cheaply grown. The cuttings of the bushes always root freely if planted in autumn, and strawberries—a few plants would give many hundreds of young plants in a short time, no matter what newspaper men may write, as they do, about the Service men put on the land to make a poor living. They can make a good one if they keep to the crops that are always wanted. With bees they can make a good living, and a happy, healthy life in the open fields. It is the man who has staying power, who keeps on trying extending each year with permanent crops; then all the year round there is always something coming in, always some

of the very best of succulent vegetables and luscious fruits for yourselves, as well as for sale.

We have plenty of asparagus, plenty of peas and broad beans, plenty for sale, plenty for ourselves; these can only be had in the best condition when gathered fresh and used at home. Those strawberries that are sent to market are never really ripe; the wealthy eaters must have sugar and cream to make them really nice, but the grower can have them fully ripe, when the calyx and stem are all red together with the fruit: then it has its sugar in the fruit, then it has the real flavour of strawberries, a luxury that town dwellers never have.—J. J. KETTLE.

---

## Jottings from Huntingdonshire

Cuckoo, Cuckoo. It was past ten o'clock at night and I had just retired, but a cuckoo was not so tired as I, for he was softly singing his lullaby to his mate. Accompanying his monotonous song, floating with the zephyrs, was the thrilling evening hymn of the nightingale. I fell asleep and dreamt; not of nightingales, alas! although I faintly in a half doze, imagined myself listening to Handel's "Nightingale and Cuckoo"; no, my dream was all about cuckoos. I dreamt I saw a hen bird lay her egg and picking it up in her beak fly off to find for it a resting, also a brooding place. She ultimately dropped it in the nest of a hedge-sparrow. The hedge-sparrow sat and sat until four young sparrows and one cuckoo were born. In a day or two's time, the young cuckoo, growing faster than his nest mates, threw himself on his back and getting well down in the nest, heaved with his legs the young sparrows from their downy home. He now has the nest to himself, and takes every morsel brought him by his foster parents, who have been so singularly duped. He grows and grows and is bigger much than those in whose charge he is placed, but not once does his mother come to see how he is progressing—the cuckoo is denied the joy of motherhood. When he is old enough, and big enough to take care of himself, he finds his parents have long since left these shores and yet by some wonderful instinct he knows which way they have gone and follows in their wake. Cuckoo! cuckoo! I open my eyes, dawn has already broken. Has our African friend been busy all night with his cucks' and oos? I cannot say, methinks however he slept when the night was dark. Again he sings, I look at my watch, it is 4.30, too early to rise, too good to sleep. The nightingale is silent, but what a chorus of song! Trees, hedges, eaves, woods, coppices, are

all alive with twittering birds. The little wren, like the piccolo in the orchestra is heard above the rest. For two hours this pæan of praise is continued. It is beautiful in summer when the day is young! Wrens, thrushes and blackbirds delight in singing not only to their mates, but also to human beings.

Last summer a faithful blackbird always came and sang to us whenever we took meals outside. On the side lawn, he would find us—on the front he would perch above us there, singing his very best, and would knowingly cock his head aside as we thanked him with pretty words. Cuckoo-Cuck-Cuck-Cuckoo. I am up now, and watch amused, a cuckoo being chased by seven small birds, they have mistaken him for a hawk, he outpaces his pursuers at last, and wings back and settles just above one of my hives. He drops lower to a fence and watches this way and that, swoops down near the alighting board, picks up a meal and is off. I wonder what he ate. Woolly caterpillars and the insect in "cuckoo spit" are his chief food, but I should like to know what he was doing near my hive, was it an expelled drone, or a discharged nymph or a real live bee? Not the latter I feel sure; no, I am not sure, I hope not. Ah, cuckoo, if you eat my bees I shall think ill of you. I love to hear you as the harbinger of spring, I love to watch you along the roadside playing can't catch me. I remember the delight I experienced when I learnt that you never sucked eggs, that you often saved our country from a caterpillar plague. But Oh! if you eat bees I shall not ever forgive you. So before you ring out your minor thirds, make a vow to leave my bees, at least my live bees—you can clear up the drones, if you wish—alone.

Honey is flowing in fast now. Whoever has a stock of bees not working the supers at this season of the year, will know that something is amiss. Bees will change their gathering ground every week if possible. Just now one field of Alsike is a-hum with honey gatherers, every flower seems to hold a bee. I wonder how much honey there is in an acre of Alsike? I venture on a guess, and say half a stone. However, ye farmers, sow your Alsike by the dozen acres, and we will help the crops to fertilise and both be satisfied.

I hope every bee-keeper read, marked and learned what Mr. Ellis, writing from that historic and romantic place Gretna Green, had to say two weeks ago about keeping one hive for securing surplus for the rest of the stocks. There will I fear, be no sugar available for feeding of bees this next autumn and spring.

A week ago a swarm issued from a hive, I did not want them out—I hate swarms

on Saturday, it generally means Monday before one can get them off, and then its rather too late, so I got them back, How? Mr. Lythgoe, what say you? By tanging. Standing near the hive I rang a bell and soon confusion reigned among the swarming bees and they all returned. A few days before I caught sight of a swarm settling on a high branch of an apple tree, I started tanging and got them to settle much lower down. I don't believe in rattling trays and saucapan lids, relicts of the times when demons were scared away, but a musical bell will soon affect a swarm. It is wise to wear a veil as sometimes tanging will result in the whole swarm coming for you. You doubters, try it.

The County Councils are doing something for bee craft, let us hope that something will be educational. It is badly needed. Only this morning a man tried to make my blood boil by telling me I was out of date in advocating re-queening, for it had been proved that the queen didn't lay the eggs, she only reigned, the egg laying being done by female workers. "Who'd proved it" I asked, his authority was a retired policeman "who'd kept bees for 40 years." I tried my utmost to convince the man that though fertile workers were known, the soul life of the hive was the queen, all however, to no purpose. So readers take heed—*it has been proved that the queen does not lay eggs*—be careful however that you have a good queen in your hive or you will be sorry.

E. F. HEMMING.

## Bee Notes from South Africa.

A.—Summer is with us (December 17), and also the bee pirates. Drones have been cast out, and all work has ceased except for an hour at sunrise and sunset. A little pollen is carried early, but only water in the evening. Though our summer here corresponds with your winter in England, the honey flow is during about the same months—mid-April to end of June, and again in August and September.

My experiment in housing seems to have been a great success, though I shall try it one more year to make certain.

The advantages of housing are:—

1. The protection of the hives from the great heat of the sun in summer and the cold winds of early winter when the main flow is on.

2. The housed bees had plenty of stores, and commenced breeding earlier. Those outside had to be fed, and lost much time.

3. Hives can be made of much cheaper material, with an ordinary flat roof.

4. Temperature is more even; rain and damp have no effect.

5. Single-walled hives are quite efficient, and badly-fitting supers no evil results.

6. Easily fed, with less fear of robbing.

7. Easier to manipulate in any weather, and with less stings, as bees leaving the entrance cannot see or get at the manipulator.

My huts are made of wattle and daub, 19 to 12 ft. square. Entrances are cut through the walls, with eight hives, one to each corner. They cost £2 each, with annual repairs of about 5s. each.

Hives I make out of old petrol cases, costing 1s. 6d. each, and the frames of the same material, to the Hoffman pattern. For the top bar I tack two strips together to prevent sagging. A hive can take ten frames of worker brood. I find here ten frames do better than either more or less. I have increased my stocks to 30, re-queening from the most prosperous hive, and also from the most docile (No. 15), which did almost as well. I find, after a few years' notes, that the temperament of the bees remains the same: lazy colonies remain lazy, industrious remain industrious, vicious remain vicious, and docile docile. I find the

Hive	Outside.		Housed.		
	Autumn	Spring	Hive	Autumn	Spring
	Lbs.	Lbs.		Lbs.	Lbs.
1	99	15	9	nil	nil
2	40	nil	10	142	30
3	nil	nil	11	139	28
4	25	nil	12	39	nil
5	67	nil	13	209	31
6	73	18	14	98	29
7	nil	nil	15	152	30
8	94	nil	16	39	nil

easiest way to re-queen, and the safest, especially with strong, savage bees, is to place a ripe queen-cell, not more than twelve days old, together with a frame of young brood, on the old stand, and remove parent hive some distance whilst the bees are flying. The parent hive becomes weak and docile next day, when the old queen can be replaced or queen-cell given. The rapidly hatching brood quickly strengthens the hive, and the result is two strong colonies.

*B.*—On July 27 I artificially swarmed a very strong colony, leaving a super of shallow frames on parent hive without an excluder. Ten days later the hive was still very strong, so I again divided, giving each a ripe queen-cell, and destroying the remainder. I then replaced excluder and super on parent hive. On September 4 I found super full of drone brood in all stages, and an empty queen-cell. No worker brood at all. I dis-

covered a small queen—a virgin, I presume—so cut out the drone brood and removed the super to a new stand. Ten days later the combs were full of worker eggs, and no drone. I strengthened with a comb of young bees, and it is now a very strong colony, but will require feeding. Is not this unusual for a queen to get mated so long after hatching? Or could she have got mated by one of the drones accidentally enclosed in the super?

*C.—Vitality of Bees.*—1. A quantity of bees got into my sitting-room and worried round the lamp. I placed a basin of water underneath, and a large number fell in (otherwise they have a nasty habit of crawling up one's trousers), and placed this on the verandah. After a cold night I threw the lot, apparently dead, into the warm sunshine, when nearly all quickly recovered and flew away. Numbers were at the bottom of the basin.

When bees are covered with honey and cannot fly, I have washed them in cold water, and they have recovered; whilst in washing them in very lukewarm water I have often found them to mostly perish.

A vicious swarm came out and tackled a span of oxen with their driver, killed several fowls, and committed general havoc. I could do nothing, so in desperation seized a tin of insect powder and emptied the contents in the hive. A few minutes later they appeared all dead, and I emptied them out on the ground. I brushed the combs and returned them to the old stand with a ripe queen-cell, so that the flying bees rejoined them. Next day, after a slight frost, I discovered those thrown on the ground reviving, and by midday the greater number had flown. This is now a strong, docile colony. Insect powder does not seem to destroy sealed brood. For an experiment, I placed an empty comb, with a little powder sprinkled on, and in, the cells, into a strong hive. It was quickly filled with eggs, which were all reared.

*D.—Curious.*—Late in spring a swarm settled in a tree just before sunset. I emptied it into a box and inverted it on the ground. A few minutes later I examined, to find the swarm split up into three large balls on the ground. In the morning the position was the same, but each ball held a dead queen, apparently a virgin. Seven days later exactly the same thing happened, but this time with three fine-looking fertile queens. One was killed; the other two I caged, and gave each one half the swarm. They both had rather weak colonies now, and have to be fed. I fancy these happenings were the result of some native honey-hunter returning with his spoil all mixed up, and the survivors cleared off together. Any other explanation?

**E.**—If weighed in the balance, would bees be found more stupid or otherwise? Why will they persist in drinking out of deep wells and tubs, and being drowned in thousands, when they have shallow basins provided?

Why will they waste their energy by stinging washing hung out to dry, vegetables and other inanimate matter?

Why will they come out of their hives to resist bee pirates when they can remain in safety inside?

We read of bee-keepers getting used to stings. How many stings do you bee-keepers call "being stung"? I have taken 212 out of one glove, and many penetrated. They get one through one's armour here everywhere, the ankles being very favoured.

I hatched eight queen-cells, just sealed, by placing them in a box and putting the box on the lid of a hive in one of the huts, and just covering with a warm bag. The rising heat was sufficient.

I obtained first prize for run honey at the Bechuanaland Show, and would not have shown but for the good report of my honey in your journal. The judge evidently knew what he was about. Customers seem to be taking to granulated honey.

Do bees die on losing their stings?—  
[Yes.—Eds.]

The report of the case bringing in the "Justinian" law seems very unjust, though legal. It simply justifies trespass. I suppose plaintiff should have been charged with "trespass and damage."—W. H. EDMUNDS.

### South Staffordshire and District Bee-Keepers' Association.

A meeting of the above Association was held at Mr. E. H. Hipkins, Castle Mill Farm Apiary, Tipton, on Saturday, June 5, 1920. There were about 100 members and friends present, including Miss Woodcock (Mayorress of Smethwick), Mr. Joseph Price (Stafford County Council expert), Mr. E. C. Middleton, Streetly, and other prominent members of the bee-keeping fraternity.

Mr. J. Price gave an interesting address, advising members to support the Apis Club. The object of the club and its monthly paper, *The Bee World*, was research, instruction, and co-ordination in all matters relating to bees and bee-keeping. Dr. Abushady, the secretary and editor, deserves the support, financial and otherwise, of all bee-keepers to carry on this valuable work to a successful issue. At no time in the history of the bee-keeping world have the objects he has set out to attain been of more importance, considering the great havoc the

disease known as "Isle of Wight" disease has made and is making. No successful remedy is known, and no ministry, institution or association is set aside for this important duty. He valiantly, at considerable personal expense, exhaustive labour, and conspicuous ingenuity, has formulated the club and edited the *Bee World* for the first year of its existence, and asks bee-keepers to help by joining the club to keep it alive.

Mr. Price exhibited a metal comb foundation as a substitute for wax foundations. He said he did not think the metal foundation perfect. More improvements would have to be made as to its finish, etc., and extensive trials are required to see what effect the heat of the hive would have upon the metal, and whether the queens would take to it successfully. His advice was, "Move slowly."

Mr. Middleton, Streetly, addressed the meeting on wintering bees. Don't commence too late in wintering. The hive should be filled and capped with combs of the very best honey; the best is none too good; do not extract too closely; leave a quantity of shallow combs of honey for food; pack the bees closely on good food. Don't pack too warm; by doing so you increase the deposit of damp, which may not kill, but produces fungoid growths and is unhealthy. Three or four quilts, single, are quite sufficient, each quilt to be a little less than the one underneath. Moisture must be absorbed; don't paint inside of hive—paint prevents absorption and creates condensation. Aim at ventilation and absorption. If in late autumn bees are fed on sugar or honeydew, it produces many waste products, which fill the intestines of the bees with too much waste, and in the uncertain winter weather they are unable to take a cleansing flight, and suffer and die, or evacuate in the hive and on the combs, which spreads disease. In the event of not having sufficient natural food in mid-winter, don't use syrup; provide candy, or, better still, a comb of sealed honey placed on top of the frames. Bees fed on sugar are not so strong in resisting disease as those honey-fed. Bees do not hibernate, strictly speaking; they slow down. Best position of hive for wintering is under north wall. Don't disturb the brood when packed for wintering; leave severely alone. Disturbance makes bees restless, and causes them to eat more food. Perfect rest and quietness is what is needed. Don't stimulate too early in spring; what you gain in speed you lose in resistance.

Mr. A. Cheshire, Coseley, gave a practical demonstration in manipulating the open hives, the brood nest, and finding the queen, pointing out the different stages

of brood, from the egg in the cell to the sealed brood and the perfect honey-bee. Many of the new members were much impressed by his cool and quiet manner in handling the bees. He also gave a demonstration in making frames out of ordinary box wood, with very simple tools of his own construction. The finished article was handed round the company for inspection, and all were impressed with its perfection and finish. These demonstrations were highly interesting and instructive to bee-keepers young and old.

Mr. G. F. Stubbs, Wednesbury, addressed the meeting, taking for his subject "Bees and Gardeners." He said everything in nature has a duty to perform; bees naturally are not only honey gatherers, but do great work in fertilising blossoms. Many fruit crops depend to a great extent on bees for fertilisation; no fertilisation, no fruit. Flowers produced nectar to attract the insects, who in obtaining it brush off with their bodies some of the pollen; this is carried to the next flower, brushed against the pistil, and thus pollinates. This cross-pollination is beneficial to plant and fruit. What Nature has made special precautions to ensure is brought about in a great measure by bees and other nectar-feeding insects.

Mr. Hildreth, Smethwick, addressed the meeting on "Don't's for beginners": Don't open the hive without some special object. Don't neglect to make notes of the condition of the hive at each inspection, that reference can be made to it. Don't delay too long supering; better too early than too late—it may prevent swarming.

Mr. E. C. Hipkins exhibited a concrete hive and explained the making of it. He said the making of concrete hives was in its infant stages, and required many improvements and testing before it could be called a success. The probable outlay would be more expensive than wood, but its life and wear would be more prolonged.

The Secretary (Mr. W. J. Walton) introduced Miss Woodcock (the Mayoress of Smethwick), who said she was not a bee-keeper, but had been interested in what had taken place and what she had heard at this interesting meeting. She might take up bee-keeping herself, and then she would be able to give her own experience.

A splendid tea was provided by Mr. E. H. Hipkins and served at the apiary, under the trees skirting the historic castle grounds. All expressed their great pleasure at the success of the meeting, and congratulated Mr. Hipkins and the secretary on the arrangements made.—(Communicated.)



*The Editors do not hold themselves responsible for the opinions expressed by correspondents. No notice will be taken of anonymous communications, and correspondents are requested to write on one side of the paper only and give their real name and addresses, not necessarily for publication, but as a guarantee of good faith. Illustrations should be drawn on separate pieces of paper. We do not undertake to return rejected communications.*

### Difficulties with "Isle of Wight" Disease.

[10196] Will you allow me a little of your space to record my agreement with the point of view of Mr. E. C. Hipkins on the subject of "A Beginner's Difficulties with 'Isle of Wight' Disease."

I, also, am scarcely more than a beginner, and went through a great deal of contradictory literature in the hope of finding a guide—

"But evermore came out by that same door wherein I went."

There exists a type of argument somewhat similar to those quoted by Mr. Hipkins, which I have met several times, and which purports to account for loss of stocks.

"Oh, dear no!" says this type of person; "indeed, I assure you my bees were perfectly healthy . . . no signs of disease at all. . . . Well, no! I didn't open the brood chamber last year, I was too busy . . . but I can assure you there was no disease. It was the wasps that killed my bees—every one!"

Well it is perhaps unnecessary to say that strong stocks can generally take care of themselves, if healthy, and are not likely to be wiped out by wasps.

But as the wasps furnish a possible solution of the disappearance of the bees, they are accepted as the true solution.

It seems to me that the trouble is not only that these people are not good bee-keepers, but that their logic is faulty.

If Messrs. Edwards and Stich will forgive my saying so, I really think that their reasoning is unsound in concluding that "Isle of Wight" disease was developed by overwork in the cases they have reported.

For consider. . . . If a man works hard at his office all day (missing his lunch) and then puts in overtime after hours, and on his return home sits up until the small hours doing other work, and if after some months of this he gets influenza and dies . . . we do not say that this case proves that influenza can be developed by overwork; far less do we say that the cause of influenza is overwork. No, we simply say, "Poor fellow, worked

too hard—got run down and caught influenza." We do acknowledge, because we so constantly have proof of it, that overwork may seriously affect a man's health; but it is most unwise to assume that what is good or bad for a man may have a similar effect on an insect.

For instance—men *must* sleep.

But *must* bees do so? In fact, do they sleep!!

I have never seen any proof that a queen's progeny are any the worse for their mother having "worked" harder than usual.

They work their queens hard enough in America, yet "Isle of Wight" disease has not devastated that country's bees.

The experience of such men as Simmins (in England) is apparently all the opposite way; for he not only recommends plenty of room for the queen, but advocates "plumping," which seems to be an intensive way of forcing a queen.

But then again *can* you force a queen, or do you merely encourage her? You can supply some queens with plenty of room and not induce them to lay more quickly.

Let me once more associate myself with Mr. Hipkins in his plea to bee-keepers not to "confuse the issue."—H. A. P. LITTLEDALE (Major).

### Beetles as Enemies of Bees.

[10197] I have never noticed beetles mentioned as enemies of bees. Last summer one of my stocks which was on twenty standard frames of comb and which in the spring had been very docile, suddenly became exceptionally vicious, so much so that manipulation was a most unpleasant task, the least touch on the hive bringing forth an angry crowd of "Deborahs" bent on attack. This went on for several weeks, and I contented myself with watching them closely. I soon noticed that they made a point of entering the hive only on one particular side of the entrance, which was opened to full width.

I determined that something would have to be done, so I removed the top brood box and commenced moving the combs from the bottom brood chamber. While doing this out ran an enormous female stag beetle, the largest I have ever seen, and, on examination of the combs, I found one had been gnawed away to such an extent that it was practically useless. It took some time for the bees to settle down again, but they eventually became quite manageable. I don't know whether other bee-keepers have had trouble with beetles, but I am fully convinced that if a stock of bees which has usually been quiet, becomes vicious, the reason very often can be traced to something having upset them. Bees seem to

have a good memory, and do not forgive very readily. Best wishes to readers of the "B.B.J." for a good season during 1920.—W. T. HOWLETT, New Malden.

### A Correction.

[10198] *Re* 10080, 8/1/20, "What's wrong with the craft."

"Perhaps you think, in stumbling on this feast,

He flew into a passion, and in fact There was no mighty reason to be pleased;

Perhaps you prophesy some sudden act, The whip, the rack, the dungeon at the least,

To teach his people to be more exact; And that, proceeding at a very high rate, He show'd the royal penchants of a pirate, You're wrong—*He was the mildest mannered man*

*That ever scuttled ship or cut a throat."* Byron, 1821.

G. B.'s rendering is by no means an improvement on the original, and insult is added to injury by ascribing the lines to a man who was not born until many years later.

This is not bee-keeping, and I do not ask of you to publish this letter, but as a lover of Byron I cannot let it pass uncorrected.—J. WHITE, Secondee, West Africa.

### Dutch Bees and "Isle of Wight" Disease.

[10199] Seven years ago Laindon had the "bee fever"; everyone was having bees, hives to be seen everywhere; soon after one could see hives empty, and some laid aside, some in the same place full of dead bees and soiled honey and combs. Isle of Wight disease was on a visit. I counted seventeen bee-keepers who lost all their stocks, mostly Italians. Not 100 yards away over the hedge were two hives of Italians; they soon got it. My friend told me my bees were turning them out. I went round, and my Dutch bees had taken full possession of their hives, and brought the honey home. They were turning dead bees out by the thousand. Then they went to Honeypot Lane, and took possession of three more diseased hives, and turned out their dead, coming home in droves. I was greatly upset, and expected to lose my lot. I got more honey than I knew what to do with at the time. I dosed them with Izal—combs, bees, hives and ground. I did not stint quantity. I simply dosed them—kill or cure. They still kept lively, and sixty hives of bees kept quite strong. I have supplied Dutch bees for miles round here, and have not heard of one loss from "Isle of Wight" disease. Dutch work early and

late in the cold, while the Italians seem afraid to move from the doors. By giving two brood boxes and tiering up early I get as much as 140 lbs. surplus. This is a very bleak place; we get more wind here than anywhere in England I should think, but have had a mild winter and no snow.—W. GREEN.

### Virgil and Bees.

[10200] Mr. E. F. Hemming's remarks about Virgil should not pass unchallenged. He seems to credit Virgil with the belief that bees could be obtained from decaying flesh. Surely it is evident from the text of the Georgics that Virgil is only relating an ancient legend, without vouching for its truth, and it is quite permissible for the author of a didactic poem to introduce such legends as a literary embellishment, without in any way discrediting the more serious part of his work.

With regard to "I.O.W." disease, I think it is evident that some such disease was present at the time, although Virgil himself diagnoses the condition as starvation. It should be noticed that the remedy suggested is to feed the bees with a decoction of honey and thyme, i.e., with a medicated syrup. (Bacterol, I believe, contains thymol among other ingredients.) Clearly some condition of stock dwindling was present in which experience had shown the advantage of a medicated syrup over plain honey, and so, one would judge, a disease rather than starvation.

Certainly Virgil was rather wanting in knowledge regarding swarming, but do we know everything about swarming yet? Obviously we cannot acclaim Virgil as an authority on modern bee-keeping, but do let us be kind—or at any rate just—to the memory of one of the greatest bee-masters of a bygone age, and hope for equal consideration at the hands of posterity, when the fallacies and ignorance of even up-to-date twentieth century bee-keepers are exposed by the constant increase of knowledge. — T. TURNER O'CALLAGHAN, Alperton, Middlesex.

### Bees Building Comb Upwards.

[10201] As a novice in bee-keeping I am much interested in this subject. Early in March I examined a hive containing a much depleted stock of bees. I found the candy (4 lb.) placed on top of a glass quilt nearly consumed, and about 2 in. comb built up through the round hole in the centre of the quilt. I cleared it away, and placed another 1 lb. cake of candy over the hole, only to find in one week that more than three parts of the candy had been consumed,

and a good piece of fresh comb had been reared up in its place. For the second time I removed the comb, and gave another pound of candy, but they have again erected an edifice of comb containing honey between what remains of the two cakes of candy.

I hope they will set about filling the sections—which I shall place for them as my next move—as industriously as they have worked on their unwanted comb.—J. SUTHERLAND.

### Uniting Bees.

[10202] May I bring before the notice of your readers a simple plan I have adopted for many years for uniting stocks? I place a stout sheet of brown-paper over the brood chamber next the frames, or two sheets of newspaper, place the brood chamber or shallow frame box to be united on the top, cover up securely and leave them. When the bees have eaten their way through the paper, they have made friends. I have never had any loss of bees by this plan, and the bees require no after attention except to remove the remains of the paper if it is wished to save the bees the trouble of doing it themselves.—E. GORDON (Miss.)

[The method given by Miss Gordon is not so well known as it might be. It will be found very useful when colonies have to be united, and it is for any reason not possible, or advisable, to adopt the usual plan of flouring both lots. Some bee-keepers make a few holes through the paper with a fine knitting needle.—Eds.]

### Re Bees Disappearing.

[10203] Reading in the *British Bee Journal* of May 27, the notes of Mr. Geo. M. Rosling under the above heading, perhaps it will be interesting to him and also to other bee-keepers who have had similar experience with their bees, to have my opinion as to what might have been the cause of death of the bees.

Mr. Rosling says that he wintered his bees with syrup and candy, when it is to be distinctly understood that no feeding of any kind is to be done in winter; remember dear readers that the bees are to be left severely alone in the dead season.

I always feed my bees in September sufficient to last until the next honey flow. A little stimulative feeding is done earlier if necessary, and by the end of the month I finish off all feeding and pack them up snugly for the coming winter, and they are then left with as little disturbance as possible till the following spring.

I have wintered successfully all my stocks this year, and I have never had



them all so forward, although Carmarthen-shire is not as a rule a very early district like those in the South of England.—D. JONES, Maeserch Apiary, Llanfangel-ar-Arth.

### The Difficulties of Italian Queen Breeders.

[10204] About a fortnight ago I had the pleasure of visiting the apiaries of Mr. E. Penna, of San Ruffillo, Bologna, and Mr. Gaetano Piana, of Castel San Pietro, and along with three other English friends I had a delightful time inspecting the hives in which are reared the excellent queens these gentlemen are sending to this country.

We met with the greatest courtesy, and no trouble was spared to make our visit to these apiaries interesting and instructive.

The main object in sending you this letter is to place before the many readers of the B.B.J. the state of things existing in Italy at the present time and the difficulties with which these gentlemen have to contend to see that the queens arrive safely in England and to answer correspondence.

It may not be known to some of your readers that for a long time a Post Office strike was in force in Italy, and the postal servants simply went to their posts and obstructed all work, with the result that many letters from England arrived a month after they were sent off. Mr. Piana especially was very grieved to receive a letter from a correspondent in England, simultaneously with another letter, complaining that he had written and had received no reply, naturally leading the correspondent to think that the matter was neglected or shelved; but I can assure your readers that the facts are as stated above, and I have no doubt your Mr. W. Herrod-Hempsall, who I believe has since visited these apiaries, will confirm all that I have said.

The integrity of these gentlemen is unquestionable, and their sole desire is that every queen sent out should give the utmost satisfaction.

When the strike was in progress Mr. Penna took the trouble to send a special messenger from Bologna to Switzerland with consignments of queens, and had them posted there so that there might be no delay and that they might arrive safely.

To describe all we saw this letter would have to be extended very considerably, and I apologise for taking up your valuable space.—JOHN RAE.

[We are pleased to publish Mr. Rae's letter, as we know that all the Italian queen rearers have had great difficulties to contend with. The above will explain any delay in receiving the queens.—Eps.]

### Skep Making.

[10205] I was rather amused at the description (or should I say instructions) of how to make a Straw Skep, in the issue of B.B.J. for May 27.

I am not a skep maker, but being a basket maker, have some knowledge of lapping and binding, as we use the same methods in our trade. And with your permission, would like to add to the instructions already given.

First then, as to the material for binding the straw in shape, a blackberry cane is all right, no doubt, but it isn't procurable by everybody, neither is it easy to cut and handle by everybody. But to those who will try it, the way to get rid of the prickles, is to pinch one end in a gate or door, then run a hair pin shaped stick up and down it. But preferable to the blackberry cane in every way is cane, as used for chair seating, any or most basket makers can supply it, and though cane is very dear at present, quite enough could be purchased for about 1s. 6d. to make one or two skeps. Ask for No. 3 or 4 chair cane, and when using it, if it is somewhat stiff, put it in hot water for about 5 or 10 minutes before using.

Secondly, to start the skep, the best way is to start on a hoop 3 in. in diameter, get a small willow or hazel stick from the hedge, and turn a hoop, or get the basket maker to turn you one in cane or willow, he will do it for a few pence, and then on the hoop start to lap the straw. Always start the base of the reed first, and add in the same way. If the straw is slightly damp when using, it will be found to "lie" (a trade term) quite nicely and properly. To make the holes for the cane, a good smooth wood skewer is as good as anything, if greased with a little bees wax.

The great secret of successful skep making, is to keep the roll of straw as you proceed of the same diameter, neither larger nor smaller, or your work will be "gouty" and the resultant skep anything but pleasant to behold. Wheat straw is mostly used, but the French use Rye straw, which grows anything up to 5 ft. in length.—R. LITMAN.

---

## Bee Shows to Come.

---

**June 29 to July 3, at Darlington.**—Royal Agricultural Society's Show, Bee and Honey Section, under the direction of the B.B.K.A. Prizes arranged in groups of counties for Associations affiliated to the B.B.K.A. Schedules from The Secretary, 23, Bedford Street, Strand, W.C.2. Entries closed.

**July 6, 7 and 8, at Cardiff.**—Royal Horticultural Society's Show. The Glamorgan B.K.A., in conjunction with R.H.S., offer prizes for Honey, Wax, Bees, and Appliances. Members, Novices, and Open Classes. Schedules, Mr. Wiltshire, Maindy School, Cardiff. Entries close June 22.

**July 14.**—Wickham Bishops and District Beekeepers' Co-operative Association. Group 2.—Open to bee-keepers resident in Essex. Class 79.—Four Sections; 1st prize, 7s. 6d.; 2nd, 5s. Class 80.—1 lb. Extracted Honey; 1st prize, 5s.; 2nd, 3s. Class 81.—1 lb. of Wax (in 2-oz. cakes); 1st prize, 5s.; 2nd, 3s. Group 3.—For bee-keepers' resident in the British Isles. Class 82.—1 lb. glass jar of 1920 Run or Extracted Honey; 1st prize, 20s.; 2nd prize, 10s. 6d. Exhibits in Class 82 to be the property of the Association, and to be given to hospitals in County of Essex. Entrance fee 6d. per class. Rules for exhibiting on back of entry form.—All entries to be sent to C. W. Cockburn, Hon. Sec., Meadow Bank, Wickham Bishops, Witham, Essex. **Entries close July 2.**

**July 15 and 16, at Grimsby.**—Lincolnshire Agricultural Society. Show of Bee Appliances, Honey, Sections, Wax, etc., under the management of the Lincs B.K.A. Open and County Classes. Valuable prizes.—Schedules from Major Hadfield, Alford, Lincs. **Entries close June 12.**

**July 17, at Guildford.**—Guildford and District Beekeepers' Association. Members and Open Classes.—Schedules and prize list from Rev. E. C. Pitt-Johnson (Hon. Sec.), Heatherwood, Pirbright, Surrey. **Entries close July 3.**

**July 20 to 23, at Aberdeen.**—Highland and Agricultural Society. Classes for Bee Appliances and Honey. Premiums £53 10s. Half of Prize Money and Silver and Bronze Medals contributed by the Scottish Beekeepers' Association.—Entry forms from John Stirling, Secretary, 3, George IV. Bridge, Edinburgh.

**July 21, at Broughton, Hants.**—Open Classes: Single 1-lb. Bottle, Single Section; prizes, 20s., 15s., 10s.—Schedules from Chas. Hoare, Broughton, Hants.

**July 21, Wyke and Normandy Horticultural Society.**—Honey Classes (Open). Best three sections, 5s., 3s., 2s.; Run Honey, light, 3 1-lb. glass jars, 5s., 3s., 2s.; Run Honey, dark, 3 1-lb. glass jars, 5s., 3s., 2s. Entrance fee, 6d.—Particulars, H. L. Mumford, Hon. Sec., Heatherside, Normandy, Guildford.

**July 28, at Blandford.**—The Blandford and District Horticultural Society are holding a Show of Fruit, Vegetables, Flowers, and Honey in the Park, adjoining the Crown Meadow, Blandford. Prizes for honey by the Dorset B.K.A. for members of the Association.—Schedules from C. G. Bone (Dorset Beekeepers' Association), County Education Office, High West Street, Dorchester.

**Monday and Tuesday, August 2 and 3, at Newport.**—Monmouthshire Beekeepers' Association Annual Show (in connection with the Newport Allotment Holders' Association). Members and Open Classes.—Schedules (post free 3d.) from Hon. Sec., "Underwood," Portskewett, near Chepstow, Monmouthshire. **Entries close July 26.**

**August 4, at Shedfield, Hants,** in conjunction with the Shedfield Horticultural Society's Show, Hants and Isle of Wight Beekeepers' Associations, Swanmore and Bitterne Branches. Classes for Comb and Extracted Honey.—Schedules from the Hon. Sec., A. F. Hardy, Esq., The Palace House, Bishop's Waltham, Hants.

**August 7, at Barnstaple.**—Barnstaple and District Horticultural Exhibition, to be held in the Market Hall. Five Open Classes for Honey.—Schedules from Hon. Secretary, 19, Grosvenor Street, Barnstaple.

**August 12, at Taunton.**—Somerset Beekeepers' Association Show of Honey, Wax, and Appliances. Seven Open Classes. Liberal prizes.—Schedules from Mr. F. J. J. Stacey, 3, Hammet Street, Taunton. **Entries close August 6.**

**August 14, at Llanelli.**—Carmarthenshire B.K.A. Show, in connection with the Llanelli and District Horticultural Society's Show. Liberal prizes (nearly £15) offered for Honey, Wax, and Appliances. 15 Classes (7 Open).—Schedules from R. Lloyd Roberts, London Joint, City and Midland, Llanelli. **Entries close August 6.**

**Saturday, August 28, at Hinckley.**—Leicestershire and Rutland Beekeepers' Associa-

tion, in connection with Hinckley Flower Show.—Open Classes for Honey, Sections and Jars. Prizes, 12s. 6d., 7s. 6d., and 4s. 6d. in each class. Judge, J. Herrod-Hempshall, F.E.S.—Schedules from A. Kimbrell, Esq., Clarendon Road, Hinckley. **Entries close August 23.**

## Special Prepaid Advertisements. One Penny per Word.

*Will advertisers please read these Rules carefully in order to save trouble, as they will be strictly adhered to.*

*Trade advertisements of Bees, Honey, Queens, and Bee goods are not permissible at above rate, but will be inserted at 1½d. per word as "Business" Announcements, immediately under the Private Advertisements. Advertisements of Hive-manufacturers can only be inserted at a minimum charge of 3s. per lin., or 5s. per inch.*

*PRIVATE ADVERTISEMENTS are only intended for readers having Surplus Stock to dispose of. Driven Bees, Nuclei, and Queens that are reared or imported for sale, are Trade Advertisements, and can only be accepted under trade terms. A charge of 6d. extra will be made if a box number is used.*

*Advertisements must reach us NOT LATER than FIRST POST on TUESDAY MORNING for insertion in the "Journal" the same week.*

*Orders for three or more consecutive insertions in "The Bee Journal" entitle advertisers to one insertion in "The Bee-keepers' Record" free of charge.*

## PRIVATE ADVERTISEMENTS.

**WANTED,** "Little Wonder" Extractor in good working order. State price.—Brushwood, Newbury. f.92

**HONEY EXTRACTOR** and Ripener, new Smoker, and other Accessories; giving up.—WHITTING, Langstone Avenue, Havant, Hants. f.93

**SWARMS,** 360-lb. strain, 35s., carriage paid; boxes to be returned. To clear, good Light Honey, 28-lb. tin, 36s., carriage paid.—BUTLER, West Road, Histon, Cambs. f.94

**GOOD** Second Swarms, 360-lb. strain, 25s., carriage paid; boxes to be returned; 6-frame Stock, 60s., carriage paid; boxes to be returned.—BUTLER, West Road, Histon, Cambs. f.95

**FOR SALE,** five Lee's Holborn Hives, clean and healthy, quantity Section Racks, Tin Dividers, new Frames in the Flat, Brood Foundation, Labels for jars, new 56-lb. Tins, 13 x 14-lb. Tins.—CHARTER, Tattingstone. f.96

**TWO** strong Stocks of Italian Hybrids on eight frames, filled with brood and store, guaranteed healthy, £4 each, carriage paid; boxes 7s. 6d. extra, returnable. Deposit system if desired.—MAY, "Lyncroft," South Nutfield, Surrey. f.97

**GEARED EXTRACTOR,** 40s.; strong Stock Special Bees, £5.—SWORDER, Waverley, Milverton, Somerset. f.98

**TWO** good Stocks on 8 frames, 70s. each; box, returnable, 10s.—FRANCIS, Kurnella, Shoe-buryness. f.99

**DUTCH VIRGIN QUEENS,** 4s. 6d.; fertile, 8s. 6d., from County Restocking Apiary.—ANDREWS, Expert, 78a, Westgate, Peterborough. f.100

**THREE** nearly new Uncapping Knives, 3s. 9d., postage 6d. each; Subjugator, as new, 4s. See Trade Advert. for Bees.—W. WOODS, Normandy, near Guildford. f.101

**OVERPLUS.**—Three pounds Dadants' Thin Section Foundation, splendid condition, 10s. 6d., carriage paid.—FLOWER, Owslebury, Winchester. f.102

**FOR SALE,** two "Rotax Roadlight 267" self-contained Acetylene Motor Headlights, very powerful, £6 the pair; one Exhaust Whistle, 10s.; one Wood-Milne Motor Foot Pump, 40s.—W. HERROD-HEMPSELL, Old Bedford Road, Luton, Beds.

**FOR SALE.**—Having sold most of my bees, have several Hives for Sale from 15s. to 25s. each, also several boxes of Shallow Frames, drone combs drawn out, 9s. per crate complete, or 1s. each frame; also several Section Crates, 3s. each, or filled with sections with drawn-out combs or sheets of foundation, 5s. per crate. All of these hives and fittings are clean and free from disease.—GRIFFIN, Brook Farm, Colnbrook, Slough, Bucks. f.103

**WANTED,** strong Swarm or Stock of pure Italian Bees; guaranteed. —MONTAGU TURNOR, Hailton, Spilsby. f.104

**WANTED,** by experienced man, situation as Manager apiary or bee department of nursery or fruit farm.—Particulars, "J." Box 89, B.B.J. Office, 23, Bedford Street, Straud, W.C.2. f.105

**FOR SALE,** two 10-frame Stocks Italian Bees, £5 each; one 7-frame ditto, £3 10s.; never had any disease in apiary; box 10s. returned, less carriage.—Box 90, B.B.J. Office, 23, Bedford Street, W.C.2. f.106

**DUTCH CROSS,** wonderful workers, Swarms £2, carriage paid; box returnable.—ALBERT COE, Apiarist, Ridgewell, Halstead, Essex. f.107

**SPLENDID** new White Clover Honey, £10 per cwt.; sample 6d.; tins to be returned.—ALBERT COE, Apiarist, Ridgewell, Halstead, Essex. f.108

**STOCK** of Dutch Bees in good hive, 70s.; good Swarm of Hybrids, taken June 1, in skep, 30s.; two well-made W.B.C. pattern Hives, also two Section Racks, one complete, 70s.—H. KEITH MURRAY, Paultons, near Romsey, Hants. f.109

**FINEST HONEY SECTIONS,** prime Swarms, also small Swarms, 1920 Queen; marked immunity from disease. Particulars, stamp.—NORTH, Cressing, Braintree, Essex. f.110

**SWARMS,** Italian Hybrids, 1919 Queens, Penna's selected strain, disease resisting, established on 6 frames, 45s.; boxes 10s. returnable. New season's Honey, in bulk, jars or pots, £9 cwt.; pots extra.—STIMSON, The Apiary, Bradford, Berks. f.111

**SWARMS,** healthy, strong, ready for despatch, 32s., carriage paid; boxes returnable.—PULLEN, Ramsbury, Hungerford. f.112

**HYBRID ITALIANS,** strong stock, 10 frames, ready for supering, very gentle, absolutely healthy, £5; expert's certificate; delivered free by hand anywhere near London. Also smaller lots.—REDDIE, Cliff Cottage, Leigh, Essex. f.113

**THREE STOCKS** on 10 frames for Sale, £4 each; travelling box 10s., returnable.—C. WOODCOCK, Molefields, Godalming. f.114

**SEVERAL** surplus Stocks of Italian and Hybrid Bees for Sale, 10 frames (Penna strain), £4 17s. 6d., carriage paid; 10s. on box, returned on receipt. Inspection invited.—H. OBORNE, 25, Guest Road, Bishopstoke, Hants. r.f.68

**A FEW** strong Stocks of guaranteed healthy Bees, in hives complete, 5 gs.—WIGGINS, 1, Swinderby Road, Wembley. f.143

**SWARMS, ITALIAN HYBRIDS.**—Several for Sale. What offers?—Particulars apply SMITH (Gardener), Hook Farm, Aldingbourne, Chichester. f.117

**A FEW LOTS** of good, healthy Bees on from 6 to 8 standard frames, 8s. per frame; travelling box to be returned.—WRIGHT, Waterworks, Sutton Poyntz, near Weymouth. r.f.28

**BEEs.**—Good Stocks May Swarms in skeps, hives, extractors, and all appliances to be cleared at once. Stamp for list. No disease.—STEEL, West Ashling, Chichester. r.f.29

**CORRESPONDENCE COURSES** in Bee-keeping.—H. E. NEWTON, Brown House, Barton-on-Sea, Hants. r.d.157

**FOR SALE,** Cottage Extractor, Smoker, 50 Shallow Frames fitted foundation, Super Clearer, two Queen Excluders, five Shallow Frame Boxes, etc., at bargain price. Stamp particulars.—PINCH, 152, Liverpool Road, Watford, Herts. f.116

**SMALL APIARY** for Sale, consisting of three strong Stocks of Bees, two Italian Hybrids, one Italian, on 10 frames supered; three W.B.C. Hives, Extractor, Clearer, Excluders, Skep, Knife, Embedder, Feeder, etc.—Offers to J. JAKUES, 66, Grove Road, Wanstead, E.11. f.131

**TWO NUCLEI,** 4 frames, Italian-Dutch, 1920 Queen, immediate delivery, 55s.; vigorous, healthy and prolific; 10s. on box.—ETHERINGTON, Pulham Market, Norfolk. f.121

**BUSINESS ADVERTISEMENTS.**  
1½d. per word.

**DUTCH BEES,** Skeps (as imported from Hans Matthes), Nuclei, Queens. Illustrated Catalogue on request, containing points on management.—Buy direct from Sole Agent, WHYTE, Bee Farmer, Cumbernauld, Dumbartonshire. b.61

**NUCLEI** (good hybrids), 1920 Queens; 3 frames, 37s. 6d.; 4 frames, 45s.; box 7s. 6d., returnable.—J. FOOKS, Normandy, Guildford. f.115

**QUEENS** (about 40) sold, may have five more mated this week, 6s. each; five more Swarms, 7s. 6d. per lb., minimum 4 lbs. Hurry up your boxes; must get them away. Only four Skeps left, 20s. to 35s. each, according to strength. Purchaser of two gets a Penna 1919 Queen given. Nuclei all sold.—THOMAS, Causeway, Burwell, Cambs. f.156

**HIVES,** W.B.C., machine-made, standard, immediate delivery, painted one coat, rubberoid top, oak legs, first-class make; cash with order 55s. delivered in Birmingham, otherwise carriage forward.—ARCHER'S, Joiners, Albert Road, Handsworth, Birmingham. f.119

**SWARMS** for Sale at 7s. 6d. per lb.; also Nuclei on frames, 7s. 6d. per frame.—WILCOX, Dyke, Bourne. f.122

**DUTCH, DUTCH-ITALIAN** 4-frame Nuclei, only a limited number for disposal, delivery now, £3 3s., cash with orders, carriage paid. Numerous letters from well satisfied customers of this fine disease-resisting strain, Dutch-Italian Hybrids. Don't look at the price. You will be well satisfied.—SPALE, Ashley Cottage, Oatlands Drive, Walton-on-Thames, Surrey. f.123

**NORVIC BEE CURE.**—The only sure and effectual remedy for all bee diseases; quart, 10s.; ½ gallon, 18s.; gallon, 30s.; carriage paid.—TROWSE, Hygienic Apiculturist, Eade Road, Norwich. f.124

**4-FRAME NUCLEI,** Italian Hybrids, June delivery, 50s.; box 10s., returnable.—ERNEST GRIFFITHS, Helsby, Cheshire. f.125

**ITALIAN COLONIES,** Simmins' and Penna strains.—No more orders for colonies. A few more Nuclei offered at 45s., 3 frames certain. Members of Middlesex Bee-keepers' Association 5 per cent. discount.—R. R. BABBAGE, 33, White-stile Road, Brentford. r.f.133

**THE FLAVINE TREATMENT.**—In 1917 we worked out a simple, cheap, and in many cases an effective treatment for the "crawling" disease in bees. We have distributed the drug and directions gratis ever since. We have never claimed it to be a "cure," and you are nothing out of pocket by giving it a trial.—S. H. SMITH, 50, Maid's Causeway, Cambridge. f.120

**ITALIANS.**—Queens, 6s.; virgins, 5s. Stamp.—HOUSTON, Ellen Villa, Sidcup. f.118

**3-FRAME NUCLEI,** 32s. 6d., with 1920 fertile Queen; good Stocks on 8 standard frames, 60s., with hives 90s.; boxes 5s., returnable; good Swarms from 25s.—W. WOODS, Normandy, near Guildford. f.126

**RE-QUEEN** with a "Lazenbee" prolific Italian. Fertile, 10s.; virgin, 5s.—YOUNG, One Hundred Elms Apiary, Central Road, Sudbury, Middlesex. r.f.127

**FOR SALE,** fertile Queens, hybrids, 7s. 6d., and Penna strain, 10s. 6d., post free.—ASH-WORTH, The Bungalow, Weymouth Street, Warminster. f.128

**STRONG DUTCH BEES** for Sale, 3 to 10 frames, 10s. 6d. per frame, carriage paid; cash with order; travelling box to be returned. Deposit system if preferred.—MUNRO, Drakies Cottage, Inverness. r.f.130

**ITALIAN HYBRID BEES** (immediate delivery), disease-resisting strain, 1920 Queens, 4-frame Nuclei, 45s.; travelling box 10s., returnable; Stocks from 10- to 20-frame at 8s. 6d. per frame.—STARKEY, 55, Stafford Rd., Brighton. r.f.134

**THREE STOCKS** of Italians on 10 frames, ready for supering, £4; Nuclei, 10s. per frame; boxes charged, returnable.—HENSLEY, 24, Queen's Road, Luton, Chatham. r.f.129

**4-FRAME NUCLEI,** headed by 1920 Italian Queen, 50s.; box charged 10s., returnable; 6-frame Stocks, 70s.; 8-frame Stocks, 90s. Immediate delivery. All guaranteed free from disease.—LEE, "Little Bowden Apiary," Burgess Hill, Sussex. r.f.177

**6-FRAME STOCKS** in bar-frame hives at £5 each, free on rail; Italian fertile Queens, 10s. 6d. each. Daily deliveries.—LEE, "Little Bowden Apiary," Burgess Hill, Sussex. r.f.178

**ITALIAN NUCLEI,** 3 frames, packed with brood and bees, carriage paid, £2 15s.; cash with order; box 10s., returnable. Satisfaction guaranteed, or money returned. Fertile Queens, 10s. 6d.; virgins, 5s.—E. H. TUNMER, "Chalfonts," Leiston, Suffolk. 1.84

**IMMEDIATE DELIVERY.**—3-frame Nuclei, Italian Hybrids, 1920 fertile Queens, 45s., carriage paid; box 5s., returnable.—EVANS, Lattiford, Wincanton, Somerset. 1.87

**4-FRAME NUCLEI,** with Italian or English Queen, 50s.; returnable box, 10s.; Queens, 10s.—HOLLINGSWORTH, Heanor. f.51

**NUCLEI,** 3-frame, £2 10s.; 4-frame, £3 5s.; Cross "White Star"; box, 5s. extra.—A. SKINNER, Oaks, Mickleover, Derby. f.32

**PENNA** specially picked me a 1919 beauty, now laying nearly 3,000 eggs daily. Spare Virgins from this mother 4s. by return, or money back; fertiles, 8s., in rotation.—"PATRICIA," Grammar School, Doncaster. f.38

**ITALIAN QUEENS DIRECT FROM ITALY.**—E. Penna, Bologna, Italy.—Mr. S. H. Smith, 50, Maid's Causeway, Cambridge, has bought all the Queens I have still for sale in this year. As agreed with him, all these queens will be sent by me direct to customers. I do not hold myself responsible for the queens that are not sent by me direct from Bologna to customers.

**1920 FERTILE Golden Italian Queens,** guaranteed imported direct from Italy, regular supplies every few days, 11s. each; specially selected, 15s.—GOODARE, New Cross, Wednesfield. f.59

**MISSIS PALING & PILLANS.**—Orders booked for strong three-frame Nuclei with pure Italian Penna Queens or home-reared Queens from best selected Italian strains, £3; choice home-bred Italian Queens, 12s.; Virgins, 6s., four for 20s.—Golden Square, Henfield, Sussex. e.101

**PUPILS** received by life-long whole-time Bee Farmer.—Terms on application to C. B. BARTLETT, Sandford Mount, Charlbury, Oxon. d.127

**HAVE YOU READ "THE BEE WORLD"?** If not, why not? Every number in itself is a useful literary work for practice and reference. Specimen copy free.—Offices: THE APIS CLUB, Port Hill House, Benson, Oxon.

**"ISLE OF WIGHT" DISEASE.**—Don't worry; use the solution that cures; 2s. per bottle.—E. PRESSEY, St. Elmo, Conisford. r.d.149

**ORDERS** booked for 3-frame Nuclei, Fertile Queens, Virgin Queens, etc. List for stamped, addressed envelope.—H. CRACKNELL, Mount Road, Thundersley, Essex. r.d.27

**BOZZALIA** tested Queens are sold at the price usually charged for untested queens.—Catalogue from H. STICH, Riccarton Avenue, Paisley. r.c.116

## ITALIAN QUEENS

Direct from Italy.

Address:  
Signor Gaetano Piana,  
Castel San Pietro,  
near Bologna, Italy.



All Queens are reared by the most up-to-date and scientific methods. Mr. W. Herrod-Hempsall has personally inspected the apiary and methods employed, with which he is perfectly satisfied.

PRICES FOR 1920.

For 1 Fertile Queen: August and September, 9/- each queen.

Can take no more orders for June & July. Booked up.

Carriage paid in Great Britain. Cash must accompany all orders, which will be executed in rotation. Guaranteed safe arrival of all Queens, but not the introduction. Bees dead upon arrival must be sent at once to "B.B.J." Office.

For the mutual convenience of all parties, Il Signor Piana has made arrangements that all communications, orders and remittances of the readers of "B.B.J." and "B.K.R." can be addressed to him, c/o British Bee Journal, 23, Bedford Street, Strand, London, W.C.2. Cheques payable to "British Bee Journal."

## SCIENTIFIC QUEEN REARING.

BEST  
in the world.  
Every  
appliance and  
instructions.

Send for  
**KAT-A-LOG**

**MEADOWS  
SYSTEM,  
Near LEICESTER.**

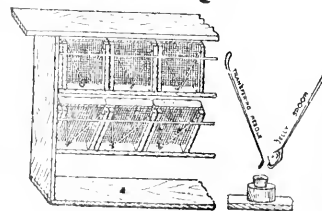

The products of the Apiary, of Poultry and Farm Stock, of the Fruit and Vegetable Garden can be Advertised and Sold through

THE  
**BAZAAR, EXCHANGE & MART**  
*Newspaper.*

Get a Copy—Thursday and Saturday 3d. The "Bazaar" publishes also practical handbooks by experts. Send for full catalogue, post free from—**WINDSOR HOUSE, Breams Buildings, LONDON, E.C.2.**

**HIVES AND APPLIANCES.**  
Immediate Dispatch. Quality O.K.  
Write for Prices.

**ANDREWS & CO.,**  
Joinery and Carving Works,  
78a, WESTGATE, PETERBOROUGH.

THE  
**British Bee-Keepers' Association.**  
Insure *now* against loss by damage done through bee stings. All particulars from  
**W. HERROD-HEMPSALL, 93, Bedford Street, Strand, London, W.C.2.**



**"BACTEROL"**  
FOR BEES

2/6 per Bottle.

Post Free.

The cure for, and preventive of, "Isle of Wight" Disease. Non-poisonous—free from stain or unpleasant odour.

**MENLEY & JAMES, LTD.,**  
39, Farringdon Road, London, E.C.1.

**PREPARE FOR EXTRACTING.**

The quickest, cleanest and most efficient on the market is the "BAIRD" EXTRACTOR, which extracts from BOTH SIDES of the COMB simultaneously.

Particulars from **G. S. BAIRD, 1, HURST ROAD, ERITH, KENT.**

**INSTRUCTION in BEEKEEPING**  
*PRACTICAL AND THEORETICAL*

My Apiary will be open for a limited number of pupils during this season. Terms and particulars from

**W. HERROD-HEMPSALL,**  
The W.B.C. Apiary, Old Bedford Road, Luton, Bedfordshire.

**NORTHERN BEE MEN**

Colonies and Nuclei from Bowen's Cotswold Apiaries are still available. Buy Now to Secure the Heather Crop.

*Booklet Free.*

**LT. A. H. BOWEN, Bee & Honey Specialist, CHELTENHAM**

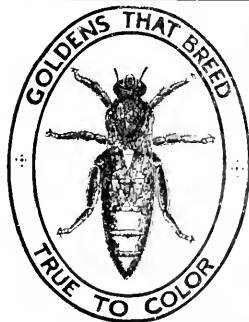

**Goldens.** Fertile Queens, 12/6 each. Mismatched Queens, 10/6 each.

Our Guinea Gold Queens are quiet, healthy, hardy, splendid workers and a lovely colour, they produce Golden workers and Golden drones, they are bred from stock that has never had "Isle of Wight" disease.

Strong 3 frame Nuclei with 1920 Golden Queens, 63/- carriage paid.

**D. ALLBON & CO., Sunnyside Apiaries, HITCHIN**

**POSITIVE FACTS.**

I am very pleased with your foundation, the aroma is right and I find the bees take to it before any other sort.—Yours faithfully, **R. B. MANLEY.**

*June 10th, 1920.*

*Illustrated Lists free by post.*

**S. J. BALDWIN, The Apiary, BROMLEY, Kent.**

# HIVES.

Compare the WORKMANSHIP and FINISH of our Hives.

All made by practical Men who know what a good hive should be.

In various designs to suit all tastes and requirements. Season's speciality—THE MANLEY HIVE for 16 in. x 10 in. Frames.

Full descriptions and illustrations in our 1920 Catalogue:

*"Everything for an Apiary."*

If you have not received your copy, send a P.C. at once.

OUR MOTTO—SERVICE & QUALITY.

**R. STEELE & BRODIE, Wormit Works, Wormit, Scotland.**



THE  
KEY TO  
YOUR SUCCESS.

## Lee's Bee Supplies.

¶ In design, material and workmanship, Lee's Bee Supplies still retain the reputation of being your best and safest investment.

¶ Our 1920 ILLUSTRATED CATALOGUE is yours for the asking. It contains detailed information on the most up-to-date hives and appliances for which the House of Lee is famous.

¶ We regret the necessity of having to advise our Customers that owing to the increased cost of production, all prices in 1920 price list are subject to 10% increase. The increase will not apply to orders received before May 10.

\* \* \* Five per cent discount to Members of THE APIS CLUB.

**JAMES LEE & SON,**  
LTD.,

Uxbridge, Middlesex.

(Telegrams: Graphicly, Uxbridge.)

Telephone: Uxbridge 181.)

## 20-Page 1920 "WHITE STAR" List,

3½d. POST FREE.

S. SIMMINS, QUEENLAND, HEATHFIELD, SUSSEX

Bees and Beekeeping Appliances. Catalogue free.  
**EDWARD J. BURTT. MANUFACTURER. GLOUCESTER.**

*I very much regret that there has been a large increase in the cost of the manufacture of bee-appliances, and therefore my prices will be advanced 10% from May 10th. Books excepted.*

PRINTED BY THE AVENUE PRESS (L. UFOOT GILL & SON, LTD.), 65-67, DRURY LANE, LONDON, W.C., AND PUBLISHED FOR THE PROPRIETOR (W. HEBBOD-HEMPBALL), BY SIMPKIN, MARSHALL, HAMILTON, KENT & CO., LTD., 31 & 32, PATERNOSTER ROW, E.C.



No. 1983. Vol. XLVIII                      JUNE 24, 1920.                      [Published every Thursday, Price 2d.]

**CONTENTS.**

SEASONABLE HINTS .....	PAGE 301	THE BATH AND WEST SHOW .....	PAGE 306
NOTICE TO ADVERTISERS .....	301	BRITISH B.K.A. ....	306
ROYAL SHOW FUND .....	301	MONMOUTHSHIRE B.K.A. ....	307
A DORSET YARN .....	302	CORSHAM B.K.A. ....	307
JOTTINGS FROM HUNTINGDONSHIRE .....	303	CORRESPONDENCE—	
THE APIS CLUB .....	304	Two Eggs in One Shell .....	308
KEEPING QUILTS CLEAR OF PROPOLIS .....	305	Fraternity Among Bee-keepers .....	308
NOTES ON BEE-KEEPING .....	305	NOTICES TO CORRESPONDENTS .....	308
		BEE SHOWS TO COME .....	308

WRITE FOR  
FREE CATALOGUE  
WITH  
INSTRUCTIONS  
FOR BEGINNERS.

AS MY

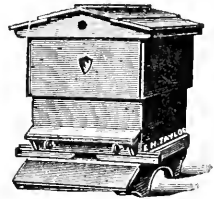

S

ARE THE  
**FOUNDATION OF SUCCESS**  
SO IS SUCCESS

MADE CERTAIN  
BY

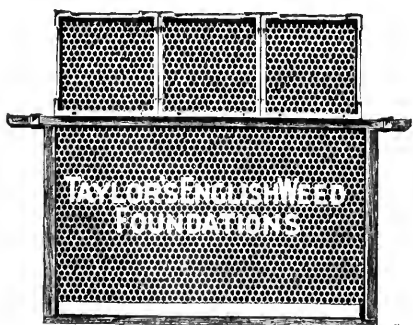

MY

**E. H. TAYLOR**  
WELWYN,  
HERTS.  
  
Telephone: 13 WELWYN.

# THE British Bee Journal

ESTABLISHED 1873.

A Weekly Journal Devoted to the  
Interests of Bee-keepers.

Edited by T. W. COWAN, F.L.S., &c.,  
and J. HERROD-HEMPSALL, F.E.S.

**Correspondence: Whom to Address.**—All matters relating to the Literary Department, Associations, Shows, etc., should be addressed, "Editors, *British Bee Journal*," and all business communications and matters relating to subscriptions and advertisements to be addressed to the "Manager," *B.B.J.* Office.

**Subscriptions.**—Annual Subscription, 10s. 10d. post free in advance; single copies 2d., or 2½d. post free. If a receipt is required by post, a stamped and addressed envelope must be sent, otherwise a printed receipt will be enclosed along with the paper.

**Note.**—Cheques and Postal Orders should always be crossed, otherwise it is very difficult to trace them if they go astray.

**How to send Money.**—Remittances can be made payable to W. Herrod-Hempsall by crossed Cheques and Postal Orders. Stamps may be sent for small amounts up to 2s.

*Halfpenny stamps are preferred.*

Scottish or Irish cheques can only be taken in payment if 6d. is added for commission charged by banks for cashing them.

The Editors are not directly or indirectly interested in the manufacture or sale of bee-hives or appliances of any kind, and must refer correspondents wishing for prices or catalogues to advertisers in the paper.

## OUR DEPOSIT SYSTEM.

You are advised to insist on this being used when dealing with strangers.

### Rules and Conditions for Depositing

In order to save trouble, it is requested that the Rules be carefully read over by persons using the Deposit System of trading.

Goods should not be despatched until notice that the money has been deposited is received from this office.

**1. Method.**—When strangers are dealing together, the purchase-money of the articles is deposited at our office. We acknowledge receipt of the deposit to both parties, and hold the money until we are satisfied that the purchase is concluded. If a sale is effected, we remit to the seller the amount deposited, less a charge of 2½ per cent. in the £, with a minimum of 6d., and the expenses of Post Office Orders and postage, &c. Cash will be forwarded by Cheque, Post Office Order, or by Postal Order as preferred. If a sale or exchange be not completed, we return the amount deposited, after making the same deduction. By this means buyers and sellers are secured against fraud.

**2. Deposits.**—Postal Orders (drawn on General Post Office) and Cheques must be made payable to W. Herrod-Hempsall, and crossed "London County and Westminster Bank." The numbers of the Postal Orders should be kept by the sender. We cannot be responsible for any loss that may occur in transit.

**3. Honey on Approval.**—All honey will be sold by sample, which must be sent direct to buyer.

**4. Bee Appliances.**—In ordering, the time allowed for completing the order to be stated to us when sending cash. If maker accepts, we hold cash until transaction is satisfactorily completed, when the amount will be remitted, subject to conditions as in Clause 1.

**5. Bees and Queens.**—These will be dealt with entirely by the parties concerned, so far as price, &c., go, and when the purchase is satisfactorily completed cash will be remitted as per Clause 1.

**6. Goods in Transit.**—These are at the seller's risk, i.e., any damage to or loss of an article on its journey is borne by the vendor; but a rejected article must be properly packed and returned by the same means as was used in sending it.

**7. Carriage.**—The carriage of all goods, except such as are sent by post, is payable by the buyer, unless otherwise agreed. If any article sent on approval be returned, each party to the transaction must pay carriage one way.

## Books for Bee-keepers NOW IN STOCK.

Cash in full must be sent with order.

		Postage
A Modern Bee Farm ... ..	7/6	... 3½d.
Advanced Bee Culture (HUTCHINSON) ... ..	6/-	... 6½d.
Beginner's Bee Book (PELLETT) BEE-KEEPING SIMPLIFIED FOR THE COTTAGER AND SMALLHOLDER (W. HERROD- HEMPSALL, F.E.S.) ... ..	5/-	... 4d.
BEE-KEEPERS' PRACTICAL NOTE BOOK (T. W. COWAN)	1/-	... 2d.
BRITISH BEE - KEEPERS' GUIDE BOOK (T. W. COWAN) (paper covers only)	1/-	... 2d.
Dissectible Model of Queen Bee ... ..	2/6	... 3d.
FERTILISATION OF FRUIT BLOSSOMS BY BEES (T. W. COWAN) ... ..	4/6	... 3d.
Fifty Years Among the Bees (MILLER) ... ..	-/3	... 1d.
Honey and Health (A. HOPE) ...	6/-	... 5½d.
Honey Vinegar (REV. G. BANKS)	-/6	... 1d.
How to Keep Bees (ANNA B. CONSTOCK) ... ..	-/2	... 1d.
Management of Out Apiaries Pollination of Fruit in relation to Commercial Fruit Growing (C. H. HOOPER, F.R.H.S.)	5/-	... 4½d.
PRODUCING, PREPARING, EXHIBITING AND JUDG- ING BEE PRODUCE (W. HERROD-HEMPSALL, F.E.S.) ...	3/-	... 2d.
Productive Bee-keeping (PEL- LETT) ... ..	-/6	... 1d.
Queen Rearing in England (F. W. L. SLADEN) ... ..	10/6	... 8½d.
Scientific Queen Rearing (DOOLITTLE) ... ..	1/6	... 2d.
The Bee-keepers' Vade Mecum (GEARY) ... ..	4/-	... 3½d.
Snelgrove's Method of Re- queening ... ..	2/6	... 2d.
The "Townsend" Bee Book ...	-/6	... 1d.
WAX CRAFT (T. W. COWAN) ...	2/6	... 2d.
Wilke's Book on Swarming ...	2/-	... 2½d.
1/-	... 1d.	

### MISCELLANEOUS.

Maeterlinck's Life of the Bee The Lore of the Honey Bee (TICKNER EDWARDS) ... ..	3/6	... 3d.
THE BEE WORLD (supplied only to members of Associations interested in the control and development of the Apis Club, apart from ordinary members of the latter), per copy ... ..	2/-	... 2½d.
	-/8	... 1½d.

British Bee Journal & Record Office,  
23, BEDFORD STREET, STRAND, LONDON, W.C.2.





### Seasonable Hints.

From reports to hand conditions vary very much in different districts. In some, bees are storing honey freely, in others none is coming in. We are fortunate in being among the first named. The weather has been warm and close, plenty of sunshine, and more or less heavy showers at fairly frequent intervals, and as a result the white clover is blooming abundantly and scenting the air around. Under these conditions bees need plenty of super room if honey is being worked for. Where the objective is increase it enables nuclei to be formed fairly rapidly, as queens are laying well, and the warmth and prosperity are especially favourable to the rearing of young queens.

In some districts clover and sainfoin in quantities to be of service to the bees, are conspicuous by their absence, and the lime trees are depended upon for surplus. Enough honey will be coming in from mixed sources to keep breeding up, and as there is not enough to cause the brood combs to be choked with honey, the queens have plenty of room to lay, and in a short time the hives contain a large population. Unless the bee-keeper is on the look-out, the bees will, under these conditions, swarm as soon as anything like a honey flow comes. Plenty of super room should be given; any queen that is very prolific must have more space for egg laying. Nuclei for queen rearing may be made, or an extra set of combs given, either standard or shallow as circumstances may dictate, as an extra brood chamber. Those who kept notes of the behaviour of their stocks last season and kept the best queens for breeding this year will now be able to reap the advantage of these records, rearing both queens and drones from selected stocks. The nuclei for hatching and mating the young queen may be made from any stock that can spare the combs and brood, the queen cells being given from the selected stock. Care should be taken to destroy all cells started in the nuclei by the bees themselves. When searching for queen cells at any time it is advisable to shake the bees from the combs, or one may be overlooked, and all the bee-keeper's plans upset.

We would emphasise the warning that has been given by several writers in the

BRITISH BEE JOURNAL lately, i.e., do not rob the bees too much, but leave them enough of their own natural stores for winter. We have preached this for years, and have no sympathy whatever for that class of bee-keepers who work on the principle that sugar is cheaper than honey, and extract every ounce of the latter possible, giving sugar syrup as a substitute. Syrup should only be used to augment scanty stores in a poor season, or for stimulative feeding when there is little or no nectar being gathered. It is quite possible that sugar for bee food will not be available this autumn.

### Notice to Advertisers.

Owing to the greatly advanced price of printing paper, and the increase of wages in the printing trade, we shall be obliged to raise the price for our "displayed" advertisements at the end of this month. We are sorry to have to do this, but if we are to carry on it is inevitable. We can only hope this will be the last increase we shall have to make, but this is by no means certain. The revised rates as given will come into force with the issue of the BRITISH BEE JOURNAL for July 1 and the July RECORD.

#### DISPLAYED ADVERTISEMENT RATES. *British Bee Journal or Bee-keepers' Record.*

	£	s.	d.
Full page ... ..	4	0	0
Half page ... ..	2	10	0
One-third page ... ..	1	16	0
Quarter page ... ..	1	12	0
1½ in. across page ... ..	1	7	0
1 in. across page ... ..	0	18	0
½ in. across page ... ..	0	10	0
1½ in. single column ... ..	0	15	0
1 in. single column ... ..	0	10	0
½ in. single column ... ..	0	6	0

Discount for a series of consecutive displayed advertisements:—Six insertions 2½ per cent.; Twelve insertions 5 per cent.; Twenty-six 15 per cent.; Fifty-two 30 per cent.

### Royal Show Fund.

The Council of British Bee-keepers' Association are anxious to take their usual part at the Royal Show to be held at Darlington this year, so that their unbroken record of representation at this show may not be spoilt. In order to defray the expenses in connection therewith the Council ask that all bee-keepers assist in this work by giving donations, which should be sent as early as possible

to the Secretary, 23, Bedford Street, Strand, London, W.C.2.

Subscriptions for this fund are coming in very slowly, and we would urge all those who can possibly do so to send a donation, however small. The sum needed is not, comparatively, large and if every one does a little should be easily forthcoming. "The Royal" is the show of the year, when the value of bee-keeping, and of the use of honey, to the community is brought to the notice of hundreds of people, and should the Bee and Honey Department have to be dropped for lack of funds, the loss to bee-keeping will be out of all proportion to the amount needed to carry on. May we also urge all those who can do so to make an entry, and exhibit at the Darlington show. A good display will help both the show and the craft. We are sure our bee-keeping friends in the North are looking forward to a good display of honey, etc., at this year's Royal Show.

	£	s.	d.
Amount received ...	12	8	2
Anon. ...	5	5	0
E. F. Ball ...	0	10	0
Mrs. E. Pharall ...	0	5	0
W. F. Jones ...	0	2	6
Total ...	18	10	8

## A Dorset Yarn.

This has been a light week for surplus honey in all the hives where a second rack was given a week since. In only one was surplus added; the others were left severely alone. On mentioning this to Mr. Butson, of Wimborne, on Saturday, he quoted a morning greeting with an old bee-man who has always had skeps. One of them is placed on top of a spring balance; he calls it his "honey clock." "How are the bees doing?" says Mr. Butson. "Doing nothing this week," says the old skeppist. He lives in the best district for honey, rich farm lands and large woods, where bees have always done well. Probably they have been waiting about for a suitable day to swarm; they have not added to stores of honey.

Mr. Butson was sending away nuclei to all the shareholders in the Dorset restocking scheme, all of them with young laying queens. He has had anything but an easy task to get all of them queened-up ready for export. In one of them, he wanted to show me what a beautiful young queen was going off as soon as mated, but opening the nucleus she was not to be seen anywhere—she was out for mating or had gone to the wrong box after the marriage flight. Most

of the queens were from one stock, where the queen laid so many eggs. Why some queens should be so much more prone to produce eggs than are others is to me a mystery, for I have noticed that some stocks always have a greater population than others, and as a natural consequence do better. This queen is not one of the largest, yet she is the best in this apiary.

Queens are sometimes lost in mating, or, at least, they do not go back to the hive from which they were reared. I had an object-lesson this week. One lot of light-coloured bees were racing about the entrance board, which showed something was wrong in the colony. On taking off the surplus racks and looking over each bar twice, no queen was to be seen. One freshly opened queen cell was not broken down, but others had been eaten off by the workers; these had not swarmed—at least, not to my knowledge. Bees seemed as plentiful as usual, but there was no queen and no other queen cells but the one that was newly opened. I looked the next day, but there was still no queen, so on Friday I gave them a queen cell from another hive. It was built on the frame of a new bar (where a full stock of bees were set over the new lot of standard bars). They have ceased their racing about the entrance, but whether it is because they have the new queen cell, or they are rearing others, it is too soon to tell yet. If it is raising new ones they are sure to raise a lot; that seems to be the rule with them. They will have to be looked after, or it will mean a lot of swarming from this hive in July. We do not like them then.

We have seen the last of the crawlers. I followed up the syringing with Flavine and sugar, and all that were sprayed at the entrance had to clean themselves. Squire Tomlinson helped with the bars, but each warm day, as they came on the entrance, they were sprayed over and over and over again. One stock must have lost more than half its population in those few days.

I notice some of the stocks are turning out drones that are fully developed, and it is early to do this. Have they shied at the rainy days? Do the workers surmise that the summer has ended? There are a lot of them outside some Italian stocks; these have never swarmed, and are immensely strong, and have given good results up to now.

Bees are flying away from the farm just now, a few are on the red heather; they do not get a lot from this in my estimation. The red clover "*Incarnatum*" is giving another crop of flowers where it was cut early for stock. These are eagerly looked over by bees; it is more than half a mile from the hives, but they go after it, or they seem to go in that direction; it

is to the big trees they go mostly. A bee-keeper in Bournemouth says his bees have gathered a lot of stores from the flowers in the gardens only. Bournemouth is mostly pines (the Scotch fir and pine aster), and they could not get stores from them; it is from the many and varied flowers in the beautiful gardens that so many wealthy people plant; it seems a continual feast for the bees.

There seems to be quite a dearth of bee goods. Boxes of sections ordered months ago cannot be got; bars are not to be had anywhere. Motoring from centre to centre not a bar or section can be got. It seems a great boom in bees is going on in Dorset, so many are increasing their stocks. A Wimborne dealer sold his last hive on Friday. Telegrams do not hasten the goods along. Cheques sent in advance do not get the goods, so stocks must be scarce. I have always found that a cheque will get the stuff, if it is to be had in the country. We shall have to co-operate, and have our own factories to make and distribute bee goods if these cannot be produced by individual traders. — J. J. KETTLE.

### Jottings from Huntingdonshire

Nature; how she astonishes us with her witchery! She has smothered most of our garden roses with blight, but the roses of the hedgerow she has given us clean, pure, and lovely. Did one ever see such wreaths and garlands as those covering our hedges to-day! Rose pink, shell pink, shaded pink, cream, yellow, white roses are rambling over the hawthorns as if to say to them, "You've had your show, now it's our turn." Beautiful flowers; who first called you the dog rose? I have heard it said your original name was God rose—how applicable—but that some one, fearing to use the sacred name, reversed the spelling of the word. Was it so? Perhaps, and perhaps not. Yet who could gaze into a wild rose bush resplendent in glory without thinking of the Creator?

I had to cycle some 15 miles into Northamptonshire the other day. Going I took the high road, but returning I sought out an old way the ancient Britons and the Romans trod. Maybe, parts of it would be uncycleable, but I meant to find it and follow it. I struck it quite easily, and it has still a fair surface. As I wheeled away from all human sounds I felt the subtle power of Nature drawing me to herself. I cycled on, and dived into Nature's very soul. The beauty of it all. No county surveyor had chanced this way, bidding the farmers level the roadside hedges within a yard of the

ground, therefore the roses grew unchecked, and methinks a fairy had passed on before me and tipped their petals with shades of beauty and filled their blossom with richest scent. Here and there a bush was half hidden by a buckthorn, so that only the morning sun smote upon its delicate flowers, just sufficient to wipe away the dew tears and then leave the petals to charm one with their delicate shades of pink. How lovely! One almost felt tempted to throw oneself on the sward beneath these wreaths of roses and dream romances and imagine things that cannot be described in words. The road descends; at the bottom of the decline a little rivulet flows—so tiny, yet so cool. Not more than 6 feet wide, the roses and the elders clasp hands across its waters, and so create a picture such as make poets sing. I stop. To peep at such a scene and leave it was impossible. One must stay and drink it all in. I watched one bush closely for signs of bees. Yes, they came; but not the insects of skep and hive. Bumble bees, miner bees, tapestry bees, and even the little osmian came along, but no Italian, no Dutch, no Brown or Black Natives. I wondered how near was the nearest hive. Perhaps nearer than I thought; it is no new thing for hive bees to leave the dog roses to bees of the wilds. I start off again. Another mile I pass a cottage—an old-world thatched cot, with windows blazing red with geraniums and pelargoniums. The garden path was lined with lilies and yellow eschscholtzias, anchusas and forget-me-nots. An archway o'er the doorway was smothered on one side with clematis, the other with a rambling rose. 'Neath the archway sat a dear old soul in a blue print sun-bonnet shelling peas. It was such a cottage and garden that one so often sees in pictures, but one thing was lacking—a skep. How incomplete these cottage gardens look without a skep or two of bees! I ventured to ask the good lady two things—one, how far she is from the next house or cottage; two, had she ever kept bees? A mile and a half was my first question answered; to my second a long tale was told. They used to keep bees, three skeps, and they did main well, but a grandson got killed in the war five years ago and Maggie forgot to turn the skeps, and never said owt to the bees about it, and they all died that winter. I listened, and smiled, and yet hadn't the heart to ask the dear old soul about her superstition. Would she believe me? Might I not appear as a pagan did I dare to attempt to prove that, maybe, "I.O.W." disease had something to do with the death of the bees. I sympathise, and begin admiring the view and her garden. She has lived alone with Nature

so long that to take her from it would be death. "A bit akkerd, sir, when you wants to get to stitions and shops, but I 'ouldn't like to leave the old place; it seems part o' meself, like." The old lady spoke only too truly. She helped to complete the scene; she was in her right setting. The soul of the country and the soul of a woman who had grown grey in years are well knit. How hateful motor-cars, trains, even bikes, seem in comparison. We dash here and there, and don't pause to commune with the beauties a-trailing round our doors. I would make the old lady still happier by fixing her up with bees, so that their soothing hum might be heard among her flowers, but she felt too old to start again, and her old man was getting past looking after them, yet there were many bumble bees about, and they pleased her with their hum.

Forming nuclei has been the feature of this week's work and renewing supers. Home some stocks do work! My No. 5 stock rebuked my negligence only yesterday. Supered a fortnight ago, they had filled twenty-one sections, eaten a hole through the quilts, and began comb building between the section and hive sides.

Alsike and field peas are the chosen flowers of this week with the Italians, white clover with the Dutch. The limes, out all too early, are ignored, as are the first bramble flowers. Bees know what they are about: they gather from where the nectar flows freest, and they much prefer some colour to the insipid shades of lime.—E. F. HEMMING, Steeple Gidding.

---

## The Apis Club.

The first general meeting of the Apis Club was held at the Central Hall, Westminster, on May 29. Mr. J. B. Lamb, Chairman of the Middlesex Bee-keepers' Association, presided.

There were present representatives of various associations and firms in the appliance trade, as well as a fairly good attendance of individual members, in spite of the advance of the bee-keepers' season, which meant inconvenience to the busy men who attended, and hindered others from doing so.

After communicating to the meeting messages of regret at inability to attend from the Rev. John Beveridge, Messrs. T. W. Cowan, Gilbert Barratt, J. Herrod-Hempall, and Thomas Holt, the Chairman paid a high tribute to the character of the work and the manner in which it has been conducted for the past year in the face of exceptionally difficult circum-

stances. Amidst cheers he emphasised the high idealism which informed the Apis Club movement and its fitness to survive.

On behalf of the Organising Secretary, Mr. A. F. Harwood, who visited the club headquarters on several occasions and examined its books and files, was called upon to review the work for the year and to give a statement of accounts, which latter showed a deficit of approximately £900. The Chairman read a communication from Mr. Thomas Holt on the organisation of the club, but the time of the conference was occupied by a lengthy financial discussion, in which—and in the rest of the proceedings—Dr. Abushâdy took part.

The conference felt that a public scheme of the character of the Apis Club could not prosper without the patronage of the whole craft. Since already fourteen bee-keeping associations in the United Kingdom, apart from societies abroad, have shown practical interest in the movement, this indicated a good beginning. But as no constructive proposals were available for greater development, it was felt that the meeting could not proceed with formulating plans and arriving at concrete proposals there and then. The following resolution was therefore passed unanimously:—"That as it is the opinion of this meeting that the Apis Club should be maintained and that its official organ should be *The Bee World*, a committee shall be appointed to go into ways and means with the founders and make arrangements with them to carry on *The Bee World*, if that course be possible, and to formulate the future of the club."

The members appointed were as follows:—Miss Annie D. Betts, Messrs. R. R. Babbage, Gilbert Barratt, A. F. Harwood, C. P. Jarmar, Dr. T. D. Newbigging, and Mr. R. Whyte.

This committee afterwards held a long sitting at the office kindly placed at their disposal by Mr. D. Fielden, in consultation with Dr. Abushâdy (as inaugurator of the movement) and Mr. Robert Lee (on behalf of Adminson, Ltd., who have strongly supported the work during the first year).

The Committee, after canvassing various proposals, finally suggested to Dr. Abushâdy that Messrs. Adminson, Ltd., be approached with a view to enlisting their further support. This was considered to be the only practicable means of safeguarding the existence of *The Bee World* and permitting the rank and file of bee-keepers to have a share in the shaping of its policy while establishing it on business lines.

A sub-committee consisting of Dr. A. Z. Abushâdy and Mr. A. F. Harwood was appointed to revise the constitution of the

club in the light of present circumstances. These gentlemen reported that it would be advisable to continue the present status for another year and to hold a second conference early in April, 1921, so as to give an opportunity to the then members, either to develop the club as an international co-operative as well as academic institute or to limit its character and scope to the latter with a modified constitution.

The members of the Select Committee feel it their duty, in view of the exceptionally heavy responsibility with which Dr. Abushâdy is still charged, to urge the bee-keeping public in the United Kingdom, as well as their confrères abroad, to do their very utmost to assist him in bringing the good work to which he is whole-heartedly devoted to a triumphant issue.—(Signed) A. F. HARWOOD, Official Reporter to the Conference.

### Keeping Quilts Clear of Propolis.

I am honoured by Mr. Richard Amies noting my idea, and I have the pleasure to explain this subject, which he will find a boon.

I don't think he noticed, in one of my articles about this idea, I said I first put a wired honey board over the brood nest. This board is a bee escape, but instead of being solid wood has a double fine wire each side of the middle, which has a narrow piece of wood running in the centre where an escape is placed, or a solid bit of tin, or a bit of queen excluder. This super-clearer gets bees out of supers quicker than the ordinary solid board as they see their pals below, and don't lose the smell of the hive. One can introduce a swarm over the hive, keeping it two days, then take the cork out of the mouth of the escape and they unite peaceably without flour or scented syrup. By putting this over the brood the deep side down one can see bees and subdue them, or feed them through the hole, or place tin, which clips on with two wire ends, over hole for wintering.

Now over this go two calico quilts with feed hole with flaps, on these the same with unbleached calico; on this four bits of wood broken frame, and a folding cork quilt laid on. Over all, a thin bit of flaxen sacking. The entrance, 8 inches wide, with Silver's non-dwindler, so as to stop draught. The air comes up through the cluster warmed, and goes up through the quilts, any moisture being taken up by the cork quilt, the whole being left alone till March. By lifting one side of cork quilt and putting one's

hand under, a nice, warm feeling comes to the hand. In February one can put candy over by sliding the tin away and see by the glass if finished, not moving too many quilts.

I won't mention maker's name, but if Mr. R. Amies will do me the honour of sending me his address, or any one interested, I will give some very useful tips I have found out by study which increase the strength of stocks in the autumn. I admire Mr. Amies' unselfish wisdom by honey feeding in the autumn. If he does what I have explained he will find his quilts pure white and clean, dry-combs and lots of honey, baby bees and brood.—CYRIL TRECROFT, Penylan Cottage, Penylan, Cardiff.

### Notes on Bee Keeping.

The honey bee in this country has been so long associated with the old straw skep that old-fashioned bee-keepers have given up the idea long ago as to any other form of outward architecture, and are assured in their own mind that straw is, and always has been, the material from which its home has been, and ought to be, constructed. So convinced were these bee-keepers of this, that upon the advent of wood hives they dubiously shook their heads and predicted a complete failure, simply because a straw hive was, according to their ideas, a more natural dwelling. I am frequently astonished even at some of our more advanced bee-keepers upholding this theory. Did our forefathers of generations ago make straw skeps? I venture to suggest that they did not; but, like many other uncivilised tribes of their day preferred to take their honey from holes in trees, where the bees' natural home is to be found. Wood in a majority of cases, not straw, is the bees' choice of architecture. Movable comb hives are made of wood. It is not my desire to assert that in all cases the inclination on the part of the bees to build their combs in hollow trees, is strictly adhered to, but will simply say that any hollow place, be it in wood, stone, iron, brick or any other place that will keep out the rain is the bees' natural habitation. Straw would be useless unless specially fashioned by man, and would be the most unlikely material in which we should expect to find a colony of bees. In our Colonies there are just a few varieties of the genus *apis* who construct their combs without any covering under the limbs of trees and shrubs, notably *Apis dorsata* of India and Ceylon (one wishes it could be acclimatised with its worker cells as large as

our English drone-cells—and a famous store of honey). There are exceptional cases in England among our ordinary native bees here and there of such occurrences (I saw a case a while ago), but successful wintering could never be accomplished under such conditions. There must be no cold draught, dampness, frost, etc., allowed to enter the hives if they are to stand the hardness of winter and come out in spring AI. No doubt it is because of the above that bees are taught by Nature to propolise their hive, as autumn is the time when this generally takes place to keep out the severe weather expected during winter. It is this that causes the messiness on the calico quilts next to the bees mentioned by different writers. What is propolis? This is another material collected in addition to honey and pollen by the worker-bee—not produced by the bees—principally from buds of resinous trees and shrubs, such as firs and horse-chestnuts, and packed by them in their pollen baskets. When taken to the hive it is removed by the other bees, and drawn out into thin lines and then used to stop up crevices, affix loose portions of the hive, and cover over any noxious substance that is too heavy for removal from the hive, thus forming an hermetically sealed casing. From the above, one cannot expect clean quilts at the end of a season. The difficulty with me is not the fastening down of the calico quilts, etc.: it is the gnawing into holes of these by the workers. It is generally a case of having to renew same at the end of each season. Perhaps some kind bee-keeper could give a hint how to prevent the bees from damaging these quilts? — P. LYTHGOE, Padgate, Warrington.

---

### British Bee-Keepers' Association.

The monthly meeting of the Council was held at 23, Bedford Street, Strand, London, W.C.2, on Thursday, June 17, 1920.

Mr. W. F. Reid presided, and there were also present:—Miss M. D. Sillar, Messrs. F. W. Watts, W. H. Simms, G. S. Faunch, G. Bryden, G. J. Flashman, J. Herrod-Hempsall, F. W. Harper (Association representatives), H. Stroud (Essex), E. G. Waldoek (Hants), R. R. Babbage (Middlesex), E. Ff. Ball (Bucks), and the Secretary, W. Herrod-Hempsall.

Letters of regret at inability to attend were read from Messrs. T. W. Cowan,

A. Richards, W. E. Moss, A. G. Pugh, C. L. M. Eales, and G. W. Judge.

The minutes of the previous meeting were read and confirmed.

The following new members were elected:—Lady Anderson, Messrs. C. S. Crutchfield, J. S. Leigh, and R. W. Frow.

The Dorset Bee-keepers' Association applied for affiliation, and were accepted. The Eastbourne Association applied for affiliation, but the request was not granted.

The Herts County Association nominated Mr. F. L. E. Watts as their representative, and he was accepted.

The report of the Finance Committee was presented by Mr. G. Bryden, who stated that the receipts for May were £19 14s. 9d., and the bank balance on June 1 was £137 11s. 1d. Payments amounting to £76 11s., were recommended.

The report on the Preliminary Examination held at Salisbury was presented, and it was resolved to grant certificates to Lady Katharine Bouverie, Miss E. J. Hardy, Rev. B. Wright, Messrs. Edmunds, Bates, Wright, Ashworth, Miles, and L. Pinder.

The Cheshire, Bucks, Gloucestershire, Aberdeenshire, Worcestershire, and Cumberland and Westmorland Associations applied for Preliminary Exams., and all were granted.

Mr. C. H. Bocoek wrote offering to procure three volumes on bee-keeping from America for the library. The offer was accepted, and a hearty vote of thanks was passed to Mr. Bocoek for his kindness.

The retail price to be charged for good English honey was discussed, and it was considered that 2s. 9d. per pound for extracted honey and 3s. 6d. for finished sections, both without packages, would be a fair price for the present season.

Next meeting of Council in the Hives and Honey Department, Royal Show Ground, Darlington, on Thursday, July 1.

---

### The Bath and West Show.

#### BEE DEMONSTRATIONS.

The throngs of people who visited the show during the five days included a large number interested in the ancient craft of bee-keeping. The Ministry of Agriculture and Fisheries, with a desire to cope with the shortage of sugar, are doing their best to encourage the gathering of honey from our own sources, instead of having to buy from abroad, which has been done of late to the extent of three times as much as we have produced in this country. The Ministry are also framing a Bill to introduce into Parliament, dealing with bee

diseases. The Ministry are using two organisations to carry out the work, namely, the County Agricultural Education Committee and the County Bee Associations. The Wilts Agricultural Education Committee, through its secretary, Mr. C. H. Corbett, and the Salisbury Beekeepers' Association organised the bee work at the Bath and West Show with excellent results. Miss E. J. Hardy, secretary of the local Bee-keepers' Association, Mr. J. E. Pinder, adviser and member of the County Bee Committee, and Mr. Cockram, county bee expert, had charge of the arrangements. The exhibition of bee products, bee-keepers' appliances, and remedies for bee diseases were shown in the County Council's gallery of forestry. Much interest was shown by the crowds who passed through the gallery in the golden honey, the photographs of bee-masters at work, cakes sweetened with honey, charts giving the anatomy of the bee, and the variety of appliances and nives where the bee community garner the honey. Those contributing to the display were Mr. Alexander, of Fordingbridge, and Mr. E. C. R. White, Winterbourne, honey and wax; Mr. J. R. Spencer and Mr. H. Ruffell, of Netherampton, photos; Mr. Ridghalgh, of Salisbury, a fine show of Flavine, an antiseptic and remedy for bee diseases; Mr. Cockram, charts; Miss E. J. Hardy, appliances; Mrs. J. E. Pinder, cakes; and Mr. J. E. Pinder, hives and appliances. The Wilts County Council Bee Tent gave much interest and pleasure to those seeing the operators handling and explaining the work of the bees as though they were domestic pets. Demonstrations were given each day, and on Friday and Saturday the bee-keepers visiting the show were privileged to hear Mr. J. Herrod-Hempsall, editor of the BRITISH BEE JOURNAL and BEE RECORD. His visit to the show was for the purpose of examining eight candidates of the local Beekeepers' Association wishing to gain third-class certificates for knowledge in bee-keeping. Mr. Herrod-Hempsall expounded the work and habits of the honey-bee with the ease of a master of the craft. In the evening he lectured to bee-keepers at the Church House, Crane Street, the Hon. Louis Greville, the president of the Salisbury Association, presiding. The crowd that entered the show ground on Bank Holiday kept the workers at the bee tent busy. Mr. J. E. Pinder, B.B.K.A. expert, of Salisbury, gave two demonstrations with the bees, keeping the audience keenly interested while dealing with the mystery and clever work of the honey-bee in the sweltering heat of the summer day. Many questions were answered and difficulties cleared away, and the operator at the close was given an ovation. Mr. Cock-

ram, the county expert, gave demonstrations on the other days of the show, which were of much value to those about to start bee-keeping. Literature on food production and bee-keeping, prepared by the Ministry of Agriculture, were distributed during the days of the show. As a result of the combined efforts of those who took part, the future should find the hum of the honey-bee in many a town and countryside garden and orchard.—(*Communicated.*)

### Monmouthshire Bee-keepers' Association.

An interesting demonstration was given in the garden at Magor House, Magor, on the 17th inst. Dr. Strong was the demonstrator, and gave an explanation of some of the rudiments of the apiary to a number of schoolboys, in charge of the head master (Mr. Barber). More advanced subjects were explained to a large gathering, in which all parts of the county were represented, and at the close tea was kindly dispensed by the hostess (Mrs. Strong). Among prominent bee-keepers present were Rev. H. G. Stanley, Ald. Graham White, Mrs. Tom Jones, Abergavenny, Mrs. Colborne, Mrs. Llewelyn Morgan, Colonel Walwyn, Messrs. Tylor, Taylor, Jackson, Lusty, and Heighton, besides a number of local ladies and gentlemen interested in apiculture.

### Corsham and District Bee-keepers' Association.

The second meeting of the season was held at Mr. Golding's residence, Pickwick, on Wednesday, June 9, when the following members were present:—Admiral Sir C. Briggs (President), Messrs. Ray, Ottaway, Funnel, Brown, Ashe, Brain, and the Secretary (Mr. W. Golding). Two new members were also present—General Lord Methuen and Mr. Brown's son, aged 14.

The financial account for 1919 and the minutes of the last meeting being confirmed, the re-stocking scheme was considered. Six four-frame nuclei were allotted to members, obtained from a hive presented last season by Colonel M. G. Talbot, who we regret has left the district.

This Association, although only formed last season, promises to be a success in giving an impetus to the industry, the membership already representing Corsham, Chippenham, Hartham, Biddestone, Yatton Keynell, and Ford.—(*Communicated.*)



### Two Eggs in One Cell.

[10206] Will you kindly tell me the reason of this. Readers (others than myself) would be glad if the Rev. E. F. Hemming would tell us the name of his "tapestry" and "miner" queens, page 254, BRITISH BEE JOURNAL.—M. E. B.

[Two—or more—eggs are laid in a cell when a colony is weak in bees. The queen produces and lays eggs beyond the capacity of the bees to cover and keep warm if only one was laid in a cell. She has to rid herself of the eggs, and as she will not lay outside the cluster of bees several are deposited in a cell. We have seen up to seven in a number of cells under those conditions.—Eds.]

### Fraternity Among Bee-Keepers.

[10207] I have been a bee-keeper and weekly reader of the BEE JOURNAL for twenty years.

During that period I have taken great interest in and derived much valuable help from its pages. The "Isle of Wight" disease, introduced into the district, robbed me some eight years ago of thirty hives—all I had in that apiary. Fortunately, six hives were on the other side of the valley.

For four years these worked well, but inadvertently placing an old comb in one of the hives, the disease started here, with the result that all were dead in two years, after struggling vainly with remedies.

By the purchase of swarms, seven hives were strong in the autumn, but all succumbed before the following Easter. Again I tried last year with a similar number, but I have not a bee left.

Now, Sir, from reading the JOURNAL. I have come to the conclusion that my experience is not a solitary one, and, knowing how kinship and mutual help are engendered by similarity in distress, I inserted an advertisement in your publication asking for swarms or nuclei (Italians), stating that all bees were dead and asking brothers to help, hoping in this way to secure bees immune from disease.

I asked for no gift, expected none, desired none.

Only three replies were received, and only one with swarms and nuclei as requested. I am an optimist by nature, but I cannot understand this indifference to

appeal among brother bee-keepers throughout the country.

Has the war made us callous?

I have ordered six nuclei, so that I am not making any appeal except that the old spirit of fraternity which before the war was so eminently manifest may again become operative in the bee world.—"Cross."

[There are exceptions to every rule, but, speaking from our own experiences the last few weeks, we are certain the "spirit of fraternity" is still very much alive, though our correspondent appears to have been rather unfortunate. We shall be pleased to hear what others have to say on the subject.—Eds.]



WISDOM (London, S.W.).—*Birds eating bees.*—We are afraid the only remedy at this time of year, if the birds are very persistent, is to shoot them. *Swarm returning to hive.*—The queen refused to leave the hive, or was lost.

MISS BARKER (Ulverstone).—*Bees killing drones.*—There is nothing wrong with the bees; it is owing to unfavourable weather, or shortage of food—or both.

J. V. THORN (S. Wales).—(1) The queen was fertile. (2) Probably a last year's queen. (3) The bees have probably superseded her; we cannot say why. (4) Italian.

*Suspected Disease.*

T. HENSHAW (Essex).—We cannot find disease in the bees sent.

M. M. (Knowle).—The bees have "I.O.W." disease. DUTCY (Worcs.).—We cannot account for the death of the bees.

## Bee Shows to Come.

**June 29 to July 3, at Darlington.**—Royal Agricultural Society's Show, Bee and Honey Section, under the direction of the B.B.K.A. Prizes arranged in groups of counties for Associations affiliated to the B.B.K.A. Schedules from The Secretary, 23, Bedford Street, Strand, W.C.2. Entries closed.

**July 6, 7 and 8, at Cardiff.**—Royal Horticultural Society's Show. The Glamorgan B.K.A., in conjunction with R.H.S., offer prizes for Honey, Wax, Bees, and Appliances. Members, Novices, and Open Classes. Schedules, Mr. Wiltshire, Maindy School, Cardiff. Entries closed.

**July 14.**—Wickham Bishops and District Beekeepers' Co-operative Association. Group 2.—Open to bee-keepers resident in Essex. Class 79.—Four Sections; 1st prize, 7s. 6d.; 2nd, 5s. Class 80.—1 lb. Extracted Honey; 1st prize, 5s.; 2nd, 3s. Class 81.—1 lb. of Wax (in 2-oz. cakes), 1st prize, 5s.; 2nd, 3s. Group 3.—For bee-keepers' resident in the British Isles. Class 82.—1 lb. glass jar of 1920 Run or Extracted Honey; 1st prize, 20s.; 2nd prize, 10s. 6d. Exhibits in Class 82 to be the property of the Association, and to be given to hospitals in County of Essex. Entrance fee 6d. per class. Rules for exhibiting on back of entry form.—All entries to be sent to C. W. Cockburn, Hon. Sec., Meadow Bank, Wickham Bishops, Witham, Essex. Entries close July 2.



**July 15 and 16, at Grimsby.**—Lincolnshire Agricultural Society. Show of Bee Appliances, Honey, Sections, Wax, etc., under the management of the Lincs B.K.A. Open and County Classes. Valuable prizes.—Schedules from Major Hafield, Alford, Lincs. Entries closed.

**July 17, at Guildford.**—Guildford and District Bee-keepers' Association. Members and Open Classes.—Schedules and prize list from Rev. E. C. Pitt-Johnson (Hon. Sec.), Heatherwood, Pirbright, Surrey. Entries close July 3.

**July 20 to 23, at Aberdeen.**—Highland and Agricultural Society. Classes for Bee Appliances and Honey. Premiums £53 10s. Half of Prize Money and Silver and Bronze Medals contributed by the Scottish Bee-keepers' Association.—Entry forms from John Stirton, Secretary, 3, George IV. Bridge, Edinburgh.

**July 21, at Broughton, Hants.**—Open Classes: Single 1-lb. Bottle, Single Section; prizes, 20s., 15s., 10s.—Schedules from Chas. Hoare, Broughton, Hants.

**July 21, Wyke and Normandy Horticultural Society.**—Honey Classes (Open). Best three sections, 5s., 3s., 2s.; Run Honey, light, 3 1-lb. glass jars, 5s., 3s., 2s.; Run Honey, dark, 3 1-lb. glass jars, 5s., 3s., 2s. Entrance fee, 6d.—Particulars, H. L. Mumford, Hon. Sec., Heatherside, Normandy, Guildford.

**July 23, at Blandford.**—The Blandford and District Horticultural Society are holding a Show of Fruit, Vegetables, Flowers, and Honey in the Park, adjoining the Crown Meadow, Blandford. Prizes for honey by the Dorset B.K.A. for members of the Association.—Schedules from C. G. Bone (Dorset Bee-keepers' Association), County Education Office, High West Street, Dorchester.

**August 2, at Bredon.**—Annual Show of the Worcestershire B.K.A. Three open classes. Schedules from Geo. Richings, 42, Barbourne Road, Worcester. Entries close July 26.

**Monday and Tuesday, August 2 and 3, at Newport.**—Monmouthshire Bee-keepers' Association Annual Show (in connection with the Newport Allotment Holders' Association). Members and Open Classes.—Schedules (post free 3d.) from Hon. Sec., "Underwood," Portskewett, near Chepstow, Monmouthshire. Entries close July 26.

**August 4, at Shedfield, Hants,** in conjunction with the Shedfield Horticultural Society's Show, Hants and Isle of Wight Bee-keepers' Associations. Swanmore and Bitterne Branches. Classes for Comb and Extracted Honey.—Schedules from the Hon. Sec., A. F. Hardy, Esq., The Palace House, Bishop's Waltham, Hants.

**August 7, at Barnstaple.**—Barnstaple and District Horticultural Exhibition, to be held in the Market Hall. Five Open Classes for Honey.—Schedules from Hon. Secretary, 19, Grosvenor Street, Barnstaple.

**August 11, at Wye.**—Kent Honey Show. Thirty classes, half of which are open to U.K. Four Silver Cups and 75 other prizes. Schedules, Mr. A. Lepper, Wye. Entries close August 1.

**August 14 and 16, at Cannock, Staffs.**—Eight open classes for honey, etc. Prizes value £12. Schedules from J. Bird, Secretary, "Glenmay," Alport Road, Cannock.

**August 12, at Taunton.**—Somerset Bee-keepers' Association Show of Honey, Wax, and Appliances. Seven Open Classes. Liberal prizes.—Schedules from Mr. F. J. Stacey, 3, Hammet Street, Taunton. Entries close August 6.

**August 14, at Llanelly.**—Carmarthenshire B.K.A. Show, in connection with the Llanelly and District Horticultural Society's Show. Liberal prizes (nearly £15) offered for Honey, Wax, and Appliances. 15 Classes (7 Open).—Schedules from R. Lloyd Roberts, London Joint, City and Midland, Llanelly. Entries close August 6.

**Saturday, August 28, at Hinckley.**—Leicestershire and Rutland Bee-keepers' Association, in connection with Hinckley Flower Show.—Open Classes for Honey, Sections and Jars. Prizes, 12s. 6d., 7s. 6d., and 4s. 6d. in each class. Judge, J. Herrod-Hempsall, F.E.S.—Schedules from A. Kimbrell, Esq., Clarendon Road, Hinckley. Entries close August 23.

**November 18.**—Annual Show of the Worcester City and County Chrysanthemum, Fruit, Root and Honey Society. Thirteen open classes in Honey Section. Schedules from Geo. Richings, 42, Barbourne Road, Worcester. Entries close November 6.

**Special Prepaid Advertisements.**  
One Penny per Word.

**PRIVATE ADVERTISEMENTS.**

**WANTED.**—Honey Extractor and Ripener.—Full particulars and price, DUXSON, 8, Hurst Road, Walthamstow. f.135

**OVERPLUS BEES FOR SALE.**—Apply early, strict rotation, enclosed stamped envelope particulars.—BARUCH-BLAKER, Warrilow Apiary, Barnham, Sussex. f.136

**FOR SALE.**—Pure and Hybrid Italians, strong stocks, Penna's strain, 8, 10 frames, 10s. per frame; also strong Blacks, 10 frames, £4; travelling box returnable.—VARLEY, Abbottsacre Lodge, Winchester. f.137

**TWO SPRING CRATES,** hold two dozen sections each, 10s.—NORTH, Cressing, Braintree, Essex. f.138

**FINEST GOLDEN HONEY SWARMS** booked, marked immunity from disease; particulars, stamp.—NORTH, Cressing, Braintree, Essex. f.139

**GOOD SECOND SWARMS,** 25s. carriage paid; boxes to be returned.—BUTLER, West Rd., Histon. f.139a

**NEW LIGHT CAMBRIDGESHIRE HONEY** for Sale, £9 10s. per cwt.; 1 tin 50s., tins and carriage free; cases to be returned; sample 6d.—WELLS & CO., Bowers Lane, Isleham, Cambs. f.140

**SPLENDID New White Clover Honey,** £10 per cwt.; sample 6d.; tins to be returned.—ALBERT COE, Apiarist, Ridgewell, Halstead, Essex. f.148

**FOR SALE.**—Strong stock Hybrid Italians, in new Conqueror hive, supered, £7 10s., nearest offer.—WATTS, Lamer, Wheathampstead, Herts. f.142

**ONE Second-hand W.B.C. and two Cottage Hives,** clean, five Shallow Boxes, three Section Racks, sale £3 15s. lot, or separate.—D. J. HEMMING, Runcorn. f.143

**WANTED.**—Good stock or two swarms in hives. Native bees preferred, in exchange for prize breeding pen of Taylor's White Runner Ducks (six and drake), or sell one guinea each (seven pounds the lot).—W., 25, Napier Road, Wembley. f.144

**PURE, LIGHT ENGLISH HONEY,** 28lb. tins, 42s.; sample 6d.—T. TUDOR, JUN., 20, Spring Cottage, Little Drayton, Market Drayton, Salop. f.145

**STRONG 10-frame Stocks,** Italian Hybrids, ready for supers, £4 10s. each; box 10s. returnable.—ERNEST GRIFFITHS, Helsby, Cheshire. f.146

**FIVE STOCKS Hybrid Italians,** 1919 Queens, healthy, £4 10s. each, on 10 frames; boxes returnable.—NICHOLSON, 176, Thorpe Road, Norwich. f.147

**TWO HYBRID ITALIAN STOCKS,** on 10 frames, 1919 Queens, guaranteed healthy, £4 10s. each, travelling box 10s., returnable; English Honey, 28 lb. tins, £2.—WALLIS, 211, Lower Road, Rotherhithe, S.E. f.150

**ROOTS** "A.B.C. of Bee-Culture," latest edition, split new, 3 doz. Simmins frames; accept best offer.—A. SMITH, 6, West Castle Road, Edinburgh. f.179

**FOR SALE**.—Pure English Honey, £9 cwt., carriage paid.—H. CADDY, Buckhorn Weston, Wincanton, Somerset. f.149

**FRESH STOCKS DUTCH BEES**, healthy; purchaser sends box, 7s. frame and carriage; Hives, etc., cheap.—Write, MATRON, Croydon Borough Sanatorium, North Cheam, Sutton Surrey. f.151

**WANTED** to Sell at once, three Hives of Bees and two Swarms; all very healthy; Dutch Italians, 15, Waldegrave Gardens, Strawberry Hill. f.152

**WANTED**.—Honey Extractor; state make and condition.—I. HOWARD, The Commons, Rayne, Essex. f.153

**WANTED**.—Geared Cottage Extractor and Ripener, in good condition; moderate price.—RALLI, Shalford, Surrey. f.154

**STOCKS**.—10 frames, ready for supering, £3; with hives, £4 10s.; travelling box 10s., refunded on return; carriage paid.—CULLEN, Bull Hill, Great Clacton. f.155

**SPLENDID** New White Clover Honey, £10 per cwt.; sample 6d., tins to be returned.—ISAAC SOUTHERLAND, East View, Brancaster Staithe, King's Lynn, Norfolk. f.156

**SWARMS**, 25s. to 35s., according to size; Swarm on 3 standard frames, 25s., carriage paid (7s. 6d. deposit on box returnable); guaranteed healthy.—STANLEY, 56, Montague Road, Cambridge. f.157

**FOR SALE**.—A Simmins Conqueror Hive, standard frames, 3 crates, complete, in use for 2 years.—HOLLAND, Cornhill-on-Tweed. f.158

**SEVERAL** Surplus Stocks of Natives, on 10 frames, very strong, £4 10s. each.—WRAY, Thorpe Bassett, Rillington, York. f.159

**SWARMS**, strong, healthy, ready for despatch, 24s. carriage paid; boxes returnable.—PULLEN, Ramsbury, Hungerford. f.160

**FOR SALE**, several stocks healthy Bees, supered, £4 10s. per stock.—GIDDINGS, South Mimms, Barnet. f.182

**SALE**.—Exhibitor proceeding abroad; complete Apicultural Requisites, including Plate-glass Trophy, Observatory, and other Hives, Extractor, Smokers, etc.; half catalogue prices.—SWABEY, Bracoberidge Heath, Lincoln. f.162

**REMAINDER** of a small Apiary, Italian-Dutch, thoroughly healthy 1920 Queens, and consisting of 2 double brood Hives, 4 single, and 2-5 frame Nuclei Hives; will divide; what offers?—ETHERINGTON, Pulham-Mary, Norfolk. f.163

**BASSES** selected Fish supplied, carriage paid, exchanged for Swarms.—ELVIDGE, Wholesale Fish Merchant, Grimsby. r.f.164

**WILL** exchange good Hives for Swarms.—PRPSLEY, Bakestone Moore, Whitwell, Mansfield, Derbyshire. f.177

**BRITISH** HYBRIDS, colonies in Skeps, 57s. 6d.—PRYOR, Breachwood Green, Welwyn. r.f.178

**SALE**, strong hive, new last year.—MISS BIRKBECK, Kirby Stephen. f.183

**FOR SALE**, Second-hand all guaranteed clean exceptionally well made W.B.C. hives, with oak legs; also combination hives, £2 each; well-made shallow frame boxes, 3s. each; Queen excluders, 1s. 3d. each.—DAVID HANCOX, Grove Lodge, Deddington, Oxon. f.181

**IMMEDIATE DELIVERY**.—A few 5-frame stocks Italians with imported Penna Queens, guaranteed, £3 5s.; box 10s., returnable. Also Italian virgin Queens, Penna mother, 4s. 6d.—Box 91, B.B.J. Office, 23, Bedford Street, Strand, London. f.180

**HONEY**, extracted.—Two 28lb. tins prime Berkshire, 27s. 6d. each.—BOWREY, Swallowfield, Berks. f.172

**TWO** strong Stocks of Italian Hybrids on eight frames, filled with brood and store, guaranteed healthy, £4 each, carriage paid; boxes 7s. 6d. extra, returnable. Deposit system if desired.—MAY, "Lyncroft," South Nutfield, Surrey. f.97

**DUTCH VIRGIN QUEENS**, 4s. 6d.; fertile, 8s. 6d., from County Restocking Apiary.—ANDREWS, Expert, 78a, Westgate, Peterborough. f.100

**THREE** nearly new Uncapping Knives, 3s. 9d., postage 6d. each; Subjigator, as new, 4s.; 2 W.B.C. Uncapping Knives, 3s. 9d. each, postage 6d. See Trade Advert. for Bees.—W. WOODS, Normandy, near Guildford. f.101

**FOR SALE**, two "Rotax Roadlight 267" self-contained Acetylene Motor Headlights, very powerful, £6 the pair; one Exhaust Whistle, 10s.; one Wood-Milne Motor Foot Pump, 40s.—W. HERROD-HEMPSALL, Old Bedford Road, Luton, Beds.

**WANTED**, by experienced man, situation as Manager apiary or bee department of nursery or fruit farm.—Particulars, "J." Box 89, B.B.J. Office, 23, Bedford Street, Strand, W.C.2. f.105

**SEVERAL** surplus Stocks of Italian and Hybrid Bees for Sale, 10 frames (Penna strain), £4 17s. 6d., carriage paid; 10s. on box, returned on receipt. Inspection invited.—H. OBORNE, 25, Guest Road, Bishopstoke, Hants. r.f.68

**CORRESPONDENCE COURSES** in Bee-keeping.—H. E. NEWTON, Brown House, Barton-on-Sea, Hants. r.d.157

#### BUSINESS ADVERTISEMENTS. 1½d. per word.

**PURE ITALIANS**.—Imported Penna 1920 Queens, four frames, 45s.; six, 55s.; eight, 65s.; 10, 75s. Hybrids, good strain, 5s. less. Carriage paid; boxes returnable.—WADHAM, Gold Street, Cardiff.

**FERTILE QUEENS**.—1920 home bred Natives, finest strain obtainable, immediate delivery, 12s. 6d. each; nuclei, 3-frame, £2 5s., carriage paid.—GOATH, Cottage Apiary, Endlebury Road, Chingford, Essex. f.167

**THE FLAVINE TREATMENT**.—Free samples, 12 packages, 1s.; a janned sprayer, 6s.; "Let the Bees Tell You" 2s.; a Camb's "Bee Barometer" free with all orders this week.—S. H. SMITH, 30, Maid's Causeway, Cambridge. f.168

**THE "BAIRD PATENT HONEY EXTRACTOR"** can be seen at the Royal Show, Darlington. Mr. Robert Wright, the manufacturer, will be pleased to answer all inquiries. f.169

**NUCLEI** and Swarms from £1 each, free on rail; boxes returnable or 10s.—RATCLIFF, Croft Apiary, Thaxted, Essex. f.170

**ITALIANS**.—Two good swarms, 40s. each; nuclei, strong, 3-frame, 42s. 6d.; 4-frame, 50s.; 6 frames, crowded, 70s.—BOWREY, Swallowfield, Berks. f.171

**THREE** STOCKS of Italians, on 10 frames, ready for supering, £4; Nuclei, 10s. per frame; boxes charged returnable.—HENSLEY, 24, Queen's Road, Luton, Chatham. f.141

**"WIGHT" DISEASE**, prevention and removal; advice 5s.—ALFD. RYALL, Kenwood Apiary, Elcombe, Stroud. r.f.161

**ITALIAN HYBRID QUEENS**, quiet, hardy, prolific strain, fertiles 10s., virgins 3s., by return. Satisfaction, or I replace them.—**TICKELL**, below. f.175

**3-FRAME NUCLEI**, 50s., car. paid; box 10s., returnable.—**JACK TICKELL**, Westbourne Apiary, Cheltenham. f.174

**NUCLEI**, 1920 Italian Queens, 4-frame, 50s.; swarms, Italian, 45s.; boxes 10s., returnable.—**C. HOGAN**, Boxford, Suffolk. r.f.175

**STRONG healthy Stocks**, delivery by return.—Seven frames, crowded with bees and brood. Young Queens, Penna's strain, good new combs, well wired, excellent condition for surplus, 70s.; box 10s., returnable.—**HILLMAN**, Bridge House, Stonehouse, Glos. f.176

**NUCLEI** (good hybrids), 1920 Queens; 3 frames, 37s. 6d.; 4 frames, 45s.; box 7s. 6d., returnable.—**J. FOOKS**, Normandy, Guildford. f.115

**DUTCH, DUTCH-ITALIAN** 4-frame Nuclei, only a limited number for disposal, delivery now, £3 3s., cash with orders, carriage paid. Numerous letters from well satisfied customers of this fine disease-resisting strain, Dutch-Italian Hybrids. Don't look at the price. You will be well satisfied.—**SEALE**, Ashley Cottage, Oatlands Drive, Walton-on-Thames, Surrey. f.123

**ITALIAN COLONIES**, Simmins' and Penna strains.—No more orders for colonies. A few more Nuclei offered at 45s., 3 frames certain. Members of Middlesex Bee-keepers' Association 5 per cent. discount.—**R. R. BABBAGE**, 33, Whitestile Road, Brentford. r.f.133

**NUCLEI**—Three frames, best hybrids, Penna, etc.; young fertile Queens, immediately, 42s.—**MOORE**, 31, Monmouth Road, Dorchester. f.165

**ITALIANS**—Queens, 6s.; virgins, 3s. Stamp.—**HOUSTON**, Ellen Villa, Sidcup. f.118

**3-FRAME NUCLEI**, 32s. 6d., with 1920 fertile Queen; good Stocks on 8 standard frames, 60s., with hives 90s.; boxes 5s., returnable; good Swarms from 25s.—**W. WOODS**, Normandy, near Guildford. f.126

**RE-QUEEN** with a "Lazenbee" prolific Italian. Fertile, 10s.; virgin, 5s.—**YOUNG**, One Hundred Elms Apiary, Central Road, Sudbury, Middlesex. r.f.127

**FOR SALE**, fertile Queens, hybrids, 7s. 6d., and Penna strain, 10s. 6d., post free.—**ASH-WORTH**, The Bungalow, Weymouth Street, Warminster. f.128

**ITALIAN HYBRID BEES** (immediate delivery), disease-resisting strain, 1920 Queens, 4-frame Nuclei, 45s.; travelling box 10s., returnable; Stocks from 10- to 20-frame at 8s. 6d. per frame.—**STARKEY**, 55, Stafford Rd., Brighton. r.f.134

**4-FRAME NUCLEI**, headed by 1920 Italian Queen, 50s.; box charged 10s., returnable; 6-frame Stocks, 70s.; 8-frame Stocks, 90s. Immediate delivery. All guaranteed free from disease.—**LEE**, "Little Bowden Apiary," Burgess Hill, Sussex. r.f.77

**6-FRAME STOCKS** in bar-frame hives at £5 each, free on rail; Italian fertile Queens, 10s. 6d. each. Daily deliveries.—**LEE**, "Little Bowden Apiary," Burgess Hill, Sussex. r.f.78

**PUPILS** received by life-long whole-time Bee Farmer.—Terms on application to **C. B. BARTLETT**, Sandford Mount, Charlbury, Oxon. d.127

**1920 FERTILE Golden Italian Queens**, regular supplies every few days, 11s. each; specially selected, 15s.—**GOODARE**, New Cross, Wednesfield. f.159

**ITALIAN NUCLEI**, 3 frames, packed with brood and bees, carriage paid, £2 15s.; cash with order; box 10s., returnable. Satisfaction guaranteed, or money returned. Fertile Queens, 10s. 6d.; virgins, 5s.—**E. H. TUNMER**, "Chalfonts," Leiston, Suffolk. 1.84

**"ISLE OF WIGHT" DISEASE**—Don't worry; use the solution that cures; 2s. per bottle.—**E. PRESSEY**, St. Elmo, Coulsdon. r.d.149

**HAVE YOU READ "THE BEE WORLD"?** If not, why not? Every number in itself is a useful literary work for practice and reference. Specimen copy free.—Office: **THE APIS CLUB**, Port Hill House, Benson, Oxon.

**ORDERS** booked for 3-frame Nuclei, Fertile Queens, Virgin Queens, etc. List for stamped, addressed envelope.—**H. CRACKNELL**, Mount Road, Thundersley, Essex. r.d.27

**BOZZALLA** tested Queens are sold at the price usually charged for untested queens.—Catalogue from **H. STIOH**, Biccartebar Avenue, Paisley. r.c.116

## ITALIAN QUEENS Direct from Italy.

**E. PENNA, BOLOGNA, ITA Y.**

I assume again the direct sale of my queens. Special offers from July 10 till countermanded. For queens in lots of 4 at a time £1 8s. Cash with orders. Payment by cheques or **British Postal Orders**. International Money Orders are **not** accepted. I do not hold myself responsible for the queens that are not sent by me direct to customers. All orders should be sent direct to me. In May the queens dead in the journey have been **less** than 1%  
ORDERS BOOKED IN ROTATION.

## SCIENTIFIC QUEEN REARING.

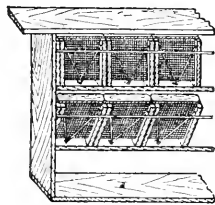

**BEST**  
in the world.  
Every  
appliance and  
Instructions.  
Send for  
**KAT-A-LOG**  
**MEADOWS**  
SYSTEM,  
Near LEICESTER.

## CLARKE'S

**I.O.W. POWDER** Cure and Preventative.

No Spraying and sure cure. Simply place a quantity on the floor board.

Extracts from testimonials:—

"I tried it on 9 stocks badly infected—and one badly infected 10 days since, swarmed yesterday. I can only say how grateful I feel to you.—Yours,  
17th June, 1919.  
"G. C., M.I.Mun.Eng."

"Please send me some more of your remedy, I cured every hive I treated last year, and one or two friends who used it speak highly of it."—Yours,  
6th April, 1920.  
"G. C., M.I.Mun.Eng."

Originals and others can be seen at any time on request.

Price 3/6 per packet, post free, enough for six hives.

**G. F. CLARKE**, Blythburgh, Halesworth,

## ITALIAN QUEENS

Direct from Italy.

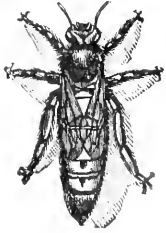

Address:  
Signor Gaetano Piana,  
Castel San Pietro,  
near Bologna, Italy.

All Queens are reared by the most up-to-date and scientific methods. Mr. W. Herrod-Hempsall has personally inspected the apiary and methods employed, with which he is perfectly satisfied.

PRICES FOR 1920.

For 1 Fertile Queen: August and September,  
9/- each queen.

Can take no more orders for June & July. Booked up.

Carriage paid in Great Britain. Cash must accompany all orders, which will be executed in rotation. Guaranteed safe arrival of all Queens, but not the introduction. Bees dead upon arrival must be sent at once to "B.B.J." Office.

For the mutual convenience of all parties, if Signor Piana has made arrangements that all communications, orders and remittances of the readers of "B.B.J." and "B.K.R." can be addressed to him, c/o British Bee Journal, 23, Bedford Street, Strand, London, W.C.2.

Cheques payable to 'British Bee Journal.'

The products of the Apiary, of Poultry and Farm Stock, of the Fruit and Vegetable Garden can be Advertised and Sold through

THE  
BAZAAR, EXCHANGE & MART

Newspaper.

Get a Copy—Thursday and Saturday 3d. The "Bazaar" publishes also practical handbooks by experts. Send for full catalogue, post free from—  
WINDSOR HOUSE, Brems Buildings, LONDON, E.C.2.

## Dutch Bees.

I am Sole Agent for Hans Matthes, the Dutch Bee Farmer who supplied the British Government last season with Skep stocks for their County Restocking Scheme.

These bees are hardy, prolific, healthy.

Send for Illustrated Catalogue giving methods of management, characteristics, honey-gathering and disease-resisting powers of this race of bee.

Address—

R. WHYTE,

The Bee Farm,

Cumbernauld, Dumbartonshire.

5 per cent. discount allowed to members of the Apis Club.

### HIVES AND APPLIANCES.

Immediate Dispatch. Quality O.K.

Write for Prices.

ANDREWS & CO.,

Joinery and Carving Works,

78a, WESTGATE, PETERBOROUGH.

THE  
British Bee-Keepers' Association.

Insure now against loss by damage done through bee stings. All particulars from

W. HERROD-HEMPSALL, 23, Bedford Street, Strand, London, W.C.2.

**BRADBURY, TAUNTON,**  
FOR QUALITY BEE GOODS.

Illustrated Bee  
Guide free.

Telephone: TAUNTON 176.

**QUEENS, NUCLEI and STOCKS of the Highest Quality.** Carefully bred from American and Italian strains of world-wide reputation. Queens raised naturally under the best conditions in strong stocks, are very vigorous and prolific. Virgins mated and selected breeding queens. Delivery in rotation. Commencing at once. **STURGES, Hartford, Cheshire.**

**ROYAL LANCASHIRE AGRICULTURAL SOCIETY'S SHOW**  
at Bolton, July 29th, 30th, 31st and August 2nd, 1920.

£30 prizes for Honey. 6 Classes.

Entries close July 5th.

Applications (stating Honey Section) to

**REG. O. BRADBURY, Secretary, Derby House, PRESTON.**



# “BACTEROL” FOR BEES

2/6 per Bottle.

Post Free.

The cure for, and preventive of,  
“Isle of Wight” Disease.  
Non-poisonous—free from stain  
or unpleasant odour.

MENLEY & JAMES, LTD.,  
39, Farringdon Road, London, E.C.1.

## PREPARE FOR EXTRACTING.

The quickest, cleanest and most efficient on the market is the “BAIRD” EXTRACTOR,  
which extracts from BOTH SIDES of the COMB simultaneously.

Particulars from G. S. BAIRD, 1, HURST ROAD, ERITH, KENT.

## INSURE YOUR STOCKS AGAINST “I.O.W.” AND OTHER INFECTIONS.

Science has now placed within reach of every Apiarist a safe  
and certain preventive of infection in “Yadil” Antiseptic.

For SPRING FEEDING “Yadil” may be added freely to Syrup.

For DISINFECTING Bees and Combs a five-per-cent. solution in tepid water  
should be used with a fine spray.

ASK FOR GREEN LABEL.

Our Bee Brochure sent Free on Application.

CLEMENT & JOHNSON, 19, Sicilian Avenue, W.C.1.

## INSTRUCTION in BEEKEEPING PRACTICAL AND THEORETICAL

My Apiary will be open for a limited number of pupils  
during this season. Terms and particulars from

W. HERROD-HEMPSALL,

The W.B.C. Apiary, Old Bedford Road, Luton, Bedfordshire.

## BEAUTIFUL HYBRID QUEENS—REVISED PRICE 10/6

Queens Ready to Mail from June 21st onwards.

Booklet of Varieties Free.

LT. A. H. BOWEN, QUEEN BREEDER, CHELTENHAM.

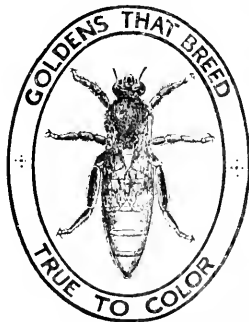

## Goldens. Fertile Queens, 12/6 each. Mismated Queens, 10/6 each.

Our Guinea Gold Queens are quiet, healthy, hardy,  
splendid workers and a lovely colour, they produce  
Golden workers and Golden drones, they are bred from  
stock that has never had “Isle of Wight” disease.

Strong 3 frame Nuclei with 1920

Golden Queens, 63/- carriage paid.

D. ALLBON & CO., Sunnyside Apiaries, HITCHIN

## POSITIVE FACTS.

I am very pleased with your foundation, the aroma is right and I find the bees take  
to it before any other sort.—Yours faithfully, R. B. MANLEY,  
*June 10th, 1920.*

*Illustrated Lists free by post.*

S. J. BALDWIN, The Apiary, BROMLEY, Kent.

# HIVES.

Compare the WORKMANSHIP and FINISH of our Hives.

All made by practical Men who know what a good hive should be.

In various designs to suit all tastes and requirements.

Season's speciality—THE MANLEY HIVE for 16 in. x 10 in. Frames.

Full descriptions and illustrations in our 1920 Catalogue:

*"Everything for an Apiary."*

If you have not received your copy, send a P.C. at once.

OUR MOTTO—SERVICE & QUALITY.

**R. STEELE & BRODIE, Wormit Works, Wormit, Scotland.**



THE  
KEY TO  
YOUR SUCCESS.

## Lee's Bee Supplies.

In design, material and workmanship, Lee's Bee Supplies still retain the reputation of being your best and safest investment.

Our 1920 ILLUSTRATED CATALOGUE is yours for the asking. It contains detailed information on the most up-to-date hives and appliances for which the House of Lee is famous.

We regret the necessity of having to advise our Customers that owing to the increased cost of production, all prices in 1920 price list are subject to 10% increase. The increase will not apply to orders received before May 10.

\* \* Five per cent discount to Members of THE APIS CLUB.

**JAMES LEE & SON,**  
LTD.,

Uxbridge, Middlesex.

(Telegrams: Graphicly, Uxbridge.)

Telephone: Uxbridge 181.)

## 20-Page 1920 "WHITE STAR" List,

3½d. POST FREE.

S. SIMMINS, QUEENLAND, HEATHFIELD, SUSSEX

Bees and Beekeeping Appliances. Catalogue free.  
**EDWARD J. BURTT. MANUFACTURER. GLOUCESTER.**

*I very much regret that there has been a large increase in the cost of the manufacture of bee-appliances, and therefore my prices will be advanced 10% from May 10th. Books excepted.*

PRINTED BY THE AVENUE PRESS (L. UPCOTT GILL & SON, LTD.), 65-67, DEURY LANE, LONDON, W.C., AND PUBLISHED FOR THE PROPRIETOR (W. HERROD-HEMPBALL), BY SIMPKIN, MARSHALL, HAMILTON, KENT & CO., LTD., 31 & 32, PATERNOSTER ROW, E.C.

No. 1984. Vol. XLVIII

JULY 1, 1920.

[Published every Thursday, Price 2d.]

CONTENTS.

	PAGE		PAGE
MARKETING HONEY .....	313	CORRESPONDENCE—	
NOTICE TO ADVERTISERS .....	313	Size of Frame .....	318
A DORSET YARN .....	313	Apis Club Conference Impressions and a Suggestion .....	319
JOTTINGS FROM HUNTINGDONSHIRE .....	314	Clean Quilts .....	319
OBLIGING BEES AT MAIDSTONE .....	315	Overworked Queens .....	320
CONFIDENCE AND DIFFIDENCE .....	316	Skep Making .....	320
SURREY AND GUILDFORD B.K.A. ....	317	Record Number of Queens .....	321
BEE SHOWS TO COME .....	321	Were There Two Queens in the Swarm? ....	321

WRITE FOR  
FREE CATALOGUE  
WITH  
INSTRUCTIONS  
FOR BEGINNERS.

AS MY

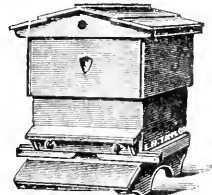

S

ARE THE  
**FOUNDATION OF SUCCESS**  
SO IS SUCCESS

MADE CERTAIN  
BY

MY

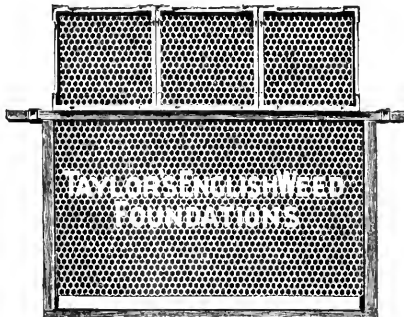

**E. H. TAYLOR**  
WELWYN,  
HERTS.

Telephone: 13 WELWYN.

## THE British Bee Journal

ESTABLISHED 1873.

A Weekly Journal Devoted to the  
Interests of Bee-keepers.

Edited by T. W. COWAN, F.L.S., &c.,  
and J. HERROD-HEMPSALL, F.E.S.

**Correspondence: Whom to Address.**—All matters relating to the Literary Department, Associations, Shows, etc., should be addressed, "Editors, *British Bee Journal*," and all business communications and matters relating to subscriptions and advertisements to be addressed to the "Manager," *B.B.J.* Office.

**Subscriptions.**—Annual Subscription, 10s. 10d. post free in advance; single copies 2d., or 2½d. post free. If a receipt is required by post, a stamped and addressed envelope must be sent, otherwise a printed receipt will be enclosed along with the paper.

*Note.*—Cheques and Postal Orders should always be crossed, otherwise it is very difficult to trace them if they go astray.

**How to send Money.**—Remittances can be made payable to W. Herrod-Hempsall by crossed Cheques and Postal Orders. Stamps may be sent for small amounts up to 2s. *Halfpenny stamps are preferred.*

Scottish or Irish cheques can only be taken in payment if 6d. is added for commission charged by banks for cashing them.

The Editors are not directly or indirectly interested in the manufacture or sale of beehives or appliances of any kind, and must refer correspondents wishing for prices or catalogues to advertisers in the paper.

### OUR DEPOSIT SYSTEM.

You are advised to insist on this being used when dealing with strangers.

### Rules and Conditions for Depositing

*In order to save trouble, it is requested that the Rules be carefully read over by persons using the Deposit System of trading.*

Goods should not be despatched until notice that the money has been deposited is received from this office.

1. **Method.**—When strangers are dealing together, the purchase-money of the articles is deposited at our office. We acknowledge receipt of the deposit to both parties, and hold the money until we are satisfied that the purchase is concluded. If a sale be effected, we remit to the seller the amount deposited, less a charge of 2½ per cent. in the £, with a minimum of 6d., and the expenses of Post Office Orders and postage, &c. Cash will be forwarded by Cheque, Post Office Order, or by Postal Order as preferred. If a sale or exchange be not completed, we return the amount deposited, after making the same deduction. By this means buyers and sellers are secured against fraud.

2. **Deposits.**—Postal Orders (drawn on General Post Office) and Cheques must be made payable to W. Herrod-Hempsall, and crossed "London County and Westminster Bank." The numbers of the Postal Orders should be kept by the sender. We cannot be responsible for any loss that may occur in transit.

3. **Honey on Approval.**—All honey will be sold by sample, which must be sent direct to buyer.

4. **Bee Appliances.**—In ordering, the time allowed for completing the order to be stated to us when sending cash. If maker accepts, we hold cash until transaction is satisfactorily completed, when the amount will be remitted, subject to conditions as in Clause 1.

5. **Bees and Queens.**—These will be dealt with entirely by the parties concerned, so far as price, &c., go, and when the purchase is satisfactorily completed cash will be remitted as per Clause 1.

6. **Goods in Transit.**—These are at the seller's risk, i.e., any damage to or loss of an article on its journey is borne by the vendor; but a rejected article must be properly packed and returned by the same means as was used in sending it.

7. **Carriage.**—The carriage of all goods, except such as are sent by post, is payable by the buyer, unless otherwise agreed. If any article sent on approval be returned, each party to the transaction must pay carriage one way.

## Books for Bee-keepers NOW IN STOCK.

Cash in full must be sent with order.

		Postage
A Modern Bee Farm ... ..	7/6	... 8½d.
Advanced Bee Culture (HUTCHINSON) ... ..	6/-	... 6½d.
Beginner's Bee Book (PELLET)	5/-	... 4d.
BEE-KEEPING SIMPLIFIED FOR THE COTTAGER AND SMALLHOLDER (W. HERROD- HEMPSALL, F.E.S.) ... ..	1/-	... 2d.
BEE-KEEPERS' PRACTICAL NOTE BOOK (T. W. COWAN)	1/-	... 2d.
BRITISH BEE - KEEPERS' GUIDE BOOK (T. W. COWAN) (paper covers only)	2/6	... 3d.
Dissectible Model of Queen Bee ... ..	4/6	... 3d.
FERTILISATION OF FRUIT BLOSSOMS BY BEES (T. W. COWAN) ... ..	-/3	... 1d.
Fifty Years Among the Bees (MILLER) ... ..	6/-	... 5½d.
Honey and Health (A. HOPE) ...	-/6	... 1d.
Honey Vinegar (REV. G. BANCKS)	-/2	... 1d.
How to Keep Bees (ANNA B. COMSTOCK) ... ..	5/-	... 4½d.
Management of Out Apiaries	3/-	... 2d.
Pollination of Fruit in relation to Commercial Fruit Growing (C. H. HOOPER, F.R.H.S.)	-/6	... 1d.
PRODUCING, PREPARING, EXHIBITING AND JUDG- ING BEE PRODUCE (W. HERROD-HEMPSALL, F.E.S.) ...	2/-	... 3d.
Productive Bee-keeping (PEL- LETT) ... ..	10/6	... 8½d.
Queen Rearing in England (F. W. L. SLADEN) ... ..	1/6	... 2d.
Scientific Queen Rearing (DOOLITTLE) ... ..	4/-	... 3½d.
The Bee-keepers' Vade Mecum (GEARY) ... ..	2/6	... 2d.
Snelgrove's Method of Re- Queening ... ..	-/6	... 1d.
The "Townsend" Bee Book ...	2/6	... 2d.
WAX CRAFT (T. W. COWAN) ...	2/-	... 2½d.
Wilke's Book on Swarming ...	1/-	... 1d.

### MISCELLANEOUS.

Maeterlucck's Life of the Bee The Lore of the Honey Bee (TICKNER EDWARDS) ... ..	3/6	... 3d.
THE BEE WORLD (supplied only to members of Associations interested in the control and development of the ARIS CLUB, apart from ordinary members of the latter), per copy ... ..	2/-	... 2½d.
	-/8	... 1½d.

British Bee Journal & Record Office,

23, BEDFORD STREET, STRAND, LONDON, W.C.1.





## Marketing Honey.

Marketing their produce is a great problem to many bee-keepers, for it is not all who have the business ability, or are good salesmen. We have often pointed out the value of shows in obtaining a market for honey, and it is gratifying to see our list of "Bee Shows to Come" approaching its pre-war dimensions. The small local shows are of great assistance to the cottage bee-keeper, enabling him to bring his wares to the notice of consumers in the immediate neighbourhood, and to sell his honey locally, thus obtaining better prices than if he sold wholesale. Shows are also educative, not only to the consumer, but to the producer. The consumer is educated to the value of honey as a food, and to the superiority of that produced at home to the great bulk of the imported article. The producer will learn that if he is to secure honours on the show bench, he must not only stage a good article, but it must be put up in a clear and attractive manner. The points that will gain prizes on a show bench will, coupled with fair prices, secure a permanent market.

The advertising possibilities of a show are not exhausted by the show itself, and the notices in the local press. Mr. J. E. Pinder, of Salisbury, sends a suggestion which, though not entirely new, is not carried out to the extent it might be with advantage to all concerned. He proposes to get a local tradesman, grocer, or dairyman, with a good shop front, to have, if possible, the whole of the exhibits at the annual show of the Salisbury and District Association in the window for, say, a fortnight, with the list of awards. The idea might be adopted more generally than is done, and will be found an excellent method of creating a market for honey, especially if, as Mr. Pinder intends, up-to-date advertising is done in the local press.

## Notice to Advertisers.

Owing to the greatly advanced price of printing paper, and the increase of wages in the printing trade, we shall be obliged to raise the price for our "displayed" advertisements at the end of this month. We are sorry to have to do this, but if we are to carry on it is inevitable. We can

only hope this will be the last increase we shall have to make, but this is by no means certain. The revised rates as given will come into force with the issue of the BRITISH BEE JOURNAL for July 1 and the July RECORD.

### DISPLAYED ADVERTISEMENT RATES. *British Bee Journal or Bee-keepers' Record.*

	£	s.	d.
Full page ... ..	4	0	0
Half page ... ..	2	10	0
One-third page ... ..	1	16	0
Quarter page ... ..	1	12	0
1½ in. across page ... ..	1	7	0
1 in. across page ... ..	0	13	0
½ in. across page ... ..	0	10	0
1½ in. single column ... ..	0	15	0
1 in. single column ... ..	0	10	0
½ in. single column ... ..	0	6	0

Discount for a series of consecutive displayed advertisements:—Six insertions 2½ per cent.; Twelve insertions 5 per cent.; Twenty-six 15 per cent.; Fifty-two 30 per cent.

## A Dorset Yarn.

"Show me the hive that had the crawlers. I cannot credit that Flavine cured them." So said a gentleman visitor to me on Friday. I lifted the covering and showed him how they were filling the supers (they had left them alone for three weeks). The bees and combs were sprayed twice, but the bees at the entrance were sprayed fifteen to twenty times in the hot part of the day. They knew they could not fly, they crowded the large square board that was laid in the front. Most of them had the kink in the wings, and they tried to fly a few inches, but seemed paralysed. The exereta was plentiful and of an ochre colour; the sprayer held a quart of water in which two handfuls of loaf sugar were dissolved, with the small packet of Flavine as sent out by Mr. Smith, of Cambridge. The extra sweetness of the spray polished the entrance of hive, the bees sipped up the syrup, and it stopped them from crawling away, and as others came out they were sprayed. This followed up has saved me a fine, strong stock of bees, and they are now working with feverish haste to make up for past inaction. It cost me a good bit of sugar, as I sprayed the fronts of all blacks and hybrids, but it was money well spent. The Italians up to now have never shown any crawlers.

A demonstration of transferring bees from skeps on to bars was given to a village gathering at Verwood, on Friday,

by Messrs. Tomlinson and Garret. The skep was a very old one, and had for a cover a large brown clay washing receptacle holding about two bushels, as practised by most village people in Dorset. Large clusters of bees were hanging round the entrance; these were placed on the top of bars, and the parts covered up that the skep did not cover, then the old entrance in the skep was stopped with clay. The combs in the next hive were taken out and inspected by the class, queen cells destroyed, and each comb sprayed with Flavine and sugar. Mr. Garret, who is the able secretary for the East Dorset branch of our county association, spoke of the advantages of all being members of the bee fraternity, how each would try and help others in any difficulty. The demonstration was of great teaching value, as so many seem afraid to handle bees. Squire Tomlinson seems to have an extra amount of acumen in manipulating the combs and showing the villagers how simple it is to handle them. Mr. Knight, the able schoolmaster, invited the demonstrators, and sent out notices of the meeting at the village club and hostel at Verwood.

Our bees seem to be now at their greatest in numbers. Some of them having the two lots of brood chambers show no disposition to swarm, and are storing surplus rapidly. A lot that was started with three combs in May has finished the first super. Two lots that were made up of four combs the first week in June have now filled the other new bars, and these should do a super each when the heather is in full flow. The stocks that had the frames of comb taken from them do not look like swarming yet, but seem to be in a hurry to store honey, yet these with two brood chambers hang at the entrance every night. I have placed a strip of wood between the lifts of the case so as to make them as cool as possible, and have also lifted the bottom with a strip, with a strip under the brood chamber entrance as well, as with so many bees it must be excessively hot. As I stated last week, one has an entrance into the second brood chamber above the lower. One can well understand the text books stating, "Keep your stocks strong." One skep of Italians has already filled a brood chamber of nine bars and I have placed it on the second lot of ten bars. By doing so we have no swarms; they have plenty to do without the necessity of going away to start another colony.

This week has seen a lot of visitors at the farm, mostly to see the bees, some to see the raspberries, but the bee-keepers seem to be the best class, whether they ride

in a motor or pedal their own cycle. All are full of enthusiasm for bees, both those in the full energy of youth and those of "crabbed age," for the lure of bees has entered into their lives. An old man said, "I could not have so much pleasure in life without my bees."

Bees are not much on the white clover in our field. I have never seen so much for years as there is this season. The abundant rains have made it grow wonderfully in the pasture fields; the bees go mostly away from the farm on to the corn-fields; they are busy on the laurel hedges, on the new flowers of raspberries and asparagus, and on the late flowering strawberries, but not in such numbers as when the gooseberries bloom. There is so much in the woods for them; the false acacia and the chestnuts both have so many flowers for them. I have quoted before, "Happy is the man who plants a tree, so that others can sit beneath its shade, and bless the hand that planted it." Surely every bee-keeper should bless those who planted these large flowering trees, from which the bees get so much surplus honey.

—J. J. KETTLE.

## Jottings from Huntingdonshire

It is a long time since the days immediately preceding the Norman Conquest, yet it is well to know that our Saxon forefathers kept bees, and bees kept them. Even in the days of Alfred the Great, bee farmers were not rare. Some of the best apiaries, it is true, were confined within the grounds of monasteries, yet outside their walls many a hive could be found buzzing with life. From the Code of Laws of Edward the Confessor we learn that, as hitherto, tithes were to be paid of sheep, pigs, and bees. For many centuries this was religiously done, but there came a time when here and there a bee-owner showed an unworthy desire "to best the parson." In a certain parish in the West of England lived a beeman, who did all he could to outwit the parson and his agent. He cunningly somehow contrived to keep his hives to the number of nine, and since ten will not go into nine, his tithe, or tenths, of bees never turned up. One year, however, he placed a brand new skep in his apiary, an incident his vicar did not fail to note, and asked for his tithe of bees. "It's an empty skep, sir, wait till it's a humming, then call," was the bee-man's reply. The parson had not long to wait, for a swarm issuing from one of the skeps when the apiarist was not at home, took flight just upon his returning. Diligently chasing it o'er plough and pasture, the whole village soon knew that Owd Tom, the bee-

man, had a swarm which he had to chase. This news reached the parson's ears, and consequently he strolled out next day to have a look at Owd Tom's bees, and, sure enough, there were ten skeps, and bees busily entering and leaving each one.

"Now, Tom, let's have my tithe of bees, lad, and the blessing of the Lord be with thee and thine house."

"Right thee away, Parson," said Tom Store, "afore dark o' the night I'll be along wif 'em, and may they bring thee luck."

True to his promise, Old Tom appeared at the Vicarage door about one hour before sundown, and with a violent shake he cast the bees at the parson's feet with a "The bees be thine, but the skep is mine," he walked away, leaving the Vicar to collect his wits and his bees.

A week has made much difference in the appearance of the hedge-rows. The pink dog-roses are fading away, a more modest creamy white rose is taking its place. These latter peep forth from the foot of the hedge, and do not ramble. Sweet and pretty they, nevertheless, have not the charm of the rambling briar. It's wonderful what can be seen in a few miles. Here one field red with poppies, here another white with bladder campion—further is a field of purple clover, the next, maybe, a riot of corn cockle and scabious, while the roadside has samples of them all.

Many thanks to those readers who have kindly written to express their appreciation of my last week's "Jottings." One reader thought Huntingdonshire was all dykes and fenland, bare of hedges, and, therefore, of briars. A strip of land in this county running between the Ouse at Earith and the Nene at Peterborough is fenland; productive but hedgeless, but the greater portion of the county is very pretty and undulating. This reader has evidently not heard of the schoolboy who wrote that Huntingdonshire was noted for ash-trees and dog-roses—but since the same boy wrote that in Gloucestershire the hedges were built of stone—she perhaps felt the lad was not to be taken too seriously.

1920 has been a year of surprises, not the least being the manifestation of a new disease among bees. This disease shows itself in swarms that are sent away vigorous; crawling and distorted wings are the prominent symptoms. Catch a few and send to a bacteriologist, and the report is: "No bacteria of any known bee disease present." My attention was first called to it by Mr. Andrews, the Peterborough expert, next by a swarm from Leighton, and again by my kinsmen of Runcorn. It is not deadly nor (so I believe) infectious. While half the bees

are crawling about the other half work at an amazing pace. The crawlers return to the hive at night. Spraying with disinfectants is waste of time. I am inclined to think the trouble is of the nature of constipation, but should like to hear and see more of it before deciding.

As last year this is proving to be a year of swarms, but if you are hard put to to accommodate all your swarms and have to fall back on a skep, do not stick a tin pan on the top without any non-conductor of heat between the pan and the skep top. I called at an apiary the other day, and was asked to explain the cause of crowds of bees clustering outside the skep. The sun was shining in his strength, and consequently the pan over the skep was frizzling bees and wax beneath. Poor things! *Careless bee-keepers!* The same day I had the pleasure of looking over the apiary of Miss Banks, of Paxtenhall, Bedfordshire, and saw hives and hives of strong, vigorous, healthy bees. If Bedford people are short of sweetstuff they had better call that way.

Steeple Gidding. E. F. HEMMING.

### Obliging Bees at Maidstone.

The members of the Kent Bee-keepers' Association, who, on the invitation of Mr. John W. Price, were present at his apiary on Saturday last to see a demonstration of commercial queen-rearing, had a unique experience.

Mr. Price began by giving a short account of the natural history of the hive bee—particularly of the queen—and showed that any bee-keeper could rear queens. All that it was necessary to do was to find and kill the queen in a hive, and the bees would do the rest. This method was wasteful, and did not make for improvement of stocks.

He then went on to demonstrate the methods he used in queen production. Just as he began to show how Doolittle cups were moulded, a member of the audience facing the apiary announced that a stock 30 yards away was swarming. As the visitors had come from all parts of the county in order to see the queen-rearing, it was decided to carry on as arranged; while Mr. Richards, one of the members present, undertook to syringe and quieten down the swarm. The bees circled in the air, and, coming nearer and nearer to the seated audience, finally settled on a plum tree four yards behind the lecturer and about eight from the front row of chairs.

Swarms notoriously emerge at inconvenient times, but here was the perfection of what should be. With an audience comfortably seated, from the nearest

hive in the apiary the bees emerged, and after travelling three-quarters of the way towards the spectators, quietly settled like a picture swarm. Had it been stage-managed it could not have been so well arranged. The soaking swarm having settled, the audience was once more able to give full attention to the demonstration.

The cups were prepared; then, as the grafting house was too small to accommodate all the visitors, the process was demonstrated with dead material. Royal jelly was shown. Eggs and larvæ of various ages were passed round and the correct size for use in queen production pointed out. The preparation of the stock for these grafted cups was next indicated, and from such a hive, consisting of a brood chamber full of communal frames, two supers of shallow frames topped by a second crowded brood chamber, the lecturer removed for inspection three magnificent queen-cells due to hatch the following day.

Each queen-cell is next placed in a nucleus or small stock of bees. Here the queen leaves the queen-cell, and a few days later flies out on her mating trip. Then she is called a fertile queen, and is ready to become the mother of countless thousands. Very occasionally, when the virgin queen leaves for her nuptial flight, the bees of the hive accompany her. The "Outlook" bees had that afternoon completed the demonstration of queen-rearing, for the swarm witnessed was due to the bees of the hive accompanying the virgin queen on her wedding journey.

A very small hive was pointed out, containing a 1918 Penna queen, the mother of all this year's "Outlook" queens. Other hives were shown or opened where the 1922 mother was being sought. Italian queens from six world-known breeders were on trial for wintering, building, storing, beauty and behaviour, so that the best could be approximated to.

At the conclusion of the lecture the cast was taken. A specially prepared sack, with a stiff circle of wire sewn in the bottom, was used. The wide, open mouth was got round and over the bees. A good shake having dropped them all into the bag, the mouth was tied up and the sack, with the stiff circle turned upwards, was hung in the tree. This swarm could not decamp; also the flying bees collected on the outside of the bag, and all hung till evening, when the re-hiving took place. Through the mosquito netting, of which the sack is made, the bees could be seen hanging from the top like an inverted cone.

Tea, kindly provided by Mrs. Price, brought to a conclusion this very exciting afternoon.—(Communicated.)

## Confidence and Diffidence.

It is surprising how seldom bees will sting if they are only treated with ordinary fairness. Of course, one must have a respectable lot of bees to begin with; but, given these two things, decent bees and rational treatment, the budding apiarist need have little fear of too frequent sub-cutaneous injections of formic acid. At least, that has been my own experience. In my home apiary the hives are grouped round flower-beds, which need constant attention to keep them in good order. When doing this work, I am never more than a few feet from the entrance of one or other of the hives, but I do not remember being stung when thus employed, although at such times I wear neither gloves nor veil.

For the successful handling of bees, with or without smoke, confidence is a first requisite, and it is just as necessary for the bees to have confidence in the manipulator as it is for him to have confidence in the bees. If the past treatment of a stock has been such as to inspire the bees with animosity to the bee-keeper, his task will always be attended with difficulty. What is still worse, the consequences of the disagreement will frighten away from the craft many who would otherwise become ardent bee-keepers.

I have frequently observed incidents which illustrate the value of confidence in handling bees, some of which occur to me now.

"Willie," said She-Who-Must-Be-Obedied, one day, "you must really get out of my way for a little. Take Hilda down to the apiary and show her the bees, and come back in ten minutes."

Well pleased, Willie (*act. 3*) and Hilda (*act. 2*) toddle off hand in hand, and disappear through the gate that gives from the garden into the apiary.

A quarter of an hour later there are alarms and excursions in the domestic quarter. Scoldings, upbraidings, and tearful protestations mingled in confused clamour.

"I never hurted them, mummy; I never did. I just did what you told me."

"I never told you to open a hive, you naughty boy."

"Well, you said I was to show Hilda the bees, and I couldn't, 'cos there was none coming out of the holes: so I stood on a box and took the lid off the big one and pulled off their clothes: and when they all came creeping out Hilda was frightened and runned away, but I staved and covered them up, and put on the lid, and they wasn't hurted a bit." . . .

An examination showed that the little fellow's tale was perfectly true. A big stock of Ligurians had its roof tip-tilted and the quilts disarranged, and a con-

siderable number of the population were perambulating in the space between roof and supers.

It may be a good thing to begin the practice of one's vocation at an early age, but I think (though I am open to correction) that the age of three is a little too soon to be giving demonstrations of the art of manipulating stocks without smoker, gloves or veil, and there is a lock on that gate now.

I now recall an incident that emphasises the importance of cultivating the confidence of the bees.

Once, while on a holiday, in a district that shall be nameless, I formed the acquaintance of a gentleman who had bees that he was going to get rid of because they were so savage that he dared not go near them. They were looked after by a local rule-of-thumb "expert," who came, generally late in the evenings, and overhauled them, when, I was assured, they stung most ferociously.

I contrived to be on hand when the "expert" made his next visit, and had quite an interesting chat with him. The bees, which I could plainly see were either natives or black Dutch, he assured me were pure "Lagoonians"; he had bred them himself, and sold them to my friend as a swarm. He did not believe in making increase by means of the new-fangled "new-cell-hussies"; "better let 'em swarm." And so forth.

Darkness was just falling, and there was a frosty nip in the air, but the "expert" uncovered that hive and examined all the combs, standing a number of them outside the hive to give him room to handle the remainder.

I pointed out to the owner of the bees what was being done, and asked him how he thought he would feel if someone came and turned him and his family out of their warm beds in the middle of a cold frosty night, and left them on the streets without protection. He admitted that he would be savage and probably resist.

Well, those bees resisted—magnificently. They were certainly "bonnie fechtlers," and it did me good to see how they punished that "expert." They could not reach his "onion," because he wore a veil, but they filled his hands and arms with stings, and got him on the legs through his trousers. When he had finished his examination and restored things to their normal state, except for the hundred or more bees left crawling on the grass in the dark, the perpetrator of the monstrous outrage wiped the sweat from his brow and murmured, "Them bees are a hot lot, and no mistake."

I conclude with a curious example of lack of confidence, when challenged by inquisitive though not unfriendly bees,

in an individual otherwise courageous enough.

In the last summer of the war I had the pleasure of a visit from a very dear friend, a young officer home on leave from the front. He was full of curiosity about my bees, but obviously distrustful of them, and although he had won his commission by personal bravery on the battlefield, he flinched every time a bee went near him. At length, in spite of my warning, he raised his hand to beat them off, and that settled it. He had to run.

A little later he returned to the front and took part in the great attack that burst the Hindenburg defences and opened the gate of victory to the Allies. A brother officer told us how they went into action. It was in the face of a storm fiercer and infinitely more deadly than any that Nature ever loosed. Each drop of rain was a German bullet, every blast-stone a fragment of shrapnel, every hail the united moan of innumerable shells. And into that inferno the soldier who had winced at the hum of a bee walked as unconcernedly as if he had been setting out for a morning stroll, and now fills an honoured grave in the land which he helped to save from destruction.—HUGH HOUSTON, Sidecup.

### Surrey County and Guildford and District Bee-Keepers' Associations.

A most enjoyable joint garden meeting of the above Associations was held at Heatherwood, Pirbright, on the afternoon of Saturday, June 26, on the kind invitation of the Rev. E. C. and Mrs. Pitt-Johnson. About 50 members attended, including Mr. A. Seth Smith, chairman of the Surrey B.K.A., who presided. A very instructive address on "Manipulations and Supering" was given by Mr. W. H. J. Prior, hon. secretary Kent (Eltham District) B.K.A. After emphasising the desirability of wintering bees upon ample *natural* food by leaving over the brood chamber a store of honey in shallow frames of worker comb, which also encourages early brood rearing the next season, thus ensuring a strong force of bees in readiness for the fruit blossoms, the lecturer gave clear instructions for the working of an apiary throughout the year. He explained several methods of swarm prevention including the "Demarce" system, which was specially favoured for out-apiaries, and gave directions on nucleus and artificial swarming, when and how to super, and when to remove the honey to allow reasonable time for the bees to gather their winter stores, regard being had to the flora of the district. Many valuable hints were given, and ques-

tions were answered at the close of the address.

The Chairman, in the course of a few remarks, mentioned that the Guildford Association had arranged a honey show in July and the Surrey Association one in August, both at Stoke Park, Guildford, and he expressed the hope that now that the Surrey Association had decided to form district branches the new system would prove advantageous, and that the membership would rapidly increase. He also hoped that the Guildford Association would become one of the branches. After an excellent tea, served in the delightful garden, the members inspected the well-kept apiary, where friendly bee-chats were indulged in, and in addition to further advice and instruction given by Mr. Prior, the company listened to helpful hints by Mr. C. T. Overton, Surrey expert, who was also present. Votes of thanks were passed, and the members departed feeling that they had increased their knowledge of apiculture. — (*Communicated.*)



*The Editors do not hold themselves responsible for the opinions expressed by correspondents. No notice will be taken of anonymous communications, and correspondents are requested to write on one side of the paper only and give their real name and addresses, not necessarily for publication, but as a guarantee of good faith. Illustrations should be drawn on separate pieces of paper. We do not undertake to return rejected communications.*

### Size of Frame.

[10208] Your long note on my letter (10191) is an extremely easy one to reply to, seems to require a reply, and, though I am heartily sick of the subject, I am sending you the following.

I note that you do not believe that a division through the brood chamber is no detriment and that you have never said so. Also that I cannot resist reading more into your statements than is intended. The words were: "We do not attach the slightest importance to the theory that the space between the top and bottom sets of combs would hinder either queen or bees."

Well, what does this sentence mean—not what it seems to me to mean, anyway?

[It means exactly what it says. We do not attach any importance to the theory, etc.; it does not say that the space never makes the slightest difference; it may do

at times, but is so little it is not worth taking into consideration.]

Again, I am not playing skittles. I recommended the 16 x 10 frame because I find it a good one. I have well tried it for years. When you say I am unable to see any fault in anything that suits me you make a statement which is not in accordance with fact. I do not care at all whether any one uses the 16 x 10 or any other size, except that I wish to try and help others.

What I deprecate is just this. You, sir, say plainly you think the standard the best frame. Well and good. But why not stick to it? You have not had much experience of this 14 x 12 frame, yet you recommend people to take it up in preference to the 16 x 10. I know by experience it is a bad—in fact, an impracticable frame—and I am bound in common honesty to say so. Why, then, should you be put out? This deep, square frame was a failure in America, and was abandoned. You attempted to show that this was not so in the September number of *The Bee World*, and I tried to set you right, but you stuck to your guns until the A1 Root Company finally pointed out that you had made a mistake.

It is not that I want or care to persuade you, but I must in common honesty tell people what I know, and that is, that whoever takes up the 14 x 12 is courting disaster. There are many good frames in use, viz., the Langsworth, Dadant, Jumbo and 16 by 10. If people want a change, why not use one of these; or if they don't want a change, why not stick to the standard.

I must ask you to believe one statement, and that is that the whole question is with me entirely impersonal. I do not, personally, care if every one takes up a square frame; but I must state what I know to be facts about it.

With regard to the last part of your first paragraph. Twenty years ago few Italians were in use. The British bee was in use in overwhelming proportions. Consequently, there was less demand for a large frame. Also, the very strong conservatism of the B.B.K.A., will, I expect, have acted as a strong deterrent. However, I have yet to hear of any one having once started on it who has given it up in favour of standard, except breeders, who must supply the public, and even these often keep large-frame stocks for honey production themselves.

The last paragraph of your remarks is pure theory. I need not comment on it, as it has very little bearing on the subject of frame sizes.

In conclusion, may I point out that what suits you or me or any one is of no importance. The question is what

suits the bees. But I willingly admit that I can see no benefit in using an appliance such as the 14 x 12 frame that has been proved over and over again, both here and in America, to be unsuitable for the bees.—Yours faithfully,  
R. B. MANLEY.

P.S.—Could not Mr. Tedcroft explain the meaning of paragraph 5 in his letter "Sugar Feeding," "By being fed in early autumn they raise a large brood, and don't eat so much"? I'm rather thick in the head, and can't quite make it out, and I feel quite anxious to understand what it's all about.

[We assure Mr. Manley we are not in the least "put out," and our remarks as to reading more into our notes than we said, or intended, did not refer to that letter only. As regards the size of the frame, we made our position quite clear, and we leave those who have read Mr. Manley's letters to judge whether he would or would not like to persuade everyone to scrap the standard frame and adopt the "commercial" size. No doubt some will do so, but we venture to say the present standard frame will not only survive, but still be the standard years hence. It may be interesting to our readers to know that in one of the best known and largest queen-rearing apiaries in Italy—the native home of the prolific Italian queens—the colonies of bees that are doing the best are on *British standard frames*.

The above letter was received before Mr. Atkinson's article appeared in the B.B.J. for June 10.—Eds.]

### Apis Club Conference Impressions and a Suggestion.

[10209] Considering the far-reaching range of the Apis Club and the newness of its constitution, the attendance at the first annual conference at the Central Hall, Westminster, on the last Saturday afternoon in May, was not altogether disappointing; many members having travelled long distances to be present at the initial meeting, with an eagerness that betokens enthusiasm and keen interest in the welfare and future proceedings of the Club.

Yet it must be acknowledged that the rate of one out of every twenty is a very meagre proportion, and members should look to it, and feel that their presence, even if their voices are silent, is required at the next meeting, whenever and wherever that may be.

The gathering was certainly to be congratulated in having in its midst, such an able and capable chairman as Mr. J. B. Lamb, to preside over their meet-

ing, and the fullest confidence of all present went with the representative committee elected towards the close.

As may be imagined, from the commencement the whole of the proceedings were centred round and dominated by the financial affairs of the undertaking, which, when made known, put aside every other consideration for the time being; and the members were visibly nonplussed by the overwhelming task Dr. Abushady had borne with such perseverance and with such inadequate support for a whole year in bringing forth that finest publication in beedom—the "Bee World"—apart from the enormous work in the formation of the Club.

One very cheering note was the fact that new members were still being enrolled, and at the average rate of two or three every day; and on reviewing the discussions the writer feels that this fact is an extremely hopeful foundation to build upon, and he would like to make the suggestion that his fellow members do their utmost to encourage and increase this enrolment if possible, by each canvassing his or her bee-keeping friends with a view to inducing them to join. Lend them any copy of the "Bee World" (they are too precious to give away) for their perusal, if they have the craft at heart, a glimpse through its pages will be sufficient inducement; in this way, we can swell the membership and thereby greatly encourage the work of the representative committee authorised by the conference in their deliberations with the founders.

We have hitched our wagon to a star; our aims are high and noble, and we cannot retract or reduce them. But their attainment can only be fulfilled by each doing his share, and that for the moment seems to be to help to swell the numbers.

We cannot do less.—L. W. WALTON,  
West Bridgford, Nottingham.

### Clean Quilts.

[10210] *Re* 1075, Mr. Manley's note to Mr. Aimes. I was very interested in this note, and should like to point out a little mistake.

Mr. Manley thinks I had few bees under the quilts. May I state I had seven frames of baby bees, much brood and abundance of honey. After putting them into a large, wide hive which was built to my idea, having  $2\frac{1}{2}$  in. between supers and outer casing for room to tuck down quilts, also see supers on straight, I took a swarm 12 lbs. in weight. Why my quilts are perfectly clean is, I place a double-wired honey board over brood, so queen and bees have the run of all combs. My

quilts are placed on top, feed holes cut and cork-folding quilt slightly raised on top on four thin sticks. The bees never touch a quilt. All is well till March, and by giving a puff of smoke and lifting board off, like lifting a table top, one can uncap honey which lasts into May. Syrup time arrives, and the platform for bottle is placed where the candy box was. This all prevents having to spread brood, as all combs are occupied by bees and brood. One does not find a stiff, hot quilt in a filthy state, but these quilts are washed and ironed and put in a drawer. When super time arrives the board is placed over the shallow frame supers, tiered up to allow air to pass through this huge mass of bees that are working on two shallow supers, holding 15 frames each over wired excluder. Have I made myself clear?—C. TREDCROFT.

### Overworked Queens.

[10211] Concede me the space of a few lines to comment upon letter 10196, BRITISH BEE JOURNAL, June 17, by Major Littledale.

The overwork theory propounded by me and discussed by Mr. Edwards and others has no reference to the queen. Mr. Cobb, of Plumstead, holds that the queen lays eggs which produce debilitated bees when overworked. I maintain that the lowering of stamina in the bees which gives rise to "Isle of Wight" disease or which renders the individual bee prone to attack by this disease, has its incidence some time after the bee has left its cocoon, and that the rate of ovipositing of the queen affects *not the brood* but the *brooding bees*. In fact, my theory is but an elaboration of Gerstung's "Futtersaftlehre" of which I knew nothing when I first discussed the idea of overwork in connection with "Isle of Wight" disease.

Major Littledale is at some trouble to cite a parallel case of an overworked man, I am afraid his "reasoning is unsound." too. Why drag in man? Is it not possible to argue out the points of the overwork theory without leaving the subject, i.e., the bee colony? I think so.

Mention is made of Simmins' "plumping" method of building up a colony of bees. Here is the opportunity for the opponents of my "overwork" theory if they would only recognise it. If plumping, as advocated and described by Mr. Simmins, is a success, then the overwork theory is finally disposed of; not only, but Gerstung's brood juice theory is also so much empty drivel. Perhaps the advocates and users of the plumping method will state their experiences. I quite appre-

ciate that the regular administration of a comb full of eggs to a well-balanced colony of bees with an indifferent queen will work wonders if the bee-keeper knows *just how much brood* that colony can rear; but to state that a colony of bees with a good queen can, and will, rear more brood than it can obtain from its own queen requires proof which it will be very difficult to furnish. On the other hand, the arguments against plumping are numerous and easily substantiated, but this letter being already longer than I had intended, I will leave the bee colony as my critic did, and ask him what he thinks would happen if unto a female mammal in milk were given the offspring of a sister to be reared along with her own? Then when his thoughts return to the bee colony let him remember that the mammary glands, or their equivalent, are not organs possessed by the queen mother, but *by the nurse bees*. H. M. STICH, Paisley.

### Skep Making.

[10212] Seeing instructions in the BEE JOURNAL about making straw skeps I may be able to help. In the first place, the brambles (blackberry) should be cut in the winter months, and should not be 12 months' old, then they should be split and left to dry for a little while. When using them scrape the inside out with a rather blunt knife, and they will work without wetting. The straw should be what is called in Cornwall, hand-made reed. All the flags (leaves) should be pulled off, and the ears cut off, then take a little reed about the size of a man's finger and bind it very tightly with a bramble, keeping it as round as possible. Have it long enough so that when turned it will make a hole as large as required, then proceed gradually, making the rings a little larger until you have them about an inch thick. A bullock's horn is the best guide for the reed; pull the brambles as tight as ever they can be pulled. For making the holes for the brambles use a bradawl about  $\frac{1}{4}$  in. thick. About 22 or 23 rings will make a large hive. My father used to keep a lot of bees, all in straw skeps with flat tops, and made them all himself. He had as many as 70 stocks one time, all in wooden houses, about 20 in a house.

I myself drove some bees 20 years ago from a skep that the man said my father made 50 years before, so they were made fairly well.

If I can, by writing, help anyone how to make it I will do my best if they will write to me, c/o BRITISH BEE JOURNAL Office.—J. SHORT.



### Record Number of Queens.

[10213] I give you some interesting information regarding another of my hives:—

May 21.—Swarmed.

May 22.—Cut out queen cells and put swarm back, killing old queen as presumed; young queen had emerged although I did not see her.

June 3.—Weather been cold and dull for about a week. Found six dead queens thrown out on alighting board.

June 4.—Swarmed.

June 5.—Two casts came off. Opened hive and cut out 18 queen cells from which 13 young queens emerged at once; queens piping. Put back into hive swarm and two casts, swarm had two queens, one cast had one queen, one cast had three queens. Total—six queens thrown out, thirteen queens from hive, six queens from swarms and five queens cells—30. Surely this is a record.

I have given them plenty of super room in advance of requirements, and they have already gathered about 30 lbs. honey.—J. N. TITHERLEY.

[The colony has certainly reared a large number of queen cells. If foreign races of bees are taken into account it is by no means a record. We have seen a *single comb* at the Apis Club House at Benson with more than that number of queen cells on it, which had been taken from a colony of hybrid Egyptian. The Egyptian bees rear an enormous quantity of queens. In an interesting conversation we had with Dr. Gough, from the Ministry of Agriculture, Cairo, he said he had known 300 queens in one hive. We do not think 30 will be a record for the Italian, Dutch, natives, or their various crosses we now have in this country.—Eds.]

### Were There Two Queens in the Swarm?

[10214] On May 26, a swarm came out and I hived it same evening. This lot has been doing well ever since. Three days later I went through parent hive which had two racks on, and took out three empty queen cells. Ten days later I was looking for casts, but weather was bad, and nothing happened until today (June 11). A second and third lot came out, settling near each other at midday. After about three hours, one lot dispersed and appeared to return to hive. At 5.30 I took the other which was quite a good swarm. They took to the skep quite well, and went into a hive in good

style. From this I presumed there must have been a queen. After securing the swarm I saw a small cluster—size of cocoon—still in bush, and these I got into a little bell skep. Throwing them to the parent hive I saw and killed another queen. I have it now, so that there appears to have been two queens in the swarm. Is this an unusual occurrence?—F. KNIGHT.

[It is not unusual for more than one queen to issue with second, or later swarms. We have seen more than two queens in one cluster of bees, sometimes several clusters of bees will be formed, each one accompanied by a queen, and as a rule these are all virgins.—Eds.]

## Bee Shows to Come.

*A nominal charge of 2s. 6d. is made for notices (not exceeding 7 lines) in this column, 10 lines charged 3s. 6d., up to 15 lines 5s., which covers cost of insertion from order till date of show. Cash should accompany orders for insertion.*

**June 29 to July 3, at Darlington.**—Royal Agricultural Society's Show, Bee and Honey Section, under the direction of the B.B.K.A. Prizes arranged in groups of counties for Associations affiliated to the B.B.K.A. Schedules from The Secretary, 23, Bedford Street, Strand, W.C.2. Entries closed.

**July 6, 7 and 8, at Cardiff.**—Royal Horticultural Society's Show. The Glamorgan B.K.A., in conjunction with R.H.S., offer prizes for Honey, Wax, Bees and Appliances. Members, Novices, and Open Classes. Schedules, Mr. Wiltshire, Maindy School, Cardiff. Entries closed.

**July 14.**—Wickham Bishops and District Beekeepers' Co-operative Association. Group 2.—Open to bee-keepers resident in Essex. Class 79.—Four Sections; 1st prize, 7s. 6d.; 2nd, 5s. Class 80.—1 lb. Extracted Honey; 1st prize, 5s.; 2nd, 3s. Class 81.—1 lb. of Wax (in 2-oz. cakes), 1st prize, 5s.; 2nd, 3s. Group 3.—For beekeepers' resident in the British Isles. Class 82.—1 lb. glass jar of 1920 Run or Extracted Honey; 1st prize, 20s.; 2nd prize, 10s. 6d. Exhibits in Class 82 to be the property of the Association, and to be given to hospitals in County of Essex. Entrance fee 6d. per class. Rules for exhibiting on back of entry form.—All entries to be sent to C. W. Cockburn, Hon. Sec., Meadow Bank, Wickham Bishops, Witham, Essex. Entries close July 2.

**July 15 and 16, at Grimsby.**—Lincolnshire Agricultural Society's Show of Bee Appliances, Honey, Sections, Wax, etc., under the management of the Lines B.K.A. Open and County Classes. Valuable prizes.—Schedules from Major Hafield, Alford, Lincs. Entries closed.

**July 20 to 23, at Aberdeen.**—Highland and Agricultural Society. Classes for Bee Appliances and Honey. Premiums £53 10s. Half of Prize Money and Silver and Bronze Medals contributed by the Scottish Beekeepers' Association.—Entry forms from John Stirton, Secretary, 3, George IV. Bridge, Edinburgh.

**July 21, Wyke and Normandy Horticultural Society.**—Honey Classes (Open). Best three sections, 5s., 3s., 2s.; Run Honey, light, 3 1-lb. glass jars, 5s., 3s., 2s.; Run Honey, dark, 3 1-lb. glass jars, 5s., 3s., 2s. Entrance fee, 6d.—Particulars, H. L. Mumford, Hon. Sec., Heatherside, Normandy, Guildford.

**July 21, at Broughton, Hants.**—Open Classes: Single 1-lb. Bottle, Single Section; prizes, 20s., 15s., 10s.—Schedules from Chas. Hoare, Broughton, Hants.

**July 21, Bishopstoke, Hants,** at the Royal Southampton Horticultural Society's Show.—Bitterne and Swanmore Bee-keepers' Association's Honey Show. Four Open Classes.—Schedules, C. D. Cawsey, Clifton Villa, Bitterne, Hants.

**July 24 (postponed from 17th), at Guildford.**—Guildford and District Bee-keepers' Association. Members and Open Classes.—Schedules and prize list from Rev. E. C. Pitt-Johnson (Hon. Sec.), Heatherwood, Pirbright, Surrey. Entries close July 10.

**July 28, at Blandford.**—The Blandford and District Horticultural Society are holding a Show of Fruit, Vegetables, Flowers, and Honey in the Park, adjoining the Crown Meadow, Blandford. Prizes for honey by the Dorset B.K.A. for members of the Association.—Schedules from C. G. Bone (Dorset Bee-keepers' Association), County Education Office, High West Street, Dorchester.

**July 29 to August 2, at Bolton.**—Royal Lancashire Agricultural Society's Show. £30 prizes for Honey. Six Classes.—Schedules (stating Honey Section) from R. O. Bradbury, Secretary, Derby House, Preston. Entries close July 5.

**August 2, at Bredon.**—Annual Show of the Worcestershire B.K.A. Three open classes. Schedules from Geo. Richings, 42, Barbourne Road, Worcester. Entries close July 26.

**Monday and Tuesday, August 2 and 3, at Newport.**—Monmouthshire Bee-keepers' Association Annual Show (in connection with the Newport Allotment Holders' Association). Members and Open Classes.—Schedules (post free 3d.) from Hon. Sec., "Underwood," Portskewett, near Chepstow, Monmouthshire. Entries close July 26.

**August 4, at Shedfield, Hants,** in conjunction with the Shedfield Horticultural Society's Show, Hants and Isle of Wight Bee-keepers' Associations, Swanmore and Bitterne Branches. Classes for Comb and Extracted Honey.—Schedules from the Hon. Sec., A. F. Hardy, Esq., The Palace House, Bishop's Waltham, Hants.

**August 7, at Barnstaple.**—Barnstaple and District Horticultural Exhibition, to be held in the Market Hall. Five Open Classes for Honey.—Schedules from Hon. Secretary, 19, Grosvenor Street, Barnstaple.

**August 11, at Wye.**—Kent Honey Show. Thirty classes, half of which are open to U.K. Four Silver Cups and 75 other prizes. Schedules, Mr. A. Lepper, Wye. Entries close August 1.

**August 14 and 16, at Cannock, Staffs.**—Eight open classes for honey, etc. Prizes value £12. Schedules from J. Bird, Secretary, "Glenmay," Allport Road, Cannock.

**August 12, at Taunton.**—Somerset Bee-keepers' Association Show of Honey, Wax, and Appliances. Seven Open Classes. Liberal prizes.—Schedules from Mr. F. J. J. Stacey, 3, Hammet Street, Taunton. Entries close August 6.

**August 14, at Llanelly.**—Carmarthenshire B.K.A. Show, in connection with the Llanelly and District Horticultural Society's Show. Liberal prizes (nearly £15) offered for Honey, Wax, and Appliances. 15 Classes (7 Open).—Schedules from R. Lloyd Roberts, London Joint, City and Midland, Llanelly. Entries close August 6.

**Saturday, August 28, at Hinckley.**—Leicestershire and Rutland Bee-keepers' Association, in connection with Hinckley Flower Show.—Open Classes for Honey, Sections and Jars. Prizes, 12s. 6d., 7s. 6d., and 4s. 6d. in each class. Judge, J. Herrod-Hempall, F.E.S.—Schedules from A. Kimbrell, Esq., Clarendon Road, Hinckley. Entries close August 23.

**November 18.**—Annual Show of the Worcester City and County Chrysanthemum, Fruit, Root and Honey Society. Thirteen open classes in Honey Section. Schedules from Geo. Richings, 42, Barbourne Road, Worcester. Entries close November 9.

## Special Prepaid Advertisements. One Penny per Word.

*Will advertisers please read these Rules carefully in order to save trouble, as they will be strictly adhered to.*

*Trade advertisements of Bees, Honey, Queens, and Bee goods are not permissible at above rate, but will be inserted at 1½d. per word as "Business" Announcements, immediately under the Private Advertisements. Advertisements of Hive-manufacturers can only be inserted at a minimum charge of 3s. per lin., or 6s. per inch.*

*PRIVATE ADVERTISEMENTS are only intended for readers having Surplus Stock to dispose of. Driven Bees, Nuclei, and Queens that are reared or imported for sale, are Trade Advertisements, and can only be accepted under trade terms. A charge of 6d. extra will be made if a box number is used.*

*Advertisements must reach us NOT LATER than FIRST POST on TUESDAY MORNING for insertion in the "Journal" the same week.*

### PRIVATE ADVERTISEMENTS.

**F**OR SALE, five W.B.C. Section Racks, 5s. each; 50 slotted Metal Dividers, 6s., or 1s. 6d. per dozen.—FOLDS, Breachwood Green, Welwyn. g.1

**F**OR SALE, W.B.C. Hives, Wax Extractor, Shallow Frames, drawn out; other Appliances.—HOUGHTON, Market Street, South Normanton, Derbyshire. g.2

**N**EW HIVE, fitted out complete, 12 standard frames, wired rack of drawn-out shallow frames, excluder, and a rack of sections, foundation in all, £3 3s.—GREEN, New Dale, Wellington, Salop. g.3

**F**OR SALE, several surplus Stocks and Nuclei, Dutch-Italians. — BROOKS, Winthorpe, Newark-on-Trent. g.4

**I**TALIAN HYBRIDS.—Three strong, healthy 6-frame Nuclei, 55s. each; box 10s., returnable; cash with order. 1920 Queens. Three strong Swarms, 25s. and 30s. each.—H. ROBINS, 290, Priory Road, St. Denys, Southampton. g.5

**N**UCLEUS, 6 frame, 1920 Queen, Dutch, 32s. 6d., carriage paid; box 6s. 6d., returnable.—BLADES, 75, Chestnut Grove, New Earswick, York. g.6

**N**EW Light Lincolnshire Honey for Sale, £8 8s. per cwt.—WILLIS, New Leake, Boston. g.7

**E**XCHANGE, Italian or Hybrids, Jap Fiddle with case, "Hobbies," with over 50 designs, "Watch" Camera (postage stamps) and Enlarger, Telescopic Tripod, 4 ft. to 14 in., in leather case, Watkins' Tank for ½-plate and 3½ x 2½, Roller Burnisher for prints. Stamp for replies. Deposit B.B.J.—McCATHIE, Rosebank, Victoria Road, Kirkealdy. g.8

**C**OLONIES, 50s.; Casts, 32s. 6d.—MRS. FRED C. BATCHELOR, Bailey's Farm, near Bendish, Whitwell-Herts. For telegrams, Whitwell-Herts is counted one word. g.9

**3** CWT. new Light Cambridgeshire Honey, £8 3 per cwt. to take bulk; 28-lb. tin. 42s. 6d.; tins to be returned; sample 6d.—SULMAN, Wilburton, Ely. g.10

**W**ANTED, to sell at once, three surplus Stocks healthy Bees, 10 frames, £4 per stock. Purchaser to send boxes.—JEWITT, Hensall, near Goole, Yorks. g.11

**G**OOD Second Swarms, 360-lb. strain, 25s., carriage paid; boxes to be returned.—BUTLER, West Road, Histon, Cambs. g.12

**F**INEST Golden Clover Honey, sample and price 6d.; also Swarms.—NORTH, Crissing, Braintree, Essex. g.13

**STRONG STOCK**, 7 or 8 frames, this year's swarm. What offers? Deposit.—**ANDREWS**, Beech House, Marlow. g.14

**FOR SALE**, strong Stock on 6 frames, 1920 Queen, Italians, £2 10s.; crate, returnable, 7s. 6d.—**SMART**, "Mithian," Warlingham, Surrey. g.15

**FOR SALE**, two 4-lb. June Swarms, hived on 6 frames, full sheets foundation and wired, 50s. each, carriage paid; boxes charged 7s. 6d., returnable.—**KNIGHT**, Kenwyn, Truro. g.16

**THREE** strong 10-frame Stocks, supered, Italian Blacks. What offers for bees, supers, hives, etc.? Guaranteed healthy; must clear.—**E. WATERHOUSE**, Watford Field House, Watford. g.17

**FOR SALE**, two bar frame Hives, good condition, 9 dozen Metal Ends, two Queen Excluders, one Brice Swarm Catcher, one Porter Escape in board, four Supers, including frames, one Smoker, 33 sheets Super Foundation, 14 sheets Standard Foundation, 12 Standard Frames with foundation, Spurr Embedder, one Rapid Feeder, one Taylor's Stage Feeder; all in good condition and free from disease. What offers the lot?—Apply, **WARREN**, Alagwyn Farm, Llanely. g.18

**WANTED**, good reversible Extractor, 4-frame preferred, with large pockets.—Full particulars and price, **E. W. D. MADOC**, Mattishall, Dereham. g.19

**WANTED**, few pounds each First Grade Light, Medium, Dark Honey, also light-coloured Moulded Wax, light Golden Sections, Honey, Mead and Vinegar for school object lesson.—**J. OLLIER**, 32, Stanfield Road, Burslem, Stoke-on-Trent. g.20

**EXTRACTOR** wanted for standard and shallow frames.—**W. COLDICOTT**, Westfield Road, Wellingborough. g.21

**FOR SALE**, strong Stock on 8 frames, £3; also one 5-frame Nuclei, 35s. (both 1920 Queens); boxes extra.—**BROWN**, 3, Maidens Bridge, Waltham Cross. g.22

**OVERPLUS BEES FOR SALE**.—Apply early, strict rotation, enclosed stamped envelope particulars.—**BARUCH - BLAKER**, Warrilow Apiary, Barnham, Sussex. r.f.136

**ONE** Second-hand W.B.C. and two Cottage Hives, clean, five Shallow Boxes, three Section Racks, sale £3 15s. lot, or separate.—**D. J. HEMMING**, Runcorn. r.f.143

**TWO HYBRID ITALIAN STOCKS**, on 10 frames, 1919 Queens, guaranteed healthy, £4 10s. each, travelling box 10s., returnable; English Honey, 28 lb. tins, £2.—**WALLIS**, 211, Lower Road, Rotherhithe, S.E. f.150

**FOR SALE**, several stocks healthy Bees, supered, £4 10s. per stock.—**GIDDINGS**, South Mims, Barnet. f.182

**SALE**.—Exhibitor proceeding abroad; complete Apicultural Requisites, including Plate-glass Trophy, Observatory, and other Hives, Extractor, Smokers, etc.; half catalogue prices.—**SWABEY**, Bracebridge Heath, Lincoln. r.f.162

**BASSES** selected Fish supplied, carriage paid, exchanged for Swarms.—**ELVIDGE**, Wholesale Fish Merchant, Grimsby. r.f.164

**WANTED**, by experienced man, situation as Manager apiary or bee department of nursery or fruit farm.—Particulars, "J.," Box 89, B.B.J. Office, 23, Bedford Street, Strand, W.C.2. f.105

**FOR SALE**, Second-hand all guaranteed clean exceptionally well made W.B.C. hives, with oak legs; also combination hives, £2 each; well-made shallow frame boxes, 3s. each; Queen excluders, 1s. 3d. each.—**DAVID HANCOX**, Grove Lodge, Deddington, Oxon. f.181

**BRITISH HYBRIDS**, colonies in Skeps, 57s. 6d.—**PRYOR**, Breachwood Green, Welwyn. r.f.178

**DUTCH VIRGIN QUEENS**, 4s. 6d.; fertile, 8s. 6d., from County Restocking Apiary.—**ANDREWS**, Expert, 78a, Westgate, Peterborough. f.100

#### BUSINESS ADVERTISEMENTS.

1½d. per word.

**DOES BREEDING SPECIALISATION PAY—FOR YOU?**—"The queens I have had from you so far are absolutely 'it.' I'm gone on them. I have recommended several men to have bees from you."—**R. M.**, 25/6/20. Now does it?—**ATKINSON**, Fakenham. r.g.23

**PURE ITALIAN QUEENS**, prompt delivery; select Italian, extra golden, rare honey-producing stock, August-September.—**ATKINSON**, Fakenham. r.g.23

**NUCLEI**.—Hybrids, 3 frames, 32s. 6d.; 4 frames, 42s.; boxes 5s., returnable.—**EKINS**, Hill Top, Burntwood, Staffs. g.25

**STRONG**, healthy Stocks and Nuclei, delivery by return, crowded with bees and brood, young Queens, Penna's strain, good disease resisters, new combs well wired, excellent condition for surplus; seven combs, 70s.; four combs, 45s.; boxes 10s., returnable.—**HILLMAN**, Bridge House, Stonehouse, Glos. g.26

**"BRITALIANS"**.—A fine strain of British Bees, queens mated to selected Penna Italian drones; 3-frame Nuclei, 47s. 6d., carriage paid. Send for particulars.—**ALUN JONES**, Halkyn, Flintshire. g.27

**DUTCH-ITALIAN NUCLEI**, 2, 3 and 4 frame, 1920 Queens, 30s., 40s. and 50s. respectively; immediate delivery; cash with order.—**ALFD. PARKIN**, 72, Doncaster Road, Leicester. g.28

**FEW STOCKS** of Italians on 10 frames, ready for supering, £4; Nuclei, 10s. per frame; boxes 10s., returnable.—**HENSLEY**, Luton Apiary, Queens Road, Chatham. g.29

**EGYPTIAN-ITALIAN VIRGIN QUEENS**, per return post, 5s.; also pure Italian Virgins, 3-frame Nuclei, Italian or Egyptian, 50s. Immediate delivery.—**BARLOW**, Bee Expert, Newcastle, Staffs. g.30

**NUCLEUS** (surplus), 3 frames, fine condition, satisfaction guaranteed, fertile Italian Queen (from Penna's 1920 queen), 50s.; box 10s., returnable; Queens as above, fertile, 10s.; Queens, Hybrid Italian, fertile, 8s. 6d., virgins, 4s. In rotation.—**WARD**, 16, Church Road, West Kirby. g.31

**TO CLEAR**, a few dark fertile Hybrids, 6s.—**ASHWORTH**, The Bungalow, Weymouth Street, Warminster. g.32

**6-FRAME COLONIES**, Italian Hybrid, crowded 6 bees and brood, disease-resisting Penna strain, splendid workers, 60s., carriage paid; boxes, returnable, 10s.—**STIMSON**, The Apiary, Bradfield, Berks. g.33

**1920 PURE Fertile Italian Queens**, direct from the well-known French breeder, Abbé Warre, 7s. 6d. each.—Orders for execution in rotation to **ELLIOTT**, Kelvin Road, Ipswich. r.e.104

**PROLIFIC ITALIAN QUEENS**, fertile 10s., virgin 5s.; few more Nuclei, 42s. 6d.—**YOUNG**, One Hundred Elms Apiary, Central Road, Sudbury, Middlesex. r.f.127

**THE FLAVINE TREATMENT**.—We should have been glad to have told about our experiments with Flavine in the bee papers, but the editors would not accept our notes. So in 1918 we published some of them under the title "Intensive Bee-keeping for Honey Production and Disease Control" at 6d. The 4th edition of this booklet is now ready.—**S. H. SMITH**, 30, Maid's Causeway, Cambridge. g.36

**ITALIAN HYBRID QUEENS**, quiet, hardy, prolific strain; fertiles, 10s.; virgins, 3s.—**JACK TICKELL**, Westbourne Apiary, Cheltenham.

**DUTCH** and Dutch-Italian 4 (four) frame Nuclei, 50 for July, delivery now, £2 5s., carriage paid.—**SEALE**, Ashley Cottage, Oatlands Drive, Walton-on-Thames, Surrey. g.35

**DUTCH BEES**, Skeps (as imported from Hans Matthes), Nuclei, Queens. Illustrated Catalogue on request, containing points on management.—Buy direct from Sole Agent, **WHYTE**, Bee Farmer, Cumbernauld, Dumbartonshire. b.61

**PURE ITALIANS**.—Imported Penna 1920 Queens, four frames, 45s.; six, 55s.; eight, 65s.; 10, 75s. Hybrids, good strain, 5s. less. Carriage paid; boxes returnable.—**WADHAM**, Gold Street, Cardiff. r.f.166

**FERTILE QUEENS**.—1920 home bred Italians, finest strain obtainable, immediate delivery, 12s. 6d. each.—**GOATH**, Cottage Apiary, Endlebury Road, Chingford, Essex. f.167

**"WIGHT" DISEASE**, prevention and removal; advice 5s.—**ALFD. RYALL**, Kenwood Apiary, Elcombe, Stroud. r.f.161

**NUCLEI**, 1920 Italian Queens, 4-frame, 50s.; swarms, Italian, 45s.; boxes 10s., returnable.—**C. HOGAN**, Bexford, Suffolk. r.f.175

**ITALIAN COLONIES**, Simmins' and Penna strains.—No more orders for colonies. A few more Nuclei offered at 45s., 3 frames certain. Members of Middlesex Bee-keepers' Association 5 per cent. discount.—**R. R. BABBAGE**, 33, White-stile Road, Brentford. r.f.133

**NUCLEI**.—Three frames, best hybrids, Penna, etc.; 1920 Queens, fertile, immediately, 35s.—**MOORE**, 31, Monmouth Road, Dorchester. f.165

**ITALIANS**.—Queens, 6s.; virgins, 3s. Stamp.—**HOUSTON**, Ellen Villa, Sidcup. f.118

**ITALIAN HYBRID BEES** (immediate delivery), disease-resisting strain, 1920 Queens, 4-frame Nuclei, 45s.; travelling box 10s., returnable; Stocks from 10- to 20-frame at 8s. 6d. per frame.—**STARKEY**, 55, Stafford Rd., Brighton. r.f.134

**4-FRAME NUCLEI**, headed by 1920 Italian Queen, 50s.; box charged 10s., returnable; 6-frame Stocks, 70s.; 8-frame Stocks, 90s. Immediate delivery. All guaranteed free from disease.—**LEE**, "Little Bowden Apiary," Burgess Hill, Sussex. r.f.177

**6-FRAME STOCKS** in bar-frame hives at £5 each, free on rail; Italian fertile Queens, 10s. 6d. each. Daily deliveries.—**LEE**, "Little Bowden Apiary," Burgess Hill, Sussex. r.f.178

**PUPILS** received by life-long whole-time Bee Farmer.—Terms on application to **C. B. BARTLETT**, Sandford Mount, Charlbury, Oxon. d.127

**1920 FERTILE** Golden Italian Queens, guaranteed imported direct from Italy, regular supplies every few days, 10s. each; specially selected, 14s.—**GOODARE**, New Cross, Wednesfield. f.59

**"ISLE OF WIGHT" DISEASE**.—Don't worry; use the solution that cures; 2s. per bottle.—**E. PRESSEY**, St. Elmo, Couledon. r.d.149

**HAVE YOU READ "THE BEE WORLD"?** If not, why not? Every number in itself is a useful literary work for practice and reference. Specimen copy free.—**Offices: THE APIS CLUB**, Port Hill House, Benson, Oxon.

**BOZZAZZA** tested Queens are sold at the price usually charged for untested queens.—Catalogue from **H. STICH**, Riccartisbar Avenue, Paisley. r.c.116

### HIVE ROOFS.

Why risk losing your bees through having leaky roofs when you can get

**ABSOLUTELY WEATHERTIGHT ROOFS?**  
24 in. x 24 in., 13s. 6d.; 24 in. x 20 in., 13s. 3d.; and 20 in. x 20 in., 13s. each; f.o.r. London.

Roofs are galvanised, and also treated by a special process to prevent condensation. Special terms for quantities. Order early, and avoid delay in delivery.

LARMUTH,  
MONAHAN AVENUE, PURLEY.

## ITALIAN QUEENS Direct from Italy. E. PENNA, BOLOGNA, ITALY.

I assume again the direct sale of my queens. Special offers from July 10 till countermanded. For queens in lots of 4 at a time £1 8s. Cash with orders. Payment by cheques or **British** Postal Orders. International Money Orders are **not** accepted. I do not hold myself responsible for the queens that are not sent by me direct to customers. All orders should be sent direct to me. In May the queens dead in the journey have been **less** than 1%  
ORDERS BOOKED IN ROTATION.

I wish to thank Mr. S. H. Smith for the help he has given me during the crisis in our postal service.

## SCIENTIFIC QUEEN REARING.

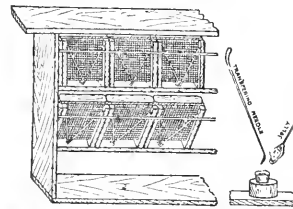

**BEST**  
In the world.  
Every  
appliance and  
instructions.  
Send for  
**KAT-A-LOG**

**MEADOWS**  
SYSTON.  
Near LEICESTER.

## ITALIAN QUEENS

Direct from Italy.

Address:  
**Signor Gaetano Piana,**  
Castel San Pietro,  
near Bologna, Italy.

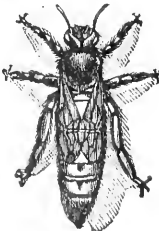

All Queens are reared by the most up-to-date and scientific methods. Mr. W. Herrod-Hempsall has personally inspected the apiary and methods employed, with which he is perfectly satisfied.

PRICES FOR 1920.

**For 1 Fertile Queen: August and September,**  
9/- each queen.

Can take no more orders for June & July. Booked up.

Carriage paid in Great Britain. Cash must accompany all orders, which will be executed in rotation. Guaranteed safe arrival of all Queens, but not the introduction. Bees dead upon arrival must be sent at once to "B.B.J." Office.

For the mutual convenience of all parties, Il Signor Piana has made arrangements that all communications, orders and remittances of the readers of "B.B.J." and "B.K.R." can be addressed to him, c/o British Bee Journal, 23, Bedford Street, Strand, London, W.C.2.

Cheques payable to "British Bee Journal."

**BEES FROM HOLLAND**

The **BEST** Dutch Stocks offered in original skeps by

**H. J. VAN LANGEVELD,**

Gasthuisingel 42 Rood, HAARLEM, HOLLAND

THE

**British Bee-Keepers' Association.**

Insure *now* against loss by damage done through bee stings. All particulars from

**W. HERROD-HEMPSALL, 23, Bedford Street, Strand, London, W.C.2.**

The products of the Apiary, of Poultry and Farm Stock, of the Fruit and Vegetable Garden can be Advertised and Sold through

THE

**BAZAAR, EXCHANGE & MART**

*Newspaper.*

Get a Copy—Thursday and Saturday 3d. The "Bazaar" publishes also practical handbooks by experts. Send for full catalogue, post free from—**WINDSOR HOUSE, Breams Buildings, LONDON, E.C.2.**



**"BACTEROL"**  
FOR BEES

2/6 per Bottle.

Post Free.

The cure for, and preventive of, "Isle of Wight" Disease. Non-poisonous—free from stain or unpleasant odour.

**MENLEY & JAMES, LTD.,**  
39, Farringdon Road, London, E.C.1.

**BRADBURY, TAUNTON,**  
FOR QUALITY BEE GOODS.



*Illustrated Bee Guide free.*

Telephone: TAUNTON 176.

**INSTRUCTION in BEEKEEPING**  
*PRACTICAL AND THEORETICAL*

My Apiary will be open for a limited number of pupils during this season. Terms and particulars from

**W. HERROD-HEMPSALL,**

The W.B.C. Apiary, Old Bedford Road, Luton, Bedfordshire.

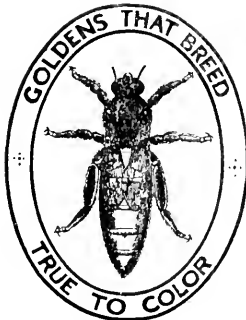

**Goldens.** Fertile Queens, 12/6 each.

Our Guinea Gold Queens are quiet, healthy, hardy, splendid workers and a lovely colour, they produce Golden workers and Golden drones, they are bred from stock that has never had "Isle of Wight" disease.

Strong 3 frame Nuclei with 1920 Golden Queens, 63/- carriage paid.

**D. ALLBON & CO., Sunnyside Apiaries, HITCHIN**

**POSITIVE FACTS.**

*June 10th, 1920.*

I am very pleased with your foundation, the aroma is right and I find the bees take to it before any other sort.—Yours faithfully, R. B. MANLEY.

*Illustrated Lists free by post.*

**S. J. BALDWIN, The Apiary, BROMLEY, Kent.**

# HIVES.

Compare the WORKMANSHIP and FINISH of our Hives.

All made by practical Men who know what a good hive should be.

In various designs to suit all tastes and requirements. Season's speciality—THE MANLEY HIVE for 16 in. x 10 in. Frames.

Full descriptions and illustrations in our 1920 Catalogue: "*Everything for an Apiary.*"

If you have not received your copy, send a P.C. at once.

OUR MOTTO—SERVICE & QUALITY.

**R. STEELE & BRODIE, Wormit Works, Wormit, Scotland.**



THE  
KEY TO  
YOUR SUCCESS.

## Lee's Bee Supplies.

¶ In design, material and workmanship, Lee's Bee Supplies still retain the reputation of being your best and safest investment.

¶ Our 1920 ILLUSTRATED CATALOGUE is yours for the asking. It contains detailed information on the most up-to-date hives and appliances for which the House of Lee is famous.

¶ We regret the necessity of having to advise our Customers that owing to the increased cost of production, all prices in 1920 price list are subject to 10% increase. The increase will not apply to orders received before May 10.

\*\*\* Five per cent discount to Members of THE APIS CLUB.

**JAMES LEE & SON,**  
LTD.,

Uxbridge, Middlesex.

(Telegrams: Graphicly, Uxbridge.)

Telephone: Uxbridge 181.)

## 20-Page 1920 "WHITE STAR" List,

3½d. POST FREE.

S. SIMMINS, QUEENLAND, HEATHFIELD, SUSSEX

Bees and Beekeeping Appliances. Catalogue free.  
**EDWARD J. BURTT. MANUFACTURER. GLOUCESTER.**

*I very much regret that there has been a large increase in the cost of the manufacture of bee-appliances, and therefore my prices will be advanced 10% from May 10th. Books excepted.*



No. 1985. Vol. XLVIII

JULY 8, 1920.

[Published every Thursday, Price 2d.

**CONTENTS.**

	PAGE	PAGE	
THE ROYAL SHOW .....	325	ROYAL SHOW FUND .....	331
A DORSET YARN .....	326	CORRESPONDENCE—	
JOTTINGS FROM HUNTINGDONSHIRE .....	326	"Commercial" or "Standard" Frames .....	331
ADVICE TO BEGINNERS .....	327	Fraternity Among Bee-keepers .....	331
NOTES ON BEE-KEEPING .....	328	Bees in South Africa .....	331
BRITISH BEE-KEEPERS' ASSOCIATION .....	329	SUGAR FOR AUTUMN FEEDING .....	332
PORTSMOUTH AND DISTRICT B.K.A. ....	330	QUERIES AND REPLIES—	
KINGSTON AND DISTRICT B.K.A. ....	330	Too Much Drone Comb .....	332
HUNTS B.K.A. ....	330	NOTICES TO CORRESPONDENTS .....	332
ESSEX AGRICULTURAL SHOW .....	330	BEE SHOWS TO COME .....	333

WRITE FOR  
FREE CATALOGUE  
WITH  
INSTRUCTIONS  
FOR BEGINNERS.

AS MY

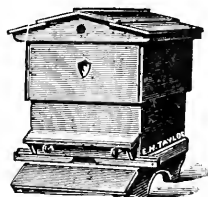

S

ARE THE  
**FOUNDATION OF SUCCESS**

SO IS SUCCESS

MADE CERTAIN

BY

MY

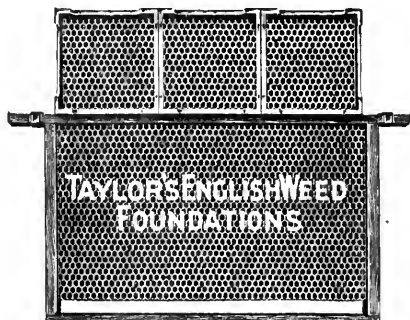

**E. H. TAYLOR**  
WELWYN,  
HERTS.

Telephone: 13 WELWYN.

# DADANT'S WEED FOUNDATION.

**T**HIS Foundation is made from pure Beeswax and guaranteed free from all disease germs.

Give your bees the **BEST**, and the best is **DADANT'S**.

No acids or other chemicals are used in the manufacture, and the makers guarantee that "**EVERY INCH, EVERY POUND, EVERY TON**, is equal to any sample ever sent out."

We have just received a fresh consignment, and are in a position to give immediate despatch.

Rear healthy bees on clean, natural combs.

None genuine without the watermark "**DADANT**" on every sheet.

*Our Catalogue, entitled "Everything for an Apiary,"  
is sent post free on Application.*

---

**R. STEELE & BRODIE,**

Bee Appliance Makers,

**WORMIT, FIFE.**





## The Royal Show.

The Honey Department at the Royal Show was better both in quality and quantity than last year at Cardiff. At the same time, if the Department is to continue as a feature of the Royal Agricultural Society's annual show, it will have to receive a greater measure of support in the future than it has done in the past, and we would urge bee-keepers to reserve a portion of their surplus this year to show at next year's exhibition at Derby.

This year only one appliance dealer staged a collection of appliances—Mr. E. J. Burtt, of Gloucester. The stand was of such an excellent character that the judges awarded him the Silver Medal of the B.B.K.A.

Major F. Sitwell and Mr. J. Tinsley judged the exhibits. Their duties were light except in Classes 14 and 15, where the competition was keen. Mr. J. Pearman won the W. Broughton Carr Memorial Gold Medal with 20 points, being closely run by Mr. W. J. Goodrich, of Gloucester, with 19 points.

The following are the awards:—

**CLASS 1.**—Collection of Hives and Appliances: Silver Medal, B.B.K.A., 1, E. J. Burtt.

**CLASS 6.**—Four Sections of Comb Honey of any year, approximate weight, 4 lbs.: 1, Mrs. H. Egglestone.

**CLASS 7.**—Four Jars of Extracted Light-coloured Honey of any year, gross weight to approximate 4 lbs.: 1, D. E. Harding; 2, Mrs. H. Egglestone.

**CLASS 8.**—Four Jars of Extracted Medium-coloured Honey of any year, gross weight to approximate 4 lbs.: 2, Mrs. Egglestone.

CLASSES 6, 7, and 8 were open only to members of the Durham B.K.A.

### OPEN CLASSES.

**CLASS 10.**—Twelve Sections of Comb Honey, excluding Heather Honey, of any year—approximate weight, 12 lbs.: 1, J. Pearman; 3, Miss E. A. Birwick.

**CLASS 11.**—Twelve Jars of Extracted Light-coloured Honey of any year, gross weight to approximate 12 lbs.: 1, J. Price; 2, J. Birkett; 3, J. Pearman.

**CLASS 12.**—Twelve Jars of Extracted Medium or Dark-coloured Honey, of any year, excluding Heather Honey, gross weight to approximate 12 lbs.: 1, J. Price; 2, Mrs. L. Morgan.

**CLASS 13.**—Six Jars of Granulated Honey, excluding Heather Honey, of any year, gross weight to approximate 12 lbs.: 1, J. Pearman; 2, J. Price, 3, G. J. Flashman.

**CLASS 14.**—Twelve Sections of Comb Honey, excluding Heather Honey, of any year, approximate weight, 12 lbs.: 1, G. Bryden; 2, Miss Debenham; 3, W. J. Goodrich; h.c., A. Willmott.

**CLASS 15.**—Twelve Jars of Extracted Light-coloured Honey of any year, gross weight to approximate 12 lbs.: 1, W. J. North; 2, A. E. Warren; 3, G. Bryden; h.c., Miss Debenham and W. J. Goodrich.

**CLASS 16.**—Twelve Jars of Extracted Medium or Dark-coloured Honey, of any year, excluding Heather Honey, gross weight to approximate 12 lbs.: 1, Mr. J. Goodrich; 2, G. Bryden.

**CLASS 17.**—Six Jars of Granulated Honey, excluding Heather Honey, of any year, gross weight to approximate 6 lbs.: 1, G. Bryden; 2, W. J. Goodrich; 3, A. E. Warren.

**CLASS 18.**—Three Shallow-frames of Comb Honey, for extracting, gathered during 1920: 1, W. J. Goodrich, 2, G. Bryden.

**CLASS 19.**—Six Jars of Heather Honey, of any year, gross weight to approximate 6 lbs.: 1, M. J. Lambroll; 2, J. Pearman.

**CLASS 20.**—Six Jars of Heather-mixture Extracted Honey of any year, gross weight to approximate 6 lbs.: 1, Mrs. Anderson; 2, J. Pearman.

**CLASS 21.**—Best and Most Attractive Display of Honey: 1, G. Bryden.

**CLASS 22.**—Exhibit of not less than 2 lbs. of Bees' Wax in two cakes only, the produce of the Exhibitor's Apiary: 1, Mrs. Scott; 2, J. Pearman; 3, W. J. Goodrich.

**CLASS 23.**—Exhibit of not less than 3 lbs. of Bees' Wax, the produce of the Exhibitor's Apiary; to be shown in shape, quality and package suitable for the retail trade: 1, Mrs. Scott; 2, J. Pearman; 3, W. J. Goodrich; h.c., J. Price.

**CLASS 24.**—Honey Vinegar: 1, J. Pearman; 2, W. J. Goodrich.

**CLASS 25.**—Mead.—1, W. J. Goodrich; 2, J. Pearman; 3, G. Bryden.

**CLASS 26.**—Exhibit of an interesting nature connected with Bee Culture, not mentioned in the foregoing Classes, including Candy for Bee Feeding: 1, W. J. Goodrich.

**CLASS 27.**—Exhibit of a Scientific nature not mentioned in the foregoing Classes.—No entry.

The W. Broughton Carr Memorial Gold Medal awarded to Mr. J. Pearman.

## A Dorset Yarn.

We have just been for a motor ride into Somerset to see the Cheddar cliffs and wonderful caves, the beautiful cathedral at Wells, and the ruins of Glastonbury, through 170 miles of farming lands, but only in one place was there to be seen bees. When we reached home our lot had thrown out three swarms, and Mr. Butson had seen to them for me. One of them was from a double brood chamber stock—a very heavy lot they were. They are now on to new bars of foundation; it will be interesting to see how soon they draw out the ten combs, it cannot be long with so many bees. One lot in two weeks had begun to build upwards above the bars to the glass covering, yet with so much wet one cannot call it a good season. Across the road in the school playground are limes in blossom, and thousands of flowers on the asparagus; they have not to go far for food, they are still adding surplus, though those that have swarmed with so many bees cannot do for the farm what they did before.

It has been a busy week at the farm—so much fruit to get off each day just now. One cannot send off half what one would, as rains interfere with gathering. Prices are very much inflated. Black currants at 15s. per dozen, but raspberries are the most paying, and people will give high prices for the large berries like logans. Was able to take some to the R.H.S. meeting last Tuesday. Lord Lambourne, the president, was showing the Queen and Princess Mary the good things exhibited, and did not pass by without appreciation of the exhibit from the Violet Farm. Good to the eye, sweet to the taste, they cannot fail to sell well; and with us we have the bees who gathered honey from all the flowers before the fruit could be harvested.

There is a change in the wants of our people just now; even the working class are wanting these fruits, although the price is high. No bee-keeper need be afraid to venture on fruit for a living, especially bush fruits and strawberries. Early peas and broad beans also sold well last month, but the heaviest cheques are for fruit; besides, it makes employment for others to get the baskets filled for sale. On our fifty acres we have found employment for ten hands, where the 200-acre dairy farms have only two besides the owner (most all the farms are the freeholds of the farmers). From small fields one can produce large quantities of berries, and each year add other acres, and we find the weight is doubled by the extra trees as they come to fruiting age, and

then the harvest of honey on top of the whole.

It is very encouraging for the owner, especially as he used to pay rent for the same fields which have been purchased with the produce from them, which is perfectly true. Of course, the bees got their surplus from other farmers' fields as well as our own, but the cheques all come to this farm when honey is sold. The bees go over the estates of the wealthy, they take the best of all the honey-bearing plants, but they fertilise the flowers in return for taking the nectar. What a lot of pleasure is missed by those bee-keepers who work in populous centres all day, and as a sequence live near their businesses. I know that many of them do their bees well, and get a lot of surplus, but they cannot get the pleasures of life as we who live among fruit and flowers.

Was not able to get to the Bournemouth Show, but my son told me of the fine observatory hive that was exhibited. It was the same date as the R.H.S. meeting, but a bit early for large exhibits of honey. We go to Cardiff on Monday for a three days' show, where we hope to meet the bee-keepers of the West, as well as many horticulturists.—J. J. KETTLE.

---

## Jottings from Huntingdonshire

Friday was cool, and a southerly wind was blowing half a gale. It was amusing to note how differently the various bees regarded this sudden drop in the temperature. The Ligurians seemed to enjoy it, for they were tumbling over one another to leave and enter the hive. The golden Italians appeared unconcerned; the hybrids were working, but in a very half-hearted manner; while, as for the Dutch, they clustered closely over their brood. One or two could be seen lingering on the alighting board, but feared to launch away. There is no bee more consistent than the Italian. The vagaries of the English climate trouble them little, providing they can find nectar and pollen, propolis and honeydew, and water—preferably a running stream. They settle—not on algæ, but on grasses or reeds near the brink of the stream, to take liquid refreshment. I have never yet seen a pure Italian extracting moisture from a manure heap, but have noticed hybrids are not averse to a little highly-seasoned drink.

Referring to my reference of last week to the new disease, an urgent message arrived one day from a place some ten miles distant asking if I could come at once. I went. There were bees crawling everywhere, with wings awry. The trouble seemed to be merely a wing weak-

ness, for the little creatures had boundless energy. They would walk yards and yards at a furious pace, and even walk up stalks into flowers, collect pollen, and walk back to the hive-stand, up the legs and into the hive. Many of us would like to know whether Miss Annie Betts has met with this mystery. These bees, again, have revealed no micro-organisms, so what is the trouble? Bowel trouble, or trouble in the ohyle stomach, or whatever it may be, it is somewhat distressing. It seems to pass like May pest, and the stock is left healthy and very lively.

I have been watching closely the habits of drones of late, and I am gradually coming to the conclusion that they are not quite senseless, as they are generally imagined to be. To attract a possible virgin princess they have other things to do than soil combs, gorge honey, and make the sentinels angry. I hope to have more to say about this at a later date.

June has passed, and the

“Pale privet petals, white as milk,  
Are blown into a snowy mass.

The roses lie upon the grass,  
Like little shreds of crimson silk.”

The cuckoo is silent; the nightingale, too, does not now lift up his voice in song. Thrush and blackbird, wren and finch, bunting and robin, however, are still full of bird songs. Would they were never quiet!

Limes are out in plenty; so, too, is the white clover. Brambles are painting their bushes white and shaded pink. The wayside glows with colour, so what have the bees to fear if the weather be kind? Hereabouts white clover honey is impossible. Although one sees acres of the flower, the bees—Dutchmen excepted—are busier with other blooms. Last Monday I sat for a while on the gate of a field white with clover blossom, and watched a patch closely. What did I see of insect life? Many currant moths—red admiral, fritillary, tortoiseshell, chalkhill blue and brimstone butterflies, but not more than a dozen bees. Ah, me!

“Full many a flower is born to blush  
unseen,

And waste its sweetness on the desert  
air.”

So, too, if I may paraphrase—

“Full many a flower is filled with nectar  
sweet;

It dies unvisited by a single bee.”

If only the nectar could be harvested, we might laugh at the sugar shortage. Hasten the day when every home's a hive or two, or every cot a skep.

Too late for this paper, I see “M. E. B.” is asking for information about the “tapestry” and “miner” bees. I will

try and make a few jottings next week about these very interesting insects. They are so beautiful and attractive, and yet so lonely. They simply love to be petted, and delight in the companionship of man. At least, they love human beings to watch them at work, and are very fond in the autumn of a rest in one's armpit. I think they locate by smell; at any rate, pet one and it does not ever forget. Alas that their lives should be so short!

E. F. HEMMING.

Steeple Gidding.

P.S.—Mr. Composer, my writing is your despair, I know; but please note that Miss Banks lives at Pertenhall, not Paxtenhall, as printed last week.—  
E. F. H.

## Advice to Beginners.

Father came home one night full of enthusiasm about Bees—he had been to a lantern lecture. A family council was held and it was decided to purchase a swarm of bees. The children were delighted at the prospect of getting honey for breakfast and tea, and the good housewife welcomed the idea of a substantial increase in the best substitute for sugar in the larder.

With the advent of spring the bees arrived, the hive was considered a great ornament to the garden, but father had forgotten to take some practical lessons in bee-keeping, and in consequence of his untimely and awkward manipulations not only himself, but also mother and the children got badly stung, and the domestic threatened to give notice to leave, as the bees took a liking to her hair, and even the dog gave that part of the garden where the bees were located a wide berth.

Time did not improve matters. The bees swarmed, of course, settled in the neighbours' garden, were voted a nuisance, and the swarm escaped; a cast ten days later shared the same fate, and as the honey season was not a good one, no honey appeared on the breakfast table. The bees were left to themselves, and for sale, and on inquiry why? the information volunteered was “Oh, nobody could go into the garden without being stung, and we thought it better to be rid of them for peace and quietness sake.”

This is not an isolated case, there are numbers like it every year, and suffering humanity blames the bees for their stinging propensity, we are not told how often the hive had been opened in all sorts of weather to ascertain “if the bees are making honey,” or to show “Her Majesty” to visiting friends, or to uncap

honey in order to stimulate the bees to greater effort, because the book tells you so.

These are some of the pitfalls every beginner is liable to, and they may be pardoned, but one who wants to become successful in the art of bee-keeping should first of all learn how to keep bees in good temper, look upon them as friends and treat them as such, and a good feeling between the master and his bees will soon be established. To bring about this happy result no fixed rules can be laid down, an understanding of the bees' nature and ways is requisite, and the right thing must be done at the right moment. Nervous and irritable people will not make good bee-keepers. There must be no hesitation to carry out what manipulations are necessary; if the bee-keeper loses his temper he will find the bees have one to lose too, and if their ire is roused they will quickly turn tables upon him in a way to be remembered.

Whatever operations you have to perform with bees, always endeavour to remain cool and collected and keep your mouth closed during operations as bees are very sensitive to offensive breath; if you are a smoker, put your pipe or cigarette out of the way, however good the flavour may be, bees do not relish it. If you don't want a bee in your bonnet, don't anoint your hair with perfumed cosmetics, else the bees will submit your head to an uncomfortable scenting in search of the flowers which are not there. Don't place your hive next to a fowl-house, or there will be trouble. Keep the surroundings of your hives free from unpleasant smells, and always have clean hands when commencing operations.

Do not go near bees when you are hot with perspiration from gardening or cycling, cool down first, and always stand at the back of the hive when operating to allow the bees a free flight. Do not open hives, unless under cover, in wet or windy weather or when rather cool in the morning, wait till midday, and when you remove quilts, do not rip off the quilt in one move, and thus expose all the seams of bees at once. Have several strips three inches wide and lift one back at a time to uncover one frame to begin with. Do not suffocate the bees with smoke, just give those coming to the top a puff or two and wait a minute to allow them time to fill themselves with honey, as in that condition they are not inclined to sting. Do not jar against the hive or knock things about by hasty movements, do everything deliberately and quietly and not

in a hurry, and if some bees alight on your hands, keep calm and jerk them off in front of the hive.

Limit your appliances to as few as possible, an old kitchen knife with a good stiff back and ground down is most handy, see that your smoker is well alight—corrugated brown packing paper makes excellent fuel—and before you start operations make sure you have everything necessary at your elbow to carry same out expeditiously.

To prevent bees from over propolisising supers use plenty of vaseline along the inside edges of top and bottom of supers, also rub some along the metal ends and rests, edges and cross bars of queen excluders and you will have no use for a crowbar.

Every beginner should study a good book on bees, but theory is not everything; to put same into practice, he should go to some bee-keeper for a lesson or two, and see and learn from experience, and if he bears in mind most of the "Don'ts" enumerated above, he will find his bees a pleasure to himself and others, and his little insect friends will not fail to reward him with some surplus honey, if season permits, in return for the labour of love he has bestowed upon them.—O. PUCK.

---

## Notes on Bee-Keeping.

Our bees just now are having a fine time working the white Dutch clover. This is our chief source of honey supply here in Lancs. Every bee-keeper is familiar with the little, round bunched heads of the white, or Dutch, clover. We pass them scores of times in a season, for they grow in the fields and by the dirtiest roadside all among the grass and groundsel and the plantains, yet each bunch is lovely to look upon, and the whole plant a very interesting study. The flowers have short stalks, and at first all the florets stand erect in the bunch, the hidden ones being in the bud and the outer ones most mature. Our hive bees, in addition to gathering nectar, pollenate the blossoms, and though when they visit them they find the stamens neatly tucked out of sight within the keel, their movements burrowing for nectar cause these organs to be jerked out, so that pollen is deposited on the underside of the bees' hairy bodies. Directly a bee retires the stamens retire too, and they remain within the keel until the next bee comes along. After a few such visits the pollen is deposited of. These stamens wither and the pistil lengthens, so that when the

flower is visited later this organ projects and comes in contact with exactly the same part of the bee's body. In this way it receives any pollen that may be adhering there, and which, of course, has been deposited during visits to younger flowers—that is, flowers in the pollen-shedding stage. After fertilisation has been effected the tiny clover flowers drop, and this makes it quite easy for the bees to visit the younger, fast maturing upper blossoms in the bunch. No doubt bee-keepers who are acquainted with the white Dutch clover will have noticed the flower heads in these three positions. When all the flowers are fertilised the whole bunch droops.

Alsike, another important nectar-bearing plant of the clover species, is a taller, more erect, and glabrous plant, very like white clover, but though both species have pink and white blossoms—in spite of name "white" clover—alsike clover's pink is usually much richer, and its leaflets are a little more pointed. It, too, droops its fertilised blossoms, and both flowers turn brown as they wither.

Sainfoin is yet another of the clover species, and a rich nectar-producing plant. It is a fine-looking clover, with leaves made up of seventeen to twenty-five pointed oval leaflets. Wherever a stem branches off one may find thin, brown, leaf-like appendages, that botanists call "stipules." The rosy pink flowers grow in clusters of pyramidal form at the end of long stalks, and if examined it will be found that the wing petals are very tiny and undeveloped. Crimson lines decorate the standard, and point to the nectar store below; this can be reached by any insect with a short proboscis, outside the hymenoptera class.

There is cow-wheat, zig-zag clover, purple loosestrife, golden ragwort, fleabane, thistles, field bindweed, figwort, and teasel. Some of these are with us here, and prove to be good honey producing plants for our bees. Have often coveted a study on some of these bee-plants, but, being of humble parentage, was never able to accomplish this, especially now that books are such an exorbitant price. Each is a study and a hobby of itself. Some of us may be tempted to think his hobby (bee-keeping) the best. "The chemist who can trace the atomic process of matter upon earth, or the metaphysician who can assign the laws of human thought, or the grammarian who can discriminate the niceties of language, the astronomer who can unravel the mechanism of the heavens, or the naturalist who can clas-

sify the flowers, the birds, shells, minerals, and the insects which so teem and multiply in this world of wonders; each of these respective inquirers is apt to become the worshipper of his, or her, own theme, and to look with a sort of indifference, bordering perhaps on contempt, towards what he imagines the far less interesting track of his fellow labourers. I may say that, like our bees, we should discard that narrow-mindedness, and work together in harmony in this great field of research, and enjoy still more gloriously the Eternal Mind from whose conception it arose, and gave birth to it, in all its vastness and variety."—P. LYTHGOE, Padgate, Warrington, Lancs.

### British Bee-Keepers' Association.

The monthly meeting of Council was held in the Hives and Honey Department, Royal Show Ground, Darlington, on July 1, 1920.

Mr. A. G. Pugh presided, and there were also present Mr. Bryden, Association Representatives: Messrs. J. Pearman (Derby), W. E. Richardson (Yorkshire), J. Watson Egglestone (Durham), and the Secretary, Mr. W. Herrod-Hempsall.

Letters of regret at inability to attend were read from Miss M. D. Sillar, Messrs. T. W. Cowan, C. L. M. Eales, G. W. Judge, and Major Sitwell.

The minutes of the previous meeting were read and confirmed.

The Report on the Paper work for Final Examination was presented, and out of sixteen candidates who presented themselves, it was resolved to ask the following to attend for the lecture test in due course:—Mrs. M. K. Hodson, Miss A. D. Betts, Miss D. Y. Knowles, Major E. H. Wilkinson, Messrs. E. D. Lowes, C. H. Brown, H. E. C. Carter, G. W. Judge, and Rev. W. Murdoch.

The Staffordshire Association applied for a Preliminary Examination, and the same was granted.

A letter was read from the Beverley Bee-keepers' Association *re* legislation, and the Secretary was instructed to deal with same.

After considerable discussion, Mr. W. E. Richardson proposed, and Mr. Pearman seconded, and it was carried, "That a recommendation for further consideration be made to the Council that in future the Council meeting, hitherto held at the Royal Show be abandoned, and in its place a conference of bee-keepers be held.

Upon the recommendation of the judges,

it was resolved to grant the Silver Medal of the B.B.K.A. to Mr. E. J. Burt, for his collection of appliances.

Next meeting of Council, September 16, 1920, at 23, Bedford Street, Strand, London, W.C.2.

### Portsmouth and District Bee-Keepers' Association.

A meeting of the members of the Portsmouth and District Bee-keepers' Association was held in St. Michael's Parish Hall on Saturday, June 19. The President, Dr. F. Beddow, T.C., took the chair. The Secretary reported that since the commencement of the year 25 new members had joined, bringing the membership, since the formation of the Association last year, up to 70. The expert, Mr. Smith, gave the members a report on the association apiary in Victoria Park, and said that he would be in a position to supply three-framed nuclei in about a fortnight, and it was resolved that members should be supplied at 21s. per nucleus. It was also resolved that this association apply to the B.B.K.A. for affiliation direct.—P. E. WHIN, hon. secretary.

### Kingston and District Bee-Keepers' Association.

#### RULES ADOPTED AND OFFICERS ELECTED.

Bee-keepers assembled in goodly numbers at a general meeting of the newly-formed Kingston and District Bee-keepers' Association, held at the Surbiton District Council offices on Tuesday evening, under the presidency of Mr. H. Forbes George.

The objects of the Association are to encourage and advance bee-keeping in the districts of Kingston, Surbiton, Malden and Coombe, Esher and the Dittons, East and West Molesey, Ham, Claygate, Oxshott and Worcester Park, and to furnish the members with information as to the most profitable manner of managing their bees and disposing of their produce; also to arrange exhibitions, lectures, demonstrations, etc.

Draft rules were adopted, and officers for the year were elected as follows:—President, Sir Charles Burge, J.P.; vice-presidents, Messrs. H. Forbes George, J. Cawter, P. G. Wigley, and Capt. K. E. Howell; hon. treasurer, Mr. R. J. Lamb; hon. secretary, Mr. B. Carter; committee, Messrs. Hart, Bowden, George, Cawter, Cooper, Allen, and Pardy; auditors, Messrs. A. Watkins and H. J. Shelbourne.

The hon. secretary explained that the Association was not at all antagonistic to the County Association. The latter intended to follow the example of Kent and form branch associations, of which the

Kingston and District Association might become one.

A member mentioned that the County Association provided the assistance of experts on bee-keeping, and the chairman replied that their own Association proposed to do likewise.—(Communicated.)

### Hunts. Bee-Keepers' Association.

A meeting of the Hunts. branch of the Soko of Peterborough and Hunts. Bee-keepers' Association was held in the Town Hall, Huntingdon, on Monday, June 7. The meeting was called to consider whether the time had arrived to form a separate bee-keepers' association for Huntingdonshire. There were some forty members present. After some discussion it was decided to form an association for the county. The Rev. E. F. Hemming was elected first president; vice-presidents, the Countess of Sandwich, Mrs. Scott Gatty, Mrs. Marshall, the Revs. E. A. Porter and J. Griffin, Commander O. Locker Lampson, M.P., Messrs. Spurling and Welstead.

Committee, Miss Locker, Mrs. Dudley, Mrs. Herbert, Rev. E. Snitch, Messrs. Bull, Childs, Emmerson, Hedge and Smith. Secretaries, Messrs. Woodford and Hodgson. Treasurer, Mr. Pack.

### Essex Agricultural Show, Colchester.

JUNE 9 AND 10.

In connection with the above the Essex Bee-keepers' Association held a honey show, which, considering the early date, was well supported, but whilst more exhibits were desirable, the quality of the honey left little to be desired. The two observatory hives staged proved a tremendous attraction, and during the whole of the time were the centre of interested spectators. The bee tent was also a great attraction, Mr. G. R. Alder, the county expert, lecturing on both days to large audiences, amongst those visiting the tent being General Colvin, M.P., C.B., Lady Byng of Vimy, Mr. L. Belsham (chairman of the Re-stocking Committee), and Mr. C. N. Brooks, J.P., E.C.C. The last-named gentleman assisted in the lecture tent. Mr. F. M. Claridge, the well-known bee specialist, of Copford, kindly lent the bees used for demonstration. These were some of his "Special Golden," and were immensely admired. This gentleman also assisted on both days in the exhibition tent, where he was kept exceptionally busy. Mr. H. Stroud, of Ilford, kindly gave much help at the close of the show in packing up exhibits, staging, etc. The exhibits were judged by

Mr. G. B. Alder, who made the following awards:—

Complete Frame Hive.—F. M. Claridge, first.

Observatory Hive.—F. M. Claridge, first.

Six 1-lb. Sections.—Miss Wilson, Canfield.

Shallow Frame.—H. Stroud, Ilford.

Six 1-lb. Jars Extracted.—F. M. Claridge, first; H. Stroud, second.

Three 1-lb. Jars Extracted.—F. M. Claridge, first; H. Stroud, second; A. Gamble, Battlebridge, third.

Six 1-lb. Jars Granulated.—F. M. Claridge, first and second.

1 lb. Extracted (Gift Class).—F. M. Claridge, first.

Bees' Wax, 2 lbs.—F. M. Claridge, first.

Any Useful Invention for Bee-keeping.—F. M. Claridge, first; E. W. Dempster, Ilford, second.

Honey Cake.—A. Gamble, first.

Hive (Amateur-made).—F. M. Claridge, first.

B.B.K.A. silver medal won by F. M. Claridge; bronze, H. Stroud.

**Royal Show Fund.**

	£	s.	d.
Amount received ...	18	10	8
Miss Gulland ...		2	6
Miss Harding ...		2	6
H. W. Anderson ...	10	6	
J. Lee ...	10	0	
H. M. Stich... ..	4	9	
H. Stubbs ...	2	6	
	£20	3	5



**“Commercial” or “Standard” Frames.**

[10215] (*Re* 10208). No, sir, you are quite mistaken. I certainly would *not* like to persuade everyone to scrap the standard frame and adopt the “commercial” size. I would use all in my power to prevent that. The standard is quite good enough for the majority of British bee-keepers, who, as is well known, merely keep bees as a hobby, and it would be a disaster if all these should be persuaded to scrap a frame they understand little for another they understand less. The Standard frame and the “Guide Book” are what I advise those to stick to. It’s true they will never do any good as a matter of business, but neither will they

lose much, and they can play with their bees to their heart’s content.

My letters have been written for those who wish to make a business of bee-keeping and who can see that it cannot be done on present lines.—R. B. MANLEY.

**Fraternity Among Bee-Keepers.**

[10216] I quite agree with Editorial comment *re* 10207, June 24, as the following experience will no doubt prove.

Some two years ago I decided to purchase a stock of bees on frames. Through a mutual friend, a bee-keeper became aware of my intention, and immediately sent me a host of books to read, including “Simmins’ Bee Farm.”

When I eventually knew the stock was coming he offered to hive it for me; fortunately, I managed to do this myself. Since then I have had two visits from him. At the first one he cut out all queen cells after a swarm had issued; second visit he found parent hive queenless, and is now endeavouring to obtain or rear me a queen.

Now this gentleman has to cycle 9 or 10 miles each visit. Further, his attentions are not confined solely to “your humble,” as I gather from conversation with him, he had several friends whom he visits regularly, and keeps things right with the bees, and *without any payment*; in fact, to offer anything of this nature would be looked upon as an insult.

I submit this bee-keeper (he is a “live” one) is keeping the old “spirit of fraternity” well alive.—“FOX-CROFT.”

**Bees in South Africa.**

[10217] Your correspondent, W. H. Edmunds, gives you in some rather long notes on bees in South Africa what are, I suppose, some of his experiences.

Well, sir, I, too, have been a bee-keeper in South Africa, although it is now 20 years since I lived there. I do not suppose that the honey bees, or, as the native call them, enyonic, have changed since then, and I can hardly let our mutual friends (the bees) receive quite so bad a character as he has given them. First and foremost, if I had had such bees as he describes them, I should soon have got rid of them, for although savage bees have the credit of being good workers, I hardly know how they get that character unless it is by their being left alone.

At any rate, I myself could always obtain the best results both in England and South Africa from bees of a mild disposition, and I can truly state that I have opened as many as a dozen hives of

an evening in South Africa without a veil, let alone gloves, and very little smoke. I can hardly realise a decent bee-keeper wearing gloves; fancy 212 bees at least destroyed by stings alone at one opening! why at this rate he would soon deplete an apiary. This is more I should say than I have received in 30 years, also, how could he pick up a queen? I like coat off and sleeves turned back.

Now my experience of South African bees (Natal) was that they were exceptionally quiet, rather smaller than our native black bee, and with one yellow band instead of the three of the Italians.

Next he writes of bee-pirates. Well, the only robbers (except man) were the ants, of course, and Death's Head moth, which one could sometimes find right on the comb in the middle of the bees, stealing their honey, and when these were numerous the bees would build a wall of propolis right across the entrance of hive, leaving entrances too small for the moth to get through.

I might mention that I, too, have shown and taken prizes for bees, honey and wax there, and have also acted as demonstrator in Pietermaritzburg Agricultural Show when living there. I have received stings here, but the only occasion that I received any was when transferring bees from the observatory hive in which they had travelled from Durban Show to Pietermaritzburg when one of the combs broke away from the frame owing to the heat; quite a number of the bees found their way up my trousers on the inside, and, of course, on pressure, I did then receive several stings, but this was an accident.

At one time, about 1901 or thereabouts, you used to receive and publish notes from Mr. Sewell, of Durban, a fine bee-keeper, and often a fellow competitor with me on the show benches there.

I am sorry that I am not now in a position to keep bees; first, I have had them all die off on two occasions with "Isle of Wight" disease, and since then I have had to move into a house where there is no garden. But even if I had accommodation for them I hardly think that it would be possible to keep bees in Oxford free from disease for any length of time whilst the Ministry of Agriculture engage a scientist here to study "Isle of Wight" disease, which, of course, means that it must be cultivated here if it is to be successfully treated.

This may be encouraging to bee-keepers as a whole, but how about working men such as myself twice losing all their stocks, especially when one is congratu-

lating oneself on having got clean stocks in new hives. I myself think that when the investigations here are finished that we bee-keepers in Oxford who have lost our bees a second, and some a third, time, should then be given a fresh start at least.  
—J. E. COLLIER.

### Sugar for Autumn Feeding.

The Ministry of Agriculture have secured the issue of a ration of sugar for autumn and winter feeding of bees, of 14 lbs. per stock, for the period August 1 to December 31, 1920. The ration may be procured in the usual manner by applying to the Horticultural Sub-Committee for a registration form.



### Too Much Drone Comb.

[9905] May I have a reply in your paper, the BRITISH BEE JOURNAL, as to what to do with brood-frames on which there is a superabundance of drone cells? Are the drawn-out combs any good for brood rearing, or should they be kept apart for honey storage, or have the drone cells cut out, or be destroyed? Why did my swarm suddenly begin so many drone cells?—D. CARRUTHERS.

REPLY.—The combs may be used in the supers, or if you rear your own queens they would be useful for rearing drones in the colony selected for that purpose. The only sure method of getting worker comb built in its place is to cut the whole of the comb out of the frame, and insert a new sheet of worker formation. They were crowded, and preparing to swarm again.



DR. K. BELL (Berks).—Zinc honey strainer.—It is not advisable to store honey in zinc vessels, but simply passing it through a zinc strainer will not harm it. The strainer should be washed each time immediately after it has been used. The "A.B.C. and X.Y.Z. of Bee Culture" says: "Tanks holding more than 500 lbs. are ordinarily made of galvanised iron. Some objection has been made to this metal because of the zinc contained in the spelter; but in large-sized tanks no injury to the honey has ever been noticed. However, it would be a mistake to leave a very thin layer of honey for a long time in the bottom of a galvanised tank, as the honey might take on enough of the zinc to be poisonous."



G. HENLEY (S. Devon).—*Price of honey.*—See report of monthly meeting of B.B.K.A. on page 306 of B.B.J. for June 24.

"Moors" (Durham).—*Moving bees to the moors.*—You can move the bees in the daytime. The main point is to give ample ventilation. Also, of course, see that everything is secure so that no bees escape during the journey. Cover the tops of the frames with perforated zinc, or cheese-cloth fixed on a frame, removing all quilts, and open the ventilator in floorboard. (2) You will find several advertised in the Journal. Bees may be destroyed by sulphur fumes, chloroform, or a solution of cyanide of potash. From half to one ounce of chloroform may be poured through the calico quilt between the frames; 4oz. of cyanide dissolved in about 2oz. of warm water may be used in the same way. Cyanide is a deadly poison, and must be used with great care. (3) It is a matter of fancy. We prefer W.B.C. ends.

F. C. JONES (Linton).—*Bees refusing to enter sections.*—One or more sections which have been drawn out, or partly drawn out, and if containing a little honey it is an advantage, placed in the centre of a rack as "bait" will generally induce the bees to enter. If you have not these by you, smearing a little honey on several of the pieces of foundation in the sections may serve, or a piece of comb cut from a frame and fitted into a section. If a queen excluder is used, try removing it for a time. The yellowish-brown substance is probably pollen. Probe it with a match stick and you will be able to determine.

T. S. (Alton).—The plan was given in the B.B.J. for May 8, 1919, and in the "Record" for June this year. We can supply either for 2½d.

#### *Suspected Disease.*

F. W. (Astbury), H. LAW (Biddulph), J. S. (York). J. P. (Wood Green).—The bees were suffering from "I.O.W." disease.

## Bee Shows to Come.

**July 14.**—Wickham Bishops and District Beekeepers' Co-operative Association. Group 2.—Open to bee-keepers resident in Essex. Class 79.—Four Sections; 1st prize, 7s. 6d.; 2nd, 5s. Class 80.—1 lb. Extracted Honey; 1st prize, 5s.; 2nd, 3s. Class 81.—1 lb. of Wax (in 2-oz. cakes), 1st prize, 5s.; 2nd, 3s. Group 3.—For bee-keepers' resident in the British Isles. Class 82.—1 lb. glass jar of 1920 Run or Extracted Honey; 1st prize, 20s.; 2nd prize, 10s. 6d. Exhibits in Class 82 to be the property of the Association, and to be given to hospitals in County of Essex. Entrance fee 6d. per class. Rules for exhibiting on back of entry form.—All entries to be sent to C. W. Cockburn, Hon. Sec., Meadow Bank, Wickham Bishops, Witham, Essex. Entries closed.

**July 15 and 16, at Grimsby.**—Lincolnshire Agricultural Society. Show of Bee Appliances, Honey, Sections, Wax, etc., under the management of the Lincs B.K.A. Open and County Classes. Valuable prizes.—Schedules from Major Hafeld, Alford, Lincs. Entries closed.

**July 20 to 23, at Aberdeen.**—Highland and Agricultural Society. Classes for Bee Appliances and Honey. Premiums £53 10s. Half of Prize Money and Silver and Bronze Medals contributed by the Scottish Beekeepers' Association.—Entry forms from John Stirling, Secretary, 3, George IV. Bridge, Edinburgh.

**July 21, at Broughton, Hants.**—Open Classes: Single 1-lb. Bottle, Single Section; prizes, 20s., 15s., 10s.—Schedules from Chas. Hoare, Broughton, Hants.

**July 21, Wyke and Normandy Horticultural Society.**—Honey Classes (Open). Best three sections, 5s., 3s., 2s.; Run Honey, light, 3 1-lb. glass jars, 5s., 3s., 2s.; Run Honey, dark, 3 1-lb. glass jars, 5s., 3s., 2s. Entrance fee, 6d.—Particulars, H. L. Mumford, Hon. Sec., Heatherside, Normandy, Guildford.

**July 21, Bishopstoke, Hants,** at the Royal Southampton Horticultural Society's Show.—Bitterne and Swanmore Beekeepers' Association's

Honey Show. Four Open Classes.—Schedules, C. D. Casewy, Clifton Villa, Bitterne, Hants.

**July 24 (postponed from 17th), at Guildford.**—Guildford and District Beekeepers' Association. Members and Open Classes.—Schedules and prize list from Rev. E. C. Pitt-Johnson (Hon. Sec.), Heatherwood, Pirbright, Surrey. Entries close July 10.

**July 28, at Blandford.**—The Blandford and District Horticultural Society are holding a Show of Fruit, Vegetables, Flowers, and Honey in the Park, adjoining the Crown Meadow, Blandford. Prizes for honey by the Dorset B.K.A. for members of the Association.—Schedules from C. G. Bone (Dorset Bee-keepers' Association), County Education Office, High West Street, Dorchester.

**July 29 to August 2, at Bolton.**—Royal Lancashire Agricultural Society's Show. £50 prizes for Honey. Six Classes.—Schedules (stating Honey Section) from R. O. Bradbury, Secretary, Derby House, Preston. Entries closed.

**August 2, at Bredon.**—Annual Show of the Worcestershire B.K.A. Three open classes. Schedules from Geo. Richings, 42, Barbourne Road, Worcester. Entries close July 26.

**Monday and Tuesday, August 2 and 3, at Newport.**—Monmouthshire Beekeepers' Association Annual Show (in connection with the Newport Allotment Holders' Association). Members and Open Classes.—Schedules (post free 3d.) from Hon. Sec., "Underwood," Portskewett, near Chepstow, Monmouthshire. Entries close July 26.

**August 3, 4 and 5, at Abington Park, Northampton.**—Northants Beekeepers' Association Show, in connection with the Municipal Horticultural Society's Show. Open Classes for single bottle and section.—Schedules from Mr. H. F. Swann, 41, St. Michael's Mount, Northampton. Entries close July 30.

**August 4, at Sheffield, Hants,** in conjunction with the Sheffield Horticultural Society's Show, Hants and Isle of Wight Beekeepers' Associations, Swanmore and Bitterne Branches. Classes for Comb and Extracted Honey.—Schedules from the Hon. Sec., A. F. Hardy, Esq., The Palace House, Bishop's Waltham, Hants.

**August 7, at Barnstaple.**—Barnstaple and District Horticultural Exhibition, to be held in the Market Hall. Five Open Classes for Honey.—Schedules from Hon. Secretary, 19, Grosvenor Street, Barnstaple.

**August 11, at Wye.**—Kent Honey Show. Thirty classes, half of which are open to U.K. Four Silver Cups and 75 other prizes. Schedules, Mr. A. Lepper, Wye. Entries close August 1.

**August 14 and 16, at Cannock, Staffs.**—Eight open classes for honey, etc. Prizes value £12. Schedules from J. Bird, Secretary, "Glenmay," Allport Road, Cannock.

**August 12, at Taunton.**—Somerset Beekeepers' Association Show of Honey, Wax, and Appliances. Seven Open Classes. Liberal prizes.—Schedules from Mr. F. J. J. Stacey, 3, Hammet Street, Taunton. Entries close August 6.

**August 14, at Llanely.**—Carmarthenshire B.K.A. Show, in connection with the Llanely and District Horticultural Society's Show. Liberal prizes (nearly £15) offered for Honey, Wax, and Appliances. 15 Classes (7 Open).—Schedules from R. Lloyd Roberts, London Joint, City and Midland, Llanely. Entries close August 6.

**August 25, at Prestbury, Cheltenham.**—Flower, Fruit and Honey Show. Open Class for single 1-lb. jar of honey. Several classes open to beekeepers living within a radius of 12 miles.—Schedules from A. H. Bowen, Coronation Road, Cheltenham. Entries close August 13.

**Saturday, August 28, at Hinckley.**—Leicestershire and Rutland Beekeepers' Association, in connection with Hinckley Flower Show.—Open Classes for Honey, Sections and Jars. Prizes, 12s. 6d., 7s. 6d., and 4s. 6d. in each class. Judge, J. Herrod-Hempall, F.E.S.—Schedules from A. Kimbrell, Esq., Clarendon Road, Hinckley. Entries close August 23.

**November 18.**—Annual Show of the Worcester City and County Chrysanthemum, Fruit, Root and Honey Society. Thirteen open classes in Honey Section. Schedules from Geo. Richings, 42, Barbourne Road, Worcester. Entries close November 6.

## Special Prepaid Advertisements. One Penny per Word.

Advertisements must reach us NOT LATER than FIRST POST on TUESDAY MORNING for insertion in the "Journal" the same week.

### PRIVATE ADVERTISEMENTS.

**FOUR STOCKS** of Bees for Sale, 10 frames, with supers covered, £5 each; also 1920 fertile Queen, 10s.; Geared Extractor, four Hives, 30s. each. 30 Snallow Bars drawn out with the lot, best offer.—G. MILLER, Glenlee, Auele Street, Motherwell. g.37

**FOR SALE**, Stock of Bees on 10 new combs, healthy, hard-working strain, £3 15s.; travelling hive loaned, deposit 10s.—WHITE, 143, Alexandra Road, Grantham. g.40

**SOME SURPLUS** 1920 Queens (Hybrid), delivery directly, price 7s. each, post free.—R. B. MANLEY, Brightwell, Walingford. g.39

**SPECIAL BARGAIN**.—Goods must be moved. Wrought Iron Greenhouse Boiler, with 100 ft. 4-in. Pipe and all joints, just as new and worth £22 net to-day; one Dicker and Cane Sidecar for motor-cycle, worth £6; one Taylor's 10-frame Bee Hive, quite new, worth 30s. I will separate or sell the lot for £18, or exchange for 2 cwt. of good English Honey.—CLAY, Kingsleigh, Wellington, Salop. g.42

**BEE SWAX**, pure, for Sale, 3 cwt. packed in ½-cwt. bags, £8 16s. per cwt. net, f.o.r. London.—Apply, Box 92, 23, Bedford Street, Strand, London, W.C.2. r.g.43

**TWO STOCKS** of Bees for Sale, plenty of brood and honey, £6 each.—MASTER, Morion Grange, Thornbury, Glos. g.44

**WANTED**, Honey Extractor and Ripener, in good condition.—NEWMAN, Kennardington Rectory, Ashford, Kent. g.45

**SALE**, "Little Wonder" Honey Extractor, 12s.—EVANS, Lattiford, Wincanton, Somerset. g.48

**TWO TAYLOR'S HIVES**, good condition, 50s.—NEVARD, 2, Norwood Road, Herne Hill, S.E.24. g.47

**DUTCH VIRGIN QUEENS** from imported stocks, the surplus from the Restocking Apiaries of the Edinburgh and East of Scotland College of Agriculture, 3s. each.—AVERY, 13, George Square, Edinburgh. g.50

**TWO SWARMS** on frames, one Italian, one Italian Hybrids, certified healthy by Middlesex expert, 50s. each.—E. MACKAY, M.M.B.K.A., 9, Priory Gardens, Highgate, N. g.51

**WANTED**, small Portmanteau or Gladstone Bag; exchange Nuclei.—Box No. 94, B.B.J. Office, 23, Bedford Street, Strand, W.C.2. g.52

**SALE**, Single-walled Hives, 5s. 6d. upwards; approval.—HUNT, Bank Street, Somercotes, Alfreton. 1.67

**STRONG STOCK** on 10 new combs, May Swarm, 1919 Italian Hybrid Queen, purchaser must remove, £4 10s.; also strong Nucleus on 4 combs, pure Italian 1920 Queen (Penna strain), £2 5s.—ROUND, 38, Arngask Road, Catford, S.E.6. g.57

**SPLENDID** new White Clover Honey, £10 per cwt.; tins to be returned; sample 6d.—ALBERT COE, Apiarist, Ridgewell, Halstead, Essex. g.58

**SACRIFICE**.—Bees, 20 strong Stocks, 10 frames, £3 per stock; crate 10s., returnable; room wanted.—GITTINGS, Bleak House, Bleak Hill, Plumstead Common. r.g.59

**THREE STRONG STOCKS** on 8 frames, 3 gs. each, carriage paid; boxes 10s., returnable.—HODSON, Harley Lodge, Enfield. g.60

**ONE GOOD STOCK** on 8 frames in box, one early Swarm on 10 frames, £3 10s. each; one June Swarm on 8 frames, in box, £2 10s.—Post Office, Bowsby, Bourne, Lincs. g.61

**JUNE SWARMS** on 3 to 6 standard frames, guaranteed healthy, queens laying and plenty of brood, 7s. 6d. per frame (7s. 6d. deposit on box, returnable); Swarms from 18s. 6d.; new Cambridge Honey, £8 cwt.—STANLEY, 56, Montague Road, Cambridge. g.62

**TWO STRONG STOCKS** for Sale, guaranteed 8 frames of brood and perfect health, 70s. each.—FRANCIS, Kurnella, Shoeburyness. g.63

**WANTED**, a few lots of healthy Driven Bees before July 31.—Price and particulars to KING, 3, Castlereigh Road, Stockton-on-Tees. g.65

**WANTED** to sell at once, surplus Stocks healthy Bees, 10 frames, £4 per stock; purchaser to send boxes.—JEWITT, Hensall, near Goole, Yorks. g.64

**STRONG STOCKS**, Blacks £4 10s., ditto Hybrids; also strong Stock Italians, £5; all on 10 frames; guaranteed healthy.—G. GREEN, Dore, Sheffield. g.66

**FEW STOCKS** of Italians on 10 frames, ready for supering, £4; boxes 12s., returnable.—HENSLEY, Luton Apiary, Queen's Road, Chatham. g.67

**FOR SALE**, strong Stock Italians, 10 frames, 1920 Queen, £4.—WALLACE, Hedenham Lodge, Bungay. g.68

**FOR SALE**, six Standard Hives, £1 each; four Section Racks, 4s. each; guaranteed healthy.—Apply, GRIFFIN, 84, High Street, Slough. g.69

**HEALTHY**, strong Stock Italian Bees, 6 frames, £2 15s.—15, Kelvin Avenue, Bowes Park, London. g.70

**THREE** good healthy Stocks of Italian Hybrids, 10 frames, Penna strain, £3 10s., carriage paid; 10s. on box. Seen by appointment. (Am overstocked.)—H. OBORNE, 25, Guest Road, Bishopstoke, Hants. r.g.71

**FINEST GOLDEN HONEY**, splendid quality, sample 6d.; also Swarms.—NORTH, Cressing, Braintree, Essex. g.72

**WANTED**, Honey Extractor, side gear, also Ripener.—Particulars to T. HOWARD, Rayne, Essex. g.87

**TWO** choice 10-frame Stocks with prolific Italian Queens, £5 each; also two 4-frame Nuclei, Italians, £2 2s. each; never had disease in apiary; 10s. box, returnable, less carriage.—Box No. 93, B.B.J. Office, 23, Bedford Street, Strand, London, W.C.2. g.56

**NEW** Light Lincolnshire Honey for Sale, £8 8s. per cwt.—WILLIS, New Leake, Boston. g.7

**COLONIES**, 50s.; Casts, 32s. 6d.—MRS. FRED BATCHELOR, Bailey's Farm, near Bendish, Whitwell-Herts. For telegrams, Whitwell-Herts is counted one word. g.9

**EXTRACTOR** wanted for standard and shallow frames.—W. COLDICOTT, Westfield Road, Wellingborough. g.21

**OVERPLUS BEES FOR SALE**.—Apply early, strict rotation, enclosed stamped envelope particulars.—BARUCH - BLAKER, Warrilow Apiary, Barnham, Sussex. r.1.136

**BASSES** selected Fish supplied, carriage paid, exchanged for Swarms.—ELVIDGE, Wholesale Fish Merchant, Grimsby. r.1.164

**SALE.**—Exhibitor proceeding abroad; complete Apicultural Requisites, including Plate-glass Trophy, Observatory, and other Hives, Extractor, Smokers, etc.; half catalogue prices.—**SWABEY**, Bracebridge Heath, Lincoln. r.f.162

**FOR SALE**, Second-hand all guaranteed clean exceptionally well made W.B.C. hives, with oak legs; also combination hives, £2 each; well-made shallow frame boxes, 3s. each; Queen excluders, 1s. 3d. each.—**DAVID HANCOX**, Grove Lodge, Deddington, Oxon. f.181

**BRITISH HYBRIDS**, colonies in Skeps, 57s. 6d.—**PRYOR**, Breachwood Green, Welwyn. r.f.178

### BUSINESS ADVERTISEMENTS.

1½d. per word.

**6-FRAME STOCKS**, with 1920 Queens, 60s. each; travelling box 10s., returnable.—**MEGGITT**, Bramhall, Stockport. r.g.49

**"PATRICIA"**, Grammar School, Doncaster. still has spare Virgins from her wonderful selected Penna queen, 4s. by return, or money back. Send stamps for reply. r.g.46

**ITALIAN HYBRID NUCLEI**, 4-frame, £3, 6-frame, £4 5s.; grand laying Queen, vigorous, healthy stock (average honey yield 120 lbs.).—Particulars from **VICAR**, Brizenorton, Bampton, Oxon. Wanted, really good Geared Extractor. g.41

**SPECIAL OFFER** in gentle strain of Italian Hybrids, packed with bees and brood, 2-frame Nuclei, 20s.; 3 frames, 27s. 6d.; boxes 6s., returnable; immediate delivery; carriage paid; deposit if preferred.—**A. LONGLEY**, 35, Tharp Road, Wallington, Surrey. g.73

**DUTCH AND GOLDENS.**—A few strong Stocks, ready to super, £3; 4 and 5-frame Nuclei, 30s. and 35s.; full of brood.—**W. GREEN**, Laindon, Essex. g.74

**NUCLEI.**—Italian Hybrid, 3 frames, 32s. 6d.; 4 frames, 42s.; guaranteed healthy; boxes 6s., returnable; Virgin Hybrid Queens, 3s.—**EKINS**, Burntwood, Staffs. g.75

**ITALIAN HYBRID QUEENS.**—Orders booked for July-August delivery. Fertiles, 10s.; Virgins, 3s.—**JACK TICKELL**, Westbourne Apiary, Cheltenham. g.76

**STRICTLY BUSINESS.**—Six packages of Flavine, 6d.; a Japanned Sprayer, 6s.; "Let the Bees Tell You," 2s. All post paid.—**S. H. SMITH**, 30, Maid's Causeway, Cambridge. g.77

**BRED FOR IMMUNITY.**—Queens, 9s. 6d.; Bees per frame, "Standards" 10s. 6d., 16 x 10 15s. Immediate delivery. Send for particulars.—**COBB**, 33, Bevan Road, Plumstead. g.78

**IMPORTED ITALIAN QUEENS**, 11s. 6d. each; selected Hybrids, 9s.; English, 7s. Safe delivery guaranteed. Catalogue free.—**C. T. OVERTON & SONS**, Crawley. r.g.79

**STOP? LOOK HERE!**—Having despatched all orders I can still spare a number of 3- and 4-frame Nuclei at 45s. and 52s. 6d. respectively, carriage paid, 7s. 6d. being refunded on box. Also a limited number of Stocks on 8 frames. Price on application. All above are home-reared Italians, highly resistant to disease, and splendid honey gatherers.—**HERBERT VALLEY**, Apiarist, Saxilby, Lincoln. r.g.80

**FOR SALE**, fertile 1920 Penna Queen's daughters, 10s. 6d.; a few dark Hybrids, 6s. Last week in July or first week in August a few Stocks for Sale, each headed by a Penna Queen imported this year; 10-frame, £4 7s. 6d.; 8-frame, £3 15s.; 4-frame, £2 5s.—**ASHWORTH**, The Bungalow, Weymouth Street, Warminster. g.81

**CHOICE** home-reared Italian Queens, 10s.; Virgins, 4s. 6d.; July-September.—**MISSES PALING & PILLANS**, Golden Square, Henfield, Sussex. r.g.82

**STRONG 4-FRAME NUCLEI**, Italian Hybrids, 40s., carriage paid; boxes returnable.—**BARNES**, 20, Bourdon Road, Anerley. g.83

**HARDY** natural-raised 1920 Queens, 5s. each.—**WOOLDRIDGE**, Woodleys, Winchcombe, Glos. g.84

**VIRGIN QUEENS—THE WELSH APIARY STRAIN.**—Hybrid Italian, guaranteed bred from highly prolific stock, never had "I.W." D. in apiary, the Queens to revitalise your stock, hardy and virile, 5s. each.—**LT.-COLONEL WEAVER PRICE**, Welsh Apiary, Ashgrove, Brecon, S. Wales. r.g.85

**4-FRAME NUCLEI**, 63s.—**PRYOR**, Breachwood Green, Welwyn. g.86

**STRONG 3-FRAME NUCLEI**, 1920 fertile Queens, 30s.; box 5s., returnable; Stocks on 8 frames, 60s.; boxes 10s., returnable.—**W. WOODS**, Normandy, near Guildford. g.83

**NUCLEI**, good hybrids, 1920 fertile Queens, 10s. per frame.—**EVANS**, Lattiford, Wincanton, Somerset. g.84

**BOWEN'S SPECIALITIES.**—Having bought a complete Apiary, I offer grand Hybrid Colonies on 8 combs, 93s.; 3-comb Nuclei, solid with brood, 48s.; immediate delivery.—Below.

**BEAUTIFUL HYBRID QUEENS** from hardy disease-resisting stock, 10s. 6d. each.—Below

**SOUND** Second-hand Hives, 25s. to clear.—**BOWEN**, Queen Breeder, Cheltenham. g.85

**DOES BREEDING SPECIALISATION PAY—FOR YOU?**—"The queens I have had from you so far are absolutely 'it.' I'm gone on them. I have recommended several men to have bees from you."—**R. M.**, 25/6/20. Now does it?—**ATKINSON**, Fakenham. r.g.23

**PURE ITALIAN QUEENS**, prompt delivery; select Italian, extra golden, rare honey-producing stock, August-September.—**ATKINSON**, Fakenham. r.g.24

**NUCLEUS** (surplus), 3 frames, fine condition, satisfaction guaranteed, fertile Italian Queen (from Penna's 1920 queen), 50s.; box 10s., returnable; Queens, as above, fertile, 10s.; Queens, Hybrid Italian, fertile, 8s. 6d., virgins, 4s. In rotation.—**WARD**, 16, Church Road, West Kirby. g.31

**1920 PURE Fertile Italian Queens**, direct from the well-known French breeder, Abbé Warre, 7s. 6d. each.—Orders for execution in rotation to **ELLIOTT**, Kelvin Road, Ipswich. r.e.104

**DUTCH** and Dutch-Italian 4 (four) frame Nuclei, 50 for July delivery now, £2 5s., carriage paid.—**SEALE**, Ashley Cottage, Oatlands Drive, Walton-on-Thames, Surrey. g.35

**PURE ITALIANS.**—Imported Penna 1920 Queens, four frames, 45s.; six, 55s.; eight, 65s.; 10, 75s. Hybrids, good strain, 5s. less. Carriage paid; boxes returnable.—**WADHAM**, Gold Street, Cardiff. r.f.166

**"WIGHT" DISEASE**, prevention and removal; advice 5s.—**ALFD. BYALL**, Kenwood Apiary, Elcombe, Stroud. r.f.161

**NUCLEI**, 1920 Italian Queens, 4-frame, 50s.; swarms, Italian, 45s.; boxes 10s., returnable.—**C. HOGAN**, Boxford, Suffolk. r.f.175

**NUCLEI.**—Three frames, best hybrids, Penna, etc.; 1920 Queens, fertile, immediately, 35s.—**MOORE**, 31, Monmouth Road, Dorchester. f.165

**PUPILS** received by life-long whole-time Bee Farmer.—Terms on application to C. B. BARTLETT, Sandford Mount, Charlbury, Oxon. d.127

**1920 FERTILE** Golden Italian Queens, guaranteed imported direct from Italy, regular supplies every few days, 10s. each; specially selected, 14s.—GOODARE, New Cross, Wednesfield. f.59

**"ISLE OF WIGHT" DISEASE.**—Don't worry; I use the solution that cures; 2s. per bottle.—E. PRESSEY, St. Elmo, Coulsdon. r.d.149

**HAVE YOU READ "THE BEE WORLD"?** If not, why not? Every number in itself is a useful literary work for practice and reference. Specimen copy free.—Offices: THE APIS CLUB, Port Hill House, Benson, Oxon.

**BOZZALLA** tested Queens are sold at the price usually charged for untested queens.—Catalogue from H. STICH, Riccarton Avenue, Paisley. r.c.116

## HIGHLAND SHOW



**ABERDEEN, July 20-23.**

**£4,608 in PRIZES.**

**Horses, Cattle, Sheep, Goats, Pigs, Poultry, Wool, Bee Appliances and Honey, Dairy Produce, Implements and Machinery.**

**PARADES OF CATTLE AND HORSES, GREAT JUMPING COMPETITIONS.**

Forestry Exhibition, Agricultural Education, Butter Making Demonstrations, Wool Demonstrations.

**ADMISSION.**—Tuesday, 20th July, 7/6; Wednesday, 5/- (after 5 p.m.), 2/-; Thursday, 3/- (after 5 p.m.), 1/6; Friday, 2/-. Children under 12, Thursday and Friday, 1/-. Season Tickets, 15/- each.

Holders of Society's Long Service Medal admitted Free to Show.

**GENERAL MEETING OF MEMBERS IN PAVILION** on Wednesday, at 12.30 p.m.

John Stirton, Secretary.

3, GEORGE IV. BRIDGE, EDINBURGH.

## THE British Bee-Keepers' Association

Insure *now* against loss by damage done through bee stings. All particulars from

W. HERROD-HEMPSELL, 23, Bedford Street, Strand, London, W.C.2.

## ITALIAN QUEENS Direct from Italy.

**E. PENNA, BOLOGNA, ITALY.**

I assume again the direct sale of my queens. Special offers from July 10 till countermanded. For queens in lots of 4 at a time £1 8s. Cash with orders. Payment by cheques or **British** Postal Orders. International Money Orders are **not** accepted. I do not hold myself responsible for the queens that are not sent by me direct to customers. All orders should be sent direct to me. In May the queens dead in the journey have been **less** than 1%  
ORDERS BOOKED IN ROTATION.

## Dutch Bees.

I am Sole Agent for Hans Matthes, the Dutch Bee Farmer who supplied the British Government last season with Skep stocks for their County Restocking Scheme.

These bees are hardy, prolific, healthy.

Send for Illustrated Catalogue giving methods of management, characteristics, honey-gathering and disease-resisting powers of this race of bee.

Address—

**R. WHYTE,**  
The Bee Farm,  
Cumbernauld, Dumbartonshire.

5 per cent. discount allowed to members of the Apis Club.

## ITALIAN QUEENS

**Direct from Italy.**

Address:  
**Signor Gaetano Piana,**  
Castel San Pietro,  
near Bologna, Italy.



All Queens are reared by the most up-to-date and scientific methods. Mr. W. Herrod-Hempshall has personally inspected the apiary and methods employed, with which he is perfectly satisfied.

**PRICES FOR 1920.**

**For 1 Fertile Queen:** August and September, 9/- each queen.

Can take no more orders for June & July. Booked up.

Carriage paid in Great Britain. Cash must accompany all orders, which will be executed in rotation. Guaranteed safe arrival of all Queens, but not the introduction. Bees dead upon arrival must be sent at once to "B.B.J." Office.

For the mutual convenience of all parties, Il Signor Piana has made arrangements that all communications, orders and remittances of the readers of "B.B.J." and "B.K.R." can be addressed to him, c/o British Bee Journal, 23, Bedford Street, Strand, London, W.C.2.  
Cheques payable to "British Bee Journal."

**Vigorous American and Italian Strains of world wide reputation.**

**QUEENS** raised by natural methods in the strongest stocks under the swarming impulse. Immediate delivery of virgin, mated, and breeding queens.

**NUCLEI** of young bees covering all sealed brood; will build up rapidly into stocks. Supplied on one to four frames as required. Immediate delivery.

**STOCKS** supplied on six to ten frames. No swarms or bees by weight.

**STURGES, Hartford, Cheshire.**

**THE ONLY CURE !!**

Nothing messy. No spraying.

**Clarke's 'I.O.W.' CURE**

A powder to sprinkle on the floorboard. What's simpler? **3/6** per packet.

Inundated with testimonials.

**G. J. CLARKE, Blythburgh, Halesworth.**

**HIVE ROOFS.**

Why risk losing your bees through having leaky roofs when you can get

**ABSOLUTELY WEATHERTIGHT ROOFS?**  
24 in. x 24 in., 13s. 6d.; 24 in. x 20 in., 13s. 3d.; and 20 in. x 20 in., 13s. each; i.o.r. London.

Roofs are galvanised, and also treated by a special process to prevent condensation. Special terms for quantities. Order early, and avoid delay in delivery.

LARMUTH,  
MONAHAN AVENUE, PURLEY.

The products of the Apiary, of Poultry and Farm Stock, of the Fruit and Vegetable Garden can be Advertised and Sold through

THE  
**BAZAAR, EXCHANGE & MART**  
Newspaper.

Get a Copy—Thursday and Saturday 3d. The "Bazaar" publishes also practical handbooks by experts. Send for full catalogue, post free from—**WINDSOR HOUSE, Breams Buildings, LONDON, E.C.2.**

**BARGAINS IN SURPLUS CLOTHING.**

- Khaki Serge Riding Breeches, good condition . . . . . pair **12/6**
- Bedford Cord Riding Breeches, good condition . . . . . " **9/6**
- New Bedford Cord Officers' Breeches . . . . . " **42/-**
- New Cord Riding Breeches, strapped . . . . . " **22/6**
- Blue Serge Trousers, for Working Men . . . . . " **12/6**
- Blue Serge Trousers, as new . . . . . " **14/-**
- Blue Serge Trousers, new . . . . . " **21/-**
- Khaki Drill Trousers, all sizes . . . . . " **7/6**
- Khaki Drill Jackets, with pockets each **7/6**
- Army re-soled Boots, all sizes . . . . . pair **12/6**

Army Rubber Ground Sheets 72 x 36, brass eyelets, good condition, 2 for **9/-**, 4 for **16/-**. Large Canvas Cart Covers about 6ft. square, with brass eyelets, **7/6** each. These are useful for making Tents or Camping Outfits. Black Rubber Combination Suits, all sizes, complete with Sou'wester, **25/-** each; cost Government **63/-**. New Heavy Black Boots made specially for outdoor workers, **21/-** pair. Large Australian Wool Blankets, **26/-** pair—bargains. New Full-size Army Grey Wool Blankets, **35/-**. Best bargain in Blankets ever offered.

**SPECIAL OFFER FOR THIS HOT WEATHER:—**

- Khaki Drill Suits, Officers' quality, complete with pockets, **20/-** per suit.
- Khaki Drill Suits, another quality, complete with pockets, **14/-** per suit.

**SACAR'S (Universal) STORES (Dept. 27), ARDWICK, MANCHESTER.**

"A GOOD QUEEN IS WORTH £5." I can supply a small number of this quality of best Italian and American Strains in "Full House" four frame nuclei at **63/-** f.o.r. Box 10/- Returnable at once.

**ALAN K. THOMPSON, Croft House, SANDIWAY, Cheshire.**

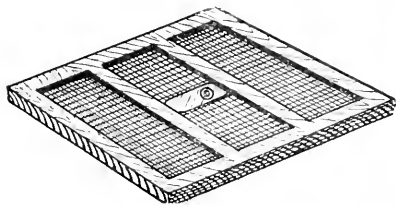

**B<sup>c</sup> B<sub>w</sub> BOARD**

A Necessity on all Hives all the Year Round.  
**SUPER CLEARER.  
QUEEN EXCLUDER.  
WINTERING BOARD,**  
&c.

SEND FOR KAT-A-LOG

**MEADOWS, Syston, Leicester.**

**POSITIVE FACTS.**

I am very pleased with the foundation. The bees undoubtedly prefer it to any other make I have, and have even gone the length of missing two sheets of other new foundation, and working out a sheet of yours placed behind them at the back of the hive. Full sheets have not sagged in the least in 16 x 10 frames.

Yours faithfully, R. B. MANLEY.

Illustrated Lists free by post.

June 13th, 1920.

**S. J. BALDWIN, The Apiary, BROMLEY, Kent.**



THE  
KEY TO  
YOUR SUCCESS.

## Lee's Bee Supplies.

¶ In design, material and workmanship, Lee's Bee Supplies still retain the reputation of being your best and safest investment.

¶ Our 1920 ILLUSTRATED CATALOGUE is yours for the asking. It contains detailed information on the most up-to-date hives and appliances for which the House of Lee is famous.

¶ We regret the necessity of having to advise our Customers that owing to the increased cost of production, all prices in 1920 price list are subject to 10% increase. The increase will not apply to orders received before May 10.

\*\*\* Five per cent discount to Members of THE APIS CLUB.

**JAMES LEE & SON,**  
LTD.,  
Uxbridge, Middlesex.

(Telegrams: Graphicly, Uxbridge.)

Telephone: Uxbridge 181.)



## "BACTEROL" FOR BEES

2/9 per Bottle.

Post Free.

The cure for, and preventive of, "Isle of Wight" Disease. Non-poisonous—free from stain or unpleasant odour.

MENLEY & JAMES, LTD.,  
39, Farringdon Road, London, E.C.1.

**BRADBURY, TAUNTON,**  
FOR QUALITY BEE GOODS.

ORDER

*Illustrated Bee  
Guide free.*

Telephone: TAUNTON 176.

## 20-Page 1920 "WHITE STAR" List,

3½d. POST FREE.

S. SIMMINS, QUEENLAND, HEATHFIELD, SUSSEX

**Bees and Beekeeping Appliances. Catalogue free.**  
**EDWARD J. BURTT. MANUFACTURER. GLOUCESTER.**

*I very much regret that there has been a large increase in the cost of the manufacture of bee-appliances, and therefore my prices will be advanced 10% from May 10th. Books excepted.*

PRINTED BY THE AVENUE PRESS (L. UPOOTT GILL & SON, LTD.), 65-67, DRURY LANE, LONDON, W.C., AND PUBLISHED FOR THE PROPRIETOR (W. HERROD-HEMPHILL), BY SIMPKIN, MARSHALL, HAMILTON, KENT & CO., LTD., 31 & 33, PATERNOSTER ROW, E.C.

**BRITISH BEE JOURNAL**  
 & Bee-keepers' Adviser.  
 A Weekly Journal Devoted to the Interests of Bee-keepers.

Edited by  
 T.W. Cowan, F.L.S.  
 and J. Herrod-Hempesall, F.E.S.

Office:-  
 23 Bedford Street,  
 Strand,  
 London, W.C.

ESTD 1873

W&K

No. 1986. Vol. XLVIII

JULY 15, 1920.

[Published every Thursday, Price 2d.]

**CONTENTS.**

	PAGE		PAGE
SEASONABLE HINTS .....	337	How to Sell British Honey .....	345
DORSET YARN .....	337	"Isle of Wight" Disease, or Creepers All Over Hives .....	344
JOTTINGS FROM HUNTINGDONSHIRE .....	338	Bee Building Comb Upwards .....	344
THE SIMPLE AND GENTLE ART OF KILLING BEES .....	339	Is this a Record? .....	344
JOTTINGS .....	340	Is it "Isle of Wight" Disease? .....	344
APICULTURE IN HOLLAND .....	341	An Early Morning Swarm .....	344
YORKSHIRE BEE-KEEPERS' ASSOCIATION .....	342	Birds and Bees .....	344
CORRESPONDENCE—		ROYAL SHOW FUND .....	344
Quilts for Bee Hives .....	343	NOTICES TO CORRESPONDENTS .....	345
Re Bees Disappearing .....	343		

WRITE FOR  
 FREE CATALOGUE  
 WITH  
 INSTRUCTIONS  
 FOR BEGINNERS.

AS MY

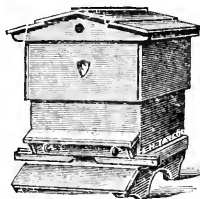

S

ARE THE  
**FOUNDATION OF SUCCESS**  
 SO IS SUCCESS

MADE CERTAIN  
 BY

MY

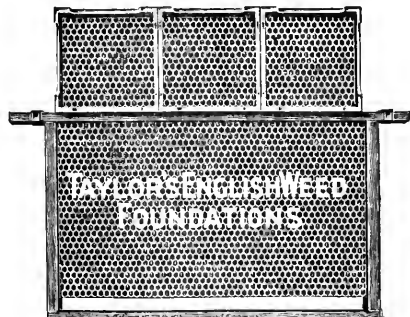

**E. H. TAYLOR**  
**WELWYN,**  
**HERTS.**

Telephone: 13 WELWYN.

THE  
**British Bee Journal**

Office: 23, Bedford Street, Strand, London, W.C.2.  
ESTABLISHED 1873.

A Weekly Journal Devoted to the  
Interests of Bee-keepers.

Edited by T. W. COWAN, F.L.S., &c.,  
and J. HERROD-HEMPSALL, F.E.S.

**Correspondence: Whom to Address.**—  
All matters relating to the Literary Department, Associations, Shows, etc., should be addressed, "Editors, *British Bee Journal*," and all business communications and matters relating to subscriptions and advertisements to be addressed to the "Manager," *B.B.J.* Office.

**Subscriptions.** - Annual Subscription, 10s. 10d. post free in advance; single copies 2s., or 2½d. post free. If a receipt is required by post, a stamped and addressed envelope must be sent, otherwise a printed receipt will be enclosed along with the paper.

**Note.**—Cheques and Postal Orders should always be crossed, otherwise it is very difficult to trace them if they go astray.

**How to send Money.**—Remittances can be made payable to W. Herrod-Hempsall by crossed Cheques and Postal Orders. Stamps may be sent for small amounts up to 2s. *Halfpenny stamps are preferred.*

Scottish or Irish cheques can only be taken in payment if 6d. is added for commission charged by banks for cashing them.

The Editors are not directly or indirectly interested in the manufacture or sale of beehives or appliances of any kind, and must refer correspondents wishing for prices or catalogues to advertisers in the paper.

**OUR DEPOSIT SYSTEM.**

You are advised to insist on this being used when dealing with strangers.

**Rules and Conditions for Depositing**

*In order to save trouble, it is requested that the Rules be carefully read over by persons using the Deposit System of trading.*

Goods should not be despatched until notice that the money has been deposited is received from this office.

1. **Method.**—When strangers are dealing together, the purchase-money of the articles is deposited at our office. We acknowledge receipt of the deposit to both parties, and hold the money until we are satisfied that the purchase is concluded. If a sale be effected, we remit to the seller the amount deposited, less a charge of 2½ per cent. in the £, with a minimum of 6d., and the expenses of Post Office Orders and postage, &c. Cash will be forwarded by Cheque, Post Office Order, or by Postal Order as preferred. If a sale or exchange be not completed, we return the amount deposited, after making the same deduction. By this means buyers and sellers are secured against fraud.

2. **Deposits.**—Postal Orders (drawn on General Post Office) and Cheques must be made payable to W. Herrod-Hempsall, and crossed "London County and Westminster Bank." The numbers of the Postal Orders should be kept by the sender. We cannot be responsible for any loss that may occur in transit.

3. **Honey on Approval.**—All honey will be sold by sample, which must be sent direct to buyer.

4. **Bee Appliances.**—In ordering, the time allowed for completing the order to be stated to us when sending cash. If maker accepts, we hold cash until transaction is satisfactorily completed, when the amount will be remitted, subject to conditions as in Clause 1.

5. **Bees and Queens.**—These will be dealt with entirely by the parties concerned, so far as price, &c., go, and when the purchase is satisfactorily completed cash will be remitted as per Clause 1.

6. **Goods in Transit.**—These are at the seller's risk, i.e., any damage to or loss of an article on its journey is borne by the vendor; but a rejected article must be properly packed and returned by the same means as was used in sending it.

7. **Carriage.**—The carriage of all goods, except such as are sent by post, is payable by the buyer, unless otherwise agreed. If any article sent on approval be returned, each party to the transaction must pay carriage one way.

**HIGHLAND SHOW**



**ABERDEEN, July 20-23.**

**£4,608 in PRIZES.**

**Horses, Cattle, Sheep, Goats, Pigs, Poultry, Wool, Bee Appliances and Honey, Dairy Produce, Implements and Machinery.**

**PARADES OF CATTLE AND HORSES, GREAT JUMPING COMPETITIONS.**

Forestry Exhibition, Agricultural Education, Butter Making Demonstrations, Wool Demonstrations.

**ADMISSION.**—Tuesday, 20th July, 7/6; Wednesday, 5/- (after 5 p.m.), 2/-; Thursday, 3/- (after 5 p.m.), 1/6; Friday, 2/- Children under 12, Thursday and Friday, 1/- Season Tickets, 15/- each.

Holders of Society's Long Service Medal admitted Free to Show.

**GENERAL MEETING OF MEMBERS IN PAVILION** on Wednesday, at 12.30 p.m.

John Stirton, Secretary.

3, GEORGE IV. BRIDGE, EDINBURGH.

THE  
**British Bee-Keepers' Association.**

Insure *now* against loss by damage done through bee stings. All particulars from

W. HERROD-HEMPSALL, 23, Bedford Street, Strand, London, W.C.2.





### Seasonable Hints.

The one thing certain about our climate is its uncertainty, and since the advent of July it has been anything but ideal for the bee-keeper. The rainfall has been above the average, and often the temperature has been below the normal. There is an abundance of forage in our district, white clover bloom being abundant, but the bees have not been able to take full advantage of it. We have noticed in previous years that swarms are usually numerous if a spell of warm, sunny weather follows a wet period, and, no doubt, the same will hold good this season. The first sunny day that comes will see a number of swarms issuing, often to the anything but pleasant surprise of the bee-keeper.

Those who have been queen rearing should keep an eye on the virgins. The last fortnight has been bad for mating, and numbers of queens that have emerged during that time have still to take their marriage flight. When looking through a hive or nucleus containing a virgin queen on a sunny morning, do not be unduly alarmed if neither queen or eggs are to be found; quite likely the queen is out on her mating trip, and the hive should be closed up and another examination made in a couple of days. We examined six nuclei one day several years ago, and not one queen could be found. The owner was rather despondent, for the virgins were from a selected strain, but on looking through them again a few days later was delighted to find every one mated and laying. It is, of course, better if a queen is mated within a week of emerging from the cell. How old a queen may be before mating becomes impossible is not decided. On two occasions we have known queens not mated for six weeks after leaving the cell, when it was successfully accomplished, but we believe *once an unmated queen commences to lay drone eggs she will never mate.*

Queens are now coming in from Italy, and so far we have not heard the complaints of difficulty of introduction that were so common last year; probably this is due to the experience gained. A good plan is to adopt the method of re-queening we have given before, *i.e.*, make a nucleus from the colony to be re-queened and stand it about a foot to one side and in front of the hive. Put the cage containing the new queen to the nucleus about 10 or 12 hours afterwards. The queen will thus be introduced to *young*

bees, as all the old flying bees will return to the parent colony. Do not be in a hurry to liberate the queen; she will not hurt if she is in the cage for several days.

Those who are working for increase must be on guard that the newly-established colonies do not suffer from lack of food. In some parts of the country the weather has been so unfavourable that bees have been unable to collect enough food to keep going. We have heard of nuclei dying of starvation during the last fortnight.

### A Dorset Yarn.

A visit to Cardiff brought us into contact with bee-keepers in Glamorgan, and bee-keepers from other parts of the United Kingdom, even Ireland sent men with floral exhibits who recognised the name over the exhibit of the Violet Farm. Many men who, like myself, have the snows of winter in the hair, and some who have the vigour of young manhood, are all enthusiastic on these small insects that are of such benefit to mankind. To the horticulturist the Cardiff Show was an object-lesson that will be long remembered. The miscellaneous collections had many flowers that were of great service to the bee-keeper. In the large tents hive bees, with bumble bees, were on certain units of the floral kingdom continuously; flowers rich in pollen, "*Thalictrum*," "*Cicimifugia*," had them each day; at all times some bee or another was on them, so some of these plants will come to the Violet Farm. If only as food for our bees, they will be a good investment.

Mr. W. Herrod-Hempsall, who acted as judge of the honey classes, was met. The demonstrations by the experts were very instructive, and all proved that the Glamorgan bee-keepers were very much alive. Though the Show was a bit early for heavy exhibits of honey, what was shown was of high quality and finish.

On getting home to the farm on Friday evening we found that there was another huge swarm. This had come out of a hive that had two brood chambers; it is a pity they come out in the honey flow. I would have sent them back, but after two days out of the hive I did not like to risk it; had it been the same day it would have been different. Am indebted to my esteemed bee friends for the safe hiving of this enormous swarm—there is no lack of the fraternal help with each other in East Dorset.

It is of great interest to me to note the time that bees build so much drone comb. I took from one stock three bars of brood bees, and the queen; these were placed into a brood chamber with ten other

drawn-out combs, and they have filled two racks of sections, and have not swarmed. The stock from which these were taken had three bars with brood foundation, placed alternately with other bars, and in ten days they were all drawn out with drone comb, excepting an inch or so at the top. By taking the queen away in May they had to raise more queens, but to raise whole combs of drones is inexplicable. Another hive that was depleted of four bars of comb for increase did not do this, but only built a few patches of drone, as is usual in most stocks. Why should one lot do so many and another so few drones? These bars were taken out on the same day in May, the combs that were drawn-out drone had to come out, and new ones were added, but on the outside this time; on some of these were patches of drone comb, but not like the others that were placed in the centre or hive. Neither the parent stock nor the increase has swarmed, which is what the bee-keeper wants—honey, not continual swarming. Still, many bee-keepers have made money with swarms this year, and now so much wet has come in the honey flow they will have the greatest money balance this season, because, since the advent of so many Dutch bees, the swarming has been much more than in former years.—J. J. KETTLE.

### Jottings from Huntingdonshire

Roadsides purplish-red with Rest Harrow; what wealth is here! yet, oh busy bee, don't go too often to this flower. Rest Harrow honey is pungent, a touch of it adds piquancy to the honey of clover and lime, but too much of it spoils rather than improves the flavour. Had the fine weather continued the mowing machine had passed along the roadside herbage and laid Rest Harrow and aught else low. Hereabouts the roadsides are not grazed as in most parts, consequently wayside flowers have a romping time before haymaking. Haymaking checks awhile the honey flow, but is not to be compared to the check given by a cold, blustering, damp wind which holds sway for a week at a time. This past week has been a trying one for the hive; even our Italian bees are content with what the garden and the fields close at hand can offer. Radish flowers and anchusa are receiving unusual attention just now; it needs more than a cyclone to stay these busy creatures from working. Last Tuesday it rained in torrents all the morning and cleared for a brief spell in the afternoon, and out came a swarm! The remarkable thing about this swarm is it came from a hive into which a swarm of 4½ lbs. was introduced

last month. I didn't expect it, and didn't want it, for I hadn't a hive quite ready, so had to set to work to complete the making of a hive I began some few days ago. It is not a record I know; yet not every queen would fill up three-fourths of ten standard frames with brood and bring a hive up to swarming pitch in a little more than a month. The honey flow was certainly exceptionally good during June, and we all know how a lavish flow of honey puts her majesty into a humour for depositing eggs sometimes three or even four in a cell. Poor workers! their patience is high inexhaustible, they've enough to do without emptying cells over-filled by their queen.

A pretty thing happened this morning; as I was walking towards home a worker, tired with her load of nectar and pollen, settled on my arm, and there she clung until I reached the garden, when she flew off to her hive.

But I'm wandering on, forgetting my promise of last week *re* "miner" and "tapestry" bees. Several species of solitary bees are miners. Some prefer hard earth, well rolled garden walks or tennis lawns, some bore holes straight down into the earth, others in the sloping sides of the roads. Some mining bees are the size of a house fly, others are larger than the hive bee.

The tapestry bee—a species of the upholsterer bee—is a leaf cutter, but instead of making holes for their cylindrical nests in the ground they choose softened mortar of park or garden walls. Their holes or galleries they make very beautiful by adorning and furnishing with tapestries of various colours, they are also lined throughout with brilliant scarlet hangings cut from the petals of the wild poppy. Her home complete, the tapestry bee begins to lay in a stock of bee bread, and then deposits a single egg, covers it over with a piece of leaf and fills in the hole with earth. This done she proceeds to prepare a home for her next egg, and so on—each home occupying about three days of the busy insect's time.

The Peterborough Show was a success in every way—bee craft excepted. No bee tent! no display of honey! Alas, that those who control these shows do not advance a little and meet bee-keepers half way! Who wishes to be demonstrating in a show-ground on sufferance?

Before apiculture comes into its own the farmers will have to interest themselves far more than they do. One now and again comes across a farmer as anxious as the rest of us to make bee-keeping a profitable side line. These gentlemen are generally men with both eyes wide open. I do not mean that our husbandmen are

all asleep, but I do maintain that their attitude towards bee craft is proof that they have at least one eye half shut.

They have much to try them one knows, as at present, rain almost daily while the hay is lying about and the corn just turning from green to pale fawn, dashed to the ground by wind and hail, all the more reason why they should encourage those side lines which, to say the least, help them overcome many difficulties, and surely a clover field near a few colonies of bees is worth twice as much as one such unvisited by nectar gatherers. From great men we expect great things.—E. F. HEMMING, Steeple Gidding.

### The Simple and Gentle Art of Killing Bees.

It was a day of pleasant summer-time when I remembered, and my conscience smote me about those bees which had strayed away on their own, and were masterless, and who inhabit the roofs of village churches, the hollows of trees and similar places, and who transmit from one to another colony pestilent diseases, and who must be dealt with thoroughly to clear the country of such diseases. It being stated by someone recently that such bees are easy to kill, I decided that now was the time to deal with them.

So the Boy and I gathered together certain appliances for the pleasant and gentle art of killing bees; there was a spade to dig with, and an axe for chopping, a double-handed saw, a 12-foot ladder, several sticks of sulphur, and various other things which as a total load made the Boy look serious until I consented to help him. I intended to help him with advice, but finally found myself like a travelling workshop; he had given the advice. Our first difficulty was which way to go—to north, south, east or westward ho! It was the Boy's idea to shade the compass and note in which direction it pointed at a chosen second. The result was not satisfactory, excepting as a time delayer, though it seemed west was most favoured; and considering that we had a river to the north, a sea to east, and high hills to the south, it was the only serviceable path for us, if the Boy had only used some common sense in the first instance, without tinkering with the compass. So behold us *en avant* loaded up with the gear and intent on killing those bees which someone (perhaps it was the office boy) had said were so easy to kill. We found the ladder very useful to use to get over the hedges; it was only necessary to prop the ladder against the hedge with the top high above it, and walk up until

the top see-sawed down to the ground on the other side and then walk down. The Boy was very dubious about the plan, but when he saw me up and slip on the top and fall on my face into a holly hedge he saw beauties in it. As he said, only a great mind could have thought of this method of getting over a hedge, which mollified me somewhat, although my face felt dreadful with the scratches that it had received, for it is very rare now that the Boy says anything about my ideas. We went on a little way after this until we approached a village, which are likely places in which to find stray swarms, specially the churches in whose roofs they often are. So we sought out the church, laid our tackle in the churchyard, and went carefully round the outside of the building looking for likely places for bees, but could see none the bees were making use of. This did not matter, for I knew bees were in church roofs, and bees were easy to kill, and I intended to kill them. So I directed the Boy to gather as much wood, paper and twigs as he could and follow me inside the church, where, after choosing a suitable place in the centre of the floor, we made up our heap of wood, etc., and proceeded to light it; but our material proved damp, and after striking several matches in vain, I was considering collecting up the numerous books around us and adding them to our heap, when a vulgar individual came in and asked us what we were doing. I carefully explained that there were bees in the church roof and probably with pestilent diseases on them, and as they did not like smoke and were easy to kill, I was intending to smoke them out. But he said, "You will burn down the church." This had not occurred to me, but I told him I would still kill the bees. "But you must not," he said, "or, if you must, let me bring the Vicar; he will come and help you, for he also likes to kill bees." On this he hurried away and along the village street. The Boy said, "Let us get a move on, master." "Why!" said I; "he has only gone to bring the Vicar to help us." "Not he," said the Boy, "he has gone for the *police*, for I know where the police lives." On this I thought it time to go, for the Boy's knowledge, though somewhat peculiar, was generally accurate, so we went without the parting and loving cup being given to us by the villagers after we had gathered up our killing appliances. "No," continued the Boy, "the Vicar, he don't like bees, they irritate the folks in church and make them unable to sleep peacefully; if he had his way he would supply everyone with a dummy soother, and if would pay, for it would

prevent a lot of hard remarks about his preaching." We plunged almost immediately into a plantation after leaving the village, which I considered lucky, for woods are famous places for bees, and we soon found a tree in which I could distinctly see bees' nests.

The Boy had his doubts, for he had a vague recollection of squirrels' nests being in similar places; but this I said was absurd, for I could see they were bees, and so propping up the ladder against the tree I sent him up it to report. The Boy proved a good climber to the top of the ladder, but refused to go further. I could have done better myself, excepting that I wanted one foot on the ground during my climbing, so we were in a fix, though not up a tree. I decided to try the use of the saw. We soon found a double-handed saw was no joke to use on a tree standing upright, especially in inexperienced hands, with a Boy at one end who would pull at the same time I did. My violent instructions to him soon brought a man with a gun on his shoulder to the scene. To his inquiries I patiently explained that bees were in trees and supposed to be easy to kill, and that it was our duty to kill those bees. I heard him say, "Surely they have not all escaped from the Big House." "No, no," I hastened to assure him, "they came probably from a small hive." "I did not exactly mean bees," he said. I had to attend to the Boy just then, it sounded as if he were choking; the foolish fellow was trying to breathe with his handkerchief in his mouth. When I got him recovered the man said it was also his mission in life to kill things, and that I must leave all the things in that wood to him; he would kill those bees if he had to shoot them one at a time, and as for the damage done to the tree by our saw we would hear further about it. He would take us to the edge of the wood and direct us to a better one which belonged to a retired colonel whom we would know by his red face; no doubt he would welcome us in his own way, sorry he could not go with us to see it. Thus we went on our way. We saw several bees flying about, but it proved a tricky business chasing them, and we could not catch any, for we had forgotten to bring with us any salt. We saw one bee curious near a hole in the ground, and we promptly commenced to dig at longer or shorter spells with the one spade; at least, I got the longer and the Boy the shorter, and I was unable to alter the rotation. After we had made the hole umpteen feet wide and double umpteen feet deep, we were in doubt. As a country-looking man said, it was too hot for bees down there, and if we went

further we would come to where the earth was in a fluid state; as for the hole, it it need not be wasted, for we could start business and sell grave spaces, separate or wholesale for families. This so disgusted me I decided to move on to fresh woods and pastures new. To do this we must cross a fairly wide and deep brook. I pushed the ladder across and started to walk across; due, probably to fear, the Boy followed closely after me, thinking company was best; but this broke the ladder, and let me down up to my neck in a nasty mixture of mud and water.

By some marvellous luck the Boy escaped the fate, and he sat on the bank and consoled me. He said I was now ready to follow bees under water; but I could not remember where it says in the text-book anything about bees dwelling under water, although I knew fishes made nests. After I had got out of the water the Boy decided it was time to go home, so we cast off all our gear to look after itself and made for home. And so the result of our killing was nil, and we lost all the gear through being too heartbroken to carry it away.

There is a little moral in this tragic history; if not, there should be, and ought to be. It is easier to *kill* than to *find* the bees; but this I know, I want something less exciting than the easy and simple killing of bees.—Yours, in despair, F. B. CHARLTON, Stockton-on-Tees.

## Jottings.

*Super Packing.*—Somewhat late in the day I offer the suggestion that wisps from wine bottles make excellent packing around the supers, or for that matter, extra or light quilting, and if used before the binders are broken will keep all both clean and compact.

*The Gambol of Bee-keeping.*—I prefer to use this lighter vein of thought in connection with our pleasant occupation, but in the complications and disappointments set up in the present season's review I am afraid I may be accused of linking our thoughts to the more heavy and serious aspect of competition and investment.

In this locality we found the spring at least six weeks advanced, colonies simply packed with bees, but with very little stores, and many at starvation point. Fruit blossoms were suddenly withdrawn, and a very serious state of affairs presented itself to many, the strongest colonies causing the most anxiety. Then during the dull days of May we found immature brood being thrown out, and some colonies completely starved. June proved, if anything, more fickle, with an

occasional day of warmth, just enough to allow breeding to proceed. The reduced numbers were much in evidence in the puny swarms which issued towards the middle of the month, while at the end they were either four to six pounds, or a continuation of small ones. I hived a six-pounder on July 3, the parent hive had no honey in the brood chamber, about 20 lbs. in sixty sections, very few filled, while the hive was a mass of brood and bees. A swarm hived seven days previously, secured a fair proportion of honey in a week, and we now get day upon day of dulness and wet storms, and the height of the season upon us. A change for the better would just "save our bacon," with the prospect of a brighter tale, this seems especially trying to beginners, of whom he have a good number, who generally think it is only necessary to secure bees to get the honey.

Still another hive was killing drones June 20; these had swarmed several times.

A friend finds my "lift-up" advice a failure, and he thinks there is no cure for swarming, while in my own hive worked in this way this is the only one that has any appreciable amount of honey as yet. Where are we?

*Fraternity* (1020).—First, I would thank the kindly thought and interest of Mr. Harwood, which prompted him to so kindly send me the package of honey plants, which were, indeed, a pleasant surprise. I have had a couple of hunts for his address, but failed, so I will ask him to please accept this as acknowledgment. More I must not say in face of the "law." I don't quite see the force of your correspondent's argument, Mr. Editor, as he says, he has taken great interest in, and derived much valuable help, from the pages of this Journal. Surely this is in contradiction to the last portion of his letter, which I think must have been written in his "cross" mood.

Fraternising often takes a heavy toll from a few by way of the helping hand, but I have met very few who would not pass on most that has been picked up elsewhere. Really I fail to see why a request of this sort should receive offers of bees galore when it is purely a business proposition, and generally the advertisement columns of the Journal are full of such offers. And it is not any one of us who always has a special kind to dispose of. I do not think we have much to reproach ourselves about compared with most hobbies and undertakings, unless it is that too many of us rely on others, and leave the study to be of the smallest elementary character when once the bees are hived.

Since writing the above we had an hour's sunshine, which prompted two or three swarms to come out which were due. One cluster was at least seven pounds, a foot below that was another one, three parts of a gallon, the following twenty-four hours the poor creatures were hanging in a deluge of rain. I accommodated the big lot with some bars, mounting a ladder with a large sugar-box, and put the smaller one into a skep. Raining all the time. One wonders if they always are weather prophets, but internal pressure works wonders I suppose. Anyhow, I hope they have some fine weather in view.—A. H. HAMSHAR.

## Apiculture in Holland.

Possibly the appended translation of an official report on apiculture in Holland may be of interest to some of your readers at the present time, when an insistent movement is being made for an Act of Parliament for the promotion of the bee industry in this country.

"L'APICULTURE EN HOLLANDE."

"A delegate of the Syndical Chamber of Apiculture of Belgium, Monsieur H. Smeyers, has just published in the Journal *L'Apiculture Rationelle* a report on his official journey through Holland. This is what he writes:—

"The Organisation of Apiculture in Holland includes a great federation. This Society possesses a 'House of Apiculturists' at Wageningen, so called because the members of the Society can there obtain everything that is required for apiculture. They can sell there all the products of the apiary. This establishment, like the co-operative undertakings that one meets with in Belgium, is carried on by the commercial department of the National Federation of Apiculturists. It has a saw-mill for the construction of frame-hives, cylindrical machines for the manufacture of foundation, honey extractors, wax extractors, and a counter for the sale of numerous bee appliances, as well as of honey. The receipts in 1918 reached over 2,000,000 francs, yielding a net profit of 13,000 francs to the Association. The Federation buys and receives annually about 1,000,000 lbs. of sugar, required for wintering the bees of all beekeepers. This sugar is exempt from Excise duty, which amounts to 27 florins per 100 kilos. (about 200 lbs.). Its medication is carried out at the 'House of Apiculturists.'

"The result of this is that the Dutch Government thus favours apiculturists to the amount of about 405,000 francs of Excise duty. In Belgium, the remission

of Excise duty on sugar for bees scarcely reaches the amount of 100,000 francs for a similar quantity of sugar, i.e., four times less.

"The Federation possesses a valuable apicultural library, and also a series of small 'circulating' libraries, the books of which, enclosed in small boxes, are sent in rotation to the various sections of different districts. Holland possesses school-apiaries, and stations of observation installed in different localities, where bee-keepers come to obtain useful and precise instruction for the management of their hives.

"Instruction in apiculture engages especially the attention of the Dutch Government, and, with this in view, it has created a post of 'Apicultural Adviser,' the duties of which are discharged by M. Vangiersbergen, who possesses a theoretic and practical knowledge of apiculture in a marked degree. The 'official' adviser is authoritative between the Government and the bee-keepers whom he visits and whose apiaries he inspects. All questions relating to apiculture are submitted to him by the Government. He undertakes the verification and inspection of the hives at the frontier to prevent the introduction into the country of infected stocks. Among his duties are the organisation and oversight of the courses of instruction and of conferences on apiculture. He holds conferences himself in those districts where he considers it useful to do so. He controls the school apiaries, and collects all documents concerning apiculture. He often, and of his own accord, moves from place to place where invited, or when he considers it useful to do so. He draws up all the scientific statistics useful for popularising bee-keeping, and he forms a link between horticulturists and apiculturists, to promote the sending of colonies of bees useful for the fertilisation of flowers into districts which are distinctly fruit-producing.

"Thus it happens that in certain parts horticulturists offer a payment of 50 per cent. per hive for bee-keepers to bring their bees to them. In this connection the Federation of Dutch Horticulturists has forwarded to the Minister of Agriculture a request that the exportation of bees should be prohibited through fear of seeing their fruit-harvests diminish.

"Instruction in apiculture is carried out on serious foundations. Conference members have to pass a theoretic and practical examination before an official jury, including the 'Apicultural Adviser.' There are given every year in Holland twenty courses in apiculture, including twenty theoretic and four practical lessons. The courses are given at the head-

quarters of the Apicultural Societies and under their auspices. At the end of these courses an examination for obtaining the diploma of Member of Conference lasts several days, and is preceded by a special preparatory course directed by the 'Adviser' and his assistant.

"Nominations to the Apicultural Conferences are made by the Government on the recommendation of the Apicultural Adviser. This method of proceeding results in giving to instruction in apiculture a character and form entirely scientific and practical."—W. WINTER-  
TON, Stoke Mandeville.

## Yorkshire Bee-Keepers' Association

### ANNUAL MEETING.

The annual meeting of the association was held at Darlington on July 1 in the Bee and Honey Tent, Royal Show ground, kindly lent by the B.B.K.A. The Chairman, the Rev. T. H. Hutchinson, presided. The minutes of the last meeting were read and confirmed. The Secretary, Mr. W. E. Richardson, read his report and balance-sheet, which showed a large increase of paying members and good financial state. The Secretary reported that 95 Dutch-Italian nuclei were raised in 1919 from the 30 Dutch skeps purchased by the Yorkshire Council for Agricultural Education under the Government Re-stocking scheme, and 26 skeps had wintered well, and up to July 1, 1920, 40 nuclei had been sent out, and given good weather there was every prospect of reaching 100. Yorkshire bee-keepers owe a debt of gratitude to the gentlemen who so kindly came forward, sparing neither time nor trouble in looking after the skeps, raising and despatching the nuclei so successfully. The Secretary was glad to report disease on the wane, and he represented the county at the Conference of Bee-keepers in London on the Bee Disease Bill, and he knew all Yorkshire bee-keepers were anxiously awaiting its progress through Parliament, for with empty disease-infested hives and skeps scattered all over the country and no means of prevention it was impossible to retard or stamp out disease.

It was decided to have a meeting and conference of bee-keepers every quarter in different parts of the county, and the first will be held at Harrogate in September.

The Earl of Harewood, K.G., was re-elected president, with a number of vice-presidents and the committee *en bloc*. The deaths of three prominent Yorkshire bee-keepers were recorded with deep regret, viz., Mr. Grimshaw, late secretary, and well-known writer in the 'eighties under the *nom de plume* of "The

Hut"; Mr. Rymer, inventor of the honey press and board, and the Rev. Jannings, who found all life's pleasures from his bees, and making handy appliances for their comfort and welfare.—W. E. RICHARDSON, hon. secretary.



*The Editors do not hold themselves responsible for the opinions expressed by correspondents. No notice will be taken of anonymous communications, and correspondents are requested to write on one side of the paper only and give their real name and addresses, not necessarily for publication, but as a guarantee of good faith. Illustrations should be drawn on separate pieces of paper. We do not undertake to return rejected communications.*

### Quilts for Bee Hives.

[10218] Several correspondents have written about their quilts being torn into holes by the bees. I do not think the holes are "bitten" by the bees, but that the bees pull the ends of the fibres and so pull the fibres of the calico out. This "nap" or ends of fibres sticking up, prevents the bees from getting an easy foothold on the quilt, and to get this foothold is the cause of the work of the bees and the destruction of the quilt.

Bee-keepers may remove this "cause" by starching, painting, or waxing the calico before it becomes a quilt. Of the three ways, "waxing" I find the most successful in point of service and comfort to the bees, for now I have quilts of many years' wear the calico for which only cost 2½d. per yard.

If the calico for the quilts is rubbed over on both sides with warmed bees-wax and then run over with a warm flat iron, it will give a suitable surface to the quilt. Quilts so treated, give the bees a comfortable easy foothold, are flexible when warm over the hive, fitting snugly on top of bars and sides of hives, preventing draughts through the hive, easy to peel off, no propolis, and if occasionally re-ironed, say at spring-cleaning and autumn packing for wintering, it will make a quilt as near perfect as possible, as I have found in many years of bee-keeping.

I might add that my quilts have a hole about 4 in. square, and are made of two thicknesses of calico with the cut edges both of hole and sides turned inside and then stitched. I use a sheet of glass over hole when not required for feeding or other purposes, as it enables me to look at combs in winter or early spring without the disadvantage of opening the hive in cold weather.—J. BINT, Bucknall, Lincoln.

### Re Bees Disappearing.

[10219] I have not the copy of my original letter now, but if I used the words "wintered my bees," I did not mean that I opened the hives in the winter, but that I fed them with syrup in the late autumn. I think I mentioned that at time of closing the hives for the winter the bees were very strong, that was in October. I did not examine them again until the spring.

No. 3 hive, the strongest stock of all, had plenty of stores when I made my final examination of combs before destroying them, no brood, but three fully-developed queen cells from which young queens had been hatched. These were not on the combs in October. I think the bees must have killed their queen and hatched virgins, and they must have come out during one of the very mild days we had this winter here in South Devon.

The loss of bees in other hives still remains a mystery. I found no queen cells, or brood, in any of their combs.

My remaining bees are doing very well, and I hope to end this season with a dozen stocks or more.

The queen in No. 3 hive was an old one, and her wings had been cut; she was the best I ever had, and I raised all my young queens from her. I had intended to re-queen this hive with one of Mr. Simmin's White Star queens, but, unfortunately, he was not able to fulfil my order last year, and having waited until it was too late to rear one, I was forced to leave the old queen in hive.—GEO. M. ROSLING.

### How to Sell British Honey.

[10220] In this country we are getting well stocked with bees; this will mean surplus bees and honey. To sell our honey—British honey—we must create a demand for it; also labels must be made to state whether *imported* or *British*. Our labels should include the words, "Support home industries, and beware of imported honey."

Also a leaflet should be enclosed with each jar, or section, with facts about honey, a few recipes and such like. The uses of honey are numerous; how many of the general public know of its many uses? An example: have you tried lemons cut up, boiling water added and sweetened with honey; this is a most refreshing healthy drink, and beats "John Barley-corn" on the harvest field and elsewhere. Also, black currants, boiled and strained; add honey. This made hot on a cold day is fine. This should appeal to our rev. friends. I am sure they would give the

sweetest sermon ever known and no one will regret it.

Nursing mothers will benefit along with the wee ones. Don't tell people what I heard at a lecture once, that a pound of honey is equal in food value to a pound of beef, etc.; this will hold us up to ridicule. Everything has its uses, and comparison and place.

In reply to many correspondents, they can use the words of my label. I think it could be improved with a garland of flowers and printed in colours, being too plain. A skep may look picturesque, but is not up to date, and only looks well in a football cartoon.

A honey stall on the local market would help, also a tour of the shops in a seaside town will add to the pleasure and profit of the day; no need for stage fright, you will be welcomed. After all we are truly British, now it's up to you.—A. TROWSE, Eade Road, Norwich.

### "Isle of Wight" Disease, or Creepers all Over Hives.

[10221] Last night a friend came to see me. He asked me if I remembered the hives covered with creepers (not a bee on the wing) some years ago. I went and tried to kill them off. I put flowers of sulphur on the paper well alight in smoker and puffed in the opening of hives to suffocate them, but instead of doing that, in a few days there was not a creeper to be seen. He says they carried in pollen, and the bees were stronger. I remember doing a good many stocks like it, only they were not so strong, but creepers soon disappeared, and no more came out crawling. I had forgotten this until my friend reminded me, but I hope some bee-keepers when they see crawlers will try it and report. These hives were not stained or spotted at all, but quite clean, only all the bees were crawlers.—W. GREEN, Laindon, June 24.

### Bees Building Comb Upwards.

[10222] With reference to Mr. A. C. Grimshaw's letter (10161) on bees building comb upwards. I had standing in my apiary last year a skep, and wishing to super same, I placed on it another skep. On looking in the top skep a few days afterwards I found that the bees had built upwards from the hole in the bottom skep to about four inches high. When they reached the top they spread out and filled the skep with combs. I have never seen combs built upwards in a bar-frame hive.—LESLIE R. FITCH, Birdbrook, Essex.

### Is This a Record?

[10223] At the beginning of the season I lost what I considered my best queen whilst out for a flight. I picked her up outside another stock, dead.

Five queen cells were raised, and the queen from the one which I left started laying on June 5. There were then two combs of eggs one and two days old, so I put another brood box on, making a total of 21 brood combs.

Last Sunday I looked again, and found 19 combs packed full of brood—19 combs of brood in 15 days. Some scorching!

If the bees turn out good workers, as no doubt they will, I intend to raise all my future queens from this mother.

Leicester bee-keepers are invited to visit our apiary if they will send us a card. These bees are Italian hybrids.—JOHN W. EARL.

### Is it "Isle of Wight" Disease?

[10224] Referring to Rev. Hemming's jottings in July 1 JOURNAL, "we are experiencing the same thing with our swarms as he mentions. They are hived apparently healthy, but in a day or so of hiving we find them crawling, although the parent hive is going strong. There is not one exception in our apiary. We have been treating them with Flavine, which certainly is doing good. If not "Isle of Wight" disease, it is something very near approaching it.—WM. S. HALFORD, West Wrattling, Cambs.

### An Early Morning Swarm.

[10225] At 7.35 a.m. (summer time) this morning (June 12) I received a message to say that one of my hives had swarmed. I immediately went to the apiary and found a fair sized swarm on an apple tree. Is not this rather early in the day for a swarm? I have already had two very good swarms from this hive. Can any reader tell me of any earlier swarms?—K. WALKER.

### Birds and Bees.

[10226] I see in "Notices to Correspondents" you give shooting the tits as the only remedy.

I had been much troubled in the same way, but by putting a piece of ordinary chicken wire above the porch it prevented the tits getting to the alighting board, and did not interrupt the passage for the bees.—J. H. PRITCHARD.

### Royal Show Fund.

Amount received ...	£20	3	5
Signor Bozzalla ...	£1	0	0
Total ...	£21	3	5



## Notices to Correspondents

T. H. LAWSON (Staffs).—*Are bees livestock?*—We should certainly class bees as "livestock"—providing they were alive.

A. E. S. (Loughton) and C. M. (Shropshire).—*Disinfecting hives and combs.*—The best method of disinfecting hives is by scorching the inside with a painter's lamp, or with a brush apply a strong solution of some disinfectant and water. The outside of hive may be washed with disinfectant in water. The combs may be fumigated with Bacterol or Formalin, or soaked for several hours in disinfectant and water. For this purpose use Bacterol, Yadil, or Formalin. They will then be safe. It will be wise to treat the sections before using.

"WILLIAM" (Somerset).—If you are going in for the final examination you will need to study all the bee literature you can. A dissectible model of queen bee would be of assistance. Sorry we do not know where you could obtain mounted specimens of the various hive and wild bees.

### Suspected Disease.

T. JONES (Edeyrn), Miss E. M. B. (Ulverston).—So far as we could tell the bees were not diseased.

"LAND" (Hants), C. E. C. (Ipswich).—The trouble is "I.O.W." disease.

## Bee Shows to Come.

**July 15 and 16, at Grimsby.**—Lincolnshire Agricultural Society. Show of Bee Appliances, Honey, Sections, Wax, etc., under the management of the Lincs B.K.A. Open and County Classes. Valuable prizes.—Schedules from Major Hadfield, Alford, Lincs. Entries closed.

**July 20 to 23, at Aberdeen.**—Highland and Agricultural Society. Classes for Bee Appliances and Honey. Premiums £53 10s. Half of Prize Money and Silver and Bronze Medals contributed by the Scottish Bee-keepers' Association.—Entry forms from John Stirling, Secretary, 3, George IV. Bridge, Edinburgh.

**July 21, at Broughton, Hants.**—Open Classes: Single 1-lb. Bottle, Single Section; prizes, 20s., 15s., 10s.—Schedules from Chas. Hoare, Broughton, Hants.

**July 21, Wyke and Normandy Horticultural Society.**—Honey Classes (Open). Best three sections, 5s., 3s., 2s.; Run Honey, light, 3 1-lb. glass jars, 5s., 3s., 2s.; Run Honey, dark, 3 1-lb. glass jars, 5s., 3s., 2s. Entrance fee, 6d.—Particulars, H. L. Mumford, Hon. Sec., Heatherside, Normandy, Guildford.

**July 21, Bishopstoke, Hants,** at the Royal Southampton Horticultural Society's Show.—Bitterne and Swanmore Bee-keepers' Association's Honey Show. Four Open Classes.—Schedules, C. D. Cawsey, Clifton Villa, Bitterne, Hants.

**July 24 (postponed from 17th), at Guildford.**—Guildford and District Bee-keepers' Association. Members and Open Classes.—Schedules and prize list from Rev. E. C. Pitt-Johnson (Hon. Sec.), Heatherwood, Pirbright, Surrey. Entries closed.

**July 23, at Over Wallop, Hants.**—Wallop Horticultural Society. Open Class, single 1-lb. bottle Light Honey; prizes, 7s. 6d., 5s., 2s. 6d.—Hon. Secretary, P. E. Roberts, School House, Nether Wallop, Hants. Entries close July 24.

**July 23, at Blandford.**—The Blandford and District Horticultural Society are holding a Show of Fruit, Vegetables, Flowers, and Honey in the Park, adjoining the Crown Meadow, Blandford. Prizes for honey by the Dorset B.K.A. for members of the Association.—Schedules from C. G. Bone (Dorset Bee-keepers' Association), County Education Office, High West Street, Dorchester.

**July 29 to August 2, at Bolton.**—Royal Lancashire Agricultural Society's Show. £50 prizes for Honey. Six Classes.—Schedules (stating

Honey Section) from R. O. Bradbury, Secretary, Derby House, Preston. Entries closed.

**August 2, at Bredon.**—Annual Show of the Worcestershire B.K.A. Three open classes. Schedules from Geo. Richings, 42, Barbourne Road, Worcester. Entries close July 26.

**Monday and Tuesday, August 2 and 3, at Newport.**—Monmouthshire Bee-keepers' Association Annual Show (in connection with the Newport Allotment Holders' Association). Members and Open Classes.—Schedules (post free 3d.) from Hon. Sec., "Underwood," Portskewett, near Chepstow, Monmouthshire. Entries close July 26.

**August 3, 4 and 5, at Abington Park, Northampton.**—Northants Bee-keepers' Association Show, in connection with the Municipal Horticultural Society's Show. Open Classes for single 1-lb. jar and section.—Schedules from Mr. H. F. Swann, 41, St. Michael's Mount, Northampton. Entries close July 30.

**August 4, at Shedfield, Hants,** in conjunction with the Shedfield Horticultural Society's Show, Hants and Isle of Wight Bee-keepers' Associations. Swanmore and Bitterne Branches. Classes for Comb and Extracted Honey.—Schedules from the Hon. Sec., A. F. Hardy, Esq., The Palace House, Bishop's Waltham, Hants.

**August 7, at Barnstaple.**—Barnstaple and District Horticultural Exhibition, to be held in the Market Hall. Five Open Classes for Honey.—Schedules from Hon. Secretary, 19, Grosvenor Street, Barnstaple.

**August 11, at Wye.**—Kent Honey Show. Thirty classes, half of which are open to U.K. Four Silver Cups and 75 other prizes. Schedules, Mr. A. Lepper, Wye. Entries close August 1.

**August 14 and 16, at Cannock, Staffs.**—Eight open classes for honey, etc. Prizes value £12. Schedules from J. Bird, Secretary, "Glenmay," Allport Road, Cannock.

**August 12, at Taunton.**—Somerset Bee-keepers' Association Show of Honey, Wax, and Appliances. Seven Open Classes. Liberal prizes.—Schedules from Mr. F. J. J. Stacey, 3, Hammet Street, Taunton. Entries close August 6.

**August 14, at Llanely.**—Carmarthenshire B.K.A. Show, in connection with the Llanely and District Horticultural Society's Show. Liberal prizes (nearly £15) offered for Honey, Wax, and Appliances. 15 Classes (7 Open).—Schedules from R. Lloyd Roberts, London Joint, City and Midland, Llanely. Entries close August 6.

**August 18 and 19, at Coventry.**—Worcestershire Bee-keepers' Association, in connection with the County Agricultural Show. Lectures on both days.—Schedules from Mr. J. R. Ingerthorpe, Knowle, Warwick.

**August 18 and 19, at Derby.**—Derbyshire B.K.A. Honey Show to be held on the grounds of the Derbyshire Agricultural Society. Two Open Classes. Three Cups in Members' Classes.—Secretary, F. Meakin, 37, Pybus Street, Derby. Entries close August 4.

**August 25, at Prestbury, Cheltenham.**—Flower, Fruit and Honey Show. Open Class for single 1-lb. jar of honey. Several classes open to beekeepers living within a radius of 12 miles.—Schedules from A. H. Bowen, Coronation Road, Cheltenham. Entries close August 18.

**August 23, at Hounslow.**—Hounslow and District Allotment Holders' Association Second Annual Exhibition of Vegetables and Fruit. Honey exhibits under the control of the Twickenham and Thames Valley B.K.A. Open Classes for single bottle and section.—Schedules from Miss M. Byatt, "Hawthorn," Hanworth, Middlesex.

**Saturday, August 23, at Hinckley.**—Leicestershire and Rutland Bee-keepers' Association, in connection with Hinckley Flower Show.—Open Classes for Honey, Sections and Jars. Prizes, 12s. 6d., 7s. 6d., and 4s. 6d. in each class. Judge, J. Herrod-Hempsall, F.E.S.—Schedules from A. Kimbrell, Esq., Clarendon Road, Hinckley. Entries close August 23.

**November 13.**—Annual Show of the Worcester City and County Chrysanthemum, Fruit, Root and Honey Society. Thirteen open classes in Honey Section. Schedules from Geo. Richings, 42, Barbourne Road, Worcester. Entries close November 6.

## Special Prepaid Advertisements. One Penny per Word.

Advertisements must reach us NOT LATER than FIRST POST on TUESDAY MORNING for insertion in the "Journal" the same week. Orders for three or more consecutive insertions in "The Bee Journal" entitle advertisers to one insertion in "The Bee-Keepers' Record" free of charge.

### PRIVATE ADVERTISEMENTS.

**S** PARE NUCLEUS, strong, on 4 frames, 1920 Queen, 42s.—SHAW, Betula, Parkview Road, New Eltham. g.88

**S** TRONG STOCK ITALIAN HYBRIDS on 10 frames, 1919 Queen, £3 10s.; healthy; purchaser to send box.—SHARPE, Bentinck, Kirkby-in-Ashfield, Notts. g.89

**S** PARE six Italian-Dutch Queens, just laying, splendid lot, 6s. 6d. each.—HILL, Belmont, Ockbrook, Derby. g.91

**S** ELL, Stock Italian Hybrids, 1920 Queen, 10 frames, in W.B.C. Hive with lift, 21 sections full sheets, bees up, £7; £5 5s. without hive.—DR. LLOYD, Stocksbridge, Sheffield. g.92

**S** EVERAL STOCKS ITALIAN HYBRIDS, warranted healthy, on 6 frames, 1920 Queens, £3; travelling box 10s., returnable.—SAUNDERS, Nurseries, Downend. g.94

**E** X-SERVICE MAN, lost all stocks during five years' service (12 stocks). Will some kind bee-keeper oblige with a small Swarm?—J. S. WATSON, 4, Kimberley Terrace, Soham, Cambs. g.95

**T** HREE ITALIAN HYBRIDS, 10-frame stocks, vigorous condition, £3 10s. each; box 10s., returnable.—MEAD, 27, Godson Road, Croydon. g.96

**W** ANTED, Nos. 2, 3, 6 and 7 of the *Bee World*, in good condition.—MANAGER, B.B.J. Office, 23, Bedford Street, Strand, W.C.2.

**F** EW STOCKS of Italians on 10 frames, ready for supering, £4; boxes 12s., returnable.—HENSLEY, Luton Apiary, Queen's Road, Chatham. g.97

**S** URPLUS BEES.—Stocks, Nuclei, for disposal from 35s. for 4 frames, 1920 Queens. State your requirements.—WHITE, 10, Northern Parade, Portsmouth. g.99

**S** MALL APIARY.—Twelve healthy Stocks, 1920 Queens, 7s. 6d. per frame; 10 Hives, nearly new, well painted, at half list prices; four new Conqueror Hives, 57s. 6d. each. Section Racks, Shallow Frames, most drawn out, and other Appliances. Would prefer to sell as a whole. Stamp for particulars and appointment to view.—F. HOOD, Horton, Slough. g.100

**T** WO strong Stocks, 8 frames, filled with brood, this year Queen, £3; 4-frame Nucleus, 35s.; boxes 10s., returnable.—COOPER, 15, Overcliffe, Gravesend. g.101

**I** TALIAN HYBRID QUEENS, fertiles, 10s., booked to order only; few Virgins, by return, 3s. Satisfaction, or replaced.—JACK TICKELL, Westbourne Apiary, Cheltenham. g.102

**C** OWAN EXTRACTOR, perfect condition; first cheque £4 10s. gets it.—Box 94, B.B.J. Office, 23, Bedford Street, W.C.2.

**F** OR SALE, Second-hand all guaranteed clean exceptionally well made W.B.C. hives, with oak legs; also combination hives, £2 each; well-made shallow frame boxes, 3s. each; Queen excluders, 1s. 3d. each.—DAVID HANCOX, Grove Lodge, Deddington, Oxon. g.38

**W** ANTED, one or two Standard Hives; must be in good condition and guaranteed free from disease.—State price and particulars, G. GORDON-LANGLEY, Station Hotel, Chertsey, Surrey. g.103

**S** TRONG STOCK of Italians, 6 frames, £2 5s.—15, Kelvin Avenue, Bowes Park, London. g.104

**A** FEW A1 quality Italian Stocks of Bees for Sale, 6, 8, or 10 frames; fine for heather; guaranteed healthy. Only letters accompanied by stamp will be answered.—CROWE, Merriott, Crewkerne. g.106

**F** INE quality Honey, £10 per cwt. Only inquiries accompanied by stamp will be answered.—CROWE, Merriott, Crewkerne. g.105

**T** WO STOCKS Dutch-Italian Bees on 9 frames, ready super, prolific, 1920 Queens, 70s. each, or 85s. with small hives.—POLHILL, Monkwood, Chingford, E.4. g.107

**S** URPLUS 1920 Hybrid Fertile Queens, Penna strain, immediate delivery, 7s. 6d. each, post free.—EVANS, Lattiford, Wincanton, Somerset. g.108

**M** AY SWARM on 8 frames for 55s.; strong, healthy; expert's guarantee.—BURFOOT, Chipstead, Sevenoaks. g.109

**B** ARGAINS.—Strong Nucleus, 1920 Italian Queen, 4 combs, 35s.; strong Stock, 10 combs, Italian Hybrids, £3 10s.—ROUND, 38, Arngask Road, Catford, S.E.6. g.110

**E** XTRACTOR, chain gear, 26 x 18, Ripener, 28 x 11, 32s. 6d., f.o.r.—DUTTON, Rhosnesney, near Wrexham. g.119

**O** FFER wanted for four supered mahogany Observation bar-framed and other Hives, Supers, Bell Glasses, Feeders and other Bee Appliances.—KIBBLE, 22, Battle Road, Erith, Kent. g.121

**F** OR SALE, Honey Extractor, Ripener, etc., etc.—AUDEN, "Hillington," Jersey Road, Isleworth. g.120

**P** URE Bell's or Barron's Leghorn Cockerels, 15 weeks, 10s., carriage paid; basket 10s., returnable.—HOWLETT, "Sylvabelle," Tring. g.117

**B** EESWAX, pure, for Sale, 3 cwt. packed in ½-cwt. bags, £8 16s. per cwt. net, f.o.r. London.—Apply, Box 92, 23, Bedford Street, Strand, London, W.C.2. r.g.43

**D** UCH VIRGIN QUEENS from imported stocks, the surplus from the Restocking Apiaries of the Edinburgh and East of Scotland College of Agriculture, 3s. each.—AVERY, 13, George Square, Edinburgh. g.50

**T** WO SWARMS on frames, one Italian, one Italian Hybrids, certified healthy by Middlesex expert. 50s. each.—E. MACKAY, M.M.B.K.A., 9, Priory Gardens, Highgate, N. g.51

**S** ACRIFICE.—Bees, 20 strong Stocks, 10 frames, £3 per stock; crate 10s., returnable; room wanted.—GITTINGS, Bleak House, Bleak Hill, Plumstead Common. r.g.59

**W** ANTED to sell at once, surplus Stocks healthy Bees, 10 frames, £4 per stock; purchaser to send boxes.—JEWITT, Hensall, near Goole, Yorks. g.64

**T** HREE good healthy Stocks of Italian Hybrids, 10 frames, Penna strain, £3 10s., carriage paid; 10s. on box. Seen by appointment. (Am overstocked).—H. OBORNE, 25, Guest Road, Bishopstoke, Hants. r.g.71

**C** OLONIES, 50s.; Casts, 32s. 6d.—MRS. FRED BATCHELOR, Bailey's Farm, near Bendish, Whitwell-Herts. For telegrams, Whitwell-Herts is counted one word. g.9

**THREE STRONG STOCKS** on 8 frames, 3 gs. each, carriage paid; boxes 10s., returnable.—**HODSON**, Harley Lodge, Enfield. g.60

**BUSINESS ADVERTISEMENTS.**  
1½d. per word.

**50 COLONIES** extra prolific Hybrids, in one lot or separate; 10 combs, 85s.; 5 combs, 55s. Inspection by appointment. Immediate delivery.—**I. E. SWAFFIELD**, the largest breeder of bees and queens on the Cotswolds, Haselton, Glos. g.90

**"LAZENBEE"** ITALIAN QUEENS, fertile 10s., by return, virgins 5s.; 9-in. and 6-in. Frames, 3s. 2d. per dozen.—**YOUNG**, Hundred Eims Apiary, Central Road, Sudbury, Middlesex. g.111

**4-FRAME NUCLEI**, Italian Hybrids, 1920 Queens, 30s.; box 10s., returnable.—**ANTHONY**, 34, Knavesmire Crescent, York. g.112

**"HARDY AND PROLIFIC"** HYBRIDS, 3-comb Nuclei, some stores, solid brood, ample bees, 45s. Note.—The reduced list prices for July are hereby cancelled.—**LIEUT. BOWEN**, Queen Breeder, Cheltenham. g.113

**4-FRAME NUCLEI**, headed by 1920 Italian Queen, 50s.; box charged 10s., returnable; 6-frame Stocks, 70s.; 8-frame Stocks, 90s. Immediate delivery (weather permitting). Italian fertile Queens, 10s. 6d. English Run Honey and Sections wanted.—**LEE**, "Little Bowden Apiary," Burgess Hill, Sussex. r.g.114

**ITALIAN HYBRID NUCLEI**, a few left, 9s. frame; very gentle; absolutely healthy; very strong; expert's certificate.—**REDDIE**, Cliff Cottage, Leigh, Essex. g.115

**VERY strong Nuclei**, Italian Hybrids (Simmins'), 4 frames packed bees, brood, stores, with tested 1920 Queens, guaranteed healthy, 45s., carriage paid; box 10s., returnable. g.116

**ITALIANS**.—Choice Virgins, 3s. Immediate. Stamp.—**HOUSTON**, Ellen Villa, Sidcup. r.g.123

**NUCLEI** (good Hybrids), 1920 Queens, 4 frames, £2 2s.; Stocks, 6 frames, £3 5s.; boxes 7s. 6d., returnable.—**E. G. WALDOCK**, Upwey, The Mount, Guildford. g.122

**STRONG 8-frame Stocks**, brood on all frames, 65s., carriage paid; boxes to be returned.—**MAGSON**, Kirkham, Lancashire. g.93

**BEEES.—BROOKS**, Carnation Specialist, 9, Dudley Road, Finchley. r.g.98

**THREE** to six-frame disease-proof, quiet, industrious lots, swarm-raised Queens, 10s. per frame and returnable box.—**BARRETT**, Sunnyside, Cecil Park, Pinner. g.118

**6-FRAME STOCKS**, with 1920 Queens, 60s. each; travelling box 10s., returnable.—**MEGGITT**, Bramhall, Stockport. r.g.49

**IMPORTED ITALIAN QUEENS**, 11s. 6d. each; selected Hybrids, 9s.; English, 7s. Safe delivery guaranteed. Catalogue free.—**C. T. OVERTON & SONS**, Crawley. r.g.79

**CHOICE** home-reared Italian Queens, 10s.; Virgins, 4s. 6d.; July-September.—**MISSSES PALING & PILLANS**, Golden Square, Henfield, Sussex. r.g.82

**STRICTLY BUSINESS**.—Six packages of Flaming, 6d.; a Japanned Sprayer, 6s.; "Let the Bees Tell You," 2s. All post paid.—**S. H. SMITH**, 30, Maid's Causeway, Cambridge. g.77

**"BRITALIANS"**.—A fine strain of British Bees, queens mated to selected Penna Italian drones; 3-frame Nuclei, 47s. 6d., carriage paid. Send for particulars.—**ALUN JONES**, Halkyn, Flintshire. g.27

**STOP! LOOK HERE!**—Having despatched all orders I can still spare a number of 3- and 4-frame Nuclei at 45s. and 52s. 6d. respectively, carriage paid, 7s. 6d. being refunded on box. Also a limited number of Stocks on 8 frames. Price on application. All above are home-reared Italians, highly resistant to disease, and splendid honey gatherers.—**HERBERT VALLEY**, Apiarist, Saxilby, Lincoln. r.g.80

**STRONG 4-FRAME NUCLEI**, Italian Hybrids, 40s., carriage paid; boxes returnable.—**BARNES**, 20, Bourdon Road, Anerley. g.83

**VIRGIN QUEENS—THE WELSH APIARY STRAIN**.—Hybrid Italian, guaranteed bred from highly prolific stock, never had "I.W." D. in apiary; the Queens to revitalise your stock, hardy and virile, 5s. each.—**LT.-COLONEL WEAVER PRICE**, Welsh Apiary, Ashgrove, Brecon, S. Wales. r.g.85

**4-FRAME NUCLEI**, 63s.—**PRYOR**, Breachwood Green, Welwyn. g.86

**STRONG 3-FRAME NUCLEI**, 1920 fertile Queens, 30s.; box 5s., returnable; Stocks on 8 frames, 60s.; boxes 10s., returnable.—**W. WOODS**, Normandy, near Guildford. g.53

**DOES BREEDING SPECIALISATION PAY—FOR YOU?**—"The queens I have had from you so far are absolutely 'it.' I'm gone on them. I have recommended several men to have bees from you."—**R. M.**, 25/6/20. Now does it?—**ATKINSON**, Fakenham. r.g.23

**PURE ITALIAN QUEENS**, prompt delivery; select Italian, extra golden, rare honey-producing stock, August-September.—**ATKINSON**, Fakenham. r.g.24

**"WIGHT" DISEASE**, prevention and removal; advice 5s.—**ALFD. RYALL**, Kenwood Apiary, Elcombe, Stroud. r.f.161

**PUPILS** received by life-long whole-time Bee Farmer.—Terms on application to **C. B. BARTLETT**, Sandford Mount, Charlbury, Oxon. d.127

**1920 FERTILE** Golden Italian Queens, guaranteed imported direct from Italy, regular supplies every few days, 10s. each; specially selected, 14s.—**GOODARE**, New Cross, Wednesfield. f.59

**"ISLE OF WIGHT" DISEASE**.—Don't worry; I use the solution that cures; 2s. per bottle.—**B. PRESSEY**, St. Elmo, Coulsdon. r.d.149

**BOZZALLA** tested Queens are sold at the price usually charged for untested queens.—Catalogue from **H. STICH**, Riccartbar Avenue, Paisley. r.c.116

**DUTCH BEES**, Skeps (as imported from Hans Matthes), Nuclei, Queens. Illustrated Catalogue on request, containing points on management.—Buy direct from Sole Agent, **WHYTE**, Bee Farmer, Cumbernauld, Dumbartonshire. b.61

**ITALIAN QUEENS**  
Direct from Italy.  
**E. PENNA, BOLOGNA, ITALY.**

I assume again the direct sale of my queens. Special offers from July 10 till countermanded. For queens in lots of 4 at a time £1 8s. Cash with orders. Payment by cheques or British Postal Orders. International Money Orders are not accepted. I do not hold myself responsible for the queens that are not sent by me direct to customers. All orders should be sent direct to me. In May the queens dead in the journey have been less than 1%  
ORDERS BOOKED IN ROTATION.

**HAVE YOU READ "THE BEE WORLD"?**  
If not, why not? Every number in itself is a useful literary work for practice and reference. Specimen copy free.—Offices: THE APIS CLUB, Port Hill House, Benson, Oxon.

## ITALIAN QUEENS

Direct from Italy.

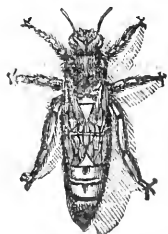

Address:  
**Signor Gaetano Piana,**  
Castel San Pietro,  
near Bologna, Italy.

All Queens are reared by the most up-to-date and scientific methods. Mr. W. Herrod-Hempsall has personally inspected the apiary and methods employed, with which he is perfectly satisfied.

PRICES FOR 1920.

**For 1 Fertile Queen:** August and September, 9/- each queen.

Can take no more orders for June & July. Booked up.

Carriage paid in Great Britain. Cash must accompany all orders, which will be executed in rotation. Guaranteed safe arrival of all Queens, but not the introduction. Bees dead upon arrival must be sent at once to "B.B.J." Office.

For the mutual convenience of all parties, if Signor Piana has made arrangements that all communications, orders and remittances of the readers of "B.B.J." and "B.K.R." can be addressed to him, c/o British Bee Journal, 23, Bedford Street, Strand, London, W.C.2.

Cheques payable to 'British Bee Journal.'

## THE ONLY CURE !!

Nothing messy. No spraying.

### Clarke's 'I.O.W.' CURE

A powder to sprinkle on the floorboard.

What's simpler? 3/6 per packet.

Inundated with testimonials.

G. J. CLARKE, Blythburgh, Halesworth.

### HIVE ROOFS.

Why risk losing your bees through having leaky roofs when you can get

**ABSOLUTELY WEATHERTIGHT ROOFS?**

24 in. x 24 in., 13s. 6d.; 24 in. x 20 in., 13s. 3d.;

and 20 in. x 20 in., 13s. each; f.o.r. London.

Roofs are galvanised, and also treated by a special process to prevent condensation. Special terms for quantities. Order early, and avoid delay in delivery.

LARMUTH,

MONAHAN AVENUE, PURLEY.

The products of the Apiary, of Poultry and Farm Stock, of the Fruit and Vegetable Garden can be Advertised and Sold through

## THE BAZAAR, EXCHANGE & MART

Newspaper.

Get a Copy—Thursday and Saturday 3d. The "Bazaar" publishes also practical handbooks by experts. Send for full catalogue, post free from—WINDSOR HOUSE, Breams Buildings, LONDON, E.C.2.

## BARGAINS IN SURPLUS CLOTHING.

- Khaki Serge Riding Breeches, good condition .. pair 12/6
- Bedford Cord Riding Breeches, good condition .. " 9/6
- New Bedford Cord Officers' Breeches .. 42/-
- New Cord Riding Breeches, strapped .. 22/6
- Blue Serge Trousers, for Working Men .. " 12/6
- Blue Serge Trousers, as new .. " 14/-
- Blue Serge Trousers, new .. " 21/-
- Khaki Drill Trousers, all sizes .. " 7/6
- Khaki Drill Jackets, with pockets each 7/6
- Army re-soled Boots, all sizes .. pair 12/6

- Army Rubber Ground Sheets 72 x 36, brass eyelets, good condition, 2 for 9/-, 4 for 16/-
- Large Canvas Cart Covers about 6ft. square, with brass eyelets, 7/6 each. These are useful for making Tents or Camping Outfits.
- Black Rubber Combination Suits, all sizes, complete with Sou'wester, 25/- each; cost Government 63/-.
- New Heavy Black Boots made specially for outdoor workers, 21/- pair.
- Large Australian Wool Blankets, 26/- pair—bargains.
- New Full-size Army Grey Wool Blankets, 35/-
- Best bargain in Blankets ever offered.

### SPECIAL OFFER FOR THIS HOT WEATHER:—

- Khaki Drill Suits, Officers' quality, complete with pockets, 20/- per suit.
- Khaki Drill Suits, another quality, complete with pockets, 14/- per suit.

**SACAR'S (Universal) STORES (Dept. 27), ARDWICK, MANCHESTER.**

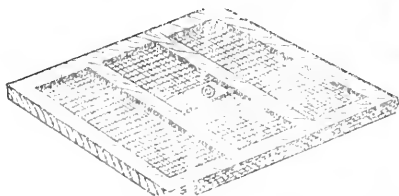

## B<sup>G</sup> B<sub>W</sub> BOARD

A Necessity on all Hives all the Year Round.

**SUPER CLEARER. QUEEN EXCLUDER. WINTERING BOARD, &c.**

SEND FOR KAT-A-LOG

**MEADOWS, Syston, Leicester.**

## POSITIVE FACTS.

June 13th, 1920.

I am very pleased with the foundation. The bees undoubtedly prefer it to any other make I have, and have even gone the length of missing two sheets of other new foundation, and working out a sheet of yours placed behind them at the back of the hive. Full sheets have not sagged in the least in 16 X 10 frames.

Yours faithfully, R. B. MANLEY.

Illustrated Lists free by post.

**S. J. BALDWIN, The Apiary, BROMLEY, Kent.**

# DADANT'S WEED FOUNDATION.

**T**HIS Foundation is made from pure Beeswax and guaranteed free from all disease germs.

Give your bees the BEST, and the best is DADANT'S.

No acids or other chemicals are used in the manufacture, and the makers guarantee that "EVERY INCH, EVERY POUND, EVERY TON, is equal to any sample ever sent out."

We have just received a fresh consignment, and are in a position to give immediate despatch.

Rear healthy bees on clean, natural combs.

None genuine without the watermark "DADANT" on every sheet.

*Our Catalogue, entitled "Everything for an Apiary,"  
is sent post free on Application.*

---

**R. STEELE & BRODIE,**  
Bee Appliance Makers,  
**WORMIT, FIFE.**



## Lee's Bee Supplies.

¶ In design, material and workmanship, Lee's Bee Supplies still retain the reputation of being your best and safest investment.

¶ Our 1920 ILLUSTRATED CATALOGUE is yours for the asking. It contains detailed information on the most up-to-date hives and appliances for which the House of Lee is famous.

¶ We regret the necessity of having to advise our Customers that owing to the increased cost of production, all prices in 1920 price list are subject to 10% increase. The increase will not apply to orders received before May 10.

\*\*\* Five per cent discount to Members of THE APIS CLUB.

**JAMES LEE & SON,**  
LTD..

Uxbridge, Middlesex.

(Telegrams: Graphicly, Uxbridge.)

Telephone: Uxbridge 181.)



## "BACTEROL" FOR BEES

2/9 per Bottle.

Post Free.

The cure for, and preventive of, "Isle of Wight" Disease. Non-poisonous—free from stain or unpleasant odour.

MENLEY & JAMES, LTD.,  
39, Farringdon Road, London, E.C.1.

**BRADBURY, TAUNTON,**  
FOR QUALITY BEE GOODS.

*Illustrated Bee  
Guide free.*

Telephone: TAUNTON 176.

## 20-Page 1920 "WHITE STAR" List,

3½d. POST FREE.

S. SIMMINS, QUEENLAND, HEATHFIELD, SUSSEX

**Bees and Beekeeping Appliances. Catalogue free.**  
**EDWARD J. BURTT. MANUFACTURER. GLOUCESTER.**

*I very much regret that there has been a large increase in the cost of the manufacture of bee-appliances, and therefore my prices will be advanced 10% from May 10th. Books excepted.*

PRINTED BY THE AVENUE PRESS (L. UPCOTT GILL & SON, LTD.), 65-67, DECRY LANE, LONDON, W.C., AND PUBLISHED FOR THE PROPRIETOR (W. HERROD-HEMPSELL), BY SIMPKIN MARSHALL, HAMILTON, KENT & CO., LTD., 31 & 32, PATERNOSTER ROW, C.

...griculture  
College

No. 1987. Vol. XLVIII

JULY 22, 1920.

[Published every Thursday, Price 2d.]

**CONTENTS.**

	PAGE		PAGE
TRoubles OF THE PUBLISHER .....	349	CORRESPONDENCE—	
A DORSET YARN .....	349	The Apis Club .....	354
JOTTINGS FROM HUNTINGDONSHIRE .....	350	The "Futtersaft" Theory .....	355
ROYAL SHOW FUND .....	351	Action for Damages Caused by a Bee Sting .....	355
NOTES ON BEE-KEEPING .....	352	Swarms .....	355
ASSOCIATION NEWS—		HONEY IMPORTS .....	356
Monmouthshire B.K.A. ....	353	WEATHER REPORT .....	356
Twickenham and Thames Valley B.K.A. ..	353	NOTICES TO CORRESPONDENTS .....	356
Carmarthenshire B.K.A. ....	353	BEE SHOWS TO COME .....	356
Glasgow and District B.K.A. ....	354		

WRITE FOR  
FREE CATALOGUE  
WITH  
INSTRUCTIONS  
FOR BEGINNERS.

AS MY

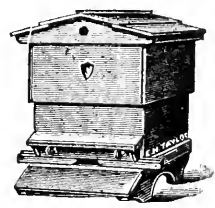

S

ARE THE  
**FOUNDATION OF SUCCESS**  
SO IS SUCCESS  
MADE CERTAIN  
BY

MY

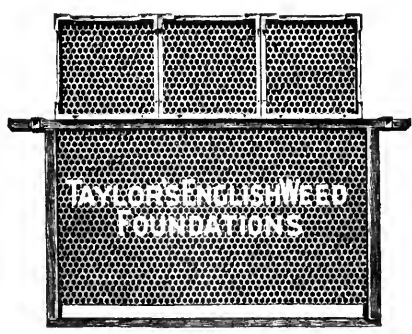

**E. H. TAYLOR**  
WELWYN,  
HERTS.  
  
Telephone: 13 WELWYN.

**THE  
British Bee Journal**

Office: 25, Bedford Street, Strand, London, W.C.2.  
ESTABLISHED 1873.

A Weekly Journal Devoted to the  
Interests of Bee-keepers.

Edited by T. W. COWAN, F.L.S., &c.,  
and J. HERROD-HEMPSELL, F.E.S.

**Correspondence: Whom to Address.**—  
All matters relating to the Literary Department, Associations, Shows, etc., should be addressed, "Editors, *British Bee Journal*," and all business communications and matters relating to subscriptions and advertisements to be addressed to the "Manager," *B.B.J.* Office.

**Subscriptions.** - Annual Subscription, 10s. 10d. post free in advance; single copies 2s., or 2½d. post free. If a receipt is required by post, a stamped and addressed envelope must be sent, otherwise a printed receipt will be enclosed along with the paper.

*Note.*—Cheques and Postal Orders should always be crossed, otherwise it is very difficult to trace them if they go astray.

**How to send Money.**—Remittances can be made payable to W. Herrod-Hempshall by crossed Cheques and Postal Orders. Stamps may be sent for small amounts up to 2s. *Halfpenny stamps are preferred.*

Scottish or Irish cheques can only be taken in payment if 6d. is added for commission charged by banks for cashing them.

The Editors are not directly or indirectly interested in the manufacture or sale of beehives or appliances of any kind, and must refer correspondents wishing for prices or catalogues to advertisers in the paper.

**OUR DEPOSIT SYSTEM.**

You are advised to insist on this being used when dealing with strangers.

**Rules and Conditions for Depositing**

*In order to save trouble, it is requested that the Rules be carefully read over by persons using the Deposit System of trading.*

Goods should not be despatched until notice that the money has been deposited is received from this office.

1. **Method.**—When strangers are dealing together, the purchase-money of the articles is deposited at our office. We acknowledge receipt of the deposit to both parties, and hold the money until we are satisfied that the purchase is concluded. If a sale be effected, we remit to the seller the amount deposited, less a charge of 2½ per cent. in the £, with a minimum of 6d., and the expenses of Post Office Orders and postage, &c. Cash will be forwarded by Cheque, Post Office Order, or by Postal Order as preferred. If a sale or exchange be not completed, we return the amount deposited, after making the same deduction. By this means buyers and sellers are secured against fraud.

2. **Deposits.**—Postal Orders (drawn on General Post Office) and Cheques must be made payable to W. Herrod-Hempshall, and crossed "London County and Westminster Bank." The numbers of the Postal Orders should be kept by the sender. We cannot be responsible for any loss that may occur in transit.

3. **Money on Approval.**—All money will be sold by sample, which must be sent direct to buyer.

4. **Bee Appliances.**—In ordering, the time allowed for completing the order to be stated to us when sending cash. If maker accepts, we hold cash until transaction is satisfactorily completed, when the amount will be remitted, subject to conditions as in Clause 1.

5. **Bees and Queens.**—These will be dealt with entirely by the parties concerned, so far as price, &c., go, and when the purchase is satisfactorily completed cash will be remitted as per Clause 1.

6. **Goods in Transit.**—These are at the seller's risk, i.e., any damage to or loss of an article on its journey is borne by the vendor; but a rejected article must be properly packed and returned by the same means as was used in sending it.

7. **Carriage.**—The carriage of all goods, except such as are sent by post, is payable by the buyer, unless otherwise agreed. If any article sent on approval be returned, each party to the transaction must pay carriage one way.

**Books for Bee-keepers  
NOW IN STOCK.**

	Postage
A Modern Bee Farm ... ..	7/6 ... 8½d.
Advanced Bee Culture (HUTCHINSON) ... ..	6/- ... 6½d.
Beginner's Bee Book (PELLETT) ... ..	5/- ... 4d.
<b>BEE-KEEPING SIMPLIFIED FOR THE COTTAGER AND SMALLHOLDER</b> (W. HERROD-HEMPSELL, F.E.S.) ... ..	1/- ... 2d.
<b>BRITISH BEE - KEEPERS' GUIDE BOOK</b> (T. W. COWAN) Paper covers ... ..	2/6 ... 3d.
... .. Cloth covers ... ..	3/6 ... 4d.
Dissectible Model of Queen Bee ... ..	4/6 ... 3d.
<b>FERTILISATION OF FRUIT BLOSSOMS BY BEES</b> (T. W. COWAN) ... ..	-/3 ... 1d.
<b>Fifty Years Among the Bees</b> (MILLER) ... ..	6/- ... 5½d.
<b>Honey and Health</b> (A. HOPE) ... ..	-/6 ... 1d.
<b>Honey Vinegar</b> (REV. G. BANCKS) ... ..	-/2 ... 1d.
<b>How to Keep Bees</b> (ANNA B. COMSTOCK) ... ..	5/- ... 4½d.
<b>Management of Out Apiaries</b> ... ..	3/- ... 2d.
<b>Pollination of Fruit in relation to Commercial Fruit Growing</b> (C. H. HOOPER, F.R.H.S.) ... ..	-/6 ... 1d.
<b>PRODUCING, PREPARING, EXHIBITING AND JUDGING BEE PRODUCE</b> (W. HERROD-HEMPSELL, F.E.S.) ... ..	2/- ... 3d.
<b>Productive Bee-keeping</b> (PELLETT) ... ..	10/6 ... 8½d.
<b>Queen Rearing in England</b> (F. W. L. SLADEN) ... ..	1/6 ... 2d.
<b>Scientific Queen Rearing</b> (DOOLITTLE) ... ..	4/- ... 3½d.
<b>The Bee-keepers' Vade Mecum</b> (GEARY) ... ..	2/6 ... 2d.
<b>Snelgrove's Method of Re-queening</b> ... ..	-/6 ... 1d.
<b>The "Townsend" Bee Book</b> ... ..	2/6 ... 2d.
<b>WAX CRAFT</b> (T. W. COWAN) ... ..	2/- ... 2½d.
<b>Wilke's Book on Swarming</b> ... ..	1/- ... 1d.

**MISCELLANEOUS.**

<b>Maeterlinck's Life of the Bee</b> ... ..	3/6 ... 3d.
<b>The Lore of the Honey Bee</b> (TICKNER EDWARDS) ... ..	2/- ... 2½d.
<b>THE BEE WORLD</b> (supplied only to members of Associations interested in the control and development of the APIS CLUB, apart from ordinary members of the latter), per copy ... ..	-/8 ... 1½d.

**British Bee Journal & Record Office,  
25, BEDFORD STREET, STRAND, LONDON, W.C.2.**





## Troubles of the Publisher.

Publishers of papers in other countries are up against much the same troubles that we have to contend with here. Under the heading given above, *The American Bee Journal* for July says:—"Never has the publisher found it more difficult to meet the problems of the day than at present. Every month brings some rise in price in some commodity that enters into the making of a magazine." It goes on to say that owing to these continually increasing prices—paper is four times, and engravings cost three times pre-war prices—many publications have suspended. At the present price the paper is being published at a loss, but it is proposed to continue at the same price for a little longer, when, if prices of raw materials do not fall, the subscription will have to be raised.

We can appreciate *The American Bee Journal's* difficulties, seeing that we have similar ones to face here, and we trust their readers and advertisers will prove as loyal as ours have done. We held on at old prices until our papers were being run at an actual loss, and have been most agreeably surprised, and greatly encouraged, at the way our circulation has not only kept up but increased since prices were raised. It fell considerably the first year of the war, but gradually increased, only falling very slightly when the price was raised. Since then it has gradually increased, until at the present time the circulation is as high as it was before the war; but, on the other hand, our expenses are still increasing, and we have all our work cut out to make ends meet, though we hope to continue without further increase in our charges. The cost of printing only is over 100 per cent. higher than in July, 1914. A printing account that would have been, say, £100 then, now mounts up, with the various increases, to £220 14s. 2d. In addition, all other expenses have increased in like proportion, with the exception of cost of paper, which is not content with a paltry 100 per cent., but is from three to four times that figure. We take this opportunity of thanking our readers one and all for their loyalty and co-operation, and for the many letters of appreciation and encouragement we are continually receiving. We are not only "still going strong," but going stronger.

## A Dorset Yarn.

A week of delightful sunshine. Bees have been having a fine time at the Violet Farm; they seem to have done more in this fine week than they did in four wet ones, there is so much for them to collect just now, as blackberries are in abundance everywhere. Chestnuts are going brown, at least the white pollen flowers of the male blossoms have the appearance of withering off; their mission in life is finished, the pollen has been taken to the female flowers, they may be pollinated by wind, but bees are with them the whole time the blossoms last, which proves they get food from them in quantity. The fields have another crop of charlock among the mangel this year, there is a lot in flower where they have escaped the man with the hoe, or have grown on again with so much wet. Bees cannot but store a lot of surplus now, if weather only keeps fine for them. They were out in crowds in the afternoon on Saturday after a damp morning, up to quite late in the evening. Several more of the strong stocks show symptoms of swarming, they were hanging in dense masses round the side of brood chamber. Another rack of sections and some shallow bars were added to them, a piece of wood inserted between the lifts, which let in the cold, made them move away from the sides of the case, and get on with the surplus stores in the legitimate manner; if they stay round the sides and it is warm they soon fill it up with comb and honey. One very strong lot from a double brood chambered hive, which swarmed the last day in June, has already started building outside the brood chamber; they were put on eight bars with full sheets of foundation. Two more were added a day or two after, these are all finished and the clusters are hanging round the outside of brood chamber, showing that they must have more room for stores overhead. Shall give them to-day a rack of sections with a rack of shallow bars on the top; we find that they store the bars with heather honey when the common ling is in flower. This is the quickest time in which I have noticed 10 bars filled, especially in wet weather. It proves the teaching of the old writers is right, "keep your stocks strong for surplus honey."

Since that strong swarm came out of the double brood chambered hive two others have swarmed out, one of them even larger than the first, the largest was put on nine bars, the smaller one was given one of the brood chambers from the parent hive, with a rack of sections for them to carry on with surplus. Five unfinished sections of the parent hive were

placed in the centre row, these were full of honey, but not completely capped; the next day one could hear the hurrying movement of bees through the sections.

The large swarm on the nine bars also had a rack of sections with three full ones added; by doing this one has bees up in the sections at once. This double brood chambered hive did the best early sections, the great number of bees could not but do good work, they are still immensely strong, and should do a lot of work yet.

This last week two swarms came out on the same day, one from a black and one a light-coloured Italian. On turning up the blacks I was fortunate enough to spot the young queen, and was able to catch her and take her away. On going to the other lot was able to catch the queen as she came out of the hive. On taking the Italian queen over to the blacks, they were just finding that the queen was not with them, so gave them this light-coloured one; the results were what I expected, they balled her at once, many of the blacks took flight back to the parent stock; a ball of bees as large as a cricket ball kept rolling round the skep amongst the other blacks; they kept on getting less till only the ball was left, these I opened with my finger, and the light-coloured young queen was taken back to the hive from whence she came, the bees had all gone back, and were in great crowds at the entrance. She went into the hive in double quick time; since then have not seen her out. The deduction I made was that the young queen was going out on her marriage flight, the bees were off with her thinking to swarm and make another colony, but her rough treatment by the blacks has not given her a good opinion of the outer world, she has not since ventured out with a swarm.

Bees do not do each year as they did the preceding year, they are never quite the same. One stock that did exceptionally well last season has not finished one lot of sections, another that did not do anything last year has already filled two racks of sections, all but the outer ones were perfect. The raising of their own queens to carry on is not always a success.

Some queens are very productive. In taking four bars of brood and the queen for increase, the latter has now three racks of sections, the parent has three racks, neither has swarmed; if I see them hanging about inside I always lift the outer case and let the cold in at night. I do this at the bottom and between the lifts.

This method of increase is better than a lot of risks; there is always some risk from natural swarms going away. One lot that was in a skep for three hours this week left it and moved off into a thick

hedge. The same skep was placed on the top and they all went into it again. Another lot from which Mr. Tomlinson took out four bars and the queen when he was helping me with them, the parent stock has done nothing yet for surplus, but the increase has done famous; the new queen raised in the parent hive has been a poor breeder, even though the parent was a good one. This uncertainty all adds interest, though it does not add to the banking account, it shows she must be dethroned and another added to reign in her stead.

Then the colouring. Some colonies that were blacks have gone coloured, drones are as beautifully marked as the Italians, showing that they have requeneed themselves and the young one was mated with an Italian drone; now the bees are a mixture, some with one band, some with two bands. Some of the light stocks have thrown out black drones, they have requeneed themselves, but have mated with a black drone. All this makes them more interesting. One must keep them away from each other if they are to be kept true to colour.  
—J. J. KETTLE.

---

### Jottings from Huntingdonshire

An interesting trial took place at Steple Gidding apiary on Friday last when 700 bees were charged with robbery with violence. The prosecution alleged that the defendants made a great onslaught upon their hive, and had forcibly entered and robbed much honey, after first killing some 150 sentinels. In answer to the judge, who asked how it was the prosecuting bees were unable to completely withstand the robbers, it was explained that some four weeks back the hive sent out a swarm, leaving behind six queen cells. The first princess emerged three days after the swarm went forth, and being a very promising virgin was allowed to destroy the remaining five baby princesses. The day arrived when she took wing for her mating flight, but mischief having befallen her she did not return. Consequently the colony was queenless. Attempts were made to remedy matters by building other queen cells, and in the meantime many bees disheartened by the loss of their queen, and lingering on the alighting board, were swallowed by birds and toads, and the colony in consequence got too weak to withstand vigorous robbers. It was also declared that several attempts were made to attract the owner's attention to the state of affairs, but he being much occupied for many days, failed to understand his bees were in distress. At long last several bees saw him busy in

his garden and succeeded in informing him that his help was needed, and he at once came to the rescue, gave them another queen and a frame full of brood from another hive, took away the supering crates, and contracted the entrance to one bee space. For the defence it was urged that according to ancient bee law, which is like the law of the Medes and Persians, which altereth not, it was considered not a crime to rob out a colony too weak to be of any use to itself. The defendants also stated that the prosecutors were invited to attach themselves to their colony provided they came loaded with honey, and assisted in emptying the cells of their hive and so helped in building up their adopted home. On being asked why they did not wait until such time as other queens were hatched before deciding on robbing, they stated that presuming a virgin was born to-morrow it would be nearly a month before young bees could be of any assistance, and in the meantime it was possible that wasps would clear out the stock.

The judge, in summing up, said he thought when there was an abundance of nectar to be gathered, the prisoners in the dock ought not to have contemplated robbing. It might be law, but he would remind them there was such a thing as being superior to the law; he would therefore pass sentence as follows:—The defendants were to be "Claustered" for two days, they were to yield up one frame of brood, and at least two pounds of honey to the robbed stock, and be of good behaviour for the rest of the season.

The above speaks for itself. It is not nice to be caught napping, but one does get so caught at times. Having been very full up with engagements the last ten days or so my hives did not receive quite the same attention as they usually do, and the weather being cold I did not worry, knowing every colony had ample stores. Alas! that the very stock which was my Al colony should become queenless. The mother queen and the swarm she brought with her are doing well, and doubtless her daughter would have done equally well had she been permitted to stay. Heavily supered, I had not looked into the brood chamber of this hive for some considerable time, otherwise I should soon have noticed the lack of brood. However, with a fresh queen I hope they will soon pull round, but surplus honey will not be stored by this stock this year beyond an occasional pound or two.

Those hedgerows covered with bramble blossom are well visited just now. Bees are happy sipping nectar from the blackberry flower; both pollen and honey are good.

I wonder is it possible to take a census

of bee-keepers. Would it not be interesting to know which county led, taking size and population into consideration. One day last week my churchwarden asked if I would accompany his wife and himself to Stratford-on-Avon—he was motoring there. Being free of engagements for the day I gladly accepted the invitation. We went via Oundle, Market Harborough, Rugby, Leamington, and Warwick, and returned via Banbury, Brackley, Towcester, Blisworth, Hardingstone, Wellingborough, and Thrapston, thus passing through portions of seven counties, a total distance of 164 miles, and so far as we could observe, passed only seven apiaries. One cottage garden had nine skeps standing wall to wall, and each skep was busy, others had both skeps and bar frame hives, a few, bar frame hives only. How motoring has affected the countryside! The road from Market Harborough to Rugby is still as delightful as ever. From Rugby to Leamington and on to Stratford-on-Avon quite a different story has to be told. Stratford-on-Avon to Banbury is still as charming a road as ever—the same cannot be said of the road through Towcester. Once a famous old-world road, the jerry-builder and the motor bus have been busy destroying that truly rural appearance which is so delightfully restful, speaking so much of peace.

My concluding remarks must be a grumble. I wish to state that I cannot continue to answer letters from brother or sister bee-keepers unless a stamped addressed envelope is sent for reply. The majority of my correspondents have been good enough to do this; but not a few have written asking my advice on various phases of beecraft without enclosing a franked envelope. I have generally replied. Now, however, with increased postage and increased correspondence I am bound to state that letters seeking advice must have at least a stamp for reply or they will remain unanswered.—E. F. HEMMING, Steeple Gidding.

P.S.—At the time of writing a letter comes to hand—"my bees are not working in the supers, what am I to do?" Reply:—The cold spell we have just had will have kept the bees in the brood chamber and consuming stores. These stores will be replaced before much supering goes on; therefore take courage, the section rack, if the bees are strong and healthy, will soon be getting heavier, daily.—E. F. H.

**Royal Show Fund.**

Amount received ...	£21	3	5
Mr. Rowlands ... ..		2	6
Total ... ..	£21	5	11

### Notes on Bee Keeping.

Re Rev. Hemming on tanging. He seems to reveal to us a new suggestion!—that bees drink in the sweet sound of music, and by its effect are stayed for the time being, thus ignoring the advice given out by the returning scouts who were sent out to find a suitable home. No doubt this is another of his points in favour of the sensitiveness of the honey-bee. Perhaps he will suggest to us in another issue how this (chiming) is accomplished, one is ever pleased to read and learn any suggestions put forward by such an able writer as Rev. Hemming. I admire his writings for wit and humour. But he is not as far advanced in revelations as my spiritualist neighbour in the next parish—the Rev. Vale Owen, Orford, Lanes. His church bell is chiming for evensong as I write these few lines. This rev. gentleman tells us what scientists have been trying to solve for 6,000 years, "Life beyond the Veil," of birds, of trees, flowers, animals, etc., but have never seen in any of his writings that this fair land is the home of the honey-bee. I am afraid, for the time being, I shall have to be content with the Apostle Paul's share of the vision "That now we see as through a glass darkly," and confine my remarks to bee-life on mother earth as I know it.

A prospective bee-keeper writes me that he has a desire for bee-keeping, but knows nothing whatever of the craft. Before making a commencement in bee-keeping a prospective bee-keeper should thoroughly study the art by reading up some good bee-book (it is not wise to read more than one, as reading a number often mystifies), in order to master which the assistance of a friend—an adept in the business—should be requisitioned. One might almost wish that the skill required might be given to others by writings, but we know it cannot be; but much time, trouble, and expense may be saved by watching and listening to the teachings of others, or by reading their writings. "Example is better than precept," but where both precept and example can be obtained, by following both success must be assured, and it is this that makes me call attention to the good that may be gained by taking a course of instruction from some apiarist of note. By watching his movements, that delicacy of handling, in which so many are deficient, may easily be obtained, and bee-keeping becomes a pleasure rather than a fear, especially is this so if one can just get in company with a bee-keeper who does not mind giving information for the benefit of others. If the preliminaries have been sufficiently mastered,

a hive should be purchased; note, not two or three, but only one. In the matter of hives, do not on any account purchase one that has not the British standard size frames, because in my opinion the standard size frames are the best up here in the North. The whole success of the modern movable comb hive rests upon its interchangeability; therefore, if we have two sizes in an apiary we might almost as well have all straw skeps, as their interchangeability, on account of the different sized frames, nullifies the advantages of the modern system. Do not purchase any hives that the bees have died out in, and I wish to emphasise this, as it is quite possible that they have died out from disease, and it is sure to be a contagious one, unless you know positively that they have been starved, or died out from loss of queen.

With this one hive go through all details of its management without the bees, until you have gained a knowledge of all its parts and uses. Then further purchases may be made: a stock or swarm of bees, a smoker and bee-veil. If you purchase bees from a distance, have them from some responsible and *thoroughly reliable* person, as perhaps only diseased bees may be sent. In that case all your prospects of bee-keeping will be destroyed, as well as nearly all the money you have spent in necessities being wasted. For run honey Italian and Dutch are in preference, but for section none can beat our native bees, as their cappings are nice and white and not too thick, making them easily saleable in the market. There are many varieties of the honey-bee now introduced in this country, but I venture to suggest that all are liable to disease should they meet with contagion. Choose a good location for the hives to stand in, a south-east aspect is the best, especially if you can provide shade for them during the hot part of the day: this is very important unless hives are made with double walls all round and painted a light colour to counteract the heat. The danger from any hive being exposed to the sun is that the combs are liable to break down from its heat in conjunction with the heat from the bees, which is a very serious accident—the queen is apt to be drowned in the honey, along with a considerable number of her progeny. If one desires honey, the best time to commence bee-keeping is at the beginning of April with a strong stock; but if a swarm is purchased, you will have to wait until May or June. If so, you are very unlikely to get much surplus honey the same season. The English honey season is so short, they will only have time

to get sufficient for their own use for winter. Of course this does not apply to heather districts. Sometimes a May swarm will give a good return if well fed.

A four-frame nuclei can be purchased in July, and if stimulated will prove a good stock for the following year. The old legend "a swarm of bees in July, etc." does not apply now under modern methods. Bees have been known to be hived on drawn out combs in August, and turned out a good stock the following spring. A person suited to bee-keeping is one who will neglect no opportunity of attending at the proper time to the wants of his charges, procrastination must form no part of his character, that is if he desires to make it a financial success.—P. LYTHGOE, Padgate, Warrington, Lanes.

### Monmouthshire Bee-Keepers' Association.

A committee meeting was held on Saturday at the County Hall, Newport, Dr. Strong presiding. The financial report was presented by the hon. treasurer. It was reported that a number of swarms had been dispatched from the re-stocking apiary at Marshfield, also that the distribution of the pure Italian nuclei from Rogiet had been commenced. The distribution had been delayed owing to the late arrival of the Government Italian queens, and the abnormally wet weather prevailing last month. This delay, although unavoidable, is regretted by the Committee. It was decided to support the Beekeepers' Convention at Gloucester, which is being held during the last week in July, and which is open to members of the Gloucestershire, Monmouthshire, Herefordshire, Somerset and Worcestershire Bee-keepers' Associations. A letter was read from Mr. T. G. James, Director of Education, with reference to the financial grant applied for some time ago, and the hon. treasurer and hon. secretary were authorised to reply. The matter of the bees from Ireland in 1919 season was again brought up, and it was reported that certain correspondence relating to the matter had been handed to a member of the County Council in order that the latter body should understand that the Association had no liability. It was decided to support the Agricultural Show at Monmouth on August 6. The Committee are very grateful to Dr. Strong and Mr. E. M. Hughes for having placed gardens at their disposal for demonstrations last month, and to Mr. T. G. James for his kindness in making arrangements for their meeting room.—L. MORGAN (Mrs.).

### Twickenham and Thames Valley Bee-Keepers' Association.

Threatening clouds did not deter the members of the Association from mustering in strength on the afternoon of Saturday, July 10, on the ground on which it has established its apiary. The President, Sir W. Joynton-Hicks, Bart., M.P., wrote regretting his inability to be present, but a number of visitors accepted the invitation to attend, among whom were the Secretary and the Treasurer of the newly-formed Kingston and District Association. Tea was served by some of the ladies, and an *al fresco* meeting followed. The Rev. R. Dixon Box presided, and at his invitation Mrs. C. D. Burnet, wife of one of the Vice-Presidents, declared the apiary open. Mr. W. Herrod-Hempsall was to have given a demonstration, but the strong wind prevented the opening of the hives, and only an informal talk was possible. He exposed himself to a running fire of questions of all kinds, and answered them with his usual readiness and good humour. A hearty vote of thanks was passed to him and to all who had contributed to the success of the gathering.—(Communicated.)

### Carmarthenshire Bee-Keepers' Association.

#### ANNUAL MEETING.

The annual meeting was held at Llanelly on Saturday, July 3, when there was a fair attendance of members. A letter expressing regret at inability to attend was received from Lady Dynevor, President of the Association.

The report presented showed that the Association had had a successful year. This was in part due to the grant of £75 received from the County Council for educational purposes, and which enabled the Association to purchase apparatus for lantern lectures and to defray the necessary expense of these. It is hoped that much use will be made of the lantern during the coming winter, when the experts of the Association, working under the direction of the committee, will lecture in various parts of the county. During the year a number of apiaries have been visited and much valuable advice given, for both foul brood and "I.O.W." disease are still with us.

Last year there was no re-stocking scheme in the county, but this season a bee re-stocking committee has been appointed, which has drawn up a scheme and has made a start by acquiring two skeps of Dutch bees. It is hoped that these will provide several nuclei each this season, and that the experience gained

will enable more stocks to be worked in the future and also that queen rearing may be carried out. This will enable beekeepers to maintain a good strain of bees throughout the county.

Several members passed the B.B.K.A. intermediate and preliminary examinations during the year.

Great regret was expressed at the resignation of Mr. A. Preston, who, as secretary, had done so much to develop the Association. Mr. W. Comery, B.Sc., was elected secretary in his place.—(*Communicated.*)

### Glasgow and District Bee-keepers' Association.

#### VISIT TO ERSKINE APIARY.

On Saturday, June 26, in glorious weather, a most interesting visit was paid to the apiary in connection with the Princess Louise Hospital for Limbless Sailors and Soldiers.

Between 50 and 60 members took advantage of the courtesy of Mr. Alec. Steven, President of the Association, and spent an instructive afternoon there.

The apiary is part of the training scheme carried on by the Hospital Committee on behalf of limbless men.

Here the men are taught bee-keeping, a carefully graded and extensive scheme of instruction is systematically pursued.

As soon as a man shows himself sufficiently advanced he is given a stock of bees to attend to under guidance.

Since the inception of the hospital in 1916 Mr. Steven, the hon. bee master, has carried out this work and with much success, nearly 400 men have received instruction, some more, some less, but the great majority sufficient to enable them to make a start. Letters received from some of these men testify to the benefit they have received.

Last year the Ministry of Labour recognised this excellent work by payment of a grant.

The visitors were shown over the apiary, many hives were opened for inspection, and all found to be in a very healthy, thriving condition. As the place is primarily intended for purposes of instruction, there were seen different races of bees, British, Italian, Dutch, Egyptian. Some stocks were in straw skeps, others literally in soap boxes, others, again, of course, in modern hives.

A visit was also paid to a substantial little brick built bee house, where almost everything in the way of appliances were to be seen. Here the honey is extracted and the indoor work performed.

During the winter regular series of lectures, fully illustrated, are given, a distinguishing feature of the latter is the

display of natural colour photography pictures.

During the afternoon Mr. Steven gave a ten minutes' address, the subject being "The three factors essential to successful bee-keeping."

1st. The necessity of having a great force of bees per stock.

2nd. This force should synchronise with the period of the honey flow.

3rd. The proper weather to secure the harvest.

The first two factors can be controlled by the intelligent apiarist, the third factor is, of course, beyond control, but much could be learned by a study of the prevailing outside temperatures, maximum and minimum.

The Hon. Secretary drew attention to the visits arranged for on July 10 and August 7, a good response being made to his appeal for subscriptions in aid of the show of honey, etc., in connection with the Glasgow and West of Scotland Horticultural Society on September 1 and 2.

At the conclusion a vote of thanks was accorded Mr. Steven for his kindness.—P. BEBBINGTON, Hon. Secretary.



*The Editors do not hold themselves responsible for the opinions expressed by correspondents. No notice will be taken of anonymous communications, and correspondents are requested to write on one side of the paper only and give their real name and addresses, not necessarily for publication, but as a guarantee of good faith. Illustrations should be drawn on separate pieces of paper. We do not undertake to return rejected communications.*

### The Apis Club.

[10227] Your continued support to the aims of the *Apis Club* have my keenest appreciation.

Since you have already published the official report relative to the May Conference, I need only add that the necessary reorganisation for carrying *The Bee World* on business lines is steadily progressing, and although it has necessitated a delay in the issue of the magazine, there is no reason why all arrears should not be cleared directly a sound foundation is established. In the course of a few weeks a full announcement will reach your publicity section, meanwhile I should like to avail myself of your courtesy and goodwill in thanking the hundreds of friends whose messages I am unable to promptly and individually acknowledge, trusting I may depend on their consideration for this forced dereliction of duty.—A. J. ABUSHADY.

### The "Futtersaft" Theory.

[10228] In Mr. Desmond's excellent translation of Gerstung's chyle-food theory, I notice one small (but rather important) slip. It occurs on p. 243, 22 lines from bottom of second column, THE BRITISH BEE JOURNAL, May 20.

He there writes: "Elder sisters get the excess"—whereas what Gerstung says is: "Aelteren Geschwistarn ist Eiweiss 'Breachmittel'." That is: "*To elder sisters albumen is an 'emetic'*" [and they therefore cannot eat it.] The point is of some interest, as therein consists the vital difference between Gerstung's theory and my own modification of it. (See *Bee World*, December, 1919.) He leaves the mechanism of the swarming-impulse totally unexplained, as far as it affects the foraging bees. (My edition of Gerstung is the 1919 one; but it is scarcely likely he has modified his views on so important a point during the last few years.)

Thinking that you and Mr. Desmond may be glad to have your attention called to this, I send it.—ANNIE D. BETTS.

### Action for Damages Caused by a Bee Sting.

[10229] I send you this little, but important cutting, as I think every bee-keeper should know about such a decision—and the country crying out for more bee-keepers!—J. RAE, Dumbarton.

Paisley, Saturday.

An action of interest to bee-keepers in residential districts was heard at Paisley Sheriff Court to-day when Edward Cook, manufacturer, 22, Whitehaugh Drive, sued Robert Walker, draper, 24, Whitehaugh, for £10, which pursuer stated was his personal loss as the result of a sting by one of defender's bees.

Mr. Cook stated that he had been stung by one of defender's bees when in his garden, and he told Mr. Walker about the matter. Defender replied that he must have been touching the bees. Witness then told defender to take his bees away from the place. Mr. Walker said he would not, and witness replied that the matter would end in Court.

It was not a wasp or a humble bee that stung him, but one of defender's. No one else kept bees in the district. As well as the sting on the forehead, he had been stung on the eyelid, and his eye closed at night.

Cross-examined: Do you know that a bee will not sting unless fought with?

Pursuer: My experience of bees is quite the reverse.

Mr. Dykes Brown: Would you know a wild bee?

Pursuer: No.

Mr. Brown: Then it might have been a wild bee that stung you.

Mr. Wm. Kelso, sanitary inspector of the burgh, said he had received complaints about defender's bees. He thought the locality was not suitable for the purpose.

Dr. Tallet said he was satisfied that the stings received by Mr. Cook were bee stings. A bee left its sting, but a wasp did not.

For the defence, Mr. Walker said that Mr. Cook kept a rubbish heap in his garden, and that was a place for wasps and wild bees. Another bee-keeper said the defender's garden was a suitable place for keeping bees. He said it was quite possible that it was one of his bees, and not Mr. Walker's, that stung Mr. Cook, for when a bee left its hive it took to full flight.

Sheriff Blair said he was satisfied that this garden was not a proper place to keep bees, but on the understanding that defender would dispose of the bees at the end of the present season, he said it was unnecessary to assess damages, but found defender liable to pay expenses.

[Our correspondent does not say from what paper the cutting is taken. It is dated June 20, 1920.—EDS.]

### Swarms.

[10230] Has anyone heard of so many swarms as there are about this year? I have heard of thirty within two miles of my house, and my wife and I have taken and dealt with fourteen—most of them of about 3 lbs. each—in three weeks; yet I only know of eleven stocks so near to me where they could have come from.

On June 3 my wife (aged 61) took a swarm off a short post which carries the signal wire on the railway, about 18 in. from the ground. Just as she had got most of the bees in the skep a fast passenger train came along, which took her hat and veil off and blew the skep over, so she had to start afresh. Having got them all in again and looking round just to make sure there were no more about, she found another swarm on the next post about 10 yards away. Having but one skep, she drove them both into the one, and so made up a lot of about 7 lbs. When she got home one of my hives had swarmed, and settled on a standard rose tree—about 5 lbs. of them—so she took three swarms in about two hours.

A friend of mine told me he found a swarm a few years ago on the top of a thistle—a tall one known about here as a "Boar thistle." Having nothing to put them in, he knew not what to do, so after thinking for a short time, he took off his shirt, tied up the neck, and slipped it over the bees, thistle and all,

tied a string round the bottom, then cut the thistle down and took the lot home. When there he set an old cheese box near the neck of the shirt, untied the string, and they all walked into the box. They gave 25 lbs. of honey, but, alas! the "Brimstone Pit" ended the bees.

I have never known so many queens to get lost as this year. I have had two swarms without a queen, and to-day I have hived a swarm I took yesterday late in the evening off a pear tree, but again I failed to find a queen. They came out of one of my own hives on June 11, but returned again. They had eleven brood bars in the hive, and two racks of shallow bars on nearly finished. I cut out all queen cells, but they came out again on June 12. There were about 7 lbs. of them. A friend tells me he had a swarm come out three weeks ago, but he failed to find the queen. Three days after he found her with about twenty bees some yards away, dead. One of my hives swarmed about the same time, and I found the queen and about twenty bees on the garden about ten yards away. Can you say why so many queens should drop?

[We cannot give any explanation beyond that for some reason the queens were unable to fly far.—Eds.]

Like Mr. Oldham (10195, June 10) I find that when some of the bees we now have make up their minds to swarm they will do so. I have had a case this year where one lot swarmed, although they had ten brood frames, four of which they had not begun to draw out, and two racks of shallow bars on, so they had plenty of room, yet out they came. I find it best to mix two or three of the small lots together, and let the queens fight it out.—C. REED.

### Honey Imports.

The registered value of honey imported into the United Kingdom during the month of March was £18,963, April £7,854, May £15,183, and June £30,493.—From a return furnished by the Statistical Office, H.M. Customs.

### Weather Report.

WESTBOURNE, June, 1920.

Rainfall, 2.19 in.	Frosty nights, 0.
Heaviest fall, .89 in. on 20th.	Mean maximum, 66.4.
Rain fell on 10 days.	Mean minimum, 50.8.
Above average, .09 in.	Mean temperature, 58.6
Maximum temperature, 78 on 2nd.	Above average, 1.7
Minimum temperature, 38 on 5th.	Maximum barometer, 30.383 on 1st.
Minimum on grass, 33 on 5th.	Minimum barometer, 29.755 on 11th.

L. B. BIRKETT.

## Notices to Correspondents

"DRONE" (Yorks).—*Young queen not laying.*—The cause of the queen not mating is the unfavourable weather. If she is not mated and laying by now it will be advisable to remove her and give another queen, preferably a mated one. Four weeks is a long time, and often young unmated queens will commence laying and become drone breeders before that. See "Seasonable Hints" last week.

MRS. BEVILLE (Boxed).—*Painting hives.*—(1) The hives may be painted now without harming the bees, if it is done in the evening. If the paint is properly mixed it will be dry by morning. The smell will not affect the bees. (2) Use paint.

## Bee Shows to Come.

*A nominal charge of 2s. 6d. is made for notices (not exceeding 7 lines) in this column, 10 lines charged 3s. 6d., up to 15 lines 5s., which covers cost of insertion from order till date of show. Cash should accompany orders for insertion.*

**July 20 to 23, at Aberdeen.**—Highland and Agricultural Society. Classes for Bee Appliances and Honey. Premiums £53 10s. Half of Prize Money and Silver and Bronze Medals contributed by the Scottish Bee-keepers' Association.—Entry forms from John Sturton, Secretary, 3, George IV. Bridge, Edinburgh.

**July 24 (postponed from 17th), at Guildford.**—Guildford and District Bee-keepers' Association. Members and Open Classes.—Schedules and prize list from Rev. E. C. Pitt-Johnson (Hon. Sec.), Heatherwood, Pirbright, Surrey. Entries closed.

**July 28, at Over Wallop, Hants.**—Wallop Horticultural Society. Open Class, single 1-lb. bottle Light Honey; prizes, 7s. 6d., 5s., 2s. 6d.—Hon. Secretary, P. E. Roberts, School House, Nether Wallop, Hants. Entries close July 24.

**July 28, at Blandford.**—The Blandford and District Horticultural Society are holding a Show of Fruit, Vegetables, Flowers, and Honey in the Park, adjoining the Crown Meadow, Blandford. Prizes for honey by the Dorset B.K.A. for members of the Association.—Schedules from C. G. Bone (Dorset Bee-keepers' Association), County Education Office, High West Street, Dorchester.

**July 29 to August 2, at Bolton.**—Royal Lancashire Agricultural Society's Show. £30 prizes for Honey. Six Classes.—Schedules (stating Honey Section) from R. O. Bradbury, Secretary, Derby House, Preston. Entries closed.

**August 2, at Bredon.**—Annual Show of the Worcestershire B.K.A. Three open classes. Schedules from Geo. Richings, 42, Barbourne Road, Worcester. Entries close July 26.

**Monday and Tuesday, August 2 and 3, at Newport.**—Monmouthshire Bee-keepers' Association Annual Show (in connection with the Newport Allotment Holders' Association). Members and Open Classes.—Schedules (post free 3d.) from Hon. Sec., "Underwood," Portskewett, near Chepstow, Monmouthshire. Entries close July 26.

**August 3, 4 and 5, at Abington Park, Northampton.**—Northants Bee-keepers' Association Show, in connection with the Municipal Horticultural Society's Show. Open Classes for single 1-lb. jar and section.—Schedules from Mr. H. F. Swann, 41, St. Michael's Mount, Northampton. Entries close July 30.

**August 4, at Shedfield, Hants,** in conjunction with the Shedfield Horticultural Society's Show, Hants and Isle of Wight Bee-keepers' Associations, Swanmore and Bitterne Branches.



**Classes for Comb and Extracted Honey.**—Schedules from the Hon. Sec., A. F. Hardy, Esq., The Palace House, Bishop's Waltham, Hants.

**August 7, at Barnstaple.**—Barnstaple and District Horticultural Exhibition, to be held in the Market Hall. Five Open Classes for Honey.—Schedules from Hon. Secretary, 19, Grosvenor Street, Barnstaple.

**August 10, at The Park, Cartmel.**—Cartmel Agricultural Society's 43rd Annual Show. Open Classes for Comb and Extracted Honey.—Schedules, etc., from W. Dickinson, Secretary, Cartmel-Cartmel. Entries close July 28.

**August 11, at Wye.**—Kent Honey Show. Thirty classes, half of which are open to U.K. Four Silver Cups and 75 other prizes. Schedules, Mr. A. Lepper, Wye. Entries close August 1.

**August 14 and 16, at Cannock, Staffs.**—Eight open classes for honey, etc. Prizes value £12. Schedules from J. Bird, Secretary, "Glenmay," Allport Road, Cannock.

**August 12, at Taunton.**—Somerset Beekeepers' Association Show of Honey, Wax, and Appliances. Seven Open Classes. Liberal prizes.—Schedules from Mr. F. J. J. Stacey, 3, Hammet Street, Taunton. Entries close August 6.

**August 14, at Llanelly.**—Carmarthenshire B.K.A. Show, in connection with the Llanelly and District Horticultural Society's Show. Liberal prizes (nearly £15) offered for Honey, Wax, and Appliances. 15 Classes (7 Open).—Schedules from R. Lloyd Roberts, London Joint, City and Midland, Llanelly. Entries close August 6.

**August 18 and 19, at Coventry.**—Warwickshire Bee-keepers' Association, in connection with the County Agricultural Show. Lectures on both days.—Schedules from Mr. J. R. Ingerthorpe, Knowle, Warwicks.

**August 18 and 19, at Derby.**—Derbyshire B.K.A. Honey Show to be held on the grounds of the Derbyshire Agricultural Society. Two Open Classes. Three Cups in Members' Classes.—Secretary, F. Meakin, 37, Pybus Street, Derby. Entries close August 4.

**August 25, at Chester.**—Cheshire Beekeepers' Association, in connection with Cheshire Agricultural Society. Several Open Classes. Good prizes.—Schedules from Thos. A. Beckett, St. Werburgh Chambers, Chester.

**August 25, at Prestbury, Cheltenham.**—Flower, Fruit and Honey Show. Open Class for single 1-lb. jar of honey. Several classes open to beekeepers living within a radius of 12 miles.—Schedules from A. H. Bowen, Coronation Road, Cheltenham. Entries close August 13.

**August 28, at Hounslow.**—Hounslow and District Allotment Holders' Association Second Annual Exhibition of Vegetables and Fruit. Honey exhibits under the control of the Twickenham and Thames Valley B.K.A. Open Classes for single bottle and section.—Schedules from Miss M. Byatt, "Hawthorn," Hanworth, Middlesex.

**Saturday, August 28, at Hinckley.**—Leicestershire and Rutland Beekeepers' Association, in connection with Hinckley Flower Show.—Open Classes for Honey, Sections and Jars. Prizes, 12s. 6d., 7s. 6d., and 4s. 6d. in each class. Judge, J. Herrod-Hempall, F.E.S.—Schedules from A. Kimbrell, Esq., Clarendon Road, Hinckley. Entries close August 23.

**Saturday, September 11.**—Fforest-Fach Horticultural Society, Swansea. Three Open Classes for Honey, extracted and sections. Help to foster bee cult this end. 1st prizes, 10s.; 2nd and 3rd in proportion.—Schedules ready from G. L. Williams, Fforest-Fach, Swansea.

**September 22.**—Altrincham Show. Several Open Classes for Honey and Appliances.—Schedules from H. Turner, 1, Market Street, Altrincham.

**November 18.**—Annual Show of the Worcester City and County Chrysanthemum, Fruit, Root and Honey Society. Thirteen open classes in Honey Section. Schedules from Geo. Richings, 42, Barborne Road, Worcester. Entries close November 6.

## Special Prepaid Advertisements. One Penny per Word.

Will advertisers please read these Rules carefully in order to save trouble, as they will be strictly adhered to.

Trade advertisements of Bees, Honey, Queens, and Bee goods are not permissible at above rate, but will be inserted at 1½d. per word as "Business" Announcements, immediately under the Private Advertisements. Advertisements of Hive-manufacturers can only be inserted at a minimum charge of 3s. per lin., or 5s. per inch.

PRIVATE ADVERTISEMENTS are only intended for readers having Surplus Stock to dispose of. Driven Bees, Nuclei, and Queens that are reared or imported for sale, are Trade Advertisements, and can only be accepted under trade terms. A charge of 6d. extra will be made if a box number is used.

Advertisements must reach us NOT LATER than FIRST POST on TUESDAY MORNING for insertion in the "Journal" the same week.

Orders for three or more consecutive insertions in "The Bee Journal" entitle advertisers to one insertion in "The Bee-Keepers' Record" free of charge.

### PRIVATE ADVERTISEMENTS.

**ON SALE,** two very strong Stocks of healthy Hybrids on 10 frames, working in supers, young Queens, nearly new W.B.C. and Holborn Hives on legs, sold just as they are advertised, £5 5s. They are in grand strength for the heather.—STOKES, Aller, Langport, Somerset. g.125

**ITALIAN HYBRIDS.**—Strong Stocks on 10 frames, 1920 Queens, £4; ditto, with Hive, £5 5s.—BEA, Hornclyffe, Warrington, Surrey. g.126

**EIGHT STOCKS** of Bees and Hives, 10 W.B.C. pattern Hives, 120 Shallow Bars and Boxes. What offers? Can be seen at any time.—S. WILLIAMS, Danygraig House, Ghysmaerdy Road, Briton Ferry. g.127

**SELL,** four strong Stocks Italians on 10 frames, 1920 Queens, healthy, £3 10s.; also several Taylor's No. 10 W.B.C. Hives, £1 10s.—PARKER, Trevaldwin, Llandrindod Wells. g.128

**BEEES,** immune strain, six colonies each on eight well-filled W.B.C. frames, £3 per stock. Satisfaction guaranteed. Cash with order. Immediate delivery.—WARD, Stoughton, Emsworth. r.g.129

**FOUR** strong Stocks of Hybrid Italians for Sale in serviceable hives, 10 frames, ready to super immediately; purchaser must remove; £4 10s. each.—BLENKARN, The Lodge, Burford, Dorking. g.130

**SURPLUS STOCKS** healthy Bees, £4; June Swarms on frames, 50s.—JEWITT, "Hensall," Whitley Bridge, Yorks. r.g.131

**FOR SALE,** a small Apiary of 15 well-made and painted W.B.C. Hives to take 14 standard frames with bees on 10 combs, £6 each, hive with bees. Stamp for particulars.—DOBSON, Hunton Bridge, Herts. g.132

**SMALL APIARY,** nine strong Stocks, five single and three double Hives, Geared Extractor, Ripener, Supers, etc., £57 10s. Purchaser to remove.—PULSFORD, Paignton, Devon. g.133

**WANTED,** ten lots Driven Bees, guaranteed healthy, 10 Nuclei, also 20 young fertile queens.—LOUDON, Strathaven. g.172

**FOR SALE,** two "Rotax Roadlight 267" self-contained Acetylene Motor Headlights, very powerful, £6 the pair; one Exhaust Whistle, 10s.; one Wood-Milne Motor Foot Pump, 40s.—W. HERROD-HEMPALL, Old Bedford Road, Luton, Beds.

**SURPLUS BEES.**—Fifteen 8-frame Stocks Italian Hybrids, Penna and Piana strains, free from disease, £3 5s., carriage paid; cash or deposit; 10s. extra for box, returnable. A few 1920 Queens, Hybrids, 8s. 6d.; correctly mated Italians, 12s.—**DR. BERNARD**, "Glenizla," Upper Deal, Kent. g.134

**WILL** exchange collection of Foreign Stamps in Album and book "All About Stamps," worth £4, for Bees or Appliances.—**HOPPER**, Kidlington, Oxon. g.135

**CAN SPARE** a few 6-frame Stocks, headed by Italian Queens, very prolific, £3 10s., carriage paid. A customer says: "Bees are doing very well. Send three more stocks."—**URIAH WOOD**, Arnold, Notts. g.136

**ITALIAN HYBRIDS** on 5 frames, 1920 Queen, carriage paid, £2 7s. 6d.—**STRATTON**, Barn Lane, Kings Heath, Birmingham. g.137

**SEVERAL** strong Stocks of Bees and a variety of Appliances for Sale. Stamp reply.—**GEORGE**, Oak Drive, Oswestry. g.139

**LADY** would like to hear of suitable Rooms for August and September for herself and school-boy, where she can learn about bee-keeping, in Scotland.—Box 95, B.B.J. Office, 23, Bedford Street, Strand, London, W.C.2. g.140

**SALE**, single-walled Hives, 5s. 6d. upwards; approval.—**HUNT**, Bank Street, Somercotes, Alfreton. r.f.67

**FEW STOCKS** of Italians on 10 frames, ready for supering, £4; boxes 12s., returnable.—**HENSLEY**, Luton Apiary, Queen's Road, Chatham. g.141

**FEW** spare Virgin and Fertile prolific Hybrid Queens, ex County Re-stocking Apiary, 3s. 6d. and 7s. 6d., post free.—**LITMAN**, Castle Cary, Somerset. g.142

**PATHE CINEMATOGRAPH OUTFIT**, complete with mechanism, lenses, stand, lamp house, arc, spool boxes, etc., in perfect order; sell £40, or exchange for 10 good Stocks Bees.—**EVERY**, Deverill, Warminster. g.143

**FINEST** Golden Clover Honey, sample 6d.; also Hives, Swarms.—**NORTH**, Cressing, Braintree, Essex. g.144

**FOR SALE**, 12 Shallow Frames, 11 drawn out, one sealed 6 to 7 lbs. honey; just as new; any reasonable offer taken.—**WADE**, 82, Mount Street, Rotherham. g.149

**ITALIAN HYBRID NUCLEUS**, 6 frames, 50s.; 2 Dutch 1920 fertile Queens, 5s. each.—**LILLEY**, Lamarsh, Bures, Suffolk. g.146

**THE** famous "Jay Smith" Italian Queens.—One 1919 breeder, imported direct from Vincennes, U.S.A., fine colour, highly disease resistant and prolific, 25s.—**DEIGHTON**, High Conscliffe, Darlington. g.148

**STOCK** healthy Bees, Black Italian Hybrids, 1920 Queen, 10 frames, £4.—**PARKER**, Ravenscar, Lyndhurst Avenue, Mill Hill, N.W. g.147

**SURPLUS.**—Three Stocks of healthy Bees on 8 combs, £4 each, carriage extra.—**L. DAVEY**, Mawneys, Romford. g.153

**STOCKS** or Swarms on frames for Sale cheap; never had disease.—**VICAR**, Worsbro' Bridge, Barnsley. g.150

**COWAN GEARED EXTRACTOR**, perfect condition, 50s., f.o.r. Apply, Box 96, B.B.J. Office, 23, Bedford Street, Strand, London. g.151

**FOR SALE**, new light Lincolnshire Honey, finest quality, £8 8s. per cwt.—**WILLIS**, New Leake, Boston. g.157

**STRONG STOCK** on 8 frames, £2 15s.; ditto 6 frames, £2 2s.; two Nuclei, 4 frames, £1 15s. each; boxes returnable.  $\frac{1}{2}$  gross  $\frac{1}{2}$ -lb. Honey Bottles, ditto 1 lbs., without caps, £1 10s. Bees carriage paid.—**MATTHEWS**, 25, Cray Road, Crockenhill, Swarley, Kent. g.152

**SECOND SWARMS**, 1920 Queens, Italian Hybrids, ready for despatch.—Particulars apply W. P. SMITH, Hook Farm, Aldingbourne, Chichester. g.154

**SACRIFICE—BEES.**—Twenty strong Stocks, 10 frames, £3 per stock; crate 10s., returnable. Room wanted.—**GITTINGS**, Bleak House, Bleak Hill, Plumstead Common. g.155

**THE CARMARTHENSHIRE BEE-KEEPERS' ASSOCIATION** invite applications from bee-keepers in the county for Lectures and Demonstrations in Bee-keeping.—Apply to W. COMERY, Hon. Sec., 15, New Road, Ammanford. r.g.156

**FOR SALE**, one 5-frame Nucleus, Dutch Hybrid, 1920 Queen, £2; also three fertile Hybrid 1920 Queens, 5s. each.—**ASHWORTH**, Redfern, Limpsfield, Surrey. g.160

**SEVERAL STOCKS ITALIAN HYBRIDS**, warranted healthy, on 6 frames, 1920 Queens, £3; travelling box 10s., returnable.—**SAUNDERS**, Nurseries, Downend. g.94

**BEE SWAX**, pure, for Sale, 3 cwt. packed in  $\frac{1}{2}$ -cwt. bags, £8 16s. per cwt. net, f.o.r. London.—Apply, Box 92, 23, Bedford Street, Strand, London, W.C.2. r.g.43

**SACRIFICE.**—Bees, 20 strong Stocks, 10 frames, £3 per stock; crate 10s., returnable; room wanted.—**GITTINGS**, Bleak House, Bleak Hill, Plumstead Common. r.g.59

**THREE** good healthy Stocks of Italian Hybrids, 10 frames, Penna strain, £3 10s., carriage paid; 10s. on box. Seen by appointment. (Am overstocked).—**H. OBOBNE**, 25, Guest Road, Bishopstoke, Hants. r.g.71

**THREE STRONG STOCKS** on 8 frames, 3 gs. each, carriage paid; boxes 10s., returnable.—**HODSON**, Harley Lodge, Enfield. g.60

#### BUSINESS ADVERTISEMENTS.

1½d. per word.

**PROLIFIC NATIVE NUCLEI**, 4 frames, 45s., carriage paid.—**TROWSE**, Eade Road, Norwich. g.158

**NUCLEI**, 3 frames, best Italian Hybrids, fertile 1920 Queen, delivery immediately, 35s.; also fertile Queens 7s. 6d., and 6-frame Stocks for heather.—**MOORE**, 31, Monmouth Road, Dorchester. g.159

**PROLIFIC ITALIAN VIRGINS** only, by return this week, 5s.—**YOUNG**, Hundred Elm Apiary, Central Road, Sudbury, Middlesex. g.161

**FAMOUS** Hybrid Cotswold Queens, bred from highest honey yielders, 10s. 6d. each.—**BOWEN**, below.

**FOR HEATHER HARVEST.**—Prime 8-comb colonies, ready for supers, 93s.; 3-comb Nuclei, 45s., by return.—**LIEUT. BOWEN**, Cotswold Bee and Honey Specialist, Cheltenham. g.162

**4-FRAME NUCLEI**, Italian Hybrids, 1920 Queens, 30s.; box 10s., returnable.—**ANTHONY**, 34, Knavesmire Crescent, York. g.163

**NORVIC BEE CURE** is a necessity; indifference means loss; quart, 10s.;  $\frac{1}{2}$  gallon, 18s.; gallon, 30s.—**TROWSE**, Eade Road, Norwich. g.138

**SURPLUS.**—Nuclei, Hybrids, crowded, 1920 Queens, very prolific strain, 30s.; box 10s., returnable; immediate.—**F. BIGGE**, Tyburn, Birmingham. r.g.145

**DUTCH NUCLEI**, 3-, 4-, 5-frames, 1920 Queens, 9s. frame; well stocked; box 10s., returnable.—ANDREWS, 78a, Westgate, Peterborough. g.164

**QUEENS**.—1920 home-bred Italians, delivery by return, 10s. 6d. each.—GOATH COTTAGE APIARY, Endlebury Road, Chingford. g.165

**FOR SALE**, immediate delivery, 10-frame Stock, £4 7s. 6d.; 8-frame, £3 15s.; 4-frame, £2 5s., with Penna 1920 Queens. Others cheaper. Discount for number of Stocks.—ASHWORTH, Weymouth Street, Warminster. g.166

**ITALIANS**.—Few second Swarms, 25s.; 3-frame Nuclei, 25s.—H. BOWREY, Swallowfield, Berks. g.167

**ITALIAN HYBRID QUEENS**.—Fertiles, 10s.; virgins, 3s.—JACK TICKELL, Westbourne Apiary, Cheltenham. g.168

**QUEENS**, Italian and English, 1920, 10s.; Nuclei, strong, 4 frames 50s., 3 frames 40s., carriage paid. Stamp reply.—HOLLINGSWORTH (First Class Expert), Heanor. g.169

**ITALIAN HYBRID NUCLEI**, 8s. frame to clear; very gentle; absolutely healthy; very strong; expert's certificate. Splendid Stocks, 1920 Queens, 7s. 6d. bar. Owner overstocked.—REDDIE, Cliff Cottage, Leigh, Essex. g.170

**NUCLEI**, 1920 fertile Italian Queens, 6 frames brood, 63s.; boxes 7s. 6d., returnable. Satisfaction guaranteed. Over 36 years' experience.—J. CLARKE, Mill Road, Marpool, Derbyshire. g.171

**4-FRAME NUCLEI**, headed by 1920 Italian Queen, 50s.; box charged 10s., returnable; 6-frame Stocks, 70s.; 8-frame Stocks, 90s. Immediate delivery (weather permitting). Italian fertile Queens, 10s. 6d. English Run Honey and Sections wanted.—LEE, "Little Bowden Apiary," Burgess Hill, Sussex. r.g.114

**VERY strong Nuclei**, Italian Hybrids (Simmins'), 4 frames packed bees, brood, stores, with tested 1920 Queens, guaranteed healthy, 45s., carriage paid; box 10s., returnable.—HOWLETT, "Sylvabelle," Tring. g.116

**ITALIANS**.—Choice Virgins, 3s. Immediate. Stamp.—HOUSTON, Ellen Villa, Sidcup. r.g.123

**BEEES**.—BROOKS, Carnation Specialist, 9, Dudley Road, Finchley. r.g.98

**6-FRAME STOCKS**, with 1920 Queens, 60s. each; travelling box 10s., returnable.—MEGGITT, Bramhall, Stockport. r.g.49

**IMPORTED ITALIAN QUEENS**, 11s. 6d. each; selected Hybrids, 9s.; English, 7s. Safe delivery guaranteed. Catalogue free.—C. T. OVERTON & SONS, Crawley. r.g.79

**CHOICE home-reared Italian Queens**, 10s.; Virgins, 4s. 6d.; July-September.—MISSES PALING & PILLANS, Golden Square, Henfield, Sussex. r.g.82

**STRICTLY BUSINESS**.—Six packages of Flavine, 6d.; a Japanned Sprayer, 6s.; "Let the Bees Tell You," 2s. All post paid.—S. H. SMITH, 30, Maid's Causeway, Cambridge. g.124

**STOP! LOOK HERE!**—Having despatched all orders I can still spare a number of 3- and 4-frame Nuclei at 45s. and 52s. 6d. respectively, carriage paid, 7s. 6d. being refunded on box. Also a limited number of Stocks on 8 frames. Price on application. All above are home-reared Italians, highly resistant to disease, and splendid honey gatherers.—HERBERT VALLEY, Apiarist, Saxilby, Lincoln. r.g.80

**STRONG 3-FRAME NUCLEI**, 1920 fertile Queens, 30s.; box 5s., returnable; Stocks on 8 frames, 60s.; boxes 10s., returnable.—W. WOODS, Normandy, near Guildford. g.63

**VIRGIN QUEENS—THE WELSH APIARY STRAIN**.—Hybrid Italian, guaranteed bred from highly prolific stock, never had "I.W." D. in apiary, the Queens to revitalise your stock, hardy and virile, 5s. each.—LT. COLONEL WEAVER PRICE, Welsh Apiary, Ashgrove, Brecon, S. Wales. r.g.65

**4-FRAME NUCLEI**, 63s.—PRYOR, Breachwood Green, Welwyn. g.86

**DOES BREEDING SPECIALISATION PAY—FOR YOU?**—"The queens I have had from you so far are absolutely 'it.' I'm gone on them. I have recommended several men to have bees from you."—R. M., 25/6/20. Now does it?—ATKINSON, Fakenham. r.g.23

**PURE ITALIAN QUEENS**, prompt delivery; select Italian, extra golden, rare honey-producing stock, August-September.—ATKINSON, Fakenham. r.g.24

**"WIGHT" DISEASE**, prevention and removal; advice 5s.—ALFD. RYALL, Kenwood Apiary, Elcombe, Stroud. r.f.161

**PUPILS received by life-long whole-time Bee Farmer**.—Terms on application to C. B. BARTLETT, Sandford Mount, Charlbury, Oxon. d.127

**1920 FERTILE Golden Italian Queens**, guaranteed imported direct from Italy, regular supplies every few days, 10s. each; specially selected, 14s.—GOODARE, New Cross, Wednesfield. f.69

**"ISLE OF WIGHT" DISEASE**.—Don't worry; use the solution that cures; 2s. per bottle.—B. PRESSEY, St. Elmo, Couleodon. r.d.149

**BOZZALLA tested Queens** are sold at the price usually charged for untested queens.—Catalogue from H. STICH, Riccartsbar Avenue, Palsley. r.c.116

**DUTCH BEES**, Skeps (as imported from Hans Matthes), Nuclei, Queens. Illustrated Catalogue on request, containing points on management.—Buy direct from Sole Agent, WHYTE, Bee Farmer, Cumbernauld, Dumbartonshire. b.61

## ITALIAN QUEENS Direct from Italy. E. PENNA, BOLOGNA, ITALY.

I assume again the direct sale of my queens. Special offers from July 10 till countermanded. For queens in lots of 4 at a time £1 8s. Cash with orders. Payment by cheques or British Postal Orders. International Money Orders are not accepted. I do not hold myself responsible for the queens that are not sent by me direct to customers. All orders should be sent direct to me. In May the queens dead in the journey have been less than 1%  
ORDERS BOOKED IN ROTATION.

## Cartmel Agricultural Society. 43rd ANNUAL SHOW, The Park, Cartmel, TUESDAY, AUGUST 10, 1920.

OPEN Classes for COMB HONEY and RUN or EXTRACTED HONEY.  
Entries close JULY 28th, 1920.  
Schedules, Entry Forms, etc., from the Secretary,  
W. DICKINSON, Cark-in-Cartmel.

**HAVE YOU READ "THE BEE WORLD"?**  
If not, why not? Every number in itself is a useful literary work for practice and reference. Specimen copy free.—Offices: THE APIS CLUB, Port Hill House, Benson, Oxon.

## ITALIAN QUEENS

Direct from Italy.

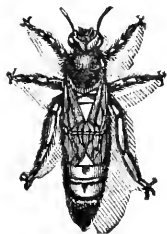

Address:  
Signor Gaetano Piana,  
Castel San Pietro,  
near Bologna, Italy.

All Queens are reared by the most up-to-date and scientific methods. Mr. W. Herrod-Hempsall has personally inspected the apiary and methods employed, with which he is perfectly satisfied.

PRICES FOR 1920.

For 1 Fertile Queen: August and September,  
9/- each queen.

Can take no more orders for June & July. Booked up.

Carriage paid in Great Britain. Cash must accompany all orders, which will be executed in rotation. Guaranteed safe arrival of all Queens, but not the introduction. Bees dead upon arrival must be sent at once to "B.B.J." Office.

For the mutual convenience of all parties, Il Signor Piana has made arrangements that all communications, orders and remittances of the readers of "B.B.J." and "B.K.R." can be addressed to him, c/o British Bee Journal, 23, Bedford Street, Strand, London, W.C.2.

Cheques payable to 'British Bee Journal.'

## BRITISH BEE-KEEPER'S GUIDE BOOK.

By T. W. COWAN, F.L.S., &c.

"Indispensable for success in bee-keeping."  
Upwards of 150 Illustrations, including fine Half-tone Blocks from Photos.  
Paper Covers, 2/6 net; postage 3d.  
**BRITISH BEE JOURNAL and RECORD OFFICE**  
23, Bedford Street, Strand, London, W.C.2.

## THE British Bee-Keepers' Association.

Insure now against loss by damage done through bee stings. All particulars from  
W. HERROD-HEMPSALL, 23, Bedford Street, Strand, London, W.C.2.

The products of the Apiary, of Poultry and Farm Stock, of the Fruit and Vegetable Garden can be Advertised and Sold through

## THE BAZAAR, EXCHANGE & MART

Newspaper.

Get a Copy—Thursday and Saturday 3d. The "Bazaar" publishes also practical handbooks by experts. Send for full catalogue, post free from—**WINDSOR HOUSE, Breams Buildings, LONDON, E.C.2.**

## BARGAINS IN SURPLUS CLOTHING.

Khaki Serge Riding Breeches, good condition .. .. .	pair 12/6
Bedford Cord Riding Breeches, good condition .. .. .	9/6
New Bedford Cord Officers' Breeches .. .. .	42/-
New Cord Riding Breeches, strapped .. .. .	22/6
Blue Serge Trousers, for Working Men .. .. .	12/6
Blue Serge Trousers, as new .. .. .	14/-
Blue Serge Trousers, new .. .. .	21/-
Khaki Drill Trousers, all sizes .. .. .	7/6
Khaki Drill Jackets, with pockets each .. .. .	7/6
Army re-soled Boots, all sizes .. .. .	pair 12/6

### SPECIAL OFFER FOR THIS HOT WEATHER:—

Khaki Drill Suits, Officers' quality, complete with pockets, 20/- per suit.  
Khaki Drill Suits, another quality, complete with pockets, 14/- per suit.

**SACAR'S (Universal) STORES (Dept: 27), ARDWICK, MANCHESTER.**

Army Rubber Ground Sheets 72 x 36, brass eyelets, good condition, 2 for 9/-, 4 for 16/-  
Large Canvas Cart Covers about 6ft. square, with brass eyelets, 7/6 each. These are useful for making Tents or Camping Outfits.  
Black Rubber Combination Suits, all sizes, complete with Sou'wester, 25/- each; cost Government 63/-  
New Heavy Black Boots made specially for outdoor workers, 21/- pair.  
Large Australian Wool Blankets, 26/- pair—bargains.  
New Full-size Army Grey Wool Blankets, 25/- Best bargain in Blankets ever offered.

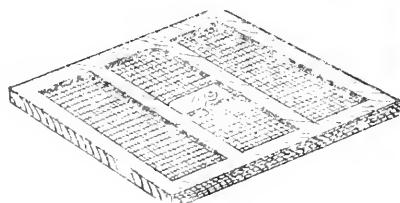

# B<sup>C</sup> B<sup>W</sup> BOARD

A Necessity on all Hives all the Year Round.

**SUPER CLEARER.  
QUEEN EXCLUDER.  
WINTERING BOARD,  
&c.**

SEND FOR KAT-A-LOG

**MEADOWS, Syston, Leicester.**

## POSITIVE FACTS.

June 13th, 1920.

I am very pleased with the foundation. The bees undoubtedly prefer it to any other make I have, and have even gone the length of missing two sheets of other new foundation, and working out a sheet of yours placed behind them at the back of the hive. Full sheets have not sagged in the least in 16 x 10 frames.

Yours faithfully, R. B. MANLEY.

Illustrated Lists free by post.

**S. J. BALDWIN, The Apiary, BROMLEY, Kent.**

# DADANT'S WEED FOUNDATION.

**T**HIS Foundation is made from pure Beeswax and guaranteed free from all disease germs.

Give your bees the **BEST**, and the best is **DADANT'S**.

No acids or other chemicals are used in the manufacture, and the makers guarantee that "**EVERY INCH, EVERY POUND, EVERY TON**, is equal to any sample ever sent out."

We have just received a fresh consignment, and are in a position to give immediate despatch.

Rear healthy bees on clean, natural combs.

None genuine without the watermark "**DADANT**" on every sheet.

*Our Catalogue, entitled "Everything for an Apiary,"  
is sent post free on Application.*

---

**R. STEELE & BRODIE,**

Bee Appliance Makers,

**WORMIT, FIFE.**



THE  
KEY TO  
YOUR SUCCESS.

## Lee's Bee Supplies.

¶ In design, material and workmanship, Lee's Bee Supplies still retain the reputation of being your best and safest investment.

¶ Our 1920 ILLUSTRATED CATALOGUE is yours for the asking. It contains detailed information on the most up-to-date hives and appliances for which the House of Lee is famous.

¶ We regret the necessity of having to advise our Customers that owing to the increased cost of production, all prices in 1920 price list are subject to 10% increase. The increase will not apply to orders received before May 10.

\*.\* Five per cent discount to Members of THE APIS CLUB.

**JAMES LEE & SON,**  
LTD.,  
Uxbridge, Middlesex.

(Telegrams: Graphicly, Uxbridge.)

Telephone: Uxbridge 181.)



## "BACTEROL" FOR BEES

2/9 per Bottle.

Post Free.

The cure for, and preventive of, "Isle of Wight" Disease. Non-poisonous—free from stain or unpleasant odour.

MENLEY & JAMES, LTD.,  
39, Farringdon Road, London, E.C.1.

**BRADBURY, TAUNTON,**  
FOR QUALITY BEE GOODS.

BOOKS

*Illustrated Bee  
Guide free.*

Telephone: TAUNTON 176.

## 20-Page 1920 "WHITE STAR" List,

3½d. POST FREE.

S. SIMMINS, QUEENLAND, HEATHFIELD, SUSSEX

**Bees and Beekeeping Appliances. Catalogue free.**  
**EDWARD J. BURTT. MANUFACTURER. GLOUCESTER.**

*I very much regret that there has been a large increase in the cost of the manufacture of bee appliances, and therefore my prices will be advanced 10% from May 10th. Books excepted.*

PRINTED BY THE AVENUE PRESS (L. UPCOTT GILL & SON, LTD.), 65-67, DRURY LANE, LONDON, W.C., AND PUBLISHED FOR THE PROPRIETOR (W. HEROD-HEMPHILL), BY SIMPKIN, MARSHALL, HAMILTON, KENT & Co., LTD., 31 & 33, PATERNOSTER ROW, E.C.



No. 1988. Vol. XLVIII

JULY 29, 1920.

[Published every Thursday, Price 2d.]

**CONTENTS.**

	PAGE		PAGE
SEASONABLE HINTS .....	361	CORRESPONDENCE—	
JOTTINGS FROM HUNTINGDONSHIRE .....	361	Late Flowering Limes .....	366
RUNCORN NOTES .....	362	Troubles of the Publisher .....	366
SUGAR FOR BEE FOOD .....	363	Fraternity Among Bee-keepers .....	367
A HANDY APIARY .....	364	Two Queens with a Swarm .....	367
CARMARTHENS. B.K.A. ....	365	QUERIES AND REPLIES—	
GUILDFORD AND DISTRICT B.K.A. ....	365	Screen for Road .....	368
GREAT TOTHAM COTTAGE GARDEN SOCIETY SHOW ..	365	BEE SHOWS TO COME .....	368

We have just received a consignment of  
**Lewis Superb Snow White Basswood**  
**SECTIONS**

Which we are offering at the moderate figure of catalogue price, plus 15%.

As this essential branch of Beeware is likely to increase in price next season we strongly advise our customers to purchase with a view to the future.

**HONEY BOTTLES**

1lb. actual size.

We are in a position to give prompt delivery of honey bottles. These are of the finest quality.

Price - 1-lb. 55/- per gross.

„ ½-lb. 47/- „ „

Reductions for LARGE quantities.

**E. H. TAYLOR, WELWYN, HERTS.**

**THE  
British Bee Journal**

Office: 24, Bedford Street, Strand, London, W.C.2.  
ESTABLISHED 1873.

A Weekly Journal Devoted to the  
Interests of Bee-keepers.

Edited by T. W. COWAN, F.L.S., &c.,  
and J. HERROD-HEMPSELL, F.E.S.

**Correspondence: Whom to Address.**

All matters relating to the Literary Department, Associations, Shows, etc., should be addressed, "Editors, *British Bee Journal*," and all business communications and matters relating to subscriptions and advertisements to be addressed to the "Manager," B.B.J. Office.

**Subscriptions.**

Annual Subscription, 10s. 10d. post free in advance; single copies 2s., or 2½d. post free. If a receipt is required by post, a stamped and addressed envelope must be sent, otherwise a printed receipt will be enclosed along with the paper.

Note.—Cheques and Postal Orders should always be crossed, otherwise it is very difficult to trace them if they go astray.

**How to send Money.**—Remittances can be made payable to W. Herrod-Hempshall by crossed Cheques and Postal Orders. Stamps may be sent for small amounts up to 2s. *Halfpenny stamps are preferred.*

Scottish or Irish cheques can only be taken in payment if 6d. is added for commission charged by banks for cashing them.

The Editors are not directly or indirectly interested in the manufacture or sale of beehives or appliances of any kind, and must refer correspondents wishing for prices or catalogues to advertisers in the paper.

**OUR DEPOSIT SYSTEM.**

You are advised to insist on this being used when dealing with strangers.

**Rules and Conditions for Depositing**

In order to save trouble, it is requested that the Rules be carefully read over by persons using the Deposit System of trading.

Goods should not be despatched until notice that the money has been deposited is received from this office.

1. Method.—When strangers are dealing together, the purchase-money of the articles is deposited at our office. We acknowledge receipt of the deposit to both parties, and hold the money until we are satisfied that the purchase is concluded. If a sale be effected, we remit to the seller the amount deposited, less a charge of 2½ per cent. In the 2, with a minimum of 6d., and the expenses of Post Office Orders and postage, &c. Cash will be forwarded by Cheque, Post Office Order, or by Postal Order as preferred. If a sale or exchange be not completed, we return the amount deposited, after making the same deduction. By this means buyers and sellers are secured against fraud.

2. Deposits.—Postal Orders (drawn on General Post Office) and Cheques must be made payable to W. Herrod-Hempshall, and crossed "London County and Westminster Bank." The numbers of the Postal Orders should be kept by the sender. We cannot be responsible for any loss that may occur in transit.

3. Honey on Approval.—All honey will be sold by sample, which must be sent direct to buyer.

4. Bee Appliances.—In ordering, the time allowed for completing the order to be stated to us when sending cash. If maker accepts, we hold cash until transaction is satisfactorily completed, when the amount will be remitted, subject to conditions as in Clause 1.

5. Bees and Queens.—These will be dealt with entirely by the parties concerned, so far as price, &c., go, and when the purchase is satisfactorily completed cash will be remitted as per Clause 1.

6. Goods in Transit.—These are at the seller's risk, i.e., any damage to or loss of an article on its journey is borne by the vendor; but a rejected article must be properly packed and returned by the same means as was used in sending it.

7. Carriage.—The carriage of all goods, except such as are sent by post, is payable by the buyer, unless otherwise agreed. If any article sent on approval be returned, each party to the transaction must pay carriage one way.

**Books for Bee-keepers**

NOW IN STOCK.

Cash in full must be sent with order.

		Postage
A Modern Bee Farm ... ..	7/6	... 8½d.
Advanced Bee Culture (HUTCHINSON) ... ..	6/-	... 6½d.
Beginner's Bee Book (PELLET) ... ..	5/-	... 4d.
<b>BEE-KEEPING SIMPLIFIED FOR THE COTTAGER AND SMALLHOLDER</b> (W. HERROD-HEMPSELL, F.E.S.) ... ..	1/-	... 2d.
<b>BRITISH BEE - KEEPERS' GUIDE BOOK</b> (T. W. COWAN) Paper covers ... ..	2/6	... 3d.
Cloth covers ... ..	3/6	... 4d.
Dissectible Model of Queen Bee ... ..	4/6	... 3d.
<b>FERTILISATION OF FRUIT BLOSSOMS BY BEES</b> (T. W. COWAN) ... ..	-/3	... 1d.
Honey and Health (A. HOPE) ... ..	-/6	... 1d.
Honey Vinegar (REV. G. BANGKS) ... ..	-/2	... 1d.
How to Keep Bees (ANNA B. COMSTOCK) ... ..	5/-	... 4½d.
Management of Out Apiaries Pollination of Fruit in relation to Commercial Fruit Growing (C. H. HOOPER, F.R.H.S.) ... ..	3/-	... 2d.
<b>PRODUCING, PREPARING, EXHIBITING AND JUDGING BEE PRODUCE</b> (W. HERROD-HEMPSELL, F.E.S.) ... ..	-/6	... 1d.
Productive Bee-keeping (PELLETT) ... ..	2/-	... 3d.
Queen Rearing in England (F. W. L. SLADEN) ... ..	10/6	... 8½d.
Scientific Queen Rearing (DOOLITTLE) ... ..	1/6	... 2d.
4/-	... 3½d.	
<b>The Bee-keepers' Vade Mecum</b> (GARY) ... ..	2/6	... 2d.
Snelgrove's Method of Re-queening ... ..	-/6	... 1d.
The "Townsend" Bee Book ... ..	2/6	... 2d.
<b>WAX CRAFT</b> (T. W. COWAN) ... ..	2/-	... 2½d.

**MISCELLANEOUS.**

Maeterlinck's Life of the Bee The Lore of the Honey Bee (TICKNER EDWARDES) ... ..	5/-	... 3d.
2/-	... 2½d.	
<b>THE BEE WORLD</b> (supplied only to members of Associations interested in the control and development of the APIS CLUB, apart from ordinary members of the latter), per copy ... ..	-/8	... 1½d.
The Bee Master of Warrilow (TICKNER EDWARDES) ... ..	7/6	... 4½d.

British Bee Journal & Record Office,

23, BEDFORD STREET, STRAND, LONDON, W.C.2.





## Seasonable Hints.

The weather has on the whole been very unfavourable for the bees during the month of July, and we are still hearing of colonies being short of food. We repeat our warning of a fortnight ago to keep an eye on the stores, especially of newly established colonies, either swarms or nuclei.

In giving these hints from time to time we are in somewhat of a difficulty. Conditions vary very considerably in different parts of the country, and we can only be guided by those prevailing in our own district, and from information given by callers at the office, and we feel that our hints may be quite unsuitable for localities further afield—north and west especially. It would be a great help to us, and also to many bee-keepers in those parts of the country, if some experienced bee-keepers could give through the *JOURNAL*, a few hints that would be suitable to their district.

## Jottings from Huntingdonshire

Some of the finest run honey I have seen this year was tabled at Lilford Hall Fête on July 22. Staged at 3s. a pound jar, it found a very ready sale. As one wandered through the park and noticed the wealth of limes in full bloom, one felt it only needed seasonable weather to give the bees an opportunity of relieving the myriad lime blossoms of some of their nectar. Alas! the weather has again changed. Boisterous, nippy winds are not the ideal thing in July, and when the bees are hindered in July it makes not a little difference to the honey harvested. However, we hope August will bring true harvest weather, and then the bees will work like fury to get the supers filled.

Have bees a password? Does each hive have a password or sign of its own? One is led to think this to be so, and yet, if such methods are adopted, how is it strange bees are not always attacked? We all know what a struggle goes on when robber bees appear at the entrance; yet a strange bee, if filled with honey, could gain admittance to almost any hive. True, the stranger will pause on the alighting board and hesitate to push forward, and maybe one or two sentinels would come out and challenge her, passing their antennæ over her abdomen as if to say, "Friend or foe?" and so soon

as they learned the stranger was anxious to unload her honey-sack permission would be immediately granted.

A lady living some five miles from here had three hives of pure Dutch bees, and every bee was true to type. Being anxious to introduce Italian blood into her apiary, she asked me to fix her up with some Italian bees. I did so. Last week, in looking through her hives, I found Italian bees in each colony, quite at home and happy. Often, too, when young bees leave a hive for their first foraging trip, if other hives of same colour and pattern are standing near, it is not unusual for them, on returning, to enter the wrong hive and be accepted. It is not so with drones. Any drone settling on the wrong alighting board would be instantly despatched, unless the colony within that hive was queenless or decimated with disease, in which case drones from other hives would be welcomed gladly. Why this should be so is not quite clear. True, drones assist in a little way in keeping up the temperature of the hive, and, moreover, despite what has been said to the contrary, give a hand (I suppose one ought to say leg) in cleansing of the home; but why they should be welcomed among the weak and in great numbers is somewhat of a puzzle to me.

I mentioned a few weeks back that my notice had been called to what appears to be a new bee disease. Many readers, jumping to the conclusion that the diseased bees were crawling about my own grounds, have written to advise me what to do:—"I see in the *B.B.J.* you are troubled with crawlers; use Flavine." "From the *B.B.J.* I note you have symptoms of 'Isle of Wight' disease. I have a certain cure; sample bottle will be sent for 2s. 6d." "Reading your Jottings the other day, I was so sorry to see you were troubled with disease in your apiary; I was troubled in the same way, and used sulphur and Izal and lime, etc.," are types of letters I have received. Let me here and now say that so far I have not had a single crawler in my apiary, nor any other bee disease. I say this not boastfully, but with profound thankfulness. If you would ask how I manage this, my first reply would be cleanliness; second, continuous introduction of fresh blood and equability of temperature. If bees are too hot, ventilate; if too cold, add additional covering. The coverings may be copies of the *Daily Mail*, *Daily News* or the *Labour Leader*—any newspaper will do—but don't use *Punch*. Bees don't like *Punch*. They may enjoy the jokes, if they have time, when by chance they get imprisoned 'twixt the quilts and the roof; and if no super cones are available for exit the wit of *Punch* may stave off the pangs

of hunger, but the bees beneath are not so happy about it. Ordinary newspaper is more absorbent than the superior papers on which *Punch* and the *Bystander* and other such papers are printed.

I have frequently remarked on the neglected white clover blossoms, and this has been a most remarkable clover year. Now, however, the mowing machines have levelled down the first blooms, and the second crop is flowering. My bees are quite literally in clover. In fact, the white clover and bramble blossom are being worked with great zeal.

Five weeks ago I introduced a virgin Egyptian queen to half a pound of Dutch bees on a drawn-out comb. She mated with an Italian drone, and her progeny are now emerging in great numbers. Already built up to five frames of comb, there seems little doubt but that ten frames will be needed before the season closes. I did a similar thing two months ago; the colony is now ready for supering. Bees of colonies built up from nuclei are much better-tempered than those built up from swarms, but for gentleness of temper I take off my hat to Holmewoods, and since their docility is accompanied with energy I cannot but praise this strain of bee the late Mr. Howard built up with so much care.

July passes, but despite the cold spells one sees hosts of flowers gay in field and hedge. Sneezewort, oxeye, goutweed, bedstraw, rest harrow, agrimony, tansy, succory, bugloss, figwort, tormentil, knapweed, the vetchlings, clovers, hawbit and nipplewort are a few which catch one's eye; while near the stream where the bee sips and the chaffinch goes frequently to bathe can be seen meadow sweet, valerian, loose strife and red campion.—E. F. HEMMING, The Rectory, Steeple Gidding.

### Runcorn Notes.

The *New Bee Disease*? My kinsman has christened this peculiar malady a new disease. Is it? It is new however to my experience. I have not yet any theory to offer as to its origin. I will, with the Editor's permission, give as concisely as possible my observations. I had a stock with failing queen, so decided to unite with a swarm. This I procured from my kinsman; an Italian united in the usual way by first taking away old queen and running bees on to combs. The old stock covered only three frames at the beginning of June. The swarm had been in the travelling box 48 hours. The evening the operation was performed was rather cool, and the bees consequently rather slow. There were rather more casualties during transit than usual. All

appeared to be well for a couple of days, when crawlers commenced to appear. These increased in numbers rapidly, despite persistent spraying with weak syrup strongly medicated with Izal. From covering eight frames of comb they had dwindled by half in ten days, and in a few days after (when on-examination I found the queen was a virgin laying only drone eggs, I destroyed them in disgust and burnt contents of hive, with bees) they covered hardly three combs.

A few days after I received another swarm headed by a Dutch queen. About half the bees were Dutch and half Italian. The swarm was not a large one and was hived on six frames with starters only. (More of this, perhaps, another time.) All was going merry as a marriage bell for about four or five days. Then crawlers. Spraying as before, no result, bees got worse. My disgust can be imagined. Isle of Wight disease was, of course, in my mind. Before destroying the first swarm I sent about a dozen of the crawlers to Dr. Helen Goodrich for bacteriological examination. The report received was "No *Microsporidiosis* found, or any known disease." Swarm No. 2 got worse, and I had had about decided it should follow the first, when it occurred to me, perhaps, as the weather was decidedly chilly during their transit, that they were suffering from chill, and that when the new brood hatched out matters would mend. So I waited—in vain. The young bees were as bad as the old, but the queen being vigorous after the brood commenced to emerge, the young bees about kept pace with the casualties, so that although they did not decrease in numbers they did not increase. When these were at their worst I sent some to Dr. Goodrich for examination. The report reads: "Only three arrived alive, but in these there is no trace of any known disease." About this time I read in Mr. Kettle's article that he had been successful in treating crawling stocks with Flavine, so decided to try the treatment, and I am happy to say that five days after the first spraying all trace of crawlers had disappeared.

Now as to the exact symptoms the bees showed. The bees were unable to fly, owing to apparent paralysis of their anterior wings; though they could vibrate the posterior without difficulty, the anterior were immobile. Also, when first attacked they were very nimble on their legs. They crawled as much as a dozen yards from the hive. Like my kinsman I observed bees working on *Limnanthes* which were unable to fly back to the hive. Whether they crawled to the flowers, which were quite near the hives, I am unable

to say. During the hottest part of the day most of the affected bees would be seen crawling up the front of the hive on to the roof, where they assembled in clusters. Later, those that did not fall to the ground re-entered the hive. They also showed swollen abdomens, which on examination were found to contain an accumulation of faeces which they seemed unable to evacuate. The queer point about this complaint is that it seems to affect swarms only. I am assured that the parent stocks show no signs of crawlers. A hive standing six feet from my first affected swarm threw two swarms, but no symptoms of crawlers have appeared in these. If the case mentioned by Mr. W. Green in *B.B.J.* for July 15 (10221) is identical with mine it would seem as if it is a form of bee-paralysis, sulphur being a recognised specific for this.—  
D. J. HEMMING, Runcorn, Cheshire.

### Sugar for Bee Food.

Bee-keepers requiring a supply of sugar for feeding should apply at once to the Secretary of the Committee dealing with this matter in their respective counties for a registration form, which must be filled in and returned to the source from which it is obtained. A certificate will then be issued entitling the holder to 14 lbs. of sugar per stock any time from August 1 to December 31, 1920. This must be presented to the Local Food Committee, who will issue the necessary coupons for the amount allocated from his grocer. *All needing sugar must register, whether registered before or not.* The address from which the registration forms can be obtained in each county are as follows:—

#### ENGLAND.

WHERE TO APPLY FOR THE AUTUMN AND WINTER RATION OF SUGAR FOR BEE-FEEDING PURPOSES.

- BEDFORDSHIRE.—The Director of Education, Shire Hall, Bedford.
- BERKSHIRE.—The Clerk, Berks. County Council, Shire Hall, Reading.
- CITY OF BIRMINGHAM.—A. E. Griffiths, Esq., Parks Department, Council House, Birmingham.
- BUCKINGHAMSHIRE.—The Secretary, Bucks. Agricultural Instruction Committee, Education Sub-Office, Kingsbury Square, Aylesbury.
- CAMBRIDGESHIRE.—The Executive Officer, Cambs. Agricultural Executive Committee, 10, Trinity Street, Cambridge.
- CHESHIRE.—The Agricultural Organiser, Education Department, Reaseheath, Nantwich.
- CORNWALL.—The Secretary for Education, County Hall, Truro.
- CUMBERLAND.—John Steel, Esq., Cardewlees, Carlisle.
- DERBY.—F. Meakin, Esq., 37, Pybus Street, Derby.

- DEVONSHIRE.—The Agricultural Organiser, Devon County Agricultural Committee, 1, Richmond Road, Exeter.
- DORSET.—The Director of Education, County Education Office, West High Street, Dorchester.
- DURHAM.—The Director of Education, Shire Hall, Durham.
- ESSEX.—The Secretary, Essex Education Committee, East Anglian Institute of Agriculture, Chelmsford.
- GLOUCESTERSHIRE.—The Agricultural Organiser, County Education Office, Shire Hall, Gloucester.
- HANTS.—The Director of Education, The Castle, Winchester.
- HEREFORD.—The Organiser of Agricultural Education, Shire Hall, Hereford.
- HUNTS.—The Clerk to the Education Committee, County Education Offices, Walden House, Huntingdon.
- HERTS.—Frank Lipscomb, Esq., Estate Office, Woodhall Park, Hertford.
- ISLE OF ELY.—The Education Secretary, Education Offices, March.
- ISLE OF WIGHT.—The Clerk, Isle of Wight County Council, County Hall, Newport.
- KENT.—The Agricultural Organiser, Sessions House, Maidstone.
- LANCASHIRE.—The Director of Education, Education Department, County Offices, Preston.
- LEICESTER.—The Secretary, Leicester Education Committee, Agricultural Department, 6, Millstone Lane, Leicester.
- LINCOLNSHIRE:—
  - HOLLAND.—The Horticultural Superintendent, Agricultural Education Committee, The Agricultural College, Kirton, near Boston, Lincs.
  - KESTEVEN.—Mr. S. Greenall, The Manor, Carlton Scroop, Grantham.
  - LINDSEY.—The Organiser of Horticultural Education, Lindsey County Council, 286, High Street, Lincoln.
- MIDDLESEX.—The Secretary, Middlesex Education Committee, The Guildhall, Westminster, S.W.1.
- NORFOLK.—The Secretary, Norfolk Education Committee, Shirehall, Norwich.
- NORTHAMPTON.—The Education Secretary, County Education Office, Northampton.
- NORTHUMBERLAND.—C. Mayhew, Esq., 66, Louvaine Place, Newcastle.
- NOTTS.—The Director of Education, Shire Hall, Nottingham.
- OXFORD.—The Education Secretary, The Agricultural Sub-Committee, County Offices, Oxford.
- RUTLAND.—The Agricultural Organiser, Rutland Education Committee, Oakham.
- SALOP.—The Secretary, Agricultural Committee, Salop County Council, Kenneth House, Dogpole, Shrewsbury.
- SOKE OF PETERBOROUGH.—The Clerk, Soke of Peterborough Education Committee, Committee Clerk's Office, Peterborough.
- SOMERSET.—The Secretary, Agricultural Instruction Committee, Agricultural Education Office, Cannington Court, near Bridgewater.
- STAFFORDSHIRE.—The Secretary, Agricultural Education Committee, Secondary and Technical Department, County Education Office, Stafford.
- SUFFOLK (EAST).—The Secretary, East Suffolk Education Committee, County Hall, Ipswich.
- SUFFOLK (WEST).—The County Education Secretary, West Suffolk County Council, Shire Hall, Bury St. Edmunds.

**SURREY.**—The Secretary, Surrey Education Committee, County Education Offices, Kingston-on-Thames.  
**SUSSEX (EAST).**—The Secretary, Horticultural Sub-Committee, Agricultural Education Committee, County Hall, Lewes.  
**SUSSEX (WEST).**—The Agricultural Organiser, County Hall, Chichester.  
**WARWICK.**—The Director of Education, County Education Office, Warwick.  
**WESTMORLAND.**—The Director of Education, Lowther House, Kendal.  
**WORCESTERSHIRE.**—S. Leedham, Esq., Webb's Farm, Lower Bentley, Bromsgrove.  
**WILTSHIRE.**—The Secretary, Agricultural Education Department, Wilts. County Council, County Offices, Trowbridge.

**CARNARVON.**—The Director of Education, County Hall, Carnarvon.  
**DENBIGHSHIRE.**—The Principal, Llyssasi Farm Institute, Dentre, Celyn, Ruthin.  
**FLINT.**—The Secretary, Flint Agricultural Education Sub-Committee, County Council Offices, Broughton, Chester.  
**GLAMORGAN.**—The Secretary, Glamorgan Agricultural Executive Committee, 30, Park Place, Cardiff.  
**MERIONETH.**—The Secretary, Merioneth Education Committee, Education Office, Towyn.  
**MONTGOMERY.**—The Agricultural Organiser, Agricultural Office, Welshpool.  
**MONMOUTH.**—The Director of Agricultural Education, County Council Offices, Newport, Mon.

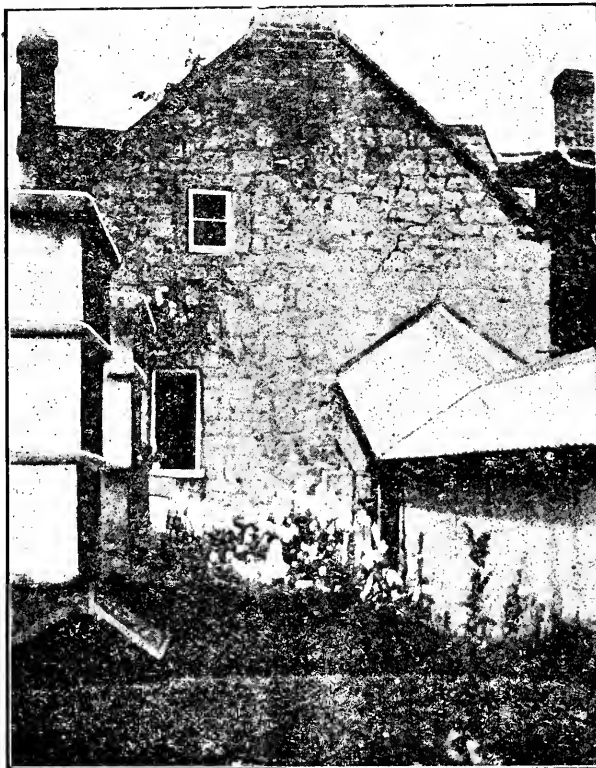

PART OF MR. G. G. DESMOND'S APIARY.

**YORKSHIRE (THREE RIDINGS).**—The Clerks, Joint Agricultural Council, Yorkshire Council for Agricultural Education, County Hall, Beverley.

#### WALES.

**ANGLESEY.**—The Secretary, Anglesey Agricultural Instruction Committee, Shire Hall, Llangefni.  
**BRECON.**—The Agricultural Organiser, Agricultural Office, Builth Wells.  
**CARDIGAN.**—The Agricultural Organiser, Cardigan Education Committee, Nythfa, Tregaron, Card.  
**CARMARTHEN.**—The Clerk, Carmarthen Education Committee, County Education Office, Carmarthen.

**PEMBROKE.**—The Director of Education, 8, Victoria Place, Haverfordwest.  
**RADNOR.**—Included in Brecon.

### A Handy Apiary.

Perhaps no one has an apiary situated exactly as mine is. From the cottage to the workshop runs a covered passage, east and west. On the south side of this the land rises sharply, and here are the hives with entrances about four feet below the ridge of the corridor and ten feet away from it, so that there is a perfectly easy

flight-line to the north, and shelter from the north wind. The corridor has several windows from which one can look straight into the hive-entrances. My wife is seen in the enclosed photograph looking from one of them. The little box under the upper window of the cottage has a nest of tits every year. Though these birds help themselves to a good many bees during the winter (and would whether they nested here or not) they never feed their young on anything but green caterpillars.—G. G. DESMOND, Sheepscombe, Gloucestershire.

### Carmarthenshire Bee-Keepers' Association.

Report of Council meeting of above Association, held July 16 at Ammanford, Mr. Winterbottom in the chair.

On the application of the committee of the Llangadock Horticultural Show, to be held on August 21, Mr. Samways, F.R.H.S., the expert of the Association, consented to give a demonstration in bee-keeping at the Show.

It was decided to advertise for applications for lectures and demonstrations by the experts of the Association, with a view to the establishment of new branches in the more remote parts of the county.

The Secretary was asked to draw the attention of local secretaries to the Preliminary Examination to be held August 14 at Llanelly and to the sugar ration for autumn feeding.

The Bee Re-Stocking Committee report that the bees in the Dutch skeps are in flourishing condition and are ready for the formation of nuclei, but delay is experienced owing to difficulty of getting delivery of fertile queens.

A vote of sympathy with Mrs. J. W. Jones, widow of the late Rev. J. W. Jones, Vicar of Ammanford, was passed. The Vicar had been a valued member of the Association since its commencement. A long illness prevented his working among his bees, so that several members of the Association undertook the care of them.—W. COMERY, Hon. Sec.

### Guildford & District Bee-Keepers' Association.

This young society was able to stage some good samples of honey at a show held at Stoke Park, Guildford, on Saturday, 24th July. The competition in the eight classes arranged, resulted as follows:—

*Open to members of the Association.*

Class A.—Three 1 lb. sections of comb honey: 1st, E. G. Waldock; 2nd, H. J. Snell.

Class B.—Three 1 lb. glasses of light

run or extracted honey: 1st, J. Fooks; 2nd, Mrs. W. Fawcett.

Class C.—Three 1 lb. glasses of medium run or extracted honey: 1st, A. Cox; 2nd, A. H. Hamshar.

Class D.—One shallow frame of comb honey: 1st, J. Fooks; 2nd, E. G. Waldock.

*Open to the United Kingdom.*

Class E.—Three 1 lb. sections of comb honey: 1st, Miss H. Graham; 2nd, H. J. Snell.

Class F.—Three 1 lb. glasses of light run or extracted honey: 1st, E. G. Waldock; 2nd, H. J. Snell.

Class G.—Three 1 lb. glasses of medium run or extracted honey: 1st, A. H. Hamshar; 2nd, H. J. Snell.

Class H.—One shallow frame of comb honey: 1st, J. Fooks; 2nd, H. J. Snell.

Judge—Mr. C. T. Overton, Surrey Association expert.

An additional feature of the show was an observation hive of bees kindly lent by Mr. H. J. Snell, a beekeeper of over 25 years experience. The trade exhibit of Messrs. F. A. Brown & Co., of Guildford, was complete from hives to honey labels. As the event was combined with the Flower and Vegetable Show of the allotment holders of the town, the visitors were numerous, and the many enquiries at the honey tent indicated that beekeeping in Surrey is making good headway as a business, as well as a pleasant hobby.—*Communicated.*

### Great Totham, Little Branted and Wickham Bishops Cottage Garden Society.

The above-named Society held a very successful show on July 14, at which the honey exhibits showed a very great improvement on previous years, both in quantity and quality. This was due to the efforts of the Wickham and District Bee Keepers' Co-operative Association, and particularly to their able and energetic expert Mr. Hammond. Nineteen exhibitors staged 51 exhibits out of 69 entries, and the following were the fortunate prize winners:—

Class 79.—5 sections, 10 entries, 5 exhibits.—1st, Mr. H. Sayer; 2nd, Mrs. Boulton.

Class 80.—1 jar open to all Essex, 13 entries, 11 exhibits.—1st, Mr. A. C. Tew; 2nd, Mrs. J. Taylor.

Class 82.—1 jar open to British Isles, 16 entries, 15 exhibits.—1st, Mr. P. J. North; 2nd, Mrs. Boulton.

Class 75.—6 sections, 7 entries, 4 exhibits.—1st, Miss Collins; 2nd, Mr. Crouch.

Class 76.—3 bottles honey, 9 entries, 7

exhibits.—1st, Mr. Lake; 2nd, Mr. Crouch.

Class 77.—Shallow frame, 9 entries, 7 exhibits.—1st, Miss F. Weston; 2nd, Mr. Crouch.

Class 78.—Best display of honey, 3 entries, 2 exhibits.—1st, Mr. A. C. Tew; 2nd, Mr. Hammond.

Mr. Alder, Essex County expert, and Mr. Belsham, Heybridge, kindly acted as judges. The former gave a very interesting lecture and demonstration on handling bees, which aroused much interest, and was greatly appreciated.—CHARLES W. COCKBURN, *Hon. Sec.*



The Editors do not hold themselves responsible for the opinions expressed by correspondents. No notice will be taken of anonymous communications, and correspondents are requested to write on one side of the paper only and give their real name and addresses, not necessarily for publication, but as a guarantee of good faith. Illustrations should be drawn on separate pieces of paper. We do not undertake to return rejected communications.

### Late Flowering Lime.

[10231] Herewith I send some specimens of *Tilia petiolaris*, the Caucasian lime tree, which are now (July 26) bursting into bloom and yielding honey of excellent quality. You will recollect that you were good enough to publish a letter from me on this useful tree on September 14, 1899, in which I called attention to the possibility of doubling the time available for the lime-tree honey harvest by planting this tree. In that year I myself planted a number of them, one of which is now 3 ft. 4 in. in girth two feet from the ground, and more than 30 ft. in height. In addition to its utility as a source of honey the buds of *Tilia petiolaris* furnish an excellent vegetable in the spring. When they measure about three-quarters of an inch in length they can be collected by shaking the branches sharply, especially soon after rain. They are cooked like spinach, and are delicious when subsequently heated with a little butter or fat. The bark of the branches is tough, and can be used in the garden for tying purposes. The propagation of the tree is easy, either by grafting on stocks of the common lime or linden, or by cuttings. I have had very few seedlings from my trees as yet.—WALTER F. REID, *Addleston.*

[The thanks of beekeepers are due to Mr. Reid for again bringing this tree to notice. The specimens sent by him are full of flower, and as we are writing are filling the room with their fragrance. No

wonder the bees are fond of them. Where the roadsides are planted with trees they should have a good proportion of this late flowering lime among them. They are both useful and ornamental—more ornamental than some trees we have seen. Those of our readers who have any influence in the planting of trees to beautify parks, roadsides, or other places, should use it to get at least some of this variety included. Mr. Reid finds another point in its favour, it is not so liable to honey dew as the ordinary lime.—Eds.]

### Troubles of the Publisher.

[10232] It is only fair to the publishers of the *American Bee Journal* to say that they have not raised their subscription, and that they are not doing so, at any rate for some months, and that meanwhile they are giving all their subscribers the option of renewing their subscriptions at the present rate for as long as they care to pay for in advance. Whether it pays to subscribe five or ten years in advance to secure the paper at a lower price is a matter of opinion. It certainly would not pay English people to do so at present rate of exchange.

I have a sort of recollection of the B.B.J. subscription being raised some time ago because of the higher postage rates. I have no time to look it up now, but several people have mentioned it to me lately, and saying that the stamp on the JOURNAL is still a halfpenny one. Perhaps it might be worth while to explain. Personally, I think the price of the JOURNAL is not high, seeing that it is the only largely-used advertising medium at the present time.

Referring to "Notes on Bee-keeping," perhaps Mr. Lythgoe would cultivate the Rev. Owen and win a few bee-keeping secrets. For instance, he might hear what kind of bees they use and what size of frames, etc. Anyway, if Mr. Owen reads the B.B.J., I shall be surprised if he does not get a message about bees soon. I wonder what they say "beyond the veil" when they get stung.—R. B. MANLEY.

[The subscription to the B.B.J. and RECORD was not raised on account of the higher postage rates. The rate proposed for printed papers was dropped, and for the present remains the same. We only issued a warning that if the postage was increased we should have to add the amount to the subscription, but the price of the paper would have remained unaltered. Our thanks are due to a number of subscribers who sent cash in anticipation of an increased postage, and if anyone has not had this returned it will be on receipt of a post-card to that effect.—Eds.]

### Fraternity Among Bee-Keepers.

[10233] Though sympathising with his misfortunes, I quite fail to understand what it is that friend Cross wanted but did not get.

I did not see his "Ad.," but he explains that he wished to buy and desired no gift. Well, the "Ad." columns of the B.B.J. are crowded with sellers, probably in the proportion of 20 to 1 of buyers. What a simple matter to apply to these sellers for what he wanted! If these sellers had more orders than they could cope with it would be unreasonable to expect them to apply to him; the initiative should have been on his side, for orders should be executed in rotation to give justice to *all*.

I wanted nuclei this season, and applied to some of the many advertisers of them.

In seeking for Italian bees, Mr. Cross is on the high road to victory over the plague. (Having no experience of Dutch I cannot speak for them; I am satisfied with the others.) What other advice can be given than *Avoid the native bee*? But if Mr. Cross wishes this advice reiterated, or any other hints which experience of the disease may have given, he is welcome to my address by applying for it to the Editor, I suppose, with stamp for reply. A neighbourly visit I fear would hardly be practicable.

I am always delighted to see and talk with brother bee-keepers, and wish him every success.—"Buzz," Isle of Man.

[10234] The letter from "Cross" and your invitation appears to make appropriate the story I unfold below, which has smouldered in my mind for some time. I would say with you, gentlemen, that my experience among bee-keepers of all classes has been that a stronger fraternity exists than is found in any other craft; and because I believe that more good than harm will result from the relation of a circumstance entirely unlike that fraternity, I give the tale without embellishment and strictly according to facts.

A. was a smallholder who joined the Army in 1915. Until he was sent overseas in the following year, his wife carried on, but finding it impossible to continue, she gave up the holding, all that A. was able to do being to intimate his approval of the step.

Just at that time a bee-keeper, we will call B., newly arrived in the village, hearing that A.'s wife was disposing of bees, and having none himself, approached her with an offer of one pound for the strongest of twelve stocks. She declined the offer, and subsequently sold six stocks at fifty shillings each. During the winter

three of the remaining stocks died out from shortage of stores, but the others were strong; and as A. had asked that if possible, the strain should be kept for him, she suggested to B. that he should take care of these stocks—on his own premises—on condition that he shared the honey with her, and that any increase should be divided equally on A.'s return. B. jumped at the offer. A.'s wife removed to a distant county.

At the end of 1917, having heard nothing from B. about the bees, she wrote and asked how they had fared, but received no reply. Some time afterwards, she mentioned the matter in a letter to a friend in the village, who said she believed that B. had done very well with the bees. Another letter failed to meet with any response from B., and the matter drifted till the end of 1918, when she wrote again, but still there was no response.

Early in 1919 A. returned, and, concluding that it was no use trying to deal with the matter by letter, made an expensive journey to see B. He learnt from him that the bees had indeed done very well the first year, and besides an increase of three stocks, had provided over half cwt. of honey. In 1918, however, they contracted disease, and only one survived the winter. A. decided not to take over this hive on B. undertaking, if it recovered, to send him a nucleus from it. B. also promised to pack up and despatch A.'s appliances, mentioning casually that he had paid out a small sum for cartage on the stocks sent away when the six were sold. (He had not packed them, by the way, A.'s wife having to pay a professional from a distant village to do this.) A. ignored the hint, and left. A month afterwards, not having received the appliances, he wrote to B. rather sharply, and a fortnight later the appliances arrived, carriage forward.

Since then, A. has heard nothing further from B., nor has he been able to procure bees on terms which he can afford.

I make no comment, but should like to hear what brethren of the craft have to say about the matter. Also, in order that there may be no suspicion of bias or malice, I depart from my usual rule and pseudonymously sign myself.—"AMAZED."

### Two Queens with a Swarm.

[10235] Can you please find a small space in your valuable B.B.J. in answer to Mr. F. Knight's question? On July 1 he said he found two queens in a swarm; I found two on Saturday, July 3, in one small swarm, about 3 lbs. On Tuesday, July 6, I found five queens in a small swarm, about 2 lbs. or 3 lbs. in weight. I

caught all five queens and I have got them in a match-box. Two and three queens are very rare in small swarms round Egham, Surrey, this year, but I have taken seven queens from two swarms: average about 5 to 6 lbs. I should think this is a record, as I have not seen any of our readers report so many; one queen I gave away, the other six I still hold. I shall be pleased to hear if any reader can beat this record for queens in swarms for their size. Wishing you all a good success.—L. TIDBURY.



### Screen for Road.

[9906] I want to plant a hedge to screen a road, and want to put in something that will grow quick. Some kind of privet would suit, but I have an idea that privet blossom is not good for bees, and mine are quite close to where the hedge will be. I shall be greatly obliged if you will advise me on this point, or perhaps some of your readers could suggest a better shrub. Soil, loam over chalk.—B. DUNNING.

REPLY.—Privet would not hurt the bees, but the honey from it has a disagreeable flavour. We should say Myrabella plum would be suitable. Possibly some of our gardener readers could suggest something else.

## Bee Shows to Come.

**July 29 to August 2, at Bolton.**—Royal Lancashire Agricultural Society's Show. £30 prizes for Honey. Six Classes.—Schedules (stating Honey Section) from R. O. Bradbury, Secretary, Derby House, Preston. Entries closed.

**August 2, at Bredon.**—Annual Show of the Worcestershire B.K.A. Three open classes. Schedules from Geo. Richings, 42, Barbourne Road, Worcester. Entries closed.

**Monday and Tuesday, August 2 and 3, at Newport.**—Monmouthshire Bee-keepers' Association Annual Show (in connection with the Newport Allotment Holders' Association). Members and Open Classes.—Schedules (post free 3d.) from Hon. Sec., "Underwood," Portskewett, near Chepstow, Monmouthshire. Entries closed.

**August 3, 4 and 5, at Abington Park, Northampton.**—Northants Bee-keepers' Association Show, in connection with the Municipal Horticultural Society's Show. Open Classes for single 1-lb. jar and section.—Schedules from Mr. H. F. Swann, 41, St. Michael's Mount, Northampton. Entries close July 30.

**August 4, at Shedfield, Hants,** in conjunction with the Shedfield Horticultural Society's Show, Hants and Isle of Wight Bee-keepers' Associations, Swanmore and Bitterne Branches. Classes for Comb and Extracted Honey.—Schedules

from the Hon. Sec., A. F. Hardy, Esq., The Palace House, Bishop's Waltham, Hants.

**August 7, at Barnstaple.**—Barnstaple and District Horticultural Exhibition, to be held in the Market Hall. Five Open Classes for Honey.—Schedules from Hon. Secretary, 19, Grosvenor Street, Barnstaple.

**August 10, at The Park, Cartmel.**—Cartmel Agricultural Society's 43rd Annual Show. Open Classes for Comb and Extracted Honey.—Schedules, etc., from W. Dickinson, Secretary, Cartmel-Cartmel. Entries closed.

**August 11, at Wye.**—Kent Honey Show. Thirty classes, half of which are open to U.K. Four Silver Cups and 75 other prizes. Schedules, Mr. A. Lepper, Wye. Entries close August 1.

**August 14 and 16, at Cannock, Staffs.**—Eight open classes for honey, etc. Prizes value £12. Schedules from J. Bird, Secretary, "Glenmay," Allport Road, Cannock.

**August 12, at Taunton.**—Somerset Bee-keepers' Association Show of Honey, Wax, and Appliances. Seven Open Classes. Liberal prizes.—Schedules from Mr. F. J. J. Stacey, 3, Hammet Street, Taunton. Entries close August 6.

**August 14, at Llanely.**—Carmarthenshire B.K.A. Show, in connection with the Llanely and District Horticultural Society's Show. Liberal prizes (nearly £15) offered for Honey, Wax, and Appliances. 15 Classes (7 Open).—Schedules from R. Lloyd Roberts, London Joint, City and Midland, Llanely. Entries close August 6.

**August 18 and 19, at Coventry.**—Warwickshire Bee-keepers' Association, in connection with the County Agricultural Show. Lectures on both days.—Schedules from Mr. J. R. Ingerthorpe, Knowle, Warwick.

**August 18 and 19, at Derby.**—Derbyshire B.K.A. Honey Show to be held on the grounds of the Derbyshire Agricultural Society. Two Open Classes. Three Cups in Members' Classes.—Secretary, F. Meakin, 37, Pybus Street, Derby. Entries close August 4.

**August 25, at Chester.**—Cheshire Bee-keepers' Association, in connection with Cheshire Agricultural Society. Several Open Classes. Good prizes.—Schedules from Thos. A. Beckett, St. Werburgh Chambers, Chester.

**August 25, at Prestbury, Cheltenham.**—Flower, Fruit and Honey Show. Open Class for single 1-lb. jar of honey. Several classes open to bee-keepers living within a radius of 12 miles.—Schedules from A. H. Bowen, Coronation Road, Cheltenham. Entries close August 13.

**August 28, at Hounslow.**—Hounslow and District Allotment Holders' Association Second Annual Exhibition of Vegetables and Fruit. Honey exhibits under the control of the Twickenham and Thames Valley B.K.A. Open Classes for single bottle and section.—Schedules from Miss M. Byatt, "Hawthorn," Hanworth, Middlesex.

**Saturday, August 28, at Hinckley.**—Leicestershire and Rutland Bee-keepers' Association, in connection with Hinckley Flower Show.—Open Classes for Honey, Sections and Jars. Prizes, 12s. 6d., 7s. 6d., and 4s. 6d. in each class. Judge, J. Herrod-Hempsall, F.E.S.—Schedules from A. Kimbrell, Esq., Clarendon Road, Hinckley. Entries close August 23.

**September 8, 9 and 10.**—Portsmouth B.K.A. Honey Show, in conjunction with the Portsmouth Allotment Holders' Show, at Connaught Drill Hall, Portsmouth. Six Open Classes. Judge, W. Herrod-Hempsall, F.E.S.—Schedules from Show Secretary, Mr. J. Smett, 154, Essex Road, Southsea.

**Saturday, September 11.**—Forest-Fach Horticultural Society, Swansea. Three Open Classes for Honey, extracted and sections. Help to foster bee cult this end. 1st prizes, 10s.; 2nd and 3rd in proportion.—Schedules ready from G. L. Williams, Forest-Fach, Swansea.

**September 22.**—Altrincham Show. Several Open Classes for Honey and Appliances.—Schedules from H. Turner, 1, Market Street, Altrincham.

**November 18.**—Annual Show of the Worcester City and County Chrysanthemum, Fruit, Root and Honey Society. Thirteen open classes in Honey Section. Schedules from Geo. Richings, 42, Barbourne Road, Worcester. Entries close November 6.



## Special Prepaid Advertisements. One Penny per Word.

### PRIVATE ADVERTISEMENTS.

**EXTRACTOR**, two Standard Frames, not geared, good condition; offers.—218, Brownhill Road, Catford, S.E.6. g.174

**STRONG STOCK** healthy Bees, 8 frames, £3 10s., with Clausral Hive £4 15s.; several Swarms, 4 to 8 frames, 7s. 6d. per frame; two Cottage Hives, 25s. each.—MRS. BRUCE CULVER, Broomfield Hall, Swanley, Kent. g.173

**FOR SALE**, a few strong, healthy Stocks on 10 bars, guaranteed healthy, £4 10s.—FRANK SEAMAN, Sibsey, Boston. g.175

**FOR SALE**, one 18-in. bevel-geared Extractor, 13-in. Ripener, one Uncapping Table with trays, knives, etc., 12 crates of drawn-out Comb Supers. Offers.—14, Mill Road, Salisbury. r.g.176

**SPARE NUCLEUS**, on 4 frames, 1920 Queen, *Simmins'* strain, 45s.; also strong Stock Hybrids, on 8 combs, 65s.—JEFFERY, Pump House Road, Barnet Green, Birmingham. g.177

**WANTED**, an Italian Stock of Bees in good straw skep. Give price.—C. GIBSON, Aspen Ing, Wortley, Leeds. g.178

**FOR SALE**, two 4-lb. July Swarms on 6 frames, 37s. 6d. each; two smaller ones on 4 frames, 27s. 6d. each, carriage paid; boxes 7s. 6d. each, returnable.—KNIGHT, Kenwyn, Truro. g.179

**W.B.C. PATTERN HIVES**, never used, painted white, 10s. and 15s. each. Honey Press, Foundation, Swarm Catchers, Sections, etc., at half cost.—THOS. THIRKILL, Kirky Malzeard, Ripon. r.g.181

**TWO STOCKS OF BEES**, 10 frames, very strong, for sale, £4 each; one Stock of 8 frames, £3; guaranteed healthy; carriage paid; boxes, returnable, 10s.—BISSET, Broadwater, Worthing. g.182

**STRONG**, healthy Stocks of Italian Hybrids and pure Dutch; overstocked.—REV. COOPER, 102, Elers Road, Ealing. g.183

**SECOND-HAND** Bee Hives and Appliances, all in excellent condition, cheap to clear; no disease; list.—J. MILLARD, Old Churchstoke, Churchstoke, Mont. g.184

**SURPLUS STOCKS**, Italian, vigorous, £4 10s., carriage extra; box returnable.—DR. JONES, Peatling Magna, Leicester. g.185

**WILL EXCHANGE** for this season's Honey two Hives in first-class condition, with anti-swarmer chambers and supers to take 20 standard and 20 shallow frames, painted, and guaranteed free from disease.—D. M. CUTHBERTSON, Finmere, Buckingham. g.186

**W. A. WOODS**, Normandy, near Guildford, has for Sale, owner leaving, ten strong Stocks in good hives on standard frames, 10 and 12 in each, four with two racks of shallow frames, others with one and two section racks, and excluders to all; three July Swarms in large new Skeps; two Smokers, Vells, Gloves, etc. Can remain till end of heather if required. Price £47 10s. g.187

**STRONG** 10-frame Stocks Hybrid Bees, supers just removed, with this year's Queens, 55s., carriage paid; boxes to be returned.—VINCENT, 132, Croydon Road, Anerley, S.E. g.188

**SIX STOCKS OF BEES** on 10 frames, 60s. each, —OXBORROW, Kirby, Essex. g.189

**FOR SALE**, Light Cambridgeshire Honey, £9 10s. per cwt.; sample 6d.—WELLS & CO., Bowers Lane, Isleham, Cambs. g.193

**SEVERAL** Stocks of Hybrid Italians, Penna strain, 1920 Queens, 10 frames, healthy, £4 10s., carriage paid; 10s. refunded on box.—HUNT, 14, King's Road, Cardiff. g.190

**PROPERTY SOLD**, must sell, small Apiary, six strong, healthy Stocks, supered in new hives, two 4-frame Nuclei; Extractor, cog geared, only used one season. Seen by appointment.—Particulars, W. BARNES, Exning, Newmarket. g.194

**STRONG STOCK**, 10 frames, packed bees, brood stores, £4 4s.; box, returnable, 10s.—MISS GRAHAM, Womersley, near Guildford. g.195

**FOR SALE**, new Light Lincolnshire Honey, finest quality, £3 8s. cwt.—WILLIS, New Leake, Boston. g.197

**USEFUL SUNDRIES TO CLEAR**.—Cottage Extractor, 30s. (cost 47s.); Queen Excluders, three 4s. 6d.; three empty Cottage Hives (healthy), 15s. each; Wide Ends, 4d. dozen; empty Shallow Crates, 2s.; Section Racks, 2s. 6d. Particulars, stamp.—H. BOWEN, Pittville Street, Cheltenham. g.198

**FEW** surplus Virgins, good hybrid strain, price 3s. 6d.—EVANS, Lattiford, Wincanton, Somerset. g.199

**SPLENDID** White Clover Honey, £2 cwt.; sample 6d.—ALBERT COE, Apiarist, Ridgewell, Halstead, Essex. g.200

**DUTCH CROSS**, wonderful workers, two 4-frame Nuclei, £2 10s. each; two 8-frame Stocks, £3 15s. each.—ALBERT COE, Apiarist, Ridgewell, Halstead, Essex. g.201

**SALE**, Observatory Hive, standard, shallow and sections. Few 1920 fertile Italian Queens, 9s. 6d., by return.—FROST, Sandyford, Stone, Staffs. g.202

**A FEW** surplus Stocks Bees for Sale on 8 combs, price 70s.—HEATHERLANDS BEE FARM, Thursley, Godalming. g.203

**FOR SALE**, eight frames of Bees and Queen, Italians, carriage paid, box to be returned, 3 gs.—HAGUD, Ribby Road, Kirkham, Lancs. g.204

**SURPLUS HIVES** and Appliances for Sale, good condition, cheap.—PEARSON & GALE, Marlborough. g.205

**FOR SALE**, cheap, strong, healthy Stocks, new 4-frame reversible Cowan, Ripeners, Foundation, Wire, Frames, Hives, Electric Embedder, etc. Particulars, stamp.—GEORGE, Oak Drive, Oswestry. g.206

**EIGHT STOCKS HYBRIDS**, 1920 Queens, 10 frames, guaranteed healthy, £2 17s. 6d. each, £22 the lot; 50 drawn-out Shallow Frames, 1s. 6d. each. Selling owing to removal.—F. HOOD, Horton, Slough. g.207

**STRONG STOCK** on 10 frames, with hive complete, 1920 Queen, £5; exchange Indian Runner Ducks.—WILLIAM JENNINGS, Flackwell Heath, near High Wycombe, Bucks. g.208

**OVERSTOCKED**.—For Sale, 12 strong Colonies, six pure Italians and six Hybrids, also two 3-frame Nuclei, 1920 Queens, from Penna's strain; I have never had disease, all are splendidly strong, and in fine condition for the heather; £61 the lot, or near offer, f.o.r.; boxes returnable. Can be viewed by appointment.—CURTIS HART, F.R.H.S., Newgate Street, Hertford. g.221

**FINEST** Golden Clover Honey; sample 6d.—NORTH, Cressing, Braintree, Essex. g.223

**EIGHT STOCKS** of Bees and Hives, 10 W.B.C. pattern Hives, 120 Shallow Bars and Boxes. What offers? Can be seen at any time.—S. WILLIAMS, Danygraig House, Ghysmaerdy Road, Briton Ferry. g.127

**B**EES, immune strain, six colonies each on eight well-filled W.B.C. frames, £3 per stock. Satisfaction guaranteed. Cash with order. Immediate delivery.—WARD, Stoughton, Emsworth. r.g.129

**S**URPLUS STOCKS healthy Bees, £4; June Swarms on frames, 50s.—JEWITT, "Hensall," Whitley Bridge, Yorks. r.g.131

**W**ANTED, ten lots Driven Bees, guaranteed healthy, 10 Nuclei, also 20 young fertile queens.—LOUDON, Strathaven. g.172

**C**AN SPARE a few 6-frame Stocks, headed by Italian Queens, very prolific, £3 10s., carriage paid. A customer says: "Bees are doing very well. Send three more stocks."—URIAH WOOD, Arnold, Notts. g.136

**S**EVERAL strong Stocks of Bees and a variety of Appliances for Sale. Stamp reply.—GEORGE, Oak Drive, Oswestry. g.139

**S**ALE, single-walled Hives, 5s. 6d. upwards; approval.—HUNT, Bank Street, Somercotes, Alfreton. r.f.67

**S**URPLUS.—Three Stocks of healthy Bees on 8 combs, £4 each, carriage extra.—L. DAVEY, Mawneys, Romford. g.153

**S**ACRIFICE—BEEES.—Twenty strong Stocks, 10 frames, £3 per stock; crate 10s., returnable. Room wanted.—GITTINGS, Bleak House, Bleak Hill, Plumstead Common. g.155

**T**HE CARMARTHENSHIRE BEE-KEEPERS' ASSOCIATION invite applications from bee-keepers in the county for Lectures and Demonstrations in Bee-keeping.—Apply to W. COMERY, Hon. Sec., 15, New Road, Ammanford. r.g.156

#### BUSINESS ADVERTISEMENTS. 1½d. per word.

**F**AMOUS HYBRID QUEENS, 10s. 6d.; extra selected, 12s.; August delivery. An excellent opportunity to obtain high-class breeding stock from Cotswold out apiaries.—LIEUT. BOWEN, Queen Breeder, Cheltenham. g.180

**I**TALIAN HYBRID QUEENS.—Fertiles, 10s.; virgins, 3s. 6d.—TICKELL, below. g.192

**4**-FRAME NUCLEI, some stores, plenty of brood, and packed with bees, 40s., carriage paid; box 10s., returnable.—TICKELL, below. g.192

**F**RAMES made up and wired, standard or 1½-in. shallows, 8s. 6d. dozen; complete with foundation, 16s.; drawn shallow combs, wired, drone, 18s. dozen; all carriage paid.—JACK TICKELL, Westbourne Apiary, Cheltenham. g.192

**P**URE ITALIANS, 1920 Penna imported Queens, 6 frames, 60s., 8, 70s., 10, 80s., carriage paid; boxes returnable; Hybrids 10s. less; 1920 Hybrid Queens, 7s.—WADHAM, Gold Street, Cardiff. r.g.210

**H**AVE only a few 6-, 8-, or 10-frame Stocks left; four very fine 1920 Italian Queens to spare; guaranteed healthy. Stamp reply.—CROWE, Merriott, Crewkerne. g.191

**A** FEW 1920 fertile Queens, dark hybrid, 5s. each.—ASHWORTH, Weymouth Street, Warminster. g.196

**F**OR SALE, 6-, 8-, or 10-frame Stocks Italian Bees, 1920 Queen, 10s. per frame; had no disease.—Box 97, B.B.J. Office, 23, Bedford Street, Strand, London, W.C.2. g.209

**N**EW STRONG NUCLEI for immediate delivery (weather permitting), crowded with bees, brood and stores, 1920 Queens, hybrids; exceptionally good strain; perfectly healthy; inspection invited; 3 combs, 40s.; 4 combs, 50s.; 6 combs, 60s.; box 10s. extra, returnable.—STEVENSON, Thames View Apiary, Flackwell Heath, Bucks. r.g.222

**H**EALTHY DRIVEN BEEES, with Queen, 10s. per lot, carriage paid; boxes returnable. Cash with order. Orders in rotation.—PULLEN, Ramsbury, Hungerford. r.g.211

**V**IGOROUS ITALIAN HYBRID, Stocks and Nuclei, with 1920 Queens, 10s. 6d. frame, carriage paid; box 10s., returnable.—ALFD. RYALL, Elcombe, Stroud. g.212

**H**YBRID ITALIAN 4-frame Nuclei, 45s., carriage paid; fine disease-resisting strain.—HOWLETT, 138, Seaforth Avenue, New Malden. g.213

**E**XCEPTIONALLY FAVOURABLE VACANCY occurs under influential management for thoroughly experienced practical Bee-keeper, preferably with some business experience; must understand all branches of work and have initiative; good salary and very attractive prospects. State full personal qualifications, age, and bee-keeping experience. Travelling expenses of interview, London, paid to suitable applicants.—Box 98, B.B.J. Office, 23, Bedford Street, Strand, London, W.C.2. g.214

**I**TALIAN QUEENS from Penna's queen, virgins 4s., fertile 9s. 6d.; Hybrid Italians, virgins 3s. 6d., fertile 8s. 6d.; Hybrid Stocks on 4 frames, 50s.; box, returnable, 10s.—WARD, Deeside Nursery, West Kirby. r.g.215

**W**ANTED, Stevenson Skyscraper Hives; must be good condition and free from disease; good price given.—Box 99, B.B.J. Office, 23, Bedford Street, Strand, London, W.C.2. r.g.216

**1920 FERTILE** (Italian Hybrids) Queens; wonderful strain; a limited number now ready; prices, 10s. 6d., selected, others 8s. 6d.—HOSEGOOD, 26, Purley Park Road, Purley, Surrey. g.217

**Q**UEENS.—1920 home-bred Italians, delivery by return, 10s. 6d. each.—GOATH COTTAGE APIARY, Endlebury Road, Chingford. g.218

**Q**UEENS, English or Italian, 1920, fertile 10s., virgin 5s., sent by post. Neither strain had disease.—JACKSON (Certificated Expert), Post Office, Bleasby, Notts. g.219

**S**TOCKS OF ITALIANS on 10 frames, ready for supering, £4; boxes 12s., returnable. Money returned if not satisfied.—HENSLEY, Luton Apiary, Queen's Road, Chatham. g.220

**S**URPLUS.—Nuclei, Hybrids, crowded, 1920 Queens, very prolific strain, 30s.; box 10s., returnable; immediate.—F. BIGGE, Tyburn, Birmingham. r.g.145

**D**UTCH NUCLEI, 3-, 4-, 5-frames, 1920 Queens, 9s. frame; well stocked; box 10s., returnable.—ANDREWS, 78a, Westgate, Peterborough. g.164

**F**OR SALE, immediate delivery, 10-frame Stock, £4 7s. 6d.; 8-frame, £3 15s.; 4-frame, £2 5s., with Penna 1920 Queens. Others cheaper. Discount for number of Stocks.—ASHWORTH, Weymouth Street, Warminster. g.166

**Q**UEENS, Italian and English, 1920, 10s.; Nuclei, strong, 4 frames 50s., 3 frames 40s., carriage paid. Stamp reply.—HOLLINGSWORTH (First Class Expert), Heanor. g.169

**N**UCLEI, 1920 fertile Italian Queens, 6 frames brood, 65s.; boxes 7s. 6d., returnable. Satisfaction guaranteed. Over 36 years' experience.—J. CLARKE, Mill Road, Marlpool, Derbyshire. g.171

**4**-FRAME NUCLEI, headed by 1920 Italian Queen, 50s.; box charged 10s., returnable; 6-frame Stocks, 70s.; 8-frame Stocks, 90s. Immediate delivery (weather permitting). Italian fertile Queens, 10s. 6d. English Run Honey and Sections wanted.—LEE, "Little Bowden Apiary," Burgess Hill, Sussex. r.g.114

**VERY strong Nuclei, Italian Hybrids** (Simmins'), 4 frames packed bees, brood, stores, with tested 1920 Queens, guaranteed healthy, 45s., carriage paid; box 10s., returnable.—**HOWLETT**, "Sylvabelle," Tring. g.116

**BEEs.—BROOKS**, Carnation Specialist, 9, Dudley Road, Finchley. r.g.98

**IMPORTED ITALIAN QUEENS**, 11s. 6d. each; selected Hybrids, 9s.; English, 7s. Safe delivery guaranteed. Catalogue free.—**C. T. OVERTON & SONS**, Crawley. r.g.79

**CHOICE home-reared Italian Queens**, 10s.; Virgins, 4s. 6d.; July-September.—**MISSES PALING & PILLANS**, Golden Square, Henfield, Sussex. r.g.82

**STRONG 3-FRAME NUCLEI**, 1920 fertile Queens, 30s.; box 5s., returnable; Stocks on 8 frames, 60s; boxes 10s., returnable.—**W. WOODS**, Normandy, near Guildford. g.53

**VIRGIN QUEENS—THE WELSH APIARY STRAIN**—Hybrid Italian, guaranteed bred from highly prolific stock, never had "I.W." D. in apiary, the Queens to revitalise your stock, hardy and virile, 5s. each.—**LT.-COLONEL WEAVER PRICE**, Welsh Apiary, Ashgrove, Brecon, S. Wales. r.g.85

**PURE ITALIAN QUEENS**, prompt delivery; select Italian, extra golden, rare honey-producing stock, August-September.—**ATKINSON**, Fakenham. r.g.24

**"WIGHT" DISEASE**, prevention and removal; advice 6s.—**ALFD. RYALL**, Kenwood Apiary, Elcombe, Stroud. r.f.161

**1920 FERTILE Golden Italian Queens**, guaranteed imported direct from Italy, regular supplies every few days, 10s. each; specially selected, 14s.—**GOODARE**, New Cross, Wednesfield. f.59

**"ISLE OF WIGHT" DISEASE**.—Don't worry; use the solution that cures; 2s. per bottle.—**B. PRESSEY**, St. Eimo, Coulsdon. r.d.149

**DUTCH BEES**, Skeps (as imported from Hans Matthes), Nuclei, Queens. Illustrated Catalogue on request, containing points on management.—Buy direct from Sole Agent, **WHYTE**, Bee Farmer, Cumbernauld, Dumbartonshire. b.61

## ITALIAN QUEENS Direct from Italy. E. PENNA, BOLOGNA, ITALY.

I assume again the direct sale of my queens. Special offers from July 10 till countermanded. For queens in lots of 4 at a time £1 8s. Cash with orders. Payment by cheques or **British Postal Orders**. International Money Orders are **not** accepted. I do not hold myself responsible for the queens that are not sent by me direct to customers. All orders should be sent direct to me. In May the queens dead in the journey have been **less** than 1%  
ORDERS BOOKED IN ROTATION.

**HAVE YOU READ "THE BEE WORLD"?** If not, why not? Every number in itself is a useful literary work for practice and reference. Specimen copy free.—**Office: THE APIS CLUB**, Port Hill House, Benson, Oxon.

## ITALIAN QUEENS

Direct from Italy.

Address:  
**Signor Gaetano Piana**,  
Castel San Pietro,  
near Bologna, Italy.



All Queens are reared by the most up-to-date and scientific methods. Mr. W. Herrod-Hempsall has personally inspected the apiary and methods employed, with which he is perfectly satisfied.

PRICES FOR 1920.

**For 1 Fertile Queen: August and September,**  
9/- each queen.

Can take no more orders for June & July. Booked up.

Carriage paid in Great Britain. Cash must accompany all orders, which will be executed in rotation. Guaranteed safe arrival of all Queens, but not the introduction, Bees dead upon arrival must be sent at once to "B.B.J." Office.

For the mutual convenience of all parties, if Signor Piana has made arrangements that all communications, orders and remittances of the readers of "B.B.J." and "B.K.R." can be addressed to him, c/o British Bee Journal, 23, Bedford Street, Strand, London, W.C.2.

Cheques payable to 'British Bee Journal.'

## THE British Bee-Keepers' Association.

Insure **now** against loss by damage done through bee stings. All particulars from

**W. HERROD-HEMPSALL**, 23, Bedford Street, Strand, London, W.C.2.

The products of the Apiary, of Poultry and Farm Stock, of the Fruit and Vegetable Garden can be Advertised and Sold through

## THE BAZAAR, EXCHANGE & MART Newspaper.

Get a Copy—Thursday and Saturday 3d. The "Bazaar" publishes also practical handbooks by experts. Send for full catalogue, post free from—**WINDSOR HOUSE**, Brems Buildings, LONDON, E.C.2.

## POSITIVE FACTS.

June 13th, 1920.

I am very pleased with the foundation. The bees undoubtedly prefer it to any other make I have, and have even gone the length of missing two sheets of other new foundation, and working out a sheet of yours placed behind them at the back of the hive. Full sheets have not sagged in the least in 16 X 10 frames.

Yours faithfully, R. B. MANLEY.

Illustrated Lists free by post.

**S. J. BALDWIN**, The Apiary, **BROMLEY**, Kent.



# DADANT'S WEED FOUNDATION.

**T**HIS Foundation is made from pure Beeswax and guaranteed free from all disease germs.

Give your bees the BEST, and the best is DADANT'S.

No acids or other chemicals are used in the manufacture, and the makers guarantee that "EVERY INCH, EVERY POUND, EVERY TON, is equal to any sample ever sent out."

We have just received a fresh consignment, and are in a position to give immediate despatch.

Rear healthy bees on clean, natural combs.

None genuine without the watermark "DADANT" on every sheet.

*Our Catalogue, entitled "Everything for an Apiary,"  
is sent post free on Application.*

---

## R. STEELE & BRODIE,

Bee Appliance Makers,

### WORMIT, FIFE.



## Lee's Bee Supplies.

¶ In design, material and workmanship, Lee's Bee Supplies still retain the reputation of being your best and safest investment.

¶ Our 1920 ILLUSTRATED CATALOGUE is yours for the asking. It contains detailed information on the most up-to-date hives and appliances for which the House of Lee is famous.

¶ We regret the necessity of having to advise our Customers that owing to the increased cost of production, all prices in 1920 price list are subject to 10% increase. The increase will not apply to orders received before May 10.

\*\*\* Five per cent discount to Members of THE APIS CLUB.

**JAMES LEE & SON,**  
LTD.,  
Uxbridge, Middlesex.

(Telegrams : Graphicly, Uxbridge.)

Telephone : Uxbridge 181.)



## "BACTEROL" FOR BEES

2/9 per Bottle.

Post Free.

The cure for, and preventive of, "Isle of Wight" Disease. Non-poisonous—free from stain or unpleasant odour.

MENLEY & JAMES, LTD.,  
Menley House, Hatton Garden, E.C.1.

**BRADBURY, TAUNTON,**  
FOR QUALITY BEE GOODS.

*Illustrated Bee Guide free.*

Telephone : TAUNTON 176.

## 20-Page 1920 "WHITE STAR" List,

3½d. POST FREE.

S. SIMMINS, QUEENLAND, HEATHFIELD, SUSSEX

**Bees and Beekeeping Appliances. Catalogue free.**  
**EDWARD J. BURTT. MANUFACTURER. GLOUCESTER.**

*I very much regret that there has been a large increase in the cost of the manufacture of bee-appliances, and therefore my prices will be advanced 10% from May 10th. Books excepted.*

PRINTED BY THE AVENUE PRESS (L. UPCOTT GILL & SON, LTD.), 55-57, DRURY LANE, LONDON, W.C., AND PUBLISHED FOR THE PROPRIETOR (W. HERROD-HEMPBALL), BY SIMPKIN, MARSHALL, HAMILTON, KENT & CO., LTD., 31 & 32, PATERNOSTER ROW, E.C.

LIBRARY

P 17 1920  
 Agricultural College



No. 1989. Vol. XLVIII

AUGUST 5, 1920.

[Published every Thursday, Price 2d.]

**CONTENTS.**

	PAGE		PAGE
EARLY BEE-KEEPING IN HEREFORDSHIRE .....	373	Remedies for Ants .....	379
A DORSET YARN .....	374	Present Day Foundation .....	379
NOTES ON BEE-KEEPING .....	374	A Beginner's Experience .....	380
HEALTHY BEE-KEEPING .....	375	A Note from Surrey .....	380
SWARM PREVENTER AND DRONE TRAP .....	376	Is This a Record? .....	380
WILD BEE HUNTING IN AUSTRALIA .....	377	Prolific Swarming .....	380
ROYAL SHOW FUND .....	377	A New Disease .....	381
CORRESPONDENCE—		Superstition Regarding Bees .....	381
Fraternity Among Bee-keepers .....	378	Introducing Italian Queens to Dutch Bees .....	381
Larger Frames .....	378	Bees in "Big Bertha" .....	381
Increasing Stocks in Autumn .....	379	NOTICES TO CORRESPONDENTS .....	381
Bee-keepers' Conference at "The Royal" ..	379	BEE SHOWS TO COME .....	381

We have just received a consignment of  
**Lewis Superb Snow White Basswood**  
**SECTIONS**

Which we are offering at the moderate figure of catalogue price, plus 15%.

As this essential branch of Beeware is likely to increase in price next season we strongly advise our customers to purchase with a view to the future.

**HONEY BOTTLES**

1lb. actual size.

We are in a position to give prompt delivery of honey bottles. These are of the finest quality.

Price - 1-lb. 55/- per gross.  
 „ ½-lb. 47/- „ „

Reductions for LARGE quantities.

**E. H. TAYLOR, WELWYN, HERTS.**

THE  
**British Bee Journal**

Office: 25, Bedford Street, Strand, London, W.C.2.  
ESTABLISHED 1873.

A Weekly Journal Devoted to the  
Interests of Bee-keepers.

Edited by T. W. COWAN, F.L.S., &c.,  
and J. HERROD-HEMPSELL, F.E.S.

**Correspondence: Whom to Address.**—All matters relating to the Literary Department, Associations, Shows, etc., should be addressed, "Editors, *British Bee Journal*," and all business communications and matters relating to subscriptions and advertisements to be addressed to the "Manager," *B.B.J.* Office.

**Subscriptions.**—Annual Subscription, 10s. 10d. post free in advance; single copies 2d., or 2½d. post free. If a receipt is required by post, a stamped and addressed envelope must be sent, otherwise a printed receipt will be enclosed along with the paper.

*Note.*—Cheques and Postal Orders should always be crossed, otherwise it is very difficult to trace them if they go astray.

**How to send Money.**—Remittances can be made payable to W. Herrod-Hempshall by crossed Cheques and Postal Orders. Stamps may be sent for small amounts up to 2s.

*Halfpenny stamps are preferred.*

Scottish or Irish cheques can only be taken in payment if 6d. is added for commission charged by banks for cashing them.

The Editors are not directly or indirectly interested in the manufacture or sale of beehives or appliances of any kind, and must refer correspondents wishing for prices or catalogues to advertisers in the paper.

**OUR DEPOSIT SYSTEM.**

You are advised to insist on this being used when dealing with strangers.

**Rules and Conditions for Depositing**

*In order to save trouble, it is requested that the Rules be carefully read over by persons using the Deposit System of trading.*

Goods should not be despatched until notice that the money has been deposited is received from this office.

**1. Method.**—When strangers are dealing together, the purchase-money of the articles is deposited at our office. We acknowledge receipt of the deposit to both parties, and hold the money until we are satisfied that the purchase is concluded. If a sale be effected, we remit to the seller the amount deposited, less a charge of 2½ per cent. in the £, with a minimum of 6d., and the expenses of Post Office Orders and postage, &c. Cash will be forwarded by Cheque, Post Office Order, or by Postal Order as preferred. If a sale or exchange be not completed, we return the amount deposited, after making the same deduction. By this means buyers and sellers are secured against fraud.

**2. Deposits.**—Postal Orders (drawn on General Post Office) and Cheques must be made payable to W. Herrod-Hempshall, and crossed "London County and Westminster Bank." The numbers of the Postal Orders should be kept by the sender. We cannot be responsible for any loss that may occur in transit.

**3. Honey on Approval.**—All honey will be sold by sample, which must be sent direct to buyer.

**4. Bee Appliances.**—In ordering, the time allowed for completing the order to be stated to us when sending cash. If maker accepts, we hold cash until transaction is satisfactorily completed, when the amount will be remitted, subject to conditions as in Clause 1.

**5. Bees and Queens.**—These will be dealt with entirely by the parties concerned, so far as price, &c., go, and when the purchase is satisfactorily completed cash will be remitted as per Clause 1.

**6. Goods in Transit.**—These are at the seller's risk, i.e., any damage to or loss of an article on its journey is borne by the vendor; but a rejected article must be properly packed and returned by the same means as was used in sending it.

**7. Carriage.**—The carriage of all goods, except such as are sent by post, is payable by the buyer, unless otherwise agreed. If any article sent on approval be returned, each party to the transaction must pay carriage one way.

**Books for Bee-keepers  
NOW IN STOCK.**

Cash in full must be sent with order.

A Modern Bee Farm ... ..	7/6	... 8½d.
Advanced Bee Culture (HUTCHINSON) ... ..	6/-	... 6½d.
Beginner's Bee Book (PELLETT) ... ..	5/-	... 4d.
BEE-KEEPING SIMPLIFIED FOR THE COTTAGER AND SMALLHOLDER (W. HERROD-HEMPSELL, F.E.S.) ... ..	1/-	... 2d.
BRITISH BEE-KEEPERS' GUIDE BOOK (T. W. COWAN) ... ..		
Paper covers ... ..	2/6	... 3d.
Cloth covers ... ..	3/6	... 4d.
Dissectible Model of Queen Bee ... ..	4/6	... 3d.
FERTILISATION OF FRUIT BLOSSOMS BY BEES (T. W. COWAN) ... ..	-/3	... 1d.
Honey and Health (A. HOPE) ... ..	-/6	... 1d.
Honey Vinegar (REV. G. BANCKS) ... ..	-/2	... 1d.
How to Keep Bees (ANNA B. COMSTOCK) ... ..	5/-	... 4½d.
Management of Out Apiaries ... ..	3/-	... 2d.
Pollination of Fruit in relation to Commercial Fruit Growing (C. H. HOOPER, F.R.H.S.) ... ..	-/6	... 1d.
PRODUCING, PREPARING, EXHIBITING AND JUDGING BEE PRODUCE (W. HERROD-HEMPSELL, F.E.S.) ... ..	2/-	... 3d.
Productive Bee-keeping (PELLETT) ... ..	10/6	... 8½d.
Queen Rearing in England (F. W. L. SLADEN) ... ..	1/6	... 2d.
Scientific Queen Rearing (DOOLITTLE) ... ..	4/-	... 3½d.
The Bee-keepers' Vade Mecum (GEARY) ... ..	2/6	... 2d.
Snelgrove's Method of Re-queening ... ..	-/6	... 1d.
The "Townsend" Bee Book ... ..	2/6	... 2d.
WAX CRAFT (T. W. COWAN) ... ..	2/-	... 2½d.

**MISCELLANEOUS.**

Maeterlinck's Life of the Bee The Lore of the Honey Bee (TICKNER EDWARDES) ... ..	5/-	... 3d.
THE BEE WORLD (supplied only to members of Associations interested in the control and development of the APIS CLUB, apart from ordinary members of the latter), per copy ... ..	-/8	... 1½d.
The Bee Master of Warrirow (TICKNER EDWARDES) ... ..	7/6	... 4½d.

**British Bee Journal & Record Office,**

25, BEDFORD STREET, STRAND, LONDON, W.C.1.





## Early Bee-Keeping in Herefordshire.

One of the most interesting subjects for the study of modern bee-keepers is that of early bee-keeping, not only in a general, but in a local sense. Many counties can lay claim to either some ancient bee-keeper or writing or custom worthy of note, if some historian could be found to undertake the necessary research work. This has been done for Herefordshire by Mr. A. Watkins, J.P., F.R.P.S., and the result of his labours was given in a paper read for his retiring address as President of the well-known Woolhope Naturalists' Field Club, which has its headquarters at Hereford. Mr. Watkins very kindly sent the paper on to us for publication, and it was printed in full in the RECORD for July.

Space—or the want of it—prohibits printing the full text, but we give the following extracts:—

That variety of bee known as the hive-bee is probably indigenous to Great Britain. I can find no information to the contrary, and no suggestion that the Romans introduced it, as they did pheasants and other fowls. Our local bee is not quite the same as the varieties in and about Italy, but identical with the bee of Northern and Middle Europe.

Records of bees, hives, and honey come early in the Anglo-Saxon period, and the Normans did not supply the words bee, hive, honey, wax, which all come from roots common to original Teutonic and Northern European languages. Although in modern Welsh, the words bee and beehive are Celtic (*gwenyn* and *cwch-gwenyn*), the words for honey and wax (*mel* and *cwyr*) are of Latin origin. This suggests that in Romano-British days, Britain produced and traded in both products long before Hengest and Horsa landed the first of the Engleland and Saxon invaders in 449 A.D.

It is certainly a fact that in the time of Domesday, it is the Welsh tenants—as in Archenfield—who chiefly pay their customary rents in honey, and they descend from the Celts whom the Romans found in Britain.

### RETAINING SWARMS.

In Cockayne's *Laecedom*, a book of charms in Anglo-Saxon, there is a charm for preventing a swarm (*yambe*) of bees going off to the woods—obviously from a hive at the homestead. It gives instruc-

tions: "Take earth, throw it up with thy right hand from under thy right foot," and a long formula to be recited, of which part of the end reads: "Sit down, victory women, sink to the earth, never to fly wild to the woods."

### BEE LAW.

Let me here touch upon a fascinating aspect of bee law which goes back even earlier than Anglo-Saxon times. There is from the first a fundamental difference in English law between wild and domesticated animals. In wild animals their property does not lie in man but in the animal itself, and man cannot acquire a property in such animal except by reducing it into his possession. As Blackstone puts it, "in animals *feræ naturæ* a man can have no absolute property, but in such as are of a tame nature and domestic, a man may have an absolute property."

The curious thing about bees is that those in hives partake both of the domestic and wild nature, while those established in woods are wholly wild. When bees swarm, therefore, it is a toss up whether they settle within their owner's reach and remain his property, or make a bolt for it and become either free, or the property of whoever may hive them.

Until after the Conquest, honey, being the only sweet available, was of first importance, wax was considered indispensable for the candles of church services, and mead or *metheglen* (made from honey) was largely drunk. Sugar was unknown until the first crusaders tasted the product from sugar canes growing on the plains of Tripoli. The use of sugar then increased until, in 1289, the Household Roll of Swinfield, Bishop of Hereford, makes it clear that it had taken the place of honey in upper-class households, for (classified with spices) it was purchased in quantities from dealers in Hereford and Ross, and honey is never mentioned.

As surnames in Herefordshire I find Henry le Meleward, temp. Ed. 1st; John Honywode, temp. Ed. IV., and Bee, Honey and Honeyfield in recent days. As place names, Bannister records *Honeymoor Common* (Madley) and *Huniesmedewe* in the county.

### EARLY HIVES.

The earliest bee-hives (*rusca*) were evidently sections of hollow tree or made from bark cylinders. But it is clear that "skeps" of straw or basket work of twigs (plastered with mud) soon took their place, and one or other of these were general until the 18th century. Southerne's book on bees, 1593 (printed partly in black letter and the second English book on bees, that of Thomas Hyll, 1568, being the first) assumes the hives

to be of straw, but mentions that in some places they are "made of twigges" plastered over. This last type was not extinct until my time, and I was fortunate in taking a photograph in the "eighties" of hives at the back of the water mill at Upton (on the Worcestershire border near Brimfield), woven of strands of woodbine and coated with cow-dung and mud. Storifying boxes were used by Sir Christopher Wren in 1654, and described by Gedde in 1675.

#### LOCAL BIBLIOGRAPHY.

- Evans, John, M.D. "The Bees," a poem in 4 books (3 only published), Shrewsbury, 1806, 1808, 1813.
- Bevan, Edward, M.D. "The Honey Bee," London, 1827, 1838.
- Jones, J. "The Eclectic Hive," directions for management of, Hereford, 1843. And the following pamphlets:
- Bevan, Edward, M.D. "History and Management of the Honey Bee," two lectures, Hereford, 1851.
- Glinn, Mrs. H. "Beeswing's Advice to Bee-keepers," Hereford, N.D. (about 1875); 3rd edition, 1877.
- Watkins, Alfred. "Lantern Reading" (for set of 30 original photographs) on Bees and Bee-keeping, London, 1st edition, N.D.; 2nd edition, N.D.

As regards two of the above authors, Dr. Evans's son became a Canon of Hereford Cathedral, and wrote the charming "Songs of the Birds."

Dr. Bevan was a famous bee-man, and his book is scholarly, sound, and the most reliable and best of its time. He lived at one time at the Old Friars, Hereford, and his bees were swept down the Wye in the great flood of 1852.

The paper closes with a brief historical sketch of the Herefordshire Bee-keepers' Association, of which Mr. Watkins was Secretary for many years.

Herrod-Hempsall was much appreciated by the bee-keepers of Dorset. In the meadow by the River Stour one could see the beautiful woods of Bryanstone Park. Some of the trees are of immense girth and height. Close to the river the soil has been washed from the roots when the river has been in flood. The wonderful way that these roots have crossed and re-crossed each other, and all grown together, making an uneven floor of growing bark—to the lover of nature it is most interesting. Many writers assert that there is as much below the soil as there is in the branches. To see the roots in these woods that are parallel with the river, one could not see but that the old writers knew of this very place. These woods have so many trees from which bees get surplus stores—huge chestnuts, cherries, limes, etc.—that it must be a fine place for them.

They tell me in these woods there are many colonies of wild bees; they have found the trees that are hollow, they have been cleaned out by the woodpeckers at nesting time. These strong-billed birds carry out large pieces that bees could not, so Nature wills it that the wild bees should have a home prepared for them. A few years ago I spent one whole day in these delightful woods, with its miles of drives, all beautifully kept and clean. One never saw a human being, so great a space do they cover, but all animated Nature is here in abundance. Truly this is sublime. Of course, I kept to the woods—did not go to the house, which is said to cover three acres, or the stables, which seem to cover the same area; but in the woods one is alone with Nature—so lofty the trees that the wind is only in the tops. All seem to accompany the music of thousands of birds and insects.—  
J. J. KETTLE.

## A Dorset Yarn.

In North Dorset, at Blandford, last week, in connection with horticulture, there was a fine exhibition of honey. The classes were very keenly competed for, sections were beautifully finished and clean, the extracted honey was very attractive and the colours were varied, some was a bit thin, but most of it was of great density. Some was exhibited by farmers' sons; one of them (Farmer Old) said it was taken off before the limes were in flow. It was, he assumed, from sainfoin, which in that district grows freely. It was the best show of honey I have seen for several years. So many say they have very little surplus; it was nice to meet so many bee-keepers. The lecture and demonstration with bees carried out by Mr.

## Notes on Bee Keeping.

The weather has been treacherous of late for our bees up here in the north. Bad weather means no surplus. Bee-keepers will find that some of their surplus honey already stored in the supers will be taken down by the bees into the brood chambers, to feed the fast maturing brood. In addition to this, bees kept active indoors, and unable to take a cleansing flight owing to climatic conditions, is a sure source of disease.

Should not be surprised to hear of another outbreak of disease similar to the one in 1915. I see that Flavine is mentioned as a cure for Isle of Wight Disease. In my case it has been successful during the active season, but the disease has always returned to the same

hives during the dead season, wiping out all stocks affected. I am rather inclined to accept Zander's view, that once a stock is affected with this malady it is doomed—that is my experience with it. We do not seem to hear of a good reliable remedy as yet, that will effect a cure. Are we sure that this so called new disease is not Isle of Wight Disease under a new guise? Does Isle of Wight Disease *always* show the germ matter of spores of *Nosema apis* in every case? Our experts do not seem to be agreed as to symptoms, there seem to be many conflicting views on the subject. Cooper, of the Isle of Wight, told us in 1906, when investigating the disease, that "the abdomen of the affected bees is not distended in every case, while the wings are often twisted back, with a look of being dislocated." Then he notices that since they became affected with "paralysis," dysentery has developed. "The most common symptom is the presence of large numbers of crawling bees with distended abdomens, in front of a hive that is affected, and in many cases the bees are affected long before this stage is reached." Another report states "The bees just hatched drag their legs like the older ones, and some quite young bees are found outside on the ground dead." The abdominal distension appears to result from inability to fly. The loaded state may be a normal result of long confinement during winter and wet weather, and of the preparation of brood food at other times; this latter necessitates a consumption of a large quantity of pollen. The bee always voids its excrement on the wing, even in violent dysentery the bees seem to make an attempt to save the comb from their excreta, as the front, inside of the brood chamber seems to be heavily soiled, more than the combs. Evidence was found of bees being affected with *Nosema* and yet able to fly as stated above, and to defecate. In some cases the affected bees seem to lose control over the sphincter muscles of the bowels, so that the combs and hives are heavily soiled with excrement. Others have noticed that minute quantities of excrement tipped the abdomen of both the worker and drone bees in affected stocks. Have noticed drones, especially this summer, in an affected stock crawl out from the hive and discharge a creamy substance on the flight board before dropping on the ground. Dysentery, for this reason, must always be regarded with suspicion, as it is caused by an organism which sets up fermentation in the contents of the bowel.

The fæces from bees, if suffering from dysentery, vary in shade from cream to dark brown. From accounts one can

glean that sometimes the loss of the power of flight has been gradual, in other instances it has developed suddenly. Some bees collapse on the wing, others make progress by short flights; again some try to fly from the alighting board, jump forward and fall to the ground. In some cases they seem aware of their inability to fly, so creep towards the top of the hive to get a better start, and fail as the others did. Many beekeepers attach great importance to the outstanding wing as a never failing sign of Isle of Wight Disease, but it can be found in stocks in a normal condition, so undue prominence ought not to be given to this symptom.—P. LYNBGE, Padgate, Warrington, Lancs.

### Healthy Bee Keeping.

Rat! Tat! at the door.  
"Queen bee, sir, by post."

"Bring her in. New blood for motherless stock," I said, "after two years." That evening she was placed over platform with trap shut, over feed hole of honey board with elastic rings over ends to keep firm. A porous quilt to allow air of hive to surround her and her small retinue. Here she remained until next evening, when, lifting quilt and pushing lever, I released her. A pleasant hum sounded from the depths, the cage being left till the morning, until bees finish candy, then replaced by a slow feeder of one's own honey. The hive was left alone for a week. Pollen carrying began; hive working well.

After a week, gently lifting board and quilts, one found eggs and brood. Some drone brood, owing to queen not being able to lay for some time, relieved herself in this way, which gave the important item of the drones she would throw in the following spring, ensuring the large drone and excellent queens. This important re-queening is the essence of good bee-keeping.

Keeping old blood means mongrels develop. I have not time for rearing queens at back of hives.

My advice.—Start with a good stock, get large swarms in the early spring. By so doing increase your stocks ready for sale. Keep one strong stock for queens, enabling you to send out stocks with young blood.

Use 12-frame hives, made by the best makers, wide and airy, using wire excluders, air vent in floor boards, honey boards and porous quilts. Spraying front of hives with Rosamond spray three times a day with diluted Bacterol defies all disease in hot weather. As little manipulation as possible. Hives well tiered up

with shallow frames and sections sometimes prevents swarming. Carbolie subduing cloth unrolled over brood just enough to make them turn keeps clean air, and dispel moth with balls of naphthaline. This is a huge help.

Queens allowed on double supers, standard size, is asking for trouble and dirty honey through too much walking over the combs. Remember the word "shallow." Go to the best breeder for new queens. You soon get known for your celebrated stocks. Reducing to three stocks in winter means clean hives for the spring, more care and less to worry about, with interesting winter months clearing up and getting ready for the next bout at the time of the song of the thrush, bloom, and sunshine, which denotes a prosperous year ahead, with bees and honey in large demand.—CYRIL TREDCROFT.

## Swarm Preventer and Drone Trap.

In the days of the English bee, one had only to give room a little in advance of the requirements of the stock, and swarming would rarely happen. Now, however, swarming is one of the worst troubles a bee-keeper has to contend against. All sorts of suggestions have been made, and hives with non-swarming chambers introduced (in these my bees swarmed before those in ordinary hives had thought of doing so), but, in spite of all precautions, they have swarmed out, leaving an empty super above the brood chamber, an empty compartment below it, and three sheets of foundation in the middle of the brood nest itself.

Swarm catchers are cumbersome and unsightly, and, besides, it is not the swarm, but the queen, one has to catch.

The device I use is simplicity itself, and is one any bee-keeper could contrive for himself.

A piece of wire queen-excluder is cut to fit the entrance of the hive; a brass cone clearer is soldered on to the excluder, and the wires passing beneath the clearer are cut away, leaving a way into the clearer as large as the clearer itself. A piece of perforated zinc is bent round to form a tube, and is soldered. The diameter of the tube is the same as the large end of the clearer. On one end of the tube a piece of excluder is soldered. The device is now fitted in front of the hive, leaving no way for any bee to pass out except through the excluder. The tube is quite separate from the rest of the appliance, and is now placed with its open end over the brass clearer, and is held in position with a wire hook.

Workers readily pass between the wires of the excluder. They get used to it in an hour or two; their work is not in the least impeded, no pollen is lost, and I have been much surprised at the ease and celerity with which they pass through.

Drones, finding their way barred by the excluder, go through the brass clearer into the tube; there they are trapped. Any workers passing through the clearer escape through the end of the tube; in fact, the perforated zinc I use is coarse enough to allow workers to pass through the perforations.

Should a queen attempt to lead a swarm, she is trapped in the tube, and the workers cluster round it. If a swarm

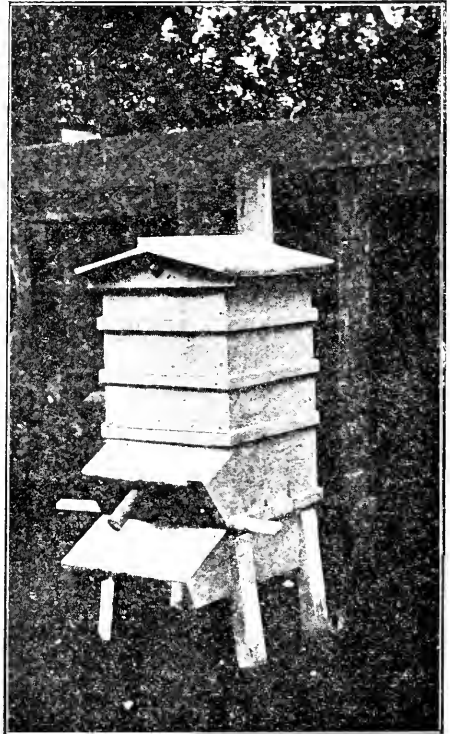

SWARM PREVENTER AND DRONE TRAP.

is wanted, cage the queen, and put her in a skep close to the entrance; the skep will soon be full of bees, and the swarm can be disposed of as desired. If a swarm is not desired, cut out the queen cells and put the queen back, cage and all; she can be liberated in the evening; the workers will follow.

By clearing the tube twice a day (the drones die if left in the tube till evening), and setting the pure Italian drones free, and destroying others, I can maintain pure Italian drones in my apiary.

The liberated ones find their way into other hives to which the device is not attached, such hives being used for queen raising.

I now fit runners to the entrance of the hives, and slide the device in, so that it can be taken in and out with ease. As bees do most of their house-work at night, I raise the device a little in the evening. They can bring out the dead, and clear any rubbish, but I slide it right down in the morning. Bees only swarm during the sunny hours of the day, and it must be kept closed then. As any drones are accepted, it does not follow that the open hives are free from undesirable drones, but they are exceedingly few in number.—L. GLASSPOLE, Altona, Hockliffe Street, Leighton Buzzard.

## Wild Bee Hunting in Australia.

By J. H. LAWRENCE.

When on a prospecting tour in the back blocks of New South Wales we camped at a waterhole one day. I happened to notice a number of bees coming and going at the edge of the water. I thought it would be a good idea to have a day honey gathering. My mates being agreeable, we started the next day. Armed with a feather and a piece of weed that exudes a sort of milky substance when broken, we proceeded to the waterhole. Having selected a bee that was quietly drinking, I plucked a bit of fluff off the feather, and, touching it on the sticky weed, stooped down and placed it on the back of the bee between its wings. It immediately rose, and made off in a straight line for its hive. Being weighted with the fluff, it could only fly slowly and at a height of about six feet from the ground, so that it was easy for us to follow, which we did, my mates blazing (or chipping) a tree here and there, so that we could find our way to the hive when we came for the honey. We followed the bee for about a mile to a large hollow tree, where we could see the bees going in and out of a spout, about 15 feet from the ground. Having marked the tree, we made back to the waterhole and repeated the process. Altogether we located five hives.

We then went to our camp and got a horse and cart, taking several kerosene tins for buckets, also our axes, and then made our way to the first hive. We soon had our axes to work, and it was not long before we had the tree on the totter: a gust of wind gave it the finish, and down it fell with a loud crash. We now had to locate the place where the nest was, as sometimes it is some distance from where the bees enter. By putting our

ears close to the trunk of the tree and listening, we soon found the spot by the humming noise. We put a deep cut on each side of it, and splitting the centre out, the honey-comb was exposed. Of course, the jar of the tree striking the ground smashed some of the comb, lots of bees being smothered in honey. We soon raked it all out with our hands, filling a couple of our buckets. We got stung a bit, but stuck to the job until we finished it. I got a sting on the end of my nose, which was very painful, also between my fingers; one of my mates got a sting in the eye, which made him dance about for a while. We went on from one hive to another until we had filled our buckets. On getting back to camp, we suspended the honey-comb in bags from the branch of a tree, putting our big prospecting dishes underneath to catch the honey as it drained through the bags.

It was just about this time that we had a plague of mice; thousands of them seemed to come quite suddenly. I put a stick in the mouth of a flour bag to hold it open. On getting up in the morning I grabbed it quickly, and found there were quite a lot of mice inside. I shook them in front of a little terrier dog belonging to one of my mates. The dog got tired of killing them, and at last would let them run on him; he must have killed hundreds in a couple of days. I went over to where we had suspended our honey-comb to see how much honey we had got from it. I found the dishes nearly full, but to my disgust I found a ring of tails round each dish. The mice had got to the top of the dishes, slipped in, and got smothered in honey, only their tails showing out. I pulled them all out. We boiled the honey and preserved it in tins, but I never told my mates about the mice.

I may say that the bees are descended from some originally imported from England, and have multiplied and spread over hundreds of miles of country. The real Australian bee is much smaller and has no sting, and is not much sought after, the hives being very small.

### Royal Show Fund.

Amount received	£21	5	11
Anon. ... ..	1	1	0
	£22	6	11

### Sugar for Bee Feed.

ERRATUM.

In the address given for Denbighshire "Dentre" should have been "Tentre."



*The Editors do not hold themselves responsible for the opinions expressed by correspondents. No notice will be taken of anonymous communications, and correspondents are requested to write on one side of the paper only and give their real name and addresses, not necessarily for publication, but as a guarantee of good faith. Illustrations should be drawn on separate pieces of paper. We do not undertake to return rejected communications.*

### Fraternity Among Bee-Keepers.

[10236] May I try to show the continued existence of Fraternity among Bee-keepers (10207)? I saw "Cross's" advertisement, and owe him an apology; from its wording I thought he was "cadging." May I suggest that the wording was unfortunate; the use of the word "brother" in an advertisement rather connotes a begging letter.

May I give him my experience?

January, 1918. — Bought two second-hand W.B.C. hives, but could not get any bees locally till September, when I purchased two stocks; as they were dead by January I think I was not treated quite fairly. This disaster told me I did not know enough about bees—or bee-keepers—so I joined the Cheshire B.K.A. (*verbum sap.*), and found the Secretary most encouraging and helpful. Among many other kindnesses he introduced me to a member, who sold me a fine stock in July, 1919, at a very low price. I next joined the Apis Club, and wrote to one of its members (unknown to me) about the Conqueror Hive. This bee-keeper, in a large way, with a great amount of work, has given me in a series of long letters most valuable advice, and lent me a score of the latest and most expensive books, as well as hive plans.

My stock wintered well, but, working for increase, I lost queens in mating, so had four lots with only one queen that was laying. I approached the bee master I got the stock from. He explained he had eleven nuclei immediately wanted, and only two new queens mated, so could not let me have a 1920 queen, but as I was in difficulties, would part with the queen from which he was breeding, an exceedingly fine 1919 queen. He was very loath to part with combs, but to prevent this valuable tested queen from running the risk of my introduction, he suggested I should buy the three frames she was on at a most reasonable figure. Whilst I was trying to get queens I visited the apiary of a friend, and after explaining the position, he offered me a virgin from some

that were being sent him for experimental work free of cost.

This morning another bee-keeper came to see me with a virgin of a very good strain; he had heard from our Secretary that I was in straits, and hastened to help. This gentleman came out to see my bees 15 miles from his home, although I had known him but a week.

I would like to mention these bee-keepers' names, but refrain from so doing, as I feel certain it would be repugnant to them.

I am glad "Cross" has made a new start, and hope he will be successful. One more suggestion: Join the local B.K.A. and the Apis Club, and he will have no further doubt as to fraternity among bee-keepers not only existing, but flourishing.—W. STOKOE.

### Larger Frames.

[10237] I did not intend to write on the subject of larger frames for a few months, for I wished to see how they suited on the heather in August, but I cannot let Mr. R. Manley's statement that the 14 by 12 frame is a bad and impractical frame, pass. He will remember that in a letter, No. 10141, of March 4th last, he recommends Mr. Flashman to take 10 stocks and test for three years, and then the results will be worth consideration, and also, further, in letter No. 10191, of June 2nd, he says he tried a frame 14 by 11½ for two or three seasons in two stocks, but he found it to be an utterly worthless frame. If he acted on the advice given in his first letter, then, with the practical experience he received with only two stocks he could not draw the conclusion which he does. It has been stated that the Americans have given over the use of the square frames, but there is no comparison with these square frames and the 14 by 11½ which I use. To compare this frame with the American 12 by 12, the Gallup 11¼ by 11¼, or even with the Adair, 13¾ by 11¼, is trifling with the subject, when we consider the difference of practice and climate of America. If we had the climate and honey flow of America, we probably would go in for much larger frames, such as the Langstroth, of 320 square in. area. As Mr. R. Manley probably knows, there is much patient experiment now going on with the larger frames, and it is not suitable to give at present the results of such experiments, but I shall be able and willing to contribute to increase the knowledge of the value of such frames in the course of a few months. When I suggested the deep standard frames I gave the size as 14 by 11½ to fit in a brood chamber 12 in. deep.

This has become known as the 14 by 12 frame, and in some cases the manufacturers have made the frame actually that size, which is a pity. That I believed in the advantage of the 14 by 11½ frames is evidenced when I state that I made during last winter 30 new hives, to take in each 11 of these frames, and provided new frames, but I have only been able to put 20 in use. To do this I have bought 13 swarms; this, with 40 section boxes and sections, has been a great outlay. So that the results of my experience will be practically the behaviour of these 20 lots of bees, which have come to me from all directions, and are of various hybrid as well as pure varieties, so that it should be fairly conclusive; but as I said, the behaviour and result on the heather is an important question, more so to the northern bee keepers, who depend on the heather flow for a profit. It has been stated that the larger frame is a mistake for using on the heather, if so, I will soon be able to judge for myself.—F. B. CHARLTON, Stockton-on-Tees.

### Increasing Stocks in Autumn.

[10238] Weak stocks are helped in the autumn after the honey flow. Place over a strong stock a brood frame super, in this place eight drawn out combs, and a dummy at each end. These combs will soon be filled with honey; no excluder underneath. As soon as they are full with uncapped honey remove all except the four in the centre. Do not touch these, but push up the dummies. Take out the other four, extract uncapped honey and feed slowly over the four frames of comb left.

When the time arrives for inspection of stocks; find the weak ones; if an empty comb just hatched out is there remove it. Now go to your super, give a puff of smoke, and gently pull away dummies, and you will find the queen gone down and two combs crammed with capped brood from top to bottom. Place these in the weak stocks and feed up with honey.

Result in March will be a large number of baby bees, honey and brood, if the queen is not confined to one comb by using honey board.—CYRIL TRECROFT.

### Bee-Keepers' Conference at "The Royal."

[10239] Many bee-keepers who attended the recent Royal Show and read your report of the B.B.K. Association meeting will be pleased by the sensible proposition by Mr. Richardson, seconded by Mr. Pearman, that instead of the usual Council meeting held at the tent a conference of bee-keepers be held. Surely this is what is needed. Many who attended the show

were disappointed. Here is an opportunity for something educational, sociable, and profitable, which should not be lost sight of in future shows. We shall be indebted to the above gentlemen for their suggestion.—J. SIDNEY GILES.

### Remedies for Ants.

[10240] Three or four months ago we wrote asking you, or the readers of THE BRITISH BEE JOURNAL to give us a remedy for preventing ants from infesting hives.

We are now pleased to say that, after a loss of twenty colonies, we have discovered that Cooper's Sheep Dipping Powder has proved effective.

All our hives stand on bricks, and we thoroughly sprinkled the powder round the legs, over and round the bricks, and under the hives, with the result that ants have now disappeared and not a sign of them to be seen.

To yourself and all your readers who so kindly gave us remedies, we offer our best thanks.

Pretoria. CAIRNCROSS & ZILLEN.

### Present Day Foundation.

[10241] One remembers pre-war English made foundation, all shades representing as near as possible real wax. I have known cases of half-hearted refusal, and one got the imported foundation, which is excellent, with which to replace the other. I got, a week ago, a packet of English-made foundation made by a well-known advertiser, quite honey coloured, and had a strong aroma of honey. I tried one sheet with a new queen, and in a very few days she was on it, completely drawn out filled with worker brood. This I am keeping in a tin airtight box till my new hive arrives. The improvement since pre-war days is greatly marked, which is a great boon to bee-keepers and breeding of stocks, as a swarm, fairly large, will develop in no time.—C. TRECROFT.

### A Beginner's Experience.

[10242] I should like to give my experience in starting bee-keeping. After longing for some years to keep bees of my own, I ordered two stocks of pure Italian bees. They arrived at the station on May 5 in travelling boxes, and made a great buzz. The weather was rather cold when transferring the seven frames to W.B.C. hives, and after placing the frames in the body box the bees remaining in the travelling box were shaken on to the alighting board, some falling on the ground quickly became numb with cold. A lady bee-keeper who was assisting me took some up in her hand and the warmth

revived them. Then we gathered up handfuls, breathed warmly on them, and in a minute or two bees apparently dead were able to walk briskly into the hive. In this way we were able to rescue about 200 bees, and got one stock hived with the loss of less than a dozen bees. The other stock was transferred much quicker, the bees remaining in the box after the frames were transferred were shaken over the body box and the quilts placed over them at once. I think Italian bees are just the thing for lady bee-keepers, mine are so quiet and need very little smoking. I look forward with pleasure every week for the BEE JOURNAL, which I have read since the year 1917.

Wishing you success in the extension of bee craft.—S. JOHN COOKSON.

### A Note from Surrey

[10243] Bees here have bred very fast this season, and though I have no fears of starvation, as yet, there is very little in supers, except bees, so our hopes are for a fine and warm August. To give some idea of how bees are breeding, one stock on May 1 is now represented by seven, of which three are working in one rack of sections each, one in two racks, one in 20 shallow frames, above brood chamber. The other two are on eight frames each, and building up rapidly. No more swarms should be accepted now, they should be returned to where they came from, as there will not be time to build up to sufficient strength for wintering.

Re your reply to Mr. Dunning, I most emphatically endorse your remark about Myrabella Plum, it makes a hedge second to none, is a quick grower, it is strong, and will keep back all kinds of cattle, even the human kind, and makes a thick screen; there is no comparison between it and Privet, which is a very brittle, soil exhausting plant. Any nurseryman would supply.

Re letter from Amazed, I strongly sympathise with A., and am more than disgusted with B., but I know such things are done, I have been bitten myself. Does A. need any assistance now?—W. MRS.

### Is This a Record?

[10244] I am sorry in my letter (10,223) under the above heading in the B.B.J. for July 15, the typist made a mistake. Instead of "19 combs," it should be "17 combs of brood in 15 days." Since writing I have raised another queen laying about the same.

On July 11, when so many swarms were about, I had a rather unusual occurrence. Two strong stocks swarmed. One went back after flying round, presumably

through the queen not coming out. Number two clustered and were hived. In this case the fertile queen, which we found in the hive, was still in the parent stock, and a virgin came out with swarm. We have no doubt that the bees were ours, as they clustered in exactly the same spot as one from the same hive a month previously. This is, I think, unusual. Can you supply an answer? Shall be much obliged if you can give an explanation.—JOHN W. EARL.

[We cannot give an explanation of the occurrence without more details. We think the bees probably came from another hive. Finding them on the same spot chosen by a swarm from that hive a month previously cannot be taken as conclusive proof that it came from that hive. It is no unusual occurrence for swarms from different hives to choose the same spot for clustering.—Eds.]

### Prolific Swarming.

[10245] A bee-keeper living in the district has just given me this remarkable result from one hive of Italian bees, and I think it may be of interest to your readers:—May 24, 1920.—Swarm out, full strength. June 7, 1920.—Swarm out, full strength. June 8, Cast out, full strength. June 11, 1920.—Cast out, full strength. June 12, 1920.—Cast out, went back, full strength. June 13, 1920.—Cast out, full strength.—FRANCIS O. HALE, Purton, Wilts.

### A New Disease.

[10246] Rev. E. F. Hemming, in your issue of July 1, page 315, speaks of a new disease among bees, which shows itself in swarms that are sent away vigorous.

This is not at all an uncommon occurrence in some parts of Scotland and further afield. The appearance of the bees of the affected swarms does not materially differ from that of the bees of any typical "I.O.W." disease affected stock, and microscopically they resemble the true form so closely that on two occasions known to the writer an eminent bacteriologist engaged in work connected with research regarding the cause of "I.O.W." disease pronounced this to be the true form of that complaint.

Many years ago I met with several cases where swarms, which undoubtedly left the South of England in a vigorous condition, showed all the symptoms of "I.O.W." disease on arrival in Scotland, eventually dying out, while the apiary they came from, including the parent stocks, remained healthy.

Among several nuclei all made from one stock and sent to different parts of the



country and placed in seemingly quite healthy localities, one may show the well-known symptoms of "I.O.W." disease on arrival, or soon after, while the others, including the parent stock, remain to all appearance quite healthy.

Two years ago a friend sent me two united swarms weighing over 11 lbs., which on being released and hived on foundation in a new hive, almost at once showed the usual symptoms. They were all dead in a month, yet the stock the swarms came from are still going strong.—G. W. AVERY.

### Superstition Regarding Bees

[10247] I wonder if any of your readers can give me information regarding certain superstitions regarding bees.

Rudyard Kipling in "The Bee Boy's Song," says:

Marriage, birth or buryin',  
News across the seas,  
All you're sad or merry in,  
You must tell the bees.

In another stanza of this poem we are told that if "you hate where bees are" they will pine away or leave you:

Pine away—dwine away  
Anything to leave you!

But if you never grieve your Bees,  
Your Bees 'll never grieve you.

Popular fancy in the past has idealised the bees into household spirits guarding the family, and I have heard, that it was the custom in some parts of the country, for a young couple to inform the bees, and request their favour on becoming engaged or married. I should be grateful for any account of bee superstitions amongst the country-folk at the present day.—R. THURSTON HOPKINS.

### Introducing Italian Queens to Dutch Bees.

[10248] At one of the meetings of the Cambs. Bee-keepers' Association it was impressed on me by two bee-keepers of authority of the great difficulty they had experienced in successfully introducing Italian queens to Dutch bees by the ordinary method, the queens being invariably thrown out dead. A method was described to me which proved a success, but being a rather complicated process I adopted a more simple plan, which also proving a success, I herewith give the method, which may prove useful to others who may be introducing queens to the Dutch strain.

Before the introduction I placed the usual travelling cages on the top of the frames in the stock boxes. I then sprayed

between the combs, including the cages (which stood edgewise) containing the Italian queens, and also at the entrance, with a solution of one tablespoonful of Yadil to a pint of water, this operation taking about two minutes to each hive. Out of eight Italian queens seven were introduced successfully. I am pretty sure the eighth swarmed and flew away before I made an examination of the frames.

To those who have not used Yadil I may explain that this disinfectant has a strong scent—not altogether pleasant to the human olfactory organs—but this peculiarity is the reason of my using it; for the same reason I have adopted it in adding swarms to established stocks without a failure, which is more than I can say in dusting the two with flour.—JAMES LEE, Fulbourne, Cambs.

### Bees in "Big Bertha."

[10249] I was quite recently making a tour of the battlefields, and coming across the "Big Bertha" used for shelling Paris—which the Germans were evidently unable to remove in time, so had dismantled and blown up as much of the heavy mass of machinery as possible—I was much struck on observing that, "Out of the strong came forth sweetness," as a swarm of bees had taken possession of one part of the death-dealing monster.—H. E. BROAD.

## Notices to Correspondents

H. G. T. DYSON (Watford).—*Colonies without brood.*—We are afraid the queens have disappeared. Possibly the bad weather may have caused a cessation of brood rearing, but we should expect to find a few eggs and unsealed larvae. Can you get a comb containing eggs to give them? If this is done, and there is no queen, the bees will build queen cells. If a queen is present, stimulative feeding will most likely cause her to lay.

#### Suspected Disease

B. J. F. (Essex).—The bees are affected with "I.O.W." disease.

MRS. SMAL (Hayes).—We do not find any disease.

## Bee Shows to Come.

A nominal charge of 2s 6d. is made for notices (not exceeding 7 lines) in this column, 10 lines charged 3s. 6d., up to 15 lines 5s., which covers cost of insertion from order till date of show. Cash should accompany orders for insertion.

August 7, at Barnstable.—Barnstable and District Horticultural Exhibition, to be held in the Market Hall. Five Open Classes for Honey.—Schedules from Hon. Secretary, 19, Grosvenor Street, Barnstable.

**August 10, at The Park, Carmel.**—Carmel Agricultural Society's 43rd Annual Show. Open Classes for Comb and Extracted Honey.—Schedules, etc., from W. Dickinson, Secretary, Carmel-Carmel. Entries closed.

**August 11, at Wye.**—Kent Honey Show. Thirty classes, half of which are open to U.K. Four Silver Cups and 75 other prizes. Schedules, Mr. A. Lepper, Wye. Entries closed.

**August 12, at Taunton.**—Somerset Beekeepers' Association Show of Honey, Wax, and Appliances. Seven Open Classes. Liberal prizes.—Schedules from Mr. F. J. J. Stacey, 3, Hammet Street, Taunton. Entries close August 6.

**August 14 and 16, at Cannock.**—Staffs.—Eight open classes for honey, etc. Prizes value £12. Schedules from J. Bird, Secretary, "Glenmay," Allport Road, Cannock.

**August 14, at Llanelly.**—Carmarthenshire B.K.A. Show, in connection with the Llanelly and District Horticultural Society's Show. Liberal prizes (nearly £15) offered for Honey, Wax, and Appliances. 15 Classes (7 Open).—Schedules from R. Lloyd Roberts, London Joint, City and Midland, Llanelly. Entries close August 6.

**August 18 and 19, at Coventry.**—Warwickshire Beekeepers' Association, in connection with the County Agricultural Show. Lectures on both days.—Schedules from Mr. J. R. Ingerthorpe, Knowle, Warwicks.

**August 18 and 19, at Derby.**—Derbyshire B.K.A. Honey Show to be held on the grounds of the Derbyshire Agricultural Society. Two Open Classes. Three Cups in Members' Classes.—Secretary, F. Meakin, 37, Pybus Street, Derby. Entries closed.

**August 25, at Chester.**—Cheshire Beekeepers' Association, in connection with Cheshire Agricultural Society. Several Open Classes. Good prizes.—Schedules from Thos. A. Beckett, St. Werburgh Chambers, Chester.

**August 25, at Prestbury, Cheltenham.**—Flower, Fruit and Honey Show. Open Class for single 1-lb. jar of honey. Several classes open to beekeepers living within a radius of 12 miles.—Schedules from A. H. Bowen, Coronation Road, Cheltenham. Entries close August 13.

**August 28, at Hounslow.**—Hounslow and District Allotment Holders' Association Second Annual Exhibition of Vegetables and Fruit. Honey exhibits under the control of the Twickenham and Thames Valley B.K.A. Open Classes for single bottle and section.—Schedules from Miss M. Byatt, Hawthorn, Hanworth, Middlesex.

**Saturday, August 28, at Hinckley.**—Leicestershire and Rutland Beekeepers' Association, in connection with Hinckley Flower Show.—Open Classes for Honey, Sections and Jars. Prizes, 12s. 6d., 7s. 6d., and 4s. 6d. in each class. Judge, J. Herrod-Hempsall, F.E.S.—Schedules from A. Kimbrell, Esq., Clarendon Road, Hinckley. Entries close August 23.

**September 8, 9 and 10.**—Portsmouth B.K.A. Honey Show, in conjunction with the Portsmouth Allotment Holders' Show, at Connaught Drill Hall, Portsmouth. Six Open Classes. Judge, W. Herrod-Hempsall, F.E.S.—Schedules from Show Secretary, Mr. J. Sinnett, 154, Essex Road, Southsea.

**Saturday, September 11.**—Fforest-Fach Horticultural Society, Swansea. Three Open Classes for Honey, extracted and sections. Help to foster bee cult this end. 1st prizes, 10s.; 2nd and 3rd in proportion.—Schedules ready from G. L. Williams, Fforest-Fach, Swansea.

**September 22.**—Altrincham Show. Several Open Classes for Honey and Appliances.—Schedules from H. Turner, 1, Market Street, Altrincham.

**October 5 to 8.**—Essex Fruit and Honey Show at Institute of Agriculture, Chelmsford. Open from 12 to 8 p.m. Admission free. Lectures and demonstrations each day.—Schedules from G. R. Alder, 7, Bulwer Road, Lextonstone.

**November 18.**—Annual Show of the Worcester City and County Chrysanthemum, Fruit, Root and Honey Society. Thirteen open classes in Honey Section. Schedules from Geo. Richings, 42, Barbourne Road, Worcester. Entries close November 6.

## Special Prepaid Advertisements. One Penny per Word.

Trade advertisements of Bees, Honey, Queens, and Bee goods are not permissible at above rate, but will be inserted at 1½d. per word as "Business" Announcements, immediately under the Private Advertisements. Advertisements of Hive-manufacturers can only be inserted at a minimum charge of 3s. per lin., or 5s. per inch.

PRIVATE ADVERTISEMENTS are only intended for readers having Surplus Stock to dispose of. Driven Bees, Nuclei, and Queens that are reared or imported for sale, are Trade Advertisements, and can only be accepted under trade terms. A charge of 6d. extra will be made if a box number is used.

Orders for three or more consecutive insertions in "The Bee Journal" entitle advertisers to one insertion in "The Bee-Keepers' Record" free of charge.

Advertisements must reach us NOT LATER than FIRST POST on TUESDAY MORNING for insertion in the "Journal" the same week.

### PRIVATE ADVERTISEMENTS.

**SPLENDID** White Clover Honey, £10 cwt.; sample 6d.—ALBERT COE, Apiarist, Ridgewell, Halstead, Essex. h.26

**SURPLUS BEES.**—Several Stocks of Dutch Bees, 6 to 10 frames, 8s. per frame, 1920 Queens; boxes 10s., returnable; three Cottage Hives, 15s. each.—Cash with order.—A. W. WISKIN, Walpole St. Andrew, Wisbech, West Norfolk. h.4

**A FEW** lots of good, healthy Bees on from 5 to 8 standard frames, 8s. per frame, carriage paid. Travelling box to be returned.—WRIGHT, Waterworks, Sutton Poyntz, near Weymouth. h.5

**SURPLUS QUEENS** for Sale, Italian-Dutch, 7s. 6d. each; postage 2d.; excellent strain.—F. HARE, 42, Pinner Road, Watford. h.6

**BEES.**—A few lots of good, healthy Hybrids, 6 to 8 standard frames, 7s. 6d. per frame; travelling box 7s. 6d., returnable.—"Colewood," New Road, Mitcham. h.7

**FOUR** 8-frame Hybrid Italian Stocks only remaining unsold, guaranteed healthy, £3 5s., carriage paid; box to be returned promptly; one pure Italian Penna 1920 Queen on 8 frames, £4; two 1920 Hybrid Queens, 7s. 6d. each, and one pure Italian, 9s. Cash or deposit.—D. R. BERNARD, Glenzila, Upper Deal, Kent. h.8

**THREE** strong Stocks Italian Hybrids, with or without hives, supers drawn and on ready for August flow. What offers?—REA, Horncliffe, Warrington, Surrey. h.9

**£650.**—TWO FOUR-ROOMED COTTAGES, 2½ acres, near Bournemouth, £200 on mortgage; ingoing, £300, includes 100 head poultry, houses, runs, incubator, foster mothers, six stocks bees, horse hoe, plough. Particulars, stamped, addressed envelope.—Box No. 100, B.B.J. Office, 23, Bedford Street, Strand, London, W.C.2. h.10

**THREE** strong Stocks of Bees, 8 and 6 frames, £2 10s. and £2, carriage paid.—MATTHEWS, 25, Cray Road, Crockenhill, Swanley, Kent. h.11

**FOR SALE,** Hybrid Italians, strong 10-frame stock, £3.—NICHOLL, 254, Friern Road, East Dulwich, S.E. h.12

**SURPLUS.**—Two 3-comb Nuclei, 40s.; two 6-comb Stocks, 65s.; four fertile cross-bred Queens, 5s.; travelling boxes returnable.—DAVEY, Mawneys, Romford. h.21

**FOR SALE,** five strong Stocks Italian Hybrids, 10 frames, 1920 Queens, £4 each.—W. T. BRISCOE, Hughtenden, near High Wycombe. h.14

**O**FFERS wanted for 1920 (light) Honey in bulk; tins to be sent; sample 6d.—**HOWLETT**, "Sylvabelle," Tring. h.15

**S**TRONG STOCKS, Hybrids, no disease, two 10 frames, £4 each; one 6 frames, 50s.; carriage paid; boxes, returnable, 10s.—**DAVIES**, 40, Blackheath Park, S.E.3. h.16

**S**ALE.—Boxes (8 frames), drawn out, 8 bars, S Observatory Hive (Lee's), 3 frames, four sections, feeder.—51, Lower Mortlake Road, Richmond, Surrey. h.17

**F**EW STOCKS of Italians on 10 frames, packed with bees, £4; boxes 12s., returnable; some on 13 frames.—**HENSLEY**, Luton Apiary, Queen's Road, Chatham. h.18

**T**HREE STOCKS for Sale, 10 frames, healthy Italian Hybrids, £4 each; boxes 10s., returnable.—**GIBBS**, Carterton, Oxon. h.19

**R**EADY FOR HEATHER.—Reducing apiary. For Sale, 10-frame Stocks, 1920 Italian Queens, price £3 15s., free on rail; carriers returnable.—**ASHWORTH**, Weymouth Street, Westminster. h.20

**F**OR SALE, one 18-in. bevel-gear Extractor, 13-in. Ripener, one Uncapping Table with trays, knives, etc., 12 crates of drawn-out Comb Supers. Offers.—14, Mill Road, Salisbury. r.g.176

**W.B.C.** PATTERN HIVES, never used, painted white, 10s. and 15s. each. Honey Press, Foundation, Swarm Catchers, Sections, etc., at half cost.—**THOS. THIRKILL**, Kirkby Malzeard, Ripon. r.g.181

**A** FEW surplus Stocks Bees for Sale on 8 combs, price 70s.—**HEATHERLANDS BEE FARM**, Thursley, Godalming. g.203

**S**URPLUS HIVES and Appliances for Sale, good condition, cheap.—**PEARSON & GALE**, Marlborough. g.205

**F**OR SALE, cheap, strong, healthy Stocks, new 4-frame reversible Cowan, Ripeners, Foundation, Wire, Frames, Hives, Electric Embedder, etc. Particulars, stamp.—**GEORGE**, Oak Drive, Oswestry. g.206

**B**EES, immune strain, six colonies each on eight well-filled W.B.C. frames, £3 per stock. Satisfaction guaranteed. Cash with order. Immediate delivery.—**WARD**, Stoughton, Emsworth. r.g.129

**S**URPLUS STOCKS healthy Bees, £4; June Swarms on frames, 50s.—**JEWITT**, "Hensall," Whitley Bridge, Yorks. r.g.131

**S**ALE, single-walled Hives, 5s. 6d. upwards; approval.—**HUNT**, Bank Street, Somercotes, Alfreton. r.f.67

**H**AVE only a few 6-, 8-, or 10-frame Stocks left; four very fine 1920 Italian Queens to spare; guaranteed healthy. Stamp reply.—**CROWE**, Merriott, Crewkerne. r.g.191

**T**HE CARMARTHENSHIRE BEE-KEEPERS' ASSOCIATION invite applications from bee-keepers in the county for Lectures and Demonstrations in Bee-keeping.—Apply to **W. COMERY**, Hon. Sec., 15, New Road, Ammanford. r.g.156

**BUSINESS ADVERTISEMENTS.**  
1½d. per word.

**F**OR MOORS.—Grand 8-frame colonies, 85s.; famous Coiswold Queens, 10s. 6d.; healthy driven lots, 10s. 6d. Lists.—**BOWEN**, Queen Breeder, Cheltenham. h.13

**Q**UEENS.—Quiet, hardy, prolific Italian Hybrids; fertiles 10s., virgins 4s.; satisfaction or replaced.—**JACK TICKELL**, Westbourne Apiary, Cheltenham. h.23

**F**OR SALE, 4-frame Nuclei, also 1920 Italian and Hybrid Queens, from the "Re-stocking" Apiaries of Somerset Bee-keepers' Association.—Prices and particulars from **L. BIGG-WITHER**, Birdwood, Wells, Somerset. h.22

**T**HREE 4-frame Nucleus, 16 x 10 frames, 65s.; four 4-frame Nucleus, standard, 52s.; pure Italian Penna direct Queens, 10s. extra on box, returnable.—**SEAL**, Eastcliffe Apiary, Tutshill, Glos. h.24

**S**TRICTLY BUSINESS.—100 August, imported, fertile Italian Queen Bees at a reduction to D.B.'s. "Let the Bees Tell You," 2s. per copy.—**S. H. SMITH**, 30, Maid's Causeway, Cambridge. h.25

**A** PARTNERSHIP in Bee-keeping and Bee Appliance Business offered to experienced bee-keeper (lady or gentleman). Opportunity for big development. Capital essential, £1,000 to £5,000.—Write, in strict confidence, "Apis," c/o BRITISH BEE JOURNAL, 23, Bedford Street, Strand, W.C.2. h.2

**P**URE ITALIANS, 1920 Penna imported Queens, 6 frames, 60s., 8, 70s., 10, 80s., carriage paid; boxes returnable; Hybrids 10s. less; 1920 Hybrid Queens, 7s.—**WADHAM**, Gold Street, Cardiff. r.g.210

**F**EW STRONG NUCLEI for immediate delivery (weather permitting), crowded with bees, brood and stores, 1920 Queens, hybrids; exceptionally good strain; perfectly healthy; inspection invited; 3 combs, 40s.; 4 combs, 50s.; 6 combs, 60s.; box 10s. extra, returnable.—**STEVENSON**, Thames View Apiary, Flackwell Heath, Bucks. r.g.222

**H**EALTHY DRIVEN BEES, with Queen, 10s. per lot, carriage paid; boxes returnable. Cash with order. Orders in rotation.—**PULLEN**, Ramsbury, Hungerford. r.g.211

**I**TALIAN QUEENS from Penna's queen, virgins 4s., fertile 9s. 6d.; Hybrid Italians, virgins 3s. 6d., fertile 8s. 6d.; Hybrid Stocks on 4 frames, 50s.; box, returnable, 10s.—**WARD**, Deeside Nursery, West Kirby. r.g.215

**W**ANTED, Stevenson Skyscraper Hives; must be good condition and free from disease; good price given.—Box 99, B.B.J. Office, 23, Bedford Street, Strand, London, W.C.2. r.g.216

**S**URPLUS.—Nuclei, Hybrids, crowded, 1920 Queens, very prolific strain, 30s.; box 10s., returnable; immediate.—**F. BIGGE**, Tyburn, Birmingham. r.g.145

**Q**UEENS, Italian and English, 1920, 10s.; Nuclei, strong, 4 frames 50s., 3 frames 40s., carriage paid. Stamp reply.—**HOLLINGSWORTH** (First Class Expert), Heanor. g.169

**4-FRAME NUCLEI**, headed by 1920 Italian Queen, 50s.; box charged 10s., returnable; 6-frame Stocks, 70s.; 8-frame Stocks, 90s.—Immediate delivery (weather permitting). Italian fertile Queens, 10s. 6d. English Run Honey and Sections wanted.—**LEE**, "Little Bowden Apiary," Burgess Hill, Sussex. r.g.114

**C**HOICE home-reared Italian Queens, 10s.; Virgins, 4s. 6d.; July-September.—**MISSES PALING & PILLANS**, Golden Square, Henfield, Sussex. r.g.82

**S**TRONG 3-FRAME NUCLEI, 1920 fertile Queens, 30s.; box 5s., returnable; Stocks on 8 frames, 60s.; boxes 10s., returnable.—**W. WOODS**, Normandy, near Guildford. g.53

**P**URE ITALIAN QUEENS, prompt delivery; select Italian, extra golden, rare honey-producing stock, August-September.—**ATKINSON**, Fakenham. r.g.24

**"WIGHT" DISEASE**, prevention and removal; advice 5s.—**ALFD. RYALL**, Kenwood Apiary, Elcombe, Stroud. r.h.3

**1920 FERTILE Golden Italian Queens,** guaranteed imported direct from Italy, regular supplies every few days, 10s. each; specially selected, 14s.—**GOODARE, New Cross, Wednesfield.** 1.69

**"ISLE OF WIGHT" DISEASE.**—Don't worry; use the solution that cures; 2s. per bottle.—**B. PRESSEY, St. Elmo, Coulsdon.** r.d.149

**HAVE YOU READ "THE BEE WORLD"?** If not, why not? Every number in itself is a useful literary work for practice and reference. Specimen copy free.—**Offices: THE APIS CLUB, Port Hill House, Benson, Oxon.**

**ITALIAN QUEENS**  
**Direct from Italy.**  
**E. PENNA, BOLOGNA, ITALY.**

I assume again the direct sale of my queens. Special offers from July 10 till countermanded. For queens in lots of 4 at a time £1 8s. Cash with orders. Payment by cheques or **British Postal Orders.** International Money Orders are **not** accepted. I do not hold myself responsible for the queens that are not sent by me direct to customers. All orders should be sent direct to me. In May the queens dead in the journey have been **less** than 1%  
**ORDERS BOOKED IN ROTATION.**

**Would You Winter 100% ?**

Then have some of Clarke's "I.O.W." cure and preventive on the floor of your hives from now onward. No spraying, simply a powder. Don't let your bees die.

**G. J. CLARKE, Blythburgh, HALESWORTH**

**JOT DOWN** the deficiencies of your present equipment and your needs for future improved working. Then book for "**MASHEATH**" (Regd.) Equipment for autumn construction.

The **MASHEATH LIST** contains an unique series of Hives unequalled to-day. You should not enter upon another bee season without them. "The Hives (Porchless Masheaths) are excellent in every way, and I am very pleased indeed with them. '**PORCHLESS!**' Yes, every time. Need I say more? I will get you to send me two more."  
—W. F., June 17, 1920.

The **MASHEATH HIVES TALK** as soon as they are delivered.

**ATKINSON, Proprietor and Fakenham.**  
Sole Maker,

**ITALIAN QUEENS**

**Direct from Italy.**

Address:  
**Signor Gaetano Piana,**  
**Castel San Pietro,**  
**near Bologna, Italy.**



All Queens are reared by the most up-to-date and scientific methods. Mr. W. Herrod-Hempsall has personally inspected the apiary and methods employed, with which he is perfectly satisfied.

**PRICES FOR 1920.**

**For 1 Fertile Queen:** August and September, 9/- each queen.

Carriage paid in Great Britain. Cash must accompany all orders, which will be executed in rotation. Guaranteed safe arrival of all Queens, but not the introduction, Bees dead upon arrival must be sent at once to "B.B.J." Office.

For the mutual convenience of all parties, if Signor Piana has made arrangements that all communications, orders and remittances of the readers of "B.B.J." and "B.K.R." can be addressed to him, c/o British Bee Journal, 23, Bedford Street, Strand, London, W.C.2.

**Cheques payable to 'British Bee Journal.'**

The products of the Apiary, of Poultry and Farm Stock, of the Fruit and Vegetable Garden can be Advertised and Sold through

**THE BAZAAR, EXCHANGE & MART**  
*Newspaper.*

Get a Copy—Thursday and Saturday 3d. The "Bazaar" publishes also practical handbooks by experts. Send for full catalogue, post free from—**WINDSOR HOUSE, Breams Buildings, LONDON, E.C.2.**

**THE British Bee-Keepers' Association.**

Insure *now* against loss by damage done through bee stings. All particulars from **W. HERROD-HEMPSALL, 23, Bedford Street, Strand, London, W.C.2.**

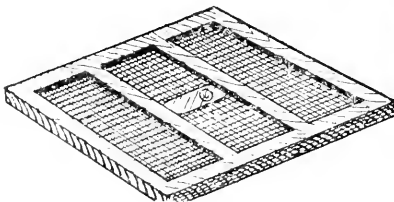

**B<sup>G</sup> B<sup>W</sup> BOARD**

A Necessity on all Hives all the Year Round.  
**SUPER CLEARER.**  
**QUEEN EXCLUDER.**  
**WINTERING BOARD,**  
&c.

SEND FOR KAT-A-LOG

**MEADOWS, Syston, Leicester.**

**POSITIVE FACTS.**

June 13th, 1920.

I am very pleased with the foundation. The bees undoubtedly prefer it to any other make I have, and have even gone the length of missing two sheets of other new foundation, and working out a sheet of yours placed behind them at the back of the hive. Full sheets have not sagged in the least in 16 X 10 frames.

Yours faithfully, R. B. MANLEY.

Illustrated Lists free by post.

**S. J. BALDWIN, The Apiary, BROMLEY, Kent.**

# DADANT'S WEED FOUNDATION.

**T**HIS Foundation is made from pure Beeswax and guaranteed free from all disease germs.

Give your bees the BEST, and the best is DADANT'S.

No acids or other chemicals are used in the manufacture, and the makers guarantee that "EVERY INCH, EVERY POUND, EVERY TON, is equal to any sample ever sent out."

We have just received a fresh consignment, and are in a position to give immediate despatch.

Rear healthy bees on clean, natural combs.

None genuine without the watermark "DADANT" on every sheet.

*Our Catalogue, entitled "Everything for an Apiary,"  
is sent post free on Application.*

---

**R. STEELE & BRODIE,**

Bee Appliance Makers,

**WORMIT, FIFE.**



THE  
KEY TO  
YOUR SUCCESS.

## Lee's Bee Supplies.

¶ In design, material and workmanship, Lee's Bee Supplies still retain the reputation of being your best and safest investment.

¶ Our 1920 ILLUSTRATED CATALOGUE is yours for the asking. It contains detailed information on the most up-to-date hives and appliances for which the House of Lee is famous.

¶ We regret the necessity of having to advise our Customers that owing to the increased cost of production, all prices in 1920 price list are subject to 10% increase. The increase will not apply to orders received before May 10.

\* \* \* Five per cent discount to Members of THE APIS CLUB.



**JAMES LEE & SON,**  
LTD.,  
Uxbridge, Middlesex.

(Telegrams: Graphicly, Uxbridge.)

Telephone: Uxbridge 181.)



## "BACTEROL" FOR BEES

2/9 per Bottle.

Post Free.

The cure for, and preventive of, "Isle of Wight" Disease. Non-poisonous—free from stain or unpleasant odour.

MENLEY & JAMES, LTD.,  
Menley House, Hatton Garden, E.C.1.

**BRADBURY, TAUNTON,**  
FOR QUALITY BEE GOODS.



*Illustrated Bee  
Guide free.*

Telephone: TAUNTON 176.

## 20-Page 1920 "WHITE STAR" List,

3½d. POST FREE.

S. SIMMINS, QUEENLAND, HEATHFIELD, SUSSEX

**Bees and Beekeeping Appliances. Catalogue free.**  
**EDWARD J. BURTT. MANUFACTURER. GLOUCESTER.**

*I very much regret that there has been a large increase in the cost of the manufacture of bee appliances, and therefore my prices will be advanced 10% from May 10th. Books excepted.*

PRINTED BY THE AVENUE PRESS (L. UPCOTT GILL & SON, LTD.), 55-57, DRURY LANE, LONDON, W.C., AND PUBLISHED FOR THE PROPRIETOR (W. HERROD-HEMPSELL), BY SIMPKIN, MARSHALL, HAMILTON, KENT & CO., LTD., 31 & 32, PATERNOSTER ROW, E.C.

SEP 17 1920



No. 1990. Vol. XLVIII

AUGUST 12, 1920.

[Published every Thursday, Price 2d.]

**CONTENTS.**

	PAGE		PAGE
SEASONABLE HINTS .....	385	MORE GOOD HINTS .....	391
A DORSET YARN .....	385	CORRESPONDENCE—	
JOTTINGS FROM HUNTINGDONSHIRE .....	386	The "Futtersaft" Theory .....	391
COTSWOLD NOTES .....	387	Stray Swarms Free Ride .....	391
NOTES ON BEE-KEEPING .....	388	Autumn Breeding .....	392
HONEY AT THE BLETCHLEY HORTICULTURAL SHOW .....	389	Wanted, An Explanation .....	392
STAFFS. BEE-KEEPERS' ASSOCIATION .....	389	Action for Damages Caused by a Bee Sting .....	392
KENT BEE-KEEPERS' ASSOCIATION — WESTERN .....	390	Fraternity Among Bee-keepers .....	393
DIVISION .....	390	NOTICES TO CORRESPONDENTS .....	393
DONCASTER AND DISTRICT BEE-KEEPERS' ASSOCIATION .....	390	BEE SHOWS TO COME .....	393

We have just received a consignment of  
**Lewis Superb Snow White Basswood**  
**SECTIONS**

Which we are offering at the moderate figure of catalogue price, plus 15%.

As this essential branch of Beeware is likely to increase in price next season we strongly advise our customers to purchase with a view to the future.

**HONEY BOTTLES**

1lb. actual size.

We are in a position to give prompt delivery of honey bottles. These are of the finest quality.

Price - 1-lb. 55/- per gross.  
 " 1/2-lb. 47/- " "

Reductions for LARGE quantities.

**E. H. TAYLOR, WELWYN, HERTS.**

**THE  
British Bee Journal**

Office: 25, Bedford Street, Strand, London, W.C.2.  
ESTABLISHED 1873.

A Weekly Journal Devoted to the  
Interests of Bee-keepers.

Edited by T. W. COWAN, F.L.S., &c.,  
and J. HERROD-HEMPSELL, F.E.S.

**Correspondence: Whom to Address.—**

All matters relating to the Literary Department, Associations, Shows, etc., should be addressed, "Editors, *British Bee Journal*," and all business communications and matters relating to subscriptions and advertisements to be addressed to the "Manager," *B.B.J.* Office.

**Subscriptions.** - Annual Subscription, 10s. 10d. post free in advance; single copies 2s., or 2½d. post free. If a receipt is required by post, a stamped and addressed envelope must be sent, otherwise a printed receipt will be enclosed along with the paper.

*Note.*—Cheques and Postal Orders should always be crossed, otherwise it is very difficult to trace them if they go astray.

**How to send Money.**—Remittances can be made payable to W. Herrod-Hempshall by crossed Cheques and Postal Orders. Stamps may be sent for small amounts up to 2s.

*Halfpenny stamps are preferred.*

Scottish or Irish cheques can only be taken in payment if 6d. is added for commission charged by banks for cashing them.

The Editors are not directly or indirectly interested in the manufacture or sale of bee-hives or appliances of any kind, and must refer correspondents wishing for prices or catalogues to advertisers in the paper.

**OUR DEPOSIT SYSTEM.**

You are advised to insist on this being used when dealing with strangers.

**Rules and Conditions for Depositing**

*In order to save trouble, it is requested that the Rules be carefully read over by persons using the Deposit System of trading.*

Goods should not be despatched until notice that the money has been deposited is received from this office.

1. **Method.**—When strangers are dealing together, the purchase-money of the articles is deposited at our office. We acknowledge receipt of the deposit to both parties, and hold the money until we are satisfied that the purchase is concluded. If a sale be effected, we remit to the seller the amount deposited, less a charge of 2½ per cent. in the £, with a minimum of 6d., and the expenses of Post Office Orders and postage, &c. Cash will be forwarded by Cheque, Post Office Order, or by Postal Order as preferred. If a sale or exchange be not completed, we return the amount deposited, after making the same deduction. By this means buyers and sellers are secured against fraud.

2. **Deposits.**—Postal Orders (drawn on General Post Office) and Cheques must be made payable to W. Herrod-Hempshall, and crossed "London County and Westminster Bank." The numbers of the Postal Orders should be kept by the sender. We cannot be responsible for any loss that may occur in transit.

3. **Money on Approval.**—All money will be sold by sample, which must be sent direct to buyer.

4. **Bee Appliances.**—In ordering, the time allowed for completing the order to be stated to us when sending cash. If maker accepts, we hold cash until transaction is satisfactorily completed, when the amount will be remitted, subject to conditions as in Clause 1.

5. **Bees and Queens.**—These will be dealt with entirely by the parties concerned, so far as price, &c., go, and when the purchase is satisfactorily completed cash will be remitted as per Clause 1.

6. **Goods in Transit.**—These are at the seller's risk, i.e., any damage to or loss of an article on its journey is borne by the vendor; but a rejected article must be properly packed and returned by the same means as was used in sending it.

7. **Carriage.**—The carriage of all goods, except such as are sent by post, is payable by the buyer, unless otherwise agreed. If any article sent on approval be returned, each party to the transaction must pay carriage one way.

**Books for Bee-keepers  
NOW IN STOCK.**

Cash in full must be sent with order.

A Modern Bee Farm ... ..	7/6	Postage ... 8½d.
Advanced Bee Culture (HUTCHINSON) ... ..	6/-	... 6½d.
Beginner's Bee Book (PELLET) ... ..	5/-	... 4d.
<b>BEE-KEEPING SIMPLIFIED FOR THE COTTAGER AND SMALLHOLDER</b> (W. HERROD-HEMPSELL, F.E.S.) ... ..	1/-	... 2d.
<b>BRITISH BEE - KEEPERS' GUIDE BOOK</b> (T. W. COWAN) Paper covers ... ..	2/6	... 3d.
Cloth covers ... ..	3/6	... 4d.
Dissectible Model of Queen Bee ... ..	4/6	... 3d.
<b>FERTILISATION OF FRUIT BLOSSOMS BY BEES</b> (T. W. COWAN) ... ..	-/3	... 1d.
Honey and Health (A. HOPE) ... ..	-/6	... 1d.
Honey Vinegar (REV. G. BANCKE) ... ..	-/2	... 1d.
How to Keep Bees (ANNA B. COMSTOCK) ... ..	5/-	... 4½d.
Management of Out Apiaries Pollination of Fruit in relation to Commercial Fruit Growing (C. H. HOOPER, F.R.H.S.) ... ..	3/-	... 2d.
<b>PRODUCING, PREPARING, EXHIBITING AND JUDGING BEE PRODUCE</b> (W. HERROD-HEMPSELL, F.E.S.) ... ..	2/-	... 3d.
Productive Bee-keeping (PELLET) ... ..	10/6	... 8½d.
Queen Rearing in England (F. W. L. SLADEN) ... ..	1/6	... 2d.
Scientific Queen Rearing (DOOLITTLE) ... ..	4/-	... 3½d.
The Bee-keepers' Vade Mecum (GEARY) ... ..	2/6	... 2d.
The "Townsend" Bee Book ... ..	2/6	... 2d.
WAX CRAFT (T. W. COWAN) ... ..	2/-	... 2½d.

**MISCELLANEOUS.**

Maeterlinck's Life of the Bee The Lore of the Honey Bee (TICKNER EDWARDES) ... ..	5/-	... 3d.
(TICKNER EDWARDES) ... ..	2/-	... 2½d.
<b>THE BEE WORLD</b> (supplied only to members of Associations interested in the control and development of the Apis Club, apart from ordinary members of the latter), per copy ... ..	-/8	... 1½d.
The Bee Master of Warrilow (TICKNER EDWARDES) ... ..	7/6	... 4½d.

**British Bee Journal & Record Office,**

25, BEDFORD STREET, STRAND LONDON, W.C.1.



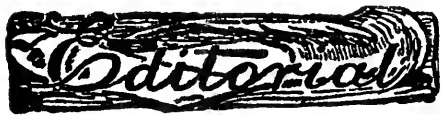

## Seasonable Hints.

Reports from most districts are to the effect that the honey season is again a failure. There is a chance that if fine, warm weather prevails from now onwards, bees may store honey enough for winter, or, at any rate, a good portion of the amount necessary. We have not heard how the heather is blooming, or the prospects for surplus from that source. Many stocks have needed feeding continuously the last fortnight or longer, and we are afraid that on the whole much feeding will be necessary this autumn or many stocks will go under.

Now we have had a few days' sunshine it is quite likely some swarms will have issued, and more may do so. The best method of dealing with them at this late period is to cut out all queen cells and return the swarm.

Re-queening should be done now as soon as possible, giving the new queen an opportunity of laying and getting thoroughly settled down for the winter with a fair number of her own progeny.

Great care must be exercised to prevent robbing. Entrances should be reduced, especially where colonies are on the weak side. No honey, comb or syrup should be exposed outdoors, and the places where they are stored should be bee-proof.

May we give a few hints to correspondents and advertisers. We have lately had several letters addressed to "Office, 23, Bedford Street." We have aforetime pointed out that we do not occupy the whole of the building, but there are half-a-dozen other offices whose address is 23, Bedford Street. If the name "British Bee Journal," or even "B.B.J.," is not on the envelope, how is the postman to know for which office a letter is intended? Better omit the name of the street than our name, for letters simply addressed "British Bee Journal, London," are delivered, even from abroad, and one of these was sent to "British Bee Journal, England."

To those sending prepaid advertisements we suggest sending in good time, especially when the advertisement is for the next issue. The Post Office is by no means infallible, or the service as good as in pre-war days. Letters are often delayed or lost, and it is no unusual thing for a letter to take three days to get across London. There is no need for us to tell our readers that the conditions

of labour are very different now to what they were, and if the *Journal* is to be printed in time for post on Wednesday, it must be made up on *Tuesday evening*, and advertisements that reach us after mid-day on Tuesday are too late. Last week we had nine on Wednesday morning for insertion in Thursday's *Journal*, and it was being printed at the time!

## A Dorset Yarn.

In looking round the stocks each day one cannot help but see how one lot far exceeds another, how bar after bar is filled by some natural swarms, and others only fill half of them in the same hive. It is all a question of numbers. Some swarms filled the largest skeps. One that Mr. Butson shook in for me when I was away at Cardiff had to have a box, so huge was the cluster. Now this one had filled the ten bars in a week, had completed the supers of shallow bars the next week, lots of them are now capped over, yet the small lot, with a fine yellow queen, had only done three bars in the same time. One could see that they would be robbed by the strong ones when autumn came, and when a strong lot of blacks swarmed out into two clusters the small Italian lot had about twenty times its weight of bees added to it to "ginger it up" a bit. They ran in too fast for me to catch the black queen, but the next day, when Squire Tomlinson came up, we had out the bars to see how the fusion of blacks and yellows had developed. We found that the blacks were balling the yellow queen, and the yellows were balling the black one. I took out the yellow queen in a box, and put it under the quilts to keep her warm, taking the black one away altogether.

The yellow queen was separated from the colony three hours. The whole of the bars were sprayed with flavine and sugar, the queen liberated and also sprayed as she went down among the bees. The workers began cleaning her at once, others began to feed her; she was in no hurry to go down among the masses who had used her so roughly only a few hours before. It was our opinion that each would have gone under but for our timely intervention. On looking at the bars yesterday, August 6, after nine days' interval, most of them were complete, and the yellow queen had got over her rough handling by the blacks. She looked a finer queen than she did nine days before; whether she had developed more by having more cells to lay in, or whether the blacks had fed her more to make up for rough usage, I can't say. It proves

to me more than ever it is only the strong stocks that are profitable.

The other cluster was given to another lot that had wintered through, but had never worked up its population. I had already taken off the shallow bars and given them to one that was filling up surplus fast. It is no use leaving on the weak stocks any surplus racks; if they have not gone up in them they will not late in the season.

Another strong swarm which came out the last day in June drew out its ten bars in as many days, but did not go into sections. I opened the rack and put in a section that was drawn out and full of uncapped honey. A few of the bees were always round this one section, but no other progress was made. I put on a box of standard bars on the top of the sections. They immediately went into them and began drawing them out. This lot were very strong, yet when every bar was full of honey and brood they would not work in the sections, though each one had full pieces of foundation, yet when the bars were added with the thick brood foundation they immediately began drawing them out. It seems to me that the bees take to the thick foundation more readily than the very thin sheets for sections.

We had another strong swarm that had done nothing in sections (these were given to another strong lot, who filled them in a week); but since the rack has been taken from them they have begun to build on the top of the bars up to the glass covering. It is too late for more sections, yet these would do shallow bars, even though it is August 8, but I do not want to stock in more shallow bars, as I find that the standard bars are much more useful for extension.

Bees seem to be swarming very late this season. We had one last Sunday when I came home from the 10 o'clock Communion service. The beautiful music was fresh in the mind when the music of bees in swarming-time gave me something else to think of. They settled on to a brick wall. I waited patiently till the queen settled on the swarm, and at once caught her. I took her away. The huge swarm soon found she was not with them, and they flew back to the parent hive and laid about on the big board that was in front, singing quite a different song to the one they had all sung so little time before. They have not been out since. Another lot swarmed on one of the warm days this week; these were pitched in the front of the hive when nearly dark. I could not see the queen as she went in with the rest, and they have not been

out again, even though it was very warm yesterday (Saturday, August 7).

We are getting quite a lot of visitors just now—motors cover such a long way in a few hours. One car came from near Bristol, another from Bath. I seem to have a good friend somewhere, who is telling others of the bees at the Violet Farm. Sometimes they go in to the bee run by themselves, when I am at another part of the farm. I do not see them myself, but they are beekeepers who are not afraid of bees. There is a card in each hive on which the visitors can read what progress has been made this season. This seems to be the best way to keep a record of what is done by each colony.

Flowers are really wonderful this season. Many acres of grass are not yet cut; the fields of upland grass which were cut early are now in full bloom again, while in many of the fields there is lucerne and sainfoin, which is in blossom. In one fine day the upper cells in the bars are nearly full. The blackberries are still in blossom, asparagus has still the thousands of blossom, the men have the bees round them as they are working in the long lines of violets. The asparagus plants are growing between the long lines of black currants, the great plumes of feathery foliage 8 and 9 ft. high covered with the little flowers, while the red clover seems to be everywhere, wild scabious and the ling healer. Bees should gather a great deal of surplus if the weather will only be fine. So many visitors say that there is little honey gathered in many parts of England, but I think it is those who only work for sections; bees will take to bars much more readily.—J. J. KETTLE.

---

### Jottings from Huntingdonshire

The rain descends and the wind blows boisterously over the sea as I write, while an excellent band is trying to bewitch us into thinking we are in Italy by playing "A Day in Naples," but we are in Bournemouth nevertheless, and half the world seems here with us. Some seem quite at home, others are evidently out of their element. Not a few, one gathers, are visiting Bournemouth for the first time. Many have come with the idea that, whatever weather prevailed elsewhere, at Bournemouth it would be fine and warm. It is pathetic to see brave lasses shivering in sponge-cloths and muslins. One sees taste and refinement side by side with the strangest mixtures of humanity. It is cheering to see people, out for enjoyment, doing the thing in an orderly manner, but I am always unable to plumb the psychology of those human beings who seem to

delight in passing rude remarks concerning everyone more well ordered than themselves. Life is nothing without brotherhood, and brotherhood is impossible when those who delight in being vulgar refuse to fraternise with those who would enlarge their outlook and build up their best. A man passes dressed in a black coat, grey vest, white flannel trousers, and nigger-brown boots. His taste has gone awry, but what matters it; on either arm hangs a girl, ages about 8 and 10, one blonde, the other as fair as day—all are as happy as the weather will let them be. Two leering Johnnies pass them, and with a smirking laugh one is heard to say loudly so that the man may hear, "What a fool Jack is to have his wenches spoiling his sport. I've left mine at home with the old dutch," and swings round to receive sympathetic smiles from the crowd; but the crowd doesn't smile, and the Johnnies-smirk their displeasure at our supposed lack of humour. Such individuals do not keep bees; did they do so, the little insects would teach them better manners. I will paraphrase Solomon, and say, "Go to the bee ye fools, consider her ways, and be wise."

We motored down here, my warden and I. Of course, as county after county unfolded itself, one compared their pasturage for bees. Some districts in Buckinghamshire were rich with honey flowers; others, like the stretches between Steventon and Newbury, and between Andover and Salisbury, appeared to be devoid of any flower of advantage to bee life. As we entered Dorsetshire the heather bloom was rich and full, and rest harrow had literally taken possession of many fields. We hope to return by another way—maybe the hills and plains, downs and headlands, will each reveal a secret which only bee-keepers understand. My jottings didn't get written last week. I was too busy, among other things, returning postal orders to readers who had misread my jottings of a fortnight ago. I was not proclaiming a certain cure for crawlers, but quoting a letter I received. If the gentleman who claims to have this specific is sure of his ground, his duty is to advertise his potion in the *Journal*. If he has a certain cure, he will not lack for orders.

Referring to the new disease—if it be one—I am most grateful to those readers who have written to me. It appears by one and another, samples of these crawlers have been sent to bacteriologists of every university in the kingdom, and in no case has a trace of any known bee disease been found. My kinsman's experience is noteworthy, as showing that

Flavine is the remedy to use. Yet a lady writes to say she had stocks so afflicted, and in disgust determined to destroy them, and sulphured them with that object in view, and instead of dying they took a new lease of life, and never crawled again. Poor Virgil! What would he have said to "Izal" and "Flavine," and "Yadil" and "Bacterol"? He has something to say about crawlers, but then bees emerged from dead oxen, and crawlers were bees which hadn't fully grown their wings; but, withal, if every bee-keeper were as observant as Virgil, at this time we should have learnt the language of the bee.

E. F. HEMMING.

Steeple Gidding.

---

## Cotswold Notes.

Now that we have reached August—the month of re-queening—a few remarks on queen introduction may be timely, in view of this operation always being attended with more or less risk.

I suppose that, in spite of our advanced knowledge of bee-keeping, at least 5 per cent. to 10 per cent. of queens given to queenless stocks are killed, or balled by hostile bees.

Removing a fertile queen and giving a strange one attended by strange bees, is only successful when the colony is placed in the right condition to prevent hostility to the queen we wish to introduce. Bees openly hostile always will either kill the queen outright or ball her so badly as to render her practically worthless.

When, however, stores are plentiful, honey is coming in, and the colony has plenty of sealed brood with young hatching bees, it will usually accept a queen given in the ordinary mailing cage in which she is liberated by the candy at one end being eaten away. A full colony in possession of a virgin queen will quickly accept a fertile queen when the virgin is removed and the candy method of introduction employed. This also applies to stocks having cells in an advanced stage.

Queens are accepted very readily when the cells are torn down, and the bees find themselves hopelessly queenless without means of commencing fresh cell-cups. And, as a general rule, the stronger the stock the greater is the risk of getting the queen killed, unless every precaution is taken.

There is a marked difference amongst colonies in this respect, and the mildest-tempered ones are frequently very easy to deal with.

For this reason, in systematically re-queening in August or September, the nucleus plan has its good points, and,

indeed, is the one I prefer in dealing with valuable imported queens.

Place two combs of daily emerging brood—either from a queen-excluded deep super or the hive you wish to re-queen—into a small box or hive holding three frames; add one comb of honey, and, after shaking in the bees from two other combs place the cage containing the queen on the comb and cover up with a porous cloth or sack. The newly formed nucleus should be placed beside the stock we wish to requeen, and its small entrance stuffed with grass.

About an hour before sunset remove the plug of grass temporarily to give the field bees an opportunity of rushing back to where they were taken from, and the non-arrival of food-laden bees has a quieting effect on those that remain.

On the evening of the second day after formation the grass can be removed altogether, and in about five days the queen will be found amongst the bees, and nine times out of ten will be laying.

All that is then necessary is to remove the failing queen, and the following evening flour both lots and unite them.

A few years ago, when driven bees were plentiful, and could be had for the driving, we used these largely for requeening purposes.

If, during the autumn examination, a colony was found to be weak, with little brood, the queen was killed, and a day or two later a young-queened lot of driven bees was shaken in after dark.

Late casts were most useful for this purpose. This is a simple operation, and rarely caused any fighting. Bees of a nucleus, if shaken off their combs, can also be united in this way to any colony needing a queen without the slightest risk if carried out always at night when the bees are too sleepy to attack one another. The absence this season of bright sunshine and a steady flow has had quite a noticeable effect on the colour of the queens bred during the cool and wet periods. None are so bright in colour as those raised in May under better conditions, and this year even queens from pure Italian mothers are quite dark, I find.

Some, also, have waited 19 days before mating, owing to the low temperature and lack of warm sunshine. As a rule imported queens do not survive very long after introduction. They either swarm on the first opportunity or the bees supersede them, probably due to some defect caused by the long confinement in the mailing cage.

For this reason I have practically discontinued getting queens from very long distances.—A. H. BOWEN, Cotswold Apiaries, Cheltenham.

## Notes on Bee Keeping.

Apiculture, or bee-keeping as it is termed by bee-keepers, has made rapid strides during the last half-century. It is scarcely credible that even thirty years ago it was an exceptional thing to see a movable comb hive in a cottager's garden. Now, owing to the exertions of many in promoting this most useful employment and greatly to the spread of information contained in bee-books, and to many bee-keepers giving a share of their valuable time in lecturing to promote its advancement, it has spread throughout these shores, nay, to many countries far distant, even to the Antipodes. It has assumed such extensive proportions that whereas some years ago no one thought of sending bees any distance by rail or otherwise, now they are sent thousands of miles. Hives of bees have been sent to Australia and India; in fact, with modern devices one can hear of bees being sent successfully to Persia, a journey occupying over a month, the greater part of the route being overland in a very hot climate, a feat unthinkable in days gone by, owing to the danger of combs breaking down from heat. Our forefathers netted a considerable amount of income from their ancient methods of bee-keeping; how much more now that we have foundation with us, which means a prolongation of life to our bees—to say nothing of regulating the queens' laying capacity. Then we have the extractor, which has proved itself such a boon in modern bee-keeping, an appliance used for the purpose of extracting the honey from the combs without any injury that would impair their future utility in being refilled by the bees with honey. It was a practice by our old-time bee-keepers to remove their surplus from the combs by straining out the honey through a muslin bag hung up before the fire, and allowing it to drain into a receptacle below, the last portion being squeezed out—a mixture of lacerated brood and honey. With the honey extractor the combs, after removal of cappings, can be relieved of their contents by centrifugal action, after which, if desirous, they can be returned to the hive to be filled. There are many other inventions that could be mentioned, all a saving of time and labour for our bees, and in the end an increased honey harvest to the bee-keeper.

One wishes that our English farmers would take up the craft as some of our Colonial farmers do, notably Australian. I have been surprised when hearing the quaint ideas put forward by some of our farmers here, who deprecate bee-keeping as being detrimental to their crops. In what manner are they so? The answer

has been, "They take the saccharine matter from the clover, and so rob the hay of its sweetness." When we come to examine this in its true light we ask the question, what is the nectar in the clover flower produced for? As an attraction to the bees and other insects who, whilst collecting same, carry the pollen from the male to the female flower, or from the male to the female portions of different flowers, and so fertilise them. By this we obtain the production of seeds, a great impetus is given the plant in order to produce them, and they—the seeds—contain the chief elements necessary for the formation of flesh upon cattle that is fed upon them. Without the seeds hay would be, in comparison, of little value. Would a farmer give as much per ton for hay that has been threshed for its seed? I should suggest not. Or would his cattle fatten as well as on seed hay? Certainly not; any cattle farmer would substantiate this. Without bees and insects, flowers would not be fertilised, and would produce no seeds. If my statement be correct, then, after all, the bees are a profit to the farmer, the stock-keeper, and the bee-keeper; in fact, the consumers of the meat reap their share of the benefit. This also applies to other species of flowers besides the ordinary clover flower. Without bees, apple, cherry, raspberry, currant and plum would be less productive. An apple and pear grower of my acquaintance stated that since he had lost his bees the fruit was more scanty and the trees not half so productive. These are things that speak for themselves.—P. LYTHGOE. Padgate, Warrington.

### Honey at the Bletchley Horticultural Show.

In connection with the above Show the Bucks County Bee-keepers' Association held a small honey show on August 2, 1920, at which the honey exhibits showed a very great improvement on previous years, both in quantity and quality. An observatory hive, staged by Mr. A. E. Warren, proved a tremendous attraction during the whole time.

The exhibits were judged by Mr. A. E. Warren, who made the following awards:

Four 1-lb. Sections.—First, J. Kent, Milton Keynes; second, Mrs. Faral Smith Simpson, Bletchley.

Four 1-lb. Bottles Light Honey.—First, W. Goom, Bletchley; second, Col. A. W. H. Good, Broughton; third, Mr. Faral Smith.

Four 1-lb. Bottles Medium.—First, J. Kent; second, Col. A. W. H. Good; third, David Jones, Little Brickhill, Bletchley.

### Staffordshire Bee-keepers' Association.

LICHFIELD AND DISTRICT BRANCH.

The members of above Association successfully revived the "Honey and Bees" section this year at Lichfield's Floral and Horticultural Societies' Centenary Exhibition, on 2nd and 3rd instant, after a lapse of many years.

The Exhibition was held in "Beacon Park," Lichfield, being well supported by the local bee-keepers, and proved a great attraction to the thousands who visited the Show.

The awards were as follows:—

OPEN TO ALL.

Class 1.—Four 1-lb. Sections of Honey: 1, G. H. Mytton (no other entries).

Class 2.—Four 1-lb. Jars of Light Honey: 1, E. Jacques; 2, M. Craddock; 3, G. H. Mytton.

Class 3.—Four 1-lb. Jars of Granulated Honey: 1, E. Jacques; 2, M. Craddock; 3, G. Dale.

Class 4.—Four 1-lb. Jars other than Light Honey: 1, E. Jacques; 2, G. H. Mytton; 3, T. W. Stewart.

Class 5.—Shallow Frame of Honey: Equal 3, E. Jacques and G. H. Mytton.

Class 6.—Beeswax, Not Less than ½ lb.: 1, E. Jacques; 2, M. Craddock; 3, G. H. Mytton.

The judge, Mr. J. Price, County Expert, expressed his satisfaction at the quality of the exhibits, and during the afternoon gave two interesting lectures on bees, holding his audience spellbound while he explained the development of the bee from the egg onwards, in which he was greatly assisted by the presence of two observatory hives, each stocked with bees. These were honorary exhibits, together with two trophies of honey, and proved to be a great attraction, exhibited by E. Jacques and G. H. Mytton. Those provided by the former were headed by an Italian queen, imported under the Government Re-Stocking Scheme.

At 3 o'clock and 5 o'clock open-air demonstrations were given with bees by the County Expert to crowded audiences, enabling him to drive home theories advanced while lecturing in the "Honey and Bees" tent.

An interesting educational exhibit was staged by Mr. J. Price on behalf of the Staffs. Educational Committee, by whom he is employed. It occupied two 8-ft. tables, and contained many interesting specimens of ancient and modern bee appliances.

The Silver Medal was awarded to E. Jacques, and the Bronze Medal to G. H. Mytton, being provided by the Staffs. B.K.A.—E. JACQUES, Hon. Sec.

### Kent Bee-Keepers' Association: Western Division.

LECTURE ON BEE-KEEPING AT WORCESTER LODGE, DULWICH, BY THE KIND INVITATION OF J. H. HARRIS, ESQ.

Dr. C. Courteney Lord, of Orpington, first class expert of the B.B.K.A., gave an interesting lecture on bee-keeping.

The weather was fine, and about 40 enthusiastic bee-keepers were seated on the lawn, where one of Mr. Harris's hives was brought for the demonstration.

The lecturer, who was introduced by Mr. Harris in a few suitable words, first explained the advantages of the modern hive over the straw skep. Stress was laid on starting with a good standard hive on the W.B.C. pattern.

Frames were exhibited, wiring and full sheets of foundation were recommended.

The lecturer then opened the hive, after subduing the bees with the smoker, and the three kinds of bees were shown, great interest being taken in the queen.

The whole economy of the hive was gone through, use of pollen, with a short life history of the bee, from the egg to the fully developed bee. The lecturer impressed upon his audience that gentleness and firmness were the chief points to be remembered in the manipulation of the hive. The methods of treating bee stings was gone into, but there was no need for application, as the bees were in good humour.

A hearty vote of thanks was accorded the lecturer for his most interesting and instructive address.

In proposing a hearty vote of thanks to Mr. Harris for his kind invitation and use of his garden and bees for the demonstration, Mr. A. E. Barnes, of Anerley, said it gave him pleasure to accept Mr. Harris's invitation, and invited all bee-keepers there, if they did not belong to an Association, to join the Western Division of the Kent Bee-keepers' Association.

Among many reasons why people should take up bee-keeping—

(1) It is an interesting and healthy hobby, and a hobby, if managed properly, that could be made to pay.

(2) Bees should be kept for fertilisation of fruit trees, for although there are many agents, there is none so perfect as the bee.

(3) Honey is not only a sweetening agent, but a *food*, and if we can add only a few pounds of food to the national supply it is our duty to do so. We want bee-keepers to unite and strengthen the hands of the mother Association (B.B.K.A.) in research work and obtaining legislation, both of which are sadly needed in battling the existing bee diseases, especially the "Isle of Wight" disease.—  
W. E. C.

### Doncaster & District Bee-Keepers' Association.

An interesting hour was spent at Doncaster Grammer School apiary on July 21, a good company being present.

The feature of the apiary is queen-raising.

The first item was the "introduction" of queens. Two Penna queens had arrived from Italy the previous day, and had been caged in hives for 24 hours. Both hives had been queenless some days, and cells removed. With the first, the cage was opened, and the bees and queen released on a frame taken from the hive for the purpose; the bees at once attacked the queen's attendants, and, though the queen herself was not attacked, it was thought advisable to cage her for another day. With the second, the queen was taken without her attendants and placed on a comb; the hive bees immediately caressed and fed her, and she was deemed "accepted."

Nucleus mating boxes were next shown. These were made in four compartments, consisting of 3, 2, 2 and 3 baby frames respectively. These baby frames are each 8 in. by 4½ in., three just filling a standard frame, the standard frame being drawn out in an ordinary hive and filled with brood. When the nucleus hive is to be furnished, each baby frame has a 10-in. top-bar attached to it by two thin strips of tin passing over the top-bar and tacked to each side of the frame, the longer edge now being horizontal, whereas it was originally vertical. The frame, when prepared, is placed among some queenless bees in a top storey, and those which adhere to the comb are placed with it in the nucleus box; the young bees remain with the nucleus and readily accept a virgin or cell. In every case the yellow queen was easily discoverable even by the merest tyro.

This method of getting queens mated had proved a failure, only about 20 per cent. of the virgins becoming fertile, but it was thought the extraordinarily bad season was mainly responsible for this want of success. A great number of drones had been specially reared to ensure quick and true mating.

The method advocated by some American writers, notably Doolittle, Pellett and Alexander, of mating queens above "queenright" colonies, was then examined.

Over a brood-chamber strong in bees, and having a vigorous young queen, was placed a queen excluder; above this a shallow box, and above this another excluder. Above this again a further chamber, taking standard frames containing stores, sealed brood and bees; this chamber was divided by excluder

division-boards, making queen-proof chambers one at each side of the hive, and each containing two standard frames. The floor of each of these compartments was carpeted with sacking so that there was no direct communication with the chamber below. (The central part of this top storey was found excellent for raising grafted cells in carriers.) Bees in the outer compartments either built out their own cells or accepted those given, and these emerged; but, though there was an opening to the outer air at the back of the hive for each compartment, no queen had ever been mated in the course of the three months the experiment had been tried, nor was a virgin ever found alive after more than three days from emerging. When the back holes were kept closed, the virgin would be discovered dead, but if the holes were open, she would disappear or be found dead outside. Only in one instance was a cast observed, though it is probable that several virgins were lost that way. The experiment with six compartments in three very strong hives had every time been a complete failure.

Doolittle's dictum that "if a virgin hatched above finds its way into the brood-chamber below, the reigning queen is invariably superseded by her," was disproved; at least, two virgins somehow got below, but had been promptly ejected dead.

Next were shown some wonderful photographs taken by the Rev. G. H. Hewison, secretary to the Association. A particularly fine microphotograph of the tip of the bee's sting clearly showed the poison ducts. Mr. Hewison makes a speciality of photomicrography and lantern slides of bees and their anatomy, and those shown included the "tip of the tongue," showing the capillary hairs at the tip; "section through a compound eye," the "blind louse" of the honey bee and its wonderful foot, the different legs of the honey bee, showing the different "tools" with which each is equipped, etc. He also showed a series of photos of hives from prehistoric times up to date, and one felt bound to give to Germany the credit of using the movable comb before it was "invented by Langstroth."

For part of the hour the sun very kindly disclosed himself.

Truly a crowded hour!

(Communicated.)

### More Good Hints.

If it is good to paint the bee-hives white, then paint the honey tanks black, and your honey will cure better, can easier and also save the tank.—From the *Western Honey Bee*.



The Editors do not hold themselves responsible for the opinions expressed by correspondents. No notice will be taken of anonymous communications, and correspondents are requested to write on one side of the paper only and give their real name and addresses, not necessarily for publication, but as a guarantee of good faith. Illustrations should be drawn on separate pieces of paper. We do not undertake to return rejected communications.

### The "Futtersaft" Theory.

[10250] I am grateful, with all the readers of the B.B.J., to Miss Betts for her correction of my translation of the Futtersaft theory. Of course, the young bees are loaded with albumen by the elder bees. It is their vomit, and the young bees cannot pass it up to them against the stream. The only way out is through the queen, and this means in the end, through drones, young queens and the swarm. Gerstung says: "What the elder links of the chain cannot use . . . flows to the younger as superfluity, and *vice versa*." And again: "It is apparently carbohydrates or warmth that flows from the young upwards, and albumen and fat that flow from the old members to the young." Would it not be as distressing to the foraging bees as to anyone else, not to be able to get rid of their special superfluity because the hive was already over-warm, and the young bees required no fat?—G. G. DESMOND, Sheepscombe, Gloucestershire.

### Stray Swarm's Free Ride per M.R. Goods, Ashchurch to Birmingham.

[10251] It may be of interest to some of your readers, particularly one bee-keeper somewhere near Ashchurch (Gloucestershire), to hear that a swarm (about 4 lbs.) took possession of a corner of an open railway truck at Ashchurch, loaded with sacks of chaff, but which had previously contained some sugar, and had a free ride to Birmingham.

About 1 p.m. to-day a friend and myself had a phone message from the M.R. Goods Yard (through the Birmingham *Gazette* office), saying there was a swarm of bees in one of their trucks, and if we "took a hive" down and hived them we could have same. Needless to say, this was soon done, and by 2.40 the truck was "unloaded" without any demurrage charges.

I do not know if "Nature Notes" in the Birmingham *Daily Mail* are intended to educate the people, but, according to their issue of Saturday, July 10. I think

it was, speaking of first swarms, they say: "As soon as the first queen hatches out she leaves the hive with a lot of the bees to seek a fresh home." And later, in same article, mentions "bees and other animals." Oh, dear! Birmingham *Daily Mail*, who is your writer of these "Nature Notes"?—W. GOLDSMITH, Birmingham.

[The last statement is not altogether incorrect, for though bees cannot be classed as "animals" they belong to the "animal" kingdom.—Eds.]

### Autumn Breeding.

[10252] It would save many stamps to bee-keepers if they referred to my article about the above item in Vol. XLVII., October 2, 1919, Letter 10006, page 436, BRITISH BEE JOURNAL. I take it a wise man keeps his JOURNAL, and does not throw it in the waste-paper basket as finished, or valuable information is lost for good, and causes endless trouble to renew. This valuable little paper is well worth keeping for reference. Make it part of your library for winter evenings.—CYRIL TREDCROFT.

### Wanted, an Explanation.

[10253] Can you, or any of your correspondents excuse or explain the vagaries of the bees, of this neighbourhood at any rate, this year?

My own experience is as follows, and several neighbours within a radius of from half-a-mile to five miles have had more or less similar ones. From three strong stocks I took two good swarms before May 9; these were duly hived, and very quickly established themselves on three, and eventually nine, frames. They were fed whenever the weather demanded it, even after they had made considerable store.

In due course swarms, as well as the original stocks, were provided with racks of sections with full sheets of wax. One of the original stocks partially filled its rack; and, acting on expert advice, and against my own judgment founded on repeated experience of an unsatisfactory description, I put another rack of sections under the partially filled one—with the result that the partially filled one was forsaken uncompleted, and the lower rack altogether ignored.

The other hives treated their racks of sections with complete contempt.

All stocks are extremely strong; the lower frames full of brood and honey. But in one case they had deliberately filled up nearly all the holes in the queen excluder with wax, so as to prevent bees going up to the sections! I have cut

out queen cells several times, fed the bees when the weather was wet and cold for any length of time, not unduly "fussed" over them, which I have been warned is often an amateur failing; the hives are in an ideal place, in a garden full of fruit trees, as well as lime, privet, acacia and honey-producing flowers; within 700 yards of the front of the hives was a large field of white clover; quite near, the bees were also revelling in a field of beans.

In May our local expert paid me a visit, was warm in praise of the "best stocks he had seen so far," and complimented me on their care and management. Last week two large swarms came out, but in each case I secured the queen and drove them back, and they settled down happily, and apparently are working well—but with no surplus honey results.

I ask, what more could bees desire that I have not done for them? Yet, if I find twenty full sections from the four hives it will be more than the bees at present have given me reason to expect.

I read your JOURNAL, as well as the article on bees in *Gardening*, every week with great interest, and shall be most grateful for any information or criticism.—BEATRICE GRANT.

[Our correspondent's experience has been general. The behaviour of the bees is due to the unfavourable season. Had there been a decent "honey flow" the bees would have occupied and filled the sections; they would have had no time to get into mischief and fill up the queen excluder.—Ed.]

### Action for Damages Caused by a Bee Sting.

[10254] *Re* report of action in Paisley Sheriff Court in *B.B.J.* of July 22, the report was in most of the Glasgow papers. I read it in the *Evening Times* and also in some other paper.

I think the Sheriff was very considerate for the defender, knowing what ground is usually attached to a house in any residential neighbourhood. It was a most unsuitable place to keep bees, and the defendant was asking for trouble.

Living under similar conditions and keeping bees, I have them about two miles out in the country. They annoy no one, and but for a little trouble in the hiving season I get on all right.

As I write this I have one eye partly closed, my nose is increased in size on one side, and a lump on one cheek. I was out last night visiting friends when I was asked to look at some hives of bees. It was not possible to get a veil, nor did I want one for all I had to do, but ere I was done three bees got home. Stings don't annoy me, but they might hurt and



annoy my next door neighbour, and I have no right to expose him to that danger.

We are having one of the worst seasons on record. With ten stocks I don't think I could get 30 lbs. of honey from the lot; some are being fed to keep them going.

I was in Dumfriesshire last week holidaying, and the same conditions were holding there. Perhaps the heather will help.—J. C. A., Grangemouth.

### Fraternity Among Bee-Keepers.

[10255] I was quite under the impression that (10216), July 8, was "writ sarcastic," and as I am comparatively a novice should have left it at that. As, however, other bee-keepers, including men of experience, have asked me what I made of it, I feel that to comment on "Foxcroft's" letter may help dispel some misunderstanding from the mind of some other novice.

I will confine myself to saying that if "Foxcroft" is quoted correctly and I were in his place—

(1) I should not be surprised if the stock were found queenless if all queen cells were cut out after swarm had issued.

(2) I should expect the friendly bee-keeper responsible to cycle his nine or ten miles pretty quickly and produce me a queen forthwith (and not let the stock dwindle while he "endeavoured to obtain or rear me a queen").

(3) This beekeeper may be a "live" one, but the queen and cells are gone, and unless they are replaced the stock is as good as dead.

Surely, Mr. Editor, your usual parenthetical comment was mislaid by the "printer's devil."—A. M. WALKER.

[We did not see that any comment on the letter from "Foxcroft" was needed, and we think our correspondent has misunderstood his letter. It does not follow that if all queen cells were cut out the colony was left queenless. A young queen had probably emerged from one and was lost later.—Eds.]

## Notices to Correspondents

MRS. BEVILLE (Essex).—*Transferring from skeps.*—Better leave the bees in the skeps till next spring. We cannot say how much sugar they will need, as this will depend on the amount of honey stored in the combs. An average colony requires from 25 to 30 lbs. of stores in the combs for winter. You could take combs from those that have more than they want and give to others needing more stores. A standard comb when full of honey contains about 5 lbs. We prefer to leave the ten combs if bees cover them

all. Close the bees up on to the number of combs they will cover when packing down for winter, taking out those with the least food.

"CANDY" (Yorks).—*Softening hard candy for winter use.*—Keep it for a time in a damp place, first removing the wrapping paper. We have softened it by putting the cakes in a box, covering with a damp cloth, and closing the box lid.

"GREENFIELD" (Glanton).—The bees are hybrids, but there appears to be very little Italian in them.

#### Suspected Disease.

E. MACKENZIE (Staffs), H. F. (Sheffield).—The bees are affected with "I.O.W." disease.

## Bee Shows to Come.

*A nominal charge of 2s. 6d. is made for notices (not exceeding 7 lines) in this column, 10 lines charged 3s. 6d., up to 15 lines 6s., which covers cost of insertion from order till date of show. Cash should accompany orders for insertion.*

**August 12, at Taunton.**—Somerset Beekeepers' Association Show of Honey, Wax, and Appliances. Seven Open Classes. Liberal prizes.—Schedules from Mr. F. J. Stacey, 3, Hammet Street, Taunton. Entries close August 6.

**August 14 and 16, at Cannock, Staffs.**—Eight open classes for honey, etc. Prizes value £12. Schedules from J. Bird, Secretary, "Glenmay," Allport Road, Cannock.

**August 14, at Llanelly.**—Carmarthenshire B.K.A. Show, in connection with the Llanelly and District Horticultural Society's Show. Liberal prizes (nearly £15) offered for Honey, Wax, and Appliances. 15 Classes (7 Open).—Schedules from R. Lloyd Roberts, London Joint, City and Midland, Llanelly. Entries close August 6.

**August 18 and 19, at Coventry.**—Warwickshire Beekeepers' Association, in connection with the County Agricultural Show. Lectures on both days.—Schedules from Mr. J. R. Ingerthorpe, Knowle, Warwick.

**August 18 and 19, at Derby.**—Derbyshire B.K.A. Honey Show to be held on the grounds of the Derbyshire Agricultural Society. Two Open Classes. Three Cups in Members' Classes.—Secretary, F. Meakin, 37, Pybus Street, Derby. Entries closed.

**August 25, at Chester.**—Cheshire Beekeepers' Association, in connection with Cheshire Agricultural Society. Several Open Classes. Good prizes.—Schedules from Thos. A. Beckett, St. Werburgh Chambers, Chester.

**August 25, at Prestbury, Cheltenham.**—Flower, Fruit and Honey Show. Open Class for single 1-lb. jar of honey. Several classes open to beekeepers living within a radius of 12 miles.—Schedules from A. H. Bowen, Coronation Road, Cheltenham. Entries close August 13.

**August 28, at Hounslow.**—Hounslow and District Allotment Holders' Association Second Annual Exhibition of Vegetables and Fruit. Honey exhibits under the control of the Twickenham and Thames Valley B.K.A. Open Classes for single bottle and section.—Schedules from Miss M. Byatt, "Hawthorn," Hanworth, Middlesex.

**Saturday, August 28, at Hinckley.**—Leicestershire and Rutland Beekeepers' Association, in connection with Hinckley Flower Show.—Open Classes for Honey, Sections and Jars. Prizes, 12s. 6d., 7s. 6d., and 4s. 6d. in each class. Judge, J. Herrod-Hempsall, F.E.S.—Schedules from A. Kimbrell, Esq., Clarendon Road, Hinckley. Entries close August 23.

**September 1 and 2, at Glasgow.**—Glasgow and District Beekeepers' Association Second Annual Show, in conjunction with Glasgow and West of Scotland Horticultural Society.—Open Classes in Honey Section.—Schedules from Peter Robbington, Hon. Secretary, 65, Robertson Street, Glasgow.

**September 8, 9 and 10.**—Portsmouth B.K.A. Honey Show, in conjunction with the Portsmouth Allotment Holders' Show, at Connaught Drill Hall, Portsmouth. Six Open Classes. Judge, W. Herrod-Hempsall, F.E.S.—Schedules from Show Secretary, Mr. J. Sinnett, 154, Essex Road, Southsea.

**Saturday, September 11.**—Fforest-Fach Horticultural Society, Swansea. Three Open Classes for Honey, extracted and sections. Help to foster bee cult this end. 1st prizes, 10s.; 2nd and 3rd in proportion.—Schedules ready from G. L. Williams, Fforest-Fach, Swansea.

**September 22.**—Atrincham Show. Several Open Classes for Honey and Appliances.—Schedules from H. Turner, 1, Market Street, Atrincham.

**October 5 to 8.**—Essex Fruit and Honey Show at Institute of Agriculture, Chelmsford. Open from 12 to 8 p.m. Admission free. Lectures and demonstrations each day.—Schedules from G. R. Alder, 7, Bulwer Road, Leytonstone.

**November 18.**—Annual Show of the Worcester City and County Chrysanthemum, Fruit, Root and Honey Society. Thirteen Open Classes in Honey Section.—Schedules from Geo. Richings, 42, Barbourne Road, Worcester. Entries close November 6.

## Special Prepaid Advertisements.

One Penny per Word.

*Will advertisers please read these Rules carefully in order to save trouble, as they will be strictly adhered to.*

Trade advertisements of Bees, Honey, Queens, and Bee goods are not permissible at above rate, but will be inserted at 1½d. per word as "Business" Announcements, immediately under the Private Advertisements. Advertisements of Hive-manufacturers can only be inserted at a minimum charge of 3s. per ¼ in., or 5s. per inch.

PRIVATE ADVERTISEMENTS are only intended for readers having Surplus Stock to dispose of. Driven Bees, Nuclei, and Queens that are reared or imported for sale, are Trade Advertisements, and can only be accepted under trade terms. A charge of 6d. extra will be made if a box number is used.

Orders for three or more consecutive insertions in "The Bee Journal" entitle advertisers to one insertion in "The Bee-Keepers' Record" free of charge.

Advertisements must reach us NOT LATER than FIRST POST on the 27th of the month for insertion in the next month's Record.

### PRIVATE ADVERTISEMENTS.

**TEN** 1920 Queens, British-Italian Hybrids, first cross, 7s. 6d. each.—WHITE, Penny Hill, Holbeach, Lincs. h.27

**TWO STOCKS** good healthy Bees, 8 and 10 frames, 7s. 6d. frame, carriage paid; box 12s., returnable.—BEESON, Southwell, Notts. h.28

**FOR SALE**, good Swarms of Bees, Italian cross, May, June and early July.—STRATTON, St. Andrew's, Warminster. h.29

**BEEES.**—Few surplus Stocks, fine strain, 70s., carriage forward.—UNDERWOOD, Cogenhoe, Northampton. h.30

**GOOD VALUE.**—Three Stocks on 5 frames, brood and stores, covered with bees, strong and vigorous, 50s. each, or £7 5s. the lot, carriage paid; boxes free; prolific 1920 Queen, 5s.—ALUN JONES, Halkyn, Flintshire. h.31

**FINEST GOLDEN HONEY**, sample 6d.; also Swarms. NORTH, Crossing, Braintree, Essex. h.33

**STRONG**, healthy Stocks of Italian Bees on 10 frames, and strong Swarms, also on frames, for Sale. PAINE, Dovenden, Tenterden, Kent. h.34

**OFFERS WANTED** One Stock of Bees (cross-bred) on 8 frames, one Nucleus, 5 frames; travelling boxes returnable; also 6 lbs. of Wax.—BROWN, 3, Maidens Bridge, Waltham Cross. h.35

**TWO** strong, healthy Stocks of Bees for Sale, plenty of brood and honey, with Hives, £10.—BEATLEY, 23, Tirlmont Road, S. Croydon. h.36

**STRONG**, healthy 10-frame Stocks Hybrid Bees, just cleared from supers with this year's Queens, 50s. each; boxes to be returned.—VINCENT, 132, Croydon Road, Anerley, S.E. h.37

**TWO** healthy Stocks of Bees for Sale on 10 frames, £3 each.—BURGESS, Newport Pagnell, Bucks. h.38

**HYBRID BEES**, 7s. 6d. per frame; splendid workers; overstocked.—COOKSON, Beech Cottage, Longton, Preston. h.39

**SURPLUS** 1920 Hybrid Fertile Queens, Penna strain, 7s. 6d. each, post free.—EVANS, Lattiford, Wincanton, Somerset. h.40

**FEW STOCKS** of Italians and Hybrids, packed with bees, on 10 frames, £4; boxes 12s., returnable.—HENSLEY, Luton Apiary, Queen's Road, Chatham. h.41

**SIX STOCKS** of healthy Bees for Sale on 6 or 8 frames, £2 10s. and £3.—J. & J. WILLIAMS, 20, Howitt Street, Hyson Green, Nottingham. h.42

**SURPLUS.**—Twenty-five Stocks of Bees on 10 frames, crowded mostly, headed by young Penna Queens; will sell separate if required £3 per stock.—MASCALL, Bridge Foot Apiary, Radwinter, Saffron Walden, Essex. h.43

**10-FRAME** Stocks Italian Hybrids, 1920 Queens, crowded with bees, just right for heather, £3 10s., carriage paid; immediate delivery; crate 10s., returnable.—ANTHONY, 34, Knavesmire Crescent, York. h.44

**BARGAIN.**—Strong Stock of pure Dutch Bees, pure Queen, on eight 16 x 10 frames, plenty brood, price £4, carriage extra; body box (for W.B.C.) 10s., returnable.—FROST, 28, Chatfield Road, Sheffield. h.45

**WANTED**, Observation Hive, one frame.—DAY, St. Asaph, Stevenage. h.46

**FOUR STOCKS HYBRIDS**, Geared Extractor, new Frames, 56 lbs. Candy, Metal Ends, Foundation, Observation Hive; £30 the lot, or near offer. Must clear owing to alterations. Can be seen any time; any examination.—44, Ashburnham Road, W. Greenwich. h.47

**STRONG STOCK ITALIAN HYBRIDS**, £3, carriage paid.—SPILLER, "Cresta," St. Fagan's, Cardiff. h.48

**TWO STOCKS BEES** for Sale, one on 7 combs, 1920 Queen, £2 10s.; other 10 combs, full, Penna 1919 Queen, £4. Purchaser to remove or send travelling box.—WILSON, 33, Turney Road, Dulwich, S.E.21. h.53

**ITALIAN BEES.**—Several strong 10-frame Stocks, 1920 Queens, 8s. per frame; ready for heather; never had disease; 10s. box, returnable, less carriage; immediate delivery.—Box 101, B.B.J. Office, 23, Bedford Street, Strand, London, W.C.2. h.64

**A FEW** lots of good, healthy Bees on from 5 to 8 standard frames, 8s. per frame, carriage paid. Travelling box to be returned.—WRIGHT, Waterworks, Sutton Poyntz, near Weymouth. h.5

**FOUR** 8-frame Hybrid Italian Stocks only remaining unsold, guaranteed healthy, £3 5s., carriage paid; box to be returned promptly; one pure Italian Penna 1920 Queen on 8 frames, £4; two 1920 Hybrid Queens, 7s. 6d. each, and one pure Italian, 9s. Cash or deposit.—D. R. BERNARD, Glenzla, Upper Deal, Kent. h.8

**SURPLUS.**—Two 3-comb Nuclei, 40s.; two 6-comb Stocks, 65s.; four fertile cross-bred Queens, 5s.; travelling boxes returnable.—DAVEY, Mawneys, Romford. h.21

**12 STOCKS** of healthy Bees on 10 frames, ready for supering, £3 5s. per lot, and 10s. for box, returnable. Inspection with pleasure.—**F. HOLLOWAY**, Windmill House, Croxby Green, Herts. r.h.1

**READY FOR HEATHER**.—Reducing apiary. For Sale, 10-frame Stocks, 1920 Italian Queens, price £3 15s., free on rail; carriers returnable.—**ASHWORTH**, Weymouth Street, Warminster. h.20

**FOR SALE**, one 18-in. bevel-gear Extractor, 13-in. Ripener, one Uncapping Table with trays, knives, etc., 12 crates of drawn-out Comb Supers. Offers.—**14**, Mill Road, Salisbury. r.g.176

**W.B.C.** painted white, 10s. and 15s. each. Honey Press, Foundation, Swarm Catchers, Sections, etc., at half cost.—**THOS. THIRKILL**, Kirkby Malzeard, Ripon. r.g.181

**A FEW** surplus Stocks Bees for Sale on 8 combs, price 70s.—**HEATHERLANDS BEE FARM**, Thursley, Godalming. r.g.203

**SURPLUS HIVES** and Appliances for Sale, good condition, cheap.—**PEARSON & GALE**, Marlborough. r.g.205

**FOR SALE**, cheap, strong, healthy Stocks, foundation, 4-frame reversible Cowan, Ripeners, Foundation, Wire, Frames, Hives, Electric Embedder, etc. Particulars, stamp.—**GEORGE**, Oak Drive, Oswestry. g.206

**HAVE** only a few 6-, 8-, or 10-frame Stocks left; four very fine 1920 Italian Queens to spare; guaranteed healthy. Stamp reply.—**CROWE**, Merriott, Crewkerne. r.g.191

#### BUSINESS ADVERTISEMENTS.

1½d. per word.

**1920 FERTILE** Dutch Queens, 5s.—**EX-SER-VICE MEN'S HORTICULTURAL SCHOOL**, Cherryhinton Road, Cambridge. h.32

**"SELECT STOCK"** direct from famous American breeders, "Moore, Kentucky," "Davis, Tennessee," "Forehands, Alabama," strains, noted for honey gathering and disease-resisting qualities. Strong 3-frame Nuclei, 35s.; 4-frame, 40s.; 6 and 8-frame Stocks, 55s. and 72s.—**GEARY**, Florist, Barwell, Hinckley. h.50

**ITALIANS**.—Can spare few Nuclei, 3 combs crowded, 1920 Queens, 25s. each.—**BOWREY**, Swallowfield, Berks. h.51

**MASHEATH MEMS**.—My visitors greatly admire your hives. It is fun to hear them say what fine hives they have—until they see yours, when one hears no more about their own.—**M. ATKINSON**, Fakenham. h.52

**ITALIAN HYBRID QUEENS**.—Fertiles, 10s., virgins, 4s. Satisfaction or replaced.—**JACK TICKELL**, Westbourne Apiary, Cheltenham. h.54

**1920 FERTILE** (Italian Hybrids) Queens.—Wonderful strain. A number can now be had by return; prices, 10s. 6d. selected, others 8s. 6d.—**HOSEGOOD**, 26, Purley Park Road, Purley, Surrey. h.55

**SURPLUS**.—Strong 10-frame Stocks with brood box, good condition, £4, carriage paid; healthy Driven Bees with Queen, 10s. per lot; extra strong lots, 12s. 6d., carriage paid; box returnable.—**E. G. BANHAM**, West Meon, Hants. h.56

**DRIVEN BEES**, strong lots, young Queens, 10s. per lot; boxes free and carriage paid; cash with order.—**RUSBRIDGE**, Newdigate, Surrey. n.57

**FEW** 4-frame Nuclei, "Hybrids," 36s., boxes free, carriage paid; Hives, W.B.C. pattern, with stock box, 25s.; Queen Excluders, 2s.; Section Racks, 2s. 6d. Cash with order.—**F. SOFTLY**, Letchworth, Herts. h.58

**DRIVEN BEES**, with Queen, Hybrids, good workers, 8s. 6d. per lot, carriage paid; cash.—**LEIGH**, Broughton, Hants. h.59

**FAMOUS HYBRID COTSWOLD QUEENS**, 10s. 6d.; specially selected, 12s.; strong 6-frame Colonies, 65s. (An excellent opportunity to secure high-class stock from Cotswold queen-rearing apiaries).—**LIEUT. BOWEN**, Queen Specialist, Cheltenham. h.60

**SILVER MEDAL QUEENS**.—"Finest I have ever seen"—*vide* testimonial. From 7s. 6d. If interested send postcard for booklet.—**EDWARDS**, 22, Barts. Road, Reading. h.61

**DRIVEN BEES** with Queen, towards end of month, 10s. 6d. per lot; boxes returnable; spare Queens, 4s. each.—**MORETON**, Hallow, Worcester. h.62

**STRICTLY BUSINESS**.—Imported Italian Fertile Queens: Special discount to D.B's. Flavine Candy: Now being made up. Sainfoin Honey; Now being extracted. Free samples Flavine on request.—**S. H. SMITH**, 30, Maid's Causeway, Cambridge. h.63

**ITALIAN QUEENS**, pure imported, 11s. 6d. each; safe delivery guaranteed; immediate delivery.—**C. T. OVERTON & SONS**, Crawley. r.h.49

**ITALIANS**.—Choice Virgins, 3s.; also Fertiles. Particulars, stamp.—**HOUSTON**, Ellen Villa, Sidcup. r.g.123

**PURE ITALIANS**, 1920 Penna imported Queens, 6 frames, 60s., 8, 70s., 10, 80s., carriage paid; boxes returnable; Hybrids 10s. less; 1920 Hybrid Queens, 7s.—**WADHAM**, Gold Street, Cardiff. r.g.210

**FEW STRONG NUCLEI** for immediate delivery (weather permitting), crowded with bees, brood and stores, 1920 Queens, hybrids; exceptionally good strain; perfectly healthy; inspection invited; 3 combs, 40s.; 4 combs, 50s.; 6 combs, 60s.; box 10s. extra, returnable.—**STEVENSON**, Thames View Apiary, Flackwell Heath, Bucks. r.g.222

**HEALTHY DRIVEN BEES**, with Queen, 10s. per lot, carriage paid; boxes returnable. Cash with order. Orders in rotation.—**PULLEN**, Ramsbury, Hungerford. r.g.211

**ITALIAN QUEENS** from Penna's queen, virgins 4s., fertile 9s. 6d.; Hybrid Italians, virgins 3s. 6d., fertile 8s. 6d.; Hybrid Stocks on 4 frames, 50s.; box, returnable, 10s.—**WARD**, Deeside Nursery, West Kirby. r.g.215

**WANTED**, Stevenson Skyscraper Hives; must be good condition and free from disease; good price given.—Box 99, B.E.J. Office, 23, Bedford Street, Strand, London, W.C.2. r.g.216

**4-FRAME NUCLEI**, headed by 1920 Italian Queen, 50s.; box charged 10s., returnable; 6-frame Stocks, 70s.; 8-frame Stocks, 90s. Immediate delivery (weather permitting). Italian fertile Queens, 10s. 6d. English Run Honey and Sections wanted.—**LEE**, "Little Bowden Apiary," Burgess Hill, Sussex. r.g.114

**CHOICE** home-reared Italian Queens, 10s.; Virgins, 4s. 6d.; July-September.—**MISSES PALING & PILLANS**, Golden Square, Henfield, Sussex. r.g.82

**STRONG 3-FRAME NUCLEI**, 1920 fertile Queens, 30s.; box 5s., returnable; Stocks on 8 frames, 60s.; boxes 10s., returnable.—**W. WOODS**, Normandy, near Guildford. g.63

**PURE ITALIAN QUEENS**, prompt delivery; select Italian, extra golden, rare honey-producing stock, August-September.—**ATKINSON**, Fakenham. r.g.24

**"WIGHT" DISEASE**, prevention and removal; advice 6s.—**ALFD. RYALL**, Kenwood Apiary, Elcombe, Stroud. r.h.3

**1920 FERTILE** Golden Italian Queens, guaranteed imported direct from Italy, regular supplies every few days, 10s. each; specially selected, 14s.—GOODARE, New Cross, Wednesfield. f.59

"ISLE OF WIGHT" DISEASE.—Don't worry; use the solution that cures; 2s. per bottle.—E. PRESSEY, St. Elmo, Conisdon. r.d.149

**HAVE YOU READ "THE BEE WORLD"?** If not, why not? Every number in itself is a useful literary work for practice and reference. Specimen copy free.—Offices: THE APIS CLUB, Port Hill House, Benson, Oxon.

### Aberdeenshire and Kincardineshire Bee-Keepers' Association.

The **HONEY SHOW** of the above Association will be held in conjunction with the Royal Horticultural Society's Show in the **DUTHIE PARK, ABERDEEN**, on August 19, 20 and 21, 1920.

Exhibitors must send a list of their entries to the SECRETARY, Edwin Rezin, 20, Belmont Street, Aberdeen, on or before Saturday, the 14th instant. He will on application issue to entrants particulars of the Rules regulating the Show, the Schedule of Prizes, and Entry Forms.

## ITALIAN QUEENS

### Direct from Italy.

**E. PENNA, BOLOGNA, ITALY.**

I assume again the direct sale of my queens. Special offers from July 10 till countermanded. For queens in lots of 4 at a time £1 8s. Cash with orders. Payment by cheques or British Postal Orders. International Money Orders are not accepted. I do not hold myself responsible for the queens that are not sent by me direct to customers. All orders should be sent direct to me. In May the queens dead in the journey have been less than 1%  
ORDERS BOOKED IN ROTATION.

## Would You Winter 100%?

Then have some of Clarke's "I.O.W." cure and preventive on the floor of your hives from now onward. No spraying, simply a powder. Don't let your bees die.

3/6 per packet, post free.

**G. J. CLARKE, Blythburgh, HALESWORTH**

## ITALIAN QUEENS

Direct from Italy.

Address:  
**Signor Gaetano Piana,**  
Castel San Pietro,  
near Bologna, Italy.

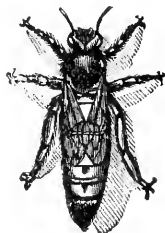

All Queens are reared by the most up-to-date and scientific methods. Mr. W. Herrod-Hempsall has personally inspected the apiary and methods employed, with which he is perfectly satisfied.

PRICES FOR 1920.

For 1 Fertile Queen: August and September, 9/- each queen.

Carriage paid in Great Britain. Cash must accompany all orders, which will be executed in rotation. Guaranteed safe arrival of all Queens, but not the introduction. Bees dead upon arrival must be sent at once to "B.B.J." Office.

For the mutual convenience of all parties, if Signor Piana has made arrangements that all communications, orders and remittances of the readers of "B.B.J." and "B.K.R." can be addressed to him, c/o British Bee Journal, 23, Bedford Street, Strand, London, W.C.2.  
Cheques payable to "British Bee Journal."

The products of the Apiary, of Poultry and Farm Stock, of the Fruit and Vegetable Garden can be Advertised and Sold through

### THE BAZAAR, EXCHANGE & MART

Newspaper.

Get a Copy—Thursday and Saturday 3d. The "Bazaar" publishes also practical handbooks by experts. Send for full catalogue, post free from—WINDSOR HOUSE, Breems Buildings, LONDON, E.C.2.

### THE British Bee-Keepers' Association.

Insure now against loss by damage done through bee stings. All particulars from

**W. HERROD-HEMPSALL, 23, Bedford Street, Strand, London, W.C.2.**

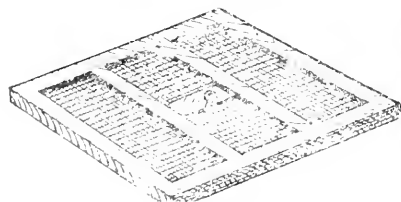

# B<sup>G</sup> B<sub>W</sub> BOARD

A Necessity on all Hives all the Year Round.

**SUPER CLEARER.  
QUEEN EXCLUDER.  
WINTERING BOARD,**  
&c.

SEND FOR KAT-A-LOG

**MEADOWS, Syston, Leicester.**

## POSITIVE FACTS.

June 13th, 1920.

I am very pleased with the foundation. The bees undoubtedly prefer it to any other make I have, and have even gone the length of missing two sheets of other new foundation, and working out a sheet of yours placed behind them at the back of the hive. Full sheets have not sagged in the least in 16 X 10 frames.

Yours faithfully, R. B. MANLEY.

Illustrated Lists free by post.  
**S. J. BALDWIN, The Apiary, BROMLEY, Kent.**

# DADANT'S WEED FOUNDATION.

**T**HIS Foundation is made from pure Beeswax and guaranteed free from all disease germs.

Give your bees the BEST, and the best is DADANT'S.

No acids or other chemicals are used in the manufacture, and the makers guarantee that "EVERY INCH, EVERY POUND, EVERY TON, is equal to any sample ever sent out."

We have just received a fresh consignment, and are in a position to give immediate despatch.

Rear healthy bees on clean, natural combs.

None genuine without the watermark "DADANT" on every sheet.

*Our Catalogue, entitled "Everything for an Apiary,"  
is sent post free on Application.*

---

**R. STEELE & BRODIE,**

Bee Appliance Makers,

**WORMIT, FIFE.**



THE  
KEY TO  
YOUR SUCCESS.

## Lee's Bee Supplies.

¶ In design, material and workmanship, Lee's Bee Supplies still retain the reputation of being your best and safest investment.

¶ Our 1920 ILLUSTRATED CATALOGUE is yours for the asking. It contains detailed information on the most up-to-date hives and appliances for which the House of Lee is famous.

¶ We regret the necessity of having to advise our Customers that owing to the increased cost of production, all prices in 1920 price list are subject to 10% increase. The increase will not apply to orders received before May 10.

\* \* \* Five per cent discount to Members of THE APIS CLUB.

—♦♦♦—  
**JAMES LEE & SON,**  
LTD.,  
Uxbridge, Middlesex.

(Telegrams: Graphicly, Uxbridge.)

Telephone: Uxbridge 181.)



## "BACTEROL" FOR BEES

2/9 per Bottle.

Post Free.

The cure for, and preventive of, "Isle of Wight" Disease. Non-poisonous—free from stain or unpleasant odour.

MENLEY & JAMES, LTD.,  
Menley House, Hatton Garden, E.C. 1.

**BRADBURY, TAUNTON,**  
FOR QUALITY BEE GOODS.

BOOKS

*Illustrated Bee  
Guide free.*

Telephone: TAUNTON 176.

## 20-Page 1920 "WHITE STAR" List,

3½d. POST FREE.

S. SIMMINS, QUEENLAND, HEATHFIELD, SUSSEX

**Bees and Beekeeping Appliances. Catalogue free.**  
**EDWARD J. BURTT. MANUFACTURER. GLOUCESTER.**

*I very much regret that there has been a large increase in the cost of the manufacture of bee appliances, and therefore my prices will be advanced 10% from May 10th. Books excepted.*

PRINTED BY THE AVENUE PRESS (L. UPCOTT GILL & SON, LTD.), 55-57, DRURY LANE, LONDON, W.C., AND PUBLISHED FOR THE PROPRIETOR (W. HERROD-HEMPSELL), BY SIMPKIN, MARSHALL, HAMILTON, KENT & CO., LTD., 31 & 32, PATERNOSTER ROW, E.C.



No. 1991. Vol. XLVIII

AUGUST 19, 1920.

[Published every Thursday, Price 2d.

**CONTENTS.**

	PAGE		PAGE
OBITUARY NOTICE—		CORRESPONDENCE—	
Mr. T. Bevan .....	397	Fraternity Among Bee-keepers .....	403
A DORSET YARN .....	398	Virgin Queen In Supers .....	403
JOTTINGS FROM HUNTINGDONSHIRE .....	399	Swarm in a Hedge .....	403
AN OCCASIONAL GROWL .....	400	Action for Damages Caused by a Bee Sting .....	403
THE SEASON OF 1920 .....	400	Screen for Road .....	404
JOTTINGS FROM S. WALES .....	401	Notes from Wallingford .....	404
VISIT TO WEST OF SCOTLAND AGRICULTURAL COLLEGE APIARY .....	401	Advice to Beginners .....	404
SCOTTISH BEE-KEEPERS' ASSOCIATION .....	401	QUERIES AND REPLIES—	
BRANSFORD AGRICULTURAL SHOW .....	402	Using Foreign Honey for Feeding .....	405
HONEY IMPORTS .....	402	NOTICES TO CORRESPONDENTS .....	405
WEATHER REPORT .....	402	BEE SHOWS TO COME .....	405

# FOOD FOR BEES.

Owing to the continued bad weather there is a likelihood shortage this Winter. To prevent loss of Stocks order at once TAYLOR'S renowned

## SYRUP

In tins, 7 lb., 14 lb. and 28 lb. at **1/3** per lb., Carriage extra.

We are in a position to supply, without vouchers, the best

## CANDY

made from pure Sugar, plain or medicated, **1/6** lb. Carriage extra.

**E. H. TAYLOR, WELWYN, HERTS.**

Telephone—WELWYN 13.

**THE  
British Bee Journal**

Office: 23, Bedford Street, Strand, London, W.C.2.  
ESTABLISHED 1873.

A Weekly Journal Devoted to the  
Interests of Bee-keepers.

Edited by T. W. COWAN, F.L.S., &c.,  
and J. HERROD-HEMPSELL, F.E.S.

**Correspondence: Whom to Address.**—  
All matters relating to the Literary Department, Associations, Shows, etc., should be addressed, "Editors, *British Bee Journal*," and all business communications and matters relating to subscriptions and advertisements to be addressed to the "Manager," *B.B.J.* Office.

**Subscriptions.** — Annual Subscription, 10s. 10d. post free in advance; single copies 2s., or 2½d. post free. If a receipt is required by post, a stamped and addressed envelope must be sent, otherwise a printed receipt will be enclosed along with the paper.

*Note.*—Cheques and Postal Orders should always be crossed, otherwise it is very difficult to trace them if they go astray.

**How to send Money.**—Remittances can be made payable to W. Herrod-Hempshall by crossed Cheques and Postal Orders. Stamps may be sent for small amounts up to 2s. *Halfpenny stamps are preferred.*

Scottish or Irish cheques can only be taken in payment if 6d. is added for commission charged by banks for cashing them.

The Editors are not directly or indirectly interested in the manufacture or sale of beehives or appliances of any kind, and must refer correspondents wishing for prices or catalogues to advertisers in the paper.

**OUR DEPOSIT SYSTEM.**

You are advised to insist on this being used when dealing with strangers.

**Rules and Conditions for Depositing**

*In order to save trouble, it is requested that the Rules be carefully read over by persons using the Deposit System of trading.*

Goods should not be despatched until notice that the money has been deposited is received from this office.

**1. Method.**—When strangers are dealing together, the purchase-money of the articles is deposited at our office. We acknowledge receipt of the deposit to both parties, and hold the money until we are satisfied that the purchase is concluded. If a sale is effected, we remit to the seller the amount deposited, less a charge of 2½ per cent. in the £, with a minimum of 6d., and the expenses of Post Office Orders and postage, &c. Cash will be forwarded by Cheque, Post Office Order, or by Postal Order as preferred. If a sale or exchange be not completed, we return the amount deposited, after making the same deduction. By this means buyers and sellers are secured against fraud.

**2. Deposits.**—Postal Orders (drawn on General Post Office) and Cheques must be made payable to W. Herrod-Hempshall, and crossed "London County and Westminster Bank." The numbers of the Postal Orders should be kept by the sender.

We cannot be responsible for any loss that may occur in transit.

**3. Honey on Approval.**—All honey will be sold by sample, which must be sent direct to buyer.

**4. Bee Appliances.**—In ordering, the time allowed for completing the order to be stated to us when sending cash. If maker accepts, we hold cash until transaction is satisfactorily completed, when the amount will be remitted, subject to conditions as in Clause 1.

**5. Bees and Queens.**—These will be dealt with entirely by the parties concerned, so far as price, &c., go, and when the purchase is satisfactorily completed cash will be remitted as per Clause 1.

**6. Goods in Transit.**—These are at the seller's risk, i.e., any damage to or loss of an article on its journey is borne by the vendor; but a rejected article must be properly packed and returned by the same means as was used in sending it.

**7. Carriage.**—The carriage of all goods, except such as are sent by post, is payable by the buyer, unless otherwise agreed. If any article sent on approval be returned, each party to the transaction must pay carriage one way.

**Books for Bee-keepers  
NOW IN STOCK.**

Cash in full must be sent with order.

		Postage
A Modern Bee Farm ... ..	7/6	... 8½d.
Advanced Bee Culture (HURCHINSON) ... ..	6/-	... 6½d.
Beginner's Bee Book (PELLET) ... ..	5/-	... 4d.
<b>BEE-KEEPING SIMPLIFIED FOR THE COTTAGER AND SMALLHOLDER</b> (W. HERROD-HEMPSELL, F.E.S.) ... ..	1/-	... 2d.
<b>BRITISH BEE - KEEPERS' GUIDE BOOK</b> (T. W. COWAN) ... ..		
Paper covers ... ..	2/6	... 3d.
Cloth covers ... ..	3/6	... 4d.
Dissectible Model of Queen Bee ... ..	4/6	... 3d.
<b>FERTILISATION OF FRUIT BLOSSOMS BY BEES</b> (T. W. COWAN) ... ..	-/3	... 1d.
Honey and Health (A. HOPE) ... ..	-/6	... 1d.
Honey Vinegar (REV. G. BANCKS) ... ..	-/2	... 1d.
How to Keep Bees (ANNA B. COMSTOCK) ... ..	5/-	... 4½d.
Management of Out Apiaries	3/-	... 2d.
Prevention of Swarming (WILKES) ... ..	1/-	... 1d.
Pollination of Fruit in relation to Commercial Fruit Growing (C. H. HOOPER, F.R.H.S.) ... ..	-/6	... 1d.
<b>PRODUCING, PREPARING, EXHIBITING AND JUDGING BEE PRODUCE</b> (W. HERROD-HEMPSELL, F.E.S.) ... ..	2/-	... 3d.
Queen Rearing in England (F. W. L. SLADEN) ... ..	1/6	... 2d.
Scientific Queen Rearing (DOOLITTLE) ... ..	4/-	... 3½d.
The "Townsend" Bee Book ... ..	2/6	... 2d.
WAX CRAFT (T. W. COWAN) ... ..	2/-	... 2½d.

**MISCELLANEOUS.**

Maeterlinck's Life of the Bee	5/-	... 3d.
The Lore of the Honey Bee (TICKNER EDWARDS) ... ..	2/-	... 2½d.
<b>THE BEE WORLD</b> (supplied only to members of Associations interested in the control and development of the Apis Club, apart from ordinary members of the latter), per copy ... ..	-/8	... 1½d.
The Bee Master of Warrilow (TICKNER EDWARDS) ... ..	7/6	... 4½d.

**British Bee Journal & Record Office,**

23, BEDFORD STREET, STRAND LONDON, W.C.2.



## Editorial

### Obituary Notice.

MR. THOMAS BEVAN.

It is with the deepest regret that we record the death of Mr. T. Bevan, which occurred suddenly on July 17. Mr. Bevan was a horticulturist of great experience and skill, and was well known to a wide circle of Metropolitan horticulturists. He was born in 1848, and in the early days of his horticultural career, which commenced in 1862, he spent some time at the Royal Horticultural Society's Gardens at Chiswick. He received his training in

were his favourite flower). He was a member of the Council of the Hospital Saturday Fund, a governor of Brompton Hospital, and for many years had been on the Council of the British Bee-keepers' Association. Mr. Bevan was superintendent of St. Marylebone Cemetery, Finchley, for 30 years, retiring from that position about a year ago.

Mr. Bevan commenced bee-keeping 30 years ago, his interest being aroused by his acquaintance with a Mr. Ward, of Highgate, who had about half a dozen stocks in movable comb hives. He not only liked honey as a food, but held that bees were very necessary to the gardener for fertilising blossoms, masses of which he produced for decorative purposes. Though he did not go in for bee-keeping on a large scale, he derived great pleasure



MR. AND MRS. T. BEVAN.

fruit culture, tree grafting, etc., at the Municipal Horticultural Establishment at La Minette, Paris, where he was when the Franco-German war broke out in 1870. He was a very acceptable lecturer on both horticulture and bees, and has acted as judge at important horticultural shows on the Continent—Paris, Ghent, Lyons, Turin, etc.—and had himself also received several awards, including the gold medals of the Royal Horticultural and Royal Botanic Societies. He also received a diploma and gold medal at the Paris Exhibition of 1900. He was a member of several horticultural societies, and was for a long time chairman of the National Chrysanthemum Society (chrysanthemums

from watching the bees at work on the various flowers, and planted borage and other flowers for their use. He kept bees for the love of them, ten stocks probably being the highest number he ever had. More he had not the time to manage, as the time of year when bees need attention is also the busiest time of the year for those producing plants and preparing places to receive them. He was always pleased to lend bees and appliances at the local flower shows, and had some success as an exhibitor of honey, etc. During a tour he made in Italy he met some of the expert bee-keepers there, and brought home charts and information.

Sometimes the bees would have an

attack of "swarming fever" just as he wanted to get away for a holiday, or to fulfil some engagement, which would be delayed perhaps for two or three days, until the bees had settled down; but the joy of possessing a strong swarm seemed to quite compensate him for the trouble and inconvenience of having them. His genial personality, experience, and advice will be missed at the Council meetings by his fellow-members, by whom he was held in high esteem. Mr. and Mrs. Bevan celebrated their golden wedding on March 13 last, when the photographs which we give were taken. Mr. Bevan leaves a widow, son, and daughter to mourn their loss, and to them we, and all who knew Mr. Bevan, extend our sympathy.

### A Dorset Yarn.

"Will you come and look at our bees? they are not working in the supers." This was from a lady living at Poole, who had come five miles on a push-cycle on Sunday. She looked disappointed when I said, "I cannot come till evening." Looking at our lot crowded with bees, some of them were giving off a great noise with so many bees, she said, "Mine are not like these, for numbers or noise." Looking through her hives in the evening, there was a fine crowd of bees, no crawlers about on the ground, only three bars had brood, there could not have been 4 ozs. of stores in the whole ten combs. They were a bit too far from the heather, and with so much wet, they were starving for food; the queen could not fill the empty cells, there was no food to feed her or the larvæ. If this is like other nuclei sent from the re-stocking centres, in my opinion it will be a bad winter for bees; I advised them to write for a sugar ration and feed strong.

Late last night, another bee-keeper (a head gardener) came to me. Would I see his lot? He had a swarm on the 12th; his employer advised him to put them in a new hive and feed up for increase. They were a fine lot; they had in the three days built a good bit of comb. I happened to have five bars ready made up, and we soon had the bees running into the hive; they are in the heather area, so these will get a good lot of stores.

Our lot have done a good week's work. They are filling up the outer racks of sections (these had been lifted up in early June to give another over the brood nest), the three end ones in each are the last to be finished, but they are now filling and furnishing them. I lifted to see if the lower ones were complete. In

all but one instance they were filled, one that had swarmed twice had not touched the thin foundation, but of course it had not the population. Another lot that had swarmed in June, after it had two racks of sections given it, has taken another spell of section filling, and the bees are finishing off the end ones in the upper rack—nearly two months without adding to surplus, it looks as if the new queen had to fill the bars with young brood twice, before there were enough bees to gather any.

The best for production this season is a stock started with four bars with the queen and plenty of capped brood in May. These have never swarmed, but have looked as if they would several times; each evening they have lined the outer case with their numbers, there could not be room for them inside the brood nest and sections, these have completed two; they have now four others, three of them partly filled by other stocks, but which did not look like completing them. To keep them from getting too hot, I lifted the front of the outer case with an inch strip, also placed more strips between the lifts at the back, so that there was a current of air all round the brood nest; this is a tarred hive, made of sugar boxes; if one lifts the front one must lift the back, or when there are four racks on top the lifts will not cover them, as it would not be level.

A lot with four bars in June has completed two racks, and has another partly finished one added to it; but the most rapid workers are those with the standard bars on the top of sections. These seem to give them an extra incentive to store up surplus. I was away three days at Taunton; the extra capped over in those three fine days was very marked. It is not all ling heather from which they get their stores, though there are a great number of bees on it; but many thousands are on the ragweed, a species of *Senecio*, a large-headed groundsel that is abundant in some pastures—it is the plant on which the Cinnabar moth lays her eggs and the caterpillar feeds in summer. This plant makes very poor honey; according to some writers it is the worst gathered in the year, but the heather gathered at the same time gives the better flavour to the honey, and the ragweed cannot be found disagreeable. There are still a lot of male chestnut blossoms on some of the trees, but charlock is in abundance in the fields of mangel and swedes; so much wet, it has been impossible to keep it down by hoeing.

We have not had such good results as

last year up to the present, but we shall do very well for a wet season. When bees could not work, we have increased our stocks, and cannot expect to have it all ways, but so many have had a poor harvest this year. A visitor from Windsor said their harvest always finished in July. We shall have an extra month of good weather; cannot yet tell what the total yield will be; we have many standard and shallow bars that will weigh up well at the end.

Bees are rapidly on the increase in Dorset; one bee-keeper (after five years in India) had one lot in March, 1919, now he has thirty in skeps and hoxes. Another one writes he has still a lot for sale; without a doubt, bees are getting more resistant to the malady that has devastated them so long.—J. J. KETTLE.

## Jottings from Huntingdonshire

From Bournemouth to Cowes is no great distance, yet it enabled us to get from cloudy skies and many showers to blue sky and cheering sunshine. The Cowes regatta was in progress on our arrival, and, as it had been in abeyance for five years, a goodly company of people was there. The townspeople were overjoyed to see the place so lively once again, and we entered into their spirit of elation, but one must confess one was not quite prepared to hear an Isle of Wight cleric say, "How delightful! I am so pleased to see so many old Cowes faces once again." Doubtless we are all guilty of expressing ourselves clumsily at times, as when a certain divine, hoping the spark of love might be planted in every breast, prayed that the spark might be well watered from above. The white wings on the Solent looked gay and fascinating, but we, or at least I, could not keep my thoughts from other wings—those of the honey bee. Here we were on so charming an island—pleasing prospects from every point—and yet the most dreaded disease among apiculturists bore the island's name. Cowes, Ventnor, Ryde, Yarmouth, Shanklin, Newport, why did *Microsporidiosis* develop its sinister power midst your fields and gardens? More hives of bees than inhabitants of your island have perished since your beekeepers first noticed the disease sixteen years ago. Sixteen years, and still we are baffled; not one of us can put forth a sure and certain cure. We have discovered that the protozoan in the chyle stomach is not *Nosema Apis*, which is something, but how one wishes some great mind in your island would discover a specific, and so wipe out the disease and enable us to visit your beautiful watering places with subconscious and conscious pleasure; while at

present we experience a conscious pleasure and a sub-conscious pain.

We left the island by the Southampton boat, and landed at that ancient town in a downpour, and ever since the weather has been showery, alas! The middle of August is here; therefore it is not the least likely we shall get much more surplus honey. Indeed, we shall be thankful if our hives have plentiful stores. It is up to all of us, if the weather does not improve, to do all we can to stimulate our queens to lay! lay!! lay!!! Otherwise there will be many sad hearts before the spring of 1921 is here.

I have been demonstrating a little lately, and found myself one day in an apiary of Holmewoods. So recently I wrote of the good temper of these bees. Alas! that they should belie their character on this occasion. From the first hive I received a sting right between the eyes; the next hive sent forth a youngster to puncture the back of my head; and another hive resented angrily any interference, and six zealous little ladies got their stings home in various parts of my visage. The result of this was a face very like a well-pummelled pugilist's. Poor things, they meant well, and thought I meant evil. Considering bees are always anxious to be busy—dull, damp days one after another must perforce irritate them, and we freely forgive them their little pricks. One is more pained at the thought that each sting left behind means one bee less in the world.

This morning comes a letter asking what flowers are open for bees in August, the writer adding that every flower in her district seems over. Doubtless much depends upon the district and the soil, but hereabouts I can walk a mile and gather many different kinds. To cheer up the disconsolate I will mention some of them, most of which are worked by bees for pollen or nectar, or both. There is the brown Reed mace, the Blue Devil's Bit scabious, Succory, Blue bottle, and Giant bell flower, while purple flowers are a great show. Betony, Fine-leaved heath, Knapweeds or Hardheads, Campions, Field gentians, Crane's bills, Ketchlings, Valerians and Stork's bill, not forgetting the Willow herb the bees are so fond of just now. White flowers, too, are sprinkled about—Millefoil, Oxeye, Sneezewort, Mayweed, Hemlock, Hodge parsley, Water crowfoot, Dutch clover, Goatweed, Meadow sweet, Fumitory, Great and Stone bedstraw, Speedwell, and Arrowhead are some of the plants flowering to-day. As for the yellow flowers, their name is legion; at no time in the year does Nature leave us without yellow flowers. At this time Tansy and Golden rods, Ragwort and Corn marigolds, Hawkweed and Nippleworts.

Hawkbit and Dandelions, Rocket and Charlock, Hop trefoil and Loosestrife, Tormentil and Agrimony, St. John's Wort and Melilot hold sway. Some, like Agrimony, will soon be over; others, like Hawkweed and Charlock, will continue flowering right into November. It is surprising, to the uninitiated, what a lot of nectar is found in cornfields. Hidden from view by the standing corn, flowers nevertheless make good—farmers will call them weeds: they are, but not useless to the farmer who keeps bees—and it is no uncommon sight to see bees winging their way to fields of wheat and finding all they want from the flowers unseen by man, until the reaper comes swishing along and reveals the beauties the bees had seen before us. Let the corn be cleared, and then we shall walk across the stubble and sing, with Van Dyke—

“For us the fields are new,  
For us the woods are rife  
With fairy secrets deep and true,  
And Heaven is but a tent of blue  
Above the game of life.”

E. F. HEMMING.

The Rectory, Steeple Gidding.

### An Occasional Growl.

The weather is—Ugh! rain, rain, and then more rain. This morning my optimistic neighbour greeted me—“Eh, man! it's the pride of the morning,” at which time it was teeming down, and it's still coming—hard. Well, “it's a long lane, etc.,” but this season beats every previous attempt at beating the Noah's Ark period, and the result for surplus in this district is the worst in my experience.

Many hives hold big stocks of bees, with barely enough stores to enable them to live on the “hand to mouth” principle; and heavy feeding will have to be the order of the day to carry the stocks through the coming winter and spring, so get your requisitions in for the 14 lbs. per stock. Government grant, and then you will be able to purchase the sugar at the same rate as if you had no grant!

Yes! I'm in the same street as Pat, for “I'm agin the Government.” You have probably heard of a scheme adopted for stocking the country anew with bees; well, if the so-called Dutch bees that I have been pestered with are a fair sample of their kind, then there must be some bee-keepers who will agree with my opinion that they are “dog-goned rotters,” for when they were not busy swarming they carried on developing their leg muscles by holding walking contests—Yes! “over the top” too, Mr. Hemming, and I don't think there's anything new about it either.

As regards the Flavine remedy for

“Isle of Wight” disease, I am pleased to note some members of the fraternity have achieved satisfactory results from its application; at the same time, in my case this summer, it failed to have the slightest effect on a stock thoroughly sprayed on June 8, 12 and 16, although on former occasions it appeared to prove beneficial.

The County Bee supply schemes are, in my opinion, somewhat mixed blessings. Here in Staffordshire we have an expert whose time is chiefly occupied in breeding bees to supply bee-keepers who had lost all their stocks; and what homes some of these have landed at has only been discovered when too late! No fault of the expert, but most discouraging facts; and, by the way, he is not one of Mr. Manley's pet aversions, third class, but first class, although I suppose he started to climb the tree at the bottom like some others did. Anyway, it is gratifying to know he is not spreading Dutch bees about the country, as I am sorry to note one first class county expert is doing.

The queen bees imported and distributed under the Government scheme received by me have proved quite satisfactory—although late; but when compared with the hoped for delivery of three queens, ordered and paid for in March, 1919, and still on order with a noted British queen breeder of Italians, it was really a lightning process. Here I will close, with the hope that all who read this have had a better season during 1920 than we have in this district.—E. JACQUES, Lichfield.

[Our correspondent has “got 'em bad.” We hope now that the rain has stopped and the weather generally has improved, he is not feeling so “blue,” and is looking at the brighter side.—Eds.]

### The Season of 1920.

I fear 1920 must be classed a bad honey season hereabouts.

The season opened very early. I was able for the first time in the eleven years I have kept bees to transfer to clean hives as early as April 3—a good month earlier than usual, and on April 24 I divided a stock of Italians.

May was generally a good bee month; after June 4 we had a cold spell till the 11th, then warm again. July had some bright days, but was generally bad, and up to the present (August 9) August does not seem to promise anything better.

There has been the most blossom on everything this year I ever saw, but the weather has generally been unfavourable for the gathering of nectar—especially was this the case with the limes. Here we are surrounded by hundreds of lime trees, and

the blossoms were profuse, but no appreciable amount of surplus can be attributed to this source.

I don't know the experience of other districts, but it appears to me, looking back over a good many years, that the weather at the time of lime blossom is seldom favourable.

Referring to my bee notes of 1919, I find that the bulk of the honey I took (it was the best year I ever had) was stored after August 1, most of it between the 8th and 22nd. There is not much chance of a like experience this year.—  
RICHARD H. AMIES, Roydon, Diss, Norfolk.

### Jottings from South Wales.

"I say! come to the sea with us, old boy; you are a slave to your bees."

"Ah!" I said. "my garden, in spite of the rain, is still full of bloom; I shall get the advantage of you by staying here."

"But how," asked my friend.

"Well, by a kiss from the sun for — pardon,

The song of the birds for mirth;

One's nearer God's heart in a garden,  
Than anywhere else on this earth."—

C. TRECROFT.

### A Visit to the West of Scotland Agricultural College Apiary.

On Saturday, July 31, the members of the Arr. Glasgow, Greenock, and Kilmarnock Bee-keepers' Associations visited the model apiaries of the West of Scotland Agricultural College at Kilmarnock. The party, numbering about 100, were met by Mr. Joseph Tinsley, who is in charge of the work, and he and his assistants spent the afternoon in showing the visitors round the apiaries and explaining the various experiments.

Probably the most interesting experiment was in connection with large frames. The Dadant hive and also Root's Langstroth hive complete were imported from America, and are being worked in the apiary, together with the Manley hive. It was a pleasing sight to see these large frames populated with brood. The hives were only obtained late in the season, and it will not be possible to publish any of the experimental work until next year.

Over 100 colonies of bees were on view, together with 50 nuclei. Blacks, Italians, Carniolans, and Cyprians all came in for a share of admiration. Several very interesting diagrams have been added to the apparatus, showing the anatomy and natural history of the bee.

In the votes of thanks which followed it was remarked that the bee-keepers in

the West were exceedingly fortunate in having the college to help them. Three capable experts in charge of apiculture are now on the permanent staff of the college, so that bee-keeping will not be in the background in the future in the West of Scotland.—*Communicated.*

### Scottish Bee-keepers' Association.

The quarterly meeting of Council, and annual conference of the S.B.A., was held in the meeting room during the Highland Show in Aberdeen. In the absence of the Hon. President, the Duke of Athol, the chair was taken by Mr. J. J. Moubray, Lord Lieutenant of Kinross, who expressed his pleasure at presiding over such a large and representative gathering from all parts of the country. The Hon. Secretary, Rev. J. Beveridge, M.B.E., read apologies from the Duke of Richmond and Gordon, Mr. J. R. Dickson, vice-president, and others. The minutes of last meeting were read and confirmed. It was reported that since the beginning of the year six new associations had been affiliated, and the membership now exceeded 5,000. On account of the increasing size of the Association it was resolved to remit to a special committee the task of preparing the draft of a revised constitution to be submitted for consideration at the next meeting.

The resolution that the Council should henceforth meet in a different centre each quarter in order that the various associations may have an equal opportunity of sharing in the conduct of affairs, was unanimously confirmed; and the next meeting was appointed to be held in Glasgow in October.

It was also agreed to appoint a new committee to deal with all matters relating to the subject of bee-keeping for women, Lady Salvesen and five other ladies being nominated as the nucleus of the committee.

#### REGISTER OF BEE-KEEPERS.

It was reported by the Registrar that considerable progress had been made with the Register, which now contains the names of over 7,000 bee-keepers, with 23,000 hives. As the verification and supplementing of the registration proceeds it is estimated that the actual number of bee-keepers will considerably exceed 10,000, and may possibly reach 15,000, with 50,000 hives. The possession of this Register will enable the S.B.A. in due time to organise the bee-keepers systematically in every corner of the country. At present we have discovered that there is at least one bee-

keeper for every six square miles and for every 1,000 of the population, and one hive for every 800 acres. But Aberdeenshire has the splendid record of a bee-keeper for every six square miles and for every 150 of the population, and a hive for every 200 acres. But so far as is known, there are no bee-keepers in Shetland or in Barra, and in many of the smaller isles, and only eight in Selkirkshire.

The Markets Committee recommended that the price of first-grade sections and extracted honey should be 3s. per lb., and second-grade sections 2s. 9d. The heather honey price will be fixed later on, and will be published on September 10.

The Shows Committee was congratulated on the excellent arrangements for the annual exhibition which had been so successful, and which was continuing to attract the Aberdeen crowds. Special thanks were awarded to the convener, Mr. A. A. Blair, and to Mr. Anderson, of the North of Scotland College, as well as to the various lecturers and demonstrators in the Bee Tent, which was in constant use every day of the Show.

The Education Committee reported that there was a large number of applicants for examination for the various certificates, and the full list would be issued in a day or two giving the successful candidates.

The Secretary reported that he had just received notice from the Board of Agriculture that a sugar-ration of 14 lbs. had been secured for all who applied to the local Food Officer specifying the number of stocks and the retailer selected.

The usual hearty votes of thanks to Chairman and Secretary brought the meeting to a close.

#### EXAMINATION RESULTS.

##### *Honey Judge (eight candidates).*

John Anderson, M.A., B.Sc., Aberdeen; Henry Crombie, M.A., Dunkeld; James R. Fenwick, E.B., S.B.A., Perth.

##### *Expert Bee-master Certificate (E.B.: S.B.A.), 16 entries.*

James S. Barron, M.A., Wick; Donald Corrigal, M.A., Rothiemay; James R. Fenwick, Perth; James K. Greig, Clovenstone; Alexander Low, Newmachar; Miss M. Mayor, Rafford; Forbes; Miss N. Meston, Auchedly, Tarves; Miss Margaret F. Pirie, Aberdeen; Alexander W. Ross, M.A., Rora, Longside; Alec Steven, L.R.A.M., Glasgow.

##### *Bee-master Certificate (B.: S.B.A.), 40 Candidates.*

Miss Andrina Goudie, Geosetter, Shetland; Bryce Whiteford, Stranraer; John Cunningham, Bonhill; H. M. Stich, A.B.T.C., and Walter Stich, B.Sc., Paisley; Mrs. Isa. Valentine, G. Martin, J.

Webster, R. Harper, Knock, Banffshire; J. Buie and P. Milne, Cornhill, Banff; William Walker, Glentanar; W. Brand, Hatton; Henry Dow, Robieston, Huntly; Marshall K. Watt and J. L. Archibald, Aberdeen; John A. Dawson, Laurencekirk; Rev. T. F. Best, Broughty Ferry; D. R. Brown, Kilmany; Alex. Penman, Peter and Andrew Marshall, Lochgelly; J. C. Anderson and Thomas Christie, Kinglassie; James Gow and Thomas Thomson, Ballingry; Mrs. E. R. Noble, Peter Duncan and Lewis Eadie, Milnathort; David Miller, Kinnesswood and David McLeish, Scotlandwell, Leslie.

### Honey at Bransgore Hants, Agricultural Show.

A very creditable display of honey was made at the above show, held on August 11. During the afternoon Mr. Bellairs, the veteran bee expert and lecturer, gave a very interesting lecture on bee-keeping. Miss Greening drove a skep. Mr. L. Thorpe, the local appliance agent, supplied the bees and assisted.

The Horticultural Society gave prizes in two classes. The Christchurch and District B.K.A., Branch of Hants and Isle of Wight B.K.A., of whom Miss Greening, of Barton Hall, is the hon. secretary, also gave prizes in two classes. Mr. Bellairs was judge, and awarded the following prizes:—

Horticultural Society's Class.—Six sections: 1, J. Cook; 2, Hall; 3, Hill. Six bottles extracted honey (colour not stated): 1, Cobb; 2, Hill; 3, Cook.

Christchurch and District B.K.A.—Three sections: 1, Cook; 2, Cobb; 3, Folliot. Three bottles extracted honey (colour not stated): 1 and 2, Miss Greening and Cobb, equal; 3, Cook.—*Communicated.*

### Honey Imports.

The registered value of honey imported into the United Kingdom during the month of July, 1920, was £2,460.—From a return furnished by the Statistical Office, H.M. Customs.

### Weather Report.

WESTBOURNE, July, 1920.

Rainfall, 5.15 in.	Frosty nights, 0.
Heaviest fall, 1.08 in. on 5th.	Mean maximum, 63.4.
Rain fell on 17 days.	Mean minimum, 55.2.
Above average, 2.83 in.	Mean temperature, 59.3
Maximum temperature, 69 on 15th and 29th.	Below average, 1.1
Minimum temperature, 42 on 25th.	Maximum barometer, 30.328 on 20th.
Minimum on grass, 38 on 25th.	Minimum barometer, 29.581 on 26th.

L. B. BIRKETT.



The Editors do not hold themselves responsible for the opinions expressed by correspondents. No notice will be taken of anonymous communications, and correspondents are requested to write on one side of the paper only and give their real name and address, not necessarily for publication, but as a guarantee of good faith. Illustrations should be drawn on separate pieces of paper. We do not undertake to return rejected communications.

### Fraternity Among Bee-Keepers.

[10256] I am sorry my letter has been the cause of some misunderstanding, especially with "Bee-keepers of Experience."

However, Mr. Editor, you are quite correct in your explanatory note, as you will gather from the following:—

*Swarm Issued May 27.*—Parent hive not examined through pressure of work until two days later, when a virgin queen was seen, then all queen cells were cut out by the "live bee-keeper."

*June 19.*—Hive again examined when queen could not be found and no brood seen; conclusion queenless, but in the light of later events queen was evidently out on mating flights.

*June 30.*—Upon examining hive, found fertile queen and brood in all stages. The weather during early part of June was cold, and probably the queen would not risk a previous flight.

Please accept my humble apologies for not explaining more fully in my first letter, which I can assure you was *not* "writ sarcastic."

Further, has it occurred to Mr. W. or his friends that hive might have been left queenless with a view to superseding that particular race of bees?—"FOXROFT."

### Virgin Queen in Super.

[10257] It may be of interest to your readers to recount the following:—One of my hives of hybrid Italians has swarmed three times this year, and lately showed signs of great irritation, together with the presence of very numerous drones. The hive was opened and the honey chamber of ten shallow frames found to contain large patches of drone cells; a further examination discovered an unfertile queen in the super, the brood chamber also contained a fertile queen and ten well-filled, healthy frames of brood. The super of shallow frames was put on May 18 above the zinc queen excluder, and has never been moved since. The combs were well drawn out by June 10, and no signs of the drone cells appeared until about a week ago. How did this unfertile queen

get into the super? Did she possibly escape through the zinc excluder before fully grown after leaving her cell in the lower brood chamber?—GORDON W. MOORE.

[Bees do not grow after leaving the cells. The queen may have been a small one, or have found a flaw in the excluder, or an egg may have been carried into the super and the queen reared there; in that case, the queen cell, or the remains of it, will still be there.—EDS.]

### Swarm in a Hedge.

[10258] I have just seen a curious instance of a swarm having settled in a hedge and built combs quite 10 ins. long, and apparently were contented to remain there.

The cluster was quite exposed to the light, sealed brood being on the outside of the combs. The bees must have been there a considerable time, and in spite of the weather having been wet and cold (nearly to freezing point on two mornings), apparently took no harm.

This has made me wonder whether bee-keepers as a whole use too many quilts, and thus cause excessive swarming. If bees can live and build comb quite exposed to the weather, would not bees in a good hive be better if only a light covering were put on the top of the frames? I think, Sir, your opinion on this point would be appreciated by others besides

RICHARD H. AMIES.

[We have often given our view on the question of light or heavy covering for bees. We favour a fair amount of covering during the summer—felt or carpet to, say, 1 to 1½ ins. thick. In our opinion, this tends to keep the temperature among the combs more even. The wraps absorb the heat during the day and keep the bees warm at night. With thin wraps, and we have seen only a piece of calico used, the bees are almost roasted by the sun's rays during the day, and are nearly frozen during the cold nights.—EDS.]

### Action for Damages Caused by a Bee Sting.

[10259] I am keenly interested in reference to cutting sent by J. Rae (10229), p. 355. Some time ago we had a case reported in THE BRITISH BEE JOURNAL, where a bee-keeper's bees swarmed but had not left his grounds; the second party fetched the bees from the bee-keeper's hedge. When taken into Court, the bee-keeper lost the case. I am interested in such cases. Is the British Bee-keepers' Association all that it might be? We want a live Association, one to protect bee-keepers in such cases as the above, and for such purpose

we should have a special fund. I myself would not object to paying 2s. 6d. per year, for I think it is a disgrace that we should stand by and see a brother bee-keeper go under in such unjust cases as the above. No other Association would allow one of its members to suffer in this way.—J. PEARMAN.

[So far as the action for damages is concerned, Mr. Pearman has overlooked the fact that the B.B.K.A. was "live" enough to inaugurate a scheme of insurance to cover such cases. Had the bee-keeper been insured against damage to third parties, the company would have paid the damages, or contested the case. We confess we have very little sympathy with anyone who fails to take advantage of the B.B.K.A. insurance scheme, and is mulcted in damages as a consequence.

The other case was a dispute between two bee-keepers, and we do not agree with the judgment given; but these cases are so few that we do not see that a special fund would be of much service. However, Mr. Pearman is a member of the Council of the B.B.K.A., and he can bring the matter up at one of the meetings.—Eds.]

### Screen for Road.

[10260] In reply to B. Dunning (9906), to be effective a screen should be at least 7 ft. high; privet would take a long time to grow to this height. Young Lombardy poplars 6 ft. high, planted in October, would make a screen at once if planted 18 in. apart. Espalier-trained lime trees would also make a good screen, rather better than the poplars, if good-shaped plants could be obtained. The limes would be planted 6 or 8 ft. apart, according to the spread of branches. The cost of poplars as above would be about 15s. to 18s. per dozen; the cost of limes would be 30s. to 40s. per dozen. Privet could be planted underneath the limes to fill up any space if there is no wood fence.

Loganberries would make a good and profitable screen, but would take two years to get established.—W. BROADHURST.

### Notes from Wallingford.

[10261] You ask for the accounts of various weather conditions in various districts. I can give you some idea of those prevailing here.

Judging from correspondence and weather reports, I think that this year it is probable that N. Berks and neighbourhood has had about the worst weather for bees of anywhere in the country. February and March were very fine—much too fine and warm; April was cold and

wet throughout. The last half of May was fine—indeed, May would have been a good month but for the fact that we had so many night frosts. However, from the middle of May till the end of the first fortnight of June our bees did well on the whole. We do not get much, ever, at so early a period here. From June 14 to June 30 no honey was gathered, and with the exception of about five days July was an utter failure—in fact, the bees did not get enough honey during that month to feed the brood. I am feeding young lots, while the whole place is simply a mass of white clover and alsike! Last year all our honey was got in August. Perhaps it will be so this year. Let us hope so. There have not been two fine days together for more than 14 days, and we are in a very backward state on the land—hay not finished and corn almost ready to cut. However, with good weather now for a month or so, we shall be all right. Harvest must be a long one, as the corn is badly knocked about by the very heavy rains.

(10231) Happy is the bee-keeper who has plenty of late lime trees in his district in a season like the present. Bees will work on this flower at times when it is too cold for white clover to secrete nectar. One side of a tree, if of any size, is bound to be sheltered.

(1023) I do not see what there is to be "amazed" about in this case. There are rogues everywhere, and some of 'em keep bees. As a general rule, I believe, bee-keepers are straighter than most people, and most of them are willing to be friendly and do one another a good turn, but exceptions there are and always will be. Trust no one unless you know him, and you will be on the safe side.

(10232) I only made that statement for your information. I feel sure you understand this. [Quite so. We were pleased you gave us the "cue" to mention the matter.—Eds.]

(10235) The old story again. In bad weather casts have more often than not from two to twenty queens. I have knelt by the hive entrance as they have been coming out, and having closed the entrance to an inch or so, have killed the queens as they came out. What is Mr. Tidbury keeping those virgins in match-boxes for, I wonder? It would be "a happy release" to kill them, I should think.—R. M. MANLEY.

### Advice to Beginners.

[10262] Will Mr. O. Puck kindly state what trouble is likely to arise to bees from proximity of hive to a fowlhouse kept on the intensive system.—"C. E. C.," Ipswich.



## QUERIES AND REPLIES.

Queries reaching this office not later than **FIRST POST** on **MONDAY MORNING** will, if possible, be answered in the "Journal" the following Thursday. Those arriving later will be held over until the following week. Only **SPECIALLY URGENT** queries will be replied to by post if a **STAMPED** addressed envelope is enclosed. All queries must be accompanied by the name and address of the sender, not necessarily for publication, but as a guarantee of good faith. Correspondents are requested to write on one side of the paper only.

### Using Foreign Honey for Feeding

[9907] Last year I started bee-keeping with two swarms, and fed up in the autumn with sugar syrup as advised in the "Bee-keeper's Guide." Result, I lost both stocks, not through starvation, as they left 20 lbs. of honey after dying out. I have grave doubts of the sugar, so this year I propose feeding up three stocks (which at the time of writing have not an ounce of stores) on Australian honey. I am writing this hoping some kind bee-keeper will give his experience, advice, and method in your correspondence column.—A. E. H. WASLEY.

REPLY.—If a good quality honey is used it will be all right. The danger of using imported honey is that it may have come from diseased colonies. To minimise this risk the honey should have water added, say, three to five ounces to each pound of honey, and be boiled for 20 minutes, and when cool be medicated. If any of our readers have tried feeding with imported honey we should be pleased to hear the result.

## Notices to Correspondents

M. T. (Yorks).—*Sending bees by train.*—It was an error in judgment for the seller of the bees to put them on rail on a Saturday, as this would certainly mean no delivery until Monday, and in case of a swarm the bees might starve, or might be left during Sunday buried in other parcels and be suffocated. We should think the seller would be responsible for loss.

E. H. OLDHAM (Folkestone).—*Uniting bees in September.*—It will not be too late. Bring the hives together as soon as you can. Find the queens if you can, remove one and cage the other. Putting all the combs in one hive alternately from each stock will be quite right, but both lots of bees must be floured. Another method is to place one lot on the top of the other with a sheet of paper between. When the bees have eaten through the paper they will unite without fighting.

"EROR" (Dorset).—*Winter stores.*—It is not necessary for the 25 to 30 lbs. of stores to be all in four or five combs. The quantity a comb will hold was given as a guide in estimating what stores the bees have. If there is any quantity of unsealed stores when packing for winter it is better to extract it. If there is only 2 or 3 lbs. unsealed the bees will use it up before the cold weather.

C. D. (Haslemere).—*Preparing for winter.*—(1) If there is any nectar to be gathered the bees will store it in the combs as the young bees leave the cells, but whether they will store enough for winter we cannot say; it will depend on the weather and if there is any forage. If they have not stored enough by the second week in September they must be given syrup in a rapid feeder to make up the amount needed. (2) If you leave a rack of sections full of honey it would probably be enough, coupled with what is stored in the brood combs, but an examination of these should be made to be certain that there is plenty. (3) Better drive the bees from the skep and unite them to the queenless stock. (4) The method given is quite right, only flour both lots of bees thoroughly when uniting.

H. LOWTHER (Shropshire).—The insect is a Sawfly. The bees would most likely fill up as much of the slots as they could get at, but they could be easily cleared by heat.

#### Honey Sample.

H. R. (Catford).—A very nice sample, mainly from lime. The other sources we cannot determine, but there appears to be a little from beans.

#### Suspected Disease.

W. F. JONES (Anglesea).—The bees have "I.O.W." disease. Spray with one of the remedies advertised for that purpose.

## Bee Shows to Come.

A nominal charge of 2s. 6d. is made for notices (not exceeding 7 lines) in this column, 10 lines charged 3s. 6d., up to 15 lines 5s., which covers cost of insertion from order till date of show. Cash should accompany orders for insertion.

**August 25, at Chester.**—Cheshire Beekeepers' Association, in connection with Cheshire Agricultural Society. Several Open Classes. Good prizes.—Schedules from Thos. A. Beckett, St. Werburgh Chambers, Chester.

**August 25, at Prestbury, Cheltenham.**—Flower, Fruit and Honey Show. Open Class for single 1-lb. jar of honey. Several classes open to beekeepers living within a radius of 12 miles.—Schedules from A. H. Bowen, Coronation Road, Cheltenham. Entries close August 18.

**August 28, at Hounslow.**—Hounslow and District Allotment Holders' Association Second Annual Exhibition of Vegetables and Fruit. Honey exhibits under the control of the Twickenham and Thames Valley B.K.A. Open Classes for single bottle and section.—Schedules from Miss M. Byatt, "Hawthorn," Hanworth, Middlesex.

**Saturday, August 28, at Hinckley.**—Leicestershire and Rutland Beekeepers' Association, in connection with Hinckley Flower Show.—Open Classes for Honey, Sections and Jars. Prizes, 12s. 6d., 7s. 6d., and 4s. 6d. in each class. Judge, J. Herrod-Hempall, F.E.S.—Schedules from A. Kimbrell, Esq., Clarendon Road, Hinckley. Entries close August 23.

**September 1 and 2, at Glasgow.**—Glasgow and District Beekeepers' Association Second Annual Show, in conjunction with Glasgow and West of Scotland Horticultural Society. Open Classes in Honey Section.—Schedules from Peter Bebbington, Hon. Secretary, 65, Robertson Street, Glasgow.

**September 3, 9 and 10.**—Portsmouth B.K.A. Honey Show, in conjunction with the Portsmouth Allotment Holders' Show, at Connaught Drill Hall, Portsmouth. Six Open Classes. Judge, W. Herrod-Hempall, F.E.S.—Schedules from Show Secretary, Mr. J. Sennett, 154, Essex Road, Southsea.

**Saturday, September 11.**—Fforest-Fach Horticultural Society, Swansea. Three Open Classes for Honey, extracted and sections. Help to foster bee cult this end. 1st prizes, 10s.; 2nd and 3rd in proportion.—Schedules ready from G. L. Williams, Fforest-Fach, Swansea.

**September 22.**—Altrincham Show. Several Open Classes for Honey and Appliances.—Schedules from H. Turner, 1, Market Street, Altrincham.

**October 5 to 8.**—Essex Fruit and Honey Show at Institute of Agriculture, Chelmsford. Open from 12 to 8 p.m. Admission free. Lectures and demonstrations each day.—Schedules from G. R. Alder, 7, Bulwer Road, Leytonstone.

**November 18.**—Annual Show of the Worcester City and County Chrysanthemum, Fruit, Root and Honey Society. Thirteen Open Classes in Honey Section.—Schedules from Geo. Richings, 42, Barbourne Road, Worcester. Entries close November 6.

## Special Prepaid Advertisements. One Penny per Word.

Trade advertisements of Bees, Honey, Queens, and Bee goods are not permissible at above rate, but will be inserted at 1½d. per word as "Business" Announcements, immediately under the Private Advertisements. Advertisements of Hive-manufacturers can only be inserted at a minimum charge of 3s. per 3in., or 6s. per inch.

PRIVATE ADVERTISEMENTS are only intended for readers having Surplus Stock to dispose of. Driven Bees, Nuclei, and Queens that are reared or imported for sale, are Trade Advertisements, and can only be accepted under trade terms. A charge of 6d. extra will be made if a box number is used.

Orders for three or more consecutive insertions in "The Bee Journal" entitle advertisers to one insertion in "The Bee-Keepers' Record" free of charge.

Advertisements must reach us NOT LATER than FIRST POST on the 21th of the month for insertion in the next month's RECORD.

### PRIVATE ADVERTISEMENTS.

**7-FRAME STOCK** with 1920 Queen, Natives, healthy, 45s., or near offer; also W.B.C. Hive with strong Stock on 10 frames, £5.—SOYER, Granville Road, Sevenoaks. h.94

**SURPLUS STOCKS**, Italian and Hybrid, vigorous, £4 each; box returnable.—DR. JONES, Peatling Magna, Leicester. h.65

**CARNIOLAN.**—Wanted, at once, fertile 1920 Queen.—J. HENRY WATSON, F.E.S., 70, Ashford Road, Withington, Manchester. h.66

**FOR SALE**, two Stocks on 6 frames, £2 each; box 7s. 6d. extra, returnable.—CLARKE, Orsett Hall, Grays, Essex. h.63

**HONEY** wanted, any quantities up to 5 cwt.; tins forwarded.—MIDDLETON, Hardwick Road, Streetly, Staffs. h.70

**BEEES**, all Penna's strain, 5 to 12-frame Stocks, 50s. to 60s., with Hives 20s. extra.—MIDDLETON, Hardwick Road, Streetly, Birmingham. h.69

**1920 (MAY) HANSAN MOTOR CYCLE**, Villiers 2½, Amac, C.A.V., Albion 2-speed, aluminium footboards, fitted complete; £68. or nearest.—J. BLOOM, Temple Gardens, Letchworth, Herts. h.71

**SURPLUS 1920 Fertile Queens**, Hybrid, Penna strain, 7s. 6d. each.—EVANS, Lattiford, Wincanton, Somerset. h.72

**SURPLUS ITALIAN STOCKS**, 6 frames, plenty of bees, 65s.; box 10s. extra, returnable. Only Penna's strain kept; never had disease.—A. FARROW, Garage, Staplefield Grange, Sussex. h.75

**FIRST-GRADE Clover Honey**; sample 6d.—NORTH, Cressing, Braintree, Essex. h.73

**STRONG STOCKS**, Hybrids, no disease, two 10 frames, 75s.; one 6 frames, 45s.; carriage paid; boxes, returnable, 10s.—DAVIES, 40, Blackheath Park, S.E.3. h.74

**STOCK OF BEES** in large new skep. What offers? Stamp for reply; seen any time.—E. CHRISTIE, Hill View, Oxted Road, Godstone, Surrey. h.76

**1920 ITALIAN HYBRID QUEENS**, swarm reared, excellent strain, surplus through uniting late swarms, 8s. 6d. each.—ATWELL, "Brookhurst," Cove, Farnborough, Hants. h.77

**WHAT OFFERS** for one 12-framed Hive, packed with Italian Bees, also one Skep and one box full of Italians, and 24 drawn-out Shallow Frames?—Particulars, A. NICHOLLS, 38, Oxford Road, High Wycombe. h.78

**FOR SALE**, about 35 Stocks and Swarms of Hybrid Ligurian Bees on 8 to 10 frames and under; mostly this year's Queens; excellent workers.—REV. A. H. HALLEY, Crathie, Wellington College, Berks. r.h.79

**FOR SALE**, new Light Lincolnshire Honey, splendid quality, £3 cwt.—TAYLOR, Schoolmaster, New Leake, Boston. h.80

**EIGHT STOCKS** on 10 frames, headed by 1920 Italian Hybrid Queens from same mother as my 3-frame nuclei, but not purely mated; good, hardy, disease-resisting stock reared on the East Coast; £4 7s. 6d., carriage paid.—E. H. TUNMER, "Chalfonts," Leiston, Suffolk. r.h.81

**FOR SALE**, a few 5, 6 and 7-frame Stocks, Italian Hybrids, 6s. per frame; one on 10 frames, 55s.—MRS. J. E. WALKER, Winthorpe, Newark, Notts. h.82

**FOR SALE**, eight W.B.C. Hives and a few Stocks of Bees. Seen only by appointment. Stamp for particulars.—MISS HINDLEY, Bourton, Dorset. h.83

**CARNIOLANS.**—Surplus 4-frame Nucleus for immediate delivery, 50s., carriage paid; 1920 Queen.—ROBERTS, 50, Otter Street, Derby. h.85

**WANTED**, B.B.J. September 12, 1918.—STECHELT, 2, Star Yard, Carey Street, W.C.2. h.92

**TEN 1920 Queens**, British-Italian Hybrids, first cross, 7s. 6d. each.—WHITE, Penny Hill, Holbeach, Lincs. h.27

**BEEES.**—Few surplus Stocks, fine strain, 70s., carriage forward.—UNDERWOOD, Cogenhoe, Northampton. h.30

**HYBRID BEEES**, 7s. 6d. per frame; splendid workers; overstocked.—COOKSON, Beech Cottage, Longton, Preston. h.39

**A FEW** lots of good, healthy Bees on from 5 to 8 standard frames, 8s. per frame, carriage paid. Travelling box to be returned.—WRIGHT, Waterworks, Sutton Poyntz, near Weymouth. h.5

**12 STOCKS** of healthy Bees on 10 frames, ready for supering, £3 5s. per lot, and 10s. for box, returnable. Inspection with pleasure.—F. HOLLOWAY, Windmill House, Croxby Green, Herts. r.h.1

**READY FOR HEATHER.**—Reducing apiary. For Sale, 10-frame Stocks, 1920 Italian Queens, price £3 15s., free on rail; carriers returnable.—ASHWORTH, Weymouth Street, Warminster. h.20

**W.B.C.** PATTERN HIVES, never used, painted white, 10s. and 15s. each. Honey Press, Foundation, Swarm Catchers, Sections, etc., at half cost.—THOS. THIRKILL, Kirkby Malzeard, Ripon. r.g.181

**BUSINESS ADVERTISEMENTS.**

1½d. per word.

**MASHEATH MEMO.**—I am delighted with the Porchless and Baby Masheath Hives.—N. C. —ATKINSON, Fakenham. h.67

**FERTILE** Italian Hybrid Queens, 10s.—**JACK TICKELL**, Westbourne Apiary, Cheltenham. h.84

**FAMOUS HYBRID COTSWOLD QUEENS**, 10s. 6d.; vigorous and prolific. Buy now and insure against spring dwindling and "I.O.W." disease.—**LIEUT. BOWEN**, Queen Breeder, Cheltenham. h.86

**SUGAR NOW PROCURABLE.**—Send 10s. 6d. for vigorous lot Driven Bees; makes ninety shilling spring stock if ordered forthwith. Specially packed for Scotland.—**LIEUT. BOWEN**, Driven Bee Specialist, Cheltenham. h.86

**FLAVINE CANDY.**—6lb. packages, 10s.; postage 1s. 3d. Made in Cambridge under our supervision from the best white sugar.—**S. H. SMITH**, 30, Maid's Causeway, Cambridge. r.h.87

**PURE IMPORTED ITALIANS**, 6 frames, 45s.; Italian Hybrids, 6 frames, 42s.; boxes 7s. 6d., returnable; Hybrid Fertile Queens, 6s.—**EKINS**, Burntwood, Staffs. h.88

**SURPLUS QUEENS.**—Owing to the bad honey crop I am uniting many nuclei, and can offer a few good young fertile Italian Queens per return at 10s. each. If desired they can be had on 1, 2, or 3 combs at 10s. per frame extra. Special note.—Clients desiring early delivery of my well-known Nuclei for next season should book their orders now, as I have been booking for some weeks for 1921.—**F. M. CLARIDGE**, Copford Apiary, Colchester. h.89

**A FEW** strong 4-frame Nuclei, young Queens, 27s. 6d. each; two lots of Driven Bees, young Queens, average 3 lbs. per lot, 12s. each; boxes returnable.—**MATTHEWS**, 25, Cray Road, Crockenhill, Swanley, Kent.

**CRAWLING DISEASE.**—Reliable treatment for curing and prevention; recipe 2s. 6d.—**A. W. SALMON**, Cashfield, Chingford.

**DRIVEN BEES**, strong, healthy lots, with Queen, 9s. each; boxes returnable; spare fertile Queens, 4s. each.—**MORETON**, Hallow, Worcester. h.90

**FOR SALE**, two 4-frame Nuclei, 27s. 6d. each, carriage paid; boxes 7s. 6d., returnable.—**KNIGHT**, Kenwyn, Truro. h.91

**QUEENS.**—Home-bred fertile Italians, immediate delivery, 10s. each.—**GOATH COTTAGE APIARY**, Endlebury Road, Chingford. h.93

**"SELECT STOCK"** direct from famous American breeders, "Moore, Kentucky," "Davis, Tennessee," "Forehands, Alabama," strains, noted for honey gathering and disease-resisting qualities. Strong 3-frame Nuclei, 35s.; 4-frame, 40s.; 6 and 8-frame Stocks, 55s. and 72s.—**GEARY**, Florist, Barwell, Hinckley. h.50

**DRIVEN BEES**, with Queen, Hybrids, good workers, 8s. 6d. per lot, carriage paid; cash.—**LEIGH**, Broughton, Hants. h.59

**SILVER MEDAL QUEENS.**—"Finest I have ever seen"—*vide* testimonial. From 7s. 6d. If interested send postcard for booklet.—**EDWARDS**, 22, Barts. Road, Reading. h.61

**HEALTHY DRIVEN BEES**, with Queen, 10s. per lot, carriage paid; boxes returnable. Cash with order. Orders in rotation.—**PULEN**, Ramsbury, Hungerford. r.g.211

**ITALIANS.**—Choice Virgins, 3s.; also Fertiles. Particulars, stamp.—**HOUSTON**, Ellen Villa, Sidcup. r.g.213

**ITALIAN QUEENS** from Penna's queen, virgins 14s., fertile 9s. 6d.; Hybrid Italians, virgins 3s. 6d., fertile 8s. 6d.; Hybrid Stocks on 4 frames, 50s.; box, returnable, 10s.—**WARD**, Deeside Nursery, West Kirby. r.g.215

**ITALIAN QUEENS**, pure imported, 11s. 6d. each; safe delivery guaranteed; immediate delivery.—**C. T. OVERTON & SONS**, Crawley. r.h.49

**4-FRAME NUCLEI**, headed by 1920 Italian Queen, 50s.; box charged 10s., returnable; 6-frame Stocks, 70s.; 8-frame Stocks, 90s. Immediate delivery (weather permitting). Italian fertile Queens, 10s. 6d. English Run Honey and Sections wanted.—**LEE**, "Little Bowden Apiary," Burgess Hill, Sussex. r.g.114

**CHOICE** home-reared Italian Queens, 10s.; Virgins, 4s. 6d.; July-September.—**MISSSES PALING & PILLANS**, Golden Square, Henfield, Sussex. r.g.82

**STRONG 3-FRAME NUCLEI**, 1920 fertile Queens, 30s.; box 5s., returnable; Stocks on 8 frames, 60s; boxes 10s., returnable.—**W. WOODS**, Normandy, near Gullford. g.53

**PURE ITALIAN QUEENS**, prompt delivery; select Italian, extra golden, rare honey-producing stock, August-September.—**ATKINSON**, Fakenham. r.g.24

**"WIGHT" DISEASE**, prevention and removal; advice 6s.—**ALFD. RYALL**, Kenwood Apiary, Elcombe, Stroud. r.h.3

**1920 FERTILE** Golden Italian Queens, guaranteed imported direct from Italy, regular supplies every few days, 10s. each; specially selected, 14s.—**GOODARE**, New Cross, Wednesfield. f.59

**JOT DOWN** the deficiencies of your present equipment and your needs for future improved working. Then book for **"MASHEATH"** (Regd.) Equipment for autumn construction.

The **MASHEATH LIST** contains an unique series of Hives unequalled to-day. You should not enter upon another bee season without them. "The Hives (Porchless Mas sheath) are excellent in every way, and I am very pleased indeed with them. **'PORCHLESS!'** Yes, every time. Need I say more? I will get you to send me two more."—**W. E.**, June 17, 1920.

The **MASHEATH HIVES TALK** as soon as they are delivered.

**ATKINSON**, Proprietor and **Fakenham**. Sole Maker.

**Altrincham Agricultural Society.**  
**ANNUAL SHOW,**  
**Wednesday, September 22.**

**£2,500 IN PRIZES.**  
Silver Cups and Medals for Horses, Cattle, Pigs, Turnouts, Hunters, Jumpers, Roots, Grain, Butter, Cheese, Implements, Dogs, Poultry, Pigeons, Rabbits, and Cavies.  
Open Classes for Honey.  
Increased Prize Money in All Sections.  
Prize List may be had from the Secretary,  
**HERBERT TURNER,**  
1, Market Street, Altrincham  
Tel. 174.

Entries close September 4. Double fecs, September 8.  
Dog entries close September 10.

**DAIRY SHOW, LONDON.**  
OCTOBER 19, 20, 21, and 22.

**GREAT EXHIBITION OF DAIRY CATTLE, PRODUCE, APPLIANCES, &c.**  
ENTRIES CLOSE SEPTEMBER 6.

Particulars of the **SECRETARY**, British Dairy Farmers' Association, 28, Russell Square, London, W.C.1.

"ISLE OF WIGHT" DISEASE.—Don't worry; use the solution that cures; 2s. per bottle.—**E. PRESSEY, St. Elmo, Coulsdon. r.d.149**

**HAVE YOU READ "THE BEE WORLD"?** If not, why not? Every number in itself is a useful literary work for practice and reference. Specimen copy free.—Offices: **THE APIS CLUB, Port Hill House, Benson, Oxon.**

## ITALIAN QUEENS

Direct from Italy.

**E. PENNA, BOLOGNA, ITALY.**

I assume again the direct sale of my queens. Special offers from July 10 till countermanded. For queens in lots of 4 at a time £1 8s. Cash with orders. Payment by cheques or **British Postal Orders**. International Money Orders are **not** accepted. I do not hold myself responsible for the queens that are not sent by me direct to customers. All orders should be sent direct to me. In May the queens dead in the journey have been **less than 1%**

ORDERS BOOKED IN ROTATION.

## Would You Winter 100% ?

Then have some of Clarke's "I.O.W." cure and preventive on the floor of your hives from now onward. No spraying, simply a powder. Don't let your bees die.

3/6 per packet, post free.

**G. J. CLARKE, Blythburgh, HALESWORTH**

THE

## British Bee-Keepers' Association.

Insure now against loss by damage done through bee stings. All particulars from

**W. HERROD-HEMPSALL, 23, Bedford Street, Strand, London, W.C.2.**

## ITALIAN QUEENS

Direct from Italy.

Address:

**Signor Gaetano Piana,  
Castel San Pietro,  
near Bologna, Italy.**

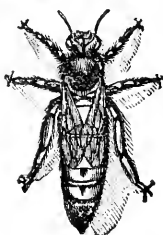

All Queens are reared by the most up-to-date and scientific methods. Mr. W. Herrod-Hempsall has personally inspected the apiary and methods employed, with which he is perfectly satisfied.

PRICES FOR 1920.

**For 1 Fertile Queen: August and September, 9/- each queen.**

Carriage paid in Great Britain. Cash must accompany all orders, which will be executed in rotation. Guaranteed safe arrival of all Queens, but not the introduction. Bees dead upon arrival must be sent at once to "B.B.J." Office.

For the mutual convenience of all parties, Il Signor Piana has made arrangements that all communications, orders and remittances of the readers of "B.B.J." and "B.K.R." can be addressed to him, c/o British Bee Journal, 23, Bedford Street, Strand, London, W.C.2.

Cheques payable to 'British Bee Journal.'

The products of the Apiary, of Poultry and Farm Stock, of the Fruit and Vegetable Garden can be Advertised and Sold through

THE

## BAZAAR, EXCHANGE & MART

Newspaper.

Get a Copy—Thursday and Saturday 3d. The "Bazaar" publishes also practical handbooks by experts. Send for full catalogue, post free from—**WINDSOR HOUSE, Breams Buildings, LONDON, E.C.2.**

## INSURE YOUR STOCKS

AGAINST "I.O.W." AND OTHER INFECTIONS.

Science has now placed within reach of every Apiarist a safe and certain preventive of infection in "Yadil" Antiseptic.

For **SPRING FEEDING** "Yadil" may be added freely to Syrup.

For **DISINFECTING** Bees and Combs a five-per-cent. solution in tepid water should be used with a fine spray.

ASK FOR GREEN LABEL.

Our Bee Brochure sent Free on Application.

**CLEMENT & JOHNSON, 19, Sicilian Avenue, W.C.1.**

**B  
C  
W  
B**

BEST CLEARING and  
WINTERING BOARD,  
SUPER CLEARER, &c.

A Necessity for all Bee-Keepers  
all the year round.

MEADOWS, SYSTON, LEICESTER.

## POSITIVE FACTS.

June 13th, 1920.

I am very pleased with the foundation. The bees undoubtedly prefer it to any other make I have, and have even gone the length of missing two sheets of other new foundation, and working out a sheet of yours placed behind them at the back of the hive. Full sheets have not sagged in the least in 16 x 10 frames.

Yours faithfully, R. B. MANLEY.

Illustrated Lists free by post.

**S. J. BALDWIN, The Apiary, BROMLEY, Kent.**

# DADANT'S WEED FOUNDATION.

**T**HIS Foundation is made from pure Beeswax and guaranteed free from all disease germs.

Give your bees the BEST, and the best is DADANT'S.

No acids or other chemicals are used in the manufacture, and the makers guarantee that "EVERY INCH, EVERY POUND, EVERY TON, is equal to any sample ever sent out."

We have just received a fresh consignment, and are in a position to give immediate despatch.

Rear healthy bees on clean, natural combs.

None genuine without the watermark "DADANT" on every sheet.

*Our Catalogue, entitled "Everything for an Apiary,"  
is sent post free on Application.*

---

**R. STEELE & BRODIE,**  
Bee Appliance Makers,  
**WORMIT, FIFE.**



THE  
KEY TO  
YOUR SUCCESS.

## Lee's Bee Supplies.

¶ In design, material and workmanship, Lee's Bee Supplies still retain the reputation of being your best and safest investment.

¶ Our 1920 ILLUSTRATED CATALOGUE is yours for the asking. It contains detailed information on the most up-to-date hives and appliances for which the House of Lee is famous.

¶ We regret the necessity of having to advise our Customers that owing to the increased cost of production, all prices in 1920 price list are subject to 10% increase. The increase will not apply to orders received before May 10.

\*\*\* Five per cent discount to Members of THE APIS CLUB.



## JAMES LEE & SON, LTD.,

Uxbridge, Middlesex.

(Telegrams: Graphicly, Uxbridge.)

Telephone: Uxbridge 181.)



## "BACTEROL"

FOR BEES

2/9 per Bottle.

Post Free.

The cure for, and preventive of, "Isle of Wight" Disease. Non-poisonous—free from stain or unpleasant odour.

MENLEY & JAMES, LTD.,  
Menley House, Hatton Garden, E.C.1.

## BRADBURY, TAUNTON,

FOR QUALITY BEE GOODS.



Illustrated Bee  
Guide free.

Telephone: TAUNTON 176.

## 20-Page 1920 "WHITE STAR" List,

3½d. POST FREE.

S. SIMMINS, QUEENLAND, HEATHFIELD, SUSSEX

Bees and Beekeeping Appliances. Catalogue free.  
EDWARD J. BURTT. MANUFACTURER. GLOUCESTER.

*I very much regret that there has been a large increase in the cost of the manufacture of bee appliances, and therefore my prices will be advanced 10% from May 10th. Books excepted.*



No. 1992. Vol. XLVIII

AUGUST 26, 1920.

[Published every Thursday, Price 2d.]

**CONTENTS.**

	PAGE		PAGE
SEASONABLE HINTS .....	409	CORRESPONDENCE—	
A DORSET YARN .....	409	Notes and Comments .....	414
JOTTINGS FROM HUNTINGDONSHIRE .....	410	Prolific Swarming .....	415
CONVENTION OF BEE-KEEPERS .....	411	Swarms Affected with "I.O.W." Disease .....	415
NOTES FROM GREINA GREEN .....	412	A Sweet from the Laurel .....	415
COTSWOLD NOTES .....	412	A Swarm in a London Suburb .....	416
WARWICKS. BEE-KEEPERS' ASSOCIATION .....	413	The Longer Frame .....	416
SWARM PREVENTER AND DRONE TRAP .....	414	Vagaries of Swarms .....	416
COPIES OF B.B.J. FOR DISPOSAL .....	414	Notes on the Past Season .....	417
BEEES IN A CHIMNEY .....	414	Effect of Weather on Bees .....	417
ECHOES FROM THE HIVES .....	414	Bees in a Hedge .....	417
		Aluminium Foundation .....	417
		BEE SHOWS TO COME .....	418

# FOOD FOR BEES.

Owing to the continued bad weather there is a likelihood shortage this Winter. To prevent loss of Stocks order at once TAYLOR'S renowned

## SYRUP

In tins, 7 lb., 14 lb. and 28 lb. at  $1/3$  per lb., Carriage extra.

We are in a position to supply, without vouchers, the best

## CANDY

made from pure Sugar, plain or medicated,  $1/6$  lb. Carriage extra.

**E. H. TAYLOR, WELWYN, HERTS.**

Telephone—WELWYN 13.

**THE  
British Bee Journal**

Office: 24, Bedford Street, Strand, London, W.C.2.  
ESTABLISHED 1873.

A Weekly Journal Devoted to the  
Interests of Bee-keepers.

Edited by T. W. COWAN, F.L.S., &c.,  
and J. HERROD-HEMPSELL, F.E.S.

**Correspondence: Whom to Address.**—All matters relating to the Literary Department, Associations, Shows, etc., should be addressed, "Editors, *British Bee Journal*," and all business communications and matters relating to subscriptions and advertisements to be addressed to the "Manager," *B.B.J.* Office.

**Subscriptions.**—Annual Subscription, 10s. 10d. post free in advance; single copies 2s., or 2½d. post free. If a receipt is required by post, a stamped and addressed envelope must be sent, otherwise a printed receipt will be enclosed along with the paper.

*Note.*—Cheques and Postal Orders should always be crossed, otherwise it is very difficult to trace them if they go astray.

**How to send Money.**—Remittances can be made payable to W. Herrod-Hempshall by crossed Cheques and Postal Orders. Stamps may be sent for small amounts up to 2s.

*Halfpenny stamps are preferred.*

Scottish or Irish cheques can only be taken in payment if 6d. is added for commission charged by banks for cashing them.

The Editors are not directly or indirectly interested in the manufacture or sale of beehives or appliances of any kind, and must refer correspondents wishing for prices or catalogues to advertisers in the paper.

**OUR DEPOSIT SYSTEM.**

You are advised to insist on this being used when dealing with strangers.

**Rules and Conditions for Depositing**

*In order to save trouble, it is requested that the Rules be carefully read over by persons using the Deposit System of trading.*

Goods should not be despatched until notice that the money has been deposited is received from this office.

**1. Method.**—When strangers are dealing together, the purchase-money of the articles is deposited at our office. We acknowledge receipt of the deposit to both parties, and hold the money until we are satisfied that the purchase is concluded. If a sale is effected, we remit to the seller the amount deposited, less a charge of 2½ per cent. In the £, with a minimum of 6d., and the expenses of Post Office Orders and postage, &c. Cash will be forwarded by Cheque, Post Office Order, or by Postal Order as preferred. If a sale or exchange be not completed, we return the amount deposited, after making the same deduction. By this means buyers and sellers are secured against fraud.

**2. Deposits.**—Postal Orders (drawn on General Post Office) and Cheques must be made payable to W. Herrod-Hempshall, and crossed "London County and Westminster Bank." The numbers of the Postal Orders should be kept by the sender.

We cannot be responsible for any loss that may occur in transit.

**3. Honey on Approval.**—All honey will be sold by sample, which must be sent direct to buyer.

**4. Bee Appliances.**—In ordering, the time allowed for completing the order to be stated to us when sending cash. If maker accepts, we hold cash until transaction is satisfactorily completed, when the amount will be remitted, subject to conditions as in Clause 1.

**5. Bees and Queens.**—These will be dealt with entirely by the parties concerned, so far as price, &c., go, and when the purchase is satisfactorily completed cash will be remitted as per Clause 1.

**6. Goods in Transit.**—These are at the seller's risk, i.e., any damage to or loss of an article on its journey is borne by the vendor; but a rejected article must be properly packed and returned by the same means as was used in sending it.

**7. Carriage.**—The carriage of all goods, except such as are sent by post, is payable by the buyer, unless otherwise agreed. If any article sent on approval be returned, each party to the transaction must pay carriage one way.

**Books for Bee-keepers  
NOW IN STOCK.**

Cash in full must be sent with order.

A Modern Bee Farm ... ..	7/6	...	8½d.
(To be obtained from this Office only.)			
Advanced Bee Culture (HUTCHINSON) ... ..	6/-	...	6½d.
Beginner's Bee Book (PELLETT)	5/-	...	4d.
<b>BEE-KEEPING SIMPLIFIED FOR THE COTTAGER AND SMALLHOLDER</b> (W. HERROD-HEMPSELL, F.E.S.) ... ..	1/-	...	2d.
<b>BRITISH BEE - KEEPERS' GUIDE BOOK</b> (T. W. COWAN) Paper covers ... ..	2/6	...	3d.
Cloth covers ... ..	3/6	...	4d.
Dissectible Model of Queen Bee ... ..	4/6	...	3d.
<b>FERTILISATION OF FRUIT BLOSSOMS BY BEES</b> (T. W. COWAN) ... ..	-/3	...	1d.
Honey and Health (A. HOPE) ...	-/6	...	1d.
Honey Vinegar (REV. G. BANCKS)	-/2	...	1d.
How to Keep Bees (ANNA B. COMSTOCK) ... ..	5/-	...	4½d.
Management of Out Apiaries	3/-	...	2d.
Prevention of Swarming (WILKES) ... ..	1/-	...	1d.
Pollination of Fruit in relation to Commercial Fruit Growing (C. H. HOOPER, F.R.H.S.)	-/6	...	1d.
<b>PRODUCING, PREPARING, EXHIBITING AND JUDGING BEE PRODUCE</b> (W. HERROD-HEMPSELL, F.E.S.) ...	2/-	...	3d.
Queen Rearing in England (F. W. L. SLADEN) ... ..	1/6	...	2d.
Scientific Queen Rearing (DOOLITTLE) ... ..	4/-	...	3½d.
The "Townsend" Bee Book ...	2/6	...	2d.
<b>WAX CRAFT</b> (T. W. COWAN) ...	2/-	...	2½d.

**MISCELLANEOUS.**

Maeterlinck's Life of the Bee	5/-	...	3d.
The Lore of the Honey Bee (TICKNER EDWARDES) ... ..	2/-	...	2½d.
<b>THE BEE WORLD</b> (supplied only to members of Associations interested in the control and development of the APIS CLUB, apart from ordinary members of the latter), per copy ... ..	-/8	...	1½d.
The Bee Master of Warrilow (TICKNER EDWARDES) ... ..	7/6	...	4½d.

**British Bee Journal & Record Office,  
23, BEDFORD STREET, STRAND LONDON, W.C.1.**





## Seasonable Hints.

We are greatly obliged to those of our readers who have responded to our request for particulars as to conditions in other parts of the country. All tell pretty much the same tale—little or no honey, and considerable feeding will probably be necessary.

Supers should now be taken off, except in heather districts. Breeding is in most cases being still carried on, but where it has ceased it is advisable to feed gently in order to stimulate the queen to lay. Those bees that are reared from now onwards will not only survive the winter, but carry on in the spring until others are reared to take their place. Old bees in the autumn mean rapidly dwindling stocks in the spring.

Great care must now be taken to prevent robbing. No comb, honey, or syrup must be left exposed. Hives should be opened as little as possible, and not kept open longer than necessary, or a crowd of bees will soon be hovering round attempting to rob, and these will continue their attempts after the hive is closed and the manipulator has left.

## A Dorset Yarn.

A sudden stop to surplus honey. Top sections, which were crowded with bees, are now deserted; in the bars they go down during the night, but when the sun is up in the daytime they are again covering them. I am not quite sure whether they are emptying the uncapped cells and taking the honey down into the brood chamber. They certainly did this with some of the sections before I took them off.

The racks of sections below the bars are beautifully filled, but not of the purest colour: so many thousands running over them to the bars above have soiled it somewhat. I left them late as they had not finished the two outside rows.

Bees are working their hardest when weather is fair; in fact, there are so many going one way that the staff fetched me back to the farm with the call, "The bees are swarming"; but when I came back it was a sudden burst of warm sunshine, and they were all hurrying off in one direction, and that to the heather, which now is delightful. All round the Broadstone golf links there are many square miles of all three varieties—the deep-coloured *Erica cinerea*, the light-coloured five-cleft heath,

*Erica tetralix*, and the common ling, *Caluna vulgaris*—making the whole a perfect dream of colour. Have never yet found wild a white form of *cinerea*, but have found many clumps of the ling that are white. Why it should sometimes come white is one of the peculiarities of nature, but it is always so; white forms of so many flowers are found as seedlings, also the coloured species will throw out sports when there are the white and coloured forms on the one plant, but certainly the bees do well near heather.

I called in to see the secretary of the East Dorset Branch of the Dorset Beekeepers' Association. He had just unloaded seven boxes of shallow, with three or four boxes of standard bars, all filled and capped with the finest quality honey, of very fine flavour and of rich perfume. Mr. Garrett has the finest lot that I have yet seen in Dorset, and he is only a beginner. He bought the first lot in a box for 15s.; now he has a line of hives. Some of them have a brood chamber with 15 frames. No wonder he has such a lot of fine honey! These are blacks, and a fine working lot they are: two years of delightful work he has had with them. He knew nothing of them before, but he has made good with them. A retired business man, he gets to know and do everything well. The same success that followed him in business is following him as a beekeeper. He goes miles to see and help others with their bees. He has the bee fever badly; his enthusiasm has gained us 80 members in about three months. He lives in a delightful place, with miles of heather all round him.

Truly Dorset is a land of "milk and honey." Yet a distinguished visitor from Winchester, who had motored down, told me this was the worst year he had known for surplus honey. He had in good years a great quantity of surplus; he used bars, and extracted as soon as full, and gave them back again to be refilled. But it is the fringe of heather that adds to the success of this part of East Dorset. In other parts of Dorset, where it is farm land only, the yield of surplus has been small, as the season was so wet.

Just round here there are fields of clover, both white and red, with rye grasses, very beautiful to see, and bees can get at the white flowers as they grow with length of stem trying to keep up with the long grasses. The flowers want to be well up to the sun to get the high quality of nectar, but the many other flowers among the grass are very inviting to bees. This second cut of rye grass and clover is owing to so much wet, yet it all helps our bees.

When at Taunton's great show on the 12th I was privileged to meet many beekeepers who write to the *JOURNAL*, but

most distinguished of all was Mr. Cowan, the grand old man of the craft. He looks well and fit. He spoke at the luncheon about bees and honey. They know him and appreciate him down there, as he lived among them.

Mr. Bigg-Wither demonstrated with bees. He had an appreciative audience for some time, with bees outside the screen as well as inside. He had two hives brought from the re-stocking station two miles away.

There were two lots of live bees in the show tent in hives with glass sides, so that the public could see something of the wonderful work that is done by these little creatures. There was not a great show of honey, but it was of good quality. There was not nearly so much as at Blandford, but the wonderful stage of bee appliances set up by Messrs. Bradbury was a sight to be seen. The men of this staff are efficient bee-keepers themselves. Each can lecture well, and can manipulate them without trouble, which speaks well for the teaching of the Somerset Bee-keepers' Association.—J. J. KETTLE.

## Jottings from Huntingdonshire

And so it comes to pass that the brambles which began flowering before their time are ripening later than usual. What antics the weather of 1920 has played with field and hedgerow! This will ever be a memorable year. Who could forget it? The soft summer warmth of February and March, the rain and wind of April, the bewitching glories of May and June, with a soaking and cold July, followed by an August that feels for all the world like October. The oak came out before the ash, and so we decided the summer would be a splash, but it's been a soak. I remember when I was a very small boy hearing my grandfather say that oak and ash wisdom must only be relied on when February, true to its tradition, filled the dyke. Should the second month of the year be dry then oak and ash could please themselves which first shot forth their leaves, the summer would be a cold and wet one. Hereabouts we are being spared the heavy rains which have fallen elsewhere, but we have our share of cold winds and sunless days, and so the bees are distressed. Tons of nectar waiting to be gathered and the weather preventing the eager insects getting it harvested. Small wonder their wrath waxes warm.

Bee-keepers must take things as they are and see to it that their queens continue to lay for some weeks yet. This is not going to be so easy this year as it sometimes is, for our friends of the hive

are preparing for a stiff winter. Why, is not clear. Possibly the autumnal feeling in the air has misled the bees into thinking that we are nearer Christmas than is the case, or—and I am inclined to think this the truer conclusion—the little ladies are scenting a long winter ahead, and preparing accordingly. Despite the weather some bees are out and gathering nectar and pollen, which is stored in the brood chamber, leaving her majesty precious little room for laying.

What do our colonial brethren call that complaint—if it deserves to be called by that name—of forsaking hives after a season or more's occupation? "The Bunkitis"? Anyway it is an unpleasant weakness; more of it than usual is prevalent this year—another item to mark 1920 as a famous, nay, infamous, year for apiculturists. Mayhap September will be a month of sun and softened winds. In the year 1903, if I mistake not, we had a wet June, July and August—wet but not cold. September came in bringing all the beauties of summer with her, cloudless days and balmy nights, plant life revived, and even the dog-roses were unable to resist blooming again.

Most of my hives, however, will be relieved of their supers this week; indeed, I have already taken several off. Some of my stocks, especially the Egyptian, will need considerable feeding up, others, like the Ligurians, seem full up with stores. Singularly, the lot I did not super for the purpose of keeping weaklings supplied, having some six times yielded up well-filled frames of brood and store for strengthening weak stocks, is now on strike, and has completely emptied the outside combs. A little attention and coaxing with good syrup will put the stock in a good temper again. What is the best method to adopt in autumn feeding? Personally I am inclined to think a pint of syrup given once a week quickly is preferable to slow feeding—other beekeepers do not agree, I know. Various opinions, too, obtain with regard to the thickness of feeding syrups and medication. As touching the latter some hold that feeding medicated syrup and candy to healthy stocks is injurious—others say that prevention being better than cure it is wise to take precautions in case disease may be lurking about. We shall get unity among bee-keepers, but not uniformity. It is best so. Uniformity stultifies originality and kills imagination and encourages fear, which reminds me of a gentleman not many miles away who asked me to go and look at his bees. I went. Four white-enamelled hives stood on asphalt flooring facing a high brick wall one yard away. As I prepared to go and inspect he brought

me gloves and gauntlets galore. "No thanks," I said, "just a veil and I shall be all right." But he was distressed; his bees were a furious sort. I must have gloves, would I just slip on a pair. He urged me so vehemently that I drew a pair over my hands, and I might have just as well placed my hands in my pocket—for all the use they left me—the gloves were thick enough to repel the sting of an African hornet. I drew them off. "Prefer stings to those," I said, and walked towards the hives. He, veiled and gloved, took refuge in an outhouse and watched me through an aperture covered with perforated zinc. The first hive was as strong a lot as I ever wish to see, and some 40 lbs. of honey was stored in the supers—no stings. The next hive revealed a rack of sections as empty as when first put on. In opening up the brood chamber I got a sting. "There now," came a muffled voice through the veil and zinc, "I thought so. If only you'd have kept the gloves on." This hive was "tight." Every comb below filled with honey and about ten cells of brood on one frame only. I brushed the bees off two combs and took them to the house for extraction, so as to give the queen room to lay; but my friend was obdurate. Extract stores! never; how could they live in the winter? I tried to explain that unless the queen continued laying so that young bees could hatch out the stock would be dead before spring. Too old to be taught the old gent had his way, and I left him. He has sent for me again. I wonder is he wiser?—E. F. HEMMING, Steeple Gidding.

## South Western Counties Convention of Bee-Keepers.

What is probably the first general convention of bee-keepers ever held in England took place in Gloucester on July 27, 28 and 29.

Thanks to the energy of the Hon. Secretary of the G.B.K.A., the Rev. Edward J. Bartleet, Quedgeley Rectory, Gloucester, ably assisted by the committee, invitations to take part in this proposed convention were sent to the Hereford, Monmouth, Somerset and Worcester Associations; and their respective secretaries met some time beforehand to arrange details. The idea was very enthusiastically taken up, and the result was a large and representative gathering of bee-keepers from all parts of the above-named counties.

A most attractive programme had been arranged, and the weather, departing from its late usual depressing character, allowed it to be carried out under favourable conditions.

The meetings were held in the Shire Hall, Gloucester, and at the first of these on Tuesday, July 27, the Mayor of Gloucester presided, and gave the members, on behalf of the ancient and historic city, a real hearty welcome. In the course of a capital speech he said another link in its history had been forged, by the first known convention of bee-keepers in this country being held within its walls. He himself was not a bee-keeper, he regretted to confess, but he well knew the absorbing interest of the craft, and its great national importance as a most useful and necessary food producing agent.

Mr. G. W. Bullamore was the first lecturer on the programme.

In "The Evolution of Bee-Keeping," most ably treated, he gave the large audience an extremely interesting account of the history of the honey bee from the earliest times right down to the present, dealing, *en passant*, with "Telling the bees," "Tanging," "Bee hunting," etc., finishing with modern methods, size of frames, and other details of interest.

At the close of the lecture he kindly answered many questions put by the audience.

In acknowledging a very hearty vote of thanks, Mr. Bullamore said he hoped that as a result of the work being carried on by the Bee-Keepers' Institute he would, at a later date, be able to deal with present day problems and practice as a sequel to "The Evolution of Bee-keeping."

After tea, which was as welcome as usual, many of the members were taken for a tour of the city, under the able guidance of Messrs. J. W. Barnett and Max Bellows, who pointed out the various points of interest connected with "Old Gloucester," others visited Mr. Burt's bee appliance factory, and several went to Quedgeley to inspect the Rev. E. J. Bartleet's apiary.

There was a large attendance at the Parkend Empire Picture House on Wednesday morning, when a cinematograph entertainment entitled "The Craft of the Bee Hunter" was given.

A number of children from the County Schools were present, by arrangement with the County Education Committee.

In the afternoon the president of the G.B.K.A. (H. Dent-Brocklehurst, Esq.) most kindly received a large number of those attending the convention, and he and his family showed them over his intensely interesting and beautiful house, Sudeley Castle, Winchcombe, at one time the home of Katherine Parr, wife of Henry VIII. The weather was fine, and

a most enjoyable afternoon came all too quickly to an end.

On Thursday morning a visit was paid to Gloucester Cathedral. Bishop Frodsham gave a most hearty welcome to those attending, on behalf of the Dean and Chapter. In the course of a splendid address he traced the connection of bees with religious thought from the earliest times, quoting many interesting legends, and showing how bee-keeping was a symbol of that beneficent power which "shapes our ends rough hew them as we will."

He subsequently conducted the members of the convention round the building.

Following this, the members gathered in the Shire Hall and listened to a lecture by Mr. G. G. Desmond, of the G.B.K.A., the Rev. E. J. Bartleet presiding. Mr. Desmond said his lecture was entitled "The Bee as a Seedsman." He showed that flowers could only be successfully fertilised by the pollen of other flowers. If fruit growers were to have the best crops it was necessary that they should plant trees which would allow of cross fertilisation, and also provide the bees to distribute the pollen. It might be thought that the bumble bee would be sufficient to fertilise the fruit blossoms and other flowers, but they had found that certain common kinds of bumble bees, instead of taking the pollen from the top of a flower, perforated the back of the blossom and so caused the blossom to fail. As a result of his experience he would say that all seedsmen would be well advised to keep hive bees for the purpose of producing seed.

In conclusion, the lecturer advised all who depended upon fruit and other crops not to forget the bees. If they provided an adequate supply of bees they were bound to enjoy better crops.

It was a splendid lecture, and at its close Mr. Desmond was heartily thanked.

Mr. Graham Burttt then gave an interesting account of his efforts in helping to re-stock with bees devastated areas in France, and spoke of the practice adopted by the French bee-keepers.

In the afternoon Col. E. S. Sinnott presided over a meeting at which the question of the holding of a future convention was discussed. Opinion was unanimously in favour of making the convention an annual event, and the arrangement of details was left to a committee, the suggestion being that a convention shall be held in rotation in the five counties—Gloucester, Hereford, Monmouth, Somerset, and Worcester—connected with the South-Western Association.

A very cordial vote of thanks was passed to the Rev. Edward J. Bartleet (Hon. Sec. of the G.B.K.A.), together with the

committee, and Mr. E. J. Burttt, for the energetic and successful manner in which the convention had been arranged and carried through.

The concluding lecture was given by Mr. Leedham (Worcestershire), who furnished many interesting and informative details relative to "Queen Introduction," and the conditions under which such introduction was successful or failed.

Questions were afterwards asked and answered by the lecturer.

So ended an historic and most successful and helpful convention, which, without doubt, will have a great influence on the future of bee-keeping in England.—(Communicated.)

---

## Notes from Gretna Green.

The honey season here has been the worst on record, in fact I have not yet taken off a single finished section.

Supers were fairly well filled by mid-June, but are little heavier now in mid-August. There is just a chance that heather may save the situation, but only the strongest colonies, or those made strong by uniting can be relied on for surplus.

I note that some bee-keepers are trying large brood frames at the moors, and expect they will find out, as in my case, that brood nest storage is a certainty. I had the Dadant-Quinby brood frames in use many years ago, but although noted for production of enormous populations, results were not always satisfactory.

This season I worked the large frame colony on an entirely new system of dividing and re-uniting, with complete success. The colony still has 80 sections packed with bees, and its increase two racks also crammed full. The season of 1921 will probably make amends for the present one, and I have prepared by increasing and improving my stock, discarding natives entirely, and introducing eight different strains of Italian bees of the best home-reared and imported types.—J. M. ELLIS, Gretna.

---

## Cotswold Notes.

Usually at this period on the Cotswolds, though not this year I am sorry to find, the condition of a 10-frame colony is as follows:—

The two outside combs are solid with sainfoin honey from top to bottom, weighing rather over 6 lbs. each; the inside eight frames have honey and pollen in the top half and brood in the remainder, except where the queen is an old one of the Native variety, in which case she stops laying early.

So that the eight combs would contain perhaps 20 lbs. of stores, and it was often possible to remove one comb of solid honey and still leave the colony amply stored.

This year on August 1 in most cases there was brood in nine or ten combs, but only a tiny rim of honey.

This rim, however, during the short period of warmer weather deepened somewhat, and with the profusion of late blossoms which still hang on the feeding bill may be reduced, to say nothing of better tempered bees. Just now bees are collecting a little honey from charlock, with which the turnip fields are yellow, and from the willow-herb that blossoms beautifully in the plantations. Whenever a still and sunny day occurs it is a pleasure to work hour after hour among the bees and scarcely receive a sting.

Whereas, whilst the late limes blossomed and the weather was stormy, bees were awfully bad tempered, and many times I have groaned on receiving eight or ten stings on the wrist.

For comfort I work with sleeves rolled up, and, usually speaking, bees object less to this than any other way I have tried.

Queenless stocks seem to be richest in stores on account of having no brood to feed, which is a proof of the costly process of raising young bees.

One point in favour of Native stocks is that the queens discontinue laying early, thus conserving late-gathered honey, whereas Italian bees maintain a full brood-nest till frost sets in, and in this way use largely their winter supply.

With regard to situation and management—two points which are always being discussed—I think for successful bee-keeping location comes first, with knowledge afterwards, because the duffer living in a good honey district will obtain, if his colonies are strong, much more honey than a bee-keeper of experience living in a poor locality.

Indeed, in some parts of this county village bee-keepers scarcely secure from each stock more than a rack of sections per season, whereas a few miles away two and three racks is the general rule.

Skep stocks are very light in weight, I find.

June casts are found to be full of bees and brood, some empty comb and a little honey—generally unsealed.

Old stocks and early swarms are a shade heavier, but in each case there are more bees than anything else.

It seemed a shame to take them up, because, if fed, the skeppist would have some excellent young colonies for 1921.—A. H. BOWEN, Cotswold Apiaries, Cheltenham.

## Warwickshire Bee-Keepers' Association.

The annual show was held in connection with the show of the Warwickshire Agricultural Society at Coventry on Wednesday and Thursday, August 18 and 19. The number of entries was much below those of last year owing to the poor season, but though quantity was lacking the quality left nothing to be desired. Mr. G. Franklin showed a collection of appliances for which he was deservedly awarded a first prize. Three observatory hives were staged, and were a source of interest to great numbers of people. Mr. T. A. Denison took all premier honours for sections, those he showed being of uniform excellent quality. Unfortunately the show was spoiled by a steady downpour of rain during nearly the whole of the first day, so that it was impossible to give a demonstration. A lecture was given in the exhibition tent in the afternoon by Mr. J. Herrod-Hempall. On the second day the sun shone in the morning; the demonstration tent was set up, and lectures were given to large and interested audiences by Messrs. J. Herrod-Hempall and G. Franklin, the well-known county expert. Mr. J. Herrod-Hempall judged the exhibits, and made the following awards:—

### OPEN CLASSES.

Class 1, collection of appliances.—1. Geo. Franklin, Burton Green, Kenilworth.

Class 2, bees in observatory hive.—1, T. A. Denison, Napton, Rugby; 2 and h.c., C. W. Dutton, Little Packington.

Class 3, display of honey.—No entries.

Class 4, twelve sections.—1. T. A. Denison; 2. W. J. Goodrich, Gloucester; 3, Miss Edith C. Reynolds, Leamington.

Class 5, twelve jars extracted light-coloured honey.—1. W. J. Goodrich; 2. G. Franklin; 3, T. A. Denison; v.h.c., A. E. Warren, Bletchley.

Class 6, twelve jars medium-coloured honey.—1, W. J. Goodrich; 2, T. A. Denison.

Class 7, best 1lb. section.—1, T. A. Denison; 2, Miss Edith C. Reynolds; 3, W. J. Goodrich.

Class 8, best 1-lb. jar of honey.—1, W. J. Goodrich; 2. Geo. Franklin; 3. T. A. Denison; v.h.c., Miss Edith C. Reynolds.

### OPEN ONLY TO MEMBERS OF THE WARWICKSHIRE BEE-KEEPERS' ASSOCIATION.

Class 9, twelve sections.—1, T. A. Denison.

Class 10, twelve 1-lb. jars light-coloured honey.—1. H. W. Edwards, Coleshill; 2, T. A. Denison; 3, C. W. Dutton.

Class 11, twelve jars medium-coloured honey.—1, Miss F. J. Verrall, Walsgrave, Coventry; 2, H. W. Edwards; 3, W. Bayliss, Coventry.

Class 12, six sections and six jars extracted honey.—1, T. A. Denison.

Class 13, two shallow combs.—No entries.

Class 14, beeswax.—1, H. W. Edwards; 2, T. A. Denison; 3, Miss J. H. Jackson.

### Swarm Preventer and Drone Trap.

Mr. L. B. Glasspole writes:—"I have received by post from various parts of the country inquiries as to this. Some have asked me to make it for them. Will you kindly mention it in your next issue that I cannot undertake to make it, or even to reply to each letter—my time is too much taken up; but, as the illustration explains itself, any amateur could make it. I sincerely hope those who have not received replies will not attribute it to want of courtesy, but want of time."

### Copies of "B.B.J." for Disposal.

I have *B.B.J.* (unbound) for about five years past (one or two numbers missing), which I shall be pleased to give to any new recruits to the craft willing to pay carriage on same, if you care to insert a paragraph to that effect.

Applicants should send a postcard with name and address, stating if they have a preference for any particular year.—L. ILLINGWORTH, 241, Winchester Road, Shirley, Southampton.

### Echoes from the Hives.

NORTH STAFFS.

If my experience *re* stores in North Staffs and North-West Staffs is of any use, I may say that unless there is liberal feeding hundreds of stocks will die of starvation. I have about 25 stocks, and without exception they have insufficient stores to last the winter, and I have not taken a single pound of honey from them; in fact, I was feeding up to June 27. My advice to all novices is either to get an expert or capable bee-keeper to tell them exactly how their bees are for food, or look them up themselves, but they cannot do wrong if they feed up now for winter.—W. J. PALMER.

### Bees in a Chimney.

A few days since a swarm of bees settled in the chimney at Hillbury, the residence of the Rev. W. Loveland, and so troublesome did they become indoors that the services of some firemen were requisitioned, and they dislodged the intruders from the chimney by means of a hose-pipe.—From the *Dorset Telegraph*, July 29.



*The Editors do not hold themselves responsible for the opinions expressed by correspondents. No notice will be taken of anonymous communications, and correspondents are requested to write on one side of the paper only and give their real name and addresses, not necessarily for publication, but as a guarantee of good faith. Illustrations should be drawn on separate pieces of paper. We do not undertake to return rejected communications.*

### Notes and Comments.

[10263] May I have space for a few notes in *THE BRITISH BEE JOURNAL* again.

Page 400. I may as well say that I have no aversion for experts of any "class." I can't stick a man, though, who must always sign himself "Expert" or "Bee Master"—i.e., "Tom Jones, third-class expert." Does your Lichfield "Growler" get me?

Page 401. That was jolly smart of our friend C. Tredcroft. No wonder he sent it on to you. So you do not (10259) have much sympathy with any one who does not insure with the B.B.K.A.

Surely this is a very one-sided view for the Editor of *THE BRITISH BEE JOURNAL* to take, especially as there is no connection, I am told, between the two. As I have said before, and Mr. Pearman is saying now, "We want an alive association." I want more myself; I want one that is awake.

So long as the papers flatter the association and the association flatters the papers, and everybody pats one another on the back all round, it will be very pleasant and all that, but for any use the British Bee-keepers' Association is, as far as I can see, it might as well be in Hades.

[We are surprised at this outburst from Mr. Manley; we gave him credit for more perspicacity. It would seem he is following the lead of other detractors of the B.B.K.A., who make assertions that it does, and has done, nothing in any shape or form for bee-keeping, and then do all in their power to belittle anything it has done or is doing when it is brought to their notice. The one-sidedness is not with us.

There is no business connection between ourselves and the B.B.K.A. Nor do we reap any benefit whatever from the insurance scheme. If we said we had very little sympathy with anyone who suffered damage by fire and was not insured, would any person of average intelligence take it that we had some connection with an insurance company? The Association do not even confine the benefits of insurance against damage to

third parties by bee-stings to its own members and those of affiliated Associations, which, had they been selfish, they might have done, though they very properly charge the small registration fee of 1s. to non-members. In the case mentioned the bee-keeper could have secured himself for at the most 1s. 9d., unless he had more than nine hives, and 1d. extra per hive above that number. A claim for doctor's fees was paid from the B.B.K.A. insurance last year.

This is only one thing for which the B.B.K.A. "might as well be in Hades."—Ebs.]

(1907). Poor chap. You did not lose your bees through feeding with syrup. Try "Isle of Wight" disease. It will be a better guess, I expect. Perhaps I may warn your correspondent, Mr. Wasley, as I see you have not done so. Be very, VERY careful in feeding honey—not so much because of disease, but because it is difficult always to feed honey without starting robbing, and he might lose his bees that way, which would be almost as bad as the other.

(10256). Yes; but why not have said so at first?

It must be very encouraging to live near heather in a season like this one. I see Mr. Kettle's bees are working on it. I may say here that Mr. Kettle is a little difficult to follow, or many people seem to find it so. His bees work on all the year round, except just a little while about mid-winter, and mostly on raspberries. What sort of a district is Corfe Mullen at all?

Page 399. Why are we to stimulate our queens to lay specially? I advise the opposite if stocks are strong and queens are young—as they are in most cases. Why stimulate your queen to use up your winter food before winter comes?—R. B. MANLEY.

### Prolific Swarming.

[10264] Further to the letter published August 5 from Mr. F. C. Hale (10245), *re* Prolific Swarming. This shows a total of six lots from one stock, but I have found a record which exceeds it. I have been in the habit of looking after some bees for a farmer friend for the last ten years, going a twenty-mile journey when I can get away from business to put things straight, as he is very busy, and cannot give proper attention. I left him at Easter with two bar-frame hives, containing ten frames each of natives. As they were then very forward I put section racks on each. Up to August Monday these had increased to fifteen stocks, including the original two. This is not counting one which died of

starvation and two which he failed to secure, the swarms going to a neighbour's farm. This represents a net increase of sixteen from two hives. I suggested that probably a stray swarm or so had flown over to their apiary, but they assure me they have watched every lot leave the various hives and boxes.—H. W. STRATTON.

### Swarms Affected with I.O.W. Disease.

[10265] I have been a reader of your Journal for a number of years, and have kept bees for over twenty years, and wonder if you or any of your readers have had a similar experience to these I shall try to relate below of the old stock being apparently immune from "I.O.W." disease, yet the swarms being affected.

Last year I lost all my bees except one lot with "I.O.W." disease. This lot gave a swarm in May, 1919, from which I took several sections, and they eventually died out. A second swarm issued, and these died out in the autumn. The old stock survived again this season, and a swarm issued from it which was hived, but in about a week I noticed the bees were crawling and the colony began to dwindle, so I burnt the lot. A second swarm came out, which I put back with the old lot, after catching the queen, and these do not show any signs of disease yet.

Having tried a number of so-called cures, I decided *not* to treat another stock I got this season which showed signs of "I.O.W." disease, and after about a fortnight they recovered, and are going strong without anything being done. Had I tried a remedy, no doubt I should have attributed their recovery to that.

I have bought rather heavily this year of swarms and nuclei, but the weather the past month has been very disappointing for honey gathering in this part of the country.—J. SALT.

### A Sweet from the Young Leaves of the Common Laurel.

[10266] This is an example which possibly very few bee-keepers may have noticed. I do not remember any writer noticing this fact.

Many years ago in Surrey I noticed bees working on the under side of the young leaves of the common laurel. On examination I found what I concluded to be nectar glands, from four to six, distributed near the base and on each side of the midrib. Bees were sucking the

contents after piercing the tender covering.

As I write (August 7) I have many examples in my garden, as bees are working on the leaves for the simple reason that in my district there is an abundance of sainfoin and white clover in flower, but ants are energetic in collecting the contents of these glands.

Looking through a lens I notice there is a tiny aperture which the ants have made. I enclose a specimen leaf, which I hope will reach you sufficiently preserved to enable you to see the formation of these glands; and also, may I ask, if it has come under the notice of any other bee-keeper?

I have been told that a preparation of the leaves of the common laurel is sometimes used in a killing bottle used by insect collectors, and if so the question occurs to one that if the sweet is taken in quantity whether it would be of a poisonous nature?—JAMES LEE, Fulbourne, Cambs.

[We have often seen bees working on the laurels, and the fact has been mentioned in the JOURNAL several times. Ants are also very fond of the sweet substance which exudes from the underside. We have used young laurel leaves, chopped up and put in a corked bottle, for killing insects.—Eds.]

### A Swarm in a London Suburb.

[10267] It may be of interest to you to know that I took a small swarm or cast at 12, Hereford Road, Notting Hill Gate, a very busy thoroughfare.

They had settled and made comb on some virginia creeper, which is overhanging an iron rail fence between the two houses, and had a comb with brood about 6 in. long.

I cut the boughs (small) and placed them in a butter box, cut a piece of glass to fit, pasted brown paper round bottom. I then cut the paper and turned it inwards, so that the returning bees could get in but not get out. I also placed a little piece of candy and syrup in lid of a tin inside. So, you see, have cheap observation hive. Should be glad to know proper course to adopt now.—W. BARBER.

[Better try and winter them in the box, and transfer them to a frame hive next spring.—Eds.]

### The Longer Frame.

[10268] *Re No. 10237.* The frame in use by Mr. Charlton is for all intents precisely the same frame as the "Adair." It is a fraction of an inch larger each way,

but not enough to make any practical difference. It is quite possible for anyone to find out when an appliance is thoroughly bad in a very short time.

The United States is a continent, and has within it practically every possible type of climate.

No, I did not know of much patient experiment with larger frames. I do know that 16 by 10 and Langstroth hives are selling by hundreds in this country.

I am sorry Mr. Charlton has bitten so deep on 14 by 12 frames. I hope he will not regret it. He does not say if he is also trying Langstroth and 16 by 10.

Truly, Mr. Editor, bee-keepers are a mixed crowd. Some write to me to say I have done a good turn to bee-keeping; others, like yourself, that I have done a disservice—only some put it stronger. Others, again, say I was an idiot not to recommend the Langstroth; and yet others that the 16 by 10 is far too small, and the Quinby or Dadant-Blatt is the frame, or the Root Jumbo. Perhaps it would be no harm for me to say I am not trying to please anyone. I don't care whether they are pleased at all.

It is perfectly obvious to me that the future frame in this country for commercial use will be either the "Langstroth" or the "Commercial." I have not and never had any wish to persuade people to take up a larger frame, though I strongly recommend it to those who are not satisfied. A man who supplies bees on frames would indeed be foolish to try and get those who wish to keep to the standard to change from it. I hope to supply bees on all sizes of frames, but it is hardly necessary for me to say that it is far easier to supply on standards. This is not an advertisement; I have nothing to sell this year.

Mr. Charlton bought or made 30 hives. Well, I have this year bought or made 85—but they are not 14 x 12.—R. B. MANLEY.

### Vagaries of Swarms.

[10269] Perhaps the following may be of interest to some of your readers:—

On June 16 last one of our hives swarmed; the swarm was hived the following morning after spending the night in the skep owing to wet weather. This was a noticeably strong swarm, quite 6 lbs. A fortnight later, June 30, a cast issued, apparently from same hive. They settled on the side of a chimney of our employer's house, too high for our longest ladder to reach. Immediately afterwards it came on to rain; Thursday, July 1 it poured all day, also most of Friday. Saturday was cold and showery, and although



there were about two or three hours fine, warm weather on Friday, the bees have not yet moved. Are they comatose as in winter? If not, they will surely be hard up for food! A second small group settled at same time on the roof of a coal-shed near, and they, too, are still quiet (sheltered by a slate). We think each group *may* have a queen, and as one stock is, we believe, queenless, we think of throwing in the smaller group with this, flooring both lots first. If the larger group on chimney moves and settles on a reasonable place, we shall probably do same with them.

For about a fortnight the weather has been too wet and cold for us to open the brood chambers to see what the various stocks are doing. This is a hilly district, with a number of tall trees near hives, including limes and sycamores, and swarms have twice this season settled about 40 ft. from ground, or more usually in trees unsafe to climb, *e.g.*, Scotch fir.

Would a set of handles such as are used by a sweep, attached to a skep, be an effective device for securing these from a ladder?

When a swarm lifts and flies away, how is the bee-keeper to keep them in sight as the law demands, I believe, having regard to the rapidity with which they move.—  
VIOLET HODGINS.

### Notes on the Past Season.

[10270] I notice you invite comments on the past season, so will give you a brief summary of the season in Westmorland.

The spring was late, very cold, and wet. Bees that were left to themselves were slow in gaining strength and were late in getting up to swarming pitch, consequently swarms were late. Many other stocks have not even swarmed. Stocks that were fed early gave good results, swarming early, queens getting mated, and building up in good time for the clover season. This district is not one for early surplus from fruit, etc., so we rely mainly upon clover and heather. The clover season has been a complete failure. It is many years since we had such a glorious prospect, with abundance of clover, but the continual rain and cold nights have ruined this source of surplus. The same conditions are in evidence at present, with the heather just showing bloom. We still hope for a reward for the energies of our bees' labours by obtaining a goodly surplus of heather honey.

The rivers are in flood at the time of writing. This has been typical of the past season—two fine days only in July, 29 on which we had rain some part of the day.

A poor record for 1920, and sugar at 1s. 7d. per lb. is poor encouragement to the bee-keeping industry in this district.—G. C., Kendal.

### Effect of Weather on Bees.

[10271] We were wisely told to keep supers on for autumn. The result—I found a swarm on a low bush. This, I take it, was owing to bad weather. Young queens were hatched, and, having many drones still in the hive, bees flew out during a sunny day. I was able to borrow a big hive till mine arrives—soon, I hope. Now, on opening the large hive they left, I found one empty queen cell, much brood, honey, and drones. The bees attacked me like nothing I ever saw before; but I got supers and quilts on and covered up, and walked towards the house simply covered with stinging bees. My wife said, "Come inside," which I did, threw off my veil and coat, and filled the room with bees in all stages. We soon got them out, and I found I had a good many stings on my wrists and other places. So look out during this season. Don't go through your hive without a large smoker and large carbolic cloths, or, my word! you will hear the "zip" of the angry bees by the thousand, and their kiss is most warm—too much "vim" in it!—CYRIL TREDCROFT.

### Bees in a Hedge.

[10272] Last evening a lad came to me with a message saying that there were some bees hanging on a hedge belonging to his father, and would I go and fetch them away. It appears that cutting round a field of beans ready for the machine, they had come upon them. When I reached the place I found a large swarm in the bottom of the hedge, with five large pieces of comb with sealed brood. These bees must have been there for some weeks (especially as we have been having very cold weather and rain). They were quite open to the elements, and I regret not having had a snapshot taken before I got them into a skep. I have never seen anything like it before.—WM. S. HALFORD, West Wratting, Cambs. August 20, 1920.

### Aluminium Foundation.

[10273] Have any of your readers had any success with the aluminium comb foundation? I have tried it on several occasions upon swarms, giving a few frames of the metal together with those of wax. Usually the bees have refused to work the metal foundation at all; in one

instance, however, they built comb parallel to the aluminium but only attached to it by brace comb. In no instance did the bees build a single cell upon the hexagonal pattern of the metal. I have not tried a swarm on metal foundation only; possibly with the mixed foundation the superior attractions of the wax have handicapped my results.—  
EDWARD TURNER.

## Bee Shows to Come.

A nominal charge of 2s. 6d. is made for notices (not exceeding 7 lines) in this column, 10 lines charged 3s. 6d., up to 15 lines 5s., which covers cost of insertion from order till date of show. Cash should accompany orders for insertion.

**Saturday, August 28, at Hinckley.**—Leicestershire and Rutland Bee-keepers' Association, in connection with Hinckley Flower Show.—Open Classes for Honey, Sections and Jars. Prizes, 12s. 6d., 7s. 6d., and 4s. 6d. in each class. Judge, J. Herrod-Hempall, F.E.S.—Schedules from A. Kimbrell, Esq., Clarendon Road, Hinckley. Entries close August 23.

**September 1 and 2, at Glasgow.**—Glasgow and District Bee-keepers' Association Second Annual Show, in conjunction with Glasgow and West of Scotland Horticultural Society. Open Classes in Honey Section.—Schedules from Peter Bebbington, Hon. Secretary, 65, Robertson Street, Glasgow.

**September 8, 9 and 10.**—Portsmouth B.K.A. Honey Show, in conjunction with the Portsmouth Allotment Holders' Show, at Connaught Drill Hall, Portsmouth. Six Open Classes. Judge, W. Herrod-Hempall, F.E.S.—Schedules from Show Secretary, Mr. J. Sিনnett, 154, Essex Road, Southsea.

**Saturday, September 11.**—Fforest-Fach Horticultural Society, Swansea. Three Open Classes for Honey, extracted and sections. Help to foster bee cult this end. 1st prizes, 10s.; 2nd and 3rd in proportion.—Schedules ready from G. L. Williams, Fforest-Fach, Swansea.

**September 15, at Twickenham.**—Twickenham Horticultural Society's Great Vegetable Exhibition. Honey exhibits under the control of Twickenham and Thames Valley B.K.A. Two Open Classes for Comb and Extracted Honey.—Schedules from Miss M. Byatt, "Hawthorn," Hanworth, Middlesex. Entries close September 8.

**September 18 to 24.**—Grocers' Exhibition, Agricultural Hall, London. Honey and Bee Appliance Competitions, open to the United Kingdom. Good prizes. Entrance fee in each class 1s.—Schedule of Competitions sent on application, referring to this journal, to H. S. Rogers, 31, Queen Victoria Street, E.C.2. Entries close September 11.

**September 22.**—Altrincham Show. Several Open Classes for Honey and Appliances.—Schedules from H. Turner, 1, Market Street, Altrincham.

**October 5 to 8.**—Essex Fruit and Honey Show at Institute of Agriculture, Chelmsford. Open from 12 to 8 p.m. Admission free. Lectures and demonstrations each day.—Schedules from G. R. Alder, 7, Bulwer Road, Leytonstone.

**October 19 to 22.**—Dairy Show, Agricultural Hall, London. Open Classes for Honey, etc.—Particulars, Secretary, Dairy Farmers' Association, 23, Russell Square, London, W.C.1.

**November 13.**—Annual Show of the Worcester City and County Chrysanthemum, Fruit, Root and Honey Society. Thirteen Open Classes in Honey Section.—Schedules from Geo. Richman, 42, Barbourne Road, Worcester. Entries close November 6.

## Special Prepaid Advertisements. One Penny per Word.

Trade advertisements of Bees, Honey, Queens, and Bee goods are not permissible at above rate, but will be inserted at 1½d. per word as "Business" Announcements, immediately under the Private Advertisements. Advertisements of Hive-manufacturers can only be inserted at a minimum charge of 3s. per lin., or 5s. per inch.

PRIVATE ADVERTISEMENTS are only intended for readers having Surplus Stock to dispose of. Driven Bees, Nuclei, and Queens that are reared or imported for sale, are Trade Advertisements, and can only be accepted under trade terms. A charge of 6d. extra will be made if a box number is used.

Orders for three or more consecutive insertions in "The Bee Journal" entitle advertisers to one insertion in "The Bee-keepers' Record" free of charge.

Advertisements must reach us NOT LATER than FIRST POST on the 27th of the month for insertion in the next month's RECORD.

### PRIVATE ADVERTISEMENTS.

**SURPLUS STOCKS,** Italian and Hybrid, vigorous, £4 each; box returnable.—DR. JONES, Peatling Magna, Leicester. h.65

**HONEY** wanted, any quantities up to 5 cwt.; tins forwarded.—MIDDLETON, Hardwick Road, Streetly, Staffs. h.70

**FOR SALE,** about 35 Stocks and Swarms of Hybrid Ligurian Bees on 8 to 10 frames and Nuclei; mostly this year's Queens; excellent workers.—REV. A. H. HALLEY, Crathie, Wellington College, Berks. r.h.79

**EIGHT STOCKS** on 10 frames, headed by 1920 Italian Hybrid Queens from same mother as my 3-frame nuclei, but not purely mated; good, hardy, disease-resisting stock reared on the East Coast; £4 7s. 6d., carriage paid.—E. H. TUNMER, "Chalfonts," Leiston, Suffolk. r.h.81

**CARNIOLANS.**—Surplus 4-frame Nucleus for immediate delivery, 50s., carriage paid; 1920 Queen.—ROBERTS, 50, Otter Street, Derby. h.85

**WANTED,** Second-hand Extractor.—HULBERT, Châlet, Warwick Road, Olton, Warwickshire. r.h.95

**FOR SALE,** Second-hand, three W.B.C. Hives, £1 each, complete; three long Hives to take 15 frames, two lifts and roof lift, £1 10s. each.—MISS GORDON, Wethersfield, Braintree. h.96

**FERTILE** August, 1920, surplus Italian Hybrid Queens, Penna strain, 6s. each.—THOMAS, Mansawel Vicarage, Briton-Ferry, Glam. h.97

**REMOVAL SALE.**—Strong Stocks healthy Bees in good hives, £5 each hive; deposit; carriage paid.—MRS. MOATE, Welwick, Hull. h.98

**SIX SURPLUS** Black English 1920 Fertile Queens for Sale, 5s. each; vigorous strain; no disease.—DAVIDSON, Forest Road, Burton-on-Trent. h.99

**FOR SALE,** strong Stock Hybrid Bees on 10 standard frames.—HARVATT, Beauchief, Sheffield. h.100

**SURPLUS.**—Four 8-frame Stocks, 60s.; 4-frame Nucleus, 30s.; boxes 10s., returnable, or purchaser send own boxes.—WITT, South Ascot, Berks. h.101

**FOR SALE**, new light Lincolnshire Honey, fine quality, £8 8s. cwt.—**SCHOFIELD**, Spilsby Road, New Leake, Boston. h.102

**FOR SALE**, Apiary about 12 first-class healthy Stocks, famous Doolittle strain; buyer must remove; inspection any time.—**GOLDEN**, Leire, Lutterworth, Lincs. h.103

**PULLETS**.—One dozen White Leghorn and Wyandottes, April birds, 11s. 6d. each; crates and carriage extra.—**W. WOODS**, Normandy, near Guildford h.104

**FOR SALE**, about 5 cwt. Honey, £8 per cwt.—**F. SEAMAN**, Sibsey. h.105

**TWO** strong Stocks Italian Hybrids, £3 each, carriage forward.—**HANNA**, East Knoyle, Salisbury. h.106

**OVERSTOCKED**.—I have still for Sale several Stocks of Italians and Hybrids, all strong, with plenty of stores and at reasonable prices, free on rail in W.B.C. hives or travelling boxes as required.—**CURTIS HART**, F.R.H.S., Newgate Street, Hertford. h.107

**WANTED**, two lots Driven Hybrid Italian Bees. **SUTHERLAND**, Merchant, Latheronwheel, Caithness. h.108

**FOR SALE**, 11 Stocks very strong and healthy Hybrid Bees (Italian-English) with W.B.C.

Hives and absolutely all appliances required, including Honey Extractor, Ripener, and 15 Shallow Racks with drawn combs, the whole in perfect order; leaving neighbourhood; price for lot £68.—**I. G. PELLY**, Epping, Essex. h.109

**TEN** good Stocks of Italian Hybrids, all in new 50s. hives, mostly on 11 frames, packed with honey; lowest £50 the lot, or separate £6 per hive.—**GILES**, Winston Avenue, Bournemouth West. h.132

**TWO** splendid Stocks Hybrid Italians, 1920 Queens, 10 frames, packed brood, young bees and stores, very gentle, absolutely healthy, expert's certificate, owner overstocked, £4.—**REDDIE**, Cliff Cottage, Leigh, Essex. h.133

**WANTED**, Cheshire's Diagrams.—**KENWARD**, Berwyn House, Lewes, Sussex. h.112

**SURPLUS STOCKS** and Appliances for disposal, property of gentleman giving up bee-keeping. Particulars, stamp.—**HOLMAN**, Dunton Green, Sevenoaks. h.113

**WANTED**, pure Native English Fertile Queen Bee. State age and price.—**D. H. DURRANT**, New Eden Apiary, Petersfield. h.114

**1920 QUEENS**, English and Italian, a few good ones, 7s. 6d. each.—**HILLS**, Alton. h.115

**SELLING OUT** small Apiary healthy Hybrids.—14 10-framed Stocks, two 8-framed ditto, two 4-framed Nuclei. Offers invited. Purchaser to send boxes.—**E. G. BANHAM**, Westmeon Cycle Works, Westmeon, Hants. h.116

**FEW STOCKS** of Italians on 10 frames, packed with bees, £4; boxes 10s., returnable.—**HENSLEY**, Luton Apiary, Queen's Road, Chatham. h.117

**SURPLUS 1920 fertile Golden and Leather-colour Italian Queens**. Penna strain, 10s. each.—**J. PALMER**, Longford Farm, near Market Drayton, Salop. h.118

**SPECIAL OFFER**.—Few surplus 1920 Italian Hybrid Queens, 4s. each.—**A. LONGLEY**, 35, Sharp Road, Wallington, Surrey. h.121

**SURPLUS**.—Ten healthy Stocks of Bees on 10 frames, 55s. per stock.—**MASCALL**, Bridge Foot Apiary, Radwinter, S. Walden, Essex. h.123

**FOR SALE**, a few strong, healthy Stocks on 10 bars, guaranteed healthy, £4 10s.—**FRANK SEAMAN**, Sibsey, Boston. g.175

**SURPLUS HIVES** and Appliances for Sale, good condition, cheap.—**PEARSON & GALE**, Marlborough. h.131

#### BUSINESS ADVERTISEMENTS. 1½d. per word.

**FLAVINE CANDY**.—6lb. packages, 10s.; postage 1s. 3d. Made in Cambridge under our supervision from the best white sugar.—**S. H. SMITH**, 30, Maid's Causeway, Cambridge. r.h.87

**CRAWLING DISEASE**.—Reliable treatment for curing and prevention; recipe 2s. 6d.—**A. W. SALMON**, Cashfield, Chingford. h.120

**DRIVEN BEES**, with Queen, Hybrids, good workers, 8s. 6d. per lot, carriage paid; cash.—**LEIGH**, Broughton, Hants. h.59

**HEALTHY DRIVEN BEES**, with Queen, 10s. per lot, carriage paid; boxes returnable. Cash with order. Orders in rotation.—**PULLEN**, Ramsbury, Hungerford. r.g.211

**ITALIAN QUEENS** from Penna's queen, virgins 4s., fertile 9s. 6d.; Hybrid Italians, virgins 3s. 6d., fertile 8s. 6d.; Hybrid Stocks on 4 frames, 50s.; box, returnable, 10s.—**WARD**, Deeside Nursery, West Kirby. r.g.215

**ITALIAN QUEENS**, pure imported, 11s. 6d. each; safe delivery guaranteed; immediate delivery.—**C. T. OVERTON & SONS**, Crawley. r.h.49

**4-FRAME NUCLEI**, headed by 1920 Italian Queen, 50s.; box charged 10s., returnable; 6-frame Stocks, 70s.; 8-frame Stocks, 90s. Immediate delivery (weather permitting). Italian fertile Queens, 10s. 6d. English Run Honey and Sections wanted.—**LEE**, "Little Bowden Apiary," Burgess Hill, Sussex. r.g.114

**STRONG 3-FRAME NUCLEI**, 1920 fertile Queens, 50s.; box 5s., returnable; Stocks on 8 frames, 60s; boxes 10s., returnable.—**W. WOODS**, Normandy, near Guildford. g.53

**PURE ITALIAN QUEENS**, prompt delivery; select Italian, extra golden, rare honey-producing stock, August-September.—**ATKINSON**, Fakenham. r.g.24

**"WIGHT" DISEASE**, prevention and removal; advice 5s.—**ALFD. RYALL**, Kenwood Apiary, Elcombe, Stroud. r.h.3

**1920 FERTILE Golden Italian Queens**, guaranteed imported direct from Italy, regular supplies every few days, 10s. each; specially selected, 14s.—**GOODARE**, New Cross, Wednesfield. f.69

**ITALIANS**.—Fine Queens from 8s.; quick delivery; stamps.—**HOUSTON**, Ellen Villa, Sidcup. h.110

**MASHEATH MEMS**.—"I badly wanted to pinch those 6-frame chambers (double six Masheath). The whole thing was so nicely made, one's mouth waters at sight of a decently made hive. I'd like to have 'em to show how things can be made (supplied)."—**E. R.** at Cambridge Lecture and Demonstration, February 20.—**ATKINSON**, Fakenham. h.111

**SELECT TESTED QUEENS.**—Three-banded leather-coloured Italians, gentle, hardy and prolific and disease resisting, one year old or less, right in their prime, 10s. 6d.; also untested 1920 Queens, same price; safe arrival guaranteed.—**THE APIARY**, Buckfast Abbey, S. Devon. r.h.125

**ITALIAN Hybrid Queens**, fertiles, 10s.—**JACK TICKELL**, Westbourne Apiary, Cheltenham. h.126

**DRIVEN BEES**, four lots. What offers?—**BOOKER**, Alfold, Billingshurst. h.127

**STRONG 3-FRAME NUCLEI**, 1920 fertile Queen, splendid strain, 25s.; case 5s., returnable; extra brood and bees, 7s. 6d. per frame. Driven Bees with Queen, 12s. 6d.-15s. 6d. per lot; case 5s., returnable.—**W. WOODS**, Normandy, near Guildford. h.128

**FOR SALE**, Natives or Italian Hybrids, a few Stocks on 8 combs, 80s.; Nuclei, 4 combs, 50s.; Queens, 7s. 6d.; boxes 10s., returnable; carriage extra; all first-class stock. Some Driven Bees, middle September, strong lots with young Queen, 10s.—**W. ROBERTS**, Ninfield, Battle, Sussex. h.129

**HEALTHY DRIVEN BEES**, with Queen, 8s. per lot, carriage paid, to clear; boxes returnable; cash with order.—**PULLEN**, Ramsbury, Hungerford. h.130

**A FEW 1920 Queens and Nuclei for Sale.**—**BEE SUPPLIES & PRODUCTS ASSOCIATION, LTD.**, 39, Wandle Road, S.W.17. h.122

**"ISLE OF WIGHT" DISEASE.**—Don't worry; use the solution that cures; 2s. per bottle.—**E. PRESSEY**, St. Elmo, Coulsdon. r.d.149

**HAVE YOU READ "THE BEE WORLD"?** If not, why not? Every number in itself is a useful literary work for practice and reference. Specimen copy free.—**Offices: THE APIS CLUB**, Port Hill House, Benson, Oxon.

**HONEY FOR FEEDING BEES.**—Finest West Indian, tin of about 60 lbs., 68s. 6d., carriage paid 100 miles.—**LONDON TRADING AGENCY**, 32, St. Mary Axe, E.C.3. r.h.134

## Altrincham Agricultural Society.

### ANNUAL SHOW,

Wednesday, September 22.

#### £2,500 IN PRIZES.

Silver Cups and Medals for Horses, Cattle, Pigs, Turnouts, Hunters, Jumpers, Roots, Grain, Butter, Cheese, Implements, Dogs, Poultry, Pigeons, Rabbits, and Cavies.

Open Classes for Honey.

Increased Prize Money in All Sections.

Prize List may be had from the Secretary,

**HERBERT TURNER**,

1, Market Street, Altrincham.

Tel. 174.

Entries close September 4. Double fees, September 8.  
Dog entries close September 10.

## THE British Bee-Keepers' Association.

Insure now against loss by damage done through bee stings. All particulars from

**W. HERROD-HEMPSALL, 23, Bedford Street, Strand, London, W.C.2.**

## ITALIAN QUEENS

Direct from Italy.

Address:

**Signor Gaetano Piana,**  
Castel San Pietro,  
near Bologna, Italy.

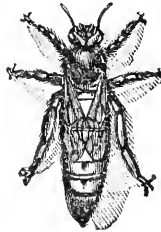

All Queens are reared by the most up-to-date and scientific methods. Mr. W. Herrod-Hempsall has personally inspected the apiary and methods employed, with which he is perfectly satisfied.

#### PRICES FOR 1920.

**For 1 Fertile Queen: August and September,**  
9/- each queen.

Carriage paid in Great Britain. Cash must accompany all orders, which will be executed in rotation. Guaranteed safe arrival of all Queens, but not the introduction. Bees dead upon arrival must be sent at once to "B.B.J." Office.

For the mutual convenience of all parties, Il Signor Piana has made arrangements that all communications, orders and remittances of the readers of "B.B.J." and "B.K.R." can be addressed to him, c/o British Bee Journal, 23, Bedford Street, Strand, London, W.C.2.

Cheques payable to 'British Bee Journal.'

The products of the Apiary, of Poultry and Farm Stock, of the Fruit and Vegetable Garden can be Advertised and Sold through

THE  
**BAZAAR, EXCHANGE & MART**  
Newspaper.

Get a Copy—Thursday and Saturday 3d. The "Bazaar" publishes also practical handbooks by experts. Send for full catalogue, post free from—**WINDSOR HOUSE, Breams Buildings, LONDON, E.C.2.**

**BCB  
WVB**

**BEST CLEARING and  
WINTERING BOARD,  
SUPER CLEARER, &c.**

**MEADOWS, SYSTON, LEICESTER.**

A Necessity for all Bee-Keepers  
all the year round.

## POSITIVE FACTS.

June 13th, 1920.

I am very pleased with the foundation. The bees undoubtedly prefer it to any other make I have, and have even gone the length of missing two sheets of other new foundation, and working out a sheet of yours placed behind them at the back of the hive. Full sheets have not sagged in the least in 16 x 10 frames.

Yours faithfully, R. B. MANLEY.

Illustrated Lists free by post.

**S. J. BALDWIN, The Apiary, BROMLEY, Kent.**

## BARGAINS IN SURPLUS CLOTHING.

Blue Serge Trousers for Working Men **12/6**  
 Blue Serge Trousers, as new **14/-**  
 New Blue Serge Trousers, best quality **21/-**  
 New Holeproof Trousers, highly recommended **18/-**  
 New Bedford Cord Breeches, Officers' quality **42/-**  
 New Cord Riding Breeches, strapped **22/6**  
 Khaki Drill Trousers, Officers' quality **10/6**  
 Khaki Drill Jackets with pockets, Officers' quality **10/6**  
 Khaki Drill Trousers, ordinary **7/6**  
 Khaki Drill Jackets, ordinary **7/6**  
 New Blue Drill Overalls, complete with pockets **12/6**  
 New Oilskin Overcoats, extra quality **26/6**  
 Army Waterproof Ground Sheets, 72 x 36, brass eyelets, slightly soiled, 9/- for 2, 4 for **17/-**

Black Rubber Combination Cyclists' Suits, complete with Sou'wester, **20/-**; cost Government **63/-**.  
 New Heavy Workmen's Boots, **18/9** pair.  
 New Brown Boots, all sizes, **22/6**; worth double.  
 New Full-size Australian Wool Blankets, **21/-** each.  
 New Full-size Australian Grey Blankets, **18/6** each.  
 New Full-size White Fleecy Blankets, **16/9** pair.  
 Selected Army Wool Blankets, all colours and sizes, **12/-** each.  
 Heavy Woollen Check Fringed Rugs, new, **22/6** each.  
 Heavy Woollen Check Motor Rugs, **30/-** each.

Now is the time to buy Blankets; they will be very scarce and dear later.

WRITE TO-DAY FOR LIST OF NUMEROUS OTHER BARGAINS.

**SACAR'S UNIVERSAL STORES (Dept. 3), ARDWICK, MANCHESTER.**

## STANDARDIZE

BY USING

**KENT DEWEY STANDARD FRAMES  
 AND KENT STANDARD HIVES**

WHICH NEVER VARY.

SUPPLIED FROM STOCK.

LIST FREE.

LONDON OFFICE:—39, WANDLE ROAD, S.W. 17.



**“BACTEROL”  
 FOR BEES**

2/9 per Bottle.

Post Free.

The cure for, and preventive of, “Isle of Wight” Disease. Non-poisonous—free from stain or unpleasant odour.

**MENLEY & JAMES, LTD.,**  
 Menley House, Hatton Garden, E.C.1.

**BRADBURY, TAUNTON,**  
 FOR QUALITY BEE GOODS.

*Illustrated Bee  
 Guide free.*

Telephone: TAUNTON 176.

## 20-Page 1920 “WHITE STAR” List,

3½d. POST FREE.

S. SIMMINS, QUEENLAND, HEATHFIELD, SUSSEX

**Bees and Beekeeping Appliances. Catalogue free.  
 EDWARD J. BURTT. MANUFACTURER. GLOUCESTER.**

*I very much regret that there has been a large increase in the cost of the manufacture of bee appliances, and therefore my prices will be advanced 10% from May 10th. Books excepted.*

# FOUR FIRST PRIZES.

Our HIVES and APPLIANCES were again awarded FOUR PRIZES at the Highland Agricultural Society's Show at Aberdeen, thus testifying to the superiority of our goods. Order now and ensure your bees wintering in good hives.

**BOTTLES.** We hold a large stock and can give immediate despatch.

**CANDY.** Safeguard your bees from starvation by feeding with our FAMOUS BEE CANDY. Send sugar vouchers with order.

Sole Agents for DADANT'S WEED FOUNDATION. Absolutely pure. Once used, always used.

Large illustrated catalogue, entitled, "Everything for an Apiary," post free on application.

**R. STEELE & BRODIE,**  
*Bee Appliance Makers,*  
**WORMIT, FIFE.**



THE  
KEY TO  
YOUR SUCCESS.

## Lee's Bee Supplies.

¶ In design, material and workmanship, Lee's Bee Supplies still retain the reputation of being your best and safest investment.

¶ Our 1920 ILLUSTRATED CATALOGUE is yours for the asking. It contains detailed information on the most up-to-date hives and appliances for which the House of Lee is famous.

¶ We regret the necessity of having to advise our Customers that owing to the increased cost of production, all prices in 1920 price list are subject to 10% increase. The increase will not apply to orders received before May 10.

\*\*\* Five per cent discount to Members of THE APIS CLUB.

**JAMES LEE & SON,**  
LTD.,  
Uxbridge, Middlesex.

(Telegrams: Graphicly, Uxbridge.)

Telephone: Uxbridge 181.)

0011  
Agricultural  
College



No. 1993. Vol. XLVIII SEPTEMBER 2, 1920. [Published every Thursday, Price 2d.]

**CONTENTS.**

	PAGE		PAGE
ROYAL SHOW FUND .....	421	NEW YEAR HONEY CAKE .....	427
A DORSET YARN .....	421	HONEY RECIPES .....	427
JOTTINGS FROM HUNTINGDONSHIRE .....	422		
NOTES ON BEE-KEEPING .....	423	CORRESPONDENCE—	
A BRIEF REPORT .....	424	Notes and Comments .....	428
NOTES FROM NORWICH .....	424	Notes on Laurels .....	428
PRICE OF SWARMS IN GERMANY .....	425	Crawling Disease in Bees .....	428
TWICKENHAM AND THAMES VALLEY B.K.A. ....	425	Foreign Honey Feeding .....	429
SALISBURY AND DISTRICT B.K.A. ....	425	Notes on Notes and Comments .....	429
DERBY B.K.A. ....	426	High Price for Honey .....	429
GUILDFORD AND DISTRICT B.K.A. ....	427	Aluminium Foundation .....	429
STAFFORDSHIRE B.K.A. ....	427	Swarms Affected with "I.O.W." Disease ..	430

# FOOD FOR BEES.

Owing to the continued bad weather there is a likelihood shortage this Winter. To prevent loss of Stocks order at once TAYLOR'S renowned

## SYRUP

In tins, 7 lb., 14 lb. and 28 lb. at  $1/3$  per lb., Carriage extra.

We are in a position to supply, without vouchers, the best

## CANDY

made from pure Sugar, plain or medicated,  $1/6$  lb. Carriage extra.

**E. H. TAYLOR, WELWYN, HERTS.**

Telephone—WELWYN 13.

THE  
**British Bee Journal**

Office: 25, Bedford Street, Strand, London, W.C.2.  
ESTABLISHED 1873.

A Weekly Journal Devoted to the Interests of Bee-keepers.

Edited by T. W. COWAN, F.L.S., &c., and J. HERROD-HEMPSELL, F.E.S.

**Correspondence: Whom to Address.**—All matters relating to the Literary Department, Associations, Shows, etc., should be addressed, "Editors, *British Bee Journal*," and all business communications and matters relating to subscriptions and advertisements to be addressed to the "Manager," *B.B.J.* Office.

**Subscriptions.**—Annual Subscription, 10s. 10d. post free in advance; single copies 2d., or 2½d. post free. If a receipt is required by post, a stamped and addressed envelope must be sent, otherwise a printed receipt will be enclosed along with the paper.

*Note.*—Cheques and Postal Orders should always be crossed, otherwise it is very difficult to trace them if they go astray.

**How to send Money.**—Remittances can be made payable to W. Herrod-Hempshall by crossed Cheques and Postal Orders. Stamps may be sent for small amounts up to 2s.

*Halfpenny stamps are preferred.*

Scottish or Irish cheques can only be taken in payment if 6d. is added for commission charged by banks for cashing them.

The Editors are not directly or indirectly interested in the manufacture or sale of beehives or appliances of any kind, and must refer correspondents wishing for prices or catalogues to advertisers in the paper.

**OUR DEPOSIT SYSTEM.**

You are advised to insist on this being used when dealing with strangers.

**Rules and Conditions for Depositing**

*In order to save trouble, it is requested that the Rules be carefully read over by persons using the Deposit System of trading.*

Goods should not be despatched until notice that the money has been deposited is received from this office.

1. **Method.**—When strangers are dealing together, the purchase-money of the articles is deposited at our office. We acknowledge receipt of the deposit to both parties, and hold the money until we are satisfied that the purchase is concluded. If a sale be effected, we remit to the seller the amount deposited, less a charge of 2½ per cent in the £, with a minimum of 6d., and the expenses of Post Office Orders and postage, &c. Cash will be forwarded by Cheque, Post Office Order, or by Postal Order as preferred. If a sale or exchange be not completed, we return the amount deposited, after making the same deduction. By this means buyers and sellers are secured against fraud.

2. **Deposits.**—Postal Orders (drawn on General Post Office) and Cheques must be made payable to W. Herrod-Hempshall, and crossed "London County and Westminster Bank." The numbers of the Postal Orders should be kept by the sender.

We cannot be responsible for any loss that may occur in transit.

3. **Honey on Approval.**—All honey will be sold by sample, which must be sent direct to buyer.

4. **Bee Appliances.**—In ordering, the time allowed for completing the order to be stated to us when sending cash. If maker accepts, we hold cash until transaction is satisfactorily completed, when the amount will be remitted, subject to conditions as in Clause 1.

5. **Bees and Queens.**—These will be dealt with entirely by the parties concerned, so far as price, &c., go, and when the purchase is satisfactorily completed cash will be remitted as per Clause 1.

6. **Goods in Transit.**—These are at the seller's risk, i.e., any damage to or loss of an article on its journey is borne by the vendor; but a rejected article must be properly packed and returned by the same means as was used in sending it.

7. **Carriage.**—The carriage of all goods, except such as are sent by post, is payable by the buyer, unless otherwise agreed. If any article sent on approval be returned, each party to the transaction must pay carriage one way.

**Books for Bee-keepers  
NOW IN STOCK.**

Cash in full must be sent with order.

A Modern Bee Farm ... ..	7/6	... 3½d.
(To be obtained from this Office only.)		
Advanced Bee Culture (HUTCHINSON) ... ..	6/-	... 6½d.
Beginner's Bee Book (PELLETT) ... ..	5/-	... 4d.
BEE-KEEPING SIMPLIFIED FOR THE COTTAGER AND SMALLHOLDER (W. HERROD-HEMPSELL, F.E.S.) ... ..	1/-	... 2d.
BRITISH BEE-KEEPERS' GUIDE BOOK (T. W. COWAN) ... ..		
Paper covers ... ..	2/6	... 3d.
Cloth covers ... ..	3/6	... 4d.
Dissectible Model of Queen Bee ... ..	4/6	... 3d.
FERTILISATION OF FRUIT BLOSSOMS BY BEES (T. W. COWAN) ... ..	-/3	... 1d.
Honey and Health (A. HOPE) ... ..	-/6	... 1d.
Honey Vinegar (REV. G. BANKS) ... ..	-/2	... 1d.
How to Keep Bees (ANNA B. COMSTOCK) ... ..	5/-	... 4½d.
Management of Out Apiaries Prevention of Swarming (WILKES) ... ..	3/-	... 2d.
... ..	1/-	... 1d.
Pollination of Fruit in relation to Commercial Fruit Growing (C. H. HOOPER, F.R.H.S.) ... ..	-/6	... 1d.
PRODUCING, PREPARING, EXHIBITING AND JUDGING BEE PRODUCE (W. HERROD-HEMPSELL, F.E.S.) ... ..	2/-	... 3d.
Queen Rearing in England (F. W. L. SLADEN) ... ..	1/6	... 2d.
Scientific Queen Rearing (DOOLITTLE) ... ..	4/-	... 3½d.
The "Townsend" Bee Book ... ..	2/6	... 2d.
WAX CRAFT (T. W. COWAN) ... ..	2/-	... 2½d.

**MISCELLANEOUS.**

Maeterlinck's Life of the Bee The Lore of the Honey Bee (TICKNER EDWARDS) ... ..	5/-	... 3d.
... ..	2/-	... 2½d.
THE BEE WORLD (supplied only to members of Associations interested in the control and development of the Apis Club, apart from ordinary members of the latter), per copy ... ..	-/8	... 1½d.
The Bee Master of Warrilow (TICKNER EDWARDS) ... ..	7/6	... 4½d.

**British Bee Journal & Record Office,**  
25, BEDFORD STREET, STRAND LONDON, W.C.1.





## Royal Show Fund.

The following further donations have been received:—Mr. Julian E. Lockwood, £1 1s.; Miss Sillar, 5s., bringing the total to £23 12s. 11d.

## A Dorset Yarn.

"We have snow on the hills," wrote a lady bee-keeper last week. This last week at our farm has been a wonderful one. We had a few very cold nights in the week ending August 21, but this has been a record one for heat, Thursday and Friday being very hot.

Bees are filling bars at a record rate. Yesterday (August 28) they were drawing out standard bars, a thing I have never known them do before, unless it was with driven bees. A mighty swarm which came in July had seven bars with drawn-out comb. Ten days back I gave it a box of eight standard bars of foundation, with one from another hive that was full of surplus. The bees have quite drawn out the one on either side and one side of the two adjoining. These are very black bees, but it is the same with the Italians and the crosses—all seem to be making up for the long time of wet. Even on the top rack of sections one can see through the glass cover that the outer cells are being capped over, and in others the shining nectar all freshly stored. It is not all heather, though that is the greater part, as so many fly in a "bee line" to the moorland, but they are on raspberries, violets, and ragweeds, and the honey is of very fine flavour.

I wrote a week or two back of the vagaries of bees. Each week shows me still more of their preference for the thick brood foundation in standard bars. One had two racks of sections that were finished all but the outer rows. These were taken off the first week in August, a rack of sections with full pieces of foundation being placed over the brood chamber, with a box of standard bars over the sections. They started on the bars at once, have filled five of them and drawn out two others, but the sections have not been drawn out. In another that was treated in the same way at the same time the sections were completed first, and they are doing the bars even as fast as the other lot that had not worked the sec-

tions. The sections in each were new, the foundation clean, but very thin, yet one lot ran through them; the other worked them out first and filled them before starting the standard bars.

I have found this year, in some that had three racks of sections, that a new one placed between the two lower ones was filled and capped in a week. In another hive it was left severely alone, but when the three were taken off and the empty one placed over the brood nest they at once started on it. This was a lot started with four bars of foundation in May, with nine other bars drawn out. These have never swarmed, are exceptionally strong, and have but a few drones. This one has still on top of the rack mentioned two others that other stocks had not finished.

This method of increase is to me the best; in neither instance have they swarmed. The workers rule the hive; from the outset they knew they would not swarm, as there was plenty of room for extension in the empty bars; only a moderate lot of drones, quite late. Then they seem to have superseded the old queen and started with a young one (in one instance I saw her as she came back from the marriage flight), so as to make sure of another good queen for another year. With bees nothing is left to chance; all must be made sure that the race shall be carried on.

It is the same with another lot of this same natural order—the wasps. I dug out one nest twice and gave the young grubs to the fowls, but some that were away started another nest in the same hole. They soon had a paper dome as large as a cricket ball. This I destroyed, and this week there was another as large as a tennis ball. They wanted to rear a few queens to carry on the race for another year, but this time they are checkmated, as it is too late, and they have ceased to try to raise another paper home.

These vagaries of bees all add to the interest of them, and it proves to me that the workers rule. When no drones are raised till late in the season they raise a young queen; when drones are raised early then the workers will it they shall swarm and found new colonies to carry on the race.

We have kept careful notes this season of all the stocks. It is only the strong that are of any use for surplus, or perhaps of use at all, because the weak ones are sure to be robbed out. We had one cleared out in one day (Thursday) while at Bournemouth, the first this year; but the bars are clean, and will do for increase next year. As our acreage of fruit increases we must of necessity have more

stocks of bees in the different areas, as it is better to have them near the fields than for them to have to go so far for food. It is the same with the heather; if the hives are closer more could be gathered. It is not wise to have too many in one place, as they must all go so far for food at different times. Our lot cannot fill up the brood chamber with stores from the raspberries close home. There are about a million canes now in bloom, and these will flower till the frost destroys them. We find that it is not wise to cover down for the winter too soon, as they have swarmed quite late. When the surplus racks are taken off there is no room for them. One lot that had a rack of sections taken away and given to another to finish has covered the tops of bars with comb and stores, entirely blocking up the centre, where the small piece of glass gives the owner a chance to see them in the long days of winter. Another lot did not do anything in sections; after they were taken away bees were hanging round the entrance as if going to swarm (this was a Taylor hive with no free way all round the brood box). I gave them a rack of sections made up of those that were not perfect, only second grade; now they have filled most of them.

The seasons are different now; one cannot work to rule as we do our seed sowing. If we want our peas in different months we sow them to allow so many weeks to develop, but with our bees it is the weather that alters things for them. They are now making up for so much forced inaction, but have a great deal of "leeway" to cover.—J. J. KETTLE.

---

## Jottings from Huntingdonshire

Yellow dominates the roadside. The Goldenrod is a very handsome plant, standing up well above the uncut grasses of the thicket, while the Ragworts cluster closely along the ditches and send their conspicuous heads through the hedges, looking, in the moonlight, like stars in an emerald sky. Nearer the roadway are our old friends the Hawkweed and Catsear, but more charming than them all is the Meadow Vetchling which rambles over the low-cut hedges, literally smothering the hawthorns with their delicate flowers. Less conspicuous, but sweeter-scented, is the Bird's-foot Trefoil. At home in dry pastures, this little plant provides much nectar for insect life, and incidentally food for cattle when in its seeding state. Oh, yes, there are plenty of flowers about, but at the time of writing a northerly wind is blowing, the skies are grey, and the hive-fronts are not scenes of throbbing life.

Queens in disgust are ceasing to lay; only a few drones are left, and they chiefly in queenless hives. The best way to get more brood is to re-queen. Why a young queen will cease laying in her own home, and when introduced to another will begin depositing eggs in every available cell, is not quite clear. Maybe in a new home she is anxious to show what she can do, or mayhap she has to give a good account of herself to her new subjects to prevent being thrown out as an intruder.

Harking back to drones. I was looking through a friend's apiary ten days ago and found one colony queenless, and of course choked with drones. A new queen was immediately ordered, but lest there should be great delay in her arrival I introduced a frame of comb from another hive containing brood in all its stages. On looking in a week after, the bees had begun to build a queen cell, and had also expelled quite nine-tenths of the drones. Drones, we know, are stingless, but they have strength, and since, in this particular hive, there were as many, or more, drones than workers, it shows what worker bees can do. Fancy a thousand women expelling 1,200 men!

Mr. Editor, I have brought the wrath of not a few bee-masters (?) down upon my head for stating that so far no certain cure for "Isle of Wight" disease has been found. I am accused of "stupid ignorance," a "swelled head," "a slave to ignorant but highly paid officials," "one ready to swallow any rubbish written by men sitting in offices with frock coats who read about but never keep bees." Poor me! But I'm still smiling. Others write to say they have a certain cure and have advertised, but people don't readily buy—as one writes, "because I don't happen to be in the inner circle of the bee-men of the country." What is meant by this "inner circle"? I do not know. Where are its offices? Who are its members? Not that I want to join them. Were I a fly, I'd rather travel round a wheel near the rim than the hub; I should see more. But I am a little bit inquisitive as to that "inner circle." Can you enlighten us, Mr. Editor? [Sorry, we cannot. So far as we know, it only exists in the imagination of a few disgruntled and disappointed folk who would like an "inner circle"—composed of themselves and their friends.—Eds.]

To continue my experience with the old gentleman whom I mentioned last week. He sent for me again as he was worrying about the non-laying queen. Perhaps it would be best if I extracted a frame of honey to enable the queen to lay. In course of conversation, however, he men-

tioned standard brood frames ready drawn out he had stored away from last year. After satisfying myself they were free of disease, I placed two of them in the centre of the brood nest and took two frames of honey away, to be used for feeding purposes, covered the rest down snugly after placing two tablets of Apicure on the floor and a crushed naphthaline ball on the quilt. A cursory glance in a few days will soon reveal whether or no her majesty is laying. On opening hive No. 3, the number of wasps present told its own tale. The hive was queenless. Strange that in every apiary, with one exception, which I have examined this summer at least one hive was queenless. In this particular hive there were stores of honey and pollen down below, and some 10 lbs. in the super, but as the colony had dwindled down to about 500 workers, and as many drones, I suggested uniting, but my friend would not agree. He'd get a new queen by return of post; he'd telegraph straightway. I expostulated that fertile queens were not knocking about in such prolific numbers that they could be got so easily. "Try and save them then, if you can; I should hate to see a hive and no bees issuing therefrom." I passed on to hive No. 4. Here was some queen, a rack of sections well filled, brood in six combs, thousands of young bees, and—I was glad to see this as it happened—a ripe queen cell on one of the combs. I was undecided what to do. Introduce the queen to the queenless hive and leave the unhorn princess to carry on the colony, or transfer the frame containing the queen cell into the queenless hive and leave the live queen where she was. As the old gentleman wanted his No. 3 colony sparing, a fertile queen would be the thing to do it; on the other hand, the weather was cold and drones were scarce except in hive No. 3, and it's pretty certain they would be turned out on the appearance of a queen. If, then, the virgin queen was not able to mate, No. 4 would soon be in a helpless condition. I decided to transfer the live queen and request my host to get another fertile queen as soon as possible in case the virgin left to No. 4 should never become fertile. I caught her majesty and placed her in hive No. 3 (a risky thing to do). She was welcomed with great elation, but she herself showed fight. It was most pathetic to see the movements of the bees in their anxiety to convince the queen they wanted her to stay. They offered her honey, hummed to her, saluted and what not. My only fear was she would fly off. So I sprayed her well, covered the hive down, and left it. I shall be visiting them again in a few days, when I shall be able to know the result.—E. F. HEMMING, Steeple Gidding.

## Notes on Bee Keeping.

Almost immediately after the honey flow ceases bees will commence to rob where they have the opportunity—any weak stock will be a desirable object for their attention. We must therefore take preventive measures to stop this inveterate habit of the bee, for bees are by nature inveterate robbers. If honey is coming in plentifully no robbing will be done, but in such seasons when, from dearth of blossoms of honey-producing plants, nectar cannot be obtained, every bee seems to be possessed with a spirit to obtain this, or a substitute, in any possible manner. A bee-keeper who has once experienced a determined case of robbing in his apiary will not soon forget it. The air is alive with angry bees dashing about here and there in all directions. Matters appear worse around the entrances of hives, fighting, stinging, and struggling taking place, as if their very existence depended upon the amount of damage they could do in a given time. The killed are cast down in hundreds, whilst all around the combatants are struggling in each other's embrace. Woe betide any bee-keeper who attempts to go among this angry crowd without some protection. Any living creature would receive a more than fair allowance of the bees' spite. In most cases it is usually a fault, or accident, on the part of the bee-keeper, such as honey left about, syrup spilt, or hives carelessly left uncovered. Before robbing has reached this stage the fact should have been found out—it may then easily be stopped; but when such dimensions have been reached it is an exceedingly difficult job to tackle. It is very rarely an observant bee-keeper has such a mishap of such wholesale robbery, as when a knowledge is gained of the time of the year when such is likely to take place extra precautions are taken. It is to the bee-keeper's advantage to keep a sharp look-out after the close of the honey flow, and until cold weather sets in. Very little trouble need be taken with strong colonies, as they are usually in a position to look after themselves, but in the case of nuclei or weak stocks narrow the entrances to about two bee-space width, and the greatest care must be taken that no honey, honeycomb (having honey, or the smell of such attached to it), syrup, even freshly expelled larva hanging around the apiary will sometimes be the cause of it. Where a hive is being attacked a tuft of grass laid against the entrance will often baffle the invaders, as in attempting to gain an entrance the besieged can tackle them singly in the blades of the grass. Glass laid in front of the entrances, or carbolic acid smeared

on the alighting-board and around the entrance, will sometimes check it; but where none of these take effect and stop the strife, throw a carbolised cloth over the attacked colony, and leave on until nightfall. This will generally overcome the attention of the besiegers. Where this will not answer—and this is exceedingly rare—move the besieged hive to a cool, dark cellar, fastening in the inmates with perforated zinc. When returned to its original stand—say after about two days' time—the enemy will have forgotten all about it. Spring, before honey commences to come in, and autumn, after the flow has ceased, or in the interim between the cessation of one species of flower blossom and the commencement of another, is the time when robbing is likely to take place. Spring robbing is a mild affair as compared with autumn. If we take the necessary precautions ("prevention is better than cure"), keep all colonies strong, and be sure there are no queenless colonies in our apiaries, robbing will become unknown.

It will be necessary to continue gentle feeding to ensure plenty of young bees to carry stocks through the winter, for the weather is still wet and cold, with little prospects of any change as yet here in Lancs., and the queens can be kept laying until about the middle of September before feeding up for winter. A Cheshire bee-keeper has been experiencing difficulties in getting his bees to accept Italian queens under the method termed "direct queen introduction." My advice to new beginners is to use the cage, especially when introducing valuable queens. In my own experience it has been sometimes difficult to introduce queens of a different race of bees: they do not so readily take to the queens, and when introducing fresh queens of other varieties it is the safest method of introduction to adopt.—P. LYTHERGUE, Padgate, Warrington, Lancs.

### A Brief Report.

Honey at last! Bees began storing on August 22, and have secured more honey in one week than during the preceding three months.

Strong forces were obtained by uniting two adjoining colonies on one set of combs packed with brood, and these composite lots have already two racks of sections filled with heather honey.

Given another week's sunshine, the honey season of 1920 may turn out a good one after all.—J. M. ELLIS, Gretna, August 30.

### Notes from Norwich.

It may be of interest to know that we run all our stocks with British standard frames. I find that with a 12-frame brood nest full of honey and bees, in early June, is as much as I can conveniently lift; for anyone to favour a larger frame—well, they must be extra strong in body and mind to pull about such teeming weights on a hot summer day; surely they don't lift out frames one by one in these larger brood nests. Shallow frames are too small in size, and require more time in handling, also make more lumber.

The reason given for a larger frame is because the queen does not like passing the top or bottom bar; mine are extra thick, as, thin ones being too flimsy, I do not entertain them. The queens, I find, will take to two storeys of standard frames easily, making one huge slab of brood in the middle combs, and stores on those outside. I took up all my honey the first week in June, as I did not wish to encourage the wicked price of sugar to feed.

Had the weather been any way favourable I should have reduced the combs down to one brood nest of ten or twelve frames, with the most brood and stores; they would then winter well.

With a few spare standard, or, if preferred, shallow frames, one can easily bruise and lay one on top of frames in early spring, if short of stores. Frankly, I have no use for such large frames; good queens, if a hive was tiered up with all shallow frames, would answer just the same. I find swarming to be the nature of bees, and, try what one may, the best is to de-queen after a stock has built up immensely and shows queen cells. Cut out all queen cells and take away queen, or cage her. If the stock can spare a small nucleus with a queen cell, kill the old queen, make a small nucleus with a queen cell or two, cut out all queen cells in the stock, and again in ten to twelve days. The bees will not have any nursing to do: they then become all honey workers. After three or four weeks unite the nucleus and young queen, which would be laying, to the stock, which would then work with double vigour and no farther swarming. By de-queening, the bees can clean up well, or the bee-keeper can, if he or she wishes to help; I do. The combs will then be more hygienic. The bees may be good cleansers: *you must assist them in this*. Our hives would not be very healthy if they were used morning and night. As a cell so soon gets another egg after the young bee is hatched, no wonder bees wish to swarm and build new, clean homes.

Some talk of queens being forced to lay;

I cannot understand this. I note some of mine have as many as seven eggs in some cells; considering the weather now I wish they would slacken off. I agree with Mr. Bowen that imported queens are not what one would wish; they want hardening off. I had one small stock that wintered on candy, quite large slabs on top; this was ready to swarm the beginning of April. I fancy this dark Italian queen must have kept laying all winter for them to be so strong. In one apiary near here bees have ample stores. I shall have to feed; this will mean honey off the money earned. As I cannot afford increase and have no room for more stocks, I shall rest content with a few, looking for a brighter season for all next year.—A. Trowse, Eade Road, Norwich, August 22.

### Price of Swarms in Germany.

A reader of the German paper "Bienenzucht" asked the editor what was the right price to pay for a swarm. The editor replied at some length, saying at last that in June bees were worth two and a half times as much as honey per lb., and in July twice as much as honey. "Thus," continued the editor, "when honey is 1 mark per lb., swarms are 25 marks, when honey is 15 marks bees are 37.50 marks, and when honey is 20 marks—a price that may well be reached this year—bees in June are worth 50 marks per lb.—we hold that an average price of 25 marks per lb. for bees is right at this time. Bee-keepers with a rich, late honey flow will easily make use of bees at this price, given good bloom and good weather together."

From which it appears that, other things being equal, heather bee-men are lucky to be able to buy bees 20 per cent. cheaper than the white clover man. This year the white clover has let us down badly. Let us hope the heather will be more kindly.

*Eighteen Days' C.B.*—Germany's June must have been much like our July. Teacher Pauls, writing from beautiful old Marienburg his monthly notes for "Die Deutsche Bienenzucht," says:—"In the last week of May the windows of Heaven were opened and a mighty rain fell, inflicting on our bees eighteen days' C.B. They could only snatch here and there an hour or so a day to drive their trade in the wet fields." He goes on to say that wherever bee-keepers meet their first word is one of lamentation on account of the poor sugar ration, which in many apiaries has caused a loss of 90 per cent.. This also is very much as in England.—G. G. DESMOND.

### Twickenham and Thames Valley Bee-keepers' Association.

By the courtesy of the Hounslow Allotment Association, an exhibition of honey was held at their annual show on August 28. Mr. A. G. Gambrell, of Richmond, officiated as judge, and made the following awards:—

#### OPEN CLASSES.

1-lb. section of comb honey.—Mrs. G. Scott, Hull.

1 lb. jar of extracted honey.—Rev. J. Morley Davies, N. Devon.

#### CLASSES RESTRICTED TO MEMBERS OF THE ASSOCIATION.

Three sections of comb honey.—1, Mr. J. Curtis, Teddington; 2, Mr. G. Patterson, Isleworth; 3, Mrs. Fox, Twickenham. Shallow frame.—1, Mr. J. Curtis; 2, Mrs. Fox.

Three 1-lb. jars of extracted honey.—1; Mr. J. Curtis; 2, Mrs. Fox; 3, Mr. G. Patterson.

Three 1-lb. jars of granulated honey.—1, Mr. J. Curtis; 2, Miss Shaw, Feltham; 3, Mr. G. Patterson.

Messrs. James Lee & Son, of Uxbridge, staged an excellent exhibit of hives and appliances.

During the evening Mr. Gambrell delivered an exceedingly interesting and instructive lecture on modern bee-keeping, which was very well attended.

At the conclusion of the show the honey in the open classes was sold for the benefit of Hounslow Hospital.

The Committee take this opportunity to thank all who contributed to the gift classes, thus helping to make the show a success.—M. BYATT.

### Salisbury and District Bee-keepers' Association.

The second annual honey show of the Salisbury and District Bee-keepers' Association, since the termination of the war, took place on Wednesday, August 25, at the Wardrobe, the Close, Salisbury, by the invitation of the Misses Hussey. There was a large attendance of bee-keepers, including the Hon. Louis Greville, president of the Association. The honey and produce were staged in the drawing-room. Although the season has not been one tending to quantity, the quality of the exhibits was adjudged as exceptional, and such as would rank with the best gathered. The exhibits of Mr. E. C. R. White, of Winterbourne, who acted as judge, were very effective. Mr. J. E.

Pinder, of Salisbury, staged a non-competitive display of honey of various colours and blends which was much admired. A well finished shallow frame super was shown by Canon Farrer, of the South Canonry, the Close, while an observation hive of working bees also attracted attention.

On the lawn, in the afternoon, Mr. E. H. Young, of Hyde, late secretary to the British Bee-keepers' Association, who, in the course of 51 years of activity in the bee-keeping world has gained considerable knowledge of his subject, gave an address on the subject of "Honey Production." His address aroused a good deal of interest.

The Misses Hussey, with the assistance of Lady Katharine Bouverie, entertained the company at tea, after which the Hon. Louis Greville, the president of the Association, distributed the prizes to the successful competitors. The following were the prize-winners:—

Class 1 (three bottles of light honey).—1, Mrs. N. Allen, Over Wallop; 2, Mrs. Penny, Broadchalke; 3, Mr. F. Grinter, Great Durnford.

Class 2 (three bottles medium or dark honey).—1, Mr. F. Grinter; 2, Mr. F. J. Bates, Morgans Vale; 3, Mr. J. E. Pinder, Salisbury.

Class 3 (three sections of comb honey).—1, Mr. J. E. Pinder; 2, Mrs. N. Allen; 3, Mr. F. Grinter.

Class 4 (one shallow frame).—1, Canon Farrer, South Canonry, the Close; 2, Mr. F. Grinter.

Class 5 (best exhibition of wax).—1, Mr. E. R. Hardiman, jun., Bowerchalke; 2, Mr. J. E. Pinder.

Class 6 (gift class, one section).—1, Mr. F. Grinter; 2, Mr. J. E. Pinder.

Class 7 (gift class, one bottle of extracted honey).—1, Mrs. N. Allen; 2, Mr. F. Grinter; 3, Mr. F. Miles, Shrewton.

Class 8 (cake, approximately 1 lb., or half-dozen small cakes, sweetened with honey).—1, Miss F. M. Pinder; 2, Mrs. E. Miles, Shrewton; 3, Mrs. F. Miles, Shrewton.

Following the distribution of prizes, the bee-keepers inspected the apiary in the grounds, where the hives were opened and the bees examined, and an Italian queen bee, received that morning from the Ministry of Agriculture, was introduced to one of the stocks.

Votes of thanks to the Misses Hussey, the Hon. Louis Greville and Mr. E. Young, proposed by Mr. J. E. Pinder and seconded by Mr. E. C. R. White, brought to a close one of the most successful days the Association has experienced.—J. E. P.

## Derby Bee-keepers' Association.

### HONEY SHOW AT DERBY.

Derby Show, which was held on August 18 and 19, may be regarded as a fairly successful resumption of the event after the long period of suspension. The entry, by no means a heavy one, was considered satisfactory. Fortunately the services of Mr. W. Herrod-Hempsall were secured, he officiated as judge, lecturer, and examiner of candidates.

The leading features were two displays of honey staged by Mr. J. Pearman and Mr. S. T. Durose respectively, the artistic arrangement of the first-named exhibit being superb, and Mr. Pearman was awarded a silver cup, given by W. E. Ann, Esq.; the same exhibitor also secured the Association's cup for the highest number of points.

The novices cup, given by Dr. St. John, being captured by Mr. T. Arnold by a bare point against his opponent, Mr. A. A. Chapman.

Appended is the result:—

Open classes:—

One lb. jar of honey.—J. Pearman, 1; Major J. H. Hadfield, 2; S. T. Durose, 3, J. Thomson, 4.

One section.—J. Pearman, 1; S. T. Durose, 2.

Members' Classes:—

Display of honey.—J. Pearman, 1; S. T. Durose, 2.

Twelve jars light honey.—S. T. Durose, 1; J. Pearman, 2; Miss Simmons, 3.

Twelve jars dark or medium.—J. Pearman, 1; S. T. Durose, 2; A. A. Chapman, 3.

Six jars granulated.—J. Pearman, 1; T. Arnold, 2; S. T. Durose, 3.

Twelve sections.—J. Pearman, 1; S. T. Durose, 2.

One shallow frame.—A. A. Chapman, 1; A. Pakin, 2; T. Arnold, 3.

One sample of wax.—J. Pearman, 1; J. Kirkland, 2; Rev. Ellison, 3.

Novices' class:—

Six jars of honey.—T. Arnold, 1; Miss Riley, 2; A. A. Chapman, 3.

At the close of the show Mr. F. S. Linnell kindly undertook to sell by auction a portion of the prize honey, the proceeds being devoted to the funds of the Derbyshire Royal Infirmary. His novel style of dealing with sales for charitable objects created much amusement. The premier jar, staged by Mr. Pearman, realised £2 19s. 6d., while the mere handful of jars and sections reached the substantial sum of £10.

Mr. Linnell, who was subsequently thanked, replied: "It always gives me the greatest pleasure to assist any time for good charitable objects, and you can

always rely on me helping you whenever occasion arises.'—Mr. Editor, I am afraid I have trespassed too deeply on your space in endeavouring to show others how easy £10 can be acquired.

It is with regret that we have to announce the death of Mr. J. Hinton. While on his holidays he contracted a chill followed by pneumonia. An active member of the Council, and an enthusiastic bee-keeper, Mr. Hinton was respected by all, and our warmest sympathy is extended to his bereaved family.—F. MEAKIN.

### Guildford and District Bee-Keepers' Association.

A meeting of the members took place (by kind invitation of Miss D. Y. Knowles) at Heatherlands Bee Farm, on Thursday, August 14. About 30 members were present, and were conducted round the apiary and workshop by Miss Knowles, who afterwards kindly provided tea. After tea, Miss Knowles read a paper on "Artificial Swarming," which was followed by a discussion. A very enjoyable and profitable afternoon was spent, and those present were most grateful for the invitation so kindly given.

### Staffordshire Bee-Keepers' Association.

#### LICHFIELD AND DISTRICT BRANCH.

The members of above Association successfully revived the "Honey and Bees" section this year at Lichfield's Floral and Horticultural Societies' Centenary Exhibition, on 2nd and 3rd instant, after a lapse of many years.

The Exhibition was held in "Beacon Park," Lichfield, being well supported by the local bee-keepers, and proved a great attraction to the thousands who visited the Show.

The awards were as follows:—

#### OPEN TO ALL.

Class 1.—Four 1-lb. Sections of Honey: 1, G. H. Mytton (no other entries).

Class 2.—Four 1-lb. Jars of Light Honey: 1, E. Jacques; 2, M. Craddock; 3, G. H. Mytton.

Class 3.—Four 1-lb. Jars of Granulated Honey: 1, E. Jacques; 2, M. Craddock; 3, G. Dale.

Class 4.—Four 1-lb. Jars other than Light Honey: 1, E. Jacques; 2, G. H. Mytton; 3, T. W. Stewart.

Class 5.—Shallow Frame of Honey: Equal 3, E. Jacques and G. H. Mytton.

Class 6.—Beeswax, Not Less than  $\frac{1}{2}$  lb.: 1, E. Jacques; 2, M. Craddock; 3, G. H. Mytton.

The judge, Mr. J. Price, County Ex-

pert, expressed his satisfaction at the quality of the exhibits, and during the afternoon gave two interesting lectures on bees, holding his audience spellbound while he explained the development of the bee from the egg onwards, in which he was greatly assisted by the presence of two observatory hives, each stocked with bees. These were honorary exhibits, together with two trophies of honey, and proved to be a great attraction, exhibited by E. Jacques and G. H. Mytton. Those provided by the former were headed by an Italian queen, imported under the Government Re-Stocking Scheme.

At 3 o'clock and 5 o'clock open-air demonstrations were given with bees by the County Expert to crowded audiences, enabling him to drive home theories advanced while lecturing in the "Honey and Bees" tent.

An interesting educational exhibit was staged by Mr. J. Price on behalf of the Staffs. Educational Committee, by whom he is employed. It occupied two 8-ft. tables, and contained many interesting specimens of ancient and modern bee appliances.

The Silver Medal was awarded to E. Jacques, and the Bronze Medal to G. H. Mytton; being provided by the Staffs B.K.A.—E. JACQUES, Hon. Sec.

### The Grocers' Exhibition.

May we draw our readers' attention to the Grocers' Exhibition. The entry fees are low and the prizes good. Particulars will be found in "Bee Shows to Come."

### New Year Honey Cake.

One-third cup shortening, half cup sugar, one cup honey, one egg, two cups flour, two tablespoonfuls baking powder, one-third teaspoonful salt, half cup raisins. Beat together sugar and shortening; then add the well-beaten yolk of egg, then honey, flour, and raisins. Sift salt and baking powder in flour, and add last the white of egg and flavouring.—*The Western Honey Bee*.

### Honey Recipe.

The following may be useful before the winter is over:—

#### *Honey as a cure for Influenza.*

At the commencement of the attack a cup of yarrow tea with a table-spoonful of honey in it should be taken morning and evening, and if commenced in time a speedy cure follows. A cold in the head is generally cured after taking one dose, and delicate or ailing children, as well as grown-up people, are greatly benefited by making this their usual drink.



The Editors do not hold themselves responsible for the opinions expressed by correspondents. No notice will be taken of anonymous communications, and correspondents are requested to write on one side of the paper only and give their real name and addresses, not necessarily for publication, but as a guarantee of good faith. Illustrations should be drawn on separate pieces of paper. We do not undertake to return rejected communications.

### Notes and Comments.

[10274] You surely must see very clearly that simply blind backing up of the B.B.K.A. on your part is not very convincing. It is very easy to denounce everyone who does not agree with you in thinking it of use. If you would, instead of blaming my lack of vision or "perspicacity," or whatever you like to call it, give us some concrete facts as to work of really practical and progressive importance that the B.B.K.A. has done, it would be of greater help. I have read reports of the Council meetings for years, and all I can say is that if anything worth while is ever done it is not reported.

However, if you and the B.B.K.A. like that kind of thing—why, I can just flatter them like the rest.

I wish to apologise for having written in such a way as to make it possible for you to get the idea that I intended to imply that you supported the insurance scheme because you were financially interested. Such an idea never crossed my mind.

The Secretary of the B.B.K.A., in a letter to me some months ago, said that the history of the Association would be shortly published in *THE BRITISH BEE JOURNAL*.

If this is so, perhaps we shall have a chance to hear of the good works of this body.

[We make no comment on the above. Judging from some of the letters we have received since last Thursday our readers will make their own.—Eds.]

[10266]. I remember about 12 years ago that the bees worked on vetches or tares, but not on the flower. It was a bad season, 1907, I fancy. A small speck of jet-black saccharine matter exuded at the base of the leaf, and the bees spoiled a quantity of honey for me. It was as black as tar! Do you know it?

[We have never had honey from tares in any quantity, but it is a dark honey. We have had honey (?) as black as tar, but put it down to honeydew.—Eds.]

[10273]. It seems that one must face the fact. I have never seen a sheet of

metal foundation worked on properly either, and doubt if anyone ever will.

At Benson (Messrs. Adminsons, Ltd.) I have seen bees working on the MacDonald metal comb satisfactorily, except that the brood seems rather scattered. I should be sorry to have any shares in the A1. Honeycomb Co. I know that all the same.

(10271). Is it generally known that a little neat Izal rubbed over the hands and wrists almost entirely stops the bees from stinging?—R. B. MANLEY.

### Notes on the Laurel

[10275] *Re* 10266. The chopped leaves of the common laurel (*Prunus Lauro-cerasus*), which has no affinity with the true laurel, the latter being our bay-tree (*Laurus nobilis*), are in common use by entomologists in their killing bottles. The lethal agent is hydrocyanic, commonly called prussic acid. The weak acid, besides killing the insect, inhibits the action of saprophytic bacteria, and preserves it until its captor can attend to the setting. Insects killed in the cyanide bottle become very brittle and difficult of subsequent relaxation; those preserved in chopped laurel leaves keep relaxed.

The saccharine exudation from the leaves is not poisonous. Indeed, the expressed juice of the leaves can itself be used in reason as a flavouring agent, otherwise the writer would have been dead many times over.

Other species of *Prunus* are the cherry, the apricot, the sloe, and all varieties of plums. The almond, the peach, and the nectarine belong to the genus *Amygdalus*, differing from *Prunus* only in the wrinkled surface of the stone.—C. HANSLOPE BOCOCK, F.E.S.

### Crawling Disease in Bees.

[10276] In response to the Rev. Hemmings' request for a remedy for crawling disease, I am advertising in *THE BRITISH BEE JOURNAL* a remedy I have tried for a considerable period amongst bee-keepers with success. For some years I have noticed "crawling" under certain conditions when the symptoms of "I.O.W." disease were not present. I have known such cases certified by experts as "I.O.W." disease when I was certain it was not so. One case in particular where the bees had been travelling, and were confined for two days, produced "crawlers," and also the same season produced bees and honey to the extent of four stocks increase and nearly sixty pounds of honey. The following season the stocks were still doing well.—A. W. SALMON.



### Foreign Honey for Feeding.

[10277] Our attention has been called by one of our customers—who is a large bee-keeper—to the article in your issue of the 19th inst on "Using Foreign Honey for Feeding." We have been in the habit for some time of selling West Indian honey to this gentleman as well as to many other people for feeding their bees. Those who have tried it speak very highly of its value when used for this purpose.—THE LONDON TRADING AGENCY.

### Notes on Notes and Comments.

[10278] *Re* 10263. Many undoubtedly agree with you, Mr. Editor, and like myself are greatly surprised at Mr. R. B. Manley's great want of perspicacity. While agreeing with him on some points, such as "experts," and everybody patting one another on the back, he doubtless forgets, or does he know the hard, uphill struggles of the B.B.K.A.? and while preferable to have a more live and instructive Association, one must not forget it is not run as a Philanthropic Association. Where would bee-keeping be to-day in this country if it were not for the B.B.K.A.? Maybe Mr. Manley, along with other detractors, prefers a so-called live club with a huge debit balance, which like others would fizzle out after a year or so.

*Re* 9907. Mr. Manley would, I venture to suggest, help the craft if he gave advice without sarcasm, and while his remark *re* feeding with honey is good, does he seriously suggest that to lose a stock by robbing is almost as bad as "Isle of Wight" disease, and as to stimulating queens to lay, does he not yet realise that a large, young population saves food being consumed in the winter?

*Re* 10,268. Large brood frames, Langstroth, Jumbo, Quinby, etc., have been tried repeatedly in this country but over a run of years they have generally proved a failure for surplus honey (see also *Gretna Notes*, page 412). The Langstroth hives had a large sale this season, they were often the only ones available locally, and there is always a certain amount of healthy experiment going on amongst bee-keepers. Mr. Manley is undoubtedly doing bee-keeping a dis-service, as his followers will be bound to admit in the course of time, while those who are experimenting with large frames should remember the British Standard Brood Frame was brought about by real, live veterans of the craft after long and careful study, and it is undoubtedly the ideal frame for surplus honey for the majority of bee-keepers in this country.—W. F. JUDGE.

### High Price for Honey.

[10279] I am sure you will be interested to know the result of the sale of the honey in the "Hospital Class" at the Derby Show. Nine jars and two sections made £10. My first prize jar made £3 19s. 6d. My section 10s. I do not know, but I should say the price for the jar is a record.—J. PEARMAN.

### Aluminium Foundation.

[10280] My experience with above has been exactly similar to that of Mr. Edward Turner (10,273), in B.B.J. of 26th inst. I got a dozen sheets of the foundation and tried it with established stocks (in brood chamber), with swarms (mixed with sheets of wax foundation) and in nucleus hives (with sheets of wax foundation). In every case the bees absolutely refused to work the metal foundation at all, and in several cases built comb parallel to the aluminium foundation and united to it by brace combs.

The season has been a very bad one here (Co. Waterford), and I shall try the aluminium again next season, which I hope will be better. My bees swarmed most unnecessarily, though I gave them lots of room; they were confined to hives by bad weather, and so I suppose turned their energies to rearing queens.—EDWIN B. JACOB.

[10281] As I understand that Mr. Edward Turner's letter [10,273] has given some bee-keepers the impression that "Aluminium Foundation" is available on the market, I regret to say it is not.

In the first place it is not intended to be manufactured of pure aluminium or of aluminium only, hence the name "Metal Foundation" is more appropriate.

A consideration of the most economical type to be produced at the beginning led to selecting an embossed form, for which a special mill was designed, and the order for its manufacture placed in the hands of a good firm, who promised delivery within a certain time. On the strength of this assurance, advertising was done. Unfortunately, the makers of the mill did not strictly adhere to the specifications supplied to them, when great accuracy in this branch of engineering is vital. The result was, after long delay and to the disappointment of everybody, an imperfect machine, producing nothing approaching worker cell foundation; in fact the models produced were much cruder than the original crude specimens. Immediately this was realised, advertising was stopped, and only an insignificant number of specimens were supplied to

those who were anxious to experiment. A circular issued at the beginning of June by Messrs. James Lee & Son, Ltd., clearly revealed a growing interest in the metal foundation, both at home and abroad. This was even stimulated by the difficulties of production.

Every effort to rectify the mill having failed, preparations are being now made for the evolution of a different type, originally hampered by lack of capital, and it is possible that, after satisfactory testing, the foundation will be on the market next season.—A. Z. ABUSHADY.

### Swarms Affected with "Isle of Wight" Disease.

[10282] With reference to letter 10265 swarms affected with "Isle of Wight" disease while parent stock remains healthy, may not the persistent rainy and cold weather, taken in conjunction with the fact that swarms, even if being fed, have no accumulated store of pollen, give a clue to this peculiar condition.

Honey or syrup supply bees with heat-producing elements, but pollen is essential to repair waste tissue, and thus to maintain a vigorous vitality.

I would advocate the trial with any swarms so affected, and which are short of pollen owing to bad weather, well dusting the bees with pea-flour or other pollen substitute, and the filling of some cells in portion of comb with the same.

Pollen starvation may be the diagnosis of the "crawling disease" with which established stocks—as well as swarms—are affected.—J. BALLANTYNE.

### Notices to Correspondents.

We are sorry we are obliged to hold these over till next week, as the printers were unable to set the type owing to a mishap to the machine.

### Bee Shows to Come.

*A nominal charge of 2s 6d. is made for notices (not exceeding 7 lines) in this column, 10 lines charged 3s. 6d., up to 15 lines 5s., which covers cost of insertion from order till date of show. Cash should accompany orders for insertion.*

**September 8, 9 and 10.**—Portsmouth B.K.A. Honey Show, in conjunction with the Portsmouth Abolition Holders' Show, at Connaught Drill Hall, Portsmouth. Six Open Classes. Judge, W. Herrod-Hempall, F.E.S.—Schedules from Show Secretary, Mr. J. Sinnett, 154, Essex Road, Southsea.

**Saturday, September 11.**—Forest-Fach Horticultural Society, Swansea. Three Open Classes for Honey, extracted and sections. Help to foster bee cult this end. 1st prizes, 10s.; 2nd and 3rd in proportion.—Schedules ready from G. L. Williams, Forest-Fach, Swansea.

**September 15, at Twickenham.**—Twickenham Horticultural Society's Great Vegetable Exhibition. Honey exhibits under the control of Twickenham and Thames Valley B.K.A. Two Open Classes for Comb and Extracted Honey.—Schedules from Miss M. Byatt, "Hawthorn," Hanworth, Middlesex. **Entries close September 8.**

**September 18 to 24.**—Grocers' Exhibition, Agricultural Hall, London. Honey and Bee Appliance Competitions, open to the United Kingdom. Good prizes. Entrance fee in each class 1s.—Schedule of Competitions sent on application, referring to this journal, to H. S. Rogers, 31, Queen Victoria Street, E.C.2. **Entries close September 11.**

**September 22.**—Altrincham Show. Several Open Classes for Honey and Appliances.—Schedules from H. Turner, 1, Market Street, Altrincham.

**October 5 to 8.**—Essex Fruit and Honey Show at Institute of Agriculture, Chelmsford. Open from 12 to 8 p.m. Admission free. Lectures and demonstrations each day.—Schedules from G. R. Alder, 7, Bulwer Road, Leytonstone.

**October 19 to 22.**—Dairy Show, Agricultural Hall, London. Open Classes for Honey, etc.—Particulars, Secretary, Dairy Farmers' Association, 28, Russell Square, London, W.C.1.

**November 18.**—Annual Show of the Worcester City and County Chrysanthemum, Fruit, Root and Honey Society. Thirteen Open Classes in Honey Section.—Schedules from Geo. Richings, 42, Barbourne Road, Worcester. **Entries close November 6.**

### Special Prepaid Advertisements.

One Penny per Word. . .

*Trade advertisements of Bees, Honey, Queens, and Bee goods are not permissible at above rate, but will be inserted at 1½d. per word as "Business" Announcements, immediately under the Private Advertisements. Advertisements of Hive-manufacturers can only be inserted at a minimum charge of 3s. per lin., or 6s. per inch.*

*PRIVATE ADVERTISEMENTS are only intended for readers having Surplus Stock to dispose of. Driven Bees, Nuclei, and Queens that are reared or imported for sale, are Trade Advertisements, and can only be accepted under trade terms. A charge of 6d. extra will be made if a box number is used.*

*Orders for three or more consecutive insertions in "The Bee Journal" entitle advertisers to one insertion in "The Bee-Keepers' Record" free of charge.*

*Advertisements must reach us NOT LATER than FIRST POST on TUESDAY MORNING for insertion in the "Journal" the same week.*

### PRIVATE ADVERTISEMENTS.

**FOR SALE**, about 35 Stocks and Swarms of Hybrid Ligurian Bees on 8 to 10 frames and Nuclei; mostly this year's Queens; excellent workers.—REV. A. H. HALLEY, Crathie, Wellington College, Berks. r.h.79

**EIGHT STOCKS** on 10 frames, headed by 1920 Italian Hybrid Queens from same mother as my 3-frame nuclei, but not purely mated; good, hardy, disease-resisting stock reared on the East Coast; £4 7s. 6d., carriage paid.—E. H. TUNMER, "Chalfonts," Leiston, Suffolk. r.h.81

**CHARNTOLANS.**—Surplus 4-frame Nucleus for immediate delivery, 50s., carriage paid; 1920 Queen.—ROBERTS, 50, Otter Street, Derby. h.85

**SURPLUS STOCKS** and Appliances for disposal, properly of gentleman giving up bee-keeping. Particulars, stamp.—HOLMAN, Dunton Green, Sevenoaks. h.113

**FOR SALE**, new light Lincolnshire Honey, fine quality, £8 8s. cwt.—**SCHOFIELD**, Spilys Road, New Leake, Boston. h.102

**FOR SALE**, Apiary about 12 first-class healthy Stocks, famous Doolittle strain; buyer must remove; inspection any time.—**GOLDEN**, Leire, Lutterworth, Leics. h.103

**OVERSTOCKED**.—I have still for Sale several Stocks of Italians and Hybrids, all strong, with plenty of stores and at reasonable prices, free on rail in W.B.C. hives or travelling boxes as required.—**CURTIS HART**, F.R.H.S., Newgate Street, Hertford. h.107

**FOR SALE**, 11 Stocks very strong and healthy Hybrid Bees (Italian-English) with W.B.C. Hives and absolutely all appliances required, including Honey Extractor, Ripener, and 13 Shallow Racks with drawn combs, the whole in perfect order; leaving neighbourhood; price for lot £68.—**I. G. PELLY**, Epping, Essex. h.109

**SURPLUS STOCKS**.—Strong, healthy Bees, immediate sale.—**JEWITT**, Hensall, Whitley Bridge, Yorks. r.h.135

**FOR SALE** (property sold), five Stocks of Native Bees with Hives, all in good condition, £4 each; a bargain.—**POLDEN**, The Beeches, Dinton, Salisbury. h.137

**WANTED**. "Little Wonder" Extractor.—Box No. 102, B.B.J. Office, 23, Bedford Street, Strand, W.C.2. h.138

**COMPLETE APIARY FOR SALE**, including 10 Stocks Italian Hybrids, 10 W.B.C. pattern, five Travelling and two 5-frame Nucleus Hives, Extractor, Ripener, Shallow Combs, 1 cwt. Sugar, and numerous Accessories and Sundries for modern apiary; never had disease; £65, or near offer; could be divided. Seen by appointment.—**HOWLETT**, 138, Seaforth Avenue, New Malden. h.139

**THREE** strong Stocks of Bees on 10 frames, headed by specially bred 1920 Queens, £3 each; travelling crate (returnable) and carriage extra.—**NEEDHAM**, Hemel Hempstead. h.141

**FIVE HIVES** strong, healthy Bees for Sale, each hive containing at least 30 lbs. of honey; owner leaving South; £6 hive, or offer.—**Broomlands**, Limpsfield, Surrey. r.h.142

**HEALTHY BEES**, 8-frame Stock, 1920 Queen, 55s.—**HULBERT**, Chalet, Warwick Road, Olton, Warwickshire. h.144

**FOR SALE**, Italian Hybrids, two 6-frame and two 9-frame Stocks, 6s. per frame; purchaser to pay carriage.—**MRS. J. E. WALKER**, Wintorpe, Newark, Notts. h.145

**LARGE EGG STRAIN**.—White Wyandotte pedigree Cockerels from 15s. 6d.—**MISSES COATES**, Broadheath, Presteign. r.h.146

**GOOD** quality White Clover Honey for Sale, £8 10s cwt, free time, on rail; samples 6d.—**BARLOW**, Stanley Terrace, Newcastle, Staffs. h.147

**SALE**, or exchange for gent's clothing or anything useful, eight Bee Hives in new condition, large quantity of Sections, Frames, Glass, Boxes, Jars, and all Appliances.—**W. BERRY**, Carr Fields Farm, Chorley. h.148

**ITALIANS**.—Two Stocks on 10 frames with 1920 Queens (one Hybrids), £3 each; box 10s.; 1920 Italian Queen, 8s.—**PEARS**, Scotby, Carlisle. h.149

**FOUR HIVES BEES**, very strong and healthy, all frames standard, Feeders, Excluders, Smoker, Veils, etc., £22 the lot, or £6 per hive inspection invited. Carriage forward.—**BAKER**, 20, Quentin Avenue, Merton Park. h.150

**STOCK ITALIAN BEES**, hive and combs, £6 6s.—**MILLER**, Broadway, Haywards Heath. h.155

**HIVES, ETC.**—W.B.C., 30s.; Cottage, 20s.; Racks, complete, 8s., etc.; no disease; bargain prices; carriage forward.—**MATRON**, Croydon Borough Sanatorium, North Cheam, Sutton, Surrey. h.157

#### BUSINESS ADVERTISEMENTS.

1½d. per word.

**FLAVINE CANDY**.—6lb. packages, 10s.; postage 1s. 3d. Made in Cambridge under our supervision from the best white sugar.—**S. H. SMITH**, 30, Maid's Causeway, Cambridge. r.h.87

**CRAWLING DISEASE**.—Reliable treatment for curing and prevention; recipe 2s. 6d.—**A. W. SALMON**, Cashfield, Chingford. h.120

**4-FRAME NUCLEI**, headed by 1920 Italian Queen, 50s.; box charged 10s., returnable; 6-frame Stocks, 70s.; 8-frame Stocks, 90s. Immediate delivery (weather permitting). Italian fertile Queens, 10s. 6d. English Run Honey and Sections wanted.—**LEE**, "Little Bowden Apiary," Burgess Hill, Sussex. r.g.114

**PURE ITALIAN QUEENS**, prompt delivery; select Italian, extra golden, rare honey-producing stock, August-September.—**ATKINSON**, Fakenham. r.g.24

**"WIGHT" DISEASE**, prevention and removal; advice 5s.—**ALF. RYALL**, Cottage Farm, near Camp, Stroud. r.h.124

**1920 FERTILE Golden Italian Queens**, guaranteed imported direct from Italy, regular supplies every few days, 10s. each; specially selected, 14s.—**GOODARE**, New Cross, Wednesfield. 1.59

**SELECT TESTED QUEENS**.—Three-banded leather-coloured Italians, gentle, hardy and prolific and disease resisting, one year old or less, right in their prime, 10s. 6d.; also untested 1920 Queens, same price; safe arrival guaranteed.—**THE APIARY**, Buckfast Abbey, S. Devon. r.h.125

**"ISLE OF WIGHT" DISEASE**.—Don't worry; use the solution that cures; 2s. per bottle.—**E. PRESSEY**, St. Elmo, Coulsdon. r.d.149

**HAVE YOU READ "THE BEE WORLD"?** If not, why not? Every number in itself is a useful literary work for practice and reference. Specimen copy free.—**Offices: THE APIS CLUB**, Port Hill House, Benson, Oxon.

**HONEY FOR FEEDING BEES**.—Finest West Indian, tin of about 60 lbs., 68s. 6d., carriage paid 100 miles.—**LONDON TRADING AGENCY**, 32, St. Mary Axe, E.C.3. r.h.134

**SEVEN DAYS SALE OF QUEENS**.—For quick sale the following prices are accepted for Bowen's famous Queens;—Extra selected Hybrids, 10s. 6d.; dark Hybrids and Natives, 7s. 6d.; mailed in rotation.—**LIEUT. BOWEN**, Commercial Queen Breeder, Cheltenham. h.151

**FEW** surplus 1920 Native and Hybrid Queens, 8s. 6d. each; bargain.—**PEARSON & GALE**, Marlboro'. h.140

**LANTERN SLIDES** for Lectures on Bee-keeping. Complete sets, practical and scientific. Prints on approval.—**REV. G. H. HEWISON** (1st Class Expert, B.B.K.A.), Marr Vicarage, Doncaster. h.136

**MASHEATH MEMS**.—"Your Masheath Hive is a very good design, and the flat roof I heartily endorse, having used it for the past forty years and more."—**A. D. C.—ATKINSON**, Fakenham. h.143

**STRONG** 3-frame Nuclei, 25s., 7s. 6d. per frame, bees and brood, extra stocks; state requirements; healthy Driven Bees, 10s. 6d.-12s. 6d. per lot with Queen; all cases 6s., returnable.—**W. WOODS**, Firs Apiary, Normandy, near Guildford. h.153

**HEALTHY DRIVEN BEES**, very strong, 11s. per lot, also two strong Stocks, £3 10s. each, or near offer.—"N." c/o 69, Blythswood Road, Acocks Green, Birmingham. h.153

**FERTILE 1920 QUEENS**, Hybrid Italians, 6s. 6d.; Italians, 8s. 6d.; Penna strain.—**WHITE**, Penny Hill, Holbeach, Lincs. h.154

**ITALIAN HYBRID QUEENS**, 10s.; Virgins, 5s. Sundry Appliances to clear. Stamp for list.—**JACK TICKELL**, Westbourne Apiary, Cheltenham. h.156

**WANTED**, Carpenter experienced in making bee hives and appliances.—Box 103, B.E.J. Office, 23, Bedford Street, Strand, W.C.2. h.158

**JOT DOWN** the deficiencies of your present equipment and your needs for future improved working. Then book for "**MASHEATH**" (Regd.) Equipment for autumn construction.

The **MASHEATH LIST** contains an unique series of Hives unequalled to-day. You should not enter upon another bee season without them. "The Hives (Porchless Masheaths) are excellent in every way, and I am very pleased indeed with them. **'PORCHLESS!'** Yes, every time. Need I say more? I will get you to send me two more."—W. F., June 17, 1920.

The **MASHEATH HIVES TALK** as soon as they are delivered.

**ATKINSON**, Proprietor and Fakenham Sole Maker,

Preserve your Bees during the Winter by feeding with

## PINK BACTEROL BEE CANDY

Manufactured by

**HAWKES BROS., LTD.,**  
— Chelmsford, Essex —

Prices on application.

Altrincham Agricultural Society.

ANNUAL SHOW,

Wednesday, September 22.

£2,500 IN PRIZES.

Silver Cups and Medals for Horses, Cattle, Pigs, Turnouts, Hunters, Jumpers, Roots, Grain, Butter, Cheese, Implements, Dogs, Poultry, Pigeons, Rabbits, and Cavies.

Open Classes for Honey.

Increased Prize Money in All Sections.

Prize List may be had from the Secretary,

**HERBERT TURNER,**

1, Market Street, Altrincham.

Tel. 174.

Entries close September 4. Double fees, September 8. Dog entries close September 10.

## THE British Bee-Keepers' Association

Insure *now* against loss by damage done through bee stings. All particulars from

**W. HERROD-HEMPSELL, 23, Bedford Street, Strand, London, W.C.2.**

## ITALIAN QUEENS

Direct from Italy.

Address:  
**Signor Gaetano Piana,**  
Castel San Pietro,  
near Bologna, Italy.

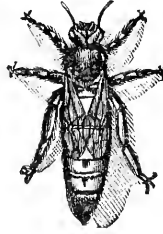

All Queens are reared by the most up-to-date and scientific methods. Mr. W. Herrod-Hempshall has personally inspected the apiary and methods employed, with which he is perfectly satisfied.

PRICES FOR 1920.

For 1 Fertile Queen: August and September, 9/- each queen.

Carriage paid in Great Britain. Cash must accompany all orders, which will be executed in rotation. Guaranteed safe arrival of all Queens, but not the introduction. Bees dead upon arrival must be sent at once to "B.B.J." Office.

For the mutual convenience of all parties, Il Signor Piana has made arrangements that all communications, orders and remittances of the readers of "B.B.J." and "B.K.R." can be addressed to him, c/o British Bee Journal, 23, Bedford Street, Strand, London, W.C.2.

Cheques payable to 'British Bee Journal.'

The products of the Apiary, of Poultry and Farm Stock, of the Fruit and Vegetable Garden can be Advertised and Sold through

THE BAZAAR, EXCHANGE & MART

Newspaper.

Get a Copy—Thursday and Saturday 3d. The "Bazaar" publishes also practical handbooks by experts. Send for full catalogue, post free from—**WINDSOR HOUSE, Brems Buildings, LONDON, E.C.2.**

## POSITIVE FACTS.

June 13th, 1920.

I am very pleased with the foundation. The bees undoubtedly prefer it to any other make I have, and have even gone the length of missing two sheets of other new foundation, and working out a sheet of yours placed behind them at the back of the hive. Full sheets have not sagged in the least in 16 x 10 frames.

Yours faithfully, R. B. MANLEY.

Illustrated Lists free by post.

**S. J. BALDWIN, The Apiary, BROMLEY, Kent.**

## BARGAINS IN SURPLUS CLOTHING.

Blue Serge Trousers for Working Men **12/6**  
 Blue Serge Trousers, as new .. **14/-**  
 New Blue Serge Trousers, best quality .. **21/-**  
 New Holeproof Trousers, highly recommended .. **18/-**  
 New Bedford Cord Breeches, Officers' quality .. **42/-**  
 New Cord Riding Breeches, strapped .. **22/6**  
 Khaki Drill Trousers, Officers' quality .. **10/6**  
 Khaki Drill Jackets with pockets, Officers' quality .. **10/6**  
 Khaki Drill Trousers, ordinary .. **7/6**  
 Khaki Drill Jackets, ordinary .. **7/6**  
 New Blue Drill Overalls, complete with pockets .. **12/6**  
 New Oilskin Overcoats, extra quality .. **26/6**  
 Army Waterproof Ground Sheets, 72 x 36, brass eyelets, slightly soiled, 9/- for 2, 4 for **17/-**.

Black Rubber Combination Cyclists' Suits, complete with Sou'wester, **20/-**; cost Government **63/-**.  
 New Heavy Workmen's Boots, **18/9** pair.  
 New Brown Boots, all sizes, **22/6**; worth double.  
 New Full-size Australian Wool Blankets, **21/-** each.  
 New Full-size Australian Grey Blankets, **18/6** each.  
 New Full-size White Fleecy Blankets, **16/9** pair.  
 Selected Army Wool Blankets, all colours and sizes, **12/-** each.  
 Heavy Woollen Check Fringed Rugs, new, **22/6** each.  
 Heavy Woollen Check Motor Rugs, **30/-** each.

Now is the time to buy Blankets; they will be very scarce and dear later.

**WRITE TO-DAY FOR LIST OF NUMEROUS OTHER BARGAINS.**

**SACAR'S UNIVERSAL STORES (Dept. 29), ARDWICK, MANCHESTER.**

## STANDARDIZE

BY USING

**KENT DEWEY STANDARD FRAMES  
 AND KENT STANDARD HIVES**

WHICH NEVER VARY.

SUPPLIED FROM STOCK.

LIST FREE.

**LONDON OFFICE:—39, WANDLE ROAD, S.W. 17.**

## "BACTEROL" FOR BEES



2/9 per Bottle.

Post Free.

The cure for, and preventive of, "Isle of Wight" Disease. Non-poisonous—free from stain or unpleasant odour.

**MENLEY & JAMES, LTD.,**  
 Menley House, Hatton Garden, E.C.1.

**B<sup>c</sup>  
 W<sup>b</sup>  
 B**

**BEST CLEARING and  
 WINTERING BOARD,  
 SUPER CLEARER, &c.**

**A Necessity for all Bee-Keepers  
 all the year round.**

**MEADOWS, SYSTON, LEICESTER.**

**8/-**

Of the Author, S. SIMMINS, QUEENLAND, HEATHFIELD, SUSSEX.

**SIMMINS "A MODERN BEE FARM"**

**POST FREE**

Nearly 500 pages. A few more copies at 8/-. Any further edition must cost 50% more

**Bees and Beekeeping Appliances. Catalogue free.  
 EDWARD J. BURTT. MANUFACTURER. GLOUCESTER.**

*I very much regret that there has been a large increase in the cost of the manufacture of bee-appliances, and therefore my prices will be advanced 10% from May 10th. Books, excepted.*

## FOUR FIRST PRIZES.

Our HIVES and APPLIANCES were again awarded FOUR PRIZES at the Highland Agricultural Society's Show at Aberdeen, thus testifying to the superiority of our goods. Order now and ensure your bees wintering in good hives.

**BOTTLES.** We hold a large stock and can give immediate despatch.

**CANDY.** Safeguard your bees from starvation by feeding with our FAMOUS BEE CANDY. Send sugar vouchers with order.

Sole Agents for DADANT'S WEED FOUNDATION. Absolutely pure. Once used, always used.

Large illustrated catalogue, entitled, "Everything for an Apiary," post free on application.

**R. STEELE & BRODIE,**  
*Bee Appliance Makers,*  
**WORMIT, FIFE.**



### Lee's Bee Supplies.

¶ In design, material and workmanship, Lee's Bee Supplies still retain the reputation of being your best and safest investment.

¶ Our 1920 ILLUSTRATED CATALOGUE is yours for the asking. It contains detailed information on the most up-to-date hives and appliances for which the House of Lee is famous.

¶ We regret the necessity of having to advise our Customers that owing to the increased cost of production, all prices in 1920 price list are subject to 10% increase. The increase will not apply to orders received before May 10.

\* \* Five per cent discount to Members of THE APIS CLUB.

**JAMES LEE & SON,**  
LTD.,  
Uxbridge, Middlesex.

(Telegrams: Graphichly, Uxbridge.)

Telephone: Uxbridge 181.)



No. 1994. Vol. XLVIII

SEPTEMBER 9, 1920.

[Published every Thursday, Price 2d.]

**CONTENTS.**

	PAGE		PAGE
POSTAGE ON NEWSPAPERS .....	433	CORRESPONDENCE--	
A DORSET YARN .....	433	Bee-keeping Experiences .....	440
JOTTINGS FROM HUNTINGDONSHIRE .....	434	The Season in Northants .....	440
NOTES ON BEE-KEEPING .....	435	Foreign Honey for Feeding Bees .....	440
BEE-KEEPING IN SOUTH MONMOUTHSHIRE .....	436	The Use of Experts .....	440
SURREY B.K.A. ....	437	Difficulties of Bee-keeping .....	441
GLASGOW AND DISTRICT B.K.A. ....	438	The Honey Season .....	441
MID-CHESHIRE FARMERS' ASSOCIATION .....	438	NOTICES TO CORRESPONDENTS .....	441
CHESHIRE B.K.A. ....	439	WEATHER REPORT .....	442
		BEE SHOWS TO COME .....	442

# FOOD FOR BEES.

Owing to the continued bad weather there is a likelihood shortage this Winter. To prevent loss of Stocks order at once TAYLOR'S renowned

## SYRUP

In tins, 7 lb., 14 lb. and 28 lb. at  $1/3$  per lb., Carriage extra.

We are in a position to supply, without vouchers, the best

## CANDY

made from pure Sugar, plain or medicated,  $1/6$  lb. Carriage extra.

**E. H. TAYLOR, WELWYN, HERTS.**

Telephone—WELWYN 13.

THE  
**British Bee Journal**

Office: 25, Bedford Street, Strand, London, W.C.2.  
ESTABLISHED 1873.

A Weekly Journal Devoted to the  
Interests of Bee-keepers.

Edited by T. W. COWAN, F.L.S., &c.,  
and J. HERROD-HEMPSELL, F.E.S.

**Correspondence: Whom to Address.**—  
All matters relating to the Literary Department, Associations, Shows, etc., should be addressed, "Editors, *British Bee Journal*," and all business communications and matters relating to subscriptions and advertisements to be addressed to the "Manager," *B.B.J.* Office.

**Subscriptions.** — Annual Subscription, 10s. 10d. post free in advance; single copies 2d., or 2½d. post free. If a receipt is required by post, a stamped and addressed envelope must be sent, otherwise a printed receipt will be enclosed along with the paper.

*Note.*—Cheques and Postal Orders should always be crossed, otherwise it is very difficult to trace them if they go astray.

**How to send Money.**—Remittances can be made payable to W. Herrod-Hempshall by crossed Cheques and Postal Orders. Stamps may be sent for small amounts up to 2s.

*Halfpenny stamps are preferred.*

Scottish or Irish cheques can only be taken in payment if 6d. is added for commission charged by banks for cashing them.

The Editors are not directly or indirectly interested in the manufacture or sale of beehives or appliances of any kind, and must refer correspondents wishing for prices or catalogues to advertisers in the paper.

**OUR DEPOSIT SYSTEM.**

You are advised to insist on this being used when dealing with strangers.

**Rules and Conditions for Depositing**

*In order to save trouble, it is requested that the Rules be carefully read over by persons using the Deposit System of trading.*

Goods should not be despatched until notice that the money has been deposited is received from this office.

1. **Method.**—When strangers are dealing together, the purchase-money of the articles is deposited at our office. We acknowledge receipt of the deposit to both parties, and hold the money until we are satisfied that the purchase is concluded. If a sale be effected, we remit to the seller the amount deposited, less a charge of 2½ per cent. in the £, with a minimum of 6d., and the expenses of Post Office Orders and postage, &c. Cash will be forwarded by Cheque, Post Office Order, or by Postal Order as preferred. If a sale or exchange be not completed, we return the amount deposited, after making the same deduction. By this means buyers and sellers are secured against fraud.

2. **Deposits.**—Postal Orders (drawn on General Post Office) and Cheques must be made payable to W. Herrod-Hempshall, and crossed "London County and Westminster Bank." The numbers of the Postal Orders should be kept by the sender.

We cannot be responsible for any loss that may occur in transit.

3. **Honey on Approval.**—All honey will be sold by sample, which must be sent direct to buyer.

4. **Bee Appliances.**—In ordering, the time allowed for completing the order to be stated to us when sending cash. If maker accepts, we hold cash until transaction is satisfactorily completed, when the amount will be remitted, subject to conditions as in Clause 1.

5. **Bees and Queens.**—These will be dealt with entirely by the parties concerned, so far as price, &c., go, and when the purchase is satisfactorily completed cash will be remitted as per Clause 1.

6. **Goods in Transit.**—These are at the seller's risk, i.e., any damage to or loss of an article on its journey is borne by the vendor; but a rejected article must be properly packed and returned by the same means as was used in sending it.

7. **Carriage.**—The carriage of all goods, *except such as are sent by post*, is payable by the buyer, unless otherwise agreed. If any article sent on approval be returned, each party to the transaction must pay carriage one way.

**Books for Bee-keepers  
NOW IN STOCK.**

Cash in full must be sent with order.

		Postage
A Modern Bee Farm	7/6	... 8½d.
(To be obtained from this Office only)		
Advanced Bee Culture (HUCHINSON)	6/-	... 6½d.
Beginner's Bee Book (PELLETT)	5/-	... 4d.
BEE-KEEPING SIMPLIFIED FOR THE COTTAGER AND SMALLHOLDER (W. HERROD-HEMPSELL, F.E.S.)	1/-	... 2d.
BRITISH BEE - KEEPERS' GUIDE BOOK (T. W. COWAN)		
Paper covers	2/6	... 3d.
Cloth covers	3/6	... 4d.
Dissectible Model of Queen Bee	4/6	... 3d.
FERTILISATION OF FRUIT BLOSSOMS BY BEES (T. W. COWAN)	-/3	... 1d.
Honey and Health (A. HOPE)	-/6	... 1d.
Honey Vinegar (REV. G. BANCKS)	-/2	... 1d.
How to Keep Bees (ANNA B. COMSTOCK)	5/-	... 4½d.
Management of Out Apiaries	3/-	... 2d.
Prevention of Swarming (WILKES)	1/-	... 1d.
Pollination of Fruit in relation to Commercial Fruit Growing (C. H. HOOPER, F.R.H.S.)	-/6	... 1d.
PRODUCING, PREPARING, EXHIBITING AND JUDGING BEE PRODUCE (W. HERROD-HEMPSELL, F.E.S.)	2/-	... 3d.
Queen Rearing in England (F. W. L. SLADEN)	1/6	... 2d.
Scientific Queen Rearing (DOOLITTLE)	4/-	... 3½d.
Snelgrove's Method of Re-queening	-/6	... 1d.
The "Townsend" Bee Book	2/6	... 2d.
WAX CRAFT (T. W. COWAN)	2/-	... 2½d.
Wilke's Book on Swarming	1/-	... 1½d.

**MISCELLANEOUS.**

Maeterlinck's Life of the Bee	5/-	... 3d.
The Lore of the Honey Bee (TICKNER EDWARDES)	2/-	... 2½d.
THE BEE WORLD (supplied only to members of Associations interested in the control and development of the APIS CLUB, apart from ordinary members of the latter), per copy	-/8	... 1½d.
The Bee Master of Warrilow (TICKNER EDWARDES)	7/6	... 4½d.

**British Bee Journal & Record Office,**  
25, BEDFORD STREET, STRAND, LONDON, W.C.2.





## Postage on Newspapers.

It is gratifying to be able to inform our readers that the new postage rate for newspapers will not affect either the "B.B.J." or the RECORD. Neither paper is registered as a newspaper. The RECORD, being a monthly publication, cannot be registered, and the registration of the JOURNAL was dropped several years ago, as we found that under the restriction imposed it was a disadvantage. The postage rate for printed papers has not been altered, and under that rate we are still able to post our papers for  $\frac{1}{2}$ d.

We fully appreciate the kindness of several subscribers who have sent stamps for the extra postage they thought would be due, but it would have been better to wait until a notice appeared in the papers, as the cost of posting to us and the return of the stamps will be a total of 4d. on each amount.

## A Dorset Yarn.

A week of splendid weather. Bees have done wonders in East Dorset, and it is not alone at the Violet Farm. At Wimborne market a farmer brought forty-eight sections; he said all were put on the stocks on August 2. These were sold under the hammer at 2s. 4d. each. One dairy representative bought all that were there. All this was from the fringe of heather which runs from Ringswood to Wareham. This particular lot came from Bloxworth, with its seven miles of heath and its lonely road, of which Thomas Hardy, the novelist, has written so delightfully. It shows that with co-operation bee-keepers on the rich farmlands of Dorset could get another harvest did they bring their stocks to these miles of heath, where nectar in many hundredweights is wasted because there are no little harvesters to sip it from these thousands of tiny bells massed so closely together on every yard of moorland. It is only those who are living near that have any idea of the millions of bees that work the common ling heather in August and September. They are out on it every hour of favourable weather, yet there are miles where no bee is to be seen, as there are no

houses or hollow trees within the radius of bee journeys for food. A large lorry with the stocks of bees planted in this rich heather county would get many hundredweights of the finest flavoured honey.

We have had boxes of standard bars all filled since the heather began. In others six of the combs are already capped over; even the sections have had the outer ones filled with the shining liquid. All this is plainly seen with the glass covering on the top of the racks. Those that have had the sections taken away are still building comb on the tops of bars up to the glass. On looking at the bars below, the outer ones are filled with honey in cells, and between the capped brood where the brood has already perfected its form of pupation, the honey is being stored. There were many cells that had the larvæ still in the bottom, but I could not see any eggs in this particular comb. On lifting off the standard bars and looking at those below, it is the same; the brood chamber is being filled as fast as the larvæ emerge, and yet the upper standard bars are being filled and capped over.

We still get a great many visitors. I sometimes think it is to see if what I write is strictly true. I never hesitate to take off the tops and show them that they are as I have stated. After all the years of bee-keeping, there is still a lot to learn, still a lot of variations that make them interesting as the years go by. Those that are not bee-keepers, who see the wonderful work that the bees do, and lift the great weight of standard bars filled with honey, and see the sections, rack after rack, all filled, tier upon tier, go away singing the praises of the Violet Farm, and what it will produce. I have written before, "What man has done man can do." There is room for workers on the land, fortunes are still to be made if you stick to it well, harness up the bees to production, as well as the horses, give them plenty of scope to pile up the nectar that is wasting in every part of our beloved land at some seasons of the year. The harvest of the bees is the best, as there is so little labour to pay, but with all other parts of farming there is labour at high prices; but even after paying the men, there is a margin that will help to buy the land that you are renting. Field after field can be bought, but the bees do the most towards the purchase, as they go over all the fields of other farmers for the surplus that they store.

I notice one writer in the "B.B.J." states that "it is difficult to follow the yarns." The simple writer feels that he is indeed honoured that they are read.

The writer of them would give up sending when others take to sending what is more readable. He places no value on these yarns; only wants to see the craft carried on to greater perfection; he writes to encourage, and has no time to carp at others—life is too short, time is of too much value. I believe that there is a great future before us; it is only those that stick to it who reap the reward. Mine is but a small farm of fifty acres, and we employ only ten hands, but we have managed to buy field after field until it is all our own, even some of it at £70 an acre. If better men won't contribute to the Journal, then the lesser ones, like myself, must still write the simple yarns of Dorset. We state what we see, we write what we know; some of us have only the lesser talents, others have the full ten. The great God that rules the universe has given us an understanding heart, and we make as much of the talents He gives us, so our thoughts are always pleasant. I think it was Ruskin that wrote, "Make yourself nests of pleasant thoughts . . . none of us yet knows, for none of us were taught in early youth, what favourite palaces we may build of beautiful thoughts."

So we write of what we see, what we know, and what we think. It must be the last that others find it "difficult to follow." The two first are concrete facts that a long life with Nature in all its best, has given me great facilities of knowledge. Long years as a director of labour, so as to get the most out of the land, has taught me many things. One is that it is of no use to find fault unless you can show something better. Many of us feel that we could do great things, better than they are done by others. In my young life I had soon to learn that the first empire to rule was self. As Shelley puts it, "Man who man would be, must rule the empire of himself." In it he must be supreme. One soon finds that there are many things to which one cannot attain, because one has not the ten talents, only the five, so the man with the lesser talents writes the yarns of Dorset because he who has the ten talents will not write constructive readable matter.—J. J. KETTLE.

[Numbers of our readers tell us, both verbally and by letter, how much they enjoy the Dorset Yarn. We think all will enjoy and appreciate this one, which is, if not the best, one of the best Mr. Kettle has written. We commend the latter part to our readers, especially those who are inclined to be super-critical. Mr. Kettle has put the matter so clearly and eloquently that to make any comment would spoil it.—Eps.]

## Jottings from Huntingdonshire

*Populus vult decipi, et deceptiatur*, which being interpreted is, "Let the people be deceived as they wish it." No, I am not alluding to present day politics, although probably the policy of some people is a wish to be deceived even in affairs of statemanship; I am, of course, referring to those who have to do with bees. This morning I remarked to a lady interested in, though not a keeper of bees, that the summer had been a very bad one for honey harvesting. She agreed. "Yet," she said, "Miss — was telling me yesterday she had done remarkably well, and it's her first year of bee-keeping." I sought out this fortunate individual and heard from her own lips an exciting account of her industry. She worked me up by saying she bought her swarm only last May. The bees set to work at once and covered their brood frames very quickly. A fortnight after she put on a box of shallow frames and a rack of sections. She looked in last week and there were still a few bees in the sections, so she left them alone. I suggested it was time she learnt something of the state of the brood chamber. "Would you like to have a look at them?" she asked. I said I should. I was led down a long garden walk bordered with African marigolds, zinnias and godetias, with a background of phlox and shasta daisies, 'neath two or three arches of roses to a back corner of asphalt, on which stood the hive. There were more wasps round the entrance than I cared to see, while a cluster of guilty-looking bees before the opening gave me a shock. I drew in my breath. "What's the matter?" asked the lady. "I'm afraid you'll see in a minute," I replied. "Surely," she went on, "there's nothing wrong; look at the bees at the entrance." "Ah," said I, "they are there to make believe; bees are as artful as spiders. I fear those bees are there just to try and deceive any other bees chancing that way. Watch." I gave them a puff of smoke; they flew up and off, like naughty boys out of an orchard at the approach of the village constable. "I'm afraid you're robbed out," I said. "No! no!" my lady replied, "you cannot mean that. I don't think you quite understand bees; bees never rob another hive, only wasps do that." "Indeed," I responded, "that's interesting, but if you'll allow me to look in the hive I think I shall find both bees and wasps on the rob." She drew herself up and said, "I prefer to manage my own bees my own way, thank you." "Very well," I said, "but I'm quite sorry for you, really, because I know you're in for a great disappointment." At this her brother appeared and

heard the end of my sentence, and asked the meaning of it. I explained, and he expostulated. "Mabs, don't be a fool," said he, "let's have the hive open," and suiting the action to the words he began by lifting off the roof, and turning to me, said, "Several bees up here, one or two wasps, and about five million earwigs; what's wrong?" "Tell you when I've seen the brood chamber," was my reply. He stood aside and I lifted the rack of sections—quite devoid of honey. The box of shallow frames was in a similar condition, except that there were signs of honey having been stored on two combs. The brood chamber was pathetic. Combs in every frame had been drawn out, and not more than four ounces of honey left, which the wasps and robber bees were intent upon stealing. Not more than a dozen dead bees were on the floor; a mouse had been in chewing the combs, and the wax moth was busy. The colony of bees had gone! Poor woman, she must believe her eyes, and her eyes were called upon to relieve her feelings—she wept! For some little time those naughty bees, thick around the entrance, had succeeded in deceiving her.

Now let us turn to the old man's hives I was writing of last week. Hive three was, as it were, enjoying a new lease of life. The queen was laying vigorously, and soon the hive will be filled with young bees. In hive four the queen had emerged, but so far has not yet mated—the new fertile queen ordered has not yet arrived, but if she comes soon it will not be too late to introduce her. Strange is the mind of man. My old friend seems half indifferent as to the fate of hive four so long as his third hive shows renewed life.

One thing which surprises some people who pay me visits now and again is that I allow grass to grow well up before the front of the hives. They expect to see every hive placed upon grass as well cut as a bowling green. I venture to say that bees do better if their hives are somewhat overgrown. I have again and again noticed that where hives are placed on a closely cut lawn or asphalt flooring or such like, the wasps will be a pest, whereas let your hive front be protected with long grass, ay, and even weeds, robbing will not be nearly so evident. I have a skep behind a rose bush, which bush has half smothered it. The swarm I took in early July when just off to fulfil an engagement, and it has remained there ever since. Considering the season, these bees have done famously, and I've never seen a robber bee or a wasp go near. All these things are worth noting.

I've had a warm time this past week taking off supers. Anger and stings were

the order of the apiary. One lot was so furious I was obliged to close down for another day. Strangely enough, it originated from the best tempered swarm I have handled for many a day; it was one of the earliest this year, and has done better than any stock this season. Swarms are, of course, generally good tempered, but one generally notes a few bees among the cluster rather edgy. I often think of the first swarm I took. I was but a youth. My eldest brother was building up an apiary, and incidentally receiving orders for swarms by every post. He had to go away on business, and I saw him making anxious excursions to the hives; and at last the time arrived for him to start off, and an expected swarm had not come out. In his distress he asked me to take the swarm if it came out. "Just shake the bees in a skep, reverse it with one edge on a stone and leave them; they'll be all right. If the sun is very hot shade them a bit." Hitherto I had always kept a safe distance from his hives, although I was glad enough to help glaze, or eat, the filled sections. He had been gone about two hours when out came the swarm. It settled on a young apple-tree branch. Covering myself like an Egyptian woman, I put the skep on the ground, shook the bees into it, tossed it over with my foot and fled—expecting to be pursued by a thousand angry bees. But not a bee followed me, so I took courage and returned and propped the skep up. No signs of anger; and from that day I have felt affection for, rather than a dread of, *Apis mellifica*.—E. F. HEMMING, Steeple Gidding.

## Notes on Bee Keeping.

Here in South Lancs one can consider the honey harvest is now over, and which, to my mind, has proved a poor one; this has been my experience. Our bees have had to use up some of the surplus honey stored to feed the fast maturing brood. There have been plenty of nectar-producing flowers here, such as our bees like, but the weather has been adverse for them, confining them indoors. This, in my opinion, has been the cause of so much swarming this season, for bees must work; idleness forms no part of their character, whether the work is indoors or out of doors foraging. With the young bees hatching at a rapid rate they soon became overerowed; results, queen cells started, and the first suitable day swarms issue forth. Now we are about to start another year, and much depends at this time whether our bees live or die during the rigour of

winter and come out a prosperous colony next spring. We must begin (if the weather continues bad, and the bees are unable to gather from an outside source) by stimulating the queens into laying. From the beginning of August until the middle of September the queens should be kept laying; a little gentle feeding will accomplish this. If the combs in the centre of the hive are filled with honey, as in many a case, it will be necessary to extract them, or otherwise give them to stocks in need of stores, replacing same with empty combs. These will be readily claimed by the queen for depositing her eggs. The young bees hatched at this season will be of great benefit to the hive in early spring. The old bees of a colony die off the first, leaving the younger members to carry on the work. Autumn is the time to supersede old and failing queens. If a queen is old and unprolific the colony is bound to dwindle, as the number of eggs laid is not in proportion to the natural decay of its numerous members. A prolific queen in early summer will lay so many eggs that the hive will become overpopulated; this is just what the bee-keeper wants, and by enlarging the hives just at that time he has a number of willing workers to carry in the harvest from the hedgerows and meadows. If an unprolific queen is in the hive, instead of increasing in numbers as the harvest time advances the bees, by their indefatigable work in endeavouring to bring in as much as they possibly can, dwindle gradually away by the extra exertions imposed upon themselves, and get less and less in numbers. As the colony gets smaller and smaller, its members in proportion seem to relax in their efforts, and quickly lose heart, becoming an encumbrance in the apiary instead of a use. When selecting queens, it is well to have them from specially selected mothers that have shown their superiority in the apiary. Queens have become quite a regular traffic through post in these days of modern devices. I should think, owing to the cold season we have had, many queens have died *en route*. It is a good plan when sending queens through post to place a piece of cardboard over the exposed part of the wired cage, taking care to leave sufficient ventilation; it conserves the heat. Have had two queens chilled on arrival, and on both occasions the cages were too much exposed to the cold when travelling. Queen introduction is quite easy if certain precautions are taken when placing her in the hive, or, as it is termed, "introducing" her. If these precautions are not taken the bees will certainly kill any strange queen that may

enter. For many years the system adopted has been caging, especially if she is a valuable queen. This is performed by placing the queen in a cage made for the purpose, and allowing her to remain thus protected from the assaults of the inhabitants of the hive for about forty-eight hours. On the expiration of this time the bees have got acquainted with her, and when released she will be accepted by them with the usual tokens of filial respect. Some bee-keepers contend that caging is not the perfection of queen introduction, though for a novice I should say it is the safest plan. Often, while confined, the queen may poke a leg through the bars or wires of the cage; this is instantly seized by some of the crowd of angry bees, who thickly surround the cage containing her, and it may be torn off, thus damaging the queen. Therefore we must remember that with queen introduction a certain amount of loss is inevitable.—P. LYTCHGOE, Padgate, Warrington, Lancs.

## Bee-Keeping in South Monmouthshire.

*The Weather.*—Mr. G. K. Chesterton says in one of his books—I quote from a not very good memory—"Talking about the weather is our pagan way of beginning every conversation with prayer." This year the weather is about past praying for. Occasionally we have had two or three warm days; honey has come in as we have piled up the supers. Then has come weeks of rain. Nevertheless bees have somehow managed to store a moderate quantity. Nine stocks—five spring count—have given me about 230 lbs., and I expect at least another 200 lbs. This in spite of incessant swarming. This year I have applied the Demaree system after the event, and it has answered pretty well, although in some cases the bees have come out again in a day or two.

*The So-called New Disease.*—Nearly every apiary about here, including my own; has had one or more stocks affected, and I have seen a lot of it. As far as I know they have all recovered eventually, some much weakened, others not appreciably so, except one stock, which was thought by the owner to be queenless. Spraying with various substances has been tried in May. Some of us, myself included, used flavine according to Cocker. The stocks so treated have mostly recovered, but those that got over the trouble most quickly were the ones not treated in any way! The disease is said not to be infectious, and it certainly does

not appear to be. What, then, can be the use of spraying with antiseptics? Possibly the sugar which is generally added does good by its aperient action. It is quite a mistake to think that swarms only are affected, although they certainly appear more susceptible. I have seen several stocks and one or two nuclei suffering with the disease. I do not think it is a new disease at all. I believe it has hitherto been confused with "Isle of Wight" disease, and accounts for the many reports of cases of that disease in summer.

*The Honey Flows.*—To revert to this subject, the early date honey was of excellent quality and in fair quantity. The limes yielded fairly well, and there was an abundance of white clover, which the bees worked whenever they had a chance, which was not often. During the few hot days last week-end they were chiefly on bramble flowers. On one of these days I was visiting two of my stocks which are at a farm about 2½ miles away. Next to them was a 10-acre field of alsike and white clover in full bloom. The whole field was full of bees, and my heart rejoiced. While I was shaking hands with myself the farmer arrived with a mowing machine.

*Drones.*—Where did the Rev. E. F. Hemming get that amazing piece of information that if a drone enters a wrong hive he is immediately pitched out unless the hive is queenless? I thought every bee-keeper knew that strange drones are tolerated in any hive that is not turning out its drones. This can easily be verified at any time during the drone season.—G. R. STRONG, Major, Monmouthshire.

### Surrey Bee-Keepers' Association.

The above Association held their annual show at Guildford on August 25 in connection with the Surrey Agricultural Society's show. This is the first show held by the Surrey B.K.A. since 1913, and was a great success. There were over 90 exhibits, a very good number taking into account the bad season. The samples of honey were well up to the standard.

PRESENTATION TO MR. F. B. WHITE.

During the afternoon a presentation was made to Mr. F. B. White, of Redhill, late secretary and treasurer of the Association, with which he has been connected since its formation over 24 years ago. The gift took the form of a cheque for 30 guineas, and a beautifully illuminated address expressing grateful appreciation of Mr. White's active work in the interests of apiculture in the county of Surrey for over 24 years, and offering him sincere thanks for his unflinching courtesy and

valuable assistance and advice. They hoped the accompanying gift might enable him to enjoy a well-earned holiday and so regain good health. The address was signed by Sir Jeremiah Colman, Bart. (president), Mr. William Welch and Mr. Edwin B. Jay, J.P., C.A. (vice-presidents), Mr. A. S. Smith (chairman), Mr. W. E. Hamlin (secretary and treasurer), and Mr. C. T. Overton (expert).

Ald. W. T. Patrick, J.P., of Guildford, a member of the Association's committee, handed the gifts to Miss White, on behalf of her father, who was unable to attend owing to ill-health. Ald. Patrick referred to the need of increasing food production after the war, which he described as one of the first planks in the work of reconstruction. When they considered the sugar shortage and the fact that thousands of pounds were sent abroad each year for the purchase of foreign honey, it would be realised that it behoved everyone to do what they could to help produce a local supply. He referred to the good fellowship which existed between large and small bee-keepers, all being ever ready to help a brother who was in difficulties. The speaker also made allusion to the valuable help given to bee-keeping by Mr. White during his long term of office. He gave a brief review of the work of the Association. Its activities had been somewhat restricted by the war, but it was hoped it would now go on with increased vigour. It was proposed to reconstruct the Association somewhat on the lines adopted in Kent, the county being divided into districts. Secretaries for many districts were needed, and bee-keepers who were willing to undertake the work were invited to give their names to the secretary. A map showing the proposed boundaries of the districts was on view so that any bee-keeper could see in which one he resided.

Mr. Seth Smith, of Cobham, who has been associated with the Association as chairman the whole of its existence, responded on behalf of Mr. White.

There was only one cup for competition this year, but at the next show it is hoped that there will be several trophies, and that the exhibition will be on a much bigger scale. This year's cup, for the member winning the most points, went to Mr. J. Fooks, of Normandy.

Mr. C. T. Overton was the judge, and made the following awards:—

Class 1.—8 entries for 6 1-lb. sections Comb Honey (free from heather), gathered during 1920: 1 (Silver Medal and 3s. 6d.), Mrs. Fawcett, of Guildford; 2 (Bronze Medal and 3s. 6d.), J. Fooks, of Normandy; 3 (4s.), E. G. Waldoek, of Guildford.

Class 2.—5 entries for six 1-lb. sections of Comb Heather Honey, gathered during 1919 or 1920: 1 (Bronze Medal and 4s. 6d.), Miss Unwin, of Churt; 2 (Certificate of Merit and

3s. 6d.), M. J. Lamboll, of Chiddingfold; 3 (3s.), A. Seth Smith, of Cobham.

Class 3.—5 entries for one shallow frame of Comb Honey for extracting, gathered during 1920: 1 (Bronze Medal and 4s 6d.), J. Fooks; 2 (10s. order for goods given by Messrs. F. A. Brown & Co.), E. G. Waldock; 3 (rack of sections or shallow frames, given by Mr. A. H. Hamshar), A. Seth Smith.

Class 4.—14 entries for six 1-lb. jars of Medium-Coloured Extracted Honey (free from Heather), gathered during 1920: 1 (Bronze Medal and 4s 6d.), F. A. Brown, of Guildford; 2 (10s. order for goods, given by Messrs. F. A. Brown & Co.), A. Cox, of Merrow; 3 (Certificate and 2s. 6d.), H. J. Snell, of Guildford.

Class 5.—9 entries for six 1-lb. jars of Light-Coloured Extracted Honey (free from heather), gathered during 1920: 1 (Bronze Medal and 4s. 6d.), M. J. Lamboll; 2 (5s.), E. G. Waldock; 3 (Certificate and 2s. 6d.), F. A. Brown.

Class 6.—4 entries for six 1-lb. jars of Extracted Heather Honey, gathered during 1919 or 1920: 1 (Bronze Medal and 4s. 6d.), M. J. Lamboll; 2 (5s.), J. Fooks; 3 (Certificate and 2s. 6d.), G. Bullen, of Cobham.

Class 7.—4 entries for six 1-lb. jars of Extracted Honey (heather blend), gathered during 1919 or 1920: 1 (Bronze Medal and 4s. 6d.), J. Fooks; 2 (Certificate and 3s.), M. J. Lamboll; 3 (3s.), Miss Unwin.

Class 8.—8 entries for six 1-lb. jars of Granulated Honey (free from heather), gathered any year: 1 (Bronze Medal and 4s. 6d.), H. J. Snell; 2 (Certificate and 3s.), Miss Whyte Johnstone, of Reigate; 3 (3s.), Mrs. Fawcett.

Class 9.—3 entries for six 1-lb. jars of Granulated Honey (heather or heather blend), gathered any year: 1 (Bronze Medal and 4s. 6d.), A. Seth Smith; 2 (Certificate and 3s.), G. Bullen; 3 (3s.), H. J. Snell.

Class 10.—8 entries for Wax, not less than 1 lb. (may be in 1, 2, or 3 pieces): 1 (Certificate and 2s. 6d.), F. B. White, of Redhill; 2 (4s.), H. J. Snell; 3 (3s.), Miss Unwin.

Class 11.—5 entries for three 1-lb. jars of Extracted Honey (not granulated), gathered during 1919 or 1920: 1 (Certificate and 3s.), F. A. Brown; 2 (3s.), O. St. C. O'Malley, of Ockham.

Class 12.—2 entries for three 1-lb. sections of Comb Honey, gathered during 1920: 1 (Certificate and 3s.), W. E. Eustace, of Lightwater; 2 (3s.), R. H. Savory, of Chertsey.

Class 13.—2 entries for six 1-lb. sections of Comb Honey (free from heather), gathered during 1920: 1 (Bronze Medal and 4s. 6d.), J. Silver, of Croydon; 2 (Certificate and 3s.), R. H. Savory.

Class 14.—2 entries for six 1-lb. sections of Comb Honey (free from heather), gathered during 1920: 1 (Certificate and 4s. 6d.), M. J. Lamboll; 2 (4s.), Miss Unwin.

Class 15.—7 entries for six 1-lb. jars of Light-Coloured Extracted Honey (free from heather), gathered during 1920: 1 (Bronze Medal and 4s. 6d.), J. Fooks; 2 (4s.), F. A. Brown; 3 (3s.), A. Cox.

Class 16.—2 entries for one shallow frame of Comb Honey for extracting, gathered during 1920: 1 (Certificate and 4s 6d.), J. Fooks; 2 (4s.), A. Seth Smith.

Class 17.—3 entries for Wax. For the best exhibit of not less than 1 lb. of Beeswax, produced by exhibitor's own bees: 1 (Certificate and 2s. 6d.), Miss Unwin; 2 (4s.), A. H. Hamshar, of Womersley; 3 (3s.), J. Silver.

Class 18.—2 entries for the largest and best collection of Hives and Appliances, the whole to be staged by the exhibitor or his representative, price to be fixed to each article, and to

include every portion of the exhibit staged: 1 (Silver Medal and 30s.), C. T. Overton & Sons, of Crawley; 2 (Certificate and 25s.), F. A. Brown & Co., of Guildford.

The holder of the Silver Cup for the year will be Mr. J. Fooks, whose points were equivalent to 5 first prizes.

## Glasgow and District Bee-Keepers' Association.

By the courtesy of the Glasgow and West of Scotland Horticultural Society an exhibition of honey, hives and appliances was held in conjunction with the Flower Show at St. Andrew's Hall, Glasgow, on September 1 and 2.

Owing to the very poor season only a few members exhibited; consequently, some of the prizes were withheld. The following being winners:—

Three Sections Honey: Mr. Howieson, 1st.

Three Jars Honey: Mr. R. Whyte, 1st; Mr. J. C. Finlay, 2nd.

Three Jars Granulated Honey: Mr. R. Whyte, 1st; Mr. J. C. Finlay, 2nd.

Messrs. Austin McAslan staged a very complete assortment of hives and appliances.

Messrs. Steele & Brodie, Wormit, very kindly sent for exhibition hives and appliances. A hive very favourably commented being their new commercial hive, which has some novel features.

The President, Mr. Alec. Steven, exhibited a Nicholson observatory hive, which was the centre of attraction.

The Hon. Secretary, along with two or three members, was in continuous attendance to explain the various exhibits and answer questions. Several new members were enrolled.—P. BEBBINGTON, Hon. Sec.

## Mid-Cheshire Farmers' Association

The twentieth annual show of the above Association was held at Knutsford on Wednesday, September 1.

### HONEY SECTION.

Considering the wretched season experienced in the North, the exhibits—30—may be considered very satisfactory. The honey generally was of very good colour, consistency, and quality; a splendid set of sections was put up by Mr. W. Emery. The following were the awards:—

Class 69.—Twelve bottles of run or extracted honey, gathered during 1920, approximate weight 12 lbs.: 1, W. H. Barlow; 2, W. Emery; 3, W. Bradburn.

Class 70.—Observatory hive with bees and queen, each comb to be visible on both sides: 3, B. T. Abell.

Class 72.—Six sections of comb honey, gathered during 1920, approximate weight 6 lbs.: 1, W. Emery; 2, B. T. Abell.

Class 73.—Twelve bottles of run or extracted honey, light coloured, gathered during 1920, approximate weight 12 lbs. (B.B.K.A. standard of colour): 1, W. Emery; 2, Wm. Burrows; 3, F. H. Davenport; h.c., F. S. Ireland.

Class 75.—Two shallow frames of comb honey, gathered during 1920: 2, W. Emery.

Class 76.—Exhibit of not less than 1 lb. of wax, the produce of the exhibitor's apiary, extracted and cleaned by the exhibitor or his assistants; to be exhibited in pieces similar in size and shape: 1, W. Emery; 2, B. T. Abell; 3, Wm. Burrows.

Class 77.—Twelve bottles of run or extracted honey gathered during 1920, approximate weight 12 lbs.: 1, W. H. Barlow; 2, Wm. Burrows; 3, Mrs. Crossland; h.c., B. T. Abell.

Class 78.—Six bottles of run or extracted honey, gathered during 1920, approximate weight 6 lbs.: 1, Wm. Burrows.

Special.—A special prize was awarded to B. T. Abell for three sets of twelve bottles of run honey, which arrived too late to be judged.

The Rev. Canon T. J. Evans and Mr. A. J. Blakeman acted as judges.

### Cheshire Bee-Keepers' Association.

The annual show of the C.B.K.A. was held in connection with the Cheshire Agricultural Society's Exhibition at Chester on August 25. This was the first show held at Chester since the war, and considering the unusually cold and wet season experienced throughout the country, and especially in these parts, the honey shown was of very good quality. Some of it was exceptionally light in colour, and reminded us of some fine sainfoin honey we had seen at this show some years ago. As we expected, the number of entries was much below the average. Many bee-keepers—who had been keen exhibitors—had just passed through the worst season in all their long experience, and had nothing whatever to show for their labours. But bee-keepers are always full of hope, and we are already laying the foundation for another season, when we hope to have a real good time again.

Rev. Canon T. J. Evans, M.A., Knutsford, and Mr. E. P. Hinde, Liverpool, officiated as judges, and made the following awards:—

Best Complete Frame Hive.—F. Newport, Brookdale House, Tattenhall.

Beginner's Outfit.—F. Newport.

Twelve sections of comb honey.—One entry, for which a 3rd prize was awarded,

B. T. Abell, Stallington Apiary, Blythe Bridge, Staffs.

Twelve bottles honey.—1, John Birkett, Blundell's Lane, Rainhill, Lancs.; 2, B. T. Abell; 3, J. C. Dutton, Acton Nurseries, Wrexham.

Observatory hive, with bees and queen.—1, F. Newport; 2, B. T. Abell.

Six sections of comb honey.—1, J. C. Dutton; 2, B. T. Abell.

Twelve bottles light-coloured honey.—1, B. T. Abell; 2, J. C. Dutton; 3, F. Newport.

Twelve bottles medium-coloured honey.—1, B. T. Abell; 2, J. C. Dutton; 3, T. Alun Jones, Halkyn, Flintshire.

Twelve bottle dark-coloured honey.—1, B. T. Abell.

Two shallow frames of comb honey.—1, F. Newport.

Beeswax.—1, T. Alun Jones; 2, John Boden, 36 Tunnel Top, Barnton, Northwich; 3, J. C. Dutton; reserve, B. T. Abell.

Twelve bottles of honey (class 117) open to members who had not won a first or second prize at the C.B.K.A. show in 1919.—1, Mrs. Frank S. Smith, Puddington, near Birkenhead; 2, Will Davies, Pentre, Northop Hall, Flints.; 3, B. T. Abell.

Six bottles honey (open to members who had never won a prize before).—1, Mrs. Frank S. Smith.

Nearly all the exhibitors had sent in an entry for the gift class. No entrance fee was charged, and the honey entered was given to the Chester Royal Infirmary.—1, B. T. Abell; 2, Mrs. F. S. Smith; reserve, J. C. Dutton.

The lecture and demonstration in the Association's bee tent, delivered in his usual most interesting style by the Rev. Canon Evans, attracted the largest audience we have ever seen at the shows. A keen interest is being taken in the craft, and although the season has been most unfavourable to start new beginners, much good seed has been sown at this show that will bear fruit next season. The C.B.K.A.'s pamphlet "On the Keeping of Bees" and the B. of A.'s leaflets were in great demand.

The show is an ideal rendezvous to meet old friends, and also to make new acquaintances. Bee-keepers are soon brothers, even without the formality of an introduction.

Disease is much less prevalent in the county than in past years, and when we learn of the energy some of our members have put to the craft, sparing neither brains nor capital to secure the finest bees from both hemispheres, and building them into most wonderful strains, it is no

wonder that our bees are healthier, and our hopes high.

As with many other enterprises, the secretary is the "pivot" from whom most of the members' energy is radiated, and our Association is fortunate in having in Mr. Franklin, of Mouldsworth,, undoubtedly one of the finest secretaries in the kingdom, and the success of the C.B.K.A. and its shows is due to his able steering of affairs. T. ALUN JONES.

Halkyn.



### The Season in Northants.

[10283] If the same season conditions exist in other parts of the country as they are here (Mid-Northants), it would be advisable at once to advise new bee-keepers to examine their stocks for a properly fertilised queen. I find since June 27 that no queen has been fertilised out of many placed in nuclei, and that no queens get fertilised in the stocks which have swarmed since that date. These stocks are labouring along either without a queen or with one that is producing drones. No doubt the early season gave us bees. I am afraid the late season will take a great toll of many stocks. It has been a wicked bee season here, not nearly enough honey being gathered to keep the bees going, and in some cases absolute starvation.—GEORGE F. SMITH.

### Foreign Honey for Feeding Bees.

[10284] In reply to [9907], my bees have always been fed on imported honey, and have never had sugar in any form. I think it is unwise to medicate the honey when cold, as honey, being so thick, you would have difficulty in mixing it. I always boil the honey in bulk and dilute it afterwards with water (medicated) when required for use. Diluted honey goes mouldy, and would cause trouble with the bees. Shake well before using, and it will mix.

Imported honey is cheaper than sugar, and honey is their natural food. I stimulated the bees with honey early in the year, and had my first swarm on June 1. I have never seen any trouble with them. I have never had "I.O.W." or any other disease in my apiary, and I have six hives to every one I started with this year. All combs are covered with bees. I believe there is plenty of honey for winter use in every hive, but I have had little or none for myself.—JOHN HUGHES.

### Bee-Keeping Experiences.

[10285] In 1917 I started bee-keeping. I bought a swarm of bees, which arrived about the middle of June, were successfully hived, established themselves strongly, but gave me no surplus. They wintered apparently well, and were flying strong early in the spring of 1918. Then in April came a snowstorm, and after that every bee was a crawler. (At the time I sent you some of the bees, and your diagnosis was that they appeared to have "I.O.W." disease.) I could not delay treatment, so placed the lot in a large box, with glass cover, and put this in the greenhouse. They were sprayed with hydrogen peroxide, and fed on syrup medicated with Bacterol, and kept warm. In three days many were flying again, and the queen started to lay. What were left of them were then hived in a clean hive—they barely covered two frames of comb. They worked well, and came through the winter of 1918-19 successfully.

In 1919 I got a five-frame nucleus and 28 lbs. of honey from this stock, and they wintered principally on their own stores.

In 1920 I formed a nucleus on May 1; on May 15 they were hanging out again. I just caught the queen as she was off, and as I wanted to increase stock I formed another nucleus with her to head it, which I will call No. 2.

I was away all June, and though I put on supers before I went the bees preferred to swarm rather than work them.

No. 2 swarmed first on Sunday, June 27, again Thursday July 1, and again Wednesday, July 7. On July 8 I cut out fifteen queen cells. The swarms were very kindly hived for me. The first one was very strong, and is now working a rack of shallow frames.

On July 3 the hive formed as a nucleus in 1919 swarmed.

It seems to me rather wonderful that there should now be eight lots of vigorous bees where two seasons ago there was but a handful of bees threatening to die out.—M. T.

### The Use of Experts.

[10286] Every Association ought to encourage bee-keepers to get their certificate, now we have increased bee-keeping so much of late.

A man can be of the greatest use to beginners by lectures, etc., also giving and receiving visits. Examination is hard in parts, and requires study, but is well worth the trouble.

I heard one say, "Oh! I shall go to pieces in front of a board of experts." But why? they will not eat you. Get in



the habit of looking a man straightforwardly and not shyly. There is a way to get over this. I always look for the sunshine of his smile, and we are soon on terms. My first exam., with our beloved editor—(We had not the pleasure, it was Mr. W. Herrod-Hempsall.—Eds.)—we both sat on the edge of a table. Something tickled him about me, and we spent a happy time over many questions of great interest, and put me at my ease. Anything he thought I was not certain about a little help came in a charming manner. Let them see you are keen and your troubles are over.

As I was saying great help can be given owing to confidence in what you say which is badly needed amongst many. Offer your help and you become real brother bee-keepers.—CYRIL TREDGROFT.

### Difficulties of Bee-Keeping.

[10287] I wonder whether any other bee-keeper is meeting with the same difficulties as myself in this very unsatisfactory season.

My bees are all very short of stores, and the queens appear to have struck work for some time, as there is very little or no brood, although plenty of bees and nice young queens.

They must be fed and I need sugar, so acting on your valued instructions of July 29, I wrote to the secretary of the Norfolk Education Committee for the necessary registration forms, and after about ten days, having had no reply, I wrote again pointing out the urgency of the matter—but I have had no response.

Meanwhile I notice from your advertisement columns that syrup and candy can be supplied *without vouchers*. What is wrong with this sugar business, and why these apparently unnecessary restrictions?

To save my bees I am feeding back the honey I had already taken.

RICHARD H. AMES.

[Our correspondent is not the only bee-keeper in Norfolk who has had the same trouble. So far as we can find out, it is caused by the fact that almost the whole of the staff at the Education Office at Norwich are away on holiday, and for all practical purposes the office has been closed during their absence. In the meantime hundreds of colonies of bees in the county are starving as their owners are unable to get permits for the purchase of sugar. There appears to have been gross mismanagement somewhere. The syrup and candy without vouchers are, no doubt, made from "free sugar," that is sugar the Government allowed to be imported free of control, but we are not certain if it can be procured now.—Eds.]

### The Honey Season.

[10288] In the County of Stafford we have had a very poor season this year, the weather having been wet and cold all the time, except a few days at Whitsuntide (and the fruit crop is one of the worst on record). Most hives in my district have no more honey than will be required for wintering, and when taken off its equivalent must be given back in feeding.

"I.O.W." disease is still progressing, and threatens to stamp out all the old-fashioned British bees, but the county authorities are doing what they can to raise Italians for re-stocking.

I have been amused, and almost filled with envy at times when reading Mr. Kettle's "Dorset Yarn," and have occasionally wondered if it was quite true, especially when he talked of putting on supers for gooseberry honey, and for other flowers which in this district bees never look at.

Lord! What a land he must live in for honey to be flowing in such quantities.

However, let us not envy him, but wish him every success, and may next year be a better one for all of us.—THOS. HARPER, Uttoxeter, Staffs.

## Notices to Correspondents

S. M. RUSSELL (Hants).—*Bees frequenting drains, etc.*—We cannot say why bees do this. It has been suggested that the salts contained in the water is the attraction. To keep earwigs out of the hives keep them supplied with naphthaline powder some among the quilts, and if W.B.C. hives place some balls between the brood box and outer cover.

H. G. T. DYSON.—*Absence of brood.*—It is possible the queens were out of the hive on a mating flight when you examined them. If there is still no brood, it will be better to give them a fertile queen, first examining the combs carefully to find and remove any queen that may be present.

"THAMES VALLEY" (Bucks).—*Feeding with foreign honey.*—It will be safe if a good quality honey is used. It should be thinned with 3 or 4 oz. of water and boiled.

M. NELSON (Ayrshire).—*Reason for having hives in a row.*—The only reason is that when in a row they do not occupy so much ground, and they are more convenient for working. It is better to have them in different parts of the garden to minimise the risk of disease spreading, if it can be done.

F. E. ASHLEY (Middlesex).—*Various queries.*—(1) If the district is so good you should be able to make a fair increase and also obtain some surplus honey. You cannot do better than adopt the method you describe. It is the one followed in our apiary. (2) We use the Porter bee escape, and find no difficulty in getting the bees cleared out of the supers. Try a wire cloth clearer. It is not advisable to use a roof escape at this time of year; it may cause robbing. (3) We are

afraid not. (4) This will be sent by the B.B.K.A. (5) The hives should be thoroughly cleaned down at least once a year (in the spring), and the floor board should be cleaned when packing up for winter. If you have no spare hive, use a box or makeshift to hold the combs temporarily. (6) We prefer shallow frames.

"BLANDFORD" (Stratford).—(1) The escape board will answer all right. (2) Yes, if the colony is strong.

F. E. S. (Ipswich).—(a) No. (b and c). Yes.  
A. C. FRASER (Lincs.).—Bees affected with "I.O.W." disease fall to the ground and are unable to fly.  
E. SNORT (Cornwall).—We are unable to account for the bee's sudden fit of bad temper.

## Weather Report.

WESTBOURNE, August, 1920.

Rainfall, 1.14 in.	Frosty nights, 0.
Heaviest fall, .66 in. on 18th.	Mean maximum, 65.2.
Rain fell on 7 days.	Mean minimum, 49.3.
Below average, 1.61 in.	Mean temperature, 57.2.
Maximum temperature, 75 on 14th.	Below average, 3.3.
Minimum temperature, 40 on 20th.	Maximum barometer, 30.425 on 29th.
Minimum on grass, 34 on 20th and 31st.	Minimum barometer, 29.511 on 5th.

L. B. BIRKETT.

## Bee Shows to Come.

*A nominal charge of 2s. 6d. is made for notices (not exceeding 7 lines) in this column, 10 lines charged 3s. 6d., up to 15 lines 5s., which covers cost of insertion from order till date of show. Cash should accompany orders for insertion.*

**Saturday, September 11.**—Forest-Fach Horticultural Society, Swansea. Three Open Classes for Honey, extracted and sections. Help to foster bee cult this end. 1st prizes, 10s.; 2nd and 3rd in proportion.—Schedules ready from G. L. Williams, Forest-Fach, Swansea.

**September 15, at Twickenham.**—Twickenham Horticultural Society's Great Vegetable Exhibition. Honey exhibits under the control of Twickenham and Thames Valley B.K.A. Two Open Classes for Comb and Extracted Honey.—Schedules from Miss M. Byatt, "Hawthorn," Hanworth, Middlesex. Entries close **September 8.**

**September 18 to 24.**—Grocers' Exhibition, Agricultural Hall, London. Honey and Bee Appliance Competitions, open to the United Kingdom. Good prizes. Entrance fee in each class 1s.—Schedule of Competitions sent on application, referring to this journal, to H. S. Rogers, 31, Queen Victoria Street, E.C.2. Entries close **September 11.**

**September 22.**—Altrincham Show. Several Open Classes for Honey and Appliances.—Schedules from H. Turner, 1, Market Street, Altrincham.

**October 5 to 8.**—Essex Fruit and Honey Show at Institute of Agriculture, Chelmsford. Open from 12 to 2 p.m. Admission free. Lectures and demonstrations each day.—Schedules from G. R. Alder, 7, Bulwer Road, Leytonstone.

**October 19 to 22.**—Dairy Show, Agricultural Hall, London. Open Classes for Honey, etc.—Particulars, Secretary, Dairy Farmers' Association, 28, Russell Square, London, W.C.1.

**November 18.**—Annual Show of the Worcester City and County Chrysanthemum, Fruit, Root and Honey Society. Thirteen Open Classes in Honey Section.—Schedules from Geo. Richings, 42, Barbour Road, Worcester. Entries close **November 8.**

## Special Prepaid Advertisements. One Penny per Word.

*Will advertisers please read these Rules carefully in order to save trouble, as they will be strictly adhered to.*

*Trade advertisements of Bees, Honey, Queens, and Bee goods are not permissible at above rate, but will be inserted at 1½d. per word as "Business" Announcements, immediately under the Private Advertisements. Advertisements of Hive-manufacturers can only be inserted at a minimum charge of 3s. per ¼ in., or 5s. per inch.*

*PRIVATE ADVERTISEMENTS are only intended for readers having Surplus Stock to dispose of. Driven Bees, Nuclei, and Queens that are reared or imported for sale, are Trade Advertisements, and can only be accepted under trade terms. A charge of 6d. extra will be made if a box number is used.*

*Orders for three or more consecutive insertions in "The Bee Journal" entitle advertisers to one insertion in "The Bee-Keepers' Record" free of charge.*

*Advertisements must reach us NOT LATER than FIRST POST on TUESDAY MORNING for insertion in the "Journal" the same week.*

### PRIVATE ADVERTISEMENTS.

**WANTED,** new Run Honey. — WYATT, Bishopswood, Chard, Somerset. h.159

**FOR SALE,** two strong Stocks of healthy Bees with brood and stores in 10-frame hives, £5 each (deposit), free on rail.—C. LITTLE, Chester, Bicester. h.160

**FOR SALE.**—What offers? Seven Stocks of Bees in W.B.C. hives, two Stocks of Bees in skeps, May swarm. Can be seen by appointment.—N. W. GURNEY, Hollywood, Bucks Road, Beaconsfield. h.161

**THREE** Pedigree White Leghorn Cocks, 8s. 6d. each, carriage extra.—W. WOODS, Normandy, near Guildford. h.163

**FOR SALE,** three strong Stocks of Hybrids, one on 11 standard frames, two on 10 each, £5 10s. and £4 15s. each, respectively. Each stock in large double-walled hive, free from disease; hives with bees; carriage paid.—H. HAYTON, Lowca Lane, Seaton, Workington, Cumberland. h.164

**FOR** spare 1920 Italian-Dutch Queens, 6s. 6d. each.—J. STONELY, Wrexham. h.165

**SURPLUS APPLIANCES,** Books, etc., for Sale, property of gentleman giving up bee-keeping. Particulars, stamp.—HOLMAN, Dunton Green, Sevenoaks. h.166

**FOR SALE,** 1920 Queens, one Italian, one Hybrid, 5s. each.—HEWITT, Balne Avenue, Wakefield. h.167

**FOR SALE,** 14-lb. tin Taylor's Syrup, unopened, 10s. 6d.; also two Zinc Excluders, 16 x 16, slightly used, 3s.; no disease.—ABRAM, Blakenham Mill, Ipswich. h.168

**STRONG Hybrid Italian Stocks** on 8 or 10 frames, £3 and £3 10s., free on rail.—TEMPLE, Meads, Eastbourne. h.169

**SIX STOCKS** on 5 frames, Sladen's strain, 1920 Queens, 40s. each, carriage paid; boxes free.—ERNEST WALKER, Spring Grove, Cobham, Surrey. h.170

**STRONG STOCK** on 8 frames, 1920 Queens, £2 15s.; box 7s. 6d., returnable.—NORMAN, 40, Howards Lane, Putney, S.W.15. h.171

**EIGHT-FRAME STOCK** with young Queen, splendid strain, £3; two young fertile Queens, 7s. 6d. each; 6-frame Stock, young Italian Queen, 50s.—**FURBANK**, 1, Whitefriars Road, King's Lynn. h.172

**SURPLUS**.—A few 6-frame Stocks, pure Italian Penna's strain, 1920 Queens, crowded bees and brood, 60s.; box 10s. extra, returnable.—**FARROW**, Garage, Staplefield Grange, Handcross, Sussex. h.173

**FOR SALE**, about 35 Stocks and Swarms of Hybrid Ligurian Bees on 8 to 10 frames and Nuclei; mostly this year's Queens; excellent workers.—**REV. A. H. HALLEY**, Crathie, Wellington College, Berks. r.h.79

**EIGHT STOCKS** on 10 frames, headed by 1920 Italian Hybrid Queens from same mother as my 3-frame nuclei, but not purely mated; good, hardy, disease-resisting stock reared on the East Coast; £4 7s. 6d., carriage paid.—**E. H. TUNMER**, "Chalfonts," Leiston, Suffolk. r.h.81

**SURPLUS STOCKS**.—Strong, healthy Bees, immediate sale.—**JEWITT**, Hensall, Whitley Bridge, Yorks. r.h.135

**FIVE HIVES** strong, healthy Bees for Sale, each hive containing at least 30 lbs. of honey; owner leaving South; £6 hive, or offer.—**Broomlands**, Limpsfield, Surrey. r.h.142

**LARGE EGG STRAIN**.—White Wyandotte pedigree Cockerels from 15s. 6d.—**MISSES COATES**, Broadheath, Presteign. r.h.146

**GOOD** quality White Clover Honey for Sale, £8 10s cwt, free tins, on rail; samples 6d.—**BARLOW**, Stanley Terrace, Newcastle, Staffs. h.147

**SALE**, or exchange for gent's clothing or anything useful, eight Bee Hives in new condition, large quantity of Sections, Frames, Glass, Boxes, Jars, and all Appliances.—**W. BERRY**, Carr Fields Farm, Chorley. h.148

#### BUSINESS ADVERTISEMENTS. 1½d. per word.

**FEW** surplus Italian Hybrid Queens, fertiles 7s. 6d., virgins 2s., by return.—**JACK TICKELL**, Westbourne Apiary, Cheltenham. h.174

**YOU CAN'T STOP** the Masheath talking immediately on delivery!—"Masheath to hand safely August 30. Very well suited, design, workmanship, excellent. Thanks for prompt business-like way you dealt with my order. Bee-keeping friends are highly impressed. Don't doubt you will receive further orders from this locality the very near future."—**J. W. That's that**.—**ATKINSON**, Sole Maker, Fakenham. h.176

**GENUINE** pure Golden Italian Queens, imported direct from Penna. Can now supply per return. 100 due in 14 days. Prices while they last: One Queen, 9s.; two, 17s.; three, 24s.; specially selected, 10s. 6d. each.—**GOODARE**, Italian Specialist, New Cross, Wednesfield. r.h.177

**1ST AND SILVER MEDAL**, Sections, Surrey County Show. Entered hurriedly after some best of crop had previously been consumed (forgetful beggar!), won in a Masheath 16 x 10 Hive without excluders.—**ATKINSON**, Sole Maker, Fakenham. r.h.175

**FLAVINE CANDY**.—6lb. packages, 10s.; postage 1s. 3d. Made in Cambridge under our supervision from the best white sugar.—**S. H. SMITH**, 30, Maid's Causeway, Cambridge. r.h.87

**CRAWLING DISEASE**.—Reliable treatment for curing and prevention; recipe 2s. 6d.—**A. W. SALMON**, Cashfield, Chingford. r.h.162

**4-FRAME NUCLEI**, headed by 1920 Italian Queen, 50s.; box charged 10s., returnable; 6-frame Stocks, 70s.; 8-frame Stocks, 90s. Immediate delivery (weather permitting). Italian fertile Queens, 10s. 6d. English Run Honey and Sections wanted.—**LEE**, "Little Bowden Apiary," Burgess Hill, Sussex. r.g.114

**PURE ITALIAN QUEENS**, prompt delivery; select Italian, extra golden, rare honey-producing stock, August-September.—**ATKINSON**, Fakenham. r.g.24

**"WIGHT" DISEASE**, prevention and removal; advice 5s.—**ALF. RYALL**, Cottage Farm, near Camp, Stroud. r.h.124

**SELECT TESTED QUEENS**.—Three-banded leather-coloured Italians, gentle, hardy and prolific and disease resisting, one year old or less, right in their prime, 10s. 6d.; also untested 1920 Queens, same price; safe arrival guaranteed.—**THE APIARY**, Buckfast Abbey, S. Devon. r.h.125

**"ISLE OF WIGHT" DISEASE**.—Don't worry; use the solution that cures; 2s. per bottle.—**E. PRESSEY**, St. Elmo, Coulsdon. r.d.149

**HAVE YOU READ "THE BEE WORLD"?** If not, why not? Every number in itself is a useful literary work for practice and reference. Specimen copy free.—**Offices: THE APIS CLUB**, Port Hill House, Benson, Oxon.

**HONEY FOR FEEDING BEES**.—Finest West Indian, tin of about 60 lbs., 68s. 6d., carriage paid 100 miles.—**LONDON TRADING AGENCY**, 32, St. Mary Axe, E.C.3. r.h.134

**FEW** surplus 1920 Native and Hybrid Queens, 8s. 6d. each; bargain.—**PEARSON & GALE**, Marlboro'. h.140

**STRONG 3-frame Nuclei**, 25s., 7s. 6d. per frame, bees and brood, extra stocks; state requirements; healthy Driven Bees, 10s. 6d.-12s. 6d. per lot with Queen; all cases 6s., returnable; 1920 Fertile Queens, 6s. 6d.-8s. 6d.—**W. WOODS**, Firs Apiary, Normandy, near Guildford. h.152

**HEALTHY DRIVEN BEES**, with Queen, 8s. per lot, carriage paid, to clear; boxes returnable; cash with order.—**PULLEN**, Ramsbury, Hungerford. h.130

**SURPLUS HIVES** and Appliances for Sale, good condition, cheap.—**PEARSON & GALE**, Marlborough. h.131

## INSURE YOUR STOCKS AGAINST "I.O.W." AND OTHER INFECTIONS.

Science has now placed within reach of every Apiarist a safe and certain preventive of infection in "Yadil" Antiseptic.

For **SPRING FEEDING** "Yadil" may be added freely to Syrup.

For **DISINFECTING** Bees and Combs a five-per-cent. solution in tepid water should be used with a fine spray.

ASK FOR GREEN LABEL.

Our Bee Brochure sent Free on Application.

**CLEMENT & JOHNSON**, 19, Sicilian Avenue, W.C.1.

Preserve your Bees during  
the Winter by feeding with

## PINK BACTEROL BEE CANDY

Manufactured by

**HAWKES BROS., LTD.,**  
— Chelmsford, Essex —

Prices on application.

The products of the Apiary, of  
Poultry and Farm Stock, of  
the Fruit and Vegetable  
Garden can be Advertised  
and Sold through

THE  
**BAZAAR, EXCHANGE & MART**  
*Newspaper.*

Get a Copy—Thursday and Saturday 3d. The  
"Bazaar" publishes also practical handbooks by  
experts. Send for full catalogue, post free from—  
WINDSOR HOUSE, Breams Buildings, LONDON, E.C.2.

## ITALIAN QUEENS

Direct from Italy.

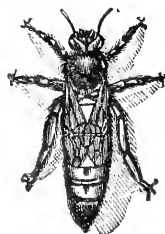

Address:  
**Signor Gaetano Piana,**  
Castel San Pietro,  
near Bologna, Italy.

All Queens are reared by the most  
up-to-date and scientific methods.  
Mr. W. Herrod-Hempsall has  
personally inspected the apiary  
and methods employed, with which  
he is perfectly satisfied.

PRICES FOR 1920.

For 1 Fertile Queen: August and September,  
9/- each queen.

Carriage paid in Great Britain. Cash must accompany  
all orders, which will be executed in rotation. Guar-  
anteed safe arrival of all Queens, but not the introduction,  
Bees dead upon arrival must be sent at once to "B.B.J."  
Office.

For the mutual convenience of all parties, if Signor  
Piana has made arrangements that all communications,  
orders and remittances of the readers of "B.B.J." and  
"B.K.R." can be addressed to him, c/o British Bee  
Journal, 23, Bedford Street, Strand, London, W.C.2.  
Cheques payable to 'British Bee Journal.'

THE  
**British Bee-Keepers' Association.**

Insure now against loss by  
damage done through bee  
stings. All particulars from.

W. HERROD-HEMPSALL, 23, Bedford  
Street, Strand, London, W.C.2.



## "BACTEROL" FOR BEES

2/9 per Bottle.

The cure for, and preventive of,  
"Isle of Wight" Disease.  
Non-poisonous—free from stain  
or unpleasant odour.

Post Free.

MENLEY & JAMES, LTD.,  
Menley House, Hatton Garden, E.C.1.

**B<sub>w</sub>B**

BEST CLEARING and  
WINTERING BOARD,  
SUPER CLEARER, &c.

A Necessity for all Bee-Keepers  
all the year round.

MEADOWS, SYSTON, LEICESTER.

8/-

Of the Author, S. SIMMINS, QUEENLAND, HEATHFIELD, SUSSEX.  
**SIMMINS "A MODERN BEE FARM"**

POST FREE Nearly 500 pages. A few more copies at 8/-. Any further edition must cost 50% more

Bees and Beekeeping Appliances. Catalogue free.  
**EDWARD J. BURTT. MANUFACTURER. GLOUCESTER.**

*I very much regret that there has been a large increase in the cost of the manufacture of bee  
appliances, and therefore my prices will be advanced 10% from May 10th. Books excepted.*

### POSITIVE FACTS.

June 13th, 1920.

I am very pleased with the foundation. The bees undoubtedly prefer it to any other make I have, and have  
even gone the length of missing two sheets of other new foundation, and working out a sheet of yours placed  
behind them at the back of the hive. Full sheets have not sagged in the least in 16 X 10 frames.

Yours faithfully, R. B. MANLEY

Illustrated Lists free by post.

**S. J. BALDWIN, The Apiary, BROMLEY, Kent.**

# The Bee World.

(Founded 1919.)

THE Select Committee appointed by the General Meeting of members of **The Apis Club**, having decided on the issue of **THE BEE WORLD** on business lines, the necessary reorganisation for this purpose had to be completed before the second volume of the magazine was started. This entailed a good deal of work which is now successfully brought to a close.

On the 15th of September four numbers of **THE BEE WORLD** will be simultaneously issued with the Business Prospectus. All lovers of the magazine at home and abroad are invited to promptly give the partisans and sycophants their only answer—the maximum possible working capital for ensuring the prosperity of a broad-minded and a popular bee review of a national and international importance.

Offices:—**The Apis Club, Benson, Oxon, England.**

[Annual Membership Fee, commencing June 1920, 10s. 6d.]

## BARGAINS IN SURPLUS CLOTHING.

Blue Serge Trousers for Working Men	12/6	Black Rubber Combination Cyclists' Suits, complete with Sou'wester, 20/-; cost Government 63/-.
Blue Serge Trousers, as new	14/-	New Heavy Workmen's Boots, 18/9 pair.
New Blue Serge Trousers, best quality	21/-	New Brown Boots, all sizes, 22/6; worth double.
New Holeproof Trousers, highly recommended	18/-	New Full-size Australian Wool Blankets, 21/- each.
New Bedford Cord Breeches, Officers' quality	42/-	New Full-size Australian Grey Blankets, 18/6 each.
New Cord Riding Breeches, strapped	22/6	New Full-size White Fleecy Blankets, 16/9 pair.
Khaki Drill Trousers, Officers' quality	10/6	Selected Army Wool Blankets, all colours and sizes, 12/- each.
Khaki Drill Jackets with pockets, Officers' quality	10/6	Heavy Woollen Check Fringed Rugs, new, 22/6 each.
Khaki Drill Trousers, ordinary	7/6	Heavy Woollen Check Motor Rugs, 30/- each.
Khaki Drill Jackets, ordinary	7/6	
New Blue Drill Overalls, complete with pockets	12/6	
New Oilskin Overcoats, extra quality	26/6	
Army Waterproof Ground Sheets, 72 x 36, brass eyelets, slightly soiled, 9/- for 2, 4 for 17/-.	17/-	

Now is the time to buy Blankets; they will be very scarce and dear later.

WRITE TO-DAY FOR LIST OF NUMEROUS OTHER BARGAINS.

**SACAR'S UNIVERSAL STORES (Dept. 29), ARDWICK, MANCHESTER.**

## STANDARDIZE

BY USING

**KENT DEWEY STANDARD FRAMES  
AND KENT STANDARD HIVES**

WHICH NEVER VARY.

SUPPLIED FROM STOCK.

LIST FREE.

LONDON OFFICE:—39, WANDLE ROAD, S.W. 17.

## FOUR FIRST PRIZES.

Our HIVES and APPLIANCES were again awarded FOUR PRIZES at the Highland Agricultural Society's Show at Aberdeen, thus testifying to the superiority of our goods. Order now and ensure your bees wintering in good hives.

**BOTTLES.** We hold a large stock and can give immediate despatch.

**CANDY.** Safeguard your bees from starvation by feeding with our FAMOUS BEE CANDY. Send sugar vouchers with order.

Sole Agents for DADANT'S WEED FOUNDATION. Absolutely pure. Once used, always used.

Large illustrated catalogue, entitled, "Everything for an Apiary," post free on application.

**R. STEELE & BRODIE,**  
*Bee Appliance Makers,*  
**WORMIT, FIFE.**



THE  
KEY TO  
YOUR SUCCESS.

### Lee's Bee Supplies.

¶ In design, material and workmanship, Lee's Bee Supplies still retain the reputation of being your best and safest investment.

¶ Our 1920 ILLUSTRATED CATALOGUE is yours for the asking. It contains detailed information on the most up-to-date hives and appliances for which the House of Lee is famous.

¶ We regret the necessity of having to advise our Customers that owing to the increased cost of production, all prices in 1920 price list are subject to 10% increase. The increase will not apply to orders received before May 10.

\*\*\* Five per cent discount to Members of THE APIS CLUB.

**JAMES LEE & SON,**  
LTD.,

Uxbridge, Middlesex.

(Telegrams: Graphicly, Uxbridge.)

Telephone: Uxbridge 181.)

LIBRARY  
 OCT 13 1920  
 college



No. 1995. Vol. XLVIII SEPTEMBER 16, 1920. [Published every Thursday, Price 2d.]

**CONTENTS.**

	PAGE		PAGE
EXAMINATION OF BEES .....	445	SOMERSET B.K.A. ....	450
A DORSET YARN .....	445	CORSHAM AND DISTRICT B.K.A. ....	451
HONEY IMPORTS .....	446	CORRESPONDENCE—	
JOTTINGS FROM HUNTINGDONSHIRE .....	446	Notes and Comments .....	451
DE VIRGINIBUS .....	447	Feeding with Imported Honey .....	452
NOTES FROM WEST HERTS .....	448	The Metal Foundation and the Metal Comb .....	453
ECHOES FROM CORNWALL .....	449	Difficulties of Bee-keeping .....	453
NOTES FROM GRETN GREEN .....	449	Copies of B.B.J. for Disposal .....	453
A FEW REMARKS FROM NOTTS .....	449	Flowers of Sulphur for Bees .....	453
SCOTTISH HEATHER HONEY HARVEST .....	450	NOTICES TO CORRESPONDENTS .....	454

# FOOD FOR BEES.

Owing to the continued bad weather there is a likelihood shortage this Winter. To prevent loss of Stocks order at once TAYLOR'S renowned

## SYRUP

In tins, 7 lb., 14 lb. and 28 lb. at  $\frac{1}{3}$  per lb., Carriage extra.

We are in a position to supply, without vouchers, the best

## CANDY

made from pure Sugar, plain or medicated,  $\frac{1}{6}$  lb. Carriage extra.

**E. H. TAYLOR, WELWYN, HERTS.**

Telephone—WELWYN 13.

THE  
**British Bee Journal**

Office: 21, Bedford Street, Strand, London, W.C.2.  
ESTABLISHED 1873.

A Weekly Journal Devoted to the  
Interests of Bee-keepers.

Edited by T. W. COWAN, F.L.S., &c.,  
and J. HERROD-HEMPSELL, F.E.S.

**Correspondence: Whom to Address.**—All matters relating to the Literary Department, Associations, Shows, etc., should be addressed, "Editors, *British Bee Journal*," and all business communications and matters relating to subscriptions and advertisements to be addressed to the "Manager," *B.B.J.* Office.

**Subscriptions.**—Annual Subscription, 10s. 10d. post free in advance; single copies 3d., or 2½d. post free. If a receipt is required by post, a stamped and addressed envelope must be sent, otherwise a printed receipt will be enclosed along with the paper.

*Note.*—Cheques and Postal Orders should always be crossed, otherwise it is very difficult to trace them if they go astray.

**How to send Money.**—Remittances can be made payable to W. Herrod-Hempshall by crossed Cheques and Postal Orders. Stamps may be sent for small amounts up to 2s. *Halfpenny stamps are preferred.*

Scottish or Irish cheques can only be taken in payment if 6d. is added for commission charged by banks for cashing them.

The Editors are not directly or indirectly interested in the manufacture or sale of beehives or appliances of any kind, and must refer correspondents wishing for prices or catalogues to advertisers in the paper.

**OUR DEPOSIT SYSTEM.**

You are advised to insist on this being used when dealing with strangers.

**Rules and Conditions for Depositing**

*In order to save trouble, it is requested that the Rules be carefully read over by persons using the Deposit System of trading.*

Goods should not be despatched until notice that the money has been deposited is received from this office.

1. **Method.**—When strangers are dealing together, the purchase-money of the articles is deposited at our office. We acknowledge receipt of the deposit to both parties, and hold the money until we are satisfied that the purchase is concluded. If a sale be effected, we remit to the seller the amount deposited, less a charge of 2½ per cent. in the £, with a minimum of 6d., and the expenses of Post Office Orders and postage, &c. Cash will be forwarded by Cheque, Post Office Order, or by Postal Order as preferred. If a sale or exchange be not completed, we return the amount deposited, after making the same deduction. By this means buyers and sellers are secured against fraud.

2. **Deposits.**—Postal Orders (drawn on General Post Office) and Cheques must be made payable to W. Herrod-Hempshall, and crossed "London County and Westminster Bank." The numbers of the Postal Orders should be kept by the sender.

We cannot be responsible for any loss that may occur in transit.

3. **Honey on Approval.**—All honey will be sold by sample, which must be sent direct to buyer.

4. **Bee Appliances.**—In ordering, the time allowed for completing the order to be stated to us when sending cash. If maker accepts, we hold cash until transaction is satisfactorily completed, when the amount will be remitted, subject to conditions as in Clause 1.

5. **Bees and Queens.**—These will be dealt with entirely by the parties concerned, so far as price, &c., go, and when the purchase is satisfactorily completed cash will be remitted as per Clause 1.

6. **Goods in Transit.**—These are at the seller's risk, i.e., any damage to or loss of an article on its journey is borne by the vendor; but a rejected article must be properly packed and returned by the same means as was used in sending it.

7. **Carriage.**—The carriage of all goods, except such as are sent by post, is payable by the buyer, unless otherwise agreed. If any article sent on approval be returned, each party to the transaction must pay carriage one way.

**Books for Bee-keepers  
NOW IN STOCK.**

Cash in full must be sent with order.

	Postage	
A Modern Bee Farm ... ..	7/6	... 8½d.
(To be obtained from this Office only.)		
Advanced Bee Culture (HUTCHINSON) ... ..	6/-	... 6½d.
Beginner's Bee Book (PELLETT)	5/-	... 4d.
BEE-KEEPING SIMPLIFIED FOR THE COTTAGER AND SMALLHOLDER (W. HERROD- HEMPSELL, F.E.S.) ... ..	1/-	... 2d.
BRITISH BEE - KEEPERS' GUIDE BOOK (T. W. COWAN)		
Paper covers ... ..	2/6	... 3d.
Cloth covers ... ..	3/6	... 4d.
Dissectible Model of Queen Bee ... ..	4/6	... 3d.
FERTILISATION OF FRUIT BLOSSOMS BY BEES (T. W. COWAN) ... ..	-/3	... 1d.
Honey and Health (A. HOPE) ...	-/6	... 1d.
Honey Vinegar (REV. G. BANCKS)	-/2	... 1d.
How to Keep Bees (ANNA B. COMSTOCK) ... ..	5/-	... 4½d.
Management of Out Apiaries	3/-	... 2d.
Prevention of Swarming (WILKES) ... ..	1/-	... 1d.
Pollination of Fruit in relation to Commercial Fruit Growing (C. H. HOOPER, F.R.H.S.)	-/6	... 1d.
PRODUCING, PREPARING, EXHIBITING AND JUDG- ING BEE PRODUCE (W. HERROD-HEMPSELL, F.E.S.) ...	2/-	... 3d.
Queen Rearing in England (F. W. L. SLADEN) ... ..	1/6	... 2d.
Scientific Queen Rearing (DOOLITTLE) ... ..	4/-	... 3½d.
Snelgrove's Method of Re- queening ... ..	-/6	... 1d.
The "Townsend" Bee Book ...	2/6	... 2d.
WAX CRAFT (T. W. COWAN) ...	2/-	... 2½d.
Wilke's Book on Swarming ...	1/-	... 1½d.

**MISCELLANEOUS.**

Maeterlinck's Life of the Bee The Lore of the Honey Bee (TICKNER EDWARDS) ... ..	5/-	... 3d.
THE BEE WORLD (supplied only to members of Associations interested in the control and development of the APIS CLUB, apart from ordinary members of the latter), per copy ... ..	-/8	... 1½d.
The Bee Master of Warrilow (TICKNER EDWARDS) ... ..	7/6	... 4½d.

**British Bee Journal & Record Office,  
21, BEDFORD STREET, STRAND LONDON, W.C.2.**





## Examination of Bees.

The Ministry of Agriculture informs us that arrangements exist for the examination at the Ministry's Bee Disease Investigation Department of live bees suspected of disease.

Bee-keepers who wish to have specimens examined should pack them in accordance with instructions given on a form, a copy of which we give below, and should answer the questions as fully as possible. These answers should be enclosed with the bees, or sent separately direct to Dr. Helen Goodrich, Department of Comparative Anatomy, University Museum, Oxford. Bees should not be sent to the Ministry of Agriculture, and it must be noted that *live* bees only are of any use for microscopical examination; dead bees are useless for this purpose, as decay sets in very rapidly after the bees have died. We again advise bees being sent to Dr. H. Goodrich in preference to our office. Our time is fully taken up with other work, and while we are always ready to give any help, or advice we can, we are unable to carry out the bacteriological examination with anything like the skill and thoroughness given at the Oxford University Museum.

### MINISTRY OF AGRICULTURE AND FISHERIES.

#### *Examination of Live Bees Suspected of Disease.*

#### *History of Stock from which suspected Bees were taken.*

1. Origin of Stock.
2. Queen. Age. Whence obtained.
3. Has the stock been artificially fed?
4. Approximate amount of honey produced. Last year. This year.
5. First signs of disease. Symptoms. Date.
6. Are there other cases of disease in the neighbourhood?
7. Have you any clue as to when the queen ceased laying?
8. Any other details.

#### INSTRUCTIONS FOR DESPATCH OF LIVE BEES SUSPECTED OF DISEASE.

1. *Boxes for specimens* should be strong (preferably of wood) and with ventilating holes.
2. Any candy given should be wrapped in muslin and firmly fixed to the inside of the box.

3. A piece of muslin nailed across the box gives the bees something to cling to during transit.

4. After the bees have been put in, the box should be closed and tied with string.

5. A label should be tied on, addressed Dr. Helen Goodrich, Department of Comparative Anatomy, University Museum, Oxford, with the *name and address of sender*, crossed through to prevent an error in the post, on the other side.

6. The details as to history should be enclosed, or despatched separately.

## A Dorset Yarn.

This has been a week of unloading surplus, and Squire Tomlinson, of Wimborne, came up to help. Those stocks that had not enough stores and were weak in numbers were given bars of stores and bars of brood to make up the strength to go over the long days of winter; some of them were immensely strong, a bar from each would not be a great loss from twelve and thirteen of them. It is of no use to leave weak ones at our farm, they are sure to be robbed out, and die fighting to defend their stores.

Have had two skeps that wintered well last winter cover two lots of ten bars each; each of them was placed over the new bars in May, and when furnished with brood below and the queen in the new bars, the skep was again placed on ten more bars. Last Friday, when taking stock, the skeps were full of stores, and the bars below full of brood; the skeps were taken away and the honey was run out on Saturday. One of them was Italians and one Blacks. Have been aiming to get an increased apiary on new bars; as some of our bars are many years old, these will all be used for extracting next season, and new ones placed beneath the old.

We had a fine lot of well-filled sections, but a great many were only partly finished; many are left on the stocks, only the best filled will be sold, the bars were of great weight. Some visitors from Basing-toke came to see the harvest of honey, veteran bee-keepers. Some bars were not all capped, proving to them that the bees were still adding surplus stores to the hives. All of them have had some left, partly-filled sections, but where we robbed them of a bar the winter cover was placed directly over the brood chamber. Some that were covered up a week since, the bees have built comb over the bars, and filled up the space to the glass in the centre of covering board. This is better than the usual strips across the

bars, and will give the bee way over the bars for stores in winter.

Our Wimborne bee-keepers always follow this plan of wintering with the covering board with bee space over the bars. Mr. Butson has a 3-in. hole cut in the top for a feeder. One lot of standard bars that were not capped we have left on for the winter above the brood nest, to see what they do next season with such a quantity of surplus.

The stocks that had wholly sections, three of which have not swarmed at all this season, have been the most profitable this year, as the dairies gave me 2s. 6d. each for them, and we have sold many of the best at 3s. each.

It was interesting to see where many of the drones were at this season; they were all round the sides of the outer case. We have a free way round the brood chamber; the workers would not have them in the brood nest to eat the honey—they had gone round the outside, and when the lifts were off they flew away out in the sunshine, I expect for the last time, and as the workers would not let them feed they must soon die. It shows that the workers do not kill them from choice, but keep them away from stores till they die. Yet at another hive one will see the workers hauling them away from the entrance with great pertinacity, as some of the males are very strong.

We have plenty of food for our bees close by the stocks. Raspberries are in flower in many thousands, and they will be able to fill up the empty cells in quick time. A visitor from Ireland was surprised to see these all in blossom just now. The success with bees is where there is food in plenty for them at all times. In May ours did well, and I was able to take out sections from many of the hives and give them new ones before the whole rack was complete. In June and July the rain spoilt the collecting, but this month of fine weather has been a good time for our lot.

"Everything comes to him who waits," so the harvest came late in the season for us, but it was a good one when it came. Another distinguished visitor the last week was Mr. W. Herrod Hemsall, the secretary of the B.B.K.A.; it was kind of him to come to the farm on his tour through the South.—J. J. KETTLE.

### Honey Imports.

The registered value of honey imported into the United Kingdom during the month of August, 1920, was £27,905.—From a return furnished by the Statistical Office of H.M. Customs.

### Jottings from Huntingdonshire

Mr. Kettle generally manages to give us of his best when "the silly season" is here. I am not so fortunate. In fact, the season has so affected me that I have been scribbling some doggerel verse. Perhaps it will draw a smile. I am in that condition of having heaps to say, but am unable to say it—none has an addled-brain feeling at times. Phew! how hot it is. Dog days; surely July is upon us? No, I am wrong. As I look out and see the stubbled fields, the browning pasture, the hips and haws dead ripe, and the trees clothing themselves with the softest tints of yellow and gold, I know autumn is near. The bees are almost chirping with delight. Unless troubled with robbers, they are sparing every available worker to go and gather nectar. One quite small lot which I had got in a box ready for uniting up gathered 11½ ozs. in one day. A field of mustard flower is offering the bees a liberal gathering ground. Howbeit, I shall feed up, for the bees, knowing more about it than I do, keep telling me that we have a longish winter to face, so I mustn't fail them. Dr. Strong, I see, is bringing me to task about drones which enter wrong hives being pitched out unless the hive is queenless. What have I said that ought not to be said? Surely Dr. Strong is aware that the only hives which welcome strange drones or keep their own after "turning out time" are hives devoid of a queen, or those decimated by disease. In an apiary where every colony is healthy and queened, drone expelling is done by a system—one hive starts, the rest follow suit, and drones are littered about everywhere. At the time of the year when drones are being bred it is true a strange drone might be admitted to another hive, but not without an escort. Drones pal up—in other words, drones from one hive pal up with those of another, and accept invitations to dine, and thus enter strange hives, but not otherwise; but I am letting the cat out of the bag. I said some time back I had something to say about drones later on. I must keep it all for one article; and now for the doggerel:—

Most people keeping honey bees,  
Know well the nature of the breed,  
That when they're handled by their  
boss,

And feel a great delight to tease—  
Their owner caring not a toss,  
Can smile upon their venomous sting,  
As if there scarce were such a thing.  
The insects, not to be outdone,  
Look round about for painful fame.  
Alas! some lady, standing near,  
Begins to shout: "Bee in my hair"! 1

Ah, a bee in the bonnet's a bad enough thing,  
But nought to a bee in the hair.

The other day a message came:  
Do come and help us clear away  
A swarm of bees, which 'neath the slates

Of a cottage porch have come to stay.  
With prodger, smoker, cloth and veil,  
I climbed upon the sun-baked roof,  
And started prizing up a nail,  
And wished my hands were hard as hoof.

The bees came out in buzzing crowd—  
And saw me there on robbing bent.  
Said naughty things, showed me their stings.

"Clear off," I said; and off they went.  
Just where they went I could not tell,  
Until an awful, fearful yell  
Of "Murder! quick! come here! come here!!

There's a bee in my hair! there's a bee in my hair!!!"

Revealed that they had gone to see  
A lady farther down. I swear  
That a bee in a bonnet, though a sad, sad thing,  
Is nought to a bee in the hair.

"When ere I take my walks abroad"  
(That's one of Dr. Watt's remarks),  
I find among the honey flies

Some very naughty, gay young sparks.  
A lady resting 'neath some trees,  
Engrossed in Methuen's latest book,  
While o'er a wall a man of bees,

Within his hive just went to look.  
A sting or two upon his hands  
Produced no tremble, quake or fear,  
So out for fun right o'er the wall  
Flew bees to try to draw a tear,  
That they succeeded all too well,  
Is what I'm going to relate.

For after many shrieks and screams  
That lady entered "weeping state."  
Between her sobs we just could hear  
That a bee had got into her hair.  
A bee in a bonnet's a troublesome thing,  
But nought to a bee in the hair.

A tennis party once was on,  
And balls were flying everywhere.  
Then one got lost, and all began  
Trying to find its hiding lair.  
"It is a thing, well known to most,  
That when so e'er a thing is lost,  
We seek it ere it come to light  
In every cranny but the right."  
So many people looking round  
Roused the curious mind of a honey bee:

And ere the missing ball was found,  
That worker—well, of course, for spree,  
Just settled, truly, I declare,

Within a lady's auburn hair.  
A shout, a cry, a piercing yell,  
The rest—I'd rather not just now tell.  
For a bee in the bonnet's a fearsome thing,  
But nought to a bee in the hair.

E. F. HEMMING.

Steeple Gidding.

## De Virginibus.

Re-queening with virgins is an excellent way of heading a number of colonies with high-class stock at a very low cost. The drawback is the uncertainty which is usually felt as to the ultimate result of the operation. And yet when the rules of the game are properly understood, it is just about as easy to get virgins accepted as fertile queens.

Some people find it extraordinarily difficult to introduce virgins to established stocks or nuclei. Sladen, whose book on queen-rearing is the British classic on the subject, says that it is not advisable to make the attempt, as too many virgins get killed.

Formerly I followed Sladen's practice of always giving a queen-cell after taking away a fertile queen. Of late, however, I have used the virgins almost exclusively, and find fewer failures than with the queen-cells.

Re-queening with virgins has one great recommendation; you see beforehand what kind of queen you are giving to your stock. When a queen-cell is inserted, any kind of queen may come forth: perhaps a first-grade one, perhaps only a third or fourth grade. Whatever it is, you are in a manner committed to that queen. But by allowing the virgins to hatch in a nursery, the very best only need be used, for the quality of the queens can be seen from the first.

It must be remembered that all virgins from the same mother are not of the same class by any means. And this is through no fault of the stock queen. Mr. Bowen, in "Cotswold Notes," complains that the bad weather of July changed the colour of his queens, rendering them darker than those reared when the weather was fine. I did not find it affect mine in that way; on the contrary I have this summer bred some of the brightest Ligurian queens that I have seen. One example in particular is devoid of marking of any kind, and is almost the counterpart of an American Golden, excepting that the colour is clear lemon yellow instead of orange red.

The amount of nourishment provided, and more particularly the amount of heat during incubation, has, I find, an important influence on the colour of queens. In a row of, say, fifteen queen-cells, the two

at each end are nearly sure to be the darkest in colour, the two next them not quite so dark, while those in the centre of the row, and consequently in the warmest part of the hive, are of the brightest yellow. I have therefore discontinued giving long rows of queen-cells, preferring three rows of ten to two rows of fifteen. (Which seems to confirm Mr. Bowen's conclusion, that in warm weather the queens will be lighter in colour.—Eus.)

If everything is all right it is the easiest thing in the world to get virgins accepted by established stocks. If the stock, the virgin, and the weather are all exactly suitable it is possible to pick the fertile queen off a comb, then go to the nursery and lift a virgin and drop her on the comb where the fertile queen was, close the hive, and at the end of about three weeks find her a laying queen. I have not a few fine queens which were introduced in that way.

But it is not often that all the conditions are exactly favourable, and some kind of caging is generally necessary.

The best cage is the old pipe-cover. Put the virgin under this on plenty of honey and pollen, and leave her for three days. At the end of this time open the hive quietly, using no smoke, and see whether the bees are going to receive her. If the omens are favourable, let her run down, and close the hive gently. If unfavourable, leave her caged and try next day. In very bad cases it may be necessary to wait till the fifth day before she will be gladly accepted.

On the day after the queen has been released, open the hive again as gently as possible. Do this about the middle of the day when all the field bees are absent, and only a few youngsters are at home. As soon as the queen is glimpsed replace everything gently, and *leave that hive severely alone for at least a fortnight.*

That is where most apiarists go wrong; they will hunt up the virgin to see if she is all right, and by their anxiety produce the very calamity they are so anxious to avoid. But if she has been seen the day after her introduction she will be all right; if the bees had been going to kill her, they would have done so on the first day. She has been accepted, and barring the ordinary accidents attending honey-moons, will be all right if left alone.

It is different with a fertile queen. In a day or two after her introduction it is generally quite safe to hunt her up, to admire her, and note how her eggs and brood are developing. But with a virgin, any interference from the day when she is ready for her first mating trip to the day when she lays her first eggs, is usually fatal.

I admit it is very hard at times to keep from interfering. Particularly so to the queen-rearer, who has had all his nuclei and mating boxes filled with virgins, and sits looking out at the rain and the cold, gloomy skies, which have kept them indoors perhaps for weeks; and who knows that the next post will bring him angry letters demanding to know why the queen that the writer ordered by return of post did not arrive at the appointed hour.

I say it is very hard to refrain from having just one look. Perhaps that virgin there, which has been out to mate for three weeks, may now be fertilised, and the means provided of stilling at least one insistent voice. There is a stealthy glance, a sharp hiss, a more or less successful attempt at rescue, but the result is always the same—a dead virgin outside next morning.

That in my experience is the heart of the problem of successful re-queening with virgins. It is easy to get them introduced, it is easy to get them accepted. It is *not* easy to let them alone.—HUGH HOUSTON, Sidcup.

---



---

### Notes from West Herts.

I have never known such a bad honey season in this district as it has been this year. I have not taken more than three pounds of honey from all my eleven hives, and, at the present time, most of the stocks are devoid of stores. All the supers have been taken off, and I am feeding as fast as the bees will take the syrup down. Most of the bee-keepers in this neighbourhood are in the same plight, and only the fortunate have secured any surplus. A friend of mine has even lost two stocks—a late swarm and a Government nucleus—from starvation. In Scotland I think the conditions are just as bad, and of the bee-keepers I visited while on a holiday there, all had the same tale to tell, "no surplus honey," the summer had been too wet and cold. Nearly every house or cottage near Aberdeen had some hives standing in the garden, and, as I passed in the train up the valleys of the Dee and Don, through this beautiful land of heather, it was the exception to see a garden without its neat row of modern hives. All the bees I saw were blacks, and I did not notice a single yellow bee.

I chanced to be wandering through Barnet Fair on the Saturday, and, whilst passing a sweetstuff stall, I noticed a number of bees sucking the sweet juice from the ends of some sticks of peppermint. Even at 8 p.m., as it was growing dusk, there were still some bees and wasps buzzing round the sweets. It is curious how late bees will work when there is

plenty of honey, or other substance, for them to gather. At present the evenings are so cool and draw in so quickly that there are very few bees flying from my hives after 7 p.m., except on very warm and sunny days.

To-day (Sunday), on the alighting board of one of the hives, I spied a wasp attempting to carry off the dead body of a bee, but, the weight was too much, and it could not rise from the ground. It then proceeded to cut through the joint, connecting the body to the head, with its strong jaws, and I could hear the latter snapping as it worked away. After a short time it had severed the body in two, and carrying a portion a short distance it hung upside down by one of its hind legs from a leaf of a plant while it readjusted its load with its other legs. At that moment I happened to be too eager endeavouring to watch its movements, and disturbed the plant from which it was suspended, and it flew up into the air and passed out of sight.—W. H. NEEDHAM.

### Echoes from Cornwall.

August is rapidly nearing its end, and yet in these parts practically no surplus has been secured. Our stocks will have just about enough to carry them safely through the coming winter without much feeding. Swarms have been numerous, and many are still coming off, far too late to be of any service as separate stocks, and returning them to the parent hive is the most profitable. I have just returned from a visit to a farmer friend of mine whose stocks I looked over this morning. The brood chambers were well stocked with honey, and the greatest number of bees I have seen, stock after stock crowded from back to front, a seething mass, and oh! such fiery tempered little vixens as I have ever met. They simply delighted in plastering my hands with stings. My poor hands are about three times their normal size. Fortunately, my veil stood me in good stead, or else, well, I shouldn't be writing this. If I had bees of that temperament I should soon be trying experiments I reckon: they were simply awful, and as my friend hadn't been too careful about the spacing of the frames in the brood chamber and hadn't looked at them for the season, the result was combs braced, etc., and my parting them to get things a bit more ship-shape did not improve the bees' tempers, and they were nothing loth to let me know it.

"I.O.W." disease appears to have about run its course this way. Has any brother bee-keeper given Flavine an extended trial on diseased stocks? and, if

so, with what result? It certainly arrests the disease temporarily.

Since writing the above, the weather has settled in very dull, and as cold as one might expect in December, and the bees are keeping indoors.

I notice quite a number of apple trees blooming again, also arabis in flower; everything seems topsy-turvy this year.—A. D. BENNETT, Redruth, August 23.

### Notes from Gretna Green.

That one week of sunshine in late August filled the hives with heather honey and averted the menace of a big sugar bill. The season was rather far advanced to expect much in the way of surplus, but had the honey flow lasted a few days more some fair returns would have been secured.

In the case of united forces on eight combs of brood, two racks were filled in a week, but a sudden change in the weather left most of the sections in a partly sealed condition, and in one hive, where the two racks weighed over 50 lbs. gross, only 15 sections were fully sealed. The season has been a very unsatisfactory one, and the total surplus of six spring stocks rather less than I have often had from one. However, matters might have been worse, and as I have increased the six to twelve strong colonies, 100 per cent. capital appreciation is some consolation for the small dividend earned by my bee stocks in 1920. J. M. ELLIS.

### A Few Remarks from Notts.

The flow is over in this part of the country. I say "flow," but as a matter of fact, there has not been one here this season. Strong stocks did well in May, but since then there has been nothing doing owing to the bad weather, which has been one long spell of cold and wet. Stocks that had nothing in the supers have had to be fed for some time now. It has been the worst season I have known in all my experience, and many bee-keepers will have a loss on the year's working.

I can't help envying friend Kettle of the weather conditions he has been enjoying in Dorset. If he had had the same sample that we have here, the bees would not have stored anything in shallow combs, let alone sections, for the simple reason that they have not been able to get anything to put in them. However, "Hope springs eternal in the human breast," and we are hoping for better things next year.

A sharp look-out should be kept for

robbing now that bees are flying freely and nectar is scarce. A gentleman asked me to go and look at his bees last week as they were robbing. One stock had been cleared right out of stores, and the population reduced to less than half, through fighting.

This vice is not easy to stop once it gets real hold, and the best policy is to "nip it in the bud" by reducing entrances according to the strength of the stock inside. Above all, don't leave even the scent of any syrup or honey about in the daytime, and do all the feeding at dusk. Hives should not be opened in the middle of the day if it can be avoided.

I have noticed one or two little "scraps" in my apiary, but nothing of a serious nature has occurred. I paid dearly for my experience some years ago, and am now always on the alert when the "flow" is declining.—H. MORTON LOWE, Chilwell, Notts.

## Scottish Heather Honey Harvest.

The honey harvest this year has been a most uncertain one. In some districts there has been a fair crop, but in most parts of the country the sunless, wet summer meant the starvation of bees and the loss of many stocks. There has seldom been such a good show of bloom, continuing so long; but the cold nights prevented the distillation of nectar. Most of the shows, therefore, have had comparatively few entries, and the honey has not been so fine as usual. On the mountains and moors heather is most luxuriant in many places, but the stocks of bees are not in good trim for storing the honey, although, perhaps, where the bees are strong, should the nights be warm and the weather favourable, sufficient nectar may be stored to keep the bees through the winter.

In consequence of these facts, there will be comparatively little heather honey on the market. The reports received from all quarters by the Scottish Bee-keepers' Association show that the price of first-grade heather honey in comb or in jars will be 42s. per dozen wholesale, or 4s. 6d. per pound retail. These are the prices which can be obtained at the honey depôts in Edinburgh, Dundee, and Perth; but, naturally, in some districts where the demand is greater, higher prices will be expected and may be obtained. By the end of September a further and fuller report may be issued. Meantime, we fear that 1920 must be set down as a poor honey year, as regards both the clover and the heather harvest.—*Communicated.*

## Somerset Bee-Keepers' Association

The annual show of the above Association was held at Taunton in connection with the Taunton Deane Flower Show, on August 12.

Owing to the unfavourable season the number of exhibits was much smaller than usual, but the quality of the honey shown was in most cases excellent.

During the afternoon demonstrations in the bee tent were given by Mr. L. Bigg-Wither, lecturer to the Somerset County Council.

Mr. T. W. Cowan, F.L.S., F.G.S., and Mr. L. Bigg-Wither acted as judges, and made the following awards:—

### Open Classes.

Twelve 1 lb. Bottles Extracted Honey.—1, W. Peirce, North Petherton, Somerset; 2, G. Greedy, West Monkton, Taunton.

Twelve 1 lb. Sections.—No entries.

Single 1 lb. Bottles Extracted Honey.—1, G. Greedy; 2, J. H. Oldfield, Laughton, Rotherham; 3, W. A. Withycombe, The Docks, Bridgwater; 4, W. Peirce; h.c., E. W. Sherwood, Nether Wallop.

Single 1 lb. Section.—1, G. Greedy; 2, W. Peirce; 3, Miss M. B. Debenham, Buckland St. Mary, Chard.

Exhibit of an Educational or Scientific Nature.—1, the Rev. G. H. Hewison, Marr Vicarage, Doncaster.

*Classes Open to Members of the Association and Residents in Somerset.*

Collection of Six 1 lb. Sections and Six 1 lb. Bottles.—2, G. Greedy.

Beeswax (not less than  $\frac{1}{2}$  lb.).—1, G. Greedy; 2, W. Peirce; 3, W. A. Withycombe.

Observatory Hive, with Bees.—1, W. A. Withycombe.

Two Shallow Frames of Comb Honey.—1, F. W. Penny, Taunton; 2, G. Greedy; 3, W. Peirce.

Honey Products.—1, W. Peirce; 2, W. A. Withycombe.

Three Bottles of Granulated Honey.—1, W. A. Withycombe.

Six 1 lb. Sections.—1, H. Hickley, Taunton; 2, G. Greedy; 3, Miss M. B. Debenham.

Six 1 lb. Bottles Extracted Honey (light or medium).—1, W. A. Withycombe; 2, W. Peirce; 3, Mrs. W. J. Villar, Taunton.

Six 1 lb. Bottles of Dark Honey.—1, W. A. Withycombe.

### Novice Classes.

Three 1 lb. Sections.—2, Miss M. B. Debenham.

Three 1 lb. Bottles.—No entries.

The challenge honey pot, presented by the chairman of the S.B.K.A., Lieut.-Col. H. F. Jolly, for the highest aggre-

gate of points in the show was won by G. Greedy.

The special prizes offered by T. S. Penny, Esq., J.P., open to members of the Taunton Division only, were won by G. Greedy, 1; Miss M. Debenham, 2; H. Hickley, 3.—(*Communicated.*)

### Show at Cannock.

The Cannock and District Horticultural and Agricultural Society held their 22nd annual show on August 14 and 16.

The honey classes were well filled with some 80 entries.

The judges, Messrs. H. C. Barlow, Newcastle, Staffs., and J. Kendrick, Stone, reported the general quality of honey as excellent, and several of the exhibits were the finest they had seen for some years. The following were their awards:—

#### Open Classes.

6 lb. jars Light Honey.—1, M. Partridge, Cannock; 2, E. Jacques, Lichfield; 3, B. Warren, Shifnal, Salop.

6 lb. Sections.—1, G. Evans, Newport; 2, G. Gripton, Bromstead; 3, A. E. Warren, Bucks.

6 lb. jars, Medium.—1, W. P. Vassie, Althorne, Essex; 2, A. Berrisford, Cannock; 3, G. Mytton, Lichfield.

6 lb. jars, Dark.—1, A. E. Warren; 2, E. Jacques; 3, J. H. Oldfield, Rotherham.

6 lb. jars, Granulated.—1, M. Partridge; 2, A. E. Warren; 3, H. J. Bryan, Cannock.

$\frac{1}{2}$  lb. Beeswax.—1, G. Evans; 2, E. Jacques; 3, A. Berrisford.

Frame of Honey.—1, A. Pegg, Cannock; 2, G. Mytton; 3, A. Berrisford.

Honey Cake.—1, Mrs. J. Halls, Cannock; 2, A. E. Warren.

#### Local Classes.

6 lb. jars Light Honey.—1, M. Partridge; 2, A. Berrisford; 3, A. Pegg.

6 lb. jars, Medium.—1, H. J. Bryan; 2, M. Partridge.

3 lb. jars, Granulated.—1, M. Partridge; 2, A. Berrisford.

6 lb. jars of Honey (Special Prize).—1, A. Pegg; 2, A. Berrisford.

M. Partridge secured the Staffs. Bee-Keepers' Association Silver Medal, and A. Berrisford the Bronze.—(*Contributed.*)

### Corsham and District Bee-Keepers' Association.

On August 28 the members were very kindly invited to tea at Biddestone by the president, Admiral Sir C. Briggs, to which about seven members responded. The president then conducted those present round his apiary, and a very interesting time was spent there.

A meeting was afterwards held, when it was decided to apply for a more suitable site for the Association apiary.

The members expressed their pleasure by passing a cordial vote of thanks to Sir Charles and Lady Briggs for their kindness.

The next meeting was fixed for September 25.—*Communicated.*



*The Editors do not hold themselves responsible for the opinions expressed by correspondents. No notice will be taken of anonymous communications, and correspondents are requested to write on one side of the paper only and give their real name and addresses, not necessarily for publication, but as a guarantee of good faith. Illustrations should be drawn on separate pieces of paper. We do not undertake to return rejected communications.*

### Notes and Comments.

[10289] Before the thunders which you predict (10274) descend, may I suggest that apologists, or protagonists, if you like it better, of the B.B.K.A. should produce a few facts. No doubt it is comforting both to you and others to abuse me, and I really don't mind in the least, but it seems rather waste of energy and paper space, doesn't it? The trouble is that I do not know of anything worth while that this Association has done. Does any one else?

One of the difficulties in this matter is that directly one challenges the system, every one who favours it at once makes it a personal matter. "What good men the Council are," etc., etc. From this eternal evasion of the point a mere outsider is apt to get the idea that these men have the whole thing in their pocket, and mean to keep it there. I don't say they have; I merely say that this is the firm opinion of many, and I ask for refutation.

The Association is not popular, as witness its wretched membership. The greater its popularity the greater its membership, and the greater its membership the greater its wealth and power.

If you want to see how popular it is, make the subscription £1 instead of 5s.

However, as I say, just trot out a few facts about it. It's quite time. We don't want pious opinions or generalities, but facts.

Mr. Judge (19263). I know nothing of the "hard, uphill struggle of the B.B.K.A." I should judge they are pretty close to the bottom of the hill now. This letter is "just what we do not

want." He says: "Where would bee-keeping be to-day, etc." Well, why does he not say where — if he knows?

The last sentence in his first paragraph is, I suppose, a cut at the Apis Club; but if Mr. Judge is not man enough to say what he means, I can't answer him.

Next paragraph. *Re* a large late stimulated young population saving food. I know nothing of the sort, and neither does Mr. Judge or any one else.

I fail to see any difference whatever between loss of a stock by robbing and by "I.O.W." disease, except that robbing usually upsets the whole apiary.

The statement made at the beginning of paragraph 3 is entirely wrong, and quite contrary to fact. Even if the British standard frame was produced under the circumstances described it is of no moment, because the bees are quite different now.

The British Standard frame is exactly the opposite in every way from Mr. Judge's description. I cannot find a better description than that.—Yours faithfully, R. B. MANLEY.

[Mr. Manley's ideas must be strangely warped. So far as we are concerned, we certainly have not abused him, nor did we suggest for a moment that anyone else had, or that "thunders would descend upon him." We merely refrained from any comment on his letter as we were certain our readers would make their own and come to their own conclusions as to the value of his opinions, and whatever Mr. Manley may do, it is surely possible to make comments without indulging in abuse. It is not the least use giving any "facts," whatever he may mean by that. We have mentioned just one—the insurance scheme—and all the effect it had on Mr. Manley—was to provoke the retort that the B.B.K.A. and ourselves were patting each other on the back. Mr. Manley and other critics of the B.B.K.A. forget one thing—that its work has been, and is now, educational. We do not say that bee-keeping in this country cannot be further improved, but to whatever position it has attained, and it is no mean one, is due mainly, if not wholly, to the work of the B.B.K.A., and we do not take the narrow-minded view that the B.B.K.A. consists of a dozen members of the Council, but it means the whole of the affiliated associations. Educational work does not lend itself to a display of fireworks, but this work is being carried on quietly and effectively by the parent society and the affiliated associations. We are quite aware that Mr. Manley will dub this as futile. The trouble with him is he has already made up his mind, and it is closed to anything anyone may say. He can only argue—to

reason is beyond him. It is only necessary to read the above letter to verify that statement.

The membership of the Association is still growing, both in direct membership and affiliated members. Has Mr. Manley the remotest idea how large the total is? His suggestion to test its popularity by making the subscription £1 is puerile. No doubt, if that was done, he would be one of the first to say the Association wished to exclude the ordinary working-man bee-keeper.

We have neither time nor space to traverse all the letter, but we ask our readers to study it carefully, and not only this, but all that Mr. Manley has written regarding the B.B.K.A., and see if they can find one single helpful suggestion; so far as we can see, there is nothing but carping criticism.

*Re* Mr. Judge's last sentence in first paragraph of his letter (10278), page 429, we did not and do not for a moment take it as having any reference whatever to the Apis Club. We have no knowledge that the club has "fizzled out." It is still going on, and we hope it will continue to prosper. We believe the remark is meant in general, and does not refer to any particular organisation. We are extremely sorry if it has given anyone the impression of a veiled attack on the Apis Club, or if it has done it the slightest harm. Needless to say, had we the least idea it would have been taken that way, the blue pencil would have been used, especially as Mr. Judge asked us to delete anything objectionable.

Third par from the bottom. Can Mr. Manley see any difference between an epidemic of small-pox and a famine, except that the latter is apt to lead to food riots?

For the rest, we hope that until Mr. Manley has some practical suggestions to make, and will indicate how the means for carrying them out are to be obtained, he will not occupy time and space in quite futile criticism of the B.B.K.A. or its work. It is doing no good, even to himself.—EDS.]

### Feeding with Imported Honey.

[10290] *Re* Query 9907, you might be interested to know that last year I wintered four nuclei, of four frames each, fed with imported honey, and the trial was an unqualified success, and as 1920 has been such a bad season I propose feeding all my stocks on similar food early this autumn. The honey was boiled, mixed with water, and medicated, as you advise in B.B.J. of August 19. The cost of the honey being so much less than sugar, and the results so satisfactory, I have no hesitation in recommending it.—C. A. EKINS.



### The Metal Foundation and the Metal Comb.

[10291] I read with much surprise Mr. Manley's comments on the metal foundation and the metal comb, which he dismisses with a wave of the hand.

Regarding the former, a detailed addition to my last communication is needless. In fact, it was in a sense hardly necessary, seeing that its contents were well known to many of your interested readers. The growing interest of practical business bee-keepers in the matter, although they are perfectly aware of what we have done, despite our small means, and of what we are still unable to do, sufficiently shows that we are not generally thought to be embarking on a mad adventure.

I did not have the pleasure this season of showing Mr. Manley more than two ordinary specimens—one of which did not substantiate his statement, and the other partly did—for reasons already discussed in the last volume of the *Journal* and also in the *Bee World*. No data were asked for; and as I did not think he was sufficiently interested in the tests, no serious discussion, therefore, was made.

After spending over two years in close study of the artificial comb, and especially of the metal comb, I cannot help saying that were the latter a complete failure in the brood chamber (which is far from being the case, especially under English conditions), it would still be worth a mine of gold, in view of its established utility for surplus honey.—A. Z. ΑΒΥΣΠΑΔΥ.

### Difficulties of Bee-Keeping.

[10292] I sympathise very deeply with your correspondent, Mr. Richard H. Amies (No. 10287, *Journal* dated September 9).

Bee-keepers in Preston are experiencing trouble, but of a different nature to that he complains of.

The season has been most unsatisfactory, and a very small quantity of honey has been taken from my six stocks. At the beginning of August, all supers (mostly empty) were removed from the hives, but during the month practically no honey has been stored in the brood chambers, and I found it necessary to feed with sugar. Application was made to the Education Department at Preston, and a form was provided by them. After declaring the number of my stocks and returning this form to them a permit was posted on to me authorising the Food Controller in Preston to allocate to me 84 lbs. of sugar. After requesting me to furnish the name of my sugar supplier, they sent to me a blue form, which stated that I was to

present the vouchers attached to my sugar supplier. The vouchers were presented to the sugar supplier, and I was informed that the price would be 1s. 5d. per lb.

Now this is the unsatisfactory part of the business. Free sugar is 1s. 5d. per pound. Any Tom, Dick and Harry can buy free sugar at 1s. 5d. per lb., no vouchers necessary. A neighbour told me on Friday, September 11, that his wife had bought free sugar at 1s. 3d. The price has come down.

Now, Mr. Editor, what was the use of these Government Forms? I have gained nothing by spending about 1s. in postage stamps, and lots of trouble and waiting; on the other hand, I have lost 84 twopences, equals 14s., owing to purchasing before the price came down.

Who, and where is the friend of the lonely bee-keeper?—JOSEPH WHITEHEAD.

[The "free" sugar is only *brown*, and not suitable for bee food. We have seen some as low as 10d. per lb. All white sugar—and white sugar only should be used for feeding bees—is still under Government control, and for the benefit of numerous inquirers as to price, can only be supplied at the price charged to manufacturers of confectionery, etc., 1s. 5½d. per lb. This may vary to the extent of ¼d. either way in different localities. White sugar for domestic purposes is rationed and subsidised; the price is 1s. 2d.—Eds.]

### Copies of B.B.J. for Disposal.

[10293] I have had many applications for the unbound volumes of THE BRITISH BEE JOURNAL which I offered to give away, far more than I can possibly satisfy, and still they come!

Perhaps some others of your readers may like to follow my lead by offering any back volumes they may happen to possess if they do not keep them for reference or binding. It costs nothing but the trouble of making them into parcels and taking them to the post office or railway station.

Bees are very short of food round here; some have not a drop of honey in the hive. May I warn all readers, especially beginners, to look well to this matter, and to lose no time about it.—L. ILLINGWORTH.

### Flowers of Sulphur for Bees.

[10294] Some time back I noticed in your columns that a bee-keeper recommended flowers of sulphur for "Isle of Wight" disease. Since then I have seen an experiment made on the lines advocated, and am sending you the result in the hope that it may be of some use to

others. I may say in passing that I have been fortunate enough to keep my forty hives quite free from disease thus far, but I have a friend who had a hive of badly diseased bees. One sunny afternoon, when most of the healthy bees were out gathering honey, my friend, with the aid of the bellows, blew flowers of sulphur into the hive. Next day he examined the colony and found that the queen and all the diseased bees had been smothered, only healthy bees now occupying the hive. The hive was cleaned and a new queen introduced. This took place about six weeks ago, and since then there had been no sign of disease, the bees being quite healthy and rapidly increasing in numbers. They now cover eight combs, with brood in all stages and no sign of disease. If any of your readers wish to try this experiment I should advise them before emitting the sulphur into the hive to remove the queen and only replace her after thoroughly cleaning out the hive.—T. REES, Ty'r Waun Apiary, Carmarthen.

## Notices to Correspondents

- H. A. T. (Derbs).—*Heather honey for winter food.*—Leave the honey; it will be all right. You cannot extract it without destroying the combs.
- "GREENFIELD" (Glanton).—*Using super clearer for winter cover.*—There will be no harm in using this. Remove the bee escape.
- J. JONES (Pinner).—*Wintering with empty brood chamber below.*—We are afraid a brood chamber would give too much empty space. A shallow frame box would be better, or the usual 3-in. eke. It would be an advantage with a strong colony.
- D. ABRAM (IpSwich).—The Secretary of the Devon B.K.A. is Mr. R. W. Furse, Woodbury, S.O., Devon.
- J. BINT (Lines).—From what you say we judge the remedy had something to do with it. Better send some bees to Dr. Goodrich if "I.O.W." disease is suspected. See Editorial.

## Bee Shows to Come.

- September 18 to 24.**—Grocers' Exhibition, Agricultural Hall, London. Honey and Bee Appliance Competitions, open to the United Kingdom. Good prizes. Entrance fee in each class 1s.—Schedule of Competitions sent on application, referring to this journal, to H. S. Rogers, 31, Queen Victoria Street, E.C.2. Entries closed.
- September 22.**—Altrincham Show. Several Open Classes for Honey and Appliances.—Schedules from H. Turner, 1, Market Street, Altrincham.
- October 2 (Saturday).** Rochester.—Combined County, Northern and Midland Division Honey Show, Masonic Hall, Gundulph Square, Rochester. 11 Classes open to members of K.B.K.A.—W. Carter, 2, York Road, Rochester, Secretary. Entries close September 22.

**October 5 to 8.**—Essex Fruit and Honey Show at Institute of Agriculture, Chelmsford. Open from 12 to 8 p.m. Admission free. Lectures and demonstrations each day.—Schedules from G. R. Alder, 7, Bulwer Road, Leytonstone.

**October 19 to 22.**—Dairy Show, Agricultural Hall, London. Open Classes for Honey, etc.—Particulars, Secretary, Dairy Farmers' Association, 28, Russell Square, London, W.C.1.

**November 18.**—Annual Show of the Worcester City and County Chrysanthemum, Fruit, Root and Honey Society. Thirteen Open Classes in Honey Section.—Schedules from Geo. Richings, 42, Barbourne Road, Worcester. Entries close November 6.

## Special Prepaid Advertisements. One Penny per Word.

Will advertisers please read these Rules carefully in order to save trouble, as they will be strictly adhered to.

Trade advertisements of Bees, Honey, Queens, and Bee goods are not permissible at above rate, but will be inserted at 1½d. per word as "Business" Announcements, immediately under the Private Advertisements. Advertisements of Hive-manufacturers can only be inserted at a minimum charge of 3s. per line, or 5s. per inch.

PRIVATE ADVERTISEMENTS are only intended for readers having Surplus Stock to dispose of. Driven Bees, Nuclei, and Queens that are reared or imported for sale, are Trade Advertisements, and can only be accepted under trade terms. A charge of 6d. extra will be made if a box number is used.

Orders for three or more consecutive insertions in "The Bee Journal" entitle advertisers to one insertion in "The Bee-keepers' Record" free of charge.

Advertisements must reach us NOT LATER than FIRST POST on TUESDAY MORNING for insertion in the "Journal" the same week.

### PRIVATE ADVERTISEMENTS.

PURE CAMBRIDGESHIRE HONEY for Sale, £9 per cwt., tins free, carriage paid; sample 6d.—WELLS & CO., Bowers Lane, Isleham, Cambs. h.178

THREE good second-hand Hives, 15s. each; odd Excluders, 1s. 6d. each; Section and Shallow Racks, 2s. 6d.; property of amateur giving up; stamp.—BOWEN, Coronation Road, Cheltenham. h.179

PURE ITALIAN BEES, 6-frame stock, 60s.; 10-frame stock, 90s.; box 10s. extra, returnable.—FRANK WAKEFIELD, Hindolveston, Norfolk. h.180

BARGAIN.—Four Stocks Italian Hybrids, on 10 frames (wired), 1920 Queens, 50s., carriage paid; boxes 10s., returnable.—F. BIGGE, Tyburn, Birmingham. h.181

FOR SALE, three strong Stocks of Bees in new skeps; healthy; £5 the three, carriage paid.—TAYLOR, Schoolmaster, New Leake, Boston. h.182

WALLFLOWER PLANTS, Sutton Phoenix and Blood Red, 25 for 1s. 2d.—LINDSAY, Bretforton, Honeybourne. h.183

ITALIAN QUEENS.—Owing to reduction of stocks, two 1920 fertile Italian Queens available for immediate delivery, 6s. 6d. each.—W. B. IBBOTSON, "Brookhill," Park Road, New Barnet, Herts. h.184

SEVERAL Stocks healthy Hybrids for Sale, £4 10s. each; prolific.—W. E. AVEY, 9, St. Mary's Square, Bury St. Edmund's. h.185

BEE BOOKS, MAGAZINES, wanted, especially Allen, Butler, Cheshire, Huber.—J. MOIR, Librarian, Scottish Bee-keepers' Association, 64, Polwarth Terrace, Edinburgh. r.h.186

**"WIGHT" DISEASE**, prevention and removal; advice 5s.—ALF. RYALL, Cottage Farm, near Camp, Stroud. r.h.187

**WOULD** anyone exchange four Buff Rock nuclei for two swarms healthy Hybrids in boxes?—TUCKER, Shaw, Newbury, Berks. h.188

**FOR SALE**, two 1920 Hybrid Italian Queens, 6s. 6d. each.—BADMIN, 35, Girtton Road, Sydenham. h.189

**36 RAPID FEEDERS**, as new, 70s., f.o.r.—WILLIS & ACOCKS, Sudbury, Suffolk. h.191

**ITALIAN HYBRIDS**, 1920 Queen, on 10 standard frames, guaranteed free from disease, £4, free on rail Attleborough; box 10s., returnable. Stamp reply.—CO-OPERATIVE BEE CLUB, Codsall, Wolverhampton. h.193

**TWO** extra prolific Hybrid Fertile Queens, ex County Re-stocking Apiary, just right for 1921, 8s. 6d. each.—LITMAN, Castle-Cary. h.194

**BEEES FOR SALE**, strong, on 6 frames, £2; 10 frames, £2 10s.; healthy.—D. COLE, Amber Green, Chart Sutton, near Maidstone, Kent. h.195

**FOR SALE**, 2½ cwt. of pure English Honey, £8 8s. per cwt., carriage paid, for cash or deposit; sample 1s.—SWAIN, Apiary, Belmistorpe, Stamford. h.196

**FOR SALE**, three W.B.C. Hives, Extractor, Supers, and other Appliances, also small Nucleus (Hybrids), cheap; owner going abroad.—A. McCABE, 54, Backmarch Crescent, Rosyth, Dunfermline. h.197

**FOR SALE**, a few cwt. Honey.—F. SEAMAN, Sibsey, Boston. h.198

**TO BE SOLD**, three hives of Bees in bar-frame hives.—Apply, J. P. WONNE, 50, Sunningfields Road, Hendon, N.W.4. h.199

**HONEY**, new season's, light colour (28-lb. tins), £8 8s. per cwt.; sample 4d.—THOMPSON, Helpringham, Sleaford. h.200

**TWO CARNIOLAN STOCKS**, 8 frames, 1920 Queens, £4.—NEILSON, Cuddesdon, Wheatley, Oxon. h.202

**WANTED**, new Run Honey.—WYATT, Bishopswood, Chard, Somerset. h.159

**FOR SALE**, about 35 Stocks and Swarms of Hybrid Ligurian Bees on 8 to 10 frames and Nuclei; mostly this year's Queens; excellent workers.—REV. A. H. HALLEY, Crathie, Wellington College, Berks. r.h.79

**SURPLUS STOCKS**—Strong, healthy Bees, immediate sale.—JEWITT, Hensall, Whitley Bridge, Yorks. r.h.135

**FIVE HIVES** strong, healthy Bees for Sale, each hive containing at least 30 lbs. of honey; owner leaving South; £6 hive, or offer.—Broomlands, Limpsfield, Surrey. r.h.142

**LARGE EGG STRAIN**.—White Wyandotte pedigree Cockerels from 15s. 6d.—MISSES COATES, Broadheath, Presteign. r.h.146

**WANTED**, Cheshire's Diagrams.—KENWARD, Berwyn House, Lewes, Sussex. h.112

**BUSINESS ADVERTISEMENTS.**  
1½d. per word.

**SIX** imported Penna Queens, expected September 20, 10s.; two 1920 home-raised Penna Fertiles, 8s.—"PATRICIA," Grammar School, Doncaster. h.201

**QUEENS**.—Choice Dutch-Goldens, by return, 7s., fertile.—GREEN, Bee-keeper, Laindon, Essex. h.203

**AUSTRALIAN HONEY FOR FEEDING BEES**.—Cases containing two tins, about 60 lbs. each, 110s. per case; carriage paid 100 miles, Remittances with orders.—SOUTHWOOD, 95, Acton Vale, London. r.h.190

**NO SUGAR VOUCHERS NEEDED**.—Flavine or Plain Candy, same price, 6 lbs., 10s., postage 1s. 3d. extra; larger quantities by passenger or goods train. Made in Cambridge, and the wrappers on the Flavine Candy bear our name and the maker's address.—S. H. SMITH, 30, Maid's Causeway, Cambridge. h.192

**MASHEATH MEMS**.—"The Masheath has arrived. It's a joy; a work of art."—A. S. ATKINSON, Fakenham. h.204

**GENUINE** pure Golden Italian Queens, imported direct from Penna. Can now supply per return, 100 due in 14 days. Prices while they last: One Queen, 9s.; two, 17s.; three, 24s.; specially selected, 10s. 6d. each.—GOODARE, Italian Specialist, New Cross, Wednesfield. r.h.177

**1ST AND SILVER MEDAL**, Sections, Surrey County Show. Entered hurriedly after some best of crop had previously been consumed (forgetful beggar!), won in a Masheath 16 x 10 Hive without excluders.—ATKINSON, Sole Maker, Fakenham. r.h.175

**FLAVINE CANDY**.—6lb. packages, 10s.; postage 1s. 3d. Made in Cambridge under our supervision from the best white sugar.—S. H. SMITH, 30, Maid's Causeway, Cambridge. r.h.87

**CRAWLING DISEASE**.—Reliable treatment for curing and prevention; recipe 2s. 6d.—A. W. SALMON, Cashfield, Chingford. r.h.162

**4-FRAME NUCLEI**, headed by 1920 Italian Queen, 50s.; box charged 10s., returnable; 6-frame Stocks, 70s.; 8-frame Stocks, 90s. Immediate delivery (weather permitting). Italian fertile Queens, 10s. 6d. English Run Honey and Sections wanted.—LEE, "Little Bowden Apiary," Burgess Hill, Sussex. r.g.114

**PURE ITALIAN QUEENS**, prompt delivery; select Italian, extra golden, rare honey-producing stock, August-September.—ATKINSON, Fakenham. r.g.24

**"WIGHT" DISEASE**, prevention and removal; advice 5s.—ALF. RYALL, Cottage Farm, near Camp, Stroud. r.h.124

**SELECT TESTED QUEENS**.—Three-banded leather-coloured Italians, gentle, hardy and prolific and disease resisting, one year old or less, right in their prime, 10s. 6d.; also untested 1920 Queens, same price; safe arrival guaranteed.—THE APIARY, Buckfast Abbey, S. Devon. r.h.125

**"ISLE OF WIGHT" DISEASE**.—Don't worry; use the solution that cures; 2s. per bottle.—E. PRESSEY, St. Elmo, Coulsdon. r.d.149

**HAVE YOU READ "THE BEE WORLD"?** If not, why not? Every number in itself is a useful literary work for practice and reference. Specimen copy free.—Offices: THE APIS CLUB, Port Hill House, Benson, Oxon.

**HONEY FOR FEEDING BEES**.—Finest West Indian, tin of about 60 lbs., 60s. 6d., carriage paid 100 miles.—LONDON TRADING AGENCY, 32, St. Mary Axe, E.C.3. r.h.134

**STRONG 3-frame Nuclei**, 25s., 7s. 6d. per frame, 5 bees and brood, extra stocks; state requirements; healthy Driven Bees, 10s. 6d.-12s. 6d. per lot with Queen; all cases 6s., returnable; 1920 Fertile Queens, 5s. 6d.—W. WOODS, Firs Apiary, Normandy, near Guildford. h.152

**SURPLUS HIVES** and Appliances for Sale, good condition, cheap.—PEARSON & GALE, Marlborough. h.131

**ALTRINCHAM SHOW**

(FEDERATED)

**Wednesday, September 22, 1920****GREAT SHOW OF HUNTERS, TURNOUTS,  
CATTLE, DOGS, ETC., ETC.****JUMPERS OVER HURDLES & WATER.**

Increased Prize Money in All Sections.

Covered Grand Stands for 2,000 persons.

**Military Band.**

Show open at 10 o'clock.

Public Luncheon at One o'clock.

Admission to Show Ground, all day, 2s. 6d.

(Including Tax).

Trains from all Stations.

See Railway Company's Bills.

Preserve your Bees during  
the Winter by feeding with

## PINK BACTEROL BEE CANDY

Manufactured by

**HAWKES BROS., LTD.,**

— Chelmsford, Essex —

Prices on application.

The products of the Apiary, of  
Poultry and Farm Stock, of  
the Fruit and Vegetable  
Garden can be Advertised  
and Sold through

### THE BAZAAR, EXCHANGE & MART

*Newspaper.*

Get a Copy—Thursday and Saturday 3d. The  
"Bazaar" publishes also practical handbooks by  
experts. Send for full catalogue, post free from—  
WINDSOR HOUSE, Breams Buildings, LONDON, E.C.2.

**JOY DOWN** the deficiencies of your present  
equipment and your needs for future improved  
working. Then book for "**MASHEATH**"  
(Regd.) Equipment for autumn construction.

The **MASHEATH LIST** contains an unique  
series of Hives unequalled to-day. You should  
not enter upon another bee season without them.

"The Hives (Porchless Masheaths) are excellent  
in every way, and I am very pleased indeed with  
them. '**PORCHLESS!**' Yes, every time. Need  
I say more? I will get you to send me two more."  
—W. E., June 17, 1920.

The **MASHEATH HIVES TALK** as soon as  
they are delivered.

**ATKINSON**, Proprietor and **Fakenham**.  
Sole Maker.

## ITALIAN QUEENS

Direct from Italy.

Address:

**Signor Gaetano Piana,**  
**Castel San Pietro,**  
**near Bologna, Italy.**

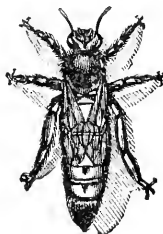

All Queens are reared by the most  
up-to-date and scientific methods.  
Mr. W. Herrod-Hempsall has  
personally inspected the apiary  
and methods employed, with which  
he is perfectly satisfied.

PRICES FOR 1920.

For 1 Fertile Queen: August and September,  
9/- each queen.

Carriage paid in Great Britain. Cash must accompany  
all orders, which will be executed in rotation. Guar-  
anteed safe arrival of all Queens, but not the introduction,  
Bees dead upon arrival must be sent at once to "B.B.J."  
Office.

For the mutual convenience of all parties, Il Signor  
Piana has made arrangements that all communications,  
orders and remittances of the readers of "B.B.J." and  
"B.K.R." can be addressed to him, c/o British Bee  
Journal, 23, Bedford Street, Strand, London, W.C.2.  
Cheques payable to "British Bee Journal."

THE

### British Bee-Keepers' Association.

Insure now against loss by  
damage done through bee  
stings. All particulars from.

**W. HERROD-HEMPSALL, 23, Bedford  
Street, Strand, London, W.C.2.**



## "BACTEROL" FOR BEES

2/9 per Bottle.

Post Free.

The cure for, and preventive of,  
"Isle of Wight" Disease.  
Non-poisonous—free from stain  
or unpleasant odour.

**MENLEY & JAMES, LTD.,**  
Menley House, Hatton Garden, E.C.1.



**BEST CLEARING and  
WINTERING BOARD,  
SUPER CLEARER, &c.**

A Necessity for all Bee-Keepers  
all the year round.

**MEADOWS, SYSTON, LEICESTER.**

### POSITIVE FACTS.

June 13th, 1920.

I am very pleased with the foundation. The bees undoubtedly prefer it to any other make I have, and have  
even gone the length of missing two sheets of other new foundation, and working out a sheet of yours placed  
behind them at the back of the hive. Full sheets have not sagged in the least in 16 x 10 frames.

Yours faithfully, R. B. MANLEY

Illustrated Lists free by post.

**S. J. BALDWIN, The Apiary, BROMLEY, Kent.**

**SPECIAL OFFER.****Honey for Feeding Bees.**  
**QUICK DELIVERY.**

**FINE WHITE CLOVER AUSTRALIAN.** In cases containing 2 tins, each about 60 lbs., **114/6** per case.

**FINEST WEST INDIAN.** Cases containing 1 tin about 60 lbs., **68/6** per case; cases containing 2 tins, each about 60 lbs., **135/-** per case.

*ALL CARRIAGE PAID (within 100 miles).*

*Cash with Order.*

**London Trading Agency,** 32, ST. MARY AXE,  
E.C.3.

**BARGAINS IN SURPLUS CLOTHING.**

Blue Serge Trousers for Working Men **12/6**  
Blue Serge Trousers, as new .. **14/-**  
New Blue Serge Trousers, best quality .. **21/-**  
New Holeproof Trousers, highly recommended .. **18/-**  
New Bedford Cord Breeches, Officers' quality .. **42/-**  
New Cord Riding Breeches, strapped .. **22/6**  
Khaki Drill Trousers, Officers' quality .. **10/6**  
Khaki Drill Jackets with pockets, Officers' quality .. **10/6**  
Khaki Drill Trousers, ordinary .. **7/6**  
Khaki Drill Jackets, ordinary .. **7/6**  
New Blue Drill Overalls, complete with pockets .. **12/6**  
New Oilskin Overcoats, extra quality .. **26/6**  
Army Waterproof Ground Sheets, 72 x 36, braes eyelets, slightly soiled, 9/- for 2, 4 for **17/-**.

Black Rubber Combination Cyclists' Suits, complete with Sou'wester, **20/-**; cost Government **63/-**.

New Heavy Workmen's Boots, **18/9** pair.  
New Brown Boots, all sizes, **22/6**; worth double.

New Full-size Australian Wool Blankets, **21/-** each.

New Full-size Australian Grey Blankets, **18/6** each.

New Full-size White Fleecy Blankets, **16/9** pair.

Selected Army Wool Blankets, all colours and sizes, **12/-** each.

Heavy Woollen Check Fringed Rugs, new, **22/6** each.

Heavy Woollen Check Motor Rugs, **30/-** each.

Now is the time to buy Blankets; they will be very scarce and dear later.

**WRITE TO-DAY FOR LIST OF NUMEROUS OTHER BARGAINS.**

**SACAR'S UNIVERSAL STORES (Dept. 29), ARDWICK, MANCHESTER.**

**8/-** Of the Author, S. SIMMINS, QUEENLAND, HEATHFIELD, SUSSEX.  
**SIMMINS "A MODERN BEE FARM"**

POST FREE

Nearly 500 pages. A few more copies at 8/-. Any further edition must cost 50% more

**Bees and Beekeeping Appliances. Catalogue free.**  
**EDWARD J. BURTT. MANUFACTURER. GLOUCESTER.**

*I very much regret that there has been a large increase in the cost of the manufacture of bee appliances, and therefore my prices will be advanced 10% from May 10th. Books excepted.*

# FOUR FIRST PRIZES.

Our HIVES and APPLIANCES were again awarded FOUR PRIZES at the Highland Agricultural Society's Show at Aberdeen, thus testifying to the superiority of our goods. Order now and ensure your bees wintering in good hives.

**BOTTLES.** We hold a large stock and can give immediate despatch.

**CANDY.** Safeguard your bees from starvation by feeding with our FAMOUS BEE CANDY. Send sugar vouchers with order.

Sole Agents for DADANT'S WEED FOUNDATION. Absolutely pure. Once used, always used.

Large illustrated catalogue, entitled, "Everything for an Apiary," post free on application.

**R. STEELE & BRODIE,**  
*Bee Appliance Makers,*  
**WORMIT, FIFE.**



## Lee's Bee Supplies.

¶ In design, material and workmanship, Lee's Bee Supplies still retain the reputation of being your best and safest investment.

¶ Our 1920 ILLUSTRATED CATALOGUE is yours for the asking. It contains detailed information on the most up-to-date hives and appliances for which the House of Lee is famous.

¶ We regret the necessity of having to advise our Customers that owing to the increased cost of production, all prices in 1920 price list are subject to 10% increase. The increase will not apply to orders received before May 10.

\*.\* Five per cent discount to Members of THE APIS CLUB.

**JAMES LEE & SON,**  
LTD.,  
Uxbridge, Middlesex.

(Telegrams: Graphicly, Uxbridge.)

Telephone: Uxbridge 181.)

Noted  
OCT 14 1920  
Natural  
lege



No. 1996. Vol. XLVIII SEPTEMBER 23, 1920. [Published every Thursday, Price 2d.]

**CONTENTS.**

	PAGE		PAGE
NOTICE TO ADVERTISERS .....	457	CORRESPONDENCE—	
MONGREL BEES .....	457	Honey from Laurel .....	463
I.O.W., OR CRAWLING DISEASE—A REMEDY .....	458	A Kentish Echo .....	462
NOTES ON BEE-KEEPING .....	459	The Season in Berks .....	463
LECTURE AT DARENTII .....	459	The Honey Flow in Dorset .....	464
THE BEE (POEM) .....	460	Showing Honey at the Royal Lancs. Show .....	464
NOTES FROM SHROPSHIRE .....	460	Winter Feeding of Bees .....	464
WARWICK NOTES .....	461	Excessive Swarming .....	464
ECHOES FROM THE HIVES—		Bees Building Combs in the Open .....	465
Boxhill .....	461	Bee-keeping in N.E. Yorks .....	465
A Kentish Echo .....	461	Feeding with Imported Honey .....	466
Echo from Hants .....	462	QUERIES AND REPLIES—	
FORESTFACH HORTICULTURAL SOCIETY .....	462	Queen Emerging through Base of Cell .....	466
TWICKENHAM AND THAMES VALLEY B.K.A. ....	463	Dealing with Wasps .....	466
PORTSMOUTH AND DISTRICT B.K.A. ....	462	NOTICES TO CORRESPONDENTS .....	457

# FOOD FOR BEES.

Owing to the continued bad weather there is a likelihood shortage this Winter. To prevent loss of Stocks order at once TAYLOR'S renowned

## SYRUP

In tins, 7 lb., 14 lb. and 28 lb. at 1/3 per lb., Carriage extra.

We are in a position to supply, without vouchers, the best

## CANDY

made from pure Sugar, plain or medicated, 1/6 lb. Carriage extra.

**E. H. TAYLOR, WELWYN, HERTS.**

Telephone—WELWYN 13.

## THE British Bee Journal

Office: 23, Bedford Street, Strand, London, W.C.2.  
ESTABLISHED 1873.

A Weekly Journal Devoted to the  
Interests of Bee-keepers.

Edited by T. W. COWAN, F.L.S., &c.,  
and J. HERROD-HEMPSELL, F.E.S.

### Correspondence: Whom to Address.—

All matters relating to the Literary Department, Associations, Shows, etc., should be addressed, "Editors, *British Bee Journal*," and all business communications and matters relating to subscriptions and advertisements to be addressed to the "Manager," *B.B.J.* Office.

**Subscriptions.**—Annual Subscription, 10s. 10d. post free in advance; single copies 2i., or 2½d. post free. If a receipt is required by post, a stamped and addressed envelope must be sent, otherwise a printed receipt will be enclosed along with the paper.

**Note.**—Cheques and Postal Orders should always be crossed, otherwise it is very difficult to trace them if they go astray.

**How to send Money.**—Remittances can be made payable to W. Herrod-Hempshall by crossed Cheques and Postal Orders. Stamps may be sent for small amounts up to 2s.

**Halfpenny stamps are preferred.**

Scottish or Irish cheques can only be taken in payment if 6d. is added for commission charged by banks for cashing them.

The Editors are not directly or indirectly interested in the manufacture or sale of beehives or appliances of any kind, and must refer correspondents wishing for prices or catalogues to advertisers in the paper.

## OUR DEPOSIT SYSTEM.

You are advised to insist on this being used when dealing with strangers.

### Rules and Conditions for Depositing

In order to save trouble, it is requested that the Rules be carefully read over by persons using the Deposit System of trading.

Goods should not be despatched until notice that the money has been deposited is received from this office.

**1. Method.**—When strangers are dealing together, the purchase-money of the articles is deposited at our office. We acknowledge receipt of the deposit to both parties, and hold the money until we are satisfied that the purchase is concluded. If a sale be effected, we remit to the seller the amount deposited, less a charge of 2½ per cent. in the £, with a minimum of 6d., and the expenses of Post Office Orders and postage, &c. Cash will be forwarded by Cheque, Post Office Order, or by Postal Order as preferred. If a sale or exchange be not completed, we return the amount deposited, after making the same deduction. By this means buyers and sellers are secured against fraud.

**2. Deposits.**—Postal Orders (drawn on General Post Office) and Cheques must be made payable to W. Herrod-Hempshall, and crossed "London County and Westminster Bank." The numbers of the Postal Orders should be kept by the sender.

We cannot be responsible for any loss that may occur in transit.

**3. Honey on Approval.**—All honey will be sold by sample, which must be sent direct to buyer.

**4. Bee Appliances.**—In ordering, the time allowed for completing the order to be stated to us when sending cash. If maker accepts, we hold cash until transaction is satisfactorily completed, when the amount will be remitted, subject to conditions as in Clause 1.

**5. Bees and Queens.**—These will be dealt with entirely by the parties concerned, so far as price, &c., go, and when the purchase is satisfactorily completed cash will be remitted as per Clause 1.

**6. Goods in Transit.**—These are at the seller's risk, i.e., any damage to or loss of an article on its journey is borne by the vendor; but a rejected article must be properly packed and returned by the same means as was used in sending it.

**7. Carriage.**—The carriage of all goods, except such as are sent by post, is payable by the buyer, unless otherwise agreed. If any article sent on approval be returned, each party to the transaction must pay carriage one way.

## Books for Bee-keepers NOW IN STOCK.

Cash in full must be sent with order.

		Postage
A Modern Bee Farm ... ..	7/6	8½d.
(To be obtained from this Office only.)		
Advanced Bee Culture (HUTCHINSON) ... ..	6/-	6½d.
Beginner's Bee Book (PELLETT)	5/-	4d.
BEE-KEEPING SIMPLIFIED FOR THE COTTAGER AND SMALLHOLDER (W. HERROD- HEMPSELL, F.E.S.) ... ..	1/-	2d.
BRITISH BEE - KEEPERS' GUIDE BOOK (T. W. COWAN)		
Paper covers ... ..	2/6	3d.
Cloth covers ... ..	3/6	4d.
Dissectable Model of Queen Bee ... ..	4/6	3d.
FERTILISATION OF FRUIT BLOSSOMS BY BEES (T. W. COWAN) ... ..	-/3	1d.
Honey and Health (A. HOPE) ...	-/6	1d.
Honey Vinegar (REV. G. BANCKS)	-/2	1d.
How to Keep Bees (ANNA B. COMSTOCK) ... ..	5/-	4½d.
Management of Out Apiaries	3/-	2d.
Prevention of Swarming (WILKES) ... ..	1/-	1d.
Pollination of Fruit in relation to Commercial Fruit Growing (C. H. HOOPER, F.R.H.S.)	-/6	1d.
PRODUCING, PREPARING, EXHIBITING AND JUDG- ING BEE PRODUCE (W. HERROD-HEMPSELL, F.E.S.) ...	2/-	3d.
Queen Rearing in England (F. W. L. SLADEN) ... ..	1/6	2d.
Scientific Queen Rearing (DOOLITTLE) ... ..	4/-	3½d.
Snelgrove's Method of Re- queening ... ..	-/6	1d.
The "Townsend" Bee Book ...	2/6	2d.
WAX CRAFT (T. W. COWAN) ...	2/-	2½d.
Wilke's Book on Swarming ...	1/-	1½d.

### MISCELLANEOUS.

Maeterlinck's Life of the Bee	5/-	3d.
The Lore of the Honey Bee (TICKNER EDWARDS) ... ..	2/-	2½d.
THE BEE WORLD (supplied only to members of Associations interested in the control and development of the Apis Club, apart from ordinary members of the latter), per copy ... ..	-/8	1½d.
The Bee Master of Warrilow (TICKNER EDWARDS) ... ..	7/6	4½d.

British Bee Journal & Record Office,  
23, BEDFORD STREET, STRAND LONDON, W.C.2.





## Notice to Advertisers.

A few weeks ago we told how our circulation had increased, and was still increasing. This is, of course, eminently satisfactory from all points of view, but we find this increase has created a difficulty, which we must ask our advertisers to help us overcome. Of course, the more papers to print the longer time it takes to get them off, as there is a limit to the capacity of even the best machine. By our going to press at the usual time the printers find it impossible to get the printing done early enough to get all the Journals out to time on Wednesday. We must therefore go to press a day earlier, and ask advertisers to let us have their advertisements on MONDAY instead of TUESDAY morning, or we shall be unable to guarantee their insertion in that week's Journal. Displayed advertisements should, if possible, be sent earlier.

## Sugar for Bee Food.

We are informed by the Ministry of Agriculture that the price of sugar for bee food from September 6 to October 2 is 1s. 2d.

## Errata.

The following words were dropped by error from the beginning of paragraph 3, column 1, page 453: "As to the latter," the reference being to the Metal Comb, not the Metal Foundation, as the meaning of the sentence would otherwise imply.

## Mongrel Bees.

The title of this article seems an unkind one. We are all so fond of bees that we naturally dislike calling any of them mongrels. Such bees, however, do exist, and in very large numbers—in fact, just as one sees so many mongrel or barn-door fowls about the country so, too, does one see bees that are so crossed and inter-crossed that to recognise their breed is an impossibility. Without a doubt, the importation into this country of many foreign bees has meant salvation to many bee-keepers, and most of us are grateful for the Italians, Dutch, Carniolan, Egyptian, aye, and even Tunisian and Cyprian queens which have found their way to our

apiaries; it has been all to the good, but alas! as evil ever follows the good, the importation of all these various breeds of bees has produced such hopeless mongrels that their owners become first disappointed, then fed up, and ultimately disgusted with keeping bees. I know that the owners are themselves to blame, and too often they are of that ilk which do not welcome advice, and live on a stock phrase, "Nature's own way." Forgetting that Nature has a habit of running waste and wild, these individuals pride themselves on their wisdom in giving Nature full play. There are, however, stranger individuals—those who never neglect to prune their fruit and rose trees, who continually introduce new blood into their poultry pen yet scorn to follow the same wise path in dealing with their bees. We get our word "mongrel" from the Anglo-Saxon *mang*, meaning a mixture; and, strictly speaking, any animal with mixed blood in its veins is a mongrel, but I believe it is generally accepted to-day that a mongrel is an animal of many mixtures. We cross our Leghorn hens with a Wyandotte cockerel, and call them first cross, and might even go so far as to cross their progeny with Plymouth Rocks, and class the resultant chicken as Wyandotte-Leghorn-Rocks; but if we go further than this, what could we expect but a flock of mongrels? So, too, a dog of two breeds in his veins is described as a first cross; if a hopeless mixture of breeds, he is rightly described as a mongrel. Now then, a man starts bee-keeping. He buys a stock of Italians. Later on, he gets a swarm, which he hives; the virgin in the parent stock mates, maybe, with a British brown drone, her progeny are, of course, crossbred. Later on, she goes out with a swarm, leaving a British-Italian virgin to carry on, and she mates, say, with a Dutch drone, and stays where she is until the next spring. The time arriving, she goes off to found another colony. The virgin queen she leaves behind may mate with a British Black, or even a drone from an already hopelessly mixed breed. In 15 months or so the bees of the parent hive are mongrels, yet their owner will calmly describe them as Italians. Someone buys his next swarm, and finds himself saddled with a collection of bees which disappoint him at every turn. The remedy is education. The ignorance in the country concerning bees is appalling. One talks to quite intelligent bee-keepers who haven't realised that when a swarm has left a pure colony the bees of the parent stock will possibly be, to say the least, hybrids, unless a pure fertile queen is introduced. Only the other day when I warned a man who still persists in placing his oldest stock over

the sulphur pit that he was, in so doing, killing his youngest queen, he looked up and said, "Dang it, I'd never thought o' that."

However, the only redeeming feature of that barbarous custom is that the most mongrel or inbred queen is destroyed. Legislation is necessary in stamping out bee diseases one knows, but legislation ought to be accompanied by education. Utility bee-keeping should be as carefully studied by the masses as rotation of crops. Please, someone, don't write and remind me of the "survival of the fittest"—we want every hive of bees in the country to be "fittest." Perhaps if we peg away we shall succeed in getting the powers that be:—1, To recognise the necessity of teaching bee craft in our schools; 2, to encourage frequent re-queening among the apiaries already in existence with queens pure and of a good strain, and thus hasten the day when bee diseases shall cease to be of the nature of a plague.—  
E. F. HEMMING, Steeple Gidding.

### 'I.O.W.' or Crawling Disease; A Remedy.

I wish to place on record my recent experience of the above, and what I hope may prove to be a very simple and effective remedy for the same.

Early in July of this year, on looking through one of my stocks, which were then covering ten combs with brood on eight, I noticed a considerable number of bees with dislocated wings, so kept my eyes open for further developments, and in about a fortnight the ground in front of hive was covered with crawling bees each morning, which died during the night.

I made up some Flavine solution, and sprayed bees, brood, combs, quilt, brood chamber and floorboard at intervals of four or five days for the next two weeks. Then thinking the weather was too chilly to spray, I fed with Flavined syrup instead, but all to no good purpose, for each morning the casualties were just as numerous, so that in about four weeks they had dwindled to about four combs of bees with a small patch of brood in two combs. Large numbers of capped brood had failed to emerge on account of loss of heat, and I feared the stock would soon be wiped out if something was not done quickly.

The queen was a fine-looking hybrid, twelve months old, but owing to the poor season had not produced a great number of eggs, and should be good for another season, if she survives. I came to the conclusion that as this malady appears to be an affection of the intestines spray-

ing was no use. What they seemed to need was a laxative to relieve the bowels. I thought of various things that might be beneficial, and finally resolved to try an onion.

I have seen it stated that bees have a great aversion to the odour of onions, but I have frequently carried out manipulations shortly after eating raw onions without making them unduly "ratty." I have also had my onion bed immediately in front of hives without any ill effects, and have watched bees very zealously working on the flowering heads of leeks and onions.

I accordingly took an onion about 3 ozs. in weight, cut it in quarters, put it into a quart of water, and gently boiled down to about a pint and a-half, strained off the liquor, stirred in 1½ lbs. of sugar, and a level teaspoonful of salt, and just brought to the boil again. Filled a pound jam jar with the syrup after cooling, tied over with muslin and inverted over brood nest on August 24, 26, and 28. On the second day the number of casualties was greatly diminished, and by the sixth day ceased entirely, the bees working with redoubled energy, coming home loaded with pollen, seeming anxious to make up for their recent heavy losses. The two centre combs were filled with eggs and brood, and the dead brood in the outer combs was being turned out, the floorboard being littered with debris, so I lifted the brood chamber and cleaned it off.

On the 31st I gave another jar of the syrup, but have now limited them to three holes, and intend to keep doing so for the next two or three weeks to stimulate the queen to keep laying until there is a sufficient number to winter with.

It may be said that I am jumping at conclusions, and that it has not had a fair trial, but it is getting so late in the year now that my object is to get this letter published in THE BRITISH BEE JOURNAL as soon as possible, with the Editor's kind permission, so that other members of the craft may test it for themselves before the approach of winter, and then let us have their verdict.

I would strongly advise not to feed with onion syrup too late in the year, when weather conditions prevail to prevent the bees taking a cleansing flight.

There is one point I am dubious about, and that is, whether the bees will be able to ripen the onion syrup and seal it over without fermentation taking place.

Up to the time of writing, September 3 there have been no more crawlers, and the bees are exceptionally busy. I will report on further conditions when I close down, and also in the spring.

I have had it suggested to me that I should keep this a secret, and place it on the market to compete with other "cures" (?), but I prefer not to do so for many reasons: one is, that it would be a couple of seasons before I could hope to gain the confidence of bee-keepers who were in need of it, during which time hundreds of colonies may perish which might otherwise be saved, and I have reasons to believe there are many bee-keepers in this country who, like me, either cannot afford, or don't feel inclined, to spend money for a recipe remedy, or advice in such matters.—T. H. WITNEY.

### Notes on Bee Keeping.

A Lancashire bee-keeper writes me, that he is unable to find the queen in three of his hives, that they are minus eggs and brood; he fears they are queenless. Not a few hives in spring and autumn become queenless through being over-manipulated. It is a bad plan to excite the bees too much, as oftentimes they are apt to blame the queen for any disturbance that might take place, and ball her, forming a compact mass something like the size of a walnut, and thus suffocate her. Have known cases when bees of the same hive have fought with one another after an examination of combs. No doubt this is also on account of being attacked by robber bees and wasps, as notably at this season bees appear to be most vicious. I have advised this bee-keeper to make another careful examination of his stocks, for although there may be no eggs or larvæ present in the hives yet it is quite possible the bees might be accompanied by a young fertile queen.

A young fertile queen is very active, and requires a lot of finding among 20,000 or 30,000 bees. Cessation of brood rearing is not always a correct indication that a stock is queenless, especially in a rainy season like the one we have just passed through. Upon two occasions this summer I examined stocks minus brood and eggs, and was unable to find the queen, yet at a later date upon examination I found both brood and eggs. Cells in the centre of the brood nest having a highly polished appearance is a sure indication of the presence of a fertile queen, these having been got ready by the workers for the queen to deposit her eggs in.

Another lover of Nature, after walking about 15 miles, came to see me. He wanted to see these interesting little insects he had read so much about in the bee-books, and was wondering if it was possible to keep bees in a town. After

hearing his explanation, *re* locality, I had to advise him it would prove rather dangerous to passers by if he were to attempt to keep bees in his locality. One cannot help feeling for some of our kinsmen in the towns, when possessed with a desire to see and experience the practical side of apiculture, and yet be debarred from doing so owing to the peculiar position of their surroundings being unsuitable for bee-keeping.

The dead season is fast approaching us. Examine stocks to see their strength; if weak, unite to other stocks. Strong colonies always winter better than weak ones, and come out most profitable in early spring. Successful wintering means an abundance of sealed stores, plenty of young bees, and a young, fertile queen. Feed up if short of stores as fast as possible. When this has been done place narrow strips of wood about  $\frac{1}{2}$  in. thick here and there across the top of the frames; when the quilts are laid over these they form tunnels for the bees to pass over the tops of the combs. Roofs of hives should be thoroughly examined before winter and repaired where found defective; dampness is a source of many of the evils attendant upon bee life. Many bee-keepers ignore the idea of plenty of packing on the tops of the frames. They argue that it prevents the fresh air from reaching the bees in the winter cluster. I am of the opinion that the strong atmospheric pressure surrounding the hives, forcing its way through the entrances, is sufficient means of supplying the cluster with the necessary fresh air to support their existence; therefore, my advice is, provide plenty of thick cushions for covering over the quilts; these conserve the heat in the hive, which means less work for the bees in keeping up the temperature, and less stores consumed.—P. LYTHGÖE, Padgate, Warrington.

### Lectures at Darenth.

Mr. S. H. Smith, of Cambridge, has devoted considerable time and thought to bee diseases during the last six years, and the Kent bee-keepers who accepted Mr. W. Wilson's kind invitation to visit and inspect his apiary of over 100 stocks at Chalk Croft, Darenth, on Saturday last heard a lecture altogether out of the ordinary, and one that gave every bee-keeper present something to "tack in his hat." Mr. Smith urged the necessity of keeping all stocks strong with young, vigorous queens, both for honey gathering and disease resisting, explained the Alexander skyscraper system, and gave interesting accounts of his colonial and American experiences. Mr. W. Wilson

and Mr. G. Bryden (two successful exhibitors of honey) gave short addresses, and Mr. A. Fry (Gillingham) explained his Kent Infallible Queen Introducing Cage. Tea (served in the apiary) was kindly provided by Mrs. Wilson, and the usual votes of thanks terminated a most successful afternoon.—(Contributed.)

## The Bee.

I be a Bee—a worker Bee:  
 Studied by man from antiquity;  
 That is the reason I write to thee.  
 Imperfect is my prosody:  
 Iambus, Dactyl and Trochee,  
 Are all alike unknown to me.  
 I simply rhyme my melody:  
 For this I make apology,  
 And now review my history.  
 In 30 B.C. Virgil sang of me:  
 His Georgic IV. may be known to thee;  
 It treats of me exclusively.  
 Pliny, most earnest student, he  
 Wrote of me voluminously.  
 His period—23-79, A.D.  
 Huber, born in Geneva, 1750;  
 Most learned as a Naturalist; he  
 Published a work, "Sur les Abeilles."  
 Maeterlinck, Modernist though he be,  
 Wrote a treatise on the Bee,  
 Full of wise philosophy.  
 Modern writers there be, devoted to  
 me,  
 Allotting much time to controversy.  
 (I would that they wrote more appreciatively.)  
 Many study me with profundity:  
 Discuss my habits most learnedly:  
 And marvel at my economy.  
 Foreign blood you can easily trace in  
 me—  
 I came from the East originally—  
 My mother came over from Italy.  
 A Queen was she, a Republican me;  
 A Republican of royal descent, you see,  
 Considering the good of the community.  
 No "Strikes" for me, though a worker  
 I be:  
 The success of the hive depends upon  
 me.  
 And mine upon it most assuredly.  
 Ours is a hive of industry:  
 Ca' canny is scorned unrelentingly;  
 It conducteth not to prosperity.  
 When nollen and nectar cease to be;  
 We kill off the Drones mercilessly;  
 Non-workers receive scant sympathy.  
 I live in a hive specially made for me,  
 And usually known as a W.B.C.:  
 Though some bees dwell in a hollow  
 tree.  
 My work, at first, was to feed the  
 larvæ:

After that I became a scavenger Bee,  
 Cleaning the hive most scrupulously.  
 Later on, I became a foraging Bee,  
 Attaining my height of activity,  
 In the search for nectar in plant and  
 tree.

Scenting the flowers with my antennæ:  
 Sipping nectar therefrom with avidity:  
 Carrying it home right merrily:  
 Storing in combs most delightful to  
 see:

Making provision for futurity—  
 That is the work of a foraging Bee.  
 Honey, from nectar, distilled in me,  
 By a process, to many, a mystery;  
 Is welcomed by all for its purity.  
 It is easy to see that I, a Bee,  
 Labour for others unselfishly:  
 Please learn the lesson intended for  
 thee.

My life as a Bee is full of glee;  
 Except when men interfere with me:  
 It is chiefly then that I angry be.  
 Buzzing around most angrily:  
 Seizing the right opportunity:  
 I give a thrust at the enemy.  
 Men sometimes say a bad word to me;  
 But I only attack in defence, you  
 see:—

They should not intrude injudiciously.  
 Though normally healthy as a Bee,  
 Diseases occasionally visit me.  
 Especially Foul Brood and Dysentery.  
 Death, dreaded by many, has no dread  
 for me:

I fulfil my life's work conscientiously,  
 And then "pass out" quite quietly.  
 Thus, in God's most wise Economy,  
 I play my part contentedly:  
 Fulfilling His Will concerning me.  
 May this talk with thee, dear reader,  
 be

Taken to heart most seriously;  
 And benefit thee eternally.

Dictated and signed by me,

A BEE.

—T. E. PETERS, Prestwood, Bucks.

## Notes from Shropshire.

All bee-keepers who were present at the Shrewsbury Floral Fête must have rejoiced to see that the horticultural department of the Salop County Council Agricultural Committee have added apiculture to the other subjects in their curriculum, and that they afforded a place in their unique educational exhibit for the display of appliances and products of an up-to-date apiary. In addition to a fully furnished hive, extractor, ripener, feeders, etc., etc., an observatory hive with bees and brood in various stages of development, and sections in process of completion, was staged, and attracted

much attention. A small but exquisitely dainty trophy of excellent clover honey was on view, as well as an array of honey of various shades and flavours, all carefully labelled—amongst them being samples of artificial honey and foreign honeys, often foisted upon the public as "pure English." The specimens of honey comb, beeswax at the different stages of refining—from the old combs to the finished article—and the collection of bee flowers were of exceptional interest, and reflected great credit upon the Rev. G. E. H. Pratt, the County Council expert.

It was welcome news to be told that the Committee have a small re-stocking apiary, from which, in spite of the bad season, some twenty nuclei have already been sent out to bee-keepers in districts certified free from disease.

Much good educational work is being done, I am given to understand, by means of lectures and demonstrations throughout the county, and there is the happy prospect of Shropshire again taking the place she once held as one of the premier honey-producing counties of England.—*Communicated.*

## Warwick Notes.

I notice you invite bee-keepers to relate their experiences of the season, so may I have space for the following brief notes from Warwickshire?

Following the very mild winter we had an abnormally warm spring. Although this is an advantage in early honey districts, it was the cause this year of the loss of a great amount of bee life through excessive excitement.

May in this district was very unlike itself, and the chilly weather necessitated continued feeding. We had a beautiful fine spell at Whitsuntide, and many Italian stocks that had been breeding extensively throughout the spring sent out strong swarms.

Bees got very little store from the fruit blossom. June turned out miserably wet and cold, and the clover harvest was a failure. Our main crop, limes and brambles, was also ruined by the atrocious weather of July. One came back from the holiday and found most stocks starving. One fairly strong lot of natives, left packed on eight frames, had dwindled to a bare four, and not a cell of honey in the hive; nor, of course, any brood. Constant heavy feeding with warm autumn syrup has put new life into them. I packed them down to a crowded three-frame nucleus and have hopes of wintering them, with care. Another lot of

Italian hybrids, of a friend's, were in the same plight. I had them fed heavily, and within a fortnight the queen had two combs packed with brood again. In general, the season is a failure. There is opportunity now, however, to get stocks conditioned for winter, as the weather at present is glorious.

*Re "Crawling Disease."* I had a stock affected in this way early in the year. I attribute it to an unusually warm day following a cold or rainy spell, enticing out young bees who are not yet able to fly strongly. I differentiated the symptoms from those of "Isle of Wight" disease in that the bees had not distended abdomens, and were profusely covered with new "down." The dislocation of wings so often noticed I attribute to the violent effort to fly, and not to internal disease.

[Were the bees covered with "new down" or was it the powdery appearance of May pest?—Eds.]

*Re 10263.* Is there ever anything about which Mr. Manley does not say something which only reveals the fact that he is *not* out to help the industry, but to hinder it by picking petty, and very often personal quarrels of absolutely no value? If Mr. Manley really wants to do something big for bee-keepers, may I suggest that he commences really serious research work in his own apiary, and that he makes concrete notes on the prominent Association with which he finds fault, and reads a paper on both subjects at the next meeting of the Association? He would then have the opportunity of opening up a discussion amongst those who are qualified to make reforms, rather than obstruct the Journal with matter which is of no use to anybody.—R. NOEL AVELINE.

## Echoes from the Hives.

BOXHILL.

The season here (Boxhill), which I suppose is one of the finest from a bee-keeper's point of view near London has been most disappointing, and although swarms have been numerous, I have not been able to take more than one-third the amount anticipated in actual honey. The bees only had two days on the limes, of which there are many huge trees round about, and most of the honey obtained appeared to come from the Brassica family and the hawthorn.

There is still (August 29) a small amount coming in from the second crop of clover, and also from heather, but my

bees must go well over a mile for the latter, to Ranmore Common, where the heather is making a wonderful show this year. Wasps, I am thankful to say, appear to be much fewer in numbers than last year.—STANLEY A. BLENKARN.

#### A KENTISH ECHO.

My experience corresponds with your correspondents, Messrs. Turner and Jacob. Really these things should have been tried before being put on the market. I shall be chary of unnatural inventions in future.

"A Dorset Yarn" fills me with envy. The season here has been shocking; have had to feed all the summer off and on. I looked through my six stocks this morning. Five will require the full ration to save them; two stocks that swarmed and were returned are queenless. Fortunately, I had two queens on hand when the plums were in flower; there was so much honey in brood nests that there was little room for the queen to lay. I therefore put supers on the strongest, hoping to get some apple honey, but the bees simply ignored the apple when in flower. Full sheets of wax foundation, in many instances, have not been drawn out. Only the Italians have been working these last cold days of August, and they have been at it as if it were the height of the honey flow; the others, including a White Star queen, have been idling at the entrances as if the vats were full and no more stores were required.—T. F. NEWMAN, Sidcup.

#### ECHO FROM HANTS.

From reports I read in the B.B.J. We in this district are very well off, much better than those who have no late Dutch clover or heather for their bees to gather from. I find about here bees generally are doing very well during this spell of summer weather, and very few will want feeding to carry them through the winter. I took off twelve good sections to-day, and put on twelve more that were not quite saleable. If this weather continues I think they will finish them off. I noticed the combs were crammed up with sealed honey below.

Nuclei with me are doing very well, but swarms developed crawlers during the wet time, but are recovering now, fast, thanks to flavine. Stocks that swarmed and were kept out have given but little surplus, but have plenty of stores.

I am under the mile to the heather, the edge of the New Forest.

I should like to see more reports from bee-keepers from other districts in the B.B.J.—J. COOK, Bockhampton, Hants. September 11, 1920.

## Fforestfach Horticultural Society.

### REPORT OF HONEY CLASSES.

Honey classes were included at this year's Show, Saturday, Sept. 11, for the first time in its history, for the purpose of fostering an interest in bees in a district which has, apparently, only one bee-keeper in an area of three square miles or so, to the north-west of Swansea. Many good exhibits were received from distant counties, but only one from the home county of Glamorgan. Much interest was taken in the exhibits by visitors to the Show, and the committee have decided that the honey classes shall be continued at next year's Show, when it is hoped Glamorgan bee-keepers will rally up.

Edward Gibbon, Esq., Clydach-on-Tawe, ably judged the exhibits, his decisions being fully endorsed afterwards by interested bee-keepers, included amongst whom was friend Boobier, of Bishopstone.

Mr. Gibbon complimented the 1st prize exhibits as being amongst the finest he had ever judged. The awards were as follows:—

Three honey sections.—1, J. Morley Davies, The Manse, Braunton, Devon.

Three 1-lb. pots extracted.—1, H. Aubrey Felinfoel, Carm.; 2, D. J. Griffiths, Reservoir, Felinfoel, Carm.

One 1-lb. gift class extracted.—1, H. Aubrey; 2, A. H. Bowen, Cheltenham.

G. W. WILLIAMS.

## Portsmouth and District Bee-keepers' Association.

The above Association held their second annual Show in conjunction with the Portsmouth Allotment Holders' Association in the Connaught Drill Hall on September 8, 9 and 10.

The exhibits, which numbered over 50, showed an increase over last year, and in view of the scarcity of honey in this district this year, the number of exhibits was gratifying, and the quality was satisfactory.

An interesting exhibit was staged by the "Bee Master of Warrilow," and included a frame of his "Bat Bees," from a strain that he has been twenty years perfecting, and which are immune from "I.O.W." disease; he also included a case in six parts, showing "The birth and making of a section," and several other interesting novelties.

Lieut. G. Boddie, a member of this Association, exhibited a three-framed observation hive with bees, which proved to be one of the attractions of the Show.

Lectures and demonstrations were given by members of the Association during the afternoons and evenings, which were of

great interest to the thousands who visited the Show.

The judge, Mr. W. Herrod-Hempsall, made the following awards:—

#### HONEY CLASSES.

##### Open to Members.

Best three 1-lb. sections of honey.—1, Mr. G. Leverton, Fareham; 2, Mrs. P. E. White, Portsmouth; 3, Mr. P. E. White.

Best jars extracted honey.—1, Mr. P. J. Pannell, Havant; 2, Mr. P. E. White; 3, Mr. G. Leverton.

Best jars granulated honey.—1, Mr. A. J. Steele, West Ashling; 2, Mr. P. E. White.

Best W.B.C. hive made by a member.—1, Mr. Steele.

##### Open to British Isles.

Best three sections of honey.—1, Mr. G. Leverton; 2, Mr. P. E. White; 3, Mr. B. J. Pond, Blandford.

Best jars extracted honey.—1, Mr. B. J. Pond; 2, Mr. W. P. Vassie, Essex; 3, Mr. J. Evans, Milton.

Best jars granulated honey.—1, Mr. E. Tattersall-Williams, Branton; 2, Mr. P. E. White; 3, Mr. A. E. Warren, Bletchley.

Best shallow comb for extracting.—1, Mr. Baruch-Blaker, Barnham; 2, Mrs. Baruch-Blaker.

Best tablets of wax.—1, Mr. Baruch-Blaker; 2, Mr. P. E. White; 3, Mr. Smith, Portsmouth.

### Twickenham and Thames Valley Bee-Keepers' Association.

The second annual exhibition promoted by the above Association was held at the Twickenham Horticultural Society's Show on September 15, at the Town Hall, Twickenham, and was in every way a success.

The exhibits were not quite so numerous as one would have liked to see them. This was no doubt due to the exceedingly unfavourable season. On the whole the standard was very good.

Messrs. J. Lee & Son, of Uxbridge, staged an excellent exhibit of hives, etc., which was closely inspected by visitors, who were evidently much interested in modern bee-keeping appliances.

Mr. A. G. Gambrell, of Richmond, delivered an interesting lecture during the evening, and also officiated as judge.

Mr. J. Curtis, of Teddington, was the most successful exhibitor, obtaining the silver medal of the B.B.K.A.. Mr. C. D. Burnet, of Twickenham, winning the bronze medal, and Mrs. Fox, of Twickenham, the certificate of merit.

The following is a full list of awards:—

##### Open Classes.

Three Bottles Extracted Honey:—1,

Mr. J. Curtis, Teddington; 2, Green Lane Poultry Farm, Essex; 3, Mrs. Fox, Twickenham.

Three Sections:—1, Mr. J. Curtis; 2, Mr. C. D. Burnet, Twickenham.

##### Local Classes.

Extracted Honey:—1, Mr. J. Curtis; 2, Mr. C. D. Burnet; 3, Mrs. Fox.

Sections:—1, Mr. J. Curtis; 2, Mr. G. Patterson, Isleworth; 3, Mr. C. D. Burnet.

Shallow Frame:—Mr. J. Curtis.

Wax:—Mr. C. D. Burnet.

Granulated Honey:—Mr. J. Curtis.

Home-made Hive Appliance.—Mr. C. D. Burnet.

M. BYATT, Hon. Sec.



*The Editors do not hold themselves responsible for the opinions expressed by correspondents. No notice will be taken of anonymous communications, and correspondents are requested to write on one side of the paper only and give their real name and addresses, not necessarily for publication, but as a guarantee of good faith. Illustrations should be drawn on separate pieces of paper. We do not undertake to return rejected communications.*

### Honey from Laurel.

[10295]—In reply to Mr. Jas. Lee, it is not the sweet, but the scent, given off by young laurel shoots that is highly poisonous; it is prussic acid, and the leaves can not only be used for killing insects, but I also use them for relaxing coleoptera and hepidoptera. Strangely enough, the variegated varieties do not contain the poisonous elements.—STANLEY A. BLENKARN.

### The Season in Berks.

[10296]—The enclosed cutting from this week's *Windsor and Eton Express* referring to the passing season may be of interest.—A. L. LANGLEY.

##### BEE'S BAD TIME.

In common with those in other parts of the country, Berkshire bee-keepers have secured little honey during the season which is now at its close. Small quantities of surplus honey were obtained in some districts by those who happened to have their stocks sufficiently strong to take advantage of the first short flows. Subsequently bees were unable on account of the wet weather to forage properly, or the temperature was so low at other times that little or no nectar was secreted. Almost continuous rain prevailed while the limes were in bloom, and bee-keepers were deprived of the expected yield of honey from this source. The abnormal weather

led to swarming, which again prevented surplus being stored, because the small supplies coming in from day to day were converted into bees instead of going to the surplus chambers. Only small quantities of nectar are now procurable, even in fine weather, and these are being used to meet current requirements. Few colonies have more than sufficient stores to last until the end of the year, and the majority are on the point of starvation. Some have during the past few weeks been found actually dying for want of food. There is little prospect of weak stocks and late swarms surviving the winter. If there is no suspicion of disease these small colonies should be united and fed with syrup made from 12 lbs. of refined cane sugar, 8 pints of water, and a table-spoonful of vinegar. "Isle of Wight" disease is prevalent in some parts of the country. As affected stocks are not likely to be profitable, it is not worth going to the expense of feeding them with sugar at its present high price. They should therefore be destroyed.

### Showing Honey at the Royal Lancs. Show.

[10297]—I should be pleased if any other exhibitor at the above Show would let me know when they received their honey back by rail. Mine has taken three weeks to get back, after a good lot of trouble. Now they say my box was left on the showground by the railway company. This is rather funny, as at most shows all boxes are packed and put in one heap for the railway company; and if that had been done my box should not have been left behind. When it did come six bottles were missing from it. My wax also was packed up with Mr. G. Rose's parcels, and sent to Liverpool, and I am greatly obliged to him for returning it to me. Where my prize cards are I do not know, but I do know that before I show there again things will have to be managed better. I am not downhearted, but I like to be treated fairly.—A. E. WARREN, Bletchley, Bucks.

[There appears to have been some mismanagement somewhere. Mr. Warren enclosed a note from the foreman of works at the Show saying he had found the box left on the showground, and had taken it to Lo-stock Junction and returned it.—Eds.]

### The Honey Flow in Dorset.

[10298]—Mr. Kettle (page 434) is mistaken in the conclusion he draws from what I said. He appears to look on it as a sneer at his position. I do not know what his position is, and if I did I would not be such a cad as to sneer at it, I hope.

What I mean is that it would be interesting to know how the perpetual bee-weather and honey flow in Dorset (Corfe Mullen) is accounted for. Perhaps life is not too short for Mr. Kettle to give an explanation. Mr. Harper (p. 441) seems to be a bit puzzled, too.—R. B. MANLEY.

### Winter Feeding of Bees

[10299]—With regard to the subject of feeding bees I think perhaps a repetition of the elementary chemistry of sugar may be of interest if you can spare the space.

Cane sugar and beet sugar are forms of sucrose. When sucrose is hydrolysed—boiled with an acid—it changes to a mixture (called invert sugar) of glucose—dextrose or grape sugar—and fructose, fruit sugar.

Each of these substances interferes with the crystallisation of the other by lowering the freezing point, and fondant sugar is the result.

Honey is invert sugar produced by chemical action in the bee from the sucrose in nectar.

Glucose can also be manufactured from starch by hydrolysis and commercially the contact agent is a mineral acid. This is known as brewers' glucose.

Now imported honey has often been subjected to the addition of brewers' glucose for the purpose of assisting the blending and running into jars, and I venture to suggest that in consequence it is likely to be detrimental for winter food for bees.

On the other hand syrup from cane sugar is sterilised and free from pollen, and in some districts is more suitable for wintering than natural stores, especially where early candying prevents assimilation without the addition of water.

I see that the absence versus the presence of pollen in the food is being discussed. I do not want to be contentious, but it seems possible that modern disease weakens the power of the bee to digest pollen rather than sugar.

I have always been at a loss to understand the prejudice against the use of beet sugar, unless it is due to the calcium hydroxide used in its manufacture. However, at the present time this last point does not arise owing to the absence of beet sugar from our markets.—E. G. TREMLETT.

### Excessive Swarming.

[10300]—My experience with regard to one stock may be interesting, so I record it.

I bought it—an old English Black strain—last year, and lifted two supers off it in June. Unlike my other stocks, which swarmed incessantly, it showed no



signs of swarming till about July 21, when an enormous swarm issued, and voluntarily returned at once. The following day it issued afresh, and I returned half, catching the queen. The remainder clung to a dense holly bush, whence I finally extracted it on July 24 with a second queen, which I also caught, and returned her followers.

Again, a huge swarm issued on July 29, and was returned less its queen.

On August 4 I took it with two other stocks to a wide expanse of heather on the Mendip Hills, and, as the population was so enormous, gave it three supers.

I visited it on August 8 when bees were well up in the supers. I however found a knot of bees outside the entrance on the ground with a young queen, which I removed. On visiting the bees again, on August 15, I found the hive three-quarters empty. They had evidently realised their ambition at length about the 12th or so, and swarmed.

I at once removed the supers. On going through the hive to-day I found it broodless and obviously queenless, tenanted by a few haggard and dejected workers and an over-large proportion of blousy drones.

Fortunately, I am expecting my third Italian queen from the Ministry of Agriculture. But is it not very unusual for a swarm to issue so late and for so strong a stock to collapse so completely, especially with so much room and with hundreds of acres of ling under its nose?

—H. W. KETTLEWELL.

### Bee-Keeping in N.E. Yorks.

[10301]—You have lately invited bee-keepers from various parts of the country to send you reports of the honey harvest. I have seen no word from N.E. Yorks yet. Are there no bees or bee-keepers left about Whitby? During the few warm days we had before this memorable August departed I took the opportunity of visiting the moors while the heather was at its best.

The first day we walked from Scarborough to the once-famous Levisham, and on to Newton, but saw only two hives of bees in the twenty-odd miles, though I hear of a number having been sent from Malton for the heather harvest. The second day we left all roads and tracks, and struck straight across the moor towards Goathland. What a wealth of purple bloom, unbroken for miles, and never a bee to gather the tons of wasting nectar! The heather reached to our waists, and clouds of nollen almost choked us as we pushed through it. This is a very lonely and wild district. No motor-car or cycle has ever approached

it, though as we rested on one of the numerous prehistoric burial mounds—so common on the moors—we could see the long, perfectly straight, strip of white road where chariots and horsemen probably enjoyed the very same scenery as they journeyed from York to Whitby two thousand years ago. This particular piece of country seems to have been free from invasion ever since, as even the trippers and other holiday-makers do not seem to have discovered it yet. Indeed, so little has modern life influenced the very few inhabitants that at one of the farms we visited none of the family had ever been to school, and they could neither read nor write! This is the twentieth century!

We eventually made our way to the more populous Esk Valley, and finally home again over the Whitby Moor. We found several lots of white heather of both varieties now flowering, but no hives and no bees. I suppose they have succumbed to the "I.O.W." disease. But it seems strange that in these moorland areas the cottagers do not keep a few hives each, and utilise that great natural wealth around them. There is a small holding not far away, consisting of a substantial little stone cottage and out-buildings, four or five acres of grassland and "tillage," and about forty acres of moor, with heather all round it. It is difficult for a man to make a living on it; yet a dozen hives of bees would pay his rent, which is only £12.

I see the Rev. E. F. Hemming speaks about the oak being out before the ash. Does the reverse ever occur?—J. No. D. TICKLE.

### Bees Building Comb in the Open.

[10302]—Mr. W. S. Halford's account of bees in a hedge is very interesting. We have had a similar experience in a neighbouring garden. A fortnight ago we were asked to take away a swarm which had settled on a bough of a tree. The bees were in an unfrequented part of the garden, and no one had seen them arrive. We found what appeared to be a large swarm hanging under a bare and exposed branch of an elm tree, about ten feet from the ground. Holding a skep underneath, a vigorous shake dislodged some very angry bees and disclosed good-sized combs built on to the branch. Exit the operator with many stings, and pursued by a crowd of infuriated bees!

A few days later a skep was tied to the branch, two long skewers were put right through skep and combs to support the latter; the combs were cut away and a cloth placed over the skep, and the bees were safely removed, this time without

any stings being received. They were then shaken off the combs and run into a hive, being given some frames of brood and honey from another hive. There were between three and four pounds of bees, Italians, with a nice-looking queen.

It would be interesting to know whether Italian bees, coming from a warmer climate, are more likely than our native bees to build in exposed places. Perhaps some of your readers could give an opinion.—EMMA HEATLY, Trottscliffe.

### Feeding with Imported Honey.

[10303]—Will you kindly insert the following in your next issue under the head of correspondence?

Mr. Hughes' letter (10,284) states:—"I always boil the honey in bulk and dilute it afterwards with water," and then continues: "Diluted honey goes mouldy and would cause trouble with the bees." Why does he recommend diluted honey under these circumstances, or does he mean only sufficient is to be made to feed at once? What is the proportion of honey to water?—VERNON R. DEAN.

[Mr. Hughes means that the honey is only diluted when given to the bees. The amount of water will depend on the density of the honey. Three or four fluid ounces to each pound of honey will generally be sufficient.—Eds.]



Queries reaching this office not later than FIRST POST on MONDAY MORNING will, if possible, be answered in the "Journal" the following Thursday. Those arriving later will be held over until the following week. Only SPECIALLY URGENT queries will be replied to by post if a STAMPED addressed envelope is enclosed. All queries must be accompanied by the name and address of the sender, not necessarily for publication, but as a guarantee of good faith. Correspondents are requested to write on one side of the paper only.

### Queen Emerging Through Base of Cell.

[1905] I came across a rather curious case in one of my hives yesterday, and should like to know if you have experienced a similar.

I gave a frame of candy and a queen cell to a weak, queenless nucleus, but the wasps discovered a side entrance, and, after a fierce fight, took possession of the hive, the bees huddling in one corner. The cell was due to hatch the day after,

but on looking in three days ago I found the above state of affairs, the cell being left in the cold, so I concluded it was chilled, but I left it in, as I intended to sulphur the few bees and the wasps later. Yesterday, however, on looking into the hive I noticed that the queen had eaten through the *base* of the cell, and I found her, a fine, big virgin, with the dozen bees left.

I enclose cell for your inspection. It seems curious that the queen should have hatched out, in spite of no covering bees, this very cold weather, also four days late, yet turn out bright in colour and large in size.—S. POLHILL.

REPLY.—It is the only case of its kind we have heard of. Of course, the young queen did not liberate herself, but we should say either bees or wasps gained access to the cell by getting into the cell protector, and, by biting away the wax at the base of the cell, enabled the queen to "back" out. There can be no doubt she came out that way, for the cell is intact except for this hole.

### Dealing with Wasps.

[9909]—The wasps are doing immense damage to my bees. Can you recommend a remedy? They have killed a late swarm and extracted all the honey, and are now attacking the regular hives. Have narrowed entrances.—A REGULAR SUBSCRIBER.

REPLY.—The following plan is from the *Record* for November, 1913. We have not personally tried it, as, fortunately, we have never been troubled by wasps to any extent. It is as follows:—"In this great year of wasps it has been hard to preserve our bees from their much stronger and more active foe. With a weak lot, the mere narrowed entrance is of little use, and often ends with a great loss of bees if not a clean rob-out. A late and very weak cast I have guarded in this way: Take a strip of  $\frac{3}{8}$ -in. wood, say 7 in. long, and tack to it a wider strip of  $\frac{1}{4}$ -in., so that it projects about  $\frac{3}{8}$  in. Narrow the entrance to a bee-space or rather more, and fix these joined strips of wood on the alighting board, so that they make a tube running at right angles to the entrance, which is in the middle of it. If you like you can, of course, close one entrance of the tube, but I have kept them both open. It gives the bees more freedom, and I can almost say that not a single wasp or robber-bee gets past the guards in this bewildering and easily defended passage. I expect, indeed, that the fact that the portico has daylight at both ends makes it more puzzling than it would be if one of them was closed."

# Notices to Correspondents

Correspondents desiring an answer in the next issue should send questions to reach this office NOT LATER than the FIRST POST on MONDAY MORNING. Only SPECIALLY URGENT questions will be replied to by post if a STAMPED addressed envelope is enclosed. All questions must be accompanied by the sender's name and address, not necessarily for publication, but as a guarantee of good faith. There is no fee for answering questions.

A. E. S. (Loughton).—*Time to cease autumn feeding.*—This is one of those things for which a definite date cannot be fixed. As a rule, it should be not later than the end of September. It may vary in different parts of the country, and according to the weather, but we should say under the most favourable conditions it should not be prolonged beyond the first week in October.

D. M. S. (Hants).—*Moving bees in January.*—(i.) It is not advisable to move bees in the winter, as the jarring disturbs them. If they must be moved, then pack as directed in "The British Bee-keepers' Guide Book," page 119. It will be better to move them during the next six weeks if possible, or leave them until March or April. (ii.) Adminsons, Ltd., Port Hill House, Benson, Oxon. (iii.) We cannot say; it would depend on the weather. If it was warm they might do it in a fortnight or three weeks.

### Suspected Disease.

W. F. JONES (Anglesea), J. SHEARD (Wakefield), C. ARDEN (Sheffield), E. M. KEEN (Birmingham).—In our opinion the bees sent were affected with "I.O.W." disease.

G. S. Y. (Denbigh).—(a) There are symptoms of "I.O.W." disease. Better send some, alive, to Dr. J. Rennie, Mareschall College, Aberdeen. (b) The brown mass in cells was pollen. (c) If there is any quantity of unsealed honey it is safer to extract it. A little, say, up to between 1 and 2 lbs. will do no harm, as the bees will probably use it before it ferments. The danger from unsealed honey is that it is likely to ferment. It will not harm the bees if it keeps sweet.

## Bee Shows to Come.

A nominal charge of 2s. 6d. is made for notices (not exceeding 7 lines) in this column, 10 lines charged 3s. 6d., up to 15 lines 5s., which covers cost of insertion from order till date of show. Cash should accompany orders for insertion.

**October 2 (Saturday), Rochester.**—Combined County, Northern and Midland Division Honey Show, Masonic Hall, Gundulph Square, Rochester. 11 Classes open to members of K.B.K.A.—W. Carter, 2, York Road, Rochester, Secretary. **Entries closed.**

**October 5 to 8.**—Essex Fruit and Honey Show at Institute of Agriculture, Chelmsford. Open from 12 to 3 p.m. Admission free. Lectures and demonstrations each day.—Schedules from G. R. Alder, 7, Bulwer Road, Leytonstone.

**October 19 to 22.**—Dairy Show, Agricultural Hall, London. Open Classes for Honey, etc.—Particulars, Secretary, Dairy Farmers' Association, 23, Russell Square, London, W.C.1.

**November 18.**—Annual Show of the Worcester City and County Chrysanthemum, Fruit, Root and Honey Society. Thirteen Open Classes in Honey Section.—Schedules from Geo. Richings, 42, Barbourne Road, Worcester. **Entries close November 6.**

## Special Prepaid Advertisements. One Penny per Word.

Trade advertisements of Bees, Honey, Queens, and Bee goods are not permissible at above rate, but will be inserted at 1½d. per word as "Business" Announcements, immediately under the Private Advertisements. Advertisements of Hive-manufacturers can only be inserted at a minimum charge of 3s. per ¼ in., or 5s. per inch.

PRIVATE ADVERTISEMENTS are only intended for readers having Surplus Stock to dispose of. Driven Bees, Nuclei, and Queens that are reared or imported for sale, are Trade Advertisements, and can only be accepted under trade terms. A charge of 6d. extra will be made if a box number is used.

### PRIVATE ADVERTISEMENTS.

**HIGH-CLASS HONEY** (white), in 7, 14 and 28-lb. tins, 2s. lb.; also in screw-cap bottles, 28s. cozen, f.o.r.—WHYTE, Bee Farm, Cumberland, Dumbartonshire. h.205

**WANTED**, set Lantern Slides on Bee-keeping. State description and price.—BRIGHT, Coxhill, Lymington, Hants. h.206

**FOR SALE**, 1½ cwt. fine quality Honey, also three high-grade Italian Queens, through having to unite stocks. Stamp reply.—CROWE, Merriott, Crewkerne. h.207

**FOR SALE**, two strong Stocks of healthy Hybrid Italian Bees in Taylor's Hives, new, last year, £3 15s.; also June Swarms on 6 and 7 frames, £2, carriage paid; box 10s., returnable.—JAYS, Bellavista, Four Marks, Alton, Hants. h.208

**OVERSTOCKED.**—I have still a number of splendid Colonies of Italians and Hybrids for Sale, 1920 Queens, and of Penna's strain, with W.B.C. hives or travelling boxes, as desired. They are on 10 frames each, with ample stores, and I guarantee safe delivery and reasonable prices.—Inquiries to CURTIS HART, F.R.H.S., The Gardens, Tolmers. h.209

**THREE-FRAME NUCLEUS**, 25s.; young Fertile Queen, 5s.—FURBANK, 1, Whitefriars Road, King's Lynn. h.211

**WANTED**, imported 1920 Carniolan Queen.—Particulars to HARRISON, Shaw House, Witheral, Carlisle. h.213

**1920 FERTILE ITALIAN HYBRID**, Simmins' strain, 8s. 6d.—WILLIAMS, 17, Aveling Park Road, Walthamstow, E.17. h.212

**PURE ITALIAN BEES**, 6-frame stock, 60s.; 10-frame stock, 90s.; box 10s. extra, returnable.—FRANK WAKEFIELD, Hindovestone, Norfolk. h.214

**WANTED**, genuine pure British Honey, preference slight heather blend, fully ripe; samples.—GRIMSHAW, Queen's Buildings, Rawtenstall. h.215

**1920 HYBRID Italian fertile Queen**, 7s. 6d. by return of post.—LILLEY, Lamareh, Bures, Suffolk. h.216

**TWO surplus 1920 Queens**, one pure Italian, one Banat Origin, 7s. 6d. each.—HARPER, 39, St. James Road, Watford. h.217

**"WIGHT" DISEASE**, prevention and removal; advice 5s.—ALF. RYALL, Cottage Farm, near Camp, Stroud. r.h.187

**FOR SALE**, about 35 Stocks and Swarms of Hybrid Ligurian Bees on 8 to 10 frames and Nuclei; mostly this year's Queens; excellent workers.—REV. A. H. HALLEY, Crathie, Welling-ton College, Berks. h.h.79

**WANTED**, Cheshire's Diagrams.—KENWARD, Berwyn House, Lewes, Sussex. h.112

**BEE BOOKS, MAGAZINES,** wanted, especially Allen, Butler, Cheshire, Huber.—J. MOIR, Librarian, Scottish Bee-keepers' Association, 64, Polwarth Terrace, Edinburgh. r.h.186

**BUSINESS ADVERTISEMENTS.**  
1½d. per word.

**ITALIAN QUEENS.**—Signor Penna is sending us a few selected Fertile Queens, which we can offer at the unusually low rate of 7s. 6d. each. Orders in rotation. Supply very limited.—PEARSON & GALE, Marlborough. h.221

**"PORCHLESS BABY MASHEATH** received. More than satisfied. Workmanship certainly a revelation. Glad I had the porch attachment; will be very useful. It certainly is 'nobby.'—R. R., 14/9/20. A dead cert. No mistake either.—ATKINSON, Sole Maker, Fakenham. h.219

**SURPLUS QUEENS** from driven bees, all this year's rearing, mostly black stock, 5s. each per return.—CLARIDGE, Copford, near Colchester. h.220

**SACRIFICE.**—Must be sold. Forty Fertile 1920 Black and Hybrid Queens, 5s. each; delivery by return.—PEARSON & GALE, Marlborough. h.222

**MASHEATH MEMS.**—"They seem beautifully made and finished."—H. T. B.—ATKINSON, Fakenham. h.210

**AUSTRALIAN HONEY FOR FEEDING BEES.**—Cases containing two tins, about 60 lbs. each, 110s. per case; 1 tin 56s., carriage paid 100 miles. Remittances with orders.—SOUTHWOOD, 95, Acton Vale, London. r.h.190

**NO SUGAR VOUCHERS NEEDED.**—Flavine or Plain Candy, same price, 6 lbs., 10s., postage 1s. 3d. extra; larger quantities by passenger or goods train. Made in Cambridge, and the wrappers on the Flavine Candy bear our name and the maker's address.—S. H. SMITH, 30, Maid's Causeway, Cambridge. h.218

**GENUINE pure Golden Italian Queens,** imported direct from Penna. Can now supply per return. 100 due in 14 days. Prices while they last: One Queen, 9s.; two, 17s.; three, 24s.; specially selected, 10s. 6d. each.—GOODARE, Italian Specialist, New Cross, Wednesfield. r.h.177

**FOR TWO WEEKS ONLY.**—To clear, 40 Fertile 1920 Black and Hybrid Queens, 5s. each; delivery by return; unique bargain.—PEARSON & GALE, Marlborough. h.223

**1ST AND SILVER MEDAL,** Sections, Surrey County Show. Entered hurriedly after some best of crop had previously been consumed (forgetful beggar!), won in a Masheath 16 x 10 Hive without excluders.—ATKINSON, Sole Maker, Fakenham. r.h.175

**CRAWLING DISEASE.**—Reliable treatment for curing and prevention; recipe 2s. 6d.—A. W. SALMON, Cashfield, Chingford. r.h.162

**4-FRAME NUCLEI,** headed by 1920 Italian Queen, 50s.; box charged 10s., returnable; 6-frame Stocks, 70s.; 8-frame Stocks, 90s. Immediate delivery (weather permitting). Italian fertile Queens, 10s. 6d. English Run Honey and Sections wanted.—LEE, "Little Bowden Apiary," Burgess Hill, Sussex. r.g.114

**PURE ITALIAN QUEENS,** prompt delivery; select Italian, extra golden, rare honey-producing stock, August-September.—ATKINSON, Fakenham. r.g.24

**HAVE YOU READ "THE BEE WORLD"?** If not, why not? Every number in itself is a useful literary work for practice and reference. Specimen copy free.—Offices: THE APIS CLUB, Port Hill House, Benson, Oxon.

**"ISLE OF WIGHT" DISEASE.**—Don't worry; use the solution that cures; 2s. per bottle.—E. PRESSEY, St. Elmo, Coulsdon. r.d.149

**SURPLUS HIVES** and Appliances for Sale, good condition, cheap.—PEARSON & GALE, Marlborough. h.131

## Australian Honey for Feeding Bees.

Cases containing two tins, about 60 lbs. each, 110s. per case, 1 tin 56s., carriage paid 100 miles, Remittances with orders.—

**SOUTHWOOD, 95, Acton Vale, London.**

**AYRSHIRE AGRICULTURAL ASSOCIATION,** Sixty-Sixth Annual Show of DAIRY and FARM PRODUCE; also BUTTERMAKING COMPETITION at **KILMARNOCK, 21st & 22nd OCTOBER, 1920.**

Special Competitions for POTATOES, VEGETABLES, FRUIT AND HONEY.

Also ALLOTMENT HOLDERS' CLASSES and HOME BAKING COMPETITIONS.

Total Premiums - £500. Entries close, Friday, 8th October. Premium Lists on application to—**JOHN HOWIE, Sec., 58, Alloway St., Ayr.**

## ITALIAN QUEENS

Direct from Italy.

Address:  
**Signor Gaetano Piana,**  
Castel San Pietro,  
near Bologna, Italy.



All Queens are reared by the most up-to-date and scientific methods. Mr. W. Herrod-Hempsall has personally inspected the apiary and methods employed, with which he is perfectly satisfied.

### PRICES FOR 1920.

**For 1 Fertile Queen: August and September, 9/- each queen.**

Carriage paid in Great Britain. Cash must accompany all orders, which will be executed in rotation. Guaranteed safe arrival of all Queens, but not the introduction. Bees dead upon arrival must be sent at once to "B.B.J." Office.

For the mutual convenience of all parties, the Signor Piana has made arrangements that all communications, orders and remittances of the readers of "B.B.J." and "B.K.R." can be addressed to him, c/o British Bee Journal, 23, Bedford Street, Strand, London, W.C.2.

Cheques payable to "British Bee Journal."

THE  
**British Bee-keepers' Association.**

Insure now against loss by damage done through bee stings. All particulars from

**W. HERROD-HEMPSALL, 23, Bedford Street, Strand, London, W.C.2.**

Preserve your Bees during the Winter by feeding with  
**PINK BACTEROL BEE CANDY**

Manufactured by

**HAWKES BROS., LTD.,**  
— Chelmsford, Essex —

Prices on application.

The products of the Apiary, of Poultry and Farm Stock, of the Fruit and Vegetable Garden can be Advertised and Sold through

THE  
**BAZAAR, EXCHANGE & MART**  
Newspaper.

Get a Copy—Thursday and Saturday 3d. The "Bazaar" publishes also practical handbooks by experts. Send for full catalogue, post free from—**WINDSOR HOUSE, Brems Buildings, LONDON, E.C.2.**

**BARGAINS IN SURPLUS CLOTHING.**

Blue Serge Trousers for Working Men **12/6**  
Blue Serge Trousers, as new .. **14/-**  
New Blue Serge Trousers, best quality .. **21/-**  
New Holeproof Trousers, highly recommended .. **18/-**  
New Bedford Cord Breeches, Officers' quality .. **42/-**  
New Cord Riding Breeches, strapped .. **22/6**  
Khaki Drill Trousers, Officers' quality .. **10/6**  
Khaki Drill Jackets with pockets, Officers' quality .. **10/6**  
Khaki Drill Trousers, ordinary .. **7/6**  
Khaki Drill Jackets, ordinary .. **7/6**  
New Blue Drill Overalls, complete with pockets .. **12/6**  
New Oilskin Overcoats, extra quality .. **26/6**  
Army Waterproof Ground Sheets, 72 x 36, brass eyelets, slightly soiled, 9/- for 2, 4 for **17/-**.

Black Rubber Combination Cyclists' Suits, complete with Sou'wester, **20/-**; cost Government **63/-**.  
New Heavy Workmen's Boots, **18/9** pair.  
New Brown Boots, all sizes, **22/6**; worth double.  
New Full-size Australian Wool Blankets, **21-** each.  
New Full-size Australian Grey Blankets, **18/6** each.  
New Full-size White Fleecy Blankets, **16/9** pair.  
Selected Army Wool Blankets, all colours and sizes, **12/-** each.  
Heavy Woollen Check Fringed Rugs, new, **22/6** each.  
Heavy Woollen Check Motor Rugs, **30/-** each.

Now is the time to buy Blankets; they will be very scarce and dear later.

**WRITE TO-DAY FOR LIST OF NUMEROUS OTHER BARGAINS.**

**SACAR'S UNIVERSAL STORES (Dept. 29), ARDWICK, MANCHESTER.**

**8/-** Of the Author, S. SIMMINS, QUEENLAND, HEATHFIELD, SUSSEX.  
**SIMMINS "A MODERN BEE FARM"**

**POST FREE** Nearly 500 pages. A few more copies at 8/-. Any further edition must cost 50% more

**Bees and Beekeeping Appliances. Catalogue free.**  
**EDWARD J. BURTT. MANUFACTURER. GLOUCESTER.**

*I very much regret that there has been a large increase in the cost of the manufacture of bee appliances, and therefore my prices will be advanced 10% from May 10th. Books excepted.*

 **"BACTEROL"**  
**FOR BEES**

2/9 per Bottle.

Post Free.

The cure for, and preventive of, "Iste of Wight" Disease. Non-poisonous—free from stain or unpleasant odour.

**MENLEY & JAMES, LTD.,**  
Menley House, Hatton Garden, E.C.1.

**B<sup>c</sup>B<sup>w</sup>B** BEST CLEARING and WINTERING BOARD, SUPER CLEARER, &c.

A Necessity for all Bee-Keepers all the year round.

**MEADOWS, SYSTON, LEICESTER.**

**POSITIVE FACTS.**

June 13th, 1920.

I am very pleased with the foundation. The bees undoubtedly prefer it to any other make I have, and have even gone the length of missing two sheets of other new foundation, and working out a sheet of yours placed behind them at the back of the hive. Full sheets have not sagged in the least in 10 x 10 frames.

Yours faithfully, R. B. MANLEY

Illustrated Lists free by post.

**S. J. BALDWIN, The Apiary, BROMLEY, Kent.**

## FOUR FIRST PRIZES.

Our HIVES and APPLIANCES were again awarded FOUR PRIZES at the Highland Agricultural Society's Show at Aberdeen, thus testifying to the superiority of our goods. Order now and ensure your bees wintering in good hives.

**BOTTLES.** We hold a large stock and can give immediate despatch.

**CANDY.** Safeguard your bees from starvation by feeding with our FAMOUS BEE CANDY. Price 1/6 per 1-lb., carriage extra.

Sole Agents for DADANT'S WEED FOUNDATION. Absolutely pure. Once used, always used.

Large illustrated catalogue, entitled, "Everything for an Apiary," post free on application.

**R. STEELE & BRODIE,**  
*Bee Appliance Makers,*  
**WORMIT, FIFE.**

Telegrams:—"Bees, Wormit."

Telephone:—28 Wormit.



THE  
KEY TO  
YOUR SUCCESS.

### Lee's Bee Supplies.

¶ In design, material and workmanship, Lee's Bee Supplies still retain the reputation of being your best and safest investment.

¶ Our 1920 ILLUSTRATED CATALOGUE is yours for the asking. It contains detailed information on the most up-to-date hives and appliances for which the House of Lee is famous.

¶ We regret the necessity of having to advise our Customers that owing to the increased cost of production, all prices in 1920 price list are subject to 10% increase. The increase will not apply to orders received before May 10.

\*.\* Five per cent discount to Members of THE APIS CLUB.

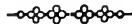

**JAMES LEE & SON,**  
LTD.,  
Uxbridge, Middlesex.

(Telegrams: Graphicly, Uxbridge.)

Telephone: Uxbridge 181.)



No. 1997. Vol. XLVIII SEPTEMBER 30, 1920. [Published every Thursday, Price 2d.]

**CONTENTS.**

	PAGE		PAGE
HONEY U. SUGAR FOR WINTER FEEDING .....	469	CORRESPONDENCE—	
JOTTINGS FROM HUNTINGDONSHIRE .....	469	De Virginibus—and Others .....	476
A SWARMING PROBLEM .....	470	Introduction of Virgins .....	476
NOTES ON BEE-KEEPING .....	472	Mongrel Bees .....	477
THE CROCUS .....	473	Bees in a Tree .....	477
GROCERS' EXHIBITION .....	474	COMBS FROM OTHER HIVES .....	477
BRITISH BEE-KEEPERS' ASSOCIATION .....	474	NOVELTIES FOR 1920 .....	478
SHEFFIELD AND DISTRICT B.K.A. ....	475	BEE SHOWS TO COME .....	478

# FOOD FOR BEES.

Owing to the continued bad weather there is a likelihood shortage this Winter. To prevent loss of Stocks order at once TAYLOR'S renowned

## SYRUP

In tins, 7 lb., 14 lb. and 28 lb. at  $1/3$  per lb., Carriage extra.

We are in a position to supply, without vouchers, the best

## CANDY

made from pure Sugar, plain or medicated,  $1/6$  lb. Carriage extra.

**E. H. TAYLOR, WELWYN, HERTS.**

Telephone—WELWYN 13.

## THE British Bee Journal

Office: 23, Bedford Street, Strand, London, W.C.2.  
ESTABLISHED 1875.

A Weekly Journal Devoted to the  
Interests of Bee-keepers.

Edited by **T. W. COWAN, F.L.S., &c.**,  
and **J. HERROD-HEMPSALL, F.E.S.**

### Correspondence: Whom to Address.—

All matters relating to the Literary Department, Associations, Shows, etc., should be addressed, "Editors, *British Bee Journal*," and all business communications and matters relating to subscriptions and advertisements to be addressed to the "Manager," *B.B.J.* Office.

**Subscriptions.**—Annual Subscription, 10s. 10d. post free in advance; single copies 2d., or 2½d. post free. If a receipt is required by post, a stamped and addressed envelope must be sent, otherwise a printed receipt will be enclosed along with the paper.

*Note.*—Cheques and Postal Orders should always be crossed, otherwise it is very difficult to trace them if they go astray.

**How to send Money.**—Remittances can be made payable to W. Herrod-Hempsall by crossed Cheques and Postal Orders. Stamps may be sent for small amounts up to 2s.

**Halfpenny stamps are preferred.**

Scottish or Irish cheques can only be taken in payment if 6d. is added for commission charged by banks for cashing them.

The Editors are not directly or indirectly interested in the manufacture or sale of beehives or appliances of any kind, and must refer correspondents wishing for prices or catalogues to advertisers in the paper.

## OUR DEPOSIT SYSTEM.

**You are advised to insist on this being used when dealing with strangers.**

### Rules and Conditions for Depositing

*In order to save trouble, it is requested that the Rules be carefully read over by persons using the Deposit System of trading.*

Goods should not be despatched until notice that the money has been deposited is received from this office.

**1. Method.**—When strangers are dealing together, the purchase-money of the articles is deposited at our office. We acknowledge receipt of the deposit to *both* parties, and hold the money until we are satisfied that the purchase is concluded. If a sale be effected, we remit to the seller the amount deposited, less a charge of 2½ per cent. in the £, with a minimum of 6d., and the expenses of **Post Office Orders** and postage, &c. Cash will be forwarded by Cheque, Post Office Order, or by Postal Order as preferred. If a sale or exchange be not completed, we return the amount deposited, after making the same deduction. By this means buyers and sellers are secured against fraud.

**2. Deposits.**—Postal Orders (drawn on General Post Office) and Cheques must be made payable to W. Herrod-Hempsall, and crossed "London County and Westminster Bank." The numbers of the Postal Orders should be kept by the sender.

We cannot be responsible for any loss that may occur in transit.

**3. Honey on Approval.**—All honey will be sold by sample, which must be sent direct to buyer.

**4. Bee Appliances.**—In ordering, the time allowed for completing the order to be stated to us when sending cash. If maker accepts, we hold cash until transaction is satisfactorily completed, when the amount will be remitted, subject to conditions as in Clause 1.

**5. Bees and Queens.**—These will be dealt with entirely by the parties concerned, so far as price, &c., go, and when the purchase is satisfactorily completed cash will be remitted as per Clause 1.

**6. Goods in Transit.**—These are at the seller's risk, i.e., any damage to or loss of an article on its journey is borne by the vendor; but a rejected article must be properly packed and returned by the same means as was used in sending it.

**7. Carriage.**—The carriage of all goods, *except such as are sent by post*, is payable by the buyer, unless otherwise agreed. If any article sent on approval be returned, each party to the transaction must pay carriage one way.

## Books for Bee-keepers NOW IN STOCK.

Cash in full must be sent with order.

	Postage
A Modern Bee Farm ... ..	7/6 ... 8½d.
(To be obtained from this Office only.)	
Advanced Bee Culture (HUTCHINSON) ... ..	6/- ... 6½d.
Beginner's Bee Book (PELLITT) ... ..	5/- ... 4d.
BEE-KEEPING SIMPLIFIED FOR THE COTTAGER AND SMALLHOLDER (W. HERROD-HEMPSALL, F.E.S.) ... ..	1/- ... 2d.
BRITISH BEE-KEEPERS' GUIDE BOOK (T. W. COWAN)	
Paper covers ... ..	2/6 ... 3d.
Cloth covers ... ..	3/6 ... 4d.
Dissectible Model of Queen Bee ... ..	4/8 ... 3d.
FERTILISATION OF FRUIT BLOSSOMS BY BEES (T. W. COWAN) ... ..	-/3 ... 1d.
Money and Health (A. HOPE) ... ..	-/6 ... 1d.
Honey Vinegar (REV. G. BANCKER) ... ..	-/2 ... 1d.
How to Keep Bees (ANNA B. COMSTOCK) ... ..	5/- ... 4½d.
Prevention of Swarming (WILKES) ... ..	1/- ... 1d.
Pollination of Fruit in relation to Commercial Fruit Growing (C. H. HOOPER, F.R.H.S.) ... ..	-/6 ... 1d.
PRODUCING, PREPARING, EXHIBITING AND JUDGING BEE PRODUCE (W. HERROD-HEMPSALL, F.E.S.) ... ..	2/- ... 3d.
Queen Rearing in England (F. W. L. SLADEN) ... ..	1/6 ... 2d.
Scientific Queen Rearing (DOOLITTLE) ... ..	4/- ... 3½d.
Snelgrove's Method of Re-Queening ... ..	-/6 ... 1d.
The "Townsend" Bee Book ... ..	2/6 ... 2d.
WAX CRAFT (T. W. COWAN) ... ..	2/- ... 2½d.
Wilke's Book on Swarming ... ..	1/- ... 1½d.

### MISCELLANEOUS.

THE BEE WORLD (supplied only to members of Associations interested in the control and development of the Apis Club, apart from ordinary members of the latter), per copy ... ..	-/8 ... 1½d.
The Bee Master of Warrilow (TICKNER EDWARDS) ... ..	7/6 ... 4½d.

**British Bee Journal & Record Office,  
23, BEDFORD STREET, STRAND LONDON, W.C.2.**





## Honey v. Sugar for Winter Feeding.

We have always been an advocate for leaving bees their own natural food, honey, in preference to extracting every bit of honey possible from both supers and brood chamber and feeding back sugar-syrup in its place. We notice in *Gleanings in Bee Culture* for September the editor is at one with us on this point, but his notes are headed "Good Honey," etc. This qualification should be noted; better good sugar-syrup than inferior honey. Owing to the high price of sugar many bee-keepers are buying imported honey, which is cheaper than sugar, for feeding purposes, but we would warn them to get a good-quality honey. Editor Root says: "There is no greater foolishness in all bee-dom than to extract honey, or extract too close, and feed sugar-syrup. When honey was relatively higher-priced, almost two to one, there was some justification for feeding syrup, but now that sugar-syrup is more expensive than honey the good bee-keeper will of course let the bees have their natural food. It will be admitted probably that sugar-syrup is the equal, if not the superior, of good honey during the coldest part of the winter, when there is no brood-rearing, but after that starts, in February and March for outdoor-packed hives, honey is unquestionably better. Honey, as we now know, contains vitamins and other essential elements that neither sugar-syrup, nor even combs of pollen, contain." What we cannot quite understand in the passage just quoted is why, if there is no greater foolishness than to extract honey and feed syrup, there is any justification for so doing when honey is dearer than syrup. The relative prices of the two can make no difference to their relative value as food for bees. We say the good bee-keeper will always, if possible, let the bees have their natural food.

Further on in the same article an instance is given of an extensive bee-keeper who fed sugar-syrup to one portion of his bees in the autumn, another portion being allowed their natural stores, honey from all kinds of sources. Both lots were packed the same for winter, and came through all right till March. The spring was very bad, and bees were confined to their hives for a month or six weeks. The sugar-fed bees died out almost entirely, while the bees with natural stores

came through in fine condition. The sugar-fed bees could not raise brood owing to the unsuitability of sugar-syrup for that purpose, and the bees spring-dwindled.

## Jottings from Huntingdonshire

The season of 1920 is over for bee-keepers. A new year for apiarists is just about to begin. Now? Yes, now! We must begin to make preparations for next year's honey flow. Bees will be packed down with bee ways or Rymer boards on the top of the frames, a nice cake of candy will be slipped under the quilt which may need renewing once or twice before spring feeding commences. Those stocks which had no, or scarcely any, stores should be united up to stocks of strength in numbers and honey. Wires across the entrances will prevent mice entering the hives. All signs of wax moth should be removed, apiece on the floor-board, and naphthaline balls in the quilts will do more than a little towards keeping the bees happy and healthy.

Just at this time bees get demoralised, disgracefully so at that. I extracted a box of shallow combs a week ago, and, after extraction, placed them back for the bees to clear up. Alas! every bee in the apiary smelt out that honey, and the hive in which the extracted combs were became a castle besieged on all sides. Experience makes fools wise, so never again do I give extracted combs to a stock, unless it be at night, to be removed in the morning. This particular hive lost all too heavily in its endeavour to keep robbers at bay. Not till I had covered the hive with sacks soaked in carbolic did the besiegers cease their warlike and thieving intentions.

Apart from the purple clover bloom and mustard there is very little nectar about; our friends, the knapweed, and rest-harrow are running to seed. The weather has been windy and wet, with occasional fine days these two weeks last past. Nights are decidedly nippy, but when one reads of snow in Westmorland and floods in Cheshire, one feels thankful that the weather has permitted the bees to take a flight most days. In a few days' time the ivies will be in full bloom, and when the days are warm every drain of nectar will be extracted and the blossoms fertilised, so that the seeds may be ready for the pigeons in winter. But although September has, like its two preceding months, disappointed us this year as far as our honey gatherers are concerned, it has its usual beauties. The tinted hedges, the variegated trees, the brilliance of the

ampelopsis and virginia creeper, the soft brown earth where the ploughs are busy just now, all add their charm to September. Newly-ploughed fields are, moreover, smothered with rooks and daws and starlings. Already birds are coming back to us from Norway and Sweden, while swallows and martins are preparing for their cross-continent flights to where in a warmer atmosphere the older birds may shed their feathers and re-plume themselves for another spring. Each year brings its outstanding features. What I have noticed particularly this past summer is the large number of weasels, snakes and herons. Weasels are a blessing; they prey on rats and mice, and a weasel or two in the vicinity of the apiary will keep marauding mice at bay—not so snakes. In 1917 I saw no snake; in 1918 one; in 1919 one, but this year I have seen scores. They are timid creatures, and soon dash off at the sight of human beings unless they are in a particularly comfortable spot, and it happens that beneath a hive is such a spot. I am not sure how many bees a snake would want for a good meal, but judging by what a toad will consume, I imagine that a snake would soon polish off a hundred, so if you go near a hive and hear a hissing noise coming from underneath, a stick had better be used for breaking the reptile's back.

Does the ash ever come out before the oak? is a question asked in last week's JOURNAL. Yes, it did in 1917, but not in 1918. In 1919 the oak and ash had a neck and neck race, and I think the ash won by a few hours; but singularly, the elms, which are generally well clothed long before oak and ash have hidden their branches behind green tracery, were left behind, and were the last trees to cover their winter nakedness. This year, the elms were unusually early, while the ashes were remarkably late. So far as my observation goes, oaks come out each year with little variation—at the most three or four days—while the ashes seem to depend altogether on February's weather, and the elms are guided by the dryness or wetness of the winter season. When elms are late in flowering they hold their leaf till late in the autumn; ashes, when out late, fade off early, and when out early hold tenaciously to their leaves until forced by autumnal gales to let them go. The only fault I have to find with Nature is there is so much of it. One cannot keep pace with the lessons she is continually teaching us, so one must concentrate on one subject; and if I notice the earliness or lateness of trees, the wealth or meagreness of flowers, it is because they have something to do with the honey flow. So while I am making candy, clean-

ing section racks, overhauling empty hives, and other things to do with an apiary, I shall be watching the drooping of the lime and poplars, as these trees, like the cypresses, exude a sugary substance of which the bees are very fond.—E. F. HEMMING, Steeple Gidding.

P.S.—Referring to onions as a remedy for bee diseases. This has been known for some time. A year ago I remarked that bees worked onion and leek flowers as a tonic. That excellent antiseptic, Yadil, is produced chiefly from garlic, and no bee-keeper should be without it.—E. F. H.

## A Swarming Problem.

A short time ago you were kind enough to answer some questions of mine about dividing my stock of Italian bees; perhaps the sequel may interest you—the sequel, that is, so far as it has developed.

My bee adventures seem never to end, but always to leave something "to be continued in our next."

If you remember, I was leaving home in the middle of April, and as I found a good many queen cells started, and drone brood formed, I was afraid the bees might swarm in my absence. So I cut out queen cells and put on a rack of shallow combs. I hoped the bees would work in this, and with your approval I was going to use it to divide the stock on my return.

I came home on Tuesday, April 27, and was obliged to be out the whole of the following day. My annoyance on my return at being told that the bees had meanly taken advantage of my absence to swarm was turned to relief when I heard that after clustering on a shed for a quarter of an hour they had gone back to the hive. Now they must be ready for division, I thought, and the next day I gathered an astonishing amount of apparatus round me and prepared for the fray. But there seemed to be so few bees in the rack and so few stores below (much less than when I went away owing to the bad weather that had intervened) that my inexperienced heart failed me, and I decided to leave the decision to Nature and wait for a swarm. Nothing happened that day; I waited in vain for "the scene of joyful enthusiasm which rarely fails to communicate itself to the bee-keeper," so graphically described in the text books. I was hastily summoned to witness it on Friday, but my own enthusiasm soon departed when after a mad dance in the air the bees draped themselves on the front and legs of the hive and finally went in.

I was now as keen on getting that

natural swarm as I had been previously on making an artificial division; and on Saturday I hardly stirred from the garden. My patience was rewarded when the bees came out once more, and this time clustered on the post supporting an espalier pear. They were nice and low—and I do dislike wobbly ladders—and the only question was whether the post would prove too firmly fixed to shake. I was immersed in my bee library, weighing the relative merits of brushing the bees down, or smoking them up, when the problem was solved for me. The post may have been immovable—the bees were not—and back to the hive they went.

This was getting past a joke, and that afternoon I went to take counsel of a more experienced bee-keeper. But his bees were a steady and self-respecting lot. All he could say was, that they had behaved so, perhaps three or four times in a quarter of a century—and mine had done it three times in four days! However, he was sure the bees would swarm properly the next day if the weather was suitable.

Sunday was showery and overcast, not at all inviting for bees. Still I didn't dare go out, but hovered over my flock till 1.30, and as they were quite quiet, then I went indoors for an hour. At 2.30 I came out once more—to see the all-too-familiar sight of a hive wreathed in bees. By now I was desperate—I couldn't contemplate spending the rest of my natural life glued to one spot waiting their pleasure—and I decided to divide them whether the time were propitious or not. I rushed indoors for my appliances, and coming out with the collection saw a cluster of bees up a pear tree. Evidently, in addition to those on the hive, a swarm had gathered there during my hour off guard. They were much too high up for my taste, but with someone to hold the ladder I got them into a skep. Now I made a mistake. The swarm wasn't big, and partly to increase its size, partly because I had read that bees wouldn't forsake brood, I decided to add a couple of combs from the parent hive. But a sharp shower came on, and I was hurried, and—without noticing, I put in a comb with a queen cell on it. You can guess the sequel. On the Monday I was shocked by an "S.O.S." call to my beautiful new hive that I thought I had established so nicely. While the swarm was in the air an agitated gardener (who hates bees) came running to say that the parent hive was swarming also. Two swarms at once! Only those hands as raw as myself can sympathise with the hectic hour that followed. I fled from one swarm to the

other, syringing each with water, afraid to lose sight of either, and in the intervals opened the two hives. The new one hadn't much in it, and the offending queen cell was soon out. But the other had six or eight ripe queen cells. As I watched, one princess came out, and others seemed ready to do so. I cut out about half a dozen, but didn't dare to be too drastic in case I left this hive queenless; and a high wind was blowing all the time, which made manipulation awkward, and made me afraid of chilling the brood; and then, too, I didn't like to leave my two swarms too long, so my examination wasn't very thorough. When it was over I turned my attention to the swarms. The cast from the original hive was up a fairly high apple tree, but I was getting inured to ladders, and took it in a skep all right. The other swarm was most conveniently placed on another low espalier in just the sort of place to encourage a beginner. I hadn't another skep, but I used the half of one of those double "pilgrim" travelling baskets in vogue ten or twenty years ago. I placed the two swarms on boards near their respective trees, and went in to a well-deserved dinner. Now, Mr. Editor, I should be glad of your comments on what followed. I planned that in the evening when returning the swarm to its hive, I would add the cast to strengthen it, at the same time removing the old queen and letting the virgin go in, to ensure the stock having a young queen. Was this idea all right? (Yes.—Eds.). All the afternoon I kept an eye on the swarm and the cast in their respective basket and skep, into both of which the old bees left drew in nicely. Then I left them for an hour and a half. Before 5.45 I went out to hive them—and found the skep empty! I was never so sold in my life. I could understand the cast flying off if they had done so before, but isn't it very unusual for it to have left the skep? They could not have done so in a mass, but must have come out and re-clustered after 4.15; and as the gardener does not leave till 5.30 it is a marvel how they could have done so unseen. I am quite sure that they did not trickle back to the parent hive during the afternoon.

[It is not unusual for a swarm or cast to abscond.—Eds.]

I should be very glad, if, in addition to telling me what you think of this, you would also let me know whether it is a common occurrence for bees to return to the hive so often before swarming, and whether Monday was not very soon for a cast to issue, even counting from the previous Wednesday when the swarm first came out? My bees are becoming a by-

word in the family, who are inclined to regard them as pests rather than pets—all we can say in their favour is that if they don't give much honey they give a novice plenty of opportunities of practice.—M. T.

[It is not unusual for a cast to come out only a few days after a swarm has issued. Much depends on previous conditions. If these are normal the cast usually comes out about the ninth day after the swarm, but should the weather be unfavourable for swarming when that event is due, i.e., about three days before the first virgin is due to emerge, and the swarm is delayed for perhaps three or four days, it follows the cast will most likely to come out only four or five days after the swarm, if the weather is suitable. In the above case the old queen was unable, or unwilling, to go out with the swarm, and thus delayed the event some days. She might eventually be lost or deposed, and the swarm issue with a young queen. The second swarm, headed by another young queen, would normally follow in about three or four days.—Ebs.]

### Notes on Bee Keeping.

A knock at the door. "Heigh, bi sharp, mester." "Why, whatever —" "Oh! mon, a bee-feight, folk wi yeards like Pat said th'edjog looked like—a pin-cushion wi pins stuck in rung road!" "But —" "Oh! do come win yo? Bees flyin' abate in aw derections. Women skarking like jays, as if somebody were sticking um like a pig. Such a mess as I ne'er seed afore; they flyin' in thouses an sheds, folk conna hoppen their durrs and windurrs, but they flyin' abate th'inside o't' hon'es everywee." I arrived on the scene, and found it exactly as my friend had stated. It was the old familiar song of robbing. Angry bees were dashing about in all directions; they had cleared out the poor man's lamb—a new beginner, with only one stock, this suffering from "I.O.W." disease, and bees too weak to defend themselves against intruders. Once the bees become accustomed to plunder, so far as they are concerned, "necessity knows no law"—they must have honey, or a substitute, at all costs. Hence the bees entering people's houses during an attack. We were busy removing the cause, when a voice rang out: "Ayr dun yo gerum inside thive, mester, in fust place, before yo start tacking thoney from um?" "Well, you see, we purchase bees established on drawn-out comb—these come to us in a travelling box, and are transferred into our own hive or we some-

times purchase a swarm in a receptacle, usually a straw skep or swarm box. Upon arrival we place them in a position where we intend the stock to stand, and leave them there until about an hour before sunset. If we were to leave them in a place other than where we intend the stock to stand for any length of time, the bees will mark the spot, and should we move them again more than two yards per day (and then only when the bees have been flying for the day), quite a number will be unable to locate their homes, and be lost." "Oh! But ha dun they find their road whoam tut th'ive?—they must be summut like pigins." "Yes, there is no doubt that bees, like pigeons, find their way home by landmarks. The compound eyes of the honey-bee are set well apart. The ocelli, or simple eyes (three), on the forehead between the two compound eyes, can be easily noticed through a strong magnifying glass, and these, according to experts, are able to see objects at a long distance. Now, coming back to the question of hiving, we then start to prepare a movable comb hive for their reception, filling up with frames of foundation—that is, sheets of bees-wax impressed by means of a machine with the shape of the base of the natural cells." "Oh! But what dun yo mean bi a stock or swarm o' bees?" "A stock is the term used when bees have already founded a home, with comb and brood attached, and a swarm of bees is a company which migrate in a body, leaving the parent stock, with a view to finding a suitable home." "Well, I see—nai ayr done you ger a swarm o' bees int' hive? I should think a chap stonds er good chance o' gerrin stung t' dee-ath—it's a quare job, I'm sure." "When a stock of bees decide to send out a swarm, members of that stock who intend to form part of the migrating body fill their honey-sac with honey from the cells in the hive, to last them about four or five days, and in this condition, gorged with honey, they are usually happy and less inclined to sting you, but if the bees have been hanging about a week or more before hiving takes place, they are usually very vicious and difficult to handle, owing to all honey having been consumed in their honey-sac. Now, in the matter of transferring the bees from the travelling box to empty hive, as mentioned, the bees will have to be brought into a state of subjection. To accomplish this, the bees must be frightened, which is a different procedure than frightening other members of the animal kingdom. It was discovered that when smoke was blown in among the bees, they were at once thrown in a state of great commotion, and in this condition they would gorge themselves

with honey, rendering them almost harmless. An appliance known as the 'smoker' accomplishes this. We then do what is required gently and quickly, cover up, and leave the bees to gather nectar —" "Nectar! What's that? Is it summut as grows on trees?" "Nectar is the product of flowers, and is met with in varying ways and quantities, in all flowers fertilised by insects, and is produced by Nature as an inducement for insects to visit these flowers, that they may, by their instrumentality, be rendered capable of the reproduction of their species. It is supposed by some betanists that not only is the nectar produced for this purpose, but also for nourishing the seeds in their early youth. The ground for this supposition lies in the fact that many flowers produce nectar even after they have been properly fertilised." "O-oh! Well, I'm sure I'm much obliged to yo for yore inflammation; it's gerrin' tay time, and mi bally's troubling mi abit, so I'll say good-day to yo, mester, and 'ope to see yo agin some day, and ha another talk abaat bees; maybi ast tack it int yead, start misell some day, and want yore advice; so good-day, mester."

Our questioner leaving us, we cleared up the appliances and returned home, feeling it was a day not spent in vain.

[I fancy, somehow, I shall be hearing again from my Lancashire friend, giving his experience "re bees." With your kind permission, I will communicate same to your readers.—P. LYTCHOE.

Padgate, Warrington, Lanes.

## The Crocus.

Who is the happy man or woman who has crocuses in flower and bees not far off? How much greater is his happiness if he realises just what is taking place. So I write in the hopes of adding to the happiness of some.

Let us imagine a bed of crocuses of mixed colours. Here is the first to flower the beautiful golden yellow; next comes the rather large flower of the purple, and the white comes about at the same time; but always the yellow first. Here they are all ablow in the sun.

The structure in each kind is much the same; six coloured petals all joined to form a narrow tube which is lost to sight at the bottom among the leaves. On three of these petals and growing from them are the three stamens with short, white stalks, and the most beautiful arrow-head anthers. It is these anthers which produce and hold the pollen so much sought after by the bees in these early days of the year. Right in the centre of the flower is the stigma, a gorgeous golden

brush. If we press it gently it will divide into three chief rays, each of them branched again.

Who knows the crocus seeds and fruit? We buy the flattened corms of the crocus in the autumn to plant, not seeds. After the flowers are over in the spring we hurriedly knot up the crocus leaves to make the bed look tidy and make room for the next flowers to bloom. Let us watch one plant for a week or two when the flower is over. If the seed has "set," as the gardeners say, we shall see, as the leaves wither, a small white pyramid pushing up among them. Taller it grows until it is hoisted up on a stalk a couple of inches long. This is the fruit—a capsule. Later it becomes dry and splits lengthways, showing six rows of pinkish seeds.

How have the seeds been "set?" If we pick a crocus flower we shall find that the brush-like stigma grows from a long, white stem which passes down the centre of the flower and is not joined to anything at the bottom. But if we pull up a plant and then trace the stigma down we shall find that the white stem of the stigma passes underground and is joined to a tiny white pyramid which is the immature fruit. The seeds are inside this, but have not yet been fertilised, and so are not ready to grow.

We will stand in the hot sun and watch the bees on a magnificent purple crocus. Here one comes all yellow with pollen on its underside and flies straight on to the brush-like stigma in the centre. This forms a good alighting place. The clever flower wants some of the pollen grains brought on the hairy body of the bees, and has provided itself with a brush as the best means of getting some.

For a moment we will leave the bee and follow the doings of the pollen grain. Soon it begins to push forth a white tube, which makes it look rather like a seed pushing out its first tiny root. But this pollen tube is hollow, and the contents of the pollen grain pass down into it. Longer and longer it grows, working its way down through the stem to which the stigma is attached and which is also hollow until finally it reaches that underground pyramid. Here it winds about until at last it reaches an opening in one of the immature seeds or ovules. Then the contents of the pollen tube pass into the ovule, fertilising it and turning it into a seed, which later will be capable of growing into a new crocus plant.

How quickly this pollen tube must grow! Crocus flowers are so short-lived! The third day generally sees them fallen over on to their side in such a way that the tube of the petals is bent and would not allow the pollen tube to pass. Must

the pollen tube then have grown some three or four inches in half as many days?

We left the bee on the stigma, allowing the flower to steal its pollen. Although it wants the pollen for its bread it can spare a few grains for so important a purpose as the fertilisation of the seeds. It soon leaves the stigma and crawls to the anthers where it busies itself in collecting more pollen. If when it was ready to leave the flower it climbed back to the stigma it would probably leave there some of the flower's own pollen which in the present stage of our knowledge we believe to be less good for fertilisation than the pollen brought from another plant. Fortunately then, for the flower, the bee finds it easier to climb up one of the petals, and it thus leaves the flower without touching the stigma again.

It is a curious fact that in the purple and white crocuses the stigma is ripe before the pollen, while in the yellow ones the pollen is ripe first. But in either case this lessens the chances of a stigma receiving pollen from the same flower or, as botanists say, of being self-pollinated.—I. H. JACKSON, Warwick.

[Those who are thinking of growing crocuses for early pollen for bees in the spring should plant the bulbs now.—EDS.]

## Grocers' Exhibition.

As a whole this exhibition is the best for some years, but, so far as quantity is concerned, the same cannot be said of the honey department. It was, however, a most creditable display, taking into consideration the very unfavourable season. The position allotted to it was not a very good one, and the honey did not show to the best advantage. The task of judging was no easy one, especially in the class for light honey, in which almost every exhibit was worthy of a prize. Two trophies were staged, two veterans of the show-bench, Messrs. Pearman and Bryden, competing, the former taking premier honours with a well-balanced and neatly staged exhibit. Wax was a very good though small class. There were only two colonial exhibits—one of honey and one of wax. The honey was a very fair sample. The wax was not so good. The only appliance staged was a wax extractor designed by Mrs. Willis, of Beaswing, Sudbury. The judge was Mr. J. Herrod-Hempall.

### LIST OF AWARDS.

Class 64. Complete outfit for beginner.—No entry.

Class 65. Trophy or display of honey, to be viewed from the front only.—1 and silver medal B.B.K.A., Mr. J. Pearman,

Derby; 2, Mr. G. Bryden, Star Hill, Rochester.

Class 66. 12 1-lb. sections gathered in the current year (not heather).—1 and bronze medal, B.B.K.A., Mr. G. Bryden; 2, Mr. J. Pearman; 3, Mr. W. J. Goodrich, Gloucester; 4, Mr. A. F. Knight, Kenwyn, Truro; 5, Mr. J. Silver, Croydon.

Class 67. 12 1-lb. jars light-coloured honey.—1 and certificate, B.B.K.A., Mr. G. Bryden; 2, Mr. W. J. Goodrich; 3, Mr. J. Pearman; 4, Mr. T. M. Taylor, Newenden, Kent; 5, Mr. W. Trinder, Edwinstowe, Notts; v.h.c., Major Hadfield, Alford, Lincs, Mrs. Essell, Beven Knoll, Worcester.

Class 68. 12 1-lb. jars medium-coloured honey (free from heather).—1, Mr. L. W. Matthews, Croekenhill, Swanley; 2, Mr. G. Bryden; 3, Mr. W. J. Goodrich; 4, Mrs. Essell; v.h.c., Mr. C. H. Rose, New Malden.

Class 69. 12 1-lb. jars granulated honey (of any year).—1, Mr. W. J. Goodrich; 2, Mr. J. Pearman; 3, Mr. G. J. Flashman, Shenley, Herts; 4, Mr. A. E. Warren, Simpson, Bletchley.

Class 70. Beeswax, not less than 3 lbs., in cakes suitable for retail counter trade.—1, Mrs. F. Harris, Sibsey, Lincs; 2, Mr. J. Pearman; 3, Mr. G. Scott, Brandesburton, Hull; 4, Mr. W. J. Goodrich; v.h.c., Mr. J. L. Davey, Spalding, Lincs.

### COLONIAL HONEY

Class 71. 12 1-lb. jars granulated honey.—2 (silver medal), Mr. C. Vaillancourt.

Class 72. Beeswax, 3 1-lb. cakes, judged for quality of wax only.—3 (diploma), Mr. C. Vaillancourt.

## British Bee-Keepers' Association.

The monthly meeting of the Council was held at 23, Bedford Street, Strand, London, W.C.2, on Thursday, September 16, 1920.

Mr. W. F. Reid presided, and there were also present:—Miss M. D. Sillar, Messrs. G. Bryden, G. S. Faunch, G. J. Flashman, G. R. Alder, W. H. Simms, J. B. Lamb, J. Herrod-Hempall. Association representatives, H. L. Stroud (Essex), R. R. Babbage (Middlesex), E. J. Waldock (Hants.), E. Watts (Herts.), W. E. Hamlin (Surrey), W. M. Valon (Staffs.), and the Secretary, W. Herrod-Hempall.

Letters of regret at inability to attend were read from Messrs. T. W. Cowan, C. L. M. Inles, F. W. Harper, W. Sanderson, G. Thomas, E. Burnett and Sir Ernest Spencer.

The Chairman referred feelingly to the loss of one of the oldest members of Coun-

cil, Mr. E. Bevan, and a vote of sympathy to the widow and family was passed.

The minutes of the previous meeting were read and confirmed.

The following new members were elected:—Mrs. E. F. Elias, Mrs. Stockley, Sister Mary of Ipswich, Mrs. W. Maxwell, Miss M. Heard, Lieut.-Col. H. W. Kettlewell, Messrs. T. Elston, A. P. Thomas, H. M. Stich, H. E. Read, E. J. Batten, F. Colburn, F. H. Dwyer, S. G. Kavas and W. M. Valon.

The following nominations of representatives on Council were accepted:—Devon: R. W. Furse; Kent: C. P. Jarman.

The report of the Finance Committee was presented by Mr. Bryden, who stated that the receipts for July were £48 7s. 2d., and the bank balance on August 1 was £159 12s. 5d. Payments amounting to £90 12s. 5d. were recommended.

The Herts. Association applied for a Preliminary Examination, and the same was granted.

Reports on Preliminary Examinations were presented, and it was resolved to grant certificates to the following:—Mrs. K. Mellroy, Mrs. Mappin, Mrs. A. Holman, Mrs. A. Goodrich, Mrs. Painter, Mrs. N. Joshua, Misses M. L. Barter, C. M. Holmes, D. M. Cooper, M. Hodgkins, E. Mead, D. Adam, H. Adam, K. Capewell, S. Fox, E. Beard, R. Laurens, R. Tamplin, W. Miller-Hallett, E. Bendall, E. Fisher, C. Dyson, M. Billinghurst, M. Alden, D. Watson, A. Hetherington, I. Rutherford, K. Miller, E. Watt, M. Bindley, M. Tait, K. Anear, J. Frost, D. Butterfield, K. Wilmot, M. Wray, D. Welti, V. Browning, N. King, I. Ruys, C. Bandium, K. Worsley, H. Lambert, M. Meakin, Rev. E. J. Phillips, Rev. E. Chilcott, Rev. B. H. Tyrwhitt-Drake, Rev. C. H. Whitfield, Messrs. C. Walker, E. Allcock, W. Armor, H. Ward, J. W. Cadman, J. Pickston, G. E. Cox, K. Dawson, W. Hodgson, G. G. Ray, H. J. Sawyer, E. C. Scott, W. F. Hayward, M. K. Watt, W. Hamilton, F. J. Hayman, M. Kale, A. F. Birch, J. Enoch, J. Winterbottom, P. C. Guthrie, H. James, T. Morris, W. Comery, H. Aubery, D. J. Griffiths, P. H. Bray, W. J. Cook, F. Jefferies, E. J. Hawkins, A. E. Goodead, W. Trinder, C. Wellings, P. Ryan, R. Harris, W. H. Barnacle, J. W. Earl, J. Humphries, G. W. Harrison, W. H. Smith, E. Jeffery, F. Watson, S. Williams, J. C. Quale, A. W. Austin, J. C. Anderson, W. E. Sandars, J. B. Leighton, T. Stanley, H. P. Young, W. E. Parsons, A. Collett, P. J. Franklin, G. H. Brooks, J. L. Tickell, C. M. Rickards, J. Merriek, P. Skidmore, W. Pullen, H. Lanchbury, W. J. Bailey, P. Lennard,

A. Holman, T. H. Clarkson, J. Pugh, J. D. Stafford, W. H. Cook, H. B. Wisdom, F. W. Wibberley, H. Slack, A. Green, W. Davidson, G. Bannister, S. Milton, R. Roberts and J. Bannister.

Arrangements were made for the autumn conversazione to be held on Thursday, October 21, 1920, Dairy Show week, in the Central Hall, Westminster, to commence with a reception by the Chairman and Council at 2 p.m. At 3 p.m. Mr. G. Bryden will give his experience of bee-keeping in Italy. Tea will be provided for members and friends at 4 p.m., and at 5 p.m. Mr. J. Price will speak on "The Production of Heather Honey."

Arrangements were made for the Intermediate Examination to be held on the last Friday and Saturday in November.

A letter was read from the Aberdeenshire Association *re* examinations. After some discussion the matter was deferred till the November Council meeting.

Next meeting of Council, Thursday, October 21, at the Central Hall, Westminster.

### Sheffield and District Bee-Keepers' Association.

A show of honey and wax was held at the Weston Park, Sheffield, in connection with the Exhibition of Allotments Produce, on September 9, 10 and 11. There was an excellent display of exhibits, and the staging was extremely well carried out. The Rev. G. H. Hewison, of Marr, Doncaster, acted as judge of the exhibits, and he gave lectures and demonstrations in the bee tent each day. The lectures were well attended and much appreciated. In class 5 there was a splendid display of comb honey, which well merited first prize and the award of a silver medal. The sections exhibited were uniform and perfect.

Class 8 consisted of a magnificent display of over 60 lbs. of honey and wax, in different forms, and reflected great credit on the exhibitor and well merited the medals awarded.

Mr. Garwell showed an observatory hive of three frames (not for competition), and this created much interest amongst the visitors to the show.

Some 36 feet of bench space were allotted for the bee-keeping products, and the space was well occupied. Mr. Garwell and other members of the Association spared no pains to make the show a success. One interesting part of the exhibition was a splendid display of appliances. Everything necessary for bee-keeping was on show, including a complete W.B.C. hive.

Some photomicrographs of parts of the

honey bee, taken by the Rev. G. H. Hewison, created much interest, and were much appreciated.

The show altogether was a great success, and reflects much credit for the work done by the members of the Association.

#### LIST OF AWARDS.

Class 1: Six bottles of extracted honey.—1, Mr. W. Bashforth (also bronze medal); 2, Mr. P. Ridge; 3, Mr. C. M. Hansell.

Class 2: Six bottles of granulated honey.—1 and 2, Mr. W. Garwell; 3, Mr. P. Ridge.

Class 3: One-pound bottles of extracted honey.—1, Mr. W. Garwell; 2, Mr. P. Ridge; 3, Mr. W. Bashforth. Gift class. All exhibits in this class to be given to the Children's Hospital.

Class 4: Heather honey.—No entries.

Class 5: Twelve sections of comb honey.—1 and silver medal, Mr. W. Garwell.

Class 6: Six sections of heather honey.—1, Mr. W. Garwell.

Class 7: Two shallow frames of honey.—No entries.

Class 8: Display of comb and extracted honey and wax.—1 and gold medal, also a silver medal from the City of Sheffield Corporation for a most meritorious exhibit, Mr. W. Garwell.

Class 9: One-pound cake of wax.—1, Mr. W. Garwell; 2, Mr. P. Ridge; 3, Mr. F. P. Tyas.



*The Editors do not hold themselves responsible for the opinions expressed by correspondents. No notice will be taken of anonymous communications, and correspondents are requested to write on one side of the paper only and give their real name and addresses, not necessarily for publication, but as a guarantee of good faith. Illustrations should be drawn on separate pieces of paper. We do not undertake to return rejected communications.*

### De Virginibus—and Others.

[10304] I am afraid Mr. Houston is doing the craft a disservice by advising the re-queening of full stocks with virgins. It is a very serious thing for a stock to be without a laying queen for any length of time. Mr. Houston says, "if the stock, the virgin, and the weather are exactly right, a safely introduced virgin may, in about three weeks, be found a laying queen." The inference being that, under unfavourable conditions, the period will be longer. It will be found that Italian virgins nearly always take longer to mate than natives, and this militates against the system, to which must be added the risk of loss through mating. Criticism is

of little use without construction, therefore I would suggest the older method, when a stock is to be re-queened, of making a nucleus from that stock, standing them close together, and giving that (the nucleus), the virgin, allowing the old queen to hold the stock together until the virgin is mated and tested, then join up again. Mr. Houston's "great recommendation" is here just as valuable, with the added advantage of being able to test the queen for purity of mating, with no break of brood rearing in the stock.

*Re Colour of Queens.*—A newly-sealed queen cell, given to a small nucleus, will always, in cool weather, produce a darker queen, but as this has no colour effect on her progeny it is of little consequence, unless reared for sale. The moral is evident: do not use small nuclei.

(10,278) I, like Mr. Manley, cannot grasp Mr. Judge's remark, that a large young population saves food in the winter. Perhaps Mr. Judge will amplify. Also regarding size of frames; if Mr. Judge means exactly what he says, I am in agreement with him, that standard frames are ideal for surplus honey, but I prefer the 16 by 10 for brood. I am pleased to read the Editorial comment that Mr. Judge's remarks did not refer to the Apis Club; I am afraid a great many readers, myself included, thought otherwise. Am I correct in presuming that the writer is not the genial member of the Kent B.A.? (Yes. It will be noticed the initials are F. W. not G. W.)

*Metal Combs*, pp. 453.—Several users of the Macdonald combs have complained that the brood is scattered in these combs, and that the queen will not oviposit in the cells traversed by the sustaining wires. I am inclined to put most of the blame on the queen. I enclose a rough photograph of a comb of "aluminium brood," which I think you will agree is fairly compact.—GILBERT BARRATT.

[The photograph shows a comb well filled with brood. A comb at this office, given by Dr. Abushady, has also evidently been filled compactly with brood, but we notice the cells traversed by the sustaining wires have not been used. This is not so marked in the photograph, though there are indications that these cells would probably be used last, nearly all the cells on one wire, and about half on another not being used.—Ems.]

### Introduction of Virgins.

[10305] I was pleased to read the article "De Virginibus" by Mr. Houston in the B.B.J. of September 16. The directions given for the introduction of virgins are good, and may be relied upon to give excellent results. Mr. Houston says that



to leave the hive severely alone for at least a fortnight after the virgin has been introduced "is the heart of the problem of successful re-queening with virgins." This is a *sine qua non*, as I can vouch for by my own experience, though my methods are slightly different. I have found two which have given quite satisfactory results; they are as follows:—

*1st Method.*—After feeding the virgin with honey, she is put in a cage by herself for 36 hours over the feed hole. At the end of that time she is released, first of all making sure that the bees are favourably disposed. An examination is made the next day, and after finding the virgin, the comb on which she is found is well sprayed with thin syrup before replacing in the hive. This last procedure may be superfluous, but I use it as an extra precaution. The hive is then left entirely alone for a fortnight, or longer, if the weather conditions are unfavourable.

*2nd Method.*—The virgin is placed in an ordinary travelling and introducing cage with candy. The colony to which she is to be introduced is then opened up and about a dozen nurse bees (the very youngest) are picked from the comb and placed with the virgin in the cage, which is then placed over the feed hole and the hive closed. The bees release the virgin by eating through the candy. An examination is not made until the weather conditions have been favourable, and have lasted sufficiently long to give full opportunities for the necessary flight. In determining the requisite length of time the following are taken into consideration:—

(1) First week after introduction not to be taken into account.

(2) If weather conditions unsatisfactory during the second week, leave well alone.

(3) If weather conditions are favourable during the second week, examine at noon on the sixth or seventh day of that week. Prior to this examination taking place the bees are sprayed through the tops of the frames. I have found that if the virgin has not been out for her flight, this spraying keeps the bees busy whilst the examination is taking place, and thus tends to avert a calamitous consequence.

T. W. WILKINSON.

### Mongrel Bees.

[10306] I would like to congratulate Mr. Hemming on his article "Mongrel Bees." It is pure common sense all through. The extent to which bees have become mongrels is deplorable. The con-

trol of mating is, of course, the crucial point. It would be most interesting, I think, if some of the queen breeders in England could give their views on this. It seems to be so usual for queens to mate with another variety of drone that perhaps we must allow that the queens actually prefer a drone of another variety or that the choice is on the side of the drones. What do you think about this yourself?

[Our impression is that queens prefer, at any rate, a drone from another hive, and possibly of another variety, judging by the number of hybrids or "mongrels" there are.—Eds.]

I can only say how sorry I feel for poor Mr. Aveline. There seems little else to be said. He should comfort himself with the reflection that your humble correspondent is in such a state of mental disability that "reason is beyond him." I am sure he will find comfort in that.

R. B. MANLEY.

### Bees in a Tree.

[10307] A friend of mine had a colony of bees in a cavity of an old ash tree, and as our experience in inducing them to leave their home for a skep may be of interest to other bee-keepers I send you these details.

Swarms from the old ash tree were very frequent, and as my friend was unable to catch any of them he asked me to try and get the colony out of their home. First I fixed a stand near the hole in the trunk and placed on it a skep, the opening being directly opposite the bees' outlet from the tree. After a week's interval there came a swarm from the tree and made its home in the skep. This was then put in a W.B.C. hive and the skep replaced as before. A fortnight later the whole colony migrated from the ash tree to the skep, and all are now safely housed in W.B.C. hives.—T. REES, Ty'r Waun Apiary, Carmarthen.

### Combs from Other Hives.

#### Intoxicated Bees.

The following cutting may be interesting and amusing.—E. W. FRANKLIN, Mouldsworth.

#### THE BLACK SPOT.

[The Department of Agriculture, says a Central News message from Washington, has received a report from a farmer in Fairfax County, Va., that he is experiencing considerable trouble with his bees. They have tired of their regular work of filling honeycombs, he says, and from pure devilment have dropped on the ground under his apple trees and there

made themselves drunk by consuming the oozing juice of decaying fruit. The farmer anticipates a serious financial loss owing to his bees' behaviour this year.]

How doth the busy little bee

Go posting to perdition—

The only U.S. native free

To mock at Prohibition!

From sea to sea no human thirst

Affronts that sober scheme;

Only the bee is on the burst

And breaks Columbia's dream.

How strange that in that land of drought

Our old industrious model

Should take to drink and lie about

Too screwed to fly or toddle!

With all his labours unbegun

He snores beneath a tree

(Forgive an unintended pun)

As drunk as drunk can be.

O Massa Johnson (Pussyfoot),

Ere next you cross our border,

You'd better hustle round and put

Your own affairs in order:

To all the birds, from rook to wren,

St. Francis preached with ease—

Before you tackle us again

Convert those horrid bees!—LUCIO.

From the *Manchester Guardian*,  
August 11, 1920.

## Novelties for 1920.

THE "WILLIS" WAX EXTRACTOR.

This useful extractor has been designed by Mrs. Willis, of Beeswing, Sudbury. It is intended more especially for those having only a small amount of comb, etc., to deal with, and it is claimed that it will

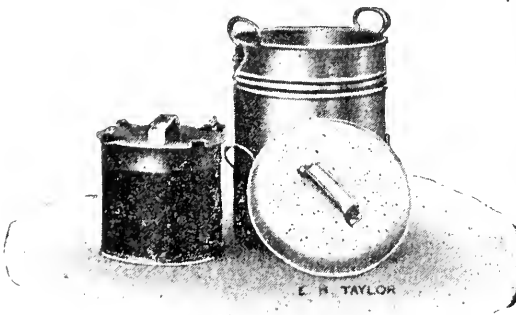

extract the wax from the toughest brood combs with about three-quarters of an hour's boiling. With softer wax it requires no boiling at all, but simply simmering.

Simplicity itself, it consists of a perforated basket which, after being filled

with old broken comb, is fastened down in a container filled with soft water and allowed to boil until wax is dissolved. Thereafter nothing remains to be done but to lift off cake of wax from surface when cooled, and empty basket of refuse.

The price is 33s., from L. Willis, Beeswing, Sudbury, Suffolk, or E. H. Taylor, Welwyn, Herts.

## Bee Shows to Come.

**October 2 (Saturday), Rochester.**—Combined County, Northern and Midland Division Honey Show, Masonic Hall, Gundulph Square, Rochester. 11 Classes open to members of K.B.K.A.—W. Carter, 2, York Road, Rochester, Secretary. **Entries closed.**

**October 5 to 8.**—Essex Fruit and Honey Show at Institute of Agriculture, Chelmsford. Open from 12 to 8 p.m. Admission free. Lectures and demonstrations each day.—Schedules from G. R. Alder, 7, Bulwer Road, Leytonstone.

**October 19 to 22.**—Dairy Show, Agricultural Hall, London. Open Classes for Honey, etc.—Particulars, Secretary, Dairy Farmers' Association, 28, Russell Square, London, W.C.1.

**November 18.**—Annual Show of the Worcester City and County Chrysanthemum, Fruit, Root and Honey Society. Thirteen Open Classes in Honey Section.—Schedules from Geo. Richings, 42, Barbourne Road, Worcester. **Entries close November 6.**

## Special Prepaid Advertisements. One Penny per Word.

Will advertisers please read these Rules carefully in order to save trouble, as they will be strictly adhered to.

**Trade advertisements of Bees, Honey, Queens, and Bee goods are not permissible at above rate, but will be inserted at 1½d. per word as "Business" Announcements, immediately under the Private Advertisements. Advertisements of Hive-manufacturers can only be inserted at a minimum charge of 3s. per lin., or 6s. per inch.**

**PRIVATE ADVERTISEMENTS are only intended for readers having Surplus Stock to dispose of. Driven Bees, Nuclei, and Queens that are reared or imported for sale, are Trade Advertisements, and can only be accepted under trade terms. A charge of 6d. extra will be made if a box number is used.**

Advertisements must reach us **NOT LATER** than **FIRST POST** on **MONDAY MORNING** for insertion in the "Journal" the same week.

Orders for three or more consecutive insertions in "The Bee Journal" entitle advertisers to one insertion in "The Bee-Keepers' Record" free of charge.

## PRIVATE ADVERTISEMENTS.

**FOUR STOCKS ITALIAN HYBRIDS, 1920** Queens, guaranteed healthy, two on 10 frames, £4, each; two on 6 frames, £2 10s. each, including travelling boxes and carriage paid.—**JAMES GLADDING**, London Road, Copdock, Ipswich. h.224

**BEE HIVES**, Bottles, Extractor, and other Appliances for Sale; all good stuff. Send stamp for list.—**JAMES GLADDING**, London Road, Copdock, Ipswich. h.225

**VACANCY** for permanent situation occurs for good Carpenter thoroughly experienced in hive-making and bee carpentry generally; must be capable of acting as Foreman.—Box 103, B.B.J. Office, 23, Bedford Street, Strand, London, W.C.2. h.158

**B**EES FOR SALE, very strong stock, warranted free from disease, 10 frames, price £4, carriage extra.—Forest Lodge, Penselwood, Bourton, Dorset. h.227

**F**EW vigorous 1920 Fertile Queens, 10s.; Dutch Hybrids.—H. WILCOX, 46, Lyndon Road, Olton, Warwickshire. h.228

**H**EATHER HONEY wanted for cash.—A. GORDON ROWE, 28A, Moy Road, Cardiff. h.229

**F**IVE good Stocks, pure Italian and Hybrids, 1920 Queens, in hives with supers, etc., new extractor. What offer?—"W." "Rowstock," King's Road, Horsham. h.226

**10**-FRAME STOCK, healthy Hybrids, £3; hive 10s. extra.—TUCKER, Shaw, Newbury, Berks. h.235

**T**WO pure 1920 Italian Queens for 17s. 6d., 9s. each.—HOLLINGSWORTH, 1st Class Expert, Heanor. h.237

**L**ARGE HONEY PRESS, Stand and Tank, 32s.; worth 70s.—McLOUGHLIN, Littlethorpe, Ripon. h.238

**H**IGH-CLASS HONEY (white), in 7, 14 and 28-lb. tins, 2s. lb.; also in screw-cap bottles, 28s. dozen, f.o.r.—WHYTE, Bee Farm, Cumbernauld, Dumbartonshire. h.205

**F**OR SALE, about 35 Stocks and Swarms of Hybrid Ligurian Bees on 8 to 10 frames and Nuclei; mostly this year's Queens; excellent workers.—REV. A. H. HALLEY, Crathie, Wellington College, Berks. r.h.79

**W**ANTED, Cheshire's Diagrams.—KENWARD, Berwyn House, Lewes, Sussex. h.112

**B**EE BOOKS, MAGAZINES, wanted, especially Allen, Butler, Cheshire, Huber.—J. MOIR, Librarian, Scottish Bee-keepers' Association, 64, Polwarth Terrace, Edinburgh. r.h.186

**BUSINESS ADVERTISEMENTS.**  
1½d. per word.

**I**TALIAN QUEENS.—Signor Penna is sending us a few selected Fertile Queens, which we can offer at the unusually low rate of 7s. 6d. each. Orders in rotation. Supply very limited.—PEARSON & GALE, Marlborough. h.221

**H**ONEY 9d. PER LB.—Choicest Colonial Honey, in original cases, two tins 60 lbs. each in case, 9d. lb. on rail Liverpool; cash with order.—AYSCOUGH, 3, Duke Street, London Bridge, S.E.1. Est. 1899. h.232

**S**AVE YOUR BEES.—Finest Australian Honey, two 60-lb. tins, 112s., carriage paid 100 miles, elsewhere 2s. less, carriage forward; cash with order.—SUNUT, LTD., Australian Merchants, New Hibernia Chambers, London Bridge, S.E.1. h.233

**M**ASHEATH MEMS.—"I am more than satisfied with the Masheath—I am very well pleased."—W. G. ATKINSON, Fakenham. h.234

**I**TALIAN HYBRIDS.—Few small Stocks in boxes with young Queens, 12s. 6d.; Driven Bees with ditto, 8s. 6d.; Queens, 6s.—BOWREY, Swallowfield, Berks. h.236

**A**USTRALIAN HONEY FOR FEEDING BEES.—Cases containing two tins, about 60 lbs. each, 110s. per case; 1 tin 56s., carriage paid 100 miles. Remittances with orders.—SOUTHWOOD, 95, Acton Vale, London. r.h.190

**"W**IGHT" DISEASE, prevention and removal; advice 5s.—ALF. RYALL, Cottage Farm, near Camp, Stroud. r.h.187

**S**ACRIFICE.—Must be sold. Forty Fertile 1920 Black and Hybrid Queens, 5s. each; delivery by return.—PEARSON & GALE, Marlborough. h.222

**N**O SUGAR VOUCHERS NEEDED.—Flavine or Plain Candy, same price, 6 lbs., 10s., postage 1s. 3d. extra; larger quantities by passenger or goods train. Made in Cambridge, and the wrappers on the Flavine Candy bear our name and the maker's address.—S. H. SMITH, 30, Maid's Causeway, Cambridge. h.218

**G**ENUINE pure Golden Italian Queens, imported direct from Penna. Can now supply per return. 100 due in 14 days. Prices while they last: One Queen, 9s.; two, 17s.; three, 24s.; specially selected, 10s. 6d. each.—GOODARE, Italian Specialist, New Cross, Wednesfield. r.h.177

**F**OR TWO WEEKS ONLY.—To clear, 40 Fertile 1920 Black and Hybrid Queens, 5s. each; delivery by return; unique bargain.—PEARSON & GALE, Marlborough. h.223

**H**AVE YOU READ "THE BEE WORLD"? If not, why not? Every number in itself is a useful literary work for practice and reference. Specimen copy free.—Offices: THE APIS CLUB, Port Hill House, Benson, Oxon.

**"I**SLE OF WIGHT" DISEASE.—Don't worry; use the solution that cures; 2s. per bottle.—E. PRESSEY, St. Elmo, Coulsdon. r.d.149

**S**URPLUS HIVES and Appliances for Sale, good condition, cheap.—PEARSON & GALE, Marlborough. r.h.151

**ITALIAN QUEENS**

Direct from Italy.

Address:  
**Signor Gaetano Piana,**  
Castel San Pietro,  
near Bologna, Italy.



All Queens are reared by the most up-to-date and scientific methods. Mr. W. Herrod-Hempsall has personally inspected the apiary and methods employed, with which he is perfectly satisfied.

**PRICES FOR 1920.**

**For 1 Fertile Queen: August and September, 9/- each queen.**

Carriage paid in Great Britain. Cash must accompany all orders, which will be executed in rotation. Guaranteed safe arrival of all Queens, but not the introduction. Bees dead upon arrival must be sent at once to "B.B.J." Office.

For the mutual convenience of all parties, if Signor Piana has made arrangements that all communications, orders and remittances of the readers of "B.B.J." and "B.K.R." can be addressed to him, c/o British Bee Journal, 23, Bedford Street, Strand, London, W.C.2., Cheques payable to "British Bee Journal."

**THE British Bee-Keepers' Association.**

The recognised centre of practical and scientific bee-keeping in Great Britain. Particulars and conditions of membership may be obtained from the Secretary, **W. HERROD-HEMPSALL, 23, Bedford Street, Strand, London, W.C.2.**

**SPECIAL OFFER.****Honey for Feeding Bees.  
QUICK DELIVERY.**

**FINE WHITE CLOVER AUSTRALIAN.** In cases containing 2 tins, each about 60 lbs., **114/6** per case.

**FINEST WEST INDIAN.** Cases containing 1 tin about 60 lbs., **68/6** per case; cases containing 2 tins, each about 60 lbs., **135/-** per case.

**ALL CARRIAGE PAID (within 100 miles).  
Cash with Order.**

So great has been the demand for our Honey that there has been some little delay in delivering the Australian variety. We beg to apologise to those of our customers who have had to wait for their goods. The trouble has now been rectified and we can promise immediate dispatch.

**LONDON TRADING AGENCY, 32, ST. MARY AXE, E.C. 3.**

**INSURE YOUR STOCKS****AGAINST "L.O.W." AND OTHER INFECTIONS.**

Science has now placed within reach of every Apiarist a safe and certain preventive of infection in "Yadil" Antiseptic.

For **SPRING FEEDING** "Yadil" may be added freely to Syrup.

For **DISINFECTING** Bees and Combs a five-per-cent. solution in tepid water should be used with a fine spray.

**ASK FOR GREEN LABEL.**

**Our Bee Brochure sent Free on Application.**

**CLEMENT & JOHNSON, 19, Sicilian Avenue, W.C.1.**

**AYRSHIRE AGRICULTURAL ASSOCIATION.**

Sixty-Sixth Annual Show of **DAIRY** and **FARM PRODUCE**; also **BUTTERMAKING COMPETITION** at

**KILMARNOCK, 21st & 22nd OCTOBER, 1920.**

Special Competitions for **POTATOES, VEGETABLES, FRUIT AND HONEY.**

Also **ALLOTMENT HOLDERS' CLASSES** and **HOME BAKING COMPETITIONS.**

Total Premiums **£500.** Entries close, **Friday, 8th October.** Premium Lists on application to—

**JOHN HOWIE, Sec., 58, Alloway St., Ayr.**

**JOT DOWN** the deficiencies of your present equipment and your needs for future improved working. Then book for "**MASHEATH**" (Regd.) Equipment for autumn construction.

The **MASHEATH LIST** contains a unique series of Hives unequalled to-day. You should not enter upon another bee season without them.

"The Hives (Porchless Masheaths) are excellent in every way, and I am very pleased indeed with them. '**PORCHLESS!**' Yes, every time. Need I say more? I will get you to send me two more."  
—W. F., June 17, 1920.

The **MASHEATH HIVES TALK** as soon as they are delivered.

**ATKINSON, Proprietor and Sole Maker, Fakenham.**

Preserve your Bees during the Winter by feeding with **PINK BACTEROL BEE CANDY**

Manufactured by

**HAWKES BROS., LTD.,**  
— Chelmsford, Essex —

Prices on application.

The products of the Apiary, of Poultry and Farm Stock, of the Fruit and Vegetable Garden can be Advertised and Sold through

THE **BAZAAR, EXCHANGE & MART**  
Newspaper.

Get a Copy—Thursday and Saturday 3d. The "Bazaar" publishes also practical handbooks by experts. Send for full catalogue, post free from—**WINDSOR HOUSE, Breems Buildings, LONDON, E.C.2.**

**BARGAINS IN SURPLUS CLOTHING.**

FOR 14 DAYS ONLY TO CLEAR.

Best quality new full size Fawn Australian Blankets, **42/-** pair.  
Best quality new full size Grey Australian Blankets, **35/-** pair.  
Best quality Officers' Bedford Cord Riding Breeches, **42/-** pair.  
Best quality Officers' Cord Riding Breeches, strapped, **25/-** pair.  
Good quality Cord Riding Breeches, **10/6** pair.  
Dark Heavy Tweed Overcoats, suitable farmers, etc., **25/-** each.  
Best quality new Army Puttees, **4/6** pair.  
Good Blue Serge Trousers, suitable for working men, **12/6** pair.  
Good Blue Serge Trousers, as new, **15/-** pair.  
New Blue Serge Trousers, best quality obtainable, **21/-** pair.  
Khaki Drill Trousers, as new, all sizes, **7/6** pair.

Khaki Drill Jackets, as new, all sizes, **7/6** each.  
Khaki Drill Jackets, Officers' quality, **10/6** each.  
Khaki Drill Trousers, Officers' quality, **10/6** pair.  
Cardigan Jackets, as new, **8/6** each.  
Bath or Carriage Sponge, large size, to clear, **1/6** each.  
New Holeproof Trousers, everlasting wear, **18/6** pair.  
New Blue Trousers, all sizes, **16/6** pair.  
New Officers' Poplin Soft Collars, **4/-** dozen.  
New Officers' Khaki Collars, **4/6** dozen.  
New Striped Union Shirts, best quality, **8/6** each.  
New Indigo Blue Serge Ladies' Skirts, **15/6** each.  
As new Indigo Blue Serge Ladies' Skirts, **8/6** each.

THOUSANDS OF OTHER BARGAINS. SEND FOR LISTS FREE.

**SACAR'S ARMY SURPLUS STORES (Dept. 29), ARDWICK, MANCHESTER.**

**8/-** Of the Author, S. SIMMINS, QUEENLAND, HEATHFIELD, SUSSEX.  
**SIMMINS "A MODERN BEE FARM"**

POST FREE Nearly 500 pages. A few more copies at 8/-. Any further edition must cost 50% more

**Bees and Beekeeping Appliances. Catalogue free.**  
**EDWARD J. BURTT. MANUFACTURER. GLOUCESTER.**

*I very much regret that there has been a large increase in the cost of the manufacture of bee appliances, and therefore my prices will be advanced 10% from May 10th. Books excepted.*



**"BACTEROL"**  
FOR BEES

2/9 per Bottle.

Post Free.

The cure for, and preventive of, "Isle of Wight Disease." Non-poisonous—free from stain or unpleasant odour.

**MENLEY & JAMES, LTD.,**  
Menley House, Hatton Garden, E.C.1.



**BEST CLEARING and WINTERING BOARD, SUPER CLEARER, &c.**

A Necessity for all Bee-Keepers all the year round.

**MEADOWS, SYSTON, LEICESTER.**

**POSITIVE FACTS.**

June 13th, 1920.

I am very pleased with the foundation. The bees undoubtedly prefer it to any other make I have, and have even gone the length of missing two sheets of other new foundation, and working out a sheet of yours placed behind them at the back of the hive. Full sheets have not sagged in the least in 16 x 10 frames.

Yours faithfully, R. B. MANLEY

Illustrated Lists free by post.

**S. J. BALDWIN, The Apiary, BROMLEY, Kent.**

# FOUR FIRST PRIZES.

Our HIVES and APPLIANCES were again awarded FOUR PRIZES at the Highland Agricultural Society's Show at Aberdeen, thus testifying to the superiority of our goods. Order now and ensure your bees wintering in good hives.

**BOTTLES.** We hold a large stock and can give immediate despatch.

**CANDY.** Safeguard your bees from starvation by feeding with our FAMOUS BEE CANDY. Price **1/6** per 1-lb., carriage extra.

Sole Agents for DADANT'S WEED FOUNDATION. Absolutely pure. Once used, always used.

Large illustrated catalogue, entitled, "Everything for an Apiary," post free on application.

**R. STEELE & BRODIE,**  
*Bee Appliance Makers,*  
**WORMIT, FIFE.**

Telegrams:—"Bees, Wormit."

Telephone:—28 Wormit.



## Lee's Bee Supplies.

¶ In design, material and workmanship, Lee's Bee Supplies still retain the reputation of being your best and safest investment.

¶ Our 1920 ILLUSTRATED CATALOGUE is yours for the asking. It contains detailed information on the most up-to-date hives and appliances for which the House of Lee is famous.

¶ We regret the necessity of having to advise our Customers that owing to the increased cost of production, all prices in 1920 price list are subject to 10% increase. The increase will not apply to orders received before May 10.

\*.\* Five per cent discount to Members of THE APIS CLUB.

**JAMES LEE & SON,**  
LTD.,  
Uxbridge, Middlesex.

(Telegrams: Graphicly, Uxbridge.)

Telephone: Uxbridge 181.)

NOV 1 - 1920

No. 1998. Vol. XLVIII

OCTOBER 7, 1920.

[Published every Thursday, Price 2d.]

**CONTENTS.**

	PAGE		PAGE
SEASONABLE HINTS .....	481	SCIENTIFIC WINTERING .....	487
A DORSET YARN .....	481	BEE DRIVING IN SARK .....	488
JOTTINGS FROM HUNTINGDONSHIRE .....	482	ECHOES FROM THE HIVES .....	489
JOTTINGS .....	483	MONMOUTHSHIRE BEE-KEEPERS' ASSOCIATION .....	489
MEMS. FROM MONMOUTHSHIRE .....	484	CORRESPONDENCE—	
BEE-KEEPING INSTRUCTION .....	484	Bee Notes from South Devon .....	490
MINER AND TAPESTRY BEES .....	485	Treating "I.O.W." Disease .....	490
ALUMINIUM COMBS .....	485	A Line from Lincolnshire .....	490
NOTES ON STOCKS .....	486	Young Bees for Wintering .....	491
EXPERIENCES WITH QUEENS IN 1920 .....	486	NOTICES TO CORRESPONDENTS .....	491
WINTERING .....	487		

# FOOD FOR BEES.

Owing to the continued bad weather there is a likelihood shortage this Winter. To prevent loss of Stocks order at once TAYLOR'S renowned

## SYRUP

In tins, 7 lb., 14 lb. and 28 lb. at  $\frac{1}{3}$  per lb., Carriage extra.

We are in a position to supply, without vouchers, the best

## CANDY

made from pure Sugar, plain or medicated,  $\frac{1}{6}$  lb. Carriage extra.

**E. H. TAYLOR, WELWYN, HERTS.**

Telephone—WELWYN 13.

THE  
**British Bee Journal**

Office: 23, Bedford Street, Strand, London, W.C.2.  
ESTABLISHED 1873.

A Weekly Journal Devoted to the  
Interests of Bee-keepers.

Edited by T. W. COWAN, F.L.S. &c.,  
and J. HERROD-HEMPSELL, F.E.S.

**Correspondence: Whom to Address.**—All matters relating to the Literary Department, Associations, Shows, etc., should be addressed, "Editors, *British Bee Journal*," and all business communications and matters relating to subscriptions and advertisements to be addressed to the "Manager," *B.B.J.* Office.

**Subscriptions.**—Annual Subscription, 10s. 10d. post free in advance; single copies 2d., or 2½d. post free. If a receipt is required by post, a stamped and addressed envelope must be sent, otherwise a printed receipt will be enclosed along with the paper.

**Note.**—Cheques and Postal Orders should always be crossed, otherwise it is very difficult to trace them if they go astray.

**How to send Money.**—Remittances can be made payable to W. Herrod-Hempshall by crossed Cheques and Postal Orders. Stamps may be sent for small amounts up to 2s. *Half-penny stamps are preferred.*

Scottish or Irish cheques can only be taken in payment if 6d. is added for commission charged by banks for cashing them.

The Editors are not directly or indirectly interested in the manufacture or sale of beehives or appliances of any kind, and must refer correspondents wishing for prices or catalogues to advertisers in the paper.

## OUR DEPOSIT SYSTEM.

You are advised to insist on this being used when dealing with strangers.

### Rules and Conditions for Depositing

*In order to save trouble, it is requested that the Rules be carefully read over by persons using the Deposit System of trading.*

Goods should not be despatched until notice that the money has been deposited is received from this office.

1. **Method.**—When strangers are dealing together, the purchase-money of the articles is deposited at our office. We acknowledge receipt of the deposit to both parties, and hold the money until we are satisfied that the purchase is concluded. If a sale is effected, we remit to the seller the amount deposited, less a charge of 2½ per cent. in the £, with a minimum of 6d., and the expenses of Post Office Orders and postage, &c. Cash will be forwarded by Cheque, Post Office Order, or by Postal Order as preferred. If a sale or exchange be not completed, we return the amount deposited, after making the same deduction. By this means buyers and sellers are secured against fraud.

2. **Deposits.**—Postal Orders (drawn on General Post Office) and Cheques must be made payable to W. Herrod-Hempshall, and crossed "London County and Westminster Bank." The numbers of the Postal Orders should be kept by the sender.

We cannot be responsible for any loss that may occur in transit.

3. **Honey on Approval.**—All honey will be sold by sample, which must be sent direct to buyer.

4. **Bee Appliances.**—In ordering, the time allowed for completing the order to be stated to us when sending cash. If maker accepts, we hold cash until transaction is satisfactorily completed, when the amount will be remitted, subject to conditions as in Clause 1.

5. **Bees and Queens.**—These will be dealt with entirely by the parties concerned, so far as price, &c., go, and when the purchase is satisfactorily completed cash will be remitted as per Clause 1.

6. **Goods in Transit.**—These are at the seller's risk, i.e., any damage to or loss of an article on its journey is borne by the vendor; but a rejected article must be properly packed and returned by the same means as was used in sending it.

7. **Carriage.**—The carriage of all goods, *except such as are sent by post*, is payable by the buyer, unless otherwise agreed. If any article sent on approval be returned, each party to the transaction must pay carriage one way.

## Books for Bee-keepers NOW IN STOCK.

Cash in full must be sent with order.

	Postage	
A Modern Bee Farm ... ..	7/6	8½d.
(To be obtained from this Office only.)		
Advanced Bee Culture (HUTCHINSON) ... ..	6/-	6½d.
Beginner's Bee Book (PULLIN)	5/-	4d.
BEE-KEEPING SIMPLIFIED FOR THE COTTAGER AND SMALLHOLDER (W. HERROD-HEMPSELL, F.E.S.) ... ..	1/-	2d.
BRITISH BEE-KEEPERS' GUIDE BOOK (T. W. COWAN)		
Paper covers ... ..	2/6	3d.
Cloth covers ... ..	3/6	4d.
Dissecting Model of Queen Bee ... ..	4/6	3d.
FERTILISATION OF FRUIT BLOSSOMS BY BEES (T. W. COWAN) ... ..	-/3	1d.
Honey and Health (A. HOPE) ...	-/6	1d.
Honey Vinegar (REV. G. BANCKS)	-/2	1d.
How to Keep Bees (ANNA B. COMSTOCK) ... ..	5/-	4½d.
Prevention of Swarming (WILKES) ... ..	1/-	1d.
Pollination of Fruit in relation to Commercial Fruit Growing (C. H. HOOPER, F.R.H.S.)	-/6	1d.
PRODUCING, PREPARING, EXHIBITING AND JUDGING BEE PRODUCE (W. HERROD-HEMPSELL, F.E.S.) ...	2/-	3d.
Queen Rearing in England (F. W. L. SLADEN) ... ..	1/6	2d.
Scientific Queen Rearing (DOOLITTLE) ... ..	4/-	3½d.
Snelgrove's Method of Re-queening ... ..	-/6	1d.
The "Townsend" Bee Book ...	2/6	2d.
WAX CRAFT (T. W. COWAN) ...	2/-	2½d.
Wilke's Book on Swarming ...	1/-	1½d.

### MISCELLANEOUS.

THE BEE WORLD (supplied only to members of Associations interested in the control and development of the APIS CLUB, apart from ordinary members of the latter), per copy ... .. -/8 ... 1½d.

The Bee Master of Warrilow (TICKNER EDWARDS) ... .. 7/6 ... 4½d.

British Bee Journal & Record Office,  
23, BEDFORD STREET, STRAND LONDON, W.C.2.





### Seasonable Hints.

Syrup feeding should, as a rule, be now finished, but as in most matters connected with the keeping of bees, it is open to the bee-keeper to use his discretion. If the weather is warm and appears likely to continue so, syrup may be continued for a week or ten days longer. It should be given warm—almost hot—and, of course, in the evening. If put in the feeder hot, and the feeder itself covered with plenty of wrapping, the bees will take it down rapidly, and ripening and sealing will be facilitated. Make the syrup thick, rather under than over the regulation half pint of water to every pound of sugar.

The reason for ceasing syrup feeding now is that mainly owing to the advent of cold weather, the bees will not seal it over. Unsealed syrup, or honey, will do no harm to the bees *if it keeps sweet*, but during the damp weather of autumn and early winter unsealed stores take up moisture from the air and are then likely to ferment. There is, before very cold weather comes, still warmth enough inside the hive to enable yeast germs to grow, and it is feeding on the thin *fermented* stores during the winter, when it is too cold to permit a cleansing flight for perhaps several weeks at a stretch, that is harmful to the bees.

It is not yet too late to unite where necessary, but it should be done at the earliest opportunity. Two weak colonies in separate hives do not stand much chance of wintering successfully, or, if they do survive, are so weak in the following spring as to be worthless, so far as honey production is concerned, that season. If the two weak lots of bees and stores are concentrated in one hive they will make a fairly strong colony, with more than double the chances of wintering, and coming out strong in the spring. The probability is that ere the next season is far advanced the colony may be again divided and each division give a good account of itself.

Entrances should still be kept narrow. About two inches for a strong colony, less for weak ones, or, if there are signs of robbing, down to one bee space.

### A Dorset Yarn.

With a week in the west country, one was able to see the extensive fruit farms at Topsham, near Exeter; to see the rich, red soils of Devon, and what it will grow. It was an object lesson to the East Dorset grower to see the fields of raspberries in blossom and fruit, with the bees flying eagerly to the lines of flowers. At the Denver nursery and fruit farm many of the newest and finest raspberries have been raised; it is only those that see these large fields of flowering rasps in September who can have any idea of the immense amount of late food that can be stored away in the brood chamber for winter use by bees. There are acres of plums, apples and pears, together with fields of gooseberries and currants, and every conceivable berry that is grown for food, including the black raspberry from America. The owner of this farm is one of Nature's noblemen. His productive fields, with the immense wealth of young trees, for this season's dispersal, in addition to the permanent plantations, are among the finest I have ever seen.

At Messrs. Robert Veitch's nursery there were many plants from different parts of the world, and which are not hardy farther north. In the south and west they withstand the elements. One saw a large bush of St. John's Wort from China full of blossom, covered with bees, as were some of the magnolias. This firm's Exeter branch was like a botanic garden—to the bee-keeper it was an object lesson in plants that bees delight in. Many of the pea-flowering trees of Australia were there in bloom, as were many of the order of Leguminosa, so much sought after by bees. Then the herbaceous flowers had bees in great numbers, especially the perennial asters; these, with golden rod, seem to be a great source of enrichment to the hive bee, as well as other bees and flies.

In some parts, near the wilds of Dartmoor there were bees, but for miles and miles there was not a bee to be seen, though the sun shone out in all its autumn splendour.

It was our first visit to Devonshire—a truly wonderful holiday. Where the waters of the River Dart meet, between the Two Bridges Hotel and Holme Chase, running between immense stones, with primitive bridges made with huge flat stones placed over big ones to form a way over the river when in flood; all showed that man had used the material at hand to master the river, and make it amenable to his will. This seems to be a favourite spot for tourists, if the number of cars there was an index of popularity. We

passed in the car the road that showed Buckfastleigh; the driver told me of Buckfast Abbey as we went along. One would have liked to see the bees there, but it all takes so much time; we were all one day, as it was, we simply told the driver to motor us to the chief places of interest, and it took such a long time, one seems to want to spend days on the moor and in the forests surrounding it to get the full enjoyment of such grand moorland and sylvan scenery.

There were several parties on foot, and one had a sleeping van. This seems to be the best way to do Dartmoor thoroughly, as there are so few places where one can sleep at night. We made Exeter our base, it was an easy distance to the Devon coast from Exmouth to Torquay; all the West country we saw was very pleasing, and the memory of a week in the West, with its old history, its old churches, its old customs, and the cheery, hospitable people, will be a long time before it passes from the mind of the Dorset fruit grower.—J. J. KETTLE.

[The "Dorset Yarn" this week will supply the answer to several inquiries, and explain its absence from our last two issues. Mr. Kettle has been taking a well-earned holiday, and revelling in the beauties of fair Devon, and, we hope, incidentally gleaning material for further yarns. Eds.]

## Jottings from Huntingdonshire

A thousand rooks or so have settled in some elm trees overhead, and are holding one of their mysterious meetings: what they are all saying I would dearly like to know. It seems that one leading rook makes a suggestion and the audience voices its unanimous approval, or, perhaps, disapproval. One thing is certain, they are very happy. The shortening days, the tinted trees, the harvested corn do not disturb their peace of mind, they go on caw-cawing away oblivious of threatened coal strikes, strife in Ireland and aught else that is disturbing the peace of the world. When they have finished their meeting, they will be joined by as many Jackdaws and twice their number of Starlings, and wing away to clear up the grubs on some stubbled field, or to gobble up the wireworms, earth worms and other creepy crawlies which the moving plough reveals to their vigilant eyes. The rook belongs to the crow family, but is distinguishable from a crow by its lustrous plumage and its

scabrous face. Some rooks stay round about the rookeries in winter, others move farther south, and already one notices many which have come down from Scotland, and are halting awhile before winging their way to counties south of the Thames. Soon the grey crows will be with us; we shall then know that our brethren north of the Tweed are feeling the bite of winter. Virgil makes mention of rooks and their gregarious ways. I wonder if they chattered to him when among his bees. Yesterday I went through six of my hives and a score of rooks settled overhead to watch, and a great cackling went on. Whether they were laughing at me, or offering me advice, I know not. Maybe the vision of a man with his head and face veiled amused them; perhaps they thought I was partially encaged and a fit object for mirth. Be that as it may, as I closed down the sixth hive, and made tracks for the house in response to the luncheon bell, my black onlookers departed and I was sorry.

St. Francis of Assisi must have been a very happy man, since birds of all degrees sought his company, and he must have found rooks interesting. Are they beneficial to the farmer? Do they do more harm than good? In England we say the good they do more than compensates for the damage to bean and pea crops, and the few seeds they consume at sowing time; but in Scotland they have little or no praise for them. Now, what did they see as I went from hive to hive? The first hive I opened was well supplied with stores, and the queen, cheered by the genial weather and the incoming honey, was laying vigorously; how one loves to see frames of brood in early October! I gave them a bee way and covered them down for the winter. Hive two was full of bees, and brood in three combs, but very short of stores. I am still feeding this colony with syrup. Hive three was in excellent heart, plenty of young bees, and about 25 lbs. of stores. I shall slip a cake or two of candy under the quilt later on. The fourth hive welcomed my appearance, but yet were rather cross, and small wonder, for as I lifted the first frame of comb the bottom bar adhered to the floor board. One knows, of course, what this usually means—wax moth. I lifted the whole brood box from the floor board and found that the larvæ of the wretched moth were everywhere. I scraped and scrubbed the board and cleaned the bars of each frame, and if ever bees showed their gratitude these bees did. If you want to know how bees feel when their hives have been made comfortable after being compelled to exist in discomfort, compare it to the feeling of ease that is

experienced by an invalid who has just returned to a newly-made bed after lying in discomfort for a while. In my fifth hive the same trouble was met with, but in a lesser degree—this stock had also much brood, but little store. At the sixth I had an angry reception, and a dozen stings was my reward for looking in to see all was well. It was—bees, and stores and great plenty. This is my star stock. Despite the bad season, this colony has given me some 50 lbs. of surplus, and so full are the combs down below that they have even found a way into the space between the brood chamber and outer wall, which they have filled with comb, mostly drone. I should say there is forty pounds of store here, so I shall possibly get a few more stings when I go to borrow a little for a weaker stock. This is all the rooks saw; I hope they took it all in. October opened well, and how one hopes the whole month may be a "St. Luke's Summer." The opening of the wild mustard and the third crop clover heads is proving a valuable asset to bee-keepers, and this past week pollen and nectar have been coming in as fast as at any time during the summer, and one feels very thankful. The early morning mists are very beautiful, but our hive friends wish they would vanish an hour earlier than they do.

What a pest earwigs are! Is there any remedy other than the iron shoe? Naphthaline balls will keep them away from the quilt, but not from the interstices between the lifts. Powdered mustard will clear them from these secreting places; but one does not like using it where bees are—it may be harmless enough.

We shall be very careful to see our hives are weatherproof; I find Pluvex roofing felt excellent for roofs. No, I've no interest in its manufacture. I have frequently mentioned "Yadil" in my jottings and I hear that I do it because I have shares in the company manufacturing it. I have not, and don't even know the proprietors of this valuable antiseptic.

Out in the garden I am sowing borage seeds, propagating the African box thorn, planting crocus bulbs, transplanting seedling hollyhocks and anehusas, thinking as the work progresses of the little insects who visit all these flowers at one time or another. Radishes planted six weeks ago will be early in flower, so also will be the turnips. Autumn is here, and already we are looking forward to spring. Meanwhile let us be prepared—using the intervening months cleaning and refixing racks, getting ready sections and frames, which will be wrapped away in newspaper until needed for next year's honey flow.—E. F. HEMMING, Steeple Gidding.

## Jottings.

Other gambols. Mid-July found me with a great many small colonies, and the prospect of an alarming sugar item if these were to be preserved. The weather was still very fitful, with little or no sun; a few days would have made such a difference then. August came in, and I gave it up as a bad job; but the next fortnight more honey was stored in most of my hives than I had previously secured, and all were thus able to receive a substantial addition of natural stores, with a welcome decrease in the sugar bill. I don't remember getting honey in August to this extent before. Colonies were ready in numbers for the few shining hours. I don't think we had a hot night at all. Four small apiaries in a half-mile triangle came out very curiously: four colonies on one side had ample stores and a good few sections, two at an end got hardly anything, and the other point have enough to live on.

I visited a lady beginner somewhat out of my distance, who feared she had diseased brood. I thought this serious enough to warrant the visit. I had a lovely cycle ride, with spurts of sunshine. Half-way on I had to take cover on a friendly stile, with a convenient tree and bank, as it had not forgotten how to rain. We were able to get on after half an hour or so, and were quickly taking in the possibilities of a splendid clever crop, red and white, on one side, and miles of heather on the other—a sight few of us can often see, I think.

On reaching my destination I found one colony which looked as if it was enjoying this prospect, and in spite of two racks and a shallow box were laying on the front in hundreds, stopping what air there was to be found—at least, so I thought. The doubtfuls contained nothing more than a nicely developed but unfertile queen. And what vicious beasts they were! The brood in the bottom was all drone, but the cells in the shallows, where her majesty was found, contained eggs, seemingly perfect, but an interval was apparent; if this was so she must have lately mated. However, as they were in disgrace on account of their vicious behaviour, it was decided not to prove this, and arrangements were made to re-queen them.

I have recently successfully introduced four Italians, two in large colonies and two in nuclei. One nucleus developed a second batch of queen cells during the period before the queen was released, and I was relieved to find her laying all right; the others did not make this apparent safeguard, while the new-comer was in the cage, so even here nothing is certain.

Another colony where a cast was apparently safely returned lost its queen after

a spell of drone laying, so it is obvious, if we interfere with their arrangements we must duly examine to verify all correct, or no honey is the result, and perhaps no colony in another case.

A. H. HAMSHAR.

## Mems. from Monmouthshire

I feel it my duty to begin **this** by\* apologising for my appalling writing, which has caused one or two errors to appear in my recent notes. Someone has thrown away the copy of the Journal containing them, but "early date honey" should read "early dark honey," and "cases of 'Isle of Wight' disease," cures of 'Isle of Wight' disease."

I seem to be somewhat at cross-purposes with Mr. Hemming. I certainly understood him, so I think would anyone else, to say that a strange drone was promptly pitched out of any hive that was not queenless, *before* the general drone slaughter.

Of course, I am aware that a hive which has turned out its own drones will not accept those from other hives. As for the stuff about drones "palling up" and "escorting" each other—come, Mr. Hemming, you surely do not expect to be taken seriously!

I wish the bees here were forecasters of the weather as Mr. Hemming's are. Here they are obviously unable to foretell bad weather even a few hours distant. Time after time this year swarms have issued during a bright spell, followed by torrential rain before they could be hived. In some cases where the swarm was not seen to issue, they have hung in a half-drowned condition for days together. I think that in the national interest the Rev. E. F. Hemming should present one of his stocks to the Royal Meteorological Society.

During the past season I witnessed an incident which I have never seen described, and which must, at any rate, be sufficiently rare to be worth recording. I was hiving a swarm headed by a laying queen: not seeing her run in, I looked at the skep, and found her sitting on the side. Just as I was going to pick her up she took wing, and was at once hotly pursued by a drone. This went on for about five minutes, and then the queen rested on a leaf. The drone evidently missed her, and then flew away. To anticipate possible criticisms, I would repeat that the queen was certainly a normal fertile queen: she was a native, and, I think, a 1919 queen, but of this I am not sure, as the stock originated as a swarm that came out of a tree at the end of May. I could not see what race the drone was, but it

was a drone. Editorial comments would be interesting.

[The drone must have made a mistake. Possibly the queen was not wearing her wedding-ring, or whatever symbol bees use to denote the married state, or the drone did not notice it. So far as we know, a queen remains always faithful to her first mate, and never takes another.—Eds.]

On reading the notes from other countries I think this must be a very highly-favoured district. It is true we do not get sections filled from wallflower blossom, nor frames—or bars, as it now seems fashionable to call them in the Journal—from Christmas roses. But we have a fine show of nectar-yielding blossoms throughout the season. It may be of interest to mention some of the chief of those growing within easy reach of my own hives: Fruit blossoms in plenty, sycamore, vast quantities of hawthorn (why do the bees only want this about one year in five?), birdsfoot trefoil, holly, Dutch clover, limes, and blackberries. Five miles away I have two hives which have the run of fruit blossoms, trefoil, clover, and heather—both *E. cinerea* and *Calluna vulgaris*. This year the bell heather has yielded most. The stock of natives, referred to above, although beginning as a 3-lb. swarm late in May, is now on two brood chambers, and has yielded 24 lbs. of extracted honey. The swarm which came off in July was returned, the brood being put at the top, *à la* Demaree, and a young queen hatched out and mated there. Afterwards the two brood chambers were put together with the young queen.—G. R. STRONG, Magor, Monmouthshire.

## Bee-Keeping Instruction

AT THE GORDON INSTITUTE, WELL HALL.

Residents of Eltham and the surrounding district will be interested to learn that a series of bee-keeping lectures and demonstrations are to be given at the Gordon Evening Institute, Grangehill Road, Eltham, during the winter months, to be followed by a summer course at Culham Apiary, New Eltham. Mr. W. H. J. Prior has been appointed instructor by the Education Authority of the London County Council. The lectures will be free and afford an unique opportunity to those interested to acquire both technical and practical knowledge of the subject. The winter meetings will be on the second Tuesday in each month, commencing October 12, at 7.30 to 9 p.m. Inquiries should be made of the Responsible Teacher, Mr. E. C. Pierce, at the Institute, or of Mr. Prior, Culham, Main Road, New Eltham.

## Miner and Tapestry Bees.

I was very much interested in the Rev. E. F. Hemming's account of miner and tapestry bees, and I am sending the following from Goldsmith's "Animated Nature." I trust it may be of interest to my fellow bee-keepers and lovers of nature:—

"The ground-bee builds its nest in the earth, wherein they make round holes, five or six inches deep; the mouth being narrow and only sufficient to admit the little inhabitant. It is amusing enough to observe the patience and assiduity with which they labour. They carry out all the earth, grain by grain, to the mouth of the hole, where it forms a little hillock—an Alps compared with the power of the artist by which it is raised. [I have seen hundreds of these little hills on a sandy bank, and I can only describe them as extinct volcanic craters in miniature.—W.]

"Sometimes the walks of a garden are found undermined by their labours, some of the holes running directly downward, others horizontally beneath the surface. They lay up in these cavities provisions for their young, which consist of a paste that has the appearance of corn and is of a sweetish taste.

"The leaf-cutting bees make their nests and lay their eggs among bits of leaves, very artificially placed in holes in the earth, of about the length of a toothpick-case. They make the bits of leaves of a roundish form, and with them line the inside of their habitations. This tapestry is still further lined by a reddish paste, somewhat sweet or acid. These bees are of various kinds; those that build their nests with chestnut leaves are as big as drones, but those of the rose-tree are smaller than the common bee.

"The wall-bees are so called because they make their nests in walls, of a kind of silky membrane, with which they fill up the vacancies between the small stones which form the sides of their habitations. Their apartment consists of several cells, placed end to end, each in the shape of a woman's thimble. Though the web which lines this habitation is thick and warm, yet it is transparent and of a whitish colour. The substance is supposed to be spun from the animal's body; the males and females are of a size, but the former are without a sting. The mason bees make their cells with a sort of mortar, made of earth, which they build against a wall that is exposed to the sun. The mortar, which at first is soft, soon becomes as hard as stone, and in this their eggs are laid. Each nest contains seven or eight cells, an egg in every cell, placed regularly one over the other. If the nest remains unhurt, or wants but little re-

pairs, they make use of them the year ensuing, and thus they often serve three or four years successively. From the strength of their houses, one would think these bees in perfect security, yet none are more exposed than they. A worm with very strong teeth is often found to bore into their little fortifications and devour their young.

"The wood bee is seen in every garden. It is rather larger than the common queen-bee; its body of a bluish-black, which is smooth and shining. It begins to appear at the approach of spring, and is seen flying near walls exposed to a sunny aspect. This bee makes its nest in some piece of wood, which it contrives to scoop and hollow for its purpose. This, however, is never done in trees that are standing, for the wood it makes choice of is half rotten. The holes are not made directly forward, but turning to one side and having an opening sufficient to admit one's middle finger, from whence runs the inner apartment, generally twelve or fifteen inches long. The instruments used in boring these cavities are their teeth. The cavity is usually branched into three or four apartments, and in each of these they lay their eggs, to the number of ten or twelve, each separate and distinct from the rest. The egg is involved in a sort of paste, which serves at once for the young animals' protection and nourishment. The grown bees, however, feed on small insects, particularly a louse of a reddish-brown colour, of the size of a small pin's head."

There are three other kinds of bees I have heard of—the poppy bee, carding bee, and orange-tailed. Could some reader versed in the order Hymenoptera kindly enlighten me on these. I have studied Lepidoptera, and have a fine collection of these, but I am very much delighted with the hive bee and those of the same order.

W.

---

## Aluminum Combs.

In commenting on the aluminium comb, Messrs. Root supply useful information so far as their own experience goes, and from reports to hand. In dealing with foul brood in the metal combs the article states: "We boiled the combs for 15 minutes and found that was not long enough, so we just kept on. After three hours we found the cocoons, and most of the decayed matter, stayed right in the cells, and they certainly were far from clean, and surely could not be rewaxed in that condition. Steam at high-pressure blown on the combs removes most of the cocoons in time, but not all. In handling the combs we note some of the edges of the cells were bent. In some colonies we

used aluminium combs entirely, in others some aluminium and some drawn combs. Except during a few weeks in summer, when conditions are most favourable, the queens do not do as good work as in the drawn combs, but lay their eggs very scatteringly."

"It is noted that where the two kinds of comb were used together with an aluminium comb in the centre no eggs were deposited in it, and where only aluminium combs were used the colonies dwindled. In the spring and fall the combs are too cold and the brood is chilled. The bees refused to store syrup in cool weather, but stored in the drawn combs."

"We have learned of some who are objecting that the combs get too hot. The Editor of the *Australian Bee-keeper* said that he had no use for metal combs, as they frequently have temperatures of from 100 deg. to 120 deg. Fahr. in the shade, and he felt the metal would become so hot as to cook the brood, just as it has done in some parts of our own country."—A. W. SALMON, Cashfield, Chingford.

### Notes on Stocks.

I was distressed to see how many stocks are starving owing to want of food. In my district the weather is like mid-summer, but an eye has to be kept on the brood box. Where good honey can be bought, one ought to take advantage of this, as it means a great lift-up if fed slowly.

I found it a very great advantage to leave my supers of shallow frames on and leave the hive entirely alone except for a look under quilts now and then. After a warm day one sees numbers of bees again in the supers, after having taken what there was into the brood combs. I saw new brood hatching and then flying, and the supers are now black with bees. Later I took off the top one, which I found uncapped, and the large super is getting well filled. I am not saying this out of pure brag, but bee-keepers want to know how some people do things, and pick up hints that another time may be useful.

Also, in the spring I hope to get some good swarms, to let those who are in want have them. I have one large stock left for this. I am nursing another large one which has to go to Scotland early spring. So far, by the look of things, I have all hope to pull it through this winter. I sold some good stocks this last season, and hear good results of this hardy strain. When the fine weather broke out a large swarm issued from one of the hives, to my delight, and I hived it, and glad to say it is doing well, but no supers on.

Feeding slowly with honey has a wonderful effect.

It would interest many if people wrote more about the condition of their bees—far more than about bee-keeping we have heard so much about. Just at this time we are going through a bad time, and suggestions help a great deal. Here is one: I re-queened in July, eight queens in all, by the platform method, and it seems to have stimulated the hives to a high pitch. I did this in case of a bad winter, and it's repaid me tenfold. I also sold queens to apiarists, who are delighted at results, as the swarming was so bad it weakened the stocks to a great extent.—C. TRECROFT.

### Experiences with Queens during 1920.

The past season has been a remarkable one in many ways, and more especially so with regard to the behaviour of queens. Practically no virgins have mated in the district around here since the latter part of June—a serious matter: and with many bee-keepers it is to be feared it means queenless hives this winter unless taken in hand at once. In my own apiary it was a fairly frequent thing to find that the queens were unable to fly, and for the swarms to settle all over the grass and adjacent hives: one particular hive seemed to have a fatal attraction, no less than three swarms from other hives having made it their destination, the queen naturally being balled, and eventually requiring to be replaced, owing to the excitement caused. This hive, however, harvested a bumper crop of about one hundredweight.

I tried in some cases to induce reluctant virgin queens to take a flight, after remaining some three weeks in their hive, by gently causing them to leave their comb. The result was not, however, successful, as they did not usually return. We had a number of fine days when drones were flying, but still the queens refused to make their *debut*.

More peculiar still has been the tragic fate of many of the imported Italian queens. These all arrived safely in good condition, though they were over long in the mails, seven days being the average. They were in every case successfully introduced to nuclei, and afterwards later introduced by the newspaper method to a queenless hive: for the length of nearly a week the hive was not touched, and when examined was practically always found perfectly satisfactory, the queen laying well and the bees quiet. A second examination during the following week finding matters still all right, the hive was left some weeks, when in many cases, instead of the pure Italian

queen, a virgin was to be found, and often of another colour. The hives had not swarmed during the interval, but it was evident that the Italian was superseded for some reason. I might add my bees were almost all pure Italians, so that it was not a case of strange races refusing to unite. It would be interesting and of practical value to hear some other experiences. I felt I must have lost my knack with bees this summer until I read in the B.B.J. of others reporting trouble. The honey crop was good, and hives are very strong, but many have had to be doubled up owing to the trouble with virgins.

C. HOGAN.

Boxford, Suffolk.

## Wintering.

When wintering bees I quite agree that they do better with more ventilation than the usual W.B.C. type of hive allows. The following is a method which I adopted several years ago, and I think it has been the means, together with the other usual

October the brood chambers are lifted on to the usual 3 in. ekes. The ekes themselves have several holes about 1 in. in diameter bored in each side, these holes being covered with perforated zinc.

I very seldom have any mildewed combs.—L. BIGG-WITHER, Birdwood, Wells.

## Scientific Wintering.

It has been said that the present season is the most anxious time of the year for the bee-keeper. This is to a great extent true; and does it not therefore behove every one, from the large bee-farmer down to those who, like the writer, keep one or two hives as a hobby or scientific amusement, to inquire carefully into the state of affairs most likely to result in thoroughly efficient wintering?

I do not propose to harp upon the old maxim, "Have your stocks strong." To my mind anyone who, avoidably, keeps weak stocks at any period, is not worth wasting any advice on. The first point I

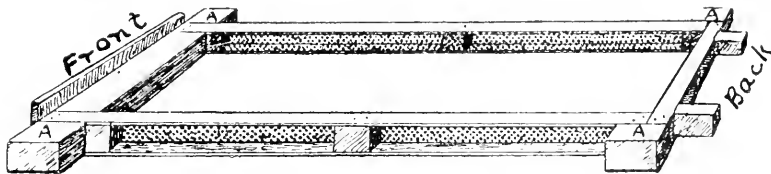

VENTILATING FRAME.

precautions, of materially reducing the number of uncontrolled swarms, at least I have had far fewer swarms from my hives since I adopted it. At the end of April or early in May, according to the season, the brood chamber is lifted on to a special frame one inch high with perforated zinc sides, as shown in the accompanying rough drawing. The outer cover is also lifted and rests on the projections marked "A," slats of wood are cut which just fit the openings between the floor board and the bottom of the outer cover. During the very hottest weather I keep these openings open night and day, but generally I close them each evening. The slats of wood are fixed in a moment by means of three buttons on the sides of the floor board, and if a spell of cold weather comes the openings can be kept shut during the day-time as well.

This plan of raising the brood-chamber allows a free current of air to pass below the combs without the slightest draught. By slightly smearing the perforated zinc with vaseline, I am not troubled with any propolis. These frames are removed when taking off the supers, and early in

will deal with is the matter of store and its arrangement. A strong stock in a good season, after removal of supers, will arrange itself perfectly for wintering. As brood-rearing gradually diminishes, and ripened honey is removed to the top half and outsides of the frame of comb, the centre will consist of *empty cells*. Thus heat is transmitted with facility throughout the winter cluster, without hindrance by solid slabs of honey. Now, when autumn-feeding, this must be borne in mind. Aim at getting the top half of ten combs well filled, and not to have six combs solid with sealed store. This can be done by continually placing an empty comb from the outside, to the centre, immediately below the middle of the rapid feeder, where, naturally, the bees will store first. Remember that with the syrup spread over so large an area it will need to be kept very warm to assist evaporation. A *thick* cork-dust quilt will keep in the warmth and let out the moisture.

There is a lot of nonsense written about candy. I entirely disagree with anyone who says that it is in any way harmful

during winter. Your correspondent, Mr. Tremlett, ably gives us the true nature of candy (fondant sugar). Notice that it is *invert sugar* and of exactly the same chemical composition as honey—only in another physical form. Now, if a slab of candy is placed over the brood nest, the bees nearest to it gradually "paint" its under side with moisture, reducing a minute quantity at a time to the consistency of honey. The liquid is then passed down to other bees of the cluster. Mr. Simmins wrongly says that candy so placed causes undue stimulation. What difference is there between the process I have just described and the gradual uncapping and absorption of naturally-stored honey by the top bees of the cluster? By all means use candy on top to make up for shortage of natural stores. But—don't put it on *warm* in the depth of winter.

A large number of bee-keepers make the mistake of disturbing the bees too early in the year. Except where fruit trees are the source of the main crop, it is never advisable to break up the winter cluster before the end of March, or later if a severe winter. Watch Nature. Directly crocuses are well out, daffodils just blooming, and the catkins show powdery yellow-green masses in every hedgerow, the bees will commence carrying in such quantities of pollen that the colony, to protect the brood, ceases to hibernate of its own free will. Then is the time to put on your slow feeder, three holes at most, and keep it *warm*. I always make a little flannel case, after the style of a tea-cosy, for mine.

I see no advantage in having a wider winter entrance than 6 ins., but a great disadvantage in a narrower one. See that the slides are wedged sufficiently tight to prevent any animal pushing them apart. Beware of those bright, frosty days. My ideal hive would have a sort of Venetian blind attachment for the porch, so that only diffused light can enter; but something of the sort may easily be extemporised. A strong stock might lose forty per cent. of its population by being tempted out on such a day.

With regard to the double chamber for wintering, there is one great danger. In all probability the top chamber is solid with honey. If the stock has been so strong as to have it filled with brood in August, the queen will certainly stop laying in it by the end of that month, when, in any case, it will become clogged with store. This is, I think, inevitable. I should like to hear of a queen who could continue laying in two sets of combs in September. She would in all probability be laying strongly down below, but this

would only force the bees to store more above. The wet-blanket type of influence of a solid chamber of honey dividing the winter cluster is obviously undesirable. If one could manage to get queens to continue laying in the top set, the arrangement would be somewhat better, but in any case it seems to me that it militates against the formation of a compact cluster.

Mr. Lythgoe is quite right about thick cushions, but he omits to say that they must be porous. The air forced in at the entrance clearly cannot get out through it unless fanned by the bees—it must get out through the top. A couple of thick cork-dust cushions will ensure a warm, but constantly fresh, atmosphere.—R. NOEL AVELINE.

---

### Bee Driving in Sark.

I have just had my first experience of bee-keeping in Sark, one of the smallest and certainly the most beautiful of the Channel Isles. Bees are not allowed to be imported from England owing to the "Isle of Wight" disease; therefore, when I came here I hoped to obtain a stock from Guernsey. I failed in this, however, and was on the point of giving up hope when a friend in Sark told me there was a strong colony in a hollow tree in her garden, which I could have if I could manage the somewhat difficult task of driving them. Although I had been an amateur bee-keeper for three years, I had had no experience of this, so, feeling that discretion was the better part of valour, I called in the aid of an expert from Guernsey. Like all true lovers of bees, he was ready to give every assistance to a fellow-craftsman (or should I say woman?) and to share his knowledge and experience with beginners. He was also a man of resource. He looked at the tree, which was about 10 ft. in height, he examined the hole through which the bees in great quantities were going and coming, and then he started operations. He first of all sawed off the upper part of the stump (for it was little else, the head of the tree having been blown off some time previously), and thus exposed the combs. He then drilled a hole about 2 ft. lower down, and, having slung a skep over the top, proceeded to smoke the bees out of the hollow into the skep. This method not being altogether satisfactory, owing to the bees running down below the smoke-hole, it was decided to cut down the tree. A few strokes of the axe proved that, fortunately, it was hollow right down to the ground, and the work of felling it was soon accomplished. It was then divided in



two, lengthways, and the whole of the nest was thus exposed. The skep, with what bees had already clustered there, was now placed where the tree had stood, and the severed halves were, with the aid of an interested spectator, shaken in front of it. It was not long before the bees had taken possession of the skep, and when they were fairly settled down they were hived in the usual way.

On examining the trunk, I found it had been hollowed out about 8 or 9 ft., and the combs, which were three in number, were each 6 ft. 3 in. in length! There was a fair amount of brood, but no honey—indeed, had there come a spell of bad weather, the stock, which was strong and included a large contingent of drones, would have fared very badly.

Although the bees were now safely housed, our troubles were not yet over. There is a tradition that some years ago a donkey was stung to death in the island, and ever since then there has been a feeling of great suspicion towards our little friends. I am not sure of the facts of the donkey's death, but I do know that, for some reason or other, I could not get my stock conveyed the two miles to its present site. We were not to be beaten, however, and one evening, after the somewhat agitated insects had all retired for the night, we carried it ourselves and deposited it in a comfortable position under a hedge at the back of my cottage. Anyone who has ever helped to carry a strong stack of bees, hived in a full-sized hive, two miles up hill, down dale, over stiles and across a stream, will appreciate the difficulties with which we had to contend, and which we overcame; and now it is with the greatest satisfaction I watch my bees busily at work on the innumerable flowers all around.

E. WEDGWOOD.

## Echoes from the Hives.

MARLBOROUGH, WILTS.

During the past month the weather conditions have been almost ideal for feeding bees and getting them in good condition for winter quarters. With the exception of occasional low night temperatures, we have had nothing to complain of in this district. We have even noticed a certain amount of honey being gathered, probably from charlock or dwarf thistle.

It is strange how a warm spell of weather enlarges the brood-areas of the hives as nothing else can; especially is this noticeable with Italian bees, who seem to make a change for the better in the first hours of warmer weather.

We should be afraid that the winter

mortality among cottagers' bees and some others would be very heavy this year, owing to the almost total absence of natural stores, and the difficulty experienced by these people in feeding their skeps and "boxes."

Honey still commands high prices owing to its extreme scarcity. A good section 3s. 3d. retail, and extracted honey 2s. 9d. per lb. jar.—C. L. N. PEARSON.

## Monmouthshire Bee-Keepers' Association.

The second annual show of the M.B.K.A. (in conjunction with the Newport Utility Show) was held at Newport on August 2 and 3.

Much gratification was felt at the large number of entries and the excellent quality of the exhibits.

Mr. W. O. Jones, Lisvane, near Cardiff, first-class expert, acted as judge, and made the following awards:—

### MEMBERS' CLASSES.

Four jars extracted honey (light).—1, Dr. Strong; 2, Mrs. Lusty; 3, Mrs. Llewelyn Morgan.

Four jars extracted honey (medium).—1, Dr. Strong; 2, Mrs. Lusty; 3, Mrs. Llewelyn Morgan.

Four 1 lb. sections.—Dr. Strong.

Two 1 lb. sections.—1, Miss E. Reese; 2, Dr. Strong.

$\frac{1}{2}$  lb. beeswax.—1, Mrs. Lusty; 2, Dr. Strong.

### OPEN CLASSES.

Four jars extracted honey.—1, Mrs. Llewelyn Morgan; 2, Mrs. Bennett; 3, Dr. Strong.

One shallow frame.—1, Dr. Strong; 2, Mrs. Lusty.

Honeycake.—1, Miss Parsons; 2, Mrs. Lusty.

One jar honey (to be given to the hospital).—1, Mrs. Llewelyn Morgan; 2, Mrs. Arnold.

Open-air demonstrations were afterwards given by Dr. G. R. Strong, assisted by Mrs. Llewelyn Morgan, also by Mr. G. R. Lusty and Mr. A. T. Young.

The stock used for the demonstrations was given by Mr. G. R. Lusty, to be afterwards sold for the benefit of the Newport Hospital. The thanks of the Association are due to Mr. J. K. Price (secretary of the Newport Allotment Holders' Association) for his help and co-operation, also to Mr. W. O. Jones for kindly acting as judge.—J. M. M.



*The Editors do not hold themselves responsible for the opinions expressed by correspondents. No notice will be taken of anonymous communications, and correspondents are requested to write on one side of the paper only and give their real name and addresses, not necessarily for publication, but as a guarantee of good faith. Illustrations should be drawn on separate pieces of paper. We do not undertake to return rejected communications.*

### Bee Notes from South Devon.

[10308] The season has not been a very good one so far as honey is concerned. There was a promise of a good yield from the fruit bloom, but the weather prevented the bees from taking advantage of this, and the swarming fever took possession of the bees, in fact it has been what may be termed a swarming season; and very little honey stored in the supers, no doubt through the nights being so cold. Most of the swarms I have come in contact with have made up well, and are now well provided with ample stores for the winter and in some cases filling a rack of sections. Where I am living is on the border of Dartmoor, with heather just a mile off, stretching for miles over the Haytor Downs, so that has helped us. The heather has been glorious this season, and since that has been in bloom the weather has been just about right. I took off 21 1 lb. sections of almost pure heather honey from a June swarm on September 25, and the bees are still busy, although I saw by the *Daily Mail* one day this week that bees are practically starving in some parts of Devon. I think the heather has saved us in this district. I am also pleased to say that "I. O. W." disease is not so prevalent as it was.

I hope the writer of the Dorset Yarns will not stop his weekly notes owing to adverse criticism by one or two readers. I, myself, have many times envied him his well stored racks of sections, and would very much like to pay a visit to his Violet Farm.

I may say we have suffered very much in the past from the "I. O. W." disease, many apiaries being entirely wiped out. There are not 40 stocks now where there used to be 200, and a lot of bee-keepers who have lost all their stocks are afraid to start again. Perhaps the swarming season has been a blessing in disguise, as I know of several who have started again this year with a trial stock and, so far,

they are doing well, plenty of stores for the winter.

The remedy we are relying on here is Izal; that seems to keep it in check.

I hope Mr. T. H. Witney will give his further experience on the onion cure.

I only wintered two stocks last year; this year I am wintering seven, and have taken just over 60 sections, hoping for a good season next year.—A. GODSLAND, Bovey Tracey.

### Treating "I.O.W." Disease.

[10309] It may be of interest to your readers to know of the successful use of "Yadil" (garlic) in cases of "I. O. W." disease. It broke out very badly in this neighbourhood last winter. A member of our association lost all his bees—20 hives. A check seems to have now been put on the spread of the disease, by constantly spraying the *healthy* bees with "Yadil," using it in the proportion of one teaspoonful to a pint of water, or applying it with a throat-sprayer, so as to produce a fine, misty spray.

The dummy boards should be taken out, the frames spaced and the bees on them sprayed with this mixture. "Yadil" should also be used in the feeding syrup and the candy—1 oz. to each pint of syrup or lb. of candy.

A cottager near here noticed lately that his bees were not able to fly, but fell to the ground; he sprayed them with "Yadil" and also gave it in the syrup; they are now quite well and strong, after treating them in this way for three weeks.

It is a good plan to spread quick-lime on ground underneath and round the hives.

"Yadil" is an antiseptic, and has also the property of subduing bees.—F. E. BUTLER, hon. sec., Kilkenny (Ireland) and District Bee-keepers' Association.

### A Line from Lincolnshire.

[10310] I should like to say how much I enjoy reading the notes and articles in your *Journal*, they are so very instructive to a novice in bee-keeping. I started last year with one hive; I have now five, but it is difficult to manage them properly and to make the most profit from them without someone to examine them and to tell one exactly how to go on, but I follow the advice given in the "B.B.J." I love bees and flowers, and should like to know how to manage them a little better.

I notice most bee-keepers have been troubled with more swarms than usual—so have I. From the one stock in the spring I have had eleven swarms; when I had four I thought I had enough for

the present, so I kept putting them back into one or other of these four. I have only had one full rack of eight shallow frames (full of honey). The swarm which produced it I took about a mile away and placed it by a seed clover field, and it did well; the others which I kept at home made nothing.

I am pleased to see a note in the *Journal* from my native county, left 12 years ago. Dear old Shropshire! I have not forgotten the old Salop toast: "All friends round the wrekin." I used to go to the Shrewsbury show regularly up to fifteen years ago, the most wonderful (for the want of a better word) thing in Shropshire. If you have never been, sir, do go next year to the show and the beautiful quarry.

We hear nothing about bees in this part. I wonder where my nearest bee neighbour is, or expert. I should like him to pay me a visit this autumn, and so tell me how to go on.

I noticed what I thought to be robbing going on in one hive which I thought was a strong stock, so I opened it and found the top of the frames covered with maggots (presumably the wax moth maggot), and what few bees were left were between the last comb and division board. I should like the advice of your expert, when to look for it and how to stop it, etc.—JAMES MEEKLE, Dowsby, Bourne, Lincs.

[We strongly advise you to join the Lincs. Bee-keepers' Association, and you will then get in touch with the local expert, and other bee-keepers. The secretary is Major Hadfield, Hamilton House, Alford, Lincs. The maggots would be wax moth larvae. Keep a look out for them in the combs any time when manipulating, and destroy them; also look over any stored spare combs occasionally. The moth may be seen in the summer during the evenings flying near the entrance of the hive, looking for opportunity to deposit eggs in some crevice containing litter from the hive. It resembles an ordinary clothes moth in colour, but is a darker shade, mottled a little, and is about twice the size.—EDS.]

### Young Bees for Wintering.

[10311] Re 10304. Mr. Barratt, I think, will agree that a large population does not consume the amount of food required for a much smaller stock, so I assume he is querying the use of the word "young."

Young bees are naturally more desirable apart from the question of food, and my observations go to show that a stock with a large proportion of young bees are more restful during the winter months, whereas

with older bees some of them will come out during somewhat unfavourable weather (a few of which never return). It is a pleasure to reply to reasonable critics, and I trust my remarks are clear. As regards Standard Frames, my wording was somewhat unfortunate; what I meant to convey was the "British Standard Frames" are ideal for brood-rearing, but do not overlook the fact that I said for the majority of bee-keepers, and spread over a period, while I admit that in the hands of real experts and those who (or their assistants) are constantly present in the apiary, the position may be reversed as against larger frames, while situation, flora and strain of bees are, of course, dominant factors.

It is regretted my remarks were taken as an attack on the Apis Club; needless to say it was not an attack on any single institution, and I trust no harm will result. The Editor's remarks, I think, should clear away any misapprehension on this point.—W. F. JUDGE.

## Notices to Correspondents

Correspondents desiring an answer in the next issue should send questions to reach this office NOT LATER than the FIRST POST on MONDAY MORNING. Only SPECIALLY URGENT questions will be replied to by post if a STAMPED addressed envelope is enclosed. All questions must be accompanied by the sender's name and address, not necessarily for publication, but as a guarantee of good faith. There is no fee for answering questions.

MISS M. CLIFFORD-BROWNE (Cards).—Price of honey.—The price recommended by the B.B.K.A. is 2s. 9d. per lb. for extracted honey and 3s. 6d. per section.

S. MCKAYE (St. Bees).—We think the bee is a malformed worker.

#### Honey Sample.

"B." (Penistone).—The honey is good in colour and flavour, but is rather thin; worth 2s. 6d. per lb. retail.

## Bee Shows to Come.

October 5 to 8.—Essex Fruit and Honey Show at Institute of Agriculture, Chelmsford. Open from 12 to 8 p.m. Admission free. Lectures and demonstrations each day.—Schedules from G. R. Alder, 7, Bulwer Road, Leytonstone.

October 19 to 22.—Dairy Show, Agricultural Hall, London. Open Classes for Honey, etc.—Particulars, Secretary, Dairy Farmers' Association, 28, Russell Square, London, W.C.1.

November 18.—Annual Show of the Worcester City and County Chrysanthemum, Fruit, Root and Honey Society. Thirteen Open Classes in Honey Section.—Schedules from Geo. Richings, 42, Barbourne Road, Worcester. Entries close November 6.

**Special Prepaid Advertisements.****One Penny per Word.**

Advertisements must reach us **NOT LATER** than **FIRST POST** on **MONDAY MORNING** for insertion in the "Journal" the same week.

Orders for three or more consecutive insertions in "The Bee Journal" entitle advertisers to one insertion in "The Bee-Keepers' Record" free of charge.

**PRIVATE ADVERTISEMENTS.**

**WANTED, HONEY PRESS;** purchase or exchange poultry. **W. WOODS,** Normandy, near Guildford. j.1

**WANTED, Stock of Driven Bees with Queen,** also one Queen.—**MACLULLOCH,** Mount Park, Gourrock. j.2

**FOR SALE, three spare Queens, 1920, slight cross,** but mostly Native, all to profit up to date, 6s. 10d. each; also 4-frame Nucleus, 35s.—**HAY,** Forest Lodge, Woodlands, Consett, Durham. j.3

**SECOND-HAND Hives and Appliances for Sale** cheap. Please send P.C. for particulars.—**CLIFFORD DE KUSEL, S.P.B.A.,** Allerton Poultry Farm, Liverpool. j.4

**EIGHT COTTAGE HIVES,** good condition, no disease, £6 10s. the lot. Other Accessories.—**MATRON, Croydon Sanatorium, North Cheam, Sutton, Surrey.** j.6

**FOUR HIVES BEES,** very strong and healthy, all frames standard. Feeders, Excluders, Smoker, Veils, etc., £22 the lot, or £6 per hive. Inspection invited. Carriage forward.—**BAKER,** 20, Quentin Avenue, Merton Park. j.7

**WANTED, three driven lots of Bees, Golden** or pure Italian.—**T. JELLINGS,** 8, Stoke Green, Coventry. j.8

**HONEY EXTRACTOR,** good condition, working order, 38s.—**NORTH, Cressing, Braintree, Essex.** j.11

**FOR SALE, ten 1-lb. bottles of pure Heather** Honey, 32s. lot, carriage paid.—**JOHN RUDD,** Duffton, Westmorland. j.9

**SURPLUS QUEENS** from driven bees, all this year's rearing, mostly black stock, 5s. each per return.—**CLARIDGE, Copford, near Colchester.** h.220

**HEATHER HONEY** wanted for cash.—**A. GORDON ROWE, 28A, Moy Road, Cardiff.** h.229

**FIVE good Stocks, pure Italian and Hybrids,** 1920 Queens, in hives with supers, etc., new extractor. What offer?—"W." "Rowstock", King's Road, Horsham. h.226

**HIGH-CLASS HONEY (white), in 7, 14 and 28-lb.** tins, 2s. lb.; also in screw-cap bottles, 28s. dozen, f.o.r.—**WHYTE, Bee Farm, Cumbernauld, Dumbartonshire.** h.205

**FOR SALE, about 35 Stocks and Swarms of** Hybrid Ligurian Bees on 8 to 10 frames and Nuclei; mostly this year's Queens; excellent workers.—**REV. A. H. HALLEY, Crathie, Wellington College, Berks.** r.h.79

**WANTED, Cheshire's Diagrams.—KENWARD,** Berwyn House, Lewes, Sussex. h.112

**HAVE YOU READ "THE BEE WORLD"?** If not, why not? Every number in itself is a useful literary work for practice and reference. Specimen copy free.—**Offices: THE APIS CLUB, Port Hill House, Benson, Oxon.**

**BUSINESS ADVERTISEMENTS.**

1½d. per word.

**MASHEATH MEMS.**—"The Masheath is a delight to manipulate, and flat roofs a blessing.—**M. A.**"—**ATKINSON, Fakenham.** j.10

**SAVE YOUR BEES.**—Finest Australian Honey, two 60-lb. tins, 112s., carriage paid 100 miles, elsewhere 2s. less, carriage forward; cash with order.—**SUNUT, LTD.,** Australian Merchants, New Hibernia Chambers, London Bridge, S.E.1. h.233

**AUSTRALIAN HONEY FOR FEEDING** BEES.—Cases containing two tins, about 60 lbs. each, 110s. per case; 1 tin 56s., carriage paid 100 miles. Remittances with orders.—**SOUTHWOOD, 95, Acton Vale, London.** r.h.190

**"WIGHT" DISEASE.**—Prevention and removal. Advice 5s.—**ALF. RYALL, Cottage Farm, near Camp, Stroud.** j.5

**NO SUGAR VOUCHERS NEEDED.**—Flavine or Plain Candy, same price, 6 lbs., 10s., postage 1s. 3d. extra; larger quantities by passenger or goods train. Made in Cambridge, and the wrappers on the Flavine Candy bear our name and the maker's address.—**S. H. SMITH, 30, Maid's Causeway, Cambridge.** h.218

**GENUINE pure Golden Italian Queens, imported** direct from Penna. Can now supply per return. 100 due in 14 days. Prices while they last: One Queen, 9s.; two, 17s.; three, 24s.; specially selected, 10s. 6d. each.—**GOODARE, Italian Specialist, New Cross, Wednesfield.** r.h.177

**"ISLE OF WIGHT" DISEASE.**—Don't worry; use the solution that cures; 2s. per bottle.—**E. PRESSEY, St. Elmo, Coulsdon.** r.d.149

**SURPLUS HIVES and Appliances for Sale, good** condition, cheap.—**PEARSON & GALE, Marlborough.** r.h.131

**HONEY FOR FEEDING BEES.**—Finest West Indian, tin of about 60 lbs., 68s. 6d., carriage paid 100 miles.—**LONDON TRADING AGENCY, 32, St. Mary Axe, E.C.3.** j.12

**DAIRY SHOW****AGRICULTURAL HALL,  
ISLINGTON, LONDON, N.**

PATRON: H.M. THE KING.

**October 19, 20, 21 and 22**

(TUESDAY TILL FRIDAY.)

Great Exhibition of Cattle, Goats, Poultry, Pigeons, Dairy Produce, New and Improved Inventions, Butter Makers' and Milkers' Contests, Cheesemaking, Poultry Trussing, and Fruit Bottling Demonstrations.

*Inclusive Prices of Admission.*—Admission on Tuesday, October 19, from 10 a.m. to 6 p.m., 3s. (the Gilbey Hall and the Poultry and Pigeon Department will not open until 1 p.m.); and from 6 to 10 p.m., 1s. 6d. On Wednesday, October 20, from 8 a.m. to 1 p.m., 3s.; from 1 p.m. to 10 p.m., 2s. On Thursday, from 10 a.m. to 10 p.m., 1s. 6d., and on Friday, from 10 a.m. to 8 p.m., 1s. 6d. The Exhibition will be closed on Friday at 9 p.m. for the removal of the Exhibits

**Finest Grade New Zealand Honey (Amber)**

For Bee Feeding. Guaranteed Pure.  
Cases, each 2 60 lb. nominal tins. 95/- per cwt.  
Carriage paid.  
Cash with order or on receipt of goods.

N.B. We are already supplying Beekeepers' Associations throughout the Country and shall be pleased to quote references.

The Bristol and Dominions Producers' Association, Ltd., Bristol.

**AYRSHIRE AGRICULTURAL ASSOCIATION.**  
Sixty-Sixth Annual Show of DAIRY and FARM PRODUCE; also BUTTERMILKING COMPETITION at

**KILMARNOCK,** 21st & 22nd OCTOBER, 1920.

Special Competitions for POTATOES, VEGETABLES, FRUIT AND HONEY.

Also ALLLOTMENT HOLDERS' CLASSES and HOME BAKING COMPETITIONS.

Total Premiums - £500. Entries close, Friday, 9th October. Premium Lists on application to—  
**JOHN HOWIE, Sec., 58, Alloway St., Ayr.**

THE

**British Bee-Keepers' Association.**

The recognised centre of practical and scientific bee-keeping in Great Britain. Particulars and conditions of membership may be obtained from the Secretary,

**W. HERROD-HEMPSALL, 23, Bedford Street, Strand, London, W.C.2.**

Preserve your Bees during the Winter by feeding with

**PINK BACTEROL BEE CANDY**

Manufactured by

**HAWKES BROS., LTD.,**  
— Chelmsford, Essex —

Prices on application.

The products of the Apiary, of Poultry and Farm Stock, of the Fruit and Vegetable Garden can be Advertised and Sold through

THE

**BAZAAR, EXCHANGE & MART**

Newspaper.

Get a Copy—Thursday and Saturday 3d. The "Bazaar" publishes also practical handbooks by experts. Send for full catalogue, post free from—  
**WINDSOR HOUSE, Breams Buildings, LONDON, E.C.2.**

**8/-**

Of the Author, **S. SIMMINS, QUEENLAND, HEATHFIELD, SUSSEX.**

**SIMMINS "A MODERN BEE FARM"**

POST FREE

Nearly 500 pages. A few more copies at 8/-. Any further edition must cost 50% more

**Bees and Beekeeping Appliances. Catalogue free. EDWARD J. BURTT. MANUFACTURER. GLOUCESTER.**

*I very much regret that there has been a large increase in the cost of the manufacture of bee appliances, and therefore my prices will be advanced 10% from May 10th. Books excepted.*



**"BACTEROL" FOR BEES**

2/9 per Bottle.

Post Free.

The cure for, and preventive of, "Isle of Wight" Disease. Non-poisonous—free from stain or unpleasant odour.

**BACTEROL LIMITED**  
19/25, Brookside Rd., Highgate, N.19.

**BGB**  
**BWB**

**BEST CLEARING and WINTERING BOARD, SUPER CLEARER, &c.**

A Necessity for all Bee-Keepers all the year round.

**MEADOWS, SYSTON, LEICESTER.**

**POSITIVE FACTS.**

June 13th, 1920.

I am very pleased with the foundation. The bees undoubtedly prefer it to any other make I have, and have even gone the length of missing two sheets of other new foundation, and working out a sheet of yours placed behind them at the back of the hive. Full sheets have not sagged in the least in 16 x 10 frames.

Yours faithfully, **R. B. MANLEY,**

*Illustrated Lists free by post.*

**S. J. BALDWIN, The Apiary, BROMLEY, Kent.**

## FOUR FIRST PRIZES.

Our HIVES and APPLIANCES were again awarded FOUR PRIZES at the Highland Agricultural Society's Show at Aberdeen, thus testifying to the superiority of our goods. Order now and ensure your bees wintering in good hives.

**BOTTLES.** We hold a large stock and can give immediate despatch.

**CANDY.** Safeguard your bees from starvation by feeding with our FAMOUS BEE CANDY. Price **1/6** per 1-lb., carriage extra.

Sole Agents for DADANT'S WEED FOUNDATION. Absolutely pure. Once used, always used.

Large illustrated catalogue, entitled, "Everything for an Apiary," post free on application.

**R. STEELE & BRODIE,**  
*Bee Appliance Makers,*  
**WORMIT, FIFE.**

Telegrams:—"Bees, Wormit."

Telephone:—28 Wormit.



### Lee's Bee Supplies.

¶ In design, material and workmanship, Lee's Bee Supplies still retain the reputation of being your best and safest investment.

¶ Our 1920 ILLUSTRATED CATALOGUE is yours for the asking. It contains detailed information on the most up-to-date hives and appliances for which the House of Lee is famous.

¶ We regret the necessity of having to advise our Customers that owing to the increased cost of production, all prices in 1920 price list are subject to 10% increase. The increase will not apply to orders received before May 10.

\*\*\* Five per cent discount to Members of THE APIS CLUB.

**JAMES LEE & SON,**  
LTD.,  
Uxbridge, Middlesex.

(Telegrams: Graphicly, Uxbridge.)

Telephone: Uxbridge 181.)



No. 1999. Vol. XLVIII

OCTOBER 14, 1920.

[Published every Thursday, Price 2d.]

**CONTENTS.**

	PAGE		PAGE
THE B.B.K.A. CONVERSAZIONE .....	495	THE HARVESTERS (POEM) .....	499
A DORSET YARN .....	495	CORRESPONDENCE—	
THE JOYS AND SORROWS OF AN INSPECTOR .....	494	Supersedure of Queens .....	499
NOTES ON BEES .....	495	Onions and "I.O.W." Disease .....	500
NOTES FROM THE WEST .....	496	Origin of the "Isle of Wight" Disease ..	501
STREET AND GLASTONBURY BEE-KEEPERS' ASSOCIA- TION .....	497	Is Poppy Pollen Injurious? .....	501
ESSEX FRUIT AND HONEY SHOW .....	498	Feeding with Imported Honey .....	502
LECTURE AT KINGSTON .....	498	Bees Building in the Open .....	502
ECHOES FROM THE HIVES .....	499	QUERIES AND REPLIES—	
HONEY IMPORTS .....	499	Bees not Transferring Themselves .....	502

Do not **LOSE YOUR BEES** for the sake of giving them a cake of our **PINK**

# SOFT CANDY

Made from guaranteed Pure Cane Sugar, medicated or plain.

Price 1/6 per lb. Carriage or postage extra.

**E. H. TAYLOR, LTD., WELWYN, HERTS.**

## THE British Bee Journal

Office: 23, Bedford Street, Strand, London, W.C.2.  
ESTABLISHED 1873.

A Weekly Journal Devoted to the  
Interests of Bee-keepers.

Edited by **T. W. COWAN, F.L.S., &c.,**  
and **J. HERROD-HEMPSALL, F.E.S.**

**Correspondence: Whom to Address.**—All matters relating to the Literary Department, Associations, Shows, etc., should be addressed, "Editors, *British Bee Journal*," and all business communications and matters relating to subscriptions and advertisements to be addressed to the "Manager," *B.B.J.* Office.

**Subscriptions.**—Annual Subscription, 10s. 10d. post free in advance; single copies 2d., or 2½d. post free. If a receipt is required by post, a stamped and addressed envelope must be sent, otherwise a printed receipt will be enclosed along with the paper.

*Note.*—Cheques and Postal Orders should always be crossed, otherwise it is very difficult to trace them if they go astray.

**How to send Money.**—Remittances can be made payable to W. Herrod-Hempsall by crossed Cheques and Postal Orders. Stamps may be sent for small amounts up to 2s. *Halfpenny stamps are preferred.*

Scottish or Irish cheques can only be taken in payment if 6d. is added for commission charged by banks for cashing them.

The Editors are not directly or indirectly interested in the manufacture or sale of beehives or appliances of any kind, and must refer correspondents wishing for prices or catalogues to advertisers in the paper.

### OUR DEPOSIT SYSTEM.

**You are advised to insist on this being used when dealing with strangers.**

#### Rules and Conditions for Depositing

*In order to save trouble, it is requested that the Rules be carefully read over by persons using the Deposit System of trading.*

Goods should not be despatched until notice that the money has been deposited is received from this office.

**1. Method.**—When strangers are dealing together, the purchase-money of the articles is deposited at our office. We acknowledge receipt of the deposit to both parties, and hold the money until we are satisfied that the purchase is concluded. If a sale be effected, we remit to the seller the amount deposited, less a charge of 2½ per cent. in the £, with a minimum of 6d., and the expenses of Post Office Orders and postage, &c. Cash will be forwarded by Cheque, Post Office Order, or by Postal Order as preferred. If a sale or exchange be not completed, we return the amount deposited, after making the same deduction. By this means buyers and sellers are secured against fraud.

**2. Deposits.**—Postal Orders (drawn on General Post Office) and Cheques must be made payable to W. Herrod-Hempsall, and crossed "London County and Westminster Bank." The numbers of the Postal Orders should be kept by the sender.

We cannot be responsible for any loss that may occur in transit.

**3. Honey on Approval.**—All honey will be sold by sample, which must be sent direct to buyer.

**4. Bee Appliances.**—In ordering, the time allowed for completing the order to be stated to us when sending cash. If maker accepts, we hold cash until transaction is satisfactorily completed, when the amount will be remitted, subject to conditions as in Clause 1.

**5. Bees and Queens.**—These will be dealt with entirely by the parties concerned, so far as price, &c., go, and when the purchase is satisfactorily completed cash will be remitted as per Clause 1.

**6. Goods in Transit.**—These are at the seller's risk, i.e., any damage to or loss of an article on its journey is borne by the vendor; but a rejected article must be properly packed and returned by the same means as was used in sending it.

**7. Carriage.**—The carriage of all goods, *except such as are sent by post*, is payable by the buyer, unless otherwise agreed. If any article sent on approval be returned, each party to the transaction must pay carriage one way.

## Books for Bee-keepers NOW IN STOCK.

Cash in full must be sent with order.

	7/6	Postage	3½d.
A Modern Bee Farm ... ..	7/6	...	3½d.
(To be obtained from this Office only.)			
Advanced Bee Culture (HUTCHINSON) ... ..	6/-	...	6½d.
Beginner's Bee Book (PELLERY)	5/-	...	4d.
<b>BEE-KEEPING SIMPLIFIED FOR THE COTTAGER AND SMALLHOLDER (W. HERROD-HEMPSALL, F.E.S.)</b> ... ..	1/-	...	2d.
<b>BRITISH BEE - KEEPERS' GUIDE BOOK (T. W. COWAN)</b>			
Paper covers ... ..	2/6	...	3d.
Cloth covers ... ..	3/6	...	4d.
Dissectible Model of Queen Bee ... ..	4/6	...	3d.
<b>FERTILISATION OF FRUIT BLOSSOMS BY BEES (T. W. COWAN)</b> ... ..	-/3	...	1d.
Honey and Health (A. HORS) ...	-/6	...	1d.
Honey Vinegar (REV. G. BANKS)	-/2	...	1d.
How to Keep Bees (ANNA B. COMSTOCK) ... ..	5/-	...	4½d.
Prevention of Swarming (WILKES) ... ..	1/-	...	1d.
Pollination of Fruit in relation to Commercial Fruit Growing (C. H. HOOPER, F.R.H.S.)	-/6	...	1d.
<b>PRODUCING, PREPARING, EXHIBITING AND JUDGING BEE PRODUCE (W. HERROD-HEMPSALL, F.E.S.)</b> ... ..	2/-	...	3d.
Queen Rearing in England (F. W. L. SLADEN) ... ..	1/6	...	2d.
Scientific Queen Rearing (DOOLITTLE) ... ..	4/-	...	3½d.
Snelgrove's Method of Re-queening ... ..	-/6	...	1d.
The "Townsend" Bee Book ...	2/6	...	2d.
WAX CRAFT (T. W. COWAN) ...	2/-	...	2½d.
Wilke's Book on Swarming ...	1/-	...	1½d.

#### MISCELLANEOUS.

<b>THE BEE WORLD</b> (supplied only to members of Associations interested in the control and development of the Apis Club, apart from ordinary members of the latter), per copy ... ..	-/8	...	1½d.
<b>The Bee Master of Warrilow (TICKNER EDWARDS)</b> ... ..	7/6	...	4½d.

**British Bee Journal & Record Office,**  
23, BEDFORD STREET, STRAND LONDON, W.C.2.





## The B.B.K.A. Conversazione.

For a number of years before the war the conversazione during "Dairy Show Week" was a fixture eagerly looked forward to by many bee-keepers, and the Council of the B.B.K.A. is anticipating a very good attendance next Thursday. In the notice of the meeting a new feature is introduced, viz., "A reception by the Chairman and Council will be held from 2 p.m. to 3 p.m." One of the pleasures and advantages of these gatherings is the meeting of old friends and making the acquaintance of new ones, but a difficulty in the way of the latter has been the short time available—generally during the hour for refreshment—to obtain introductions. This was brought forward at the last council meeting and discussed, the result being that it was decided to set apart an hour for a true "Conversazione"—a meeting for conversation—during which the Chairman and Council will be pleased to effect as many introductions as possible, and it is hoped many bee-keepers will be able to have fulfilled a desire to meet and talk with some other member of the craft whose name may have been long familiar. The hour's reception will be quite informal; just an hour for a gossip on bee matters, so pleasurable to bee-keepers of either sex.

## A Dorset Yarn.

Our bees have been out on the farm a good time this week. As we dig up the new rasps for distribution, they are all around us—it has been a week of warm weather, though wind has been eastward a good part of the time. They have been working the late flowers freely, even violets having had a share of them this week; it is advantageous to have the blossoms close to the hives, they do not go far away in catchy weather. One likes to see them out on the flowers looking for food; then they do not get the robbing fever. We see them on the ivy in great numbers, and when we look at the front of the hives as the sun is warm, there seems as many about as a month ago.

My friend, Squire Tomlinson, has extracted for me during my holiday in the West country a very heavy weight of honey, but he had to bring me back some of the bars that would not yield up the weight of heather honey; it was all in

new bars and new foundation. Even though uncapped, it would not run out of the cells; one can cut it like cheese, in junks, but it would only very slightly run from the halved cells. I conclude these are all from the ling heather. Many of these bars were only put on in August, yet the bees filled some of them solid with heather honey, but the greater part gave up the harvest when in the extractor.

Bees are advertised in our local newspaper to be sold at the different farm sales. I went over to one last Wednesday in the Isle of Purbeck, where the farmer and bee-keeper died in the harvest field, when turning the lines of corn—the last of his race—on the farm his ancestors had lived for 150 years. His bees sold for low prices, but his stock of appliances fetched good figures. He must have had a lot of bees at one time to have had such a lot of honey bottles and jars, with boxes of sections. I had never met him, but his name was well known in Dorset. He lived on one of the small farms, miles from the railway station, with only a track across the heath, far away from the town. Unless he went to market, he would see but little of other men; but there are many like him, who live out their time in quiet content. His herd of cows sold well—£40 and £50 each. They were very wild; they had never seen so many people at one time before. It was the loneliest farm I had ever seen; even the bees (they were all blacks) resented strangers—so many complained of being stung by them. I had no wish to import to our farm bad-tempered bees, so left them for the bee-keepers of the Wareham area. They may have been made all-tempered by those who wished to see them before the sale. They seemed rather small black bees to what I had from that area once before.

Mr. Dorey, another small farmer a few miles away, said his bees were all brown ones; he had sold some stocks in the spring, but his sections had not been filled so well as other years. It must be in these isolated areas that the blacks have kept true to colour; but colour does not matter to the bee-keeper if they are good workers—it is the same with bees as with men. "A man may hide his real self from you in every other way, but he cannot in his work." So with bees. The beautifully-finished sections, with snow-white cappings, are the points that tell—the finished work, as Ruskin points out, that shows the real genuine worker. Colours are not material; so long as the bees are good workers, and not too bad-tempered.

Mr. Garret (the East Dorset secretary) had some of the whitest capped, shallow

and standard combs I have ever seen. His bees were from these isolated places in the Wareham area. I have referred visitors to the same area for bees as they come to the farm. We do not sell bees, nor hives, nor appliances; we write of bees because we like them—because we see the great good they do, the income that they bring in. We believe ourselves in the gospel of work; we have always the bees as an object lesson. Goethe wrote "work is character," and bees have always been held out as an object lesson for work. In many of the cheques we get in payment for goods there is a skep hive on them; to the bee-keeper it appears a good ornament for a cheque. It is a good one for the farmer, as work is the only way to get the great harvest from the soil. "The harvest is (really) great, and the labourers are few." Many farms of 150 to 200 acres have only two hands employed on them—just a carter and cowman—beside the farmer. We have written before that "pleasure comes from toil, not from self-indulgence and indolence." Many people say, "Ruskin did not know what he was writing about," but we know it to be a real pleasure to see the results of work. In the summer the yields of fruit, and in autumn and winter the results from the fields of violets, when one inquires the number packed in one day—79 dozen, and 84 dozen another time. All this shows the value of work. Even though one draws out of the bank £20 for labour each week, on a small farm of fifty acres, the results give pleasure, in that one can reclaim another field from gorse and heather, and give employment to others, even at the high price labour now is paid.

J. J. KEFFLE

### The Joys and Sorrows of an Inspector.

It was some weeks after the lamentable expedition in the killing line, set out to some length in No. 1986 of the B.B.J., and I was enjoying myself in idleness in my garden, where the sunshine, the hum of bees, and time were gradually removing from my memory the soreness caused by this expedition. As distance lends enchantment to the view, so does time work, and as time goes on we forget most of what we have gone through.

While I was soaking thus in idleness the Boy came and handed to me a large envelope which the postman had just delivered for me. Across the top of it was, in large letters, "On His Majesty's Service."

As I had, unfortunately, forgot to include some considerable source of income

when sending in my statement of income, I felt very uneasy when I opened the envelope. However, it proved to be from the Ministry of Pickled Cabbages and Shrimps, and was an invitation to me to become an inspector under the Bees' Pestilent Disease Act.

My natural modesty will not allow me to quote fully from the letter, but sufficient to say, as the above Act was on its trial, they were extremely anxious to appoint the right persons as inspectors, and they had watched my attempts to clear my district of diseased bees, and were sure I would be an example to anyone further appointed, and if I would kindly fill in the enclosed form they would send me an official appointment in due course. To hide my blushes from the Boy, I examined the form. Fortunately I had been vaccinated in my tender childhood, also I knew the date of my birth, so I would have no difficulty in filling in those particulars, and others of an equally interesting nature to someone in authority. I communicated the nature of the letter to the Boy, who was waiting as usual to give assistance—or advice. It was generally advice and he was delighted with the idea of having a free hand, in our expeditions; no need to avoid the village constable, or we could paralyse him to impotency.

So I filled in the form and gave it to the Boy to post. In going to do so, I saw him pass by the stable and heard him tell the stableman that the master was going to be appointed an inspector. "What of?" asked the stableman, somewhat anxiously, "surely not of horses?" "No," answered the Boy; "only of bees." Oh, bees! said the stableman, "they can take care of themselves;" and I said, "The Boy can take care of him." So, as everyone seemed satisfied, I dismissed the matter from my thoughts, until the day arrived when my appointment came to hand, after which it took several days to consider it and become accustomed to the feeling of authority. But the Boy could not let this continue, for, as he said, the bees were in a terrible state with disease, and we must be up and doing something. So we sallied forth—not, as before, loaded with ladders, saws, and other things, but simply armed with the majesty of the law—to inspect the stocks of bees and advise on their treatment or destruction. We passed several fairly large apiaries of bees, but these could wait, for our objective was the cottage of Widow White, who I thought stood in need of some useful advice, to keep her bees healthy.

Before her cottage there was a large pond, where several children were catching unpleasant things and putting them in glass jars. Some had young frogs

which they had caught in the surrounding wet herbage; others had newts, and some had various kinds of water-beetles with cruel jaws.

The Boy wished to stop and assist in filling the bottles, but I reminded him we were on official business and could not delay, and so we arrived at Widow White's cottage, where, after knocking, she came to the door, whereupon we stated our business. She cordially invited us in to rest awhile, if we could spare the time from our arduous labours, so we followed her inside and into her best room, where, after carefully wiping the chairs, she invited us to sit down. She then put on the table some glasses and a bottle of elderberry wine. Here was bribery and corruption very early, and this I shall have to guard against. But she was a motherly old lady, and her elderberry wine was good. She was very entertaining, and told us how long she had kept bees and what she knew about them. She said she knew all about bees, and she also knew me. This I could not deny, for I also knew. I think, every fruit tree she had in her garden; but still I think there was no need for her to say she knew me.

After resting awhile, and the Boy had looked hard at the bottle for some time without effect, we told the old lady we wished to see her bees, so we followed her into the garden, where she had three hives. With slow step and with dignity I inspected them from various positions, and then asked the old lady if she had seen any sign of disease among the bees, but she said she had not. I informed her that one important sign was what was known as crawling, which they did when unable to fly. And as there were a number of bees on the ground crawling about, and making curious jumps, I considered it was likely that they had disease among them, but she said they were only young bees trying their wings. I thought it very natural that if they had disease she would try to hide this fact from me, the official inspector of bees. So I lifted the roof of what I considered the smallest hive, to see if they were crawling about inside. I took off also the quilts, when I soon saw they were crawling. Triumphant I turned to point out this fact to my companions, but I only saw the old lady disappear into her cottage with a loud bang of the door, and the Boy I then saw two fields away, and still running strong. Although it had been a fine day, the sun became suddenly overcast, a dense cloud seemed to be around me. It was only when something hit me under the eye and stabbed with red-hot sting, and others found other tender places, that I realised that they were bees—and mad ones. I dropped the quilt suddenly, and

within ten seconds I was laid on my face on the bottom of the pond with a foot of water above me. The majority of the bees that had chased me there went back to the hive, where they swaggered up the flight board to tell their sisters how the long-legged thing had run. I lay there until I remembered the things the children had been fishing out of that pond. I knew not what horrors there were in the pond, so I came to the top and into daylight again. The baffled bees which still remained flying round the pond did not seem to know me, or they despised me so much they took no further notice of me, and I was allowed to crawl out of the pond and join the Boy without further molestation, and so we sadly went home. No doubt this is how we both felt, although I could not see any signs of sadness in the appearance of the Boy.

F. B. CHARLTON.

Stockton-on-Tees.

---

### Notes on Bees.

Of all the studies of insect life that have been man's chief object of attraction, the honey-bee heads the list, notwithstanding that the earth is teeming with millions of other insects of various species. What is it that drew man's attention in this particular direction? Is it because of the musical hum we hear, or is it that the student has placed himself, or herself, at some time or other in the flight of these little foragers and received a fair amount of their sting? I am rather inclined to think that the chief reason of so much attention given to *Miss Apis* lies in the same objective, one of old, that we read about in the Book of Holy Writ had when he "put forth his staff to refresh himself," namely honey. Our little friend the honey-bee belongs to that branch of the animal kingdom termed by entomologists "*articulata*," as all its parts are joined, or articulated, and having no internal skeleton. Unlike other members of the animal kingdom, it also forms one of the class of insects which breathe the air through a complication of tubes, branching all over her body. The openings to these tubes are called spiracles, and are situated along each side of her body: they are fringed with hair, to exclude any dust or foreign particles from entering, other than matter in a liquid form. It will be seen by this that it is not a wise plan to give the bees too much liquid, when spraying against disease, as many of the bees are liable to be suffocated by the liquid entering these tubes. Its sub-class is the true insects, or *Hecrapoda* (i.e., six-feet), and this sub-class is noticeable by their having three divisions to the body—head, thorax, and

abdomen. Its order is *Hymenoptera*, or membranous wings, of which the bee has four. Members of this order, with few exceptions, are peculiar by their action in respecting and caring for their young, which at first are quite helpless. Its tribe, or family, is called *Apidae*; all insects of this family feed their young upon pollen, or a mixture of honey and pollen, and all of this family have the first joint of the two posterior legs widened out, which, together with the fringe of stiff hairs attached thereto, form a kind of receptacle in which they carry pollen and propolis to their hives. Bee-keepers call this receptacle their pollen-basket. The curious part about the bee when out collecting pollen is its manner of keeping to one species of flower, not on a coltsfoot and then on a box-tree, but keeping to one particular species of flower, until they return back to their hives. One sometimes wonders whether they have reserve cells, to disgorge their honey and pollen gathered from the many different kinds of flowers, and whether it is necessary to be kept separate. One thing we feel sure about, that honey in its natural state is already in a condition for absorption into the system, and requires no digestion, as it has already gone through a form of digestion in the bee's honey-sac, ready to feed the immature brood.—R. LYTHGOE, Padgate, Warrington, Lancs.

### Notes from the West.

The active season in the apiary is now over. Each stock has had its autumn ration of thick syrup, winter passages have been provided over the tops of frames, quilts fitted closely, covered with a good chaff cushion quilt, and all made snug and comfy in dry, weather-proof hives. So our bees will need very little attention till next spring.

We now have a little leisure to look over our notes for the past season, and a short account of each stock should be made on a post card and placed under the top cushion or quilt in the hive for reference when another season opens. One's memory may be relied on when the apiary consists of only a few stocks, but if it reaches to a dozen or more I find it a great help to adopt this card system.

Like all other reports this season (with the rare exceptions of that from friend Kettle and a few others favourably situated down South), the bees in this part have done badly. During my "Twenty years among the Bees" this is the first season that my apiary cash account has shown a balance on the wrong side, but as I have a few more stocks going into winter quarters than I had in the

spring, the account really should not be confined to this season alone. Owing to the unsettled weather, we had no opportunity of testing the honey-gathering qualities of the various bees in the apiary. All stocks are now headed with 1920 queens, and consist of purely mated native, native mated to Italian drone, home-raised Italian, White Star Italian, and Penna imported Italian. On the season's work I note the following remarks:—

a. I took surplus honey from one hive only. This was a stock of natives.

b. The progeny of my "British Bees" (native queen mated to Italian drone) are as gentle and easily handled as any pure variety.

c. Home raised Italians vary greatly in temper. One such stock was the most vicious I have ever handled, while others are tame as flies.

d. The best stock of autumn workers is headed by an imported Penna queen. These were busy carrying pollen into their hive during some cold days in September, when not a bee ventured forth out of any other hive in the apiary.

e. Virgin queens greatly varied in the age at which they were fertilised. Some started laying at seven days old, while others went as long as 24 and 25 days. Even the late-mated ones are promising well. Out of 21 virgin queens in nuclei and stocks at about the same time, three only were lost on their mating flights, and one only had failed to mate.

f. One stock of Italians is evidently much less hardy than any other stock I have. Their hive is in rather a shady part of the apiary, where the sun at this time of the year shines but little on them. These bees come out of their hive, and the cold air seems to chill them. Scores of them may be seen some days amongst the dew-laden grass in front of their hive, and once down they have no energy to rise again. The sight of these bees has more than once caused me some uneasiness, and anyone who has once lost all his bees through *Microsporidiosis* will understand why. Yet they showed no other symptoms of that dread disease. There was no dysentery, no dislocated wings, and no distended abdomen. I collected some of them into a box, which was taken indoors, and the warmth soon made them quite lively again. However, to relieve myself of any further anxiety regarding them I sent off a queen-cage full to the Department of Comparative Anatomy, Oxford, and was very pleased to receive Dr. H. Goodrich's reply in about seven days, which was as follows:—"Report on bees received September 25, 1920. No *Nosema* found." It was all I wanted to know, and my mind was at ease.

After all, the loss of many bees at this critical time is sure to tell on the prosperity of this stock, and I cannot hope to find them in the spring as strong as other stocks which have acted normally. Is it possible that some of the cases of crawling, etc., mentioned in the *Journal* lately, with symptoms similar to, but not identical with, "Isle of Wight" disease, are due to soft, unacclimatised bees of a foreign variety?—T. ALUN JONES, Halkyn, Flintshire.

### Street and Glastonbury Bee-Keepers' Association.

#### ANNUAL MEETING.

The annual meeting was held at Portway House, Street, on September 20. The Secretary's report showed that the number of stocks of bees in the district had doubled, there being 45 last year, compared with 90 this year. Surplus honey taken last year was 750 lbs., this year only 300 lbs. Extracted honey sold at 2s. 9d. a lb., sections at 3s. each. Members were recommended this year to charge 3s. for extracted and 3s. 6d. for sections. Last year tons of honey were wasted for want of bees to gather it. This year tons were wasted for want of sunshine to enable the bees to gather it.

#### THE HONEY SEASON

was the worst we have known. The county secretary informed us that we had to go back to 1888 to find such a bad season, and even that was believed to be not quite so bad as 1920. The best "take" from one hive this year was 34 lbs., compared with 281 lbs. last year. There was never a good honey week the whole season. The bees were never able to store surplus on more than three or four consecutive days. May was the best honey month, as usual. All the honey gathered after June 6 was eaten by the bees during the poor weather of July, August and September. Feeding will be necessary for all swarms that came off after June 6.

#### "THE 'ISLE OF WIGHT' DISEASE

still claims its victims. Five remaining stocks of the English bees in different parts of the district were affected in the spring, and by this time are believed to be all dead; we hope the disease has gone with them. In two cases the disease showed in Italian-English crosses. They appear to have now recovered. The pure Italians have not shown any sign of the disease. If we wish to keep bees at all it appears to be necessary to have Italians, or some strain capable of resisting disease. The Italians are quite suitable for this country, giving a larger yield of honey in fine weather, although in poor seasons like this one the English strains do better. They are gentle to handle,

but care should be taken to prevent them getting crossed with unsuitable strains, or the result may be a remarkable cross bee quite capable of giving the bee-keeper unpleasant surprises. Some of our members have made a speciality of increasing from selected strains and supplying others whose bees had died out, at prices varying from 30s. for the smallest nucleus up to £6 for the best stocks that changed hands in the spring. To keep the strain pure a number of queens were imported direct from Italy, and some have been obtained through the Ministry of Agriculture, the County Council Horticultural Committee have also helped, and we have had some nuclei supplied through the restocking scheme of the Somerset B.K.A. In the spring there were not sufficient bees to go round, but now we have a supply more than equal to the demand.

#### STRAY SWARMS.

Several were seen, and some captured in the early part of the summer. Our oldest bee-keeper (age 90 years) had a remarkable experience, he had one of the largest apiaries in the neighbourhood when the "Isle of Wight" disease came some five years ago, and he mourned the loss of every bee. One night this year he had a happy time in dreamland, and saw in a vision a swarm of bees coming into the garden and "pitching" on the apple tree. He told the dream to his grandchildren at breakfast time. About 11 o'clock he went into the garden and was heard shouting "The bees are coming!" and, to the astonishment of everybody, they settled in the exact place that he had described at breakfast. Another stray swarm was secured by our youngest member, who never dreamed of such a thing happening. Another member told how he had kept an empty hive out for years to attract a swarm, but he had never been favoured.

#### A NEW THEORY

as to how the "Isle of Wight" disease is spread. A good deal of experimenting has been done by bee-keepers in Street to try and find out how the disease is spread. We have been endeavouring to prove that the main cause of the spread of the disease is owing to queens mating with drones from diseased hives, the queen carrying back the infection to its own hive. In six cases where there was evidence of the queen mating with a drone from a diseased colony the stock began to show signs of the disease a month after mating. The experiments have extended over some years, but the theory is very difficult to prove, owing to mating taking place high in the air. Last year a clean queen was introduced to a very badly affected stock, the bees dying by thousands daily. A month after they

were nearly better, but only about one-twentieth part of the bees remained. For ten months after there were slight symptoms of the disease, and then they appeared to recover completely, and are now vigorous, and apparently perfectly healthy. This summer, when short of food, some combs of honey were given from a hive in which the bees had died of "Isle of Wight" disease, without doing any harm. They are being watched with much interest, and not a crawler has been seen for the last sixteen weeks. We do not recommend this treatment. One of our members tried it this year, but weather conditions were unfavourable, and all the bees were dead three weeks after the introduction of the clean queen, and a valuable queen was lost. We recommend destroying a stock as soon as the "Isle of Wight" symptoms are apparent. It is much more economical than trying remedies to save. It clears out the disease and the drones which might spread it to other stocks. *Breed only from those stocks that appear to be immune.* Some members have adopted this method, and for its size we do not know of a district in England with so large a number of healthy stocks. At the present time we do not know of a diseased stock. The secretary will be glad to give any available information on the strains of bees that are capable of resisting the "Isle of Wight" disease.

A profitable time was spent with questions on bee-keeping in general, and so pleased were the members with the answers that Mr. Bigg-Wither was asked to come to Street during the winter and give a public lecture. We look forward to this lecture and to a better season next year, when the bees will have an opportunity of showing what they can do.—  
EDWIN I. WALTER, Portway House, Street, Somerset, hon. secretary.

### Essex Fruit and Honey Show.

The above show (inaugurated by the Essex Education Committee) was held at the Institute of Agriculture, Chelmsford, from October 5 to 8, the management of the fruit section being conducted by the Essex Fruit Growers' Federation and the honey section by the Essex Bee-keepers' Association, whilst the Committee arranged for lectures to be given by the staff of the Institute each day.—Special credit was due to Miss E. Jameson, who was in charge of the Microscopical Department, for an excellent set of slides of the anatomy of the honey bee, and also for slides of bee diseases. These proved immensely attractive to interested bee-keepers, few of whom possess a really

good microscope, and the opportunity of using a dozen high-powered instruments was one not to be missed. The exhibits both of fruit and honey were of excellent quality, and clearly demonstrated the possibilities of Essex both for the fruit-grower and bee-keeper. The exhibits of honey were judged by Mr. G. R. Alder, assisted by Mr. C. Winn, of Hornchurch, and the county bee inspector, Mr. G. R. Alder, jun., the awards being as follows:—

Complete and inexpensive beehive.—1, J. Lee & Son, Ltd., Uxbridge; 2, L. Andrews & Co., Peterborough.

Observatory hive, with bees.—1, F. M. Claridge, Copford; 2, C. H. Aubrey, Chelmsford.

Six 1-lb. sections comb honey.—1, C. H. Aubrey; 2, O. Crouch, Heybridge.

One 1-lb. section.—1, O. Crouch; 2, A. C. Tew, Tiptree.

Six 1-lb. jars extracted honey.—1, Miss G. M. Darrington, Wendon; 2, F. M. Claridge; 3, A. C. Tew; v.h.c., G. A. Taylor, Ongar.

Three 1-lb. jars extracted honey.—1, Miss W. A. Hope, Hatfield Peveril; 2, L. Belsham, Heybridge; 3, Mrs. Low, Broomfield.

Six 1-lb jars granulated.—1 and 2 and B.B.K.A. certificate, F. M. Claridge; 3, L. Belsham.

One 1-lb. jar extracted.—1, F. M. Claridge; 2, O. Crouch.

Trophy class.—1, A. C. Tew.

Beeswax, about 2 lbs.—1, L. Belsham; 2, F. M. Claridge.

Interesting or useful exhibits.—1, A. C. Tew; 2, F. M. Crouch.

Honey cakes.—1, Miss Bott, Chelmsford.

The silver medal of the B.B.K.A. was won by Mr. F. M. Claridge, and the bronze by Mr. A. C. Tew.

The observatory hives were greatly appreciated by visitors each day, Mr. Claridge showing his Golden Italians, which were flying very freely the whole of the time of the show, whilst the other observatory hive, containing blacks, had but very few bees flying.—*Communicated.*

### Lecture at Kingston.

A lecture, arranged by the Surrey Education Committee, on "Wintering Bees," was given by Mr. G. W. Judge, Secretary of the Kent B.K.A., in the lecture-hall of the Kingston-upon-Thames Public Library, on October 4. The lecturer dealt very fully and clearly with his subject, and illustrated it with a number of excellent lantern slides. At the end of the lecture many questions were asked and answered. On the motion of Mr. B. Carter, Hon. Secretary of the Kingston District B.K.A.,

a hearty vote of thanks was accorded the lecturer for his very interesting and informative lecture.—B. CARTER.

## Echoes from the Hives.

YORKSHIRE.

The reports published of the honey harvest from counties from all points of the compass tell the same tale of woe, and Yorkshire can also join in the same strain so far as the early bloom and clover harvest is concerned, but the heather crop will prove one of the best for years, and beekeepers who took the trouble and expense of moving stocks to the moors will be rewarded with ample winter stores and surplus honey. It is very rare that bees will draw out comb and fill sections, but 1920 has proved an exception, the continued weeks of ideal weather giving them the opportunity. Had Mr. Tickel (10301) traversed the district, Pickering, Saltergate, Levisham, Goathland and beyond to the sea 20 years ago, he would have seen hundreds of hives, but disease has taken a very heavy toll, and the now high expense of cartage, either road or rail, makes one think twice of the venture, for it is a sporting chance whether one recovers out-of-pocket expenses. From 30 years knowledge of heather seasons I can count the good ones on the fingers of one hand, so I trust by 1926 the work of the re-stocking scheme will be rewarded by seeing all the old sites and stands occupied, and this glorious vale of Pickering again ringing with the merry hum.—W. E. RICHARDSON.

## Honey Imports.

The registered value of honey imported into the United Kingdom during the month of September, 1920, was £34,947.—From a return furnished by the Statistical Office of H.M. Customs.

## The Harvesters.

Yonder in the misty valleys,  
They are gathering up the corn,  
Here among the barren hillocks,  
Toil begins at early morn.  
  
From the purple heather patches,  
Wafted on the moorland breeze,  
Comes the drowsy note of humming,  
Joyful song of busy bees.  
  
They must fill their golden coffers,  
For the cold, dark months ahead;  
Patient workers, never ceasing,  
Till the light of day has sped.  
V. I. W.



*The Editors do not hold themselves responsible for the opinions expressed by correspondents. No notice will be taken of anonymous communications, and correspondents are requested to write on one side of the paper only and give their real name and addresses, not necessarily for publication, but as a guarantee of good faith. Illustrations should be drawn on separate pieces of paper. We do not undertake to return rejected communications.*

## Supersedure of Queens.

[10,312] It is possible that my experience may help to elucidate some of the points raised in Mr. Hogan's letter *re* queens being apparently superseded after having been successfully introduced.

Owing to an error in manipulation towards the end of the August 1919 honey flow, three stocks were found with no eggs but only brood in an advanced stage, and the queens so altered as to be unrecognisable from the description given in the tallying cards. After a terribly disappointing season, a grand honey flow set in here the beginning of August, and having successfully prevented swarming, the stocks were so strong that honey poured in; however, needing more room, the fatal mistake was made of giving them an empty box next to the brood nest, and, the flow suddenly stopping, breeding decreased to an unprecedented extent. The untoward weather looking likely to continue, their winter box of food stored above was given to them (this box being filled with honey with the exception of two combs in the centre), and within a week those queens were laying in the upper box and had changed their form and colour marvellously, in spite of the indifferent weather prevailing. These identical stocks were in fine fettle in the spring, overflowing with bees in two stock boxes, and were taken over from us with others by Mr. Hogan.

I do not suggest for a moment that bees will not supersede newly-introduced queens, as I have had them do it—they know more than we do as to the super-qualities needed in their mother-queen, and it is well never to argue with them, but re-queen early enough to allow them to settle in well before the winter; but food necessarily plays such an important part that its disposition may lead to misleading conclusions. It must not be forgotten that, unlike British Blacks, Italian bees are exceedingly prolific and on that account have often literally little or no food in their breeding quarters, taking it all above, which is excellent to a point, but needs careful manipulation and fore-

thought on the part of the bee-keeper in our uncertain climate, as unless the queen is practically confined it is good-bye to the harvest and safe wintering.

With reference to the fertilisation of virgins, Mr. Hogan will find that it is impracticable, in this country at any rate, to expect to get them fertilised after such a long period has elapsed since hatching, as there would be no chance for them unless under a long spell of settled weather, and that certainly has not been our luck the last few seasons—it is far better to cut the loss.

By the way, I am interested to hear that Mr. Hogan has also had success with the nuclei-newspaper method of introduction of queens. It is an extraordinarily safe and simple method, and allows of queen introduction in any weather and at any time of the year when bees are on the move without de-queening first, and to any sort or condition of stocks, large or small, without interruption of the work of the largest hive for a single hour: and, not least, it enables a queen to be introduced to a stock in a swarming condition, when experts know that it is the most difficult thing to get them to accept one not of their own "making." I have never had a failure by this method, always bearing in mind an evidently fundamental bee-law, that the bottom of the hive is their castle, and on the manipulation of this depends their welfare and the beekeeper's harvest.

Far from bees "doing nothing invariably," I venture to suggest that they fall into line with other livestock as to uniformity and stability of action if run on their own lines, as acting on certain premises I was enabled to deliberately oust "I.O.W." disease from the apiary, prevent swarming with ease, and make a large number of nuclei and yet pull in a good harvest, averaging  $1\frac{1}{2}$  cwt. per stock in a fortnight's flow.—L. WILLIS, Sudbury, Suffolk.

### Onions and "I.O.W." Disease.

[10,313] On September 24 two of my stocks suddenly developed crawling to an alarming extent. No. 1 stock was originally a black stock of good strain re-queened with a Piana queen obtained from Ministry of Agriculture on July 4 last. No. 2, an Italian stock, which had raised a new queen from eggs from No. 1. All stocks (five in number) were in new brood nests, new frames, and fresh foundation, and had been thoroughly flavined and fed up with thick syrup. I at once resolved to try the onion treatment, with the result that all crawling

ceased in three days, during which time the weather has been fine and warm, the bees flying freely, and can occasionally be seen carrying in pollen.

In treating these crawling stocks I used "shallots" instead of onions, and had that failed I should have tried garlic; and instead of boiling in a large excess of water I simply stewed in a covered saucepan for several hours just covering the chopped up shallots with water. The resultant extract was a thick syrup which when mixed with thick "autumn" syrup did not alter its consistency, so the syrup will no doubt be sealed over. As to whether this is merely a temporary relief or a permanent cure time alone will tell us, and it is to be hoped that all who try the treatment will keep their treated stocks under observation and report results.

I may say, here, that I collected a number of the crawling bees and sent them to Dr. Helen Goodrich, but, unfortunately, they arrived dead, so no examination was possible.

As allyl sulphide, the pungent ingredient of the onion tribe, is volatile at steam heat, and Mr. Witney in his experiment reduced the volume of his extract 25 per cent. by boiling in an open vessel (note difference in flavour betwixt a raw and boiled onion) one rather doubts as to whether the allyl components are responsible for the cure? If this is so, the comparison drawn by Mr. Hemming between "Yadil" and the onion treatment hardly holds good. And, further, I scarcely think that the active medicinal properties of plants are found in the nectar secreted in the flowers, otherwise honey would be a very dangerous food. I should be inclined to think that the cure (?) is rather due to some easily assimilated organic sulphur compound, but I don't wish to dogmatise.

If more cases of successful treatment are reported, would it not be worth while for the B.B.K.A. to take the matter up? I would suggest the issue of a form describing method of treatment, followed by a list of pertinent questions to be answered by those adopting the treatment. These forms could be sent to secretaries of affiliated associations to be issued to members. The association secretaries to be responsible for issuing and forwarding the filled up forms to the B.B.K.A. The results could then be tabulated, summarised, and a report issued. This would, of course, take time, as treated stocks, if they survived, would require to be periodically reported upon. In the meantime brief interim reports might be published in various Bee Journals.—C. JARRISON, Hayle, Cornwall.



### Origin of the "Isle of Wight Disease."

[10314] I should like to suggest a theory of the origin of "Isle of Wight" and crawling disease, on which the letter (No. 10,282, page 430, September 2) by Mr. J. Ballantyne and the article by Mr. T. H. Witney (page 458, September 23) have some bearing.

On reading the report published by the Medical Research Committee on Vitamines or the Accessory Food Factors, and being struck by the fact that the life of the animals experimented with could not persist without the absorption of such substances, I began to wonder whether bees were dependent on one or all of these factors for their normal growth. To this question I could get no answer, until a paper was published in the *Journal of the American Chemical Society*\* which showed that pollen was a source of the anti-neuritic factor, the water soluble A. Knowing this, it was not difficult to surmise that bees probably make use of this substance, and that if they are deprived of pollen signs of malnutrition would soon appear.

The effect of depriving bees of pollen is indicated by Mr. Ballantyne, who in his letter quotes 10,265 and propounds the theory that want of pollen is the cause of crawling disease, while Mr. A. W. Salmon, in letter 10,276, quotes another case where the bees could not obtain pollen and were affected with the same paralytic disease.

Experiments with mammals show that the result of depriving them of the anti-neuritic factor is a form of paralysis, and in the case of man is the eastern disease called beri-beri.

It is thus possible that the paralysis which afflicts the bee when deprived of pollen is really due to its being deprived of the anti-neuritic vitamine just as paralysis ensues when the animals experimented on are deprived of food containing this factor.

As regards the disease itself, I gather from the articles in the B.B.J. that the crawling disease is a preliminary to "Isle of Wight," which, however, is occasionally cured of itself if the weather is good enough for the bees to forage and bring in pollen. "Isle of Wight," the advanced stage, seems to be present when the bees have eaten the pollen and cannot digest it owing to paralysis. In such a case they would fall an easy prey to bacterial affection, which might account for the presence of bacteria very often reported present in bees suffering from this disease.

If this vitamine theory is correct, the

remedy for the crawling disease is to provide the bees with such food containing the anti-neuritic factor as they can easily absorb. Thus, as Mr. Ballantyne suggests, pollen, or a pollen substitute, should always be available, but it is to be noted that the pollen substitute must contain the water-soluble A. Whether peafLOUR contains it I do not know. Mr. Witney found the onion syrup was successful in curing the disease and ascribed the beneficial effect to its laxative power. It is quite likely, however, that onion juice is a source of this anti-neuritic factor, so that he might just as well have used the juice of the apple, pear, peach or prune.

The theory sketched out above points to a line of research work which should be carried out as soon as possible by the Bee-Keepers' Association, or by some similar body.

Such a research would have for its aim the following objects:—

(1) The ascertaining of which of the three food factors, anti-neuritic, anti-rachitic and anti-scorbutic are necessary for the well-being of the hive of the honey bee.

(2) The result of depriving hives of any one of these factors.

(3) The value of honey as a source of these factors.

It is pointed out that if honey be shown to contain a fair content of the anti-rachitic factor (though this is unlikely) it would soon approach the value of its own weight of cream or cod liver oil.—J. S. Dick, 6, Blendon Terrace, Plumstead.

### Is Poppy Pollen Injurious?

[10315] I have seven stocks, and all of them are in a very poor way as regards stores and will take a great amount of feeding up. I have only had 2½ lbs. of honey this season, and everyone about here is much the same. Our honey flow is entirely dependent on fruit blossoms, and clover, and the weather here up north, at that time, was worse than hopeless. In fact, I had one colony of pure Italians to feed in July, or they would have starved. The queen, which is a pure "Penna," laid at such a rate, and, no food coming in of any consequence, that they could not feed the young larvae, so they began tearing them out of the cells and throwing outside before I found out.

One of our hives swarmed five times, but the bees did not cluster properly, and then returned back to the original hive. The last time they went back I got the old queen out with three combs of brood and bees, and placed them in a new hive and all went serenely afterwards, and the new queen started laying straightaway:

\* J. J. Willamson, J.A.C.S., 42, 549-584.

but why they kept going back I cannot imagine, as they gave no one chance to hive them whilst out. Perhaps some of your readers may have had some similar case.

I wish we had some of those raspberry canes about here which seem to bloom so prolifically down in Dorset.

Can anyone tell me, please, whether the pollen from poppy flowers has any injurious amount of opium in it which could affect the young bees' food? I have a bed of the flowers and bees seem very fond of them, and seem to get a large amount of pollen from each flower. I have stood and watched them pack their legs until they could hardly move about.—  
EDWYN BRIGHTON, Bolton-le-Sands.

### Feeding with Imported Honey.

[10316] With further reference to letters 10284 and 10303, Mr. S. H. Smith, of Cambridge, in his book "Let the Bees Tell You" recommends feeding diluted unsealed honey (one honey to three of warm water), in order to keep up the flow during the season for filling sections. This is very different from your recipe of 3 or 4 fluid ozs. to each pound of honey, and as in the former case the honey is unsealed one would think that less dilution, not more, would be advisable. Of course, the time of year makes a difference, but does not account for ozs. being suitable in one case and pints in the other.—VERNON R. DEAN.

[The conditions dealt with in the two cases are quite different. In spring and summer feeding for the purpose of stimulating, or keeping up, brood rearing, the syrup or honey should be very much thinner than for autumn feeding, how much thinner is a matter for the judgment of the bee-keeper.—Eps.]

### Bees Building in the Open.

[10317] Mr. Halford's and Mrs. Emma Heatly's swarms in the open were common occurrences last season. I've had two similar cases. I was called to hive a swarm for a friend during his absence. It was shown to me very late in the evening on a gooseberry bush. After giving them a shake, I found a fairly large piece of comb fixed in the bush, and two smaller pieces had fallen with the bees into the skep. This was due to the weather being so wet. They were first discovered that morning before ten o'clock, settled, so they must have swarmed the day previous, and I hived them about six o'clock in the evening. They had evidently been there about 26 hours, and compelled to discharge their load of honey, which was made into wax. Another lot had settled under the lap of another hive's roof, and they were hiving

themselves in this roof through a knot-hole. The hole was so small, and bees a massive swarm, they took some time to enter. When I discovered them I saw what appeared to be a small cast, which were covering a piece of comb about 2 in. deep. The rest were in under the roof, which also had comb drawn out.—B. MUNDY, Bangor House, Lampeter.



*Queries reaching this office not later than FIRST POST on MONDAY MORNING will, if possible, be answered in the "Journal" the following Thursday. Those arriving later will be held over until the following week. Only SPECIALLY URGENT queries will be replied to by post if a STAMPED addressed envelope is enclosed. All queries must be accompanied by the name and address of the sender, not necessarily for publication, but as a guarantee of good faith. Correspondents are requested to write on one side of the paper only.*

### Bees Not Transferring Themselves.

[9910] Early in June, 1919, I purchased a swarm of bees from Messrs. J. Lee, and, unfortunately, hived them in a large skep, thinking that after their journey they would need nursing. On July 10, a month after being hived, a large cast issued at 4 p.m., and were lost. I then put the skep over a bar-frame hive, and nothing further occurred. This spring I thought that the queen would transfer herself, the bees filled out the foundation, and stored a good deal of honey, but on June 4 they swarmed without my being aware of it, and fell to the lot of a neighbour.

On the 10th three casts issued, and were hived, and have made one good stock. On July 5 I drove the bees from the original skep, but did not see the queen, and an examination three weeks later showed that she was still in the skep. So I drove them again, but did not see the queen, and on looking at the end of a week she was still in the skep. It was evident that drastic measures would have to be taken, so the bees were once more driven out of that skep, and all the comb taken out. I did not see the queen. The best of the brood I placed in a smaller skep over the frame hive. And I trust that the queen is in the bar frame hive.

Anyway, she is not in the original skep, which reposes in my study! This shows that we cannot always go by the book, and that some bees and some bee-keepers need really good *fool-proof* devices. — G. GRILLS, Honiton.

When the above letter was in type, but

before it was published, we received the following further letters from Rev. Grylls:—

"The queen I wrote about is still in the skep over queen excluder. She must have been among the combs I put back. I am going to drive her for the fourth time, as I can't believe in her transferring herself. Any hints from you in B.B.J. would be welcome."—G. GRYLLES.

"I found on driving the bees for the fifth time that the queen was still in the skep! She is small, and had passed through the wires. I should like to know if there are, or if you have had other examples of bees refusing to transfer themselves? If the queen has not transferred herself to-day I am going to cut out the combs and put the best brood in the stock box, separating from the bar frames with a piece of queen excluder."—G. GRYLLES.

Reply.—We have never had any difficulty in transferring bees from skeps to frame hives by this method. It appears to be just one of those instances proving the truth of that old saying: "Bees do nothing invariably." Why the queen refused to take possession of the lower combs in the first instance we cannot say. The trouble following was due mainly to the smallness of the queen. This caused her to be overlooked in the first instance and, later, when she was found and placed on the lower combs, enabled her to pass through the queen excluder back to the skep—and brood. Another cause was the lateness of the season—the amount of brood would be diminishing instead of increasing.

A better plan than putting the brood in the small skep after the first driving would have been to fix it in standard frames, it could then have been put in the standard brood chamber, and the skep removed entirely. In our early bee-keeping days we have at different times saved large quantities of brood by this method when driving bees for cottagers. The comb containing brood was, of course, no use to them, and would have been thrown away. We were allowed to cut it out after driving the bees, it was then wrapped up warmly, taken home, and at once fixed up in standard frames. Our method was to have a board a little larger than a standard frame. Across this three or four pieces of tape or string were laid; these were long enough to go right round the frame from top to bottom and tie in a knot. A frame was then laid over the strings and it was *entirely filled* with the comb. As large a piece as possible was first put in, the top edge being cut level to fit the underside of the top bar. Pieces of comb were then cut to fill up the remaining spaces, the whole being wedged

as tightly as possible into the frame. The strings were tied tightly round, and the board and frame lifted together into an upright position, and the frame of comb gently lowered into the brood box. Of course, a little brood is destroyed, and the combs when finished off by the bees are somewhat rough. They should be examined every day for a few days to see that no pieces of comb fall. The string may be left for the bees to gnaw away, or be removed as soon as the comb has been fixed by the bees. The latter course is preferable. The combs should be placed at the sides when packing down for winter, and can then be removed the following season, the comb cut out of the frame, and a sheet of comb foundation put in its place.

## Bee Shows to Come.

**October 19 to 22.**—Dairy Show, Agricultural Hall, London. Open Classes for Honey, etc.—Particulars, Secretary, Dairy Farmers' Association, 28, Russell Square, London, W.C.1.

**November 18.**—Annual Show of the Worcester City and County Chrysanthemum, Fruit, Root and Honey Society. Thirteen Open Classes in Honey Section.—Schedules from Geo. Richings, 42, Barbourne Road, Worcester. Entries close **November 6.**

## Special Prepaid Advertisements. One Penny per Word.

*Will advertisers please read these Rules carefully in order to save trouble, as they will be strictly adhered to.*

**Trade advertisements of Bees, Honey, Queens, and Bee goods are not permissible at above rate, but will be inserted at 1½d. per word as "Business" Announcements, immediately under the Private Advertisements. Advertisements of Hive-manufacturers can only be inserted at a minimum charge of 3s. per  $\frac{1}{2}$  in., or 5s. per inch.**

**PRIVATE ADVERTISEMENTS are only intended for readers having Surplus Stock to dispose of. Driven Bees, Nuclei, and Queens that are reared or imported for sale, are Trade Advertisements, and can only be accepted under trade terms. A charge of 6d. extra will be made if a box number is used.**

**Advertisements must reach us NOT LATER than FIRST POST on MONDAY MORNING for insertion in the "Journal" the same week.**

**Orders for three or more consecutive insertions in "The Bee Journal" entitle advertisers to one insertion in "The Bee-keepers' Record" free of charge.**

### PRIVATE ADVERTISEMENTS.

**E**XTRACTOR, not geared. Ripener and Wax Extractor, all in good condition, £3 10s.; also home-raised Italian Queen, 1920, 6s. 6d.—7s. St. John's Park, Blackheath, S.E.3. j.13

**B**EES, HIVES, ETC., for Sale. Send stamp for list.—JAMES GLADDING, London Road, Copdock, Ipswich. r.j.14

**W**ANTED, Stock Driven Bees, Italians preferred, or Bees without queen.—Weight and particulars, GILL, West Street, Boston. j.16

**FOR SALE**, light coloured Cambridgeshire Honey, in 28-lb. tins, £9 per cwt., on rail; sample 6d.—W. BARNES, Exning, Newmarket. j.15

**PURE LIGHT CAMBRIDGE HONEY** (guaranteed), 14-lb. tins, 30s.; 28-lb. tins, 57s. 6d., carriage paid.—YOUNG, 42, James Street, Cambridge. r.j.17

**WANTED**, at once, dozen tall Honey Jars, about 10 or 12 ins. high, screw tops or tie downs.—Price to KNIGHT, Kenwyn, Truro. j.18

**FOR SALE**, six Bee Hives, bar frames, sections, etc., also about 49 lbs. Flower Honey in sections or jars.—Apply, L. HENDERSON, Path Head, Blaydon-on-Tyne. j.19

**BEEWAX**, pure, for Sale, 5 cwt., packed in  $\frac{3}{4}$ -cwt. bags, £8 16s. per cwt. net, f.o.r. London.—Apply, Box 104, B.B.J. Office, 23, Bedford Street, Strand, W.C.2. r.j.20

**COG GEARED HONEY EXTRACTOR** and quantity of various Bee Appliances for Sale; all in good condition.—W. DRURY, 6, Smithfield Road, Gleadless, Sheffield. j.21

**BROTHER BEE-KEEPERS** with spare time wishing to commence in the Retail Fish Business write J. W. ELVIDGE, Wholesale Fish Merchant, Grimsby. r.h.59

**TWO** surplus 1919 Queens, Hybrids, 3s. 6d. each.—BARNES, 20, Bourdon Road, Anerley. j.22

**HEATHER HONEY**, 1 cwt., 2s. 6d. per lb.—WOODS, Normandy, Guildford. j.22

**HEATHER SECTIONS**, one gross required, for cash.—GORDON ROWE, 28A, Moy Road, Cardiff. h.229

**WANTED**, Stock of Driven Bees with Queen, also one Queen.—MACLULLOCH, Mount Park, Gourrock. j.2

**SECOND-HAND Hives and Appliances** for Sale cheap. Please send P.O. for particulars.—CLIFFORD DE KUSEL, S.P.B.A., Allerton Poultry Farm, Liverpool. j.4

**SURPLUS QUEENS** from driven bees, all this year's rearing, mostly black stock, 5s. each per return.—CLARIDGE, Copford, near Colchester. h.220

**HEATHER HONEY** wanted for cash.—A. GORDON ROWE, 28A, Moy Road, Cardiff. h.229

**HIGH-CLASS HONEY** (white), in 7, 14 and 28-lb. tins, 2s. lb.; also in screw-cap bottles, 28s. dozen, f.o.r.—WHYTE, Bee Farm, Cumbernauld, Dumbartonshire. h.205

**HAVE YOU READ "THE BEE WORLD"?** If not, why not? Every number in itself is a useful literary work for practice and reference. Specimen copy free.—Offices: THE APIS CLUB, Port Hill House, Benson, Oxon.

#### BUSINESS ADVERTISEMENTS. 1½d. per word.

**ITALIAN QUEENS**.—Signor Penna is sending us a few selected Fertile Queens, which we can offer at the unusually low rate of 7s. 6d. each. Orders in rotation. Supply very limited.—PEARSON & GALE, Marlborough. h.221

**MASHEATH MEMS**.—"I am very well pleased with all you have sent me.—H. E. S.—ATKINSON, Fakenham. j.23

**CRAWLING DISEASE**.—Reliable treatment for curing and prevention; recipe 2s. 6d.—A. W. SALMON, Cashfield, Chingford. r.h.162

**AUSTRALIAN HONEY FOR FEEDING BEES**.—Cases containing two tins, about 60 lbs. each, 110s. per case; 1 tin 56s., carriage paid 100 miles. Remittances with orders.—SOUTHWOOD, 95, Acton Vale, London. r.h.190

**"WRIGHT" DISEASE**.—Prevention and removal. Advice 5s.—ALE. RYALL, Cottage Farm, near Camp, Stroud. j.5

**NO SUGAR VOUCHERS NEEDED**.—Flavine or Plain Candy, same price, 6 lbs., 10s., postage 1s. 3d. extra; larger quantities by passenger or goods train. Made in Cambridge, and the wrappers on the Flavine Candy bear our name and the maker's address.—S. H. SMITH, 30, Maid's Causeway, Cambridge. h.218

**SURPLUS HIVES and Appliances** for Sale, good condition, cheap.—PEARSON & GALE, Marlborough. r.h.151

## DAIRY SHOW

AGRICULTURAL HALL,  
ISLINGTON, LONDON, N.

PATRON: H.M. THE KING.

October 19, 20, 21 and 22

(TUESDAY TILL FRIDAY.)

Great Exhibition of Cattle, Goats, Poultry, Pigeons, Dairy Produce, New and Improved Inventions, Butter Makers' and Milkers' Contests, Cheesemaking, Poultry Trussing, and Fruit Bottling Demonstrations.

*Inclusive Prices of Admission.*—Admission on Tuesday, October 19, from 10 a.m. to 6 p.m., 3s. (the Gilbey Hall and the Poultry and Pigeon Department will not open until 1 p.m.); and from 6 to 10 p.m., 1s. 6d. On Wednesday, October 20, from 8 a.m. to 1 p.m., 3s.; from 1 p.m. to 10 p.m., 2s. On Thursday, from 10 a.m. to 10 p.m., 1s. 6d., and on Friday, from 10 a.m. to 8 p.m., 1s. 6d. The Exhibition will be closed on Friday at 9 p.m. for the removal of the Exhibits.

### Finest Grade New Zealand Honey (Amber)

For Bee Feeding. Guaranteed Pure.

Cases, each 2-60 lb. nominal tins. 95/- per cwt. Carriage paid.

Cash with order or on receipt of goods.

N.B. We are already supplying Beekeepers' Associations throughout the Country and shall be pleased to quote references.

The Bristol and Dominions Producers' Association, Ltd., Bristol.

THE

## British Bee-Keepers' Association.

The recognised centre of practical and scientific bee-keeping in Great Britain. Particulars and conditions of membership may be obtained from the Secretary, W. HERROD-HEMPSELL, 23, Bedford Street, Strand, London, W.C.2.

**JOT DOWN** the deficiencies of your present equipment and your needs for future improved working. Then book for "**MASHEATH**" (Regd.) Equipment for autumn construction.

The **MASHEATH LIST** contains an unique series of Hives unequalled to-day. You should not enter upon another bee season without them.

"The Hives (Porchless Masheaths) are excellent in every way, and I am very pleased indeed with them. '**PORCHLESS!**' Yes, every time. Need I say more? I will get you to send me two more." —W. F., June 17, 1920.

The **MASHEATH HIVES TALK** as soon as they are delivered.

**ATKINSON**, Proprietor and Sole Maker, **Fakenham**.

The products of the Apiary, of Poultry and Farm Stock, of the Fruit and Vegetable Garden can be Advertised and Sold through

THE  
**BAZAAR, EXCHANGE & MART**  
Newspaper.

Get a Copy—Thursday and Saturday 3d. The "Bazaar" publishes also practical handbooks by experts. Send for full catalogue, post free from—**WINDSOR HOUSE, Breams Buildings, LONDON, E.C.2.**

## BARGAINS IN SURPLUS CLOTHING.

FOR 14 DAYS ONLY TO CLEAR.

Best quality new full size Fawn Australian Blankets, **42/-** pair.  
Best quality new full size Grey Australian Blankets, **35/-** pair.  
Best quality Officers' Bedford Cord Riding Breeches, **42/-** pair.  
Best quality Officers' Cord Riding Breeches, strapped, **25/-** pair.  
Good quality Cord Riding Breeches, **10/6** pair.  
Dark Heavy Tweed Overcoats, suitable farmers, etc., **25/-** each.  
Best quality new Army Puttees, **4/6** pair.  
Good Blue Serge Trousers, suitable for working men, **12/6** pair.  
Good Blue Serge Trousers, as new, **15/-** pair.  
New Blue Serge Trousers, best quality obtainable, **21/-** pair.  
Khaki Drill Trousers, as new, all sizes, **7/6** pair.

Khaki Drill Jackets, as new, all sizes, **7/6** each.  
Khaki Drill Jackets, Officers' quality, **10/6** each.  
Khaki Drill Trousers, Officers' quality, **10/6** pair.  
Cardigan Jackets, as new, **8/6** each.  
Bath or Carriage Sponge, large size, to clear, **1/6** each.  
New Holeproof Trousers, everlasting wear, **18/6** pair.  
New Blue Trousers, all sizes, **16/6** pair.  
New Officers' Poplin Soft Collars, **4/-** dozen.  
New Officers' Khaki Collars, **4/6** dozen.  
New Striped Union Shirts, best quality, **8/6** each.  
New Indigo Blue Serge Ladies' Skirts, **15/6** each.  
As new Indigo Blue Serge Ladies' Skirts, **8/6** each.

THOUSANDS OF OTHER BARGAINS. SEND FOR LISTS FREE.

**SACAR'S ARMY SURPLUS STORES (Dept. 29), ARDWICK, MANCHESTER.**

8/- Of the Author, S. SIMMINS, QUEENLAND, HEATHFIELD, SUSSEX.  
**SIMMINS "A MODERN BEE FARM"**

POST FREE Nearly 500 pages. A few more copies at 8/-. Any further edition must cost 50% more

Bees and Beekeeping Appliances. Catalogue free.  
**EDWARD J. BURTT. MANUFACTURER. GLOUCESTER.**

*I very much regret that there has been a large increase in the cost of the manufacture of bee appliances, and therefore my prices will be advanced 10% from May 10th. Books excepted.*



**"BACTEROL"**  
FOR BEES

2/9 per Bottle.

Post Free.

The cure for, and preventive of, "Isle of Wight" Disease. Non-poisonous—free from stain or unpleasant odour.

**BACTEROL LIMITED**  
19/25, Brookside Rd., Highgate, N.19.

**POSITIVE FACTS.**

June 13th, 1920.

I am very pleased with the foundation. The bees undoubtedly prefer it to any other make I have, and have even gone the length of missing two sheets of other new foundation, and working cut a sheet of yours placed behind them at the back of the hive. Full sheets have not sagged in the least in 16 x 10 frames.

Yours faithfully, R. B. MANLEY,

Illustrated Lists free by post.

**S. J. BALDWIN, The Apiary, BROMLEY, Kent.**

## FOUR FIRST PRIZES.

Our HIVES and APPLIANCES were again awarded FOUR PRIZES at the Highland Agricultural Society's Show at Aberdeen, thus testifying to the superiority of our goods. Order now and ensure your bees wintering in good hives.

**BOTTLES.** We hold a large stock and can give immediate despatch.

**CANDY.** Safeguard your bees from starvation by feeding with our FAMOUS BEE CANDY. Price **1/6** per 1-lb., carriage extra.

Sole Agents for DADANT'S WEED FOUNDATION. Absolutely pure. Once used, always used.

Large illustrated catalogue, entitled, "Everything for an Apiary," post free on application.

**R. STEELE & BRODIE,**  
*Bee Appliance Makers,*  
**WORMIT, FIFE.**

Telegrams:—"Bees, Wormit."

Telephone:—28 Wormit.



## Lee's Bee Supplies.

¶ In design, material and workmanship, Lee's Bee Supplies still retain the reputation of being your best and safest investment.

¶ Our 1920 ILLUSTRATED CATALOGUE is yours for the asking. It contains detailed information on the most up-to-date hives and appliances for which the House of Lee is famous.

¶ We regret the necessity of having to advise our Customers that owing to the increased cost of production, all prices in 1920 price list are subject to 10% increase. The increase will not apply to orders received before May 10.

\*\*\* Five per cent discount to Members of THE APIS CLUB.

**JAMES LEE & SON,**  
LTD.,

Uxbridge, Middlesex.

(Telegrams: Graphicly, Uxbridge.)

Telephone: Uxbridge 181.)



No. 2000. Vol. XLVIII

OCTOBER 21, 1920.

[Published every Thursday, Price 2d.]

**CONTENTS.**

	PAGE		PAGE
A SIMPLE SERMON .....	505	CORRESPONDENCE—	
OBITUARY NOTICE, REV. G. C. BRUTON .....	505	Onions and "I.O.W." Disease .....	511
A DORSET YARN .....	505	A Robbing Baffle .....	512
JOTTINGS FROM HUNTINGDONSHIRE .....	506	Queenless Bees Storing Honey .....	512
COTSWOLD NOTES .....	507	A Good Report .....	513
WINTER JOTTINGS .....	508	Bee Notes from Devonshire .....	513
HONEY BEES AS POLLENISERS AND SPRAY INJURY .....	508	Italians and "I.O.W." or Crawling Disease .....	514
WEATHER REPORT .....	514	Queens for Disposal .....	514
		COMBS FROM OTHER HIVES .....	515
		NOTICES TO CORRESPONDENTS .....	516

Do not **LOSE YOUR BEES** for the sake of giving them a cake of our **PINK**

# SOFT CANDY

Made from guaranteed Pure Cane Sugar, medicated or plain.

NO VOUCHERS REQUIRED.

Price 1/6 per lb. Carriage or postage extra.

**E. H. TAYLOR, LTD., WELWYN, HERTS.**

# THE British Bee Journal

Office: 23, Bedford Street, Strand, London, W.C.2.  
ESTABLISHED 1873.

A Weekly Journal Devoted to the  
Interests of Bee-keepers.

Edited by T. W. COWAN, F.L.S. &c.,  
and J. HERROD-HEMPSELL, F.E.S.

Correspondence: Whom to Address.—All matters relating to the Literary Department, Associations, Shows, etc., should be addressed, "Editors, *British Bee Journal*," and all business communications and matters relating to subscriptions and advertisements to be addressed to the "Manager," *B.B.J.* Office.

Subscriptions.—Annual Subscription, 10s. 10d. post free in advance; single copies 2d., or 2½d. post free. If a receipt is required by post, a stamped and addressed envelope must be sent, otherwise a printed receipt will be enclosed along with the paper.

Note.—Cheques and Postal Orders should always be crossed, otherwise it is very difficult to trace them if they go astray.

How to send Money.—Remittances can be made payable to W. Herrod-Hempshall by crossed Cheques and Postal Orders. Stamps may be sent for small amounts up to 2s. *Halfpenny stamps are preferred.*

Scottish or Irish cheques can only be taken in payment if 6d. is added for commission charged by banks for cashing them.

The Editors are not directly or indirectly interested in the manufacture or sale of beehives or appliances of any kind, and must refer correspondents wishing for prices or catalogues to advertisers in the paper.

## OUR DEPOSIT SYSTEM.

You are advised to insist on this being used when dealing with strangers.

### Rules and Conditions for Depositing

In order to save trouble, it is requested that the Rules be carefully read over by persons using the Deposit System of trading.

Goods should not be despatched until notice that the money has been deposited is received from this office.

1. Method.—When strangers are dealing together, the purchase-money of the articles is deposited at our office. We acknowledge receipt of the deposit to both parties, and hold the money until we are satisfied that the purchase is concluded. If a sale be effected, we remit to the seller the amount deposited, less a charge of 2½ per cent. in the £, with a minimum of 6d., and the expenses of Post Office Orders and postage, &c. Cash will be forwarded by Cheque, Post Office Order, or by Postal Order as preferred. If a sale or exchange be not completed, we return the amount deposited, after making the same deduction. By this means buyers and sellers are secured against fraud.

2. Deposits.—Postal Orders (drawn on General Post Office) and Cheques must be made payable to W. Herrod-Hempshall, and "crossed" "London County and Westminster Bank." The numbers of the Postal Orders should be kept by the sender.

We cannot be responsible for any loss that may occur in transit.

3. Honey on Approval.—All honey will be sold by sample, which must be sent direct to buyer.

4. Bee Appliances.—In ordering, the time allowed for completing the order to be stated to us when sending cash. If maker accepts, we hold cash until transaction is satisfactorily completed, when the amount will be remitted, subject to conditions as in Clause 1.

5. Bees and Queens.—These will be dealt with entirely by the parties concerned, so far as price, &c., go, and when the purchase is satisfactorily completed cash will be remitted as per Clause 1.

6. Goods in Transit.—These are at the seller's risk, i.e., any damage to or loss of an article on its journey is borne by the vendor; but a rejected article must be properly packed and returned by the same means as was used in sending it.

7. Carriage.—The carriage of all goods, except such as are sent by post, is payable by the buyer, unless otherwise agreed. If any article sent on approval be returned, each party to the transaction must pay carriage one way.

## Books for Bee-keepers NOW IN STOCK.

Cash in full must be sent with order.

		Postage
A Modern Bee Farm ... ..	7/6	... 8½d.
(To be obtained from this Office only.)		
Advanced Bee Culture (HUTCHINSON) ... ..	6/-	... 6½d.
Beginner's Bee Book (PELLETT)	5/-	... 4d.
BEE-KEEPING SIMPLIFIED FOR THE COTTAGER AND SMALLHOLDER (W. HERROD- HEMPSELL, F.E.S.) ... ..	1/-	... 2d.
BRITISH BEE - KEEPERS' GUIDE BOOK (T. W. COWAN)		
Paper covers ... ..	2/6	... 3d.
Cloth covers ... ..	3/6	... 4d.
Dissectible Model of Queen Bee ... ..	4/6	... 3d.
FERTILISATION OF FRUIT BLOSSOMS BY BEES (T. W. COWAN) ... ..	-/3	... 1d.
Honey and Health (A. HOPE) ...	-/6	... 1d.
Honey Vinegar (REV. G. BARCKE)	-/2	... 1d.
How to Keep Bees (ANNA B. COMSTOCK) ... ..	5/-	... 4½d.
Prevention of Swarming (WILKES) ... ..	1/-	... 1d.
Pollination of Fruit in rela- tion to Commercial Fruit Growing (C. H. HOOPER, F.R.H.S.)	-/6	... 1d.
PRODUCING, PREPARING, EXHIBITING AND JUDG- ING BEE PRODUCE (W. HERROD-HEMPSELL, F.E.S.) ...	2/-	... 3d.
Queen Rearing in England (F. W. L. SLADEN) ... ..	1/6	... 2d.
Scientific Queen Rearing (DOOLITTLE) ... ..	4/-	... 3½d.
Snelgrove's Method of Re- queening ... ..	-/6	... 1d.
The "Townsend" Bee Book ...	2/6	... 2d.
WAX CRAFT (T. W. COWAN) ...	2/-	... 2½d.
Wilke's Book on Swarming ...	1/-	... 1½d.
<b>MISCELLANEOUS.</b>		
Lure of the Honey Bee ... ..	2/-	... 2½d.
THE BEE WORLD (supplied only to members of Associations interested in the control and development of the Apis Club, apart from ordinary members of the latter), per copy ... ..	-/8	... 1½d.
The Bee Master of Warrilow (TICKNER EDWARDS) ... ..	7/6	... 4½d.

British Bee Journal & Record Office,  
23, BEDFORD STREET, STRAND LONDON, W.C.2.





### A Simple Sermon.

There's only one method of meetin' life's  
test:  
Just keep on a-strivin' an' hope for the  
best.  
Don't give up the game an' retire in  
dismay  
'Cause hammers are thrown when you'd  
like a bouquet.  
This world would be tiresome, we'd all get  
blues,  
If all the folks in it held just the same  
views;  
So finish your work; show the best of your  
skill.  
Some folks won't like it, but other folks  
will.  
If you're leadin' an army, or buildin' a  
fence,  
Do the most that you can with your own  
common sense.  
One small word of praise in this journey  
of tears  
Outweighs in the balance 'gainst cartloads  
of sneers.  
The plants that we're passin' as common-  
place weeds  
Oft prove to be just what some sufferer  
needs.  
So keep on a-goin'; don't stay standing  
still.  
Some people won't like you, but other  
folks will.

—(From *Tit-Bits*, May 29, 1920.)

Though the above is not strictly bee-keeping, we think no apology is needed for its appearance in our columns. It is a sermon that everyone may apply to their own circumstances. After the seasons of 1919 and 1920 the first three lines are an especially good motto for bee-keepers. They are an optimistic class of people, and, no matter how bad a season may be, always hope for a good one next time. To those who have only commenced during the past year, and have had no honey, but instead have had to spend a considerable amount of money in order to give their colonies some chance of surviving the winter, we would say follow the advice given in the second and third lines, and don't be discouraged to the extent of giving up in disgust. We have had the little poem on our desk for several months, and a glance through it those times when things do not go quite as one could wish have often given us encouragement. No doubt it will do the same for others, and therefore we pass it on.

### Obituary Notice.

REV. G. C. BRUTON.

It is with extreme regret that we have to record the death of the Rev. G. C. Bruton, M.A., for nearly 25 years Vicar of Great Haywood, Stafford. For the last few months he had not been in his usual state of health, and on September 20 he went to Birmingham to undergo an operation by the specialist, Dr. Balling. For a few days he seemed to be progressing favourably, but on the 4th inst. the sad news was received that he had passed away through heart failure.

Naturally of a hardworking disposition, the calls on his time were many. The Staffordshire Bee-keepers' Association loses a very good friend. He was honorary secretary and treasurer from 1902 to 1911, and has been a member of the general committee up to the beginning of this year. Amongst his other labours, apart from his many activities in the church, he was chairman of the Stafford Board of Guardians and the Rural District Pension Committee, and was also secretary of the Cannock Chase Golf Club. The funeral took place on the 8th inst., at Great Haywood, and was attended by the representatives of many public bodies, amidst the general regret of his parishioners.—W. GRIFFITHS.

### A Dorset Yarn.

There is still a lot of matter to be written about hives for bees. During the last six years I have been at farm sales where bees as well as cows were for sale; one cannot but see the diversities of hives; some are small and some very large. If one judges by results, the large hives give the finest harvest; some hives are far too small. Then some are heavy and cumbersome, others are flimsily built with material too thin to take nails well, so they are full of cracks that open in very hot weather and let in the wasps and robber bees, and the occupants of the hives have to keep at home to defend their stores, instead of gathering surplus. A well-made hive is a great asset to the bee-keeper, and where the hives are well made, then the buyer at these sales is assured that he can take them easily away. Where it is easy in summer to take out combs of bees with brood and queen and place in a travelling box, it is not so easy in winter to move bees from crazy-built hives. If the brood chamber is lifted and placed into a new case, there is sure to be a lot of bees left on the old board, which will soon die of exposure. It seems bad business to keep bees in old hives that are not sound, yet one sees so many of them in these crazy-built monstrosities. My opinion, judging

by results, is that the larger built hives are preferable to small ones. Of course, they must cost more, but the investment is a good one if the harvest is greater. By having them on the large side it is much more easy to add the surplus racks in summer; if the brood chambers are of a good thickness, the space all round will add to coolness in summer, and tend to keep it drier in winter, as the air circulating round the brood box dries up any damp that may get there. Beside this, in the honey flow one can have the brood frames in greater numbers. I am not an advocate of a larger frame, but add extra ones in the breeding time so as to get the most bees when the surplus honey is stored. My friend Mr. Garret had this year 15 bars in the brood chamber, with two lifts of ten standard bars above (these were Blacks from the Wareham area, as written of last week). These can be reduced in winter by division boards down to the standard ten frames. Now, in the small hives the manipulation in summer is more difficult, as shallow bars of ten in the racks, as sold by dealers in bee appliances, require quite a lot of space; it is impossible to get one on the small hives which are sold at a low figure. Some of them will only take a very small section rack, yet a rack that has a fillet tacked on the side to make it just cover the ten bars is what is in general use, but they won't go inside some of these small hives that I have bought at sales of bees. So much was written on this subject by able writers a few years back, they will perhaps bear with me in touching on it again, but to get a small hive that will not take the numerous section racks and boxes of shallows is not to advance commercial bee-keeping. Of course, I do not want it to be assumed from this that bees will not do good work in them; I know they will. I remember in years gone by, when I supered with two rows of sections in a bloater box and covered up the space over bars with a piece of board, in these crazy boxes the bees did well, they finished the sections completely. (Necessity is the mother of invention.) It was a year for good surplus. All the racks I then had were in use, so gave them the bloater boxes to work in, and they did them well; but they would have done better had they had the whole of the bars covered. That comes back to the subject, the larger hives are of greater advantage to the bee-keeper; the well-built ones are easily laced down, the entrance inside the hive can be made secure, the front of case made safe, and the bees can be carried with safety any distance.

On our farm the bees were out in the early part of the week in great numbers; they were on the Limanthes and rasps; all

seem to be strong in flight, and no crawlers round the hives; must assume that all is well with them. Many of them have a rack of only partly filled sections on them; some stayed on last winter; the honey they gather is the best food for them. One of them has left on a box of standard bars to see how they shape out with so much stores. Another has a rack of shallows, with six of them full; these did a rack of sections before the shallows were added.

On the land it is harvesting flowers, and sending away fruit trees in great numbers; each day some, the most in one day three loads, one whole truck (rail) to one man last week. I hope others have had the same harvest of young fruit trees as we have had. I advised the planting of gooseberries and currants in years gone by; and gave details of procedure; one cannot always foretell "a dead cert," but this year the demand is very heavy. It all adds to income, it all gives greater pleasure to the worker; that is the greatest thing in life, pleasure and happiness. This comes of simple faith, simple living, and love of all things in rural life.—J. J. KETTLE.

---

## Jottings from Huntingdonshire

Never before, one would think, has so much honey been stored, and so much brood reared in October. The ivies are alive with bees; so, too, are the evening primroses. Out in the meadows are buttercups, which are determined to cheer us before winter comes along with his breath of ice. Charlock is blooming afresh, or rather young plants are beginning to bloom on land turned up not more than six weeks ago. Not all the honey being stored, however, is gathered from plants and trees; not a little is being taken by craft and subtlety, by thieving or borrowing. Let it be said in justice that even in October bees will give up robbing when a whole field of nectar—charlock, mustard, or clover—is near. How green the countryside still is! How beautiful! What days of joy! The soft, warm air, the tempered sunshine, the scented zephyrs, and, besides all this, the morning beauties—mist and dew pearls. This morning, typical of many this month, I had to go to a neighbouring village; a slight fog enveloped the landscape, and on every hedgerow spiders had been busy overnight in suspending between twig and twig ten thousand hammocks, wherein ten thousand fairies might sink to rest. Here and there the geometric spiders had traced between hedge and bank their wondrous gossamer gates to fairy land. Methinks the fairies go to rest in the sunshine, for when the

sun arose these fairy hammocks vanished at the magic touch. On my return trees full of starlings were making merry with their friends. What strangest songs they sing! Mimicks all, they would be nightingales and throistles, finches and buntings if they could. Since that is denied them, they do their best, and sing away when most birds have laid aside their music till another year. The wonders are not over, for chalk-hill-blues are fitting about, and red admirals go winging away as if the year were young. The alder is beginning to purple-paint its leaves, the elms and ashes are choosing saffron, and soon, in the language of the poet, "every common bush will be afire with God." How monotonous bricks and mortar are compared with this, how deadly dull hard pavements, housed streets. How distracting the noise and bustle; how noxious the soot-filled atmosphere of city and town! Moreover, with all we have are the bees, humming, working, singing, striving, interesting us day by day, making us ever wiser as we older grow, so small and slight—a hundred would scarcely weigh down a half-penny piece—yet they can be for ever teaching us something new. I've met a man who claims that his bees understand whatever he says to them. A few years ago I would have laughed. To-day I am wiser; I envy him his intuition. Last week a bee followed me into the house and sat down to tea with me. I took her up and placed her outside the window; she came back to me. I turned round and placed her on my desk; she crawled down the desk front, across the floor, and up my leg, and again reached my hand. I placed her on a plate and shifted my position; she walked once round the plate, then off and straight to me. Why this persistence? I wish I could divine what the little creature wished to say.

Dare I now state a paradox? i.e., that encouraging robbing sometimes prevents it. A hive of mine seemed particularly attractive to the wasps. I closed the entrance to little more than one bee space, but, alas a dozen wasps appearing on the scene at once so cowed the defence that the robbers had a walk-over. Bees hate wasps, but it is extraordinary how they will associate with their enemies when there is plunder to be shared. In went the wasps, and in went robber bees. An occasional wasp was evicted minus a leg, or a wing frayed, and possibly a wasp's head would appear minus the body. So, too, one or two bees were hustled, dying, down the alighting board, but the robbing proceeded apace. "Here goes," said I to myself, and I drew out the two slides and threw the whole entrance open. This puzzled the attackers

more than the defenders. In a very short time sentinels were set along the whole entrance, and when robbers arrived they saw a solid phalanx of bees in battle array. An attack was made, but never did English long-bowmen repel the French cavalry in the days of Crecy, Agincourt, and Poitiers more easily than these sentinels those wasps and bees who came to pillage and plunder. This does not always work, for in another hive, to the inhabitants of which I gave the same opportunity, broke down on their left and right wings, and a forcible entrance was made. The worst of wasps is they are not content with informing their sisters in their own colony of abounding sweets, but in some mysterious way impart the news to their neighbours of another nest. This being so, we harden our hearts, and every queen wasp we see seeking snug quarters for winter we kill. I regret to say that when a small boy I often caught a wasp, extracted its sting, and then, after clipping its wings, teased it, and laughed at its fruitless endeavours to puncture some portion of my anatomy. Strangely enough, the cruelty of the sport never struck me. When in time I realised the barbarity of my youth, I felt a desire to make it up by sparing wasps from well-deserved death. Now, for the bees' sake, be their majesties the queen wasps never so beautiful, I feel unable to suffer them to live.—E. F. HEMMING, Steeple Gidding.

### Cotswold Notes.

I, too—like your correspondent on page 486 of Oct. 7—have often been struck by the frequency with which foreign queens are superseded, and think the following may be some of the causes responsible for this peculiarity:—

1. The duration taken by the queen in the mails.—A long period of confinement resulting in some defect to the queen's laying capacity, which the bees resent.

2. Age of queen when selected for mailing.—A full-grown, tested queen would not travel so well as a younger one. As a rule, for long journeys, the younger the queen the better.

3. Conditions of weather.—Few queens are found thrown out if a period of good bee weather follows introduction.

During a stormy spell this year I found two American queens cast out of strong nuclei which had readily accepted them, and the queens had been laying strongly.

On investigation, I found they were almost without stores of any kind. One way of reducing this risk is to introduce

imported queens to small nuclei only, as they are easier to please than full colonies.

As regards settling bees down for the winter, most bee-men have their particular notion of how this should be done.

Personally, I like some squares of sacking with two sticks underneath, and a couple of newspapers pressed tightly down by the 10-in. lift, which is telescopic.

All draught is excluded, and, as the paper dome is slightly higher in the centre, any rain which may leak through the roof trickles away down the sides.

One notices skeps covered with all sorts of articles, such as slates, old bags, saucepans, and earthenware pans; but to my mind the best and warmest covering of all is a straw hackle.

Everyone knows how even in temperature and cosy a thatched cottage is as compared to the modern, flimsy, slated one.

A straw hackle does not harbour mice, because it is much too draughty.

A. H. BOWEN.

Cotswold Apiaries, Cheltenham.

## Winter Jottings.

I have been unable to write my winter notes till now owing to seeing to the comforts of the hardy Rhode Island Red poultry for the winter; also studying the latest ideas of three-colour photography for lantern slides next year.

Now for the bees. As I stated, I took off large supers of capped honey on September 25, which helped me to feed three large stocks slowly. I had seen large numbers of autumn-hatched bees fly during this fine weather and work on the autumn flowers, sunflower and Michaelmas daisies. A great many wasps were killed owing to closing up the entrance a bit, and soon were rolling down the long alighting boards with two or three bees hard at it.

I have had large wired boards made this year which are over the bees, and flock quilts with feed hole cut ready for candy. If a cold spell comes I close up the entrance to 8 inches, and on goes the "Silver" entrance.

The weather here (S. Wales) is wonderful. Very mild, and even hot at times. I am ready for any turn, and hope we shall have a good winter, not too mild, as if the bees have plenty of honey stored cold weather is much the better.

Let me advise: Don't be downhearted at finding little honey after the flow, keep your supers on if mild, warm weather is about. You will find they start storing again after breeding for the winter.

None of my bees are touching a quilt, plenty of room for bees and queen under

the wired board, about which I have heard some amusing remarks during this year. One said, "Oh, he must have no bees under his quilts." But if he had seen on March 16 combs crammed with bees, he would have been rather surprised.

I wish luck to all bee-keepers, as we don't know what's ahead of us, as the weather is rather like the world, upside down, at the moment of writing.—CYRIL TREDCROFT.

## Honey Bees as Pollenisers.

By SUSAN M. HOWARD, IN MASSACHUSETTS  
REPORT, STATE BOARD OF AGRICULTURE.

Treating the subject as a fruit grower as well as a bee-keeper enables the writer to appreciate the inestimable value of the honey bee as a polleniser of certain grains, small fruits, vegetables, and tree fruits. The discussion is attempted in plain terms without resorting to confusing botanical technicalities. The writer will feel amply repaid if the article is stimulative of even a minor inquiry into the ways of bee nature.

To-day the honey bee is more and more considered an invaluable ally of the farmer. The orchardist and small fruit grower consider their colonies as a part of their equipment, and their use as much a factor in the success of horticulture as is cultivation, application of fertilisers, the growing of cover crops, pruning, spraying, and the like. To the farmer, especially if he be a fruit grower, a honey crop may be regarded as secondary, or as a by-product, while to the bee-keeper it is the primary product. Thus, while the ultimate aims of the horticulturist and bee-keeper may be different, yet they are interdependent.

While the orchardist may profit by the visits of bees from near-by apiaries, or from a wild colony in a tree, roof, or chimney, yet the uncertainty of their service is so great that the forehanded fruit grower provides a sufficient number of colonies at hand and among his trees. In this connection it may be said that it is not absolutely necessary to place the colonies actually in the orchard; yet they should be not far distant. Furthermore, the location of the bees should not prevent satisfactory cultivation.

As a factor of the importance of bees near by an orchard, it may be cited that the distance at which bees gather pollen is limited, seldom exceeding one half mile, which emphasises the desirability of bees at close range. On the other hand, bees will forage for honey at a greater distance, up to about three miles from the hive. Nevertheless, they prefer frequent and

short trips. Thus, if a radius of three miles be allowed—that is, a diameter of six miles—the area of the circle would be 28 square miles, or 18,080 acres, a part of which territory would be imperfectly worked. It should be remembered that bees foraging for honey frequently serve as the bearers of pollen in cross-pollination, as well as bees foraging for pollen alone. It is this search of the bees for their food which prompts their inestimable service to the fruit grower. The means and mechanism of their operation, though mechanical yet intricate, is referred to below. Being mechanical, it might be accomplished by man at great expense and with exceeding labour, but this is generally recognised as impracticable from the commercial standpoint. Bee labour is far cheaper than human labour.

This expensive process of hand pollination is exceptional, and only one case is reported. In this instance the process was resorted to by a cucumber grower to whom the sting of the honey bee was seriously poisonous. The process, however, is exceedingly old, and according to Herodotus is known to have been practised five centuries before the Christian era. Much the same method is to-day reported as that used by this cucumber grower who has resorted to hand pollination, and who employs the tip end of a quill feather, by which he transfers the pollen of one flower to the sensitive pistil of another. In contrast to this laborious method, the far more common practice of the growers of cucumbers under glass is to utilise a colony or more of honey bees in their greenhouses. Thousands of colonies of bees are thus used in the hothouses around Boston and in Massachusetts. Unfortunately, too, many or most of these are sacrificed, as the growers make little or no effort to save the colonies which have served them so faithfully in the tropical climate of the greenhouse—conditions averse to their well-being.

#### THE FUNCTION OF THE HONEY BEE IN THE TRANSFER OF POLLEN.

It is far from the purpose of this paper to enter the vast and intricate field of hybridisation, involving the problems of plant selection, improvement, and the production of new varieties. Neither can the details of the life history of the honey bee be given in detail, which is as unlimited and wonderful a field as are the intricacies of the plant world, yet it is desirable to make clear the relation and service of the honey bee to the setting of our common fruits and vegetables.

It should be remembered that in most plants the setting of the fruit involves a sexual process. In plants, in contrast to animals, the same individual may bear both sexes, or the sexes may be apart in

different individual flowers. More in detail these may be grouped under three headings:—

1. Both Sexes in One Flower.—Some plants produce perfect or bisexual flowers, that is, those in which both the male and the female organs of the flower, the stamen (male) and the pistil (female), are complete within the flower. As an example, Parson's Beauty strawberry may be cited.

2. The Sexes Separated in Individual Flowers.—Other plants bear flowers which are individually staminate (male) and pistillate (female). Yet both sexes appear on the same plant, as, for instance, in the squash, melon, and cucumber.

3. The Sexes Separated in Individual Flowers which are Borne on Different Plants.—As a further modification of the second class, there are also plants which produce only staminate (male) blossoms throughout the entire plant, and are spoken of as male trees or plants. Others produce pistillate (female) blossoms throughout the entire plant, and are spoken of as female trees or plants. Others of these are found in the willows and poplar. The Sample strawberry is pistillate (female).

It at once becomes apparent in recognising that most of our fruits and vegetables involve a sexual process, or the union of the pollen and germ of the egg, that there must be some means of union, especially in the second and third classes of flowers, where the two sexes are respectively separated either in individual flowers or in individual flowers on separate plants. From practical experience, moreover, it is generally conceded that the honey bee is the most important of the many agents in this service. Other insects render their service as well, but their service cannot be depended upon. Their numbers are uncertain and fluctuating. They may be absent at the very time when they are most needed, as, for instance, at the height of apple bloom. Thus it is claimed that the honey bee is first and foremost the most important, and that it should be provided and conserved by the farmer.

Since there are differences in pollen, however it might be contended by some that the wind is active in transferring the pollen from tree to tree or blossom to blossom. To be sure, some pollen is lighter than others and easier carried by the wind, but in the provisions of nature pollen which is light and transferable on the breeze is designed so to be carried, and trees which bear it are usually wind-pollinated, those which are actually independent of insects. The pines furnish an example. Observations are not infrequent where the air has been seen filled with

millions of pollen granules drifting with the wind. But among the fruits and vegetables the pollen is usually more heavy and inclined to be sticky or viscous, as is the case with the pear. This heavy pollen, in order to be transported, is dependent upon the service of some insect, usually the honey bee, and is capable of being carried by the wind to a very slight, if any, extent. In the case of apples, too, experiments have been conducted which tend to prove that little or no pollen in the apple orchard drifts on the wind.

The service of the honey bee, alluded to in transferring pollen, may be regarded as performed unconsciously or unintentionally while seeking for nectar or pollen in the flowers. In procuring the nectar, for instance, which flowers dependent upon the services of insects usually produce in abundance, there is a secretion in the nectary or honey-cup at the base of the flower. The bee, for illustration, dusts off particles of pollen, which become entangled in her hair. Then the bee, in quest of more nectar, flies to another blossom, and in the course of her search for nectar therein leaves some of the pollen on the female organ of the blossom (pistil). Thus, almost mechanically and accidentally, the function of the bee has been performed in this vital operation. Finally, the pollen lodged on the sensitive pistil germinates much as does seed, and sends forth or projects a slender growth or thread, which gradually finds its way down through the pistil and reaches the true female element or ovule which is virtually the embryonic seed. Here, there is a fusion of the male and female elements, which, when it occurs, perfects the process known as fertilisation, wherefrom results a perfect seed.

Many plants are sterile to their own pollen, and require pollen from another source. Furthermore, self-fertilisation is thought to tend to weaken the offspring, and in contrast crossing or cross-fertilisation is thought to result in greater strength and productivity. Moreover, flowers are generally constructed to favour cross-fertilisation and to prevent perpetual self-pollination.

From the standpoint of the plant, the results of crossing become apparent, especially in the second generation. Thus the Baldwin apple blossom may be fertilised by pollen from a Porter apple. The resulting apple will develop as a Baldwin, yet one or more of its seed, when planted, may produce a variety differing in many respects from its parent. Thus the bees may serve to make new crosses and to increase varieties. There is also another feature, namely, the apple requires five independent fertilisations for complete re-

sults. The lack of even one of these may impair its vigour and change its appearance, resulting in an imperfect development or malformed fruit. Incomplete fertilisation also explains the dropping of apples, and suggests that the more complete service of bees might avoid this consequent loss.

Some light may be thrown on the dependence of flowers on bees by a few concrete examples. An experiment was conducted in which 100 clover blossoms were covered with netting in order to exclude bees, with the result that not a single seed was produced. Similarly, 100 blossoms exposed to the visits of bees produced, in contrast, 2,720 seeds, showing conclusively the need of bees in seed setting in clover.

With the apple, 2,586 blossoms were covered and the entrance of bees prevented, with the result that only three apples matured.

It is not uncommon to observe from four to six bees eagerly at work gathering honey and pollen in a single squash blossom. The writer has noted eight bees simultaneously in a squash blossom; within an hour twenty-eight bees were counted flying from the same blossom.

The number of flowers a bee will visit may vary according to the amount of nectar being produced. A bee can visit ten to fifteen flowers a minute, yet she will remain longer on a flower if the nectar is flowing freely. In that case she would secure her load without visiting as many flowers.

In attracting bees to a flower, there are several stimulative factors, namely, the nectar and pollen, colour and odour. The multiplicity of trees in full bloom increases the attraction. Nevertheless, high colour or extreme fragrance do not always induce the bees to visit, for the lilac and heliotrope are neglected, while some of the less conspicuous flowers prove enticing.

Besides the nectar in the flower, bees are in search of pollen as a food. This is a highly nutritious substance, supplying nitrogen and phosphorus—two needed elements in animal economy. To be sure, this pollen is provided vastly to the excess of the actual needs of bees, but its seeming over-production may be explained on the ground of an effort on the part of the plant to ensure pollination.

It has been claimed that the honey bee sucks juices from fruits. Although bees are observed commonly on fruits, yet it is certain that the bee does not puncture a sound fruit, as has been supposed. When fruits are worked by bees, an opening has previously been made by some bird or wasp or by decay. Thus the bees take up the work begun by another or afforded them through some other agency. Many orchardists have mentioned this to the writer,

who at the same time give due credit to the bee for the good she accomplished. It has also been the writer's privilege to dispel this idea through experimentation, and by reference to high authorities, who refute the charge against the bee. It should be borne in mind that the jaws of the bee are smooth and rounding, and quite unfit to make an opening in a sound fruit. On the other hand, the jaws of the wasp are perfectly equipped for puncturing and opening fruit. In order to substantiate that bees are unable to puncture sound fruit, the writer has suspended a sound but over-ripe peach and pear in front of the entrance to a colony. These nevertheless remained untouched, even during a scarcity of nectar in the fields.



*The Editors do not hold themselves responsible for the opinions expressed by correspondents. No notice will be taken of anonymous communications, and correspondents are requested to write on one side of the paper only and give their real name and addresses, not necessarily for publication, but as a guarantee of good faith. Illustrations should be drawn on separate pieces of paper. We do not undertake to return rejected communications.*

### Onions and "I.O.W." Disease.

[10318] With reference to my previous letter I have not much to report. I examined the stock in question on September 10, when they were covering four combs with brood in four, when I ceased feeding. September 21, covering five combs, brood in three. October 14, covering six combs, with small patch of brood in two. I have not seen a crawler since my last report; they appear to be perfectly healthy, and no dislocated wings. I am very pleased to read of Mr. Harrison's success with the onion treatment, and, although he used shallots instead, it seems to me that we are on the right track.

I am not educated up to the point of naming the component parts of an onion. What I look for is results. It is sufficient for me to call an onion an onion, and, whatever name we give it, we cannot rob it of its valuable curative properties, although often despised for its odour. I don't think its virtues are dissipated by boiling, the difference in the flavour between a raw onion and a boiled one being that the components are held in solution, and when preparing a dish of boiled onions for our own consumption we should always take the liquor as well, to reap the full benefit.

I think it is quite possible that the medicinal properties are present to some extent in the nectar as well as the plant. I quite agree with Mr. Dick, inasmuch that I might have obtained the same result by using the juice of either of the fruits named. As a matter of fact, when I was casting about in my mind for a likely remedy, I thought of syrup of figs, but decided to try an onion first.

As regards the vitamin theory, does it occur to Mr. Dick that if the stomach and bowels are congested with an accumulation of indigestible pollen, the bee would suffer from malnutrition, and paralysis would ensue the same as if pollen was withheld altogether.

I very much appreciate the "Jottings" of the Rev. E. F. Hemming, but I don't quite agree with his postscript of September 30. He says the onion has been long known as a remedy for bee diseases. I should like to know by whom, and, if so, why is it not common knowledge?

I have kept bees since May, 1908, have read every copy of THE BRITISH BEE JOURNAL since that date, also several of the text-books, but don't remember seeing it mentioned as a remedy. I remember the "Jotting" alluding to onions, but would our reverend friend have us believe that when he sees a bee alight on an onion blossom that he knows it has gone there for a tonic? Similarly, I suppose he knows it would go to the horehound when suffering from a cough, and so on throughout the whole vegetable kingdom for all its ailments.

To follow that argument, they would never need the aid of man to nurse them back to health, and "Isle of Wight" disease would be unknown.

I am not disputing the idea that bees may have a wider knowledge of medical botany than us poor humans, but I am under the impression that bees get to work on that particular flower that is bearing nectar or pollen most abundantly at the time, according to their requirements. I decline to class the onion as a tonic, or garlic as an antiseptic, but that both would act primarily as a laxative. From all the evidence that has been published on the subject, it seems that "Isle of Wight" disease is neither infectious nor contagious, for swarms have been hived on combs which have been occupied by diseased bees and remained healthy; stocks have been fed on honey from diseased stocks, and stocks have remained healthy when kept in close proximity to others which have died out with the complaint.

In my humble opinion it is due to indigestible pollen that is either naturally present in some particular flower, or is

rendered so by certain climatic conditions. The microscope might reveal this if some of the pollen grains were taken from the intestines of a diseased bee, providing the characteristics have not been destroyed by partial digestion.

If indigestible pollen is the cause, we can hardly prevent it; but the best we can do is to find an antidote to administer to the bee, and a disinfectant to render the hive sanitary. I cannot think an anti-septic would serve both purposes any more than washing in Izal or Flavine would cure constipation in human beings.—T. H. WITNEY.

### A Robbing Baffle.

[10:19] One of my hives being attacked by a few robbers, I made an effective "baffle" from the outside of a matchbox by cutting away the centre part of one side and placing it in front of the entrance, *between* the two slides. I thought the idea might be useful to others. Possibly a larger army of robbers might need *half* the matchbox cover cut away—lengthways—so as to bring it closer to entrance.

I am feeding my bees on cheap Australian honey, but now I see in your issue for September 30 you warn readers against inferior honey. How is a novice to tell if it is "inferior"? And can you tell me if it will keep—if opened—until the spring? I have two tins, one *un-opened*. Or will it be likely to ferment? I could not help wishing your warning had appeared a bit *earlier*, as feeding is nearly over now!

I *began* feeding them on brown free sugar until I saw you told a correspondent that it was unsuitable. I notice you say feeding *may* be continued during the first week in October "under the most favourable weather conditions." Does this mean *warm* weather, or *dry* weather? My hives are *very* short, and I wish to do it as long as possible. Can I make candy from Australian honey?

I was much interested in Dr. Strong's experiences regarding the so-called new disease, namely that the hives *not* sprayed recovered quicker than the sprayed hives. Last May one of my hives started "crawling" badly. Some of them had the "down," on them of May sickness, and some of the brood was chilled. They were sprayed with "Yadil" solution and then fed with honey. It was nearly two weeks before the crawlers disappeared, so when another started in *June* I did no spraying, but fed them at once, putting a chopped onion in the syrup, as I had no "Yadil," and they were quite all right the next day. I lost a whole hive that was "Yadil" sprayed in *October* last

year—much too late, I suppose? I cannot help thinking that a *water* spray at any time *must* chill them, and that a syrup spray is better. Mr. Kettle's interesting experiences last spring seem to point to his generous *syrup spraying* being *really* the cure, and preventive, and not the Flavine, as your correspondent, Mr. Witney (September 23, page 459) found spraying with Flavine solution and feeding with Flavined syrup both useless, and now places *his* faith on onion *syrup*.—(Miss) A. PARKER, Leigh, N. Finchley.

[When we made the note *re* inferior foreign honey we had not Australian honey in mind. Some of that is very dark, and the flavour too strong for table use, but quite suitable for bee food. What we were thinking about was some of the cheap foreign stuff, containing a fair admixture of whole or dismembered bees and other insects, and various other undesirable ingredients. We cannot say if it will keep. If it was properly ripened and is kept covered up it will not ferment.

*Re* feeding in early October, it's better if the weather is both warm and dry, but we do not generally get the combination in this month. It is warmth that is most necessary: the bees then are active, and though they may not be able to leave the hive in wet weather, they are active enough to keep up the heat and ventilation of the hive, and thus "ripen" and seal the stores. We do not know of a satisfactory method of making candy from honey alone. Soft candy may be made by kneading honey into castor sugar, but only a very little honey would be needed. The proportion of honey might be increased by heating it until it became thicker, being careful not to burn it.—Eds.]

### Queenless Bees Storing Honey.

[10:20] During my 50 years' experience of bee-keeping, some things I have seen would quite upset the theory of men, more expert men than I am, and yet most likely both of us would be correct. It is many years since I discovered that drones had the *entre* into any hive. I keep rather a large number of hives, and have repeatedly seen the drones go from one hive to another, and yet when I mentioned the matter I was considered ??? On one occasion I was told of a swarm in my old pit field. When I got there the boys had lighted a fire under the bush and the swarm was in two parts. I took the largest. Later in the day, from the action of the bees, I judged the queen was missing. I then took the smaller portion, which was not easy, it being in the middle of a thick thorn bush, and put the two together. By this time it was getting



dark, and while I was looking at the hive Her Majesty walked from the back to the front; putting my finger down she walked on it. I at once introduced her to the entrance, but she took wing. It was too dark to follow the flight. Early next morning I searched for her, and found her inside the roof of an open apiary (bee house) with a small number of bees. Getting a glass-lidded box, she was secured and replaced in the hive. A few hours after she was discovered in the orchard, and again replaced. There is no doubt she was the right queen, because in each case the bees were running about wildly, and were pacified at once on her re-introduction. This swarm was probably the largest I ever had.

On the following day there were indications that the queen was again missing, but as they were in a straw skep I could not examine them. In a few days they were settled and working. At the end of July I found them very heavy, a few days later indications of attempted robbing. I immediately broke the hive up, and found hardly any bees, but the hive was full, and finished with virgin comb and honey. *No brood had ever been in any cell and only about a dozen with pollen.*

I think for a *queenless* colony to produce a full hive of honey is an experience quite alone.

Your readers need not doubt Mr. Kettle's word. I have visited his farm and can confirm what he says. His district is better than mine, although mine is good. My first swarm this year, which, unfortunately, I lost, came out April 14. The cast from it May 9, which has done well, although it was small. I have lost several *stocks* after swarming through the queen being either lost or unfertilised. My supers, etc., are full, but nearly all with Ling honey. The spring honey was used up by the bees for food during the wet weather.—A. LEWIS.

[We do not recollect ever before hearing of a swarm of bees settling down, building comb, and storing it with honey after losing its queen, and the experience of Mr. Lewis, who was well-known to the bee-keepers of 30 years ago, must be unique. If anyone has had anything similar we shall be pleased to hear it.—EDS.]

### A Good Report.

[10321] I have seen frequent reports in THE BEE JOURNAL as to this being a bad season for honey. It might be of interest to your readers to hear that in this district this has been the best season for honey I have known. Probably this is accounted for by the fact that we have had a considerable quantity of white

clover, which continued to flower for a long time. I have now four stocks of bees, new swarms this year, the first of which swarmed on May 16, and I hived them on bare foundation in hives which have had bees that have died of "Isle of Wight" disease. These, I must say, I cleaned thoroughly. The brood frames I boiled and used again; the super frames, with drawn-out comb, I put in as they were. All four stocks have worked well, and appear to be in good condition for the winter. Until now I have had great difficulty in wintering stocks, almost always losing them from the "Isle of Wight" disease. I have one stock that has a few pounds of unsealed honey in the super still. Would you kindly tell me if it would be advisable to remove this honey, or will they be able to winter in the super? Also, I have one hive the drones of which are still alive and were flying as recently as Sunday, Sept. 26. Thinking it was queenless, I investigated it on Saturday, Oct. 2. I found the queen on the centre comb with sealed brood, but as far as I could see there were no eggs. Could you account for this?—C. NORRIS.

[If the super is still full of bees, you might leave it on; but if almost deserted, remove it and extract the honey. It can be used up at once for domestic purposes, or fed back to the bees. It is impossible to account for all the vagaries of bees. Though drones are as a rule killed off in the late summer or early autumn, sometimes a queen-right colony will allow them to live almost into the winter.—EDS.]

### Bee Notes from Devonshire.

[10322] "Nothing beats the art of man, barring the bees," but the past summer has beaten both men and bees by its vagaries. Spring found hives, which had been closed down with ample stores for the winter, strong and flourishing. In many cases colonies had more honey stored in the supers at the end of May than they had two months later; nuclei almost invariably have had to be fed to keep them from starvation, while not a few strong stocks have "gone west" in the absence, or through the neglect of their owners. A prominent bee-keeper, who secured nearly a quarter of a ton of honey from six hives last year, has not obtained one-sixth of that total from eight hives this season, and has been obliged to convert more than that weight of sugar into syrup for bee food. These results are all the more deplorable in view of the great revival in bee-keeping caused by the Re-stocking Scheme inaugurated by the Agricultural Department last year. Many novices, and some

of the old hands at bee-keeping, will probably abandon the pursuit in disgust or despair. A bad season like the past one, however, has some compensations; it will weed out those undesirable people who only possess bees, or keep them merely for what can be obtained from them—or, in other words, for filthy lucre, and not for the love of the craft. It has also afforded opportunities for trying new and old methods of swarm prevention and control, of queen introduction and of the uniting of stocks and nuclei for which in a more normal season there would be neither leisure nor necessity. And, last of all, it has given to the writer, at least, the unique experience of a stock swarming twice during a day's demonstration at a local agricultural show. Unfortunately, owing to the too common practice adopted by a few selfish bee-men of setting out infected hives and combs to catch stray swarms, a recurrence of "Isle of Wight" disease in the county must be chronicled, as a climax to a season in which the honey harvest, speaking generally, has been almost nil.—"OUTIS."

### Italians and "I.O.W." or Crawling Disease.

[10323] I have always understood that pure Italians are great disease resisting bees. I have purchased two very strong stocks from a very reliable person: the bees seemed quite healthy when I bought them, but I only had them a week or ten days when I noticed two or three crawlers. I sprayed them with "Bacterol," also gave them syrup, medicated with "Bacterol"; but they got from bad to worse. Now they are one mass of crawlers. I cannot understand this state of affairs, as they were placed in new hives from the start, and there has been no trace of disease in this strain. I have five other stocks alongside of the diseased ones, and they are still healthy; they have resisted the disease for more than a month now, and can find no other trace of disease in this neighbourhood. Perhaps some kind reader of this most valuable paper might be able to throw some light on this subject. I have been a bee-keeper for several years; also a regular subscriber to this journal for ten or twelve years, and have found some very valuable information from the past issues.—D. G. S. HOOKER, Aldington, Hythe, Kent.

[Italian bees as a rule do resist "Isle of Wight" disease better than natives, but neither they nor any other race are immune. As the other colonies are apparently healthy, it will be advisable to destroy the diseased one, rather than risk infecting the lot while trying to cure it.—Eds.]

### Queens for Disposal.

[10324] Will you kindly allow me through you, or any responsible reader of your valuable journal, to offer to any ex-Service man, or men, or two deserving bee-keepers, two 1919 Italian queen bees. They are very prolific and produce fine workers. It will be a pleasure to pass them on, post free, on reliable recommendation.—H. CROWE, The Manse, Merriott, Crewkerne.

### Weather Report.

WESTBOURNE, September, 1920.

Rainfall, 2.34 in.	Frosty nights, 0.
Heaviest fall, .75 in. on 15th.	Mean maximum, 63.7.
Rain fell on 11 days.	Mean minimum, 48.9.
Above average, .13 in.	Mean temperature, 56.3
Maximum temperature, 71 on 3rd.	Above average, 0.2
Minimum temperature, 40 on 13th.	Maximum barometer, 30.329 on 11th.
Minimum on grass 35 on 13th.	Minimum barometer, 29.477 on 18th.

L. B. BIRKETT.

### Combs from Other Hives.

THE SOUL OF THE HIVE.

There are many curious facts about the bee world known to those who are in constant contact with it, and of these not all, only the thoughtful, are sympathetic. One of the startling facts of bee life is that it possesses a community soul, an intelligence which does not belong to the bee as an individual, but is the gathered-up life of the whole. The bee as an individual has little will power, or only in a very restricted sense; it makes no decision, it initiates nothing, it is merely a fraction, a part of the whole, and life itself passes from it if, by accident, it is long kept from the hive. It is only the ready slave, mechanical almost in its submissiveness to a general consciousness which resides in the whole, the corporate soul; and, in a way we cannot even guess out, deliberates, makes decrees, adapts, re-fashions, and in all the grave episodes of the hive acts with decision. The decisions are not always infallible and faultless; mistakes are made sometimes which bring loss and even death to the whole; but whatever it is, without question, with a common impulse, every bee of the community acts upon it. So the movements of the queen are regulated, the swarms take place, and the divisions of labour come about by what seems to our alien intelligence a presiding personality made up of a united consciousness, the spirit of the hive. These are facts of nature we

can notice and be aware of only as the mathematician is of a fourth dimension; we touch the dark edge of a world we shall never enter.

#### ALBINO DRONES.

Abnormalities occur in all forms of nature, and bees are no exception. I saw some drones this summer with white eyes, like pearls set in their head, and it gave them a most weird and uncanny appearance. The owner thought it some new species of insect come to life in his hive; it took him some time to be assured it was only one of the freaks which come and go in the animal world. Apparently the drones could see with their white eyes, but probably, like most abnormal creatures, they felt uncomfortable, as happy as a fox without its tail, or the caged bird with its wings clipped. Some of the drones were sent to the small museum of the British Bee-keepers' Association in Bedford Street, where such funnyosities are welcomed.

#### SOCIAL REBELS.

The domestic bee has not lost entirely the vagrant habits of his distant and primitive ancestors. All who have kept bees have noticed how readily sometimes they will forsake a new hive, with frames of foundation standing ready, all looking so cosy and homelike, and betake themselves to an old tree trunk, the inside of a roof or a church tower, where, amidst cobwebs and dust, they build their combs and seem to be happy. They feel, especially at swarming time, the call of the open, and, like gipsies or like children, prefer the free life of the world outside to the more artificial one of the hive, be it ever so much more comfortable. I heard of a swarm at Jevington this summer which, though duly housed in a proper hive and with everything provided a bee could wish for, refused to stay there; they took flight again and settled deep in the hollow of a dead tree trunk on the edge of the churchyard. The lady owner of the swarm sent for the wise bee-man of the village, and he, with smoker, tried to compel them to leave their chosen home. But they were obstinate bees, and refused to budge. At last the smoking became so vigorous, for the bee-man was equally obstinate, that the tree trunk, which was dead wood, took fire, and flame and smoke arose. Only after this, and when buckets of water had been poured down, did the bees capitulate; it was the combined onslaught of three plagues—smoke, fire and water. So they were carried off in triumph and replaced in their despised home, and there, after their wanderings and the unhappy experience of the tree-trunk, they submissively settled.—Rev. A. A. EVANS (from the *Sussex County Herald*).

## Up-to-Date Bee Hives.

SWARM SETTLES ON HANDLEY-PAGE  
AEROPLANE.

Bees have always been renowned for their industry, but up to yesterday their enterprise might be doubted. Now there can be no question of it. A swarm made its appearance at the entrance of one of the Handley-Page hangars, Wynberg, and flying round for a few minutes spied an open strut fitted in the top main plane. They thereupon entered the plane itself, settling between the two layers of fabric, apparently having decided that they would have a free flight in South Africa's largest aeroplane rather than tire themselves on their own wings.

The foreman fitter, Mr. Askew, was of a different opinion though, and securing a piece of smouldering canvas placed it below another opening in the plane. A tremendous buzzing ensued, and the bees cheated out of their free flight and new home poured out of the wing in frenzied haste and settled on a neighbouring pine.

They were captured by the mechanics, and are now safely housed in a hive which was speedily constructed. Those superstitiously inclined will say that this unique occurrence augurs well for the success of commercial aviation in South Africa.—*From the Cape Argus.*

## More Good Hints.

If you want to keep your smoker going good, point the nose of it to the wind each time you set it down, and you will always have a good smoke when it is needed.

If you don't want the foundation to sag, then run it in the frames out in the sun—if it isn't too hot—and then all the sag will be out of the wax before you imbed the wires.

If one wants to make a success of the bees, then keep them healthy; that's half the battle, and it isn't hard if you don't mix up the honey and combs; also clean them up when they should be and don't put it off.

You will find it will pay to use the Jumbo size smokers; they fill easier and hold fire much longer.

The hardest job some bee-keepers have or at least the job they make the hardest work of, is lighting the smoker. This is the first thing to instruct the beginner in. Take a small bit of light cotton rag (if it is greasy so much the better) or a bit of oily waste; get it burning thoroughly, all afire, then drop it in the smoker (be sure the grate of the smoker is clean, so there will be good draft). Then drop in another *small* rag; when this is also well

afire, put in all the burlap you need, but don't crowd it down, for this will obstruct the draft. In using a smoker all day, empty out the ashes often enough to keep a good draft.—A. E. LUSHER, Pasadena, Cal. From the *Western Honey Bee*.

## Notices to Correspondents

W. EVANS (Bucks).—Using granulated honey as candy. The honey would need to be very hard to be used in this way; it would then answer, but if soft or at all inclined to run it would not be wise to put it over the bees. It could be stiffened by the addition of castor sugar.  
Late mating.—A queen might mate now if there are drones and there was a day warm enough.

## Bee Shows to Come.

**November 18.**—Annual Show of the Worcester City and County Chrysanthemum, Fruit, Root and Honey Society. Thirteen Open Classes in Honey Section.—Schedules from Geo. Richings, 42, Barbourne Road, Worcester. Entries close November 6.

## Twickenham and Thames Valley Bee-Keepers' Association.

WINTER AND SPRING PROGRAMME.

### LANTERN LECTURES ON BEE-KEEPING

will be delivered by

W. HERROD HEMPSALL, F.E.S.

(Expert and Lecturer to the British Bee-keepers' Association), on

MONDAY, OCTOBER 25, 1920, at 7.30 p.m.,  
AT ST. STEPHEN'S PARISH ROOM, HOUNSLOW  
(Near L. & S.W. Railway Station and Trams),  
"The Hive as a Home."

MONDAY, NOVEMBER 15, 1920, at 7.30 p.m.,  
AT ST. STEPHEN'S PARISH ROOM, HOUNSLOW  
(Near L. & S.W. Railway Station and Trams),  
"The Hive as a Factory."

WEDNESDAY, DECEMBER 15, 1920, at 7.30 p.m.,  
AT ST. PETER'S HALL, STAINES,  
(Near L. & S.W. Railway Station),  
"Bee-keeping for Profit."

MONDAY, JANUARY 17, 1921, at 7.30 p.m.,  
AT WESLEYAN CHURCH SCHOOL HALL,  
TEDDINGTON  
(Near L. & S.W. Railway Station and Trams),  
"Elementary Bee-keeping."

TUESDAY, MARCH 15, 1921, at 7.30 p.m.,  
AT THE LIBRARY LECTURE HALL,  
TWICKENHAM  
(Near L. & S.W. Railway Station and Trams),  
"The Opening Season."

TUESDAY, APRIL 12, 1921, at 7.30 p.m.,  
AT THE LIBRARY LECTURE HALL,  
TWICKENHAM  
(Near L. & S.W. Railway Station and Trams),  
"Queen Rearing."

Entrance Free.

All persons interested in Bees and Bee-keeping are invited to attend.

Gen. Sec.: MISS M. BYATT, Hawthorne, Hanworth, Middlesex.

## Special Prepaid Advertisements.

One Penny per Word.

Advertisements must reach us **NOT LATER** than **FIRST POST on MONDAY MORNING** for insertion in the "Journal" the same week.

Orders for three or more consecutive insertions in "The Bee Journal" entitle advertisers to one insertion in "The Bee-Keepers' Record" free of charge.

### PRIVATE ADVERTISEMENTS.

**B**EES, HIVES, ETC., for Sale. Send stamp for list.—JAMES GLADDING, London Road, Copdock, Ipswich. r.j.14

**B**EAUTIFUL new Somerset Clover Honey (guaranteed) for Sale in 28-lb. tins, £3 per tin, carriage paid, and tins free.—WYATT, Keats Cottage, Buckland, Chard. j.25

**H**AVING to unite stocks, have four 1919 pure Italian Queens for disposal, 7s. each, if four taken; two Hybrids, 4s. each.—CROWE, Merrifott, Crewkerne. j.26

**S**ALE, Raspberry Canes, Superlatives, 10s. per 100, carriage paid; 50, 6s. 3d.—HUNT, Bank Street, Somercotes, Alfreton. j.27

**S**PARE QUEEN, 7s. 6d., Taylor's Hybrid, 1920.—GILL, 44, West Street, Boston. j.28

**C**OWAN'S HONEY BEE.—Three copies wanted by students for forthcoming examinations, on loan or purchase.—JUDGE, Shepherd's Lane, Dartford. j.29

**W**ANTED, long, also small, Honey Jars for show purposes.—W. ION, Healing, Lincs. j.30

**P**URE LIGHT CAMBRIDGE HONEY (guaranteed), 14-lb. tins, 30s.; 28-lb. tins, 57s. 6d., carriage paid.—YOUNG, 42, James Street, Cambridge. r.j.17

**B**EESWAX, pure, for Sale, 5 cwt., packed in ½-cwt. bags, £8 16s. per cwt. net, f.o.r. London.—Apply, Box 104, B.B.J. Office, 23, Bedford Street, Strand, W.C.2. r.j.20

**B**ROTHER BEE-KEEPERS with spare time wishing to commence in the Retail Fish Business write J. W. ELVIDGE, Wholesale Fish Merchant, Grimsby. r.h.239

**H**AVE YOU READ "THE BEE WORLD"? If not, why not? Every number in itself is a useful literary work for practice and reference. Specimen copy free.—Offices: THE APIAR CLUB, Port Hill House, Benson, Oxon.

### BUSINESS ADVERTISEMENTS.

1½d. per word.

**I**TALIAN QUEENS.—Signor Penna is sending us a few selected Fertile Queens, which we can offer at the unusually low rate of 7s. 6d. each. Orders in rotation. Supply very limited.—PEARSON & GALE, Marlborough. h.221

**M**ASHEATH MEMS.—With Masheath Hives you will introduce pleasure, profit, and pride in your bee-keeping.—ATKINSON, Fakenham. j.31

**N**O SUGAR VOUCHERS NEEDED.—Flavine Candy, made in Cambridge and the wrappers bear our name and the address of maker; a sample cake sent post paid for 1s. 6d.—S. H. SMITH, 30, Maid's Causeway, Cambridge. r.j.32

**CRAWLING DISEASE.**—Reliable treatment for curing and prevention; recipe 2s. 6d.—A. W. SALMON, Cashfield, Chingford. r.h.162

**AUSTRALIAN HONEY FOR FEEDING BEES.**—Cases containing two tins, about 60 lbs. each, 110s. per case; 1 tin 56s., carriage paid 100 miles. Remittances with orders.—SOUTHWOOD, 95, Acton Vale, London. r.h.190

**"WIGHT" DISEASE.**—Prevention and removal. Advice 5s.—ALF. RYALL, Cottage Farm, near Camp, Stroud. j.5

**NO SUGAR VOUCHERS NEEDED.**—Flavine or Plain Candy, same price, 6 lbs., 10s., postage 1s. 3d. extra; larger quantities by passenger or goods train. Made in Cambridge, and the wrappers on the Flavine Candy bear our name and the maker's address.—S. H. SMITH, 30, Maid's Causeway, Cambridge. h.218

**SURPLUS HIVES and Appliances for Sale,** good condition, cheap.—PEARSON & GALE, Marlborough. rh.131

THE

## British Bee-Keepers' Association.

The recognised centre of practical and scientific bee-keeping in Great Britain. Particulars and conditions of membership may be obtained from the Secretary,

W. HERROD-HEMPSELL, 23, Bedford Street, Strand, London, W.C.2.

## Finest Grade New Zealand Honey (Amber)

For Bee Feeding. Guaranteed Pure.  
Cases, each 2 60lb. nominal tins. 95/- per cwt.  
Carriage paid.  
Cash with order or on receipt of goods.

N.B. We are already supplying Beekeepers' Associations throughout the Country and shall be pleased to quote references.

The Bristol and Dominions Producers' Association, Ltd., Bristol.

The products of the Apiary, of Poultry and Farm Stock, of the Fruit and Vegetable Garden can be Advertised and Sold through

## THE BAZAAR, EXCHANGE & MART

Newspaper.

Get a Copy—Thursday and Saturday 3d. The "Bazaar" publishes also practical handbooks by experts. Send for full catalogue, post free from—WINDSOR HOUSE, Breams Buildings, LONDON, E.C.2.

## INSURE YOUR STOCKS

### AGAINST "I.O.W." AND OTHER INFECTIONS.

Science has now placed within reach of every Apiarist a safe and certain preventive of infection in "Yadil" Antiseptic.

For **SPRING FEEDING** "Yadil" may be added freely to Syrup.

For **DISINFECTING** Bees and Combs a five-per-cent. solution in tepid water should be used with a fine spray.

ASK FOR GREEN LABEL.

Our Bee Brochure sent Free on Application.

CLEMENT & JOHNSON, 19, Sicilian Avenue, W.C.1.

## 8/- Of the Author, S. SIMMINS, QUEENLAND, HEATHFIELD, SUSSEX. SIMMINS "A MODERN BEE FARM"

POST FREE Nearly 500 pages. A few more copies at 8/-. Any further edition must cost 50% more

Bees and Beekeeping Appliances. Catalogue free. EDWARD J. BURTT. MANUFACTURER. GLOUCESTER.

*I very much regret that there has been a large increase in the cost of the manufacture of bee appliances, and therefore my prices will be advanced 10% from May 10th. Books excepted.*



## "BACTEROL" FOR BEES

2/9 per Bottle.

Post Free.

The cure for, and preventive of, "Isle of Wight" Disease. Non-poisonous—free from stain or unpleasant odour.

BACTEROL LIMITED  
19/25, Brookside Rd., Highgate, N.19.

## POSITIVE FACTS.

June 13th, 1920.

I am very pleased with the foundation. The bees undoubtedly prefer it to any other make I have, and have even gone the length of missing two sheets of other new foundation, and working out a sheet of yours placed behind them at the back of the hive. Full sheets have not sagged in the least in 16 x 10 frames.

Yours faithfully, R. B. MANLEY.

Illustrated Lists free by post.

S. J. BALDWIN, The Apiary, BROMLEY, Kent.

## FOUR FIRST PRIZES.

Our HIVES and APPLIANCES were again awarded FOUR PRIZES at the Highland Agricultural Society's Show at Aberdeen, thus testifying to the superiority of our goods.

Order now and ensure your bees wintering in good hives.

**BOTTLES.** We hold a large stock and can give immediate despatch.

**CANDY.** Safeguard your bees from starvation by feeding with our FAMOUS BEE CANDY. Price 1/6 per 1-lb., carriage extra.

Sole Agents for DADANT'S WEED FOUNDATION. Absolutely pure. Once used, always used.

Large illustrated catalogue, entitled, "Everything for an Apiary," post free on application.

**R. STEELE & BRODIE,**  
*Bee Appliance Makers,*  
**WORMIT, FIFE.**

Telegrams:—"Bees, Wormit."

Telephone:—28 Wormit.



## Lee's Bee Supplies.

¶ In design, material and workmanship, Lee's Bee Supplies still retain the reputation of being your best and safest investment.

¶ Our 1920 ILLUSTRATED CATALOGUE is yours for the asking. It contains detailed information on the most up-to-date hives and appliances for which the House of Lee is famous.

¶ We regret the necessity of having to advise our Customers that owing to the increased cost of production, all prices in 1920 price list are subject to 10% increase. The increase will not apply to orders received before May 10.

\*\*\* Five per cent discount to Members of THE APIS CLUB.

**JAMES LEE & SON,**  
LTD.,

Uxbridge, Middlesex.

(Telegrams: Graphicly, Uxbridge.)

Telephone: Uxbridge 181.)



No. 2001. Vol. XLVIII

OCTOBER 28, 1920.

[Published every Thursday, Price 2d.]

**CONTENTS.**

	PAGE		PAGE
DEATH OF DR. C. C. MILLER .....	517	BRITISH BEE-KEEPERS' ASSOCIATION CONVER-	
THE DAIRY SHOW .....	517	SAZIGONE .....	524
A DORSET YARN .....	517	GLASGOW AND DISTRICT B.K.A. ....	525
JOTTINGS FROM HUNTINGDONSHIRE .....	518	SALISBURY AND DISTRICT B.K.A. ....	526
JOTTINGS .....	519	CORRESPONDENCE—	
THE APIARY OF KING MANUEL OF PORTUGAL .....	520	Queen and Drones .....	526
COTSWOLD NOTES .....	522	Queenless Bees Storing Honey .....	526
NOTES ON BEE-KEEPING .....	522	Poppy and other Bees .....	527
SERMONS IN STONES .....	523	QUERIES AND REPLIES—	
A BEE-KEEPER'S ALPHABET .....	524	Amount of Candy for a Foodless Colony ..	527
		BEE SHOWS TO COME .....	527

Do not **LOSE YOUR BEES** for the sake of giving them a cake of our **PINK**

# SOFT CANDY

Made from guaranteed Pure Cane Sugar, medicated or plain.

NO VOUCHERS REQUIRED.

Price **1/6** per lb. Carriage or postage extra.

**E. H. TAYLOR, LTD., WELWYN, HERTS.**

THE  
**British Bee Journal**

Office: 23, Bedford Street, Strand, London, W.C.2.  
ESTABLISHED 1873.

A Weekly Journal Devoted to the  
Interests of Bee-keepers.

Edited by T. W. COWAN, F.L.S., &c.,  
and J. HERROD-HEMPSELL, F.E.S.

**Correspondence: Whom to Address.**—All matters relating to the Literary Department, Associations, Shows, etc., should be addressed, "Editors, *British Bee Journal*," and all business communications and matters relating to subscriptions and advertisements to be addressed to the "Manager," *B.B.J.* Office.

**Subscriptions.**—Annual Subscription, 10s. 10d. post free in advance; single copies 2d., or 2½d. post free. If a receipt is required by post, a stamped and addressed envelope must be sent, otherwise a printed receipt will be enclosed along with the paper.

*Note.*—Cheques and Postal Orders should always be crossed, otherwise it is very difficult to trace them if they go astray.

**How to send Money.**—Remittances can be made payable to W. Herrod-Hempshall by crossed Cheques and Postal Orders. Stamps may be sent for small amounts up to 2s. *Halfpenny stamps are preferred.*

Scottish or Irish cheques can only be taken in payment if 6d. is added for commission charged by banks for cashing them.

The Editors are not directly or indirectly interested in the manufacture or sale of beehives or appliances of any kind, and must refer correspondents wishing for prices or catalogues to advertisers in the paper.

## OUR DEPOSIT SYSTEM.

**You are advised to insist on this being used when  
dealing with strangers.**

### Rules and Conditions for Depositing

*In order to save trouble, it is requested that the Rules be carefully read over by persons using the Deposit System of trading.*

Goods should not be despatched until notice that the money has been deposited is received from this office.

**1. Method.**—When strangers are dealing together, the purchase-money of the articles is deposited at our office. We acknowledge receipt of the deposit to both parties, and hold the money until we are satisfied that the purchase is concluded. If a sale be effected, we remit to the seller the amount deposited, less a charge of 2½ per cent in the £, with a minimum of 6d., and the expenses of Post Office Orders and postage, &c. Cash will be forwarded by Cheque, Post Office Order, or by Postal Order as preferred. If a sale or exchange be not completed, we return the amount deposited, after making the same deduction. By this means buyers and sellers are secured against fraud.

**2. Deposits.**—Postal Orders (drawn on General Post Office) and Cheques must be made payable to W. Herrod-Hempshall, and crossed "London County and Westminster Bank." The numbers of the Postal Orders should be kept by the sender.

We cannot be responsible for any loss that may occur in transit.

**3. Honey on Approval.**—All honey will be sold by sample, which must be sent direct to buyer.

**4. Bee Appliances.**—In ordering, the time allowed for completing the order to be stated to us when sending cash. If maker accepts, we hold cash until transaction is satisfactorily completed, when the amount will be remitted, subject to conditions as in Clause 1.

**5. Bees and Queens.**—These will be dealt with entirely by the parties concerned, so far as price, &c., go, and when the purchase is satisfactorily completed cash will be remitted as per Clause 1.

**6. Goods in Transit.**—These are at the seller's risk, i.e., any damage to or loss of an article on its journey is borne by the vendor; but a rejected article must be properly packed and returned by the same means as was used in sending it.

**7. Carriage.**—The carriage of all goods, *except such as are sent by post*, is payable by the buyer, unless otherwise agreed. If any article sent on approval be returned, each party to the transaction must pay carriage one way.

## Books for Bee-keepers NOW IN STOCK.

Cash in full must be sent with order.

	7/6	Postage
A Modern Bee Farm ... ..	7/6	... 8½d.
<i>(To be obtained from this Office only.)</i>		
Advanced Bee Culture (HUTCHINSON) ... ..	6/-	... 6½d.
Beginner's Bee Book (PELLET) BEE-KEEPING SIMPLIFIED FOR THE COTTAGER AND SMALLHOLDER (W. HERROD- HEMPSELL, F.E.S.) ... ..	5/-	... 4d.
BRITISH BEE - KEEPERS' GUIDE BOOK (T. W. COWAN) Paper covers ... ..	1/-	... 2d.
Cloth covers ... ..	2/6	... 3d.
Dissectible Model of Queen Bee ... ..	3/6	... 4d.
FERTILISATION OF FRUIT BLOSSOMS BY BEES (T. W. COWAN) ... ..	4/6	... 3d.
Honey and Health (A. HOPK) ...	-/3	... 1d.
Honey Vinegar (REV. G. BANCKS) ...	-/6	... 1d.
How to Keep Bees (ANNA B. COMSTOCK) ... ..	-/2	... 1d.
Prevention of Swarming (WILKES) ... ..	5/-	... 4½d.
Pollination of Fruit in relation to Commercial Fruit Growing (C. H. HOOPER, F.R.H.S.)	1/-	... 1d.
PRODUCING, PREPARING, EXHIBITING AND JUDG- ING BEE PRODUCE (W. HERROD-HEMPSELL, F.E.S.) ...	-/6	... 1d.
Queen Rearing in England (F. W. L. SLADEN) ... ..	2/-	... 3d.
Scientific Queen Rearing (DOOLITTLE) ... ..	1/6	... 2d.
Snelgrove's Method of Re- queening ... ..	4/-	... 3½d.
The "Townsend" Bee Book ...	-/6	... 1d.
WAX CRAFT (T. W. COWAN) ...	2/6	... 2d.
Wilke's Book on Swarming ...	2/-	... 2½d.
1/-	... 1½d.	
<b>MISCELLANEOUS.</b>		
Lure of the Honey Bee ... ..	2/-	... 2½d.
THE BEE WORLD (supplied only to members of Associations interested in the control and development of the Aris Club, apart from ordinary members of the latter), per copy ... ..	7/6	... 4½d.
The Bee Master of Warrilow (TICKNER EDWARDS) ... ..	-/3	... 1½d.

**British Bee Journal & Record Office,**

23 BEDFORD STREET, STRAND LONDON, W.C.2





## Death of Dr. C. C. Miller.

We were exceedingly sorry to hear of the death on September 4 of this grand old man of bee-keeping—the Sage of Marengo, he has been aptly called the last few years. Dr. Miller was in his ninetieth year. We hope to give a fuller obituary notice at an early date.

## The Dairy Show.

This is almost the last show of the year, and as at most of the shows that have been held during the season, the honey was of first-class quality, the sections were exceptionally good, but the entries were small. The staging also left much to be desired. The space allotted was somewhat cramped, and the arrangement of the exhibits was very poor. The two trophies were at one end of the table, and were crowded up at the base with the wax, Colonial honey and exhibits of an interesting nature. The two latter were staged in such a biggledy-piggledy fashion, it was almost impossible to distinguish the exhibits one from the other. The jars and sections on the staging were not spaced to the best advantage; some, notably the sections, were crowded close together, while a little further along there were spaces of from one to almost two feet between the rows of jars. The appearance of the whole exhibit would have been improved 50 per cent. had this matter received attention, and the staging been placed in the centre of the table with a trophy at either end. We are afraid that unless the honey section of the Show is managed better, and with a little less "red tape," the few bee-keepers who do exhibit will give it up in disgust; in fact, some have already decided to do so. Two of the exhibits were overlooked, and were not staged until Wednesday, when the exhibitor noticed their absence and they were found under the table.

Another grievance is the system of withholding some of the prizes unless there are a certain number of entries in the class. In our opinion this should be left to the discretion of the judge, and if an exhibit is, in his opinion, worthy of a prize, it should be awarded, no matter how few the entries. Mr. J. Price, of Stafford, judged the exhibits, and made the following awards:—

12 1-lb. Jars Light-coloured Extracted

Honey (13 entries).—1, Mr. J. Pearman, Derby; 2, Mr. J. Birkett, Rainhill, Lancs.; 3, Miss M. Shaw, Hereford; 4, Mr. N. Allin, Over Wallop, Hants.

12 1-lb. Jars Medium-coloured Extracted Honey (6 entries).—1, Mr. G. Bryden, Rochester; 2, Mr. J. Pearman; third and fourth prizes withheld.

12 Jars Dark-coloured Honey (3 entries).—1, Mr. G. Bryden; 2nd and 3rd withheld.

12 Jars Granulated Honey (4 entries).—1, Mr. J. Pearman; 2nd and 3rd withheld.

12 Sections, Other than Heather (6 entries).—1, Messrs. Robson & Cusford, Riding Mill, Northumberland; 2, Mr. J. Pearman; 3rd withheld.

Display of Honey (2 entries).—1, Mr. J. Pearman; 2, Mr. G. Bryden.

Wax: 2 lbs. in Two Cakes (6 entries).—1, Mr. J. L. Davey, Spalding; 2nd and 3rd withheld.

Wax: 3 lbs., Suitable for the Retail Trade (4 entries).—1, Mr. J. L. Davey; 2nd and 3rd withheld; reserve, Mr. J. Pearman.

Interesting Exhibit (4 entries).—1, Mrs. L. Willis, Beeswing, Sudbury, Suffolk; 2nd and 3rd withheld; reserve, Mr. J. H. Miller, Walkerslade, Chatham.

Colonial Honey: Three Vessels or Tins as Imported (1 entry).—1, gold medal, The New Zealand Honey Producers' Association.

## A Dorset Yarn.

Have just had a letter. "It seems impossible that combs in surplus racks should be filled entirely by heather honey to the exclusion of that from other flowers." Yet that is exactly how they have been at the Violet Farm. My friend, Squire Tomlinson, will bear me out that this is so. I would like my correspondent to read old Carlyle; he wrote, "Know that 'impossible,' where truth and mercy and the everlasting voice of Nature order, has no place." We have combs so solid that they can be cut into cubes like sugar, and very little honey will run, even though the weather is warm. Some of the combs extracted easily, but others would not yield to the will of the operator.

Certainly the bees are conservative, in that they follow certain flowers very closely when the honey is in full flow. The writer of the Dorset yarn cannot tell why it is so, but he has repeated many times, There are stranger things in heaven and earth than was ever dream'd of in man's philosophy. We have watched the bees this last week going over flowers of hardy fuchsias;

they are a long time on each individual flower. The pollen of these is very thick and sticky; it must take them a long time to clear off the basket-carriers after it is put on them, yet they are always on them at this time of the year—they are close to the hives.

A clerical bee-keeper came over last Friday to see the farm. He tells me that he has paid his way and covered the initial cost of this year's extra expenditure on extending his area with fruit, flowers, and vegetables, but with his bees, owing to the wet summer, he has not made any extra return in honey. His stocks of bees, however, have increased to eight, so he is solvent. He has a great value in the strong stocks that have built up since August. Like all optimists, he anticipates a surplus season next year—"Man in his time plays many parts." This parson, when the War began, unlike many other younger men in the Church, took up arms; he has led his company "over the top" in the battlefields of France. He seems to be one of the class of men that has made things hum; plenty of energy, a beautiful house, delightful gardens, rich, deep soil, things grow luxuriously, he gets the utmost out of the soil. He is a worker, he has plenty of "hot air," like the rest of his fraternity, but he is a *doer*, as well as a *talker*.

Saturday, October 23, we had warm southerly winds. Bees were everywhere about the farm, they did not seem to mind that the leaves were falling off trees, for flowers are plentiful. What they find in the fields just now seems to be of poor quality, but they seem to extend the combs above the bars, though only in some of this late-built comb is there honey. The shallow combs that were uncapped when the wealth of surplus was taken off have had the greater part taken out, but those that were sealed over are left intact. These are over a very strong lot, so we must assume that they have plenty of stores, they all make a great deal of humming when the sun gets through the clouds.

Bees are still booming. Have just had a letter, the writer of which would like stocks by the hundred. If the area is rich in big trees that bees delight in, it will be all right for the owners, but it entirely depends on the farmer's fields. If it is all grazing, there will not be so much honey as in fields where clover is run up for cutting; as we find the crimson clover gives the most just at the time that bees are building up their population, then when the wealth of nectar is ready the stocks have plenty of workers to gather it.—J. J. KETTLE.

## Jottings from Huntingdonshire

Two teams of horses were wending their way leisurely along the lane, while at the end stood a youth propping open a rusty-hinged gate, through which the horses turned into the field. In a few minutes they were hitched on to a couple of ploughs, and with a "Blossom, Smiler, Duke, Flower," the ploughman set them going along the furrow, turning over the stubble and up the sweet, brown earth, revealing insect life of many species. I wanted a word with William, so I accompanied him up and down the field while we conversed on everything except the one thing I had come to talk about. William is somewhat garrulous, but always interesting, and was never more so than on this occasion. Fieldfares, starlings, pigeons, rooks, daws, buntings, sparrows, robins, were there, and William had something good to say about them all. Fieldfares ate berries, so he said, that might poison human beings. "Starlings? why 'em saves a farmer many a eartache; but for 'em no seed ould ever get the chance to sprout, them *insectes* would eat it all. Pigeons ates corn, I know's they do, but I'll warrant they ates ten worms to every nip o' wheat; rooks? lawk! master, wireworms 'as no chance when they's about, the same wi' daws; buntings are main fond of whitee things, what they be I don't know, but I do know they hatches into crawly things; sparrows be a bit of a nuisance when harvest is on, but I reckon they think they earn their wheat since they helps it to grow by a-swallowing slugs and such like, what eats wheat off soon as it's up; as for robins, bless their purty breasts, all's good they does—friendly too, baint 'em? Sits on the plough betimes and watches for their tit-bits to turn up." Thus William talked away. At last I got an opportunity of speech. I had heard William talk of bees his old master had 50 years ago, and I wondered if I could gain any knowledge as to the methods of bee-keeping in this part, half-a-century back. Bee! oh, the magic of the word! No sooner did I mention it than William commanded his horses to stop. I explained I did not wish to hinder him and the ploughing, but William said he was on piece work, so he felt able to stop for a breather, "besides, the horses are all of a bather," he added; "what were'e going to say about bees?" I asked whether his master of old kept them in skeps or boxes; did he resort to the sulphur pit; did he import bees or queens, etc? "He didn't do any on't," said William. His hives were "fine

houses with three rooms in—one room for breeding, one for a pantry for themselves, the other was a pantry for the master," William explained, and I gathered that his master used Nutt's collateral hives. A centre brood nest, a storage chamber on the left, and a surplus chamber on the right. "How," I asked, "was the queen kept out of the pantries?" "Soft enough, sir. Just got some dairy winder wire and punched holes just big enough for the little 'uns what does all the work to get through, and sticks a piece across the doorways, and there you are." I next asked what weight of surplus honey was taken on an average from each hive, and William stated it to be about ten stone. My next query was, what did they do with swarms? William grew excited. "Swarms! never had many, only what 'e wanted. Master allus used to say keep plenty of bees in each hive, and stop 'em swarming 'cept when you wants to make another stock. Allus bought fresh queens and kings, too, did the master." "Now, William," I said, "why do you keep talking of 'king' bees when you know there are only queens, workers and drones?" "No kings in hives, sir! I wonder master don't rise from his grave and confound you, you and all your bees, and you never seen a *king* yet? Smiler, Blossom, Flower, get on with it," and the team went on and left me standing there. I stood until the team returned, when William stepped from his plough-handles for a moment, and with the paddle-handle smote the palm of his hand and thus delivered himself: "Next spring, if I'm spared, if you come for I when you're among yer king—well, I'm danged! now then, Duke, come hither; whoot 'wha," and William was off again warmed almost to anger, or was it righteous indignation, at my scepticism. I think I know what William means—of which more anon. Dr. Strong, I fear, will be angry with me when I say that William after all, is more right than wrong.

Now for a few "Jottings." If Mr. Witney will consult the BRITISH BEE JOURNAL of a year ago he will see reference is made to onions being worked as remedy for bee diseases. His recent experience is valuable as proving the potency of this vegetable where weakly bees are concerned.

The bees are still busy with the ivies, and not a few are engaged in extracting what nectar they can from the late brambles. Italians are doing amazingly; if there is nectar within five miles worth gathering they will find it, and five miles as the crow flies is less than five miles as

the bee flies. Bees strike a zigzag course as they rush through the air. This movement is a great help to them—the weight of their body assisting the rapid movement of the wings. How inquisitive they get at this season of the year! A new gate, a new fence, or even fresh rose bushes must be examined by the little ladies; they're worse than cats for nosing over anything new in October. If we light a fire for burning weeds they must come and have a look; and despite their dislike for smoke, some will fly into it, perhaps to learn its nature, so as to warn friends. Soon they will start their games, using warm days in winter for their pranks; they must be busy either at work or at play, and the season of play is here.—E. F. HEXMING, Steeple Gidding.

---

### Jottings.

*A Useful Tip.*—When the bee-lover is away, an effective, if somewhat defective and unkind manner of treating a strong colony I came across the other day. A gardener, anxious to mow around the hive, took the precaution of stuffing the entrance with grass overnight. This method was perhaps better from one point of view than one permitting light to enter the hive; while if all had been as planned, and the poor bees liberated early, one might have forgiven a really nervous culprit. But the day of action happened to be a wet one, and at twelve-thirty the job was in abeyance, and so were the bees; how long and whether they would have remained so until the weather changed I did not find out; at any rate, my business was an examination, and I preferred them buzzing around, which they were only too pleased to do. Now, gardeners, even Nature, responding to your expert aid, *needs air*.

*An Unread Book.*—I also saw some very strong colonies at another place, all short of stores though; and as the owner thought in one or two cases it must be six years since the combs were placed there, or examined, it seems to refute some of our "essentials," to health, such as changing combs, spring cleaning, and the many accidents that occur to the queen—except squeezing in this case, as it was impossible to move the frames, which were cemented to the sides of the hive, and the top bars would not stand the strain of removal. The hives only had an eighth of an inch spacing divided; I was told they were hives from a prominent maker, but I think this must have been a libel at some stage. I fancy I

could see our "Inspector" burning this lot, with half an excuse.

*Yet Another Frame.*—I made an acquaintance with another frame, and as it is supplied with the re-stocking nuclei, I suppose it is new. A saving of ends is effected; this is about all I could see in it. The shoulders extended some three-fifths of the length, and a quarter of an inch bee passage between combs made a welcome relief and air passage to the otherwise wooded outlook. A set would effectively keep the bees out of the supers with the addition of the zinc, while if one wants to have an examination, a chisel or other lever is all that is necessary to separate the frames, when a grip will be found possible. If I were a shareholder I should move that they be returned, and my letter says the bees are to be "Italians, or at least have an Italian queen." There are two sides to an agreement.—A. H. HAMSHAR.

## The Apiary of King Manuel of Portugal.

Most of our readers will probably be aware that King Manuel of Portugal is one of the craft. We believe the illustration of his apiary given on another page is the first to be published.

Mr. A. G. Gambrill, the veteran bee-keeper of Richmond, holds the appointment of "Master of the King's Bees" to King Manuel of Portugal, and is here seen at the royal apiary at Fulwell Park. An excellent position was chosen for the hives which face due South. The wall at the back of the hives is about 15 ft. high, and provides an excellent shelter during cold winter weather. There is a path at the back from which the hives can be manipulated. On the left hand there is a row of tall trees (not seen in the picture), which during hot weather provides plenty of shade on sunny afternoons. Having, in his long career of over fifty years among bees worked with every conceivable type of hive, Mr. Gambrill regards the W.B.C. as the best workable, and as he was given an entirely free hand, had no hesitation in supplying hives of that make.

King Manuel decided to keep bees when the sugar shortage began, and started with one hive at the end of April, 1918. This was supered the first week in May, but on June 18 a big swarm came off, which was secured. A second hive was suggested, but they were then hard to obtain; transit

was also uncertain. In the emergency four frames of comb, with adhering bees, and containing queen cells, were taken from the parent stock and put in an eight-frame travelling box, the perforated zinc, closing a 3-in. entrance, was opened for flight, and so they went merrily along, rearing their queen. Other frames of foundation were added as required, and when the second hive did arrive, on July 8, there was a splendid lot on eight combs to transfer from the makeshift.

To return to the parent stock. When the four combs with queen cells were taken out, all the others were carefully examined, and all the remaining queen cells destroyed, an extra super was put on, and the swarm run back the same night. A third super was put on later, and by careful manipulation—putting the end sections to the centre, and the centres to the ends, etc., and presently taking away 21 finished sections, so reducing to two supers, subsequently removing another 21 sections, thus leaving one super for the bees to complete—63 well-finished sections were handed to their Majesties on their return from their summer sojourn.

Both the King and Queen are greatly interested in the bees, and are frequently present during manipulation, asking information on every point.

As will be seen, there are four hives, which his Majesty has decided shall be the limit in number. On May 3 this year two strange swarms settled in the grounds within an hour or so of each other. One swarm selected the pear tree on the wall at the exact spot where the smoke is seen issuing from the smoker. This swarm took a long time to secure. A skep was fixed above the cluster, which was gradually smoked and feathered up.

Now in his sixty-fifth year, Mr. Gambrill does very much active work, and has charge of several other apiaries, including Rothschild's, making weekly visits in the season to Streatham, Upper Norwood, Wimbledon, Putney, Barnes, Hampton Wick, Teddington, and many other places, as well as special visits, by request, in several counties. It is interesting to note that he has opened no less than 533 hives in this season. He is a tower of strength to any association, and in one season secured eight members for the British Bee-keepers' Association. To his near neighbours, the Twickenham and Thames Valley Association, he acts as judge and lecturer, and has secured this Association several members this year. Mr. Gambrill fills up his winter time with other hobbies, being a well-known society entertainer and a public lecturer on general subjects.

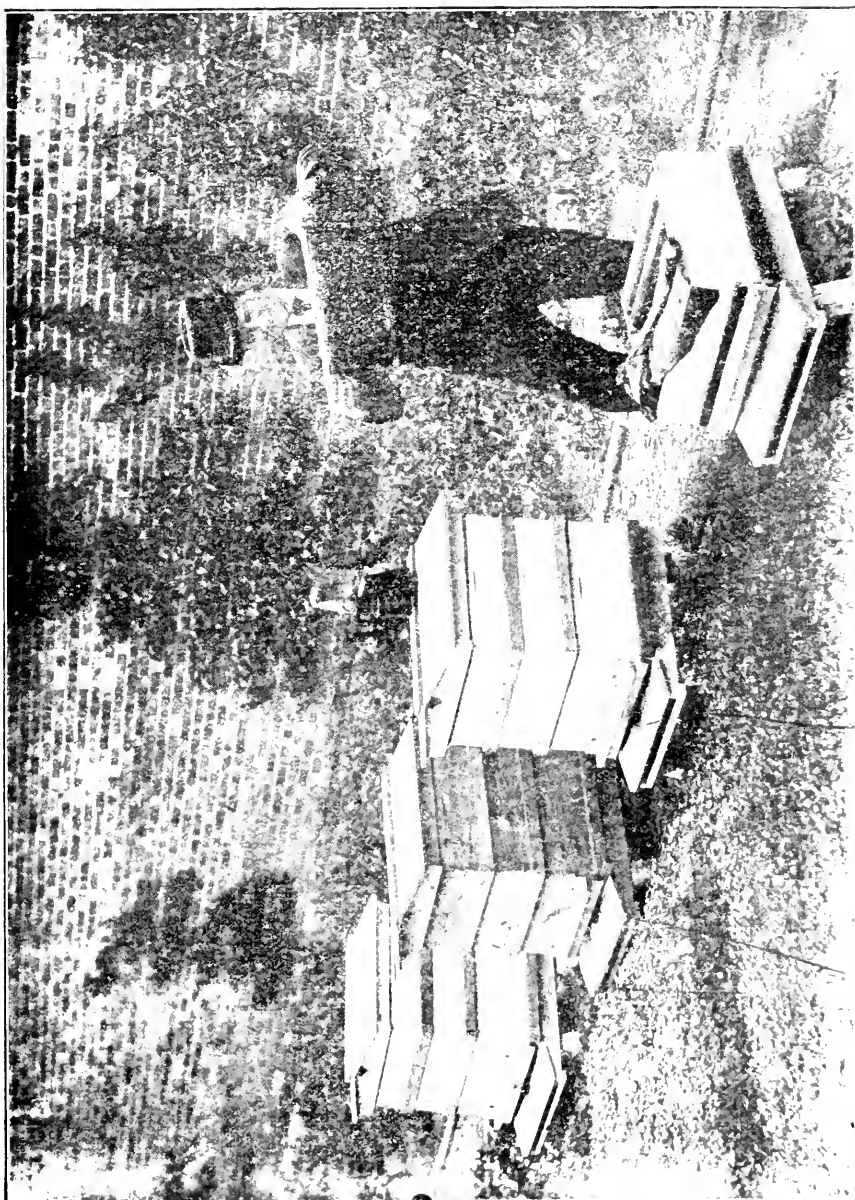

THE APIARY OF KING MANUEL OF PORTUGAL.

## Cotswold Notes.

### CYPRIAN BEES.

May I be permitted to make a few notes on this variety of bees indigenous to the Island of Cyprus, which have been collected from time to time as the result of personal management of Cyprian colonies?

Of Cyprian bees the Guide Book says: "As far as appearance goes, they are certainly the most handsome bees cultivated. They are extremely prolific, excellent honey gatherers, etc."

My first experience was in 1914, when I had two colonies—one headed by a pure queen, and the other by a Cyprian-Native cross.

That season was a good one for honey, and during the honey flow, both stocks being strong, filled up their outside combs with honey.

This, however, disappeared at a fast rate as soon as the flow came to a close.

Finally, having given no surplus and having no winter stores, both stocks had to be fed to carry them over the cold months.

This season, four more queens were imported early in the summer. Two were dead on arrival, but the remaining two queens were introduced to strong colonies of hybrid Italian bees. These queens appeared rather smaller than Italians, but very similar as regards colouring.

They laid continuously as long as the hybrid bees could bring in sufficient stores to maintain brood-raising; the brood being evenly placed over the entire comb space, and in the centre frames of comb reached the top and side bars, so that hardly any cells were available for honey.

The just hatched bees are quite golden, but smaller in size than young pure Italians. They darken off considerably on reaching maturity.

Several times during the season when a large percentage of Cyprian bees had become foragers, the colony was in danger of starvation, and continuous rapid feeding appeared to do little more than keep them breeding strongly.

As regards temper, this varies somewhat.

When smoked the bees make a peculiar hissing sound. They cling closely to their combs, and if open honey is available so that they can fill themselves their temper is not disagreeable.

Otherwise they sting savagely whenever a comb is moved.

In order to strengthen one colony I added 3 lbs. of driven bees in a manner which would have been quite successful with any other "common or garden" stocks.

A tremendous battle was in progress

during the night and almost every bee had been killed and thrown outside.

To sum up, I believe the summer climate is too cool, and the days during which bees may work too few for Cyprians to be profitable here, and their colouring is not pronounced enough to render them of much value to the bee-breeder who requires light stock for breeding purposes.

Whether the half-breeds produced by the union of Cyprian and Native or Italian drones would prove more productive from a honey-producing point of view I am at present not able to say.—

A. H. BOWEN, Cotswold Apiaries, Cheltenham.

## Notes on Bee-Keeping.

The duties of the mother bee, miscalled the queen, are of paramount importance in a hive, in fact she is the life; the success or non-success of the colony rests entirely upon her fertility or non-fertility. Each of the many thousands of workers or hundreds of drones owes its existence to this bee; she is the mother of the entire colony. Remove a mother bee from a hive, and the workers soon give evidence that there is something wrong within; although there is only one bee in a hive that has the power of reproduction, yet we sometimes find that when a hive has lost its queen, and is without the means of rearing another, one can see and hear of the worker bee or certain of the workers usurping the functions of the queen and commencing to lay eggs; but in every such case these eggs only produce drones; these bees are termed "fertile workers." Whether the drones thus produced are capable of mating is a moot point, and has yet to be satisfactorily determined. I am strongly of the opinion that they can not fertilise any young queen owing to the unnatural way they come into existence. The workers also have not been, and cannot be fertilised by the drone, as the organic structure differs from that of a young queen; thus, as stated, the eggs laid produce drones, as a consequence the stock, unless provided with a queen, will die out.

It is an easy matter to detect their presence in a hive upon examination. Although a hive may be queenless, eggs will be found in both worker and drone cells, but not laid in such a condition as with a fertile queen regularly in one large patch, but scattered about here and there, very rarely in close proximity, not more than four or five cells being used in one particular place. Even in cells occupied by eggs, they are not laid in a uniform manner, here an egg may be stuck on the side of a cell instead of its

natural position on the bottom; perhaps the next cell has four or five eggs in. The latter circumstance is sometimes observed where a prolific queen is in the hive and there are not sufficient bees to cover the number of eggs she is capable of laying. The eggs in this case will be found in both drone and worker cells at times when it is not natural for drone eggs to be laid. The drones produced from fertile workers are much smaller than drones from a fertile queen, no doubt on account of their cramped condition in so small a cradle as a worker cell. The best method of getting rid of these pests is to unite the colony to a strong stock having a fertile queen, the workers then will soon destroy any fertile worker present. Sometimes caging a fertile queen in the hive for two or three days will cause the destruction of fertile workers. It is the best policy never to allow any colony to become queenless without a means of rearing another queen, in which case fertile workers will become unknown. I see that one of your readers deprecates these notes as being stale, and that "it would interest many if people wrote more about condition of their bees." It becomes a difficult matter sometimes to discuss your bees during the dead season, when they are seldom seen out of doors. Perhaps it would "interest many" to know that these notes are not written for the "many," who are well versed in bee-keeping, but for the benefit of new beginners or would-be beginners. Judging from the many letters received from various quarters, these notes have not been written in vain. One bee-keeper may think that he is better serving the craft by giving the experience of his own bees, another by discussing bee-keeping in general. If all were sowers there would be no reapers.

Criticism is good providing it is given in the right spirit; and not like the spirit of the "Elder Brother" that we have seen given from time to time in these columns, and which is only harmful to the craft.—P. LYTCHOE, Padgate, Warrington, Lancs.

---

### Sermons in Stones.

It is the end of a very bad honey season, and the bees need a great deal of feeding if they are to winter well. Moreover, I cannot feed all my hives at once, because it means conveying syrup about a mile and a quarter, and I have a fair number of hives.

I can send up a hundredweight of syrup by the carrier in 28 lb. tins, and have done so once or twice, but as the

weather gets colder I find it more convenient to take a smaller quantity with me, and then I can give it to the bees warm. This means that I must feed fairly late in the evening, so as to run no risk of tempting the unfed to rob the fed.

My bee-farm is in a somewhat exposed place, and as I am not always at hand, especially in bad weather, I keep a brick on the top of every hive to be sure that the roof shall not be blown off during a gale.

I know that a more approved plan would be to drive in a stake by the side of each hive, and hang a brick to this with the rope going over the roof. In this case no moisture would collect under the brick, and no earwigs and other vermin would find shelter. But then my bricks would tell no tales on misty autumn evenings when I am racing the daylight to get all my syrup distributed. As it is, one glance at the rows of hives tells me where to feed.

My nuclei, I am sorry to say, have needed feeding practically all the summer, and these were the first this autumn to be, as Mr. Simmins would say, "fed solid." They were fed until they could take no more, and they told me so by leaving the syrup in the feeder. Then each was supplied with a good lump of candy and the brick on each hive was placed sloping up the left-hand side of the roof. These will only need the candy renewing occasionally.

Next the weaker stocks were fed "solid," and since they have more combs and more bees, and can therefore store more food, they will need no candy until the spring, and can be left undisturbed. Their brick lies on the topmost part of the roof, with its greatest length at right-angles to the front of the hive.

At present the strong stocks which are short of stores are taking their turn at the syrup, and their bricks slope upwards on the right-hand side of the roof. This is the position in which the brick and roof can be removed most quickly. And, lastly, I am glad to say, there are a few strong stocks which have sufficient stores to carry them through until candy-time next spring, and the bricks on the roofs of these lie on the top, but with the greatest length parallel to the hive front.

One thing which often strikes me as I read the *Journal* is the fact that many bee-keepers give some good plan which they have adopted, but have quite forgotten where they first heard of it, and have come to think of it as their own. A case in point is the "newspaper" method of uniting bees. I think that it adds greatly to the interest of the article if we quote the classics. We take a good thing from this writer and a good thing

from that, and gradually build up a system of bee-keeping which is best suited to our own circumstances, but let us try to keep in touch with our benefactors. At one time I had a number of hives which I named after the bee-masters whose various methods I was trying. There was the Doolittle hive for "shook swarming," the Simmins hive for "plumping," the Miller hive for nucleus formation, the Sladen hive for queen-rearing, and others. Now, my system is a Doolittle-Simmins-Miller-Sladen, etc., system!

But my "Sermons in Stones" plan belongs to none of these, but is given by E. R. Root in the "A.B.C. of Bee Culture" under "Record-Keeping of Hives." The sermons in this article are very much more complicated than mine, as slates are used instead of bricks, and on these slates records are kept throughout the year. I prefer to have my records all together in a book which I can carry home with me and study at my leisure, but Root's article will give many a useful hint, and, like all the rest of the book, is well worth careful study.—I. H. JACKSON, Warwick.

## A Bee-Keeper's Alphabet.

A is All the members of the British B.K.A.

B's the Bees—without them there is nothing more to say.

C, of course, is clover. How we welcome the first flower!

D's the Dutch bees. Once we glowed, but now we glow.

E must be the Editors, whom we greet one and all.

F's the Frame: and, may I ask, "Do you use large or small?"

G's the Goldenrod we look for when the summer flowers are by.

And our Hopes of Honey dwindle and our sugar bill is High!

I is (speak it low) the Isle of Wight—that dread disease;

In the JOURNAL, though, some writers say they cope with it with ease!

K's for Kettle. Every Thursday how to read his yarns we run!

L's for Limes. I've planted fifty; but their blossoms cloud the sun.

M's for Mice. Look out in winter! Keep your combs well wrapped away.

N's the Nucleus, but the weather often spoils the mating day.

O is Onions. Shades of Butler! "Let not breath of garlic smell."

P is Packing in the Winter. Is it bad or is it well?

Q's the Queen, and on Her Highness hangs our hope and hangs our fear;

So Research! we look to thee, and to our breeders far and near.

S, the Swarm, which once we longed for, but now makes our Soul to mourn,

Or it might be Sting, except that these we view with lofty scorn!

T is "Telling." Yes, we'll "tell" them. There are things we do not know;

Understanding comes but slowly, and in safety we would go!

V's the View we take of labour. Shall we work for fame or pelf?

But the Worker bee shall teach us—"Each for all and none for self,"

X must stand for our 'Xcitement when we read of perfect cures.

Y is Yadil ousting Izal, H. perox., which hives insures.

Z the Zuzz, Zuzz, Zuzz, which tells us by its note what our pets need.

May the Zuzzers live for ever, and their keepers have God-speed!

—I. H. JACKSON, Warwick.

## British Bee-Keepers' Association.

CONVERSAZIONE, OCTOBER 21, 1920.

The conversazione was a most successful one, nearly 200 persons being present. A goodly number turned up for the reception between 2 and 3 o'clock, and had the pleasure of meeting the veteran chairman of the Association, Mr. T. W. Cowan, who was remarkably well and fit, despite advancing years and the long journey. A number of well-known bee-keepers were present, and a pleasant hour was spent. At 3 p.m. Mr. Cowan took the chair, and called on Mr. G. Bryden to give his impressions of bee-keeping in Italy during a short tour in that country during the summer, which he did, as follows:—

EXPERIENCES IN ITALIAN BEE-KEEPING.

Mr. Chairman, Ladies and Gentlemen,—

I thank you for your very kind reception, and trust that these few remarks on Italian bee-keeping will be some compensation for your kindness. My experiences were gathered from the different apiarists when on a visit to Northern and Southern Italy, where I went with our friend Mr. W. Herrod-Hempsall, whose previous experience in that country was of very great assistance, though not sufficient to prevent us from being put under arms and guarded like murderers on one of the frontiers—an experience I am not likely to forget for a considerable time.

You are all aware of the time which has been allowed for my paper and remarks. I consider it much too short, but the Council thought it would give the audi-



ence more time to get out of me what they want exactly, and I expect you will hear me calling on our chairman for protection before I am finished.

I have no intention of taking up your time with our voyage, or the time which we spent in the large cities and their surroundings, as they may not be of very great interest to this meeting, although well worth a visit by anyone who likes travel and sight-seeing.

Paris was our first night out—and we were bachelors *gay* at once in gay *Parce*—but my prime intention was to pay a visit to L'Apiculture, which we did the next day. It was situated in the centre of a mound of trees and contained about twenty hives, all of different shapes and sizes, with the entrances to be seen at both back and front, top and sides. The bees also were of an experimental mixture as well as the hives. I have seen one or two apiaries in this country quite as bad, but none worse, so we put off little time there in search of knowledge—though I am informed that the French are of a very scientific nature, at a table conference. However, I hope to see a little more of the French apiaries shortly, and should I have the honour of again appearing before you I may be better instructed to deal with them and their methods.

The next apiary of importance which we visited by appointment was that of Signor Enrico Bozzalla, of Crevacuore. Nothing was left undone which could add to our comfort and knowledge of bee-keeping. Apiary after apiary was thrown open for our inspection.

He is a man full of youth and buoyancy, with a keen eye to business, carrying on large woollen and paper factories, growing his own timber for the manufacture of paper, the Acacia being one of his favourite trees, as it provides both pollen and nectar in abundance for his bees, and pulp for his paper mills. It is very prolific in its growth, and yields nectar after the third year. He did with pride point to some of these trees which he planted forty and fifty years ago.

No time was lost in getting to work, and we first went through hive and appliance factory, where we found them busy making queen cages, nucleus hives, frames, etc. The wiring of the frames puzzled them very much, but that was soon overcome by Mr. Herrod-Hempsall showing them his practical method of wiring. After that we were joined by his expert, Angelo Zanini, his two assistants, and an interpreter of great ability, Clerici Gustavo, and then went to the home and export apiary where I first caught sight of Italian bee-keeping.

Words fail to express how I felt at the first sight of those beautiful mountain insects. There are about 400 stocks and nuclei in this apiary, and we were soon at work in the fine sunshine. At once Signor Zanini proved himself master of the bees. During the examination of stocks or nuclei no veils—or protectors, as they are called there—or smoke were used by anyone, and seldom were we stung. On opening the first stock hive, I was amazed to find that no quilts were used as coverings. "Regina" was soon found and examined, also the combs, which were full of brood and honey. Here he found the large moth on the face of the brood, just under the capping, but I failed to detect this enemy in her devastations as only by practical experience can one discover where she is in hiding.

Drone breeding was very extensively carried on here for mating the virgin queens in the nuclei, which were brought in from the out-apiaries.

(To be continued.)

---

### Glasgow and District Bee-Keepers' Association.

The first of a series of winter lectures on bees and bee-keeping was held in the Royal Institute, West Regent Street, Glasgow, on Friday, 15th instant, the President, Alec Steven, Esq., E.B., S.B.A., presiding.

There was a large gathering of members and friends to meet the following gentlemen:—

John Anderson, Esq., M.A., B.Sc., E.B., S.B.A.

J. H. Langlands, Esq., E.B., S.B.A., President.

J. W. Moir, Esq., E.B., S.B.A., Treasurer.

Mr. Langlands gave an interesting address on "Hives and Appliances," illustrating his remarks with some very clever pieces of apparatus of his own design.

Mr. Anderson paid particular attention to the "Survival of the Fittest," which, as he explained, was specially applicable to bees in relation to disease.

Mr. Moir followed with some of his own "Bee-Keeping Experiences," which were very entertaining.

A vote of thanks was heartily accorded the lecturers.

The first of the monthly Bee Talks which are being arranged will take place on Friday, 29th instant, at the President's house. Due notice will be given.

A Social Evening (Whist Drive) will be held on Friday, November 12, at "Reid's" Tea Rooms, Glasgow.—PETER BEBBINGTON, Hon. Secretary.

### Salisbury and District Bee-keepers' Association.

Mr. J. J. Kettle is to give an address to bee-keepers at Church House, Crane Street, Salisbury, at 7 p.m., on Wednesday, November 3. Subject: "Profitable Bee-keeping on a Fruit and Flower Farm." Readers of Mr. Kettle's yarns will know he is well qualified to deal with his subject, and a pleasant and profitable evening may be anticipated.



*The Editors do not hold themselves responsible for the opinions expressed by correspondents. No notice will be taken of anonymous communications, and correspondents are requested to write on one side of the paper only and give their real name and addresses, not necessarily for publication, but as a guarantee of good faith. Illustrations should be drawn on separate pieces of paper. We do not undertake to return rejected communications.*

### Queen and Drones.

[10325] Whilst in the hay-field on July 8, about 3:30 p.m., I heard a loud buzzing, and a large cluster of bees dropped at my feet. Being a bee-keeper, I stooped down to look at them, and found they were drones. On examining them I discovered a young queen in their midst. I picked her up and confined her in a matchbox. Having a queenless stock on hand, I put her in a cage and introduced her. On examining the hive later I found it full of young bees (Italians).

Have any of your readers ever heard of such a curious incident?—H. WRIGHT.

### Queenless Bees Storing Honey.

[10326] In reference to Mr. A. Lewis's contribution [10320] and your invitation for other bee-keepers' experience on the above subject, it reminds me of the late Mr. Broughton-Carr's words: "Bees do nothing invariably."

I have been a bee-keeper 40 years, and have had experience on two occasions of queenless bees working well, but generally they are listless and hopeless.

Three years ago a friend of mine went away for his holiday in July, and asked me to look after his bees in his absence, and I did so, but one Saturday afternoon he had to come home for something and found that one stock had swarmed; he had no time to spare, as he must go back by the next train, so he called at my house and said there was a swarm, and

as he had nothing ready I could have them for fetching.

I was away at an allotment where I keep five stocks, not having sufficient space at home, and my wife sent me word—it was nearly 7 p.m.—but I went home, got a skep, veil, a cheese-cloth and some string, and went to my friend's garden where I found the swarm in a damson tree. I borrowed a ladder and fixed it as near as I could, but disturbed the bees a little; and as the tree was not very rigid some got on the wing, but I got perhaps three-fourths of them, and as it was getting late I covered them up at once with the cheese-cloth and came down, tied them up, and left a portion behind. Of course, I ought to have let them settle, gone up again and got the remainder, and let them remain until the next day, but being rather late on Saturday evening I wanted to finish with them, and I took them to a frame-hive on my allotment and put them on five sheets of foundation and one built-out comb. In a week I examined them, and found the combs beautifully built out, but there was no brood or eggs to be seen.

I concluded they might have a virgin queen, so left them another week, by which time the combs were filled up with honey, some of them good enough for show, but no brood. During the following week I tried to get a queen, and heard of a friend having a cast; but as it was the end of July, I told him they would do him no good, and would have to be fed up, and he sold them to me. I united them by placing his bees on three combs in a small hive, close by my swarm, and in a few days they were united, and there was soon plenty of brood. The next year they filled two racks of sections.

Another case in my experience occurred a number of years ago.

I was much pleased to see Mr. Lewis's confirmation of the (to me) wonderful "Yarns" from Mr. Kettle, whose experience must be so different to mine. Here in Staffordshire bees sometimes get a little honey from gooseberry blossom or from garden flowers, but it is so insignificant that to talk of putting supers on seemed very strange. Bees seldom store honey here until hot weather comes in May or June, and then only a little at the top of the combs, when supers may be put on if swarms are not wanted. Occasionally we get a little "honey flow" from fruit blossom or the hawthorn, but only on the average about once in eight or ten years. The clover and limes in a good year yield well for 12 or 14 days, but more often about a week in my locality—this year the limes yielded four days, clover not at all. It is then time to extract, and

I am always glad if the bees can store sufficient or nearly so in the brood nest for winter. I have taken as much as 70 lbs. from good hives in a favourable season, but am always satisfied with an average of about 30 lbs. per hive.

This year I had but very little, and have had to feed up pretty extensively.

I am hoping for a good season next year.—THOS. HARPER, Uttoxeter.

### Poppy and Other Bees.

[10327] The "*Poppy bee*" belongs to the leaf cutters, genus *Megachile*, Latreille. "*Carding bee*" to the genus *Bombus*, those who plait filaments of moss, etc., to form their nests.

*Orange-tailed Bee*.—The large black species, with orange tail, is *Bombus lapidarius*, *derbarnellus*, or *Pesithyrus rupestris*; the last-named is parasitic upon the former. A carnivorous bee that bores with its "teeth" is not known to modern scientists.—M. E. BOTT.

[10328] In reply to "W.'s" inquiries (p. 485) *re* poppy bee, carding bee, and orange-tailed bee, I presume the second-named is *Bombus agrarius*, the carder bee, so named because of the way in which it weaves or cards the moss of which its nest is lined. As the population grows, the nest is enlarged, the bees forming a chain from the entrance to the growing moss, passing the pellets backward to be mixed with wax, or rather, pseudo wax, to withstand the weather. The orange-tailed bee is possibly *Apathus rupestris*; as its name indicates, it is without affection for its progeny, it never rears its own young, but deposits its eggs in the nest of *Bombus lapidarius*, of which it is a parasite. Almost immediately after impregnation the young queens retire into the nest of *B. lapidarius* to hibernate. The male and female are of similar colour, the drone being the brighter of the two. The queen is much larger, and the three last segments of both are orange-coloured. The poppy bee I have no knowledge of by that name.

In "Notes on Bees," p. 496, your correspondent remarks that it is curious that bees confine themselves to one variety of flower when gathering a load of pollen. If grains of pollen from different flowers are examined under the microscope, they will be found to be of different shape, density and structure, and if gathered indiscriminately by the bee, would not knead compactly together for safe carriage in the corbiculae. There are no special cells in the comb, as suggested by your correspondent, as may be seen if a cell of

pollen is cut open, the different layers being pressed down and of many colours, the necessity for distinction, as above, not arising.—G. BARRATT.



### Amount of Candy for a Foodless Colony.

[9911] I have been asked several times exactly how much candy or syrup it is necessary to give to a foodless stock to ensure safe wintering?

For example, a friend of mine has bought driven bees and hived two lots in one hive on drawn-out comb, *no stores*, it is too late for syrup, and he wishes to know how many cakes of candy would carry them through?

I have suggested in case of syrup not less than 20 lbs. sugar making about 32 lbs. by weight of syrup, and not less than 24 lbs. candy, and I should like to know if you think this correct?

Of course it is not proposed to put 24 lbs. candy on top of hive, but to put two pounds at a time and add more when exhausted; the bees, of course, take the candy down and store it, and the driven lot have got through 4 lbs. this week already, doubtless stored. GEO. M. ROSLING.

REPLY.—The amount you have suggested is correct. At the rate the bees are taking the candy down they are, as you say, converting it into a liquid form and storing it in the comb.

### Bee Shows to Come.

November 18.—Annual Show of the Worcester City and County Chrysanthemum, Fruit, Root and Honey Society. Thirteen Open Classes in Honey Section.—Schedules from Geo. Richings, 42, Barbourne Road, Worcester. Entries close November 6.

The products of the Apiary, of Poultry and Farm Stock, of the Fruit and Vegetable Garden can be Advertised and Sold through

THE  
**BAZAAR, EXCHANGE & MART**

*Newspaper.*

Get a Copy—Thursday and Saturday 3d. The "Bazaar" publishes also practical handbooks by experts. Send for full catalogue, post free from—**WINDSOR HOUSE, Breems Buildings, LONDON, E.C.2.**

## Special Prepaid Advertisements. One Penny per Word.

Will advertisers please read these Rules carefully in order to save trouble, as they will be strictly adhered to.

Trade advertisements of Bees, Honey, Queens, and Bee goods are not permissible at above rate, but will be inserted at 1½d. per word as "Business" Announcements, immediately under the Private Advertisements. Advertisements of Hive-manufacturers can only be inserted at a minimum charge of 3s. per  $\frac{1}{4}$  in., or 5s. per inch.

PRIVATE ADVERTISEMENTS are only intended for readers having Surplus Stock to dispose of. Driven Bees, Nuclei, and Queens that are reared or imported for sale, are Trade Advertisements, and can only be accepted under trade terms. A charge of 6d. extra will be made if a box number is used.

Advertisements must reach us NOT LATER than FIRST POST on MONDAY MORNING for insertion in the "Journal" the same week.

Orders for three or more consecutive insertions in "The Bee Journal" entitle advertisers to one insertion in "The Bee-Keepers' Record" free of charge.

### PRIVATE ADVERTISEMENTS.

**R**ROOTS' AUTOMATIC EXTRACTOR, will extract both sides four shallow frames in one operation. Particulars, stamp. What offers?—BOLES, Heathfield, Holsworthy, Devon. j.35

**I**RONMONGER'S ASSISTANT (27), Apis Club member, 9½ years' ironmongery (agricultural, general, etc.) and bee-keeping experience, seeks situation with ironmonger doing bee appliance trade; undertake management bee department if desired.—Box 105, BRITISH BEE JOURNAL Office, 23, Bedford Street, Strand, W.C.2. j.34

**S**TRONG PLANTS.—20 Forget-me-Nots, 40 Limnanthes, 1s. 6d.—LITMAN, Castle Cary. j.35

**S**TRONG and well-made Garden Baskets, 3s. 6d., 4s. 6d., 5s. 6d.; post 9d.—LITMAN, Basket Maker, Castle Cary. j.36

**I**F YOU INTEND to launch out next season you may need an Assistant. Ex-Officer, who since demob. has taken intensive course of apiculture with view to starting professionally, needs employment to gain further experience; has thorough grounding, including commercial queen rearing, handy with any tool, knowledge I.C. engines. Do anything.—Box 106, BRITISH BEE JOURNAL, 23, Bedford Street, Strand, W.C.2. j.38

**H**ONEY TINS.—Six round 28 lbs., three square 28 lbs., one round 14 lb. What offers?—HASTINGS, 28, Dovey Road, Moseley, Birmingham. j.40

3 CWT. pure Heather Honey. Offers invited.—W. 4 WOODS, Normandy, near Guildford. j.44

**E**XTRACTOR, geared, good condition, £2; also Hive, used one season, 25s.—Full particulars, CONISBEE, Markyate, Dunstable. j.43

**B**ROTHER BEE-KEEPERS with spare time wishing to commence in the Retail Fish Business write J. W. ELVIDGE, Wholesale Fish Merchant, Grimsby. r.h.239

**B**EES, HIVES, ETC., for Sale. Send stamp for list.—JAMES GLADDING, London Road, Copdock, Ipswich. r.j.14

**P**URE LIGHT CAMBRIDGE HONEY (guaranteed), 14-lb. tins, 30s.; 28-lb. tins, 57s. 6d., carriage paid.—YOUNG, 42, James Street, Cambridge. r.j.17

**B**EESWAX, pure, for Sale, 5 cwt., packed in ½-cwt. bags, £8 16s. per cwt. net, f.o.r. London.—Apply, Box 104, B.B.J. Office, 23, Bedford Street, Strand, W.C.2. r.j.20

### BUSINESS ADVERTISEMENTS. 1½d. per word.

**R.** LITMAN having purchased one of the Somerset set Re-stocking Apiaries, can book strong Nuclei for delivery May and June, 1921. All Stocks headed by imported or home-reared from proved prolific queens, Piana, Penna, and Bozzalla strains. Doolittle and Sladen's methods employed rearing. Delivery in strict rotation, with tested or untested Queens as desired. Avoid disappointment. Book now. £1 with order, balance when ready.—Castle Cary, Somerset. j.37

**N**O SUGAR VOUCHERS NEEDED.—Flavine Candy, made in Cambridge, and the wrappers bear our name, 6 lbs., 11s. 3d., postage paid; larger quantities, 1s. 6d. per lb., carriage extra; sample 1s. 6d., post paid.—S. H. SMITH, 30, Maid's Causeway, Cambridge.

**B**EAUTIFUL CANDY, 6 lbs., 10s. 6d., delivered.—BOWEN, Coronation, Cheltenham. j.39

**M**ASHEATH MEMS.—"The Baby Masheath has been most useful.—Rev. A. L. W."—ATKINSON, Fakenham. j.41

**A** WELL-ESTABLISHED FIRM wishes to hear of bee-keepers who would guarantee to supply them with Nuclei May-June next.—Box 107, B.B.J. Office, 23, Bedford Street, Strand, W.C.2. j.42

**H**AVE YOU READ "THE BEE WORLD"? If not, why not? Every number in itself is a useful literary work for practice and reference. Specimen copy free.—Offices: THE APIS CLUB, Port Hill House, Benson, Oxon.

**A**USTRALIAN HONEY FOR FEEDING BEES.—Cases containing two tins, about 60 lbs. each, 110s. per case; 1 tin 56s., carriage paid 100 miles. Remittances with orders.—SOUTHWOOD, 95, Acton Vale, London. r.h.190

**"W**IGHT" DISEASE.—Prevention and removal. Advice 5s.—ALF. RYALL, Cottage Farm, near Camp, Stroud. j.5

**S**URPLUS HIVES and Appliances for Sale, good condition, cheap.—PEARSON & GALE, Marlborough. rh.131

## Finest Grade New Zealand Honey (Amber)

For Bee Feeding. Guaranteed Pure.

Cases, each 2-60lb. nominal Tins. 95/- per cwt. Carriage paid.

Cash with order or on receipt of goods.

N.B. We are already supplying Beekeepers' Associations throughout the Country and shall be pleased to quote references.

The Bristol and Dominions Producers' Association, Ltd., Bristol.

## THE British Bee-Keepers' Association.

The recognised centre of practical and scientific bee-keeping in Great Britain. Particulars and conditions of membership may be obtained from the Secretary, W. HERROD-HEMPSELL, 23, Bedford Street, Strand, London, W.C.2.

## BARGAINS IN SURPLUS CLOTHING.

FOR 14 DAYS ONLY TO CLEAR.

Best quality new full size Fawn Australian Blankets, **42/-** pair.  
 Best quality new full size Grey Australian Blankets, **35/-** pair.  
 Best quality Officers' Bedford Cord Riding Breeches, **42/-** pair.  
 Best quality Officers' Cord Riding Breeches, strapped, **25/-** pair.  
 Good quality Cord Riding Breeches, **10/6** pair.  
 Dark Heavy Tweed Overcoats, suitable farmers, etc., **25/-** each.  
 Best quality new Army Puttees, **4/6** pair.  
 Good Blue Serge Trousers, suitable for working men, **12/6** pair.  
 Good Blue Serge Trousers, as new, **15/-** pair.  
 New Blue Serge Trousers, best quality obtainable, **21/-** pair.  
 Khaki Drill Trousers, as new, all sizes, **7/6** pair.

Khaki Drill Jackets, as new, all sizes, **7/6** each.  
 Khaki Drill Jackets, Officers' quality, **10/6** each.  
 Khaki Drill Trousers, Officers' quality, **10/6** pair.  
 Cardigan Jackets, as new, **8/6** each.  
 Bath or Carriage Sponge, large size, to clear, **1/6** each.  
 New Holeproof Trousers, everlasting wear, **18/6** pair.  
 New Blue Trousers, all sizes, **16/6** pair.  
 New Officers' Poplin Soft Collare, **4/-** dozen.  
 New Officers' Khaki Collars, **4/6** dozen.  
 New Striped Union Shirts, best quality, **8/6** each.  
 New Indigo Blue Serge Ladies' Skirts, **15/6** each.  
 As new Indigo Blue Serge Ladies' Skirts, **8/6** each.

THOUSANDS OF OTHER BARGAINS. SEND FOR LISTS FREE.

**SACAR'S ARMY SURPLUS STORE** (Dept. 29), ARDWICK, MANCHESTER.

## 8/- Of the Author, S. SIMMINS, QUEENLAND, HEATHFIELD, SUSSEX. SIMMINS "A MODERN BEE FARM"

POST FREE

Nearly 500 pages. A few more copies at 8/-. Any further edition must cost 50% more

**Bees and Beekeeping Appliances. Catalogue free.**  
**EDWARD J. BURTT. MANUFACTURER. GLOUCESTER.**

*I very much regret that there has been a large increase in the cost of the manufacture of bee-appliances, and therefore my prices will be advanced 10% from May 10th. Books excepted.*



## "BACTEROL" FOR BEES

2/9 per Bottle.

Post Free.

The cure for, and preventive of, "Isle of Wight" Disease. Non-poisonous—free from stain or unpleasant odour.

BACTEROL LIMITED  
 19/25, Brookside Rd., Highgate, N.19.

## POSITIVE FACTS.

June 13th, 1920.

I am very pleased with the foundation. The bees undoubtedly prefer it to any other make I have, and have even gone the length of missing two sheets of other new foundation, and working out a sheet of yours placed behind them at the back of the hive. Full sheets have not sagged in the least in 16 x 10 frames.

Yours faithfully, R. B. MANLEY.

*Illustrated Lists free by post.*

**S. J. BALDWIN, The Apiary, BROMLEY, Kent.**

# Bee-keeping Simplified

FOR THE COTTAGER AND SMALLHOLDER,

By **W. HERROD-HEMPSALL, F.E.S.,**

Author of "Producing, Preparing, Exhibiting and Judging Bee Produce."

Price 1s. net. Post Free 1/1½

THE BRITISH BEE JOURNAL OFFICE, 23, Bedford St., Strand, London, W.C

## FOUR FIRST PRIZES.

Our HIVES and APPLIANCES were again awarded FOUR PRIZES at the Highland Agricultural Society's Show at Aberdeen, thus testifying to the superiority of our goods. Order now and ensure your bees wintering in good hives.

**BOTTLES.** We hold a large stock and can give immediate despatch.

**CANDY.** Safeguard your bees from starvation by feeding with our FAMOUS BEE CANDY. Price **1/6** per 1-lb., carriage extra.

Sole Agents for DADANT'S WEED FOUNDATION. Absolutely pure. Once used, always used.

Large illustrated catalogue, entitled, "Everything for an Apiary," post free on application.

**R. STEELE & BRODIE,**  
*Bee Appliance Makers,*  
**WORMIT, FIFE.**

Telegrams:—"Bees, Wormit."

Telephone:—28 Wormit.

## BEE CANDY.

**W**E are now able to supply CANDY OF OUR OWN MAKE from guaranteed Pure White Refined Cane Sugar. In 1-lb. boxes with glass tops. It can be had plain or medicated with either "Yadil" or "Bacterol."

### PRICES.

7lb.	11/-, postage 1/3
14lb.	21/6, postage 2/6
28lb.	42/-, postage 5/-
112lb.	£8 8s., packed free, carriage forward.

BEE FOOD SUGAR VOUCHERS REQUIRED.

**JAMES LEE & SON, Ltd., Uxbridge, Middlesex.**



No. 2002. Vol. XLVIII

NOVEMBER 4, 1920.

[Published every Thursday, Price 2d.]

**CONTENTS.**

	PAGE		PAGE
OBITUARY NOTICE .....	529	BRITISH BEE-KEEPERS' ASSOCIATION .....	536
THE CAUSE OF "ISLE OF WIGHT" DISEASE .....	531	CORRESPONDENCE—	
A DORSET YARN .....	533	" I.O.W.," and Other Diseases .....	537
JOTTINGS FROM HUNTINGDONSHIRE .....	533	Plants for Bees .....	538
COTSWOLD NOTES .....	534	An Appreciation from Scotland .....	538
QUEENS ON STRIKE .....	535	Re Hives .....	538
ECHOES FROM THE HIVES .....	536	QUERIES AND REPLIES—	
		Missing Queen .....	539

OWING to the FALL in the COST OF SUGAR  
WE ARE IN A POSITION TO SUPPLY

**PINK (MEDICATED OR PLAIN)**

# SOFT CANDY

Made from Guaranteed Pure Cane Sugar.

**NO VOUCHERS REQUIRED.**

1/5 per lb. (7lb. parcel post free, 11/-)  
(10lb. do. do. 15/6)

**E. H. TAYLOR, LTD., WELWYN, HERTS.**

## THE British Bee Journal

Office: 23, Bedford Street, Strand, London, W.C.2.  
ESTABLISHED 1873.

A Weekly Journal Devoted to the  
Interests of Bee-keepers.

Edited by T. W. COWAN, F.L.S., &c.,  
and J. HERROD-HEMPSELL, F.E.S.

**Correspondence: Whom to Address.**—All matters relating to the Literary Department, Associations, Shows, etc., should be addressed, "Editors, *British Bee Journal*," and all business communications and matters relating to subscriptions and advertisements to be addressed to the "Manager," *B.B.J.* Office.

**Subscriptions.**—Annual Subscription, 10s. 10d. post free in advance; single copies 2d., or 2½d. post free. If a receipt is required by post, a stamped and addressed envelope must be sent, otherwise a printed receipt will be enclosed along with the paper.

*Note.*—Cheques and Postal Orders should always be crossed, otherwise it is very difficult to trace them if they go astray.

**How to send Money.**—Remittances can be made payable to W. Herrod-Hempshall by crossed Cheques and Postal Orders. Stamps may be sent for small amounts up to 2s.

*Halfpenny stamps are preferred.*

Scottish or Irish cheques can only be taken in payment if 6d. is added for commission charged by banks for cashing them.

The Editors are not directly or indirectly interested in the manufacture or sale of beehives or appliances of any kind, and must refer correspondents wishing for prices or catalogues to advertisers in the paper.

## OUR DEPOSIT SYSTEM.

You are advised to insist on this being used when dealing with strangers.

### Rules and Conditions for Depositing

*In order to save trouble, it is requested that the Rules be carefully read over by persons using the Deposit System of trading.*

Goods should not be despatched until notice that the money has been deposited is received from this office.

**1. Method.**—When strangers are dealing together, the purchase-money of the articles is deposited at our office. We acknowledge receipt of the deposit to both parties, and hold the money until we are satisfied that the purchase is concluded. If a sale be effected, we remit to the seller the amount deposited, less a charge of 2½ per cent. in the £, with a minimum of 6d., and the expenses of Post Office Orders and postage, &c. Cash will be forwarded by Cheque, Post Office Order, or by Postal Order as preferred. If a sale or exchange be not completed, we return the amount deposited, after making the same deduction. By this means buyers and sellers are secured against fraud.

**2. Deposits.**—Postal Orders (drawn on General Post Office) and Cheques must be made payable to W. Herrod-Hempshall, and crossed "London County and Westminster Bank." The numbers of the Postal Orders should be kept by the sender.

We cannot be responsible for any loss that may occur in transit.

**3. Honey on Approval.**—All honey will be sold by sample, which must be sent direct to buyer.

**4. Bee Appliances.**—In ordering, the time allowed for completing the order to be stated to us when sending cash. If maker accepts, we hold cash until transaction is satisfactorily completed, when the amount will be remitted, subject to conditions as in Clause 1.

**5. Bees and Queens.**—These will be dealt with entirely by the parties concerned, so far as price, &c., go, and when the purchase is satisfactorily completed cash will be remitted as per Clause 1.

**6. Goods in Transit.**—These are at the seller's risk, i.e., any damage to or loss of an article on its journey is borne by the vendor; but a rejected article must be properly packed and returned by the same means as was used in sending it.

**7. Carriage.**—The carriage of all goods, *except such as are sent by post*, is payable by the buyer, unless otherwise agreed. If any article sent on approval be returned, each party to the transaction must pay carriage one way.

## Books for Bee-keepers NOW IN STOCK.

Cash in full must be sent with order.

	Postage
A Modern Bee Farm ... ..	7/6 ... 8½d.
(To be obtained from this Office only)	
Advanced Bee Culture (HUTCHINSON) ... ..	6/- ... 6½d.
Beginner's Bee Book (PELLET) BEE-KEEPING SIMPLIFIED FOR THE COTTAGER AND SMALLHOLDER (W. HERROD- HEMPSELL, F.E.S.) ... ..	5/- ... 4d.
BRITISH BEE - KEEPERS' GUIDE BOOK (T. W. COWAN) Paper covers ... ..	1/- ... 2d.
Cloth covers ... ..	2/6 ... 3d.
Dissectible Model of Queen Bee ... ..	3/6 ... 4d.
4/6 ... 3d.	
FERTILISATION OF FRUIT BLOSSOMS BY BEES (T. W. COWAN) ... ..	4/6 ... 3d.
Honey and Health (A. HORS) ...	-/3 ... 1d.
Honey Vinegar (REV. G. BANKS) ...	-/6 ... 1d.
How to Keep Bees (ANNA B. COMSTOCK) ... ..	-/2 ... 1d.
Prevention of Swarming (WILKES) ... ..	5/- ... 4½d.
1/- ... 1d.	
Pollination of Fruit in relation to Commercial Fruit Growing (C. H. HOOPES, F.E.H.S.)	1/- ... 1d.
-/6 ... 1d.	
PRODUCING, PREPARING, EXHIBITING AND JUDG- ING BEE PRODUCE (W. HERROD-HEMPSELL, F.E.S.) ... ..	2/- ... 3d.
Queen Rearing in England (F. W. L. SLADEN) ... ..	1/6 ... 2d.
Scientific Queen Rearing (DOOLITTLE) ... ..	1/6 ... 2d.
4/- ... 3½d.	
Snelgrove's Method of Re- queening ... ..	4/- ... 3½d.
-/6 ... 1d.	
The "Townsend" Bee Book ... ..	2/6 ... 3d.
WAX CRAFT (T. W. COWAN) ...	2/- ... 2½d.
Wilke's Book on Swarming ...	1/- ... 1½d.

### MISCELLANEOUS.

The Lore of the Honey Bee (TICKNER EDWARDS) ... ..	2/- ... 3d.
Life of the Bee (MAETERLINCK) ...	5/- ... 4d.
THE BEE WORLD (supplied only to members of Associations interested in the control and development of the APIS CLUB, apart from ordinary members of the latter), per copy ... ..	-/8 ... 1½d.
The Bee Master of Warriflow (TICKNER EDWARDS) ... ..	7/6 ... 4½d.

British Bee Journal & Record Office,  
23, BEDFORD STREET, STRAND LONDON, W.C.2.



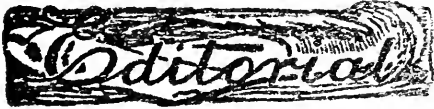

## Obituary Notice.

THE LATE DR. C. C. MILLER.

It was with sincere sorrow that we received the sad news of the death of this veteran bee-keeper at the ripe age of 89 years.

over and above his current expenses, his boarding at times not exceeding 35 cents a week. After teaching for a short time Dr. Miller studied medicine, graduating from the University of Michigan, and taking his M.D. degree at the age of twenty-five. After settling down to practice, he says, "It did not take more than a year for me to find out that I had not sufficient health myself to take care of that of others," so, with much regret, he gave up his profession.

In 1857 he married Mrs. H. M. White,



THE LATE DR. C. C. MILLER, OF MARENGO, U.S.A.

Dr. Miller was born on June 10, 1831, at Ligonier, Pennsylvania, lost his father at the age of ten years, and by working in a store for two years he obtained enough to enable him to go to the village school, and by teaching supported himself before graduation at Union College, Schenectady, New York, at the age of 22. He then supported himself by doing any sort of work, and was able to graduate with a surplus of some \$70

and spent some years in teaching vocal and instrumental music, and was for several years Principal of the Marengo public school. Dr. Miller had a natural talent for music, and his musical compositions were simple and delightful, and we were much charmed with his playing and singing when we visited him at Marengo. He spent about a year as music agent, and helped to get up the first Cincinnati Musical Festival in 1873.

The three following years he worked for the Mason & Hamlin Organ Co. in Chicago, but his love of the country induced him to give up his work and take charge of a school at Marengo at a salary of \$1,200 a year.

His wife died in the spring of 1880, and in the fall of 1881 he married Miss S. J. Wilson, whose sister, Miss Emma W. Wilson, has assisted him with his bees ever since. His first commencement with bees was in 1861, and we cannot do better than give in his own words what he wrote to us in 1909 about his experience. He said:—

“When I was a little chap I found a bumble-bees' nest, from which small beginning a large and flourishing apiary never grew. Indeed, it was not till I was thirty years old that I undertook again to do anything in the way of management of bees. At that time my wife captured a runaway swarm, and hived it in a sugar-barrel. With not the slightest thought of ever becoming a practical bee-keeper, I became quite interested in the little creatures. The first number of a bee-journal ever published on the continent, the *American Bee Journal*, appeared at the beginning of that year, 1861, but it never occurred to me to inquire whether such a thing was in existence. I did, however, get hold of Quinby's book in the course of time, and made hives after the instructions there given. They were box-hives, for at that time the book had nothing to say about movable combs.

“Of course, the bees were blacks. Five years later I got my first Italian queen. Whatever may be the case in England, there was such a marked difference between the work of the blacks and the Italians that for a number of years I made the effort to weed out all black blood. But that is not an easy thing and there has never been a time when I had none but pure Italians. Indeed, for some years I gave up trying to keep pure yellow blood, and bred from the colonies that gave me the biggest yields, whatever the colour; and the best yielders generally had more or less black blood in them. As a result, I now have bees that are hustlers, and I feel sure that under the same conditions they will store more honey than any bees I formerly had, either yellow or black. Alas, that by the side of every rose there is likely to be a thorn! Along with the hustling disposition there has been developed a temper that makes the bees veritable little demons to sting. If I had it to do over again, I would stick to pure Italian blood in the hope of having

gentler bees. I have now some pure Italians, purporting to be of the best strains, but they don't begin to store like my vicious hybrids bred for storing.

“It would be a long story to tell of all the successes and failures of those first years—perhaps the failures would make a longer story than the successes, even if not so interesting. Winter losses were heavy, so heavy, in fact, that in spite of buying colonies at times, at the end of eleven years I had only two colonies. These two were the survivors of fifty that went into winter quarters the previous fall. But as I was only playing at the business I didn't care.

“One reason for some of my failures was that my business kept me away from home, with only an occasional chance in some years to see the bees. In 1876 I determined to give myself a chance to do better, and for the sake of living where my bees were, accepted the charge of the Marengo public schools at a salary of \$1,200, less than half I could have had by staying away. Just how rich a man I should have been if I had not made that change I cannot tell. But I suppose I should have died years ago in spite of making more money. I'm still alive—that's a good deal; and I have had, and still have, the happiest kind of life—and that's a good deal more.

“In 1878 I gave up teaching, and since then have been nothing but a bee-keeper. The largest number of colonies I kept never exceeded 400, in four apiaries. For the past few years I have run only two apiaries, and the coming year expect to have only one.

“Unfortunately, I had a poor location, white clover being the only thing upon which I could depend for surplus, so I cannot boast of such big yields as some others. In late years, however, fall pasturage has helped a little. The greatest trouble with white clover is that some years it will bloom abundantly but yield no nectar. One year, instead of getting a crop of honey, I had to feed my bees with 2,800 lb. of sugar to keep them from starving. I'll give you my three best years.

“In 1882, from 174 colonies, I took 16,549 lb. of comb honey. In 1903, 124 colonies gave 18,150 lb., increasing to 284. The best colony gave 275 lb. (300 sections). Last year, 1908, with 129 colonies, I took 19,480 sections (I did not weigh them). That was not so bad, considering that all the work in the apiary and most of the other work were done by a man of seventy-seven and a none too strong woman, my sister-in-law, Miss Emma M. Wilson, who has been my assistant for twenty-six years.

"One's interest in bee-keeping never dies. I have just as keen a relish in studying bee-problems to-day as I had forty-eight years ago. Just the same enjoyment in reading the bee-journals, and I feel pretty well acquainted with quite a number of the writers in the B.B.J. Best wishes to all its readers and writers."

Dr. Miller had a good many ups and downs, but was always an optimist, and by bee culture alone was able to support his family. He had one son, who, however, took no interest in bees. Dr. Miller's experience and erudition caused him to be frequently consulted, and his advice was eagerly sought by a great many bee-keepers, who called him "The Nestor of American Bee-keeping." He was well known to our readers by his writings, which were conversational, terse, and to the point, often tinged with the fun his good nature was unable to suppress. He was the author of "A Year Among the Bees," 1885; "Bee-culture," 1901; "Forty Years Among the Bees," 1902; and "Fifty Years Among the Bees," published in 1911. He was a regular contributor to the *American Bee Journal* since 1894, managing the Question Department of the Journal, and to *Gleanings*, where, since 1890, he contributed the department "Stray Straws," which was continued until last November, when, owing to failing health, he had to give them up. "A Thousand Answers to Bee-keeping Questions," as answered by him in the columns of the *American Bee Journal*, were compiled by M. G. Dadant and published in 1917. Dr. Miller has been a valuable contributor to the bee journals for many years, and owing to his worthy character was held in high esteem by all who knew him. His whole life was one of unselfish helpfulness, and we esteem it a privilege to have been personally acquainted with him for so many years. In recognition of his loss the following resolution was unanimously passed at a largely attended meeting of the members of the British Bee-keepers' Association in London on October 21:—

"The British Bee-keepers' Association desire to record their sorrow at the news just received of the death of Dr. C. C. Miller, at the age of 89 years, who by his work and writings had done so much for bee-keeping, and by his personality had endeared himself to those with whom he came in touch. They also desire to record their sense of the loss sustained by the world of bee-keepers who valued his advice, and to extend to Mrs. Miller and family their deepest sympathy in their bereavement."

## The Cause of "Isle of Wight" Bee Disease.

IMPORTANT RESULTS BY INVESTIGATORS AT ABERDEEN.

We had the pleasure of attending, by invitation, the meeting of the Royal Society of Edinburgh, held on Monday, November 1, and hearing Dr. John Rennie and his collaborators read a series of papers, illustrated by micro-photographic lantern slides, on the work accomplished in their search for the cause of "Isle of Wight" disease in bees. That great interest is taken in this work was proved by the large audience of scientific men and women present, which included some of the most noted personalities in the medical profession.

For some years past an investigation has been conducted by Dr. John Rennie and his collaborators, Miss Harvey and P. Bruce White, B.Sc., under a special Joint Committee of the University and the College of Agriculture at Aberdeen, on the cause of "Isle of Wight" bee disease. The funds necessary to finance the investigation have been provided equally by A. H. E. Wood, Esq., of Glassel, Aberdeenshire, and the Development Commissioners. In describing the work the investigators made the important announcement that an organism had been discovered which they considered had been proved to be the causal agent in this disease. The authors stated that this disease had been known in bees in this country since 1904 at least, and it was still highly prevalent throughout the United Kingdom. Since 1907 investigations have been going on in England, and for a shorter period in Scotland. Eight years ago certain English workers claimed that the causal organism was a protozoan, named *Nosema apis*. It was due to Anderson, of Aberdeen, to state that he was the first to call in question this hypothesis, and more recent work from the Parasitology Laboratory at Aberdeen, under the joint committee above referred to, had shown *Nosema apis* to be a harmful parasite to bees, but not causally related to "Isle of Wight" disease. This disease had up till now remained an unsolved problem. The papers read by the Aberdeen Bee Research staff revealed the existence of a hitherto unknown type of parasitism in bees of a remarkable kind. In "Isle of Wight" disease the respiratory system of the bee was invaded by an extremely small mite. It belonged to a genus known as *Tarsonemus*. This crea-

ture, which was specialised in structure, was bred within the bees and was confined to an extremely limited but very important region of its breathing system. Within the space of a few cubic millimetres scores of these creatures might be found in all stages of development, sometimes packed in dense columns so as effectively to cut off the air supply from the surrounding organs. The detailed pathology described in Mr. White's paper proved the destructive character of the parasites' habits. Thousands of bees had been examined from large numbers of stocks throughout the country, and it had been found that every stock reported by reliable bee-keepers or certified by the investigators themselves as suffering from the disease harboured this parasite. Similarly, every individual bee known from its stock history and individual symptoms to be suffering from this disease was likewise found to contain these parasites and to exhibit the internal disorders which caused the disabling symptoms. The investigators stated that they were now able to diagnose the disease in its earliest stages while the bees were capable of flying and foraging. Infection appeared to occur mainly in the hive, the conditions of the cluster making this comparatively easy. Mites have been obtained from the outside of the bee apparently on their migratory passage. The *Tarsonemes* included several species destructive to plants, and there were some which have been found in malignant growths in man and in animals. The bee *Tarsonema* in its structure appeared to be more closely allied to these last.

The discovery is most important to bee-keepers, and it would appear that at long last the casual agent of this pest has been run to earth. Other investigators will now have an opportunity of confirming or refuting the conclusions of the investigators at Aberdeen. Personally, after hearing the papers and seeing the magnificent microphotographic lantern slides prepared and shown by Dr. Rennie, in which not only had individual parasites been separated and photographed, but the trachea was shown in all stages of infection, and the life history of the mite from the egg to the perfect creature could be clearly seen in formation. It seems that the mite infests the trachea of the thorax only, entering by the spiracle. Here breeding takes place until eventually the trachea becomes partially or wholly choked. In the latter case the bee dies at once, while in the former the bee is able to crawl, but as it cannot fill its air sacs it is unable to fly. In such cases the faeces are not evacuated, as normally

this is accomplished when the bee is on the wing, hence the congested condition of the bowels and consequent staming of the combs, hive front, and the alighting board, symptomatic of "Isle of Wight" disease.

Interesting experiments of blocking up the thoratical spiracles with wax were described, and by this means all the usual symptoms of "Isle of Wight" disease were produced. The work is to proceed, and we sincerely hope that the investigators will be able to find a cure for the newly-discovered mite.

Many bees from different countries outside Great Britain had been examined, and so far *Tarsonemus* had not been found in these. All the evidence hitherto obtained points to the parasite in bees being peculiar to this country. This coincided with the general testimony regarding the hitherto insular character of "Isle of Wight" disease. The name of "Isle of Wight" disease had long been regarded as unsatisfactory, and it appeared that Aearine disease would be more appropriate. In view of the great practical interest shown by Mr. A. H. E. Wood, of Glassel, in the work of the research and of bee-keeping generally, the director of the research proposed to designate the new species "*Tarsonemus woodi*." The investigators recorded their very high appreciation of the support of bee-keepers throughout Great Britain and also the Ministry of Agriculture in supplying bees and other assistance so essential for the successful conduct of the research.

We would here like to pay tribute to the thoroughly conscientious and painstaking work of Dr. Rennie, on behalf of the craft. He has continued the work, exploring all possible channels, to find the cause of the disease, and as each proved to be wrong he patiently began all over again until at last he has apparently succeeded. His unselfish work, extending over several years, also refutes the statement made so many times by irresponsible persons that no investigation had been undertaken.

We cannot conclude without placing on record the patriotic spirit of Mr. A. H. E. Wood, without whose financial support the work would not have been possible. We are the more pleased to do this, as owing to his unobtrusive method of helping the craft, not only in this case but in many other ways, and extending over many years past, his generosity is known only to a few. We can assure bee-keepers that they owe a deep debt of gratitude to this gentleman for the interest he takes and the invaluable assistance he has rendered to the craft.

## A Dorset Yarn.

In going through the beautiful gardens when in the West Country, I was struck by the number of bees that were on the malvas and verbenas. They seem to like the beautiful hybrid malvas just as much as the old varieties. The old tree mallow, also the wild native one with rosy pink flowers, has always been sought for by bees, but the beautiful coloured ones of modern times are delightful to see, and bees visit them freely. The verbenas are very beautiful, though I think the old ones that were first brought over from the temperate parts of America were sweeter than the ones that are grown to-day, but bees seem to like them. I do not know if much is got from them, or if they are only attracted by the colour and sweetness when there is nothing else handy that suits them better.

Some of the species are considered to be very old. It was known to the old Greeks as the sacred herb, Juno's tears, and dorewort, supposed to be one of the flowers dedicated to the Goddess of Beauty. Venus the Victorious wore a crown of myrtle interwoven with verbenas, though the old name by British writers was vervene or vervain.

"A wreath' of verbene heralds wear,

Among our garlands named."

It was looked on as an emblem of superstition. Old Pliny, who wrote on nearly everything, and was not always right, wrote that the Druids made use of it in magical arts:—

"Dark superstition's whisper dread

Debarr'd the spot to vulgar tread;

For there, she said, did fays resort."

It has been said that the ancient Druids held their power through the superstition of the people. Pliny, in his natural history, says they extracted the juices of this and other herbs by bruising and steeping them in wine for potions and salves. But this is getting away from the subject of bees: 'tis said in Germany this is a favourite flower with the bride, and in olden times they used to wear a chaplet over the veil, as if to put her under the protection of Venus Victorious.

A favourite flower in boyhood's days was the hollyhock. It has a single flower in the shape of mallows, and bees are always visiting this in summer just as long as they bloom. They seem to like the single flowers more than the big double ones; in the double flowers the pollen stamens are converted into extra petals, so one must assume that it is mostly pollen that is got from this plant, but Smith writes that—

"From the hollyhock nectarics

The humble bee, e'en till he faints,  
will sip."

This is also a very old plant. Pliny speaks of this flower in the fourth chapter of his 21st book, "As a rose growing on stalks like a mallow." This flower was at one time a great favourite, but of late years, with so many other introductions, it has lost its old favour. In some old gardens the single ones seed and have always a fine lot of flowers for the bees in their season. Old Pliny's description of them was very good as they were then, but, of course, years have added to the size and colour of the flowers; where they do well they are noble units of the floral kingdom, for bees, as well as beauty in the world of flowers.

Saturday, October 30, brought us a southerly wind, and the bees were exceptionally busy; they were on ivy flowers on the house. The big-leaved one, "Hedera regnerana," has big flowers, and one can see the tongues of bees going over them quite plainly. This is close to the hives; not one was to be seen in the fields—only close round the house were they seen.—  
J. J. KETTLE.

---



---

## Jottings from Huntingdonshire

How wonderful creation is! November, and still the country is clothed in summer garments. Roses blossom in the gardens and dandelions in the fields. Day by day the sun struggles through the fog, and bathes the landscape with fire. Dew pearls and gossamer threads are everywhere, the sun warms them, and they seem to vanish. As these vanish the bees appear, and make merry while the day is warm, and, moreover, they come buzzing around one telling of something amiss. One investigates, and finds that owing to the late hatching of brood an immense amount of store has been consumed, so cakes of candy had to be given where one hoped it would not be needed for some time. Robbery is still not unknown, Italians being great sinners in this respect. Strange that a nucleus of Italians should succeed in wearing down the resistance offered by a strong stock of Dutch bees, and rob them out. I hope all bee-keepers will carefully examine the stocks this autumn, for it will be found that some colonies which a month ago had stores in plenty are now running short. None of us will forget 1920; it has been altogether the strangest year for bees some of us remember. Everybody is looking hopefully forward to 1921—to a practical bee-keeper 1921 has already begun. Failure to see that stocks deficient in stores—and quite the majority will be found to be short—are provided with candy in plenty will cause

sad hearts at a later date. It is wise, too, to kill the queen wasps which have found their way into the coverings over the brood nests. I opened seven hives this morning, and found queen wasps in each one. Within their little bodies they carry whole colonies of wasps, which will try the patience of bee men next year, and, remembering that queen wasps make their nests within easy distance of their hibernating places, it will be seen how important it is to destroy these pests.

One still sees a little brood in vigorous hives, but it is doubtful whether much more will be raised until next February or thereabouts. Last winter one of my queens began depositing eggs early in January; but I'm not expecting a repetition of this, as I fear the weather will not be quite mild enough. Referring to Dr. Strong's playful banter that I should present a stock of my bees to the Meteorological Society to enable that august body to forecast the weather, I may say that last year I was consulted by an expert in meteorology as to how he might be able, by watching bees, to decide what weather the little insects were expecting. I have once or twice remarked that, in my opinion, while bees can sense the average condition of the weather for a season ahead, they are not able to tell what the weather of the morrow will be; as instance (this Dr. Strong has remarked) the issuing of swarms during a short spell of sunshine on a very showery day. We all know that if our bees were shipped over to Australia that they would very soon cease any attempt at storing surplus, sensing ahead that the winters would not be severe and the honey flow cease, as in this country. Judging merely by the honey harvest this season, one would say the winter would be very short, and spring flowers appear with the first month of the New Year; but we know that had the weather allowed it our honey flies would have hives overflowing with surplus. Think of the comb building which has gone on this summer and the amount of comb space the workers demanded in the brood chamber for storing the nectar, which the inclement weather prevented their harvesting. It's an ill wind that blows no good, and no doubt weakling stocks in trees, towers and roofs will not survive the winter ahead of us. This may help the bee diseases bill and save much cyanide of potassium. There is an element of danger if this happens. Swarms escaping the vigilant eyes of bee-keepers may choose the very spots where the defunct colonies lived, and so become diseased. This does not, however, always happen. I know of one case

where bees in an ash tree were badly afflicted with "I.O.W." disease, and became so decimated that wasps came along and finished the colony. The next year a swarm took possession, cleared out all dead bees and litter, and set to work to establish itself, and so far those bees have been very vigorous, throwing out two or three swarms a season, some of which have been taken, and have done well. For my part, however, I never take a strange swarm unless it be to destroy it. A friend of mine once took a stray swarm which settled in a garden hedge, and hived it. Within a week the dread symptoms manifested themselves, and within three months the whole apiary—eleven stocks—had succumbed.

How true it is bees do nothing invariably. Last week I was looking through a few hives of a friend, and found one stock had made a delightful bee way of wax walls over the top of the frames. Evidently there appears now and again, even among bees, an inventive genius who outlines the scheme which others follow.

I shall have to throw a book at the head of that compositor. He omitted a whole line of my Jottings last week. Doubtless he would often like to do the same to me—bad writing, overlining, and the rest must make him feel angry, so will just cry quits.—E. F. HEMMING, Steeple Gidding.

---

## Cotswold Notes.

May I be permitted to give some details of a scheme which I think has certain possibilities for increasing the honey yield in some of the varied localities in which bees are kept.

Among *B.B.J.* readers there must be many experimentalists, and to these I commend this plan, or such modifications of it as necessary for one's own particular locality or circumstances.

It is, however, a sound, workable idea, and especially suited to out-apiary management.

The essentials are as follows:—

(1) A supply of early queens, or, as an alternative, a supply of ripe cells.

(2) Extracted honey production should be worked for, and the hives should have interchangeable brood chambers, and supers of deep or shallow frames. Hives of the "W.B.C." type would be ideal.

(3) Localities where late flows predominate, such as from limes, charlock, or the late variety of white clover, which yields well into August, and the heather. Fruit honey is, of course, helpful in building up the bees strongly.

Between mid-May and June 7, accord-

ing to the season, strong ten-comb colonies are split up into three divisions, each division being placed in a separate hive and stood one on each side of the parent colony.

The divisions are then numbered 1, 2, and 3. The old queen should be taken with one of the moved portions, and each of the two fresh nuclei should have their entrance stuffed with grass to prevent the return of all the field bees to their parent colony.

The queenless nuclei, or 2 and 3, should then be given a fertile queen.

These queens are on loan only for the purpose of producing a large population on the assumption that when properly supported three queens will lay more eggs than one, no matter how young or vigorous she may be.

It is therefore necessary to make the little nuclei feel as self-supporting as possible by ensuring that the combs contain some stores, and a fair proportion of emerging brood, and that they are dummed up tightly during the first ten days of their existence.

If the nuclei are formed, say, about May 23, young workers from the new queen will be flying in great numbers five to six weeks later, or proportionately earlier if made in mid-May. As soon as each division is full with brood on ten combs you can proceed.

Remove the queen from No. 1, set an excluder and sheet of paper over the frames of No. 2, then place the entire brood chamber on top, at the same time giving a super of shallow frames to accommodate the surplus field bees.

If there is settled warm weather this large population will soon require a second shallow super, besides filling the upper brood combs with honey as fast as the young bees emerge.

The upper brood-nest should be opened or propped up for ten minutes occasionally, because unless the drones are allowed to escape many will die; and the excluder becoming clogged will seriously impede the passage of honey-laden workers.

No. 3 division can now be united to the tiered colony, putting the brood chamber on top of all the supers already in position.

The population is now at its strongest just at the right time, the laying queen in the lower brood chamber keeping up a constant supply of bees, and at the same time it restricts the area of brood when the season is past its prime.

If the weather is stormy the work of adding each storey of brood can be delayed till it appears that honey is being rapidly gathered, when both chambers can

be added at one operation to ensure a heavy force of fielders.

The queens, which become spare on the brood-chambers being de-queened, can be introduced to newly-formed nuclei, or otherwise saved till wanted for autumn re-queening.

There is practically no swarming with this plan, and to keep a large force of bees intact is one of the essential elements of the successful production of surplus.

It would be interesting to hear the views of bee-keepers on the idea outlined above.—A. H. BOWEN, Cotswold Apiaries, Cheltenham.

---



---

## Queens on Strike.

Whatever is the matter with queens this season? Frequent references have been made in the JOURNAL to hives being found to be queenless, but no satisfactory explanation appears to be forthcoming of what seems to be largely epidemic. Perhaps, if readers would give their own experience, it might help towards a solution; at any rate, here is mine and some others.

About the third week in August I united two stocks, one a very strong one, headed by a fine young queen; the other rather weak and the queen past her best. The method adopted was the brown-paper one: the stocks united quite peacefully, and all appeared to be well. The old queen was, of course, removed before uniting, and both brood chambers contained a fair amount of brood. I had previously ascertained that the young queen was there alright.

After enjoying a three weeks' holiday, I opened up the hive, to find no brood whatever, no eggs, and no signs of a queen. A second examination revealed exactly the same thing. I thereupon sought the advice of our local expert, and together we went through the hive, on two separate occasions without any satisfactory result. Several further searches failed to discover any trace of her majesty, and I then wrote a friend in Kent, asking if by chance he happened to have a spare queen. He replied that he had been through his hives, and found exactly the same state of affairs obtained; and other beekeepers to whom he mentioned the matter complained that they were in a similar plight, several of their hives being evidently queenless.

To my surprise, I received a card a few days later from the local expert to say that, after my experience, he had been through his hives, and also found no trace of brood or eggs, and suggested that

apparently the queens had all "gone on strike."

However, my Kentish friend wrote me a fortnight since that he had disposed of a nucleus, and, as the purchaser required it for strengthening purposes, and, therefore, did not want the queen, I could have her if I would go over and take her. On my visit, we went very carefully through all his hives, but found no queens, or trace of them, in any but the nucleus referred to. I brought away the royal lady, as my friend said he should not worry about the other hives; having seen the bees carrying in pollen until quite recently, he thought that, after all, the queens *might* be there—if not, he should obtain some direct from Italy in the spring. Is the carrying in of pollen an infallible sign, Mr. Editor, that a queen is "at home"? [No, it is not an infallible sign that the queen is there.—Eps.] Before introducing her into my hive, however, I went through it again, lest, perchance, I might still have made a mistake. This final examination placed the question beyond all reasonable doubt, and on Sunday week I introduced her. Nothing has been seen of her having been thrown out, and it is now tolerably certain that the hive *was* queenless, and that the new queen has been accepted. I have not opened up to see, as I had already packed it up for the winter, and merely lifted the quilt sufficiently to withdraw the cage. The springtime will continue the story.

Last year, in October, I had plenty of brood in the hive: this year there is none, and no young bees. Successful wintering, therefore, does not look very hopeful.

Altogether, among the beemen I have mentioned, some dozen to twenty hives are apparently queenless this autumn. What is the explanation, and what can have happened to all the queens?

Since writing the above I have had an interesting chat with one of the prize-winners at the Dairy Show, and he also stated that queenless hives had been quite a common thing in his district this season.

A. E. C.

## Echoes from the Hives.

BEE NOTES FROM BUCKS.

I have seen frequent reports in the "B.B.J." as to this being a bad season for honey. Bucks has fared very well with strong stocks in the early part of the season. A fair quantity of extracted honey and sections were obtained. There were not many beekeepers in this sleepy district up to this last season, but I am pleased to say I have enrolled over 20 new members for the Bucks B.K.A., and

hoping for another 20 in the spring. Wake up, Bucks!

I must say it has been a bad time to start with swarms. I did not get them until late June and early July, but I hope to pull them through. Some started with stocks of Italians, which have done very well. They are out-and-out good workers. I have not seen any "I.O.W." disease in my district this season, I am pleased to say.

A. E. WARREN,

Simpsen, Bletchley.

## British Bee-Keepers' Association.

The monthly meeting of the Council was held at the Central Hall, Westminster, on October 21, 1920. Mr. T. W. Cowan presided, and there were also present:—Miss M. D. Sillar, Sir Ernest Spencer, Messrs. W. F. Reid, H. Jones, A. G. Pugh, G. J. Flashman, W. H. Simms, J. Herrod-Hempsall, G. W. Judge, G. Bryden, and G. R. Alder. Association representatives: E. Ff. Ball (Bucks), Col. H. F. Jolly (Somerset), J. Price (Staffordshire), W. E. Moss (Leicestershire), G. Thomas (Cambridge), W. E. Hamlin, E. G. Waldock (Surrey), R. R. Babbage (Middlesex), F. W. Frusher (Lincs), J. Pearman (Derby), H. P. Whistler, and the secretary, W. Herrod-Hempsall.

Letters of regret at inability to attend were read from Messrs. C. P. Jarman and C. L. M. Eales.

The minutes of the previous meeting were read and confirmed.

The following new members were elected:—Lady A. Donaldson, Miss H. Adam, Miss D. Adam, Messrs. J. Jackson, W. C. White, J. Hill, H. F. Swann, and Capt. Christie-Crawford.

Reports on preliminary examinations were presented, and it was resolved to grant certificates to the following:—Mrs. G. Lusty, Misses E. Taunton, L. Meek, M. Garstang, D. Imray, G. Corsar, M. Gubbbns, F. Walkington, E. Moller, M. Blanch, F. Williamson, E. Sikes, M. Alford, L. Hake, Rev. M. Yate Allen, Dr. W. T. Henderson, Messrs. J. J. Hogbin, W. Wilson, J. F. Clarkson, J. Henry, R. H. Just, J. E. Giles, J. Watson Egglestone, R. Casson, W. E. Deacon, R. Todd, M. T. Todd, C. H. Jones, C. F. Davies, C. Tredcroft, O. R. Howell, C. Godfrey, G. H. Seamen, G. F. Stapleton, J. H. Landin, W. B. Towler, A. Cant, T. J. Sharpe, and Sergt. E. Hodson.

Payments amounting to £6 were recommended.

Next meeting of Council November 18, 1920, at 23, Bedford Street, Strand, London, W.C.2.





*The Editors do not hold themselves responsible for the opinions expressed by correspondents. No notice will be taken of anonymous communications, and correspondents are requested to write on one side of the paper only and give their real name and addresses, not necessarily for publication, but as a guarantee of good faith. Illustrations should be drawn on separate pieces of paper. We do not undertake to return rejected communications.*

### "I.O.W." and Other Diseases.

[10329] From the correspondence recently published on the subject of "I.O.W." and other crawling diseases, it would appear that these complaints have again become very prevalent in this country. As in many districts, the honey flow has failed and starvation will probably result, the prospects of successful wintering are very black, and many good results of the re-stocking schemes will be nullified.

Many alleged cures for "I.O.W." disease have been brought forward, but considerable scepticism should be shown in accepting these, until it has been proved, by careful experiment and microscopical examination, that those cases in which cures are claimed are cases of *true* "I.O.W." disease, and also that the so-called cures would not have occurred without any treatment whatever.

In many cases under observation, where severe crawling symptoms were noted together with dislocated wings and other symptoms, the stocks have recovered without any medical treatment. Other cases have been fed with syrup containing one of the advertised antiseptics, but no appreciable difference was noted between these and the cases in which plain sugar syrup was used.

Though the use of antiseptics will probably have good results as a preventive measure, there is, so far as can be seen, no evidence to show that these are of value in the curing of bees already attacked by disease.

From the details of the cases recently published in "B.B.J." it appears probable that, where cures have been claimed, these have been due to the hatching out of healthy young bees, and not to the restoration to health of the bees affected by disease.

This can readily be proved by the re-queening of the stock immediately on the appearance of disease—a black queen being replaced by a golden, and *vice versa*, thus ensuring a marked difference of the colour of the old and young bees.

Although a reliable remedy for these

diseases would be of the greatest value to the beekeeping fraternity, of far greater importance is the determination of the conditions under which bees can be kept free from disease.

A great amount may be learned by careful observation of the conditions of the stocks in which disease has appeared, and experiments should be carried out to determine whether the disease shows itself on artificially reproducing these conditions in healthy stocks.

During 1920 some of the conditions favourable to disease have been determined, and the symptoms produced in previously healthy stocks on reproducing these conditions. Unfortunately, the space available does not permit of the full details of these cases, and general outlines only can be given.

The experiments which have been carried out during several years show the great importance of properly-reared queens of a reliable strain in which Italian blood largely predominates. This strain must not be inbred to any extent, otherwise the disease resistancy deteriorates very considerably.

A prolonged period of queenlessness, or the use of non-prolific queens (resulting in the presence of a large proportion of old bees) must be avoided.

Indiscriminate swarming must be prevented, as this results in the isolation of the older bees, and the swarms are therefore very subject to the disease.

Stocks from which the swarms have been produced may remain queenless, or with unmated queens, for a long period during bad weather, when the conditions favourable for disease are again obtained.

Though the disease is most noticeable during the summer and autumn months, the chief losses occur during the winter, when, in many cases, the stocks consist of old bees of poor disease-resisting qualities.

These losses are largely prevented by intensive brood-production in the autumn, thus ensuring both the presence of healthy young bees which have done no appreciable work, and which are absolutely necessary for satisfactory wintering; and the absence of old worn-out bees, as these are killed off by the work entailed in raising the large amount of brood.

The presence of these old bees is not desirable in any case as, in addition to their being of very slight use for wintering purposes, they are liable to dysentery, "I.O.W." disease, and similar complaints.

The presence of a large percentage of old bees is a positive danger, as there is a great probability of their causing dysentery, etc. to spread to the other occupants of the hive.

A. M. STURGES, Cheshire.

### Plants for Bees.

[10330] Four years ago a friend gave me a small quantity of trailing thyme. This thyme grows very close to the ground, or will cover rocks very quickly. I use it as a border to the garden, and during the summer it spreads about 4 to 6 ins. over the path. It blossoms in July, continuing in full bloom for about a month, with a mass of tiny pink blossoms. The bees simply revel in it, and to walk down the garden when it is out and the sun is shining would gladden the heart of any bee-keeper, the mass of pink bloom, looking like heather, is simply humming with joyous life.

I have just been cutting it back from the path, and have got about two barrows full that I could dispense with. It seems such a pity to dry and burn it, when it might be useful to readers of THE BRITISH BEE JOURNAL. If any county secretary would care to have and distribute some to their members I should be pleased to forward some on, plus carriage or postage.—A. Mustro, Norton, Stourbridge, Wores.

### An Appreciation from Scotland.

[10331] I feel I must write to let you know how much I appreciate the writings of our friend Rev. Hemming.

It would be difficult to say whether it is the artistic temperament or poetic sentiment which is the ruling passion of his nature. The exquisite way in which he describes his surroundings makes each of his writings a beautiful poem, and reminds me of the delicious little paper, the *Country Side*, which is now, I am sad to say, extinct. Although I do not give in to him in some of his arguments, such as "tanging," I thoroughly enjoy his beautiful language and soulful expression.

As regards "tanging," I have always understood that bees have *no ears*, and if you were to blow an engine whistle beside the hive I do not think it would make one atom of difference to the bees. I was almost going to say "if you fired a cannon," but a cannon makes vibration both in the air and earth, and they certainly would not like that.

I would not like to even jar the hive or stamp my foot beside it without having my veil on. Oh, no!

If I were to breathe in the entrance I would get the same effect, perhaps worse.

I may state here that the bees I had examined at your office for "L.O.W." disease have been destroyed.

During the time I was waiting for a reply I had the entrance closed up, but somehow the bees managed to get in, as I had not time to look to them at

the moment. The whole of the honey was taken to the other hives, and the combs were torn to a great extent, but I am glad to say that none of the others are affected in the slightest degree, all healthy and full of vigour. I did not know about the "onion cure" at the time of my trouble, or I should certainly have put it into practice. If this was so well known as our friend Hemming says, why is it not mentioned in any of our latest text-books?

It is decidedly a common-sense proposition all through. For example, what would be the good of rubbing embrocation on one's arm for appendicitis?

As this is an internal trouble it must have internal treatment. I do not think that external spraying is as necessary as the attention to the internal organs.

To my mind, the only way to beat down the disease is to stop the introduction of foreigners, which are certainly weakening the vitality of our own bees, and to have recourse to the onion at the first suspicion, as it seems to be the best cure, from a common-sense point of view, that we have ever had.—JOSEPH C. WOOD, Dalbeattie, N.B.

### Re Hives.

[10332] I m interested in what Mr. Kettle states about small hives. It is a matter I noticed the year before last, and I at once ordered the large 12-frame hives which have been most successful. Large colonies that can well protect themselves and excellent for wintering down.

This year I experimented with a large swarm in a Tickner Edward hive, and am most pleased with it. It is of a stout make, cosy in summer and warm in winter. A good idea is the glass dummy; one can see when to put the supers on, and when bees are on the eleventh comb, One can see by dropping the back without disturbing the bees, but it is important not to keep it open too long as bees don't like the light. I have a large hive with 2½ in. between supers and outer casing which is a great boon.

Regarding Italian bees and "Isle of Wight" disease, I have no love for the pure Italian. Give me a well-known hybrid which will stand any kind of weather and disease. Regarding this disease, if only bee-keepers would keep a standard frame with tin troughs filled with warm "Bacterol" and place it in the brood nest. It gives off fumes, and bees also value it, and one can soon see the difference. I tried it on a friend's hive which had crawlers, and it took no time to right things. The entrance was closed up, and wire cloth board over brood, so they could get air, with a very

fine cheese-cloth quilt over it. I should advise every bee-keeper to have one of these splendid inventions. I sincerely hope this advice will be taken note of, as I am only too willing to help all I can.

Regarding "Bacterol," always spray outside hives or inside when warmed. I like "Bacterol," as it's a pure medicine one can take oneself if needed. Giving bees unnatural stuff, the smell of which in their food they don't like, does no good. Giving vinegar in syrup makes me smile. Where on earth do bees get vinegar or melted sugar in their natural life?

#### A CORRECTION.

Three-colour process for lantern slides in photography (p. 508) is incorrect, as a slow exposure has to be made so as to get three negatives fitting truly to each other. Land-cape and still life can only be taken with the beautiful real natural effect of colour on the three-coloured positives, which are transparent, cutting clean out the ultra violet rays, which is the bugbear of photography.—C. TREDCROFT.



*Queries reaching this office not later than FIRST POST on MONDAY MORNING will, if possible, be answered in the "Journal" the following Thursday. Those arriving later will be held over until the following week. Only SPECIALLY URGENT queries will be replied to by post if a STAMPED addressed envelope is enclosed. All queries must be accompanied by the name and address of the sender, not necessarily for publication, but as a guarantee of good faith. Correspondents are requested to write on one side of the paper only.*

### Missing Queen.

[9912] I shall be very grateful if you can tell me where I went wrong in the following, also what I can do against the wasps.

I had a medium-sized swarm early in August, which I decided to re-queen with a Government Italian queen, which I was daily expecting.

The queen arrived a fortnight later. I took out a good frame of brood, and put them on a new stand. Next day I put the Italian queen over them in the travelling cage. This hive I will call A.

The old bees were left on the old stand with a couple of empty combs, combs with honey, and the laying queen, as I wanted to keep her in case I failed in introducing the Italian queen; or, if I succeeded, I wanted to give her to another bee-keeper. This hive I will call B.

I was successful in introducing the Italian queen, and so commenced moving hive B 2 ft. a day, preparatory to uniting to hive A. Wasps were very troublesome, but all hives appeared to be keeping them at bay. About the fourth day I noticed that the bees, which had been flying freely from hive B, had suddenly stopped doing so, so that evening I examined the hive. To my dismay I found the floorboard covered with dead bees and wasps, every scrap of honey gone, and the remaining bees and queen half starved.

In a very short time I had them all sprinkled with warm syrup, and had a bottle feeder over them. I closed the entrance to one bee-way, instead of 1 in., with a piece of glass in front of it, and some dry grass at each side of the glass.

The next day the bees were flying well once again, but about 12 o'clock I found the queen with about a dozen bees some 2 ft. from the hive. I put her back in the hive, right into the cluster.

About five o'clock that afternoon I again found the queen out with some bees, some 12 ft. from the hive. This time, as there was no brood in the hive, I put in a comb with a small patch of brood from another hive, and put the queen on this. I also opened the entrance to about 3 in., and covered same with perforated zinc.

Three days later I took the zinc off again and gave an entrance of one bee-way only, and two days after this I examined the hive again, but the queen had disappeared, and I failed to find her dead or alive. I do not think the bees had killed her, as each time I found her outside the hive they were perfectly friendly with her, and appeared to be guarding her, surrounding her as though they were feeding and cleaning her. But why wouldn't she stay in the hive?

I have now united hives B and A: there was barely a quart of bees left in the former.

My bees are all having a very bad time with the wasps, and I have had to fasten up this hive (A) with perforated zinc to save them. I have tried hay, glass, carbolic, the long passage, as given in the JOURNAL, but nothing stops them, and for every wasp killed by the bees I should say two bees lose their lives.

I am catching great numbers in traps, but I cannot find their nests, as, although I have tried by flouring the wasps, I cannot follow their flight owing to trees.

By the way, I have trapped a great number of large wasps. Would these be "hone" wasps or queens?

I have not taken an ounce of honey from my three hives this season, and shall have to feed them all, as they have hardly any stored. I have not heard of anyone

taking surplus this year in this neighbourhood, and fancy all will have to feed their stocks.—**ANXIOUS**, Montgomeryshire.

**REPLY**.—We are unable to account for the behaviour of the queen. There is no doubt the hive had been robbed out, and this probably had something to do with it. It was not through any fault of yours except that the nucleus could have been formed close by the old hive and thus saved moving it later.

We don't know what other measures you can take against the wasps beyond closing the hive entirely during the day and allowing the bees to fly towards evening, when the wasps are not flying so much, but for this you would need a "Claustral" chamber or other means of giving plenty of ventilation.

The large wasps may be queens; they are much larger than the workers. The drones are a little larger than workers, and may be distinguished by the length of the antennæ, which are much longer than those of queens or workers.

## Bee Shows to Come.

**November 18.**—Annual Show of the Worcester City and County Chrysanthemum, Fruit, Root and Honey Society. Thirteen Open Classes in Honey Section.—Schedules from Geo. Richings, 42, Barbourne Road, Worcester. **Entries close November 6.**

## Special Prepaid Advertisements. One Penny per Word.

**Trade advertisements of Bees, Honey, Queens, and Bee goods are not permissible at above rate, but will be inserted at 1½d. per word as "Business" Announcements, immediately under the Private Advertisements. Advertisements of Hive-manufacturers can only be inserted at a minimum charge of 3s. per ¼in., or 6s. per inch.**

**PRIVATE ADVERTISEMENTS are only intended for readers having Surplus Stock to dispose of. Driven Bees, Nuclei, and Queens that are reared or imported for sale, are Trade Advertisements, and can only be accepted under trade terms. A charge of 6d. extra will be made if a box number is used.**

**Advertisements must reach us NOT LATER than FIRST POST on MONDAY MORNING for insertion in "The Journal" the same week.**

**Orders for three or more consecutive insertions in "The Bee Journal" entitle advertisers to one insertion in "The Bee-Keepers' Record" free of charge.**

### PRIVATE ADVERTISEMENTS.

**GOOD GLAZIER'S DIAMOND**, perfect, 8s. 9d.—**HUBBARDE**, North Kilworth, Rugby. k.46

**FOR SALE**, three June Swarms in boxes with stores, pure Italians with 1920 Queens. What offers or exchange for poultry?—**MURCH**, Ringmore Road, Shaldon, Teignmouth. k.47

**WANTED**, 20 lbs. or 56 lbs. good quality English Honey. Slate lowest price, carriage paid.—**D. M. CUTLERTSON**, Finmere, Buckingham. r.k.50

**32 LBS.** of pure Heather Honey in comb, 2s. 3d. 1b.; 2 dozen 1-lb. cartons pressed Heather Honey, 2s. 3d. each.—**W. WOODS**, Normandy, near Guilford. k.48

**LANTERN SLIDES** supplied for Lectures on Bee-keeping, practical and scientific. Also enlargements for demonstration purposes. Prints on approval.—**REV. G. H. HEWISON**, Marr Vicarage, Doncaster. k.51

**WANTED**, single and double Conqueror Hives; must be good condition and Simmins' dimensions.—**BLACK**, Fernhill Heath, Worcester. k.52

**APIARY** of 26 strong, well-stocked Hives for Sale, also all Stores and Appliances; owner going abroad.—**GORDON**, Tedfold, Billingshurst, Sussex. k.53

**ADVERTISER** wishes to buy for delivery next June quantity 3-frame Nuclei, Italian or Hybrid.—Write, stating number can supply with price, Box 108, B.B.J. Office, 23, Bedford Street, Strand, W.C.2. k.54

**BEE SWAX** for Sale, guaranteed pure, 3½ cwt. What offer?—**HIGH TENSION CO.**, 64, Belvedere Road, London. k.55

**BROTHER BEE-KEEPERS** with spare time wishing to commence in the Retail Fish Business write **J. W. ELVIDGE**, Wholesale Fish Merchant, Grimsby. r.h.239

**PURE LIGHT CAMBRIDGE HONEY** (guaranteed), 14-lb. tins, 30s.; 28-lb. tins, 57s. 6d., carriage paid.—**YOUNG**, 42, James Street, Cambridge. r.k.49

**BEE SWAX**, pure, for Sale, 5 cwt., packed in ¼-cwt. bags, £8 16s. per cwt. net, f.o.r. London.—Apply, Box 104, B.B.J. Office, 23, Bedford Street, Strand, W.C.2. r.j.20

### BUSINESS ADVERTISEMENTS. 1½d. per word.

**MASHEATH MEMS.**—"Herewith cheque for Masheath Hive. I never felt so happy in paying for anything I possess.—**A. S.**"—**ATKINSON**, Fakenham. k.56

**R. LITMAN** having purchased one of the Somerset Re-stocking Apiaries, can book strong Nuclei for delivery May and June, 1921. All Stocks headed by imported or home-reared from proved prolific queens, Piana, Penna, and Bozzalla strains. Doolittle and Sladen's methods employed rearing. Delivery in strict rotation, with tested or untested Queens as desired. Avoid disappointment. Book now. £1 with order, balance when ready.—**Castle Cary**, Somerset. j.37

**NO SUGAR VOUCHERS NEEDED.**—Flavine Candy, made in Cambridge, and the wrappers bear our name, 6 lbs., 11s. 3d., postage paid; larger quantities, 1s. 6d. per lb., carriage extra; sample 1s. 6d., post paid.—**S. H. SMITH**, 30, Maid's Causeway, Cambridge.

**BEAUTIFUL CANDY**, 6 lbs., 10s. 6d., delivered.—**BOWEN**, Coronation, Cheltenham. j.39

**HAVE YOU READ "THE BEE WORLD"?** If not, why not? Every number in itself is a useful literary work for practice and reference. Specimen copy free.—**Offices: THE APIA CLUB**, Port Hill House, Benson, Oxon.

**AUSTRALIAN HONEY FOR FEEDING BEES.**—Cases containing two tins, about 60 lbs. each, 110s. per case; 1 tin 56s., carriage paid 100 miles. Remittances with orders.—**SOUTHWOOD**, 95, Acton Vale, London. r.h.190

"WIGHT" DISEASE.—Prevention and removal.  
Advice 5s.—ALF. RYALL, Cottage Farm,  
near Camp, Stroud. j.5

SURPLUS HIVES and Appliances for Sale, good  
condition, cheap.—PEARSON & GALE, Marl-  
borough. rh.131

**JOT DOWN** the deficiencies of your present  
equipment and your needs for future improved  
working. Then book for "**MASHEATH**"  
(Regd.) Equipment for autumn construction.

The **MASHEATH LIST** contains an unique  
series of Hives unequalled to-day. You should  
not enter upon another bee season without them.  
"The Hives (Porchless Masheaths) are excellent  
in every way, and I am very pleased indeed with  
them. '**PORCHLESS!**' Yes, every time. Need  
I say more? I will get you to send me two more."  
—W. F., June 17, 1920.

The **MASHEATH HIVES TALK** as soon as  
they are delivered.

**ATKINSON**, Proprietor and Fakenham.  
Sole Maker,

### THE British Bee-Keepers' Association.

The recognised centre of practical and  
scientific bee-keeping in Great Britain.  
Particulars and conditions of membership  
may be obtained from the Secretary,

W. HERROD-HEMPSELL, 23, Bedford  
Street, Strand, London, W.C.2.

### Finest Grade New Zealand Honey (Amber)

For Bee Feeding. Guaranteed Pure.  
Cases, each 2-60 lb. nominal Tins. 95/- per cwt.  
Carriage paid.

Cash with order or on receipt of goods.

N.B. We are already supplying Beekeepers'  
Associations throughout the Country and shall  
be pleased to quote references.

The Bristol and Dominions Producers'  
Association, Ltd., Bristol.

The products of the Apiary, of  
Poultry and Farm Stock, of  
the Fruit and Vegetable  
Garden can be Advertised  
and Sold through

### THE BAZAAR, EXCHANGE & MART Newspaper.

Get a Copy—Thursday and Saturday 3d. The  
"Bazaar" publishes also practical handbooks by  
experts. Send for full catalogue, post free from—  
WINDSOR HOUSE, Breams Buildings, LONDON, E.C.2.

## 1920—QUEENLAND LIST—1921

In reply to many requests coming in for our Premier White Star Queens for the Season 1921, we beg to state that early delivery may not be offered, as a certain number of orders have been carried over (by request) from previous season for first 1921 delivery, in consequence of the unfavourable weather for queen-mating.

## Our Premier White Star Nucleus Stocks

will be offered as usual, and at former price; but the charges for Queens have been revised, and include the offer of well-bred and selected Virgin Queens of this renowned strain.

Full Queensland Descriptive Circular 4d., The Revised List only (to those having 1920 List, 2d.,  
post free,

OF S. SIMMINS, QUEENLAND, HEATHFIELD, SUSSEX.

## Bees and Beekeeping Appliances. Catalogue free. EDWARD J. BURTT. MANUFACTURER. GLOUCESTER.

*I very much regret that there has been a large increase in the cost of the manufacture of bee-appliances, and therefore my prices will be advanced 10% from May 10th. Books excepted.*



## "BACTEROL" FOR BEES

2/9 per Pottle.

Post Free.

The cure for, and preventive of,  
"Isis of Wight" Disease  
Non-poisonous—free from stain  
or unpleasant odour.

BAC. EROL LIMITED  
19/25, Brookside Rd., Highgate, N.19.

## POSITIVE FACTS.

June 13th, 1920.

I am very pleased with the foundation. The bees undoubtedly prefer it to any other make I have, and have even gone the length of missing two sheets of other new foundation, and working out a sheet of yours placed behind them at the back of the hive. Full sheets have not sagged in the least in 16 x 10 frames.

Yours faithfully, R B MANLEY.

*Illustrated Lists free by post.*

**S. J. BALDWIN, The Apiary, BROMLEY, Kent.**

## FOUR FIRST PRIZES.

Our HIVES and APPLIANCES were again awarded FOUR PRIZES at the Highland Agricultural Society's Show at Aberdeen, thus testifying to the superiority of our goods. Order now and ensure your bees wintering in good hives.

**BOTTLES.** We hold a large stock and can give immediate despatch.

**CANDY.** Safeguard your bees from starvation by feeding with our FAMOUS BEE CANDY. Price **1/6** per 1-lb., carriage extra.

Sole Agents for DADANT'S WEED FOUNDATION. Absolutely pure. Once used, always used.

Large illustrated catalogue, entitled, "Everything for an Apiary," post free on application.

**R. STEELE & BRODIE,**  
*Bee Appliance Makers,*  
**WORMIT, FIFE.**

Telegrams:—"Bees, Wormit."

Telephone:—28 Wormit.

## BEE CANDY.

**WE** are now able to supply CANDY OF OUR OWN MAKE from guaranteed Pure White Refined Cane Sugar. In 1-lb. boxes with glass tops. It can be had plain or medicated with either "Yadil" or "Bacterol."

### PRICES.

<b>7lb.</b>	<b>11/-</b> , postage 1/3
<b>14lb.</b>	<b>21/6</b> , postage 2/6
<b>28lb.</b>	<b>42/-</b> , postage 5/-
<b>112lb.</b>	<b>£8 8s.</b> , packed free, carriage forward.

BEE FOOD SUGAR VOUCHERS REQUIRED.

**JAMES LEE & SON, Ltd., Uxbridge, Middlesex.**



No. 2003. Vol. XLVIII NOVEMBER 11, 1920. [Published every Thursday, Price 2d.]

**CONTENTS.**

	PAGE		PAGE
USING ANTISEPTICS .....	541	NOTES FROM GREINA GREEN .....	543
BRITISH BEE-KEEPERS' ASSOCIATION CON- SATIONE .....	541	NORTH LINCOLNSHIRE NOTES .....	548
A DORSET YARN .....	542	BEE-KEEPING IN STAFFORDSHIRE .....	549
JOTTINGS FROM HUNTINGDONSHIRE .....	543	KENT B.K.A. SHOW AT ROCHESTER .....	549
WEATHER REPORT .....	544	CORRESPONDENCE—	
DO BEES "DO NOTHING INVARIABLY" .....	544	A Few Notes .....	550
A DAY WITH A HON. DISTRICT SECRETARY .....	546	Thanks to Mr. A. H. E. Wood .....	551
NOTES FROM EAST SOMERSET .....	547	QUERIES AND REPLIES—	
		Scientific Wintering .....	551
		NOTICES TO CORRESPONDENTS .....	551

OWING to the FALL in the COST OF SUGAR  
WE ARE IN A POSITION TO SUPPLY  
PINK (MEDICATED OR PLAIN)

# SOFT CANDY

Made from Guaranteed Pure Cane Sugar.

**NO VOUCHERS REQUIRED.**

1/5 per lb. (7lb. parcel post free, 11/-)  
(10lb. do. do. 15/6)

**E. H. TAYLOR, LTD., WELWYN, HERTS.**

THE  
**British Bee Journal**

Office: 23, Bedford Street, Strand, London, W.C.2.  
ESTABLISHED 1873.

A Weekly Journal Devoted to the  
Interests of Bee-keepers.

Edited by T. W. COWAN, F.L.S., &c.,  
and J. HERROD-HEMPSELL, F.E.S.

**Correspondence: Whom to Address.**—All matters relating to the Literary Department, Associations, Shows, etc., should be addressed, "Editors, *British Bee Journal*," and all business communications and matters relating to subscriptions and advertisements to be addressed to the "Manager," *B.B.J.* Office.

**Subscriptions.**—Annual Subscription, 10s. 10d. post free in advance; single copies 2d., or 2½d. post free. If a receipt is required by post, a stamped and addressed envelope must be sent, otherwise a printed receipt will be enclosed along with the paper.

*Note.*—Cheques and Postal Orders should always be crossed, otherwise it is very difficult to trace them if they go astray.

**How to send Money.**—Remittances can be made payable to W. Herrod-Hempshall by crossed Cheques and Postal Orders. Stamps may be sent for small amounts up to 2s. *Halfpenny stamps are preferred.*

Scottish or Irish cheques can only be taken in payment if 6d. is added for commission charged by banks for cashing them.

The Editors are not directly or indirectly interested in the manufacture or sale of bee-hives or appliances of any kind, and must refer correspondents wishing for prices or catalogues to advertisers in the paper.

## OUR DEPOSIT SYSTEM.

You are advised to insist on this being used when dealing with strangers.

### Rules and Conditions for Depositing

*In order to save trouble, it is requested that the Rules be carefully read over by persons using the Deposit System of trading.*

Goods should not be despatched until notice that the money has been deposited is received from this office.

1. **Method.**—When strangers are dealing together, the purchase-money of the articles is deposited at our office. We acknowledge receipt of the deposit to both parties, and hold the money until we are satisfied that the purchase is concluded. If a sale be effected, we remit to the seller the amount deposited, less a charge of 2½ per cent. in the £, with a minimum of 6d., and the expenses of Post Office Orders and postage, &c. Cash will be forwarded by Cheque, Post Office Order, or by Postal Order as preferred. If a sale or exchange be not completed, we return the amount deposited, after making the same deduction. By this means buyers and sellers are secured against fraud.

2. **Deposits.**—Postal Orders (drawn on General Post Office) and Cheques must be made payable to W. Herrod-Hempshall, and crossed "London County and Westminster Bank." The numbers of the Postal Orders should be kept by the sender.

We cannot be responsible for any loss that may occur in transit.

3. **Honey on Approval.**—All honey will be sold by sample, which must be sent direct to buyer.

4. **Bee Appliances.**—In ordering, the time allowed for completing the order to be stated to us when sending cash. If maker accepts, we hold cash until transaction is satisfactorily completed, when the amount will be remitted, subject to conditions as in Clause 1.

5. **Bees and Queens.**—These will be dealt with entirely by the parties concerned, so far as price, &c., go, and when the purchase is satisfactorily completed cash will be remitted as per Clause 1.

6. **Goods in Transit.**—These are at the seller's risk, i.e., any damage to or loss of an article on its journey is borne by the vendor; but a rejected article must be properly packed and returned by the same means as was used in sending it.

7. **Carriage.**—The carriage of all goods, *except such as are sent by post*, is payable by the buyer, unless otherwise agreed. If any article sent on approval be returned, each party to the transaction must pay carriage one way.

## Books for Bee-keepers NOW IN STOCK.

Cash in full must be sent with order.

		Postage
A Modern Bee Farm ... ..	7/6	8½d.
(To be obtained from this Office only.)		
Advanced Bee Culture (HUTCHINSON) ... ..	6/-	6½d.
Beginner's Bee Book (PELLETT)	5/-	4d.
BEE-KEEPING SIMPLIFIED FOR THE COTTAGER AND SMALLHOLDER (W. HERROD- HEMPSELL, F.E.S.) ... ..	1/-	2d.
BRITISH BEE - KEEPERS' GUIDE BOOK (T. W. COWAN)		
Paper covers ... ..	2/6	3d.
Cloth covers ... ..	3/6	4d.
Dissectible Model of Queen Bee ... ..	4/6	3d.
FERTILISATION OF FRUIT BLOSSOMS BY BEES (T. W. COWAN) ... ..	-/3	1d.
Honey and Health (A. HOPE) ...	-/6	1d.
Honey Vinegar (REV. G. BANCKS)	-/2	1d.
How to Keep Bees (ANNA B. COMSTOCK) ... ..	5/-	4½d.
Prevention of Swarming (WILKES) ... ..	1/-	1d.
Pollination of Fruit in rela- tion to Commercial Fruit Growing (C. H. HOOPER, F.R.H.S.)	-/6	1d.
PRODUCING, PREPARING, EXHIBITING AND JUDG- ING BEE PRODUCE (W. HERROD-HEMPSELL, F.E.S.) ...	2/-	3d.
Queen Rearing in England (F. W. L. SLADEN) ... ..	1/6	2d.
Scientific Queen Rearing (DOOLITTLE) ... ..	4/-	3½d.
Snelgrove's Method of Re- queening ... ..	-/6	1d.
The "Townsend" Bee Book ...	2/6	2d.
WAX CRAFT (T. W. COWAN) ...	2/-	2½d.
Wilke's Book on Swarming ...	1/-	1½d.
<b>MISCELLANEOUS.</b>		
The Lore of the Honey Bee (TICKNER EDWARDS) ... ..	2/-	3d.
Life of the Bee (MAETERLINCK) ...	5/-	4d.
THE BEE WORLD (supplied only to members of Associations interested in the control and development of the APIS CLUB, apart from ordinary members of the latter), per copy ... ..	-/8	1½d.
The Bee Master of Warrilow (TICKNER EDWARDS) ... ..	7/6	4½d.

British Bee Journal & Record Office,  
23, BEDFORD STREET, STRAND LONDON, W.C.2.





## Using Antiseptics.

The following from the *Daily Express* of October 5 sent by their Paris correspondent is interesting:—

"KEEP CHANGING THE ANTISEPTIC.

MICROBES' ACQUIRED TASTE FOR POISON.

Medicine has made another step forward with Professor Charles Richet's treatise on the employment of antiseptics.

Experiments prove that microbes which are intended to be destroyed by the use of antiseptics slowly become accustomed to whatever liquid is used. It is necessary, therefore, says the Professor, to change the antiseptic fairly often.

In fact, as soon as a certain antiseptic appears to be successful, it is time to use another."

It is quite likely the above theory will hold good in the treatment of bee diseases. In fact, it was put in practice about three years ago when Dr. Annie Porter was investigating the "Isle of Wight" disease. Our readers will doubtless recollect that two powders, the composition of which was never made known, were used alternately for a couple of weeks each. It is well known that human beings can become so accustomed to the use of drugs that they can take with impunity a dose that would be large enough to cause the death of two or three persons who were not in the habit of taking them. In treating bees, we have repeatedly advised a change of remedy when the one being used has apparently ceased to have any effect. It is a "tip" well worth keeping in mind.

## British Bee-Keepers' Association.

CONVERSAZIONE, OCTOBER 21, 1920.

(Continued from page 525.)

After a great deal of inspection and examination we found a few hives with large frames. These we closely examined, and found them very well filled both with brood and stores, but on questioning Signor Zanini as to their use, his only reply was "No good, no good; we are making W.B.C. hives and British standard frames, which suit us best." He had one hive of his own design with a frame made half-moon shape at the bottom, like an inverted skep. I was very much impressed with this hive, as I could see one or two excellent points in it viz. :—

Bees could at once reach the frames and

ascend to either side without waste of time.

All particles of loose comb, pollen, or dead bees drop into a recess and pass out at the entrance below, and so keep the hive perfectly clean inside. Very little propolis was used in any of these hives.

We were now taken right away into the country, where Signor Bozzali had one of the finest mansions I have ever visited. Oranges, lemons, figs, fruit of every kind were growing in abundance. Here was another eye-opener—an apiary for produce alone, of about 100 stocks, all in splendid working order, with nectar coming in from alfalfa, sainfoin, clover, acacia, etc., etc.

A great many of these hives were worked on the double brood chamber system, *but without queens*, so that the combs were soon filled with honey and sealed over. These are then taken away and stored for food for the stocks which had to be used for making up nuclei and rearing of queens.

It has been, and is, said here that Italians do not cap or seal the comb honey so well as the blacks or hybrids, but I saw as fine a sample there of comb honey as any ever produced by the blacks or hybrids in this country.

On another day we were taken to his mountain apiary, which was situated 8,000 ft. to 10,000 ft. above the sea-level, and very close to the snow, which was rapidly melting under a strong sun.

This apiary being much later than the others, some of the hives had not been spring-examined until that day. It was rather amusing to watch Signor Zanini, while examining the stocks, throw out "Regina" as no good; they *do* believe in young queens, and do not keep them longer than the second year.

Paper quilts were used on these mountain hives, with slabs of slate two inches thick to cover the quilts. On the top of the cover of the hive they had also large slabs, to keep them from being blown away.

It was astonishing to see how these bees had come through the winter in this Arctic region. Most of the food had been consumed, and new honey was being stored, gathered from different sources, except the acacia. Some of the mountains were purple with wild rhododendrons (bees work on these with profit), while other flowers bloom in profusion.

The apiary at Signor Bozzali's family residence was next inspected. It was impossible to be out of sight of bees here, as they were placed in the garden, round the house, on the top of the walls, and everywhere else possible.

On one of the terraces we had an exhibition of nuclei making with natural queen cells, which were carefully selected from

combs containing more than one, and where any doubt existed as to the fertility of a cell it was soon opened and the larva inspected, so that he had very few failures with the nuclei. Inspection would be made seven days later, when it was expected to find not less than 80 per cent. of the young queens hatched, mated, and laying. I should have mentioned here that the nuclei were securely fastened and transported to the home and export apiary for convenience, and mating of the virgin queens.

When Signor Zanini was satisfied with the fertility of a queen she was marked for export with her batch.

Other apiaries were visited in the Swiss locality, but these were not of the progressive character of Signor Bozzalli's, the majority being kept for surplus only.

Next, on to Signor Piana's, at Castel San Pietro, where we visited two or three very attractive apiaries kept by this gentleman. These were run on very different lines from those previously mentioned. Both natural and artificial queen rearing was adopted here. Mostly large frames were used, such as the Langstroth 17 $\frac{3}{8}$  by 9 $\frac{1}{2}$ . These were made in two parts, so that they could be divided into the nuclei boxes when queen mating was carried out. We examined a great many nuclei and stocks, also his queen rearing apparatus, and found them all in good order. This gentleman was very methodical and practical in his manipulations, no smoke or protector being used.

The weather and scenery were beautiful, the strong sunshine compelling us to retire to our bedchambers from 2 to 3 p.m., but we made good our investigations during the evening, when the bees were hard at work, which they continued until very late.

I have already exceeded my time, ladies and gentlemen, but I think you will be interested to hear of our visit to that important breeder of bees Signor Penna, of Bologna.

Here we found a large and scientific bee-breeder keeping about 1,000 nuclei and stocks for queen rearing and exportation. Honey was also produced in large quantities, but that was mostly used for feeding purposes, as sugar was at a premium, and could not be got in many places.

A grafting house and two large laboratories were erected near the apiaries to deal with the larvae of selected queens; also shaded open sheds for brood rearing, with 56 colonies of bees on 16 to 20 frames in each box.

Nine stocks were used for "Calabrone," or drone rearing, with three stocks for queens.

We also viewed his extracting house, with a storage room underneath for run

honey, which was kept solely for feeding purposes.

These commodious premises included a storage house for comb honey which was chiefly used for nuclei feeding; another for appliances, feeders, dummies, etc.; another for hives, with a repairing shop attached; and, lastly, a transport and mailing depôt.

After inspection of these magnificent premises we were taken to a queen mating apiary, with 650 nuclei hives. Many of these were opened for our benefit, much to our satisfaction, everything being carried out in a thoroughly progressive and scientific way which left no doubt in our minds as to his ability as a great bee-master in a great bee country.

Just one little incident to finish with. We were asked to select any of the hives for examination before leaving the apiary. Mr. Herrod-Hempsall at once selected one about 20 yards away. Mr. Penna opened it up. Withdrawing one frame of comb, he discovered the bees balling the queen. His assistants were called and ordered to run for "Fune FUMO" (a rope of smoke)—the only time I saw smoke used. This was brought, but not before Mr. Herrod-Hempsall had the ball of bees on the ground, whipping them with some long grass, thus delivering the queen which Mr. Penna picked up, but on examining her she got away. "Regina would soon come back." We waited in vain, so we went further down the apiary. Then Mr. Herrod-Hempsall told me to go to number so-and-so hive and get that stray queen. I did so, much to the astonishment of Mr. Penna, who, thanking me, exclaimed, "Great, good man, Herot-Hempsall!"

*(To be continued.)*

---

## A Dorset Yarn.

A bee-keeper of Buckingham, writing of cherries and bees, asks if I have noticed bees getting stores off their many thousands of flowers; another writes to me for the best varieties to plant for profit. It is difficult to advise, as in some districts all varieties do well, in others the Morello and May Duke are the only ones to regularly crop. We have the Elton, Black Eagle, Waterloo, Gov Wood and Napoleon, but the weight of fruit has never been great, although the blossom has always been very free; yet in the woods the wild cherries bloom and fruit freely round about here. Bees seem to work very freely all kinds of fruit blossom, the Morello has always given a crop, and there is nothing more beautiful than the double blossoming cherries that are now in commerce—I remember seeing them at

Col. Tinker's beautiful grounds at Chewton Glen, in Hants. The able gardener, Mr. Weaver, is enthusiastic in getting all that is beautiful to grow for the pleasure of the owner; he is successful with them all, but his bees always go under each year. I have started him two years in succession from our lot, but at the great autumn show at Bournemouth he said they had gone under again; yet the area seems to be an ideal one for bees, the woods are full of the wild cherries. These fruits are very old; I had read somewhere that it was the favourite fruit of one Mithradates the Great (a century before the birth of our Saviour Christ), who tried to crush the Roman power in Asia. The Roman generals, Flaccus, Lucullus and Pompey were sent to crush him; when these generals come back to Rome they brought with them branches of these pontic cherries that were grown by the eastern monarch, as some of the trophies of war. In that war 155,000 men fell: all that we have at this time to show for this ruthless slaughter are the cherries. Books tell us and pictures show us how well the bees in that country gather surplus honey. The Old Book tells us that the Wise men came from the East; now we have our men who soldiered in the East having the Eastern bees—these bees came from the race that fertilised the cherries of Mithradates the Great, who was supposed to be the ablest monarch of the East, a master of twenty languages, but whose chief pleasure was the cultivation of cherries.

John Evelyn, one of our clever writers on bees, states that "wine from cherries mixed with honey makes a fine conditum for the stomach." Some critics may think this is digressing from the subject of bees, still it is answering letters of bee-keepers that keep us from getting tired of writing. There is plenty more to write of cherries, but I hope the men who want to plant cherries, will not "put all their eggs in one basket." If it is cherry country then it is all right, if you can wait for your returns. If you are young, then you will get the blossoms for your bees, and fruit to sell, for weight of fruit only comes when the trees are large, the first few years it is not very heavy.

Was away four days of last week, and did not see the bees out till Saturday, then they were out in great numbers. They seemed to have the robbing song, yet I could not see which one they were clearing out (it might be my neighbours), but the hurried flight and shrill tone was like the song of robbers. The Dorset Executive of the County B.K.A. met at Wimborne on Saturday. Mr. Garret showed some of his delightful honey which was gathered when the bell heather was in bloom. It

has a blend of other flowers, giving it a delightful taste. He also said that the ling heather honey was impossible to get out of the combs with the extractor.

The question of lectures was discussed to give all the teaching to young beginners in the winter; then when the bee season is booming all will be ready. Arrangements for bees and Italian queens; an attractive label for Dorset honey, so that all our county members who sell their surplus shall have as good a name as we have for our butter. Though late in having a county association, we want to make up for lost time.—J. J. KETTLE.

## Jottings from Huntingdonshire

Jack Frost has been busy these past three nights, and together with the gorgeous sunshine of the day has succeeded in giving the elm leaves a saffron tint. Some have fallen and mingled with those of the ash and chestnut, and strewed the way with their beauties, and as one walks abroad at night the smell of decaying leaves, and the rustle beneath one's feet is good for nose and ears. 'Tis well Jack Frost has busied himself amidst the branches and twigs if only to remind the stately elms, and the statelier oaks, that as a sailor takes in sail before the storm so, too, Nature has ordained they should shed their sails before the hurricanes of winter sweep o'er the land. It has been a perfect day to-day. The sun rose in chariots of fire, dispelled the lingering mists, and set the wrens and blackbirds singing as if April were here. The lark, too, was unable to resist the call of space 'neath clear blue skies. He rose and sang to a golden world. The strifes of men distress him not. He sings at the gate of heaven, unconscious of what some men of the world are doing beneath. He sees the plodding ploughman, following his team up field and down; he sees the shepherd calling to and counting his flock; he sees the hedger slashing away at hawthorn, bramble, alder and privet—cutting into autumn and leaving the marks of winter behind him. He hears the drone of the thrashing drum, and sees the flakes of steam and smoke lazily rising and vanishing away. Yes, he sees all this and sings away; but he does not see old George, of seventy years and six, shivering before a coalless grate, nor "owd Andrew," screwed up with rheumatism, praying that strikes and unrest may cease, nor Mary Cotts, nigh distracted because with bits of wood and no coal she cannot get the oven hot enough to bake the bread. He sings away, and I ask myself why he has stayed

so long in his resting-place, why has he not, in common with the rest of his kind, flocked southward, leaving this neighbourhood for his kinsfolk of a northern clime? Could he answer me he would say that the mellow autumn had bidden him linger, and the warm, soft sunshine had enticed him to stay. He was happy, and so also the bees. At ten o'clock they came out in great numbers, scarce able to contain themselves with delight. Of course where the master was they'd be if they could. I saw a few blocks; they come to fly around and look on, and as a block falls to the ground a few settle on it and say something with their wings—in praise of my work, or condemnation, I cannot tell. I go and do a little clipping of a privet hedge, they come in scores to watch me work, while they're at play. They settle on nettles, chickweed, groundsel, anything just to pretend they are busy, too. A few decide that they would try to make me run—youngsters they. The game commences, first one comes full flight at the back of my neck, then one comes bang against my cheek, but I go on clipping away, and they, finding they have failed to frighten me, come and settle on my shears, one even walks up my sleeve to investigate. Puzzled no doubt—wondering whether shears are wings and such like things. I love to watch bees at play, they make me laugh more than a pair of kittens. The unmistakable hum, too, is infectious. By wings or spiracles, or both, I cannot say, but anger, work, play, distress are all expressed by each particular hum. Can I describe them? *Tsing*, harshly sounded, is anger, *tsang* is distress, *oown* (two syllables) is play, while *umm* is work. It is between two and three o'clock when they decide to return to their lives, and what crowds there are! My entrances are only open a two-bee space, so it is quite a time before all have joined their cluster, happy and thankful that November has, so far, belied its name.—E. F. HEMMING, Steeple Gidding.

## Weather Report.

WESTBOURNE, October, 1920.

Rainfall, 3.63 in.	Frosty nights, 0.
Heaviest fall, .84 in. on 31st.	Mean maximum, 59.4.
Rain fell on 11 days.	Mean minimum, 47.2.
Below average, .47 in.	Mean temperature, 53.3
Maximum temperature, 72 on 9th.	Above average, 4.0
Minimum temperature, 38 on 24th and 30th.	Maximum barometer, 30.394 on 26th.
Minimum on grass 29 on 30th.	Minimum barometer, 29.423 on 31st.
	L. B. BIRKETT.

## Do Bees "Do Nothing Invariably"?

(By L. Willis.)

If bees "do nothing invariably," as the slogan goes, then bee-keeping can only be hobbled, as fluke harvests are a lean proposition to the smallholder. But it cannot be so—all nature gives it the lie, as the further we go, and the deeper we delve in our puny efforts to correlate cause and effect, the more indubitably do we find that all is governed by law and order. If we wish, therefore, to subordinate anything to our own ends, it is up to us to find out these ruling influences. Particularly is this the case with live stock, as "life" permits of no mistakes; live stock does not argue in such case, it simply turns up its feet—and the smallholder is a poorer, if not a wiser, man. If a plank, therefore, can be thrown down giving a footing, it may be that wider investigation will lead to a firm platform for the use of those under the necessity of making a profit from bees, and it is in this hope that I venture to lay before the readers of the *BRITISH BEE JOURNAL* some notes of experimental work carried out in our apiary, neither scientific nor bacteriological, but sheerly practical, by which I was enabled to get control over stocks to a degree beyond expectation, even in the short time there was an opportunity of continuing and verifying such experiments.

My plank is the cult of the "bottom of the hive," and it is truly remarkable how bees approximate in their actions if this is borne in mind.

I stumbled on the first hint of this several years ago through having 18 nuclei about the apiary towards the end of the season when robbing tentatively started, and as there were also between 40 and 50 strong stocks, it was a contingency I did not care to face, so, although the nucleus queens were valuable, it was decided to chance joining them up to the stocks that evening. This was done, some at the bottom of the stocks and some at the top, with excluders and paper in between. When examined some fortnight later, a curious fact showed itself—those introduced at the bottom were comfortably installed and laying, as were also the old queens at the top as if nothing untoward had happened; but of those introduced at the top the greater percentage had been sent "West." Since then I have introduced a number of queens by this method to large stocks without first de-queening. De-queening not only means a large amount of work to the operator, even given weather suitable in all respects (and how often do we get that about the

time re-queening is necessary?), but it also means an incalculable amount of unnecessary and disorganising anguish to the bees, and it is in running counter to their happiness and well-being that we cannot hope to get them to contribute to our benefit with any degree of certainty.

The nucleus method of introduction also gives the advantage of enabling the queen to be tested and sized up before introduction to a stock; I have found the largest stock sheer crazy with delight when, after eating through the paper, they have found a fine young laying queen installed in the seat of honour; it is a picture to see such a stock in its abounding energy and renewed vigour. The Alexander method of letting all the old bees fly from a nucleus and then caging the young queen for a bit is the simplest and safest to employ; in about a week's time she is fairly started, and whenever required can be united by laying newspaper over the nucleus, and on this putting an excluder; then the stock it is wished to re-queen is placed over the paper and excluder, the old queen being again "excludered" above with super box or boxes in between. We always tried to time the breaking through of the bees to fall at night, when the suspicions of bees are at their lowest ebb, and any excitement would not be noticeable at the front of the hive before the stock operated upon could look after itself; for this reason we joined up at dusk, and also arranged the thickness or pricking of the paper so that they should neither break through in an avalanche nor hang fire too long. With the help of a few medicated cloths and Porter boards the largest stock can be prepared for uniting without bee loss or distress to the operators when the amalgamation takes place. Although we have joined up stocks with six and more stock boxes, it is better in general practice not to have the stock in more than four boxes; this can easily be arranged in advance if the queen is down below by "Portering" any excess boxes a day or so previously and driving the bees into a temporarily closer compass, always remembering that if the stock to be joined up is a strong one, and particularly if driven down, an extra box or two should be put on the top of the newspaper and excluder over the nucleus before uniting, or the bees confined above will smother before they can get through.

Our method of preparing the stock to be united was as follows:—At that time of the season queens were confined in two boxes. In the afternoon the excluder was slipped off and a Porter-escape board substituted, on which was placed the upper two boxes, which were covered over with a medicated cloth well held down. Some hours later at dusk all upper parts

of the hives were removed, and, our outer body boxes being only of "lift" height, all boxes were exposed to easy lifting. Everything being loosened earlier when the stocks were prepared this was done without the slightest suspicion being raised. After seeing that the paper on the nucleus was still intact, the upper two boxes on the stock were gently and swiftly lifted on to the nucleus, and another Porter escape-board put on to the one already covering the boxes with the queen, thus confining any stray bees which would soon find their way down; the medicated cloth was then drawn from the boxes on the nucleus and a queen excluder placed thereon; the remaining boxes with the old queen were then placed on the top of this. The bees left on the floorboard being mostly old and sentinel bees, were not thrown at the entrance, but covered over with a roof and faced into a hedge, a frame with a little honey in it being put against the inside back; in the morning those that had not already flown back were shaken in front of the joined-up stock if it were seen that the topped bees had broken through the paper.

The next morning, if through, the two top boxes with the old queen were slipped off quickly and quietly on to a spare stand with entrance slides closed temporarily, and taken back, when the old bees flying back to their old stand, it was a very simple and easy matter to de-queen, even in trying weather, as the bees being gentle and comparatively few she was found usually very quickly. The hive having been left with a medicated cloth over the top and extra excluder withdrawn, it was then a simple matter to return the boxes with brood.

Before we found out how very simple a matter it was to slip top boxes on to a spare hive without disturbing the stock below, and to carry them back for examination behind wind screens, the old queen was left on top for five days or more if the weather was not propitious; but it was found that in practice it was better to slip her off next morning when they were well united, as in very large stocks there was a danger of the bees decamping with the young queen; especially may this be the case if it has been found impossible for some time before the uniting to examine the old stock for queen cells.

In very small stocks or nuclei it is never safe to leave two queens, as it is expecting the impossible from bees—they cannot keep pace with one queen let alone two. But here again, the curious ascendancy of the bottom of the hive over bees' actions was exemplified, as in several instances where small lots were joined together on account of scarcity and ten-

dency to robbing, it was the top queen that was killed, not the new one introduced at the bottom, although both were young.

Before uniting a queenless or laying-worker lot, of course, it is always advisable to put them into a more normal state of mind by giving them a comb or two of eggs and brood; with a laying-worker the precaution was also taken of "excluder-ing" her above with a box in between, when the bees did the needful.

That is, broadly, our method of queen introduction, and it takes longer in the telling than the doing, but it *made us independent of the weather* and enabled us to go on re-queening stocks without the loss of one valuable day. Its value cannot be computed therefore in the prevention of swarming.

(To be continued.)

## A Day with a Hon. District Secretary.

Bang! Bang! on the front door. Breakfast time. "Hello! who now?" A small boy, match box in right hand, note in left, match box containing three bees; note asking "What is it? send p.c. and oblige." "All right, Sonny, I'll attend to it, good morning." A case of May Pest, these bees swarmed eight days after.

The Secretary, a market gardener, picking peas, with two others, busy getting orders for local shops. 9.30 a.m. Motor car comes down the road. "Hey! Mr. Jones, I want you." Mr. Jones: "Yes, sir, what can I do for you?" "Well, my bees have swarmed, and I wish you would run over and see to them for me. I know you are busy, I'll take you in the car and bring you back." "Thank you, sir, I'll just change, and be back with you in five minutes." "No, come as you are, you will be just the same." Off with a full-blown Brigadier-General, driving five miles out; home again at 11 o'clock. A real gem, that man, not a better to be found, a pleasure to help him, he knows how to condescend, etc.

Dinner 12 o'clock, my wife is nothing if not punctual. 12.15. Another banging. No peace for the wicked! This time a lad with a message from the 'phone.

"Mrs. Dryhams bees have swarmed, can you go at once?" "Oh, yes." Bike this time, a good old pre-war Swift. Just ready to start, another light, tap! tap! This time a gentleman. A man who calls himself a professor in apiculture, in a great hurry. "Get a move on, Mr. Jones, can you come and hive a swarm of bees? They have settled on a tree in the street, and I'm afraid people will get stung." "Oh! yes. I'll come at once." Hived Mr. Professor's bees, while he stood and

looked on. Poor fellow. I pitied him, could not hive his own; he is not an expert, but a professor. Off to Mrs. Dryhams. Yes, the bees had swarmed and settled in a lovely place, on a Dorothy Perkins rambler rose trained to some lattice work in a town garden. Yes, a garden, not a back yard. The only way to hive these, drive them up with a carbolic cloth; I never carry a smoker; too clumsy, cannot get them in the pocket. I drove them up to the top, and they hived themselves; finished at 3.30; home again.

Tea at our house is four o'clock. Don't forget, if I'm not at home I'm out, Mr. Editor. You'll find a cup of tea there at that time always, if ever you come to Babiestone. You'll find a hearty welcome, don't forget.

4.30. Back door this time. Mr. Boots! Here, half-time! What is the matter with you."

Yes, Mr. Secretary is getting "fed up" by this time. "Come on, my bees are having a nice game with me, I've hived them twice, and they are out again." "Umph!"

Went back close to Mrs. Dryham's place and gave them two combs of brood and eggs, then they settled down like kittens to new milk. With many thanks from Mr. Boots, I left him scratching his head. He'll not trouble me again if he can help it. I do like him, he is in earnest, got a severe attack of "Beeitis."

Home again on those peas, must have them off for to-morrow morning, peas are short, and making a good price. That Boy again with another 'phone message. "Three swarms up at Acorn Rectory, will you kindly go up as they are hanging on the 'phone!" "Who, the bees, my lad?" "No, sir, some one at the Parson's." "All right, tell them I'm coming." Another five miles trip, good old Swift! Three hills to climb (and we have some hills round Babiestone).

Yes, there were three swarms in a cluster, or rather in a heap, on the ground, the combined weight eleven pounds thirteen ounces. "What can you do with these, sir, you cannot get them all into one hive, and, what makes it worse, two swarms belong to my gardener, and one to my daughter; is it possible to separate them? My daughter's are Italian, and the gardener's something else, and it is getting late. 7.30, Summer time." "Well, I'll try and separate them," and separated they were. The lady had her Ligurian queen, but a mixed lot of workers. The gardener had two queens and a mixed lot of workers, all done without a sting; they were a good tempered lot. I suppose they had taken a leaf out of their owner's book. "Patience makes the gardener," and his bees were very

patient. And I do think a parson must have patience. Preaching to the same people every Sunday, and Matins and Evensong every day. Both were satisfied, and I, your humble, was, with a five mile run home, singing, "When you come to the end of a perfect day."

This last little incident found its way into some of the London dailies, as well as the local Press at the time.

Now, Mr. Editor, these names and places are not correct, other names are put in the place of the original, but the incidents are all perfectly true and as they occurred. Now, when people ask what is the B.B.K.A. doing, or the Sheepshire, or Hopshire, or some other B.K.A., for apiculture? let them have a day with a District Secretary, and see what is done by our Hon. General Secretaries of these "do-nothing" Associations. In future they will close up their little mouths, and wonder how much is done for the love of the thing, and they will be dumb for evermore. My district reaches from my house nine miles north, eight miles west, and south as far as I care to go to get new members. To the east I have the rolling sea carrying commodities for our breakfast, dinner, and tea.

Our members number twenty-eight, and only two of them have kept bees more than two years.—TOM JONES.

### Notes from East Somerset.

I have intended sending you a few "Notes" from this district for some weeks, but my spare time has been practically nil—hence they have not arrived before.

I don't suppose a season opened with such promise and possibilities as did 1920. Beautiful weather, temperature all that could be desired, and stocks simply romped away, and filled up both with brood and stores in next to no time. Too many were caught napping, and swarms began to issue before supers were anything like ready. I had my record early swarm in 20 years of bee-keeping on April 29, but alas! never a year ended so disastrously. Everywhere comes the same cry—"My bees hadn't one cell of food." I venture to say that more stocks will go under this winter from starvation than from the "Isle of Wight" disease, unless well-made, soft candy is continually supplied—I say well made, because so much candy is boiled so hard that I have failed to break it with a hammer. Bee-keepers seem to forget to use the thumb-nail test, and that the bees have to go out for water before they can make any use of candy.

Queens seem to have kept at laying

rather more than usual; I have found stocks with not a cell of food, yet with plenty of eggs—that was in the early days of October, during the best spell of weather we have had this year.

Honey is conspicuous only by its absence in our district. I only know of two bee-keepers who have taken anything worth noting. But feeding has been quite the order of the day. It's been a very costly business, too. I first fed down with sugar syrup, but later got some of the New Zealand honey and gave them that. I found that after boiling it slowly for half an hour, and giving it warm, they took it down very rapidly and sealed it much quicker than with sugar syrup. Owing to feeding for such a long time, consequent on stocks being so short, most colonies started breeding in earnest. All my stocks have 1920 queens, and they did show some hustle. It was a sight to see in my garden during the last seven weeks thousand of bees on the wing, bringing in pollen of every hue, from white to smutty purple. Many times I have seen twenty to thirty pollen-laden bees trying to enter at the same time. They must have gathered quite a lot of honey, too, as many days they were on the wing for eight hours, sometimes more; most entrances have had to be enlarged. If there is one thing I would like to emphasise more than any other it is *young queens and good, roomy hives of W.B.C. pattern*. Neither costs too much, and are a good investment. Our friend, Mr. Kettle, has very beautifully given us the same hint, and I should like to say right here and now how much I personally enjoy his "Yarns." My mother, who is a native of Corfe Mullen, knows the district well, and loves to read of what is happening near where her father kept bees, nearly a century ago. One is glad, too, that the "Isle of Wight" disease is not so virulent as it was, and I often wonder what "cure" can claim the victory. There is no real cure, I think, only what one might call a "reliever." In the early days I tried Epsom salts, Dioxogen, and Izal, but the bees went. Now I have tried and kept my bees continually in touch with "Flavine"; and though we are not yet out of the wood, and mustn't shout too soon, yet I am glad to report not a sign of the disease in my apiary at all. One cannot help admiring the way Mr. Smith gets to work and tries to help stamp out the disease. I believe he is a real bee-keeper.

My notes are getting rather long; before I close, however, I want to speak a word to those who are novices, or who are contemplating bee-keeping in the New Year. Invest in some good books and

get thoroughly conversant, as far as possible, during the winter months, with the idea of how and what to do in connection with your hobby, and do not be so ignorant and helpless when your bees arrive; then you won't buy a skep and transfer the bees from a nucleus traveling box to it like someone did that didn't read books but thought bees could live only in *skeps*.—R. LITMAN, Castle Cary.

## Notes from Gretna Green.

### Re "ISLE OF WIGHT" DISEASE.

Looking over my back volumes of the B.B.J. I find that "Isle of Wight" disease became menacing so far back as 1907. Research specialists got to work on the subject, and in due course we were told that the cause was *Nosema apis*.

By to-day's B.B.J. I perceive that these *savants* were utterly wrong, for other scientists have discovered that *Nosema apis* is innocent, can, in fact, plead an *alibi*, as "Isle of Wight" disease is caused by quite a different miscreant.

In a few years time new scientists will doubtless allocate the blame to yet another microbe, and so on *ad infinitum*.

This hide-and-seek business is rather interesting, but neither the learned men or the Government pamphlets on the subject have produced any cure for the disease.

It may be said that discovery of the cause must precede the finding of a cure, but this view of the matter is scarcely correct.

Disease has been prevalent for a dozen years, and the orthodox dictum of "No cure! destroy all affected stocks!" has been followed in many cases to the extreme limit of sulphuring the entire apiary year after year.

Those unfortunate persons must needs buy in a fresh stock of healthy bees each season, and the problem waiting solution is why the change of ownership should so affect these healthy stocks that they die, or have to be destroyed within a year of changing hands?

In one such case the bee-keeper is a veteran who has record crops of honey to his credit, but his losses through "Isle of Wight" disease total over 300 colonies. I regret to learn that even Mr. Wood's model apiary at Glassel has suffered severely—another instance of the successful honey producer being unable to master this disease.

I make no comment on the legion of "cures" and "treatments" suggested in these columns unless to remark that the latest specific, "onions," may at least do

some good in the way of inducing tears over the thousands of victims sacrificed on the "no cure" altar.

The pity of it is that a remedy has been available for some time among really competent and practical bee experts.

The "expert" who cannot keep his own apiary clear of disease is in line with the good woman whose claim to be an authority on child-rearing was based on the fact that she had "buried ten of them"!

May I venture to suggest that such practical men as Allbon, Atkinson, Smith, Simmins, and Silver tell British bee-keepers, through the B.B.J., just how their respective apiaries are kept free from "Isle of Wight" disease.

Mr. Robertson, of Steele & Brodie, is another who has solved the problem, and it is significant that these well-known beemen all hold identical views on the prevention and cure of the malady.—J. M. ELLIS, Gretna, Carlisle, November 4.

## North Lincolnshire Notes.

This year has been the worst for honey that I have experienced. Stocks that were strong very early in the season did the best, and the honey was of fine quality, also sections. This was proved by the prizes taken at local shows. No honey seemed to be gathered after the end of June. The forward stock gave me from 40 to 70 lb. of honey, whereas others gave no surplus.

Respecting nuclei, they have been fed all the summer right up to now, second week in October. Where there were young queens the stocks have responded well to the feeding. Queens have been laying right up to now. A few days ago I noticed bees bringing in large loads of pollen.

This is the state of things all over the district. On my rounds "experting" I find some stocks have done well, and others nothing. On my autumn round many beekeepers were surprised when I pointed out to them that their stocks had no food for the winter.

Many make the common mistake of taking off surplus, and covering down for winter right away without examining the brood box as to the amount of stores for winter; also to make sure the stock is queen-right.

I am sorry to say "Isle of Wight" disease is with us in various parts of this district, and we are having strange experiences with it. But all that is another story. We intend to "carry on" and hope for better times.—W. ION, Healing, Lincs., October 30.



## Bee-Keeping in Staffordshire.

EXPERT'S REPORT ON THE PENKRIDGE APIARY.

The following report on the Penkridge re-stocking apiary by the County Bee Expert (Mr. Joseph Price) was presented to Staffordshire Education Committee:—

"I am pleased to report that, despite the unfavourable season, the bees at the apiary have done well. From the 16 stocks of Italian and Dutch bees that wintered, I have secured 35 natural swarms and casts, and lost two small Dutch ones, which came off and decamped during my absence. I have received 51 queens (Italian) from the Ministry of Agriculture, and all have been successfully introduced except two, which were more dead than alive when they arrived. I have made 80 nuclei, 67 of which have been despatched to shareholders. Every shareholder has had the chance of taking a nucleus, but for various reasons some prefer to wait till next season. Therefore, I propose uniting these surplus stocks, taking into winter 16 stocks as last year. During this year 330 sheets of foundation have been drawn out into combs. This has been a most difficult job this wet season, and could not have been done without the help I obtained from ex-Service men and others. I have raised over 60 Italian queens, but owing to the inclement weather half of them either failed to mate or were lost during their mating flight. This summer the apiary has been visited by several members of the Bee Committee, all of whom I think were satisfied with the work. The expert of the Ministry of Agriculture, Mr. W. Herrod-Hempsall, paid a visit in June, and reported that he was very satisfied with all he saw. I am pleased to report that to date, September 2, all the stocks are healthy, and there has not been the least sign of any disease. Unfounded rumours have, however, from time to time been in circulation that the 'Isle of Wight' disease has broken out at this apiary. This statement I have flatly contradicted, but the report seems to have gained ground among the bee-keepers in the south of the county, possibly because it has not been possible this year to arrange a day for receiving visitors at the apiary. At a meeting of the South Staffordshire Bee-keepers' Association on June 14 it seems to have been accepted as common knowledge. I at once wrote to the Secretary of this Association asking him to contradict this statement. There is no foundation of any sort for alleging that now or at any time has there been any sign of disease at the Penkridge apiary. During the season I have received reports of nuclei supplied from this apiary both during last season and the present season, and I am pleased to

say many have done exceptionally well, whilst not one stock has succumbed to disease.

"RODEASTON APIARY.—The one stock of Italians received at the Farm Institute in April has now increased to three. All are quite healthy and strong and should winter safely."

The report was approved, and it was decided to forward a copy to the Secretary of the South Staffordshire Bee-keepers' Association.

Attention was drawn by the Director (Sir Graham Balfour) to a statement as to the circulation of unfounded rumours concerning an outbreak of "Isle of Wight" disease at the apiary, and it was resolved to issue to the Press a paragraph contradicting the rumours.

It was decided, on the recommendation of the Agricultural Education Committee, that a county scheme for instruction in bee-keeping and for the apiary at Penkridge be drafted by the Director and the Bee Expert.

## Kent Bee-keepers' Association.

SHOW AT ROCHESTER.

A large number of visitors were attracted to the Masonic Hall, Rochester, by the magnificent show of honey staged there. In spite of an unpropitious season from the bee-keepers' point of view, over 150 entries were made in the competition, and in the opinion of the judge, Mr. W. Herrod-Hempsall, F.E.S., the standard reached was a very good one. More mistakes than usual were made in the grading of the honey, but the granulated honey, wax, and sections were particularly good. Some of the cakes sweetened with honey were good, but it is never advisable to use fruit in the making, as the cake is more liable to drop. The majority of the samples of candy were very good indeed, and the appliances were well made.

In opening the show, Mr. H. M. Cobb said it was always a pleasure to be associated with the society which carried on such useful work. Last year the show was held in a small room, and he prophesied that this year they would want more space. He would not prophesy this year, but he would urge the committee to procure the Corn Exchange for next year's show and ask the Mayor of Rochester to open it. He was confident that the members would support it. The exhibit of honey, etc., sent by the disabled soldiers in training at Eynsford was most interesting, and although he did not know whether the standard in the competition classes was higher this year—it

had been a bad season for bees—they had done extraordinarily well.

Mr. G. W. Judge voiced the thanks of the association to Mr. Cobb and to the committee which had worked hard to stage all the exhibits. The quality of the honey was excellent, but they must look to the future and secure 350 competitors for next year.

During the afternoon music was played by the Gundulph Orchestra, and tea was served under the direction of the Ladies' Social Committee. Mrs. A. Fry distributed the prizes to the following:—

#### KENT MEMBERS' CLASSES.

Six sections.—1, Mr. T. M. Taylor; 2, Mr. G. Bryden.

Six jars light.—1, Mr. G. Bryden; 2, Mr. W. Wilson; 3, Mr. M. J. Hammond.

Six jars medium.—1, Mr. G. Bryden; 2, Mr. T. M. Taylor; 3, Mr. W. Wilson.

Three jars granulated.—1, Mr. W. Wilson; 2, Mr. G. Bryden; 3, Mr. G. R. Allen.

Two shallow frames.—1, Mr. G. Bryden.

Home-made hive.—1, Mr. R. H. Miller.

Home-made appliances.—1, Mr. R. H. Miller; 2, Mr. G. Bryden.

One section.—1, Mr. G. Bryden.

One jar light.—1, Mr. G. Bryden; 2, Mr. W. Wilson; 3, Mr. L. W. Matthews.

Beeswax.—1, Mr. G. Bryden; 2, Mr. A. E. Barnes; 3, Mr. R. H. Miller.

Bee candy.—1, Mr. A. E. Barnes; 2, Mr. R. H. Miller; 3, Mr. A. Fry.

#### NORTHERN DIVISION CLASSES.

Three sections.—1, Mr. G. Bryden; 2, Mrs. Kennedy.

Three jars light.—1, Mr. G. Bryden; 2, Mr. W. Wilson; 3, Mrs. Kennedy.

Three jars medium.—1, Mr. G. Bryden; 2, Mr. W. Wilson; 3, Mr. J. Reader.

Three jars dark.—1, Mr. G. Bryden; 2, Miss Heale.

Three jars granulated.—1, Mr. G. Bryden; 2, Mr. W. Wilson; 3, Mr. S. J. Barnwell.

Two shallow frames.—1, Mrs. Kennedy. One jar light.—1, Mr. W. Wilson; 2, Mrs. Kennedy; 3, Mr. A. Fry.

One section.—1, Mrs. Kennedy.

Observatory hive.—1, Mr. G. Bryden. Articles of food.—1, Mrs. Kennedy; 2, Mr. G. V. Cooper.

Honey cake.—1, Mrs. G. Bryden; 2, Mrs. G. R. Allen; 3, Mrs. R. G. Bryden.

Trophy.—1, Mr. G. Bryden; 2, Mr. W. Wilson.

Beeswax.—1, Mr. R. H. Miller; 2, Mrs. Kennedy.

Two jars (novices).—1, Mr. W. Thompson; 2, Mr. G. Hoare.

Two jars light.—1, Miss E. Heatly.

#### CUP WINNERS.

The winner of the Bryden Cup was Mr. G. Bryden with 33 points, the runners-up being Mr. R. H. Miller (13 points) and Mr. W. Miller (12 points). The Wilson Cup for members of the Northern Division was won by Mr. G. Bryden with 27 points. The runners-up were Mrs. Kennedy (23 points) and Mr. W. Wilson (16 points).

Amongst those who contributed to the prize fund were:—Mrs. Kennedy, Gillingham, 5s.; Mr. W. Wilson, Darenth, £1 1s.; Co-operative Society, Ltd., Gillingham, 10s. 6d.; Mr. C. Spurge, Gillingham, jam dish; Mr. R. Palmer, Gillingham, bowl; Mr. A. Ride, Gillingham, hyacinths; Mr. D. Kennedy, Gillingham, safety razor; Direct Boot Supply Co., Gillingham, slippers; Mr. H. Hubbard, Gillingham, tennis shoes; Mr. H. G. Croneen, Gillingham, honey server; Mr. F. White, Gillingham, tumblers; Mr. Stevens, Gillingham, server; and Mr. Brown, Gillingham, jam dish.



*The Editors do not hold themselves responsible for the opinions expressed by correspondents. No notice will be taken of anonymous communications, and correspondents are requested to write on one side of the paper only and give their real name and addresses, not necessarily for publication, but as a guarantee of good faith. Illustrations should be drawn on separate pieces of paper. We do not undertake to return rejected communications.*

#### A Few Notes.

[10333] Your report of the results of the investigations at Aberdeen are exceedingly interesting, and the results themselves should prove most important. There is one question of very great moment that it is possible may be able to be answered at once. It is this: Has it been determined at all yet for how long a period the Tarsonem will live outside the body of the bee? If only a short time many things will be explained with regard to the symptoms and effects of "Isle of Wight" disease.

It looks at least as if there may soon be some definite treatment. Let us hope this will be the case.

It may interest you and your readers to hear that a small patch of the annual sweet clover grown in my garden from seed procured from the A.I. Root Company, and planted at the end of April, has been in full blossom since the end of June, and is even now (November 6) daily

visited by crowds of bees. It seems a wonderful plant. I hope soon to send you on a photo or two of it. I am endeavouring to get a little more seed for next year.

With regard to Mr. Tredcroft's letter. My own experience has been the reverse of his. I find that while a pure Italian of a leather colour or three-band type, will not be affected at all, the hybrid is exceedingly prone to crawling. A pure Italian queen and a comb of pure (hatching) Italian brood will usually effect a complete cure.

Bacterol may be a good thing. I never used it, and I hope I never shall need to—or any other drug—but I fail to see that there is anything "natural" in dosing bees with it any more than there is in vinegar. I never used vinegar, so cannot speak about it with any certainty. At the same time, I might ask Mr. Tredcroft "Where on earth do pigs get milk and barley meal in their natural life?"

This has been a curious season altogether. I mean as to the behaviour of bees. I've never known such strange antics with queens. *Vide* (9912).

I may say I beg to differ from the sentiments expressed by Mr. Wood in his last paragraph in every particular. If it had not been for the "foreigner" my belief is there would have been no bees in this country at all at the present time, and, consequently, no bee-keepers.—  
ROBT. B. MANLEY.

### Thanks to Mr. A. H. E. Wood.

[10334] The good news published in your issue of 4th inst. respecting "Isle of Wight" disease is great indeed, and bids to mark one of the most important discoveries in connection with our craft. But do not let us forget what we all owe to Mr. Wood for his unobtrusive but effective help which you refer to so well. There are few of us who have not had serious losses from "Isle of Wight" disease, and every member of the craft must wish to thank him. This I suggest may be best done through your journal, and after a week or two the total of "thanks" printed in the ordinary course.

Now we must have patience while a cure is found for the dread disease.—T. KNIGHT.

## Bee Shows to Come.

**November 18.**—Annual Show of the Worcester City and County Chrysanthemum, Fruit, Root and Honey Society. Thirteen Open Classes in Honey Section.—Schedules from Geo. Richings, 42, Barbourne Road, Worcester. **Entries close November 6.**



Queries reaching this office not later than **FIRST POST on MONDAY MORNING** will, if possible, be answered in the "Journal" the following Thursday. Those arriving later will be held over until the following week. Only **SPECIALLY URGENT** queries will be replied to by post if a **STAMPED** addressed envelope is enclosed. **All queries must be accompanied by the name and address of the sender, not necessarily for publication, but as a guarantee of good faith. Correspondents are requested to write on one side of the paper only.**

### Scientific Wintering.

[9913] Mr. Noel Aveline, in his interesting article in the *JOURNAL* of the 7th Oct., recommends two thick cork-dust quilts. Is no other covering to be used except the ticking on the frames, or do the cork quilts function equally well with blankets on the top? Where can these quilts be obtained?—**VERNON DEAN.**

**REPLY.**—We prefer to use two or three thicknesses of blanket *under* the cork-dust cushions. The cushions are easily made at home. Make a bag a little larger than the inside of the hive, and fill it with cork-dust, which may be obtained from a fruiterers. It is generally used for packing grapes. It is better not to stuff the bag too tightly, or the cushion will not fit down nicely.



Correspondents desiring an answer in the next issue should send questions to reach this office **NOT LATER than the FIRST POST on MONDAY MORNING.** Only **SPECIALLY URGENT** questions will be replied to by post if a **STAMPED** addressed envelope is enclosed. **All questions must be accompanied by the sender's name and address, not necessarily for publication, but as a guarantee of good faith. There is no fee for answering questions.**

**BEGINNER** (W. Bromwich).—*Queen thrown out.*—We cannot account for the dead queen thrown out of the hive. Under the circumstances you had better look through the hive if there is a warm day; it is just possible there may be another queen in the hive. If not, you might try introducing one, if you can get it. A better plan will be to unite with another stock that has a queen. If you have not another stock, you might be able to purchase a nucleus or small colony with a queen.

**G. H. C.** (Wolverhampton).—*Moving bees.*—You may move the bees half-mile any time now.

## Special Prepaid Advertisements. One Penny per Word.

Advertisements must reach us **NOT LATER** than **FIRST POST** on **MONDAY MORNING** for insertion in the "Journal" the same week.

### PRIVATE ADVERTISEMENTS.

**LIFE INSURANCE IS A SOUND INVESTMENT.**—Will fellow members of the craft write for prospectus to H. M. LOWE, Park Road, Chilwell, Representative for "Royal," "Scottish Temperance," etc.?  
k.66

**13 CWT. NORFOLK HONEY**, granulated, 28-lb. 14 tins. Offers invited.—G. ASHTON, Lodge Road, Feltwell, Norfolk.  
k.65

**PLATE-GLASS MIRROR**, Shelves, and polished Mahogany Frame for trophy, one "Miller" Feeder, new, about 12 lbs., quantity first quality Wood for hive making.—Particulars, SOAL, Brook Road, Prittlewell, Essex.  
k.63

**NO BEE GARDEN** complete without "Willow Herb," plant now, 12, 2s. 3d.; second-hand Hive, 15s.; excellent Shallow Crate, 2s.; Excluders, 1s. 6d.—BOWEN, Coronation Road, Cheltenham.  
k.61

**BEE APPLIANCES FOR SALE.**—Geared Extractor, Hives, etc. List on application.—WRIGHT, Lydiate Ash, Yardley, Birmingham.  
k.60

**FINEST EXTRACTED HONEY**, £10 per cwt.; sample 5d.—DUTTON, Terling, Witham, Essex.  
k.59

**1 1/2 CWT.** fine Light Honey for Sale, 28-lb. tins; sample 6d. What offers?—CHARLES COOPER, Ashen Hall, Clare, Suffolk.  
k.57

**GOOD GLAZIER'S DIAMOND**, perfect, 8s. 9d.—HUBBARDE, North Kilworth, Rugby.  
k.46

**FOR SALE**, three June Swarms in boxes with stores, pure Italians, with 1920 Queens. What offers or exchange for poultry?—MURCH, Ringmore Road, Shaldon, Teignmouth.  
k.47

**32 LBS.** of pure Heather Honey in comb, 2s. 3d. 1 lb.; 2 dozen 1-lb. cartons pressed Heather Honey, 2s. 3d. each; 2 1/2 dozen Heather Sections, 59s. per dozen.—W. WOODS, Normandy, near Guildford.  
k.48

**WANTED**, single and double Conqueror Hives; must be good condition and Simmins' dimensions.—BLACK, Fernhill Heath, Worcester.  
k.52

**BROTHER BEE-KEEPERS** with spare time wishing to commence in the Retail Fish Business write J. W. ELVIDGE, Wholesale Fish Merchant, Grimsby.  
r.h.239

**PURE LIGHT CAMBRIDGE HONEY** (guaranteed), 14-lb. tins, 30s.; 28-lb. tins, 57s. 6d., carriage paid.—YOUNG, 42, James Street, Cambridge.  
r.k.49

**BEE SWAX**, pure, for Sale, 5 cwt., packed in 1/2-cwt. bags, £8 16s. per cwt. net, f.o.r. London.—Apply, Box 104, B.B.J. Office, 23, Bedford Street, Strand, W.C.2.  
r.j.20

### BUSINESS ADVERTISEMENTS. 1 1/2d. per word.

**WANTED**, Man, single, to help with bees and spare time odd jobs.—Full particulars in first letter, ALLBON & CO., Sunnyside, Hitchin.  
k.58

**BE PREPARED FOR 1921 HONEY SEASON.**—Hives, Brood Boxes, etc., made to your requirements. Our 12-frame W.B.C. Hive is for honey production; no nails used; is substantial; all work screwed.—Quotations from H. GILLAM, 56, Sackville Road, Bexhill.  
k.64

**NO SUGAR VOUCHERS NEEDED.**—Flavine Candy, made in Cambridge and the wrappers bear our name, 6 lbs., 10s. 6d., postage paid; larger quantities 1s. 6d. per lb., carriage extra.—S. H. SMITH, 30, Maid's Causeway, Cambridge.  
k.62

**MASHEATH MEMS.**—"Hives received in perfect condition. I am very well pleased with everything. I should be proud of them had I built them."—G. D.—ATKINSON, Fakenham.  
k.67

**R. LITMAN** having purchased one of the Somerset set Re-stocking Apiaries, can book strong Nuclei for delivery May and June, 1921. All Stocks headed by imported or home-reared from proved prolific queens, Piana, Penna, and Bozzalla strains. Doolittle and Sladen's methods employed rearing. Delivery in strict rotation, with tested or untested Queens as desired. Avoid disappointment. Book now. £1 with order, balance when ready.—Castle Cary, Somerset.  
j.37

**HAVE YOU READ "THE BEE WORLD"?** If not, why not? Every number in itself is a useful literary work for practice and reference. Specimen copy free.—Offices: THE APIA CLUB, Port Hill House, Benson, Oxon.

**"WIGHT" DISEASE.**—Prevention and removal. Advice 5s.—ALF. RYALL, Cottage Farm, near Camp, Stroud.  
j.5

**SURPLUS HIVES** and Appliances for Sale, good condition, cheap.—PEARSON & GALE, Marlborough.  
rh.131

### BEE TENT FOR SALE.

**MESSRS. ALFRED SPAIN & SON** will Sell by Auction, at the "Chestnuts," Meopham (five minutes from Railway Station), S.E. & C.R., on Thursday, November 18, at 11 o'clock, **Surplus Furniture and Effects**, including a

**BEE MANIPULATING TENT**  
and a quantity of  
**BEE REQUISITES AND APPLIANCES.**  
On View Day of Sale.

Catalogues, 3d. each, of the Auctioneers, at their Estate Offices and Sale Rooms, 36, New Road, Gravesend.

## Golden Italians that ARE Golden

**A PURE MENDELIAN BREED** for honey-grading and beauty. No other bees compare with them.

My breeder Queens are given no fancy names. Their bright golden progeny proclaim their worth.

Apiaries greatly enlarged to meet the demand. Avoid disappointment—book early. Queens and Nuclei, prompt deliveries. List, stamp.

E. COOMBER,  
Breeder of Superior Golden Bees,  
64, Ronald Park Avenue,  
WESTCLIFF-ON-SEA.

## THE British Bee-Keepers' Association.

The recognised centre of practical and scientific bee-keeping in Great Britain. Particulars and conditions of membership may be obtained from the Secretary,  
**W. HERMOD-HEMPSELL, 23, Bedford Street, Strand, London, W.C.2.**

**Finest Grade New Zealand Honey**  
(Amber)

For Bee Feeding. Guaranteed Pure.

Cases, each 2-60 lb. nominal Tins. 95/- per cwt.  
Carriage paid.

Cash with order or on receipt of goods.

N.B. We are already supplying Beekeepers' Associations throughout the Country and shall be pleased to quote references.

**The Bristol and Dominions Producers' Association, Ltd., Bristol.**

The products of the Apiary, of Poultry and Farm Stock, of the Fruit and Vegetable Garden can be Advertised and Sold through

**THE BAZAAR, EXCHANGE & MART**  
*Newspaper.*Get a Copy—Thursday and Saturday 3d. The "Bazaar" publishes also practical handbooks by experts. Send for full catalogue, post free from—**WINDSOR HOUSE, Breams Buildings, LONDON, E.C.2.****INSURE YOUR STOCKS**  
**AGAINST "I.O.W." AND OTHER INFECTIONS.**Science has now placed within reach of every Apiarist a safe and certain preventive of infection in "**Yadil**" Antiseptic.For **SPRING FEEDING** "Yadil" may be added freely to Syrup.For **DISINFECTING** Bees and Combs a five-per-cent. solution in tepid water should be used with a fine spray.**ASK FOR GREEN LABEL.**

Our Bee Brochure sent Free on Application.

**CLEMENT & JOHNSON, 19, Sicilian Avenue, W.C.1.****1920—QUEENLAND LIST—1921**

In reply to many requests coming in for our Premier White Star Queens for the Season 1921, we beg to state that early delivery may not be offered, as a certain number of orders have been carried over (by request) from previous season for first 1921 delivery, in consequence of the unfavourable weather for queen-mating.

**Our Premier White Star Nucleus Stocks**

will be offered as usual, and at former price; but the charges for Queens have been revised, and include the offer of well-bred and selected Virgin Queens of this renowned strain.

Full Queensland Descriptive Circular 4d., The Revised List only (to those having 1920 List, 2d., post free,

OF S. SIMMINS, QUEENLAND, HEATHFIELD, SUSSEX.

**For Christmas Gifts.** You can get the books of the best authorities in this and other countries, and also the leading American and foreign bee-journals, from  
**E. J. BURTT, STROUD ROAD, GLOUCESTER.***For the convenience of beekeepers I am printing a special list of these. Send a postcard for it.***"BACTEROL"**  
**FOR BEES**

2/9 per Bottle.

Post Free.

The cure for, and preventive of, "Isle of Wight" Disease. Non-poisonous—free from stain or unpleasant odour.

**BACTEROL LIMITED**  
19/25, Brookside Rd., Highgate, N.19.**POSITIVE FACTS.**

June 13th, 1920.

I am very pleased with the foundation. The bees undoubtedly prefer it to any other make I have, and have even gone the length of missing two sheets of other new foundation, and working out a sheet of yours placed behind them at the back of the hive. Full sheets have not sagged in the least in 16 x 10 frames.

Yours faithfully, R. B. MANLEY.

*Illustrated Lists free by post.***S. J. BALDWIN, The Apiary, BROMLEY, Kent.**

## FOUR FIRST PRIZES.

Our HIVES and APPLIANCES were again awarded FOUR PRIZES at the Highland Agricultural Society's Show at Aberdeen, thus testifying to the superiority of our goods. Order now and ensure your bees wintering in good hives.

**BOTTLES.** We hold a large stock and can give immediate despatch.

**CANDY.** Safeguard your bees from starvation by feeding with our FAMOUS BEE CANDY. Price **1/6** per 1-lb., carriage extra.

Sole Agents for DADANT'S WEED FOUNDATION. Absolutely pure. Once used, always used.

Large illustrated catalogue, entitled, "Everything for an Apiary," post free on application.

**R. STEELE & BRODIE,**  
*Bee Appliance Makers,*  
**WORMIT, FIFE.**

Telegrams:—"Bees, Wormit."

Telephone:—28 Wormit.

## BEE CANDY.

**W**E are now able to supply CANDY OF OUR OWN MAKE from guaranteed Pure White Refined Cane Sugar. In 1-lb. boxes with glass tops. It can be had plain or medicated with either "Yadil" or "Bacterol."

### PRICES.

7lb.	11/-, postage 1/3
14lb.	21/6, postage 2/6
28lb.	42/-, postage 5/-
112lb.	£8 8s., packed free, carriage forward.

BEE FOOD SUGAR VOUCHERS REQUIRED.

**JAMES LEE & SON, Ltd., Uxbridge, Middlesex.**



No. 2004. Vol. XLVIII NOVEMBER 18, 1920. [Published every Thursday, Price 2d.]

**CONTENTS.**

	PAGE		PAGE
THE CAUSE OF "I.O.W." DISEASE .....	553	SOUTH STAFFS. AND DISTRICT BEE-KEEPERS' ASSOCIATION .....	560
CIVIC HONOURS FOR A BEE-KEEPER .....	553	PETERBORO' AND DISTRICT BEE-KEEPERS' ASSOCIATION .....	561
A DORSET YARN .....	553	CORRESPONDENCE—	
HONEY IMPORTS .....	554	Disease in U.S.A. ....	562
JOTTINGS FROM HUNTINGDONSHIRE .....	554	QUERIES AND REPLIES—	
DO BEES "DO NOTHING INVARIABLY" .....	555	Bees Queenless in Late Autumn .....	563
NOTES FROM THE WEST .....	557	Temperature for Opening Hives .....	563
1920 NOTES .....	558	NOTICES TO CORRESPONDENTS .....	563
PROSECUTION FOR SELLING SYRUP AS HONEY .....	559		

OWING to the FALL in the COST OF SUGAR  
 WE ARE IN A POSITION TO SUPPLY  
**PINK (MEDICATED OR PLAIN)**

**SOFT  
 CANDY**

Made from Guaranteed Pure Cane Sugar.  
**NO VOUCHERS REQUIRED.**

1/5 per lb. (7lb. parcel post free, 11/-)  
 (10lb. do. do. 15/6)

**E. H. TAYLOR, LTD., WELWYN, HERTS.**

THE  
**British Bee Journal**

Office: 23, Bedford Street, Strand, London, W.C.2.  
ESTABLISHED 1873.

A Weekly Journal Devoted to the  
Interests of Bee-keepers.

Edited by T. W. COWAN, F.L.S., &c.,  
and J. HERROD-HEMPSELL, F.E.S.

**Correspondence: Whom to Address.**—All matters relating to the Literary Department, Associations, Shows, etc., should be addressed, "Editors, *British Bee Journal*," and all business communications and matters relating to subscriptions and advertisements to be addressed to the "Manager," *B.B.J.* Office.

**Subscriptions.**—Annual Subscription, 10s. 10d. post free in advance; single copies 2d., or 2½d. post free. If a receipt is required by post, a stamped and addressed envelope must be sent, otherwise a printed receipt will be enclosed along with the paper.

*Note.*—Cheques and Postal Orders should always be crossed, otherwise it is very difficult to trace them if they go astray.

**How to send Money.**—Remittances can be made payable to W. Herrod-Hempshall by crossed Cheques and Postal Orders. Stamps may be sent for small amounts up to 2s. *Halfpenny stamps are preferred.*

Scottish or Irish cheques can only be taken in payment if 6d. is added for commission charged by banks for cashing them.

The Editors are not directly or indirectly interested in the manufacture or sale of beehives or appliances of any kind, and must refer correspondents wishing for prices or catalogues to advertisers in the paper.

## OUR DEPOSIT SYSTEM.

You are advised to insist on this being used when dealing with strangers.

### Rules and Conditions for Depositing

In order to save trouble, it is requested that the Rules be carefully read over by persons using the Deposit System of trading.

Goods should not be despatched until notice that the money has been deposited is received from this office.

**1. Method.**—When strangers are dealing together, the purchase-money of the articles is deposited at our office. We acknowledge receipt of the deposit to both parties, and hold the money until we are satisfied that the purchase is concluded. If a sale be effected, we remit to the seller the amount deposited, less a charge of 2½ per cent. in the £, with a minimum of 6d., and the expenses of Post Office Orders and postage, &c. Cash will be forwarded by Cheque, Post Office Order, or by Postal Order as preferred. If a sale or exchange be not completed, we return the amount deposited, after making the same deduction. By this means buyers and sellers are secured against fraud.

**2. Deposits.**—Postal Orders (drawn on General Post Office) and Cheques must be made payable to W. Herrod-Hempshall, and crossed "London County and Westminster Bank." The numbers of the Postal Orders should be kept by the sender.

We cannot be responsible for any loss that may occur in transit.

**3. Honey on Approval.**—All honey will be sold by sample, which must be sent direct to buyer.

**4. Bee Appliances.**—In ordering, the time allowed for completing the order to be stated to us when sending cash. If maker accepts, we hold cash until transaction is satisfactorily completed, when the amount will be remitted, subject to conditions as in Clause 1.

**5. Bees and Queens.**—These will be dealt with entirely by the parties concerned, so far as price, &c., go, and when the purchase is satisfactorily completed cash will be remitted as per Clause 1.

**6. Goods in Transit.**—These are at the seller's risk, i.e., any damage to or loss of an article on its journey is borne by the vendor; but a rejected article must be properly packed and returned by the same means as was used in sending it.

**7. Carriage.**—The carriage of all goods, *except such as are sent by post*, is payable by the buyer, unless otherwise agreed. If any article sent on approval be returned, each party to the transaction must pay carriage one way.

## Books for Bee-keepers NOW IN STOCK.

Cash in full must be sent with order.

	Postage
A Modern Bee Farm ... ..	7/6 ... 8½d.
(To be obtained from this Office only.)	
Advanced Bee Culture (HUTCHINSON) ... ..	6/- ... 6½d.
Beginner's Bee Book (PELLATT)	5/- ... 4d.
BEE-KEEPING SIMPLIFIED FOR THE COTTAGER AND SMALLHOLDER (W. HERROD- HEMPSELL, F.E.S.) ... ..	1/- ... 2d.
BRITISH BEE - KEEPERS' GUIDE BOOK (T. W. Cowan)	
Paper covers ... ..	2/6 ... 3d.
Cloth covers ... ..	3/6 ... 4d.
Dissectible Model of Queen Bee ... ..	4/6 ... 3d.
FERTILISATION OF FRUIT BLOSSOMS BY BEES (T. W. COWAN) ... ..	-/3 ... 1d.
Honey and Health (A. HORN) ...	-/6 ... 1d.
Honey Vinegar (REV. G. BANCKA)	-/2 ... 1d.
How to Keep Bees (ANNA B. COMSTOCK) ... ..	5/- ... 4½d.
Prevention of Swarming (WILKES) ... ..	1/- ... 1d.
Pollination of Fruit in relation to Commercial Fruit Growing (C. H. HOOPER, F.R.H.S.)	-/6 ... 1d.
PRODUCING, PREPARING, EXHIBITING AND JUDG- ING BEE PRODUCE (W. HERROD-HEMPSELL, F.E.S.) ...	2/- ... 3d.
Queen Rearing in England (F. W. L. SLADEN) ... ..	1/6 ... 2d.
Scientific Queen Rearing (DOOLITTLE) ... ..	4/- ... 3½d.
Snelgrove's Method of Re- queening ... ..	-/6 ... 1d.
The "Townsend" Bee Book ...	2/6 ... 2d.
WAX CRAFT (T. W. COWAN) ...	2/- ... 2½d.
Wilke's Book on Swarming ...	1/- ... 1½d.
<b>MISCELLANEOUS.</b>	
The Lore of the Honey Bee (TICKNER EDWARDS) ... ..	2/- ... 3d.
Life of the Bee (MAETERLINCK) ...	5/- ... 4d.
THE BEE WORLD (supplied only to members of Associations interested in the control and development of the <i>Apis Cuv.</i> apart from ordinary members of the latter), per copy ... ..	-/6 ... 1½d.
The Bee Master of Warrilow (TICKNER EDWARDS) ... ..	7/6 ... 4½d.

British Bee Journal & Record Office,  
28, BEDFORD STREET, STRAND LONDON, W.C.2.





## The Cause of "Isle of Wight" Disease.

The announcement by Dr. Rennie of the cause of "Isle of Wight" disease, as given in our issue of November 4, has aroused widespread interest, as evidenced by the more or less lengthy reports given in almost all the daily and other papers. There are still several things to be determined, and no doubt there will be criticism; in fact, there has been some already. One of the things on which further information would be welcomed was mentioned by Mr. Manley in his letter last week (10,333, page 550), in which he asks how long *Tarsonemus Woodi* will live outside the body of the bee. Another problem is how long the mites live after the death of their host, and in a short letter we have from Mr. J. Pearman he asks a very important question, "Are the *Tarsonemes* found in the queen?" These and other queries will no doubt be cleared up in due time. We understand it is thought that the mites only live a short time after the death of the bee.

If Dr. Rennie's theory that this mite is the cause of the disease is correct, and so far we see no reason to doubt it, many puzzling things that have occurred in connection with the disease will be explained.

It must not be assumed that investigation is at an end; the discovery of the mite is only one step. In following this up, other factors may be found having a more or less important bearing on the disease. The next step, it seems to us, is to find some means or method, or both combined, for scotching these microscopical pests, and we may be certain this matter has received some attention, and now that the probable cause of the disease has been determined we imagine the most difficult part of the problem has been solved, and it will not be long ere we are able to deal effectively with the scourge.

We also congratulate whoever thought of the name "Acarine" disease" for the malady. "Microsporidiosis" is too long and difficult for the ordinary bee-keeper—too much of a mouthful, if we may use the phrase—nor is it correct in the light

of the new discovery. "Isle of Wight" disease is also too long, and in the opinion of a number of bee-keepers, especially those resident there, appears to be an ill-deserved slur on the island. "Acarine disease" is short, easily remembered, and gives a correct impression of the origin of the disease. No doubt in a short time this name will be generally used to designate what is now usually known as the "Isle of Wight" disease.

## Civic Honours for a Bee-Keeper.

We are pleased to note that Mr. E. Watson has been elected Mayor of St. Albans. We are sure all bee-keepers will, with us, wish him a successful year of office, especially those residing in the county of Hertfordshire, where he resuscitated the old Bee-keepers' Association and worked indefatigably for many years as the hon. secretary. Having placed it on a sound basis, owing to pressure of other duties and none too robust health, he had, last year, to depute his duties to other shoulders. Mr. Watson was also for several years an energetic member of the Council of the British Bee-keepers' Association.

## A Dorset Yarn.

Asparagus has come into some of the criticisms by readers of the BRITISH BEE JOURNAL, as if I had stated what was not a fact. Have just read two very delightful books, "Flowers and Unbidden Guests," by Kerner, and "Fertilisation of Flowers," by Muller, both of them are very much given to detail, in the matter of fertilisation. The latter gives a brief paragraph on asparagus, which, for the benefit of your readers who have not yet read these very fine books, I venture to give in Muller's own words: "Honey is secreted and lodged in the base of the corolla, wholly visited by Hymenopterous insects, *Apis mellifica* stands first; these flowers are very small and bell shaped, the male flowers are the largest; they have a pleasant scent, all hang downwards like small bells." There are some flowers that seem to be neither male or female, and are called hermaphrodite. When there are lines 200 yards long with thousands of flowers, they must be a great boon to bees in the months they are in bloom; they are easy to grow, can be bought of any market grower, or seed can be purchased of your favourite seeds-

man for a few shillings. We grow ours alternately with black currants, but if grown by the acre let the lines be sown or planted 3 ft. apart, they do better than in raised beds; only on wet ground is it advisable to have the beds raised, but on well-drained lands we have always found it best to plant on the flat, with potassia salts (or kainit) and sulphate of ammonia. In two years the growth will be vigorous, each year after the very best will realise good prices, with plenty for home consumption as well. In order that the plants should do well each year, do not cut the edible pieces too late in summer. As soon as peas come in liberally horticulturists do not use asparagus, they know that the more liberal the growth of feathery foliage, the better results the following season; the more of this summer's growth allowed to perfect its flowers, the more of these pendulous sweet-scented bells that give off the nectar that bees like to gather.

The same writer gives lengthy paragraphs on the varieties of thyme, so much sought after by bees, though many think that the honey tastes strongly of this pungent herb. This plant has also three varieties of blossom, some hermaphroditic flowers, others seem to be partly male and partly female, while others are perfect female flowers, which produce such quantities of seed. I remember once, when laying out a new vegetable garden on a gentlemen's estate, there was a difficulty in getting edging for the paths. A 5s. packet of common thyme was sown, and the plants used as edging for the paths; when these grew well and flowered freely, bees were always on them, and the wealth of surplus honey at that time was very marked.

We had the bees out most days this last week; they have robbed out one of the blacks, which were very strong, and also had a rack of half-filled sections. It was a hive that was bought last winter, the entrance was very large, quite an inch deep. We find it better to have a bee way nearly across the front, but only deep enough to let out the drones, not deep as was this particular one. My friend in Wimborne says the same; they had robbed out one that he had given a new Italian queen from Penna's.—J. J. KETTLE.

### Honey Imports.

The registered value of honey imported into the United Kingdom during the month of October, 1920, was £14,234.—From a return furnished by the Statistical Office, H.M. Customs.

### Jottings from Huntingdonshire

The charming weather still lingers. On yonder upland one sees the first sown wheat well up in its rows of emerald green; indeed, it began to sprout before the harvest in the next field had been cleared. Thus do the green and the golden meet together, and seed time and harvest kiss each other. Each day unfolds some new beauty of colour and shade. The sun rises clear from clouds, one day like a massive sunflower, another like a luminous blood-red rose. This morning, however, there were two clouds of haze stretching across the eastern horizon, and between them stretched a belt of gold. This belt, viewed through the delicate tracery of a white elm's branches, gave the appearance of tinselled lace beset with gems of topaz illuminated by an unflickering fire. It was a morn of wonderful warmth, and the bees came out between eight and nine. Clumps of feverfew in full blow offered pollen to those bees who wished to gather the bloom dust from these flowers, but the majority went off to the woods with the hum of work, and I watched many come back loaded, so much so that they fell as they attempted to strike the alighting board. In and out as if 'twere May rather than November; they are very excited over it too. One soon discovers the cause of this elation, a rotten bough had broken off, and opened out a store of honey within a tree. The bees who had stored it there had but a small hole through which to enter, so that guarding was not difficult, but when a gap as large as a football is made defence is hopeless. I note the tree bees are Italians—one of my lost swarms, maybe. I feel some sorrow for them, as I realise that in a very short time their small store will have been taken from them, and they, poor things, left to starve.

I went to visit an apiary some five miles distant yesterday. Alas! the tale that has to be told. Colonies which a month ago were going strong, queens laying, ample stores, clean hives, etc., were now evidently queenless.

What means all this failing and disappearing of queens? I'm rapidly coming to the conclusion that we have yet another disease to baffle us—a disease which attacks the mothers of the hive. It is logical enough. Most bee diseases we know of attack queens last; now it

seems there is one which attacks queens first. This queen's evil—disease or no disease—has shown itself everywhere this year; the columns of THE BRITISH BEE JOURNAL prove it. If disease there be, how are we going to deal with it? All one knows of it, so far, is that it gives the queen a desire to leave her home and kindred and return no more. O! Ptolemy, Hiva, Linnaeus, Virgil, Savon, Woods, Nutt, Cheshire, Root, Carr, Cowan, have none of you ought to say of this? Doctors Goodrich, Alexander, Abushady, Lord, Strong, can you enlighten us? Miss Betts, most diligent of all researchers, what say you? We fight "I.O.W." disease, foul brood, and the like, and keep it at bay, but *Nostra Regina*, if they go under we despair.

My experience with this apiary set me looking once more through my own. Yes, one queen has gone, loads of honey, much gathered from flowers, much sneaked from a skep over the hedge which a farmer had established there, bees running about like penned sheep when a dog appears. Several queen wasps in the hive, and welcomed as if, forsooth, the bees hoped that one of them might be able to carry on the colony. This gave me another thought. The large number of queen wasps about is phenomenal. Can it be that these have forced an entrance into the hives and sought out and killed the queen? If so, we may rest in our beds sadder and wiser men. Why haven't we sought out and destroyed the wasps' nests? The answer in my case is I did a lot of seeking, but found very few nests. Where all the wasps came from I knew not. Mysterious hiding places had they, and they knew it. Well, there it is, a queen disease, or queens slain by wasps.

The sun is setting now, and the blue sky turns grey. Out west clouds of flaky white are tinged with red—the colour deepens and extends; the south-western sky becomes aflame; there's a tinge of frost in the air; old William passes, and exclaims, "fine day to-morrow." Soon the blinds will fall and the lamps be lit, but not before tea is taken with the fire-light, which, with the twilight and the homelight, make autumn evenings so full of peace. Darkness is falling fast. I have a service to-night—Armistice Day—after it's over, supper and bed. May be I'll dream of queen wasps crawling over me, entering through the window, the keyhole, through the floor—like Bishop Hatto's rats—everywhere. I'll mind not, but I should like to know what has become of all those queen bees which have left their homes to dwindle and perish.—  
E. F. HEMMING, Steeple Gidding.

## Do Bees "Do Nothing Invariably"?

(By L. Willis.)

(Continued from page 546.)

It is simple enough to prevent swarming earlier in the season, but "come" July (and then owing to the bad weather, bee-keepers generally have to stand by and see their stocks playing the fool, and control going into thin air), willy-nilly the bees will, nay, apparently, *must* prepare for re-queening as the call of their nature for a young vigorous queen grows imperative, and appalling masses of drones are raised to further this end. Whether it is a swarm or a stock which has been prevented from swarming is indifferent—prepare they will with desperate energy. I have cut out cell after cell persistently from swarms hived earlier, only to find at long last a travesty of a queen, and a fiendishly tempered stock, and I doubt whether in nature bees ever take over a previous year's queen. But fulfil their necessities, and that stock, if manipulated with forethought and reason, will give up all idea of swarming and show an excellent sheet when a honey flow comes on.

Taken all round, the beginning of July is roughly about the time when, if swarming is allowed, the swarmed stocks get their new queens in full swing. Why re-queen later and run counter to them? Well and good the necessity to have plenty of young bees at the fall to carry over a stock, but who that has had a stock re-queened early July, and one interfered with in this respect in late August or September, can for a moment doubt the evidence of their eyes. The former stock overflows with bees, and has a goodly portion of eggs, young brood and food, and an uninterruptedly laying queen, and, not least, the stock is in a most happy and contented frame of mind, well bedded-in to meet the dangers ahead; the less said about the other from a small-holder's point of view the better—it is restless and vicious, unsatisfied and fearful; and in the spring the stock re-queened in its natural season leads every time, and keeps the lead.

Nor can AI queens be reared so late—not queens that can head a seven-storey hive with success and distinction. Ye gods! the specimens we have bought late in the season. The bees, while not daring to kill them, have wildly attempted to raise cells, and that in September, showing sheer hopelessness, so much so that we killed the apologies and joined the stocks up. Why re-queen out of nature's time? The bee-keeper cannot do it and *profit*. While out-of-season breeding can be done to a point with larger live stock for an extra and

added profit, I suggest it cannot be done to that end with bees, because bees peculiarly depend upon the outside temperature and floral seasons, and also because they semi-hibernate—and don't drop plumb sudden into that state either, as if they had gone off into a faint, but gradually slow down to their winter's rest, and interrupting this is to interfere with their vitality and well being. Artificially-raised queens at abnormal times of the year are anathema to any apiary run for profit; they are a sheer waste of time and money, not to speak of the health and happiness of the bees, and are a back number. Another point, you can raise queens in the season by nuclei, by de-queening, by brood skied, but none will give the large, long, shining beauties produced under natural happy swarming conditions; such a queen will head a many storied hive and stock it with bees for wintering, and an overflowing of young life in the spring, right on to her last lap when her race is nearly done, and it is for the youngsters to carry on. It is well to keep a stock or two for this purpose and get them to the swarming point, but never let the bees start swarming out—it is infectious. To see an Italian apiary on the move is in the nature of a nightmare or harlequinade (it depends upon the state of your pocket which view you take); it is almost impossible to move for bees; in and out each others' hives; in the air, the hedges, the grass; and, by the way, it is not extraordinary that some of the old queens should not exactly be high fliers, bless 'em, after their strenuous endeavours, and considering they are almost played out.

Another thing I have found to seriously upset stocks is autumn syrup feeding. There are few seasons, very few indeed, when autumn feeding is necessary if a stock has been manipulated appreciatively right through from the commencement of the season; and with the bugbear of our unsettled weather, it is wise to manipulate stocks that at no time are they so placed that it is impossible for them to carry on, and the wintering obligations should be carried in mind from the first to the last operation. It is not natural for bees to store a large quantity of liquid when the temperature does not admit of a honey flow, and the bees are forced into an abnormal activity, to their detriment, with the winter almost upon them, and I suggest that by so feeding we place them in an artificial and thoroughly wrong position; quite apart from the fact that syrup, even if they get the opportunity to thoroughly seal it, unlike Nature's ordained food, lacks valuable constituents. The difference again

between stocks wintered on their own food and wintered on syrup bears no comparison in quick building up in the spring. Admitted that the bee-keeper has to get his stocks overflowing with bees in the spring if he is to have a successful season; but I have found candy fulfil this requirement without placing a hive in an abnormal condition and damp excitement; it also guards against the strongest stock being overdrawn on its requirements, for the stronger the stock the more danger there is of this as our uncertain spring develops. Especially is this the case after the first fine snap when the bees, thinking their summer has come, breed all out; then the seeds of disease and loss can be spread broadcast in an apiary, if, as is so often the case, a bad spell follows. For this reason latterly we did not remove their winter feeding-boards until the danger was well passed and they were fairly started, so as to enable us to re-candy within 24 hours of a break.

A further point in favour of letting them prepare for winter naturally and quietly is the absence of robbing. I have no hesitation in saying that that is a far more insistent and ever-present problem than is disease, when running on a larger scale. A good tip, by the way, to enable one to control the entrances without incommoding large stocks is to cut out the middle of each slide from the centre for a matter of 5 or 6 in. and tack across a piece of fine perforated zinc; especially is this useful in the autumn when they have also the wasps to face, as in the evening and early morning, when their activity is at such a low ebb, the largest stocks can be put on one bee space or so without detriment; and they also winter finely with such slides as direct draught is eliminated. The flush side of the slide, however, should be turned inside the hive, as otherwise it forms a kind of trap and makes the bees disagreeable.

It is recognised that unless a bee-keeper prevents swarming he cannot make good, for to get a certain return it is necessary to run for two harvests; the first, the nuclei, he can count on; the second depends on a later honey flow, *as no honey may be taken from the apiary in the first part of the season*; as otherwise the shadow of profit not the substance is grasped, as with from four to six nuclei per stock to provide for, and also uncertain weather periods ahead, it is a suicidal policy to utilise the first-fruits elsewhere and expect the stocks to be in such condition that advantage can be taken of a later honey flow. A late honey flow turns up in most years, and the thing is to be ready for it.

(To be continued.)

## Notes from the West.

We so very rarely hear of "a good report" for the past season that the writer under that heading, on page 513, has made us rather curious to know whereabout he or she is located. But quite possibly the address has been purposely left out—lest all the hives in the kingdom found their way there by next season. The district seems to be such a "beekeepers' El Dorado" that, only for the housing problem, the "noble" writer would soon have a multitude of brother—and sister—beekeepers about him. But, really, I think it would be most desirable, for more than one reason, if writers to the bee papers allowed a short (if not a full) address to follow their names.

With good prolific strains of bees as we now have, and are likely to have in the future, the use of double brood-chambers has many advantages. The bee guides and periodicals of this country and America contain a good number of them, but there is one that I have not seen mentioned in any book or magazine, and that is, the way it can be used by the apiarist as a means of

### DRONE CONTROL.

All advanced beekeepers are now convinced that the male element plays an important part in the apiary, and we often wish that we could have better control over our drones. I do not mean to suggest that what I am about to write has solved the problem, but it is a short step in the desired direction, so I shall try to explain what acted very satisfactorily with me during the past season. Of course, drones from other apiaries are beyond our control, but where we are fairly isolated (as in my own case), we can expect good results from the plan. We generally decide in the autumn what stocks we intend using for queen-rearing, and also for drone-rearing. It is a good plan to insert a comb with drone cells in the centre of the latter stock or stocks before packing down for winter. This will be utilised in the production of early drones from the selected drone mothers. At the same time, all drone comb—as far as practicable—should be removed from all the other hives, as it would be nothing but waste to allow those colonies to raise a number of unnecessary drones. But, do what we will, they are sure to be found more or less in each colony, so that it becomes our task to arrange their home in such a way that they are not allowed to fly during the time our young queens are out on their mating trips. Drone traps at the entrances have been tried, and

"found wanting." They hinder the traffic so much that they have long ago been discarded in the up-to-date apiary as worthless toys.

All stocks should be built up in the spring as equally as possible, by uniting weak lots and giving combs of hatching brood from the extra strong to those in need of them, so that all will be ready for additional room at about the same time. The date of our queen-rearing operations is fixed in advance, so that, about a week before our queens are due to hatch, we take steps to make sure that no undesirable drones are free. We now adopt Alexander's plan of providing each of these stocks with an extra brood-chamber—and with a W.B.C. hive this is an easy matter. The work should be done in the evening, when no drones are out. Moving the stock box to one side, or to the back of the stand, we place the new brood box on the floor-board. The new box is already filled with frames of drawn-out comb or full sheets of foundation, one of which is taken out from the middle. We now examine the old stock box, and find the comb on which the queen is. This we carefully examine, and should there be any drones on it, we brush them—every one—back into their hive, and also cut out any drone cells that may be in this comb. If the comb contains young brood and eggs only, all the better. We now place it carefully in the space in the new brood box, which is then covered with a sheet of queen excluder. The combs in the old brood box are now closed together, so as to make room on the outside for the frame taken out of the new chamber, and it is then fixed on the new box over the excluder, and all covered up. We now have the queen below, where she will have plenty of room to exercise her ovipositing powers, and this chamber will be quite all right for a time. Periodical attention should, however, be given to the top chamber. All the drones and drone brood were left here, and if the stock persisted in rearing them in large numbers—as they sometimes will—there is a danger of the excluder being clogged up, so we must do something to rid this chamber of as many of its imprisoned drones as possible. [How will the bees persist in rearing drones with the queen below that is, beyond the eggs already laid? Eps.] In about five to seven days' time, about noon on a warm sunny day, the quilt is drawn back a little from the ends of the frames, and a drone-trap placed over the opening. The older drones will soon be attracted by the light and the warmth, and they make for the opening. In about an hour the trap may be removed, and

its contents destroyed. One trap can be used on two or three hives during the same day. The hive roof should, of course, be off while the trap is on. My traps are inexpensive boxes, long enough to cover the width of the brood-chamber. They are divided into two compartments by a board, just wide enough to allow the light to descend, and for the drones to ascend from the lower to the upper storey. The front of the upper compartment is covered with a Wilkes's wire excluder—shallow frame size—and the contrivance answers the purpose well. When the traps have been in use, it is well to look over the combs in the upper storey the same evening, in order to destroy any queen cells that may have been formed. The few remaining drones will not be eager to fly then, but may be quite ready to enter the trap when it is next put on in a few days. If we use some of these combs to form nuclei, care should be taken to brush back all drones into the hive, and also to cut out all unhatched drone-brood. By the time the combs in the lower chamber are fully occupied by the queen, and the boxes have again to be reversed, the first batch of young queens will—in an ordinary season—be all mated to drones that have been flying in great numbers from the hives selected for that purpose. With this little extra trouble, many apiarists could, in a few seasons, greatly assist in the eradication of bee disease by breeding and mating their queens from the fittest and best stocks only.

The present-day tendency of the craft is to breed for *prolificacy of queens*, as we can see from the majority of advertisements and testimonials exhibited by many breeders. The real goal of bee-keeping, viz., the *production of honey*, seems with them to be a secondary matter. There is a great danger of this tendency being overdone—at the cost of stamina and hardness in the stock produced. The *softest* bees in my apiary to-day are the progeny of a queen which I valued greatly, as she was from a first-class breeder. This may be due to *in-breeding*. While the hardiest bees are some of my own rearing from vigorous mothers mated to selected unrelated drones.

T. ALUN JONES,  
Halkyn, Flintshire.

[The point in the last paragraph does not receive the attention it should. It does not by any means follow that a large population, the progeny of a very prolific queen, will store honey in proportion to the number of bees in the colony, and, as Mr. Jones rightly says, the real goal of beekeeping is honey production.—Eds.]

## 1920 Notes.

Single walled hives are chiefly used in our apiaries, and the following is our method of wintering these. Two dummies are put into each brood chamber, two brood chambers standard size depth if possible, failing that one standard and one shallow. Eight frames in each, quilt over all, then newspaper tucked into eke or lift on top, a little hay spread over all, then more newspaper and much hay, but not enough to touch the roof. Straw is better, but as it takes two loads to winter all our socks down I consider it too expensive nowadays. Where a single brood chamber is used for winter I prefer to have an eke or shallow super underneath. Entrances are closed to about two and a half inches long, in front of this is put perforated zinc with bee space entrances cut out, saw-tooth fashion, thus preventing mice from getting in that way, and stocks can be left at our apiaries perfectly safe on that score.

French bee-keepers sometimes use an interesting contraption for their entrances, and quite a sound idea. They have a strip of metal with small close corrugations (about a bee-space corrugation, really) and this they slip in the entrance, thus preventing mice from getting into the hive. Perhaps one of our appliance dealers will put one on the market.

From letters received, I think bee-keepers experienced some trouble in getting their extracting supers free from uncapped honey, or cleaned up this autumn, owing to the cold weather. In these cases our method is to put the super to be cleaned underneath the brood chamber and not on top, removing it when empty. Two or three can be put under in this way provided the stocks are strong enough.

Two interesting experiences occurred this year, the first in No. 3 apiary. A very small swarm came out of a strong stock, leaving the old clipped queen behind and 90 per cent of the bees. One virgin had hatched out which they had with them, and there were not other queen cells in the stock.

In the autumn a similar thing happened with a superseded virgin just as some local visitors arrived. It took some considerable time to find out which stock they came from by the flour method, as there were over a hundred stocks in that apiary, and the floured bees imitated the example of the "Wandering Jew." This swarm also was a "pea nut" one.

*Mating of Queens.*—Mr. Sladen has been experimenting in Canada in regard to the mating of young queens with hand-picked selected drones and resulting im-

perfect matings, ascribing this, so far as I could gather, to the hand-picked drones. From my own experience, I should think it more probably to be due to the strong winds he experienced at that time. 1919 was a terror in that respect, and this last season has tried to cap it. We did not commence queen rearing in real earnest this year until August was well in, and struck lucky on September 10, getting quite a number mated. If bee-keepers owning microscopes would like me to send them "sports" during the season, will they please send a stamped addressed queen cage, with no candy, the candy hole not to be nailed down, but open, so that fresh candy can be inserted quickly? We really haven't the time to do anything that means a lot of fuss, and I think many can realise that, yet at the same time are ready to do what we can.

*Bee Spacings.*—When first getting out my design of hive, which afterwards turned out to be nothing else but a duplicate of one brought out by the late Mr. John Howard I decided to ignore the conventional bee space. First I arranged for  $\frac{7}{8}$  in. to 1 in. depth under the frames on the floor-board. This is now getting quite common. Instead of giving  $\frac{1}{4}$  in. space at the ends of the frames I give rather more, the dimensions across the hive being 14 and 9-16ths to  $14\frac{5}{8}$  in. I have not found this to produce any extra brace comb, but that the  $14\frac{5}{8}$  in. dimension must not be exceeded. This extra space, although very little, is of great assistance in the rapid manipulation of frames of bees, and results in quite a saving of time, a great consideration where a number of stocks have to be examined.—G. THOMAS, Burwell, Cambs.

## Prosecution for Selling Syrup as Honey.

I enclose a cutting from the *Eastern Daily Press* of November 1, which, if you will publish in THE BRITISH BEE JOURNAL, will be of interest to bee-keepers I am sure. It just shows what some of the foreign so-called honey is made of, and sold at 2s. 8d. per lb.

I have had, for the season, a very fair yield of all A1 quality honey, 13 cwt. 5 st. from 25 hives, spring count, increased to 35 stocks, packed down. Have sold 82 stone, mostly to private customers, in 7-lb. tins, some to local dairies in 1-lb.,  $\frac{1}{2}$ -lb., and  $\frac{1}{4}$ -lb. pots, but none at 2s. 8d. per lb. Every one of the 35 stocks I have packed down with as near 25 lb. of food as I could judge, most of them with a shallow box of nine frames on

the top of brood body, which, I think, makes the best winter passage. I have fed 200 lbs. of sugar to make up the balance of 25 lbs. of food per stock, which I ordered in August and obtained the first week in September, and had to pay 1s. 5 $\frac{1}{2}$ d. per lb. for it.

All my stocks except two have a young queen, which I reared and introduced in July; every one was accepted. I did not look in after introducing queens until supers were taken off the latter part of August. I judged by outside appearances. The exchange of queens was carried out in the middle of the day, when bees were busy.

At another date I will give you the method I adopted of re-queening; but this letter, I am afraid, you will think is too long now.—RICHARD LING, Briston, Melton Constable.

### BEFORE THE MAGISTRATES.

East Dereham, Friday.

(Before Messrs. A. G. Copeman (who presided), T. Redford, G. Brett, T. B. F. Daniel, A. Ruston, and W. Wilson.)

Henry Walden, grocer, High Street, Dereham, was summoned for selling honey adulterated with at least 70 per cent. of starch syrup and cane syrup.

Mr. W. B. Barry (Middleton), Inspector under the Food and Drugs Act, prosecuted, and Mr. B. H. Vores appeared for the defendant, who pleaded guilty.

Mr. Barry said the honey was sold as Californian honey, but it consisted largely of syrup, which was not a constituent of honey. It was artificially sweetened with saccharin, and was practically an artificial product. He understood the defendant had a warranty from the people who supplied him, but unfortunately he did not take advice in time, and the warranty was not available as a defence.

In evidence Mr. Barry said on September 11 he purchased at defendant's shop 2 lbs. of honey at 2s. 8d. He produced the certificate of the Public Analyst, which stated the sample submitted to him contained at least 70 per cent. of starch syrup and cane syrup, and that the proportion of genuine honey in the sample was at the most 30 per cent., and it might be much less. The mixture had been artificially sweetened by the addition of saccharin.

Mr. Vores said unfortunately the defendant was ignorant of the law with regard to the warranty he had got, and he therefore had a good defence which was cut out simply by accidental circumstances. It was purely a matter of misfortune on his part.

Edwin Watts, of the Standard Health

Food Co., Ltd., who sold the honey to defendant, deposed in effect that on the invoice he gave a guarantee that the honey was pure. He subsequently wrote a letter to the defendant to the same effect. His firm purchased the stuff as Californian honey, but they were let down in the matter, and were taking proceedings against the man who supplied it. So far as the defendant was concerned, he was perfectly innocent, and no reflection should rest upon his character in the town, and any expenses attached to the case witness's firm would be glad to meet.

The Chairman said when the defendant took these things he ran the risk, and he should be fairly satisfied that what he sold was genuine. He would have to pay £1 inclusive.

### South Staffordshire and District Bee-Keepers' Association.

#### ANNUAL ASSOCIATION SHOW.

The members of the above Association held their Annual Show of Bee Produce and Bee Appliances at St. James' School, Eve Hill, Dudley, on Saturday, October 30, 1920.

The show was opened by the Mayor of Dudley, T. W. Adshead, Esq., J.P. Mr. A. B. Whitehouse presided, and in introducing the Mayor, said they were very grateful to him for coming to open the show, especially considering he is so fully occupied as the chief citizen of the borough, a large employer of labour, and connected with so many philanthropic works. The exhibits were not so numerous as in some years, in consequence of the unfavourable season for honey gathering, and the attendance was not so large as formerly, caused undoubtedly by the difficulties of railway travelling through the miners' strike. The object of the Association was to produce honey. For many years this article has been largely imported from foreign countries, wealth leaving this country and enriching others. The Association was out to produce our own honey, and thus benefit the community.

The Mayor, in opening the show, said the Secretary had called upon him several times before to be present at the Christmas dinner at the institution of which he was master, but bees were out of his experience; he could not say anything about them. If he had been asked to say something about bedsteads he would have been in a better position. He had sought information from the dictionaries and encyclopædias, but found nothing very enlightening. He was

pleased to know that the object of the Association was to produce an article of food which was so largely imported, and so necessary; it would not only produce wealth to them, but to the country, and help in the matter of transport. He should be pleased to help the Association in its endeavours.

The Judge, Mr. Calshaw, of Cannock, said the difficult part of the judge's work was not that there were so many exhibits in consequence of the bad season, but the quality. Every exhibit was worth a prize. The ladies he would recommend not to put so much colouring ingredients in the cakes.

The prizes for the exhibits were as follows:—

Class 1.—Section Honey.—1, Mr. Cheshire; 2, Mr. Hildreth.

Class 2.—Light Run Honey.—1, Mr. Cheshire; 2, Mr. Griffiths; 3, Mr. Hildreth.

Class 3.—Dark Run Honey.—1, Mr. Cheshire; 2, Mr. Hildreth; 3, Mr. Thompson.

Class 4.—Granulated Honey.—1, Mr. Cheshire; 2, Mr. Hildreth.

Class 5.—Bees Wax.—1, Mr. Cheshire; 2, Mrs. Thompson; 3, Mr. Griffiths.

Class 6.—Bee Candy.—1, Mr. Hildreth.

Class 7.—Wired Brood Frame.—1, Mr. Hildreth; 2, Mr. Cheshire.

Class 8.—Best Wired Shallow Frame.—1, Mr. Hildreth; 2, Mr. Cheshire; 3, Mr. Thompson.

Class 9.—Best Exhibit of a Practical Nature.—1, Mr. Hildreth.

Class 10.—Best Cake.—1, Mrs. Thompson; 2, Mrs. Griffiths; 3, Mr. Cheshire.

A vote of thanks was passed to the Mayor and to the Judge for their services rendered.

Tea was provided in the Parish Hall, after which a meeting of the Association members was held. Mr. Whitehouse, President, said he was a small bee-keeper of a few years' standing. He knew a little about bees through seeing his brother with his bees, and the war causing a shortage of sugar, he determined to commence bee-keeping to help to meet the want. The first and second years he had been fairly successful, but recently he lost his stocks through "I.O.W." disease. In looking at the matter from a poor man's view, the loss of stocks through "I.O.W." was a very serious matter to him, and he thought the Association ought to adopt some method to assist the bee-keeper in his loss. Mr. Price, Stafford County Expert, perhaps would be able to enlighten them on the subject.

Mr. Price said he did not see how this could be arranged at the present time;



it was a big question, and required a lot of safeguards. Mr. Price then addressed the meeting, taking for his subject "My Visit to the Apis Club," and said: "The Club was instituted for the purpose of bringing bee-keepers together in all parts of the world with a view to discussing matters in modern bee-keeping, and for experimental and educational work. For this purpose the *Bee World*, the official organ of the Apis Club, was printed.

Dr. Abushady, the originator of this, is an Egyptian by birth, who studied medicine in this country, and practised for some time at Hurst Hill, near Bilston, nearly three years ago. Shortly after leaving this district, owing to ill-health, he closed his home and laboratory at Ealing, and went to live an open-air life at Benson. This was where I visited him. It is at present the headquarters of the Apis Club. I have never seen such an enthusiast before. He has put all his energy into the subject, and, despite his ill-health, he is establishing an apiary of considerable size. There are 90 stocks of bees, which are used for commercial, experimental and training purposes. I was greatly surprised to see everything in such splendid order; it was a treat to walk round the apiary with such an interesting companion as the Doctor. Apart from the enormous amount of work required in preparing and editing the *Bee World*, dealing with vast correspondence connected with the Club, and work among the bees, the Doctor has turned his attention to inventing a metal comb which promises to supersede anything yet attempted. His experiments with this comb are wonderful, have been necessarily costly; but it is pleasing to see that he has been able to invent a comb which undoubtedly will have a great future. I frankly admit I never expected to see such self-sacrifice as the Doctor and his English wife are making for the sake of uplifting the craft of bee-keeping and placing it on a higher plane. A scheme of shares of the Apis Club has been arranged, whereby funds can be provided for the further development of inventions and research and the distribution of the *Bee World*. It now rests entirely with bee-keepers themselves whether these two valuable assets are to be held in abeyance for want of support. I therefore appeal to all bee-keepers to do their best to help forward the good work."

The Secretary, giving an address on "The Objects of the Association, and Suggestions," said the objects were instruction, sociability, and helpfulness. Referring to bee literature, he strongly recommended the *Bee World* as being

thoroughly alive to the bee-keeper's interest. It was attractive, well printed and illustrated, and served a double purpose in helping themselves and providing funds for the Apis Club. He also referred to the establishing of an Association library of bee literature containing the best known books on bees, to demonstrations at the summer meetings for the benefit of the new members, and to the advice of experts in visiting members' apiaries. He also referred to the social side of the Association, forming a bond of union amongst bee-keepers, asking questions, comparing notes and receiving advice, and suggested that the Association should consider some scheme whereby it could help those members who have suffered loss by the "I.O.W." disease, either by a fund established or approaching an insurance company for that purpose. He wanted to make the Association a live, attractive, and useful organisation, helpful to each other and the community at large.

Votes of thanks to Mr. Egginton, Sedgley, for the loan of his specimen hives, to the Chairman, Mr. Price, and the Secretary terminated a very successful gathering.—W. J. WALTON, 10, Burton Road, Dudley, Hon. Sec.

### Peterborough and District Bee-keepers' Association.

#### BEE RE-STOCKING SCHEME.

A general meeting of the subscribers of the re-stocking scheme in connection with the Peterborough, Huntingdonshire, Oundle and District Bee-keepers' Association was held at the Bedford Hotel, Peterborough, on October 16. Present: Mr. P. C. Clarke (in the chair), Lady Margaret Proby, Messrs. Andrews (expert), Arbon, Captain Constable, Messrs. Jackson, F. Jackson, Landin (treasurer), Lilley (trustee), Oliver, Paul, B. Towler, G. F. Stapleton and Cant, with the Secretary (Mr. G. H. Seamer).

The accounts were read by the Secretary, and in moving their adoption the Chairman said he thought the scheme had proved an unqualified success. The amount standing to the credit of the scheme, allowing for the stock on hand in the Association's apiary at Neneak (at a very low valuation), was £26 10s. 4d.

Mr. Clarke said he thought the meeting would agree that this was very satisfactory, especially in view of the very reasonable terms on which subscribers had obtained their nuclei.

A discussion followed as to the future of the re-stocking scheme. The Secretary briefly outlined its inauguration and objects. Mr. L. Andrews did not seem to favour the continuance, and mentioned

the question of additional capital. He doubted whether the scheme would be a commercial success. Captain A. J. Constable objected to the phrase "commercial success." As he understood it, the scheme was never intended to come within the scope of a commercial enterprise, but was brought into existence with the definite object of ensuring that members were supplied with a nucleus of hybrid bees, to replace those destroyed by the "Isle of Wight" disease, and later, if there was any surplus, this could be disposed of to non-members at a reasonable figure, and so encourage bee-keeping throughout the district. He thought the scheme had still a useful future in front of it, and the present membership of the Association and re-stocking scheme ought to be greatly increased by propaganda work during the coming winter.

Lady Margaret Proby shared this view, and was greatly in favour of the continuance of the scheme. She thought it would be an unwise step to close down at the present time a scheme which has been so successful, and suggested that if members wished to purchase another nucleus in the coming spring, by all means let them be able to do so. If they did not actually require the stocks for their own use, they could sell them to their richer friends, or give them to cottagers, and so spread the bee-keeping industry throughout the villages. What she would like to see would be that the £30,000 worth of imported honey per month should be supplied by our own apiaries from the nectar which was in such abundance throughout the country. (Applause.)

Captain Constable proposed that the question of the maintenance of the re-stocking scheme should be left over until the annual meeting in January. This was seconded by Mr. G. Jones (Glinton), and carried unanimously.

A hearty vote of thanks was accorded the Chairman for presiding, and Mr. Clarke briefly replied.

The re-stocking scheme was instituted owing to the disastrous outbreak of "Isle of Wight" disease amongst the stocks throughout the country. The Food Production Department of the Ministry of Agriculture decided during 1918 to import a number of Dutch stocks and Italian queens. The Peterborough re-stocking scheme, through the Horticultural Subcommittee of the Peterborough Education Committee, were fortunate in obtaining six of the former stocks in skeps, and 12 Italian queens. An apiary was established in the nursery gardens of Peterborough Co-operative Society at Newark in April, 1919, under the management of Mr. L. Andrews. Sixty ladies and gentlemen became subscribers

to the scheme, and during 1919 fourteen of these were supplied with nuclei of hybrid bees. Each nucleus consisted of three combs headed by a queen reared from the Government stocks. During the year 1920 the remaining 46 members have each received a nucleus, whilst several stocks and queens were purchased by non-members. There still remain on hand 12 stocks to be wintered, which are available for breeding in the coming spring. The number of frames of comb drawn out and occupied by bees was 324, fifty-four of which form the 12 stocks on hand. A number of extra drawn-out combs were also obtained. The total receipts have been £110 15s., and the expenditure £112 1s. 2d. The stock on hand (fixed and live) amounts to £28 5s. 6d. It is hoped that a number of lectures will be given during the winter in Peterborough and district, so that a larger number of persons will take up this most interesting and profitable hobby. Mr. G. H. Seamer, of "Grace Dieu," Waterloo Road, Peterborough, secretary of the Association, will be glad to give any information as to membership, purchase of stocks, etc.



*The Editors do not hold themselves responsible for the opinions expressed by correspondents. No notice will be taken of anonymous communications, and correspondents are requested to write on one side of the paper only and give their real name and addresses, not necessarily for publication, but as a guarantee of good faith. Illustrations should be drawn on separate pieces of paper. We do not undertake to return rejected communications.*

### Disease in U.S.A.

[10335] I see from reading your JOURNAL, bee-keepers in England are having trouble with a disease you call "Isle of Wight" disease. Judging from the brief symptoms you give in answer to A. C. Fraser (Lines), viz., bees affected with "Isle of Wight" disease fall to the ground and are unable to fly. From this description it appears to be a similar disease to one which affected bees in my apiary about 10 years ago, and from which they recovered. I gave the disease a different name at the time, and called it partial paralysis, because only the wings were useless, the legs and other parts could be used, even the generative organs of the queens, so brood rearing went on. Other symptoms that were observable with the affected bees were that after falling

to the ground they ran off in a hurry to get somewhere, and apparently driven by pain would climb up blades of grass or straws, and after exhausting themselves cluster in small bunches, and eventually die. My loss from colonies dying clean out was about 5 per cent., the loss from colonies more or less affected, but that eventually recovered, was greater. I would like to know if my description of partial paralysis tallies with your "Isle of Wight" disease; if so I might say something in the line of treatment.—Wm. BELSHAW, Route 2 Everett, Wash., U.S.A.

[The symptoms given above are identical with those of "Isle of Wight" disease. In addition the abdomens of the bees are generally swollen, and the intestines full of undigested pollen. There is often also heavy soiling of the combs, and both inside and outside of the hives, though this symptom is not so prevalent now.—Eds.]

## QUERIES AND REPLIES.

Queries reaching this office not later than **FIRST POST on MONDAY MORNING** will, if possible, be answered in the "Journal" the following Thursday. Those arriving later will be held over until the following week. Only **SPECIALLY URGENT** queries will be replied to by post if a **STAMPED** addressed envelope is enclosed. All queries must be accompanied by the name and address of the sender, not necessarily for publication, but as a guarantee of good faith. Correspondents are requested to write on one side of the paper only.

### Bees Queenless in Late Autumn.

[9914] One of my stocks is queenless, the bees having "balled" her through late manipulation. A dealer informs me he cannot supply queen through lateness of season, and in any case she would probably die through post as the weather is not conducive to safe travel. The stock is strong, and well provided with stores for safe wintering. Would same live through winter queenless and be immune from disease? The only colony I have to which bees could be united is a June swarm in a box. These would have to be driven, I presume, for uniting purposes. Taking into consideration the coldness of the weather and circumstances as stated, what would you advise to enable me to retain stock safe through the winter?

(2) *Newspaper Method of Uniting.*—Having been out of touch with bee-keeping during the last five years, I do not understand the meaning of "newspaper

method" of queen introduction, nor "brown paper" uniting, and would be glad of an explanation and advice through the columns of your valuable Journal.—D. H. WILKINSON.

REPLY.—Our advice is to unite the box hive of bees to the queenless colony and winter both together. In the spring the queen may be confined below by a queen excluder, and the box removed later as described on page 150 of the Guide Book.

(2) The newspaper method is used for uniting two colonies of bees, not for queen introduction. It is a very simple and safe method. A sheet of newspaper is spread over the tops of the frames in the lower brood chamber, and the colony to be united stood on the top. The bees bite through the paper and unite peacefully.

### Temperature for Opening Hives.

[9915] Could you let one have a definite rule for temperature at which it is safe to open and examine hives? As late as your last week's issue, and again in *The Times* yesterday, one reads of the desirability of examining hives for stocks of food. Undoubtedly the weather has been fine, but an examination is the last thing I should think of at this time of the year.—G. W. MALCOLM.

REPLY.—Hives should not be opened with the temperature under 60 deg. F. Better "let the bees tell you," and only open hives when the bees are flying. It is very unwise to open them at this time of year unless absolutely necessary.

## Notices to Correspondents

Correspondents desiring an answer in the next issue should send questions to reach this office **NOT LATER than the FIRST POST on MONDAY MORNING**. Only **SPECIALLY URGENT** questions will be replied to by post if a **STAMPED** addressed envelope is enclosed. All questions must be accompanied by the sender's name and address, not necessarily for publication, but as a guarantee of good faith. There is no fee for answering questions.

E. B. G. (Sussex).—*Plain or medicated candy.*—It is wiser to medicate the candy, as a precautionary measure against disease. For an average colony leave the entrance about 4 in. wide.

G. L. B. (Rayne).—*Wintering with shallow combs over brood chamber.*—If the shallow combs contain stores leave them on. If candy is needed it can be given on top of the shallow combs, or you might fit up a shallow frame to contain candy.

"BEGINNER" (Beeston).—*Acarine disease* is the name proposed for what has hitherto been known as "Isle of Wight" disease.

## Special Prepaid Advertisements. One Penny per Word.

Trade advertisements of Bees, Honey, Queens, and Bee goods are not permissible at above rate, but will be inserted at 1½d. per word as "Business" Announcements, immediately under the Private Advertisements. Advertisements of Hive-manufacturers can only be inserted at a minimum charge of 3s. per lin., or 6s. per inch.

PRIVATE ADVERTISEMENTS are only intended for readers having Surplus Stock to dispose of. Driven Bees, Nuclei, and Queens that are reared or imported for sale, are Trade Advertisements, and can only be accepted under trade terms. A charge of 6d. extra will be made if a box number is used.

Advertisements must reach us NOT LATER than FIRST POST on MONDAY MORNING for insertion in the "Journal" the same week.

Orders for three or more consecutive insertions in "The Bee Journal" entitle advertisers to one insertion in "The Bee-Keepers' Record" free of charge.

### PRIVATE ADVERTISEMENTS.

FOR SALE, 84 Heather Sections. What offers? —MIST, Pirbright Junction, Brookwood, Surrey. k.73

WANTED, Swarms, headed by Carniolan Queens, May and June delivery. State price.—ANTHONY, 34, Knavesmire Crescent, York. k.74

PURE LIGHT ENGLISH HONEY, 56-lb. tin, £5 14s. 6d., carriage paid; sample 6d.—T. TUDOR, JUNR., 20, Spring Cottage, Little Drayton, Salop. k.71

BACK NUMBERS B.B.J., 1903-1915, also Illustrated Dutch Bee Journals, to clear.—ARCHER, 64, Kingston Road, Oxford. k.70

CORRESPONDENCE Courses in Bee-keeping.—H. E. NEWTON, Hobart Road, New Milton, Hants. r.k.69

EXTRACTED HEATHER HONEY, splendid flavour, 1 cwt. What offers?—GARRETT, Broadstone, Dorset. k.68

LEE'S GEARED EXTRACTOR, 48s.; one not geared, 35s.; excellent condition.—NORTH, Cressing, Braintree, Essex. k.79

HIVES.—A limited number of strong, sound and interchangeable, free from "I.O.W.," two lifts, brood chamber, 10 frames, metal ends, wired and new wax in each, roofs lined with zinc or iron, price 35s., free on rail; cash with order.—FOSTER & CO., Heath Side, Hillingdon Heath, Middlesex. k.78

I LOVE MY HONEY, but—O.U.B.'s! (oh! you bees!). In other words, the bees have first call on any honey produced. However, we can offer a limited quantity of fine Sainfoin Honey to connoisseurs at 36s. per 14-lb. tin, carriage paid in Great Britain.—S. H. SMITH, 30, Maid's Causeway, Cambridge. k.75

BROTHER BEE-KEEPERS with spare time wishing to commence in the Retail Fish Business write J. W. ELVIDGE, Wholesale Fish Merchant, Grimsby. r.h.239

PURE LIGHT CAMBRIDGE HONEY (guaranteed), 14-lb. tins, 30s.; 28-lb. tins, 57s. 6d., carriage paid.—YOUNG, 42, James Street, Cambridge. r.k.49

13 CWT. NORFOLK HONEY, granulated, 28-lb. 14 tins. Offers invited.—G. ASHTON, Lodge Road, Feltham, Norfolk. k.65

32 LBS. of pure Heather Honey in comb, 2s. 3d. lb.; 2 dozen 1-lb. cartons pressed Heather Honey, 2s. 3d. each; 2½ dozen Heather Sections, 39s. per dozen.—W. WOODS, Normandy, near Guildford. k.48

LIFE INSURANCE IS A SOUND INVESTMENT.—Will fellow members of the craft write for prospectus to H. M. LOWE, Park Road, Chilwell, Representative for "Royal," "Scottish Temperance," etc.? k.66

FOR SALE, three June Swarms in boxes with stores, pure Italians, with 1920 Queens. What offers or exchange for poultry?—MURCH, Ringmore Road, Shaldon, Teignmouth. k.47

### BUSINESS ADVERTISEMENTS.

1½d. per word.

BEEES AND QUEENS FOR 1921.—Send for our new Illustrated Catalogue, free on application.—PEARSON & GALE, Marlborough. k.77

A WELL-ESTABLISHED FIRM wishes to hear of bee-keepers who would guarantee to supply them with Nuclei May-June next.—Box 107, B.B.J. Office, 23, Bedford Street, Strand, W.C.2. r.j.42

IMPORTANT!—In spite of the increased cost of sugar, appliances and carriage, we are offering our celebrated 6-frame Stocks at reduced prices. New Illustrated Catalogue free on application.—PEARSON & GALE, Marlborough. k.77

MASHEATH MEMS. are speaking testimony to the merits of the Masheath Hives, the cheapest combined with best value in first-class equipment to-day. Try them, and have conviction.—ATKINSON, Fakenham. k.80

WAKE UP!—Next spring will soon be here, and then you'll be mad because you did not order our noted 6-frame Stocks early enough to ensure early June delivery.—PEARSON & GALE, Marlborough. k.77

NO SUGAR VOUCHERS NEEDED.—Flavine Candy, made in Cambridge and the wrappers bear our name, 6 lbs., 10s. 6d., postage paid; larger quantities 1s. 6d. per lb., carriage extra.—S. H. SMITH, 30, Maid's Causeway, Cambridge. k.76

IMPORTED ITALIAN QUEENS FOR 1921.—List on application.—PEARSON & GALE, Marlborough. k.77

FIRST PRIZE CANDY, 6 lbs. 10s. 6d.—BOWEN, Apiaries, Cheltenham. k.74

FIRST AGAIN!—Send for our large Illustrated Catalogue of Bees and Queens for 1921, free on application.—PEARSON & GALE, Marlborough. k.77

"WIGHT" DISEASE.—Prevention and removal. Advice 5s.—ALF. RYALL, Cottage Farm, near Camp, Stroud. j.5

BE PREPARED FOR 1921 HONEY SEASON.—Hives, Brood Boxes, etc., made to your requirements. Our 12-frame W.B.C. Hive is for honey production; no nails used; is substantial; all work e-screwed.—Quotations from H. GILLAM, 56, Sackville Road, Bexhill. k.64

HAVE YOU READ "THE BEE WORLD"? If not, why not? Every number in itself is a useful literary work for practice and reference. Specimen copy free.—Offices: THE API CLUB, Port Hill House, Benson, Oxon.

SURPLUS HIVES and Appliances for Sale, good condition, cheap.—PEARSON & GALE, Marlborough. rh.131

**Displayed Advertisement Rates.**

*British Bee Journal or Bee-keepers' Record.*

	£	s.	d.
Full page ... ..	4	0	0
Half page ... ..	2	10	0
One-third page ... ..	1	16	0
Quarter page ... ..	1	12	0
1½ in. across page ... ..	1	7	0
1 in. across page ... ..	0	18	0
½ in. across page ... ..	0	10	0
1½ in. single column ... ..	0	15	0
1 in. single column ... ..	0	10	0
½ in. single column ... ..	0	5	0

Discount for a series of consecutive displayed advertisements:—Six insertions, 2½ per cent.; Twelve insertions, 5 per cent.; Twenty-six, 15 per cent.; Fifty-two, 30 per cent.

**THE British Bee-keepers' Association.**

The recognised centre of practical and scientific bee-keeping in Great Britain. Particulars and conditions of membership may be obtained from the Secretary,

**W. HERMOD-HEMPSTALL, 23, Bedford Street, Strand, London, W.C.2.**

**Finest Grade New Zealand Honey (Amber)**

For Bee Feeding. Guaranteed Pure.

Cases, each 2-60 lb. nominal Tins. 95/- per cwt. Carriage paid.

Cash with order or on receipt of goods.

N.B. We are already supplying Beekeepers' Associations throughout the Country and shall be pleased to quote references.

**The Bristol and Dominions Producers' Association, Ltd., Bristol.**

The products of the Apiary, of Poultry and Farm Stock, of the Fruit and Vegetable Garden can be Advertised and Sold through

**THE BAZAAR, EXCHANGE & MART Newspaper.**

Get a Copy—Thursday and Saturday 3d. The "Bazaar" publishes also practical handbooks by experts. Send for full catalogue, post free from—WINDSOR HOUSE, Breams Buildings, LONDON, E.C.2.

**1920—QUEENLAND LIST—1921**

In reply to many requests coming in for our Premier White Star Queens for the Season 1921, we beg to state that early delivery may not be offered, as a certain number of orders have been carried over (by request) from previous season for first 1921 delivery, in consequence of the unfavourable weather for queen-mating.

**Our Premier White Star Nucleus Stocks**

will be offered as usual, and at former price; but the charges for Queens have been revised, and include the offer of well-bred and selected Virgin Queens of this renowned strain.

Full Queensland Descriptive Circular 4d., The Revised List only (to those having 1920 List, 2d., post free,

Of S. SIMMINS, QUEENLAND, HEATHFIELD, SUSSEX.

**For Christmas Gifts.** You can get the books of the best authorities in this and other countries, and also the leading American and foreign bee-journals, from

**E. J. BURTT, STROUD ROAD, GLOUCESTER.**

*For the convenience of beekeepers I am printing a special list of these. Send a postcard for it.*



**"BACTEROL"**  
FOR BEES

2/9 per Bottle.

The cure for, and preventive of, Isle of Wight Disease. Non-poisonous—free from stain or unpleasant odour.

**BACTEROL LIMITED**  
19/25, Brookside Rd., Highgate, N.19.

Post Free.

**CANDY** Made in our own factory by bee-keepers for bee-keepers. 6 lbs. post free 9/6

Guaranteed from Pure White Refined Cane Sugar.

Miss Chester-Master's Patent Candy Box, 4/6 each. Postage extra 9d.

**S. J. BALDWIN, The Apiary, BROMLEY, KENT.**

## FOUR FIRST PRIZES.

Our HIVES and APPLIANCES were again awarded FOUR PRIZES at the Highland Agricultural Society's Show at Aberdeen, thus testifying to the superiority of our goods. Order now and ensure your bees wintering in good hives.

**BOTTLES.** We hold a large stock and can give immediate despatch.

**CANDY.** Safeguard your bees from starvation by feeding with our FAMOUS BEE CANDY. Price **1/6** per 1-lb., carriage extra.

Sole Agents for DADANT'S WEED FOUNDATION. Absolutely pure. Once used, always used.

Large illustrated catalogue, entitled, "Everything for an Apiary," post free on application.

**R. STEELE & BRODIE,**  
*Bee Appliance Makers,*  
**WORMIT, FIFE.**

Telegrams:—"Bees, Wormit."

Telephone:—28 Wormit.

## BEE CANDY.

**WE** are now able to supply **CANDY OF OUR OWN MAKE** from guaranteed Pure White Refined Cane Sugar. In 1-lb. boxes with glass tops. It can be had plain or medicated with either "Yadil" or "Bacterol."

### PRICES.

<b>7lb.</b>	<b>11/-</b> , postage 1/3
<b>14lb.</b>	<b>21/6</b> , postage 2/6
<b>28lb.</b>	<b>42/-</b> , postage 5/-
<b>112lb.</b>	<b>£8 8s.</b> , packed free, carriage forward.

BEE FOOD SUGAR VOUCHERS REQUIRED.

**JAMES LEE & SON, Ltd., Uxbridge, Middlesex.**



No. 2005. Vol. XLVIII NOVEMBER 25, 1920. [Published every Thursday, Price 2d.]

**CONTENTS.**

	PAGE		PAGE
REVIEWS .....	565	SCOTTISH BEE-KEEPERS' ASSOCIATION .....	571
BRITISH BEE-KEEPERS' ASSOCIATION'S CONVER-		SHEFFIELD AND DISTRICT BEE-KEEPERS' ASSOCIATION .....	571
SAZIONE .....	565	STAFFORDSHIRE BEE-KEEPERS' ASSOCIATION .....	572
A DORSET YARN .....	565	SALISBURY AND DISTRICT BEE-KEEPERS' ASSOCIATION .....	572
JOTTINGS FROM HUNTINGDONSHIRE .....	566	WILTSHIRE HONEY (POEM) .....	573
DO BEES "DO NOTHING INVARIABLY" .....	567	CORRESPONDENCE—	
JOTTINGS .....	569	Queens on Strike .....	573
BEE NOTES FROM DERBYSHIRE .....	569	The Significance of Acarine Disease .....	574
NOTES FROM GRETNA GREEN .....	570	Intelligence of Bees .....	574
B.B.K.A. LIBRARY .....	570	Plants for Bees .....	575

OWING to the FALL in the COST OF SUGAR  
WE ARE IN A POSITION TO SUPPLY  
PINK (MEDICATED OR PLAIN)

# SOFT CANDY

Made from Guaranteed Pure Cane Sugar.

**NO VOUCHERS REQUIRED.**

1/5 per lb. (7lb. parcel post free, 11/-)  
(10lb. do. do. 15/6)

**E. H. TAYLOR, LTD., WELWYN, HERTS.**

THE  
**British Bee Journal**

Office: 23, Bedford Street, Strand, London, W.C.2.  
ESTABLISHED 1873.

A Weekly Journal Devoted to the  
Interests of Bee-keepers.

Edited by T. W. COWAN, F.L.S., &c.,  
and J. HERROD-HEMPSELL, F.E.S.

Correspondence: Whom to Address.—All matters relating to the Literary Department, Associations, Shows, etc., should be addressed, "Editors, *British Bee Journal*," and all business communications and matters relating to subscriptions and advertisements to be addressed to the "Manager," *B.B.J.* Office.

Subscriptions. — Annual Subscription, 10s. 10d. post free in advance; single copies 2d., or 2½d. post free. If a receipt is required by post, a stamped and addressed envelope must be sent, otherwise a printed receipt will be enclosed along with the paper.

Note.—Cheques and Postal Orders should always be crossed, otherwise it is very difficult to trace them if they go astray.

How to send Money.—Remittances can be made payable to W. Herrod-Hempshall by crossed Cheques and Postal Orders. Stamps may be sent for small amounts up to 2s. *Halfpenny stamps are preferred.*

Scottish or Irish cheques can only be taken in payment if 6d. is added for commission charged by banks for cashing them.

The Editors are not directly or indirectly interested in the manufacture or sale of beehives or appliances of any kind, and must refer correspondents wishing for prices or catalogues to advertisers in the paper.

## OUR DEPOSIT SYSTEM.

You are advised to insist on this being used when dealing with strangers.

### Rules and Conditions for Depositing

In order to save trouble, it is requested that the Rules be carefully read over by persons using the Deposit System of trading.

Goods should not be despatched until notice that the money has been deposited is received from this office.

1. Method.—When strangers are dealing together, the purchase-money of the articles is deposited at our office. We acknowledge receipt of the deposit to both parties, and hold the money until we are satisfied that the purchase is concluded. If a sale is effected, we remit to the seller the amount deposited, less a charge of 2½ per cent in the £, with a minimum of 6d., and the expenses of Post Office Orders and postage, &c. Cash will be forwarded by Cheque, Post Office Order, or by Postal Order as preferred. If a sale or exchange be not completed, we return the amount deposited, after making the same deduction. By this means buyers and sellers are secured against fraud.

2. Deposits.—Postal Orders (drawn on General Post Office) and Cheques must be made payable to W. Herrod-Hempshall, and crossed "London County and Westminster Bank." The numbers of the Postal Orders should be kept by the sender.

We cannot be responsible for any loss that may occur in transit.

3. Honey on Approval.—All honey will be sold by sample, which must be sent direct to buyer.

4. Bee Appliances.—In ordering, the time allowed for completing the order to be stated to us when sending cash. If maker accepts, we hold cash until transaction is satisfactorily completed, when the amount will be remitted, subject to conditions as in Clause 1.

5. Bees and Queens.—These will be dealt with entirely by the parties concerned, so far as price, &c., go, and when the purchase is satisfactorily completed cash will be remitted as per Clause 1.

6. Goods in Transit.—These are at the seller's risk, i.e., any damage to or loss of an article on its journey is borne by the vendor; but a rejected article must be properly packed and returned by the same means as was used in sending it.

7. Carriage.—The carriage of all goods, except such as are sent by post, is payable by the buyer, unless otherwise agreed. If any article sent on approval be returned, each party to the transaction must pay carriage one way.

## Books for Bee-keepers NOW IN STOCK.

Cash in full must be sent with order.

	Postage
A Modern Bee Farm ... ..	7/6 ... 8½d.
(To be obtained from this Office only.)	
Advanced Bee Culture (HUTCHINSON) ... ..	6/- ... 6½d.
Beginner's Bee Book (PELLITT)	5/- ... 4d.
BEE-KEEPING SIMPLIFIED FOR THE COTTAGER AND SMALLHOLDER (W. HERROD- HEMPSELL, F.E.S.) ... ..	1/- ... 2d.
BRITISH BEE - KEEPERS' GUIDE BOOK (T. W. COWAN)	
Paper covers ... ..	2/6 ... 3d.
Cloth covers ... ..	3/6 ... 4d.
Dissectible Model of Queen Bee ... ..	4/6 ... 3d.
FERTILISATION OF FRUIT BLOSSOMS BY BEES (T. W. COWAN) ... ..	-/3 ... 1d.
Honey and Health (A. HOPE) ...	-/6 ... 1d.
Honey Vinegar (REV. G. BANCKS)	-/2 ... 1d.
How to Keep Bees (ANNA B. COMPTON) ... ..	5/- ... 4½d.
Prevention of Swarming (WILKES) ... ..	1/- ... 1d.
Pollination of Fruit in relation to Commercial Fruit Growing (C. H. HOOPER, F.R.H.S.)	-/6 ... 1d.
PRODUCING, PREPARING, EXHIBITING AND JUDG- ING BEE PRODUCE (W. HERROD-HEMPSELL, F.E.S.) ...	2/- ... 3d.
Queen Rearing in England (F. W. L. SLADEN) ... ..	1/6 ... 2d.
Scientific Queen Rearing (DOOLITTLE) ... ..	4/- ... 3½d.
Snelgrove's Method of Re- queening ... ..	-/6 ... 1d.
The "Townsend" Bee Book ...	2/6 ... 2d.
WAX CRAFT (T. W. COWAN) ...	2/- ... 2½d.
Wilke's Book on Swarming ...	1/- ... 1½d.

### MISCELLANEOUS.

The Lore of the Honey Bee (TICKNER EDWARDS) ... ..	2/- ... 3d.
Life of the Bee (MASTERLINCK) ...	5/- ... 4d.
THE BEE WORLD (supplied only to members of Associations interested in the control and development of the APIS CLUB, apart from ordinary members of the latter), per copy ... ..	-/8 ... 1½d.
The Bee Master of Warrilow (TICKNER EDWARDS) ... ..	7/6 ... 4½d.

British Bee Journal & Record Office,  
23, BEDFORD STREET, STRAND LONDON, W.C.1.





## Reviews.

*The Lure of the Hive.*—This little brochure is a lecture that was delivered at the annual meeting of the Leicestershire and Rutland Bee-Keepers' Association, on March 13, 1920, by the Chairman, H. Clark, Esq. Mr. Clark has succeeded in compressing a lot of information into the one lecture, it is also given in a most interesting fashion, and is a model of what a lecture on bee-keeping in general should be. The booklet is a good investment for anyone who is commencing to give lectures on bee-keeping, giving an excellent idea of the lines on which such lectures should be framed. It is also suitable for those who are intending to take up bee-keeping and need some elementary instruction, and those who are already bee-keepers will find some good advice and useful hints in it. The booklet consists of 22 pages, and may be obtained from the publisher, P. Stevens, Printer, 7a, Slawson Street, Leicester. The price is 4d., by post 5d.

*Bee Diseases and their Treatment.*—This brochure of 16 pages is issued by Messrs. Clement & Johnstone, Ltd., the proprietors of "Yadil," and those who are using, or intend to use this remedy will do well to send for a copy. In addition to the instructions for the use of "Yadil" in the treatment of bee diseases, some useful information and advice on general management is given.

## British Bee-Keepers' Association.

CONVERSAZIONE, OCTOBER 21, 1920.

(Continued from page 542.)

At the close of Mr. Bryden's paper a discussion followed, for nearly half-an-hour questions being asked and answered.

Mr. Rae, who had also been to Italy and visited some of the queen breeders' apiaries, made a few well chosen remarks, in the course of which he told an interesting story of his visit to the Penna apiaries at Bologna. Signor Penna remarked to him, "Would you like to see me take my tonic?" and baring first one arm and then the other, applied ten bee stings to each forearm. This, he said, he did regularly, as he found the application of the stings kept him free not only from rheumatism but from most other ills as well.

Mr. Cowan said that bee-keeping in Italy thirty years ago was very crude,

bees being kept in boxes and other receptacles. Of late years there had been a great improvement, and those who had gone in for large apiaries and queen-breeding had adopted modern methods. The bee-keepers in the more out of the way places, however, still kept their bees in the old manner, swarms being hived in boxes, and generally left on the spot where they were hived.

An interval of an hour was allowed for tea, conversation, and an examination of several new appliances which were on view, including a hive designed by Mr. D. Fielden, and a wax extractor designed by Mrs. Willis.

Mr. Cowan again took the chair at six o'clock, and called on Mr. J. Price to give his paper on "The Production of Heather Honey."

(To be continued.)

## A Dorset Yarn.

Those of us who till the soil for a livelihood have to take stock of the numerous units we grow to see which gives us the greatest return. In areas where apples, pears, plums and cherries do well, the chief labour spent is harvesting and marketing the luscious fruit, and having standard trees, cattle can feed among them the greater part of the year. With this system of fruit farming, when the trees have size and plenty of wood, most years the return should be a paying one, as cattle can get enough to feed, and in three years should be worth £30 to £60 each. There should be a good harvest for bees at blossoming time, but trees do not do well when the grass is growing on top of the roots. When the trees are young, grass should not be allowed to grow round them for ten years, then they would be able to fight for themselves.

At the Violet Farm the greatest results come with apples and other tall trees, in the long lines of black currants, gooseberries, and raspberries, even when there are thirteen, and some weeks fifteen, men and boys to be paid on the 50 acres farmed. Those who till the soil know it is a race for the mastery. Nature tries her utmost to cover the soil with plants of no service to the cultivator; he wants the units which are of service to grow well. It is continually warring against Nature, and this is a costly item; the results, however, are well away beyond the area of grass orchards, but it all depends on tilling the soil well. Work the soil well, and the increase in crops will be greater, the lines of fruit bushes will be of greater value to bees as well. We keep on extending; it is obvious we should

not do so if the results were not good. No one knows better than I the great value of *Trifolium incarnatum* for bees, so much so that we have sown a field we have recently bought, which is close to the bees, so that they should have a good time when it is in bloom. We shall cut this each day for cows and horses, but there will be a large area left for the bees. Though they will get a lot of nectar from this field, and so add to the value of the harvest, the results per acre will be much on the wrong side compared with bush-fruits and flowers. Where the black currants yield fruit to the value of ten pounds each line, a seven acre field of these alone is considerable.

Then there is the harvest of flowers between the lines; the man who keeps bees with limited capital, as we began with, need not hesitate to plant up areas of bush fruits and raspberries; if planted 12 ft. to 15 ft. from row to row, so that the intervening space can be worked with horse labour, then the cost will not be so great per acre, as the horse can go through the lines of crops in summer, which will make the soil better for the crops and destroy the weeds. The hand labour will be between each plant in the lines, which ought not to be very arduous and costly; but the results to the bees will be tremendous, the nectar gathered from gooseberries being very great. Bees are an absolute necessity to the perfect fertilisation of these fruits. Kerner writes: "The honey is easily accessible." No wonder so many bees are on them at flowering time. Kerner's list of insects on them includes *Apis mellifica* very abundantly, all sucking." In his wonderful works on insects and flowers he gives all that visit them, but in this particular fruit, "*Ribes grossulariata*," not one of them carry pollen; this is a proof that honey in abundance can be had from lines of gooseberries.

Beekeepers cannot always sow crimson clover by the acre to help the bees, but they can plant up a few lines of gooseberries, which will soon grow into money, particularly if the cuttings are planted in the lines they are to occupy permanently; buy some few hundred one-year trees for a start, and then gradually extend each year, so when fruiting, as you extend, the weight of fruit each year will be doubled. It is only the first year or two that you will have to wait for the fruit, but if the spaces are all filled with vegetables—potatoes, onions, cauliflowers, etc.—these will bring in the necessaries of life until the bushes come in with their weight of fruit; then the pleasure of fruit farming is at the full, or "the flood," as Shakespeare puts it; then the young bee-

keeper and fruit farmer begins to learn. He will find that some varieties of gooseberries are susceptible to the American mildew. If he is wise he will shun those kinds as he would a "plague," for plague it is to the man who gets it. "Winham's Industry" is the worst to get it that I know of; some varieties never get it, others hardly ever have a fruit touched with it, some never; the ones we keep extending are "Careless Keepsake," "Whitesmith," "Warrington," "May Duke," and a few others. I do not know their name, but these are very productive.

It is most interesting to the student of Nature to read Kerner's description of these flowers. "the anthers dehisce when the flower opens; the styles have not as yet attained their full length, nor have the stigmas developed their papillæ; since the flowers mostly hang down perpendicularly and the stamens stand around, and on a level with the stigmas, self-fertilisation can as a rule *not* take place, even in default of insects' visits."

Perhaps I am going in strongly with horticulture, Mr. Editor, but I want to infuse others with love of fruits and flowers. He who grows gooseberries well and can let them ripen will find some of them very nice eating indeed; some of them when ripe are not so sweet. You learn the lessons of culture and harvest as you progress with each acre you extend.—J. J. KETTLE.

## Jottings from Huntingdonshire

"ACARINE." Blessed word. Begone *microsporodiosis* with your spores, plan-  
 onts, meronts, and all your sinister  
 appendages. Cheer up, ye keepers of  
 bees. Isle-of-Wight, island of beauty,  
 balmy breezes, ozone air, jewel in the  
 Channel sea, no more shall we besmirch  
 your fair name. We lose our bees  
 through carelessness, they die of starva-  
 tion; we don't like to own up, so we salve  
 our conscience with those three familiar  
 letters, "I. O. W." Now we must, to  
 be in the fashion, frame our mouths  
 to say "Acarine." A stock is queenless  
 and perishes, we rub our hands, and look  
 wise, and murmur "*Acarine, Acarine,*"  
 and the uninitiated gasp at our scien-  
 tific knowledge and go away wondering  
 whether it is some juice of oaks our bees  
 have taken and died of, or have the bees  
 been feeding on acorns themselves, or  
 some mites which batten on the fruit of  
 the oak? 'Tis a lovesome word, Mr.  
 Editor, it has a musical sound; it sug-  
 gests a Psalm tune in the major key, and  
 yet it will produce an acataleptic effect  
 on many minds. Some will imagine the  
 word has connection with acatharsia, and

reasoning by induction, and knowing nothing of the physical structure of the bee, will conclude the great bee disease is heart weakness. I wonder if old William knows anything about it? Why here he is. "William," I say, "do you know what 'Acarine' means?" "Acarine, master—I knows what an acre be, and an aker-staff, and an acarus, but that ther 'ine' puzzles I. Only 'ine' I knows owt about is margarine, and that's foul enough betimes." "Why, William," I explain, "it's the new name of the 'Isle-of-Wight' disease." William grows wise and laughs, and rising to the occasion, says, "Acarine, ump, suppose I must *accept* it, 'twill help ye to *accelerate* your bees, when you have *access* to the hives. *Accuse* 'em of laziness the'll *accost* you, get *accustomed* to 'em and the'll be in *accord* with 'ee. What d'ye say to that, master? Carried with *acclamation*?" "Steady, William," I say, "or I'll have to propose you as a Parliamentary candidate." William smiles and becomes sedate. "Acarine, well, I'm done, what d'you want wi' bee diseases for. Never was when old master kep 'em. Healthy, why they was always topping. Fed 'em with beer and sugar in an elder stick in winter, that's the way to keep 'em healthy. Tell 'ee what I thinks o' yer 'Acarine,' it's no disease at all, just weakness caused by bad 'ousing; however, you fancy chaps what keeps bees, you must 'ave fancy names, and if yer must 'ave bees what gets ill, we'll, call it 'Acarine,' must have a name for't, and Acarine's as good as acorn, or any other ac—something or another."

Why not startle the country by having posters emblazoned from John o'Groats to Penzance. "What is Acarine? Join the British Bee-keepers' Association and find out." At our next conversation why not have a huge bill stretching o'er the entrance to the Central Hall: "ACARINE, it's Cause and Cure"? We might startle the West End, at any rate. I can see crowds looking at it wonderingly. Methinks I hear someone ask a policeman its meaning, and the all-wise bobby saying—"Something sweet. I should say, sugar substitute, or something of that, granulated saccharine, maybe." The crowd enters the hall, and we rope in a few more thousand enthusiasts. Good!

Withal, I welcome the name, and endorse the Editor's remarks. Now it has come along let us use it, and not abuse it; we might even use it as a charm. What do you say to a bee-keeper's badge, triangular in shape, the word forming a kind of "Abracadabra," and as we conquer the fell disease, we might have an X put through it, to notify it has been crossed out. Further we might spend our winter

evenings in making acrostics and anagrams, and thus so familiarise ourselves with the word that we will never mention the disease as "Isle of Wight."

It is one of Hood's November days, fog and damp. "No sun no moon, no morn, no noon, no proper time o' day, no fruits, no flowers, no sunny hours, no t'other side of way," etc. We must not complain. The first half of the month was beautiful beyond words, and if the latter days of November are cold and chilly, we have Acarine to think about.

A blaz E  
C ommo N  
A gent I  
R epai R  
I nerti A  
N epti C  
E neci A.

But, enough. Let us now see that our section racks are cleaned ready for next spring, and Aca— No, I won't write it again.—E. F. HEMMING, Steeple Gidding.

## Do Bees "Do Nothing Invariably"?

(By L. Willis.)

(Continued from page 556.)

I suppose it can be taken as agreed that the question of the greatest variability of bees has turned on their treatment of that lodestar of every stock—the queen; and if, for the sake of the argument, we admit the feasibility of the fact that there is one spot in the hive, viz., the base, where, if they find a queen installed, they will accept her as the reigning unit, is it without the region of probability that the whole economy of the hive may revolve round just that position? Is it out of the bounds of possibility, for instance, that we have gone astray in forcing upon bees *our* notions of hygiene and ventilation? If this has not occurred to the reader, let him try that much-lauded stunt for prevention of swarming, of putting a box of unworked foundation, or practically empty frames below; and as, during our short season, we are favoured with a good few samples of indifferent, if not positively bad, weather, the experiment will be indelibly fixed in his mind by studying such a stock under the persistently varying conditions. In glorious weather they will do some drawing-out in it, so they will in a hedge, with great waste of laudable endeavour. But what will be found if the weather is indifferent? If the hive is really strong, whole crowds of bees are clustered on these combs (if the stock is not what you would call a strong

one, the combs look like a London street in a sudden downpour). Ha! they are drawing out! But are they? Go to that stock in one week, or two weeks, and still there are floods of bees—and, napoo, undrawn-out and mostly broken foundation. I have displaced a really good-sized swarm from such a box. Are they slacking? It is puerile to suppose so. But if it is postulated that bees are insects; that insects must have heat to breed; and that heat rises: might it not lie in the scientific economy of such heat that we can control the bees and place them in such a position that, bad weather nevertheless, while serving their own ends they will also serve ours? Is it out of the bounds of possibility that the bees' ideals of overcrowding and ventilation may differ materially from our theoretical findings, and that in manifestly running counter to them we place them in an impossible position, and one often even beyond their wit to circumscribe or remedy? To make wax they hang in solid clusters: in swarming they hang thousands deep; leave a space in a box, and if they have the bees they jam it up to suffocation; they glue up every joint or crack. Why should we presume that unless in the hive they have a hurricane whirling round them, and vast and, to them, icy caverns yawning below and above, they must be a prey to all and every disease germ? Hateful word! The normal human being does not go about eaten up with the dread of the diseases ever around; kept fit, even in an unhealthy environment, the vast majority escape. And so do the bees—if they are kept fit. The whole being of insects is wrapped in heat, and in the sun they prosper. Then, if the sun cannot be given them overhead, give it them in their bodies and let their hives radiate the sun: give them queens bred in sunshine, lapped in sunshine, abounding with the health and vitality the sun gives, and you will not have to deplore the insistence of "Isle of Wight" or any other disease. But even so, with disease about it is hopeless to dream of immunity if their whole being is thrown out of gear continually. To give the strongest stock too much emptiness, especially at the bottom, is asking for trouble in our treacherous weather, as stocks can be directly landed into the crawling diseases and foul brood by ill-advised manipulations, as I have bitterly experienced. It is just here lies the difficulty of bee-keeping in this climate. What may be done with impunity to the well-being of the bees one day becomes an overpowering menace the next day, with the added impossibility of

the bee-keeper being able to lift a finger to minimise the damage. Owing to this changeability it is imperative at no season to place them at a disadvantage, as by so doing their resistance, as a matter of course, becomes undermined.

At the same time as experimenting with the empty box below principle I also experimented in letting queens roam free in various-conditioned stocks. Here was to be the Eldorado of wondrous honey takes. She would lay illimitable brood in the boxes, and bees always store honey near brood! They do. But a good bouncing queen is a pretty spry proposition, and the bees' policy must be one of "follow my leader"; and as it is in the nature of bees to run up, up she goes, wandering from comb to comb in a more or less vertical direction, and the heat obtained from the concentrated energy and clustering of the bees, which from the *bottom* of the hive could be directed to the economical working of the *whole* hive, is gradually withdrawn and dissipated, and often losing the necessary insistent touch with their queen, cells are raised below, and it is a sorry harvest the bee-keeper will get. In point of fact, if the weather is indifferent, it will be a lucky circumstance even to be able to winter them safely, let alone get a surplus. The going and coming of such stocks, strong though they may be, is not a pretty sight; there is none of that dear excitement, that wild and happy flow, but a disheartening uncertainty and restlessness. Very different is their behaviour when in close touch with their queen immediately on entering the hive. Even human beings, coming home from work tired and weary, laden with good things, feel a bit of sinking at the heart if the board is bare and the hearth cold; and the bees' life and work depend upon satisfied instinct. Keep the queen breeding below, and do not let her dissipate the energies of the bees; at certain times of the year she will need two boxes, at other times one; and give brood in every box you raise above the excluder, for nuclei seven or eight combs, for honey one or two, i.e., if you have plenty of drawn-out combs and food to play about with, and the experience to estimate with safety the strength and capabilities of the stock; the "long chance" must never be taken with brood. Sure it is the bees' natural instinct to store honey where brood is against necessities, and this natural instinct can be utilised by the bee-master to secure a hitherto undreamed of harvest.

Doubtless, honey from stock boxes requires a little different treatment for market than that extracted from supers, but it is a fallacy to suppose it does.

not keep or cannot be made as attractive as any other. We have had no trouble in either keeping it or placing it on the market in two- to four-hundredweight casks at tip-top prices, getting repeat orders.

(To be continued.)

## Jottings.

*Antiseptics and Feeding.*—To assist the use of an antiseptic when disease attacks, would it not be more effective if less of this is used as a so-called preventative, some of these antiseptics can hardly have the effect of a tonic on the bees, and what object can be gained in dosing healthy bees I can never see. All these things, to my mind, lower vitality, and in conjunction with no attempt at introducing fresh blood into our apiaries, can only in time lay bees open to attack. The same thing, although not injurious exactly, applies to placing on candy when the colony is known to possess ample stores. There is a great tendency on the part of bee-keepers to use this as an essential rather than as an emergency aid. Bees will rest more on sealed stores, and eat less, which should mean less waste matter to dispose of when the cold snaps arrive and go again. This means more health.

*Page 539.*—I usually read Mr. C. Tredcroft's letters with interest, there is generally something to think about. It is unfair to ask, "Why use 'Bacterol?'" if Nature does not provide this as food or medicine bee-wards. I dare say syrup, which is generally given because the bees are short of "natural stores," would be just as good without, but I think a touch of vinegar gives an aromatic flavour to these artificial stores; but I am no chemist.

*Guildford Dis. S.B.K.A.*—On November 15 an interesting address was given by Mr. Judge, of Kent, who is appointed lecturer on bee-keeping under the County Council of Surrey.

Alderman W. T. Patrick acted as chairman, in the absence of Lt.-Col. J. A. C. Younger; other apologies for absence were also read. The audience numbered about forty.

The subject chosen was "Wintering Bees," which, judging by the number of questions at the conclusion, proved to be most interesting and instructive, especially candy making. Mr. Judge, during the course of his remarks, touched on the recent conclusion arrived at regarding "Isle of Wight" disease, and gave as his opinion that we are entitled to an answer or an explanation by the Agricultural Board, of their previous solution and re-

port, which we should no doubt get. But for this we must "wait and see."

By the way, my crude letter written in 1911 and entitled "Experiences and Guesses," comes very near to the experiences of to-day. I remember, how knocked out I felt when Mr. Crawshaw, I think it was, explained how the intestines were so expanded and ruptured that it was impossible for the bee to recover, and then on to the days when the Rev. Mr. Hollis claimed the Dioxygen cures. What an uproar this caused at some places, but this reads simple now, and really one wonders if we are not very near a cure, as well as a palliative. It may be recalled that I said Izal caused accelerated breathing, thus setting free this mucous accumulation. Mr. Tredcroft, page 538, also draws attention to the immediate result noticeable by the use of "Bacterol" fumes, and who will doubt, or fail to recognise, the fume of an onion.

Personally I still stick to my first love, Izal. I have saved a friend's skep stock badly affected this summer by spraying with it.—A. H. HAMSHAN.

## Bee Notes from Derbyshire.

Perhaps if I give a few extracts from my diary as regards the weather during the past bee season, or summer, it might be of interest to readers of the BEE JOURNAL in years to come; the sunny days stand out so conspicuously by their absence all the way along till September and October.

I started my diary in February, and I see there were six sunny days in that month. The 17th and 18th were very warm days—thermometer 56 deg. Fah. in the shade—bees working for pollen on cut flowers in cemetery, such as mimosa, daffodils, lillies and tulips. I also lifted one hive off the stand and put ten combs of honey under it that bees had died of "Isle of Wight" disease in five months before; fastened hive up for three days to keep them from flying out next day (went on all right). March 4, saw a queen wasp flying to-day; was very warm; had a trip to see my hive on moor. Bees flying freely, but not a bit of pollen to be got about there yet. Spring cleaned the hive; queen had just laid her first patch of eggs. March 21, a hot sunny day, thermometer 60 deg. Fah., followed by a sultry day; bees doing their best on palm, flowering currant and foal foot flowers. I find there were four sunny days in March, on five other days the sun shone a bit more or less, while the remainder made March a mixed up medley of all sorts.

An old farmer, some eighty years old now, told me ten or twelve years ago that a mixed up March meant a mixed up summer. Verily it has been all too true for bee-keepers.

On March 31 bees were on gooseberry and Victoria plum. While a "Noah's Ark," north and south, in a "mackerel" sky at ten at night denotes rain, see what follows it.

April 7, damson trees have been in full bloom a day or two, but bees have no chance, always wet; in fact, it was dull and wet for fifteen days, then came on a thunderstorm to send us some rain. Two sunny days followed that lot, and if ever anyone was glad to see sunshine we were in Derbyshire at that time. I think one other sunny day was about all we got in April. On the 15th it rained, three showers per hour all day, and wet showers too. I should say it was the wettest, dullest April in the memory of man. Highest thermometer 55 deg.

May did not come in much better. On the 8th I wrote: "I don't know when I will be able to see inside a beehive again, there has been no fit day for five weeks." May 15th, got a look in a beehive to-day. Lifted the hive off top, that I put the ten combs under in February. They had fetched all the honey out and queen had laid in five combs; brood in eight combs, eggs in twelve—a very good lot—been wintered with 3-ply wood for quilt, dead down on frames, and a few old *Daily Mails* on top—a great saving with calico so dear. A "Noah's Ark" east and west to-night betokens better weather.

May 20, we seem to have struck a bit of bee weather at last, for a week temperature rises from 60 deg. till it gets to 75 deg., then it gradually dies away again, and then turns out the hottest day this summer about here. Bees did a bit on sycamore, May bloom, and raspberries that week. I caught twenty queen wasps, and I have only seen one worker wasp about here this year. I daresay the wet July finished the rest off. We had six sunny days and five part-sunny days in May; bees just gathered barely enough to keep brood nest going.

(To be continued.)

### B.B.K.A. Library.

Major Ellison has kindly lent for a time two books on bee-keeping by F. Gerstung, "Immenleben Imkerlust" and "Der Bien und seine Zucht." Both are printed in German, and may be seen at the library by anyone interested.

## Notes from Gretna Green.

While looking through back volumes of the B.B.J. I was struck by the fact that the regular contributors of ten years ago are entirely absent from the Journal of to-day. It is scarcely credible that the former writers can have died out *en masse*, and I would like to know why these able bee-keepers have with one accord ceased to support the BRITISH BEE JOURNAL.

Personally, I miss most of all "D. M. M.," and no doubt many old subscribers will re-echo my wish that men like Macdonald and Woodley could come back once more. As regards the present day B.B.J., my candid opinion is that far too much valuable space is wasted on matters entirely alien to the craft.

I have noticed an occasional protest on this subject, and the complaints are entirely justified. The B.B.J. is, or should be, a medium for the exchange of views and experiences by bee-keepers, and its limited space ought not to be curtailed by any irrelevant matter. If my views are correct we should, every one of us, when contributing to our Journal, write *as* bee-keepers and solely about bees.

A regrettable feature is the absence of Scottish contributors to these columns, and I wish some of my countrymen would let us know how they fared during 1920.

I understand there has been a good honey season in the Highlands, but not one North Country beeman has sent even a brief note to the B.B.J. Is there no "Elisha" capable of taking up the mantle dropped by "D.M.M."? Here in the South-West our season was almost a failure, and the supers filled in early June were needed to stave off starvation during the following lean time. The real honey flow came in late August, but no sections were ready for removal until September—a unique occurrence. I have had sections filled in May, but never before had to wait until September for the first sealed section.

My average for honey actually sold was in 1919 £6 7s., and this year £2 7s. per colony. Next season the average may be £10—or perhaps as many shillings—such is the beautiful uncertainty of bee-keeping in our variable climate. But then, if the returns from apiculture were as sure and certain as, say, the income-tax demand our craft would be deprived of half its charm.—J. M. ELLIS, Gretna, Carlisle, November 20.

[Though this article is dated November 20, it did not reach us until Tuesday morning. We have therefore no time to write and comment on it this week.—Eds.]

### Scottish Bee-Keepers' Association.

The autumn quarterly Council meeting was held in the Christian Institute in Glasgow, the Rev. R. MacCowan, of Kiltarlity, Inverness-shire, and, later, the President, Mr. J. H. Langlands, of Dundee, occupying the chair. There was a very large attendance, representative of every part of the country. It was reported that the public meeting held in Glasgow the previous evening had been a great success, and it was resolved, when practicable, that such meetings should be held in connection with each Council meeting. The Treasurer reported that the finances were in a satisfactory condition, there being a balance in hand of £16, in spite of the outlay of over £50 in connection with the show at The Highland in Aberdeen in July. He was authorised, if necessary, to draw upon the reserve funds until the Ministry of Agriculture grant for this year is paid.

The Propaganda Committee reported on the work that was being done in forming new associations in various parts of the country, and expressed satisfaction that the possession of the Register of Bee-keepers made it possible for our representatives, for the first time, to approach individual bee-keepers in areas where no associations at present exist. The prospects of a considerable increase in the number of associations and branches are very good.

The Registrar, Miss Beveridge, reported that we had now a record of 8,000 bee-keepers in Scotland, with 23,000 hives, and it seems likely that when all the reports are in the total number of bee-keepers will approach 15,000, with probably 50,000 hives. The reports from some districts are all in, and in these districts we find one bee-keeper for less than four square miles and for every 600 of the population, and one hive for every 740 acres. Aberdeenshire leads the way both in actual number of hives and in proportion to its size and population.

The Education Committee reported that a considerable number of lectures had already been arranged for the winter and that the sets of lantern slides were in great demand. There were three different sets with lecture notes. The slides were sent out by parcel post free of any charge to Associates or Secretaries of Associations or to experts or bee-masters. Only the return postage need be paid. The number of candidates for the various certificates had been greater than the Committee anticipated, and, on the whole, a high standard of proficiency had been reached. The President then presented the certificates that had been

gained since last meeting to the successful candidates who were in attendance. The librarian reported that the library was in a flourishing condition, and that the arrangement had been much appreciated whereby books are sent out postage free, only the return postage being paid by the borrower. In this way a very considerable educational influence is being exerted. Gifts of valuable books had been intimated by Dr. Ross, Lochgilphead, and Rev. R. MacCowan, Kiltarlity, and the donors were heartily thanked. Gifts of books or lantern slides will be much appreciated for adding to the collections. The Librarian was authorised to issue a new catalogue.

The Markets Committee reported that the honey harvest had, on the whole, been a very disappointing one. Testimony was borne to the value of the markets leaflet issued indicating the market value of honey, for these had enabled the members in most cases to sell their honey locally to advantage, and the depôts had received very few consignments to dispose of.

It was resolved to appoint a Special Committee to suggest such revision of the constitution as might seem desirable, and to submit any proposed changes to the various Federated Associations. A scheme of insurance of hives will be considered at the next meeting of Council, which was appointed to meet in Cupar, Fife, in January next.

Votes of thanks to the Chairmen and Hon. Secretary were heartily given at the close of a most successful meeting.—  
T. BEVERIDGE, Hon. Sec.

### Sheffield and District Bee-Keepers' Association.

The monthly meeting of the Association was held in the Lecture Hall, Sheffield University, on Wednesday, November 10, the chair being occupied by Dr. W. Harwood Nutt.

All available seating accommodation was taken up, over 200 being present to hear a lecture by the Rev. G. H. Hewison, M.A., on "The Life History of the Honey Bee," illustrated with photomicrograph lantern slides, the result of the lecturer's own work. Over 80 slides were used to illustrate the lecture, showing some wonderfully clear pictures of the bee's anatomy, as seen through the microscope. The Chairman, in thanking the lecturer, said he was delighted to see the wonderful pictures that the lecturer had produced, and he thought that scientific men such as the lecturer should be a great acquisition to the bee-keeping industry. Mr. Hansell, in proposing a vote of

thanks to the lecturer, said he thought the lecturer had enjoyed himself as much as his hearers; he seemed to revel in his subject, and he had great pleasure in proposing a hearty vote of thanks to him. Mr. Helliwell seconded the vote of thanks. The meeting terminated with a vote of thanks to the chairman for presiding and to the Council of the University for use of the Lecture Hall and lantern, proposed by Mr. W. Boshforth and seconded by Mr. C. Haynes.—(Communicated.)

### Staffordshire Bee-Keepers' Association.

A meeting of the above was held on Saturday, November 6, in the Technical Buildings, Stafford, with a good attendance. The primary object of the gathering was to consider a report of a special committee which had been appointed to consider the financial status of the Association. The committee recommended that there be a Finance and Show Committee of six appointed, also that the subscription rate should be slightly altered to read, "Subscriptions shall be 5s., and cottagers 2s. 6d."; also they suggested that the annual drawing be abandoned for the present. The whole of the recommendations were adopted. It is hoped that these slight alterations, which will not inflict any hardship on members, will enable the Association to pay its way each year and keep a reasonable balance in hand for any eventualities.

In connection with the above meeting a small exhibition of honey was held: there was a good entry of first-class honey, which was highly creditable to the members, but at the county shows members do not exhibit who can stage good stuff at local shows. Is it nervousness, or lack of a sporting spirit? Perhaps next year, with the County Agricultural Show at Burton, and the Royal at Derby, we shall see a greater appreciation of the value of the show bench as an advertising medium. The prize winners on Saturday last numbered two or three new exhibitors who held their own with the best. Mr. J. H. Mytton and Mr. J. Price judged the exhibits and awarded the prizes as follows:—

Class 1.—Light Honey (open to all members): 1, Geo. Evans; 2, G. W. Buttery; 3, Geo. Gipton; v.h.c., T. Lawton; h.c., A. Cheshire; e., J. Taylor and B. Warrender.

Class 2.—Granulated Honey (open to all members): 1, Miss Capewell; 2, A. Cheshire; 3, J. Swanwick.

Class 3.—Sections (open to all members within a radius of five miles of Stafford): 1, Miss Capewell.

Class 4.—Light Honey: 1, G. W. Buttery; 2, T. Lawton; 3, J. Taylor; v.h.c., Miss Capewell; h.c., W. Griffiths and J. W. Crosby.

Class 5.—Other than Light Honey: 1, Miss Capewell; 2, T. Lawton; 3, J. W. Crosby.

Class 6.—Granulated Honey: 1, Miss Capewell; 2, J. W. Crosby.

Class 7.—Beeswax: 1, Miss Capewell; 2, W. Griffiths.

Class 8.—Useful or Interesting Exhibit: 1, W. Griffiths, for an "improved Staffordshire nuclei hive and carrier"; 2, J. W. Buttery, for a "hive tool"; 3, Miss Capewell, for nightlights made from beeswax.

A honey judging competition was held. The honey samples, of a very close order except one, which reminded the embryo judges of an old friend of their childhood "castor oil," were primarily judged by Mr. J. Herrod-Hempsall, and the scrutineers awarded certificates of merit to Messrs. W. Griffiths, J. H. Mytton, G. W. Buttery, W. Friend, B. Warrender and T. Cowleshaw.

Mrs. Leighton, whom we expect to see in the near future as holder of the certificates of the B.B.K.A., kindly presented the prizes awarded, and a vote of thanks to her and our chairman, Mr. J. H. Mytton, brought to a close a meeting that will be long remembered by those present for its geniality and good fellowship.—W. GRIFFITHS, Solway House, Silkmore, Stafford, Hon. Sec.

### Salisbury & District Bee-Keepers' Association.

LECTURE BY MR. J. J. KETTLE.

"Practical Bee-keeping on a Flower and Fruit Farm" was the subject of an interesting lecture delivered by Mr. J. J. Kettle, F.R.H.S., of Corfe Mullen, Dorset, to a meeting of the Salisbury Bee-Keepers' Association held at the Church House, on Wednesday, Nov. 3. Mr. I. T. Rule presided over a small attendance of those interested, and briefly introduced the speaker. Mr. Kettle divided his lecture into two parts, in the first of which he dealt with the beneficent influence of bees upon a fruit and flower farm, while in the second he touched upon the practical details of bee-keeping, and gave some sound advice to his hearers. Under the first heading he spoke of his own personal experience in the keeping of bees upon a fruit farm, and dilated upon the satisfactory financial results accruing from careful and systematic management. Proceeding to deal with bee-keeping generally, he urged his hearers never to buy small or cheap hives,



and said he had never in his life found anything apparently cheap to prove so in the long run. To anyone starting bee-keeping he would say—buy a good hive to begin with; if there was a good swarm he would be able to buy another in the following year. It was important to take measures to minimise dampness, which caused a lot of bees to perish. Good brood chambers were necessary, and they should never hesitate to buy fresh ones. New brood chambers should be provided for every swarm if possible. The bees did much better in a dry than in a wet summer. Whether the bees stung or not depended upon how the person went to work. Any unnecessary "jolting" should be avoided, and it was unwise to approach them in wet weather. The lecturer illustrated his remarks with an explanation of the various parts and working of a beehive, and his address, which lasted upwards of an hour, was followed with the closest attention. At the close he answered questions, and was accorded a hearty vote of thanks, upon the motion of Canon Farrer, seconded by Mr. J. E. Pinder, who urged that here was an outlet for the energies of some unemployed ex-service men, and that every facility should be afforded them for acquiring land for the purpose of bee-keeping and flower and fruit farming in combination. Mr. Kettle, he said, had shown what could be done by the individual in this respect. The extension of this opportunity to ex-service men would also enable them to compete with their honey, fruit and flowers against the tons of foreign produce of this kind which was coming into the country. (*Communicated.*)

### Wiltshire Honey.

Within this jar a golden magic lies,  
A sweet enchantment woven on the loom  
Of fragrant summer, when the clover  
bloom  
Gleams rose and pearl beneath the Wes-  
tern skies.  
Whoso its scented wizardry shall feel,  
May watch the spendthrift sunset as it  
spills  
Its dusty amber o'er the dreaming hills.  
Until the stars, in trembling beauty, steal  
Above their folded peace. And he shall  
hear  
The little sighing winds that nightly creep  
About the upland pasture, while more  
near,  
The drowsy bees hum faintly, half asleep,  
O'er one last flower ere they turn for  
home . . .  
Home, where the hives loom white across  
the gloam.  
—E. G. MOORE, Sliema, East Grinstead.



*The Editors do not hold themselves responsible for the opinions expressed by correspondents. No notice will be taken of anonymous communications, and correspondents are requested to write on one side of the paper only and give their real name and addresses, not necessarily for publication, but as a guarantee of good faith. Illustrations should be drawn on separate pieces of paper. We do not undertake to return rejected communications.*

### Queens on Strike.

[10336] On reading A. E. C. (page 535) in the JOURNAL for Nov. 4, which I look forward to very keenly every Thursday, it occurs to me some of your readers might like to have my experiences as a novice this season. Unfortunately for my bees, my wife presented me with a copy of "A Modern Bee Farm," in which I learnt a lot of, to me, new methods, and I was soon fired with enthusiasm to try "Plumping" with one out of my four stocks. I gave it a two weeks' trial the middle of April, with the result I used up about 12 lbs. of sugar and got the brood in the two hives operated upon badly chilled, from which they have never properly recovered, owing to weakening of the stocks and shortage of honey. It has been a very bad season here, and I have had the greatest difficulty to keep my stocks at all, and am much afraid two of them will go under this winter. But what I more particularly wanted to say was one of my hives (not operated on as above) threw out a dead queen on April 21, and I examined the stock and found no queen cells. Ten days later I again examined, and found there was a queen, but no eggs. A week later still no eggs, so I put in a comb of eggs from another stock, but no queen cells were formed, so I killed the queen and put in an Italian which had just arrived, and she was accepted.

Then there is my third stock; they were going along splendidly, and had covered ten frames of comb by May 1. These I wished to transfer to commercial frames, so I put the brood box on top of a box of twelve frames of foundation (commercial). A week later I lifted top box, and found they had not touched the foundation in lower box, and on examining the brood frames found no eggs.

A week later still no eggs, so I took the queen away and gave her to a neighbour, who told me she was no good, being a virgin.

Now in both these stocks the bees had evidently, for some reason best known to

themselves, superseded their queens, and the virgin had been unable to mate. Both of the superseded queens were good queens, and only one year old.

I was much surprised to notice drones in my weakest stock as recently as the third week in October, and I killed over a dozen, as they came out for a fly round. Can you tell me why these were allowed to go in and out unmolested?

[If there is a queen, and she is mated, we do not know. It is impossible to account for all the vagaries of bees.—Eds.]

I have not put candy over the brood frames of my stocks this autumn, but have fed solid with syrup instead. Does the Rev. Hemming mean that owing to the brilliant weather last month they will have consumed an abnormal amount of their stores?—W. B. IBBOTSON

### The Significance of Acarine Disease.

[10337] Whilst endorsing your tribute to the painstaking research of Dr. Rennie and his colleagues and the notable example of Mr. Wood in furthering the cause of science and education, may I be allowed to observe that it is rather premature to make definite critical comments on the brief announcements so far published?

Although it is to be appreciated that representatives of the bee Press were invited to attend the meeting of the *Royal Society of Edinburgh* on November 1, when Drs. Rennie and White and Miss Harvey made their communications, it is rather unfortunate that no detailed report for publication has so far been submitted to the bee Press, where it is bound to receive the highest appreciation. This is, of course, due to various formalities; and until these are brought to a close, we have patiently to reserve our comments.

The notes which you have already published from different correspondents amount either to hasty judgments without full knowledge of the facts of the case, or to some detached questions analogous to those answered by former researchers, and which no doubt are equally answered by our present investigators. Such criticisms and question, I repeat, are premature and your space is better served for the time being by the treatment of other important subjects.—A. Z. ABUSHADY.

[We see no reason why some comments on the discovery made by Dr. Rennie and his colleagues should not be made at this stage. We have not assumed there is nothing further to be done, on the contrary we gave our opinion last week that the discovery of *Tarsonemus Woodi* is only one

step. We are quite aware there is a possibility of other agents that may cause, or assist in causing, "Isle of Wight" disease being discovered, but if comment is withheld until finality is reached, it will never be made, or at that stage would be superfluous and useless. We have no doubt further details of the investigations will be published, that they are not available just now is due, as Dr. Abushady says, to various formalities.—Eds.]

### Intelligence of Bees.

[10338] I have heard much of the intelligence of bees, but one's own experience is of more value than any amount of vague hearsay information. May I relate two little incidents that speak for themselves?

Last Friday morning I was busy getting vegetables for our Women's Institute Market, when I noticed the persistent buzzing of a bee near me. I was at some distance from the hives, near a patch of golden rod, long since over, and there was really nothing to attract a bee, especially as the morning was cold and cheerless. But the little creature came nearer and nearer, and there was a little note of insistence in its buzz, like a tiny S.O.S. call. It followed me about, until at last I went for veil and gloves, saying to my sister, "I am sure there is something wrong with the bees, and they have sent for me."

I have three hives. Nos. 1 and 2 I had examined only two days previously, and given them candy and extra quilts. But No. 3, the strongest of all, has plenty of stores and quilts, and I had almost resolved to leave it alone. But the trouble was there.

As I lifted the roof I saw that mice had been trying to make a nest by pulling the quilts to pieces, and, looking down, I saw one of the marauders, while I could hear the other racing widely round the brood chamber. The poor bees were in an awful state, but I soon got rid of the intruders, who had not really had time to do more than nibble a little wax, and make holes in two quilts.

But if the little "queen's messenger" had not called me, whatever would they have done?

The following day a bee followed me down our drive—a much greater distance. This time the call was more like that of the Man of Macedonia, "Come over and help us!"—nothing like the insistence of the first. So I proceeded to inspect the hives, and found this state of things in No. 1:—

Some time previously a goose quill had been inadvertently dropped between the

brood chamber and the back of the hive. I found that the bees had dragged it to the front, and there it had stuck in the little groove at the entrance, and was blocking up the way, and, I expect, materially hindering the ventilation. A group of bees stood outside, evidently discussing the situation; another group had settled on the quill end, and others were walking up and down the feathered tip, evidently at their wits' end to know what to do next. Their perplexity was so real that it was almost comic, and I could not help laughing at them. But I managed to dislodge and remove the obstacle, and their contented and satisfied humming when I finally covered them down and left them was very pleasant to hear.

Who sent the messages, and who taught the messengers that I was the one to whom they must come for help? It is true that I have most to do with them, but my sister helps me sometimes.—E. BRANDFORD GRIFFITH, Northiam, Sussex, November 8.

### Plants for Bees.

[10339] My letter in the B.J. of November 4 has brought me a shoal of letters, and I shall endeavour to supply all the applicants.

To those who receive the "Thyme," I wish to point out that each rooted spray will grow and spread out from 4 to 6 inches during the following year, so that a little, with judicious separation and planting, will go a long way. To make a border, tuck it in between the stones, or brick, or whatever is used for edging the path, and it will, in the following year, cover these with a carpet of green and blossom in a rich blaze of colour; it can then be kept in bounds as required. For rock work it is best planted near the top, as it then spreads downward.

In addition to the "Thyme" I plant a good strain of "Canterbury Bells." The bees work these well, and apparently get a lot of food from them. It is best to plant the seed as early as possible in the spring, and if possible plant out into their permanent position from the seed bed.

My experience shows me that they resent moving, especially in the spring of the year in which they should bloom. As the blooms die pinch them off, and they will continue to bloom nearly all the summer.

I hope that those who receive the "Trailing Thyme" will be as successful with it as I have been. They will then not regret having received and planted it.—A. MUSTO.

## Special Prepaid Advertisements. One Penny per Word.

Trade advertisements of Bees, Honey, Queens, and Bee goods are not permissible at above rate, but will be inserted at 1½d. per word as "Business" Announcements, immediately under the Private Advertisements. Advertisements of Hive-manufacturers can only be inserted at a minimum charge of 3s. per lin., or 6s. per inch.

PRIVATE ADVERTISEMENTS are only intended for readers having Surplus Stock to dispose of. Driven Bees, Nuclei, and Queens that are reared or imported for sale, are Trade Advertisements, and can only be accepted under trade terms. A charge of 6d. extra will be made if a box number is used.

Advertisements must reach us NOT LATER than FIRST POST on MONDAY MORNING for insertion in the "Journal" the same week.

### PRIVATE ADVERTISEMENTS.

PURE LIGHT ENGLISH HONEY, three 14-lb. tins, 88s., single tin 30s., carriage paid; sample 6d.—KILLICK, Eppingham, Surrey. k.82

PURE LIGHT CAMBRIDGE HONEY (guaranteed), 14-lb. tins, 50s.; 28-lb. tins, 57s. 6d., carriage paid.—YOUNG, 42, James Street, Cambridge. r.k.84

GOOD ENGLISH HONEY, granulated, 28-lb. cans, 2s. per lb., carriage paid; sample 6d.—PEARSON & GALE, Marlborough.

SAINFOIN HONEY, scarce and getting scarcer. Our first customer was the Editor of the B.B.J., and he says "it is A1." 14-lb. tins only, carriage paid, 36s. cash.—S. H. SMITH, 30, Maid's Causeway, Cambridge. k.95

FOR SALE, a few dozen finest quality Sections of Honey (glazed), 36s. per dozen, carefully packed on rail, carriage forward.—W. WOODLEY, Beedon, Newbury. k.83

NO BEE GARDEN complete without Willow Herb, 12, 2s. 6d.—BOWEN, Apiaries, Cheltenham. k.85

EXTRACTOR, Comb Cleaner, Ripener, Excluder, £3 10s. the lot.—21, Brunswick Street, Teignmouth. k.86

NOW BOOKING ORDERS, delivery January, February, March, £2 sittings of Eggs and Day-old Chicks (Barron's), White Leghorns, Brown Leghorns; White and Fawn and White Runner Ducks, White Wyandottes, sittings 10s. 6d. to 35s. a dozen, Chicks double.—MRS. M. ANDERSON, Poultry Dept., Hermitage Poultry Farm, High Hurstwood, Sussex. Manager: Miss M. D. Sillar. k.93

ONE GROSS Sections Honey.—Offers to C. P. HAWKES, Swaffham Prior, Cambs. k.87

BROTHER BEE-KEEPERS with spare time wishing to commence in the Retail Fish Business write J. W. ELVIDGE, Wholesale Fish Merchant, Grimsby. r.h.239

CORRESPONDENCE Courses in Bee-keeping.—H. E. NEWTON, Hobart Road, New Milton, Hants. r.k.69

HIVES.—A limited number of strong, sound and interchangeable, free from "I.O.W.," two lifts, brood chamber, 10 frames, metal ends, wired and new wax in each, roofs lined with zinc or iron, price 35s., free on rail; cash with order.—FOSTER & CO., Heath Side, Hillingdon Heath, Middlesex. r.k.78

BACK NUMBERS B.B.J., 1903-1915, also Illustrated Dutch Bee Journals, to clear.—ARCHER, 64, Kingston Road, Oxford. r.k.70

**13 CWT. NORFOLK HONEY, granulated, 28-lb.**  
**14 tins. Offers invited.—G. ASHTON, Lodge**  
 Road, Feltwell, Norfolk. k.65

**LIFE INSURANCE IS A SOUND INVESTMENT.**—Will fellow members of the craft write for prospectus to H. M. LOWE, Park Road, Chilwell, Representative for "Royal," "Scottish Temperance," etc.? k.66

**BUSINESS ADVERTISEMENTS.**  
 1½d. per word.

**IMPORTED ITALIAN QUEENS FOR 1921.**—List on application.—PEARSON & GALE, Marlborough. r.k.88

**NO SUGAR VOUCHERS NEEDED.**—Flavine Candy, made in Cambridge, 6 lbs., 10s. 6d., post paid. Plain White Sugar Bee Candy, 6 lbs., 9s. 6d., post paid.—S. H. SMITH, 30, Maid's Causeway, Cambridge. k.96

**BEEES AND QUEENS FOR 1921.**—Send for our new Illustrated Catalogue, free on application.—PEARSON & GALE, Marlborough. r.k.89

**WANTED, best quality English Honey.** Please state prices.—HILES, "The Homestead," Kidderminster. r.k.92

**ENSURE A GOOD HONEY CROP** next year by purchasing one of our noted 6-frame Italian Stocks. Illustrated Catalogue free on application.—PEARSON & GALE, Marlborough. r.k.90

**MASHEATH MEMS.**—"Been painting the Masheath. Man, it's a grand bee-box! The longer I look at it the more convinced I am that it is absolutely 'it.' It ought to sell like hot cakes. A man with any pride in his apiary has only to see it to purchase.—A. L."—ATKINSON, Fakenham. r.k.97

**IMPORTANT!**—In spite of the increased cost of sugar, appliances and carriage, we are offering our celebrated 6-frame Stocks at reduced prices. Catalogues free on application.—PEARSON & GALE, Marlborough. r.k.91

**3-FRAME ITALIAN-BLACK NUCLEI.**—Should have some ready delivery April. Best book now. Want to exchange 14 or more section racks for shallow frame crates.—GILBERT HOLMES, The White Cottage, Hythe, Southampton. k.94

**A WELL-ESTABLISHED FIRM** wishes to hear of bee-keepers who would guarantee to supply them with Nuclei May-June next.—Box 107, B.B.J Office, 23, Bedford Street, Strand, W.C.2. r.j.42

**FIRST PRIZE CANDY, 6 lbs. 10s. 6d.**—BOWEN, Apiaries, Cheltenham. k.74

**"WIGHT" DISEASE.**—Prevention and removal. Advice 5s.—ALF. RYALL, Cottage Farm, near Camp, Stroud. r.j.6

**BE PREPARED FOR 1921 HONEY SEASON.**—Hives, Brood Boxes, etc., made to your requirements. Our 12-frame W.B.C. Hive is for honey production; no nails used; is substantial; all work ecrewed.—Quotations from H. GILLAM, 56, Sackville Road, Bexhill. r.k.64

**HAVE YOU READ "THE BEE WORLD"?** If not, why not? Every number in itself is a useful literary work for practice and reference. Specimen copy free.—Offices: THE APIS CLUB, Port Hill House, Benson, Oxon.

**SURPLUS HIVES and Appliances for Sale,** good condition, cheap.—PEARSON & GALE, Marlborough. r.h.131

**THE NORTH OF SCOTLAND COLLEGE OF AGRICULTURE.**

The Governors invite applications for an Assistant Lecturer in Bee-keeping at a commencing salary of £100 per annum, with a war bonus at present of £123 17s. 6d. per annum.

Thirty copies of letter of application, giving full particulars of training and experience, together with thirty copies of not more than three testimonials, should be lodged with the undersigned not later than December 18, 1920.

Further particulars may be obtained on application to—

WILLIAM MURISON, *Secretary.*  
 41½, Union Street, Aberdeen,  
 November 17, 1920.

**Finest Grade New Zealand Honey (Amber)**

**For Bee Feeding. Guaranteed Pure.**

**Cases, each 2-60 lb. nominal Tins. 95/- per cwt.**  
 Carriage paid.

**Cash with order or on receipt of goods.**

**N.B. We are already supplying Beekeepers' Associations throughout the Country and shall be pleased to quote references.**

**The Bristol and Dominions Producers Association, Ltd., Bristol.**

**The products of the Apiary, of Poultry and Farm Stock, of the Fruit and Vegetable Garden can be Advertised and Sold through**

**THE BAZAAR, EXCHANGE & MART**  
*Newspaper.*

**Get a Copy—Thursday and Saturday 3d. The "Bazaar" publishes also practical handbooks by experts. Send for full catalogue, post free from—WINDSOR HOUSE, Breams Buildings, LONDON, E.C.2.**

**THE British Bee-Keepers' Association.**

**The recognised centre of practical and scientific bee-keeping in Great Britain. Particulars and conditions of membership may be obtained from the Secretary, W. HERROD-HEMPSALL, 23, Bedford Street, Strand, London, W.C.2.**

**Displayed Advertisement Rates.**

*British Bee Journal or Bee-keepers' Record.*

	£	s.	d.
Full page ... ..	4	0	0
Half page ... ..	2	10	0
One-third page ... ..	1	16	0
Quarter page ... ..	1	12	0
1½ in. across page ... ..	1	7	0
1 in. across page ... ..	0	18	0
½ in. across page ... ..	0	10	0
1½ in. single column ... ..	0	15	0
1 in. single column ... ..	0	10	0
½ in. single column ... ..	0	6	0

Discount for a series of consecutive displayed advertisements:—Six insertions, 2½ per cent.; Twelve insertions, 5 per cent.; Twenty-six, 15 per cent.; Fifty-two, 30 per cent.

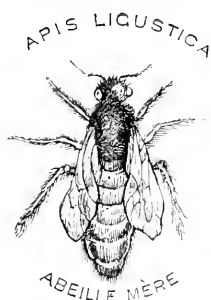

# Bozzalla Queens.

"American Bee Journal" specification Tested three banded Italians.

## DIRECT from ITALY.

May & June  
13/-

July & Aug.  
12/-

Sept.  
10 - each.

Sole Agent: H. M. STICH, Riccarton Avenue, PAISLEY, Scotland

## 1920—QUEENLAND LIST—1921

In reply to many requests coming in for our Premier White Star Queens for the Season 1921, we beg to state that early delivery may not be offered, as a certain number of orders have been carried over (by request) from previous season for first 1921 delivery, in consequence of the unfavourable weather for queen-mating.

## Our Premier White Star Nucleus Stocks

will be offered as usual, and at former price; but the charges for Queens have been revised, and include the offer of well-bred and selected Virgin Queens of this renowned strain.

Full Queensland Descriptive Circular 4d., The Revised List only (to those having 1920 List, 2d., post free.)

Of S. SIMMINS, QUEENLAND, HEATHFIELD, SUSSEX.

**For Christmas Gifts.** You can get the books of the best authorities in this and other countries, and also the leading American and foreign bee-journals, from

**E. J. BURTT, STROUD ROAD, GLOUCESTER.**

*For the convenience of beekeepers I am printing a special list of these. Send a postcard for it.*

	<h1>"BACTEROL"</h1>	<p>The cure for, and preventive of, "Isle of Wight" Disease. Non-poisonous—free from stain or unpleasant odour.</p>
	<h2>FOR BEES</h2>	
2/9 per Bottle.	Post Free.	BAC EROL LIMITED 19/25, Brookside Rd., Highgate, N.19.

**CANDY** Made in our own factory by bee-keepers for bee-keepers.  
6 lbs. post free 9/6

Guaranteed from Pure White Refined Cane Sugar.

Miss Chester-Master's Patent Candy Box, 4/6 each. Postage extra 9d.

**S. J. BALDWIN, The Apiary, BROMLEY, KENT.**

# Bee-keeping Simplified

FOR THE COTTAGER AND SMALLHOLDER,

By **W. HERROD-HEMPSALL, F.E.S.,**

Author of "Producing, Preparing, Exhibiting and Judging Bee Produce."

Price 1s. net. Post Free 1/1½

THE BRITISH BEE JOURNAL OFFICE, 23, Bedford St., Strand, London, W.C

## FOUR FIRST PRIZES.

Our HIVES and APPLIANCES were again awarded FOUR PRIZES at the Highland Agricultural Society's Show at Aberdeen, thus testifying to the superiority of our goods. Order now at catalogue prices and save money.

### SOFT BEE CANDY.

Have you tried our Famous Bee Candy? If not, you should send for a trial order now. It is made from PURE WHITE CANE SUGAR and is PERFECTION.

#### PRICES—

1 lb. at **1/5**, postage 9d., 6 lbs. at **9/6** post free,  
10 lbs. at **15/6** post free.

Can be had medicated or not, as required.

**R. STEELE & BRODIE,**  
*Bee Appliance Makers,*  
**WORMIT, FIFE.**

Telegrams:—"Bees, Wormit."

Telephone:—28 Wormit.

## BEE CANDY.

**WE** are now able to supply CANDY OF OUR OWN MAKE from guaranteed Pure White Refined Cane Sugar. In 1-lb. boxes with glass tops. It can be had plain or medicated with either "Yadil" or "Bacterol."

#### PRICES.

7lb.	11/-, postage 1/3
14lb.	21/6, postage 2/6
28lb.	42/-, postage 5/-
112lb.	£8 8s., packed free, carriage forward.

BEE FOOD SUGAR VOUCHERS REQUIRED.

**JAMES LEE & SON, Ltd., Uxbridge, Middlesex.**



No. 2006. Vol. XLVIII

DECEMBER 2, 1920.

[Published every Thursday, Price 2d.]

**CONTENTS.**

	PAGE		PAGE
THE B.B.J. AND ITS CONTRIBUTORS .....	577	A CORRECTION .....	584
BRITISH BEE-KEEPERS' ASSOCIATION CONVERSAZIONE .....	578	IMPUDENT THEFT FROM BEE HIVES .....	585
MONTHLY MEETING OF COUNCIL .....	579	CORRESPONDENCE—	
JOTTINGS FROM HUNTINGDONSHIRE .....	580	Onions and "Isle of Wight" Disease ....	585
DO BEES DO NOTHING INVARIABLY .....	581	The Aberdeen Discovery .....	586
BEE NOTES FROM DERBYSHIRE .....	582	SURREY BEE-KEEPERS' ASSOCIATION .....	586
JOTTINGS OF A BLACK COUNTRY BEGINNER .....	583	NOTICES TO CORRESPONDENTS .....	587
COTSWOLD NOTES .....	584		

OWING to the FALL in the COST OF SUGAR WE ARE IN A POSITION TO SUPPLY

PINK (MEDICATED OR PLAIN)

# SOFT CANDY

Made from Guaranteed Pure Cane Sugar.

**NO VOUCHERS REQUIRED.**

1/5 per lb. (7lb. parcel post free, 11/-)  
(10lb. do. do. 15/6)

**E. H. TAYLOR, LTD., WELWYN, HERTS.**

## THE British Bee Journal

Office: 23, Bedford Street, Strand, London, W.C.2.  
ESTABLISHED 1873.

A Weekly Journal Devoted to the  
Interests of Bee-keepers.

Edited by T. W. COWAN, F.L.S., &c.,  
and J. HERROD-HEMPSELL, F.E.S.

Correspondence: Whom to Address.—All matters relating to the Literary Department, Associations, Shows, etc., should be addressed, "Editors, *British Bee Journal*," and all business communications and matters relating to subscriptions and advertisements to be addressed to the "Manager," *B.B.J.* Office.

Subscriptions. — Annual Subscription, 10s. 10d. post free in advance; single copies 2d., or 2½d. post free. If a receipt is required by post, a stamped and addressed envelope must be sent, otherwise a printed receipt will be enclosed along with the paper.

Note.—Cheques and Postal Orders should always be crossed, otherwise it is very difficult to trace them if they go astray.

How to send Money.—Remittances can be made payable to W. Herrod-Hempshall by crossed Cheques and Postal Orders. Stamps may be sent for small amounts up to 2s. *Halfpenny stamps are preferred.*

Scottish or Irish cheques can only be taken in payment if 6d. is added for commission charged by banks for cashing them.

The Editors are not directly or indirectly interested in the manufacture or sale of beehives or appliances of any kind, and must refer correspondents wishing for prices or catalogues to advertisers in the paper.

## OUR DEPOSIT SYSTEM.

You are advised to insist on this being used when dealing with strangers.

### Rules and Conditions for Depositing

In order to save trouble, it is requested that the Rules be carefully read over by persons using the Deposit System of trading.

Goods should not be despatched until notice that the money has been deposited is received from this office.

1. Method.—When strangers are dealing together, the purchase-money of the articles is deposited at our office. We acknowledge receipt of the deposit to both parties, and hold the money until we are satisfied that the purchase is concluded. If a sale be effected, we remit to the seller the amount deposited, less a charge of 2½ per cent. in the £, with a minimum of 6d., and the expenses of Post Office Orders and postage, &c. Cash will be forwarded by Cheque, Post Office Order, or by Postal Order as preferred. If a sale or exchange be not completed, we return the amount deposited, after making the same deduction. By this means buyers and sellers are secured against fraud.

2. Deposits.—Postal Orders (drawn on General Post Office) and Cheques must be made payable to W. Herrod-Hempshall, and crossed "London County and Westminster Bank." The numbers of the Postal Orders should be kept by the sender.

We cannot be responsible for any loss that may occur in transit.

3. Honey on Approval.—All honey will be sold by sample, which must be sent direct to buyer.

4. Bee Appliances.—In ordering, the time allowed for completing the order to be stated to us when sending cash. If maker accepts, we hold cash until transaction is satisfactorily completed, when the amount will be remitted, subject to conditions as in Clause 1.

5. Bees and Queens.—These will be dealt with entirely by the parties concerned, so far as price, &c., go, and when the purchase is satisfactorily completed cash will be remitted as per Clause 1.

6. Goods in Transit.—These are at the seller's risk, i.e., any damage to or loss of an article on its journey is borne by the vendor; but a rejected article must be properly packed and returned by the same means as was used in sending it.

7. Carriage.—The carriage of all goods, except such as are sent by post, is payable by the buyer, unless otherwise agreed. If any article sent on approval be returned, each party to the transaction must pay carriage one way.

## Books for Bee-keepers NOW IN STOCK.

Cash in full must be sent with order.

	Postage	
A Modern Bee Farm ... ..	7/6	... 8½d.
(To be obtained from this Office only.)		
Advanced Bee Culture (HUTCHINSON) ... ..	6/-	... 6½d.
Beginner's Bee Book (PULLER)	5/-	... 4d.
BEE-KEEPING SIMPLIFIED FOR THE COTTAGE AND SMALLHOLDER (W. HERROD- HEMPSELL, F.E.S.) ... ..	1/-	... 2d.
BRITISH BEE - KEEPERS' GUIDE BOOK (T. W. COWAN)		
Paper covers ... ..	2/6	... 3d.
Cloth covers ... ..	3/6	... 4d.
Dissectible Model of Queen Bee ... ..	4/6	... 3d.
FERTILISATION OF FRUIT BLOSSOMS BY BEES (T. W. COWAN) ... ..	-/3	... 1d.
Honey and Health (A. HORS) ...	-/6	... 1d.
Honey Vinegar (REV. G. BANCKS)	-/2	... 1d.
How to Keep Bees (ANNA B. COMSTOCK) ... ..	5/-	... 4½d.
Prevention of Swarming (WILKES) ... ..	1/-	... 1½d.
Pollination of Fruit in rela- tion to Commercial Fruit Growing (C. H. HOOPER, F.E.H.S.)	-/8	... 1d.
PRODUCING, PREPARING, EXHIBITING AND JUDG- ING BEE PRODUCE (W. HERROD-HEMPSELL, F.E.S.) ...	2/-	... 3d.
Queen Rearing in England (F. W. L. SLADEN) ... ..	1/6	... 2d.
Scientific Queen Rearing (DOOLITTLE) ... ..	4/-	... 3½d.
Snelgrove's Method of Re- queening ... ..	-/6	... 1d.
The "Townsend" Bee Book ...	2/6	... 2d.
WAX CRAFT (T. W. COWAN) ...	2/-	... 2½d.

### MISCELLANEOUS.

The Lore of the Honey Bee (TICKNER EDWARDS) ... ..	2/-	... 3d.
Life of the Bee (MAETELINCK) ...	5/-	... 4d.
THE BEE WORLD (supplied only to members of Associations interested in the control and development of the Apis Club, apart from ordinary members of the latter), per copy ... ..	-/8	... 1½d.
The Bee Master of Warrilow (TICKNER EDWARDS) ... ..	7/6	... 4½d.

British Bee Journal & Record Office,  
23, BEDFORD STREET, STRAND LONDON, W.C.2.





## The B.B.J. and Its Contributors.

In his "Notes from Gretna Green" in the JOURNAL last week Mr. J. M. Ellis made several remarks upon which we take this opportunity to comment. Mr. Ellis says: "I was struck by the fact that the regular contributors of ten years ago are entirely absent from the JOURNAL of to-day." On looking back through our files we miss only one or two outstanding names among those who may fairly be described as "regular contributors," and who are still living. Some have passed away, and others who ten years ago were in or just getting past their prime are by now feeling the weight of years. This would be so in the ordinary course of events, but, in addition, the last few years have been so strenuous and full of anxiety for all that most of us have "aged" considerably more than would have been the case had times been normal. Is it, then, to be wondered at that some of these veterans of bee craft no longer feel equal to the task of contributing as regularly as they used to do, or even at all. Some we know have had reluctantly to give up the greater part of their bee-keeping as well. It is not every bee-keeper who has the virility of the late Dr. C. C. Miller.

Comparing the list of contributors of ten years ago with those of the present time, we find that in 1909 the contributors numbered 66, and in 1919 206. Mr. Ellis says "THE BRITISH BEE JOURNAL is, or should be, a medium for the exchange of views and experiences by bee-keepers." Looking at it from that standpoint, surely there must be at the present time a more liberal exchange of views, etc., with 206 contributors than ten years ago with 66.

Mr. Ellis also contends "that far too much valuable space is wasted on matters entirely alien to the craft," and, further on, he has "noticed an occasional protest on this subject, and these complaints are entirely justified." We do not know who has appointed Mr. Ellis a judge on this matter, and we do not in the least agree with him. We grant that every line, or even every article, is not absolutely devoted to matter that is "solely about bees," but to say that they are "entirely alien to the craft" is a "terminological inexactitude." We take it most, if not all, of the articles Mr. Ellis has in mind

are those referring to the cultivation of fruits and flowers; but without flowers bees could not exist, and "no flowers, no fruit." They are all so dependent one upon the other that no apology is needed for publishing such articles as those by Mr. C. H. Hooper, Mr. J. J. Kettle, Mr. A. H. Harwood and others. Is a love of Nature alien to the craft, and are we to cut out all reference to its beauties, to the delights of a spring ramble in country lanes, with their myriads of flowers in and by the hedgerows and orchards with their masses of bloom, and later through the meadows carpeted with clover, or by fields red with sainfoin, under sweet-smelling lime trees, or over the moors, with their rolling masses of purple heather, and with it all the almost ever present hum of the bees?

We trow not, for your true lover of bees also loves all these, not only for their beauty, but because they speak of the bees, and, far from being alien to the craft, are an absolute necessity to it. Had all writings but those "solely about bees" been barred from the pages of THE BRITISH BEE JOURNAL in years past, many of the charming writings of "Lordwood" would have been lost to our readers. We have had occasional protests, but also numbers of letters of appreciation. If those who protest had to conduct this, or any other paper, they would know it is quite impossible to suit every one, and for ourselves we may say we are not going to try. The fact that at the present time the number of readers of THE BRITISH BEE JOURNAL is higher than at any previous time in its history is proof that the matter provided is not distasteful to them. We do our best, and, to quote from the poem, "A Short Sermon," in our editorial of October 21, "Some folks won't like it, but other folks will." We suggest our readers and contributors pin that poem up where it may be constantly seen, and bear in mind another couple of lines it contains: "The plants that we're passin' as common place weeds, Oft prove to be just what some sufferer needs." The moral is plain.

We share the regret of Mr. Ellis at the absence of contributions from Scotland. We are anxious to help bee-keepers all over the country, but so far south we are somewhat out of touch with conditions prevailing in the far north, and it would be a great help to many bee-keepers there if some of our Scottish friends would give their experiences from time to time. We sincerely hope this matter will be rectified during the coming season. We also hope that more of our many Irish readers will let us know of the prospects and progress of bee-keeping in the sister isle.

## British Bee-Keepers' Association.

CONVERSAZIONE, OCTOBER 21, 1920.  
(Continued from page 542.)

### MR. PRICE'S LECTURE.

The subject I have to deal with to-day is "The Production of Heather Honey." Many beekeepers are not interested in it because they do not live where the heather grows. Others are interested because they live in heather districts, and they are in a position to secure two crops of honey in one season. It is not everyone who can get heather honey. To be able to secure good heather honey you must be prepared to use your skill, and work to a system. It requires more skill and better management to secure surplus heather honey than it does to secure the ordinary honey in the summer time. In some of the bee men we have some of the greatest fanatics. One man said his method was to shake his bees on to racks of sections and if they did spoil a few that would not be serious. But what happens to the brood and what happens to the bees on returning home?

There is a system of sending bees to the moors on shallow frames. The heather hive consists of nine shallow frames, and arrangements made for supers later. I am afraid that larger frames than the Standard have no chance among the heather bee men. In the majority of cases, and especially where there are Italian queens at the head, the brood nest is blocked with honey from top to bottom. If you use a larger frame than the standard it will not be successful.

The heather blooms at a season of the year different to other blooms. It is unnatural for the-*bee* to secrete wax or to produce combs so late in the year. If a queen has been laying all the season she cannot be expected to continue brood-rearing late in the autumn. We can rectify the matter of comb-building somewhat, and a great many prominent beekeepers secure their drawn-out combs during the summer time. Sections which do not come up to show standard are extracted and used for the heather.

There are a good many dangers in connection with heather-honey production, especially to those who have to cart their bees long distances. In the counties of Durham and Northumberland there would be few beekeepers were it not for the facilities of sending bees to the moors. The chief dangers in carting bees are bad packing, and bad roads, often resulting during hot weather in smothering the bees. With insufficient ventilation bees packed overnight will be smothered before next morning. They find a considerable number of queens have been accidentally

killed, and stocks return queenless. Then there is the danger of diseases, and in the northern counties this practice has facilitated their spread. This will be so in the future, because there are some places where there are 400 stocks together. Farmers will take 1s. per hive standing room. If there are any diseased stocks, and robbing is set up, the disease is spread to a considerable number of districts.

Motor transport and proper hives will go far in overcoming these difficulties. I have not seen a proper hive manufactured by our appliance makers, and many do not come up to my expectations.

I have here a model of a hive which may be of interest, and the hive is well adapted for carting bees to the moors.

However ornamental gable roofs may be, they do not serve any useful purpose in cartage.

The hive was made to half scale by a beekeeper who is a tailor by trade, and shows the method of securing it for transport to the moors. In moving the bees it is necessary to have a ventilated frame over the bees, or a light quilt and ventilation in the floor. I find that not so much harm results from cold as from overheating.

Some of the hives in use at the moors are most interesting, but the W.B.C. is not the hive for this purpose. In the majority of cases hives better adapted for transport are used. Northumberland beekeepers use a hive with nine standard frames. On the top of the brood nest they place a rack of sections, and on the top of that the ordinary quilt, with feed-hole open, and covered by a piece of perforated zinc.

You will have noticed in my remarks that heather-honey production does require a lot of skill and some system. What usually happens is that immediately after the ordinary flow the queens stop laying; consequently, when the bees are brought home there are not sufficient to winter. It is often necessary to replace the old queen before taking the bees to the moors, and to slow feed to get sufficient brood to occupy the combs.

I have seen good heather honey many times, and I have seen honey which has been termed heather honey. In some districts anything is palmed off as heather honey. Good heather honey is not dark. The pure honey is, however, strong, and does not suit everybody's palate. It is interesting to know that there are not many countries from which it is possible to obtain pure heather honey. At Cannoke Chase I have been able to obtain a few samples.

It is no use at all for beekeepers to take bees to the heather when there are only a few acres. Hundreds of

acres are necessary. Pure heather honey does not granulate, nor can it be extracted. There is a practice of disposing of honey in what they call "supers of honey," i.e., in boxes weighing 7 to 14 lbs. The boxes are placed in the hive and the bees build combs 3 in. thick filled with honey.

Mr. Judge asked if any particular race of bees was most suited to heather-honey production. The lecturer stated that at the present time there were very few blacks. The Italian and the hybrid had done very well this year.

Mr. Thomas asked if the floorboard ventilation was ever clogged with propolis. Mr. Price stating this did not occur if the ventilator was placed near the entrance.

Mr. Bryden inquired if the lecturer had any experience of using queenless bees for heather-honey production? Mr. Price said he had not.

Mr. W. Herrod-Hempsall said *re* the granulating of heather honey, he was taken to task some time ago because he stated in an article in the *Bee World* that pure heather honey would not granulate, and he had several samples of granulated honey sent to him as pure heather, but in every case an examination of the honey showed the presence of pollen grains from clover and other sources as well.

He also noticed some of them smiled rather audibly at the suggestion of using queenless bees for honey production. He had lived long enough to realise that there was yet much to learn with regard to the practice and science of bee-keeping, and it was just as well to be quite certain that one was quite conversant with all methods of bee-keeping before regarding any question, or suggestion, as foolish. As a matter of fact, as stated by Mr. Bryden in his paper, they found in some apiaries in Italy it was a regular practice to de-queen the stocks at the commencement of the honey flow, keeping them queenless while it continued, and the system answered well. The average yield of honey per hive in Italy was about 42 lbs.

Mr. J. Herrod-Hempsall said that when doing expert work in Lancashire, where many bee-keepers regularly moved their bees to the moors, he found it was the practice to endeavour to have the combs in the brood chamber fully occupied either by stores or brood, and it was better to have young brood in preference to that just on the point of emerging from the cells. In the latter case the honey was put in the cells as soon as the young bees were out instead of being stored in the supers, while if the brood was young the cells were occupied, possibly whilst the flow from the heather lasted, and the honey had to be placed in the supers. Did Mr. Price's

experience show that was sound. Mr. Price said that was so.

Mr. G. Thomas said, in reference to Mr. J. Herrod-Hempsall's remarks about moving hives containing young brood, if those who moved to the heather had anything like his experience of moving bees by train, they would find most of the young larvae dead at the journey's end. He found it necessary under these conditions to travel in the van with the bees, and now and again sprinkle water on the canvas used for covering the frames. If this was not done the young larvae died.

Mr. Prior asked if it would not be preferable to convey bees to the moors on standard frames, and then reduce them to shallows. The lecturer pointed out that this was impracticable, as there would be no means of taking care of the brood in the standard frames.

In reply to a further question from Mr. Judge, the lecturer stated that the sub-soil was an important factor in heather-honey production, and the higher the altitude the better.

Mr. Pearman said he never experienced any difficulty in moving his bees. He simply took the top quilt off and put a cheese-cloth in its place.

The usual votes of thanks brought a very successful meeting to a close.

#### MONTHLY MEETING OF COUNCIL.

The monthly meeting of Council was held at 23, Bedford Street, Strand, London, W.C.2, on Thursday, November 18, 1920.

Mr. W. F. Reid presided, and there were also present Miss M. D. Sillar, Messrs. G. Bryden, G. S. Fanueh, G. R. Alder, G. W. Judge, G. J. Flashman, J. Herrod-Hempsall, Association representatives: R. R. Babbage (Middlesex), E. G. Waldoek and W. E. Hamlin (Surrey), C. P. Jarman (Kent), E. Watts (Herts), W. M. Valon (Staffs.), and the Secretary, W. Herrod-Hempsall.

Mr. A. L. C. Fell was elected a member of the Council in place of the late Mr. T. Bevan, on the proposition of Mr. W. E. Hamlin, seconded by Mr. E. G. Waldoek. Mr. G. Bryden was elected on the Exhibitions' Committee in place of the late Mr. T. Bevan.

Letters of regret at inability to attend were read from Sir Ernest Spencer, Messrs. A. G. Pugh, F. W. Watts, W. H. Simms, F. W. Harper, W. Griffiths, and Rev. E. J. Bartleet.

The following new members were elected:—Miss L. W. France, Miss C. L. Peck, Messrs. G. Ord, C. T. Sanctuary, W. Wilson, and B. R. Sandwith.

The report of the Finance Committee was presented by Mr. Bryden, who stated that the receipts for September were

£8 10s. 6d., for October £19 1s. 6d.; the bank balance on November 1 was £104 15s. 9d., payments amounting to £4 8s. were recommended.

The report on Preliminary Examination in Lincolnshire was received, and it was resolved to grant the certificate to Mrs. M. L. Gill.

Arrangements were made for Insurance in 1921 upon the usual terms.

The matter of conditions for Final Examination were postponed to the next meeting of Council.

It was resolved, upon the application of the requisite number of members of the Council, to hold a special general meeting on December 16 at 6 p.m. to consider the raising of the annual subscription of members, and to alter the rules with regard to plural voting.

A letter was received from the Royal Agricultural Society of England stating the conditions which they were prepared to offer for the Honey Competition in 1921. It was resolved that, owing to the state of the finances, it would not be possible to hold an exhibition at the Royal Show in 1921. The matter of an Exhibition elsewhere was referred to the Exhibitions Committee.

Next meeting of Council December 16, 1920, at 23, Bedford Street.

## Jottings from Huntingdonshire

This week I shall devote the space at my disposal to replying to many queries. Some addressed to me through the columns of this Journal, others through the post. First, I am asked, do I seriously believe in tanging? Yes, I thought I had proved to the satisfaction of most beekeepers that tanging with an instrument giving forth a good tone has an immediate effect on swarming bees. The theory that bees are stone deaf has surely been long ago exploded. It is not necessary for insects to have ears to hear any more than it is necessary to have a nose wherewith to smell. The organ of hearing enables us to be sensible of the vibrations which take place in the atmosphere. The auditory nerve conveys these vibrations to the brain. Bees in like manner are sensible to vibrations which are not beyond their sympathetic system, by which I mean that there may be terrific sounds, the vibrations of which are too violent for such tiny things as bees. But the ringing of a bell disturbs the tone of the swarm, and either half paralyses the little creatures that they fall in a disorganised condition to the ground, or it attracts them by its insistence. From close observation I have formed the opinion that tanging dis-

turbs their rhythm of flight. Older bees get so annoyed they make for the tanger. If an after-swarm, or cast, be tanged, the bees seem helpless and sink to the ground unless they can rest on a bush before reaching *terra firma*. If one is fortunate to be on the spot when a swarm is issuing, a bell rung as one stands behind the hive will bring the swarm back to its home. It is certain bees can hear a bell as easily as they can hear a piping queen, or, if you like it better, feel the vibrations of both.

Another question I have been asked is, where would I, if I had an acre of ground, place my bees if a vein of clay ran through about half way, the other half being sandy, gravelly soil? Well, providing aspect and shelter were equal, I should place my hives on the sandy soil, as being dryer and warmer.

Question 3 is: Do I always adopt direct introduction when giving new queens to stocks? My answer is: No, not always. Four times this year to queenless stocks I have placed new queens among the distressed bees, and each time has her majesty been welcomed with great joy; but taking out a queen and introducing another within 48 hours is a different matter. Then an introducing cage comes in handy. It is not sufficiently well known that when bees show inclinations to ball an introduced queen, crushing one or two bees, drones for preference, if done early in the season, and painting the queen with the juice of the crushed bees, will generally deceive the very elect.

Now I come to the query by W. B. Tbotson in last week's *B.B.J.* I am asked whether I mean that owing to the brilliant weather last month bees will have consumed an enormous amount of their stores? Not exactly; what I meant to say was that, owing to a large amount of brood reared in October, a quantity of stores was needed to feed the grubs and set them going when out of their cells. Most of us this year, I think, saw stores vanish at an unusual rate last month. This autumn has been so exceptional. One of the most striking things about bees is that often the weaker can overcome the stronger. Early in October I got a few pounds of driven bees from an amateur bee-keeper in the county, hived them, and began feeding with syrup. After a week of syrup feeding I gave them a couple of cakes of candy and covered them down. Three days ago, the weather being warm and the bees out flying, I looked through some of my stocks to see if they needed any more candy, and was surprised to find the cakes in this driven stock scarcely touched. A closer examination revealed

an amount of stores in what were a month ago empty combs. To my mind, every stock in my apiary was stronger than this little lot, and yet it was obvious that much robbing had been done to get those combs filled in October. I intended saying a word or two with regard to Mr. Ellis's remarks in last week's *B.B.J.*, but, having a cold and feeling somewhat muddled, I will hold them over—"Thank goodness!" says the compositor.—E. F. HEMMING, Steeple Gidding.

## Do Bees "Do Nothing Invariably"?

(By L. Willis.)

(Continued from page 556.)

It would possibly be of interest to give a bird's-eye survey of the manipulations which we employed broadly covering a stock for the season:—Having been wintered in two stock-boxes, when the first glorious spell is with us, they are given a clean floor board and stock-boxes. To the bottom box is given the brood in the more advanced stage, not forgetting generous supplies of food and pollen at each side; in the top box is placed the rest of the younger brood also with good supplies; the overplus of food is taken out and stored for use in the apiary, and empty drawn-out combs inserted, as the queen will always make for the top box and there is plenty of heat arising from the necessary work going on below to send her along in fine style. They are then left till the time estimated when they will require a third box; the brood is again arranged as before, and the third box is placed above the excluder with all spare frames of comb containing young brood and eggs; in 10 days this can be utilised for queen introduction, and this process can be repeated until no more nuclei are required. By allowing the stock always to keep the more advanced brood they never are allowed to get dangerously deficient in bees to carry on. As it is not advisable to re-queen till July, should no further nuclei be required, the extra brood can be raised, periodically examining for queen cells. Generally speaking, manipulations can be extensively and quickly carried out before the end of June; after that, it is best to close down the first harvest and run for the second, so disposing of the larger stocks that only top manipulations need be attempted should the weather prove atrocious.

The spare hive stunt by the way is a very useful medium for examining nuclei

when necessary during a bad spell. Fitted up with drawn combs and a little honey they can be left on the site, taking any flying bees and preventing the slightest suspicious disturbance; we employed two, so that the first emptied while the second nucleus was being examined, and this prevented any fighting and robbing. This, however, cannot be employed with a large stock except at peril of robbing being set up; we have done it by lowering their top boxes on the empty hive, but it is not to be advised.

When re-queening is due, the nucleus to which the stock is to be joined is overhauled and combs arranged for occupation by a very large colony which will push the queen on at a smart pace. After the fifth day of joining up, weather permitting, this box is examined to see if she is "O.K.," and a full box of advanced brood again put below (of course making sure there are no queen cells in it), the queen in her box going second, and she is allowed to keep these two boxes till roughly the beginning of August. Should the weather, however, delay this operation, the queen will have plenty of scope in the one box for the time being.

Approximately at the beginning of August (or middle August if a flow is on) she is again excluder in the bottom box to enable the stock to be easily and quietly wintered without further necessity for manipulations should the weather be very unfavourable, and the rest of the brood is distributed in the upper boxes for surplus. It is advisable to allow no box on the hive without its quota of brood and food as this has a large effect on the surplus and breeding. The winter box of food is prepared solid with food and stored, if all sealed, right at top. "Portering" takes place as required, but before the last couple or so of surplus boxes are cleared, and when the flow for surplus is well over, as conditions permit, the queen excluder is lifted and a couple of combs of eggs are put into the centre of the wintering box and this is lowered without further examination of the stock; at the same time the combs used for surplus have the "Porter" escape board placed under them. Managed in this way, there is none of the anger and depression usually experienced when depriving the bees of their spoils; in fact, the bees in our yard appeared wild with delight at having suddenly thrown open to them and their queen without barrier an Eldorado of honey, and their actions showed that far from feeling that they had been robbed, they regarded "everything in the garden as lovely."

When the surplus boxes were taken off, the escape was also withdrawn from

the board, and the hole covered by a piece of glass.

We medicated all boxes and floorboards with Ayles' "Isle of Wight" cure; although we have not found this either cure or prevent the disease, we have found it a very good sanitary medicant for the hives. It would appear to be wise never to let bees be hived on untreated wood; under repeated breeding wood seems to be very infective judging from larger stock. Ayles' cure, being of the nature of creosote, makes other medication superfluous, and it lasts for some time. Veterinary Izal, in solution, was also used to dip the cloths and tools in when manipulating.

Owing to the fact that in our second extended outbreak of "Isle of Wight" disease, it was noticed that those stocks which went under most approximated to the Blacks, many near-crossed Italians in the same rows escaping, the apiary was completely Italianised, and no stock allowed beyond a first cross, and by running with and not counter to their natural instincts, we were not troubled with the disease. An Italian virgin, by the way, crossed with acclimatised drones, cannot be beaten for honey production and disease resistance, and the cross is very gentle to handle.

Three harvests cannot be run for in our uncertain weather, and many smallholders come to grief just there. You can run for nuclei (or stocks) and honey with certainty of success, but you cannot also run for queens. The fertilisation of a large number of queens requires gorgeous and settled weather, and if this fails, the nuclei you have on hand are practically worth nothing. Head your nuclei with selected Italian queens—obtained early during the natural swarming season they are glorious creatures, and you will not have to complain any more that bees give only fluke harvests. Raise a few first crosses for your own use but leave out queen-raising on a large scale for your own requeening and the nuclei if you have to run for immediate and certain profit. All years give us good spells before the end of June, and most at least one honey flow later; but for successful queen rearing you must have gorgeous weather at *specified* times!

There is another thing that should be given the serious consideration of the smallholder, and that is that owing to the uncertain weather bee-keeping is a very heavy and onerous occupation at particular seasons if the stocks are to be worked to his ends, and it is not in the multiplicity of stocks that profit lies; larger profits can be obtained from

25 stocks, having regard to personal expert labour, than can be taken from treble the number.

Such in outline has been my method of stock control by which I was enabled to forecast results with a considerable degree of accuracy even though still experimenting. Surely a most fascinating and profitable field of investigation will be opened as others confirm and amplify kindred experiments, till the day comes when it is indisputably proved that bees, like all else in Nature, are stable in their actions under given conditions, and a solid path is beaten out for struggling smallholders.

"The little more, and how much it is;  
The little less, and what worlds away!"

---

## Bee Notes from Derbyshire.

(Continued from page 570.)

June came with three warm days, and on the second the stock I had put those ten combs of honey under swarmed, although the queen had the run of twenty combs, and the stock superced with another ten brood combs, which they all but covered. The queen had brood and eggs on eighteen of the twenty, but somehow I lost her over the swarming. I did not see them come out, and I did not find them till 6.30 although I commenced to look at 3 o'clock. I saw then they had swarmed, and as I wanted increase, I split the brood up into four lots leaving two combs on which to put the swarm back. I noticed the queen cell had hatched out, but left no queen cells on the two combs I gave the swarm; but I found out after I had given them the hatched-out queen. I never saw my queen run in with the swarm; but bees ran in so fast I concluded she was all right. Two days later they were acting as if they had lost their queen. I looked but could not find her, bought another and put her in; they killed her. I was a long time before I found the virgin after that; I was beginning to think it was a fertile worker that was in. Queens mated so badly, it was nine weeks before I got a queen to lay right in that hive again; but events since have caused me to think it was that virgin that killed my laying queen when I returned the swarm. I got three young queens to lay out of the four nuclei I made. Two stocks are very gentle, but the others, well, one needs a gas mask on and armour plating, they are veritable demons. I can see an interesting time coming next summer if they are lucky enough to get over winter, and of those 100 lbs. of clover honey that I feel sure will be running about here. After the two honeyless summers we have had

here, surely we shall get a chance next time. I thought what honey that big lot of bees were going to get. The nucleus got the honey on the heather; the swarm dwindled down on to three combs and needed feeding; a three frame nucleus that I wintered beside them built up into a strong stock, swarmed on June 23, and that swarm wouldn't stop in the hive, every time I went to the garden it was hung on a hedge somewhere, and sometimes out all night; but eventually it settled down to work; then the queen got into the super, laid three or four combs full of eggs, then I put her below and put excluder between; that caused them to fight, never knew it before, but they killed a basin full, about all that were in the super; but didn't they pack the combs with brood after that, and they got quite strong. They put 30 lbs. of honey in the super on the moor, and the brood combs were solid slabs of honey.

I said I made four lots of that first swarm. Three of the queens got mated on June 17, the other got lost on mating trip, and I had my first experience of a fertile worker. Being only a few bees I could very well see it was no queen that kept laying a few eggs. They killed me three virgin queens, and the little drones were flying about before I could lay that lady by the heels. I was always looking for her, and I spotted her trying to lay and killed her. There were no more eggs after that, and as I had a queen in a cell that the bees had held in for four days I put it between the combs, and they have been all right since. I had put a frame of comb in a glass hive with two cells to see how queens went on. They did do some qualking to one another, but the bees kept one in the cell. I thought I was going to get two queens in that way, but the other flew and got lost while I was cutting this cell off.

I may say here I found a good way of re-queening a hive through using that glass hive. They were wanting some bees for a bee lesson at school, so I put a comb and bees in this glass hive and ran a virgin queen a week old in to them. They accepted her at once. Well, an hour after I thought why not re-queen in that way, so the next time I had a hive to re-queen, I killed the old queen, put a comb of bees into the glass hive. Half an hour later I ran in the new queen, a laying one, and the same night returned it to the parent hive, and it is going on grand.

It has been a catchy time to get queens mated, some never got mated: some went three weeks. One I had in a matchbox ready to put into a nucleus at night, and days had been dull, when about 1 o'clock on August 10 the sun came out bright, I thought this queen will miss a good day

if I don't liberate her, so I shot the matchbox open under the combs, and, would you believe it, that queen got mated that afternoon, for the next days were dark and dull, and on the fourth day I found a patch of eggs 6 in. across. I have kept queen bees various periods in matchboxes this year, by just smearing a drop of honey on the edge outside so they can lick it. One laying queen lived two weeks, and I was going to re-queen a colony with her when I accidentally let her drop off the table on to the floor, but it killed her, she died the same night.

*(To be continued.)*

## Jottings of a Black-Country Beginner.

From our little mis-named district, famous in industry, I observe that very little information appears in *THE BRITISH BEE JOURNAL*; therefore I offer this list of observations in an attempt to fill the gap.

Needless to say, we, in common with all districts, have marked down 1920 as a dead-letter year as far as apiarists are concerned.

Since September, however, the weather gods have attempted to compensate us for a vilely-wretched summer. With the exception of a few frosts, fogs and rainy days, we have, indeed, felt the full benefit of St. Luke's little summer.

During the week I have strolled over a near-by hill, known as the "Wren's Nest"—owing to the curious shape it possesses, caused through limestone excavations.

The mildness of the weather can be judged from the fact that on this high beauty-spot, daisies, dandelions, buttercups, pit-mound "dog daisies," and a yellow flower (perhaps Mr. Editor will give correct technical names for the last two mentioned from the specimens enclosed?) were found growing.

Yes, and behold! yesterday, in the shelter of my solitary hive I found a venturesome strawberry blossom!

Considerably interested in beekeeping, as I have been for some time, I was unable to embark on this pleasurable hobby until this autumn, as I have only been a few months demobilised.

Yet I have offered these notes, Mr. Editor, because I have faith enough to believe that the beginner has more time to study detail than his more busy brother. My stock of hybrid Italians increased from four to six frames of comb from August ending till the first week in October, when her ladyship finished her season's work. Through various causes, syrup

feeding was unavoidably prolonged until the end of October.

The busy mites are now snugly packed down beneath a new calico quilt, four pieces of woollen blanket and a 6-in. thick cork-dust pillow.

As Mr. Hemming has recently commented, this assuredly is the bees' play-time.

In the few hours' daily sunshine they make miniature circular tours, teasing their sisters by alighting pell-mell, ever filled with playful, over-brimming activity. Surely my flock are chiefly youngsters, for such demonstrations are the natural outlet of exuberant youth.

During one fine afternoon I slightly lifted the portion of the quilt on which the candy rested to see if more supplies were needed. Combs were drawn out fuller, apparently, than when I last looked, the inmates of the hive appeared to be quite cosy and active.

Since I last peeped in (some weeks ago), Mr. Editor, I notice that the bees have built from one comb to the other, in two places, both half-way down the frames.

As my spacing is correct, must I undo their handiwork?

In conversation with the District Secretary, Mr. Walton, yesterday, and Mr. E. H. Hipkins, I gathered that high hopes were entertained in all places locally of successful wintering.

This, coupled with the fact that disease is practically extinct in this district, gives us every confidence that the year 1921 will be one on which we can mark in flaming letters that glorious word "Forward!"

JAMES CASSELL, Gaston.

[The twigs were too crushed and withered for identification. One appeared to be a variety of *Senecio*, very similar to the common groundsel (*Senecio vulgaris*), which is one of the species. The other we were unable to indentify at all. The little brace comb can be removed when spring cleaning.]

---



---

## Cotswold Notes.

IS THERE A "BETTER BEE?"

My answer, backed by experience, is Yes! Perfection, or anything approaching it, has not yet been reached, but just as the desire for improvement becomes keener so will the standard of bees be gradually raised.

The "Isle of Wight" disease proved this. No bee-keeper appeared satisfied with the disease-resistant qualities of Blacks, or its faculty for rapid reproduction.

Hence the importation of Italians, which undoubtedly, for better or for worse

to the bee industry, have stemmed the tide of disease, with the result that healthy bees are now almost as numerous as ever.

Without going over the pros and cons of existing races, I do not think the average weight of honey obtained yearly during the last three or four seasons has been anything like so heavy in this locality as was the case prior to 1914.

By this I mean the yield from individual colonies, not collectively.

Whether this is due partly to disease, the result of changing from natives to Italians, or to the indifferent seasons, I cannot with certainty say.

Before we can maintain a high standard in honey production, there are still some very undesirable characters in existing strains which must be got rid of. For example we do not want bees that convert the last drop of honey into brood; raising brood for brood's sake.

Many colonies raise brood far in excess of their ability to store honey with which to feed it.

This is the root of excessive swarming. With one or two foreign races when kept in England the proportion of bees attending brood to those actually foraging is so unequal, and the total quantity of honey collected so nominal, that they rarely, if ever, are able to give a surplus.

Generally speaking the mildest tempered bees do not excel at honey-gathering. Often they are easily set upon and robbed.

Bee for bee, blacks appear to gather the most honey during the average short English summer.

Queen for queen, Italian queens produce the most brood, starting earlier, and continuing long after black queens have normally ceased laying in the autumn.

By getting a cross between the two varieties, and running them for honey only in some more or less isolated district, it should be possible to separate a finer strain for honey than anything we have had.

It costs no more to keep a good strain, while the results are infinitely greater.—A. H. BOWEN, Cotswold Apiaries, Cheltenham.

---



---

## A Correction.

Signor Piana writes us:—"I am very surprised in reading on page 542 of THE BRITISH BEE JOURNAL, 'Next on to Signor Piana's at Castel San Pietro . . . Both natural and artificial queen-rearing was adopted here.' I never adopted natural queen-rearing. I rear my queens, following the most up-to-date methods, as described by Phillips. I hope you will rectify the mistake as early as possible."



## Impudent Theft from Bee Hives.

At Sudbury, before the Mayor (Major A. Goat), Alderman H. Alston, Mr. A. Hitchcock, and Mr. R. W. Warner.

Ernest Daniel Bareham, 18, ex-soldier, and Edward Byford, 19, mat-maker, of Sudbury, were charged with stealing two hives of bees, eleven brood frames, and 2 lbs. of honey sugar, value £5, the property of Ernest William King, grocer, of 8, Market Hill, Sudbury, on the 8th Nov.

Prosecutor said he occupied a garden in Acton Road, and there kept four hives of bees. He last saw the hives on Sunday, the 7th Nov., when all were complete. On the 9th Mr. Clubb made a statement to him, and in consequence he went to the police, and, with Sergt. Smith, visited the garden. On arrival he found two of the hives had been dismantled, eleven of the brood frames had disappeared, the hives had been pulled to pieces, and the parts scattered about. In one of the hives a carton of honey sugar, containing about 2 lbs., had been taken away. He identified the carton of sugar by the manner in which the sugar had been consumed. He had looked at it on the Sunday.

Fredk. R. Clubb, engineer, of 32, Queen's Road, said he occasionally assisted Mr. King with his bees. On the 8th Nov. he saw the hives, which were then apparently all right. Next morning at 8 a.m. he went through the prosecutor's garden on his way to work, and noticed that two of the hives were dismantled. He at once informed the prosecutor.

Police-Sergt. Geo. Smith said that he and P.C. Digby visited No. 5, Metcalf's Yard, East Street, and saw Bareham. At the police station he showed him the box and frames, and told him Mr. King had identified the frames. Bareham said: "The box and what is inside are my property. The bees I got off a twig in Burndon Wood last May. I brought them home and put them into this box. The frames I got from Dupont's. Defendant was searched, and on a handkerchief found in his pocket witness found some bee stings, which were quite fresh. He pointed these out to the defendant, who said, "I got them two or three days ago when I was after some bees in a tree. I understand bees. I have been getting honey from trees on Ballingdon Hill."

Witness then saw Byford, who, in the presence of Bareham, said they had been after honey from trees, for which they had had permission. He knew nothing about

Mr. King's bees. Next morning, assisted by P.C. Digby, he took casts of the foot-prints he had covered up. He sent for Byford, showed him the casts, and examined his boots. One of the casts corresponded with his left boot, and when he pointed this out, he said: "They are alike." Witness had kept bees all his life, and with regard to the frames he had never seen frames wired like them. P.C. Digby gave corroborative evidence.

The Mayor said the Bench were perfectly satisfied that the cast of the footprint taken by Sergt. Smith corresponded exactly with Byford's boot; but for that there would have been no evidence against Byford. With regard to Bareham, they had come to the conclusion that the frames belonged to Mr. King. They had taken into consideration that this was the first offence of the defendants, and each would have to pay a fine of 30s.



## Onions and "Isle of Wight" Disease.

[10340] With your kind permission I should like to give my experience with the above cure. In August last I had two stocks of bees, one very strong, the other fair, which I decided to take to the heather about four miles away. I took them on the 18th, and after three or four days the weather took a turn for the better. They had about three weeks of splendid weather, and as there was a fine bloom they did well. I went to see them several times, when they were working hard and were to all appearances healthy. I did not fetch them back until September 23. We got there about dusk and so could not see very well, but, however, we got them made secure, but not before noticing many dead bees on the ground which I did not like to see. After bidding the farmer a cheery good night we sped on our way home, arrived there all safe, and the next morning there were a great number of dead bees cast out of the strong stock. Later in the day, which was a very fine one, bees were crawling about in scores, and the other stock was affected also.

At this stage I must tell you that this is nothing new to me, as my bees have been wiped out three times with "Isle of Wight" disease, and once with foul

brood, and was thinking that the fifth time had come, when looking at the *B.B.J.* for September 23, I saw Mr. Witney's "onion cure." I tried it at the first opportunity, which was the 25th. The worst stock I tried first, as the other was not so bad. I put on a half pint of warm syrup in the evening, and the bees were, as I thought, taking it down fast; but on looking next morning I found that they had only taken about half. However, in the evening the feeder was quite empty—that was Sunday. I put on another bottle on Monday evening, which was empty by Tuesday. Up to that time there seemed to be no fewer crawling bees, but by the Wednesday there was a great falling off, and by the end of the week not a crawling bee to be seen, so I treated the other stock with like results.

I have tried nearly all the so-called remedies, but they have all failed, and bees have always died out, so if my bees get through the winter, which I hope they will, I shall have Mr. Witney to thank. I, like Mr. Witney, have been looking for a cure for some time, and do not remember seeing any mention of onions in the *B.B.J.* at any time. If it has I should like chapter and verse. If anybody has known they must have been hiding it under a bushel. Mr. Witney, as soon as he has found what we hope will prove a good thing, like an honest man has let others know and not kept it to himself, for which, I for one, am very thankful. Now, Mr. Editor, I hope you will find a corner for this, my first letter, to the *B.B.J.*, of which I have been a reader for the last 35 years, and I hope that it has still a long life before it. All being well I will report again in the spring.—SAM TEALE, Greenside Warm Lane, Yeadon, near Leeds.

### The Aberdeen Discovery.

[10341] May I be permitted to draw your attention to the fact that the essence of my letter, published in your last issue on the Aberdeen discovery is contained in the statement that "*it is rather premature to make definite critical comments on the brief announcements so far published*"?

I doubt that you will find any of your readers advancing the strange suggestion that comment should be withheld "until finality is reached"; and I feel confident that if you will re-examine my condensed letter [10337], with an appreciation that every word in it is deliberately meant, you will do me justice by finding quite a different interpretation and that your remarks are therefore inapplicable.

It is but fair to the researchers and

much in the interest of accuracy to withhold "*definite critical comments*" until the full facts of the case are published, which I understand will shortly be done in the *Proceedings of the Royal Society of Edinburgh*, of which reprints may also be available. You, personally, are of course in a different position, since you have attended the meeting of the R.S.E.

Some bee-keepers are wondering why an apicultural discovery of this significance has not been announced to a bee-keeping convention under the auspices of the *Aberdeenshire B.K.A.*, for instance. Need I say that there is not the least doubt that Mr. Wood is as keen as any enthusiast to raise the scientific status of bee-keeping societies? Possibly he would have arranged with Dr. Rennie and his colleagues for such a convention to be held and to which interested scientists would have been invited, were it not that the *University of Aberdeen* have had also a say in the matter.

The one thing which I personally regret is that not sufficiently detailed a report has been supplied to the Bee Press in the first instance, so that at least some provisional helpful discussions, which we are all anxious to have, may not have been delayed. After all, the industrial significance of the discovery is far greater than its scientific one. What the scientific and lay Press have said and will say about it will not compare with the estimation which it will continue to receive—whatever its prospective merits may be—from the bee-keeping fraternity.—A. Z. ABUSHADY.

[We have nothing to add to or retract from our footnote to Dr. Abushady's letter last week, we see no reason why comments should not be made, and fail to see what comments Dr. Abushady takes objection to.—Eds.]

### Surrey Bee-Keepers' Association.

GUILDFORD AND DISTRICT BRANCH.

As it is desired that all parts of the county should share in the work and privileges of the educational efforts of the Association, it is hoped to hold a meeting at Cranleigh with the idea of forming a branch there, or at least making the attendance at a lecture successful. Would any bee-keepers interested, or that could get others, kindly send a card in the first instance to A. H. Hamshar, Womersh, Guildford. Members are asked to help to make this a success, and to look out for the lecture announcement. An attendance must be guaranteed, and if the branch can be formed first, this should be beneficial to all concerned.—A. H. HAMSHAR.

## Notices to Correspondents

Correspondents desiring an answer in the next issue should send questions to reach this office **NOT LATER than the FIRST POST on MONDAY MORNING.** Only **SPECIALLY URGENT** questions will be replied to by post if a **STAMPED** addressed envelope is enclosed. All questions must be accompanied by the sender's name and address, not necessarily for publication, but as a guarantee of good faith. There is no fee for answering questions.

S. F. BOWER (Bucks).—*Making soft candy.*—The recipe we use is as follows:—Use a brass or enamelled iron pan, put in one pint of water, allow to boil, then stir in 6 lbs. of loaf or best white crystallised cane sugar, set the pan beside the fire (not on it), and stir occasionally until the sugar is all dissolved. Then add one-half teaspoonful of cream of tartar, and place the pan on a brisk fire; stir without stopping until the mass begins to boil. Allow to boil for half a minute or so, then withdraw from the fire, and with a spoon drop a small quantity on a cold plate. If the sugar does not stick to the finger when pressed into it and withdrawn it is boiled enough. If sticky it must be boiled another minute, and again tested. If you have a sugar boiler's thermometer boil until the temperature reaches 235 deg. Fahr. When boiled sufficiently, allow it to stand *without stirring* until the finger may be kept in it without scalding, then stir briskly until the mixture stiffens and turns white. Before it is too stiff to run freely, pour into suitable moulds or boxes. Any medicine should be added while stirring.

R. STEVEN (Ayrshire).—*Do bees draw out foundation?*—Our own opinion is that they do, but some prominent bee-keepers hold that bees utilise the foundation, as a foundation only, and build on it.

W. H. HULTON (Leeds).—*Cheshire's diagrams.*—These were drawn on an enlarged scale from the illustrations in Cheshire's "Bees and Bee-keeping," and have been out of print for some years. We do not know of any others. Lantern slides may be hired from the British Bee-keepers' Association. For particulars apply to the Secretary.

### Honey Sample.

Miss R. R. (Essex).—The honey is a good sample, and though there is a slightly peculiar flavour, to us it is not unpleasant. So far as quality goes it is suitable for bee food, but as there is a suspicion of disease where it was produced, it must be boiled before using for that purpose. The thick honey containing much pollen will be suitable for spring feeding if diluted with water.

## Displayed Advertisement Rates.

British Bee Journal or Bee-keepers' Record.

	£	s.	d.
Full page ... ..	4	0	0
Half page ... ..	2	10	0
One-third page ... ..	1	16	0
Quarter page ... ..	1	12	0
1½ in. across page ... ..	1	7	0
1 in. across page ... ..	0	18	0
½ in. across page ... ..	0	10	0
1½ in. single column ... ..	0	15	0
1 in. single column ... ..	0	10	0
½ in. single column ... ..	0	6	0

Discount for a series of consecutive displayed advertisements:—Six insertions, 2½ per cent.; Twelve insertions, 5 per cent.; Twenty-six, 15 per cent.; Fifty-two, 30 per cent.

## Special Prepaid Advertisements. One Penny per Word.

Trade advertisements of Bees, Honey, Queens, and Bee goods are not permissible at above rate, but will be inserted at 1½d. per word as "Business" Announcements, immediately under the Private Advertisements. Advertisements of Hive-manufacturers can only be inserted at a minimum charge of 3s. per  $\frac{1}{2}$  in., or 6s. per inch.

PRIVATE ADVERTISEMENTS are only intended for readers having Surplus Stock to dispose of. Driven Bees, Nuclei, and Queens that are reared or imported for sale, are Trade Advertisements, and can only be accepted under trade terms. A charge of 6d. extra will be made if a box number is used.

Advertisements must reach us **NOT LATER than FIRST POST on MONDAY MORNING** for insertion in the "Journal" the same week.

Orders for three or more consecutive insertions in "The Bee Journal" entitle advertisers to one insertion in "The Bee-keepers' Record" free of charge.

### PRIVATE ADVERTISEMENTS.

**DRAWN-OUT WIRED COMBS**, healthy, with metal ends, 2 dozen standard, 21s. per dozen, and 5 dozen shallow, 18s. per dozen; 50 new Standard Frames, wedged top bar, made up, wired and fitted with W.B.C. ends, for 2s.; quantity of other apparatus. Particulars on request.—F. HOOD, Horton, Slough. k.99

**FOR SALE**, cheap, five good hives Bees, chain-gear Extractor, etc., £15; to be removed by purchaser.—G. SARGAN, Ravenfield, Rotherham, Yorks. k.100

**IRISH HONEY**, 14 lb. 28s., 28 lb. 55s., 56 lb. 106s.; also Section Honey, 30s. and 35s. dozen.—S. CRAWFORD, Apiaries, Castlederg, Co. Tyrone. k.101

**WANTED**, Second-hand Hives, W.B.C., Taylor's or Overton's. State price.—Box 109, B.B.J. Office, 23, Bedford Street, W.C.2. k.102

**OBSERVATORY HIVE** wanted, second-hand, to hold three frames and sections; modern pattern; revolving and feeder.—"Y," "Monken Hadley," Braintree. k.103

**PRIME HAMPSHIRE HONEY**, in 28-lb. tins, 50s. per tin, free on rail, carriage forward.—TRUEMAN, Harroway Road, Andover. k.104

**SAINFOIN HONEY.**—We have ¼ ton of this fine Honey, put up in nominal 14-lb. tins, which were sent us by a honey buyer who failed to pay for his order. These packages average 14½ lbs. gross weight, and we offer them at 35s. each, carriage paid.—S. H. SMITH, 30, Maid's Causeway, Cambridge. k.105

**PRIZES!**—To encourage the others. Prizes! If you are a D.B. and have followed the methods outlined in "Intensive Bee-keeping" and in "Let the Bees Tell You," you may have obtained 100 lbs. or more of honey in 1920, in spite of the poor season. Let us hear from you before December 16.—S. H. SMITH, 30, Maid's Causeway, Cambridge. k.106

**WANTED**, Handy Man who understands bees, horses, and can do rough joinery. State wages expected.—YOUNG, 42, James Street, Cambridge. k.107

**PURE LIGHT CAMBRIDGE HONEY** (guaranteed), 14-lb. tins, 30s.; 28-lb. tins, 57s. 6d., carriage paid.—**YOUNG, 42, James Street, Cambridge.** r.k.84

**GOOD ENGLISH HONEY**, granulated, 28-lb. cans, 2s. per lb., carriage paid; sample 6d.—**PEARSON & GALE, Marlborough.**

**NOW BOOKING ORDERS**, delivery January, February, March, £2 sittings of Eggs and Day-old Chicks (Barrou's), White Leghorns, Brown Leghorns; White and Fawn and White Runner Ducks, White Wyandottes, sittings 10s. 6d. to 35s. a dozen, Chicks double.—**MRS. M. ANDERSON, Poultry Dept., Hermitage Poultry Farm, High Hurstwood, Sussex. Manager: Miss M. D. Sillar.** k.93

**NO BEE GARDEN** complete without Willow Herb, 12, 2s. 6d.—**BOWEN, Apiaries, Cheltenham.** k.85

**BROTHER BEE-KEEPERS** with spare time wishing to commence in the Retail Fish Business write **J. W. ELVIDGE, Wholesale Fish Merchant, Grimsby.** r.h.239

**CORRESPONDENCE Courses** in Bee-keeping.—**H. E. NEWTON, Hobart Road, New Milton, Hants.** r.k.69

**HIVES**.—A limited number of strong, sound and interchangeable, free from "I.O.W.," two lifts, brood chamber, 10 frames, metal ends, wired and new wax in each, roofs lined with zinc or iron, price 35s., free on rail; cash with order.—**FOSTER & CO., Heath Side, Hillingdon Heath, Middlesex.** r.k.78

**BACK NUMBERS B.B.J.**, 1903-1915, also illustrated Dutch Bee Journals, to clear.—**ARCHER, 64, Kingston Road, Oxford.** r.k.70

**LIFE INSURANCE IS A SOUND INVESTMENT**.—Will fellow members of the craft write for prospectus to **H. M. LOWE, Park Road, Chilwell, Representative for "Royal," "Scottish Temperance," etc.?** k.66

#### BUSINESS ADVERTISEMENTS.

1½d. per word.

**IMPORTED ITALIAN QUEENS FOR 1921**.—List on application.—**PEARSON & GALE, Marlborough.** r.k.88

**HONEY FOR FEEDING BEES**.—Finest West Indian. Case of one tin, 56 lbs. net., 61s. 6d.; case of four tins, each 7 lb. net., 35s. 9d.; carriage paid 100 miles.—**LONDON TRADING AGENCY, 32, St. Mary Axe, E.C.3. Tel.: Avenue 3883.** k.103

**NO SUGAR VOUCHERS NEEDED**.—Flavine Candy, made in Cambridge, 6 lbs., 10s. 6d., post paid. Plain White Sugar Bee Candy, 6 lbs., 9s. 6d., post paid.—**S. H. SMITH, 30, Maid's Causeway, Cambridge.** k.96

**BEEES AND QUEENS FOR 1921**.—Send for our new Illustrated Catalogue, free on application.—**PEARSON & GALE, Marlborough.** r.k.89

**WANTED**, best quality English Honey. Please state prices.—**HILES, "The Homestead," Kidderminster.** r.k.92

**ENSURE A GOOD HONEY CROP** next year by purchasing one of our noted 6-frame Italian Stocks. Illustrated Catalogue free on application.—**PEARSON & GALE, Marlborough.** r.k.90

**FIRST PRIZE CANDY**, 6 lbs. 10s. 6d.—**BOWEN, Apiaries, Cheltenham.** k.74

**MASHEATH MEMS**.—"Been painting the Masheath. Man, it's a grand bee-box! The longer I look at it the more convinced I am that it is absolutely 'it.' It ought to sell like hot cakes. A man with any pride in his apiary has only to see it to purchase.—**A. L.**"—**ATKINSON, Fakenham.** r.k.97

**IMPORTANT!**—In spite of the increased cost of sugar, appliances and carriage, we are offering our celebrated 6-frame Stocks at reduced prices. Catalogues free on application.—**PEARSON & GALE, Marlborough.** r.k.91

**A WELL-ESTABLISHED FIRM** wishes to hear of bee-keepers who would guarantee to supply them with Nuclei May-June next.—**Box 107, B.B.J. Office, 23, Bedford Street, Strand, W.C.2.** r.j.42

**"WIGHT" DISEASE**.—Prevention and removal. Advice 5s.—**ALF. RYALL, Cottage Farm, near Camp, Stroud.** r.j.5

**BE PREPARED FOR 1921 HONEY SEASON**.—Hives, Brood Boxes, etc., made to your requirements. Our 12-frame W.B.C. Hive is for honey production; no nails used; is substantial; all work screwed.—Quotations from **H. GILLAM, 56, Sackville Road, Bexhill.** r.k.64

**HAVE YOU READ "THE BEE WORLD"?** If not, why not? Every number in itself is a useful literary work for practice and reference. Specimen copy free.—**Offices: THE APIS CLUB, Port Hill House, Benson, Oxon.**

**SURPLUS HIVES** and Appliances for Sale, good condition, cheap.—**PEARSON & GALE, Marlborough.** r.h.131

### Finest Grade New Zealand Honey (Amber)

For Bee Feeding. Guaranteed Pure.

Cases, each 2-60 lb. nominal Tins.

95/- per cwt. Carriage paid.

Cash with order or on receipt of goods.

N.B. We are already supplying Beekeepers' Associations throughout the Country and shall be pleased to quote references.

**The Bristol and Dominions Producers' Association, Ltd., Bristol.**

The products of the Apiary, of Poultry and Farm Stock, of the Fruit and Vegetable Garden can be Advertised and Sold through

### THE BAZAAR, EXCHANGE & MART Newspaper.

Get a Copy—Thursday and Saturday 3d. The "Bazaar" publishes also practical handbooks by experts. Send for full catalogue, post free from—**WINDSOR HOUSE, Breams Buildings, LONDON, E.C.2.**

### THE British Bee-Keepers' Association.

The recognised centre of practical and scientific bee-keeping in Great Britain. Particulars and conditions of membership may be obtained from the Secretary,

**W. HERROD-HEMPSALL, 23, Bedford Street, Strand, London, W.C.2.**



# Bozzalla Queens.

"American Bee Journal" specification Tested three banded Italians.

## DIRECT from ITALY.

May & June  
13/-

July & Aug.  
12/-

Sept.  
10/- each.

Sole Agent: H. M. STICH, Riccarton Avenue, PAISLEY, Scotland

## 1920—QUEENLAND LIST—1921

In reply to many requests coming in for our Premier White Star Queens for the Season 1921, we beg to state that early delivery may not be offered, as a certain number of orders have been carried over (by request) from previous season for first 1921 delivery, in consequence of the unfavourable weather for queen-mating.

## Our Premier White Star Nucleus Stocks

will be offered as usual, and at former price; but the charges for Queens have been revised, and include the offer of well-bred and selected Virgin Queens of this renowned strain.

Full Queensland Descriptive Circular 4d., The Revised List only (to those having 1920 List, 2d., post free,

Of S. SIMMINS, QUEENLAND, HEATHFIELD, SUSSEX.

For Christmas Gifts. You can get the books of the best authorities in this and other countries, and also the leading American and foreign bee-journals, from

**E. J. BURTT, STROUD ROAD, GLOUCESTER.**

*For the convenience of beekeepers I am printing a special list of these. Send a postcard for it.*

	<h1>"BACTEROL"</h1>	<p>The cure for, and preventive of, "Isle of Wight" Disease. Non-poisonous—free from stain or unpleasant odour.</p>
	<h2>FOR BEES</h2>	
2/9 per Bottle.	Post Free.	BACTEROL LIMITED 19/25, Brookside Rd., Highgate, N.19.

**CANDY** Made in our own factory by bee-keepers for bee-keepers.  
**6 lbs. post free 9/6**  
 Guaranteed from Pure White Refined Cane Sugar.  
 Miss Chester-Master's Patent Candy Box, 4/6 each. Postage extra od.  
**S. J. BALDWIN, The Apiary, BROMLEY, KENT.**

## INSURE YOUR STOCKS AGAINST "I.O.W." AND OTHER INFECTIONS.

Science has now placed within reach of every Apiarist a safe and certain preventive of infection in "Yadil" Antiseptic.

For **SPRING FEEDING** "Yadil" may be added freely to Syrup.

For **DISINFECTING** Bees and Combs a five-per-cent. solution in tepid water should be used with a fine spray.

ASK FOR GREEN LABEL.

Our Bee Brochure sent Free on Application.

**CLEMENT & JOHNSON, 19, Sicilian Avenue, W.C.1.**

## FOUR FIRST PRIZES.

Our HIVES and APPLIANCES were again awarded FOUR PRIZES at the Highland Agricultural Society's Show at Aberdeen, thus testifying to the superiority of our goods. Order now at catalogue prices and save money.

## SOFT BEE CANDY.

Have you tried our Famous Bee Candy? If not, you should send for a trial order now. It is made from PURE WHITE CANE SUGAR and is PERFECTION.

### PRICES—

1 lb. at **1/5**, postage 9d., 6 lbs. at **9/6** post free,  
10 lbs. at **15/6** post free.

Can be had medicated or not, as required.

**R. STEELE & BRODIE,**  
*Bee Appliance Makers,*  
**WORMIT, FIFE.**

Telegrams:—"Bees, Wormit."

Telephone:—28 Wormit.

## BEE CANDY.

**W**E are now able to supply CANDY OF OUR OWN MAKE from guaranteed Pure White Refined Cane Sugar. In 1-lb. boxes with glass tops. It can be had plain or medicated with either "Yadil" or "Bacterol."

### REDUCED PRICES:

1lb. - **1/5** per lb.

6lb. - **9/6**, post free.

10lb. - **15/6**, post free.

**JAMES LEE & SON, Ltd., Uxbridge, Middlesex.**



No. 2007. Vol. XLVIII

DECEMBER 9, 1920.

[Published every Thursday, Price 2d.]

**CONTENTS.**

	PAGE		PAGE
REVIEW .....	589	WORCESTERSHIRE BEE-KEEPERS' ASSOCIATION .....	596
A DORSET YARN .....	589	NORTH DEVON BEE-KEEPERS' ASSOCIATION .....	596
JOTTINGS FROM HUNTINGDONSHIRE .....	590	CORRESPONDENCE—	
BEE NOTES FROM DERBYSHIRE .....	591	Tarsonemus Woodi .....	597
NOTES FROM GREYNA GREEN .....	592	Disease or What? .....	597
JOTTINGS .....	593	Answers to Few Notes, November 11 .....	597
A FEW MORE NOTES .....	593	Native v. Foreign Bees .....	598
MY GERMAN BEE JOURNAL .....	594	The B.B.J. and its Contents .....	598
A VISIT TO THE HOME OF THE "WILD WHITE"		QUERIES AND REPLIES—	
SEED CLOVER .....	594	Book Wanted .....	599

OWING to the FALL in the COST OF SUGAR  
WE ARE IN A POSITION TO SUPPLY

PINK (MEDICATED OR PLAIN)

# SOFT CANDY

Made from Guaranteed Pure Cane Sugar.

NO VOUCHERS REQUIRED.

1/5 per lb. (7lb. parcel post free, 11/-)  
(10lb. do. do. 15/6)

E. H. TAYLOR, LTD., WELWYN, HERTS.

THE  
**British Bee Journal**

Office: 23, Bedford Street, Strand, London, W.C.2.  
ESTABLISHED 1873.

A Weekly Journal Devoted to the  
Interests of Bee-keepers.

Edited by T. W. COWAN, F.L.S., &c.,  
and J. HERROD-HEMPSELL, F.E.S.

**Correspondence: Whom to Address.**—All matters relating to the Literary Department, Associations, Shows, etc., should be addressed, "Editors, *British Bee Journal*," and all business communications and matters relating to subscriptions and advertisements to be addressed to the "Manager," *B.B.J.* Office.

**Subscriptions.**—Annual Subscription, 10s. 10d. post free in advance; single copies 2d., or 2½d. post free. If a receipt is required by post, a stamped and addressed envelope must be sent, otherwise a printed receipt will be enclosed along with the paper.

**Note.**—Cheques and Postal Orders should always be crossed, otherwise it is very difficult to trace them if they go astray.

**How to send Money.**—Remittances can be made payable to W. Herrod-Hempshall by crossed Cheques and Postal Orders. Stamps may be sent for small amounts up to 2s. *Halfpenny stamps are preferred.*

Scottish or Irish cheques can only be taken in payment if 6d. is added for commission charged by banks for cashing them.

The Editors are not directly or indirectly interested in the manufacture or sale of beehives or appliances of any kind, and must refer correspondents wishing for prices or catalogues to advertisers in the paper.

## OUR DEPOSIT SYSTEM.

You are advised to insist on this being used when dealing with strangers.

### Rules and Conditions for Depositing

*In order to save trouble, it is requested that the Rules be carefully read over by persons using the Deposit System of trading.*

Goods should not be despatched until notice that the money has been deposited is received from this office.

**1. Method.**—When strangers are dealing together, the purchase-money of the articles is deposited at our office. We acknowledge receipt of the deposit to both parties, and hold the money until we are satisfied that the purchase is concluded. If a sale be effected, we remit to the seller the amount deposited, less a charge of 2½ per cent. in the £, with a minimum of 6d., and the expenses of Post Office Orders and postage, &c. Cash will be forwarded by Cheque, Post Office Order, or by Postal Order as preferred. If a sale or exchange be not completed, we return the amount deposited, after making the same deduction. By this means buyers and sellers are secured against fraud.

**2. Deposits.**—Postal Orders (drawn on General Post Office) and Cheques must be made payable to W. Herrod-Hempshall, and crossed "London County and Westminster Bank." The numbers of the Postal Orders should be kept by the sender.

We cannot be responsible for any loss that may occur in transit.

**3. Honey on Approval.**—All honey will be sold by sample, which must be sent direct to buyer.

**4. Bee Appliances.**—In ordering, the time allowed for completing the order to be stated to us when sending cash. If maker accepts, we hold cash until transaction is satisfactorily completed, when the amount will be remitted, subject to conditions as in Clause 1.

**5. Bees and Queens.**—These will be dealt with entirely by the parties concerned, so far as price, &c., go, and when the purchase is satisfactorily completed cash will be remitted as per Clause 1.

**6. Goods in Transit.**—These are at the seller's risk, i.e., any damage to or loss of an article on its journey is borne by the vendor; but a rejected article must be properly packed and returned by the same means as was used in sending it.

**7. Carriage.**—The carriage of all goods, *except such as are sent by post*, is payable by the buyer, unless otherwise agreed. If any article sent on approval be returned, each party to the transaction must pay carriage one way.

## Books for Bee-keepers NOW IN STOCK.

Cash in full must be sent with order.

A Modern Bee Farm . . . . .	7/6	Postage . . . . .	8½d.
(To be obtained from this Office only.)			
Beginner's Bee Book (PELLETT)	5/-		4d.
<b>BEE-KEEPING SIMPLIFIED FOR THE COTTAGER AND SMALLHOLDER</b> (W. HERROD-HEMPSELL, F.E.S.)	1/-		2d.
<b>BRITISH BEE - KEEPERS' GUIDE BOOK</b> (T. W. COWAN)			
Paper covers . . . . .	2/6		3d.
Cloth covers . . . . .	3/6		4d.
Dissectible Model of Queen Bee FERTILISATION OF FRUIT BLOSSOMS BY BEES (T. W. COWAN)	4/6		3d.
Honey and Health (A. HOPE)	-/3		1d.
Honey Vinegar (REV. G. BANCKS)	-/6		1d.
How to Keep Bees (ANNA B. (COMSTOCK)	-/2		1d.
Prevention of Swarming (WILKES)	5/-		4½d.
Pollination of Fruit in relation to Commercial Fruit Growing (C. H. HOOPER, F.R.H.S.)	1/-		1½d.
<b>PRODUCING, PREPARING, EXHIBITING AND JUDGING BEE PRODUCE</b> (W. HERROD-HEMPSELL, F.E.S.)	-/6		1d.
Queen Rearing in England (F. W. L. SLADEN)	2/-		3d.
Scientific Queen Rearing (DOOLITTLE)	1/8		2d.
Snelgrove's Method of Re-Queening	4/-		3½d.
The "Townsend" Bee Book	-/6		1d.
WAX CRAFT (T. W. COWAN)	2/6		2d.
	2/-		2½d.

### MISCELLANEOUS.

The Lore of the Honey Bee (TICKNER EDUARDES)	2/-		3d.
Life of the Bee (MASTERLINCK)	5/-		4d.
<b>THE BEE WORLD</b> (supplied only to members of Associations interested in the control and development of the APIS CLUB, apart from ordinary members of the latter), per copy . . . . .	-/8		1½d.
The Bee Master of Warrilow (TICKNER EDUARDES)	7/6		4½d.

British Bee Journal & Record Office,  
23, BEDFORD STREET, STRAND, W.C.2.





## Review.

*Some Bee Diseases*, by Joseph Tinsley. Bulletin 96 of the West of Scotland Agricultural College. A brochure of eight pages devoted to the brood diseases of bees. Mr. Tinsley has made a study of this subject, and in the booklet gives some very good advice on the treatment of affected stocks. It is printed on good paper, and some excellent illustrations from photographs are given.

## A Dorset Yarn.

I ventured last week to write of lines of gooseberries for marketing fruits and food for bees when in blossom, but did not state that the time to plant was October to March, but cuttings should all be in by the end of the year. If inserted in the soil in November nearly every one will root and develop. We have some where the lower buds were removed at the time of insertion, only three or four buds left on the top; these make plants from beneath which it is easy to clean out weeds. Any small piece will grow, and without taking out the base buds beneath the soil; these soon grow into huge trees, by sending up strong growths from the base, which will give off plenty of flowers for the bees, with plenty of green fruit for early sale.

It is the same with black currants. Any small pieces will grow into fine fruiting bushes in two or three years; the latter gives off some of the finest berries, which always find a ready sale and realise good prices. One small plot of an acre of Baldwyn's Black Champion gave eleven dozen the first year of picking, thirty dozen the next year, and each year since sixty to ninety dozen have been gathered.

Then look at the flowers for the bees; even though they do not work these so assiduously as the gooseberries, they are with them the whole time they are in bloom. Kerner says it is "principally the hive bee," but we have the big bumble bee, *Bombus Terrestris*, on them even up till late in evening, when our bees have gone to their hive homes till another morning sun warms the atmosphere again; this fruit has been more sought after than in years gone by. The big Boscoop Giant berry, with its thin skin, makes such delightful preserve, where many of the old varieties, if off old trees, yield such small berries, with

tough skins, and make inferior jam compared with the other variety. About 100 cuttings were sent me in 1912; these have extended to four-fifths of a seven-acre field, by taking off the pieces that had fruited, and extending line after line; these bushes fruit on the young wood. By taking out the piece that has already fruited, it gives these strong vigorous growths plenty of room to develop the next season and keep the tree dwarf and vigorous. Plenty have been sent to other beekeepers who came back from the war, it would be interesting to the readers if some of them would give the *B.B.J.* an epitome of their success.

As I have said before, the small plot of land that has the bees gives by far the greatest share in the profits of the land, because bees work without wages. The bee-keeper who does not give them plenty of room to extend their stores in the honey flow is not wise to his own interests. The flowers of black currants are not showy flowers to attract bees, so it must be the honey scent of the blossoms that lures the bees to them. Kerner says "the honey is on the floor of the calyx," yet some varieties have flowers which look very graceful; the racemes are all pendulous and look like coloured lilies of the valley that are built the wrong way; most growers can name any variety by its blossom, as they all vary somewhat when in flower. Kerner states "that both stigma and anthers are alike ripe at the opening of the flowers" (the naturalist will know that this is very different with other fruits, where the male organ is perfect before the female part has perfectly developed), so every bee that enters a flower to get the honey assists in the perfect fertilisation of each individual blossom, and so ensures perfect berries and seeds. Imagine lines 200 yards long with millions of flowers and millions of bees. These flowers would fertilise themselves without the bees, but see the amount of honey that would be wasted if not harvested at the right time. The old Book states "the labourers are few;" it is so in the floral kingdom, so few bees to gather the harvests of honey. Wasted are these delightful sweets that enrich our land, and which would enrich the tiller of the soil did he extend the easily grown small fruits in our own beloved land.

I enclose a letter of this week, which is a sample of many sent me since my address has been in the *JOURNAL* from the Salisbury meeting. Were it not for such as this I should long have finished writing of bees, but as long as I can boom bees and bee-keeping by my small contributions to the *B.B.J.*, and they are appreciated, I will send on some, even if

not regularly each week; but you can always hold mine over for others of more importance.

There is no one who regrets more than myself that the contributions of Macdonald are so seldom seen now in the JOURNAL. His teachings are clear and to the point; he gives one the impression that he is a teacher of mathematics. In the old days of music, the musician with four letters after his name could not teach music as could the schoolmaster; he could teach how to get at the different intervals correctly. Those who have read the talented Scotsman, as I have, must realise that he is a fine teacher. The Westmorland writer enters the arena so seldom now; am sure you would not crowd them out did they send; the more writers the greater interest to the readers of the JOURNAL. I have nothing to gain by writing. I sell no bees; I sell no hives, or appliance of any description; have never been paid for any yarns sent.

It is because in every village there are tons of honey that are never harvested; experience proves that nothing gives so great return on the farm as bees; they get their own food. It is not so of pigs or poultry; the cost for food is so great, though it has dropped 5s. this last week. The return of poultry, after one has used what eggs are required in the house, is very small; while with bees, and boxes of thirty-six sections at 2s. 6d. each brings in such a lot more than do huge loads of cabbage and other vegetables, or even a whole van load of gooseberries. Bees are the best on the farm for profit, as the outlay is so small. This is why I boom bees as much as possible, that others may buy up their holdings, that they should have the great pleasure to be got out of rural life, as we have at the Violet Farm.—J. J. KETTLE.

[The letter referred to by Mr. Kettle, like numbers that we receive, expresses the writer's pleasure and thanks for the useful information given.—Eds.]

## Jottings from Huntingdonshire

It was a great pleasure to read the account of your correspondent, E. Brandford Griffith (10338), regarding the intelligent way her bees let her know of distress in the hives. It goes to prove how the little insects do try to draw our attention when they need our help, and yet many people smirk at the idea. When I related a similar experience some months ago a few sceptics took upon themselves to write sarcastic letters to me; in fact, if I remember rightly, it was

this article of mine which brought the very irreverent sneer, "'Tis time you burst your shell of skin and hatched yourself a Cherubim.'"

Last summer I was demonstrating at an apiary a few miles from here, and as I was addressing the company on bee-keeping generally, well away from the hives, one or two bees came and buzzed about me in a friendly way, yet sounding the obvious note of distress, and were insistent. On one lady remarking, "Won't they sting you?" I replied that I did not fear, as I was sure there was something amiss in the hives which was causing distresses. This remark brought forth a titter and a scoff from a man who kept bees, so he said, before I was born. However, as in course of time we got among the hives, the third hive opened revealed a queenless stock, loads of drones, wax moths, and a couple of mice. When we know bees as we ought to know them, we shall at once recognise the S.O.S. signals of these intelligent insects.

Let me now refer to Mr. Ellis. I am one who reads Mr. Ellis' articles with much interest. He has often given very wise hints as to the managing of bees, and I am grateful to him. Withal, I nevertheless feel that I am meant to come under his lash when he castigates with "far too much valuable space is given to matters entirely alien to the craft." His use of the word "alien" is unfortunate, as it suggests something opposed to or foreign to the craft, and it is safe to say nothing of that nature has ever found its way into THE BRITISH BEE JOURNAL. I hold no brief for Mr. Kettle, Mr. Harwood and others, but I have no hesitation in saying that, like myself, they are encouraged by many, many appreciative letters from all parts of the United Kingdom. Mr. Ellis would perhaps be surprised if he knew the number of BRITISH BEE JOURNAL readers who have written asking me to always add a few Nature notes to my jottings, and still more surprised when I tell him quite half of these requests come from Scotland. I hate saying anything that may savour of conceit, but I must say that it was a Scottish schoolmistress who, about a year ago, asked if I was a regular contributor to THE BRITISH BEE JOURNAL; if so, she would take the JOURNAL regularly. She had just seen a copy in the house of a friend. A gentleman in Wiltshire has just written me in the same strain. Some of the letters one has are pathetic. From Croydon way a cripple writes to say he is confined to one room most of his days, which room looks out across a railway line on to the back of a row of houses, and the only bit of country he sees is a few vir-

ginia creepers and an old clump of Michaelmas daisies, with an odd coltsfoot which struggles to live on the railway bank. He loves bees and the country, and THE BRITISH BEE JOURNAL is one of his joys; he almost smells the violets when he reads the Dorset Yarn, and does hope I shall go on bringing the countryside—to use his own words—"to my windowsill."

Occasionally when, for unavoidable reasons, I have been unable to send up any Jottings, scores have written to scold me for depriving them of pleasure, or have solicitously inquired if my silence meant ill-health. Editors, too, of periodicals have written to encourage me, and if any reader has thought I have demanded too much space in the JOURNAL I can assure him that if I thought only of myself "Jottings from Huntingdonshire" would be frequently conspicuous by their absence. A discharged soldier, who had been badly wounded, wrote me in the summer to ask if I could give him advice, as he wished to get a living from fruit farming and bee-keeping. I referred him to Mr. Kettle, and no doubt he wrote to the owner of the violet farm and many others, too, and, without doubt, Mr. Kettle's delightful, instructive and interesting yarns are often inspired by inquiries from BRITISH BEE JOURNAL readers—and that's that.

It is blowing a gale to-day, and any tenacious leaves clinging to elm and beech have been stripped, leaving branches and twigs bold and bare, yet still beautiful. The bees, wisely, are staying indoors, for the first time since October 9. Even a fortnight ago, when Jack Frost dug in his teeth o' nights 10 degrees deep, the days were so sunny and warm that the bees came out to frolic and play, sagaciously returning before getting chilled. Soon will be out the Christmas roses, winter aconite, snowdrops, crocuses, and thus, by the time the true winter season commences, we see harbingers of spring.—E. F. HEMMING, Steeple Gidding.

## Bee Notes from Derbyshire.

(Continued from page 583.)

There were some very cold nights in the first fortnight of June, the thermometer registering as low as 44 deg. at 7 a.m. for five mornings in succession. I was afraid I was going to get some chilled brood in my nuclei, but I never noticed any, though it was very foggy and frosty, taking all potatoes off in the valley. We got five good honey days from 14th to 19th, then it was a regular wet day on 20th, ending up with one of the most brilliant sunsets I ever saw on these hills. I thought then it was no

forerunner of any settled weather. We got a few more days in June, when bees did little work, but no more honey went into the supers. There were four sunny days and nine part sunny days in June. It was a good month for bees growing into good stocks; they just kept the brood nest going. Clover fields were a sight for bloom, but all in vain for bees. July came in a Tartar—wind, rain and cold, thermometer at 48 deg. at 10 a.m. on the 5th, and for five days the sun never shone for a minute. It came out an hour or two in the afternoon on the 6th, and caused my hive among the heather to swarm. I went up next day with another nucleus lot and found the swarm in a bush, been out all night in the rain. Returned swarm to the hive, and brought queen away *a la* Manley, left a virgin in, and destroyed all queen cells. On 14th I went again and cut ten more cells out. I said: "Now you will swarm no more. I've got you set now." But had I? No, on the 15th I went up again, and if they weren't hung out in the same bush, on the same twig. Had been there at least three days, and, what was more, they had raised five more queen cells. One young queen, no better than a worker bee, was running about. Another popped out of the cell while I was looking at it, two more cells I pulled out. One looked like a natural cell. The queen from this was like a full queen, and it has turned out a good mother. I wish I had left it to take care of the hive, but, thinking the young queen had gone out to mate when they swarmed, I tried it again. Well, it was in five weeks, did not mate, so killed it, and joined them up to another lot on August 11 between 3 and 4 in afternoon. It came on dark while I was doing it for half an hour. I could hardly see a bee; combs of two hives all opened out, could not see to put them together. I thought I'm all right if it suddenly comes on to rain, but, for one good thing, the bees kept quiet. I believe they thought night had come. Well, they joined up without killing a bee—a ticklish job, where there were 18 combs crowded with bees. I thought, "I'll crowd you on to 11 combs and put on sections; you'll about fill two racks with heather honey." But honey did not come into the heather till the 23rd. I think they had lost heart by then, for although the queen was only five weeks old, they built queen cells for swarming rather than fill the sections; so I took them off, a sadder and a wiser man. Being five weeks without a laying queen ruined that hive for getting heather honey. They filled brood combs, that was all. Had the young queen got mated when she was a week old, things

might have been different. Did those bees realise she was no good, made them persist in rearing young queens as they did? I think they must have had some idea of it.

Limes opened out their first buds on July 15, and were in bloom for a month, but I only saw bees work on them a little on two days. I said they would be over before the clover, but both these and all other flowers kept in bloom a long time. It was dull and wet, windy and cold, day in and day out, ending up with a frosty morning on the 31st, a good clear day and a thunderstorm at night, with a beautiful rainbow—a sign of better weather. There have been a lot of rainbows. I saw three one day—morning, noon and night. There were only two sunny days, and only seven days the bees worked in the whole month. No wonder there is no clover honey about here. Not half the hay was cut, either, and I know some lay out five weeks. The highest the thermometer registered was 68 deg. at 8 p.m. on the 31st. It was round about 50 nearly the whole month.

(To be continued.)

## Notes from Gretna Green.

Referring to the Editorial Notes in to-day's issue (December 2), the absence of contributions from Scotland and Ireland is conclusive proof that there is something seriously wrong.

*Candid comments.*—I wish to say that my criticisms are not inspired by ill-feeling towards any BRITISH BEE JOURNAL contributor, and no one need take offence from any remarks of mine. Its title page proclaims the BRITISH BEE JOURNAL to be a journal devoted to the interests of beekeepers, and not to farming, horticulture, or market gardening.

There are numerous and bulky weekly publications on these subjects, but there is only one BRITISH BEE JOURNAL, and why should its few pages be invaded by matter that is fully treated elsewhere? I admit at once that fruit and flowers are intimately connected with apiculture, and, within reasonable limits, admissible in these columns.

Mr. Kettle's article on fruit culture and tilling the soil (page 566) is excellent, and thoroughly practical, but what is his definition of a "weed"?

I take it to be a plant in the wrong place, and even Mr. Kettle's choicest violets would be merely weeds in a wheat field.

And contributions on tilling the soil are as much out of place in the BRITISH BEE JOURNAL as one of those £60 bullocks would be running amok in Mr. Kettle's

apiary. I know that Mr. Kettle is a good beeman, and we *all* want to hear more of his bee-keeping experiences, but only a few can appreciate those hints on soil tillage.

I note that the next-door contributor, Mr. Hemming, has a rod in pickle for me, so I'll get my blow in first.

Why, why, will the rev. gentleman punctuate his writings with quotations from "Garge," "William," and other local worthies?

Thinkest thou beekeepers resemble chickens and must have their "forage" mixed with "chaff" to ensure due exercise in extracting the useful grain? Seriously, though, if all correspondents confined their remarks to essential matters, there would be ample room for the increased number of contributors. The letter from Mr. Thomas (page 558) is a model one, so clear and lucid, yet devoid of any superfluous matter. Contributions from the commercial type of beekeeper are more in evidence than formerly, and this class of writers should be encouraged in every way.

It will surely be conceded that the professionals are best qualified to advise on honey production and kindred matters. And it must also be admitted that these practical men have in their own way mastered "I.O.W.," while theoretical scientists, after years of research, have done no more than determine one cause of the disease.

J. M. ELLIS.

Gretna, December 2.

[We do not suppose anyone has taken offence at Mr. Ellis, but if he criticises either other contributors or ourselves he must expect, and probably does, to be hit back. He appears to make a mistake common to many readers—namely, that the BRITISH BEE JOURNAL, or, it may be, any other paper, should be run on lines to suit their own particular views, but it cannot be done. Every paper one reads contains something that might very well be taken exception to, as not being in exact accordance with the object for which the paper is supposed to be published. We take daily papers to get the latest news, and find a column, more or less, devoted to a love story—for that is what most serials are—which we never read. There are papers devoted to that class of literature available. As we pointed out last week, and Mr. Hemming emphasises in this week's "Jottings," the cultivation of flowers is not alien to beekeeping, for a judicious selection of flowers, especially in the early spring, will help the bees considerably, and if both flowers for the bees and fruit for the beekeeper can be secured so much the better. We have not "wasted" any space on *farming*, or yet

on market gardening as such only. There have been very little cultural direction for growing cabbages and turnips. On the other hand, the papers that do deal with these things, give very little information on the cultivation of flowers specially for bees, though many do devote a column to beekeeping—perhaps some of their readers may write to the editors and suggest that too much space is “wasted” on bees, a subject entirely alien to gardening.

Bee-keeping is a serious business, but that is no reason why a little humour should not be introduced at times. Most of us have had or seen humorous incidents, and their relation is provocative of good humour, and we welcome an anecdote at times in the dialect of “Garge.” “William,” or any other worthy in whose quaint sayings there is most likely much hidden wisdom, which it will not harm the reader to “scratch” for. Heaven forbid that we settle down to a deadly, dull monotony of serious and scientific matter only.

We are waiting to hear how the practical beekeepers have mastered “I.O.W.” disease. We shall then be in a position to judge how much, or how little, they owe to the theoretical scientists. We have grave doubts whether anyone has yet discovered a reliable remedy that would answer in the hands of beekeepers generally.—Eds.] -

### Jottings.

**A Useful Capture.**—Working at a privet hedge the other day, I was suddenly in the midst of attacking wasps, and had to retreat, luckily without a sting on the flesh, and I prefer half-a-dozen bee-stings to one from a wasp. I returned to the attack, and by the aid of some cyanide, always kept handy, quickly laid them low. I plugged them up with a saturated rag, and dug them out the next day. After exploring two mouse galleries I was just giving it up as a bad job when I found a third which proved successful: the fumes had settled all the fliers, but had not quite reached the rest, and I was kept busy pinching and beating 45 queens: I allowed three to escape. The wasps have had a good set back this year, and Nature has endeavoured to put this right with a most remarkable autumn. We must all pay them special attention next spring.

**Do Bees Compete?**—Four colonies close up to assist the wintering as they are small, have been behaving more like April times, out of the hives at a most furious rate, and carrying exceedingly large loads up to the end of October. Curiously three

other colonies, a few yards away have been more staid and autumn-leisure like. Although busy, hardly a sound was noticeable, while with the others, early and late, there was one continual hum, and they have advanced from doubtful winter numbers to medium stocks, and with ordinary luck should come out worth the extra care and nursing.

After a few days partial confinement the bees are up and doing. They are clearing out the pollen, dust and accumulations of rubbish, and already are anxious to make a new start; lately there seems hardly any winter rest for man or bee. Watch the stores!—A. H. HAMSHAR.

### A Few More Notes.

“*British Bee Journal*,” November 18, Editorial.—Yes, Mr. Pearman is right enough, but it seems to me to go much further than that. Wherever a disease is caused by any parasite which is communicable from one bee to another hereditarily, as *may* be the case here, is it not a fact that the drones are a dangerous medium for the spread of the disease?

Page 555.—Does Mr. Hemming mean that he was looking through his bees to see if the queens were all safe anywhere near November 11? I suppose it must have been some time before. If not—!

Page 557.—If people in such districts as that *do* give their addresses they should engage a private secretary first as a precaution.

Page 558.—Mr. Jones’ last paragraph is one of the most valuable I have seen for some time. A queen breeder should be a honey producer, too, and if he does not run for honey in his queen-rearing apiary, all his queens for use as mothers should come from out apiaries run for honey, and should be the queens of the best honey producing stocks. I’ve seen enormously prolific queens whose bees do not get honey at all beyond just sufficient for their immediate needs. Bright golden are often bad offenders in this way. But please understand I am not condemning golden bees as a class. I have not had enough experience of them.

1920 Notes.—It would be interesting to hear why straw in Cambridgeshire is more expensive than hay. Whichever is cheaper, it must be a nice little job to clean up after packing or unpacking. Why not chop it up into chaff, and use it in a tray?

I see my friend Mr. Ling has been having a good time again. He must have a fine district and fine bees, and also he

must "know how." I bought in Reading the other day some "honey" at 10½d., just to see what could be got for the money. It was quite eatable, or so they said here. I can't eat honey myself, so I'm not a judge. I should say there were other things in it besides honey. It said pure honey outside.

(10335).—In Mr. E. R. Root's little book "Diseases of Bees," you see described much the same thing. Mr. Root puts the weakness which this disease exhibits in the United States down to the dryness of climate. Also to the strength as disease resisters of the *dark*, or *leather-coloured* Italian. He may be right, or —. But, any way, please note the italics.—R. B. MANLEY.

## My German Bee Journal.

By G. G. Desmond.

The leading article apostrophises the heather for joining all the other flowers in this summer's strike against the unhappy bee-father. In East Prussia and in the free state of Dantzig, Erica has somewhat unbent and yielded a middling harvest. Nevertheless the West Prussians can get scarcely any of this much-appreciated sweet, by reason of the intervening corridor, while to the corridor itself import is downright impossible—"as for smuggling the honourable bee-keeper has no talent." It is not the only intimation I have had that the boasted Free State of Dantzig is surrounded by one of the most insurmountable trade barriers in Christendom. Some bee-keepers rejoice in a late harvest from seradella, a plant much grown in Germany, but unfortunately boycotted in England.

Important to our bee-keepers and all are the words of this editorial on how to put bees away for the winter. A well-packed stock in a hive that holds the heat, and has only a narrow inlet for air, consumes 6 or 7 lbs. of honey between October and the middle of March, while in a cold or draughty hive it will need from 14 to 15 lbs. On the other hand a too narrow entry is warned against by the announcement that it has been scientifically proved that the bees require nearly six times as much oxygen in winter as in summer.

The best home method advocated for wax-extraction is to tie up the old combs in bags, boil these for ten minutes at a time, then take them out and squeeze them on a draining-board under a flat board hinged thereto, returning them to the cauldron in preparation for further squeezings.

Honey seems to be selling in Germany at 1.200 marks per centner, say 12s. per lb.

wholesale. One pound glasses cost 150 marks per hundred, and a geared extractor costs 400 marks, which must seem to the German very much as £24 would seem to us.

The ill-health of bees is a problem there as here, and the father of modern German bee-keeping, Parson Gerstung, has a long article in which he describes the swarm, with its rest from chyle-production and the sweating-out of adipose in the form of wax, as a necessity of healthy life. The stock that is prevented by the greedy bee-keeper from swarming perishes by self-poisoning, as an inactive man does by the over-accumulation of uric acid.

## A Visit to the Home of the "Wild White" Seed Clover.

The Gloucestershire Bee-keepers' Association ended a series of "Field days" held during the past summer by arranging a visit to Mr. G. C. Swaffield's apiary on July 24 last.

The weather smiled on the occasion, and a number of members availed themselves of the opportunity to see simultaneously the apiary of one of the leading West Country honey producers and the Cotswold Farm, whence the seed of our champion English honey plant is distributed far and wide. Mr. Swaffield is among the few apiarists in these islands who have the courage to depend on apiculture for a livelihood, and his visitors were not disappointed in their expectation of finding him aiming at the evolution of a honey-making bee of the highest type, in an apiary run on the most up-to-date methods.

The location proved to be an ideal one—a sheltered dip amongst the rolling uplands of the Cotswold country; on all sides stretched field after field of white clover in luxuriant bloom, five hundred acres of it!

The plant is not the usual white, or Dutch, clover of more or less temporary ley, but is the genuine perennial wild white clover of the roadside, specially cultivated for seed by the owner of that land, Mr. Wood, of Haselton. This gentleman, realising the value of bees as pollenising agents, originally invited Mr. Swaffield to establish his apiary in the parish. Now the apiary and the fields of seed clover have become a practical illustration of the mutual service and advantage that bee-keeper and seed-grower can be to each other.

In the photo. of the gathering Mr. Wood, Jun., is seen on extreme left. Mr. Swaffield is holding the brood-frame, and

Colonel Beale-Browne (whose apiary is reputed a model one) is looking over his shoulder. Other, less courageous, members remained out of range of the camera—and of the bees! but it can be seen from the headgear of those among the hives, and from their expressions, that there was no need to take cover; indeed, the bees were apparently of uniformly amiable disposition, although many were cross-bred Italians. This season has been chiefly devoted to re-establishing and multiplying colonies, for Mr. Swaffield, in common with most apiarists of military age, had till lately been serving his country abroad, and his apiary suffered accordingly. "Isle of Wight" disease, too, took toll during his absence, and he returned to *one* stock

there should be no difficulty in securing pure mating or the cross desired.

The hives in use are of a very handy and compact pattern, square, with flat roofs, which, being covered with zinc and white-painted, are weather-proof and cool.

Several stocks were examined, and a friendly rivalry developed amongst the audience, both in diagnosing the state of a hive before manipulation and in spotting queen-cells as frames of comb were lifted out. Late swarming had been the order of the day here, as throughout the district, and, in addition to those which had been returned, some 50 were to be seen in various stages of development into colonies.

After inspecting cell bars, and other



BEE-KEEPERS AT MR. SWAFFIELD'S APIARY.

of healthy bees! By purchases and natural swarms he had at the end of July increased to some 90 colonies and nuclei, several headed by pure Italian mothers. Mr. Swaffield, however, favours Carniolans, and as an illustration of the capabilities of that race, exhibited a colony headed by an imported Carniolan queen, which early in June had been but a small nucleus. In the interval it had, unaided, developed into a ten-frame stock, and was, in addition, working in its super. Next season three varieties are to be tried—pure Carniolan, Italo-Carniolan, and Carniola-Italian—the location affording such unique facilities for isolation that

queen-raising apparatus in the bee shed, the company adjourned to the village school room for tea, most hospitably provided by the host and hostess, to whom, in conclusion, a hearty vote of thanks and good wishes was passed with acclamation.

Might not many county associations adopt similar methods to promote intercourse and mutual education among their members such as these field days provide? A few, as the columns of *THE BRITISH BEE JOURNAL* show, do already organise them, and next season, perhaps, may see an extension of the practice, to the all-round benefit of our craft.—(*Communicated.*)

### Worcestershire Bee-Keepers' Association.

The Honey show held at Worcester on November 18, in conjunction with the Worcester Chrysanthemum Society's Show, was an innovation which it was intended to inaugurate in 1914, but which had to be abandoned owing to the outbreak of the war. Nevertheless, during the war, the Chrysanthemum Society held gift shows, at which honey was a notable feature, and raised by means of these shows some £300 for the Infirmary and other war relief work.

The Honey show on November 18 was a decided success, and its inauguration is fully justified from the fact that entries were attracted from all parts of the country — Northumberland, Lincoln, Devon, Wales, etc., etc.—and the exhibition of honey was undoubtedly the finest ever seen in Worcester, and will doubtless result in its being in future the annual show of the Worcestershire B.K.A., under whose auspices it was held.

Dr. W. E. Moore Ede officiated as judge (in the absence of Mr. Jos. Price, of Stafford, a former pillar of the W.B.K.A., who was prevented at the last from coming), and must have had a difficult task in judging such excellent samples.

Appended is the list of the awards:—

#### OPEN CLASSES.

1. Display of Honey and Bee Products: S. Leedham, Bromsgrove, 1; A. R. Moreton, Hallow, 2.

2 (gift class). One 1-lb. Jar of Honey (liquid): W. J. Goodrich, Gloucester, 1; A. H. Bowen, Cheltenham, 2; J. Birkett, Lancashire, 3.

3 (gift class). One 1-lb. Jar of Granulated Honey: Mrs. G. Scott, Hull, 1; S. Leedham, 2; H. W. Taylor, Earl's Croome, 3.

(The prizes in Classes 2 and 3 were: 1st, 20s.; 2nd, 10s.; 3rd, 5s.)

4. Six Sections: A. R. Moreton, 1; Hon. Mrs. Britten Kenswick, Worcester, 2; W. J. Goodrich, 3.

5. Six Jars Light Honey: A. H. Bowen, 1; S. Leedham, 2; W. J. Goodrich, 3.

6. Six Jars Medium or Dark Colour: D. J. Griffiths, Llanely, 1; A. E. Warren, Blotchley, 2; Mrs. Shinn, Malvern, 3.

7. Six Jars Granulated Honey: A. H. Bowen, 1; Mrs. Sheill, Royston, Herts, 2; A. E. Warren, 3.

8. Beeswax, 1 lb.: H. W. Taylor, 1; Mrs. G. Scott, 2; J. L. Davey, Spalding, 3.

9. Honey Cake: S. Leedham, 1; A. E. Warren, 2; Miss Essell, Worcester, 3.

10. Honey Sweetmeat: No entry.

11. Honeyed Fruit Jelly: Mrs. Shinn, 1.

12. Medicated Candy: A. H. Bowen, 1; W. J. Goodrich, 2; A. R. Moreton, 3.

13. Interesting and Instructive Exhibit: S. Leedham, 1.

#### NOVICE CLASSES.

14. Three Sections: O. Taylor, Earl's Croome, 1; A. C. Shinn, 2.

15. Three Jars Light Honey: Miss Essell, 1; D. Lindsay, Honeybourne, 2; O. Taylor, 3.

16. Three Jars Medium or Dark Honey: D. Lindsay, 1; Miss Essell, 2; Miss Jacomb, Henwick, 3.

17. Three Jars Granulated: O. Taylor, 1 (only one entry).

18. Beeswax,  $\frac{1}{2}$  lb.: O. Taylor, 1; Mrs. Joshua, Malvern, 2; D. Lindsay, 3.

#### CLASSES OPEN TO W.B.K.A. MEMBERS ONLY.

19. Six Sections: A. R. Moreton, 1; Mrs. Shinn, 2; Mrs. T. L. Walker, Knightwick, 3.

20. Six Jars Liquid Honey: S. Leedham, 1; Miss Johnson, Tewkesbury, 2; Miss Essell, 3.

21. Six Jars Granulated: Mrs. Shinn, 1; Miss Johnson, 2.

Special prize for greatest number of points gained on whole schedule, 1st, 2nd and 3rd prizes counting 3, 2 and 1 points respectively: S. Leedham.

GEORGE RICHINGS, F.R.H.S.

Hon. Sec.

### North Devon Bee-Keepers' Association.

We are pleased to say that this young Association is "getting a move on" in the right direction, under the able president, the Rev. J. Morley Davies, and the energetic Hon. Sec. Mr. E. Tattersall Williams, and a good working council.

On Saturday, November 27, an interesting lecture on Bees was given in the Town Hall of that incomparably beautiful spot, Lynton. There was a very gratifying number of bee-keepers and would-be bee-keepers present.

In the unavoidable absence of the Rev. J. Morley Davies, who sent his apologies, Mr. Sanger Tucker took the chair, and briefly explained the objects of the Association's work, and then introduced the lecturer, Mr. J. Tattersall Williams. The lecturer was greatly handicapped by not having received the lantern slides which had been ordered in good time, but was fortunate in having about a dozen fine slides of his own apiary showing different aspects of working, swarming, etc. At the close of the lecture, which was greatly enjoyed, several questions were asked and some amusing anecdotes of the early experiences of bee-keepers were related. A collection was taken to help defray expenses, and a vote of thanks to the lecturer and chairman brought a pleasant evening to a close.—*Communicated.*





The Editors do not hold themselves responsible for the opinions expressed by correspondents. No notice will be taken of anonymous communications, and correspondents are requested to write on one side of the paper only and give their real name and addresses, not necessarily for publication, but as a guarantee of good faith. Illustrations should be drawn on separate pieces of paper. We do not undertake to return rejected communications.

### Tarsonemus Woodi.

[10342] The research work of Dr. Rennie and his collaborators is of such vital interest to all bee-keepers, that a full account of these operations given in the form of a contribution to the pages of the BRITISH BEE JOURNAL would be most welcome. The question to which they have addressed themselves appears to be at the root of all steady progress and success in bee-keeping, and the circumstance that the conclusions reached differ so widely from those hitherto supported by the Ministry of Agriculture and other authorities, calls for further information than that as yet generally known. Particulars and precise answers to the following questions immediately strike one as desirable:—

If the "Isle of Wight" disease is caused by a mite "Tarsonemus," how do they explain the rapid spread of the disease during the epidemic of recent years to quite isolated apiaries? When *Nosema* spores are fed to apparently healthy bees, why does the stock produce unmistakable signs of "Isle of Wight" disease? Why can *Nosema* be obtained from the majority of stocks showing symptoms of "Isle of Wight" disease yet seldom found in healthy colonies?

Tarsonemus has not been found in bees outside Great Britain, while in Germany and Switzerland *Nosema* is recognised as the causative agent in "Isle of Wight" disease. If Tarsonemus is really the cause here, what and why is *Nosema*?—  
W. F. JUDGE.

Our own experience in examining hundreds of bees from *Nosema apis* is not in accordance with Mr. Judge's statement that it can be obtained from the majority of stocks. We found that in the majority of bees from stocks showing all the familiar symptoms of "Isle of Wight" disease, *Nosema* could not be found. Further investigation is needed, and will doubtless be undertaken, not only by Dr. Rennie and his colleagues but by others who are interested.

In the House of Commons, on November 8, Mr. Munro, in reply to Lieut.-Col. A. Murray (C.L., Kincardine and Western),

said that the recent investigation by Dr. Rennie and his colleagues at Aberdeen University into the cause of the "Isle of Wight" disease of bees had now been concluded. It seemed probable that the true cause of the disease had now been ascertained. He understood that further investigation would be directed towards preventive and remedial measures.

### Disease or What?

[10343] Reading the weekly article by the Rev. E. F. Hemming in which he suggests that there is possibly a new disease attacking our queens makes one tremble for the bee-keeping industry if such is the case. The revd. gentleman said a month ago the queens were laying well, but now the colonies appear queenless. Surely the majority of queens have practically ceased to lay now, and unless he took out and examined every comb (a thing neither he or any other practical bee-keeper would do the second week in November) he cannot say for certain the bees are queenless.

The instance he quotes in his own apiary was the usual symptom of queenlessness, one would like to know if it is possible the queen was balled through late manipulation.

I inspect and pack down a great number of stocks to winter, but I did not find more than a usual number queenless, and then mostly cases where the stock swarmed late in the season.

Re the crawling disease in swarms resembling "Isle of Wight" disease he mentioned some time ago, but on bees being sent for examination the verdict was, no germs of "any known disease." This is quite possible in the light of Dr. Rennie's new discovery, but having had eight swarms from one apiary which showed these symptoms, I was so convinced it was the same old trouble I destroyed the lot, and I fear before the winter is out the parent will be wiped out or much diminished.—L. ANDREWS, Peterboro'.

### Answer to Few Notes, 7 November 11.

[10344] I am much interested in Mr. Manley's few notes in which he asks a question which I will try to answer. Mr. Manley's ideas are full of sunshine, and sometimes tickle me to death. I can well see him smile as he writes, saying to himself, "that's one for him."

Regarding this question, I am one of those curious people who know that if one coddles animals they get delicate. Take a crofter cow, she has her calf in the open under a hedge, perhaps in the snow. Look at the prize breeders, two men to

look after each cow or bull, oil cake, douches, and made fat. As a result they are delicate.

Now for bees. Same thing. And I quote my ideas. I believe in the spring in running bees so you don't have to keep on manipulating combs. I find my combs full of brood and honey, no sugar feeding, just uncap a little honey every other day without disturbing bees. This lasts almost into May. When there are plenty of early blossoms and the bees are left *all*, the first swarm appears. That swarm is hived, or returned, the hive is inspected, queen cells are attended to. And by then the honey flow has begun. On go supers tiered up, if warm open vents in floor board—that is to say, if hive does not want cleaning. Things go on till autumn without manipulation, only to catch the old queen, before autumn breeding, to re-queen, so as to keep new blood for coming winter. Spray entrance of hives with warm "Bacterol" during the day. Lifting quilts and blowing in some carbolic air through a subjugator till they hum keeps off moth and the like, and cleans the air. Using cheese cloths for subjugating is a healthy item. By this way one can keep one's bees healthy.

Regarding Italian leatherjackets, one is allowed to run what bees one likes. With the hybrid I have used up to now I have never had a crawler. Only once from a stock arriving with braced combs. These produced cripples, which were turned out. Foundation soon put things right. Now, Mr. Manley, have I put things right? As, perhaps, I am doing what the French say, "Qui s'excuse s'accuse."—C. TREDCROFT.

### Native v. Foreign Bees.

[10345] I would like to know if the illustrations of heather and ling, Figs. 112 and 113 in "British Guide Book" are correct, for what you call common ling in England we call heather here, and vice versa. I have noticed all through the reports in the *B.B.J.* for some time back that this seems to be the general rule throughout England.

I am living in a place where there are thousands of acres of heather, namely, Grey Galloway, the land of Crockett, and ling is always the first to bloom. Our bell heather does not bloom until the middle of August. As I am not versed in botany I would much appreciate your advice on the question.

I notice Mr. Robt. B. Manley's opinion differs from mine as regards foreign bees. I do not think the humid climate of the British Isles is at all suitable for foreign bees. Fancy people bringing Italian, Cyprian, Egyptian, and other races to a

climate such as this. Our own bees are so much crossed with these races that we are scarcely able to trace any signs of our own hardy blacks.

Does it not consist with reason that bees belonging to a climate such as Italy, where the fountains reflect all the various colours of the rainbow in the radiant sunshine, and the butterflies *Vanessa Cardui* and *Atalanta* come out and fly around in winter, are not suitable for a cold, grey climate such as this?

I wonder if Mr. Manley has read the notes on Cyprian bees by Mr. Bowen, and "Mongrel Bees" by Mr. Hemming in the *B.B.J.'s* of October 28, and September 23, 1920, respectively.

How would we Britishers be able to withstand our climate if we were crossed and re-crossed with Italians, Egyptians, or any of the other races farther East? I trust Dr. Rennie's discovery will lead to the final summing up, and the ultimate defeat of the dread disease, and that bee-keepers will be content to be a little less greedy, and gradually work back to the almost extinct pure British black bee which the Creator has put in the place most suited for it.—JOSEPH C. WOOD.

[The illustrations are quite correct. Common ling (*Calluna vulgaris*) is commonly called heather in England.—Eds.]

### The B.B.J. and Its Contents.

[10346] I congratulate the editors of our darling little paper on the able defence they have published in reference to the contents of THE BRITISH BEE JOURNAL. I have been astonished and grieved at the criticisms sent in by Mr. Ellis. Just before I sat down to write this I was reading the *British Printer*, a particularly technical paper, and yet within its pages are always to be found some very dainty and delightful literary and artistic gems, quiet oases in a wilderness of wheels and hustle. So it is, and so, I hope, it always will be with our own little paper. I have never kept bees, and yet I look forward with keenest anticipations to the arrival of my JOURNAL from week to week. This has been going on now for quite ten years, and I have gained a special education through the very fact that our paper is something more, something vastly better than a grimly technical weekly, devoted to business only. The rigid utilitarian is generally short-sighted. I have no doubt but that far better champions than I am will write to you in support of your wise policy. Voices from Violet Farm and from Steeple Gidding will make themselves heard! If a motto were wanted for our paper, I should like the front page of it

to bear the words "Quicquid agunt apes."—F. DE SILVA.

[We thank our correspondent for his appreciation, the more so as we know he takes great interest in the JOURNAL, and in the past we have received valuable criticisms and suggestions, some of which we have been able to act upon to the advantage of both the paper and its readers.—Eds.]

### The Season on the East Coast.

[10347] Now that all is, or should be, snug and quiet within the hives, I, as a reader of fourteen years' standing, find time to attempt a first contribution to the JOURNAL.

In this part of the country the season has been only moderate. My apiary is only  $2\frac{1}{2}$  miles from the East Coast, and there is practically no barrier to break the force of the icy-cold and piercing winds. Nevertheless, the bees started well, and by the end of the first week in May I was able to deliver a nucleus, headed by a young queen, and from the end of the third week of that month until the end of June nuclei were made and queens mated and tested well, and it looked like being a bumper season. But, alas! from then until the end of August mating days were few, and for every queen I got mated I lost two. A few stocks I worked for honey towards the end of the season, and my best stock gave me three three-frame nuclei and 41 lbs. of honey. One neighbouring bee-keeper, four miles distant, working solely for honey, did well, but the majority can only report takes up to about 40 lbs. or swarms and weak stocks this autumn. Generally, feeding has had to be resorted to, although I have only had to feed two of my thirty-one stocks, and all went to winter with that best of all packing—abundance of bees.

One day, perhaps, I will again trespass on your space if I have your permission, and relate some of my failures and successes since my brother, aged 14, and I, at the age of 15, pooled our savings and bought our first stock.—E. H. TUNMER.



### Book Wanted.

[9,916.] I should be greatly obliged if you would tell me where I could obtain a copy of the paper entitled "The Plants and Flowers most worthy of Cultivation as Honey-producers," by W. Ingram,

Esq., and price of same; also would you tell me if there is a later edition than the second of "The British Bee-keepers' Guide Book," by T. W. Cowan, Esq., as this seems to be the only one they have at the local library. Also could you please give me the address of the A. I. Root Co.—R. WILLIAMS.

REPLY.—We do not know the book mentioned. Can you give the publisher's name? Or, perhaps, some reader can give the information.

The last edition of "The British Bee-keepers' Guide Book" was the twenty-third, and there are only a very few copies of that left. So your library is a long way behind the times.

The A. I. Root Co., Medina, Ohio, U.S.A.

## Special Prepaid Advertisements. One Penny per Word.

Advertisements must reach us NOT LATER than FIRST POST on MONDAY MORNING for insertion in the "Journal" the same week.

### PRIVATE ADVERTISEMENTS.

APIARIST seeks employment for 1921.—Box 110, B.B.J. Office, 23, Bedford Street, Strand, London, W.C.2. k.109

PURE ENGLISH HONEY (liquid), in 14-lb., 28-lb., 56-lb. tins; sample 6d.—W. CHANNELL, Grove Apiary, Histon, Cambs. k.111

"WILLOW HERB" completes the bee garden; twelve 2s. 6d.—BOWEN, Cotswold Apiaries, Cheltenham. k.113

LIMITED quantity famous pure (guaranteed) Lincolnshire Light Honey (granulated), 28-lb. tin, carriage paid, 60s.; 6-lb. tin, 16s. 6d., carriage paid; tins included; sample 6d.—CHARLES CUBLEY, Gedney, Holbeach, Lincolnshire. k.115

3 DOZEN 1-lb. glass jars Heather Honey, 2s. 6d. 1-lb. and carriage; also good Cycle, £3 17s. 6d.—W. WOODS, Normandy, near Guildford.

WANTED, Handy Man who understands bees, horses, and can do rough joinery. State wages expected.—YOUNG, 42, James Street, Cambridge. r.k.117

TWO HIVES, fitted brood and shallow frames, rack sections, excluder; good condition; removing; guaranteed; 18s. each and carriage.—OCCUPIER, 3, Foxhouse Street, Blackburn. k.118

FOR SALE, cheap, five good hives Bees, chain-gear Extractor, etc., £15; to be removed by purchaser.—G. SARGAN, Ravenfield, Rotherham, Yorks. k.100

IRISH HONEY, 14 lb. 28s., 28 lb. 53s., 56 lb. 106s.; also Section Honey, 30s. and 33s. dozen.—S. CRAWFORD, Apiaries, Castlederg, Co. Tyrone. k.101

OBSERVATORY HIVE wanted, second-hand, to hold three frames and sections; modern pattern; revolving and feeder.—"Y.", "Monken Hadley," Braintree. k.103

PURE LIGHT CAMBRIDGE HONEY (guaranteed), 14-lb. tins, 30s.; 28-lb. tins, 57s. 6d., carriage paid.—YOUNG, 42, James Street, Cambridge. r.k.84

**PRIME HAMPSHIRE HONEY**, in 28-lb. tins, 50s. per tin, free on rail, carriage forward.—**TRUEMAN**, Harroway Road, Andover. k.104

**SAINFOIN HONEY**.—We have  $\frac{1}{2}$  ton of this fine Honey, put up in nominal 14-lb. tins, which were sent us by a honey buyer who failed to pay for his order. These packages average  $1\frac{1}{2}$  lbs. gross weight, and we offer them at 33s. each, carriage paid.—**S. H. SMITH**, 30, Maid's Causeway, Cambridge. k.105

**WANTED**, Handy Man who understands bees, horses, and can do rough joinering. State wages expected.—**YOUNG**, 42, James Street, Cambridge. k.107

**GOOD ENGLISH HONEY**, granulated, 28-lb. cans, 1s. 1d. per lb., carriage paid; sample 6d.—**PEARSON & GALE**, Marlborough.

**NOW BOOKING ORDERS**, delivery January, February, March, £2 sittings of Eggs and Day-old Chicks (Barron's), White Leghorns, Brown Leghorns; White and Fawn and White Runner Ducks, White Wyandottes, sittings 10s. 6d. to 35s. a dozen, Chicks double.—**MRS. M. ANDERSON**, Poultry Dept., Hermitage Poultry Farm, High Hurstwood, Sussex. Manager: Miss M. D. Sillar. k.93

**CORRESPONDENCE** Courses in Bee-keeping.—**H. E. NEWTON**, Hobart Road, New Milton, Hants. r.k.69

**HIVES**.—A limited number of strong, sound and interchangeable, free from "I.O.W.," two lifts, brood chamber, 10 frames, metal ends, wired and new wax in each, roofs lined with zinc or iron, price 35s., free on rail; cash with order.—**FOSTER & CO.**, Heath Side, Hillingdon Heath, Middlesex. r.k.78

#### BUSINESS ADVERTISEMENTS.

1½d. per word.

**IMPORTED ITALIAN QUEENS FOR 1921**.—List on application.—**PEARSON & GALE**, Marlborough. r.k.88

**ITALIAN QUEENS** direct from Italy.—Address, **E. PENNA**, Bologna, Italy. Prist List for 1921 on application. r.k.141

**BEE BOOKS FOR CHRISTMAS PRESENTS**.—You can get the Books of the leading authorities in this and other countries from **E. J. BURTT**, Stroud Road, Gloucester. Special List free on receipt of a postcard. k.120

**FLAVINE AND BEE CANDY**, made in Cambridge, 6 lbs., 10s., post paid.—**S. H. SMITH**, 30, Maid's Causeway, Cambridge. k.110

**ADVERTISER** is open to supply 3-frame Nuclei, May-June. No nuclei despatched till three frames are crowded with brood and bees. Hybrid or pure Italian Queens. Terms, £1 with order, balance when ready. Nuclei supplied on deposit with "B.B.J." if preferred. Guaranteed healthy.—**Box 111, B.B.J. Office**, 23, Bedford Street, Strand, London, W.C.2. k.112

**KEEP IN TOUCH** with modern bee-keeping thought by reading the bee-keeping journals. I shall be pleased to book orders for "Gleanings in Bee Culture," 7s. per year; "The American Bee Journal," 10s. per year; "L'Apiculture Française," 3s. 6d. per year, each monthly and post paid.—**E. J. BURTT**, Stroud Road, Gloucester. k.119

**BEEES AND QUEENS FOR 1921**.—Send for our new Illustrated Catalogue, free on application.—**PEARSON & GALE**, Marlborough. r.k.89

**HONEY FOR FEEDING BEES**.—Finest West Indian. Case of one tin, 56 lbs. net., 61s. 6d.; case of four tins, each 7 lb. net, 35s. 9d.; carriage paid 100 miles.—**LONDON TRADING AGENCY**, 32, St. Mary Axe, E.C.3. Tel.: Avenue 3883. k.122

**G.S. SECURES 6 lbs. superb Candy**.—**BOWEN**, Apiaries, Cheltenham. k.114

**WANTED**, best quality English Honey. Please state prices.—**HILES**, "The Homestead," Kidderminster. r.k.92

**ENSURE A GOOD HONEY CROP** next year by purchasing one of our noted 6-frame Italian Stocks. Illustrated Catalogue free on application.—**PEARSON & GALE**, Marlborough. r.k.90

**MASHEATH MEMS**.—"Been painting the Masheath. Man, it's a grand bee-box! The longer I look at it the more convinced I am that it is absolutely 'it.' It ought to sell like hot cakes. A man with any pride in his apiary has only to see it to purchase.—**A. L.**"—**ATKINSON**, Fakenham. r.k.97

**IMPORTANT!**—In spite of the increased cost of sugar, appliances and carriage, we are offering our celebrated 6-frame Stocks at reduced prices. Catalogues free on application.—**PEARSON & GALE**, Marlborough. r.k.91

**A WELL-ESTABLISHED FIRM** wishes to hear of bee-keepers who would guarantee to supply them with Nuclei May-June next.—**Box 107, B.B.J. Office**, 23, Bedford Street, Strand, W.C.2. r.j.42

**"WIGHT" DISEASE**.—Prevention and removal. Advice 5s.—**ALF. RYALL**, Coitage Farm, near Camp, Stroud. r.j.5

**HAVE YOU READ "THE BEE WORLD"?** If not, why not? Every number in itself is a useful literary work for practice and reference. Specimen copy free.—**Offices: THE APIS CLUB**, Port Hill House, Benson, Oxon.

### Finest Grade New Zealand Honey (Amber)

For Bee Feeding. Guaranteed Pure.  
Cases, each 2-60 lb. nominal Tins.  
95/- per cwt. Carriage paid.  
Cash with order or on receipt of goods.

**N.B.** We are already supplying Beekeepers' Associations throughout the Country and shall be pleased to quote references.

**The Bristol and Dominions Producers' Association, Ltd., Bristol.**

The products of the Apiary, of Poultry and Farm Stock, of the Fruit and Vegetable Garden can be Advertised and Sold through

### THE BAZAAR, EXCHANGE & MART Newspaper.

Get a Copy—Thursday and Saturday 3d. The "Bazaar" publishes also practical handbooks by experts. Send for full catalogue, post free from—**WINDSOR HOUSE**, Breems Buildings, LONDON, E.C.2.

### THE British Bee-Keepers' Association.

The recognised centre of practical and scientific bee-keeping in Great Britain. Particulars and conditions of membership may be obtained from the Secretary, **W. HERROD-HEMPSALL**, 23, Bedford Street, Strand, London, W.C.2.



# Bozzalla Queens.

"American Bee Journal" specification Tested three banded Italians.

**DIRECT from ITALY.**

May & June  
13/-

July & Aug.  
12/-

Sept.  
10/- each.

Sole Agent: H. M. STICH, Riccartbar Avenue, PAISLEY, Scotland

## 1920—QUEENLAND LIST—1921

In reply to many requests coming in for our Premier White Star Queens for the Season 1921, we beg to state that early delivery may not be offered, as a certain number of orders have been carried over (by request) from previous season for first 1921 delivery, in consequence of the unfavourable weather for queen-mating.

## Our Premier White Star Nucleus Stocks

will be offered as usual, and at former price; but the charges for Queens have been revised, and include the offer of well-bred and selected Virgin Queens of this renowned strain.

Full Queensland Descriptive Circular 4d., The Revised List only (to those having 1920 List, 2d., post free,

Of S. SIMMINS, QUEENLAND, HEATHFIELD, SUSSEX.

	<h1>"BACTEROL"</h1>	<p>The cure for, and preventive of, "Isle of Wight" Disease. Non-poisonous—free from stain or unpleasant odour.</p>
	<h2>FOR BEES</h2>	
2/9 per Bottle.	Post Free.	BACIEROL LIMITED 19/25, Brookside Rd., Highgate, N.19.

**CANDY** Made in our own factory by bee-keepers for bee-keepers.  
6 lbs. post free 9/6

Guaranteed from Pure White Refined Cane Sugar.

Miss Chester-Master's Patent Candy Box, 4/6 each. Postage extra 9d.

S. J. BALDWIN, The Apiary, BROMLEY, KENT.

**SAVE MONEY** this winter by making up your own hives. Particulars of wood cut ready to make up into hives will be sent free on receipt of a post card.

**E. J. BURTT, Manufacturer, GLOUCESTER**

### SEASON 1921.

We have now amalgamated our Apiaries and are in a position to supply to time

**ITALIAN QUEENS AND NUCLEI (Speciality)**  
**COMMERCIAL (16 × 10) 3 and 4 frame Nuclei.**

Before you place your order you would be well advised to write for our new Illustrated Catalogue, which will be sent to any address post free for the asking.

**LOCKWOOD & MANLEY, THE MODEL BEE FARMS, HUNSTANTON, NORFOLK**

## FOUR FIRST PRIZES.

Our HIVES and APPLIANCES were again awarded FOUR PRIZES at the Highland Agricultural Society's Show at Aberdeen, thus testifying to the superiority of our goods. Order now at catalogue prices and save money.

## SOFT BEE CANDY.

Have you tried our Famous Bee Candy? If not, you should send for a trial order now. It is made from PURE WHITE CANE SUGAR and is PERFECTION.

### PRICES—

1 lb. at **1/5**, postage 9d., 6 lbs. at **9/6** post free,  
10 lbs. at **15/6** post free.

Can be had medicated or not, as required.

**R. STEELE & BRODIE,**  
*Bee Appliance Makers,*  
**WORMIT, FIFE.**

Telegrams:—"Bees, Wormit."

Telephone:—28 Wormit.

## BEE CANDY.

**WE** are now able to supply **CANDY OF OUR OWN MAKE** from guaranteed Pure White Refined Cane Sugar. In 1-lb. boxes with glass tops. It can be had plain or medicated with either "Yadil" or "Bacterol."

### REDUCED PRICES:

1lb. - 1/5 per lb.

6lb. - 9/6, post free.

10lb. - 15/6, post free.

**JAMES LEE & SON, Ltd., Uxbridge, Middlesex.**



No. 2008. Vol. XLVIII

DECEMBER 16, 1920.

[Published every Thursday, Price 2d.]

**CONTENTS.**

	PAGE		PAGE
REVIEWS .....	601	CORRESPONDENCE—	
A DORSET YARN .....	602	A Few More Notes .....	607
JOTTINGS FROM HUNTINGDONSHIRE .....	602	Peculiar Behaviour of Bees .....	608
BEE NOTES FROM DERBYSHIRE .....	603	Acarine Disease .....	608
NOTES FROM GREYNA GREEN .....	605	“Acarine Disease” or “Acarinus”? .....	609
THE SEASON IN ABERDEENSHIRE .....	606	COMBS FROM OTHER HIVES—	
SWARM IN A HEDGE .....	606	The Bee-keeping Parson .....	610
COTSWOLD HONEY (POEM) .....	609	Deadly Bees .....	611
A DORSET YARN (POEM) .....	609	NOTICES TO CORRESPONDENTS .....	611

We should like to take this opportunity of wishing our numerous customers and all those interested in

**T H E · B E E · I N D U S T R Y**

... A ...

**Happy Xmas**

and a Prosperous Honey Season in  
**1921.**

Xmas is a season of giving presents, and the Bees should not be forgotten. A Cake of Taylor's Pink Candy will ensure for them a happy and contented Xmas.

**E. H. TAYLOR, LTD.,** WELWYN, HERTS.

## THE British Bee Journal

Office: 23, Bedford Street, Strand, London, W.C.2.  
ESTABLISHED 1873.

A Weekly Journal Devoted to the  
Interests of Bee-keepers.

Edited by T. W. COWAN, F.L.S., &c.,  
and J. HERROD-HEMPSALL, F.E.S.

**Correspondence: Whom to Address.**—All matters relating to the Literary Department, Associations, Shows, etc., should be addressed, "Editors, *British Bee Journal*," and all business communications and matters relating to subscriptions and advertisements to be addressed to the "Manager," *B.B.J.* Office.

**Subscriptions.**—Annual Subscription, 10s. 10d. post free in advance; single copies 2d., or 2½d. post free. If a receipt is required by post, a stamped and addressed envelope must be sent, otherwise a printed receipt will be enclosed along with the paper.

**Note.**—Cheques and Postal Orders should always be crossed, otherwise it is very difficult to trace them if they go astray.

**How to send Money.**—Remittances can be made payable to W. Herrod-Hempsall by crossed Cheques and Postal Orders. Stamps may be sent for small amounts up to 2s. *Halfpenny stamps are preferred.*

Scottish or Irish cheques can only be taken in payment if 6d. is added for commission charged by banks for cashing them.

The Editors are not directly or indirectly interested in the manufacture or sale of beehives or appliances of any kind, and must refer correspondents wishing for prices or catalogues to advertisers in the paper.

### OUR DEPOSIT SYSTEM.

You are advised to insist on this being used when dealing with strangers.

### Rules and Conditions for Depositing

*In order to save trouble, it is requested that the Rules be carefully read over by persons using the Deposit System of trading.*

Goods should not be despatched until notice that the money has been deposited is received from this office.

**1. Method.**—When strangers are dealing together, the purchase-money of the articles is deposited at our office. We acknowledge receipt of the deposit to both parties, and hold the money until we are satisfied that the purchase is concluded. If a sale be effected, we remit to the seller the amount deposited, less a charge of 2½ per cent. in the £, with a minimum of 6d., and the expenses of Post Office Orders and postage, &c. Cash will be forwarded by Cheque, Post Office Order, or by Postal Order as preferred. If a sale or exchange be not completed, we return the amount deposited, after making the same deduction. By this means buyers and sellers are secured against fraud.

**2. Deposits.**—Postal Orders (drawn on General Post Office) and Cheques must be made payable to W. Herrod-Hempsall, and crossed "London County and Westminster Bank." The numbers of the Postal Orders should be kept by the sender.

We cannot be responsible for any loss that may occur in transit.

**3. Honey on Approval.**—All honey will be sold by sample, which must be sent direct to buyer.

**4. Bee Appliances.**—In ordering, the time allowed for completing the order to be stated to us when sending cash. If maker accepts, we hold cash until transaction is satisfactorily completed, when the amount will be remitted, subject to conditions as in Clause 1.

**5. Bees and Queens.**—These will be dealt with entirely by the parties concerned, so far as price, &c., go, and when the purchase is satisfactorily completed cash will be remitted as per Clause 1.

**6. Goods in Transit.**—These are at the seller's risk, i.e., any damage to or loss of an article on its journey is borne by the vendor; but a rejected article must be properly packed and returned by the same means as was used in sending it.

**7. Carriage.**—The carriage of all goods, *except such as are sent by post*, is payable by the buyer, unless otherwise agreed. If any article sent on approval be returned, each party to the transaction must pay carriage one way.

## Books for Bee-keepers NOW IN STOCK.

Cash in full must be sent with order.

A Modern Bee Farm (To be obtained from this Office only)	7/6	..	3½d.
Beginner's Bee Book (PELLETT)	5/-	..	4d.
BEE-KEEPING SIMPLIFIED FOR THE COTTAGER AND SMALLHOLDER (W. HERROD-HEMPSALL, F.E.S.)	1/-	..	2d.
BRITISH BEE - KEEPERS' GUIDE BOOK (T. W. COWAN)			
Paper covers .. .. .	2/6	..	3d.
Cloth covers .. .. .	3/6	..	4d.
Dissectible Model of Queen Bee FERTILISATION OF FRUIT BLOSSOMS BY BEES (T. W. COWAN)	4/6	..	3d.
Honey and Health (A. HOPE)	-/3	..	1d.
Honey Vinegar (REV. G. BANCKS)	-/6	..	1d.
How to Keep Bees (ANNA B. (COMSTOCK)	-/2	..	1d.
Prevention of Swarming (WILKES)	5/-	..	4½d.
Pollination of Fruit in relation to Commercial Fruit Growing (C. H. HOOPER, F.R.H.S.)	1/-	..	1½d.
PRODUCING, PREPARING, EXHIBITING AND JUDGING BEE PRODUCE (W. HERROD-HEMPSALL, F.E.S.)	-/6	..	1d.
Queen Rearing in England (F. W. L. SLADEN)	2/-	..	3d.
Snelgrove's Method of Re-queening	1/6	..	2d.
The "Townsend" Bee Book	-/6	..	1d.
WAX CRAFT (T. W. COWAN)	2/6	..	2d.
	2/-	..	2½d.

### MISCELLANEOUS.

The Lore of the Honey Bee (TICKNER EDWARDS)	2/-	..	3d.
Life of the Bee (MAEFFELINGK)	5/-	..	4d.
THE BEE WORLD (supplied only to members of Associations interested in the control and development of the Apis Club, apart from ordinary members of the latter), per copy	-/8	..	1½d.
The Bee Master of Warrilow (TICKNER EDWARDS)	7/6	..	4½d.

British Bee Journal & Record Office,  
23, BEDFORD STREET, STRAND, W.C.2.





## Reviews.

*Dadant System of Bee-keeping*, by C. P. Dadant (Hamilton, Illinois, U.S.A., "American Bee Journal" Office, price one dollar).—This book is by the well-known editor of the "American Bee Journal," who has been in the bee business since he was 18 years of age. His father, C. Dadant, emigrated from France in 1863, and settled near Hamilton, and commenced with two colonies of black bees. From these two colonies came the establishment which is now supporting a number of families, and has made them pecuniarily independent. A group consisting of Mr. Dadant, his three sons and son-in-law, all in the business, are shown on page 3, and look a happy, sturdy company, who are certainly, by their appearance, a splendid advertisement for bee-keeping, so far as its healthfulness is concerned. The author of this book gives his experience in honey production for more than half a century, and as more than 60 tons of honey have been produced in the Dadant apiaries in a single year by the system described, we can gladly recommend the book as showing how more honey can be obtained with less labour. Of course the results mentioned are not obtained in one apiary, for the Dadants have a number of out apiaries, the methods of working which are described by M. G. Dadant in "Out Apiaries and their Management," which we reviewed in our JOURNAL of May 13 last, page 229.

*Some Observations on European Foul Brood*, by G. F. White.—We are indebted to the author for a reprint of his article, which appeared in the July and August numbers of the "American Bee Journal." In this he refers to the more detailed account of his work in connection with this disease, in Bulletin 810, which we have already noticed in the B.B.J., for June 3, page 265. Dr. White states that as this disease occurs least in Australia, Denmark, England, Germany, Switzerland, Canada and the United States, it cannot be attributed entirely to climatic conditions, nor to the kind of food obtained by the bees. The course of the disease is affected somewhat by the quantity of food obtained, and by the season of the year. The disease is frequently referred to as "foul brood." In the United States it was called "black brood," for a while. The writer thinks that "stinking foul brood" and "sour

brood' are also names for this disease. It is infectious, and is caused by a germ named *Bacillus pluton*. Worker, drone and queen larvæ are all susceptible to infection, but the adult bees are not. The germ lives longer than either the one that causes *Nosema* disease or the virus that causes sac brood, but not nearly so long as the one that causes American foul brood (*Bacillus larvæ*). Dr. White considers that from "the technical viewpoint much has yet to be found out about European foul brood. For practical purposes it can be said that sufficient information has been gained to make it possible for the bee-keeper to devise a treatment for the disease which will be logical, efficient and at the same time economical.

*A Study of the Behaviour of Bees in Colonies Affected by European Foul Brood*, by Arnold P. Sturtevant (Bulletin 804, Bureau of Entomology, U.S. Dept. of Agriculture, Washington, D.C., price five cents).—The author describes the experiments carried out in a small, isolated apiary, which had been previously used in fruit pollination studies, and had no record of disease. Careful observations were made and diagrams are shown of the progress of the disease. The conclusions come to are that European foul brood is an infectious disease, the primary invader being *Bacillus pluton*. The variation in the appearance of the diseased larvæ after death is due to the presence of secondary invaders. It was noted in apiary practice that the first brood of the year usually escapes with little loss. During the first five to seven days the spread of the disease in a colony after infection is slow, after which the increase is rapid under favourable conditions. The critical time, therefore, to detect the disease and start treatment is early in its course, thus making conditions favourable. Italian bees were found to resist infection better than hybrids, and showed more ability to overcome the disease. This was largely due to their more vigorous house-cleaning characteristics rather than a natural resistance or immunity to the disease. As a rule requeening is necessary in the treatment of European foul brood, except possibly in the strongest Italian colonies, which show only slight infection, and the stronger the colony the more rapid was the recovery. A heavy honey flow tends to prevent infection from gaining a foothold, and tends to eliminate the disease if present before the start of the heavy honey flow. European foul brood is a disease of weak colonies, and it was found to be difficult to infect any but very weak colonies during the heavy honey flow. Therefore colonies kept strong up to the time of the honey

flow run very little danger of contracting foul brood.

*Control of American Foul Brood*, by E. F. Phillips (Farmers' Bulletin 1,084, Bureau of Entomology, U.S. Dept. of Agriculture, Washington, D.C., price five cents). The greater part of this bulletin consists of descriptions of the disease given in previous bulletins issued by the Department, and contains the various remedial measures employed, emphasising the fact that it does not pay to treat colonies that are considerably weakened by disease, drugs being declared useless.

## A Dorset Yarn.

"We dream of a land of sunshine,  
But we live in a land of snow."

These lines we have often sung in the old entertaining days, and this morning, December 12, our fields are white with snow, only a thin sprinkling, enough to show that winter is with us; the dream of sunshine was through reading of the traveller Humbolt, who wrote so delightfully of the wonderful flora of South America, the tropical heat, the gorgeous coloured butterflies, its bees and ants, the snakes and birds; a wonderful contrast to find the fine snow blowing in the open window this Sunday morning.

Our bees have only been seen on the wing once this week. A visitor came to see them last week, or at least he saw some on the wing, and was astonished that they should be about in December. On lifting the felt covering off the top (we have a small peep of glass to see them in winter) none could be seen at all, but on taking off the cover of case for more light, they were to be seen lower down in the brood chamber. They had such a lot of stores in the brood chamber that they had not got to the top of the bars, where others were already in great numbers.

We have over the wood top of brood chamber, first a thick piece of felt, same as placed beneath stair carpets. This seems to conserve warmth. I do not know how others have found this material answer. We have had narrow strips of new Brussels carpet. We use it now; it lasts many years, but the thick piece of felt keeps the top very warm. I was trying to teach our visitor how much more income he could make with bees than with pigs. He had bought of us two young ones in the spring. He had sold them fat the first week in December. All the profit he had made was 26s. He had the manure for his garden, but his brick pigsty had cost him £28! He has a long way to go before ever he will have a return on pigs. I showed him a stock

of bees which had given me three racks of sections, of 21 each, making 63 in all, of which 40 were sold at 2s. 6d. each, the remainder at 1s. 6d., excepting some of the outside, which were very imperfectly filled and were given back to the weak hives, and at the end of the season there were two stocks, at least of the value of £4 each, where his pigsty was empty and he had only 26s. to get more stock (that would only buy one, they are always a low price in winter months). He was moaning at the high prices of feeding stuffs for pigs and poultry. (I know of one large poultry farmer who buys white oats to the value of £80 at threshing time, so as to have some of the best.) He is inclined to try bees next season. He saw his bill for feeding-stuffs would not be heavy, as bees would go everywhere gathering the nectar from other people's land. He has had an adventurous life—at sea from boyhood till 50, captain of a tramp steamer carrying British goods to the South Sea Islands and Australia, bringing back raw material, till war made him a food-transport captain, when his ship was torpedoed. He has built himself a bungalow in which to end his days; a singular man, all his life without the loving hand of woman, he will finish his life alone. Among us are all sorts and conditions of men, every one to his fancy and happiness, one cannot help thinking he is missing a lot.—

J. J. KETTLE.

## Jottings from Huntingdonshire

Huntingdonshire luckily comes in that wonderful belt of the East Midlands which has a small rainfall, and consequently an unusual amount of sunshine. This means that while in some parts of this fair isle one dare hardly look in one's hives after mid-October, here, especially under glass quilts, one may with impunity take advantage of an exceptionally warm day in November when the bees are out busy, playing, or reconnoitring or robbing some luckless colony in a tree, for a peep within the hives; of course, one would not take out every comb, or any one of them for that matter, although I have done that on a November day without ill results. Thirteen months ago I was taking funeral duty at a village in the county when I was asked to look at the coverings of a couple of hives, the owner being a novice at bee-keeping, and he was not sure whether the quilts were sufficient for wintering. One of these hives was past words, warped boards, cracks and gaps everywhere, and impossible to make weather proof. As the owner had another hive handy, I decided to risk transferring the frames of comb from the bad to the

good hive, being perfectly sure that did the bees stay where they were they could not survive the winter. Needless to say the bees were surprised, and one or two got their stings home, but they were manifestly grateful when the transference to a clean draughtproof hive was completed. The colony came through and swarmed early.

Last winter, too, one of my goats sent a hive of ten frames hurtling across the lawn, the brood chamber landing upside down. When the hive was reset, and the half-stunned bees were swept up and returned, I feared the worst, but the worst didn't happen—all went well.

To get back to my opening remarks—it is not difficult to diagnose a queenless stock in November, and when one sees all the symptoms of queenlessness in the eleventh month of the year where four weeks or so previously the queen was laying prolifically one is justified in concluding that something very unusual has happened, and when one hears and reads of other bee-keepers having similar experiences one naturally concludes that either a disease is stalking around which attacks queen bees, or that several queen wasps force an entrance into the hive and attack her majesty within: killing and perhaps eating her.

Speaking of queenless stocks brings to my mind a question asked at the British Bee-keepers' Conversation the other day. When England experiences an ideal summer and the honey flow of August promises well, a much greater quantity of honey will be stored if strong stocks are deprived of their queens for two or three weeks. In fact, it is only by making vigorous colonies queenless for a week or two that one can get a fair idea as to the immense amount of honey 50,000 bees can gather in a given time. A lady bee-keeper whom I know, last year deprived one of her stocks of a queen for the whole month of June—the amount of honey gathered was amazing. Personally, if our seasons were not so variable I should always do this to every stock marked down for requeening. Queen introduction to these stocks is easy; that is if her majesty be fertile. Virgins are apt to show fight in direct introduction. This often annoys the bees, and if they have no drones (they usually, but not always have) she is expelled unkilld.

To many inquirers, I have not forgotten my article on "King Bees." it will be turning up one of these days. I am afraid Mr. Ellis, "William," will figure in it. To other inquirers "William" is a real live man. Easily embarrassed, he nevertheless is a walking encyclopædia. Born in the days when schools were scarce, and schooling scarcer, he hasn't received

any education, and to use his own words, "Ain't 'ad no eddication, so baint no scholard." Yet he is a man of keen observation and an amazing memory, an extraordinary command of language when he warms up, and a devoted lover of nature. Animals instinctively know him as a friend; birds in winter all know where he lives; and when he speaks to bees and calls them "my hearties" he quite believes they understand what he says, and perhaps they do.—E. F. HEMMING, Steeple Gidding.

## Bee Notes from Derbyshire.

(Continued from page 592.)

August came in windy and wet the first week. For weeks prevailing wind had been S.W. to W., and N.W., and no quantity of honey seems to come with the wind there. We had a few days of lovely bee weather in the first three weeks, but no honey seemed to come. Heather was a purple mass by the 15th, but honey lingered. The 17th was a good bee day, but the five following days were very cold, bees would hardly go out. The betting would have been 100 to 1 against the heather: it looked such a forlorn hope. But on the 23rd, wind in the north, honey began to come, and the more the wind worked round to the N.E. the faster the honey came, although the days were dull. From August 23 to September 14 the bees hardly ever lost an hour, except on September 1 and 2. As I came home from work on the morning of September 24 there was a mackerel "Noah's ark" out North and South. When I went out about 8 at night there was a black one in same direction. That denotes calm, fine weather, and has it not been so for nine weeks? There have not been four windy days, the most ideal time for bees I ever knew; if it had come in June and July, what clover honey would have been got. I think it was somewhat similar in 1889, that good honey year. But if it has been ideal bee weather, it has been bad harvest weather—such foggy nights corn would not dry or ripen. There were nine sunny days and seven part sunny days in August, the highest temperature on the 13th—67 deg.

September came in a bit wet, but it soon dried up, and bees were at it again hard as ever; but with it keeping so dull, bees two miles or so from the heather did not seem to find it at first. I was bothering all one Sunday; thought bees would die for want of something to eat. The next Saturday they were hanging out, with a rack of sections full up. I put a fresh rack on, and lifted the

cluster of bees on top, and they were soon busy at work in them. Seven years ago I did well on the heather. Six years ago was a better year, but I had no bees there. I think I have done as well this year as seven years ago. From two hives I have taken three dozen well-filled sections, about 20 partly filled, from one hive about 30 lbs. in shallow frames, from another about 10 lbs. I intended showing sections at the Grocers' Exhibition, but judge my surprise when I saw the schedule and found all heather classes cut out. I had never heard a word before about it. The heather was a purple mass for a whole month; the flow lasted till the 14th, ten days later than in 1906, and it was late that year. Some years it is over a week earlier than it started this year. It was a great gamble taking bees up this time; it seemed such a forlorn hope. It was August 16 when I took them, but those slabs of honey in the brood combs is a sight worth gambling for. On September 3 I wrote: "A good bee day on the heather, after two drizzly days; not much sun, but very warm and still." This heather season will be remembered for its dull, still days, and N. to N.E. winds prevailing for over three weeks. On the 8th the sun came out very hot for two hours in the morning, then it was dull again. While thousands were sweating and broiling, trying to see the St. Leger run, I was enjoying myself in loneliness among the heather bloom and the bees; and didn't it smell that day! The wind south, and bees had got the gallop on proper. With it being dull I could see them coming down on the wind fifty yards away from the hives—a perfect hailstorm of bees for hours. And couldn't I see racing there? Of course I could, *and they were all winners, too.* My racecourse, not the grassy sward of Doncaster Moor, where struggling humanity was trying to get glimpse of one winner trying to get to a winning-post first. (I know, for I've been there twice, what a turmoil it is. My work-mates who went this time said I had the best day's outing.) No, for a racecourse my bees had the whole of Beeley and Harwood Moors, a mass of purple heather stretching out for a mile or more on three sides of the hives; and didn't I enjoy the sport! In all my heather experience I never saw it look more beautiful; such spikes of bloom, some from 8 to 9 inches long, and to keep in full bloom such a long time. I picked heather in bloom for ten weeks, and such a variety of colour. It ran through all the shades from white to a blood-red. The last to bloom was a double-bloom kind. I never knew there was a double bloom till I came across a patch late this season of

a heliotrope colour. Friend Kettle thought there was no white Erica. I have come across both the cinerea and the tetralix in white.

One never seems to tire of roaming about these moors when they are in bloom, as one is always coming across something interesting. I found a spray of heather one day with five spikes of bloom on, the four outer spikes purple, the centre pure white. From a distance I thought it was a root of white heather (and white is rarely seen on Beeley Moors); but no, it was simply the white spike. I think it was friend Hemming who said how bees visited cornfields for honey. I think I solved that problem for him while on the moors on St. Leger day. On the moors in places there are cornfields and clover fields sandwiched in among the heather. I came across a turnip field—or, rather, it should have been turnips—but it was a mass of bloom in three colours. There were charlock yellow, dodder white, over a foot high, and a pink flower that grows in a solid knob—it looks a solid knob of pink. Up there they call it "goose tongue," but I have always known it as "willow weed." No, it's not the famous willow herb. I know that, so I got off my bike, and as I had two hives of bees not a quarter of a mile from that field (these were over two miles from the hives on Beeley Moor) I thought it would be interesting to see how many bees were working on that lot. I stood looking over the wall a long time before I saw a bee at all. At last I spotted one; but what was it following so persistently among that sea of bloom? Not a bee on the charlock, dodder or willow weed. Still this one bee was humming contentedly among all these flowers; but from where I stood I could not see what it was working, so I got over the wall, and this bee was following a little pink flower that grew on a kind of bindweed, which by the way it stuck to it must be a good honey plant. Sometimes it would be twined around the pink knob on the willow weed, and though petals of both flowers were as near alike as could be, it never touched the willow weed, so I left it that day, but with the intention of visiting that field again the first time the sun shone. Sunday, September 12, was the most glorious bee day of the whole heather season; the sun shone in a cloudless sky the whole day, with the thermometer at 68 deg. and the wind south, I went on my wanderings again. First I tried the moor that was burnt off last year. The young heather has grown about 3 inches this year, and it was in bloom even so small, a perfect hum of bees in it. Then I tried among the trees and rhododendrons on the bog;

no matter, wherever there was a sprig of heather in bloom the bees were on it. Then I knew at the back of the hives 200 yards away was an oat field, with clover coming into bloom among it. There were a few bees on it, while beyond it was this field of weeds, so I got over the wall at the other end of it from where I got into it the previous day. There was more dodder than ever here. I thought, "Oh, my, if this was a honey weed, what a feast for bees!" I did see a bee on it, that's certain, but it did not seem to be making much fuss over it. The charlock, over 2 feet high in places, contains no honey at this late season; not a bee on it. There were a few humming that beautiful tune that tells one they are happy and contented, but they were following that little pink flower on the bindweed. I thought, now if that was as thick on the ground as the dodder there would be a hum. No doubt in places it grows thick enough, and, without a doubt, it is a good honey plant. There it grew on strings about a foot long; the seed, when dry, is just like onion seed. Since then I have come across it on the next garden to mine 5 feet high up some pea rods, and I know Bedfordshire onions grew just there last year, so I guess it came in the seed; but I can't say the onion seed came from Bedfordshire. The wind was south on only six days the whole of August and September. There were six sunny days, and ten other days the sun shone more or less.

On September 26 I was taking a last look at my bees on the bog when I heard a rustle among the leaves under a tree, and out walked a little hedgehog. "Hello," I said, "what are you after?" He had evidently been before, as he seemed to know the run; he walked round about one hive front, then he went to the other, and commenced to eat the dead bees lying about, making quite a feast of them. I watched him eat about a dozen, then he walked on a little further into the sunshine and curled up to go to sleep; quite amusing.

(To be continued.)

## Notes from Gretna Green.

*Candid Comments.*—I don't in the least mind being severely criticised, but see no reason to retract my deliberately-expressed opinions on "waste." Mr. Kettle, for instance, has given us a lot of information on market gardening during 1920, this week's yarn and the previous one being very instructive on the subject. Yet his contribution this week ends up with the admission that bees are more profitable than pigs or poultry, cat-

gages and other vegetables, or even vanloads of gooseberries. If bees "are the best on the farm for profit," and Mr. Kettle wishes to "boom bees as much as possible," he should talk bees and explain his methods of working them to best advantage.

Possibly our Editor won't agree with me, but I feel sure that the majority of BRITISH BEE JOURNAL readers would prefer to hear Mr. Kettle on honey production rather than market-garden propaganda.

[We are in a better position than Mr. Ellis to judge what the majority of our readers prefer. We are under the impression that we receive more letters on the subject than Mr. Ellis or anyone else.—Eds.]

As regards the Editorial comments I may point out that there is no comparison between the BRITISH BEE JOURNAL and our daily newspapers or technical weeklies.

These are more or less bulky papers and have ample space for various subjects which can be read or passed over at discretion.

But the BRITISH BEE JOURNAL is a very small paper, and if the subjects mentioned get too much space allotted to them it is evident that legitimate matters must suffer. In fact, I have before me a letter from the Editor referring to the amount of "copy" on hand, some of which had been held up such a long time that it had become out of date and could not be used. How can our Editor reconcile this "slaughter of the innocents" with the constant publication of more or less irrelevant matter in these columns?

[The BRITISH BEE JOURNAL is a technical weekly, and we repeat that the subjects treated are relative to bee-keeping. We may say that the letter Mr. Ellis refers to was a *private* one written some time ago in reply to a complaint from him that one of his articles had been held over. It does occasionally happen that an article is held over for one that in our opinion is of more importance, and possibly for one or two weeks we may have a lot more copy than we can use, then by the time there is room some of the matter is out of date. Our *regular* weekly contributors naturally come first.—Eds.]

"Isle of Wight" Disease.—The remedy lies in better bees—and better bee-keeping. I submit that practical men have solved the problem on these lines, and if the scientists can find any better way their efforts will be appreciated. Personally I have no hesitation in saying that S. H. Smith has done more to combat "Isle of Wight" disease than any scientist, and if any bee-keeper has failed

with the Flavine methods let him say so frankly.

The question is whether Smith and other practical men have been invited to give their views in the *BRITISH BEE JOURNAL*, and, if not, why?

[This is *our* business. The question savours of impertinence, and such questions we do not answer.—EDS.]

*Heather Honey Production.*—I expected to see some comments on the paper read by Mr. Price, and hope to give my own experiences later on, when time permits. Whatever the reason, heather men are seldom heard from nowadays. Dr. Moore Ede (page 596), the "Medicus" of former times, should be able to give some useful information on the use of divisible hives at the moors.

Although our bees are hibernating at this season, bee-keepers should be very much alive in these pages discussing ways and means of working their apiaries to the best advantage when the days come for honey-gathering.—J. M. ELLIS.

Gretna, December 9.

## The Season in Aberdeenshire.

G. R. CRUICKSHANK.

In response to the request of the Editor for contributions from the North of Scotland, and as a sop (a very small and imperfectly cooked one) to Mr. J. M. Ellis, of Gretna Green, I have pleasure in giving a few notes on the 1920 season from Aberdeenshire. In spite of adverse circumstances in the shape of the continued presence of "I.O.W."—I beg pardon, Acarine—disease and the abnormally bad season, the Aberdeen and Kincardine Bee-keepers' Association continues to prosper exceedingly, and is probably the largest and most prosperous in the kingdom. This is primarily due to the tact, enthusiasm, and goodwill of Mr. Wood, of Glassel, President of the Association, and secondly to the work of the various District and Branch secretaries, most of whom give their work and time ungrudgingly to further the aims of the Association.

The Association is also blessed in the number and skill of its experts, among whom I may mention Miss N. M. Robinson, Glassel, and Mr. D. M. Macdonald, who, although now retired from the ranks of the teaching profession, is still *going strong*, and did a large amount of expert work both this year and last year, although his facile pen has been rusting recently.

The year 1920 may at once be written down in the annals of northern bee-keepers as surely the worst on record from

a honey-producing point of view. It began auspiciously with bees taking in pollen on February 23 (this in my own apiary), and matters went on hopefully through spring and early summer. Bee-keepers looked forward to a fairly good season. Stocks were, on the whole, strong (when free from disease), and ready for the clover, which begins to be available in Aberdeenshire in an ordinary summer about June 21. But "the best laid schemes o' mice an' men," and, may I add, with little need of apology to Burns—bees—"gang aft agley."

About the end of June forward stocks caught the swarming fever. This was specially marked in some districts. One careful bee-keeper, in describing the state of matters to me, said: "I never had higher hopes of a good honey crop, but now, after a fortnight of swarming, why, I don't know where I am." Other apiaries showed similar tendencies, and the *mad dance* ended more or less disastrously both for bees and owners. Possibly this upheaval was caused partly by mismanagement of the stocks on the part of the owners, who failed to keep a little ahead of the requirements of the bees; but the bees did not *SENSE* the weather even twenty-four hours ahead, and went further out of their reckoning even than the weather forecasts issued to the daily papers. The weather broke down in the beginning of July, just when there was a rich profusion of white clover showing in the fields. All through July the weather remained cold, dull, and cheerless, with so low a temperature that for days on end bees did not venture far from the hives to gather honey, and I expect that owing to the continued low temperature, which was often only about 50 deg. Fahrenheit, there was only a very limited secretion of nectar in the white clover. Moreover, a chill, persistent north-westerly wind kept blowing, and the hours of sunshine and warmth were few and far between.

(To be continued.)

## Swarm in Hedge.

I have pleasure in enclosing two photos of a "swarm" which have been in the hedge for at least six weeks. The bees had built several large combs, some of which contained brood, but very little honey. The hedge was a very thick thorn one, and almost hid the bees from sight, hence the owner (Mr. Jones, seen in the picture) did not know anything about them until he noticed one day when passing along some small pieces of comb which had got detached and fallen to the

ground. As Mr. Jones did not feel equal to tackling them, he sent to see if I could help him, which I gladly did, and for the benefit of readers of the *BRITISH BEE JOURNAL*, I give my "modus operandi." Having made a portion of the hedge level on top I placed a skep, supported on four flat battens, over the bees, leaving two stems just long enough to reach inside the skep. Next I cut away the branches around the bees, and began "driving" in the ordinary way. It was delightful and interesting to those who were watching to see how quickly the little creatures marched up, using the two stems I had left for them. During the process I had



### A Few More Notes.

[10348] I quite agree with the remarks of Mr. J. M. Ellis in last week's issue. Less about horticulture, and more about bee-keeping, is what I should like to read on taking up *B.B.J.* I greatly miss the contributions of D. M. M. Back numbers, many of them, are invaluable, and I have much of the contents of them



MR. JONES INDICATING THE SWARM.

to take off one or two of the outside combs, which were breaking away, and to my surprise "her ladyship" was on the second comb. She never attempted to fly; I took her off very quietly and gently placed her in the skep. Now, how the swarm survived the awful wet weather we had for weeks I cannot imagine.

To-day it is reposing in a W.B.C. hive on nine combs, Mr. Jones very kindly making me a present of them for my trouble (?); it was really a pleasure.

ALEX. CARSON, Aintree.

[We are sorry the other photo. was not suitable for reproduction.—Eds.]

indexed up in a note-book for handy reference, but lately very little has appeared worth noting.

With so many new bee-keepers, reprints of the articles by the late Editor, "Hints for Novices," would be useful to many.

We have a Bee-keeping Association in Kent which has, I think, swarmed and swarmed like an Italian stock, and I fancy has suffered accordingly. A monthly periodical is issued, announcing shows, etc., which comes to hand after these have taken place. There is no expert who systematically visits in spring and autumn the members' hives, and I

do not know how its members, so many of them beginners, are to be assured in good time that their hives are in good condition or not.

This season has been a trying one, a glut of honey quite early crowding out brood chambers, and little or none since; Italian queens introduced and disappearing shortly afterwards; sugar prices prohibitive, with permits for large amounts from a Government which wants to unload its stocks; and now a mild winter, during which bees are rapidly consuming candy at 1s. 6d. per lb.

I commenced the season with three stocks. One died with F.B., but with natural and artificial increases got up to 13, but, limiting, have closed down with seven stocks of Italian and two English, which I hope will pull through and do well next season.

Although I did not get a great lot of honey this season I got a splendid crop of all kinds of fruit, especially apples, which was quite the exception round here, and I put it down to the useful work done by my bees in the early spring. I visited the Kent Honey Show in the summer, but was disappointed with the exhibits; I suppose increased railway rates have something to do with the poor show. An exhibit I was intending to show, for fixing on W.B.C. ends, has now been improved on, and has been registered at the Patent Office by Mr. Hodson, of Appledon, Kent. I think it a good suggestion that contributors, when commenting on their season's work, should notify their locality.—REV. H. NEWMAN, Kennardington Rectory, Kent.

### Peculiar Behaviour of Bees.

[10349] I record the following peculiar behaviour of a stock of Italian hybrids that I purchased this last June. Perhaps some other readers of the *B.B.J.* have had a similar experience and can give an explanation of this most unusual occurrence?

The stock, which was a six-frame one, came by rail, and was immediately on arrival transferred from the travelling box to a W.B.C. hive. While transferring the frames I looked for the queen, but could not find her. There were large patches of brood, but no sign of any eggs. Thinking I had possibly overlooked her in the quick examination made of the combs I put a feeder on, and decided to examine again in a week's time. The weather being bad, it was impossible to open the hive for about a fortnight. When I did no trace of the queen could be found, but three queen cells had been built, all on one comb; two were in a

patch of worker brood and one in a patch of drone. I wrote the firm from whom the stock was obtained that it was queenless; they immediately dispatched a fertile queen, which I put over the feed hole, in the travelling box, after previously cutting out the queen cells. Two days later I found the queen dead in front of the hive. A government queen happened to be sent me at that time. I introduced it the same way as the other, over the feed hole. This one also was found dead in front of the hive. A virgin of my own was then put in by the direct introduction method, but this also proved a failure, the dead queen being found the following morning. As a last hope I intended to add a comb of eggs from another stock. Before this was done, however, a stray swarm settled in one of my pear-trees. This I captured and that evening added to the queenless stock. This was done without any previous preparation whatever; there was no attempt at fighting, and the queen, who must have been a fertile one, was apparently accepted, for within a very short time breeding was going on apace, and when they were packed down for the winter there was an abundance of stores in the brood chamber but very little surplus. The ways of bees are truly mysterious. I suppose there must have been some method in their madness, the madness being probably caused by the vile weather we experienced at that time.—H. E. NEWTON.

### Acarine Disease.

[10350] Let us welcome the late discoveries of Dr. Rennie. There seems no doubt that he is on the right track, so many peculiarities of the disease are understood now to the bee-keeper by the important results of his investigations. With regard to the earlier *Nosema apis* theory as the cause, once again it should teach us not to take anything for a fact, however great a man the discoverer may be, till it is proved a fact by our own reason and practice. So with this; now let *Nosema apis* die with the name "Isle of Wight" disease. It is my opinion the disease is slowly dying out, perhaps because it has not such masses of weak, inter-bred bees to feed on: in any case, it has a hard subject to deal with in the hybrid Dutch-Italian. We find the disease now not so fatal. Still, I have no doubt whatever that it is the old malady, whatever fancy name we call it—crawling disease or what else. The queen is the last to be affected, we have read. But why does a young queen help



so in putting things right, and why is it that it is mostly swarms with the old queens which give way to disease? The answer without doubt is the queen. Speaking of queens and their relation to disease, we have to remember they have different structure and habits to the worker; therefore they perhaps do not show the same symptoms as the worker, which is the case. As we now know, the diseased worker is prevented from flying because of the air sacks and spiracles being choked by the tarsonemus mite. She can only discharge the fæces when on the wing, so it is plain to see her doom. But it is different with the queen; she has muscular action independent of the pressure of the air sack, so that she needs not to fly to discharge the fæces. So it is seen the queen has much more hopes of living on, but is it not probable she may be infested with germs of disease, and still breathe on, becoming a sort of germ carrier for the colony? We can now understand better how the spray has been so successful, the bee gets the remedy direct to disease-laden air sacks by breathing it in vapour form. I myself have had the most success with spraying over and between the combs with Yadil, and closing down again after the bees are properly stirred up and breathing hard. I fail to see how feeding can do good unless through the evaporation of the syrup while in the comb. In fact, I think medicated candy may do harm by giving the bees cause to fly in unfavourable weather. May I be forgiven if I have made the same mistake as some I have criticised in my remarks, by being too definite in my statements. But as a young bee-keeper who has had to fight the disease almost the whole time I have kept bees, and in spite of the present 2-oz. honey season have still a bit of the bee-fever left, may I be excused? Also, for touching on this important subject, disease? What more important subject can Dr. Abushâdy find? I am sure we all are expectantly waiting for the full report from Dr. Rennie's investigations, but in the meantime we cannot let it alone.—BERNARD TOWLER, Peterboro'.

### “Acarine Disease” or “Acarinis”?

[10351] With reference to the proposal to change the name of “Isle of Wight” disease to “Acarine disease,” it would be more convenient to use the one word “Acarinis” instead of always having to repeat the word “disease.”—W. B. WALLACE.

### Cotswold Honey.

A wonder here, for in this tiny jar  
The essence of a thousand acres rests,  
Urged by our hundred million distant  
star  
From fountains of a million floral breasts.  
Comes splendid June—behold the happy  
bees  
With merry hum the amorous dew imbibe  
Of sainfoin, sweetest of the clover tribe,  
With wild white clover of wide-spreading  
leas.  
The purple beckons, where the children  
climb  
Up to blue heaven on the common's slope;  
Some few enthusiasts trace the scented  
hope,  
And prime each vessel with a dash of  
thyme,  
Lift but the cap to all this summer bliss,  
The peerless captive greets you with a  
kiss.

G. G. D.

### A Dorset Yarn.

FROM KENT.

Oh, for an apiary in Dorset fair!  
Near Violet Farm, or roundabout there,  
Where bees (so they tell us) buy land,  
or pay rent.  
Alas! Mr. E., it's not so in Kent.

There nectarous flowers in bright array  
Bloom in sweet sequence day by day;  
The honey-flow lasts six months of the  
year.  
Keepers of bees of success never fear.

Sections are worked from centre to rim,  
Cappings snow-white, full up to the  
brim,  
Supers are piled up, one, two, and  
three.  
Squire T. removes them: love only the  
fee.

The raspberry flowers in the autumn  
late,  
While virgins fly, and ne'er miss their  
mate.  
Golden swarms issue, and instantly  
settle,  
Without tanging pots, or rattling a  
kettle.

At the end of the season full stores are  
then found;  
(No feeding makeshift at eighteen the  
pound).  
So all is contentment, with industry  
rife.  
Dear Dorset Yarn, how I envy your  
life!

WRENS.

## Combs from Other Hives.

### The Bee-Keeping Parson.

A WAY TO SOLVE A TRAGIC WAGES DIFFICULTY.

*By Tickner Edwardes.*

The country parson of olden days, as pictured for us by Goldsmith—clad in a dirty overall, and giving his pigs their wash just before hastening to church—has always struck me as an unseemly, even a repulsive figure. But if, as some believe is now inevitable, the church clergy must either find some additional means of livelihood or starve, the only solution, in rural districts at least, appears to be the adoption of some kind of farming pursuit easily carried on in the intervals of parochial duty.

As the Bishop of Willesden suggests, it may be possible for the town clergy to engage in educational work during their spare time, and thus eke out their all too slender stipends. But this is not practicable in the country. What the rural clergy need is a clean, honest, not over-laborious occupation, which they can turn to at odd hours of the week-day, and upon which they can depend for, say, an additional hundred pounds a year. If this could be assured, we should hear no more about the poverty of the clergy, in country districts at least; and an end would be made to a public discussion alike offensive to every parish priest whose heart is in his high calling, and degrading to the whole body of the Church.

What can a country parson do in this matter? Must he wallow in pig-sties, or get his black clothes hopelessly fluffy in clamorous poultry-pens, or dig for dear life in a potato-patch? These things may be good and profitable enough, and I know several parsons who do succeed by these means in turning a starvation into a living wage, in spite of the ancient ecclesiastical embargo on such work. But it is neither good for a clergyman nor for the dignity of his calling to be seen about his parish in miry raiment, carrying buckets of pig-wash or carting garden produce to the railway station.

There is a means of additional livelihood which every country vicar and curate may at once take up—an occupation light, clean, interesting, undeniably profitable, which if carried through on business lines will not fail to add the "little more" that makes all the difference between uncertainty and surety in the yearly task of making ends meet.

As a life-long dweller in the country, and one specially interested in the craft, I have always wondered why the parsons

do not all keep bees. The vicarage garden is generally an ideal place in which to establish an apiary. Properly managed and installed, bees should need practically no attention at all during half the year, and the little they do require while the honey season lasts can be bestowed upon them at odd times in the day.

As to the profit, there is no question. We have only to look at the market prices for honey and wax nowadays to realise that there must be money in it for someone. And this someone need never be the middleman.

Bee-keeping is essentially a local industry. Every country district can and ought to supply only the consumers in its immediate area. The trouble in recent years is that the supply of village-produced honey has steadily decreased, and so the local demand has been as steadily throttled almost to extinction.

This almost universal neglect, however, of what was once an important rural industry surely provides the underpaid country parson with a way out of his present difficulties. Why cannot the country clergy become the bee-masters of our villages? Apiculture is a pursuit hallowed by the ages. The old religious houses all had their garden-nooks full of beehives, and honey was regularly sold by the monasteries, the wax being used to make altar candles. Some of the most famous bee-masters in early times were monks. The latter-day village priest would therefore be only following one of the most ancient traditions of his church if he revived the practice of bee-keeping as an adjunct to clerical revenue.

Only—to come down to hard matter of fact—it must always be remembered that honey and wax production constitute a business, and must be taken up in a practical business-like way. The craft must be learnt, like any other craft worth learning.

And how is the hard-working, homekeeping country parson to pick up the necessary knowledge? Above all, how is he to find the small but indispensable amount of capital wherewith to make a beginning in the craft? Well, here is a practical suggestion, and I respectfully commend it to the Bishop of Willesden and his co-dignitaries in the Church. Let each diocese employ a competent instructor in apiculture, give him a bee-van equipped with all needful appliances for demonstration, and let him go the round of the village parishes, supplying the requisite information and assistance to incumbents and others willing and ready to take up the pursuit.

And let there be a loan available from

the Diocesan Fund to all who need it, for the provision of the necessary equipment and live-stock, repayable by easy instalments out of future profits. If this plan were carried out systematically throughout the country, I believe that it would not only help materially to change a state of affairs which is nothing less than a tragic scandal, but it would end in saving for the people tons of valuable sweet food which, for want of bees to gather it, is at present going to waste.—From the *Daily Chronicle*.

### Deadly Bees.

Dr. J. O. Beven reports in the *Lancet* published to-day a terrifying experience of a doctor, his wife and daughter in Ceylon. When climbing the rock fortress of Sigiri the party were attacked and badly stung by rock bees, and forced to undertake a dangerous descent while still being tormented. Two of the sufferers collapsed, manifesting unexpected and alarming symptoms which suggested some special poison in the bees' venom.

In a short time the patients recovered, but the incident has attracted the attention of experts, who incline to the view that the rock bees' poison, while containing formic acid, like the venom of ants and ordinary bees, has in addition a peculiar toxic substance which produces severe shock. It is probable, also, that repeated stings confer immunity upon the person stung—a statement that awaits proof by some devoted naturalist who will submit to the experiment.—From the *Daily Dispatch*, October 23.

## Notices to Correspondents

MRS. ANDREWS (Bucks).—*Using old candy*.—The candy that was bought last year will not have lost any of its nutritive qualities. If it was medicated the medicine may have lost its power, or the candy may have become too hard. In the latter case we have found that keeping the hard candy in a damp atmosphere for a short time will remedy the defect.

E. WILLOUGHBY (Lincs).—*Using Creosote inside hives*.—The creosote is good for preserving the wood, and may act as a disinfectant to some extent, but the smell is very objectionable to bees. It will almost all pass off after some months, but there always appears to be a little odour left, which will be stronger in the presence of warmth.

F. L. DANGAR (Surrey).—*Using sealed comb honey for feeding*.—The combs may be laid over the feed hole instead of candy, but provision must be made for the bees to have access to the whole of both faces of the comb—say, a raised grid of wire, or wire netting, under it, covering the whole with a box. A little contrivance we hope to illustrate next week would be useful for the purpose.

#### Suspected Disease.

P. J. D. (Prescot).—We failed to find either Nosema or Tarsonemus in the bees sent.

## Displayed Advertisement Rates.

<i>British Bee Journal</i> or <i>Bee-keepers' Record</i> .		£	s.	d.
Full page ... ..	...	4	0	0
Half page ... ..	...	2	10	0
One-third page ... ..	...	1	16	0
Quarter page ... ..	...	1	12	0
1½ in. across page ... ..	...	1	7	0
1 in across page ... ..	...	0	18	0
½ in. across page ... ..	...	0	10	0
1½ in. single column ... ..	...	0	15	0
1 in. single column ... ..	...	0	10	0
½ in. single column ... ..	...	0	6	0

Discount for a series of consecutive displayed advertisements:—Six insertions, 2½ per cent.; Twelve insertions, 5 per cent.; Twenty-six, 15 per cent.; Fifty-two, 30 per cent.

## Special Prepaid Advertisements. One Penny per Word.

Trade advertisements of Bees, Honey, Queens, and Bee goods are not permissible at above rate, but will be inserted at 1½d. per word as "Business" Announcements, immediately under the Private Advertisements. Advertisements of Hive-manufacturers can only be inserted at a minimum charge of 3s. per lin., or 5s. per inch.

PRIVATE ADVERTISEMENTS are only intended for readers having Surplus Stock to dispose of. Driven Bees, Nuclei, and Queens that are reared or imported for sale, are Trade Advertisements, and can only be accepted under trade terms. A charge of 6d. extra will be made if a box number is used.

Advertisements must reach us NOT LATER than FIRST POST on MONDAY MORNING for insertion in the "Journal" the same week.

### PRIVATE ADVERTISEMENTS.

GOOD GLAZIER'S DIAMOND, perfect, 8s. 9d.—HUBBORD, Northkilworth, Rngby. k.132

WANTED, Geared Extractor, two-frame, reversible; also Uncapping Knife. Deposit.—Box 112, B.B.J. Office, 23, Bedford Street, Strand, W.C.2. k.131

WHITE LEGHORNS (Barron's strain).—Sittings of Eggs, 12s. 6d.; delivery January, February, March.—MRS. HOWARD LEE, Bowden, Burgess Hill, Sussex. r.k.130

TWO 20 lbs. splendid Honey, heather blend, guaranteed, screw-cap bottles, also 20 lbs. Sainfoin Honey, screw-cap bottles, 2s. 8d. lb., carriage paid passenger train; boxes returnable.—A. WILLMOTT, Apiarist, Higham Ferrers, Northants. k.125

BEE-KEEPER wanted to take charge of apiary of 24 hives immediately.—GORDON, Tedford, Billingshurst, Sussex. k.134

OUR ALLIES.—In the Department de la Meuse alone the Huns destroyed, plundered, or stole 25,000 bar-frame hives and 15,000 skeps of bees.—SMITH, Cambridge. k.125

WANTED, Handy Man who understands bees, horses, and can do rough joinering. State wages expected.—YOUNG, 42, James Street, Cambridge. r.k.117

FOR SALE, cheap, five good hives Bee, chain-gear Extractor, etc., £15; to be removed by purchaser.—G. SARGAN, Ravenfield, Rotherham, Yorks. k.100

IRISH HONEY, 14 lb. 28s., 28 lb. 53s., 56 lb. 106s.; also Section Honey, 30s. and 33s. dozen.—S. CRAWFORD, Apiarist, Castlederg, Co. Tyrone. k.101

**"WILLOW HERB"** completes the bee garden; twelve 2s. 6d.—**BOWEN**, Cotswold Apiaries, Cheltenham. k.113

**OBSERVATORY HIVE** wanted, second-hand, to hold three frames and sections; modern pattern; revolving and feeder.—"Y.", "Monken Hadley," Braintree. k.100

**PURE LIGHT CAMBRIDGE HONEY** (guaranteed), 14-lb. tins, 30s.; 28-lb. tins, 57s. 6d., carriage paid.—**YOUNG**, 42, James Street, Cambridge. r.k.84

**PRIME HAMPSHIRE HONEY**, in 28-lb. tins, 50s. per tin, free on rail, carriage forward.—**TRUEMAN**, Harroway Road, Andover. k.104

**SAINFOIN HONEY**.—We have  $\frac{1}{2}$  ton of this fine Honey, put up in nominal 14-lb. tins, which were sent us by a honey buyer who failed to pay for his order. These packages average 14½ lbs. gross weight, and we offer them at 35s. each, carriage paid.—**S. H. SMITH**, 30, Maid's Causeway, Cambridge. k.105

**GOOD ENGLISH HONEY**, granulated, 28-lb. cans, 1s. 1d. per lb., carriage paid; sample 6d.—**PEARSON & GALE**, Marlborough. r.k.127

**NOW BOOKING ORDERS**, delivery January, February, March, £2 sittings of Eggs and Day-old Chicks (Barron's), White Leghorns, Brown Leghorns; White and Fawn and White Runner Ducks, White Wyandottes, sittings 10s. 6d. to 35s. a dozen, Chicks double.—**MRS. M. ANDERSON**, Poultry Dept., Hermitage Poultry Farm, High Hurstwood, Sussex. Manager: Miss M. D. Sillar. k.93

**CORRESPONDENCE** Courses in Bee-keeping.—**H. E. NEWTON**, Hobart Road, New Milton, Hants. r.k.69

#### BUSINESS ADVERTISEMENTS.

1½d. per word.

**IMPORTED ITALIAN QUEENS FOR 1921**.—List on application.—**PEARSON & GALE**, Marlborough. r.k.88

**ITALIAN QUEENS** direct from Italy.—Address, **I. E. PENNA**, Bologna, Italy. Prist List for 1921 on application. r.k.141

**BEE BOOKS FOR CHRISTMAS PRESENTS**.—You can get the Books of the leading authorities in this and other countries from **E. J. BURTT**, Stroud Road, Gloucester. Special List free on receipt of a postcard. k.120

**FLAVINE BEE CANDY**, made in Cambridge and the wrappers bear our name, 6 lbs., 10s., post paid.—**S. H. SMITH**, 30, Maid's Causeway, Cambridge. k.124

**SEND POSTCARD** only for our new Illustrated Catalogue of Bees and Queens for 1921.—**PEARSON & GALE**, Marlborough. r.k.126

**"WIGHT" DISEASE**.—Prevention and removal. Advice 5s.—**ALF. RYALL**, Cottage Farm, near Camp, Stroud. r.j.5

**ENSURE A GOOD HONEY CROP** next year by purchasing one of our noted 6-frame Italian Stocks. Illustrated Catalogue free on application.—**PEARSON & GALE**, Marlborough. r.k.128

**CARNIOLAN**, or Carniolan-Italian crosses, are famous honey producers. Book now, Queens or Nuclei. Isolated apiaries for pure mating.—**SWAFFIELD**, Carniolan Specialist, Libertus Villas, Cheltenham. k.133

**IMPORTANT!**—In spite of the increased cost of appliances and carriage, we are offering our celebrated 6-frame Stocks at reduced prices. Catalogue free on application.—**PEARSON & GALE**, Marlborough. r.k.129

**KEEP IN TOUCH** with modern bee-keeping thought by reading the bee-keeping journals. I shall be pleased to book orders for "Gleanings in Bee Culture," 7s. per year; "The American Bee Journal," 10s. per year; "L'Apiculture Française," 3s. 6d. per year, each monthly and post paid.—**E. J. BURTT**, Stroud Road, Gloucester. k.119

**HONEY FOR FEEDING BEES**.—Finest West Indian. Case of one tin, 56 lbs. net., 61s. 6d.; case of four tins, each 7 lb. net, 35s. 9d.; carriage paid 100 miles.—**LONDON TRADING AGENCY**, 32, St. Mary Axe, E.C.3. Tel.: Avenue 3883. k.122

**9S. SECURES 6 lbs. superb Candy**.—**BOWEN**, Apiaries, Cheltenham. k.114

**MASHEATH MEMS**.—"Been painting the Masheath. Man, it's a grand bee-box! The longer I look at it the more convinced I am that it is absolutely 'it.' It ought to sell like hot cakes. A man with any pride in his apiary has only to see it to purchase.—**A. L.**"—**ATKINSON**, Fakenham. r.k.97

**A WELL-ESTABLISHED FIRM** wishes to hear of bee-keepers who would guarantee to supply them with Nuclei May-June next.—Box 107, B.B.J. Office, 23, Bedford Street, Strand, W.C.2. r.j.42

**BEES AND QUEENS FOR 1921**.—Send for our new Illustrated Catalogue, free on application.—**PEARSON & GALE**, Marlborough. r.k.127

**HAVE YOU READ "THE BEE WORLD"?** If not, why not? Every number in itself is a useful literary work for practice and reference. Specimen copy free.—**Offices: THE APIS CLUB**, Port Hill House, Benson, Oxon.

### Finest Grade New Zealand Honey (Amber)

For Bee Feeding. Guaranteed Pure.  
Cases, each 2-60 lb. nominal Tins.  
95/- per cwt. Carriage paid.  
Cash with order or on receipt of goods.

N.B. We are already supplying Beekeepers Associations throughout the Country and shall be pleased to quote references.

**The Bristol and Dominions Producers Association, Ltd., Bristol.**

The products of the Apiary, of Poultry and Farm Stock, of the Fruit and Vegetable Garden can be Advertised and Sold through

### THE BAZAAR, EXCHANGE & MART Newspaper.

Get a Copy—Thursday and Saturday 3d. The "Bazaar" publishes also practical handbooks by experts. Send for full catalogue, post free from—**WINDSOR HOUSE**, Breams Buildings, LONDON, E.C.2.

### THE British Bee-Keepers' Association.

The recognised centre of practical and scientific bee-keeping in Great Britain. Particulars and conditions of membership may be obtained from the Secretary, **W. HERROD-HEMPSALL**, 23, Bedford Street, Strand, London, W.C.2.



# Bozzalla Queens.

"American Bee Journal" specification Tested three banded Italians.

## DIRECT from ITALY.

May & June 13/-      July & Aug. 12/-      Sept. 10/- each.

Sole Agent: H. M. STICH, Riccarton Avenue, PAISLEY, Scotland

## 1920—QUEENLAND LIST—1921

In reply to many requests coming in for our Premier White Star Queens for the Season 1921, we beg to state that early delivery may not be offered, as a certain number of orders have been carried over (by request) from previous season for first 1921 delivery, in consequence of the unfavourable weather for queen-mating.

## Our Premier White Star Nucleus Stocks

will be offered as usual, and at former price; but the charges for Queens have been revised, and include the offer of well-bred and selected Virgin Queens of this renowned strain.

Full Queensland Descriptive Circular 4d., The Revised List only (to those having 1920 List, 2d., post free,

OF S. SIMMINS, QUEENLAND, HEATHFIELD, SUSSEX.

	<b>"BACTEROL"</b> FOR BEES	The cure for, and preventive of, "Isle of Wight" Disease. Non-poisonous—free from stain or unpleasant odour.
		BACTEROL LIMITED 19/25, Brookside Rd., Highgate, N. 19.
2/9 per Bottle.	Post Free.	

**CANDY** Made in our own factory by bee-keepers for bee-keepers.  
 6 lbs. post free 8/6      10 lbs. post free 13/6  
 Guaranteed from Pure White Refined Cane Sugar.  
 Miss Chester-Master's Patent Candy Box, 4/6 each. Postage extra 9d.  
**S. J. BALDWIN, The Apiary, BROMLEY, KENT.**

SAVE MONEY this winter by making up your own hives. Particulars of wood cut ready to make up into hives will be sent free on receipt of a post card.  
**E. J. BURTT, Manufacturer, GLOUCESTER**

**WHY WORRY WHILE INTERING?**      **BUY BRITAIN'S BEST BEES** from **CLARIDGE, COPFORD, Near COLCHESTER.**

1921 Enlarged Price List Now in Print. Make Sure of Your Copy.  
**F. M. CLARIDGE, COPFORD, Near COLCHESTER.**

## FOUR FIRST PRIZES.

Our HIVES and APPLIANCES were again awarded FOUR PRIZES at the Highland Agricultural Society's Show at Aberdeen, thus testifying to the superiority of our goods. Order now at catalogue prices and save money.

## SOFT BEE CANDY.

Have you tried our Famous Bee Candy? If not, you should send for a trial order now. It is made from PURE WHITE CANE SUGAR and is PERFECTION.

### PRICES—

1 lb. at **1/5**, postage 9d., 6 lbs. at **9/6** post free,  
10 lbs. at **15/6** post free.

Can be had medicated or not, as required.

**R. STEELE & BRODIE,**  
*Bee Appliance Makers,*  
**WORMIT, FIFE.**

Telegrams:—"Bees, Wormit."

Telephone:—28 Wormit.

## BEE CANDY.

**WE** are now able to supply CANDY OF OUR OWN MAKE from guaranteed Pure White Refined Cane Sugar. In 1-lb. boxes with glass tops. It can be had plain or medicated with either "Yadil" or "Bacterol."

### REDUCED PRICES:

1lb. - **1/5** per lb.  
6lb. - **9/6**, post free.  
10lb. - **15/6**, post free.

**JAMES LEE & SON, Ltd., Uxbridge, Middlesex.**



No. 2009. Vol. XLVIII

DECEMBER 23, 1920.

[Published every Thursday, Price 2d.]

**CONTENTS.**

	PAGE		PAGE
REVIEW .....	613	BRITISH BEE-KEEPERS' ASSOCIATION—	
VITAMINES .....	613	Monthly Meeting of Council .....	619
JOTTINGS FROM HUNTINGDONSHIRE .....	614	Special General Meeting .....	619
BEE NOTES FROM DERBYSHIRE .....	615	SURREY BEE-KEEPERS' ASSOCIATION .....	619
NORTH CHESHIRE NOTES .....	616	SOMERSET BEE-KEEPERS' ASSOCIATION .....	620
THE DAWN OF KNOWLEDGE .....	616	CORRESPONDENCE—	
TANGING .....	617	" Candid " Critics .....	620
A CORRECTION ACCEPTED .....	618	A Bee-keeper's Good Fortune .....	620
		Producing Heather Honey .....	621
		The Production of Heather Honey .....	622

We should like to take this opportunity of wishing our numerous customers and all those interested in

**T H E · B E E · I N D U S T R Y**

... **E** ...

**Happy Xmas**

and a Prosperous Honey Season in

**1921.**

Xmas is a season of giving presents, and the Bees should not be forgotten. A Cake of Taylor's Pink Candy will ensure for them a happy and contented Xmas.

**E. H. TAYLOR, LTD.,** WELWYN, HERTS.



# Bozzalla Queens.

"American Bee Journal" specification Tested three banded Italians.

## DIRECT from ITALY.

May & June  
13/-

July & Aug.  
12/-

Sept.  
10/- each.

Sole Agent: H. M. STICH, Riccarton Avenue, PAISLEY, Scotland

## 1920—QUEENLAND LIST—1921

In reply to many requests coming in for our Premier White Star Queens for the Season 1921, we beg to state that early delivery may not be offered, as a certain number of orders have been carried over (by request) from previous season for first 1921 delivery, in consequence of the unfavourable weather for queen-mating.

## Our Premier White Star Nucleus Stocks

will be offered as usual, and at former price; but the charges for Queens have been revised, and include the offer of well-bred and selected Virgin Queens of this renowned strain.

Full Queensland Descriptive Circular 4d., The Revised List only (to those having 1920 List, 2d., post free,

Of S. SIMMINS, QUEENLAND, HEATHFIELD, SUSSEX.



### "BACTEROL" FOR BEES

2/9 per Bottle.

Post Free.

The cure for, and preventive of,  
"Isle of Wight" Disease.  
Non-poisonous—free from stain  
or unpleasant odour.

BACTEROL LIMITED  
19/25, Brookside Rd., Highgate, N.19.

## CANDY

Made in our own factory by bee-keepers for bee-keepers.

6 lbs. post free 8/6      10 lbs. post free 13/6

Guaranteed from Pure White Refined Cane Sugar.

Miss Chester-Master's Patent Candy Box, 4/6 each. Postage extra 9d.

S. J. BALDWIN, The Apiary, BROMLEY, KENT.

SAVE MONEY this winter by making up your own hives. Particulars of wood cut ready to make up into hives will be sent free on receipt of a post card.

E. J. BURTT, Manufacturer, GLOUCESTER

## INSURE YOUR STOCKS

### AGAINST "I.O.W." AND OTHER INFECTIONS.

Science has now placed within reach of every Apianist a safe and certain preventive of infection in "Yadil" Antiseptic.

For SPRING FEEDING "Yadil" may be added freely to Syrup.

For DISINFECTING Bees and Combs a five-per-cent. solution in tepid water should be used with a fine spray.

ASK FOR GREEN LABEL.

Our Bee Brochure sent Free on Application.

CLEMENT & JOHNSON, 19, Sicilian Avenue, W.C.1.





## Review.

*Wintering Bees in Canada*, by F. W. L. Sladen (Bulletin No. 43, Dominion of Canada, Department of Agriculture, Ottawa). The author, who is well known in this country by his work and residence among us, and is now Dominion apiarist, discusses in this bulletin the problem of the preservation of bees during winter in Canada, much of which is equally applicable to this country. He says the long and cold winter in many parts of Canada is not so hard on bees as might be imagined, and in some respects wintering is easier than in a mild country like England, or in the Southern States. This is because the bees rest more completely during the winter in Canada. Few conditions are more trying to bees than those encountered in the British Isles during February, March and April, when they wear themselves out and die by hundreds in raising a little brood and flying out to visit the early flowers in the chilly, changeable weather. The same conditions occur in Vancouver Island. In most parts of Canada wintering bees is much easier, as their rest continues undisturbed until some time in April, after which the long, warm days come quickly and enable the bees to breed up fast and become strong in a short time. Mr. Sladen says that the requirements for successful wintering are:—1st, Strong, that is to say, populous colonies consisting mainly of young bees; 2nd, an abundant supply of wholesome stores in the combs; and 3rd, adequate protection from cold. By young bees he means those that have done little or no field work, but they should have had at least one flight before winter. He thinks these bees should be raised principally in August and early September, which can be attained by having in the hive a queen raised not later than the middle or end of July. For winter stores he thinks clover honey excellent, and bees will also winter well on alsike and buckwheat honey, while dandelion and some of the honeys gathered late in the season have proved unwholesome. Unripe honey, fruit juices and honey-dew are very injurious. For protection he recommends the four colony winter case, which takes four hives *en bloc*, usually back to back. It uses less material per colony, than cases made to take only one or two hives, and each colony is warmed on two sides by its neighbours. Mr. Sladen advises, in pre-

paring for wintering in this way, to bring the colonies together gradually, so as not to lose bees during the shifting. Care must be taken to have the flight holes in the cases opposite the entrances of the hives, and at least a foot apart. The space between hives and cases can be packed with dry leaves or planer shavings. By this method breeding begins earlier than when the bees are wintered in the cellar. Wintering in cellars is fully discussed, but it is not applicable to our country where the changes of temperature in winter are so great and so sudden. Anyway, the pamphlet gives a good deal of information useful to bee-keepers in other countries. The illustration shows the colonies of bees wintered on the principle described, embedded in snow.

## “Vitamines”: A New Scientific Term Popularly Explained.

*From a Weekly Bulletin of General Service Issued by the Ministry of Agriculture.*

The word “vitamine” is much used nowadays in treatises on the feeding of animals. Doctors, too, have begun to use the expression in connection with human nutrition, and it may be opportune to attempt a popular explanation of the term.

It is now some time since men of science turned their attention to nutrition, with the result that considerable advances have been made in knowledge. It is on the basis of these discoveries that the existing law regulating the sale of feeding stuffs was framed. We know, for example, what ingredients of food go, in the main, to the formation of muscle, or meat, and what constituents serve simply as fuels, supplying the energy necessary for carrying on the machinery of life. A living being is to some extent like a steam engine deriving energy from fuel. On this basis foods can be classified, and for long it was thought that the value of a food could be assessed merely on the basis of the percentage composition of such substances as “albuminoids,” and “carbohydrates,” names, which, roughly correspond to flesh-forming substances and fuel providers.

Practical men, however, have never been satisfied completely with this classification. They find that certain foods, for example, linseed, have a value above that expressed in terms of their chemical analyses, and this opinion is reflected in market prices. Linseed cake generally commands a higher price than other varieties. This fact has not escaped the notice of scientific men, and an explanation has long been sought. It is not suggested

that the discoveries connected with the presence of vitamins in foods provide an explanation of all the facts known to practical men, but it is undoubted that new facts have been discovered which go to show that the value of foods may depend on the presence of substances other than the regulation albuminoids, carbohydrates, etc. Now what are these new discoveries? They consist in the finding in nearly all natural foods, i.e., in uncooked fruits, seeds, herbage, etc., of small quantities of accessory food substances—substances which are essential to the healthy growth of animals. The best-known example relates to human nutrition. It has long been known that the disease of scurvy can be prevented by the use of lime-juice. So undoubted is this fact, that a law was introduced in the last century to compel the carrying of lime-juice on all ships. It has now been discovered that lime-juice (and many other raw natural products) contain a certain substance—a *vitamine*—and that if this substance is absent from diet scurvy appears. Again, we now know that the disease called beri-beri is caused by eating rice which has been polished, i.e., deprived of its husk. The husk contains a *vitamine* which, it may be noted incidentally, can be extracted and kept in a test tube. Now these vitamins cannot be classified as albuminoid, carbohydrate, etc., and yet they are definite chemical substances produced by living plants, and there is some evidence to show that animals cannot manufacture them. Butter contains a *vitamine* which the cow obtains from fresh vegetable food. She herself cannot elaborate it.

It has been said that the vitamins so far discovered regulate health. In their absence a definite disease occurs. But there is also reason to believe that vitamins may affect the amount of growth. Recent experiments with pigs have shown that a much heavier animal is obtained when a diet containing the *vitamine* present in butter is given. This *vitamine* is present in whey and pigs fed on whey, plus substances not containing the butter *vitamine*, make much better growth than pigs fed only on substances from which this *vitamine* is absent.

Enough has been said to show that the science of nutrition has taken a new aspect. We can no longer regard only the gross amount of albuminoids, carbohydrates, etc.; we have now to consider the possibility that certain foods may possess specific values which are independent of the amount present in a diet. Knowledge of this subject is in its infancy. It is hoped that the investigations, which have already begun at the

Reading Dairying Institute, will be taken up at other institutions supported by the Ministry of Agriculture.

\* \* \*

The above is interesting to bee-keepers in view of the question as to whether honey or sugar is the better for winter stores for bees. During the many processes in the manufacture of sugar the vitamins are destroyed. The same thing will, of course, happen with honey used for bee food when it is boiled as a precaution against disease. It therefore follows that the honey stored by the bees themselves is, with few exceptions, the best winter food.

---



---

### Jottings from Huntingdonshire

The wind is blowing from the east, curling up our toes and touching our backs with the tip of an ice block. Snow has fallen in powdery flakes, and the sun has hidden his face for three days. One goes forth and looks about the hives. The snow has drifted here and there, and one hive entrance is blocked with snow; it is cleared away, and one wonders, is all well within. Seven and twenty degrees of frost is a big jump down from a temperature which a day before was about 40 degrees. Well, we have stood it, and so, too, will the bees. One, however, naturally wonders whether an extra quilt or two may not be needed, but dare not lift the roof to see. The snow on the hive roofs is serving a good purpose while Jack Frost is king; when it begins to thaw it is best to brush the roofs clear. For the bees' sake, there is naught we would not do. Hive them well; feed them when necessary, help them to resist all their various enemies. Not for sharing their spoils alone do we do all this. Their intelligence, order, civilisation appeal to us, and there is no bee lover who has not felt, in one of those deep psychic moments we all experience in our life time, that he would love to descend into the body of a bee and educate the little insects up to the knowledge of man. The Christmas season reminds us that God has done all this, and more, for us. The full force of the doctrine of the Incarnation is never so distinctly felt as when we feel like this towards our bees, and the veriest sceptic could not believe that this feeling springs from anything other than love. The past history of the bee loses itself in far-off ages, ere man appeared upon the earth; when giant reptiles found this island of ours a pleasant spot for their ponderous wanderings; when monsters, long since extinct, grazed upon the valley slopes of the Severn, Thames, Tyne, Trent, Humber and Tees,

and all their many tributary streams, Bees then lived in pairs, then in schools, then colonies, forced to this last by the same reason that compelled men to live in crowds—offering greater resistance to their foes. Their ancient colonies were sometimes large enough to keep at bay every enemy save the hornet and the robber fly, and, like the Jungle ant, were able to drive all the mighty beasts of the forest before them. As time went on they became more docile, and allowed themselves to be handled and accommodated by man. Of all wonderful things the bees are continually manifesting there is nothing more moving than their swarming and settling near to their parent hive, and thus making it possible for their owner to take them, hive them, and use them for his interest and profit. We all know that bees, ere swarming, send forth scouts to select an ultimate resting place should their owner not provide them with a home; but first the trustful, conscientious little creatures must cluster near their master's home; he has the first claim on their services, and providing he or anyone like him can give them a suitable place for their activities, they are willing to stay and work themselves to death in the common cause. Yes, dear bees, this is a most unselfish trait in your characters, and what an example to us you are! but if we only could, by some great miracle, elevate you to an ideal—that killing is wrong save in self-defence, and that robbery is a crime—you would be happier, and so should we.

The voice of the Creator also speaks to us through the message and meaning of Christmas, bidding us look up, realising that eschewing evil is to make ourselves happier and to give our Maker joy. As bees' misdeeds hurt us, so must our misdeeds hurt Him who gave us a picture of Himself in the person of that babe who lay in a manger while the angels sang and the Syriaus stars looked down upon a troubled world. Soon the bells will be a-ringing—their message is, "Good Will to Men and Peace."—E. F. HEMMING, Steeple Gidding.

## Bee Notes from Derbyshire.

(Continued from page 605.)

October.—Examined most hives. Some had finished breeding for the year, while others had brood on three combs. I think I have seen the most perfect comb of brood this summer it will ever be my lot to see. It was built out to the wood all round, and brood in every cell but the five in each top corner. The queen, one of Sladen's Golden's.

Not much for bees this month about here, but they seem to keep finding pollen from something. "Isle of Wight" disease has cleared a great many out again round about here the past summer, but, so far, my eight lots look like wintering. On October 23 I went a cycle ride, down Trent-side way, and what a lot of corn out then, whole fields of barley to lead, and some to cut, but the nice sunny days that followed would enable them to get it. There seems to be very few bees that way; my informant said he did not think there was a bee left in five villages round Normanton-on-Trent. My old friend Marshall, at Norwell, had got eight good lots, and, what is more, he had taken some good clover honey this year. The "Isle of Wight" disease takes some reckoning up. At Woodhouse three years ago a stray swarm took residence in a hive. The combs were stained and full of dead bees. They cleaned it out themselves, stored it and wintered, cast two swarms the next summer, and got a lot of honey. This year they have taken 12 stones of honey from the lot and sold three swarms. Now they have five lots, and the mistress told me the bees had cleaned all the hives out themselves. It is really amusing, when one reads and sees what some people have done in the way of disinfecting hives: it makes one wonder is it all necessary? October has been out and out the best month of the year, only wet on four days, thirteen sunny days, and two part sunny: no wind, only one good drying day, had for corn drying: and such foggy nights: wind south on only four days, the prevailing wind seems to be east to south-east. Temperature 65 deg. Fah.

November 5.—BRITISH BEE JOURNAL just to hand. Sorry to see the death of Dr. Miller in it. Having read a deal of his writings, one seems to have lost a very close friend. Clover blooms freely here some seasons with nothing in it, the same as he says. I lay down on a little mound one sunny afternoon in July when one would have thought clover would yield honey freely. It was white over with heads, and three or four bees were busy in them. How long one had been there I cannot say, but I kept my eye on it twenty minutes, and it went round hundreds of heads in that time. Then I lost it, but it did not fly toward the hives then. I cannot think when there is a good flow on from clover that it takes bees all that time to load up.

November 7.—A lovely sunny day for time of year. I took a cycle ride round by Hardwick Hall. Could see plenty of ivy in bloom, but a bit too cool for my bees to be at work on it. I also saw six fields of corn that wanted leading yet. What a long drawn-out harvest this year,

from starting in some counties in July till November, and quite green now it is cut. In many places it is killing the clover with the stooks standing on it so long.

"Cotswold Notes," page 534, Mr. Bowen wants some bee-keepers' ideas of his view. It would be all right to get strong stocks like that, but one cannot extract A1 quality honey out of C3 brood combs. If it was to come bad weather till all the brood hatched out, then take them off, all well and good, and if it did that the bees might swarm in spite of you. I daresay I shall give it a trial in 1921, if we live to see. Let's hope it will be one of those years when small stocks get a lot, and large ones a lot more.

### North Cheshire Notes.

My notes must now have a new heading as I no longer live at Runcorn. I shall be unable, therefore, to say what effect the chemical fumes of that district have on bees. So far as my experience has gone, they were *not* beneficial. My two swarms developed "crawling" badly, and, despite a temporary recovery made such little progress that I decided on changing my location, to scrap them, and start afresh next year. Being now right in the country I hope to do better, and am looking forward to 1921 as an ideal bee year.

*Re* Acarine disease. Dr. Rennie's discovery, to my mind, solves one puzzle; at least, it had been a puzzle to me, viz., the reports one sometimes reads in the BRITISH BEE JOURNAL of bees which had been insufficiently sulphured recovering, and being apparently cured from *crawling disease*. The sulphur fumes had been strong enough to asphyxiate the mites. We want a lot more information yet on *crawling diseases*. To my mind, every case of *crawling* is *not* due to the same cause. We should like to know how infection is spread. Do the mites leave infected bees on their visits to flowers, and afterwards attach themselves to other bees visiting the same flowers? That once established they breed very fast is easily understood by any one who has had experience of other members of this family, i.e., so-called *red spider* in greenhouses, and the red mite of poultry, which under favourable circumstances increase in a short time by hundreds of thousands, and for such small individuals do an incredible amount of damage. *Acarine disease* being an infection of the air passages, would indicate some kind of inhalation as a remedy.

I am inclined to agree with my kinsman in regard to "Tanging." I am quite sure bees can hear. What is hearing but the conveyance of sound vibrations to the

brain? Most animals have a special organ for the purpose, and as far as we know bees have not, unless those wonderful *antennae* serve that purpose as well as others. I knew a man who was stone deaf, but who could *hear* vehicles approaching him from behind by the vibrations conveyed through the ground to him when walking along a road. I have noticed that certain noises seem to annoy bees, for instance, scraping a spade with another near their hives will often cause them to leave their cluster in the winter if the weather is mild.—D. J. HEMMING, Appleton, Cheshire.

### The Dawn of Knowledge.

By A. Z. Abushady, F.R.M.S., Editor,  
"The Bee World."

I cannot think of a better title than the foregoing for a brief commemorative article of what has truly been described as an epoch-making discovery on adult bee diseases.

As I listened and profited by the most instructive lecture by Dr. John Rennie the week before last at the Horticultural Section of the Ministry of Agriculture to a gathering of bee-keepers, I realised more than ever the great significance of the new addition to our knowledge. No student of pathology and parasitology, apart from a practical bee-keeper, could have thought otherwise.

The learned researcher, in a non-assuming manner, gave a good outline of the work done at Aberdeen, and though speaking scientifically, he left no front open for attack from any practical bee-man. Several questions were asked and clearly answered, and whatever might have been said outside the meeting room, no member of the gathering had the slightest ground for questioning the discovery when given the opportunity to criticise on the basis of the data submitted.

Years ago, almost all brood diseases were known as "foul brood." Scientific research, chiefly in America, gradually helped to classify these diseases regarding which we know at present a good deal, thanks to the work of Dr. White and others.

It is now the turn of adult bee diseases. In the light of the new discovery, the Bee Press should take the lead in education and restrict the terminology of these, according to our knowledge, to: (1) *Nosema disease*, and (2) *Acarine disease*. Disabilities simulating in outward symptoms one or the other of the foregoing diseases, but due to other causes such as senile decay, bad bee-keeping, etc., have to be denied the usual misnomers.

When the work of Dr. Graham Smith and his colleagues was first questioned, *Nosema apis* was regarded by the sceptics as an innocent organism, notwithstanding the fact that an epidemic, on the decline, would have wiped out the unfit, leaving comparatively immune strains, and also regardless of the variable course which a bee disease is bound to take in the fluctuating population of a hive or an apiary. It was again due to the work of Dr. White in America that the pathogenicity of *Nosema Apis* was confirmed. Dr. White, under American conditions, with well-bred bees to deal with, finds the disease generally a mild one. It does not follow that it is entitled to similar qualifications here. Let us not forget also the attention given within late years to selective breeding in this country, in addition to the beneficial importation of bees of reputable strains. Furthermore, we should remember the effect of climatic conditions, as in the case of flora, on the behaviour of micro-organisms. Although I still submit that there is nothing in the work of Dr. Rennie or any other researcher to disprove the findings of Dr. Graham Smith and his colleagues, or to encourage us to believe that should the stamina of our bees be appreciably lowered in future, we need not fear, in the absence of legislation, an epidemic of *microsporidiosis*. I equally submit that possibly a double infection in many cases has been missed in the past, and that we know now definitely the cause of an infectious disease presenting general symptoms similar to those of *Nosema disease*.

The ocular proof of the tracheal lesions and the bold assertion vouched for that, although the disease in some cases may pass off, the rule is malignancy; also the fact that the disease is not limited to any part of the country and can be diagnosed at a very early stage, open a field for prevention by education of the bee-keeper, and by isolation or destruction of the stock when breeding is at an end, as advised by Dr. Rennie. The future is sure to have greater aids in store.

The details submitted, not being for publication until the full report appears shortly, one can hardly say more at present except to repeat the grateful thanks due to the men who toiled so patiently and silently in order to serve the truth and save an industry. No jury would be entitled to give a verdict without being acquainted with the facts of the case on which to judge. Prejudgement is no servant of the truth. Those who want to *criticise* without having had an opportunity to attend last week's or the Edinburgh meeting, and before the appearance

of the full reports have no moral right to do so. Again, obvious questions that have already been answered in the report will serve no purpose at present, as etiquette prevents the researchers from answering them. General comments are quite a different thing, and will help to stimulate interest.

The advance in our knowledge regarding adult bee diseases is sure to have a helpful effect in relation to legislation as it is bound to dissipate many fears. Whether legislation will be introduced in the near future or otherwise, it was most gratifying to learn officially that, if introduced, a representative industrial advisory committee would be set up. Of course, there are men of sincere conviction who oppose legislation; and although the weather-cock opportunist, who unconditionally appeals for legislation one day and opposes it on the following for the dear love of notorious and cheap self-advertising, is bound not to be missed, there is no doubt that last week's meeting of bee-keepers presented on the whole that harmonious spirit of fraternity and a keen desire to learn of which some of us have for so long dreamt.

---



---

### Tanging.

This is a subject which has been discussed often enough, but is by no means worn out, because, so far, no clear evidence has been produced to enable it to be settled definitely. At present, I think I am right in saying that the most weighty arguments favour the contention that it is a distorted custom connected with the legal ownership of swarms.

The Rev. E. E. Henning, however, comes boldly out to support the belief that direct effect on swarming bees is the basis of the practice. In the course of his argument he says, "the theory that bees are stone deaf has surely been exploded long ago." Does not the real truth lie more in the other direction? All the older writers were convinced that bees could hear, although they admitted that they could not by any means locate the organs of hearing. They based their belief on the varying sounds emitted by bees under different conditions. If the subtle distinctions which must be made between those varying sounds is possible to bees, they surely must possess organs of hearing at least as elaborate as our own, which can scarcely detect the difference. The more modern investigator, however, tends to the belief that specialised sense of hearing does not exist in insects, and that touch and scent, both of which are admittedly highly developed and have definite and obvious organs, is very highly

specialised. Any bee-keeper who has united stocks with and without scented syrup must be satisfied, even without demonstration of special organs, that the sense of smell is highly developed and, indeed, the rapidity with which bees discover the honey in special flowers is in itself proof.

Another, and to my mind, more weighty argument, is the fact that in bees, particularly, hearing is not necessary. A bee lives on flowers, which, as far as we are aware, produce no sounds, and can be discovered only by the aid of sight, smell, touch and taste, and the only possible use for a sense of hearing would be the sexual one, as enabling the drones more readily to find the flying queen. But drones, we know, have highly developed eyes and special development of antennæ, almost conclusively proved to be organs of scent and touch. I am aware a theory has lately been put forward that antennæ are analogous to wireless telegraphic instruments, and the immense development of these organs in the males of many species, such as those moths which have specially developed faculties for "assembling" to virgin females, has ingeniously been likened to the aerial of a receiving station. But to my mind an insuperable difficulty in connection with this theory is that aerial waves are broken by contact with solid bodies, and it is essential that an unbroken wave ocean extends between the sending and receiving instruments. Is it conceivable, then, that a female shut in a box without clear communication with the outer air can send out waves which shall be collected by an apparatus situated at some distance with numerous intervening objects to break the waves?

Coming directly to the subject of tanging. Is there any real evidence in favour of its effectiveness? Have swarms never decamped in spite of it? Have swarms in full career across the countryside been induced to settle by someone on the line of route ringing a bell? Surely the fact that in most cases when an issuing swarm is tanged it settles, will not be taken as evidence, for it is the rarest exception for a prime swarm, at any rate, to fly off without first clustering? All our great bee-masters take the view that it is useless. As Langstroth says: "Many who have never practised tanging have never had a swarm leave without settling."

Just one more point, which I have noticed and which, I think, has not been mentioned before. Many writers have stated that swarms frequently issue on Sundays, and have argued that the ringing of church bells induces them to do so. Can the two notions be reconciled? Does the ringing of church bells cause the bees

to swarm, and the ringing of a bell behind the hive bring them back? If the sound draws the bees towards it, surely the Sunday swarms ought to converge on the sacred edifice?

\* \* \* \* \*

Concerning the remarks of Mr. Ellis and the Editorial upon the number and quality of contributors to the JOURNAL. It is true, alas, that death has robbed us of some able bee writers. Friend Smallwood of the pleasant, if not always, mark you, relevant "Blurts," for example, but I do not think this accounts for the undoubted change in the personnel of contributors. Surely the war is quite sufficient reason? Sooner or later after its outbreak, one after another was obliged to discontinue, and the Editors know best how difficult it would have been to fill the eighteen pages of reading matter which were then possible, with adequate substitutes. Having once given up the habit of writing for the JOURNAL, it is not easy to form it again. In my own case, after my return from the East, I had practically to start my career over again, with much heavier handicaps and hostages to fortune than when I first ventured forth to earn a living by the sweat of my brain. Hence it is seldom I can find time, for "buck-shee" work, much as I enjoy doing it.

This sudden breaking off of a number of practised hands was bound to make a hiatus which cannot be soon filled, as in normal times it would be, by the gradual coming forward of new and experienced men. This would account for the falling off in quality which Mr. Ellis seems to detect. I am not sure, however, that he is right. I would ask him to remember that the longer one's experience of bee reading, the less likely one is to be interested in new writing, as it is only here and there facts emerge which are new to us or are put in new and arresting fashion. I confess that I often read for weeks without finding anything fresh to me. I do not expect it, and I think allowance must be made for this when judging the past and present. After all, it is chiefly for the beginner that the JOURNAL exists, and having in our early days derived full benefit from it, we must be content that others are reaping the same advantage. It is pleasant to hear that the number is greater.—HERBERT MACE.

## A Correction Accepted.

*Re* BRITISH BEE JOURNAL, Page 584.

Mr. Bryden writes us expressing regret for his statement that both natural and artificial queen rearing was carried on at Castel San Pietro. What he saw was the home apiary of Signor Piana, and very

easily recognised that he had adopted "Doolittle's" method as his system of queen rearing. Through his very imperfect knowledge of the Italian language he misunderstood Signor Piana, that his out apiaries were conducted on the natural swarming principle.

He did not have the pleasure of inspecting the out apiaries, so could not give a definite decision from what he did not actually see, otherwise the statement would not have been made. Mr. Bryden wishes to express to Signor Piana his sincere gratitude for his kind interest shown to him when on his visits.

### British Bee-Keepers' Association.

The monthly meeting of the Council was held at 23, Bedford Street, Strand, London, W.C.2, on Thursday, December 16, 1920.

Mr. W. F. Reid presided, and there were also present:—Miss M. D. Sillar, Sir Ernest Spencer, Messrs. G. Bryden, G. R. Alder, G. J. Flashman, J. Herrod-Hempsall, J. B. Lamb, W. H. Simms; Association representatives, R. R. Babage (Middlesex), E. G. Waldock (Surrey), C. P. Jarman (Kent), and the Secretary, W. Herrod-Hempsall.

Letters of regret at inability to attend were read from Messrs. T. W. Cowan, A. G. Pugh, F. W. Watts, A. L. C. Fell, J. Pearman, C. L. M. Eales, G. Thomas, and A. J. Blakeman.

The following new members were elected:—Messrs. E. Lee and W. Low.

The Cumberland and Westmorland Association nominated Rev. D. Jones and Lancashire Mr. F. H. Taylor as their representatives, and both were accepted.

The report of the Finance Committee was presented by Mr. Bryden, who stated that the receipts for October were £19 1s. 6d., for November £49 4s. 11d. The bank balance on December 1 was £149 12s. 8d. Payments amounting to £88 6s. 6d. were recommended.

The reports of the Examining Board for lecture test for final certificate were presented by Mr. Bryden and the chairman, and it was resolved to grant certificates to Mrs. M. K. Hodson, Miss A. D. Bells, Messrs. D. Y. Knowles and E. D. Lowes.

Mr. J. Herrod-Hempsall moved, and Mr. G. J. Flashman seconded, and it was carried: "That the lecture test be eliminated from the examination for Final Certificate."

A letter was read from the manager of the Grocers' Exhibition giving the terms under which they would arrange for the annual show to be held at the Grocers' Exhibition at the Royal Agricultural

Hall, Islington, London, N., from September 17 to 23, 1921, inclusive. It was resolved to accept the same.

A letter was read from the Ministry of Agriculture asking the Council to nominate two representatives to serve on the Bee Advisory Council now being set up by the Ministry. Proposals were made and a ballot taken, when Sir Ernest Spencer and Mr. G. Bryden were declared elected.

Next meeting of Council Thursday, January 20, 1921, at 23, Bedford Street, Strand, London, W.C.2.

#### SPECIAL GENERAL MEETING.

After the Council meeting a special general meeting was called for the purpose of considering:

(a) The increase of subscription to 10s. 6d.

(b) To eliminate plural voting.

There was a good attendance, and numerous letters of regret at inability to attend were read, the majority of the writers expressing their agreement with both proposals.

After a lengthy discussion, in which the chairman pointed out that the value of money having decreased considerably, and expenses mounted up enormously, it was impossible to carry on at the old rate of subscription; also that most societies had raised their fees long ago, it was resolved that the annual subscription be raised to 10s. 6d., vice-presidents to two guineas, and life members to ten guineas. That plural voting be eliminated and the rules altered accordingly.

### Surrey Bee-Keepers' Association.

(GUILDFORD DISTRICT.)

The usual room in Ward Street Institute not being available, the monthly meeting of the Guildford Division of Surrey Bee-keepers' Association was held on Wednesday, December 8, at 7 p.m., in the Grand Jury Room, County and Borough Halls, Guildford. Mr. G. W. Judge gave an interesting lantern lecture on "Diseases and Enemies of Bees."

The chair was taken by Councillor H. G. Herbert, and the lantern was very efficiently operated by Master Reginald Patrick.

Although a very thick fog deterred many from attending the meeting, the room was fairly filled.

The lecture was very much appreciated, particularly that part of it which was devoted to the newly-named "Acarine" disease. Mr. Judge's direct and clear methods of explanation being exactly what were required for a subject of this kind.—F. M. FALSHAW, Avondale, Stocton Road, Guildford, District Hon. Sec.

## Somerset Bee-Keepers' Association.

FROME DISTRICT.

An instructive lecture on bee-keeping was given at the Red Triangle Hut on Monday evening, November 29, 1920, by Mr. L. Bigg-Wither, first-class expert British Bee-keepers' Association and County Lecturer on Bee-keeping.

The lecture was given under the auspices of the County Bee Sub-Committee (Somerset Agricultural Instruction Committee), and was illustrated by lantern slides. There was a good attendance. Chairman, the Rev. G. Hugo Heynes. During the lecture Mr. Bigg-Wither mentioned the important discovery made by Dr. John Rennie and his collaborators, and stated all bee-keepers were greatly indebted to A. H. E. Wood, Esq., of Glassel, Aberdeenshire, for the great financial assistance and deep interest he has taken in the work of research, and of bee-keeping generally, and also to the Ministry of Agriculture for their assistance.

Questions were asked after the close of the lecture, which lasted about one hour and a half, and were answered to the delight of all present.

A hearty vote of thanks was accorded to Mr. Bigg-Wither for his interesting lecture.—E. G. HAWKINS.



*The Editors do not hold themselves responsible for the opinions expressed by correspondents. No notice will be taken of anonymous communications, and correspondents are requested to write on one side of the paper only and give their real name and addresses, not necessarily for publication, but as a guarantee of good faith. Illustrations should be drawn on separate pieces of paper. We do not undertake to return rejected communications.*

### “Candid” Critics.

[10352] I see, Mr. Editor, you are again taken on the carpet for not running our Journal to suit all; the end of that perfect day will never arrive. All that appears does not appeal to me, but I do not say it should not be printed; there are others who thoroughly enjoy reading it. Your old readers miss the enjoyable articles of Lordswood, the practical notes of Wm. Woodley, the pithy “Extracts from the Hut” of “Extractor” and many others that we mourn the loss of; what, then, is to take their places? Not such articles as “How I Took My First Swarm,” “How to Take off Surplus,” or even the lengthy quibbles in regard to size of frames. Again, I say, this, no doubt, suits some, but not all; if much

of this is skipped there is still a good twopennyworth left. I and many others would miss our “Dorset Yarn.” Many times I have fancied myself working besides those lines of gooseberries and listening to the glad song of the bees, and, knowing the writer helps one all the more to appreciate his labour of love, many were extremely sorry when friend Kettle took the hump before.

Then the Rev. Hemming’s articles help us to look on Nature in a new light and to consider every flower as the bee-keeper’s friend. Bee-keepers will be better if they will only find what source their bees are gathering their income from, noting the dates thereof and taking an interest in all related subjects and items outside the hive, but to tell us all these things are “alien” (horrible word) to bee-keeping fairly takes my breath away. Get on Brothers Kettle, Hemming, Harwood, etc., we do not all envy but appreciate your capabilities.—H. HILL, Ockbrook, Derby.

### A Bee-Keeper’s Good Fortune.

[10353] I have again joined the fraternity of bee-keepers, or rather I have been forced to do so. Having lost my stocks through absence from home during the war, I had decided to “wait and see” for an opportunity of restocking. However, the unexpected happened, as follows:—On Whit-Monday, my family being away on holiday, two little boys came and said that there was a swarm of bees in the street; going with them I found a swarm of black bees in a low, thick hedge. I cut away all the small twigs until I had them nearly all on one thick stem, which I cut off with pruners, and gently laid it with adhering bees close to a skep which I had propped up with stones to receive them. Meanwhile a crowd had collected, and I received (*from a respectful distance*) plenty of well-meant, but not expert, advice, gratis. Soon all the bees were in the skep, and at night were run into a clean hive, and I again felt the exhilaration of being a proprietor of bees. A few weeks later a boy came to say that some bees were in my garden hedge. These were a mere handful, a cast, but I put them in a clean hive and fed them well, so that though it rained continually they prospered. But more bees were to follow. Early in August a young man came to the door and announced, “Our field is full of bees!” so I went with him, and sure enough the field was alive with bright yellow Italian bees which had not clustered on my arrival, but soon did so in the hedge: they were a very fine, big



lot, and must have come a long way, as I can only hear of black and Dutch bees in this neighbourhood. Again did history repeat itself, and I secured another swarm, this time Dutch, which I joined to the black cast, being short of a clean hive, and the Dutch queen was thrown out. Again I was called, and took another stray swarm which a neighbour thought were his, so I handed them over and helped him to hive them and look through his stock. I am now the proud possessor of three good stocks of bees, which I have fed continually owing to the wet season. I would, in the coming season, like to increase my colonies, and am planning a big hive on the "Wells" perforated dummy system. I have made two thin three-ply perforated wood dummies. I have read and admired Mr. Wells' letters in your old Journals wherein he replies very patiently to some heckling critics. Is Mr. Wells' pamphlet procurable now? Would it be wise to make so large a hive on the W.B.C. plan? What merits, if any, have Dutch bees? I am informed that they swarm too much. I have seldom (you will thank goodness) troubled you with questions, so hope that fact may palliate this rather long letter, which I will conclude by subscribing myself—"WOODLANDS," Derbyshire.

[Dutch bees are very prolific and too much given to swarming, so far as our experience goes, preferring to swarm rather than work in supers. When they do store honey in supers the comb is well built, and the cappings white and even. Mr. Wells' pamphlet is out of print; his hives were double-walled. We trust your good fortune will continue.—Eds.]

### Producing Heather Honey.

[10354] Being a bee-keeper of twenty years' experience, and a regular heather-going bee-keeper, I regret that Mr. Price's lecture on "The Production of Heather Honey" was so short. When I saw the heading in the BRITISH BEE JOURNAL I had hopes of learning something more. Now, will Mr. Price tell us when to start to prepare our stocks for the moors? My own experience is that we have to begin to prepare at the swarming period, namely, the middle of June, by forming nuclei of four frames of comb with a young queen, and working them up until they are packed with young bees and brood about the last week of July or the first week of August. These stocks are then just right for the heather which is just beginning to bloom, and, given a spell of fine weather, they give a good account of themselves. Much depends upon the way the bees are packed for travelling, also the method of travelling

to the moors. I have taken bees by train, motor and cart, and I prefer carting, as you go as you please. I begin to fasten my bees up as soon as they cease flying for the day—that is, close the entrances. Hives are made secure a week or two before. After the entrance has been securely fastened with perforated zinc, and no bees can escape, they are loaded upon a flat cart, and the journey of twenty odd miles begun. We are travelling all night, get to the moors about day-break, and unload the hives to allow the bees to cool after the jolting journey on the road. Now, Mr. Price, how much scalded brood have you found in hives properly packed on a flat cart after they have got to the moors in comparison to that found in hives after the rapid journey of train or motor?

I should say it is absolutely necessary to replace the old queen with a young one before going to the moors. For one reason, the old queen has been breeding heavily during the season in the lowlands, but on being transported to the highlands the difference in climate affects her so much that she stops laying, probably thinking that winter is come, owing to the change of atmosphere, especially if the bees are taken from a 400 ft. to 1,300 ft. above sea-level; that is the reason why I suggest nuclei made in June, one has a young queen laying, and bees just coming right for the honey flow.

Some bee-keepers pack all the combs of maturing brood into their hives when going to the moors. *It is a mistake.* If bees are sent upon six combs of brood, and two of honey with a young queen, you will get better results than by sending one with ten combs packed with brood and an old queen, as the change stops the old queen from laying, the brood hatches out, and there are ten empty combs to fill in the brood nest before you get one section.

Mr. Price says it is interesting to know that there are not many countries from which it is possible to obtain pure heather honey. Is there *one* country where it is possible? I think nearly all moors in England have another good honey-producing flower beside the ling. I refer to the wild thyme. It blooms at the same time as ling. I have seen bees working it on the Cheviots and on the Durham moors when the ling has been in full bloom. Good heather honey is selling at 6s. 6d. a section in Newcastle at present.

Producing heather honey is more of a gamble than a surety. Some years you may get a few pounds, but often none, but we never get downhearted, always looking forward and hoping that the next year will be a good heather year. Just as

an instance, I will mention two cases that came under my notice this season, one being a bee-keeper of twenty years, and the other just a beginner who hardly knew a bee from a wasp. The man of experience sent five hives packed with bees and brood and ten combs each, and never got any honey worth mentioning. The beginner, who got two casts in July, sent them to exactly the same place and got twenty-five good sections and eight combs well stored for winter.—H. HARMER, Sunnyside Swalwell.

### The Production of Heather Honey

[10355] On page 579 of Mr. Price's lecture I observe a paragraph which speaks about pure heather honey. Did any person ever see pure heather or clover honey? I have not yet discovered a pure honey from any one source. Has Mr. Price discovered pure heather honey? If so, I will be pleased to receive a sample of same, but I think he means pure honey with heather predominating.

But the point I want to bring out is that this is the second time it has been printed in your Journal that heather honey does not granulate. I have put a good quantity through my hands, and my experience is that heather honey does granulate; but, of course, I cannot speak of pure heather, as I have said I have not seen same. What I speak about is known as heather honey. I think the article is rather misleading.

[What Mr. W. Herrod-Hempsall said, and has been printed in the Journal, was that pure heather honey does not granulate, not that heather honey does not. The latter may be, and usually is, "pure honey with heather predominating." Mr. W. Herrod-Hempsall has a sample of almost, if not quite, pure heather honey which has been in his possession for eleven years, and has not yet granulated.—Eds.]

Now he says, "It cannot be extracted." I don't know what he means by extracted, but it can be extracted by pressure, which is the only way as yet to my knowledge. I have on my premises 2 cwts. of such treated honey in bottles, and I can tell you it is grand. The only thing that I fail to get out of it is the small air bubbles which do not rise to the top but remain throughout the whole bottle. There are other practices for disposing of heather honey. The practice Mr. Price speaks about disposing of honey by supers in boxes weighing from 7 to 14 lbs., and combs 3 in. thick, is a very old practice unless for pressing purposes. Grocers will not have this class of honey for two reasons. People are not buying a skep as they used to do long ago, and it is a sticky mass to parcel

and deal with if cut and sold per pound. It is now sold either in bottles or in 1-lb. sections.

The best heather honey is collected from hills of the blue whinstone over 800 ft. from the level of the sea, and with a dry soil. That heather is of a congealed livery substance with a fine aroma and flavour. Hills below that level are not so good, but hills above and below 800 ft. of a marshy, wet disposition give a heather honey. I would not say inferior, but it is not so congealed nor so brilliant, and the flavour and the aroma are not quite so strong. When testing the two together, to me they are quite distinct in appearance and flavour. I cannot describe exactly the flavour of the marshy ground honey, the nearest I can describe it is that it has a slight mossy flavour.—"AN ABLE BEE," Edinburgh.

["It cannot be extracted," means the honey cannot be extracted from the comb by centrifugal force in the usual manner. The air bubbles are characteristic of heather honey. It is so dense and gelatinous the air cannot rise. The quality of all honeys is, we believe, affected by the climate and soil where the flowers which produce it grow.—Eds.]

---

### Special Prepaid Advertisements. One Penny per Word.

Trade advertisements of Bees, Honey, Queens, and Bee goods are not permissible at above rate, but will be inserted at 1½d. per word as "Business" Announcements, immediately under the Private Advertisements. Advertisements of Hive-manufacturers can only be inserted at a minimum charge of 3s. per lin., or 5s. per inch.

PRIVATE ADVERTISEMENTS are only intended for readers having Surplus Stock to dispose of. Driven Bees, Nuclei, and Queens that are reared or imported for sale, are Trade Advertisements, and can only be accepted under trade terms. A charge of 6d. extra will be made if a box number is used.

Advertisements must reach us NOT LATER than FIRST POST on MONDAY MORNING for insertion in the "Journal" the same week.

Orders for three or more consecutive insertions in "The Bee Journal" entitle advertisers to one insertion in "The Bee-Keepers' Record" free of charge.

---

#### PRIVATE ADVERTISEMENTS.

**F**INEST WILTSHIRE HONEY, 3 cwt., in tins; aroma, grain and flavour perfect; samples 6d.—MELISSA, 1, Belle Vue Road, Salisbury. k.136

**H**EAATHER HONEY, finest quality Scotch, in 7, 14 and 28-lb. tins, 24s. 6d., 48s., and 96s., carriage paid; also high-class White Honey.—WHYTE, Bee Farm, Cumbernauld, Dumbartonshire. r.k.137

**E**TRICA CARNEA, the heather that blooms in February, dwarf bushy plants, now showing bud, quite hardy, 4s. dozen, post free.—S. E. LYTLE, Dunbryan, Formby, Lancs. r.k.138

**C**ORRESPONDENCE Courses in Bee-keeping.—H. E. NEWTON, Hobart Road, New Milton, Hants. r.k.69

**WHITE LEGHORNS** (Barron's strain).—Sittings of Eggs, 12s. 6d.; delivery January, February, March.—**MRS. HOWARD LEE**, Bowden, Burgess Hill, Sussex. r.k.130

**WANTED**, Handy Man who understands bees, horses, and can do rough joinering. State wages expected.—**YOUNG**, 42, James Street, Cambridge. r.k.117

**FOR SALE**, cheap, five good hives Bees, chain-gearred Extractor, etc., £15; to be removed by purchaser.—**G. SARGAN**, Ravenfield, Rotherham, Yorks. k.100

**IRISH HONEY**, 14 lb. 28s., 23 lb. 53s., 56 lb. 106s.; also Section Honey, 30s. and 35s. dozen.—**S. CRAWFORD**, Apiaries, Castlederg, Co. Tyrone. k.101

**PRIME HAMPSHIRE HONEY**, in 28-lb. tins, 50s. per tin, free on rail, carriage forward.—**TRUEMAN**, Harroway Road, Andover. k.104

**SAINFOIN HONEY**.—We have 1 ton of this fine Honey, put up in nominal 14-lb. tins, which were sent us by a honey buyer who failed to pay for his order. These packages average 14½ lbs. gross weight, and we offer them at 35s. each, carriage paid.—**S. H. SMITH**, 30, Maid's Causeway, Cambridge. k.105

**NOW BOOKING ORDERS**, delivery January, February, March, £2 sittings of Eggs and Day-old Chicks (Barron's), White Leghorns, Brown Leghorns; White and Pawn and White Runner Ducks, White Wyandottes, sittings 10s. 6d. to 35s. a dozen, Chicks double.—**MRS. M. ANDERSON**, Poultry Dept., Hermitage Poultry Farm, High Hurstwood, Sussex. Manager: Miss M. D. Sillar. k.93

#### BUSINESS ADVERTISEMENTS.

1½d. per word.

**IMPORTED ITALIAN QUEENS FOR 1921**.—List on application.—**PEARSON & GALE**, Marlborough. r.k.83

**FLAVINE BEE CANDY**, made in Cambridge, and the wrappers bear our name, 6 lbs. 10s., post paid.—**S. H. SMITH**, 30, Maid's Causeway, Cambridge. k.159

**"LET THE BEES TELL YOU."**—Third edition now ready. Price. paper 2s. 6d., cloth 4s. 6d. The proceeds will go to the relief of bee-keepers in the devastated districts of France.—**S. H. SMITH**, 30, Maid's Causeway, Cambridge. k.140

**MASHEATH HIVES** are made by their designer and originator, **M. ATKINSON**, The Bee Park, Fakenham, who will be pleased to reply to all inquires. r.k.141

**ITALIAN QUEENS** direct from Italy.—Addresses, **E. PENNA**, Bologna, Italy. Prist List for 1921 on application. r.k.144

**ENSURE A GOOD HONEY CROP** next year by purchasing one of our noted 6-frame Italian Stocks. Illustrated Catalogue free on application.—**PEARSON & GALE**, Marlborough. r.k.123

**BEE BOOKS FOR CHRISTMAS PRESENTS.**—You can get the Books of the leading authorities in this and other countries from **E. J. BURTT**, Stroud Road, Gloucester. Special List free on receipt of a postcard. k.120

**"WIGHT" DISEASE**.—Prevention and removal. Advice 5s.—**ALF. RYALL**, Cottage Farm, near Camp, Stroud. r.j.5

**BEEES AND QUEENS FOR 1921**.—Send for our new Illustrated Catalogue, free on application.—**PEARSON & GALE**, Marlborough. r.k.127

**IMPORTANT!**—In spite of the increased cost of appliances and carriage, we are offering our celebrated 6-frame Stocks at reduced prices. Catalogue free on application.—**PEARSON & GALE**, Marlborough. r.k.129

**KEEP IN TOUCH** with modern bee-keeping thought by reading the bee-keeping journals. I shall be pleased to book orders for "Gleanings in Bee Culture," 7s. per year; "The American Bee Journal," 10s. per year; "L'Apiculture Française," 3s. 6d. per year, each monthly and post paid.—**E. J. BURTT**, Stroud Road, Gloucester. k.119

**A WELL-ESTABLISHED FIRM** wishes to hear of bee-keepers who would guarantee to supply them with Nuclei May-June next.—**Box 107, B.B.J. Office**, 23, Bedford Street, Strand, W.C.2. r.j.42

**PEARSON & GALE, Marlborough.** Catalogue of Bees and Queens for 1921.—**SEND POSTCARD** only for our new Illustrated

**HAVE YOU READ "THE BEE WORLD"?** If not, why not? Every number in itself is a useful literary work for practice and reference. Specimen copy free.—**Offices: THE APIS CLUB**, Port Hill House, Benson, Oxon.

The products of the Apiary, of Poultry and Farm Stock, of the Fruit and Vegetable Garden can be Advertised and Sold through

THE  
**BAZAAR, EXCHANGE & MART**  
Newspaper.

Get a Copy—Thursday and Saturday 3d. The "Bazaar" publishes also practical handbooks by experts. Send for full catalogue, post free from—**WINDSOR HOUSE, Brems Buildings, LONDON, E.C.2.**

THE  
**British Bee-Keepers' Association.**

The recognised centre of practical and scientific bee-keeping in Great Britain. Particulars and conditions of membership may be obtained from the Secretary, **W. HERROD-HEMPSELL**, 23, Bedford Street, Strand, London, W.C.2.

**1921**

**For HARDY ENGLISH-BRED ITALIAN QUEENS**

**LOCKWOOD & MANLEY,**

The Model Bee Farm, HUNSTANTON, N. NORFOLK.

Our queens are bred from mothers whose stocks have given heavy surplus in the bad season of 1920, and only drones from similar, though unrelated queens, are permitted flight.

Send for our Illustrated Catalogue of Queens, Swarms and Nuclei.



*"I am in hopes that some of us will one day be boasting that we have subscribed to the BEE WORLD from the first number."*—JOHN ANDERSON, Esq., M.A., B.Sc.

**The Hon. Gen. Secretary to the APIS CLUB has pleasure in announcing :**

(1) That in conformity to the recommendations of the Organising Committee appointed by the General Meeting of APIS CLUB members last May, all the provisional steps in organisation have been completed, and the BEE WORLD now belongs on a share basis to the Craft in general by investing in Adminson, Ltd., to whose financial support during the first year the paper chiefly owed its existence and which has now become a public company ;

(2) That several hundred shares have already been taken up by members of the Fraternity both at home and abroad, including several members of the Trade ;

(3) That applications for shares are still being received from different parts of the Country ;

(4) That arrangements which will render possible the concentration of efforts on the production of the BEE WORLD are in the course of completion ;

(5) That with adequate working capital and the advertisements received, it will become possible to issue the BEE WORLD on at least a self-supporting basis.

### **IN THE LIGHT OF THE ABOVE INFORMATION**

He deems it fitting now to appeal to *all* readers of the B.B.J. who value the existence of the paper to impartially consider :

(1) That, practically speaking, the support of almost every one of them cannot be dispensed with ;



*"The paper is unique, high in tone, and free from extraneous matter and recrimination."*—W. HERROD-HEMPSELL, Esq., F.F.S.

(2) That the founder of the BEE WORLD gave towards its development what he could *not* afford to give, and now relies on the Craft in general to show a spirit of duty at even some inconvenience—a fraction of what he endured;

(3) That the moaning over the absence of one or two pioneers who would make this appeal unnecessary is not helpful, whilst the co-operation of every reader of the JOURNAL would immediately accelerate our progress;

(4) That in view of the easy terms arranged, it is impossible to imagine any bee-keeper, however humble his circumstances may be, who cannot take at least a single share in the Company, whilst a good many bee-keepers can apply for more.

### THEREFORE MARK THIS CHRISTMAS

For the pleasure of sharing in such a public service and help with pride to effect the early appearance of the BEE WORLD on a sound basis.

*"... a fund of information, both practical and scientific. It is to be hoped that the proprietors, Messrs. Adkinson, Ltd., meet with the encouragement they deserve, and are thus enabled to carry on the good work they have started towards the high ideal at which they aim."*—BEE CRAFT.

*"We have never seen a bee magazine with so much 'meat in the coconut.' We are not in the habit of doing any advertising for anybody, not even for ourselves, in the reading columns, but we believe this magazine should be sustained."*

—THE AMERICAN BEE JOURNAL.

The Apis Club, BENSON, OXON, ENGLAND.

## FOUR FIRST PRIZES.

Our HIVES and APPLIANCES were again awarded FOUR PRIZES at the Highland Agricultural Society's Show at Aberdeen, thus testifying to the superiority of our goods. Order now at catalogue prices and save money.

## SOFT BEE CANDY.

Have you tried our Famous Bee Candy? If not, you should send for a trial order now. It is made from PURE WHITE CANE SUGAR and is PERFECTION.

### PRICES—

1 lb. at **1/5**, postage 9d., 6 lbs. at **9/6** post free,  
10 lbs. at **15/6** post free.

Can be had medicated or not, as required.

**R. STEELE & BRODIE,**  
*Bee Appliance Makers,*  
**WORMIT, FIFE.**

Telegrams:—"Bees, Wormit."

Telephone:—28 Wormit.

## BEE CANDY.

**WE** are now able to supply CANDY OF OUR OWN MAKE from guaranteed Pure White Refined Cane Sugar. In 1-lb. boxes with glass tops. It can be had plain or medicated with either "Yadil" or "Bacterol."

### REDUCED PRICES:

1lb. - **1/5** per lb.  
6lb. - **9/6**, post free.  
10lb. - **15/6**, post free.

**JAMES LEE & SON, Ltd., Uxbridge, Middlesex.**

APR 22 1921  
Agricultural  
College



No. 2010. Vol. XLVIII

DECEMBER 30, 1920.

[Published every Thursday, Price 2d.]

**CONTENTS.**

	PAGE		PAGE
SEASONABLE HINTS .....	625	CORRESPONDENCE—	
A DORSET YARN .....	625	Native v. Foreign Bees .....	630
HONEY IMPORTS .....	626	Experience with Swarms in Ireland .....	631
NOTES FROM GREINA GREEN .....	626	The B.B.J. and its Contributors .....	632
THE SEASON IN ABERDEENSHIRE .....	627	The Production of Heather Honey .....	633
THE DRONE . . . . IN 1920 .....	628	Re-Queening, Acari, etc. ....	635
WIT AND WISDOM ON THE COTSWOLDS .....	629	Norwich Notes and Notions .....	634
NOVELTIES FOR 1920 .....	630	Peculiar Behaviour of Bees .....	634
		COMBS FROM OTHER HIVES—	
		Dr. Cummings and His Queen Bees .....	634

We should like to take this opportunity of wishing our numerous customers and all those interested in

**THE · BEE · INDUSTRY**

. . . **A** . . .

**Happy New Year**

and a Prosperous Honey Season in  
1921.

This is a season of giving presents, and the Bees should not be forgotten. A Cake of Taylor's Pink Candy will ensure for them happiness and contentment.

**E. H. TAYLOR, LTD.,** WELWYN, HERTS.

# THE British Bee Journal

Office: 23, Bedford Street, Strand, London, W.C.2.  
ESTABLISHED 1873.

A Weekly Journal Devoted to the  
Interests of Bee-keepers.

Edited by T. W. COWAN, F.L.S., &c.,  
and J. HERROD-HEMPSELL, F.E.S.

Correspondence: Whom to Address.—All matters relating to the Literary Department, Associations, Shows, etc., should be addressed, "Editors, *British Bee Journal*," and all business communications and matters relating to subscriptions and advertisements to be addressed to the "Manager," *B.B.J.* Office.

Subscriptions.—Annual Subscription, 10s. 10d. post free in advance; single copies 2d., or 2½d. post free. If a receipt is required by post, a stamped and addressed envelope must be sent, otherwise a printed receipt will be enclosed along with the paper.

Note.—Cheques and Postal Orders should always be crossed, otherwise it is very difficult to trace them if they go astray.

How to send Money.—Remittances can be made payable to W. Herrod-Hempshall by crossed Cheques and Postal Orders. Stamps may be sent for small amounts up to 2s. *Halfpenny stamps are preferred.*

Scottish or Irish cheques can only be taken in payment if 6d. is added for commission charged by banks for cashing them.

The Editors are not directly or indirectly interested in the manufacture or sale of beehives or appliances of any kind, and must refer correspondents wishing for prices or catalogues to advertisers in the paper.

## OUR DEPOSIT SYSTEM.

You are advised to insist on this being used when dealing with strangers.

### Rules and Conditions for Depositing

In order to save trouble, it is requested that the Rules be carefully read over by persons using the Deposit System of trading.

Goods should not be despatched until notice that the money has been deposited is received from this office.

1. Method.—When strangers are dealing together, the purchase-money of the articles is deposited at our office. We acknowledge receipt of the deposit to both parties, and hold the money until we are satisfied that the purchase is concluded. If a sale be effected, we remit to the seller the amount deposited, less a charge of 2½ per cent. in the £, with a minimum of 6d., and the expenses of Post Office Orders and postage, &c. Cash will be forwarded by Cheque, Post Office Order, or by Postal Order as preferred. If a sale or exchange be not completed, we return the amount deposited, after making the same deduction. By this means buyers and sellers are secured against fraud.

2. Deposits.—Postal Orders (drawn on General Post Office) and Cheques must be made payable to W. Herrod-Hempshall, and crossed "London County and Westminster Bank." The numbers of the Postal Orders should be kept by the sender.

We cannot be responsible for any loss that may occur in transit.

3. Honey on Approval.—All honey will be sold by sample, which must be sent direct to buyer.

4. Bee Appliances.—In ordering, the time allowed for completing the order to be stated to us when sending cash. If maker accepts, we hold cash until transaction is satisfactorily completed, when the amount will be remitted, subject to conditions as in Clause 1.

5. Bees and Queens.—These will be dealt with entirely by the parties concerned, so far as price, &c., go, and when the purchase is satisfactorily completed cash will be remitted as per Clause 1.

6. Goods in Transit.—These are at the seller's risk, i.e., any damage to or loss of an article on its journey is borne by the vendor; but a rejected article must be properly packed and returned by the same means as was used in sending it.

7. Carriage.—The carriage of all goods, except such as are sent by post, is payable by the buyer, unless otherwise agreed. If any article sent on approval be returned, each party to the transaction must pay carriage one way.

## Books for Bee-keepers NOW IN STOCK.

Cash in full must be sent with order.

		Postage
A Modern Bee Farm .. .. .	7/6	8½d.
(To be obtained from this Office only.)		
Beginner's Bee Book (PELLET)	5/-	4d.
<b>BEE-KEEPING SIMPLIFIED FOR THE COTTAGER AND SMALLHOLDER</b> (W. HERROD- HEMPSELL, F.E.S.) .. .. .	1/-	2d.
<b>BRITISH BEE - KEEPERS' GUIDE BOOK</b> (T. W. COWAN)		
Paper covers .. .. .	2/6	3d.
Cloth covers .. .. .	3/6	4d.
<b>Dissectible Model of Queen Bee FERTILISATION OF FRUIT BLOSSOMS BY BEES</b> (T. W. COWAN) .. .. .	-/3	1d.
Honey and Health (A. HOPE) ..	-/6	1d.
Honey Vinegar (REV. G. BANCKS)	-/2	1d.
<b>How to Keep Bees</b> (ANNA B. COMSTOCK) .. .. .	5/-	4½d.
Prevention of Swarming (WILKES) .. .. .	1/-	1½d.
Pollination of Fruit in relation to Commercial Fruit Growing (C. H. HOOPER, F.R.H.S.) .. .. .	-/6	1d.
<b>PRODUCING, PREPARING, EXHIBITING AND JUDG- ING BEE PRODUCE</b> (W. HERROD-HEMPSELL, F.E.S.) .. .. .	2/-	3d.
<b>Queen Rearing in England</b> (F. W. L. SLADEN) .. .. .	1/6	2d.
Snelgrove's Method of Re- queening .. .. .	-/6	1d.
The "Townsend" Bee Book ..	2/6	2d.
<b>WAX CRAFT</b> (T. W. COWAN) ..	2/-	2½d.

### MISCELLANEOUS.

The Lore of the Honey Bee (TICKNER EDWARDS) .. .. .	2/-	3d.
Life of the Bee (MAETELINGCK) ..	5/-	4d.
<b>THE BEE WORLD</b> (supplied only to members of Associations interested in the control and development of the Apis Club, apart from ordinary members of the latter), per copy .. .. .	-/8	1½d.
<b>The Bee Master of Warrilow</b> (TICKNER EDWARDS) .. .. .	7/6	4½d.

British Bee Journal & Record Office,  
23, BEDFORD STREET, STRAND, W.C.2.





## Seasonable Hints.

At the end of the year we almost involuntarily glance back with our mind's eye on the happenings during its passage. To bee-keepers the past season has, in general, been one of disappointment. Those who can remember say it has been the worst for 50 years.

The ranks of those engaged in the craft have been depleted. The death of the veteran, Dr. Miller, is a world-wide loss. Among those with whom we were more intimately acquainted, and who have passed over, we miss Mr. J. N. Smallwood and Mr. T. Bevan.

In spite of the bad season, the craft has advanced. Bee-keepers are more numerous, and our knowledge has been extended. The scourge of the past few years, known as "Isle of Wight" disease, appears to be definitely on the wane in the south of the country, but heavy losses are still reported in the North of England and in Scotland. The year will be memorable for the discovery by Dr. Rennie of *Tarsonemus woodi* as the probable cause, or one of the causes of the disease. No doubt we shall learn more of this mite during the next year.

We hoped to have seen legislation to deal with bee diseases in force before the end of the year, but the wheels of Government Departments move slowly, and though the proposed Bill has not been much heard about lately, it is not by any means dead, and may be on the Statute Book before the new year is far advanced.

We are afraid the mortality among bees this winter will be heavy, not from disease, but owing to a shortage of stores. It is now possible to get sugar without the trouble of vouchers, and though the price is very heavy compared with that of pre-war days, money spent in buying sugar to keep the bees alive will be a good investment. Any colony about whose supply of food there is the least doubt—and there must be many such—should be kept supplied with candy, renewing the supply as it is exhausted. If there is any suspicion of disease about, the candy should be medicated, *but do not mix any flour with it at present.*

See that the bees are kept dry; should the quilts become damp, replace them with

dry ones, and, if possible, remedy the defect that has caused the dampness. Do not forget that nothing is more penetrating than half-melted snow. In dry and frosty weather snow is a protection from the cold, but as soon as a thaw comes it should be removed from hive roofs, or it will probably make the inside of the hive both cold and damp. Hive entrances should also be protected from the light reflected from snow, especially when the sun shines, or many bees may be tempted out, to their destruction and the weakening of the colony. Protection should also be given against the depredations of mice and tits, and for this there is nothing better than a piece of small meshed wire netting secured over the entrance. Mice may find an entrance through the ventilation hole in the roof, or the roof may be slightly displaced by wind, giving them access to the quilts. Coconut shells, or small tins filled with fat, and hung about a little distance from the hives, will give tits food and occupation apart from molesting the hives.

Do not forget the main point to watch from now, until bees are able to forage freely, is the food supply. Having made this secure, we hope all our readers will have a prosperous season in 1921.

## A Dorset Yarn.

A letter from a county Durham bee-keeper queries of increase without natural swarming. This has so often been dealt with in the JOURNAL it seems a waste of space to go over the same ground again. In May and June strong stocks were divided by taking out four or five combs of brood and bees and with them the queen, place them in a new brood box, or one that has been thoroughly cleaned; add bars of new foundation firmly wired in, or other bars of comb that have been used for extraction the previous year; the parent stock having all queen cells but two cut out, and other bars added to make up the number. This was done in several stocks this year, only one of which swarmed after division. My friends demur at leaving two queen cells, but one can never be sure that each cell has a perfect queen, if both come out at once the workers have plenty to do drawing out fresh cells that they let the two queens fight it out rather than swarm at that time, that is as we found it the busy time this summer. This seems to be the least trouble in getting increase without swarming; only bees do not always act the same each year. One of my neighbours had a swarm come out with the queen from the new box the following day after division, she was put back again,

the following day being wet she had to stay there, and did not risk another try on at swarming.

"Would it do to put on a second body box on a stock of ten frames with full sheets of foundation?" The same writer says he has no drawn-out combs. We did this with several stocks this year; some we put on top, some underneath, the brood chamber. Where the combs were drawn out the queen soon took possession; those underneath were entered first.

To me, it seems best to try all ways of increase as a means to an end—that is surplus honey. If bees swarm of themselves they do not stop at one swarm, but will give off several if the queen cells are left intact.

This last season we have tried several ways to get sections filled up quickly, have placed them over the brood chamber with another box of standard bars over them after the sections were started. We always try to get sections filled as quickly as possible, as they sell best in summer when so many visitors are in Bournemouth. Have tried all methods advanced by writers of books, as well as ways advanced by writers in the JOURNAL, to build up population quickly; the extra brood box of combs with a good queen seems to be the best means to do so; even though the workers fill the tops of combs with honey, they leave a space for the queen to lay eggs in the brood circle. She only laid one lot; after the brood had developed the workers filled the cells with honey after the young bees had left them. The divided stocks gave me the most sections, and as I previously stated only one of them swarmed. I hope this has been made clear to our Co. Durham reader; will write him when time is more free.

Our bees were active on two days last week; they were dragging out some of the old ones that had gone under in the week of frost. I notice the fowls eat up these as soon as they are on the ground (they are never so eager to get near the entrance in summer). Only saw bees on the wing once, and that was on Christmas Day at noon after church; but the ball of bees under the peephole of glass were all in motion, so conclude that all is well with them—J. J. KETTLE.

---

### Honey Imports.

The registered value of honey imported into the United Kingdom during the month of November, 1920, was £8,187.—From a return furnished by the Statistical Office, H.M. Customs.

## Notes from Gretna Green.

CANDID COMMENTS.

I don't know what proportion of present-day *B.B.J.* readers were subscribers when Mr. W. B. Carr was editor; but I do know that the regular contributors under the old *régime* are with one exception entirely absent from the JOURNAL of to-day.

[Comparing the list of contributors of 1909 with that of 1919, we find seven. Mr. Ellis forgets himself.—Eds.]

I have a distinct recollection of Mr. Carr stating that the main strength of the *B.B.J.* lay in the fact of its contributions being "written by bee-keepers for bee-keepers." The leading contributors then, Mr. Macdonald and Mr. Woodley, did indeed "write as bee-keepers, and solely about bees," for the interesting and instructive articles by these truly able men are quite free from any "irrelevant matter." Their energies were not diffused over horticulture, arboriculture, and agriculture, but concentrated solely on apiculture.

The writings of "D. M. M." are a perfect mine of information on bee-keeping, the results of his own experience and gleanings from the bee literature of other lands. The two leading contributions of the present day JOURNAL are more versatile and cater for those interested in other "cultures" than apiculture, and the question is whether such "side lines" are desirable in "a journal devoted to the interests of bee-keepers." On page 605 I suggested that the majority of *B.B.J.* readers would prefer to hear Mr. Kettle on honey production rather than on market gardening.

The editorial note suggests the exact contrary, and also runs contrary to the views expressed by Mr. W. B. Carr. In the coming year let us hear less of horticulture and more about better bee-keeping. I see no reason why really practical men, such as Atkinson and many others, who are rarely heard from, should not be invited to contribute oftener to THE BRITISH BEE JOURNAL. The veteran Simmins, a former contributor, might be asked for contributions justifying his assertion that given certain treatment "no apiary and no colony need ever be lost through 'Isle of Wight' disease." And why should Smith not be asked to give his views on the subject also?

These suggestions of mine may be pertinent, but they certainly are not, or meant to be, impertinent. My views may not be acceptable to some readers, and they will doubtless send letters of protest to our editor and others. I attach little importance to such missives, written *sub*

*rosa* and probably by "nature lovers" or non-beekeepers.

In fact, the only reader who has openly challenged my views actually admits that he has never kept bees! (Page 598.)

I scarcely think this entitles him to criticise me, unless, perhaps, in the Gilbertian sense that a person who had never been to sea was best qualified to be "ruler of the King's Navee."

But I don't expect to find any practical bee-keeper finding serious fault with the suggestions put forward in this and recent contributions of mine.—J. M. ELLIS.

[We did not intend our note on page 605 to bear the interpretation Mr. Ellis puts upon it. It is one of those things that should have been worded better. Taken in conjunction with the whole of the preceding paragraph, it certainly would convey that impression. What we meant was that we are naturally more in touch with our readers than Mr. Ellis, and therefore in a better position to judge whether they prefer articles on the cultivation of flowers for bees to be published, or consigned to the waste-paper basket.

The point at issue is not whether the writings of this or that contributor are correct (was it not Mrs. Malaprop who said, "Comparisons are odorous"?), but, as stated by Mr. Ellis in his first letter on the subject (page 570), whether articles telling what flowers are best to grow for bee forage and for profit to the bee-keeper are "entirely alien" to bee-keeping, *we say they are not*, and to that opinion we still hold. Bees and flowers are too dependent one upon the other to be in any way alien to each other. One writer may tell how and when to grow forage for the bees, and what are the most useful flowers for the purpose, and another may tell how to manage the bees to take full advantage of the forage provided, but no matter how skilful the bee-keeper may be, his efforts will not avail if there is a lack of flowers, for without them bees are useless.

We adhere to our note on page 606. *That matter is our business.* We do not doubt the good faith of Mr. Ellis, and though he may have had no intention of being impertinent, the paragraph was so tactless as in our opinion to amount to that. It is not within the province of Mr. Ellis to catechise us as to whom we have asked for contributions, or why we have, or have not done so. In reference to a remark in the first paragraph of his notes on page 592, we may say that so far as the writers he mentions, and others also, our relations with them are perfectly cordial.

We suggest this matter should now drop. Mr. Ellis has had his say and made his protest. We see no reason for altering

our policy, and those who enjoy Mr. Kettle's and other writers' articles, and find in them information that is of value to bee-keepers, may be certain such articles will still find a place while the writers continue to send them. Probably in another ten or twenty years, whoever may have the honour of occupying our chair, will be receiving letters bemoaning the loss of such writers as Kettle, Hemming, etc., and asking that their articles should be reprinted!

With reference to the suggestion to invite Mr. Simmins to justify certain statements, as to treatment in order to escape "Isle of Wight" disease, possibly he may find time to do so some time in the near future. We notice in a contemporary Mr. Ellis says that "practical bee-keepers working on common-sense lines have found a remedy and succeeded in mastering 'Isle of Wight' disease," and also that these methods "have kept my small apiary free from any loss since 1918." Will Mr. Ellis give these methods for the benefit of our readers? We venture to say they will reach a far greater number of bee-keepers than they will in the columns of a newspaper, and be more acceptable to them than this controversy.—Eds.]

## The Season in Aberdeenshire.

(Continued from page 606.)

Right on to the end of July the weather conditions were most unfavourable both to bees and to the secretion of nectar. Day succeeded day, dull, cool, and sunless with cold winds often blowing and the temperature several degrees below normal July weather. There were in all only some six or seven days which could be really designated "bee weather," although the afternoons sometimes brightened up, and bees took full advantage of the few hours left to them. No "slackers" and no "ca' canny" policy with them! All through East Aberdeenshire and the North-East of Scotland generally white clover was unusually abundant, and had the weather been right a good harvest would have been reaped.

Taken all over the results may be put as follows:—Very few colonies gave up to 80lbs. surplus, and many good stocks managed up to between 30 and 40lbs.; fair stocks registered about 20lbs., and many gave no surplus at all. Late swarms and the parent stocks which gave them will require feeding to pass the winter safely.

August came in with little improvement in weather, although on the whole the temperature was a little higher, but the honey flow from white clover was over

with probably the poorest honey harvest on record. Heather districts had practically a similar tale to tell, and only about one-third of a good seasons' crop of heather sections materialised by the middle of September, which month was notoriously wet and foggy, keeping both farmers and bees in enforced idleness. Much damage was caused to corn crops by excessive rains followed by thick fogs throughout September. Since then the season has been a remarkably mild and open one.

Reference has been repeatedly made in *B.B.J.* during the past season to the large number of queens lost on mating flights. In the course of a month's touring work for the Aberdeen and Kincardine Association I found this loss very serious in some districts, especially so in the more exposed localities. In one apiary where I "drummed" five skeps, three were without queens or brood, and had dwindled greatly since they had swarmed six weeks previously.

J.O.W. disease, although still prevalent in several districts, seems to be losing its grip somewhat, and cases where stocks had thrown off the incubus and were healthy and vigorous, are on the increase. Indeed, some apiaries that had more than once been almost destroyed are now carrying on successfully. We all look forward to brighter prospects next year.

## The Drone . . . . in 1920.

Before the year closes may the writer be allowed to add to the records already made by others, his personal experience? Even if it comes, as it were, as a tale that is told, and from a novice withal, it may suggest direction for observation to others more adept at manipulation. That implies that these notes are offered in complete humility of spirit.

Be it known to all men by these presents, that . . . .

In a south-west corner of Staffordshire, in the beautiful borderland that opens upon the Severn valley and the rich Shropshire countryside, right in the heart of the Albrighton Hunt, lies a garden—just a villa garden—from the pathways of which one looks out across miles of undulating agricultural lands. There is the location of the novice's hives, and round about, in great profusion, all the nectar-yielding plants of value, in their season.

I commenced the 1920 season during the third week in April, with a splendid ten-frame stock of hybrids sent to me by a well-known breeder, as headed by a 1919 queen, and likely to swarm very early. The hive, capable of carrying twelve standard frames in the brood chamber, was made up to its full frame capacity

when the bees were installed. It was good to see how those bees went to work. Within ten days they had drawn out, and fully occupied the additional combs, and supers were added to give room. In a fortnight they had from 15 to 20 lbs. of honey in the shallow combs. They were left at that, and watched.

There appeared to be a huge preponderance of drones, and upon occasions when it seemed a swarm might issue drones were flying in great numbers. They crowded the alighting board, and the entrance and made pandemonium about the hive stand. My observations of those days led me to the conviction that the drones were to some extent masters of the situation. The foragers seemed greatly disconcerted. Coming from the hive they had difficulty in getting away. Returning they had greater difficulty in effecting entrance with their loads. Many, many loads were lost then. The little balls of golden, yellow, and grey pollen lay about all over the place. I believe that to the worker bees, as to my intelligence, the drone was an intolerable nuisance.

Eventually, the swarm issued, and I had hopes. The swarm was secured, and hived, and has made excellent progress, having apparently settled down to winter thoroughly tucked in in something approximating to its own natural way. That hive is a special one of my own construction—patented—and now in the hands of Dr. Abushady.

But those drones still persisted with their methods in the parent hive, and as a consequence no less than five strong casts emerged, at proper intervals, after the prime swarm had been taken. After the first cast I used every means I could devise to trap drones. Whole areas of drone-brood, capped and uncapped, were destroyed, and only one queen cell out of four found was left to mature. By the aid of an excluder, when signs of swarming were in evidence, I managed to trap and drown some thousands of drones, and it appeared the only way. I sought to enlist the aid of the bees themselves by removing the honey surplus, but they had been before me: they had reduced it to one quarter. Of course, I took that away.

Had I had a stock of queens to fertilise no one could have desired better specimens than the really beautiful drones I was blessed with.

In my case, to sum up, drones had a riotous season, which had its effect upon the honey storage, and evidenced itself in at least one other undesirable way. Rightly or wrongly, I have formed the conclusion that during 1920 nature has been at her vagaries with the bees as

with other creatures. Try as we might, we could not adequately control this drone preponderance. Everyone seems to have some comment upon the excessive number of *male* creatures in some direction or other. Poultry-keepers, I understand, are complaining of the number of cockerels hatched as out of all proportion to pullets. I have myself been fortunate this year in purchasing a valuable pedigree Shorthorn bull, from well-known breeders, an opportunity which would not have occurred had the sex of the animal been different.

But the most unpleasant feature of the drone's activities is one for which I shall keep close watch in future. After one period of disturbance, such as I have described, I saw upon the alighting board a worker bee in trouble; there was a protuberance from the extremity of the abdomen which I regarded as excreta. Pouncing upon her, I carried her carefully indoors, and placed her under a powerful microscope. Imagine my consternation at finding there the genital organs of a drone!

No, Sir. That bee was an ordinary worker, she was not a young queen.

A. G. CHANNON-DAVIES.

Woodcote,  
Wightwick,  
Near Wolverhampton.

## Wit and Wisdom on the Cotswolds.

I have often been much amused at the sayings of cottage bee-keepers, and in the attached have related a few of them; thinking you might like them for the BRITISH BEE JOURNAL.

He shuffled to the old wall and looked over up the crooked village street.

We had just come from the bee-garden, where a row of skeps stood along the edge of the path.

"Noa," he said, scornfully, "I never 'ave fed 'um an' I beant a-goin' ter begin now at seventy-four. As I says ter the missus, if they dies wen I takes nuthin', where 'ud they be if I did? Look at that there 'cut' (skep) now. He've got no honey I'll be bound. an' the wampses be allus a-goin' in an' out. I can't stop the varmint nowhow. Now, 'spose I fed 'um what 'ud I be doin'—Feedin' the wampses—course I 'ud."

\* \* \*

I cycled through the village in search of bees to drive. A friendly skeppist directed me to call on "owd David, 'cause 'e've got a sight o' bees in 'is garden."

Arrived at the gate of his cottage,

"owd David" came down the garden path, the two black patches on the knees of his corduroy trousers looking strange in the sunshine.

"Noa, sur, I doant want my bees druv. I allus takes 'em myself, I does. I likes ter be ke-ind ter my bees! I allus stifles 'em, then I knows wat be-comes on 'em."

\* \* \*

The old countryman looked in distress. One eye closed up, and the other nearly so, so that to open either fully required the help of thumb and forefinger.

His mountainous cheek told its own tale. He had been stung! This was how it came about.

"One o' them bee-men came ter I an' told I as if I'd let 'im put 'is bees in my gardin they 'ud fert'lise the blos-soms, an' we 'ud 'ave more fruit, more gooseberries, more broad be-ans. So I looked at 'im, then I says, 'That's wat we wants, bring 'um 'ere, and put yer boxes along yon 'edge.' Well, 'e brought 'um on a ke-art, an' we put 'um along under the 'edge. 'e used ter look at 'um a lot, I thought. 'e called it 'manip-er-lashion,' blowing of 'em with 'ee's bellis. I said 'twas messin' 'em about! Well, wen the fruit was ripe we started to pick it by 'em. We wasn't ther' long. They come out arter I, an' kiched I on me fe-oice. Talk about more fruit! We couldn't pick what we did 'ave!

"So I goes down ter the police-station an' arsts fer two summonses. They looks at I, an' says, 'What d'yer want ter take two summonses fer?' 'Well,' I says, 'I 'ad two stings, didn't I? Look at me fe-oice!'

"Noa, I beant a-gwine ter 'ave no more bee-boxes in my gardin—not if I 'nows it."

\* \* \*

I pulled up outside the cottage with a side-car load of boxes ready to begin bee-driving. Already I could hear the deep, heavy hum of bees as they flashed over the wall. Some unusual commotion seemed to be in progress, so I inquired of the cottager's wife the reason.

"Aye, maister, 'tis a sad job," waving her hand in the direction of the church, lying in a dip in the village, "all the marning they've bin at it, a-terrifying of 'em. The passon's bees be on the rampage! 'E kips them wooden bee-boxes: an' e an' 'is man be allus a-robbin' of 'em. 'E makes 'em that powerful—then 'e goes an' robs 'em o' their 'oney. As I says ter Jones (her husband) them bees baint a-gwine ter stop robbed long. No, that they baint. I'll be dazed. They turns to an' robs ourn. T'other

night Jones plastered up round the 'oles o' our skips with a bit of summut, but that didn't stop 'em; not it! They be that daring—goes in an' drags urn out, an' makes off with the 'oney. I believe they sucks our bees dry. I'll give the passon a bit o' my mind—that I will—as soon as ever I claps eyes on 'im."  
—A. H. BOWEN.

## Novelties for 1920.

CANDY FEEDING BOX.

Miss H. C. Master, of Morton Grange, Thornbury, Gloucester, has invented a

the glass cover, and the bees will once more have free entry into the box.

According to the sample sent to us for inspection and as shown in the drawing, the entrance to the bee escape *a* is always open, and it appears to us that the candy granules will tend to choke the escape. As the escape is only required when the hole *b* is closed, it might be an advantage to so construct the slide *c* that it covers the escape entrance when the hole *b* is open and uncovers it when the hole *b* is closed. Or possibly a separate slide could be provided for controlling the entrance to the escape.

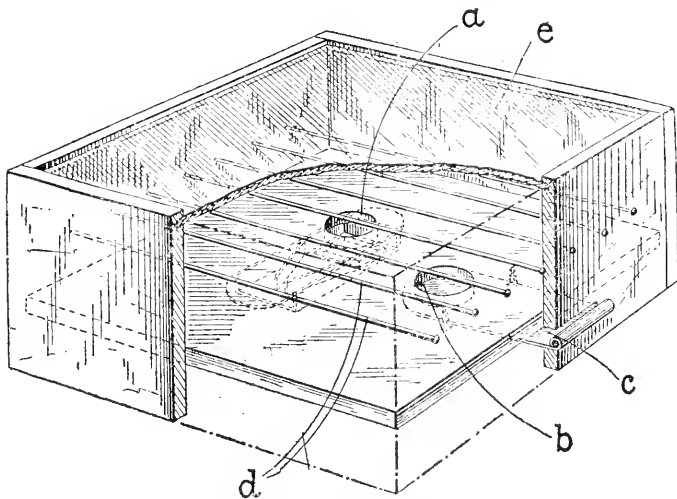

THE MASTER CANDY FEEDING BOX.

new appliance, of which we give an illustration. It consists of a candy feeding box having a bottom fitted with a Porter bee escape *a* and formed with a hole *b* that is controlled by a slide *c*. Extending across the box above the bottom are lengths of wire *d* adapted to support a cake of candy, and a glass cover *e* is arranged to slide in grooves formed in the walls of the box.

The appliance is particularly suitable for use by inexperienced persons, and will, no doubt, be welcome to nervous beekeepers, for one can see at once when a fresh cake of candy is required, and by manipulating the slide *c* so as to close the hole *b*, which is, of course, normally open to allow bees access to candy in the box, the bees will in due course pass down through the bee escape *a*, and when all the bees have in this way left the box the glass cover *e* can be withdrawn and a fresh cake of candy placed in the box in comfort, and without risk of stings or disturbing the bees. The slide *c* can then be again withdrawn, after replacing



*The Editors do not hold themselves responsible for the opinions expressed by correspondents. No notice will be taken of anonymous communications, and correspondents are requested to write on one side of the paper only and give their real name and addresses, not necessarily for publication, but as a guarantee of good faith. Illustrations should be drawn on separate pieces of paper. We do not undertake to return rejected communications.*

### Native v. Foreign Bees.

[10356] In reference to Mr. Wood's letter (10,345) I would like to say that I think we are a little at cross purposes. In speaking of "Italian" bees I always mean the Italian variety, that is the bees with three yellow bands, which are originally indigenous to Italy. It may be that they have been bred for many generations in our climate, or even a much

colder one. I cannot speak with any certainty of bees from queens imported from Italy, since I have never had such a thing. I have bred pure Italians myself, and bought them from other English bee-breeders, and also from bee-breeders in the United States. I do not think Mr. Wood will contend that bees bred for many generations in the Northern States of America can be described as delicate or unsuited to our climate.

I recognise, of course, that it is necessary for breeders in this country to procure a certain number of queens from Italy in order to have the means of breeding an acclimatised strain of Italian bees here, but I believe it a great mistake to import numbers of Italian queens and send them direct to thousands of English bee-keepers. It is a policy I am unable to understand. More especially does this appear to me to be the case when one considers the terms on which business is done in queens between this country and Italy.

Do your readers ever consider the rate of exchange in these matters? Looking at the paper to-day I find that the Italian exchange is about 98, which means that a pound sterling will buy nearly 100 lira or four times the normal rate. Therefore for every queen an Italian queen breeder sells at 10s., let us say, he gets £2 worth of Italian currency. But I may be told that the payee cannot buy much with his 100 lira—well perhaps not, but he can buy as much with 10s. sterling as he can with 50 lira paid to him by one of his own countrymen. It would be interesting to know what the charges for queens are in Italy.

However, post-war conditions have left the exchanges in an extraordinary condition all over the world, and I find if I buy a queen in America I have to buy dollars at about \$3.40, because while Italians are ready, and indeed careful to price their goods in *sterling*, Americans take jolly good care to do nothing of the sort.

Beyond all this is the fact that, as Mr. Wood says, if you want to weaken your strain of bees, purchase from a semi-tropical climate.

If I might venture to put my finger into such a very hot stew, I would suggest that possibly what Mr. Ellis (p. 592) means is that it is a mistake that *such a very large proportion* of the space of the B.B.J. is devoted to subjects alien to the business of bee-keeping, such as "Jarge and William," gardening, doggerel rhymes, etc. But myself I fully appreciate the fact that you, sir, as editor should, and no doubt do, know the stuff that sells best, which is, after all, the thing. An editor puts into a paper as far as he can what the bulk of his readers like. For instance if

business fruit growers liked to read all about bees, rabbits, poultry, etc., why I suppose the editor would put it in, and the "Fruitgrower" would change its character accordingly.—R. B. MANLEY.

### Experience with Swarms in Ireland.

[10357] I notice in THE BRITISH BEE JOURNAL that you recently expressed a wish for notes, etc., from Ireland, and possibly two experiences that I had this last year might be of interest to some of your readers. Both these experiences were in connection with swarms. The first were not my bees, but belonged to a friend of mine, who telephoned to me that the bees had swarmed in the absence of the owner. I went and got these bees with difficulty, as they had swarmed on the bough of an oak tree some 25 ft. high, and hived them. This was early in July last. They were put into a hive with ten frames, with full foundation in same, and they had these drawn out within a week, being a very strong swarm; I should imagine it weighed 6 or 7 lbs. Three racks of sections were put on, and at the beginning of September about forty-five good sections were taken from this swarm. A little later in September I examined this hive again, and found that they had over 30 lbs. of honey in the brood chamber to winter upon. At the time it was a complete mystery how these bees were doing so well, as, to start with, it was a very late swarm, and there were two other stocks in the same garden within a few feet of them that were doing nothing at all on account of the exceedingly bad weather in the district. The whole year was bad from the very start. The fruit blossom was practically a failure, as it was very wet and cold at the time the blossom was out. The clover was not much better, as there was so much rain. We also get in this district a very fine crop of blackberries, but this was also poor this year on account of the rain and cold. I examined the other two stocks at the same time, and found that they required a considerable amount of feeding for the winter. When I heard of this swarm first I thought it was most probably from one of the other stocks in the garden, but on examination of these stocks I found that this was not so, although they were the same kind of bees—pure Italians—and therefore it was a mystery where they came from. However, just about this time the owner heard by accident that a swarm of pure Italians had been lost in July from quite close by, and not only had they lost the swarm, but the hive they came out of had been robbed of prac-

tically every particle of honey that it contained. Without a doubt I think this solves the mystery of how the swarm gave such a fine surplus and stored such a large amount of honey in so short a time.

I am only a beginner with bees, having kept them only for two or three years, but I have spoken to several experienced bee-keepers about this matter, and I have not yet heard of anybody who has had a similar experience of a swarm robbing the stock that they swarmed from, and I should be much obliged if the editor would put a footnote to this letter, and let me know if this is a common occurrence.

[It is not at all a common occurrence.—Eds.]

Another interesting experience that I had with my own bees was a stock that were in a large hive with about fifteen frames, which swarmed in the middle of July last. As just at this time there had been a considerable amount of rain, I did not know they had swarmed until I received a message from some friends of mine who live about two miles distance away that there was a good swarm of bees in their apple loft. I went to this place and found that this swarm had taken possession of an old hive with ten frames of comb which had been put away in the apple loft. The previous year the bees in this hive had died from "Isle of Wight" disease, and the whole hive and frames of comb had been put in the apple loft and forgotten. This hive had about 25 lbs. of honey in the combs. I took the whole lot home and immediately examined this large hive, and found that it had swarmed a few days previously. Without a doubt these bees had swarmed from this hive, as they were hybrids, and I do not know of anybody else who has bees of this kind within the immediate vicinity. The swarm was a very good one, and covered ten combs, and they had not to be fed at all for winter, as they had ample stores. They showed no signs whatever of disease from being put into a diseased hive, and I believe they are absolutely all right. To me, at any rate, the above two experiences are of considerable interest; first, what bees will do where robbing is concerned, and secondly, the question of bees taking possession of a hive that was diseased. Naturally, I shall watch this hive closely next spring. It has been a very bad year in this district on account of the reasons mentioned before concerning the weather.

I must say, in again referring to the article in which you invite correspondence from Ireland, and also certain articles in your paper not altogether bee articles, as a very keen beginner I should be very sorry not to see such articles as are written by Mr. Kettle and others every

week. They are of great interest to me from the horticultural point of view, as well as bee-keeping.—J.S.D., Sth. Co. Dublin.

### The B.B.J. and its Contributors.

[10358] Since the matter appearing in THE BRITISH BEE JOURNAL has lately become the subject of criticism, perhaps a few candid remarks from an old reader may not be unwelcome. Whether you print the whole or only portions of this letter, or consign it to the waste-paper basket, I shall not quarrel with your judgment, but I wish to write quite frankly.

I shall not waste time praising the good qualities of THE BRITISH BEE JOURNAL. It is sufficient to state that I have taken it regularly for 20 years, and intend to go on doing so.

While fully admitting the merits and interest of the writings of Mr. Kettle and others which go outside the limits of bee-keeping proper, and recognising that they may be of considerable value to many readers who combine, or contemplate combining, bee-keeping with other kindred pursuits, I must confess that I personally prefer THE BRITISH BEE JOURNAL of 20 years ago, with its articles by Messrs. Woodley, Loveday, D. M. M., and others, with occasional extracts from American bee papers by such masters of the craft as the late Dr. Miller and G. M. Doolittle. Their writings were mostly confined to the practical apiculture, and were full of good things equally interesting to the novice or the advanced bee-keeper.

The really weak point of THE BRITISH BEE JOURNAL to my mind, however, does not lie in its excursions into market-gardening, fruit culture, etc., but in its apparent readiness to print almost any communication received. Here, I know, I am on dangerous ground. THE BRITISH BEE JOURNAL needs and deserves all the support it can get, and it is not unlikely that some persons might cease to take the paper if their letters were not printed. The Editors have to consider all this. We sometimes get letters propounding wild theories about diseases and other difficult questions, or opinions from absolute novices as to the merits of this or that hive or race of bee. Such matter could well be left out. I do not wish to see unorthodox theories excluded, nor unknown writers muzzled, and beginners' letters are worth printing when they have something interesting to relate, but nothing should be inserted unless it possesses a certain intrinsic value or interest. I refrain from giving examples, as I think the sort of thing I am criticising will be quite clear both to you and your readers.



Because I have confined myself to what I consider defects in THE BRITISH BEE JOURNAL please do not regard me as an unfriendly or hostile critic. THE BRITISH BEE JOURNAL has far more good points than weak ones.—L. ILLINGWORTH.

[We appreciate and quite understand Mr. Illingworth's criticism. Some of the letters and articles published we do not like, but if we consign them to the waste-paper basket we should at once be accused of muzzling writers with whose ideas or theories we do not agree. We do not want the JOURNAL to be a reflection of our own opinions only, but to give all a chance as far as possible. We will bear our correspondent's remarks in mind, but we cannot promise to exclude all the matter he takes exception to. We do not by any means print *all* we receive, even if otherwise short of "copy." We have a decent-sized file of unpublished manuscript.—Eds.]

[10359] I don't for a moment suppose that a little superficial clamour would lead you to put your blue pencil through the interesting nature notes interspersed through the communications of some of your best contributors; but, lest you should be adversely influenced by such criticism, I write to remind you that many of your readers would be greatly disappointed to miss the touch of human or general kinship with nature, which not only brightens the articles, but enables one to enter into an appreciative contact with the writer's mind.—FRANK T. PAUL.

### The Production of Heather Honey.

[10360] I expected someone more able to write than myself to make some remarks on Mr. Price's lecture on heather. In the first place, he states that the queen stops laying *after the honey harvest* is over, which in my district is about September 15. So, if she was to lay up to this date, they would make good bees for wintering; but my experience is that she is crowded out of empty cells to lay in as *soon as the honey flow is on*, filling every cell with honey as the bees emerge, with only a small patch of brood at the end of the harvest.

But what struck me most was the statement by such an authority as Mr. Price that pure heather honey does not granulate, when, as a matter of fact, I have never seen a sample of pure heather that would *not* granulate if not heated. I may say that I have been a bee-keeper for thirty-nine years on a large scale, and with thousands of acres of heather to work on (and I always have some bees amongst the heather, where they can have nothing

else to work on); also, I have won scores of prizes for heather honey at the best shows over England, and against some of the best Scotch exhibitors, such as Mr. McNally, etc. I am not boasting of this, but merely to prove that I know something of what I am writing about. What made me write this was that it was very misleading to buyers of pure heather honey. I should like to see a word on this by bee-keepers in heather districts.—J. BERRY, Llanrwst, N. Wales.

[Mr. Berry is well known to all bee-keepers as a producer and exhibitor of heather honey, in which class he has won a number of prizes. Anyone who can beat him on the show bench with heather honey may pride themselves on the achievement. His opinion, therefore, carries weight. We believe that Mr. W. Herrod-Hempsall first stated that pure heather honey does not granulate (see our note to letter 10355, page 622), and Mr. Price, in his lecture, agreed with him. We are open to conviction, and should be pleased if Mr. Berry could send us a sample of *pure* heather honey that has granulated.—Eds.]

### Re-Queening, Acari, etc.

[10361] I should like to tender a word of advice to those who may contemplate the de-queening of their stocks in order to secure increased surplus to be careful, or they may defeat the very end which they have in view.

I agree that it is quite necessary to exercise some form of brood-control at the time of the honey-flow, especially with Italians, whose tendency to make brood-production keep pace with the gathering of store is their great defect. But of all the known ways of effecting this, de-queening the stocks is, in my experience, the very worst, and in my own apiaries I have repeatedly seen a stock which had previously been working splendidly "down tools" immediately on being de-queened, and refuse to do another stroke of work till provided with a laying mother.

There is now a vast amount of Italian blood in the country, and I rather suspect that the imperative need for checking the brood during the honey-flow, if a surplus is to be obtained, is not so well understood as it might be, where Italians are concerned. It might not therefore be a bad thing if during the dead season you could open your columns to a good discussion of the best means of effecting this without discouraging the bees.

[We shall be very pleased to have any articles or letters on the subject.—Eds.]

With regard to the new theory of the causation of "Isle of Wight" disease, some of our friends seem a little premature in taking it for granted that every

case of crawling is due to acari, and that our old friend Nosema has nothing whatever to do with it. It is quite possible that paralysis of the wings and consequent inability to void fæces may be due to both acari and Nosema, and, indeed, to other causes at present undiscovered. So it is no use jumping to conclusions; we must simply wait and see.

"Bees do nothing invariably." I do not believe it. It is merely the house of refuge for the "expert" who tries to cover up his failure by attributing it to the perversity of the bees rather than his own lack of skill. A writer in the *American Bee Journal* recently put it more to my taste in something like the following words: "Bees invariably react in exactly the same way to a precisely similar set of conditions." That is a basis upon which science can build.—HUGH HOUSTON, Sidecup, Kent.

### Norwich Notes and Notions.

[10362] I offer a suggestion to foundation makers—why not coat a thin wood material such as used for dividers in section racks with wax with the usual worker cell impression? This would mean a stiffer foundation with less wax used. The advantages would be many, no wiring needed, no sagging, a flatter and stronger comb would be the result; this means much when one extracts from standard frames, also no breakdowns in combs when handling or travelling.

[This has been done some years ago. Other materials also have been used as a base for comb, but none of them have been a success.—EDS.]

If the wood material were cut the size of frames and sold, also a metal roller with the worker impression upon it, one could utilise his or her wax and make their own foundation these winter evenings.

I have one Italian stock I could say a lot about. This stands by itself, and for the last seven or eight years I must have had forty to fifty generations, all close in-breeding, and I can assure you that it is the best all-round bee I have had or seen, and this is saying something after all the strains I have tried. One strain I bought some years ago from a noted breeder was a Carniolan and Italian cross: this was the "stingiest" stock I have ever handled. A cross between two gentle strains makes a savage one. Dutch I have discarded long ago; Dutch and Italian cross are nearly as bad as the Carniolan and Italian cross.

In writing about perpetual honey flows, is it not a case of robbing sometimes? One of my Italian stocks did well in late October, stored enough for the winter

from somewhere. Some folks get perpetual "money" flows; the only perpetual I get is from my Percy with his "Perpetual Mobile" on the violin, it's a case of the sharps running after the flats; anyway, I must be content as a "natural."

I have seen Australian honey retailed in Norwich at 1s. per lb.; mine I sell at 2s. I have not a good pitch for getting honey, but I find that bees from a bad pitch do exceedingly well when they are removed to another one; they revel to make up for lost time, as it were.

The children are counting upon Christmas; the bee-men are looking for the New Year, and it's my sincere wish to all for a bright and prosperous one for them and the bees.—A. TROWSE, Eade Road, Norwich.

### Peculiar Behaviour of Bees.

[10363] *Re* letter No. 10349, I would suggest to Mr. H. E. Newton that the reason the fertile queens were cast out was that an unfertile queen had hatched in his six-framed stock, and she was the culprit. If the bees had balled the strange queens no doubt their wings would have been frayed very much.

When the swarm was united to the stock no doubt there were enough bees to defend their own queen.

I had a similar case this season, but only lost one fertile queen before I found the culprit, which was a queen very little larger than a worker, and I had hunted through the stock very closely before introducing the fertile queen.—RICHARD LING, Lime Tree Apiary, Briston, Norfolk.

### Combs from Other Hives.

#### Dr. Cummings and His Queen Bees.

According to Lord Frederick Hamilton, Dr. Cummings, the celebrated preacher of the Victorian era, was a great bee expert. One day he called to show Lord Frederick's mother four queen bees of a new breed, each bee travelling in a small paper bag. After displaying his treasures, being an absent-minded man, he slipped the bags into his tail-coat pocket, and shortly afterwards leaned against the mantelpiece.

The queens, resenting the pressure, stung for all they were worth. The grim parson, whose specialty was to foretell the end of the world at an early date, yelled with pain, and skipped round the room, to the great delight of the young Hamiltons, who were accustomed to see him in all his glory in the pulpit.—From *News of the World*, October 2, 1920.

## Special Prepaid Advertisements.

One Penny per Word.

Trade advertisements of Bees, Honey, Queens, and Bee goods are not permissible at above rate, but will be inserted at 1½d. per word as "Business" Announcements, immediately under the Private Advertisements. Advertisements of Hive-manufacturers can only be inserted at a minimum charge of 3s. per lin., or 5s. per inch.

PRIVATE ADVERTISEMENTS are only intended for readers having Surplus Stock to dispose of. Driven Bees, Nuclei, and Queens that are reared or imported for sale, are Trade Advertisements, and can only be accepted under trade terms. A charge of 6d. extra will be made if a box number is used.

Advertisements must reach us NOT LATER than FIRST POST on MONDAY MORNING for insertion in the "Journal" the same week.

Orders for three or more consecutive insertions in "The Bee Journal" entitle advertisers to one insertion in "The Bee-Keepers' Record" free of charge.

### PRIVATE ADVERTISEMENTS.

HEATHER HONEY, finest quality Scotch, in 7, 14 and 28-lb. tins, 24s. 6d., 48s., and 95s., carriage paid; also high-class White Honey.—WHYTE, Bee Farm, Cumbernauld, Dumbarton-shire. r.k.137

ERICA CARNEA, the heather that blooms in February, dwarf bushy plants, now showing bud, quite hardy, 4s. dozen, post free.—S. E. LYTLE, Dunbryan, Forby, Lanark. r.k.138

CORRESPONDENCE Courses in Bee-keeping.—H. E. NEWTON, Hobart Road, New Milton, Hants. r.k.69

WHITE LEGHORNS (Barron's strain).—Sittings of Eggs, 12s. 6d.; delivery January, February, March.—MRS. HOWARD LEE, Bowden, Burgess Hill, Sussex. r.k.130

WANTED, Handy Man who understands bees, horses, and can do rough joinery. State wages expected.—YOUNG, 42, James Street, Cambridge. r.k.117

NOW BOOKING ORDERS, delivery January, February, March, £2 sittings of Eggs and Day-old Chicks (Barron's), White Leghorns, Brown Leghorns; White and Fawn and White Runner Ducks, White Wyandottes, sittings 10s. 6d. to 35s. a dozen, Chicks double.—MRS. M. ANDERSON, Poultry Dept., Hermitage Poultry Farm, High Hurstwood, Sussex. Manager: Miss M. D. Sillar. k.93

PURE LIGHT CAMBRIDGE HONEY (guaranteed), 14-lb. tins, 30s.; 28-lb. tins, 57s. 6d., carriage paid.—YOUNG, 42, James Street, Cambridge. r.k.145

### BUSINESS ADVERTISEMENTS.

1½d. per word.

IMPORTED ITALIAN QUEENS FOR 1921.—List on application.—PEARSON & GALE, Marlborough. r.k.88

DEVONSHIRE.—Old Cottage with large garden, £100; Symonds Yat, two plots land, 1 acre and ½ acre. Herefordshire, seven-roomed Cottage, ½ acre land. All vacant and freehold. Ideal bees. Particulars, stamp.—SMITH, 117, Gt. Hampton Street, Birmingham. r.k.142

ARTISTICALLY Illustrated Catalogue in connection with Dutch Bees and Bee-keeping sent free on request, containing information about queens, management, etc., making it an interesting booklet.—WHYTE, "The Bee Farm," Cumbernauld, Dumbartonshire. r.k.144

MASHEATH HIVES are made by their designer and originator, M. ATKINSON, The Bee Park, Fakenham, who will be pleased to reply to all inquiries. r.k.141

ITALIAN QUEENS direct from Italy.—Address, E. PENNA, Bologna, Italy. Prist List for 1921 on application. r.k.144

ENSURE A GOOD HONEY CROP next year by purchasing one of our noted 6-frame Italian Stocks. Illustrated Catalogue free on application.—PEARSON & GALE, Marlborough. r.k.123

BEE BOOKS FOR NEW YEAR PRESENTS.—You can get the Books of the leading authorities in this and other countries from E. J. BURTT, Stroud Road, Gloucester. Special List free on receipt of a postcard. k.120

"WIGHT" DISEASE.—Prevention and removal. Advice 5s.—ALF. RYALL, Cottage Farm, near Camp, Stroud. r.k.143

BEEES AND QUEENS FOR 1921.—Send for our new Illustrated Catalogue, free on application.—PEARSON & GALE, Marlborough. r.k.127

IMPORTANT!—In spite of the increased cost of appliances and carriage, we are offering our celebrated 6-frame Stocks at reduced prices. Catalogue free on application.—PEARSON & GALE, Marlborough. r.k.129

KEEP IN TOUCH with modern bee-keeping thought by reading the bee-keeping journals. I shall be pleased to book orders for "Gleanings in Bee Culture," 7s. per year; "The American Bee Journal," 10s. per year; "L'Agriculture Française," 3s. 6d. per year, each monthly and post paid.—E. J. BURTT, Stroud Road, Gloucester. k.119

A WELL-ESTABLISHED FIRM wishes to hear of bee-keepers who would guarantee to supply them with Nuclei May-June next.—Box 107, B.B.J. Office, 23, Bedford Street, Strand, W.C.2. r.k.142

SEND POSTCARD only for our new Illustrated Catalogue of Bees and Queens for 1921.—PEARSON & GALE, Marlborough. r.k.126

HAVE YOU READ "THE BEE WORLD"? If not, why not? Every number in itself is a useful literary work for practice and reference. Specimen copy free.—Offices: THE APIS CLUB, Port Hill House, Benson, Oxon.

The products of the Apiary, of Poultry and Farm Stock, of the Fruit and Vegetable Garden can be Advertised and Sold through

## THE BAZAAR, EXCHANGE & MART

Newspaper.

Get a Copy—Thursday and Saturday 3d. The "Bazaar" publishes also practical handbooks by experts. Send for full catalogue, post free from—WINDSOR HOUSE, Breams Buildings, LONDON, E.C.2.

## THE British Bee-Keepers' Association.

The recognised centre of practical and scientific bee-keeping in Great Britain. Particulars and conditions of membership may be obtained from the Secretary, W. HERROD-HEMPSALL, 23, Bedford Street, Strand, London, W.C.2.

# 1921 IS COMING.

The following Unsolicited Reports may help you to ensure success, by using the Premier White Star Pedigree bees and queens.

Safe arrival of Queens and Nuclei guaranteed. Any queen lost from a Nucleus within three weeks from delivery we guarantee to replace.

## HUGE SUCCESS IN IRELAND.

"I shall come to you again for bees next year. The Nucleus you sent me was a huge success."

E. O'B.

Killiney, Co. Dublin.

## "WHITE STARS" ON TOP: IMPORTED ITALIANS A BLANK.

"The 'White Star' queen has done well. She has twelve 16 x 10 frames and twenty-four Standard frames. At present she is keeping to the 16 x 10 frames, the next (Standard chamber) is filling with honey, and the third nearly all sealed. My imported Italians have done nothing."

Rev. R. D.

Maam, Co. Galway, 1920.

## GOING AHEAD.

"The Nucleus you sent me is a very fine lot. Already they are on seven combs." (July 3.)

Cedar Road, London. W. C.

## SPLENDID LOT; ONLY ONE DEAD.

"The Nucleus is a splendid lot, and I am delighted with them. I only found one dead bee."

J. R.

Aintree, Liverpool.

## SWARMING CONDITION—EARLY APRIL.

"When doing expert work for the Cheshire Association I saw a 'W.S.' stock—such a lot as I never saw before. It was in early April, 1919, and they were at swarming point—absolutely bunged up with bees and brood."

Bowdon. H. B.

## FIVE WEEKS—A STRONG STOCK.

"The 'W.S.' Nucleus you sent me five weeks ago is going strong, and, in spite of inclement weather, and little attention through illness, it is now a good strong stock."

Teddington, August 1, 1920. J. L. N.

## APRIL 12: READY FOR SUPERING.

"The 'W.S.' queen I got from you last year has done splendidly. She has wintered well, and is ahead of any I have got, or any I have seen around here. I am extra well pleased with her."

J. S.

Tarbolton Station, Ayrshire.

## "W.S." STAND FAST: DUTCH ITALIANS, NATIVES, GO UNDER.

"I am very pleased with the 'White Star' Nucleus I had last year. It has wintered splendidly, and going ahead very fast. I have lost eight other stocks this spring—Dutch, Italians, and Blacks."

C. L. W.

Knitsford.

## HOW TO FIGHT "I.O.W." DISEASE.

"The 'W.S.' queen sent me in July I gave to a stock that had dwindled to three frames of bees. In a month she had banished all traces of 'I.O.W.', and filled eight Standard frames solid with sealed brood. I have put them into winter quarters—ten frames packed with bees; a long way my best stock."

G. B.

Sheffield.

## "W.S." NUCLEUS BUSIEST AND STRONGEST.

"The Nucleus you sent me June 23 is the strongest and busiest lot of bees I have, and never think of weather conditions. I am speaking to friends daily about them."

Ormskirk, August 27, 1920. T. R.

## ONLY RESISTANT BEES.

"Disease has emptied this district of native bees. I turn to you as the only source of resistant bees, so far as my experience goes. In my home district also disease has been rife, and none but stocks with 'W.S.' blood survive in my apiary there."

H. E. L. V.

Rhyl, N. Wales.

## OUT OF THIRTY STOCKS—THREE

### "W.S." ALONE SURVIVE.

"It may interest you to know that out of thirty stocks in the spring of 1916 only three have survived the 'I.O.W.' disease—the only stocks I had of the 'W.S.' blood."

W. V. S.

Penrith, Cumb., September 5, 1917.

## A CANDID CONFESSION—ANOTHER OF THOSE MYSTERIES.

"I must make a confession. I put the 'White Star' queen in a diseased 'I.O.W.' hive, treating it with Izal, as you advise, just to see whether you were right. Well! you ought to see them; they are almost the strongest hive I have now. It was almost cruelty to put her in such an attenuated hive. She is a marvel."

E. W. B.

Winchcombe.

## ONE "W.S." QUEEN—ONE SEASON—FIVE STOCKS, AND 142 LBS. HONEY.

"I think the 'W.S.' are the most prolific bees I have ever had. I have five stocks and 142 lbs. of honey for the season from one queen."

L. Q.

## A WEAK FOUL-BROOD LOT REGENERATED, AND—100 LBS.

"The second 'W.S.' was introduced to a very weak lot affected with foul brood. Nevertheless, she built them up to a very strong colony, and gave 100 lbs. In spite of the foul brood, this became the strongest colony I had."

Isle of Man, November, 9, 1900. L. Q.

## JUST WALKED OVER DISEASE.

"I introduced the 'W.S.' queen in June last (1914), and, although the stock was badly smitten with foul brood, they came on all right. Now during this last winter I have lost all my hives (nine), except this one, with 'Isle of Wight' disease, and they are working well, with no sign of either disease."

April 7, 1915. H. A. N.

## EXCEEDS 500 PER CENT. INTEREST.

"We have now twelve stocks to winter, besides selling one, out of the two three-frame Nuclei supplied June 20 last year." (August 15, 1917.)

Miss B. D.

Quainton, Bucks.

APIS LIGUSTICA

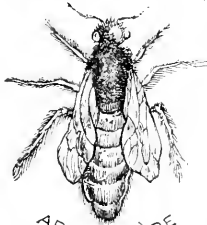

# Bozzalla Queens.

"American Bee Journal" specification Tested three banded Italians.

**DIRECT** from ITALY.

May & June 13/-      July & Aug. 12/-      Sept. 10/- each.

Sole Agent: H. M. STICH, Riccartonbar Avenue, PAISLEY, Scotland

	<b>"BACTEROL"</b> FOR BEES	The cure for, and preventive of, "Isle of Wight" Disease. Non-poisonous—free from stain or unpleasant odour.
		BACTEROL LIMITED 19/25, Brookside Rd., Highgate, N.19.
2/9 per Bottle.	Post Free.	

**CANDY** Made in our own factory by bee-keepers for bee-keepers.  
 6 lbs. post free 8/6      10 lbs. post free 13/6  
 Guaranteed from Pure White Refined Cane Sugar.  
 Miss Chester-Master's Patent Candy Box, 4/6 each. Postage extra 9d.  
**S. J. BALDWIN, The Apiary, BROMLEY, KENT.**

**SAVE MONEY** this winter by making up your own hives. Particulars of wood cut ready to make up into hives will be sent free on receipt of a post card.  
**E. J. BURTT, Manufacturer, GLOUCESTER**

- - THE - -

# BRITISH BEE JOURNAL.

ESTABLISHED 1873.

**THE NEW VOLUME COMMENCES JANUARY 6th.**

THE BRITISH BEE JOURNAL is supplied direct from the Office every week, post free for One Year, 10s. 10d.; Half Year, 5s. 5d.; Three Months, 2s. 9d. (payable in advance). Posted on Wednesday evening in time for delivery on Thursday.

Money Orders and Cheques should be made payable to W. Herrod-Hempsall and crossed "London County Westminster and Parr's Bank."

**SUBSCRIPTION FORM.**

(To be filled up by intending Subscribers, cut out, and returned to the Office.)

Please send me "THE BRITISH BEE JOURNAL" for.....

Commencing \_\_\_\_\_ 192\_\_ , for which I enclose

\_\_\_\_\_\*Name\_\_\_\_\_

Date\_\_\_\_\_ Address:\_\_\_\_\_

\*Please state whether Mr., Mrs., or Miss, etc.

*It will considerably facilitate our publishing arrangements if subscriptions are dated from the beginning of each year; the proprietor will therefore be obliged if subscribers will fill up and return the above form as early as possible.*

**COVERS FOR BINDING**

"BRITISH BEE JOURNAL" or "BEE-KEEPERS' RECORD," 18 post free.

**British Bee Journal Office, 23 Bedford St., Strand, London, W.C.2**

## FOUR FIRST PRIZES.

Our HIVES and APPLIANCES were again awarded FOUR PRIZES at the Highland Agricultural Society's Show at Aberdeen, thus testifying to the superiority of our goods. Order now at catalogue prices and save money.

## SOFT BEE CANDY.

Have you tried our Famous Bee Candy? If not, you should send for a trial order now. It is made from PURE WHITE CANE SUGAR and is PERFECTION.

### PRICES—

1 lb. at **1/5**, postage 9d., 6 lbs. at **9/6** post free,  
10 lbs. at **15/6** post free.

Can be had medicated or not, as required.

**R. STEELE & BRODIE,**  
*Bee Appliance Makers,*  
**WORMIT, FIFE.**

Telegrams:—"Bees, Wormit."

Telephone:—28 Wormit.

## BEE CANDY.

**W**E are now able to supply CANDY OF OUR OWN MAKE from guaranteed Pure White Refined Cane Sugar. In 1-lb. boxes with glass tops. It can be had plain or medicated with either "Yadil" or "Bacterol."

### REDUCED PRICES:

1lb. - **1/5** per lb.  
6lb. - **9/6**, post free.  
10lb. - **15/6**, post free.

**JAMES LEE & SON, Ltd., Uxbridge, Middlesex.**

