

\*

UMASS/AMHERST

\*



312066 0333 3310 7

LIBRARY

OF THE

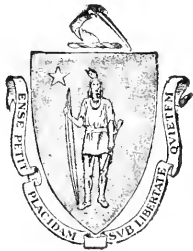

MASSACHUSETTS  
AGRICULTURAL  
COLLEGE

SOURCI

---

2

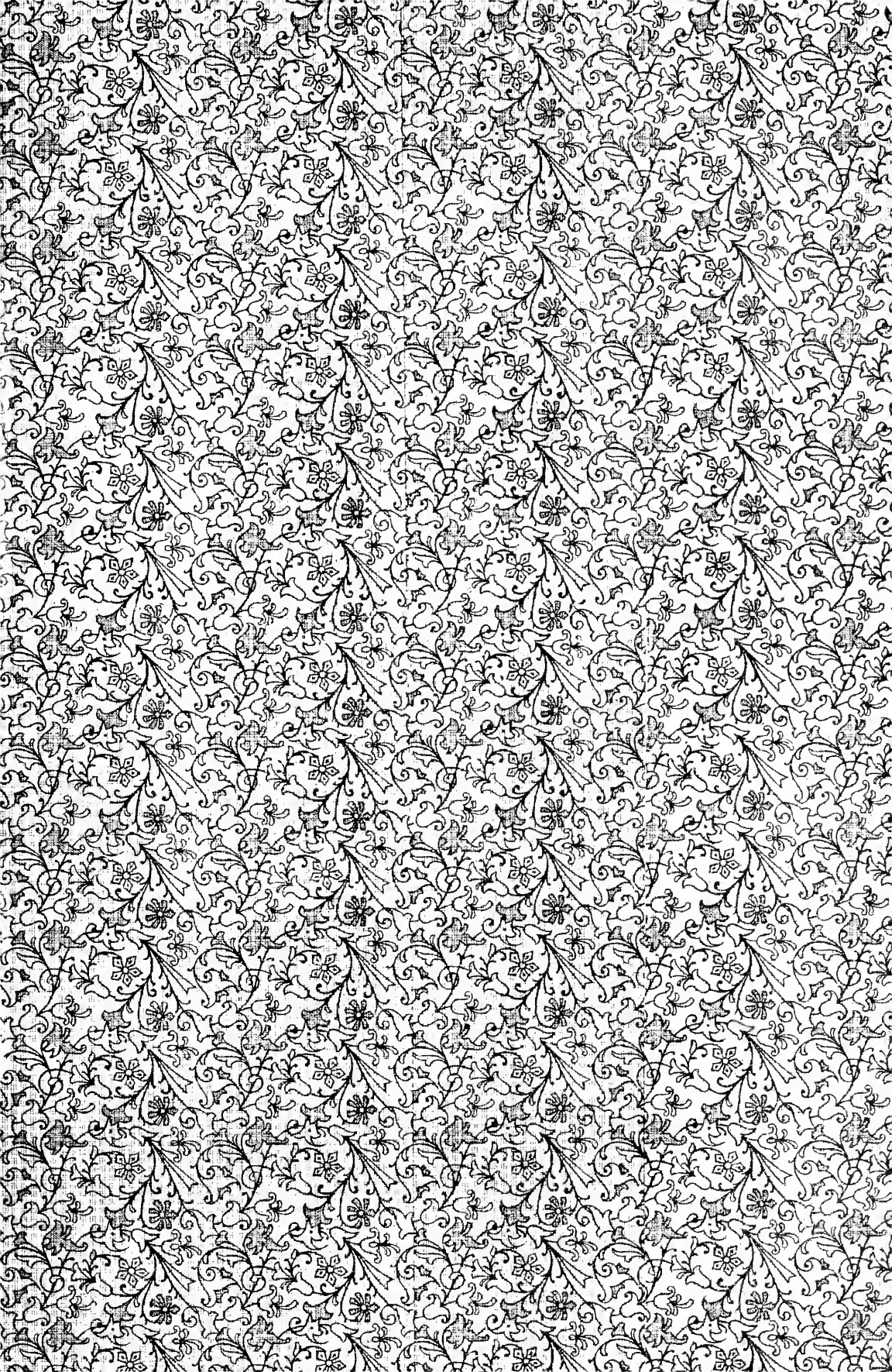













THE

# British Bee Journal,

AND BEE-KEEPERS' ADVISER.

EDITED BY

THOMAS WM. COWAN, F.G.S., F.L.S., F.R.M.S., &c.,

AND

W. HERROD, F.E.S.

---

VOLUME XLII.

JANUARY-DECEMBER, 1914.

---

PUBLISHED BY

SIMPKIN, MARSHALL, HAMILTON, KENT, & CO., LIMITED,

32-36. PATERNOSTER ROW, E.C.

LIBRARY  
UNIVERSITY OF  
MASSACHUSETTS  
AMHERST, MASS.

W. G. GILL & SON, LTD.,  
LONDON & COUNTY PRINTING WORKS,  
DRURY LANE, LONDON, W.C.

THE  
**British Bee Journal**

No. 1645. Vol. XLII. N.S. 1253.] JANUARY 1, 1914.

[Published Weekly



VOLUME FORTY-TWO.

The commencement of a new volume gives us an opportunity of surveying the progress made during the past year, and in doing so we have every reason to be satisfied. As far as "OUR JOURNAL" is concerned it is still "going strong," and with the constantly increasing number of new readers, is carrying out the instruction in modern methods which it has advocated during the last forty-one years, and has kept its readers well informed on all that is going on in the bee world. Its circulation, not only in every part of our vast Empire, but also in foreign countries all over the world, is sufficient testimony respecting its standing as an exponent of modern bee-keeping.

The past year can only be reckoned an average one for honey, the fine weather in the early part of the season being favourable; in some districts the harvest was abundant, while in others it was not up to the average. One remarkable feature of the season was the small amount of honey-dew, so that the honey obtained was uniformly good. The mortality among bees during last winter was very great, especially where colonies had not been fed up the previous autumn, and there was consequently a great demand for swarms, which it was difficult to supply. Another unfortunate factor was the prevalence of disease, which caused considerable losses. It was disappointing to bee-keepers that the "Bill to provide for the dealing with Bee Diseases," introduced again in Parliament by the President of the Board of Agriculture, was abandoned, with a number of other Bills, on account of pressure of business, but it is a measure that will have to be passed sooner or later, as not only bee-keepers, but fruit-growers and agriculturists, are beginning to find that they cannot do without bees, and that unless some compulsory powers are obtained to prevent the careless, obstinate and ignorant from propagating disease, the various industries dependent on bees will suffer.

It is satisfactory to find that the

B.B.K.A. is in a flourishing condition and on such good terms with its progressive affiliated associations, which is shown by the delegates attending the Council meetings so regularly, and taking their part in the government of the Association. At one time it was stated that the affiliated associations had no voice in the management of the parent body, but this can no longer be said, as their representatives frequently outnumber the B.B.K.A. members of the Council at the monthly meetings. There are now forty-six associations affiliated to the B.B.K.A.

The Experimental and Educational Apiary, established at the Zoological Gardens, has been completed during the year, all appliances connected with bee-keeping can be seen there, and it now compares favourably with such establishments on the Continent. The Secretary and Mr. A. Richards, a member of the Council, were deputed to visit the Experimental Apiary in Paris, to see how it was conducted, and to learn all possible about the methods adopted. The result of this visit was reported in the "B.B.J." for May 29th last. The apiary at the Zoological Gardens attracts a good deal of attention, especially when lecturing is going on, and from the numbers attending it is evident that the selection of the locality was not only justified, but hastened out a wise one. We mention this especially, as some captious persons have criticised the Council of the B.B.K.A. for selecting the Zoo, but they have overlooked the fact that the Government grant was for—among other things—an experimental apiary situated in or near London, and there was no other place where it could have been better placed or seen by more people. Although an experimental apiary is not kept for honey-getting, as a matter of fact a surplus was obtained. Regular courses of lectures were given at the apiary and in the Lecture Hall, as in the previous year, and it is satisfactory to find that these lectures are so popular that more persons applied than could be accommodated, consequently some had to be disappointed. Special lectures were given at thirty-seven places by the B.B.K.A. lecturer in different counties, at no cost to the affiliated associations, the parent body being enabled to give them as a result of the grant from the Development Fund. A special lecture was also

given in the Lecture Hall of the Zoological Society, by Mr. T. W. Cowan, F.L.S., on "Bee-keeping in Other Countries," when over 200 persons attended. Pioneer lectures were given by lecturers appointed by the B.B.K.A. in different districts, and examinations were also held in a large number of centres.

Two conversaziones were held in the Hall of the Zoological Society. At that held in March a paper was read by Mr. G. Flashman on "The Natural History of the Honey Bee," and at the October meeting papers were read by Mr. A. G. Pugh on "Judging Honey," and by Mr. H. J. Menzies on "Marketing Honey," both subjects being followed by discussions, from which much useful information was derived.

The principal additions to bee literature have been "Fungi of the Beehive," by Miss A. Betts; "Further Report on the 'Isle of Wight' Disease," by Dr. Graham-Smith and others; a new edition of Root's "A.B.C. and X.Y.Z. of Bee Culture"; and the twenty-first edition of the "British Bee-keepers' Guide Book," by Mr. T. W. Cowan, F.L.S., &c.; also a new edition of "Queen-rearing in England," by Mr. F. W. L. Sladen, F.E.S.

Among those who have passed away during the year we would mention Lord Avebury, the first President of the B.B.K.A. and a lifelong subscriber; Mr. F. H. Fisher, a former Hon. Secretary of the Lincolnshire B.K.A.; and Mr. C. N. White, who was a regular subscriber to the B.B.K.A., and at one time a member of the Council and a contributor to our pages.

We take this opportunity of thanking not only those in this country who have helped to make the "B.B.J." instructive and interesting, but also the numerous foreign correspondents who have contributed to our pages, and invite others to write to us and not to hesitate even if they cannot write in English.

In conclusion, we thank our readers for their expressions of goodwill and encouragement contained in almost every letter received, and wish them health, happiness, and prosperity during this coming year.



#### BEEES AND LUCK.

Bees from a very early date were supposed to bring either good or bad luck, according to circumstances, and in ancient

literature we very frequently find "luck" and bees closely associated. They are represented as visiting Plato as an infant in the cradle and anointing his lips with honey, from which he derived his gifts of eloquence. Several other ancient Romans, famous for their persuasive speaking and brilliant oratorical powers, or gifts of song, had the originating cause of these powers attributed to a visit from bees in the early stage of their existence. The following extract from one of Darwin's works is worth quoting under this head. He was a baby in the cradle at the time, and, of course, quotes the facts from hearsay: "The windows of my mother's room were open in consequence of the unusual warmth of the weather. For the same reason, probably, a neighbouring beehive swarmed, and the new colony, pitching on the window-sill, was making its way into the room when the horrified nurse shut down the sash. If that well-meaning woman had only abstained from her ill-timed interference the swarm might have settled on my lips, and I should have been endowed with that mellifluous eloquence which, in this country, leads far more surely than worth or honest work to the highest places. But the opportunity was lost and I have been obliged to content myself through life with saying what I mean in the plainest of plain language!"

But the landing of bees in particular places did not always bring good luck, as the following instances will show. Bees lighted on Pompey's ships, thus, according to the soothsayers, presaging his overthrow. On a swarm alighting near Brutus's army the augurs read evil from the act, and their counsels were so powerful that they induced him to shift his camp, "lest he should suffer damage and loss." The statue of Antonius at one time served as a home for a truant swarm, and the fact was considered "an ominous presage of the fate of his empire." A swarm lit on one of the ensigns just before the battle of Cannæ, and, of course, disaster followed, "for it was ever esteemed an ill-omen for swarms to light in places where they were not accustomed to resort."

Cases of bees bringing either good or bad luck might be multiplied, but these must suffice at present. Astrologers of old read men's fate by the stars; and Roman augurs read the signs of ease and plenty or the reverse "from the flight of Bees and Birds." Wise creatures, they foretold the nature of the seasons, and even a modern American poet records that previous to a severe winter their hives were "overflowing" with honey. They were storm predictors also, as the following couplet proves:

"And some by lot attend the gates to inform

Approaching showers and to foretell a storm."

Will our late abundant honey-flow pre-  
sage a severe winter, as our weather  
prophets predict? Many colonies pro-  
duced an "overflowing" harvest of honey.

The following interesting particulars of  
a belief in bees' luck came to me the  
other day from a part of Equatorial  
Africa where, I suppose, until last year  
the foot of a white man never before trod:  
"Soon after taking charge of the new  
Concession, I was one day sitting in the  
entrance of my tent, when I was surprised  
to see a chief from a native village near  
walk up with some followers, one of them  
bearing a large calabash containing  
native palm wine. Following a palaver,  
the chief formally presented the gift, the  
bearer laying it down beside me. After  
thanking the liberal-minded chief, and  
acknowledging the compliment by hand-  
ing him something in return, I noticed  
that a score or more bees came buzzing  
round the calabash, and I gave a sweep  
with my sun-hat to drive them away.  
When the chief saw me trying to injure  
the bees he got suddenly into a state of  
great excitement, and urged me  
vehemently not on any account to kill  
them, because they were *sacred* and  
bringers of good luck. I did my best to  
get him to explain why they gave them  
that character, and he informed me that  
they guided his men when they desired to  
obtain a supply of the 'palm wine.' It  
appears that to get this they must tap the  
tree just near where the male or female  
flower (I don't know which) is found to  
grow. It seems the natives watch the  
flight of the bees from some given point,  
and *line* them to the tree where these  
flowers bloom, and there they find the  
palm wine. The chief eulogised the bee as  
a 'good spirit,' who was a friend to the  
natives, giving them both food and drink,  
as his people esteemed honey highly, as  
well as the wine they guided them to.

"One day I was going through some  
very thick 'bush' when I came across a  
native cemetery. A number of rude  
earthenware pots, urns, and rough-shaped  
vases were scattered all over the ground,  
with a feeble attempt at ornamentation  
of the various graves, where the savage  
forefathers of the tribe were sleeping their  
last sleep. In the centre of the grave-  
yard was a very large tree, and the hollow  
spaces were occupied by several colonies  
of bees, just as Virgil describes them in-  
habiting the 'hollow oak.' There was  
quite a little "apiary" of them, and from  
the various exits bees were flying out and  
in in their thousands. From what some  
of the natives said later it would appear

that they regard the presence of the bees  
there as a protection from the evil spirits  
and bad 'devils' they are so frightened  
of. Bees as 'good spirits,' bringing  
'luck,' protecting the dead, and bestowing  
gifts of food and drink on the living,  
present us with rather an interesting  
theme. It is instructive, too, to discover  
that ancient and modern times so nearly  
approximate in certain ways."

The very interesting fact that this first  
issue of the JOURNAL for 1914 falls on  
New Year's Day makes it appropriate  
that I should wish every reader a bright  
and happy New Year; may the days of  
every one of them be long in the hand;  
and in this and future years may the  
bees of all bring Good Luck!

### SPECIAL LECTURES.

Special lectures in connection with the  
Development Fund Grant to the B.B.K.A.  
will be given at the following places.  
Where the time and place of meeting are  
not given, particulars can be obtained  
from the Secretary of the Association  
concerned:—

At the Lecture Hall, Zoological  
Gardens, London, by Mr. W. Herrod, on  
January 8th, 19th, 22nd, and 24th;  
February 5th and 12th, at 6 p.m.

#### SPECIAL LECTURES BY MR. W. HERROD.

Worcester, Jan. 24th, 4.30 p.m., Central  
Coffee Tavern. Subject, "A Year's Work in the  
Apiary."

Hereford, Jan. 28th, 2 p.m. Subject, "A  
Year's Work in the Apiary."

Exeter, Jan. 30th. Subject, "Queen-rearing  
and Introduction."

Barnet, Feb. 17th. Subject, "A Year's Work  
in the Apiary."

#### PIONEER LECTURES BY MR. W. HERROD.

<i>Presteign</i> . . . . .	Jan. 27th	7.30 p.m.
<i>Crayford</i> . . . . .	Feb. 2nd ..	7.30 p.m.
<i>Gravesend</i> . . . . .	Feb. 26th	7.30 p.m.
<i>Sidcup</i> . . . . .	March 30th	7.30 p.m.

### W. BROUGHTON-CARR MEMORIAL FUND.

	£	s.	d.
Amount already acknowledged	10	18	6
E. Roche	0	5	0
C. R. Pinkney	0	5	0
J. G.	0	4	0
R. Mackender	0	1	0
W. Shuker	0	1	0

£11 14 6



*The Editors do not hold themselves responsible for the opinions expressed by correspondents. No notice will be taken of anonymous communications, and correspondents are requested to write on one side of the paper only and give their real names and addresses, not necessarily for publication, but as a guarantee of good faith. Illustrations should be drawn on separate pieces of paper. We do not undertake to return rejected communications.*

#### THE DUTIES OF AN EXPERT ON TOUR.

[8915] Lieut.-Col. H. J. O. Walker's communications are always pleasing and instructive, and in the interval pending the passing of your "Diseases in Bees Act," making it compulsory to allow of inspection of apiaries by properly constituted authorities under the Act, I consider Col. Walker's suggestions under the above heading ("B.B.J." October 2nd, 1913) the best that could be adopted in the interests of British bee culture. Though I was previously aware that he is against the use of immovable comb hives, I was pleased to see in the following number (October 9th) his condemnation of ordinary skeps as domiciles for bees. Every person who has had practical experience in examining immovable comb hives for disease, be they skeps or "box-hives" (these latter appear to be somewhat of a bugbear to Mr. Crawshaw), will agree with Col. Walker with regard to the difficulties attached thereto. I will go further, and say that such examinations faithfully carried out are fruitful sources of spreading disease.

I presume that extra caution is needed to guard against carrying "Isle of Wight" disease germs from apiary to apiary by experts on tour, hence it is necessary to carry disinfectants, &c., around with them. The procedure with regard to our apiary inspectors on tour is about as follows: The outfit besides their ordinary clothes, is an overall coat, smoker, hive tool, notice forms, and a copy of the Apiaries Act, together with a carbon letter book. The stationery, &c., is snugly packed in a leather satchel, which, with the smoker and coat, is strapped to the motor bicycle. I may state that about four months ago each of our four apiary inspectors was provided with a first-class motor-bicycle, which enables them to do about three times the inspection work in a week that they were previously able to accomplish. They are supposed to use their machines all they can, but are not debarred from going by rail with their bicycles to distant districts when this will save time, or where bad roads intervene.

Arrived in a given district (no notice is required to be sent previously of his proposed visit) inspection of every known apiary in that district takes place. Every reasonable precaution is taken to avoid carrying disease germs away from an infected apiary, but there is no fussing of changing clothes and disinfecting them and oneself, as I have seen advocated by some of your correspondents. Yet disease is decreasing fast; in fact, I am justified in saying that it gives little or no concern now to commercial bee-keepers. Each inspector has a very large territory to cover, and if they had to do a lot of what we believe to be unnecessary fussing, as above indicated, they would scarcely be able to visit a district more than once in five or six years. Choose thoroughly reliable and experienced men as inspectors, and give them to understand that disease must be suppressed at all cost: pay them good salaries, and, above all, don't hedge them round with a lot of restrictions—"You must not do this" and "You must not do that." If you have the right men, give them each a copy of the Act (when you get one), and leave the rest with them.—I. HOPKINS, Auckland, New Zealand.

#### THE SKEP QUESTION.

[8916] I am filled with wonder at the comprehensiveness of the cave which Mr. Macdonald has discovered: it outrivals the classic one entirely. It may not be amiss to remind Mr. Macdonald that the Adullamites achieved a few things. Does Mr. Macdonald reflect that it is a very strong argument in favour of a cause that it is adhered to by all sorts and conditions of men? It shows that it is not a mere cranky notion, but one which has a wide appeal.

Mr. Macdonald offers an analogy (page 504, vol. 41), which one would almost have thought could only have been produced by his opponents. Carried to its logical conclusion, it would mean that because the self binder and the motor plough are far and away the best for the large farmer, a law should be passed forbidding the man who grows a modest half rood of barley to cut it with a hook, or dig it with a spade. For the rest, Mr. Macdonald's contribution to the discussion gives no single word against the skep. In his view, apparently, the frame hive is "movable," and the skep "immovable." Nothing more therefore need be said.

Mr. Macdonald's reply to my queen-rearing question is somewhat belated, and he need not have pretended to forget who asked the question. I am not very sensitive, and if I were finding fault "according to lack of knowledge" I should only be too pleased to be put right.

But there is a lack of ingenuousness in the reply, which is a trifle surprising for Mr. Macdonald entirely ignores the fact that when rearing queens in a hive containing a fertile queen, according to Mr. Sladen's method (with which I am perfectly familiar), the isolated part is given *started queen-cells*. This is a vastly different matter to the simple method of increasing for novices, which started the discussion. As I said before, if anyone can assure me that queens can be reared as a matter of course, and not by a mere fluke, by simply putting some brood behind a queen excluder, it is news to me, and as such I will gratefully add it to my stock of knowledge. I make no boast of being "advanced," and humbly realise that I have a very great deal to learn.

By the time this letter appears we shall be on the threshold of another year, so that I take the opportunity of wishing your good selves and my increasing number of bee-keeping friends and friendly opponents a very happy and prosperous New Year.—HERBERT MACE.

#### THE FLOWERS OF JANUARY.

[8917] The earliest flowers of the year are the most precious, and there are an appreciable number that may furnish a little foretaste to the bees on a bright and warm day before January is out. The Christmas rose is already in blossom. Its innumerable golden stamens are very welcome, and where they grow in considerable numbers, as at Kew, they may make the bees quite busy. *Garrya elliptica* is strictly an anemophilous flower—that is, it relies on the wind and not the bees to distribute its pollen. It has been stated, however, that the bees make use of it. In the first week of the year its long, green catkins, which it produces in profusion, may be emitting their vital dust. Winter aconite is a cheery blossom of the buttercup order that breaks through the frozen ground and usually insists upon opening in January. It is quite a favourite with the bees. The mezereon, too, may blossom this month, and a very small display of its bright purple blossoms, or the sweeter white variety, will suffice to attract our friends. It is not strictly due till the snowdrops are up and their name is "fair maids of February." The ivy is still in blossom, and a fine day will set it going again. We may expect a few great scarlet golden-stamened blossoms on the *Pyrus japonica*, or Japanese quince, and sometimes in January it blooms quite freely. The witch hazel, *Hammamelis mollis*, may become a maze of yellow worm-like flowers: it smells very sweetly, and no doubt the bees use it. Our own hazel may produce an erratic crop of pollen, and the bees sometimes collect from this

typically anemophilous flower. The sweet-scented colt's-foot or winter heliotrope is a prominent wild flower of great attractiveness that often opens in January, and the dandelion blossoms in every month, and always commands some custom. I have a note in last year's diary for January 9th, "Bees bringing in specks of white pollen." I suppose it was from ivy, though it may have been from wallflower. A bush veronica is still covered with blossom, and the bees were busy on it a few days ago. There is a field of charlock also bright and fragrant, near here, and I am sure no bee could resist it on a warm day. However, they could scarcely do better this January than remain at home and take the rest that has until now been denied them.—G. G. D.

#### THE LABELLING OF HONEY.

[8918] On and after January 1st all jam or marmalade will have to be labelled according to its contents, and if anything is added besides fruit and sugar the same must be clearly stated.

This is a step in the right direction, for besides protecting the public it aids the manufacturer of a good and reliable article.

Could not the law be strengthened and applied to the labelling of honey, to the mutual advantage of both producer and consumer? No bee-keeper minds fair competition, but when he has to compete with foreign honey sold as English he might well have something to say.

One is often told that honey can be obtained from such-and-such a store at 6d. per lb., "pure English, none better." On investigation it is generally found to be a foreign or colonial product labelled "Pure Honey," "New Season's Honey," "Genuine White Clover," &c.—terms too vague to be reliable. Some time ago I entered a shop with the object of selling some of our Cotswold honey. No sale was effected, and the manager, whom I knew slightly, told me that his "New Season's Honey" (a year old), selling at 6d. per lb., cost him 3½d. per lb., carriage paid. Who *can* compete with this? And he actually claimed that of the two his honey was the better.

I dare say I have handled more honey in one month than he had in his lifetime, and it was very inferior stuff indeed compared with the honey produced by local bee-men; in fact, it was like sugar and water, not honey. Many people who purchase such honey would probably not do so if it were labelled as it should be.

Everything except bee produce is rising in price, but unless we get some of these evils remedied we may have to accept a lower price still.

In every other line of goods there is

a standard of prices which vary but little, but in the honey trade one man makes 7s. per dozen jars, and another 11s. for the same quality honey. Why this difference? In honey selling the "get as much as you can" principle is utterly wrong, for in many cases it is precious little when you sell wholesale.

It would be interesting to have the opinion of others on the subject raised, for what benefits one benefits the community at large.—A. H. BOWEN, Cheltenham.

#### "ISLE OF WIGHT" DISEASE.

[8919] Having lost all my bees last spring through "Isle of Wight" disease, I decided to make another start, and after thoroughly cleaning and disinfecting all my hives, I prepared a new situation for the apiary some 150 yards away from the old spot.

My efforts to secure a supply of bees from healthy apiaries in the immediate neighbourhood having failed, I at length got some from about ten miles off. By July last I again possessed four stocks of healthy bees, for so I have every reason to believe they were.

Just a month later I noticed that some of the foragers belonging to one stock, instead of marching straight into the hive when returning, walked quickly once round in a circle, about the length of a bee in diameter, just before reaching the entrance. I do not recollect ever having seen this referred to. It is the first sign of anything wrong which I have been able to detect.

I next sent some bees to the Board of Agriculture for examination, and was informed that they contained young stages of *Nosema apis*, but as the infection was very slight I was advised to try and cure them by feeding with candy containing 15grs. of crude catechu to the pound. I carried out the directions, but so far as I could observe, the new "cure" did no good whatever, and the bees rapidly grew worse. The other stocks became affected, and I do not think any will survive. Another bee-keeper of my acquaintance has tried Bowen's Cure, quinine and Izal, all to no purpose. And now I come to the main object of my letter. It is this. Could not the Board of Agriculture, or you, Mr. Editors, or some bee-keeper in a position to do so, present us with a general account of the progress of the disease all over the country? One realises that business interests may make some bee-keepers averse to supplying information, and that some of the "professional" bee-men might object to their districts being put on a "Black List," yet such objections could

surely be overcome, since much information is already to hand in the columns of the "B.B.J." What is needed is a systematic summary of the facts we already possess. It would be most interesting to know where the disease is at its worst, which districts are least affected, and most important of all, those places where the disease appears to be exhausting itself, and how long elapsed before signs of exhaustion began to be noticed.

Others besides myself must be seeking an answer to the question: "Is it any use making another start next year? If not, how long must elapse before I can recommence bee-keeping with any hope of success?"—L. ILLINGWORTH, Brentwood.

#### THE W. BROUGHTON-CARR MEMORIAL FUND.

[8920] Herewith I enclose 5s. as a donation to the W. Broughton-Carr Memorial. The old thief "Procrastination" has prevented earlier attention to this matter, but the recent appeals from yourselves and Mr. Pearman should make every bee-keeper "toe the line" without further delay. In view of the excellent season we have just had, there should be no difficulty in getting the ninety-three (now ninety-two) subscribers of 5s. each, as suggested by Mr. Pearman, especially if bee-keepers will realise the great improvements in bee-keeping they owe to the late Mr. Carr.—CAMPBELL R. PINKNEY.

#### AN OLD-FASHIONED COTSWOLD APIARY.

[8921] I have pleasure in sending you for publication in the BEE JOURNAL a photograph of Mr. A. Martin and his quaint apiary. He has kept bees since a boy, and is as interested in them as ever. Being a shoemaker of the sort that "make to last," most of his time is spent in a workshop adjoining the cottage which is to the right of the picture.

From the window, a good view of the apiary is obtained, and, curious to note, nearly every swarm settles on a branch of an apple tree overhanging the hives, and none have flown farther afield or been lost. The skep in front of our worthy beeman is the original stock from which this bee-colony has sprung, and again this year it has thrown a swarm and cast as usual. Last summer was the best Mr. Martin has ever had. Starting in the spring with four skeps and the frame-hive, he has had five swarms, one cast, and a "smart," as big as a duck's egg. This latter was saved, and is now a respectable colony with a grand young queen. In August three swarms were "taken up" and from these and three



"cups," about 90lbs. of honey was strained. The frame-hive yielded twenty-one sections, a 5lb. swarm, and a cast.

Fortune has smiled on our genial bee friend, and, judging from the complaisant way he sits smoking on the wall, he is not afraid of bees either. Between the wall and the barn runs a road, and although traffic is passing all day long no one is stung. This speaks well for the gentleness of skep bees. Who would not like to possess this picturesque row of hives that always do so well and are the picture of vigorous health, with no foul brood and no spring dwindling?

Mr. Martin paid a "flying" visit to the Royal Show at Bristol, and was keenly interested in the bee department, but after admiring the light honey, he came to the

of learning in France, Germany, or the Low Countries to still further complete his education. Such men made their mark in the history of their period. Nor is it infrequent at the present time to visit other schools. No country has a monopoly of knowledge and wisdom. Men excelling in every science and learning are to be met in other lands, whose words are as precious as the pearls and diamonds which the Thousand and One Tales of the Arabian Nights narrate fell from the lips of the Princess as she spoke. Our own special study may be but one of the minor industries. It is so. Yet there are in other European countries ways of working and "wrinkles" to be picked up. He is insular and narrow-minded who would deny this. In these days of cheap and



MR. A. MARTIN'S APIARY, PRESTBURY, NR. CHELTENHAM.

conclusion all of us come to, that his own rich "bee honey" was, after all, the best.

In concluding, I might add that no one in search of a pleasant half holiday could do better than come with me and pay a visit to Mr. Martin and his cottage bee-garden.—A. H. B.

#### BLURTS FROM A SCRATCHY PEN. CONTINENTAL WANDERINGS.

It was a wise and thoughtful custom of our fathers that when a young man had finished his apprenticeship he should go to other towns to learn what they could teach him for the bettering of his handicraft. Again, it was equally wise when a student had taken his degree at Oxford or Cambridge to send him to other seats

easy travelling the fallacy has long been exploded that England is first in everything and the rest of the world but an inferior second. An hour's sojourn in any of our great capital cities would convert the most obstinate of unbelievers, and he would be convinced there is much to be learned, especially from our competitors. Now, this theory reduced to practice was the motive reason which induced a little party, consisting of your junior editor, his accomplished wife, and yours sincerely, "Blurts," to take a wandering tour through France, Switzerland, Italy and Germany, what time our annual holidays were due. If the readers of the BEE JOURNAL would care to list to my tale, I would like to recount to them some of the adventures that befel us in

our travels. If occasionally I wander away from matters apicultural, have patience, for I would amuse as well as instruct, if I am able.

The modern invader of France (amicably, of course) has many ways to choose from here. He who experiences difficulty when on the high seas of containing within him all that he holds dear, who yearns almost to bring up his very boots, would, of course, choose the shorter—Dover-Calais—route. But as for me, I much prefer the longer (as to sea passage)—*via* Newhaven-Dieppe—for I am fond of the old Norman town, and the journey to Paris through the “hills of Normandie.”

What a contrast! We have left the hurly-burly, the hustle-bustle of the London streets but a few hours. We land in an old town, narrow streets, footpaths overhung by projecting houses, pointed gables to the houses. I could fancy that its “rues” were still used by the gallants with the ever-ready rapier one reads of in Dumas and the hooped beauties so familiar on the plaques of Watteau; but I am not allowed to dream. A figure dances to the window of the “voiture,” and screeches, “Fru-e-ets, pears and grâpes—tâk Engleesen money.” And they *do* take it, for the prices they ask would make our West-End fruit-shop keepers delirious with joy at the profits. The “gare” (we call it in English “railway station”) is by a busy thoroughfare, and the Chemin-de-fer, or iron road, runs parallel with the main street without even a protecting fence. How unfamiliar to us seem the titles on the signboards—“Boulangier,” “Charentier,” “Quinecaillier.” We scarcely recognise under these disguises our old friends the baker, the butcher, and the candlestick maker. The gendarmes are neat and smart, but those soldiers—red-britched infantry and wrinkle-booted cavalry—they are everywhere. How slovenly they are dressed. Save me from hearing the “cussing” an English drill sergeant would give way to if his recruits paraded in such uniforms.

“En voiture, Messieurs, en voiture.” “Take your seats”—and to the sound of a “penny trumpet” (so one of our fellow passengers sacrilegiously calls the copper horn which substitutes our accustomed whistle) we start for Rouen.

Rouen! What schoolboy is not crammed with its history, a medley of William the Conqueror, Norman kings and queens, baronets, and Joanne of Arc. I myself, again, for the moment, am lost in the age of chivalry and knightly “derring do.” “Say, friend,” breaks in a typical Yankee figure next to me—hearing me chatting with the lady on the other side, who cannot speak a word of English—“Say, friend, I calculate you know some-

thing of France and the Frenchies. Can you tell me how long it will take to do *Ruin*?” At first I cannot grasp his meaning—“*do Ruin*.” “Blue Ruin”; I have heard of a drink of that name. Oh, I see, Ruin is the Yankee French for “Rouen.” Perhaps I may be pardoned for not being accustomed to the pronunciation. “You know,” he proceeds, “I am an American schoolmaster over here to do Eu-rope. I have only a month. I have *done* Turkey, Russia, Austria, Germany, and England. I have now three days to do France and Italy, and catch the boat at Naples. Can I do Rouen, Amiens and Paris tomorrow?”

It was a tall order. But I suggested one possible way. We were due to arrive at Rouen in the evening. He might take a midnight train to Amiens. Should he stay the remainder of the night there he would catch an early train to Paris, and a voiture to the Tour d’Eiffel would enable him to see the whole of Paris at a glance, and what was there to prevent him proceeding to Rome right away?

“Wal,” said he, “I reckon you’re smart. Come along with me.” I declined with very many thanks. I had other engagements. Now, this is no traveller’s tale—I am not even drawing the long bow. It is absolutely true, even as it occurred to your wandering contributor.—J. SMALLWOOD. (To be continued.)

## QUERIES AND REPLIES.

[8895] *Sterilising Beeswax.—Preventing Brace-combs.*—Will you kindly tell me:—(1) How to sterilise wax to be used for fixing foundation? (2) Do thick top bars prevent brace-combs to any extent? (3) If the super frames are crossed at right angles to the brood frames, is it an absolute preventive of brace-combs? (4) Is there any objection to super frames being at right angles?—J. R. T.

REPLY.—(1) A sustained temperature of 158degs. Fahr. will kill bacilli. In refining wax 1½oz. of sulphuric acid are added to every gallon of water used. This is heated, and the mass stirred with a wooden stick, so that the wax is thoroughly blended with the water. It is kept for two hours at a temperature of 158degs. Fahr., the firing is then stopped, and the mass allowed to cool very slowly. (2) They do to a great extent, but not always. (3 and 4) No.

[8896] *Ownership of Swarms.*—In replying to my enquiry in “B.B.J.” of December 4th (8895), you omitted to say

whether bees are classed as domesticated or wild animals. This is important. Both Judge Gye and yourself state what the law on the subject is, but will you kindly quote the "Act," which makes what you state to be the law? Your example of shot game falling on another's preserves is quite a different matter altogether. If the game simply flew and settled on the preserves of another, one has no *right* to follow the said game to either shoot, trap, or catch this game. (So I am of opinion that (bees are classed as wild animals) a swarm settling in a neighbour's garden is in the same position as game. A bee-keeping friend of mine is much concerned *re* this subject, and it is possible, although not likely, the trouble might happen to me.—A NOVICE.

REPLY.—(1) Add about one-eighth of the usual quantity of water, and boil until the condition given in "Guide Book" is reached. (2) In warm weather all the quilts should be removed. In the winter only the calico one should be left on.

#### NOVELTIES FOR 1914.

##### NEW "TIME-SAVING" BAR-FRAME.

Mr. C. Kusel, of Allerton, Lancs., sends us an illustration of his new patent "Time-saving Frame." Among the advantages claimed for it by the inventor are: (1) No wiring is required; (2) therefore no wires to rust; (3) at least thirty frames can be fitted with foundation in the same time as it takes to fit one of the old style; (4)

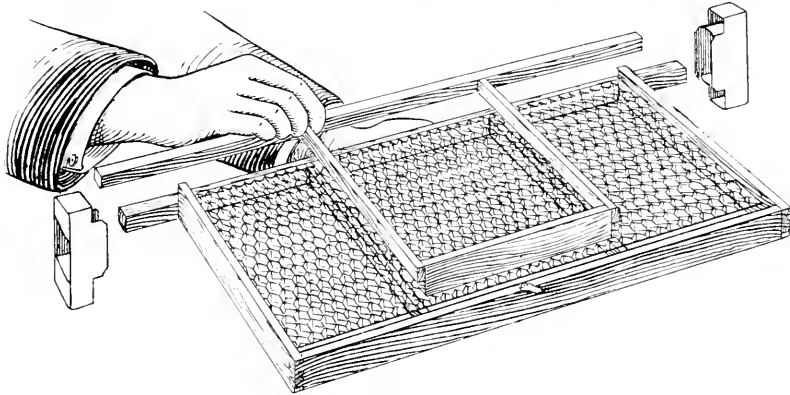

"TIME-SAVING FRAME."

REPLY.—We have submitted your questions to an eminent judge, who states: There is no Act—*i.e.*, statute—on the subject, it is the common law of England, as stated by Bracton and Blackstone. Bees are *fera natura* (wild animals). No property passes in them except by reclamation. If a swarm settles on a tree, no property passes until the bees are hived; when hived they become the property of the hiver, and if a swarm leaves the hive this property continues in the hiver (*i.e.*, owner of the hive) so long as they can be seen and followed.

[8897] *Hard Candy*.—*Moving Bees in Winter*.—(1) I have a quantity of candy which has been boiled too hard. Will you oblige by telling me how it can be utilised? Can it be boiled again, and, if so, how much water should be added per pound?

(2) As regards the directions on page 118 of "Guide Book," for despatching stocks in frame-hives by rail, should all quilts be removed for ventilation, covering the frames only with the frame of perforated zinc for ventilation, even in cold weather, or should one or more felt quilts be placed over the zinc frame for warmth?  
—STANWELL, Middlesex.

extensive experiments have been made with the frames in the Allerton Apiaries, and they have been found perfectly satisfactory. The cost is low, *viz.*, 2s. a dozen, 11s. per half gross, 20s. per gross, and they can be had from appliance dealers as advertised later.

#### SPECIAL LECTURES ON BEE-KEEPING.

##### SPEY VALLEY B.K.A.

On December 2nd, under the auspices of the Spey Valley Bee-keepers' Association, an advanced lecture on bee-keeping was delivered in the Public School, Craigellachie, by Mr. William Herrod, F.E.S., secretary and lecturer to the British Bee-keepers' Association, London. The lecture, which was illustrated by limelight views, was a most instructive one and dealt with diseases of bees, enemies of bees, and how to clean and preserve the hives. At the close of the lecture questions were invited, and several were asked and replied to. Provost Morrison, Aberlour, who presided, proposed a hearty vote of thanks to Mr. Herrod for his instructive lecture, and this was cordially responded to.

## SUFFOLK B.K.A.

At the Lecture Hall, Woodbridge, on Thursday, December 11th, a most interesting lecture was given by Mr. W. Herrod, F.E.S., Secretary to the British B.K.A., entitled "A Year's Work in the Apiary." So far as the surrounding district of Woodbridge is concerned, bee-keeping has not many adherents, so it was surprising to find a large attendance. Lady Farren, as chairman, introduced the lecturer, remarking that they were very lucky to get him, owing to his numerous engagements.

Mr. Herrod used about 100 slides. First dealing with the amateur who desired to commence, there was shown on the screen a home-made hive, constructed by a lady from a few Quaker Oats boxes, the whole cost of material being ninepence, the inside frames and wax foundation being extra, of course. Those who preferred manufactured hives could buy them at prices ranging from 21s. to 30s. all complete, but the lecturer pointed out that it was quite possible to get very good results with the cheaper hive, if thoroughly dry and warm. With regard to the bees, he advised them to get a good swarm in May, the variety did not matter a great deal but he recommended the British Blacks. Some people, he said, went in for pretty bees, but what they wanted was useful workers. The appliances for feeding, wiring frames, swarm catching, working for swarms or for surplus honey, were all discoursed upon, the lecture ending with a picture of a Suffolk apiary, consisting of one hundred hives, where the owner had managed to purchase his house with the profits.

The lecturer spoke for over an hour to a most appreciative gathering, and the outcome will no doubt be a well deserved fillip to the work of the Association in the county.

Dr. G. A. Mossop proposed a hearty vote of thanks to Mr. Herrod, thanking him for the lucidity and completeness of the address, and this was seconded by Mr. W. H. Hudson. Many questions were asked and answered.

## NORTHUMBERLAND B.K.A.

Under the auspices of the Northumberland Bee-keepers' Association, Mr. W. Herrod, F.E.S., delivered an instructive lecture in the Town Hall, Morpeth, on December 4th, on "Bees and their Produce." He explained how to get the bees strong in the springtime, how to keep them hygienically clean, how to obtain increase artificially, and how best to work for honey. Alderman Carr presided, and, on the motion of Mr. F. E. Schofield, Mr. Herrod was heartily thanked.

## OLNEY AND DISTRICT B.K.A.

A lecture on "Bee-keeping for Profit" was given under the auspices of this Association (by arrangement with the B.B.K.A.) by Mr. W. Herrod, F.E.S., at the High Street Schools, Fenny Stratford, on December 20th. Mr. W. Purvis, Loughton, took the chair and briefly introduced the lecturer. An audience of between forty and fifty listened with rapt attention to a delightful lecture, the value of which was greatly enhanced by the fact that it was accompanied by a series of excellent lantern slides. At the close of the lecture questions were invited and answered fully and concisely by the lecturer.

On the proposition of Mr. Boyes, seconded by Dr. Buxton, a hearty vote of thanks to the lecturer was unanimously accorded.

## Notices to Correspondents

G. B. (Cambridge).—*Mead*.—Both samples of mead are very good indeed, No. 2 being slightly the better of the two. The only big show where prizes are offered for "mead" is the Royal Agricultural Society's Show, particulars of which will appear in "B.B.J." early in the New Year.

C. A. M. (Newport).—*Varieties of Bees*.—(1) The bees sent are British, and, providing the strain is right, are good for honey production. (2) We are afraid from appearances that they have "Isle of Wight" disease.

### Honey Samples.

W. Parsons.—As the honey was sent in a white opaque jar we cannot give an opinion on the colour, but it appears rather dark. It has evidently been gathered from late-flowering sources, such as ivy, and, though fairly good, in flavour and density, would not sell at more than 6d. per lb. retail.

### Suspected Disease.

A. J. W. (Woodford).—Nos. 1, 2, and 4 specimens have died from "Isle of Wight" disease. No. 3 was omitted from your letter.

P. D. (Falkland) and R. (Devizes).—The bees have died of "Isle of Wight" disease.

F. K. (Hops).—The bees are suffering from "Isle of Wight" disease, the only safe treatment for which is destruction.

# Editorial

## REVIEW.

*Insect Life: Its Why and Wherefore*, by Rev. H. G. Stanley, F.E.S. (London: Sir Isaac Pitman and Sons, 2s. 6d.)—This book will be found interesting reading by old and young. Written in an easy conversational style, the author has successfully endeavoured to give the life history of some of the commoner insects in plain, simple language. The book is written for anyone interested in the subject, but more especially for farmers, gardeners, and fruit growers. Those of our bee-keeper readers who are also elementary school teachers will find "Insect Life" extremely useful in teaching elementary entomology. There is nothing of the "dry-as-dust" order about it, and from our own experience we venture to say that if placed in the hands of children in the higher standards they will be reluctant to lay it down until they have finished reading it. Though suitable for young people, it is so far removed from the nursery tale style as to be equally interesting to those of mature years.

A great deal of ignorance exists concerning insect life, most people being too ready to condemn all insects as pests, and destroy them indiscriminately. This book should do much to correct these false notions. The merits, as well as the demerits, of the insects dealt with are fairly stated; there are very few concerning which the author has not some good to mention, and even if they have no redeeming points the "mission" of the insect is pointed out. For instance, writing of the house fly, he tells us: "Its obvious mission. The house fly may be a nuisance, it may be a menace to the health of the home. Would it find a place at all in the home, at any rate in anything like such numbers, if precautions as to cleanliness were more general? The dirtier a house is, or the dirtier the neighbourhood, there will you find the greater number of flies. . . . If that troublesome little insect, with its patience-provoking, unappetising habit of perching sometimes on my plate, sometimes on the end of my nose, and anon in my eye, has succeeded in dinning into my dense mind that I must be cleanly in my habits if I would be healthy and strong, if it has succeeded in emphasising that cleanliness is nearly allied to godliness, then dare we any of us say that the fly has plagued us in vain?" There is also a good word for the wasp—that insect regarded by most bee-keepers as an inveterate foe to their

pets. In the chapter devoted to the Aphis, we are told, "At the present the nuisance of blight is increasing year by year. Of that there is no doubt whatever. The order has gone out from many an officious local committee that wasps' nests are to be destroyed—when Nature sent us wasps on purpose to counteract this evil of blight."

We would like to give more copious extracts from this delightful book, but want of space forbids, nor would it be fair to the author. There are twenty-five excellent illustrations by Winifred M. A. Brooke. We heartily commend the book to the notice of our readers.

## SPECIAL LECTURES.

Special lectures in connection with the Development Fund Grant to the B.B.K.A. will be given at the following places. Where the time and place of meeting are not given, particulars can be obtained from the Secretary of the Association concerned:—

At the Lecture Hall, Zoological Gardens, London, by Mr. W. Herrod, on January 8th, 19th, 22nd, and 29th; February 5th and 12th, at 6 p.m.

### SPECIAL LECTURES BY MR. W. HERROD.

**Worcester, Jan. 24th, 4.30 p.m.**, Central Coffee Tavern. Subject, "A Year's Work in the Apiary."

**Hereford, Jan. 28th, 2 p.m.** Subject, "A Year's Work in the Apiary."

**Exeter, Jan. 30th.** Lecture Hall, University College, 3 p.m. Subject, "Queen-rearing and Introduction."

### PIONEER LECTURES.

**Presteign, Jan. 27th, at 7.30.** By Mr. W. Herrod.

**Crayford, Feb. 2nd, at 7.30.** By Mr. W. Herrod.

**Gravesend, Feb. 26th, at 7.30.** By Mr. W. Herrod.

**Sidcup, March 30th, at 7.30.** By Mr. W. Herrod.

**Sedgley, Jan. 29th, at 7.30.** In Wesleyan Schoolroom. By Mr. Joseph Price.

## W. BROUGHTON-CARR MEMORIAL FUND.

	£	s.	d.
Amount already acknowledged	11	14	6
O. Knight	0	5	0
Rev. F. H. Fowler	0	5	0
J. L.	0	5	0
J. B. K.	0	2	6
G. Durman	0	2	6
Anon	0	1	3
J. Icinghill	0	1	0
	£12	16	9

## HELPFUL HINTS FOR NOVICES.

*By W. Herrod.*

MANIPULATING A FRAME HIVE.

*(Continued from page 496, Vol. 41.)*

In teaching any subject by writing the pupil can understand much better if the work is illustrated as well as explained, therefore I will endeavour to give by means of pictures the salient points in manipulating. To show that it is quite easy for anyone who has made up his mind to do the work properly, I give a set of illustrations from actual photographs of my little boy, just two years old. The



FIG. 4.



FIG. 5.

pictures show that there is very little danger of receiving stings when bees are properly subdued and handled. So that the operation may be realistic, the object the boy has in view is to find the queen.

The first thing is to protect the person as described. The bees must be subdued, this is done by means of smoke or the smell of carbolic acid, either of which frightens them, and they prepare for contingencies by gorging themselves with food. When

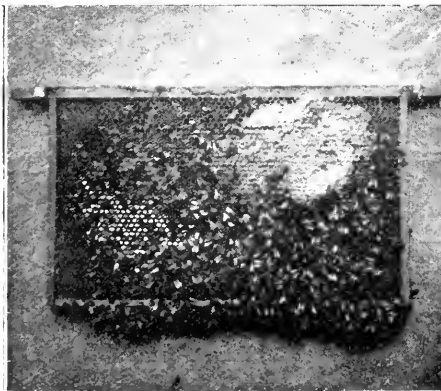

FIG. 6.



FIG. 7.

in this condition they are not disposed to sting. The smoke is not used to partly stupefy the bees as so many people imagine. If they are made stupid with smoke and they get on the flesh they are more likely to sting.

The smoker is first made ready. The fuel should be a material that will smoulder for a long time and give off plenty of smoke. Cotton waste, touchwood,

*i.e.*, wood with dry-rot, or puff ball are all suitable, but perhaps paper is the most handy material. Corrugated paper makes good fuel, but used alone it burns away too rapidly and makes the smoker very hot. If it is used in conjunction with brown paper this difficulty is obviated. The paper, either corrugated or plain, should be torn into strips about five inches wide and rolled into a cartridge, fairly firm but not too tight. If corrugated paper is used the corrugation should run lengthwise of the cartridge. The cartridge should be made up of first a strip of corrugated and then a strip of brown paper, rolled to the diameter of the smoker barrel, lighted at one end, which is put downwards in the smoker; it should not be jammed too far down or it will stop up the inlet hole. The bellows are now worked and a volume of

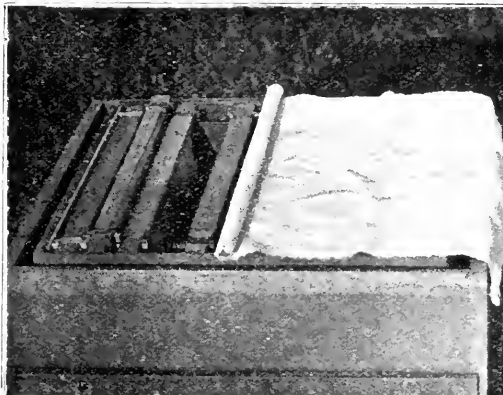

FIG. 8.

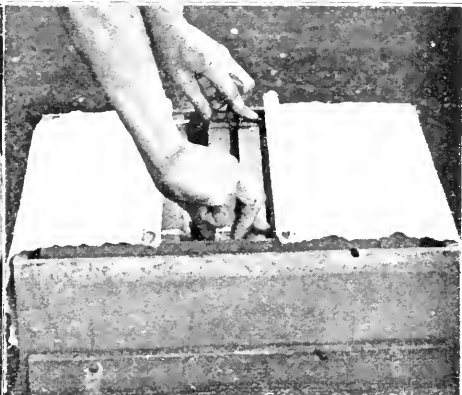

FIG. 9.

smoke will issue. Put on the nozzle, and it is ready for use. There is a proper way of doing even the latter simple operation. It is no unusual sight to see a person struggling to get the nozzle in position. If the seam of the joint in the latter is fitted on to the seam in the barrel of the smoker it will go on without the slightest difficulty, as it is fitted in that position by the maker. Don't jam the smoker barrel full of paper, then light it at the top, and wonder how it is it will not burn. A draught must pass right through from the lighted end; for

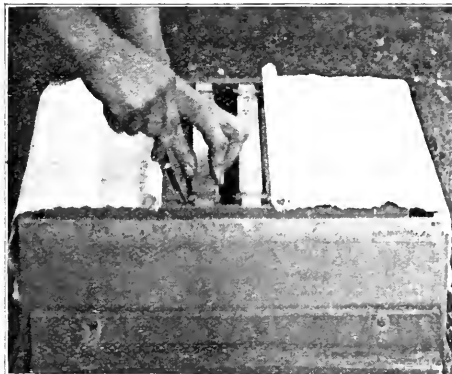
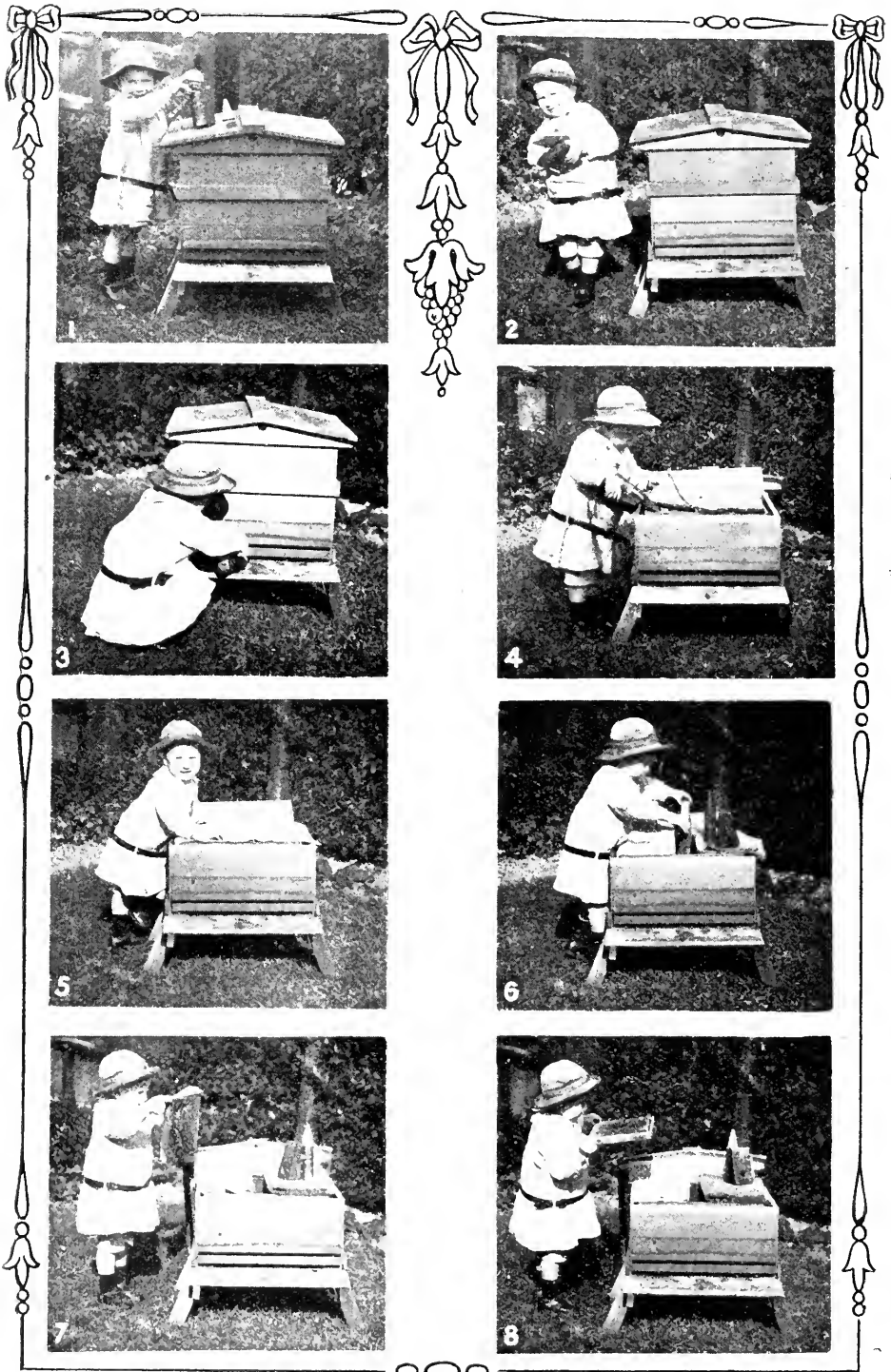

FIG. 10.



FIG. 11.

the same reason it is necessary to tear the paper into strips instead of making it into a number of folds and then rolling it into a cartridge. If brown paper only is used choose a thick felty one, as the smooth variety will not burn. The best smoker to use is the Bingham. Avoid the pattern called Clark's cold blast; in theory it is all right, but in practice it works very badly. If there is a breeze blowing the cartridge can be lighted by striking the match and putting it quickly inside the barrel of the smoker, so that it is shaded (No. 1, page 14). No. 2 shows the operator



MANIPULATING A FRAME-HIVE.



ready. Care should be taken not to jar the hive at all until the smoke has been blown in at the entrance. Only very little is required, say about four or five puffs, but it should be driven into the hive by putting the nozzle right into the entrance, No. 3 (not a volume sufficient to suffocate the bees and operator, as Fig. 4). Wait for about a minute, then take off the roof and lift, which should be placed well out of the way, so that there is no danger of tripping over them when intent upon the work in hand. Gently turn back a corner of the quilt with the left hand, using the smoker in the right, No. 4. This should not be held and worked gingerly with the finger and thumb, but held firmly by the fingers on the underside and the ball of the thumb on the top side (Fig. 5, page 12). The quilt is gently stripped back, and a little smoke puffed in at the top of the frames in its wake. This drives the bees down out of the way, as the smoke, driven in at the entrance, causes them to go to the food, which is situated at the top of the combs. Fig. 6 shows a comb immediately it has been lifted from the hive after smoking at the top. The bees will be seen gorging themselves on the face of the comb, and also clustering at the bottom when full. If the operator prefers to use carbolic as the subjugator, then a piece of calico eighteen inches square is saturated with a solution made up of one part Calvert's No. Five Carbolic Acid to two parts of water. If a little glycerine is added, the acid will mix with the water more readily. The cloth is wrung as dry as possible, and is then ready for use. The roof is lifted off very gently, and all the quilts removed except one; the carbolic cloth is hung over the hive side furthest from the manipulator, the two corners being held between the thumb and finger, while the corners of the quilt are held between the next two fingers. The hands are now drawn towards the manipulator so that the quilt is drawn off, and the carbolic cloth takes its place without the bees being able to fly (No. 5). In about a couple of minutes the bees will be subdued, and the carbolic cloth can be removed and the quilt replaced. To prevent the carbolic cloth from blowing about it is well to stitch a small piece of sheet lead into a small pocket at each corner to weigh it down. After use the carbolic cloth is kept in an airtight tin to prevent the moisture and smell from escaping. In this way it can be kept moist and ready for use for some weeks. When dry it must be dipped again. In either case, having subdued the bees, use two quilts folded, so that each covers half the frames. In handling the frames, only the one to be withdrawn is exposed between the two quilts (No. 6). This prevents the bees from flying up, keeps out robbers, and also avoids chilling the brood. The frame is put back and covered by one quilt, while the other is turned back to expose the next frame for removal. A very neat arrangement is to have two pieces of calico tacked on to rollers to use when manipulating. The quilts are all removed, and the calico on rollers used in their place. Fig. 7 shows how the calico covering is easily moved either way by rolling up the weight of the wood at one side, and a piece of sheet lead sewn into pockets at the other two corners prevents the calico covering from blowing about.

The work should be carried out systematically. If the hive does not contain the full complement of frames, the division board is drawn back to provide plenty of room for manipulating. Do not attempt to remove the central frame with the idea of finding the queen at once. If the bees were under normal conditions this might be done, but the subjugator has excited them, and the queen may have run into any position in the hive. Start at one side, and take the frames one by one. Novices often complain that a ten-frame hive does not give sufficient room to get out the first frame without crushing the bees. This can easily be accomplished by gently raising the first frame and drawing the next one so that the metal ends rest on it (Fig. 8, page 13). If the frames are stuck down very securely with propolis they can be loosened without jarring by taking hold of the lugs of the frame with the thumb and second finger, using the first finger as a lever to force it away (Fig. 9), or they can be eased with a hive tool or pocket knife. The latter is generally the handiest, and should be used as a lever (Fig. 10), the sharp edge of the knife being under the frame to be moved. If used the other way, the knife is liable to slip on to and cut the fingers.

*(To be continued.)*



*The Editors do not hold themselves responsible for the opinions expressed by correspondents. No notice will be taken of anonymous communications, and correspondents are requested to write on one side of the paper only and give their real names and addresses, not necessarily for publication, but as a guarantee of good faith. Illustrations should be drawn on separate pieces of paper. We do not undertake to return rejected communications.*

#### THE LABELLING OF HONEY.

[8922] Your contributor, Mr. A. H. Bowen (8918, page 5), raises a question which is of vital importance to us as British bee-keepers. He asks, I notice, for the experience of other bee-keepers. Here is mine.

A short time ago, having rather more heather honey on my hands than I could well dispose of retail, I offered some to a fashionable grocer in a neighbouring town. When he saw my sample, and had tasted it, he pronounced it spurious, and asked all kinds of questions as to its origin, ending by offering me 2s. per doz. less than I was asking. At the same time he showed me some "real Scottish heather honey, absolutely the best obtainable," which he was retailing at 1s. 8d. per lb. The appearance of this made me doubtful, so I took steps to obtain a sample  $\frac{1}{2}$  lb. jar. When I was able to taste and smell this sample, I was more than doubtful as to its origin. Some I sent on to the Editors, who pronounced it to be a "blend." My own opinion is that the amount of "heather" in it was very small.

I took steps to find out more about this honey. From the label on the jar I saw that it was put up by a firm of Scottish packers. Their wholesale list which I managed to see described it as a pure heather honey, quoted the price of 14s. 6d. per doz., and ended by saying that as the present heather season (1913) had been very short, orders must be placed quickly to avoid disappointment. By the way, was not 1913 one of the best heather years on record? I consider that in this case the retailer was the victim of the wholesalers, who, at the least, were guilty of rather sharp practice. Now as to the sequel. I decided to offer my honey to a rival firm. I took with me two samples, one being taken from the purchased  $\frac{1}{2}$  lb. before mentioned. This I offered first, and was nearly thrown out of the shop as a cheat. I was told that anyone selling such honey as genuine heather ought to be prosecuted. When I offered my own they agreed to take it at my own price, which,

by the way, had risen 1s. a dozen, and would take all I could supply.

Of course, if I have any honey to offer at a future time it will go to the grocer who knows good honey, and is prepared to purchase an honest article at an honest price. British honey need fear no competition which is open and above board. Those who purchase the cheaper foreign article generally do so through ignorance, believing that all honeys are alike, but I have proved that when once they know the real thing they come again for more.—D. WILSON.

#### A BEE-KEEPER'S TROUBLES.

##### MOVING BEES.

[8925] Most bee-keepers are out for adventures of one sort or another, but I think I have had a fair share of bee-keeping troubles, not to mention bad luck; for out of the two angels that are said to guard us my evil one is usually the strongest. Looking up "Lord'swood's" delightful article on his one hive out-apiary some years ago, brings to my mind the fateful June morning when I, a novice, moved my first load of bees.

At the time I was a pupil and general factotum to a 100-stock beeman, and owned a small apiary of eight hives in the vale. These I was anxious to move on to the hills for the sainfoin and clover. Everything had been arranged to a nicety, and the hives with supers on them were securely screwed down and fastened the previous evening.

As we loaded up at 5 p.m., when the air was crisp, before the sun was up, everything seemed in our favour for the trip, and I was in good hands, for the carter was a good bee-master and "knawed a swarm from a cast." But the unforeseen always happens. We had scarcely got well away on the open road and down the first hill when the carter yelled, "The bees be comin' out." To my dismay a steady stream poured from a hive in the middle row, and in a moment they settled on the carter, who darted away behind the lorry, leaving me in charge of a prancing horse, while the bees were stinging my face and hands furiously.

Luckily, I thought of the rugs, and flung one over the hives and another over the horse, which I just managed to unhitch and lead away down the road. By this time the carter had recovered, and as we dared not leave the bees on the high road we set to and dragged the lorry back up the hill along the lane, and into the orchard that was left so gaily thirty minutes before. This was not the worst, for out of eight stocks four had all their combs broken down, drowning the bees in their own honey, besides the florin it took to cure the stings on the carter's nose.

That was the first and *last* time I ever moved bees in the daytime, and if my adviser had been emphatic that night is the only safe time, this disaster would not have happened.

Moving bees has always an element of risk about it, but if the hives are screwed down and ample ventilation under and over the frames is provided, with a cool night and fairly smooth roads, they usually travel safely. I once moved twenty-seven full colonies eight miles on a sultry June night with the entrances wide open, because perforated zinc did not afford sufficient ventilation. The quilts were removed and an extra super placed on and covered with open scrim and sack-ing.

We loaded up at 9.30 p.m. and did the journey in three hours. The bees clustered outside the entrance in masses perfectly still, and neither of us was stung while unloading them.—A. H. BOWEN, Cheltenham.

#### BEE-KEEPING ACCOUNTS.

[8924] Referring to the notes on pages 434, 489 and 505 of the "B.B.J." for 1913, as Mr. Smallwood invites criticism I should like to point out for the sake of any bee-keepers who may think of adopting this method of keeping accounts that Mr. Crawshaw is undoubtedly right in his criticism, and Mr. Smallwood, in rebutting the correction, is in error. If cash and stock are to be shown in one account, then stock in hand at the beginning of the year must be shown among the payments, and stock in hand at the end of the year among the receipts. The argument adduced by Mr. Crawshaw, that the reverse arrangement makes an increase of stock show a reduction in profits, ought to make this quite clear, but perhaps the question is worth a further explanation.

In the example given by Mr. Smallwood (page 434) the value of stock at the beginning of the year was £10; the value of stock at the end of the year, £12 10s., the total cash receipts during the year £13 15s., and the total cash payments £4 14s. 6d. By adding the stock at the beginning of the year to the receipts and the stock at the end of the year to the payments the account showed a total on the receipt side of £23 15s. and on the payment side of £17 4s. 6d., the difference, £6 10s. 6d., being taken as profit. Let us suppose, however, that on the day before taking stock at the end of the year the bee-keeper had sold stock to the value of £2 10s., receiving cash for the same amount as the stock is valued at in the original account. It must be quite clear that this transaction would not, in fact, make any difference to the profit for the

year. The accounts would now show, however, stock at the beginning of the year, £10; stock at the end of the year, £10; cash receipts, £16 5s.; cash payments, £4 14s. 6d. The profit for the year now appears to be £11 10s. 6d. The stock being worth exactly as much at the end of the year as at the beginning does not now affect the account, and the true result is seen. Now, if in the original account the stock at the beginning of the year had been added to payments, and the stock at the end of the year to receipts, it will be seen that the profit would have appeared as £11 10s. 6d., which is correct.

Perhaps another example will make it clearer. Assuming a new recruit to the ranks of bee-keeping takes up account-keeping from the start. There will be no stock on hand at the beginning of the year, and very likely the cash receipts will be much less than the cash payments. Yet he has not necessarily lost money: the stock on hand at the end of the year is what he has got in exchange for the money spent over and above any cash receipts. But if Mr. Smallwood's method of account-keeping is adopted as originally propounded, the value of this stock will be added to the cash payments, and so a huge loss will be shown.

The stock on hand at the commencement of the year is to be considered as bought from the previous year's account, and the stock on hand at the end of the year is, contrariwise, sold to the subsequent year's account. The former must therefore be shown with cash payments and the latter with cash receipts.—T. M., Ilford, Essex.

#### RANDOM JOTTINGS.

*By Charles H. Heap, Reading.*

Mr. G. G. Desmond, in the "B.B.J." of December 11th, asks the important question, "Is spring dwindling fatal?" I am conscious, though I have not the means of reference, that this subject was in the past discussed at length in current bee literature; but in the light of the "Report on 'Isle of Wight' Bee Disease," issued in May, 1912, by the Board of Agriculture, the discussion is well worth re-opening. The investigators employed by the Board of Agriculture suggest that spring dwindling may be due to *Nosema apis*. If such is the case, the uniting of dwindling colonies in the spring or autumn is a practice which, in the interests of the bee-keeper himself, and the larger interests of apiculture, should be discontinued. I have united colonies, weak owing to some known cause, with beneficial results, but I never had a real case of spring dwindling until

1912, following the appearance of "Isle of Wight" disease in my apiary the previous summer. Personally, I cannot, in the circumstances, make any useful contribution to the discussion, but there are many bee-keepers whose experiences, if briefly related, might prove helpful. Of course, if such colonies when united as a rule succumb, the obvious inference to be drawn is that no attempt should be made to preserve them.

*Extension Alighting Boards.*—The treatment of dwindling colonies is not the only question in bee management that needs reconsideration. I am inclined to think that it is unwise to use extension alighting boards, which are so common in this country. If stocks are to be kept in a state of health it is important that sick bees shall not re-enter the hives. A sound, healthy bee, if it happens to miss the alighting board on returning from orchard or field with a load of nectar or pollen, will, after a short rest, rise and make its way to the hive entrance. If it cannot do this, we may take it for granted that it is weak through disease or old age, and is best left to perish. This is not a pleasant doctrine to preach, but it is what would happen if the colony were living in a state of nature. My attention was first directed to this subject in the spring of 1912. I went away from home for a fortnight. Before starting I destroyed four stocks suffering from "Isle of Wight" disease, and the day after I got back I found two more affected. About midday I was called to see one hive, and found nearly three pints of bees in a mass on the ground. By way of experiment I removed the slides, which were well apart, and gave the bees an entrance the full width of the hive. After the lapse of a few seconds, the mass of bees near the entrance gave a call, and the sick bees, except half-a-pint of stragglers, went up the extended alighting board with alacrity. Notwithstanding the use of a particular "cure," the colony lingered for a few weeks and died. I made firewood of all my extension boards, and may never use any again. The incident set me thinking, and the conclusion I came to was that extension alighting boards do more harm than good. If they are no good they are useless appliances which should be banished from the apiary.

My criticism of Mr. Crawshaw's defence of the skep has had the effect of causing him to unmask his position. I have carefully re-read what Mr. Crawshaw has written from July 3rd onwards, and though he has hedged himself about with many qualifying phrases, he has only himself to blame if he has been misunderstood. On page 266 he says, "A good deal has been

said about the skep from time to time, but I believe there is a growing body of opinion in its favour under certain circumstances. It is not the hive of the specialist, and it may, or may not, be a sealed book to many of its owners," &c. Again, on page 338 he states that he is "a defender of it for the cottage bee-keeper, who is not modern enough to use a frame hive." It is only fair to add that he goes on, "I have never contended that it was the peer of the modern hive, or adapted to modern requirements." All this leads one to suppose that Mr. Crawshaw was defending the ordinary straw skep which may be bought in Malton, Reading, or other market towns; but how surprised everybody must have been to find, on opening the *JOURNAL* on November 13th, that this was not the "fool proof" skep he had had in mind at all, but that the skep he advocates for the cottager, who is "not modern enough to use a frame hive," is one with movable combs. When I propounded the query as to how Mr. Crawshaw would discover a few cells containing odourless foul-brood towards the top of a comb in a skep, without withdrawing any of the combs, I hoped it would lead to an extension of my knowledge of practical bee-keeping. Yet here I am no wiser. I do not object—probably nobody else does—to the use of skeps from which the combs may be withdrawn for inspection, but is the cottager too old-fashioned to use a wooden hive with frames to be entrusted with a straw hive containing them? A further question arises: "Are such straw hives 'fool proof'?" I shall be glad to know exactly where Mr. Crawshaw stands amid his paradoxes. For the present I imagine that he stands in the same position as most of us who want the enormous amount of bee disease that exists swept away. If there were no brood diseases I should have no particular objection to fixed comb hives being used by people who prefer them.



*A New Feeder* (p. 466).—This lever-lid tin feeder strikes me as a good thing, but it would be improved by a piece of perforated zinc over the hole in the lid. Presumably it is laid between two frames, which prevent it from rolling, but it would be easy to solder a couple of strips along the tin to form feet, when the

feeder would be safe, and could be used across the frames.

*Confining Diseased Bees* (p. 476).—This difficulty, viz., the heating of confined bees, has never caused me any trouble in the case of large swarms tied up in ordinary skeps. I find a cellar quite satisfactory. There is usually a door or window which can be left open, but a shady wall or outhouse is often available. I always invert the skep. There is then a natural circulation or exchange of the warm air for the cooler air outside, and this takes place, even though the top hole be plugged. But for such purpose as the union of several lots an extra large skep is certainly required, and I should not dream of sacrificing a good hiving skep needlessly. There is no reason why a box, or cheap packing case, should not be used and afterwards made into excellent fire-wood. If the available box should not be roomy, a panel of perforated zinc can be nailed to a hole in the bottom, the zinc can be covered with some quilts when hiving the bees in the box. But it is inviting trouble to unite at the time of the first operation.

*All Worker Comb from Starters* (p. 483).—I have doubts as to whether some of the cases given by "D. M. M." particularly that of the upper story, would result as desired. I have had many such combs built, but have abandoned the practice with full-depth combs as unsatisfactory. Even with perfect spacing and levelling, one cannot be sure that the comb will run truly to the bottom bar. Wiring may be used, but generally results in less perfect comb-building. Where wiring is not used, the combs are weak, being often unattached on three sides with unfinished corners. These spaces may be filled with drone comb later. With shallow frames the ease is rather different, and good combs can be more readily obtained. Even if imperfect or incomplete, they can be more easily trimmed and inserted in a suitable place for completion, whilst the absence of wire is not a serious matter. The fact is, worker comb can be more readily obtained in the first five inches than in the last three, at least, experience has rather led me to that general conclusion.

*Selection of Breeding Queens* (p. 487).—A good many points are usually considered by careful and experienced breeders when selecting stock, but very few are, to my own way of thinking, so important as wintering quality. Of course, the final result of all selection is, we may take it, to be represented in the honey crop, the goal of the practical breeder's endeavour. To this result, longevity contributes almost more than "hustle." Long-lived bees cost less than

short-lived bees, however energetic such may be during their shorter life, and the daily waste of bee-life is a less serious drain upon population. Now it is more than probable that longevity under the unfavourable conditions of winter and early spring is indicative of longevity in summer. The vaunted prolificness of the Carniolan bee may be, in part at least, due to its longevity. And this quality, supposing the foregoing to be sound, may be well judged at the spring examination. At this examination I mark those colonies which have wintered best, and look up their last year's record to eliminate specially advantaged colonies, or colonies re-queened late in the year. Then, from those colonies which build up the quickest and quietly occupy supers, my stock queens are usually selected.

*Skeps or Frame-hives* (p. 498).—I do not think I was unfair to Mr. Hamshar, and if he will read my note again, I think he will agree. I certainly did not refer to his later success, other than to imply that the success went hand in hand with increased knowledge, as was evident from his letter. Other comment appeared unnecessary, but I did him the further justice of assuming that he would succeed better to-day whatever the form of hive. He misunderstands, however, my claim to fairness, which was solely relative to the merits of the skep itself. And in fairness I maintain that there is insufficient proof that the initials to which Mr. Hamshar refers, have any special relation to the skep. "I.O.W." was never a skeppist's prerogative, nor was it, I venture to assert, spread by skeppists. I agree that very few of us have championed the skep recently, but on the other hand, very few of its opponents have attacked it fairly, most correspondents showing the confusion of idea which is apparent throughout Mr. Hamshar's own letter, the title of which does not fairly state the position.

*Those "Cooked" Accounts* (p. 506).—I am surprised to find that Mr. Smallwood persists in maintaining the correctness of his accounts, and if his other accounts are run on similar lines, there must be work for the auditor! No doubt Mr. Smallwood knows the Dr. and Cr. sides apart, but why does he enter "Goods sold" on the Dr. side? I have already pointed out the result of this, but to make it clear, let us consider the result of immediate sale of the whole stock. Thus, Dr. April 1. To stock, £10. April 2. By sale, £10. Then, Cr. By balance, £20, called "Profit"! Obviously absurd, is it not? Or again, suppose an item of purchase be omitted, say, J. Smith, £1 15s. Then, as this amount is presumably taken into stock at cost, it would have to be deducted from stock at

March, 1914, thereby increasing the so-called "Profit" by £3 10s.! It is clear that profit should be unaffected by such transactions, but this is what occurs with Mr. Smallywood's method. Will he not refer the figures once more to the accountant?

## QUERIES AND REPLIES.

[8898] *Weight of Sections, Bees in Towns.*—I shall be thankful if you will tell me what weight the sections are that are sold in England at 8s. or 9s. per dozen. I read somewhere that 14oz. sections were good enough for exhibition and 12oz. very good for sale. A friend tells me that in Ireland he got sections up to 20ozs., but ordinarily 16ozs. to 18ozs., using wooden dividers. My best stock here makes sections of 12ozs. to 14ozs., others seal them when they are 9ozs. to 10ozs. What can I do to get heavier sections? I use the ordinary  $4\frac{1}{4}$ in. by  $4\frac{1}{4}$ in. by 2in. and metal dividers. Further, I should like to know if in England beekeeping is forbidden in small townships, and, if so, in which, for instance. Thanking you in anticipation for kind reply through your JOURNAL.—L. W. J. DEUSS, Nyasaland.

REPLY.—Sections sold in England at 8s. or 9s., unglazed, are never so light as 12ozs., the weight averages between 14ozs. and 16ozs. It would be no use exhibiting sections weighing 14ozs. only, as they would stand little chance of winning a prize. Sections weighing 20ozs. are very rare. We are afraid we cannot tell you what to do to obtain heavier sections; a good flow of nectar and the supers well crowded with bees, is what we look for here. Bee-keeping can be followed anywhere in England. Occasionally a person objects to bees, and if he can prove they are a nuisance through being too near his habitation he can obtain an injunction restraining the person from keeping them too near. This applies in the country as well as in the towns. It is very rarely that a case of this kind is brought into Court, and when it is it often proves more of a personal quarrel and spite than that the bees are a nuisance.

[8899] *Spring Dwindling.*—As I am a novice, I shall be obliged if you will tell me the meaning of what is termed "spring dwindling," the effects of it, and a remedy?—E. R. B., Rugby.

REPLY.—Spring dwindling is a term generally used indiscriminately when bees die off in the spring from starvation,

chill, disease, &c. True spring dwindling is caused by having an old queen in the hive in the autumn. As she ceases laying very early, and at the best only a limited number of eggs, the bees left for wintering are too old, and die off rapidly in the early part of the year before young ones are reared to take their place, so the colony perishes. The remedy is obvious.

[8900] *Bees in a Tree.*—A large swarm of bees last year settled near the top of a rotten tree in a hole, which can be reached by a ladder. I have leave to get it out, but must do so before March 31st. Our climate is warmer than yours, and the bees fly more freely in winter. Would it not be wise to take them soon, before they have started brood raising? I have a hive ready for them, and can give them two or three frames full of sealed honey from other hives. We can start syrup feeding here in February. I propose with an awl to drive a hole into the tree just below the comb, and smoke the bees up into a skep fixed above the entrance hole, and then I can cut out the comb, if worth it, at my leisure.—Guernsey Reader.

REPLY.—If you can start syrup feeding in February, we should say about the third week in January would be about the right time to get the bees out.

## Notices to Correspondents

H. W. K. (San Remo).—*Bee Records.*—

We shall be pleased to see and give an opinion on the record kept in your apiary.

W. H. W. (Notts).—*Kent as a Bee-County.*—There is no Bee-keepers' Association in South Kent. The districts you name are good for bee-keeping, and so far as we know at present are free from "Isle of Wight" disease.

COLMENA (Hinckley).—*Stock Dead in Well-stored Hive.*—The bees were far too decomposed for us to examine them for cause of death. We should judge from your particulars that the colony dwindled through having an aged queen.

W. A. C. (Somerset).—*New South Wales for Bees.*—Write to the Editor of the *Australasian Bee Journal*, c/o Messrs. Pender Bros., West Maitland, New South Wales, or to Mr. R. Beuhne, Toobarac, Victoria, South Australia, for information on the matter.

# Editorial

## THE PACKING OF SPECIMENS SENT FOR ADVICE.

During the quiet period of the year no doubt our readers have time to peruse their *Journal* more carefully than in the busy season; therefore we have reserved this article until they have leisure to carefully digest it.

We are at all times pleased to be of service to our readers, and therefore it is

must often be the case. A look at our first illustration will show the unsuitability of many of the receptacles sent.

We also find that such things as scent and sauce bottles are used without proper washing, while peppermint, aniseed, Mother Seigel's Syrup, boot polish, &c., &c., is often the only aroma we can detect. It is impossible to tell the source of honey unless the receptacle is absolutely clean.

Fig. 2 shows thought and care on the part of some of our readers. On the left is shown a block of wood with a hole bored in it to take a small glass tube; a thin piece of wood tacked on either end makes a safe case; the other two parcels were also well packed with corrugated paper,



FIG. 1.

only right that we should receive consideration, especially as our services are given gratuitously. The carelessness of those sending parcels for Editorial consideration is simply appalling, and renders our work (under the best conditions no light task, as shown in the illustration above of the samples of honey received in a single week) most difficult.

Honey is packed in all kinds of receptacles, very little or no precaution being

as will be seen at Fig. 3, where all are opened. Ingenuity is also shown at Fig. 4, where two cartridge cases are used, one being a little smaller than the other, so that it went inside as illustrated on the right hand, and enclosed the glass tube of honey, shown projecting on the left.

The rules to be observed in sending honey are as follows:—

- (1) Use a clean non-leakable vessel.
- (2) Pack carefully.

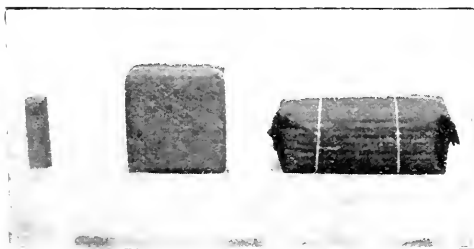

FIG. 2.

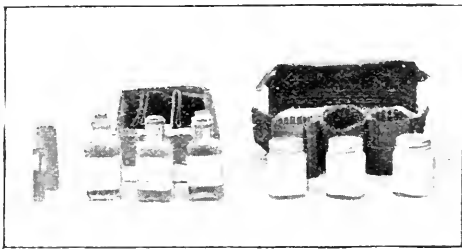

FIG. 3.

taken to prevent leakage, so that many packages arrive in an abominable state. We inherit all the Englishman's love of cleanliness, but object to having to wash our hands every three or four minutes through the carelessness of others. We often wonder what those people say who receive parcels through the post saturated with honey and the contents spoilt, as

(3) If more than one sample is sent number each plainly.

(4) Give as much information as you can about them.

(5) Send the letter separate from the sample, being careful to mark the name of the sender on the latter.

(6) Use a tie-on label on which the stamp is stuck; if it is put on the

package the latter is bound to be smashed when the stamp is obliterated. Dead bees should not be posted in an envelope or cardboard box, or the result will be as Fig. 5. When sending these use a tin box or some other strong covering. Fig. 6 shows the care of one of our readers. A section has been cut so that the lock joints are retained at two corners, shown at the right, and within these a



FIG. 4.

match box is enclosed, as seen on the left. When wrapped in paper and tied with string this forms a strong package. A letter should be sent separate, as in the case of honey, and as much information given as possible to help in the diagnosis. The



FIG. 5.

address and stamp should be placed on a tie-on label.

Diseased combs should be packed in a strong tin box, and on no account should the letter be stuck on the face of such combs, as is often done. It is impossible



FIG. 6.

to describe the disgusting mess and smell we often discover on opening a package of badly packed combs.

If a reply is required by post please do not stick a stamp down on the letter, it is difficult to get off without making the stamp unusable. It is a small matter for the one seeking advice to write his name and address, and stick the stamp on an envelope. With us the addressing of twenty or thirty envelopes is a consideration. We also receive many parcels devoid of any particulars as to who has sent them. In the course of time an indignant letter arrives asking why we have not replied.

Finally, we are anxious to do all we can to help bee-keepers, but we must live, and we consider it unfair for those who seek our aid not to subscribe to one or the other of our papers. That many are mean enough to do this is shown by the fact that they send letters addressed to offices we have left four and even eighteen years ago, showing that they have not current literature, but have looked up an old bee book for the address. The following extract from a letter recently received speaks for itself.

"Will you kindly put the reply to my query in next week's 'B.B.J.' I do not take it myself, but a friend does, and I can go and look at his."

---

#### HONEY IMPORTS.

The value of honey imported into the United Kingdom during the month of December, 1913, was £2,117.—From a return furnished to the BRITISH BEE JOURNAL, by the Statistical Office, H.M. Customs.

---

#### SPECIAL LECTURES.

Special lectures in connection with the Development Fund Grant to the B.B.K.A. will be given at the following places. Where the time and place of meeting are not given, particulars can be obtained from the Secretary of the Association concerned:—

At the Lecture Hall, Zoological Gardens, London, by Mr. W. Herrod, on January 19th, 22nd, and 29th; February 5th and 12th, at 6 p.m.

#### SPECIAL LECTURES BY MR. W. HERROD.

**Worcester, Jan. 24th, 4.30 p.m.**, Central Coffee Tavern. Subject, "A Year's Work in the Apiary."

**Hereford, Jan. 28th, 2 p.m.** Subject, "A Year's Work in the Apiary."

**Exeter, Jan. 30th.** Lecture Hall, University College. 3 p.m. Subject, "Queen-rearing and Introduction."

#### PIONEER LECTURES BY MR. W. HERROD.

*Presteign* ..... Jan. 27th ..... 7.30 p.m.

*Crayford*..... Feb. 2nd ..... 7.30 p.m.

*Gravesend*..... Feb. 25th ..... 7.30 p.m.

*Sidonup*..... March 30th ... 7.30 p.m.





By Nemo.

*Bee-keeping in Greece.*—We find, according to the *Révue Française d'Apiculture*, that there are 13,000 bee-keepers in Greece, who own 201,314 colonies of bees. The census was taken by the Agricultural Society of Greece with the assistance of the schoolmasters in the country. It is principally farmers and the country people who go in for bee-keeping. During recent years many scientists and rich landowners have taken up with enthusiasm modern methods of apiculture.

Bees gather principally from thyme, which blossoms nearly all the year, and gives Grecian honey the well-known aroma which is so appreciated by lovers of honey. Fruit blossoms and many annual wild flowers also yield an excellent honey. That from mount Hymettus, Spetsar, Hydra, Zante, and Maina sells for from 2.50 to 3.00 drachmés (2s. 1d. to 2s. 6d.) per oké (about 3lbs. 5ozs.). Late season honeys, which are more or less dark, realise a lower price, varying from 0.80 to 1 drachmé the oké. At Karistos, near Kallianou a honey is obtained from wild roses which fetches from 8 to 10 drachmés the oké. The honey, which is very light in colour, is highly aromatic and has not its equal in any part of the world. From the earliest ages this honey has been supplied for the table of the Sultans.

*Customs Officials and Bee-keepers.*—A certain area of Savoy is free from duty, and is called "Zone franche." Within this district there are a number of bee-keepers, and one of them, highly esteemed by all, who was among the founders of the "Société d'Apiculture de la Haute-Savoie," has been in the habit for the last twenty years of sending his renowned honey to many customers, principally in Lyon. The honey has always been of first-class quality and much appreciated. This year, however, the Customs have been giving him trouble, for we read in the *Messenger Agricole*, the journal of the Haute-Savoie and the "Zone franche," that he sent as usual 400 kilos of honey in barrels to Lyon, which were stopped at Belgrade, the frontier of the Zone. One of the barrels was opened, and a little liquid honey on the surface—as it had not completely granulated—caused an inexperienced Customs official to suspect adulteration. The honey was retained, and the sender was requested to pay duty

on "*miel de fantaisie*," imitation honey, in addition to a fine for making a false declaration. The bee-keeper was astounded, protested against such an accusation, and demanded a sample, which he sent to the well-known expert, M. A. Caillas, for analysis. This gentleman found the honey perfectly pure and of excellent quality. The Customs, however, kept the honey for more than two months, until their own experts had analysed it, and who also pronounced it perfectly pure. It was then released. This, however, did not end the business, for in accordance with their tariff and regulations the P.L.M. railway demanded 98fr. for storage during the time the honey was detained. The bee-keeper referred them to the Customs, who replied that they were not liable, and had the right of making a mistake, so that the bee-keeper had to bear the cost and had no redress.

*Poisonous Honey.*—There is no plant in Europe known to yield honey that is poisonous to either bees or human beings. But in *Illustrierte Monatsblätter* a fact is mentioned which has frequently been noticed of cases where the nectar of certain plants, such as the lime, heath, buckwheat, and others, appears to affect bees occasionally under certain atmospheric conditions, making them stupid, so that they are liable to lose themselves. This is specially noticeable with humble bees, which are frequently found under lime trees, where they fall and perish during the night. Dr. Alefeld grew masses of henbane and belladonna for experiment in his garden. These poisonous plants bloomed profusely, and were visited by his bees, but he never found them affected in any way, or the honey injurious to human beings. In tropical countries honey derived from laurel, yellow jasmine, and sumac is supposed to be poisonous.

*A Good Mastic for Mahogany.*—The following recipe is given in the *Union Apicole*: Melt 5ozs. of beeswax with 1½ozs. of resin, and add 1¼ozs. of Indian red. This produces a mastic the colour of mahogany, which can be usefully employed in stopping holes or cracks in furniture made of this wood.

THE W. BROUGHTON-CARR  
MEMORIAL FUND.

	£	s.	d.
Amount already acknowledged	12	16	9
A. Baldwin .....	0	3	6
J. E. W. E. ....	0	2	6
W. Winterton .....	0	2	6
Rev. R. M. Lamb .....	0	1	8
M. Robinson .....	0	1	0

£13 7 11



### QUERIES AND REPLIES.

In heading this paragraph I do not seek to usurp our Editor's function. The replies are merely given in answer to pertinent queries put recently by Mr. Crawshaw. On page 198 he asks what do I really mean? What was in my mind was a system of watering bees carried out by a friend. He heats the water for his bees, runs it out pretty warm through a pipe into a contrivance made on the same plan as is used in distilleries when "cooling" the liquid produce of the steepers. It runs in at one end of the cooler, winds about from side to side, thus making the journey not only a lengthy one, but also one occupying considerable time, until at last it finds its way to a new receptacle after becoming cold. On page 508 he asks what do I mean by the "seeds of granulation"? My idea is comb once occupied with granulated honey, even after a fairly complete cleaning by bees or bee-keeper, or both, may still retain the "germs" of granulation. Brood combs filled with syrup may contain a remnant of the inciting cause. I think I have found it so. Also sections not completed one year with some honey in the cells, and used as bait sections next season, will "breed" granulation. Again, feeders not properly cleaned when syrup has candied during the feeding process may, almost inevitably, act as an incentive to granulation at some subsequent period, even when the food has been well and properly made by the bee-keeper, and that not by any incipient cause in the syrup, but from the "seeds" present.

He queries also whether the thick syrup I advocated—2½ lbs. of solids to one of liquid—would not be certain to granulate, in spite of all precautions, from its own inherent over-consistency. I do not think so, with care. It has again and again been advised by both Dr. Miller and Mr. E. Root, and if they find it a good and efficient food, why should not we?

Perhaps there is really little difference of opinion between Mr. Mace (see page 1) and myself, and I am ready once more to shed some light on both points he raises, if I can. I certainly do not "entirely ignore" the starting of queen cells in the isolated apartment of the hive. In my original articles on "Increase" last June I advised the provision of a "fertile queen," a "virgin," or a *queen cell* in every division made. To say

that I should repeat these instructions every time I write of rearing queens in an overhead compartment, or in a chamber behind the regular brood body, is surely superficial criticism in the nature of straining at a gnat. His other point is that legislation should step in as a logical sequence to suppress the hook, &c. I did not deal with this feature of the question, and that advisedly. I do not care to quote myself, but here are the last words I wrote on skep legislation: "Let me plead for its elimination, its suppression, *not* by the strong arm of the law, but by the no less powerful influence of example and the teachings of common sense." I never set Mr. Mace down as a Cave Dweller, and I do not think he is an Adullamite.

*Selecting a Queen.*—Anomalous although the statement may sound, if I were to get my choice of a queen from among several I would not desire even to see the queen I would select. Many would, and the majority would choose likely the largest, and, according to their ideas, the most shapely queen. Looks are deceiving. Others would probably go by the beauty of the mother bee; many, indeed, make it their aim to breed for colour, as if all the virtues lay in this one taking feature. Nothing, however, in my opinion, is a greater fallacy. Three bands, five bands, all golden, are distinctive features as far as looks go, but they have no bearing on the prolificness, and other good points of a superior queen. The best way to judge the points of a good queen is to see results of her work. Go to the hive she heads, and take notice of the fine even slabs of brood she has left behind as a memento of her visit to the various frames she has visited. There will be no scattering of eggs there, no isolated patches, all will be laid evenly and systematically. A good queen will have all the central combs packed fully and uniformly, and in course of time all but a corner left for nectar will be sealed cells, young or old larvæ and eggs in all stages. While carrying out this investigation note signs of any trace of burr combs, an over-lavish use of propolis, signs of bad or careless capping, as causes for rejecting the queen. Prolificness, gentleness, and good working qualities can all be diagnosed from such an examination of the brood nest. Of course, the race desired makes a difference, but for comb honey evidence can be obtained from the nature of the cappings whether she will suit for sections. For this purpose no other strain or race suits better than the good old English bee, if found in her purity; but that is becoming yearly a greater difficulty. Alas! that it should be so!

*Examinations.*—The day is past, I think, when bee-keepers would be prepared to undervalue the good effect on any bee-keeper of the necessary study and preparation for undergoing the ordeal of a far-searching examination. The qualifications required to pass for a third Expert Certificate are not very severe, but if it be remembered that the oral examination practically covers the whole field of bee-keeping, one can appreciate the very great advantage derived from a careful and systematic study of the bee-books read before the trial comes off. One knows a good deal about bee-keeping; he has practised it for many years, and can get along fairly well; sometimes in a blundering way, because he has not really set his mind thoroughly to digest the extensive mass of facts he has loosely acquired. A good deal of matter is floating about somewhere at the back of his mind, but he has never assimilated it properly. It is in a fluid or chaotic state. In his *grind* he applies system to collect, assort, arrange, and unify all into a connective whole, ready to come to his aid at his beck and call. The first condition of undigested facts floating loosely, and wanting coherence, means chaos, the methodical arrangement and more definite co-relation of these facts mean precise and available knowledge. I am strongly of opinion that any bee-keeper who closely studies even for a third or preliminary examination is a better man or woman, as well as a better bee-keeper, for these weeks or months of close application and study.



*The Editors do not hold themselves responsible for the opinions expressed by correspondents. No notice will be taken of anonymous communications, and correspondents are requested to write on one side of the paper only and give their real names and addresses, not necessarily for publication, but as a guarantee of good faith. Illustrations should be drawn on separate pieces of paper. We do not undertake to return rejected communications.*

#### SPRING DWINDLING.

[8925] As I am afraid I may have created a false impression (page 512), with your permission I should like to say I no more thought that the "movable comb-hive" is impervious to mismanagement than I would say the skep "lack of method" is prone to it. Human control, over the brood-nest, stores, to say nothing of the liabilities of the several diseases bees are found to be inherent to, is practically *nil* in the case of the skep, though this, in our variable climate, is so essential to the very existence of the bee.

*Marketing and Labelling Honey.*—I was intensely interested in Mr. Menzies' address on the former subject, especially as it was my first visit to a conversation of the British B.K.A. It is almost impossible to pass an adverse criticism on the paper, as it was so broad and filled with the "theme of progress," but I do think the real cause of the scarcity of British Honey is the enormous losses of stocks during the past three years. While personally not admitting the need of a wholesale distributor for "wholesale" purposes for British honey, obviously there must be such distribution for the Colonial produce. As for co-operation, we have the best machinery fully organised, but do we members of Bee Associations really use it? Why, we do not even attend our annual meetings. One of the objects of the Surrey B.K.A. is the disposal of members' honey, but up to the present I am glad to say I have never used the Association for this purpose, as I cannot get enough to fill orders. I find an advertisement in the local paper brings all the trade I need. Here again I can save. I always deal first hand. I find the Association label of great assistance in selling, as the guarantee gives confidence at a glance. A better education in bee-keeping appears to me to be wanted. On our executive councils we have gentlemen holding responsible positions on educational boards, "work them," to push bee-keeping into our schools, which is about the only thing not taken seriously there. Where there is a big surplus of honey in a county it seems a simple thing to appoint a person to effect some sales in our big cities. Is it not about time we had an all-British label? We have a big affiliation now.—A. H. HAMSHAR.

#### RAISING QUEENS ABOVE EXCLUDER.

[8926] With reference to the controversy as to whether bees will raise queens as to whether bees will raise queens when brood is separated from the compartment occupied by the queen by excluder, I have had two instances myself, and in each case a queen-cell was formed. The first one was in shallow frames above excluder, the four centre ones had a small patch of brood and eggs at the bottom; whether the queen had got through the excluder, or the workers had carried the eggs there, I cannot say, but there the brood was when I took them off for extracting. I put the four frames containing brood back and filled the rack with empties, leaving them on long enough for the brood to hatch out. When removing them I found the cell from which the queen had issued.

The other case was a swarm I bought on five frames, 12in. by 10in., which I desired to transfer to standard frames. I placed the deep frames over the standards

until the latter were well occupied, when I shook all the bees on to them from the deep frames, first making sure the queen was below, put the excluder between. There was no queen-cell at that time, but when moved a month later there was an empty one. In both instances the combs were new. Being a novice (I commenced last spring), I might have overlooked the real cause, but I can assure you in neither case was it for want of room.

*Natural Food and Hardiness of Bees.*—In following my business, I cycle past a farmhouse, in the garden of which I had noticed an old hive with the roof tilted over considerably and looking altogether too dilapidated to be inhabited. Riding past one day in summer, I heard the hum of flying bees, and, stopping to see where they went, was surprised to see them make for and enter the old hive. As I stood watching them the owner came upon the scene, and thinking (rightly) that he had no further use for them, I asked if  $\text{1}$  would sell. I bought them at a speculative price without examination, beyond what I had seen from the road. When I went to prepare them for removal I found a rack containing five sections in one corner, which had contained honey and brood at some time, but was now empty. The roof was cracked and the cap was off, allowing the rain to go through. If there ever had been a quilt on, it had left no signs. I got the hive home without a hitch and proceeded, after a few days, to transfer the frames to another hive. There were nine broad-shouldered frames, and after a good deal of trouble I managed to get four out whole, the other five, like a good portion of the hive, were too decayed to hold together, and all were fastened either to the side or bottom of the hive with propolis, which had set as hard as cement.

When I bought the stock the owner told me the last time anything was done for them was seven years ago, when a commercial traveller painted the hive out of pity. The "combs" were full of stores, and, to use his own words, "they have kess'n three times this summer," which I took to be a swarm and two casts. This stock was gathering pollen on December 2nd from mignonette; on that day the bees from my other six stocks were not to be seen at all.—NOVICE.

#### KEEPING APIARY ACCOUNTS.

[8927] As I have only just become a regular reader of the "B.B.J.," I am afraid I have missed some valuable information by Mr. Smallwood. However, your correspondent's letter (8924) on page 17 will help me considerably.

I have always kept an account of my expenses and receipts, but have never yet been satisfied, in my own mind, that my

system of getting at the "profits" was correct. There are two or three points in which "T. M." might assist me.

Does he call expenses and purchases Dr., and should this appear on the left or right side of the account?

How would he treat the question of a *doubled* stock as to valuation at the end of the year?

What about the loss of a swarm, say, just as the honey-flow commences? The "surplus" from that hive would be nil, so should this be written off as a loss and placed on Dr. side?

*Depreciation.*—What would "T. M." advise with regard to this item, if one paints one's hives each year, keeping everything up to the mark, and, of course, charging the cost up? The brood-chambers and supers must deteriorate in time.—A NOVICE.

#### BLURTS FROM A SCRATCHY PEN.

CONTINENTAL WANDERINGS.

(Continued from page 8.)

"There was a sound of revelry by night,

The Norman capital had gathered then,

Her beauty and her chivalry, and bright  
The lamps shone o'er fair women and  
brave men."

Let not the ghost of Byron haunt me for thus commandeering and altering to my own sweet will his familiar lines, but had I searched the whole library of British poets I could not have found a more appropriate quotation for the reception which met our arrival in the historic city of Rouen, and had we been important folk we might have anticipated some such manifestation. But no, we were but ordinary people, and therefore to find the town *en fête* was quite unexpected. Flags and banners flaunted their gaudy colours, and from the thronged streets "the sounds of revelry" arose. It was the day of a great event. Cohorted musicians had gathered together from all parts of France and even "Algerie." It was a day of battle for laurel wreaths and crowns of honour, for those associated groups who bore themselves most bravely. In England three simple words, "A brass-band contest," would have described the event; in France it had a much more sonorous and ambitious title.

Well, then, figure us if you can, full of hope and delightful expectation of musical enjoyment for the evening. We thought we were in for a good thing, and when that we had recovered and refreshed ourselves after our voyage we would be happy and gay. We knew a good hotel—we were told of it ere we left England. What could mar our joy? "*Vive la France.*"

You never know what fate has in store

for you. At the "Ecu de France" "Monsieur le patron" was beaming with smiles and profuse in Gallie gesticulations. "Où! What accommodation did we desire; we were so welcome." Naturally it occurred to us, as Rouen was so festive, to enquire what tariff his modesty and politeness would permit him to charge us. Exactly double the ordinary rates. What would you wish? The hotels were full, and he could easily let his chambers. We were "desolated" to refuse him, but we politely declined to be "had."

Other hotels, we thought, might be less exacting. Vain was the thought! Vain! It was as if the musical army of France had emulated the German invaders of 1870, taken possession of the town, and billeted themselves on the inhabitants. Everywhere the same reply, "*Complet*," which needed no translation.

A happy thought! We have an introduction to a local apiculturist, a man of great fame. Shall we appeal to the brotherhood of bee-keepers? Would it, and could it, help us in our dire distress? Accredited duly I found my way across the city to "la rue de la Grande Horloge," whilst my fellow-travellers kept watch and ward over our baggage under the shelter of a tree. But bad fortune had another kick left for us. "Monsieur was on his holidays; he would not return until Tuesday."

Dismayed and crestfallen was my return. The next train to Paris was in the early morn, and we could not camp out in the centre of the town under the stars. But woman's wit came to the rescue. "If the hotels are so full, we must try the cafés. Even here, not at the first, nor even the second, nor the third attempt did we succeed. But valour, especially feminine, is invincible. A café near the "Grand Gare" attracted our notice by its neatness. A little bargaining, and because that we were three "*voyageurs*," and it was therefore a serious transaction, we secured a rest for our wearied selves. Nor in the end were we dissatisfied, although we had to pay 50 per cent. on normal prices.

I would gladly tell tales from the history of the old town. I would fain discourse of its Cathedral with the "Butter Tower," so called because a tax on butter provided funds for its erection; of the wonderful Church of St. Onen; of William of Normandy, brought hither, mortally wounded, to die; of Arthur of Brittany, he who pleaded so pathetically (so our Shakespeare tells) for his eyes; of Joan of Arc, here burned at the stake; of its manufactures (the Cottonopolis of France). There is no dearth of subject, but space will not permit; I must

hurry on. Nor will I narrate how next day.

"Rich strains of music wind along,

Deep, majestic, smooth and strong,"

because, as I have described our entry into Rouen, so must I also tell the story of our exit.

It was only the advanced guard of the army which had taken possession the previous night. To-day (Sunday) the main army marched in, each unit of it playing some instrument of metal or wood, or both. Wherever could they all come from? There were bands military, naval, and gendarmerie. There were bands departmental, municipal and from little villages, even, as I have said, from distant Algeria. There were bands amateur and working-men; aye, and working-women, too, and right lustily did the latter play. All bore emblazoned banners. And so the town was packed.

There *may be* advantages to the community for the railways to belong to the State. I do not see them. One would have thought that to move this great assemblage special and frequent trains would be run. Not so in France, where the proverb has it they manage these things better. The Government, having no competition, deemed the usual Sunday service to and from Paris sufficient. So when we took our departure in the afternoon (for necessarily our stay was but short) we found the platform crowded from end to end. An hour's delay, and our train (! ! !) drew up absolutely full. An English stationmaster would have dealt with the difficulty in five minutes. Not so "Monsieur le Chef de la Gare." He had to consult with some other official, who had to consult a third. All three had to argue the point (with the usual gesticulations), which took half-an-hour, aided by occasional instructions from irate passengers to "*additionnez-les*," and the result was to add half-a-dozen more carriages to the head of the train. As most of the expectant passengers were in the rear, the movement to the front, therefore, which had to be made was certainly not dignified. However, the junior editor, being more fleet of foot, secured a compartment before the writer, who is more portly of frame, could reach it. The crowd surged in. It seemed as if we were to be separated. Again woman's wit to the rescue—it was the last carriage of the addition. "Go round to the other side." The flank attack succeeded. I mounted. Final tableau. Frantic appeals from ten French passengers to the *chef* to eject *l'Anglais*. "Hold hard: hold hard," from my fellow-passengers. Useful deafness of the *chef* toot-tooting of the horn, and departure of the train for Paris.

JNO. SMALLWOOD.



## QUERIES AND REPLIES.

[8901] *Nucleus Swarming*.—In this method of increase, as described in the "Guide Book," when a stock is placed on the stand formerly occupied by the nucleus, the latter being removed to the stand vacated by the stock, I understand that the returning bees enter the respective hives on their old stand. These would be strange to them and the bees not of their own colony. Does not a lot of fighting take place?—NOVICE, Elmet.

REPLY.—There is no danger of the two lots fighting when the places are exchanged, for the bees from the "strong" hive are foragers returning laden and are welcomed. The same holds good with the flying bees of the nucleus.

[8902] *Requeening*.—I have twelve stocks of bees in an out apiary two miles away. They are free from disease, and I wish to requeen from my own bees in order to avoid the risk of introducing disease. All the stocks except two are in their second season. M. R. Leyland, Lanes.

REPLY.—You will find full instructions for requeening in Mr. Sladen's book "Queen-rearing in England," which you say you have just purchased.

[8903] *Controlling Queen-mating*.—I should be glad of your opinion on the following:—Suppose I have a hive of black bees—one of hybrids, and one of Italians—and a neighbour close at hand has nondescript varieties of bees. I make a nucleus with queen cells from one hive and wish to keep the parent stock for honey gathering only. How can I know which species of drone will fertilize the respective queens. One can prevent drones in one's own apiary but can have no control in a neighbour's. The only plan I can suggest would be to take each virgin queen with drones of the same race some distance away and chance the queen returning fertilised, failing this one can keep the species pure by having only one race of bees in the apiary, which I think is the best plan to follow for honey production.—H. C., Stafford.

REPLY.—When several different races are kept not only in one apiary but also in the neighbourhood it is impossible to know what species of drone will mate with the respective queens. The most satisfactory way is to rear queens and drones early in the season as described on page 124 of "Guide Book."

## NECTAR-PRODUCING PLANTS AND THEIR POLLEN.

By Geo. Hays, Beeston.

BUTTER BURR (*Petasites vulgaris*).

No. 27. NAT. ORDER. *Compositæ*.

(Continued from page 493).

This plant is closely allied to the Coltsfoot (*Tussilago farfara*), which was dealt with in a previous article ("B.B.J." 1911, p. 392). I doubt if it is at all well known, and have not seen it in many places in the county of Notts, but have met with it more frequently in Derbyshire and Lancashire. Where it abounds, I feel convinced that it is of great help to bees, blooming as it does so early in the year; for I have had evidence that it yields abundantly, both nectar and pollen. There is a bed of it not more than half a mile distant from Nottingham Castle, which, on warm days in March and April, is literally alive with hive bees, even to the abandonment of patches of Coltsfoot growing near it.

Like the last named, it pushes up its flower-heads before the leaves appear, and blossoms at the same time as the Coltsfoot. The flower-spikes, when full grown, are, at first sight, somewhat similar in form to those of the garden hyacinth, but are of a dull red purple colour, and owing to this it is no doubt often passed unnoticed. Later on it becomes more conspicuous by the numerous stigmas which then protrude, and, being quite white, give a speckled appearance.

It is well that it flowers before the leaves appear, for otherwise it would be difficult to recognise it unless it developed a different flower-stalk, for the leaves, which are very similar in shape to those of Coltsfoot, are of much larger dimensions, some, when full grown, measuring as much as 3ft. in diameter, and grow to a height of 12in. or 15in.

It is to be found in wet places, especially by the sides of streams. The patch I have mentioned is on the railway embankment, which at this spot is frequently flooded.

The generic name—*Petasites*—means to cover, taken, no doubt, from the fact that its large dense foliage well covers the ground, whilst *vulgaris* denotes it to be the more common species, there being several others.

The pollen as shed from the anthers is pure white, and the bees working on the flowers get covered with it, and are like millers, but when the pollen is packed on the corbicula of those I observed, it was of a dark grey, so that it was difficult to see whether a bee was loaded with it or not. This appears to be attribut-

able to two causes. First to the accumulation of dust and smuts on the flowers, for it must be remembered that those I closely observed grew on the side of the railway, and, upon examination under the microscope, I found the pollen contained about 25 per cent. of coal-dust, soot, and other matter. Secondly, to the reaction of the saliva of the bees used in kneading the pollen before placing it in the corbicule. In both cases it is much lighter in colour after desiccation.

When taken dry, the grains glisten like crystals, and by transmitted light they only show the faintest tinge of colour.

In form they are a spiny ovoid with three deep corrugations, or grooves, running from end to end, as seen at No. 1. Owing to the spines, the grains cling together in masses to such an extent that it is somewhat difficult to separate them for examination. The grains appear very regular in size, and

measure  $\frac{1\frac{1}{1000}}$  in.  $\times$   $\frac{1}{1000}$  in. No. 2 is a cross section through middle of the grain. When placed in honey the grain assumes a rather more circular form, as seen at No. 3, and, after a time, will measure  $\frac{1\frac{1}{2}}$  in.  $\times$   $\frac{1\frac{1}{1000}}$  in.

When extracted from honey, the water in it causes the processes to swell out and assume the form shown at No. 5. It will then measure from process to process  $\frac{1\frac{1}{1000}}$  in. The same takes place when it is placed direct into water.

(To be continued.)

order among the gamut of colours. Some people are blind merely to two colours, and are normal for all the rest. Sir William Ramsay is himself an example of this idiosyncrasy; and it is improbable that any two persons have exactly the same colour vision. But the commonest form of colour blindness is that which perceives green and red merely as different shades of grey; and there are reasons for believing that this is a form of colour blindness shared by many orders of animals. It is very difficult, of course, to test animals, because, as Professor Washburn has pointed out, we can never be sure that the animal tested is not making its discriminations on the ground of differing brightness of hue rather than on actual difference of colour; and there is some evidence that this is actually the case among mice. But a series of very interesting experiments have lately been made by Professor K. von Frisch, of Munich, which seem to show that whatever colour sense may be possessed by bees, the ability of distinguishing red as red is not comprised in it. Von Frisch carried on his experiments on bees in the open air near their hives, and by the aid

of what is called the food preference method he found that one day's training was enough to enable many hundreds of bees to distinguish between blue and grey. This distinction rested on the material inducement to remember (and distinguish) that whatever was coloured blue was sweet, and whatever was grey (though he employed thirty-two shades) was not sweet. In the same way they were taught later that yellow indicated sweetness. But no amount of training was ever able to teach Von Frisch's bees that there was any difference in colour between red and black. The bees are totally colour blind to red. Another experimenter in animal behaviour, Miss Christine Ladd-Franklin, induced Professor von Frisch to undertake some further experiments to ascertain whether, this being the case, he could not find a certain blue-green which

Dry.

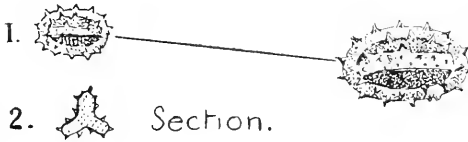

In Honey.

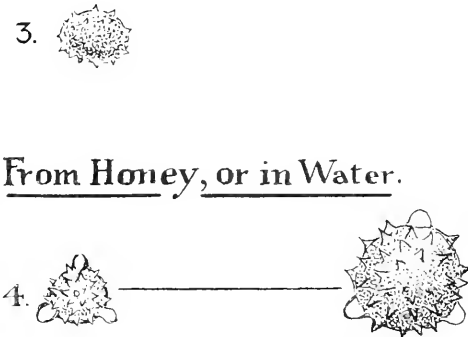

From Honey, or in Water.

POLEN OF BUTTER-BURR.

COLOUR BLINDNESS IN BEES.

A correspondent sends us the following extract on bees and colours:—

"It was recently explained by Sir William Ramsay that we are all to a certain, but differing, extent colour blind; which is to say, that there are certain hues which we may indeed distinguish, but which we do not place in the right

order among the gamut of colours. Some people are blind merely to two colours, and are normal for all the rest. Sir William Ramsay is himself an example of this idiosyncrasy; and it is improbable that any two persons have exactly the same colour vision. But the commonest form of colour blindness is that which perceives green and red merely as different shades of grey; and there are reasons for believing that this is a form of colour blindness shared by many orders of animals. It is very difficult, of course, to test animals, because, as Professor Washburn has pointed out, we can never be sure that the animal tested is not making its discriminations on the ground of differing brightness of hue rather than on actual difference of colour; and there is some evidence that this is actually the case among mice. But a series of very interesting experiments have lately been made by Professor K. von Frisch, of Munich, which seem to show that whatever colour sense may be possessed by bees, the ability of distinguishing red as red is not comprised in it. Von Frisch carried on his experiments on bees in the open air near their hives, and by the aid

is exactly complementary to red, to which also the bees would be—as we say—colour blind. Von Frisch has tried the experiment. He believes he has found this idea to be true, and that there is a certain bluish green (as it would seem to normal eyesight) which bees by no possibility can learn to distinguish. This seems to show that bees are colour blind in the ordinary acceptance of the term; their blindness resembles the ordinary form of red-green blindness; and their vision, like that of many human beings, is dichromatic instead of tetrachromatic, their “visible” colours being yellow and blue.” *Monthly Post*.

## WEATHER REPORT.

WESTBOURNE, SUSSEX.

December, 1913.

Rainfall, 2.60 in.	Minimum on grass
Below average, .59 in.	12 on 29th.
Heaviest fall, .89 on 23rd.	Frosty nights, 11.
Rain fell on 17 days.	Mean maximum, 45.8.
Sunshine, 40.3 hrs.	Mean minimum, 37.4.
Below aver., 13.8 hrs.	Mean temperature, 41.6.
Brightest day, 29th, 4.8 hrs.	Above average, 1.6.
Sunless days, 12.	Maximum barometer, 30.627 on 21st.
Maximum temperature, .55 on 1st.	Minimum barometer, 29.384 on 28th.
Minimum temperature, .27 on 25th.	
	L. B. BIRKETT.

## WEATHER REPORT FOR THE YEAR

1913.

WESTBOURNE, SUSSEX.

Rainfall, 37.78 in.	Minimum temperature, .26 on Jan. 13th.
Above average 7.31 in.	Minimum on grass, 12 on Dec. 29th.
Heaviest fall, 1.40 on August 31st.	Frosty nights, 44 below average 29.
Rain fell on 192 days above average 14.	Mean temperature, 49.9.
Sunshine, 1532.2 hrs.	Above average, 1.4.
Below average, 289.8 hours.	Maximum barometer, 30.647 on Feb. 12th.
Brightest day, June 29th, 14.8 hrs.	Minimum barometer, 28.952 on Mar. 19th.
Sunless days, 60 below average 1.	
Maximum temperature, .81 on June 29th.	
	L. B. BIRKETT.

## Notices to Correspondents

Letters or queries asking for addresses of manufacturers or correspondents, or where appliances can be purchased, or replies giving such information, can only be inserted as advertisements. The space devoted to letters, queries, and replies is meant for the general good of bee-keepers, and not for advertisements. We wish our correspondents to bear in mind that, as it is necessary for us to go to press in advance of the date of issue, queries cannot always be replied to in the issue immediately following the receipt of their communications.

M. B. S. (Middx.).—*Lectures on Bee-keeping*.—(1) No. (2) The lectures are free; no tickets are required for the winter course. (3) We cannot say at present.

E. P. J. (Cardiff).—*Honey Sweets*.—Several recipes are given in Mr. Howard's book, "Producing, Preparing, and Exhibiting Bee Produce." A recipe for Honey Toffee appeared in "B.B.J." for March 13th, 1913. In the "A.B.C. of Bee Culture" over a dozen different methods of using honey for this purpose are given. Our limited space does not allow of reprinting them.

A. M. S. (Kettering).—*Bees Refused Admittance to Hive*.—The bees are workers, not drones.

W. J. H. (Doncaster).—*Stock Found Dead*.—(1) The bees are ordinary British variety. (2) The queen is a fertile one. (3) Cause of death is "Isle of Wight" disease.

J. S. L. (Salep).—*Dead Queens*.—(1) There is nothing about the queens to indicate cause of death. (2) From your description of the circumstances we fear "Isle of Wight" disease was accountable.

### Suspected Disease.

J. A. H. (Somerset) and RAGLAN (Swansea).—The bees have died from "Isle of Wight" disease.

NOVICE (Peterboro').—The bees have dysentery, no doubt caused by feeding on beet sugar.

H. P. Y. (Hants).—(1) The bees have died from starvation. (2) The position in which they were found—head-downwards in the cells—is characteristic of this.

J. T. F. (Darlington).—We regret to report "Isle of Wight" disease is the cause of the trouble.

CONSTANT READER (Hants.).—Both lots of bees are British, and are affected with "Isle of Wight" disease.

A. G. B. (Thornton Heath).—The bees are Italians, and are badly affected with "Isle of Wight" disease.





**BRITISH BEE-KEEPERS' ASSOCIATION**

The monthly meeting of the Council was held at 23, Bedford Street, Strand, London, W.C., on Thursday, January 15th, 1914. Mr. T. W. Cowan presided. There were also present: Miss M. D. Sillar, Messrs. R. H. Attenborough, J. Smallwood, E. Watson, J. B. Lamb (Association representatives), G. J. Flashman and F. Ford (Barnet), G. Bryden and G. W. Judge (Crayford), G. F. Faunch and G. R. Alder (Essex), F. W. Harper (St. Albans), and the Secretary (W. Herrod).

Letters expressing regret at inability to attend were read from Miss Gayton, Messrs. W. F. Reid, O. R. Frankenstein, T. Bevan, A. G. Pugh, E. Walker, C. L. M. Eales, H. Jonas, and Dr. T. S. Elliot.

The minutes of the Council meeting held on December 18th, 1913, were read and confirmed.

The following new members were elected: Miss A. M. Holland, Mr. Jesse Johnson, Mr. A. Low, Mr. W. Winterton, and Rev. F. H. Fowler.

The following Associations nominated representatives to the Council, and the same were accepted: Surrey, Mr. J. Kaehler; Crayford, Mr. G. W. Judge; St. Albans, Mr. F. W. Harper.

The report of the Finance Committee was presented by Mr. Smallwood, who stated that the payments into the bank for December amounted to £65 16s. 6d., the bank balance being £193 11s. 3d. Payments amounting to £5 were recommended.

The report on the Intermediate Examination by Mr. D. M. Macdonald was presented, and it was resolved to grant certificates to the following: Misses G. Sievier, U. Thompson, E. M. Penrose, and N. M. Robinson, Messrs. T. W. Skelly, G. W. Avery, D. Hardcastle, J. S. Baldry, B. E. Bucknell, T. Payne, F. S. Elliott, O. C. Jones, J. W. Moir, W. Doleman, A. Riley, A. H. Bowen, W. J. Watkins, W. H. Tinsley, A. Briers, G. G. Desmond, F. W. Harper, J. A. Hutchison, G. Horsecroft, K. Greig, H. Watts, W. E. Richardson, and Dr. W. Anderson.

The report of the Examining Board on the lecture test was presented by Mr. T. W. Cowan, and it was resolved to grant the First Class (Expert) Certificate to Mr. C. H. Heap.

Next meeting of Council February 19th, 1914, at 23, Bedford Street, Strand, London, W.C.

**SPECIAL NOTICE.**

**DISEASES OF BEES BILL.**

As Associations will soon be holding their annual meetings, we would impress upon them the necessity for still continuing the agitation to obtain an Act as soon as possible. To this end strong resolutions should be passed, urging the necessity for legislation at an early date. These should be forwarded to the President of the Board of Agriculture, Mr. Runciman, Whitehall, Westminster, and to the Member of Parliament for their division.

We should also be pleased to have copies of same.

**TOTAL HONEY IMPORTS FOR 1913.**

	£
January .....	2,886
February .....	1,837
March .....	1,456
April .....	4,237
May .....	3,636
June .....	6,684
July .....	6,242
August .....	6,675
September .....	6,511
October .....	3,949
November .....	4,443
December .....	2,117
	<hr/>
	£50,673

**SPECIAL LECTURES.**

Special lectures in connection with the Development Fund Grant to the B.B.K.A. will be given at the following places. Where the time and place of meeting are not given, particulars can be obtained from the Secretary of the Association concerned:—

At the Lecture Hall, Zoological Gardens, London, by Mr. W. Herrod, on January 22nd and 29th, February 5th and 12th, at 6 p.m.

**SPECIAL LECTURES BY MR. W. HERROD.**

**Worcester, Jan. 24th, 4.30 p.m.,** Central Coffee Tavern. Subject, "A Year's Work in the Apiary."

**Hereford, Jan. 28th, 2 p.m.,** Subject, "A Year's Work in the Apiary."

**Exeter, Jan. 30th,** Lecture Hall, University College. 3 p.m. Subject, "Queen-rearing and Introduction."

**PIONEER LECTURES.**

**Presteign, Jan. 27th, at 7.30.** By Mr. W. Herrod.

**Crayford, Feb. 2nd, at 7.30.** By Mr. W. Herrod.

**Gravesend, Feb. 26th, at 7.30.** By Mr. W. Herrod.

**Sidcup, March 30th, at 7.30.** By Mr. W. Herrod.

**Sedgley, Jan. 29th, at 7.30.** In Wesleyan Schoolroom. By Mr. Joseph Price.



## MANIPULATING A ERAME HIVE

*(Continued from page 15.)*

To handle the frames properly, the following mechanical movements should be practised:—Lift the frames by gripping the projecting ends of the top bar (termed lugs) firmly. With the finger and thumb draw it slightly away from the next comb before lifting out, to prevent brushing off the bees. Lift it right up to the level of the eyes, and examine the side next to you carefully (No. 7). To get a view of the other side, do *not* turn it right over so as to bring it in the flat position (No. 8), as, on a warm day, it is quite possible for the comb to get so soft that the weight of brood and honey will cause it to drop out; if unwired, this is sure to happen. Lift the frame up on end (No. 9); turn it round in the fingers (No. 10) half way, showing that the frame must be turned away from the manipulator, and not towards him, to avoid catching it in the veil. No. 11 gives the position of the bottom bar, being in the place of the top bar, as at No. 9. The left hand is then lowered so that the opposite side of the comb is brought before the eyes (No. 12), while the comb has been kept edgewise all the time. The principle adopted is the same as when handling a large sheet of glass, which can be carried without breakage while kept edgewise, but which breaks if placed on the flat. To get the frame back the same motions are reversed. To replace the frame in the hive, do not try to put it straight down, but turn it at a slight angle, when it will go in quite easily without crushing the bees against the sides of the hive. The same plan should be adopted when lifting out the frame.

The bees will often get in clusters, underneath which the queen hides away. Do not blow on these to move them, as they object to the smell of human breath, and if a veil is not worn they fly straight to the mouth and sting. The use of smoke will cause them to fly. Use the back of the finger, gently pressing the bees, when the cluster will disperse (No. 13). Do not scrape them off; apply gentle pressure only. No. 14 is an unintentional snapshot showing the little chap's excitement at seeing the queen, and was taken just as he said, "There she is, daddy." At No. 15 the queen is being caught by the wings and held up to be seen (No. 16). If a child of two years can see and catch the queen, there should be no difficulty for the grown-up novice to do the same.

When examining to find the queen, a careful watch should be kept on the floor board and sides of the hive each time a frame is removed, especially on the side of the hive when the last frame has been taken out. Some queens are very prone to run off the combs when excited. If the queen is not found after all the combs have been examined, blow a little smoke in at the entrance, as she sometimes hides there. If this fails, then push the frames bodily from back to front, and examine the floor and side of the hive, as she may have run back during the manipulation.

Should the queen fly while the hive is being examined, stand quite still and keep the hive open, when, ninety-nine times out of a hundred, she will settle in again or alight upon the manipulator.

Care should be taken to keep the combs over the hive when examining them, as occasionally the queen will drop off, and if she drops on to the ground instead of into the hive, she may be either lost or killed by being trodden upon. Manipulate from that side of the hive which allows the best light to fall upon the comb.

If, after the first subjugation, the bees become restless, or are inclined to be angry, a few puffs of smoke should be driven in again, or the carbolic cloth laid over the frames for a few seconds. When not in use, the smoker should not be laid down on its side, or it will go out; if placed on end on the top of the frames, as shown in the illustration, it will keep alight while any fuel remains, and will also be within easy reach.

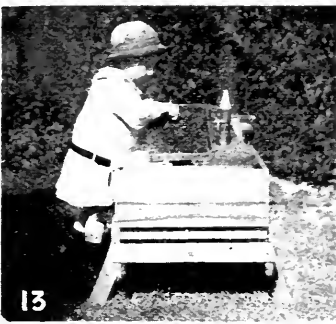
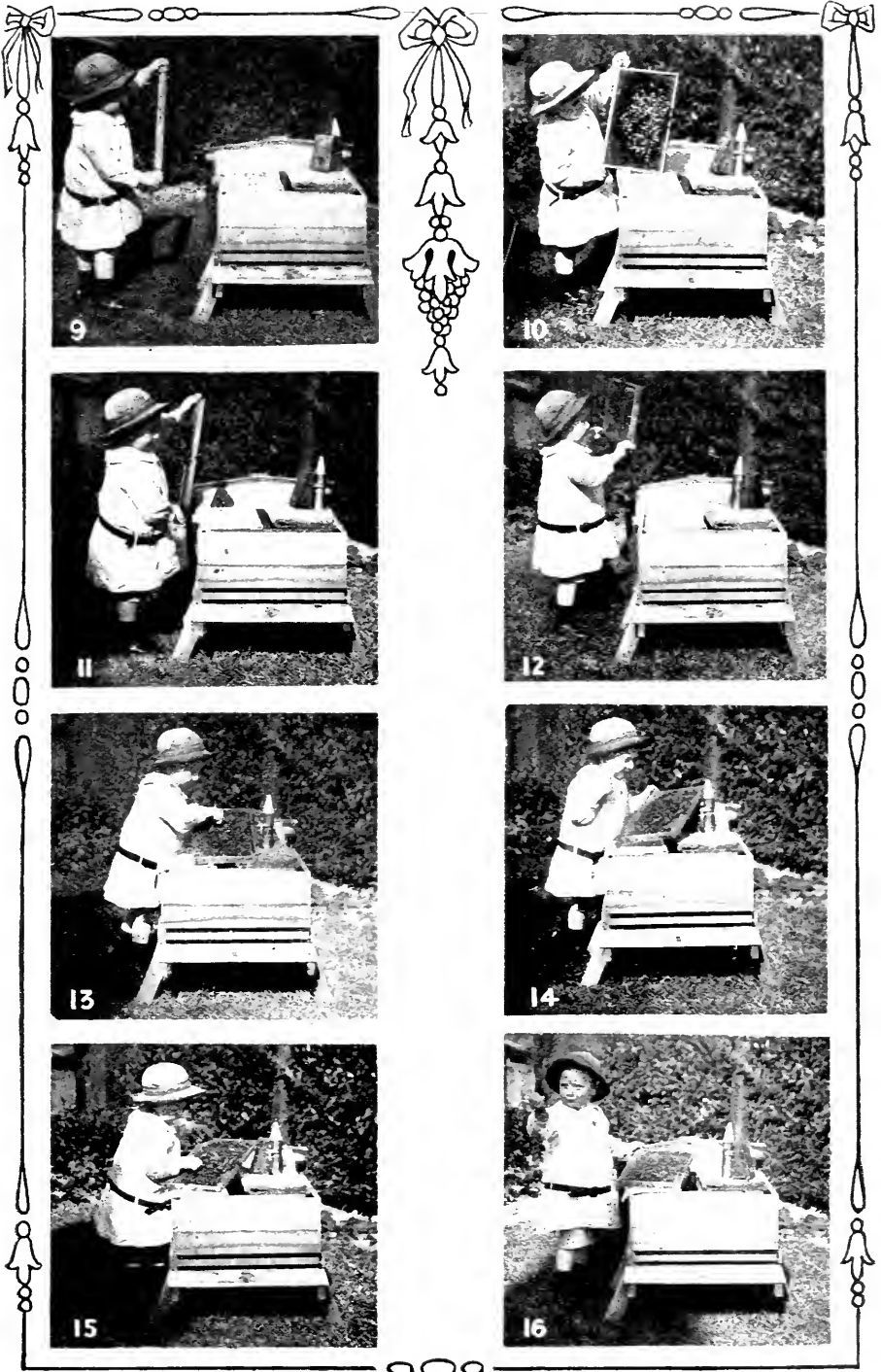

FINDING THE QUEEN.

In windy weather it will be found advantageous to keep the lift on and not to raise the combs up beyond its shelter, so that the bees are not irritated or blown off by the wind.

Stocks that are short of stores should be sprinkled with thin syrup before attempting to manipulate them.

Climatic conditions must be taken into consideration. Hives must not be opened in wet or cold weather, or yet in a thundery atmosphere. The reason for the former is very obvious, while under the latter conditions the bees are almost sure to be bad-tempered.

In the early spring and late autumn the hives should be opened as late in the evening as possible, to avoid inciting robbing. If this does start, darkness puts an end to it quickly, whereas, if they commence robbing in the morning, the bees

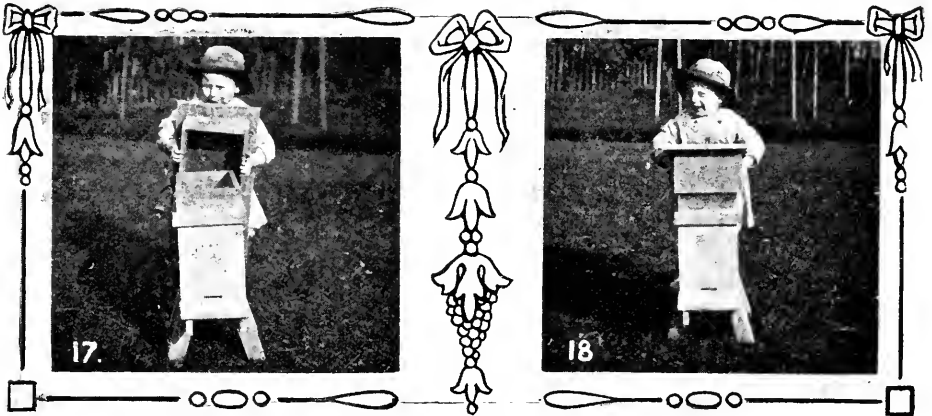

PUTTING ON THE ROOF.

become thoroughly demoralized throughout the day. If a stock which is usually good-tempered shows signs of great irritability, do not continue the manipulation. Close it down for an hour or two, or, better still, until another day, when they will be found quite docile.

Occasionally a stock will be so bad-tempered as to be absolutely impervious to the ordinary means of subjugation, and possibly dangerous to handle. It should



be requeened as soon as possible. In the meantime, it will probably be necessary to manipulate it. To render the bees harmless, chloroform can be used. Place a sponge in the smoker barrel, and soak it with chloroform; puff in at the entrance until a few bees come out and spin round on their backs on the alighting board; then cease, or the stock will be killed. The bees will be harmless for five or ten minutes, and can be handled with impunity. This method should only be resorted to in extreme cases.

Having completed the manipulation, the quilts are put back again neatly and the lift and roof replaced. The latter operation is frequently performed in a very clumsy manner, being wriggled and banged to get it on. The right way is to stand at the back of the hive, and take hold of the eaves of the roof so that the fingers project just a little over the edge (No. 17). Now put the roof well forward over the hive, and lower it so that the finger tips feel and guide it to its proper position at the sides (No. 18). Draw it back until the front edge of the rebate in the roof is brought to a stop by the edge of the lift, then lower the back portion, when the roof will go into position without the slightest hitch or jar.

No. 19 illustrates what the boy will do to protect the face when the bliss of ignorance is dispelled by years of discretion.



*The Editors do not hold themselves responsible for the opinions expressed by correspondents. No notice will be taken of anonymous communications, and correspondents are requested to write on one side of the paper only and give their real names and addresses, not necessarily for publication, but as a guarantee of good faith. Illustrations should be drawn on separate pieces of paper. We do not undertake to return rejected communications.*

#### BEE ASSOCIATIONS AND THEIR WORK.

[8928] I was recently called upon to speak at short notice on the "Advantages of Joining a Bee-keepers' Association." Surely here was an easy text for a parson with a continuous membership in one or other of two County Associations for the past nine years: and possibly the audience were surprised (certainly, I think, they were depressed) when they heard a painful and halting discourse, spun out for a few minutes with extreme difficulty. Having since had time to reflect on this doleful performance, and to refresh my mind with facts, I have decided that, considering the materials there were to work upon, I was fortunate not to have damned the Associations with still fainter praise.

Briefly, my position is this: I consider that the "advantages" referred to are over-rated. I hope I am mistaken. I write with no ill-will to Associations, quite the reverse. I endorse all that was said in the editorial remarks in the RECORD for November last regarding the energy and enthusiasm of the Hon. Secretary of my County Association, Dr. Wardleworth, and consider his keenness, ability, and geniality beyond all praise; very similar commendation can be given to those members of the committee whom I have had the pleasure of meeting (they might well also have been included in the eulogium); our workers are all right, as industrious as the bee itself; but—the "advantages" are at fault. The fact is self-evident. We have able and zealous officials; we have "one of the finest bee-

keeping counties in Great Britain" (here I quote the Editor's words in the article previously mentioned, and endorse them); and yet our members number 148—probably not one-tenth of the bee-keepers in the county (Norfolk). Surely inducements to membership must be lacking, or else the majority are singularly blind to their own interests. Twenty-nine of our members appear to belong to the "agricultural and other labouring classes" (the bettering of whose condition is one of our objects): a very sufficient indication of the labourers' estimate of the value of our philanthropy. Nor is his estimate far wrong. If philanthropy exists, it is for the outsider. From a cottager owning one hive the Association exacts an income-tax one-third more than would satisfy the Chancellor of the Exchequer: the 5s. subscriber in like case pays his super-tax quadrupled, and that, be it noted, on his *earned* income. And what does he receive in return? I give herewith a list of all benefits known to me, together with comments thereon; if any are omitted I shall be glad to hear of them.

(1) "*Expert Advice and Assistance in Dealing with Disease.*"—Very valuable indeed, more especially to the ignorant and careless bee-keeper, who would be much better out of the craft. If, instead of bolstering up such persons and doing most of their work, experts could aid in their speedy extirpation, the benefit would be greater still, and to the right people.

(2) "*Ability to Exhibit at Various Shows at Free or Reduced Entrance Fees.*"—An inducement which only appeals to the few. At our annual show in 1912, there were nine individual prizewinners—about ninety-four per cent. of the members did not benefit.

(3) "*Half-fees to Candidates for Certificates of Proficiency in Bee-keeping.*"—Here, the "advantage" was nil to over ninety-six per cent.

(4) "*The Use of the Library.*"—I knew I had read of this privilege somewhere, so recently asked for the loan of Cheshire's "Scientific Bee-keeping" from the Library of the County Association. My request was in vain, no such collection existed. I

understand that an application to the B.B.K.A. headquarters would have been more successful; but of that I was ignorant, and presumably so was our Hon. Secretary. I imagine that this "advantage" is restricted to a very limited number of members, say one per cent. at a generous estimate.

(5) "*Use of Lantern Slides for Lectures at a Reduced Charge.*"—Surely this is for the very *élite*, the aristocracy of the craft, say, one in 1,000.

(6) "*Privilege of Using the Association Honey Label, which will Assist you to Sell your Honey.*"—I have never used the privilege, and am more than doubtful as to the assistance. A label, however ornate, cannot introduce new customers; nor will it retain old ones, if the goods sold are unsatisfactory. Its greatest proved merit, as far as I know, is that it is of service to identify the supplier of inferior honey. I would scarcely call that an "advantage" to the man who has already disposed of his produce. The most that can fairly be said for an Association label (unless the Association is also a seller of honey for its members) is that it is a harmless ornament, in the same category as the fancy waistcoats and gorgeous socks of our gilded youth.

(7) "*Insurance Against Liability to Third Parties for Damages by Bees.*"—An "advantage" of great value, though it has to be paid for as an extra. It is, however, modified considerably in the case of small bee-keepers by the absurd minimum premium of 9d.; surely the interests of the "agricultural and other labouring classes" have here been somewhat overlooked! Nor is the discrimination in favour of members of much value; even with his registration fee of 1s., an outsider with five or more hives still insures at a cheaper rate than a member with two.

(8) "*'Bee-keepers' Record' will be Posted Free to all Members of 5s. Subscription Desiring it.*"—This is a very decided "advantage," in my opinion the most valuable of all. Though long conceded by many Associations, it is still a weakly hantling with us. It was, I understand, brought forth with much travail, and its continued existence is somewhat precarious.

(9) "*'Bee Journal' Supplied Post Free for 5s. 6d. a Year.*"—This also is a real concession, though I suspect it is made at no cost to the Association. Presumably, the shilling saved represents newsagents' commissions, diverted into the best place for it, the consumer's pocket. On the prowl for "advantages," I recently discovered this one; and, as a consequence, will read my JOURNALS for 1914 with added relish.

(10) "*Privilege of Attending Conversazioni, Joining in Discussions, &c.*"—An undoubted privilege, but only for the fortunate few. (For example, it would have given me great pleasure to have heard Mr. Herrod's lecture at our last annual meeting; but that would have entailed travelling over eight miles by road and seventy by rail, together with the cost of a night's lodging.) The same applies to the free lunches, &c., which some Associations, or their presidents, are kind enough to provide. These, of necessity, are restricted to those who need them least—loss of wages and cost of rail fares putting a veto on such advantages for those who could most appreciate them, viz., the "agricultural and other labouring classes."

(11) "*Association Report, List of Members and Balance Sheet.*"—Judged by its cost, this privilege seems to be very highly valued among us. After making allowance for receipts from advertisements, the net expenditure for printing, postage, stationery, &c., is £5 10s. 8d., out of a total of £21 13s. from members' subscriptions; i.e., over threepence in the shilling. Imagine the joy of the guinea subscriber in consigning to the wastepaper basket this literature: which, though costing him 5s. 4½d., is considerably smaller in bulk than a copy of your JOURNAL, and of immeasurably less value. (In justice to the local Associations, perhaps I should add that there is an insistent demand for some of these volumes at headquarters, even to the extent of a reprint on one occasion. Presumably, the B.B.K.A. keeps in mind the Statute (5 and 6 Vic., cap. 45) which grants a copy of every book printed in the United Kingdom to the British Museum, the Bodleian Library at Oxford, the Public Library at Cambridge, the Library of the Faculty of Advocates at Edinburgh, and the Library of Trinity College, Dublin.)

(12) "*The Committee shall purchase annually one or more frame-hives. . . to be drawn for by the members.*"—This "advantage" has recently been adopted by us; following the lead of more progressive Associations. The British public evidently believes in something for nothing; as witness the popularity of overweight margarine, free gifts in exchange for soap wrappers, cocoa coupons, &c. If the intelligence of bee-keepers is of the same high order, doubtless this offer of free lottery tickets, with over 98.5 per cent. blanks, will appeal to them. (By most strange chance and irony of fortune, the prize fell to my lot; but was returned for the benefit of the Association.)

(13) One other "advantage" occurs to me which has not hitherto been published. Its number on the list is not considered

lucky; but I present it as a possible aid to recruiting:—

*"Subscribers, with few exceptions, are taught the lesson, 'It is more blessed to give than to receive.'"*

There is no need to pursue the subject further. I think I have justified my assertion that "the advantages of membership are overrated." I might go further and say that, for an intelligent person worthy the name of bee-keeper, a payment of ninepence for fourpence is a good investment as compared with a subscription to a Bee-keepers' Association.

I turn with pleasure from adverse criticism to a few suggestions for improvement which occur to me.

(I) First and foremost, and absolutely essential, if membership is to be the rule and not the exception:—

*"A Lowered Subscription Rate."*—I once made this suggestion to a member of our committee. He dissented; thought that any change should be rather in the opposite direction; and instanced the ten-shilling subscription of a Farmers' Association as more to his liking. Now the capital of a tenant farmer cultivating one hundred acres might roughly be put at £1,000; he subscribes, therefore, at the rate of 1s. per £100 of his stock-in-trade—on the same basis, a reasonable subscription for a bee-keeper with three or four hives would be one penny. I agree that such a subscription is impracticable, still a cheap rate is imperative; a small charge *per hive* (to cover both the present third party insurance, and provide for some compensation for loss by disease) would seem to be the ideal system. The matter will have to be gone into sooner or later—it is bad policy to shirk the question—but assuming that things are to proceed much as at present, and that a flat rate is desirable, the ordinary subscription should be, say, 6d. per member; or 2s. 6d. for those wise ones who order the RECORD. There would be no pretensions to philanthropy—the cottager who is worth having as a bee-keeping recruit does not want charity, he is willing to pay for benefits, provided he obtains full value for his money.—REV. W. MATTINSON.

*(To be continued.)*

#### APIARY ACCOUNTS.

[8929] As, by the indulgence of the editors, I am at the moment occupying much more than my fair share of the Journal with my "Blurts," I am compelled to abbreviate my reply to my critics to the fewest words.

Of all who live, or have lived, not one in a hundred can claim infallibility. I am no exception. Let me therefore at once cry *Peccavi*, and own up to my mistake. Yet there are degrees

even in sin and sinners, so theologians tell us. Excess of zeal may even be the occasion—which is my plea—in the desire to be concise and simple. Yet, again, contributory circumstances are often an extenuation, and for this I offer in evidence the letter which has convinced me and compelled my repentance, keeping back for obvious reasons the name of the writer. Let, therefore, the document speak for itself.

9th January, 1914.

"Dear Mr. Smallwood,

"I have thought over your paper on book-keeping again, and I am sorry to say that although at a casual glance your system seems to be a correct one, yet if we give the matter a little more thought we see the error of our ways.

"Stock at the commencement of the year has to be bought at some time or the other, and therefore it should appear as the first purchase or payment in the year, and in the same way the stock on hand at the end of the year is really a receipt, and should appear among the receipts, being (if one might put it so) unsold sales.

"We all make mistakes sometimes, and you and I have come to grief here. The best way out of it seems to be to own up.

"Yours sincerely,

"(Signed)—Chartered Accountant."

As the writer has the moral courage to admit an error, so even must I.—J. SMALLWOOD.

#### "ISLE OF WIGHT" DISEASE.

[8930] Without intending any discourtesy to the Editors of the B.B.J., I welcome Mr. L. Illingworth's remarks (8919) on the above subject as the first piece of solid common sense among a bewildering fog of advice and counter-advice that has hitherto merely served to perplex the harassed bee-keeper. For, whether he is aware of it or not, your correspondent, in asking where the disease "appears to be exhausting itself," has voiced a heresy—and heresy is the mother of knowledge. And since I am a heretic myself, I would ask the courtesy of your columns to push Mr. Illingworth's words to their logical conclusion.

Some eight years ago this disease suddenly made its appearance in the Isle of Wight, and ever since our experts have been busy looking for remedies in the most approved style of the Middle Ages; but, so far as I know, not one of them has yet done what any doctor would recommend in the case of an epidemic affecting humanity—namely, to look for its place of origin and scotch it there.

It is obvious that there are two possible answers to the question as to how the disease came to the island—and only two. Either it was brought from some

other country, or else it was generated spontaneously in the Isle of Wight by the process of archebiosis or of heterogenesis. For the purpose of our inquiry we may regard these two processes as identical; but although I am aware that many biologists deny the possibility of spontaneous generation at this date of the world's history, Sir E. Schaeffer's famous address should deter us from being too positive—to say nothing of Dr. Bastian's experiments.

Now, taking the first alternative, if the offending micro-organism reached us from abroad, we are justified in asking why we have had no news of its ravages among foreign bee-keepers; and here again, as it seems to me, there are only two answers. Either it came from some country that is not, so to speak, kept permanently under the microscope (such as Central Africa or Tibet), or else it was imported from some district whose native bees have become immune by selection. But I think we may take it as certain that, if imported at all, it was imported in the body of a living queen; and as it is probable that no one has been buying queens from Central Africa or Tibet, we are faced with the certainty (unless spontaneous generation be at the root of the trouble) that there exists *somewhere* a race of bees that is immune—with the corollary that, if we can introduce a strong strain of their blood into this country, we shall at once solve the riddle that is worrying us.

And it ought not to be difficult to discover that race. Italy (and I think America) may be counted out at once. If, then, we select a district where the disease is rife (but where it is not complicated by the presence of foul-brood), and there establish healthy stocks headed by newly-imported queens from various countries and localities whence bees are imported into this country, we ought in time to discover that certain of our stocks survive while their neighbours perish. Only, in order to make the experiment complete, we should have a dozen stocks of each race; for it must be borne in mind that a queen from an immune district may breed non-immune bees, and *vice versa*. It would not, of course, be necessary to try the experiment with all races at the same time. Two or three sorts can be taken at a time; and the experiment should be repeated with each race over two or three seasons. With every failure the net must be thrown wider; and it is certain that we shall in the end discover the immune race—if such exists.

But supposing we fail, then we must turn to our other alternative—spontaneous generation. In other words, we must assume that eight years ago certain con-

ditions arose favourable to the development of this micro-organism. Naturally, we cannot hope to discover what these conditions were—still less to put an end to them. It may be that the ultra-violet rays of the sun decreased at that time to the exact amount necessary to the well-being of the microbe; and we certainly cannot alter that! What I wish to make clear, however, is that, whatever the conditions were, it is probable that they will continue in force for a longer period than will interest the present generation. That is to say, some billions of these microbes are being generated afresh every hour, and no matter how many we may kill by disinfecting hives and hive-stands, a countless army will be ever ready to take their place. This sounds alarming; but it is as well to face it, for if it is so, the destruction of infected hives is the very worst policy. Yes, I am a heretic. Until we know for certain that spontaneous generation is *not* the cause of our troubles, I maintain that we ought not to burn stocks that show symptoms of the disease, but should rather try to pull them through, in the hope of establishing a race that has become immune—for we know by analogy that immunity *will* come.

I therefore join Mr. Illingworth in asking whether there is any locality where the disease appears to be exhausting itself. And I would add an appeal for an organized experiment aimed at discovering whether, if not in these Islands, any place exists where the disease has already exhausted itself—and this before we take refuge in an Act of Parliament that may well prove our undoing.—H. CAMPBELL, Pullham St. Mary, Norfolk.



*Box-hives* (p. 4).—Mr. Isaac Hopkins describes these as somewhat of a bugbear to the writer. He must have read considerably between the lines, but I willingly confess that I consider them about the worst home for bees, and not to be compared for a moment with a sound skep. And my opinion is not based alone upon common sense and experience, but also upon the descriptive diatribes of such gentlemen as Mr. Hopkins himself. It is probable that in such countries as Canada and New Zealand, where the farmers appear to have a fancy for "cracker-boxes," or any old thing that comes first to hand, such "hives" (*sic*) may merit all the abuse which has been



showered upon them. No one can reasonably defend cracker-boxes, or cracked boxes, leaking bees at every joint. But do not, I beg of you, class them with skeps, or even with primitive native hives which have elsewhere stood the test of time.

*Brace or Burr Combs* (p. 8).—Once more I would plead for uniformity of definition so far as may be. As I understand these terms, "brace combs" are, roughly speaking, between comb and comb face, or comb and separator, whilst "burr combs" are bridges of wax between storeys, &c., at least, that is how the terms are generally used I believe. Yet here the term "brace comb" is used with the other significance, and on page 24, "D. M. M." himself uses "burr" with the significance of brace. Which is right? It would make for uniformity of speech if this small matter, upon which there seems to be a difference of opinion, can be authoritatively settled. Recently, Dr. Miller took me to task for my use of the term "hive" as meaning "stock," or as he might perhaps say "colony," although I hope not! And for the sake of this advantageous simplicity I am inclined to agree with him, although the dictionary supports my use of the term. The dictionaries were, no doubt, made long before bee-keeping attained such dimensions, and language grows with our increased need. Duplicate meanings are confusing, only it is hard to get out of old habits of speech. All this refers, of course, to terms of work, for I am the last to object to a word doubling its part, where it is understood that "the play's the thing."

*Subduing Bees* (p. 13).—May I suggest that puff-ball for ordinary use in the smoker is an entirely unsuitable material? With corrugated paper, too, much depends upon the size of the smoke nozzle. If the opening be sufficiently small, it is excellent, but with a large bore it does, as Mr. Herrod says, burn too rapidly. If a stick be placed in a hem of the carbofic cloth, so as to make a kind of flag, its use is much facilitated. The quilt can be removed with one hand, and the cloth slid along with the other. This avoids the trapping of bees between the cloths, and the operation is complete in one motion. Those charming photographs of Master Herrod, whom we are glad to welcome to the ranks, surely show one of the youngest manipulators in the world. Not merely does he hold a smoker, but apparently he is well on the way to his expert certificate. If he goes on as he has thus begun, he bids fair to out-Herrod Herrod.

*Moving Bees* (p. 16).—Mr. Bowen will forgive me for saying that it is also safe to move bees in the daytime, if it is properly

done. At any rate, I always take mine nearly twenty miles in broad daylight, and so far without mishap. If well ventilated, and properly secured—aye, there's the rub—it can be done with perfect safety, and a pleasure be made of a toil.

*The Fool-proof Skep* (p. 18).—Mr. Heap is good enough to say that I am to blame for being misunderstood by him, which I hardly deserve. For I have used simple language which a wayfaring man could understand, and my attitude towards the skep is, I believe, quite consistent as my opinion is sincere. I freely admit that such opinion is not necessarily right, but I must defend it against a charge based upon its distortion. However, as I am now "unmasked," a clear statement may disarm other possible foes. The fool-proof skep of which I have written was, of course, as Mr. Heap correctly supposed, the usual fixed comb type. The modified "Bogenstulper" suggested by me was merely an illustration to show that it was the fixed-comb principle, and not the skep itself, at which such criticism should be directed. I have undoubtedly attempted to defend the continued existence of the skep, the ordinary skep, but under particular circumstances, and not to the absurd length of advocating its general adoption. I should have thought that this consistency was clear enough and required no unmasking, for I have nothing to conceal and no intention upon this subject, at least, of writing in obscure paradox. Equally seriously, both Mr. Heap and myself, and even opponents of legislation, are upon common ground in desiring diminution of disease. It is, as in so many other pursuits, the means to the end about which we sincerely, though mistakenly, quarrel.

---

## QUERIES AND REPLIES.

---

[8904] *Removing Bees*.—I have suffered from "Isle of Wight" disease in my apiary, having lost the whole of my fourteen stocks in 1910. I ordered two swarms last June from near Shepton Mallet, and although small they have turned out well and are very healthy bees. In order to avoid risk of disease I placed them about thirty yards away from the old stands, but I find this position unsuitable in many ways, and should they swarm in the summer I should in all probability lose them by their absconding into other people's gardens. Can I, without loss of bees, remove them during the winter to the brick stands which I some time ago erected: and also when

should it be done? The bees being strong I do not want to incur any risks by loss or otherwise.

The disease (*Nosema apis*) which broke out in the Isle of Wight in 1906 has been now proved to be endemic, so I do not expect any harm to result by removing the bees to the former position, but should like your opinion.—W. H. B., Southampton.

REPLY.—We are pleased to hear from you, and to help when possible. You can move the bees at any time now. If the weather is frosty so much the better. Get a friend to help you, and carry them by hand to their new position in the evening.

## Notices to Correspondents

Will Mr. G. Bolton, of Cambridge, please send his full address to the Editors, who wish to communicate with him?

G. M. E. (Southsea).—*Hants B.K.A.*—

(1) We believe there is still a Hampshire Association, but it is evidently in a moribund condition, as we fail to find any evidence of its activity for the past few years. We do not even know the name of the Secretary. (2) Write to Johan Strgar, Wittnach, P.O., Wochiener, Feistritz, Upper Carniola, Austria, for particulars as to prices.

Oxon.—*Moving Suspected Stock.*—We should certainly advise you to destroy the slightly affected stock, both for your own sake and that of neighbouring bee-keepers. If you move it you may go nearer some other bee-keeper's apiary and endanger his bees.

BURGH HEATH (Surrey).—*Stock Casting out Live Bees.*—We cannot, from the description you give, say what is the cause of the bees acting as you describe. Send us a few of the dead bees cast out, and any particulars of the symptoms which you may have noted, and we shall probably be able to tell you what is the cause of the trouble.

R. L. (Doncaster).—*Keeping Bees in Towns.*—You should make the trellis at least 4 feet above the wall, and if you train some variety of creeper over it there will be very little danger to the public. Should any passer-by be stung you would be liable for damage done, but you can insure against this. Apply to the Hon. Secretary, Yorks. B.K.A., Mr. W. E. Richardson, Whitkirk, Leeds, for particulars of insurance.

ALPHA.—*Honey-Candy for Bees.*—(1) Honey can be made into the consistency of candy by working into it pure cane castor sugar. (2 and 3) We prefer to make and use candy made from pure cane sugar. It is cheaper, less trouble to make, and with it there is no possibility of spreading disease.

H. J. L. (Sidecup).—*Mead-making.*—The mead is quite a well-made sample, and should be very good when matured.

JEHU (Hinckley).—*Candy Made of Demerara Sugar.*—We have repeatedly warned our readers not to use Demerara sugar for either candy or syrup. Only refined (white) cane sugar should be used for bees. The candy sent will cause dysentery to the bees fed with it.

### Honey Samples.

J. A. P. (Kent).—The honey is of poor quality, with a strong flavour of ragwort. It is not worth more than 7s. 6d. or 8s. per dozen jars.

### Suspected Disease.

J. G. S. (Surrey).—The bees have died from "Isle of Wight" disease. You should destroy the stock at once.

E. J. (Lincoln).—The bees are too dry for us to diagnose cause of death with any certainty, but we do not think they have died from "Isle of Wight" disease.

F. B. L. (Hythe).—(1) The bees were crushed flat in post, and we could do nothing with them. (2) Certainly, Dutch bees are strong and vigorous, but we cannot certify that they possess the quality you mention. (3) See our advertisement column, page iv.

A. H. B. (New Malden), O. W. (Wishaw), Novice (Peterboro'), A. B. (Ayrshire), G. H. (Derbyshire), M. C., B.K.A. (Kent), G. F. S. (Essex), J. R. (Yeovil), A. F. (Dumfries), and T. W. C. (Windermere).—The bees have died from "Isle of Wight" disease.

P. L. (Leeds).—The bees were too dry for examination.

F. A. B. (Walworth).—As the bees were packed without protection they were crushed flat in the post, and we were unable to examine them.

C. P. W. (Exeter).—There is every indication of "Isle of Wight" disease.

CARDIFF.—The bees were too decomposed for examination.

E. L. (Hagley).—No. 1 lot were too dry for examination. No. 2 affected with "Isle of Wight" disease.

H. H. (Salop).—(1) We regret that we are unable to undertake the work of preparing microscopic preparations. (2) The bees died in the bottle and were so saturated that it was impossible to examine them.



THE B.B.K.A. LIBRARY.

NOTICE TO MEMBERS.

The Librarian will be glad if members will kindly return the books in their possession by the 14th of February for the annual revision. Some books have been retained longer than the specified time, and he would remind members that, according to the rules, no book should be kept longer than one month, unless an extension of time has been granted in writing. When returning books, will members please see that they are properly protected from injury in transit, as this is frequently overlooked by borrowers.—**W. HERROD.**

THE W. BROUGHTON-CARR  
MEMORIAL FUND.

	£	s.	d.
Amount already acknowledged	13	7	11
Geo. Hayes .....	0	5	0
H. Watts .....	0	5	0
J. Hawes .....	0	2	6
F. S. ....	0	2	6
Anon .....	0	2	6
T. Evans .....	0	1	7
E. H. ....	0	1	0
F. S. E. ....	0	1	0
	£14	9	0

SPECIAL LECTURES.

Special lectures in connection with the Development Fund Grant to the B.B.K.A. will be given at the following places. Where the time and place of meeting are not given, particulars can be obtained from the Secretary of the Association concerned:—

At the Lecture Hall, Zoological Gardens, London, by Mr. W. Herrod, on January 29th, February 5th and 12th, at 6 p.m.

SPECIAL LECTURE BY MR. W. HERROD.

**Exeter, Jan. 30th.** Lecture Hall, University College. 3 p.m. Subject, "Queen-rearing and Introduction."

PIONEER LECTURES.

**Crayford, Feb. 2nd, at 7.30.** By Mr. W. Herrod.

**Chichester, Feb. 11th, at 7 p.m.** Lecture Hall, Technical Institute. By Mr. F. Kenwood.

**Tunbridge Wells, Feb. 18th, at 7 p.m.** Town Hall. By Mr. F. Kenwood.

**Lewes, Feb. 24th, at 7.30 p.m.** Foresters Hall, Station Street. By Mr. F. Kenwood.

**Gravesend, Feb. 26th, at 7.30.** By Mr. W. Herrod.

**Sidcup, March 30th, at 7.30.** By Mr. W. Herrod.

OBSERVATIONS ON HIVES.

By L. E. Snelgrove.

As we are now on the threshold of a new bee season, and many readers of the BEE JOURNAL are doubtless forming their New Year resolutions in respect of their favourite hobby—some maybe to commence bee-keeping, some to improve their methods, others to increase their apiaries, and others to re-commence after having lost all their stocks through the "Isle of Wight" disease—some remarks on hives and their good and bad features may not be out of place.

To the beginner especially some information concerning the merits of various types of hives on the market is important. The choice of his first hive, more than anything else, except perhaps his bees, conduces to his pleasure or disappointment, his success or failure.

Although probably no two experienced bee-keepers are exactly agreed as to what is the best, most complete, and efficient hive, yet there are many features characteristic of all good hives, the desirability of which most bee-keepers admit. On the other hand, the imperfections of inferior hives, such, for instance, as restricted capacity, faulty design, unsound construction and material, and fanciful and purely ornamental although costly additions, are not easily detected by the beginner before purchase.

I propose in the following remarks to deal in a general way with these features, both desirable and undesirable, and also to discuss in a comparative way the merits of some well-known principles in hive construction, in the hope that some at all events may find in them some new and useful considerations.

A perusal of the various catalogues of the appliance dealers does not assist a beginner much in his choice.

Prices vary from the modest 9s. for a so-called "Cottager's" hive—a type often found, by the way, in the gardens of the rich—to the 50s. asked for some "Wells" hives.

Competition, and the modern craze for cheapness, has forced most of the manufacturers to advertise hives at considerably less than half a sovereign. Although many of them are marvellous productions "at the price," they are often the dearest to buy. They usually have some or all of the following defects: Absence of legs, suggestive of backache for the manipulator and of marauding insects; thinness of material, exposing bees to intolerable heat in summer and cold in winter; limited capacity, especially for supers; crude construction, particularly of the joints, which are often formed by merely nailing one side to the end of another, and even that with too

few nails; small alighting boards, and unprotected roofs that soon become leaky through exposure to sun and rain.

On the other hand the most expensive hives are not necessarily the best. Many of the features which cause the high prices are fanciful and ornamental. The real test of their value is—Are they successful? Efficiency is by no means proportional to complexity, and this to some extent accounts for the fact that although there have been many innovations, there has been little advance in hive design since the introduction of the Cowan Hive thirty years ago.

Many ingenious improvements, such as certain detention chambers, non-swarmer and swarm-catching compartments, have failed to become popular because their cost has been out of proportion to their usefulness.

Whilst avoiding therefore on the one hand such cheap hives as will ultimately cause dissatisfaction, the bee-keeper should be cautious in the selection of higher priced hives. He should not purchase costly adjuncts of which he does not understand the value, and which, through inexperience, he may not be able to use to advantage. I once became acquainted with a worthy retired pedagogue, who having been inspired to keep bees by reading Columella and Virgil, began by purchasing about £15 worth of expensive hives and appliances. He afterwards procured some bees, but after two or three years of difficulty, caused mainly by the complexity and variety of his hives, he became discouraged and got rid of everything.

Happy is the bee-keeper who, having made a wise choice in the beginning, purchases or makes only one kind and size of hive. Personally, I have not seen more than two or three apiaries of any size where all parts of the hives were alike and interchangeable. Indeed, the fact that most large apiaries contain many types of hives is simply an illustration of evolution, for their owners have wisely adopted improvements the value of which their enlarged experience has enabled them to realise. The advantage of only having one pattern, however, becomes apparent when the bee-keeper wishes for a spare floor-board, which he could place under each hive during the spring and autumn cleaning; when he wishes to tier a prosperous hive extra high, and finds that lifts do not fit; when he has placed the hastily prepared supers in the wrong hives, and has found at the last moment that the largest cannot be forced into the smallest hive; when a portion of one hive is to be repaired, and there is no suitable substitute; and when the division board of one hive is too large to be used in another.

Although I advocate uniformity for the sake of convenience, I cannot commend frequent interchange of hive parts. Indeed, the less there is of this the better, for it may often be the means of spreading disease from hive to hive. It is a good plan to place the supers on the same hives year after year. This is specially important in view of the infectious character of the "Isle of Wight" disease, which is often present in an apiary long before the bee-keeper is aware of it.

(To be continued.)

## BLURTS FROM A SCRATCHY PEN.

THE VALLEY OF THE SEINE, AND PARIS.

(Continued from page 27.)

And so we left Rouen. After all, when we got to rub elbows together, a very easy matter, our "*compagnons de voyage*" were not such bad fellows. We got quite chummy, even to the exchange of commissariat stores. In battle, as in peace, it is always the way with these Frenchmen. It is the first rush you have got to look for; it is *elan*, and if you can beat them at this they *are* beat and resign themselves to the inevitable, as in this instance. And perhaps this is good philosophy.

Each to his own calling. The merchant has ever his ships at sea to think of; the farmer his fields and crops; and the bee-keeper has his colonies. Thus, ascending the zig-zag Seine, every passing orchard, every garden was scrutinised for the homes of our insect friends. It was disappointing. I doubt if we saw above one apiary consisting of perhaps two or three hives. Yet I know that there is a lot of honey gathered from this district. The bee-farms must have been further afield.

The meanderings of the river are much as of our own Thames. Oft we might have been approaching Henley or Pangbourne—the same bending, wooded windings, the same eyots, the same river steamboats; aye, even the same punts and anglers. Also, the landscape was similar, except that, as we approached the capital, the market gardens seemed more numerous, and were drilled even as a regiment of infantry, each individual turnip or other vegetable standing (if I may use the word) in its own ground at equal paces from each neighbour, and the whole forming squares, trim and sharp enough for the most exacting drill-sergeant. From a bee-keeper's view the pasture, save for an occasional flash of white from a growth of buckwheat, resembled our own. But the labourer who tilled the ground was unfamiliar to the traveller. In place of spade he lifted above his shoulder an adze-shaped hoe, and as the westerling sun sank crimson over the distant hills

one of these toilers, resting on the shaft of his implement, came out boldly against the growing shadows. Then I knew from this shoulder-bent figure where Millais had found his study and conceived his "Angelus."

Paris! Why, who does not know Paris by heart. We dine in the evening in London, and have a comfortable early morning breakfast in the French capital. Nothing more easy. Equally easy, Parisians return us the visit. Why do so many go to Paris? For life, for gaiety, for fashion? She excels in the sciences, in art, in music, in drama, in all the refine-

Director of the School of Apiculture in Paris and the editor of the French bee journal, *L'Apiculture*. Unfortunately, we are unable to keep the appointment, so we wend our way to the Luxembourg, in the gardens of which the school is situated. A motor-bus from the Place Chatelet lands us at the gate, and a winding walk brings us to the "*Rucher Ecole*," the apiary school, as is our own at the Zoo. Raise your hat! Yonder, on its trestle-table, is "Huber's hive," the very hive he used when making those experiments and studying those (at that time) mysteries of bee life which mark the boundary



HUBER'S HIVE.

ments of luxury. Yes, this is Paris *la Sirène* as most of us look at her. But come with me up the hill of Montmartre; come with me on the other side of the river, the *côté gauche*, on to the streets at the back of Notre Dame, to the Faubourg St. Antoine, to beyond the Bastille, the Rue de Temple, and I'll show you slums which shall equal the most squalid East-end London slums, and there are but few of those which I do not ken. Yet again, I will take you and point out with my stick the paving-stones which even within my knowledge were piled with corpses, and the gutters that ran with human blood to the light of burning houses and the ping of rifles. This is Paris *la Pétroleuse*. She is as demoniacal in hate as she is beautiful in her enchantments.

But let us turn to scenes more pleasant. Our introductions are to M. Sevalle, the

Director of the School of Apiculture in Paris and the editor of the French bee journal, *L'Apiculture*. Unfortunately, we are unable to keep the appointment, so we wend our way to the Luxembourg, in the gardens of which the school is situated. A motor-bus from the Place Chatelet lands us at the gate, and a winding walk brings us to the "*Rucher Ecole*," the apiary school, as is our own at the Zoo. Raise your hat! Yonder, on its trestle-table, is "Huber's hive," the very hive he used when making those experiments and studying those (at that time) mysteries of bee life which mark the boundary

between ignorance and knowledge. Its leaves are hoop-bound, and still from its entrance streams forth the brown-backed throng. The light was indifferent, yet we were able to take a photograph of it, which will interest. It seems almost too sacred to permit it being exposed in open air. It is worthy a niche to itself.

I am not aware that a representation of your humble servant has ever appeared before the readers of this Journal, except once when disguised in a bee-veil. When, therefore, the junior editor suggested the ordeal, I felt that my nervousness might be lessened if I appeared in good company, and if I, a bee-keeper, had searched the world, what better place could be found than the "*Rucher Ecole*," with just the point of Huber's hive appearing 'twixt our shoulders? Behold! everything was ready—camera fixed and the execu-

tion prepared—when at the moment a shadow crossed our path (I speak metaphorically). One of the sabred, blue-coated guardians of Law and Order, as administered in Paris (a gendarme), informed us, that on the greensward whereon was pitched our tripod it was forbidden to stand. I suggested that he as an addition would give a note of dignity to the picture. A shrug of the shoulder and the single word "*Pourquoi?*" (Why?) He did not rise to the situation. Did he fear it might be used in evidence against him? Further entreaties

It seems, he said, to be a pretty general opinion in the mineral water trade that cane sugar is greatly to be preferred to beet. To a chemist, that seems rather strange on the face of it, since, when absolutely pure, no difference can be detected between cane sugar and beet sugar. It is impossible to distinguish between them by any chemical means. There is, however, one test by which it can be ascertained whether a sample of commercial sugar is cane or beet. This is as follows: Put some of the sugar in a bottle and tightly cork it (if the bottle

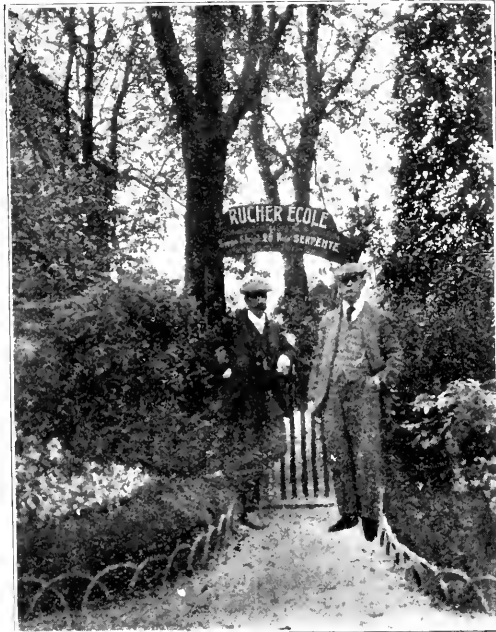

AT THE ENTRANCE TO THE SCHOOL OF APICULTURE, PARIS.

brought the same morose reply. Why waste eloquence on him? One appeal only is irresistible. I held out my hand to him, holding between thumb and finger a small silver coin. No longer did he repeat his parrot song "*Pourquoi?*" I said, "*Pourboire*" (to drink). Mrs. Herrod pressed the bulb, and you have the result before you.—JNO. SMALLWOOD.

(To be continued.)

#### TEST FOR CANE OR BEET SUGAR.

At a recent meeting of the Manchester Mineral Water Trade Association, Mr. F. G. Richards, of the Manchester School of Technology, made an important statement regarding the respective merits of refined cane and beet sugars.

possesses a glass stopper that is even better). Then allow it to remain in a warm room for several days; afterwards open it and immediately smell. Beet sugar will possess a most unpleasant smell, whilst cane sugar, under similar conditions, is practically odourless.

Why is this? Owing to the large amount of potash salts in the beet juice, it is much more difficult to refine beet sugar than cane; thus some slight trace of the unpleasant organic matter remains attached to the crystals, and the conditions of the experiment accentuate the smell. Hence, I have no doubt that with any beet sugars but the very best ones, the syrups you prepare will occasionally possess the same disagreeable smell.—*West India Committee Circular.*



The Editors do not hold themselves responsible for the opinions expressed by correspondents. No notice will be taken of anonymous communications, and correspondents are requested to write on one side of the paper only and give their real names and addresses, not necessarily for publication, but as a guarantee of good faith. Illustrations should be drawn on separate pieces of paper. We do not undertake to return rejected communications.

## BEE ASSOCIATIONS AND THEIR WORK.

(Continued from page 37.)

[8930] At the figure suggested, membership would be increased four-fold (possibly even ten times over), and the advantages now open to all would still continue, with this exception: The manual work of the expert would be curtailed, he would become more of a supervisor and adviser. Subscriptions for prize funds and other special objects would still be welcomed; but if not forthcoming the general work need not suffer, it would be on a business footing.

(2) "Co-operation in Buying."—Here are possibilities running to waste. Appliance manufacturers give discounts to their agents, and also to large consumers. Why not turn this to advantage? If an Association depot is out of the question, it is at least possible, by means of a system of counterfoils and vouchers, to draw a commission which is ready to hand. I have no belief in sweating the manufacturers, or originating among them such insane and painful competition as at present exists among honey producers; my proposal is simply to appropriate the profit which now goes to the middleman. All responsible manufacturers who embrace the proposal would be on the Association list; the member would deal with the trader of his choice; amounts purchased for cash would be checked by means of vouchers; and, finally, the discounts paid out as arranged. What the rebate would be would require to be settled with the manufacturers (by negotiation, not competitive tender), but I have reason to think that a not unlikely figure would be about 12½ per cent. for most of the year, and 5 per cent. during the busy months; or, better still (as easing the rush for all parties, and encouraging foresight on the part of bee-keepers), say, 15 per cent. during the slack season only. As the system would involve considerable trouble in book-keeping, a portion of the commission, say, 2½ per cent., might be retained by the Association, or paid to the person to whom it delegates the work.

(3) "Co-operation in Selling."—Even

greater possibilities exist here, as the turnover is so much larger. If, through a reduced subscription rate, outsiders were eliminated, and practically all bee-keepers united in a strong union, much of the honey, now offered to shop-keepers on their own terms, would be held for more rational rates; and, without affecting retail prices or checking the demand, an increased profit of about 10 per cent. would be secured for the producer.

But we must not be content with passive co-operation (if I may couple such contradictory terms), we require something more active. One of the objects of the B.B.K.A. is to "increase the home supply of honey," apparently leaving the demand to take care of itself. Mr. Menzies, in his extremely valuable address ("B.B.J.," November 20th, page 463), speaks of this as an "extraordinary omission"; but, as his subsequent remarks show, a much stronger adjective would not have been out of place. In the discussion which followed, I think the Secretary of the Association was unduly pessimistic as to the prospects of a central depot for bee produce; I choose rather to attribute his remarks to excess of modesty. Also, though I have not the honour of knowing the Council, I am sure he does its members an injustice in suggesting that they might be deterred from undertaking a public duty through fear of any idle gossip. I think we have the men both to evolve and successfully carry out a practical scheme, and I trust it will soon be brought to light.

In the meantime, can nothing be done? Mr. Menzies mentions "the ideal system, to bring the producer and consumer in direct contact," only to dismiss it as "impracticable and expensive," and falls back on the middleman as a "necessary evil." The verdict of such an experienced man of business cannot lightly be set aside, and one naturally hesitates to question it; I will, however, put the matter as it appears to me. The situation is as follows: The future of bee-keeping depends on honey finding a ready sale; to do so, it must be cheap enough to compete with jam, and to bring this about the profits of the middleman must be eliminated, or at least reduced to reasonable proportions. The following scheme would achieve this. Let each Association get out printed lists of honey-sellers among its members, and let some such advertisement, as follows, be constantly and widely circulated: "Honey.—A list of bee-keepers having honey for sale can be obtained free of charge, for any district required, on application to the Secretary, British Bee-keepers' Association, 23, Bedford Street, London, W.C. Prices (say) from 6½d. per lb. in 28lb. tins, and from 7s. 6d. per dozen in 1lb. screw-capped jars." If

an advertisement of this kind were kept well before the public, the B.B.K.A. would become a national institution, and not to know its address the supreme test of ignorance. The work of the Association would end with the posting of the required list to a prospective buyer, who would arrange privately with the seller selected such details as samples, price, carriage, returns &c. The system is simplicity itself—"ideal," as Mr. Menzies calls it; and surely his description of its working is a caricature. I have not met the "eager purchaser" who remits his 6d. or 7d. (presumably without any preliminaries) and is "sadly surprised to find himself charged 4d. more for carriage"—his innocence is refreshing; also, I trust, the bee-keeper is rare who, with an eye to future business, would so treat a customer who sends cash with his order.

I do not propose now to fill in details which suggest themselves; but submit the above outlines as fit matter for discussion. If further correspondence is permitted, I hope to see the official view, no matter how scornful; but even more eagerly do I look for contributions from "back-benchers," members of the rank and file. I understand the reluctance many feel about writing, and sympathise with them. Though a reader of one or other of your valuable papers for the past sixteen years (with the exception of a brief period when out of touch with bee-keeping), I have never before ventured even to address you a query; and would not have rushed into print on this occasion, but for the incident mentioned in my previous letter. If, sir, I have now gone to the other extreme the importance of the subject is my excuse. —(Rev'd.) W. E. MATTINSON.

#### APIARY ACCOUNTS.

[8931] Referring to the letter on page 26, signed "A Novice," it may perhaps be explained very briefly that in a complete system of book-keeping every transaction affects two separate accounts. For

Item No.	Description.	Years Old.	Estimated Life.
1	W.B.C. Hive.	3	15
2	70 unused frames at 7/6 per 100.		

example, if a merchant buys goods for cash, the transaction is shown in the "Goods" account as a "Dr." item on the left-hand side, and in the "Cash" account as a "Cr." item on the right-hand side. It is from this practice that

the term "double-entry" book-keeping is derived.

The "profit" is arrived at by means of the "Goods" account, which shows, on the Dr., or left-hand, side, the value of goods in stock at the beginning of the year, and the value of all goods purchased during the year. On the right, or "Cr.," side, are entered the amounts of all sales, and the value of stock in hand at the end of the year. Then the amount by which the Cr. side exceeds the Dr. side is the profit on the year's trading.

In the method of account keeping suggested by Mr. Smallwood recently, expenditure was shown on the Cr. side and receipts on the Dr. side. As probably many people are accustomed to keeping a cash book who do not understand the intricacies of book-keeping, this plan has the merit of simplicity, in that it agrees with what these account-keepers are in the habit of doing. It involves, however, the necessity of showing the two items "stock in hand" each on the wrong side of the account, and this has led to the recent discussion on the subject.

Bee-keepers who only require a simple method of finding whether, and to what extent, their bees pay may very well regard Dr. and Cr. as arbitrary conventionalities. For their purpose it does not matter on which side of the account the items are shown, so long as the whole arrangement is consistent.

Now with regard to the annual valuation, about which your correspondent raises several queries.

An inventory must be prepared on the last day of the book-keeping year, showing exactly what stock is on hand, and its value. A convenient arrangement is to have columns ruled as in the example given below.

The principle is to estimate as nearly as possible the number of years which the appliances will last, and to write off a proportionate part of their cost each year. The cost of painting and repairs may appear in the ordinary expenses each year. From this it will be seen that the hives

Original Cost.			Depreciation to date.			Present Value.		
£	s.	d.	£	s.	d.	£	s.	d.
1	5			5		1		
							5	3

are best valued separately from the bees and combs they contain. The latter are best dealt with by valuing at so much for each comb covered with bees (say 2s. 6d.), and so much for each drawn out beelless comb (say 4d.). This allows for stocks



of various strengths, and for the doubled stock to which "A Novice" refers.

There is no need to make any mention in the accounts of a lost swarm. Had the swarm been captured and sold, or hived, the amount of sales or of stock would have been increased. Had no swarm issued, or the issuing swarm been returned to the parent hive, the increased surplus take would have shown in the sales.

As the swarm was lost, however, the effect on the profits is automatically shown by the fact that there is no surplus honey to sell, and no additional stock of bees on hand, and no separate entry of the loss of swarm is needed. In order to estimate the profits for the year, all that is necessary is therefore to add together stock on hand at the commencement of the year, and stock or goods purchased during the year, on one side, and stock or goods sold during the year, and stock on hand at the end of the year, on the other side. If, then, the total, sales and stock, exceeds the total stock and purchases, the difference is profit. If unfortunately the stock and purchases exceed sales and stock, the difference is loss.—T. MEECH, Ilford.

#### A WORD FOR THE ITALIAN BEE.

[8932] "To the sulphur-pit with any race of bees but British blacks," or words to that effect is largely what we read in the bee journals of the British Isles. On tackling one editor I found he believed in Italian bees being best, but advised people to keep blacks because of the difficulty of keeping Italians pure, and the cross-bred ones are sometimes "holy terrors," and might put a novice off bee-keeping for life.

I have noticed that those who advocate Italian bees generally are also in favour of larger frames or larger brood-nests. Working on this idea, I gave my bees "C. D. B." hives with thirteen standard frames. Then I put on each an inner brood body of ten standard frames. Some stocks had black, some Italian, and some half-bred queens. The blacks came nowhere near the Italians or hybrids; the best black stock covered twenty-three standard frames and ten shallows. I extracted five standard and ten shallow frames. One hybrid lot occupied forty-three standard frames and ten shallows. It then started swarming; I found eighteen queen cells hatched out, and four or five others unhatched. How many swarms came off I cannot say, as the hive was at an out-apiary; one box of standard and one of shallow frames were extracted from this hive.

Another hybrid stock gave two boxes standard frames and two of shallows for

extracting. From one hive of pure-bred Italians I took off the inner brood body, consisting of ten standard frames covered with bees and the queen. Eight of the frames were full of brood. I sent this to North London, where it filled two racks of sections and covered another inner brood body. To the old hive I gave a young queen, also an empty brood chamber making the hive capacity twenty-three standard frames. I took from this hive one super of shallow frames and one rack of sections (full), and one rack of sections three-parts full. I did not put on a queen-excluder, as I wanted to prevent swarming. My district is an early one, situated at sea level, with mild, wet winters; two acres of gorse within 300 yards; also many sycamore and horse chestnut trees, &c., which give the bees a good start before the white clover comes in. This year it rained almost daily, till the white clover had been in blossom a fortnight. In fact a lot of the stocks (particularly the blacks) had to be fed up to the middle of June, then it was fine till very late in the autumn; in fact, the bees were carrying in pollen a fortnight before Christmas. From my experience I am inclined to favour the Italian bees. They build up more rapidly than blacks in spring, gather more honey (in my district, that is, as it is one most suitable for extracted honey); they send out large swarms, 7lbs. to 10lbs., and must have a large brood nest. If pure they are very quiet to handle, therefore are best for an out-apiary, where the bee-keeper has to attend them on certain fixed days, and cannot pick suitable ones.

Against this it is difficult to control swarming and mating. They do not produce white and attractive sections, as they put no air space under the cappings. —HERBERT QUINTON, Sligo.

#### LONG-LIVED BEES.

[8933] I heartily agree with Mr. Crawshaw (page 19) that an important point in selecting stock to breed from is longevity. A little experience of last year showed me much more strongly than before the importance of the old bees. By the moving of a stock to a new stand, I had queen and nurses of a hybrid strain showing one yellow band, often very faintly marked, and about a thousand foragers of a pure brown. That was the position early in May, and the bees worked well, making their winter keep, over and above their food. On June 15th I noted in my diary that all the foragers at this hive were of the pure brown kind, and though the diary does not say so, I am convinced that much the same held up till the end of July. After the browns had died out it became evident that the

hybrids were not of nearly such good stuff, and the prosperity of the hive actually waned. It really looks as though those thousand brown bees did practically all the honey-gathering of the year. At any rate, they were of immense importance, whether in a hive composed wholly of their kind or in a hive of failures, and if they only lived a week longer than the average bee span, I suppose we might write down ten or fifteen pounds of honey to their credit (if it was a week of full honey-flow). If some fellow reader by nucleus swarming will get a band of black foragers in a yellow hive he can find, by more exact record than I kept last year, how long the band continues to work, and if he had two such criteria he might well give the preference at queen-ing-time to the stock that produced the longest-lived workers.—G. G. DESMOND, Sheepscombe, Stroud, Glos.

#### DO BEES PAY?

[8934] The best way to answer this question will be to give the balance sheet for a number of years of a novice starting with no knowledge of bees. As I am going abroad, and shall be parting with my bees, I have made a careful estimate of stock in hand, and the figures given may be taken as accurate. In the autumn of 1906 I bought four skeps of bees for £2, knowing absolutely nothing about their management. Fortunately a friend gave me a copy of the "Bee-keeper's Guide Book," and I purchased four hives at a cost of £4. Since then everything bought has been paid for by honey sold, and the initial expense of £6 was paid off before 1910, which was the first year that I made a balance sheet. The results of the last four years I give in tabular form.

	Receipts.			Expenditure.		
	£	s.	d.	£	s.	d.
1910 .....	4	15	2	3	7	11
1911 .....	11	10	9	3	14	10
1912 .....	13	16	0	9	15	3
1913 .....	25	16	5	16	15	4
	<hr/>			<hr/>		
	55	18	4	33	13	4

No estimate of stock in hand is included, the figures given show only cash receipts and expenditure, but as I started with nothing, all stock goes to the credit side. I have eight colonies of strong, healthy bees. Four W.B.C. hives, with three supers each, painted and sound. Eight single walled hives, with two supers each, painted and sound. Four W.B.C. hives, with three supers each in flat. Tinned copper extractor, with four reversing baskets, two tinned copper ripeners, 160 drawn-out combs, uncapping table, solar extractor, Primus stove, six racks of

sections, honey, wax, honey vinegar and sundries. Estimated value £28.

The results of seven years' working, with four to eight stocks of bees, stands thus:—

Receipts in cash .....	£55	18	4
Estimated stock .....	28	0	0
	<hr/>		
Expenditure in cash .....	£33	13	4
	<hr/>		
Giving a return for my work ...	£50	5	0

I make no comment on the result.—W. A. CARVER.

#### "ISLE OF WIGHT" DISEASE.

[8935] While I cannot help feeling flattered at the compliment Mr. Campbell pays me (8930), yet I fear he has wholly mistaken my point of view, and that when he learns how strongly opposed I am to nearly all his conclusions he will wish to substitute something very different for the high praise which he, in his opening paragraph, bestows on my letter.

In the first place, I do not see why my question as to where the disease is "exhausting itself" should be considered heretical. I have always thought myself highly *orthodox*. The question was asked, not for the sake of establishing some pet theory of my own, but solely to ascertain facts. I have heard it stated by bee-keepers of wide experience and in a position to know, that bee-keeping is now once again becoming possible in certain districts where the disease was formerly rampant. I have no knowledge of such places, and simply desire detailed information.

There are several remedies (?) on the market, but I think it would not be unfair to label them all "quacks." Not a few letters have appeared in the "B.B.J." stating that the writers have cured stocks with "Smith's" cure or "Johnson's" remedy, but others, like myself, are convinced that the remedy (?) had very little to do with the recovery of the bees.

Now, if the statement referred to above about the decline of the disease in certain districts has any truth in it we ought to see letters in the "B.B.J." describing how X., Y., and Z., living at such-and-such places, had their whole apiaries wiped out in common with their neighbours so many years ago, but have now successfully restocked, no signs of disease having been seen since so long, or, if there has been disease, it has assumed a milder form, and has not spread from stock to stock with the usual rapidity. Detailed information of this sort would be most encouraging and profitable.

Now, as Mr. Campbell has developed a

theory out of my letter, may I be allowed to say a few words on immunity, and the origin of the disease?

I do not regard immunity as a practical solution of the problem. Here I may be somewhat unorthodox. Foul brood is generally supposed to have existed a considerable time, but since natural selection has not produced a strain of bees immune to that complaint, what hope have we that it will do so in the case of "Isle of Wight" disease? And can the apiarist hope to accomplish in his limited time what natural selection has failed to achieve in the course of centuries?

Mr. Campbell, in his desire to establish spontaneous generation, fails to do justice to his alternative theory, and leaves out altogether a third explanation of the complaint which is perhaps the best of all. It is quite possible the disease has been imported from abroad. Has it not occurred in parts of Germany and Austria? If it has not produced such disastrous results in those countries, may this not be due to peculiar climatic or other conditions in the British Isles, specially favourable to the growth of the micro-organism?

The third explanation is, I think, suggested by the report of the Board of Agriculture. It is that "Isle of Wight" disease is nothing new after all, but just a very much more malignant form of "spring dwindling." The theory is that up to a few years ago, owing to the prevalence of certain conditions favourable to the bee, or unfavourable to the germ, "spring dwindling" was not regarded as serious, but now these conditions having altered the complaint takes the much more serious form which we are accustomed to call "Isle of Wight" disease.

Our hope lies in the further scientific investigation of the disease, and the circumstances which give rise to it. Then we may find a means of curing or preventing it. In the meantime, information such as I asked for in my first letter, would assist those, like myself, who are losing all their bees for the second time, in deciding whether to make a third attempt and how long to wait before doing so.—L. ILLINGWORTH.

#### HEATHER DISTRICT.

[8936] Will any reader of the "B.B.J." tell me of the nearest heather in this district—Healing, Lines? Also the conditions under which hives may be stood there for the heather season.—W.I.

[We shall be pleased to forward any replies to our correspondent.—ED.]



By D. M. Macdonald, Banff.

#### EXTRACTS AND COMMENTS.

From "Gleanings."—Mr. Morley Pettit on being asked how he had succeeded in doubling and trebling the membership of the Ontario Association replied: "By advertising." He kept pegging away at the local Associations to affiliate with the Central, and to a large extent he has succeeded.

White clover honey is a misnomer, as I believe that three-fourths of the clover honey of Ontario is gathered from alsike. That a good proportion of the white clover honey in this country also comes from alsike must be true, because both clovers are sown as a mixture in all our fields set out for lea.

The first three lessons for a beginner should be How to Light, How to Load, and How to Use a Smoker. Some veterans will please take notice—and lessons. I verily believe these are wise words from A. C. Miller's pen. The art of smoking bees is one deserving of thorough study and consistent practice.

Mr. Holterman, at first a disbeliever in the virtues of the steam-heated uncapping knife, has become an out-and-out convert, and believes that he will never again go back to the common tool. Miss Holterman was able to uncap at the rate of three combs a minute, and Mr. Holterman's conclusion is "I believe that no uncapping machine, taking into consideration the best combs that the average producer will have, will ever exceed the steam knife."

Requeening without dequeening is the latest craze. One enthusiast says: "A young queen light in eggs will easily overpower an older queen heavy with eggs, and such a queen usually conquers an old and failing queen." Mr. Root rather countenances both statements, and asserts "I have noticed an interloping virgin will in most cases supplant the reigning mother." All these assertions are hypothetical. Some years ago I made similar claims; now I would make several reservations.

Dr. Miller favours entrances 2in. deep. I wonder if he means wide?—but he cannot, because he speaks of hot weather. Ye Editor supporting him sanctions his plea, but mentions *wide* and *narrow* entrances. Is there not some confusion of ideas somewhere? The sage of Marengo announces a record take in 1913. From seventy-two colonies he has taken nearly

20,000lbs. of comb honey, an average of 267 sections. His best gave 402lbs., his poorest sixty-eight sections. Congratulations! No wonder the doctor is giving himself and his household a holiday in Washington, and enjoying himself thoroughly.

*Africa.*—Alas! the *South African Bee Journal* has gone over to the great majority. "One more unfortunate weary of strife?" When the "Canadian" died the "Horticulturist" took up a bee section, edited by the Provincial Apiarist, Mr. Pettit. Now the *S.A. Poultry Magazine* has done the same for bee-keeping, and as the pages devoted to this fascinating pursuit are under the able editorial care of Mr. G. S. Oettle (who was the first editor of the defunct paper) apiculture has still a rallying point in South Africa.

*Australia.*—The *Australian Beekeeper* has recently absorbed *The Commonwealth Beekeeper*, and the *Bee Bulletin*. A feature of its management is its interesting prize competition, appearing monthly, conducted by the editor, and for which he provides prizes. I note that the "Langstroth" frame bids to be the standard size in the Commonwealth. Their chief honey source is more highly valued there than here, to judge by the following: "This glorious gum tree stands for greatness, grandeur, dignity, sublimity, majesty!" They do not all see eye to eye in regard to their associations, but there is no doubt these bodies are doing good work, and in many ways influencing Government in favour of apiculture. They are attempting to initiate judging by "points"; but when I read "nil" placed against *flavour* in the points for comb honey I have grave doubts of their wisdom!

*Beekeepers' Review.*—"Pinch your secretary and see if he is alive. A dead secretary means a dead association. If you have a 'live' secretary, don't turn him down; if a 'dead' one put in a 'live' one forthwith." Good advice! I would add, if you have a "crank" turn him out and secure one who has the good of bee-keeping at heart. A "one idea" secretary means stagnation or retrogression—never progress or advancement.

In Indiana bee-keepers set apart the 15th December as a "Honey Day." An attempt was made to get special paragraphs, letters and advertisements in all the local papers drawing attention to the event. Special cards were displayed in every grocer's window, and a supply was contracted for in every store. Cards were also placed on every case of honey disposed of. For a small charge the *Review* prints the name and address of every member having honey to sell. By the

way, this may be taken as a hint for our JOURNAL—both parties might benefit. I am not certain but the B.B.K.A. might benefit if members' honey was specially advertised. In Canada (Ontario) they aid members to dispose of their honey, and make an endeavour to prevent the market being glutted, or nervous people disposing of their honey at too low a price—a common fault on this side!

## Notices to Correspondents

Letters or queries asking for addresses of manufacturers or correspondents, or where appliances can be purchased, or replies giving such information, can only be inserted as advertisements. The space devoted to letters, queries, and replies is meant for the general good of bee-keepers, and not for advertisements. We wish our correspondents to bear in mind that, as it is necessary for us to go to press in advance of the date of issue, queries cannot always be replied to in the issue immediately following the receipt of their communications.

### Suspected Disease.

- RETLAW (Northumberland).—(1) The bees were too decomposed for us to be able to state definitely the cause of death, though from what we can see we fear it is a case of "Isle of Wight" disease. (2) The honey will be quite all right for household use. (3) The Hon. Secretary of the Northumberland B.K.A. is Captain Sitwell, Yearle House, Wooler. R. L. (Thurning).—The bees were badly constipated, and this, no doubt, caused their death.
- CARLISLE.—The bees were too dry for examination.
- H. P. S. (Shipton).—"Isle of Wight" disease is the cause of death of bees. Destroy all internal fittings, and thoroughly scorch the hive out with a painter's blow-lamp. It will then be fit to use again.
- R. ELLIS, EMBERTONIAN, G. G. (Bangor), D. F. (Chelmsford), and AVRSHIRE AMATEUR.—The bees have died from "Isle of Wight" disease.
- J. D. (Swanwick).—We should say the bees died from "Isle of Wight" disease. The "Izal" would not kill them. The candy is evidently under-boiled. It will keep for a long time; but bees do not require candy in June. If fed at all in spring or summer they should have syrup. If you intend starting again you must burn all the combs and internal fittings of your hive, and scorch the hive inside before it will be safe to introduce a new lot of bees.



## REVIEWS.

*Die Biene und der Breitwabenstock*, by Franz Richter (published by the author in Vienna, Kolombusgasse 1, price 2.20kr. (1s. 11d.) post free).—This book is intended to instruct the bee-keeper in the use of hives, such as those used in this country and in America, that is, with wider and shallower frames than those generally employed in Germany and Austria. The hive recommended has ten frames, the outside dimensions of which are 426mm. by 255mm. (16½ in. by 10 in.), and can be worked with supers exactly in the same way as our hives. The hive specially advocated by the author, under the name of "Richter's *Breitwabenstock*" (Richter's broad-comb hive), has been introduced into Dalmatia, and owing to its simplicity, easy manipulation and rapid development of the colony in spring has been adopted as the standard hive by the Agricultural Minister in the kingdom of Dalmatia. The author describes in detail the methods well known in this country, and the book, which consists of 175 pages, is illustrated with ninety-three figures, for many of which M. Richter states his indebtedness to Messrs. E. R. Root and Dr. Phillips, the originals having appeared in "A.B.C. and X.Y.Z. of Bee Culture" and "Bees." As the book treats of the most recent methods it should be of use to those adopting this style of hive, although most of the manipulations described can be applied to other hives in use, and in producing so useful a compilation the author has rendered a signal service to his bee-keeping colleagues.

*Vraagi Ptschel*, by A. G. Belavski (published by *Ptschelovodnaya Gisu*, Matveievskaya 11, St. Petersburg, price 20 kopecs = 6d.).—This is a little book of forty pages, devoted to descriptions of the enemies of bees. From its perusal it is evident that bees have many more formidable enemies in Russia than they have in this country, for among the mammalia we find such animals as the bear, badger, hedgehog, fox, weasel, and pole-cat. Of birds there is a list of eighteen species, amongst which we find the nightingale, redstart, swallow, fly-catcher, four species of shrike, great tit, gold-crested wren, bee-eater, two woodpeckers, honey buzzard, and white stork. Some of these are not considered as enemies with us, and it is doubtful if they do any harm while they are so scarce, and besides their beauty and usefulness to horticulture, they delight us with their song, so that these attributes

are full compensation for the small damage they may do to bees or fruit. Insect pests are numerous, and those described include several not found with us, but we were surprised that a humble-bee (*Bombus terrestris*) is mentioned, although the author does not himself share the opinion of those who class it among the enemies of the honey-bee. One of the most troublesome amongst insects is the death's-head moth, which is most persistent in its attacks on colonies of bees. The common Norway spruce (*Abies excelsa*) is stated to be injurious because of the peculiar honey-dew that is found on it at certain times, and which causes winter diarrhoea. Several orchids and a rhododendron are also included. This is a useful little compilation, as a good description is given of the various enemies so that they can be easily recognised.

## SPECIAL LECTURES.

Special lectures in connection with the Development Fund Grant to the B.B.K.A. will be given at the following places. Where the time and place of meeting are not given, particulars can be obtained from the Secretary of the Association concerned:—

At the Lecture Hall, Zoological Gardens, London, by Mr. W. Herrod, on February 5th and 12th, at 6 p.m.

## PIONEER LECTURES.

Chichester, Feb. 11th, at 7 p.m. Lecture Hall, Technical Institute. By Mr. F. Kenward.

Tunbridge Wells, Feb. 18th, at 7 p.m. Town Hall. By Mr. F. Kenward.

Lewes, Feb. 24th, at 7.30 p.m. Foresters Hall, Station Street. By Mr. F. Kenward.

Gravesend, Feb. 26th, at 7.30. By Mr. W. Herrod.

Sidcup, March 30th, at 7.30. By Mr. W. Herrod.

## NECTAR-PRODUCING PLANTS AND THEIR POLLEN.

By Geo. Hayes, Beeston.

BROOM (*Genista scoparius*) (*Sarothamnus*, Brit. II.)

No. 28. NAT. ORD. LEGUMINOSÆ.

(*Papilionacea*.)

(Continued from page 29.)

Of all our leguminous shrubs the Broom is perhaps the one most favoured. It may be gathered without the fear of the prickly protection of the "Gorse," and has besides its own attractions the interest of historic and poetic association, for it is even referred to by Pliny.

Burns, speaking of his native haunts, says:—

"Far dearer to me are you humble Broom  
bowers  
Where the Blue-bell and Gowan lurk lowly  
unseen."

Cowper, too, tells us of

"The Broom.  
Yellow and bright, as bullion unalloyed."

Its vigorous growth on open moorland, or amid the rocks, or on the bleak hill-side is often referred to.

Wordsworth says:—

"The Broom,  
Full flowered and visible on ev'ry steep  
Along the copses runs in veins of gold,"

referring, of course, to its fondness for high land. It is, however, to be found on dry, sandy situations. We have a fair supply in Notts, although we have very few hills, but it is quite at home on railway embankments on the moor and along old lane sides.

The rootstock of this shrub is creeping and very branching, as one may know if an attempt is made to pull one up. It grows from one to five feet high. The stems are angular, smooth, green, and wiry; the lower leaves are stalkless. The flowers are large, and a bright yellow colour; in form they are papilionaceous, or like a butterfly, the stamens being all jointed together and the stigma very long and thin.

The plant bears a profusion of blossoms, starting early in spring, and continuing to the end of June; these in turn are followed by large black pods. Those who have been amongst them when the seeds are ripe cannot fail to have noticed the sharp crackling sound caused by the pods, dried by the sun, springing open and shooting the seeds to a distance. The pods afterwards curl up, and in time drop off.

Before hops were introduced into this country, broom tops were used to impart

a bitter flavour to beer. The young flower buds are occasionally pickled and used as a substitute for capers. The branches evidently contain tannic acid, for they have been used for tanning leather. The seeds, when roasted, form a substitute for coffee, and the ashes of burnt broom contain a large percentage of potash. The flowers produce both pollen and nectar for the bees, so we must admit that the shrub is a very useful one to the bee-keeper.

The common name "Broom" is, no doubt, derived from "brom" or "brame," a word which signifies that from this shrub brooms, or besoms, were made, the Greek for which is *Sarothamnus*. The generic name—*Genista*—is said to come from a word meaning "the knee," in allusion to the angular or jointed appearance of the twigs; others say it is derived from the Celtic word "gen," a small brush.

In ordinary school history we learn that King Henry II. of England, wearing the Broom, *Plantagenista*, in his cap, assumed and transmitted the royal surname of Plantagenet, and we find it—like the strawberry leaf—figures very much in heraldry, both in this and other countries.

On May 30th, last year, I was in the forest, and found the Broom blossom in greater pro-

fusion than I had ever seen it before, for everywhere around the shrubs were gleaming like sunshine, and some bees which I had taken with me to pasture in that locality went to work on it with avidity in a very short time after their arrival, as it yields both pollen and nectar.

The pollen is lenticular in general outline, having three grooves running from end to end, which divide it into three lobes, and measures  $\frac{1}{1000}$  in. by  $\frac{1}{1000}$  in.

In colour, when in the corbicula of the bee, it is a deep orange, yet, when gathered

Dry.

1



In Honey.

2.



3.



4.



From Honey.

5.



6.



7



POLLEN OF BROOM.

dry and placed in a mass on a dark ground, it reflects a light brown. It is a brilliant yellow when seen in the microscope by transmitted light.

There is little change in the grains when in honey, except that they are more transparent, and increase slightly in bulk.

When taken from honey, pimples are apparent on the surface; they have from one to three processes, as seen at Nos. 5, 6 and 7—that is, they are formed irregularly. The majority have three, as shown at No. 7, which may be considered as the final form. They are inclined to be triangular, but are mostly almost spherical in outline, and measure from  $\frac{1}{1000}$  in. to  $\frac{1\frac{1}{2}}{1000}$  in.

(To be continued.)



#### SOME UNCOMMON HONEY SOURCES.

*Cascara Honey.*—Cascara sagrada is a well-known medicine, the plant is a flower-bearer, and the flowers yield honey. In some parts of California it is given as the main honey plant, and is said to remain in bloom for a full month, or even longer. One bee-keeper says: "We prefer it on our table to any other honey, and have customers who will take no other. It is not purgative, but one of the best remedies for chronic constipation known." If the last statement is correct, it ought to be better known, as this medicinal value would guarantee for it a good price and a ready sale. The plant is a rapid grower, a most prolific bloomer, and the flowers are very thickly set. One man records 1,300lbs. of honey from forty-four colonies.

*Tobacco Honey.*—"Tobacco honey," did I hear someone say? "It's fine!" The plants are allowed to blossom, each one bearing hundreds of individual flowers, and they continue to bloom from August 1st until October. Thus we have thrown open to our bees hundreds of acres of tobacco, containing myriads of flowers. The bees swarm on this, and the honey comes in fast. No bad qualities peculiar to the plant seem to be contained in the honey when ripened by the bees and removed from the hive, and the verdict is that bees winter on it as well as they do on other fall flowers. Surplus honey will sell as readily as that from buckwheat, and for many uses it will be found superior to the darker grades of honey. A peculiar feature of the nectar secretion in the

tobacco flower is that a bee will disappear in the blossom for a full minute, and when it comes out it will fly straight to the hive with a full load!

*Cranberry Honey.*—At Cape Cod they have immense stretches of the cranberry plant, thousands of acres in extent. They find that it is a good honey plant, but they value their bees far more highly as pollinators than as honey-gatherers. When the company working this "farm" bought bees the yield went up, and the manager is now increasing the number of bees as fast as his bee-keeper can carry it out. They find the yield is heaviest close to the hive, so that there has been an enormous increase in the yield of berries per acre. Excellent testimony this to the value of the bee as a pollinator. In this country bees are very fond of cranberry blossom wherever it is within their reach, but I do not know of any surplus being gathered mainly from this source.

*Cotton Honey.*—Mr. Scholl, who is in the centre of vast cotton areas, considers this source a valuable one, the honey is very light in colour, mild in flavour, and when thoroughly ripened, it compares favourably with the very best grades. During a heavy flow there is a strong odour in the apiary like that produced by bruising cotton leaves. The flow goes on from July 1st until frost. The nectaries are located under the bracts next to the stem of the blossom, and there are others on the under side of the leaves. The A.B.C. of Bee Culture values cotton honey as fit only for manufacturing purposes, and adds: "When confined it sometimes bursts the receptacle in which it is held, whether it ferments or generates gas has not been definitely determined."

*Spider Plant Honey.*—"I have experimented with this bee plant, and find it one of the best for honey, as it yields more than any other plant that grows. I watched the bees gather nectar from several flowers, and it took three bees in all cases to gather the nectar from one blossom. The first two bees stayed one-and-a-half minutes each, and the third only forty-eight seconds. I took a glass medicine-dropper with a rubber bulb to it and drew the nectar from thirteen blossoms, getting a teaspoonful in all. In one season there are several hundreds of blossoms to each plant, the stem rising to about nine feet." The writer of foregoing calls this flower the Rocky Mountain bee-plant, or *Cleome integrifolia*, but the Spider plant is *Cleome Pungens*. "A. I. Root" says, "The nectar is secreted so rapidly that a person can gather it with a teaspoon!"

*Orange Honey.*—"The orange tree is a profuse yielder of nectar, and as the trees bloom for about six weeks, during which the weather is usually fine, there is no tree

yielding more freely than this, not even the basswood. On most days, if the branches are shaken, the nectar drops so freely that the ground underneath is quite wet. A yield of from 60lbs. to 120lbs. from this source is counted on every year, and the honey is very fine." From other parts of California and Florida the reports are not quite so enthusiastic as the above statement, but all agree that where it can be got in purity, as might be expected, the quality is of the finest.

*Milkweed Honey.*—In Michigan and elsewhere in the States, milkweed is valued as a honey plant, and some report good crops. At a recent Association meeting, one member reported excellent returns. The flavour, at first strong, became milder with age, until it was little stronger than that of white clover. The colour was so light that the honey sold readily at a good price. Professor Surface recently warned bee-keepers that this plant has one objectionable feature as a bee flower. The pollen-bearing parts pull off and stick to the legs of the workers to such an extent that they disable their free flight and movement, often so much that the other bees throw them out in great numbers to die.

*Logwood Honey.*—It is claimed for the logwood of Jamaica, &c., that it is the greatest honey plant or tree in the world. The bee-keepers of that interesting island expect average takes of from 100lbs. to 200lbs. per colony from this source alone. In point of colour it is said to be as good as any honey in the world, the flavour is mild and pleasant, and the price obtained for it when fine is generally about the best on the market. This tree is a near relation of the mimosa, which yields immense quantities of excellent honey that is highly valued wherever produced.

#### OUR JUVENILE MANIPULATOR.

We have received innumerable letters with regard to the photographs on pages 14, 33, and 34 of BEE JOURNAL, of Maurice Herrod manipulating. The boy also has received a large number of letters and photographs from other children who are bee-keepers. Time does not permit us to reply individually to them, so we take this opportunity of thanking the writers for their kind expressions of appreciation and congratulation.

A few sceptics have written doubting the age of the boy, and also as to whether the hive was populated or not. We hereby inform the first-named that we are prepared to produce the boy's birth certificate, and if the latter will look closely at Nos. 2, 3, 6, 7, 8, 10, and 11 they will see bees at the entrance, of 7, 8, 10, 12, 13, 14, 15, and

16 they will see bees on the comb. The boy is so keen that he would refuse to handle combs unless bees were upon them. In any case, we claim that very few children of his age could be induced to carry out a succession of manipulations so well that to obtain nineteen photographs only twenty-one plates were exposed.



*The Editors do not hold themselves responsible for the opinions expressed by correspondents. No notice will be taken of anonymous communications, and correspondents are requested to write on one side of the paper only and give their real names and addresses, not necessarily for publication, but as a guarantee of good faith. Illustrations should be drawn on separate pieces of paper. We do not undertake to return rejected communications.*

#### BEE ASSOCIATIONS AND THEIR WORK.

[8937] The Rev. W. Mattinson (8928, "B.B.J.," Jan. 22nd) has apparently not benefited personally, and seems inclined to think all bee associations must be tarred with the same brush. Norfolk is now going ahead, but has undoubtedly been among the slack associations for some years. The members have evidently found the weak spot and taken steps accordingly to mend matters. If Mr. Mattinson would read the reports of all associations, bound in one volume by the B.B.K.A., he would perhaps not be so ready to jibe at headquarters taking the trouble to collect them. To those who have the general good of bee-keeping at heart, they are extremely interesting and valuable reading, and one can learn a lot from their perusal.

Mr. Mattinson proceeds to detail the advantages offered by his association, and then pull them to pieces. It may surprise him to know that most of them are considered advantageous by the committees of many, I might safely say the majority of other associations, or why are they circulated with their reports? This means, I take it, that scores of the best bee-keepers (on the various committees) hold contrary views to Mr. Mattinson.

(1) *Expert Advice and Assistance.*—I am glad Mr. Mattinson admits the value of this, but he is evidently out to decry associations, so he goes on to say that if instead of bolstering up the ignorant and careless bee-keepers experts could aid in their speedy extirpation, the benefits would be greater still, and to the right people. Quite so, but how are experts or associations going to do this till we get an Act? The moment the Act gives power to take



drastic measures with the careless, I for one look forward to seeing many such extirpated; but in the meantime are the ignorant to receive no instruction? Did Mr. Mattinson learn his bee-keeping by intuition, without any help?

(2) *Reduced Entrance Fee for Shows.*—If there is only one show open to members of any but the very small (as regards area) associations, or one just starting, it is a pity. In any case the large shows are open to all bee-keepers, and it is astonishing how competition increases keenness and improves bee-keeping methods. Seeing his neighbour successful often induces a man to have a try at showing himself, while once commenced, the practice is generally continued till it is as much part of the yearly programme as spring-cleaning, or, up here, going to the heather. That exhibiting improves bee-keeping methods, care, neatness and cleanliness following as a matter of course, there can be little doubt. That to be successful and make one's name as an exhibitor is by far the finest advert. for the sale of one's honey is, I fancy, beyond dispute, there is no need for the middleman in such cases. I know several who have done so, and could sell ten times the amount they produce in consequence. That the value of learning how to show, fostered by a small local association, I think is pretty clearly demonstrated in my own county. In North Northumberland there was a small but keen association, which within four years spread from first a village and its neighbourhood to the whole of the north of the county, and was rapidly spreading. At local shows, four to five classes, with perhaps twelve to fifteen exhibits, rose to eight or nine classes, with fifty to sixty exhibits. Where these exhibitors extended their area and tried more distant fields they more than held their own, one indeed last year, and another the year before, taking premier honours in open classes at the "Royal" Dairy, and other big shows. Do they owe nothing to the association for their success?

(3) *Expert Examinations.*—All cannot become expert or obtain Proficiency Certificates in a year, but if again Mr. Mattinson would read the collected reports of associations, he would see how some of the older ones have now reached the stage that they can work the whole of their spring, and in some cases autumn tours as well, at reduced cost by employing their own expert members.

(4) *Library.*—If an association professes to have a library, they should certainly not say they have till the books are in the hands of the secretary. Bad management somewhere!

(5) *Use of Lantern Slides at Reduced Charges.*—Why, in the name of common-sense, should this be an advantage only

for what Mr. Mattinson is pleased to call "the élite, the aristocracy of the craft, say one in 1000"? Is the B.B.K.A. lecturer, Mr. Herrod, travelling all over the kingdom only for the sake of the élite and aristocracy of the craft, or to do good? Are his audiences composed only of advanced and experienced bee-keepers, with only one in 1,000 of the humbler novice grade? We have one first class and five third class experts in our association, not a very numerous "aristocracy of the craft," yet the average attendance at lantern lectures this winter has been fifty, and that in sparsely populated districts.

(6) *Honey Labels.*—As Mr. Mattinson has never used this privilege, his criticism is purely theoretical. It is strange to find that those associations who have a label, sell more and more of them each year, if they are merely "harmless ornaments."

(7) *Insurance.*—This "advantage" is of great value our critic admits, yet, even at a minimum premium of 9d. it is not ruinous. Equal to the sale of one section of honey.

(8 and 9) *Bee Papers at Reduced Subscription.*—I am glad to say my friend and I agree. His comments referring to 8 I think point to one weak spot formerly in his association, since rectified.

(10) *Annual Meetings.*—I grant a few are more favourably situated for attending these than others, but "where there is a will there is a way," and a great many who do not might easily take advantage of the opportunities offered. I can quote cases of men cycling home long distances, one of twenty-five miles, after a meeting, and in the winter, too!

(11) *Association Report.*—Is it no advantage to know the name and address of the nearest experienced bee-keeper to whom to apply for help in the time of trouble? Of course, if one is perfectly satisfied with one's own bee-keeping and its results, it may not be of much interest to find out who are one's bee-keeping neighbours or how they have fared, still less perhaps how one's association has got on. Can one learn nothing from the report as to extension or checking of disease, as the case may be, of affected districts or those with a clean bill of health? When fresh blood is required in the apiary, swarms or driven bees, stocks, &c., &c., it is as well to know where to go or what districts to avoid! Some reports include Board of Agriculture leaflets on "Isle of Wight," "Foul Brood," how to begin, marketing, &c. These, of course, can be had free, but how many small bee-keepers would take the trouble to write for them? The association takes that trouble, and the members benefit thereby. "The guinea subscriber," in my experience, is not of the class who expect a

return for their subscription, but cheerfully give to try and help their fellows.

(12) *Drawing for Hive*.—On this point I cannot write from personal experience, but in theory it seems as sound to me as it does the reverse to your correspondent. It ensures one bee-keeper at least having one good hive, and if he belong to the "ignorant or careless class," his ignorance will probably be turned into wisdom, and his carelessness do less harm.

(13) This point is peculiarly brought in, but it can certainly rank among the "advantages." There is a verse on giving "not grudgingly, or of necessity, &c.," that the reverend critic might lay to heart.—NORTHUMBRIAN BEE.

(To be continued.)

#### "ISLE OF WIGHT" DISEASE.

[8938] I cordially agree with Mr. H. Campbell (8930) that heresy is the mother of knowledge; so will put forward some considerations that have occurred to me in support of Mr. L. Illingworth's suggestion (8935) that the "Isle of Wight" disease was imported from abroad—a possibility which appears to me not to have received sufficient attention hitherto.

According to the Board of Agriculture's report, May, 1912, the outbreaks of disease similar to "Isle of Wight," mentioned in old bee-books, were, most of them, due to *Nosema apis*, which has therefore long been endemic in this country. This opinion appears to be well founded; especially as we do not know of any other parasite which is commonly associated with the symptoms. But I would respectfully beg to differ from Mr. Bullamore and Dr. Malden when they state their conviction (page 13, 1912 Report) that the present widespread outbreak cannot be entirely traced back to the outbreak in the Isle of Wight in 1904. My reasons are as follows:—

(1) The view taken in the Report is based on the fact that cases of disease have been recorded previously to the main outbreak. But such cases would be accounted for by supposing the existence of a mild endemic strain of *Nosema*, occurring locally, to which our bees are mostly immune. These local outbreaks have doubtless often been severe; but is there any evidence that they ever resulted in a practically universal epidemic lasting for several years, like the present one? I would submit that the official view neglects to lay sufficient stress on this fact.

(2) There is no special evidence that the weather was particularly unfavourable to bee-life during the years when the epidemic started in the Isle of Wight (1904-1906): or that any other exceptional conditions were present that lowered the

vitality of the bees, and so gave the microbe an advantage. But if the epidemic was not due to unfavourable conditions acting adversely on the bees and so favouring the spread of the disease, it must have been due to infection with a virulent strain of the parasite to which the bees were not immune. It was, as Mr. Anderson pointed out ("B.B.J.," 1912, page 333), a case similar to that of the South Sea Islanders and the measles.

(3) Evidence is not wanting to show where that virulent strain came from. Mr. John Silver, writing in the "B.B.J." (1907, page 224), states that: "Some ascribe it (*i.e.*, the origin of the disease in the Isle of Wight) to several colonies imported from France and Switzerland about four years ago." That is to say, the stocks were imported in 1903; the disease broke out in 1904. The connection seems plain: for we know that *Nosema apis* has long been prevalent on the Continent.

(4) Why then, if, as my theory requires, the Continental strains of *Nosema* are so deadly, do they not, as Mr. Illingworth asks, produce equally "disastrous results" in their native lands? The answer is, I believe: (a) that the bees in those countries are partially, or, in some cases, wholly, immune, even to virulent strains of *Nosema* (*cf.*, the experiments of Maassen and Nithack, 1912 Report, page 109; 1913 Report, page 21), Maassen's opinion and that of Brown, in Australia (both quoted, 1912 Report, page 51). Even so, there are actually losses from *microsporidiosis*, as the reports of Drs. Maassen and Zander and others prove.

(b) The strain that was imported into the "Isle of Wight" in 1903 may not have been specially virulent as Continental strains go; but it was deadly to our bees because they were not immune to it. Dr. Graham-Smith and Mr. Bullamore state (1913 Report, page 22) that they are "of opinion that latent *Nosema* infection is not generally common in this country." In other words, either our native strain of *Nosema* is so exceedingly mild that it is seldom able to infect bees, except under very unhealthy conditions; or else the idea that *Nosema* is endemic in England is mistaken, and it is really quite new to this country.

We may therefore conclude that—

(1) *Nosema apis* existed in this country previously to 1903 in a very mild form, to which our bees were nearly all immune.

(2) A comparatively virulent strain of *Nosema* was imported into the Isle of Wight in 1903 from either France or Switzerland; it is the sole cause and origin of the epidemic that has spread, and is still spreading through the country.

(3) The bees on the Continent, and in Australia, are partially immune to

*Nosema*. Immunity is therefore not only possible but is actually known to exist.

I would therefore like to support Mr. Campbell's plea for an attempt to raise an immune race of bees, and to suggest that anyone endeavouring to do so should bear the principles of Mendelism in mind as more likely to lead to a successful result than the rather happy-go-lucky method suggested by Mr. Campbell. In this connection it is to be noted that the importing of queens, as well as of stocks, not proved to be of an immune strain, into an infected district, is fatal to all chance of breeding immune bees; and that legislation that would put a stop to that, while exercising a wise moderation in the matter of destroying slightly infected stocks, would probably prove, not our undoing, but our salvation.—ANNIE D. BETTS.

#### THE FLOWERS OF FEBRUARY.

[8939] In spite of Christmas rose and aconite, the first real bee forage comes in February. The date of the crocus is not a certain one; my 1911 diary tells me that on February 18 crocuses and snowdrops were in masses and the bees busy among them. There is no greater pleasure in all the year for a bee-keeper than to see his bees going down into the golden crocus cups, whose transparent sides show him the little gatherers as though on a lighted window. In 1910 a London park accessible to my bees had a large patch of Mediterranean heather in blossom just at the end of the month. Anyone with the right sort of ground would do well to plant a rod or so with this or with *Erica carnea*, to blossom before the colt's foot and put the bees into breeding humour, even though it gives them only very slender forage. Another exquisite and early blossom already open in ones and twos is the hepatica; my own are mostly a heavenly blue, but some of them are pink. Quite generously nectariferous is the giant saxifrage, whose name, I suppose, is *S. crassifolia*. It is sometimes called Jerusalem cowslip, and it begins to open its great pink umbels in February in an early year. The gooseberry has been known to blossom in February; when the first queen wasp is seen its time is not far off. The chief blossoms of this month, however, are wind-fertilised, and it is doubtful whether the bees visit them. The box and the yew are very good examples, each producing clouds of pollen. The alder catkins are, as Tony Weller said of a certain tea-drinker, "swelling wisely," and the trees are blushing beautifully under the influence of spring. Certainly the bees will find something to do on the occasional warm days we are entitled to expect this month.—G. G. D., Glos.

#### " ISLE OF WIGHT " DISEASE.

[8940] I fear I cannot have made the object of my former letter (8930) as clear as was desirable; for I find Mr. Illingworth, in imputing to me a wish to "establish spontaneous generation," has misunderstood me. My excuse for this lack of clarity is that, while writing the letter, I was continually haunted by the thought of the already congested columns of the "B.B.J." The fault was, of course, mine, and I beg to apologise to Mr. Illingworth.

My point is this: Whenever I discuss the disease with fellow bee-keepers they invariably tell me that destruction of infected stocks is the only remedy; and as I gather from the "Suspected Disease" column of the JOURNAL that this is also the official opinion of the central bee-keeping authority, I may be permitted to term it the "orthodox" view—and to describe myself as heretical in that I differ from it. Moreover, if Mr. Illingworth (8935) has correctly presented the Board of Agriculture's view, I appear to be in good company, my heresy being shared by Whitehall! For surely burning will not help much, if the disease be caused by a pre-existent microbe, invigorated by "climatic or other conditions." We are *indeed* going back to the Middle Ages if we imagine we can control climate with a bonfire!

And, in truth, despite his protest, I cannot but think that Mr. Illingworth is every bit as unorthodox as myself. He admits the probability of the disease "exhausting itself"; but when we use this expression regarding a disease, we mean no more than that its victims are becoming resistant to its attacks by natural selection; and so he seems to me to admit that immunity (or rather its first step, *resistance*) may be a practical solution of the problem after all. And as by destroying infected stocks we are impeding the selective processes of nature, I can only conclude that he disapproves of this wholesale use of fire.

Nor do I claim that my heresy is a new theory. I have seen it voiced before in these columns. But since there seems to be some likelihood of our being compelled by Act of Parliament in the near future to interfere with nature, I do not think we should leave the subject alone. Our ignorance of the causes of the disease is so colossal that it seems absurd to legislate on the subject, and so close the door to further inquiry. Even the view of the Board of Agriculture is no more than a theory. Let us first, then, prove the theory true before we invoke Parliament.

Legislation in the case of foul-brood can, of course, be defended, since we have learned by experience that destruction of

infected stocks does have the effect of preventing the spread of this disease: but I am not at all sure that we have learned the same of "Isle of Wight" disease. As I pointed out, it *may* be due to spontaneous generation, for anything we know to the contrary. I do not myself think this likely: it is far more probable that it came from abroad, where its ravages have not been noticeable owing to the fact that the local bees are highly resistant of it. But in either case burning seems to me to be a questionable policy to pursue, since we do not know but what resistance (and even complete immunity) may not be achieved in the course of a few generations. We have no right to argue that because immunity has not resulted after 2,000 years in connection with one complaint, the same will be true of "Isle of Wight" disease. Thus, to take an example from ourselves, once a man has had smallpox he is immune to it for the rest of his life: whereas the streptococcus that is responsible for a cold in the head will attack him time after time and show no diminution of vigour. Moreover, my own observations in a district where foul-brood was rampant make me hesitate to admit that natural selection is incapable of stamping it out. I well remember how, in the midst of the wreckage of an apiary, one stock displayed a most astonishing resistant and recuperative power; and had it not been subsequently annihilated by "Isle of Wight" disease, I cannot but think that something might have been made of it in the way of queen-rearing.

Mr. Illingworth says that I have overlooked a third alternative, *viz.*, that embodied in the view of the Board of Agriculture. Having been much abroad until recently, I have not followed the Board's researches; but if their conclusions are really as stated by him, I am not surprised at their possibility having escaped me. Let me translate this view into simple language. The "spring-dwinding" microbe has been long existent in all parts of England—at any rate, it is a complaint spoken of as common in all old guide-books. About 1906 climatic or other conditions altered in the Isle of Wight, causing an access of vigour in the microbe (or the reverse in bees). The following year these conditions spread to Hants—otherwise, on the Board's theory, the already-existing microbe there could not have become vigorous. The year after these conditions spread outwards in a circle to Sussex, Surrey, Berks, Wilts and Dorset; and, if I remember rightly, they also took the train, in company of a stock of bees, to the North, where they proceeded to invigorate the local microbe! The idea of climatic or other conditions taking a third-class railway-ticket seems

to me to admit of argument!—H. CAMPBELL, Pulham St. Mary, Norfolk.



*Bee-keeping in Nyasaland* (p. 20).—I know so little of the local conditions that I hesitate to do more than make suggestions, but Mr. Deuss might experiment in his endeavour to get heavier sections. It may be that his bees do not readily work sections, or that they leave too large a passage way between the comb and the divider. Something might be done by getting the sections worked out (possibly, even completed) without dividers. Wooden dividers (perhaps fences) which provide some portion of the bee-way (so as to increase this) might be better than metal. But if it is so difficult to get good sections, why not abandon the attempt, at least temporarily, and work for extracted honey? Mr. Deuss would do well to write for advice to Mr. G. S. Oettle, care of the *South African Poultry Magazine*, Johannesburg, and to subscribe to this journal, which devotes considerable space to South African bee-keeping. I am indebted to Mr. Oettle for such knowledge as I possess of the conditions, and he is emphatic on the subject of extracted *v.* comb-honey.

*Thick Syrup* (p. 24).—I still think that "D. M. M." is mistaken, or, at least, ill-advised, in his advocacy of 2½ lbs. of sugar to the pint of water. (His present statement of "2½ lbs. of solid to one of liquid" is evidently a slip of the pen, as this would mean 4-5ths of a pint; as also "stirring until melted" is a clerical error, which should read "dissolved.") I doubt whether a pint of water will take up 2½ lbs. of sugar under the ordinary treatment of making bee syrup, *i.e.*, boiling as advised by "D. M. M." At any rate, I have just made a small test of these proportions, bringing carefully to the boil, and allowing to cool slowly. Long before the result was cold, extensive crystallisation took place, the small remaining portion of syrup being saturated. But perhaps "D. M. M." will check the test for himself, as what is wanted is not so much the opinion of authorities as the truth. Both Dr. Miller and Mr. Ernest Root would readily confess themselves in error if this were the case, but there may be a difference in their treatment. Perhaps "D. M. M." has misunderstood them, or I may have made an error in my test, which I will willingly admit.

*Seeds of Granulation* (p. 24).—I wonder if there is anything in "D. M. M.'s" idea that combs once occupied by granulated

stores are contaminated, as it were, for ever. Judging from a limited experience, I should have thought not. But all things are possible, and I have not observed closely enough to be emphatic. I should have said that the bees could make a clean job of such combs, particularly when assisted by the bee-keeper, who is also deemed impotent in the matter. But I think I could guarantee a clean job. For one thing, granulation in the comb is usually coarse, and such granules are easily removed, whilst to fill such a comb with water should get rid of even the thought of evil! But surely no one would use bait sections containing honey, whether granulated or not! The granulation in the feeder, of which "D. M. M." writes, may be due to the use of over-thick syrup. It is well to fill all feeders with water for a time before finally washing and storing them for the winter.

*Putting on the Roof* (p. 35).—It may seem extraordinary to the possessor of one or two neatly-made hives that there should be more than one method of putting on a roof, but there are, in fact, several. Mr. Herrod's method is infinitely superior to the blundering hit-or-miss method, and works perfectly with well-made furniture. But occasionally one comes across roofs which have only two rebates, or else the rebates do not lie truly in the same plane. Here is a method which covers all possible cases where the roof will go on as placed, and which I invariably try to teach to such candidates as have the misfortune to pass through my hands for examination. Handle the roof as described by Mr. Herrod, but hold it at diagonal corners. Allow the finger-tips to project inwards, as described, to feel for the entering corner of the hive, which should pass between them. Then lower the roof, and as the one diagonal descends the other must of necessity do so truly. With this method also, a heavy roof is handled much more easily, as no leverage is exerted upon the wrists. Try it with an awkward or badly-made roof, if you should happen to possess such a thing, or, failing this, with a good one.



[8905] *A Swarm in January.*—Late last autumn I drove two stocks and a small cast, and placed all the bees on seven brood frames taken from other hives. I gave them some candy, and they did a good deal of honey collecting, the weather being so mild. On January 10th I was advised to go and see them, as they were said to be all out of the hive. The hive

was a very large one, and the seven frames did not take up half of the space. I found the bees outside crawling all over the hive, and going in at the escape vent. I looked inside and saw a large cluster, so went and got my veil and smoker, and two new frames with foundation. I gave them a good smoking, took off the quilt, found my last box of candy hardly touched, and a fair number of bees on the frames. I had previously given the bees a good dusting with flour, as I was uncertain if it was robbing. I did not gather it was on examining the other hives. I then put the two new frames in on either side of the centre frame and covered all up, opened the entrance wider, and smoked the bees again until they ran in.

I have not examined the hive since. I may say when I put the three lots of bees together I did not look for any queen and kill her, but simply let them settle the matter. I have had one suggestion, that it was a "hunger swarm," but as the combs were full of stores this cannot be right; another person told me that he expected they were too warm. Personally I thought it was simply a case of lack of room, and so gave the two frames of foundation, but as we had a cold snap a few days later I wondered if I had acted rightly. I did not examine the seven frames, but saw they were well sealed, and on moving them noted they were heavy. I began to keep bees last year, and as I am only a beginner I shall be glad if you would advise me whether it was a swarm, and if so is it not very unusual, and what should I have done? I had no drawn out brood frames.—X. Y. Z.

REPLY.—It certainly was not a natural swarm. We should imagine the bees were excited on account of queenlessness.

The frames should not have been put in the centre of hive. Remove them at once. You had better examine them on the first fine day to see if there is brood; if not, get a queen as early in the spring as possible, and introduce her.

[8906] *Working for both Increase and Surplus.*—I intend keeping bees this coming season, and before I set to work I shall be much obliged if you will kindly give me a little advice, so that I may profit to the fullest advantage. At the present time I have two new hives, "W.B.C." pattern, and I have ordered a stock of bees on eight frames through a local bee-keeper, this stock to be delivered about the end of March or beginning of April, according to the weather. My aim is to finish up the season with two stocks and a small quantity of surplus honey. I have read the "Guide Book" by T. W. Cowan several times—in fact, this book and one or two others I have read very carefully three or four times—and to accomplish my object it would appear there are two

or three ways of going about it. Given ordinary good luck and favourable weather, I suppose I can expect the extra stock of bees all right, and the question remains, how can I obtain the most surplus honey in addition? I will number my questions, and if you think the matter of sufficient interest to other novice bee-keepers, perhaps you will kindly reply in the "Queries and Replies" column in the "B.B.J."

(1) The first method would be to wait for a swarm in the ordinary way. This, however, does not altogether appeal to me, as I am away from home all day, and a natural swarm might be lost. And, of course, the bees may not swarm.

(2) The second plan would be to make an artificial swarm, but by doing this time would be lost in getting the second stock queened, unless I purchased a queen for introduction.

(3) The third way, and which in my own mind I think the best, would be to stimulate the queen to laying in the original hive, and when the stock covers ten frames, put my other empty brood-box filled with foundation over it, so that in time I get one hive with a double brood-box. The honey flow about here is, I am informed by other bee-keepers, about the second or third week in June, and the question is, could I get the hive full of bees in time? If my suggestion could be carried out, I take it with such a strong stock I should get a lot of surplus honey, and when the honey flow is over I could remove the top brood-box to my second hive, and introduce another queen, thus getting my two stocks, which would then be fed up for the winter. —H. A. DICKENSON.

REPLY.—We would advise you to stimulate the bees early to get them strong. Make a nucleus, and when the queen in it is laying, make a nucleus swarm as described on page 95 of "British Bee-keepers' Guide Book."

---

## Notices to Correspondents

---

J. G. S. (Surrey).—*Destroying Diseased Stock.* (1) If you used cyanide of potassium to kill the bees you must not eat the honey, unless you want to also depart this life. (2) The queen is not usually affected, as she is fed on digested food. (3) The microbe causing the disease is ever present, and becomes virulent and fatal under certain conditions.

W. H. (Camblesforth).—*Moving Bees.*—You should move the bees as soon as possible, while they are confined to the hives by bad weather. Cord both skeps and frame-hives, so that there is no chance of any part moving. Block the entrance with rags, and convey them to their destination on a light spring vehicle, so that they are jarred as little as possible. Tie up the hives and prepare them in the daytime, but move them at night.

R. M. B. A. (Bridge of Allen).—*Honey from Infected Hive.*—The honey is harmless enough for human consumption, but be sure that none is left about so that other bees can get at it.

A. C. K. (Hanwell).—*Candy-making.*—(1) The candy was properly made; and (2) will not do any harm to the bees. (3) No. (4) Yes. Many thanks for your kind and appreciative remarks.

A. M. S. (Kettering).—*Bees Robbing in January.*—It is not unusual for bees to rob in January on fine days.

C. A. MORGAN (Newport).—*Stock Found Dead.*—The bees have died from starvation through being too few in number to move to the food. You can use the honey for other bees as there is no disease.

A. N. C. (Neston).—*Colour of Bees.*—The light-coloured segment you refer to shows that the bees have Italian blood in them; it is not a disease.

J. Y. (Cambridge).—*Honey Vinegar.*—The vinegar is not yet a good sample. In about three years' time it will have matured and be fit for sale.

### Suspected Disease.

F. S. E. (Suffolk).—They are British bees and have "Isle of Wight" disease.

A. H. (Wavendon), J. S. (Nelson), K. H. (Middlesex), F. O. B. (Bristol), T. H. (Essex), CONSTANT READER (Wigtons), L. H. (Somerset), MRS. NORTON, BEE LOVER (Teignmouth), R. E. T. (Cheshire), W. J. O. (Horsham), and F. B. L. (Kent).—The bees have died from "Isle of Wight" disease.

W. S. A. (Chippenham).—Both lots have "Isle of Wight" disease.

F. S. SMITH.—We are sorry we cannot help you, as the bees arrived saturated with honey.

W. D. (Horsham).—The bees have died from starvation.

W. D. K. (Bearwood), G. H. (Pontefract), and F. C. (Sheringham).—The bees have "Isle of Wight" disease. There is no known remedy. Destroy them without delay.

OBSERVER (Heighington).—The bees died from "Isle of Wight" disease. We cannot say if the honey was the source of infection or not.

# Editorial

## WEAR VALLEY AND DISTRICT B.K.A.

The annual meeting of the above Association was held in the Mechanics' Institute, Wolsingham, Co. Durham, on January 24th last. The balance-sheet showed a balance of over £3. A series of lectures on bee-keeping are to be arranged by the Hon. Sec., each lecture to be given at a different place in the district. This is thought to be the best means of stimulating an interest in bee-keeping, and it is hoped that many more bee-keepers will be induced to join the Association. The following officers were elected for the year 1914:—President: Mrs. H. G. Stobart; Chairman: Mr. J. G. Westgarth; Hon. Secretary: Mr. W. S. Watson; Treasurer: Mr. W. Proud; Auditors: Messrs. Welsh and Heslop.—W. S. WATSON, Southview, Wolsingham, Co. Durham.

## REVIEWS OF FOREIGN BEE JOURNALS

By Nemo.

*Was More than a Thousand Years Old.*—We read in the *Bulletin de la Société romande d'Apiculture* that excavations made in 1905 near the town of Tönsberg, in Norway, brought to light a boat of the period of the Vikings, who occupied the country about the year 800 A.D. This boat served as a place of sepulchre for a queen, and contained a number of very interesting objects intended for the use of the deceased in the other world. Among the articles were found two cakes of wax weighing about 117 grammes, which were probably used for waxing the sewing thread, two balls of which were also found.

M. John Sebelier, a Norwegian scientist, has just made an analysis of this wax. He found it quite a normal beeswax, and it only differed from ours by containing a slightly smaller proportion of iodine and acids. This wax was of a beautiful yellow colour, and a microscopic examination showed a few grains of pollen derived from flowers of fruit trees, blackberry, lime, and others.

*Apiculture in Egypt.*—M. A. Bircher states in the *Revue Française d'Apiculture* that the Egyptian bee is a little smaller than that of Europe, but much more irascible. Its abdomen is striped with white bands. Hives are examined twice a

year, in August to remove the honey and in February to prepare them with a view to preventing the bees from swarming. Enemies of bees are numerous. Several birds of the genus *Merops* have voracious appetites for bees. There is also the heat to contend against, although this does not prevent the workers from foraging, as they, even at a temperature of 99 degs. Fahr., preserve all their ardour for work and energy for fighting the hornets, which are some of their most formidable enemies.

The movable comb-hive gives very good returns, as the average amount of honey produced by a colony is not less than 35 kilos (about 77 lbs.). Nevertheless, one finds very little honey in the country, because the owners of the hives do not understand how to manage them, and at frequent intervals remove the combs so that the bees are obliged to reconstruct them several times during the year, of course to the detriment of the honey harvest. The principal nectar-yielding plant is a white clover (*Trifolium Alcrandrinum*, known as *Bersin* or *Egyptian clover*), and the principal gathering season is in March and April. In August, during the rainy season, the honey is darker and of a brownish tint. In January, beans begin to bloom, and these are eagerly visited by the bees. Later fruit trees, such as peaches, apricots, and others, flower, and these, with *eucalyptus*, yield abundantly.

*The Position of the Cluster of Bees in Winter.*—The bee-keeper, not being certain as to the position that the cluster will occupy in winter, is obliged to arrange the stores by distributing them over the combs. M. Achmarin has been carrying out experiments in Russia with a view to determining if there was any rule guiding the bees in the formation of this cluster, and gives the results in *Ptschelorodnaya Gisa*. The entrance slide of M. Achmarin's hive consists of a single strip of zinc which, according to its position, allows either the right or the left side of the entrance to be left open. Repeated observations have forced M. Achmarin to the conclusion that the bees always cluster on that side where the entrance is open. Since making this discovery, he has always worked in accordance with it, and in consequence has not lost any colonies. If the entrance is to be open on the right side, the bulk of the stores are arranged on this side. It would be worth experimenting in this country, where we leave hives out of doors on their own stands during winter, for the hives of M. Achmarin are placed in a house as is the usual custom in so severe a climate as Russia. It would much simplify wintering if we could insure the safety of the bees by placing all their stores together within their easy reach.



### WINTERING BEES.

Each season's harvest is gathered or lost the previous autumn according to the attention given to the bees.

As a rule, the novice winters down his stocks with many misgivings as to whether he has done right or not. His anxiety is the greater owing to the fact that, unlike summer operations, he is unable to examine them from time to time during the winter months to see that all is going well.

Instead of leaving the preparation for wintering until October, it should be commenced as soon as the supers are removed. An examination of every stock will reveal their condition; careful notes made at this examination will save the trouble of further disturbance.

Our next work will be in connection with the hive. We must guard against damp getting inside; therefore attention must be given to the roof and floor-board; damp rises, and, of course, rain and snow fall from above. Many are content to see that the roof is all right, and take no care of the floor-board. The roof, if properly treated when the hive is new, and before it is occupied, by stretching calico or fine canvas over it very tightly and well painting the same, will require no attention beyond a couple of coats of good oil paint every two years. If not so treated, be it ever so well made and of the best seasoned material, changeable climatic conditions will eventually make it crack, or, as carpenters call it, shake; when this has happened thin paint should be run into the crack, and when this has set soft putty should be well worked into it from the underside until it oozes through on the top side; rub down level by means of sandpaper, allow it to stand for a day or two to allow the surface of the putty to harden, then paint. A good plan, after this has been done, is to stick strips of calico over the cracks on the underside by means of white lead. Personally, on no account would I use the stepped roof, as it is impossible to keep it watertight. The roof should be made flat on each side; if calico is used, it does not matter how many joints there are—It will be quite watertight. I have a roof made of strips of wood, none of which is more than one inch in breadth.

Avoid covering the roof with zinc, for, although well painted, it will attract the heat in the summer, and in the winter it is very cold; further, no matter how snugly it is fitted, there is bound to be a certain amount of condensation of moisture on the underside, and this does harm by slowly rotting the wood. I have seen old sacking thrown over the roofs of hives with the idea of keeping them watertight, on the top of which bricks are laid to keep it from blowing off. A better or more complete way of totally ruining even the best roof could not be found, as the damp is kept continually present under the sacks, and consequently the woodwork rapidly decays. If a roof cannot be made watertight without this addition, the sooner it is chopped up for firewood the better. Another plan followed is to bend a piece of corrugated iron to the shape of the roof, and lay this loosely over the top, again using bricks to keep it in place. This has all the disadvantages of the close-fitting zinc, and is further detrimental inasmuch as, in rough weather, the wind moves the iron, and there is jarring and noise, which excites the bees and causes them to take more food than is good for them, probably resulting in dysentery, the action being exactly that of smoke or carbolic fumes, as it frightens the bees. Even rain beating on corrugated iron will disturb the bees; for this reason alone it is a very bad covering. A remark I heard one day explained this very tersely; it was that "If it looks like rain it rattles."

We next attend to the floor-board, and in all cases this should be well painted on the underside to protect it from the damp which rises. See there are no chinks right through, or there will be a draught through the brood-nest in the early and most important part of the year; the floor-board should be quite level from side to



side, and slope about half-an-inch to the front. If the hive tilts ever so slightly to the back it is impossible to keep the interior dry. Moisture, which condenses during the winter, will saturate the debris caused by chewed cappings which collect on the floor-board, so providing a damp mouldy mess—bad for the bees in every way, and making them more susceptible to disease; and often I have seen this a seething mass of maggots, the offspring of other creatures. Again, when it rains, the wet will draw in, and the same thing will happen from melting snow; therefore, the slight tilt does away with all these drawbacks.

All weak stocks should be united with as little delay as possible, to get them into good fettle for the winter by breeding as many young bees as possible. The fallacy of trying to winter weak lots is shown in Fig. 1. The old bees die off

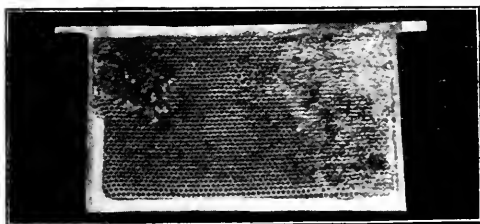

FIG. 1.

rapidly, leaving the cluster so small that they cannot generate sufficient heat to obtain energy to move from one end of the comb to the other when the food directly under them is consumed, and, as will be seen, they perish from hunger. The more bees there are, the less food is consumed. This seems paradoxical, but it is quite true, as a large quantity of bees can maintain the temperature on a very

small amount of food. There is greater body heat, and when once raised it does not escape so quickly from a large cluster as from a small one. With a small number more fuel (food) is burnt, as heat is generated by combustion of food in the body of the bee combined with oxygen, and also by mechanical movements of various parts of the body, as, for instance, respiration.

Autumn is the time to re-queen—not the spring, as so many novices seem to imagine. There are two reasons why it should be done in the autumn—first, on account of expense; if queens have to be purchased, they are much dearer in the spring than in the autumn. Secondly, to get the best out of the new queen in the early part of the year. The queen commences to lay about the last week in January; under the most favourable circumstances it is impossible to introduce new queens before the middle of April; therefore, if the work is left until the spring about three months of the most valuable part of the year is wasted by the old queen. Again, if re-queening is carried out every year the introduction of a young queen will allow of forcing the production of eggs to the utmost limit in the autumn, without injurious effects upon the stock's future welfare. Lastly, it gives the bee-keeper an opportunity for testing the reproductive powers of the queen before the winter, so that, if deficient, there is time to replace her.

The next work is to stimulate the bees so that the queen will be fed liberally on chyle food and produce more eggs than she would under normal conditions. Autumn stimulation is deprecated by some bee-keepers on the ground that the energy of the bees is taxed in brood-rearing; therefore they do not live so long. Be that as it may, I have always found those stocks in which autumn stimulation has been carried out come out best in the spring and do the most work. If there is a shortage of food this is carried out by means of a bottle-feeder, giving the bees access to about three holes. As some of the food will be stored, it is well to make the syrup a little thicker than that usually used for stimulative purposes, and if there is disease in the neighbourhood it should be medicated. A constant supply of syrup should be kept in the feeder—a shortage, if only for a few hours, will check egg-laying. Those stocks which do not require feeding must also receive attention. It often happens that the brood nest is choked with food, thus limiting the number of cells available for the queen to lay in. If the bee-keeper has a few good empty combs on hand the difficulty is soon overcome by removing a couple of combs containing honey only, replacing them with empty combs. The food combs can be used for making up stocks from driven bees later on, or stored away in a dry, warm, dust and insect-proof cupboard or box, to give to stocks that are short of stores in the spring.

Failing this, it will be necessary to extract a couple of combs from the brood

chamber. Select those which do not contain brood, extract the honey, and put them back in the centre of the brood nest—not side by side, but with a couple of combs containing brood between them. The work of extracting should be carried out in the evening, so that the bees are not excited and induced to rob on account of the smell of the wet combs—these will be cleaned up during the night. All excitement will have subsided by the morning, when the bees will work normally.

The stocks should be treated one at a time, and not a collection of a dozen combs made from half-a-dozen hives at once, to save time, or the protracted operation will cause strife. When feeding, and also when replacing wet combs, all entrances should be reduced to about half an inch, to give the inmates a better opportunity of defending the hive against robber bees and wasps.

(To be continued.)

### RANDOM JOTTINGS.

By Charles H. Heap, Reading.

#### "ISLE OF WIGHT DISEASE" AND FRUIT CROPS.

I do not intend to take part in the controversy in which Mr. Illingworth, Mr. Campbell, and Miss Betts have engaged. The question of immunity is one of considerable difficulty, and one, so far as bees are concerned, about which we know little or nothing. For the majority of us, the point of importance is to get rid of "Isle of Wight" disease as quickly as possible. I am afraid that if we wait for the strain of bees immune to *Nosema apis* some of us, in disease-smitten counties, will see the best years of our lives pass away before we can take up bee-keeping in real earnest once more. It seems to me that the most sensible and practical course of procedure is to try to stamp out the disease. Rabies was banished from Great Britain by a much-ridiculed order of the Board of Agriculture, and the Board have been successful in keeping in check such serious infectious disorders as foot-and-mouth disease, anthrax, and sheep scab. These diseases are not cured, but are kept under control by a process of elimination. Left to herself, Nature would do the work, but it is more quickly accomplished when man, after intelligent study, lends a helping hand. Supposing *microsporidiosis* is allowed to take its first leisured course, half a human generation may pass before bee-keeping on more than a very small scale may be carried on with pleasure and profit. To those who are hoping for the evolution of the "immune bee," I would point that while some strains of bees may not contract the disease quite so readily as others, foul brood was known and described 400 years before the birth of Christ. Where is the strain of *Apis mellifica* capable of resisting this pest?

A *Natural Point of View*.—While we are waiting for the strain of bees immune to *Nosema apis*, and correspondents are discussing theories, the nation, as a whole, is suffering serious loss. Speaking generally, the acquisition of large quantities of honey is the prime interest of the bee-keeper; but the bee

does much more important work than gathering honey. Its chief purpose is to effect the cross-fertilisation of flowers; indeed, some plants cannot reproduce their kind without the ministrations of insects, of which, in this respect, the honey-bee is the most important. I visited certain parts of Worcestershire and Berkshire last autumn, and I was able quite easily, especially in the latter county, to tell from the appearance of the orchards and the fruit trees in village gardens where bees were scarce. In some districts where all the honey bees were dead, there was scarcely an apple on the trees, while in other places having similar climatic and soil conditions the crops were good, owing to the presence of bees. To take another instance, in the garden of a large house situated high upon a beautiful eminence overlooking the Thames, it was impossible to grow strawberries until two or three years ago, when a fresh gardener arrived with a few stocks of bees of his own. Last season was not one of the best for strawberries, but in these gardens strawberries were so plentiful that the family had a surfeit.

I am not, however, concerned with the interests of the wealthy, but an abundance of good, sound fruit should be within the reach of millions of people, who only buy a little occasionally, or can never get it at all. If, as I understand, comparative anatomy shows that man is a frugivorous animal, it follows that fresh fruit, apart from cereals, which are also fruits, is necessary for a healthy life, but this desideratum will not be met if the country is, to a large extent, denuded of honeybees. These are matters too frequently overlooked, and I think discussion in the "B.B.J." on the relation of bees to fruit crops would be instructive and valuable.

A *Preventive Measure*.—Whether we have legislation or not, it is the duty of every enlightened bee-keeper—and I regard readers of the bee papers as enlightened—to do his utmost to prevent the spread of disease, whether it be the more familiar enemy, foul brood, or the more deadly "Isle of Wight." I wish to make a suggestion which is within the

power of all to adopt. It is that no time should be lost in examining the hives in which the bee-keeper suspects the bees have died, and that the others should be looked at on the first suitable day. If the bees have died under circumstances which point to the *Nosema apis* as the causative agent (usually small bunches of bees hanging dead on the combs with plenty of food in sight), the combs should be removed from the hives and the hives securely closed. The combs should either be destroyed at once or temporarily placed where they cannot by any possibility be reached by bees. If this is done now it may be the means of preventing the disease being contracted by colonies which have so far escaped infection. I hope to deal with another aspect of the spread of disease in my next article.



*The Editors do not hold themselves responsible for the opinions expressed by correspondents. No notice will be taken of anonymous communications, and correspondents are requested to write on one side of the paper only and give their real names and addresses, not necessarily for publication, but as a guarantee of good faith. Illustrations should be drawn on separate pieces of paper. We do not undertake to return rejected communications.*

## BEE ASSOCIATIONS AND THEIR WORK.

(Continued from page 56.)

[8941] After quoting his unusual advantage, Mr. Mattinson rubs his hands with satisfaction at having decried his own and all Associations, or, as he puts it, "justified my assertion that the advantages of membership are overrated," and then has one last slap, saying, in other words, anyone is a fool to subscribe to any Association at all!

Then he turns from adverse criticism to a few suggestions (?) by laying down a hard and fast rule, "as first, foremost, and absolutely essential," by which, in his opinion, all Associations must abide, or there is no hope for them. They must reduce their subscriptions.

I have the honour to belong to the B.B.K.A. and four county Associations, so I suppose I am a fool five times over. The fact remains that of these five Associations the one with by far the smallest subscription is more or less moribund, while the others are flourishing! In my humble opinion the reason is very simple. What is worth having is worth paying for, and if you don't pay enough to be able to afford a touring expert his expenses, the members

are just left to their own devices; the ignorant are allowed to remain in darkness; the careless are not invited, nor encouraged to mend their ways. Yet the subscription of this Association is 1s. 6d., not the sixpenny one, which, according to our friend, is to work such wonders. It is passing strange if this small subscription is so vital that of the fifty-one Associations that exist *not one* should have decided on a 6d. subscription, though the question of the amount to be charged to members is one of the very first that has to be settled on formation.

Mr. Mattinson hits the key to the situation when he says, in the last paragraph of 8928: "The cottager who is worth having as a bee-keeping recruit does not want charity; he is willing to pay for benefits, provided he gets full value for his money." If the Association is *alive*, he most assuredly does receive full value; if it is not, it is either for the reason given above or that quoted by "D. M. M." in his "Comments" (p. 50 of "B.B.J.," January 29th, 1914).

To proceed, how Mr. Mattinson arrives at the conclusion that, because the subscription is reduced to the vanishing point, and the membership increased thereby fourfold, perhaps tenfold, the manual work of the expert would be curtailed, is beyond me? I am a fivefold fool, but I think I will find myself in good company on this point. Again, further on, I don't see how lowering the subscriptions will place Associations on a "business footing." I never heard of any business succeeding that had not got a working capital to start with.

"Co-operation in Buying."—Has our friend ever tried this in practice? Some years ago I tried to help some local bee-keepers by getting a list of what they wanted, and adding them to my own order. The total amount reached a sum worthy of a considerable discount, and we got it. Well, on a small scale it illustrates what would happen if an Association tried it on a large one. I stored several large crates free; an Association would have to pay for this storage. I won't count the time I spent opening, sorting, repacking, &c., but on a large scale it would keep one man busy. A few bee-keepers changed their minds, and some of the things were not taken, so I had stuff left on my hands that I did not require, and the experiment, as far as I was concerned, resulted in a monetary loss. How much would an Association lose? Then, again, all these appliances, &c., were ordered from one firm, so the total discount was worth consideration, but bee-keepers have their own fancies *re* hives and appliances, and it would be impossible to get all members to go to one firm. The same order split up among several firms would not have secured any discount at all! Does Mr.

Mattinson expect the manufacturers to give discounts on small orders, for the sake of being able to advertise that they are "manufacturers to such and such an Association"? The list of such, I fear, would be hard to find.

*Re "Co-operation in Selling,"* between, I presume, Associations and their members, I would ask Mr. Mattinson to read "Bee Chat," February *Record*, p. 13. Now, how does he arrive at: "If, through a reduced subscription rate, outsiders were eliminated"? I am sorry, but I cannot for the life of me see the connection. I should have thought a sixpenny subscription would bring "outsiders," or, as I should call them, "undesirables," in. If not an undesirable, why is the outsider to be eliminated?

After being poles apart, I am glad to say your correspondent, for we are both bee-keepers, and myself come together again. I think his idea of lists of honey-sellers by districts would be useful, though, as things are, a bee-keeper has only to apply to the B.B.K.A. to be generally at once put into touch with a purchaser. Many bee-keepers have their own regular customers, who annually take all they can supply. Others, especially those who have made a name on the show-bench, can sell more than they can produce, but, on the other hand, many, no doubt, cannot find a market for themselves and need help. In Northumberland, as far as I can gather from constant enquiries, bee-keepers do not cut prices or take what they can get, if it is an unfair one. I lost one customer this year, as he was tempted by a low-priced offer from *outside* the county, but got another within five minutes. This was a case of a real "outsider," and one of the sort I would gladly eliminate from Northumbrian markets. Cutting prices is not "playing the game."

Mr. Mattinson has been very dogmatic in one direction—perhaps I have been as great a sinner in the other—but now that we have voiced extreme opinions let others strike the happy medium.—NORTHUMBRIAN BEE.

#### BEE ASSOCIATIONS AND THEIR WORK.

[8942] Mr. Mattinson's letter (8928) raises a most interesting subject, on which there ought to be plenty of discussion. I will venture to cross swords with him in a friendly way, as I don't agree the "advantages" of membership are so much "overrated," though, I allow, many Associations might make theirs more real and active for their members. Mr. Mattinson speaks largely from the point of view of his own Association, and I will write correspondingly from mine.

*Subscriptions.*—I agree 5s. is too much to expect from a cottager or agricultural

labourer. When he owns a fair number of hives, with the knowledge and assistance in marketing he will gain by being a member, it will *pay* him to be a member at 2s. 6d. My own Association accepts cottagers owning not more than three hives at 1s. per member. We lose on such members, but make it up out of the others on the principle that the strong must help the weak.

(1) *Expert Advice and Assistance with Disease.*—If the expert is chosen for real love of his work, this is a very real "advantage." Our own expert will always visit on receipt of a post card, and is continually assisting beginners, or showing where errors are being made and instructing how to get rid of disease. True, he cannot cure "Isle of Wight" disease, but he can show how to get rid of it.

(2) *Exhibiting at Reduced Entry Fees.*—When the entries come from a quarter of the members (a proportion of ten to one outsiders), and they only pay 3d. an entry instead of 6d., with opportunity of competing for silver and bronze medals, it is surely a proof that this is considered an advantage. I have seen that half entry fees *do* gain members.

(3) *Half Fees to Candidates for "Expert."*—There are few who can give the time to go in for examinations, but the advantage is there all the same for the few; further, the organisation for the examinations provided for them must be worth something.

(4) *Use of Library.*—I agree this is a doubtful point, and we do not put it forward. When a book is asked for there is generally a member ready to lend it; besides, there are few who have the leisure to read deeply who cannot afford the books. For such few the B.B.K.A. Library should easily fulfil their wants.

(5) *Use of Lantern Slides.*—This is a line which might be pushed more than it is. We are offering a loan of thirty slides of general interest to any member desiring to attempt a lecture. Secretaries might suggest to each branch secretary to hold a meeting for discussion on the slides.

(6) *Association Labels.*—Here I am directly in conflict with Mr. Mattinson's opinion that these do not introduce new customers. For instance, one of our members sold some honey in the town market; about a month later we received a letter from the buyer asking to be put into touch with the seller in order to buy more of the same quality. The seller was an agricultural man who would not have gone to the expense of printing his own labels, but ours, with the system of numbering, were just what he needed. The label is *not* merely an ornament (such as the "fancy waistcoat"), the middlemen have told us their use makes the

honey more attractive, especially to the summer visitors.

(7) *Insurance*.—I agree 9d. is too much to expect from the small man owning not more than three hives, and the proportion to the risk run is unfair. This is a matter for the B.B.K.A.

(8) "*Bee-keepers' Record*" with 5s. *Subscription*.—On the contrary, we do not find this an advantage. The bee-keeper who wants a bee paper would not join the Association for a saving of 6d., he would buy it direct, or through a newspaper shop; far more prefer a subscription of 2s. 6d., and leave to choose whether they will have a paper or not.

(9) "*Bee Journal*" at 5s. 6d.—This may be an advantage to those living far from a station or newspaper shop, but in these days nearly every village has its newspaper vendor; it is cheapest to order through him at a cost of 4s. 4d. per year.

(10) *Privilege of Attending Discussions, Conversations, &c.*—We do not make this a privilege because non-members are always welcomed, but nearly every meeting produces new members all the same.

(11) *Association Report*.—Obviously there is some bad management here, either excess of necessary matter to be printed or an unreasonable charge for printing. We had a 12-page (three-leaved) report printed for £2 10s., and the advertisements paid for three-quarters of it. They are found to be particularly valuable to members who cannot get to the meetings.

(12) *Hive to be Drawn for by Members*.—This, hardly "something for nothing," in that its cost is borne by each member in some degree in his subscription. It acts as an inducement to a good attendance at the annual meeting, and provides that little touch of amusement which enlivens a somewhat uninteresting but necessary affair of election of officers, passing of reports, &c. Finally, instead of a "lowered subscription rate," I would suggest a graduated subscription rate of 1s. for cottagers, &c., with not more than three hives, 2s. 6d. for ordinary members, and 5s. upwards for vice-presidents, &c. This is a fair combination of the "small charge per hive" system with a fair subscription for those who can afford to pay it. I disagree with the idea of including a regular paper for the subscription because many lack either the time or the inclination to read a paper, but are glad to obtain the other advantages, and help on the good work to the extent of 2s. 6d. each.

Finally, if every member expects the full return of his subscription, what is there left for the pioneer work of demonstrations at shows, country lantern slide lectures, &c.?—CAMPBELL R. PINKNEY, Whitby and N.E. Yorks. B.K.A.

#### "ISLE OF WIGHT" DISEASE.

[8943] I regret I misunderstood Mr. Campbell in imputing to him a desire to establish "spontaneous generation," and can sympathise with him in the difficulty he finds in making his meaning perfectly clear without being too lengthy. Our difference of opinion as to what is "orthodox" or "heretical" (8940) seems to result from our accepting different standards of orthodoxy. Mr. Campbell's standard is apparently the "B.B.J." Now, while I am quite willing to regard the "B.B.J." as the measure of orthodoxy in all matters relating to honey production, and the cure of well-understood complaints like foul brood, I mean no disrespect to our Editors when I say that the investigation of the new and mysterious problem of "Isle of Wight" disease is work for the scientific expert rather than the practical bee-keeper. The latter is usually a layman in scientific matters. As the "B.B.J." is concerned chiefly with the practical side of bee-keeping, I think it is therefore to the Board of Agriculture that we should rather look for our standard of orthodoxy in the matter under discussion.

I, myself, make no claim to scientific knowledge, and it is therefore quite possible I may have misrepresented the views of the Board. They certainly appear to differ from those of the "B.B.J." if only in regard to the disinfection of hives, which the Board scarcely considers necessary (see "Further Report on 'Isle of Wight' Disease," page 26).

If the disease is not so bad in certain places as formerly (and, unfortunately, no one has yet supplied us with any detailed information on this point), it does not necessarily prove that bees are becoming immune. It may simply mean the passing of certain conditions favourable to the disease. Certain human epidemics occur from time to time, at other times we hear little of them. This is surely not due to our becoming immune to them and then, after a few years, losing our immunity again! Mr. Campbell certainly has some hard hits at my third alternative. I admit his line of argument is difficult to meet.

Here let me thank Miss Betts for her able letter, which most certainly brings the discussion a stage further. She and Mr. Campbell between them make out a very good case for the theory that the disease was introduced from abroad.

The experiment to find an immune strain of bees is worth a trial. Unfortunately all our native bees that I have seen succumb so quickly that there are soon none left to experiment with.

As to importing from abroad, it will very likely take a long time, and involve considerable expense before we find the

right place to import from. Of course, I could myself buy a swarm of Dutch bees which I see advertised, or get a friend in France to send me some from there, but what guarantee should I have that they, too, would not all be dead in a few months' time?—L. ILLINGWORTH.

#### HANTS B.K.A.

[8944] I shall be glad if "G. M. E." (Southsea) (page 40) will communicate with me. As soon as we can get the present secretary of the Hants B.K.A. to call a general meeting, and to carry out his promise to resign, we hope to revive the Association, and I have agreed, at the request of several members, to take over the secretarial duties.—ARTHUR F. HARDY, The Palace House, Bishop's Waltham, Hants.

#### SPRING DWINDLING.

[8945] A week or two ago I observed a reader inquired what caused spring dwindling. It may interest your correspondent and others to learn of my experience of the same. To-day (February 8th), although the day was rather cold, with rain showers now and again, five of my stocks were working, the bees not taking short cleansing flights but going straight to and from a bank of whins in bloom, and on which I saw bees. They were coming home well spent in the high wind, and, missing the hives, alighted on the ground; there, as fast as he could pick up and devour them, was a blue tit. A mouse-trap with a bit of suet as a bait captured him, but he must have got many of the bees, as my wife told me he had been busy for days during the mild weather when the bees were out.

Do you think the bees can be short of stores to make them start working so early? They have abundance of last year's honey, and a section of candy in addition.—JAS. LOW.

[The bees were gathering pollen, which is necessary in brood-rearing.—EDS.]

#### A BRIEF REPORT FROM DURHAM.

[8946] Bees seem to have wintered very well so far. I have three stocks of hybrid Italian and Carniolans, and two of them were carrying pollen on the 3rd and 4th inst. We have a few early flowers, gorse, which is showing a lot of bloom just now, also I have seen some wallflowers, primroses, snowdrops, and a few dandelion blooming in sheltered places. We have had some very windy weather, but last week was splendid for the bees, and on three or four days they were out in quite

large numbers, taking a cleansing flight. They will also have been able to effect a re-arrangement of their stores. I hope we have had the worst of the winter now. I have been wondering why the report of the meeting and lecture held under the auspices of the Durham B.K.A. on December 6th, at Bishop Auckland, has not been reported in the "B.B.J."—H. HARMER, Gateshead.

#### NEGLECTED FRAME-HIVES.

[8947] Many persons with frame-hives do not give more attention to them than do those with skeps, as a proof of which I am sending you a frame—one of ten sent to me—with a most complicated make of hive.

You will see the frame has been eaten quite through the top bar by wax-moth grubs. I have also "taken up" frame hives with the combs built diagonally to the frames. In one instance a hive had six frames (though spaced for ten), with the vacant space filled in with a loose piece of sacking. A piece of board with no attempt at fitting was used to contract the brood-chamber, and the hive was left for ten years without attention. The piece of sacking was almost a solid mass of propolis. The bees were perfectly healthy, and thriving. Unfortunately the owner suffered terribly if stung, and has had to keep his bed for days at a time from the effect of a bee sting.

*Wiring Frames.*—Once again I ask why does any bee-keeper wire his frames in the complicated way that seems orthodox? Possibly I have experimented with wiring as much as any bee-keeper, and I consider crossed wires quite absurd! Far stronger wires are needed, such as will stand a 7lb. strain, or even more. Then one wire about 1½ in. and another about 4½ in. from top bar, threaded through, and fastened to fine brass pins. The wires must be pulled taut, so that when finished they sound like dulcimer wires. The *full* sheet of foundation should be fitted in so that the wires are on alternate sides of the sheets.

A small glue-kettle makes an ideal utensil for melting the wax for fixing in foundation, and the tips of three or four duck-wing feathers, neatly bound together with wire, make a first-class "soldering" tool. The melted wax put on with this tool makes a far more perfect attachment to both wood and foundation than by merely "running" the wax, and much less wax is used.

Then when embedding the wire I always hold the frame of foundation for a very few seconds before the fire, just long enough for the foundation to "blush," as it were. Thus it is not

necessary to keep the embedder in hot water.

The foundation should not reach the bottom bar by quite  $\frac{1}{4}$  in., and ought not to be "soldered" for about  $\frac{1}{2}$  in. at the lower edges. This allows for the sheet of foundation stretching, and prevents sagging and buckling. It always buckles if the sheet touches the lower bar.

Another absurdity (to me) is the split top bar. Since eschewing split top bars I have not been troubled with wax-moth. The saw cut is the favourite hiding-place for these pests.

A good trap for moths is an inverted cone made of perforated zinc placed in the neck of a jam-jar, previously baited with sweetened beer. The hole in the cone should be about  $\frac{1}{2}$  in. diameter; the above is a first-class trap for wasps, and blow-flies too.—A. HARRIS, Wavendon, Bucks.

## QUERIES AND REPLIES.

[8906] *Transferring Bees from Skeps to Frame Hives.*—Will you kindly advise me as to the earliest time I may drive my bees from straw skeps to frame-hives? I want to move my apiary to a place twenty miles from here, and I am in doubt whether to carry them in the skeps to the new location and then place them on top of frames of foundation in the hives when there, but it depends, I think, on the earliest time I can drive the bees from the skeps, as I must move them from where they now are without delay.—R. W. H.

REPLY.—The earliest time you can work the bees down is April. Driving should take place only when the combs are built in the frames, and they contain brood, therefore it will be best to take the skeps to the new position now.

## BEES AND BIRDS ON THE BIOSCOPE.

PATIENCE REWARDED.

After trying for three winters, Mr. J. C. Bee Mason has succeeded in obtaining cinematograph pictures of a tom-tit in the act of snatching a bee from the entrance to a hive, killing the bee and removing its sting.

Mr. Mason was fortunate enough to secure this picture after lying in hiding for thirty-seven hours during the spell of cold weather we experienced last month.

The film will shortly be shown to the public in a series of pictures entitled, "Bees and their Enemies." Among the latter pictured are mice, the chaffinch, toad, and spider.

## WEATHER REPORT.

WESTBOURNE, SUSSEX.

January, 1914.

Rainfall, '68 in.	Minimum on grass, 11 on 12th.
Below average, 1'95 in.	Frosty nights, 19.
Heaviest fall, '15 on 29th.	Mean maximum, 41'6.
Rain fell on 12 days.	Mean minimum, 32'3.
Sunshine, 43'5 hrs.	Mean temperature, 36'9.
Below aver., 21'7 hrs.	Below average, '9.
Brightest day, 6th, 4'8 hrs.	Maximum barometer, 30'576 on 1st.
Sunless days, 14.	Minimum barometer, 29'668 on 6th.
Maximum temperature, 52 on 9th.	
Minimum temperature, 20 on 24th.	

L. B. BIRKETT.

## Notices to Correspondents

A correspondent who is giving up bee-keeping writes us that he has "two or three hives in decent condition" that he would be willing to give away to any worthy person interested in bees, but not able to afford hives to start. Should any reader care to apply to him through the Editors, please write us.

W. P. B. (Harrogate).—*Using Naphthaline.*—(1) The sample of naphthaline sent is quite fit to use in your hives. (2) We cannot say. No doubt Messrs. Lee and Son could supply them.

A. C. (Greenock).—*Swarm-catchers.*—There was evidently some fault, either in the construction of the swarm-catcher or fitting it to the hive, which caused the swarm to go back to the stock hive.

A. Z. (Barnsley).—*Dutch Bee-keepers.*—Mr. J. C. Bee Mason, 22, Hanlon Street, Oxford Street, London, will give you the information you desire if you send a stamped envelope for reply.

C. W. (Launceston).—*Honey Sample.*—The honey is an excellent sample, worth 10s. per dozen jars, or 60s. per cwt. in bulk. We much appreciate your kind expressions with regard to the JOURNAL.

C. N. A. P. (Preston).—*Re-starting Bee-keeping.*—It is not necessary to wait for twelve months before starting again, if you can stand the hives in another part of the garden, and not on the old ground.

G. H. A. (Glos.).—*Dealing with Infected Apiary.*—If you put lime over the ground where hive stood, and dig the ground over, you can keep bees again.

(2) The plant mentioned is grown in California, and we regret we cannot say where seeds are to be had.

JOHN JONES (Cowbridge).—*Adulteration of Honey.—Curing Poul Brood.*—(1) Most of the adulteration is done with glucose or sugar, either of which is now easily detected by chemical analysis. Even if bees are fed on sugar syrup this can be certainly determined. The principal works that treat on adulteration of honey and its detection are: "Die Chemie des Honigs," by Oscar Haenle, published in Strasburg, at the Polytechnic Institute; "Les Falsifications des Miels et de la Cire," by Alin Caillas, published by the Société des Agriculteurs de France, 8 rue d'Athènes, Paris. (2) You cannot tell the exact time when every spore will turn into a bacillus, if you could do so the cure would be easy. This is why it is recommended to have an antiseptic always present. If you will carefully read the chapter on diseases in the "Guide Book" (21st edition), especially pages 176-180, you will be able better to appreciate the difficulty of the subject.

PUZZLED (N. Devon).—*Colour of Excreta of Diseased Bees.*—The colour of the excreta is determined by the colour of the pollen consumed, and this can frequently be found in an undigested or partially digested state if examined with a microscope.

TOM (Colchester).—*Packing Bees for Travelling.*—Keep the boxes in the same position they are now in, securing them firmly to the floor-board. Tack a piece of perforated zinc over the entrance and at this time of year they will travel safely.

CORNWALL.—*Bees Soiling Clothes.*—We regret we do not know of any remedy.

J. D. (Swanwick).—*Getting Honey from Combs Without Extracting.*—First cut out all the dead brood; then put the combs containing the honey into an earthenware or tin vessel. Stand this vessel in water, which is heated until the honey and wax are melted, then allow it to stand until cold. The wax can then be lifted off the honey and the latter well strained through muslin to get rid of any impurities.

REV. J. SALTER.—*Making Soft Candy.*

The recipe in 19th edition of "Guide Book," to which you refer is correct for making soft candy, and the proportions are those used by confectioners in making fondant sugars. The recipe in 14th edition made a hard candy which is not so good for bees, and in making frequently the whole of the sugar was not dissolved and remained in a crystalline form useless to the bees. The quantity of water is immaterial, as the syrup has

to be boiled until the temperature reaches 235deg., when the sugar is sufficiently boiled. In the 21st edition and the previous one Br. Columban's formula is given with the addition of one teaspoonful of cream of tartar for the purpose of cutting the grain. We have made large quantities of soft candy from this recipe, and have never experienced the difficulty you mention. Try boiling your syrup longer until it reaches the temperature indicated.

*Suspected Disease.*

T. N. (Dorchester).—The bees have died of "Isle of Wight" disease. The only precaution you can take is to burn all the loose parts of the infected hives, and thoroughly disinfect the latter by scorching with a painter's spirit-lamp.

H. M. R. (Congleton, W. B. (Croydon), W. D. G. (Briton Ferry), and READER (Holmwood).—The bees have died from "Isle of Wight" disease.

"A." (Mallendale).—The bees have died from starvation.

WESTMERIAM.—(1) The bees were much too dry for us to tell you cause of death. (2) The Secretary of the Cumberland B.K.A. will be able to tell you about the district you refer to. His address is G. W. Avery, Ivy Cottage, Wetheral, Carlisle.

W. H. (Dorset).—The bees have died from "Isle of Wight" disease. Yes, the honey is fit to use for human consumption, but must not be given to other bees.

RETLAW (Northumberland).—The bees have died from "Isle of Wight" disease. Sprinkle petrol over the grass and set it alight. You will find instructions for killing bees in "B.B.J.," for August 14th, 1913 (page 321). It will be best to start on fresh ground.

M. A. (Sussex).—The bees have died through "Isle of Wight" disease. We sympathise with you in your loss, especially under the circumstances you mention. You must burn everything inside the hives themselves, then disinfect these by scorching with a painter's spirit lamp.

F. T. (Eastbourne).—Both lots of bees are affected with "Isle of Wight" disease. There would be no harm in doing as you suggest.

G. R. C. M. (Llandaff).—(1) Yes. (2) All internal fittings of hive should be destroyed. (3) You can use the honey for household consumption. (4) You must be mistaken. Queens do not fly in November.

NOVICE (Skipton).—(1) The bees show every sign of "Isle of Wight" disease. (2) The secretary of the Yorks B.K.A. is Mr. W. E. Richardson, Whitkirk, near Leeds.





## GLAMORGAN B.K.A.

The annual general meeting of the above Association was held at Neath on February 14th, Mr. W. J. Percy Player, J.P., presiding.

The Secretary read the minutes of last meeting, which were duly passed.

The Chairman then moved the adoption of the annual report for 1913, and said the County Council had decided to increase their grant to £70 on condition that the Association added £20 out of the subscriptions to pay the fees of the local experts. Referring to bee diseases, he pointed out that there was a danger of the experts carrying diseases from infected hives. Mr. F. Gravil seconded, and the report was adopted.

The Earl of Plymouth was re-elected President, and the officers, Messrs. F. Gravil (Chairman), John Jenkins (Auditor) and W. J. Wiltshire (Secretary) were also re-elected.

Messrs. W. O. Jones and F. Gravil were appointed representatives on B.B.K.A. Council.

Mr. D. Davies, B.A., was elected to represent the Association on the Glamorgan Chamber of Agriculture.

A resolution urging the Government to re-introduce a Bee Diseases Bill similar to last year was unanimously agreed to, and ordered to be forwarded to Mr. Runciman.

The Chairman afterwards entertained the members at tea.—W. J. WILTSHIRE, Hon. Sec.

## THE NORTHUMBERLAND B.K.A.

The first annual meeting of the above was held at Morpeth on the 7th February. It was a thoroughly representative gathering, so that information from all quarters of the county was forthcoming.

That the Cheviot and Tweed Borders B.K.A. taking over the whole of Northumberland, and forming a County Association, was a popular move amongst members of the craft was evinced by the large increase in membership, it having risen from ninety-one in July last to 310 at date.

It is much to be regretted that the County Council do not assist the Association more generously, considering the educational value of the work done, but perhaps they will do so when they begin to recognise that it is a matter of county and not merely local interest. The questions of touring experts, shows, and judging were

all discussed and arrangements made, while a strong resolution urging the necessity for an Act to deal with bee diseases was carried unanimously.—*Communicated.*

## HONEY IMPORTS.

The value of honey imported into the United Kingdom during the month of January, 1914, was £1,209.—From a return furnished to the BRITISH BEE JOURNAL, by the Statistical Office, H. M. Customs.



## EARLY BROOD REARING.

The autumn of 1913 was so very fine, almost right to the close of the year, that many colonies kept on breeding without any break. This is a good thing, inasmuch as it provided these hives with a large percentage of young bees. I am not so certain, however, that it will be an unmixed blessing, in two ways. Bees bred out of season are soft, and I reason that they may be subject to various aches and pains harder bees will not experience. If so, they will not be either so energetic or long-lived in spring. Again, their "manufacture" must have cost the colony dear, for they were not made out of nothing. The winter stores were indeed rather depleted by the heavy drain on the sealed honey required in their uprearing and maintenance. If stores run down in March or April their very numbers may prove their undoing. Though not a great advocate of candy feeding in spring, this is the only food which it is permissible to use for some time. A three, four, or five pound cake of well-made candy, slipped below quilts, and carefully tucked in, may save a stock, and carry on internal progress for some weeks, at a critical period, until syrup can be fed or nectar can be obtained from the earliest sources.

*Spring Feeding.*—At times a necessity, this is in general very much overdone. Given a hive pretty well provided, stimulative feeding works evil and not good. This is where many err. As the season progresses, more and more space is required for the labours of the queen, and to feed in a way which blocks her efforts is not only a vain and foolish thing to do, but a profitless, yea a profit killing deed. The natural advance in providing young bees for the approaching season's labour is checked, with the consequence that when the flow comes the bees are not there to

profit by the mass of bloom everywhere temptingly displayed. Spring feeding, indeed, should never be carried out but under dire necessity, when stores have somehow run down and the very existence of the colony is at stake. It is not to be understood that I condemn stimulative feeding. If we were always sure of good weather, mild days wherein workers could take daily flights to carry in pollen and water in large quantities, I would highly approve of the practice, knowing, under favourable circumstances, what a boon it may prove. Remembering, however, that April weather is a mixture of smiles and tears, with the latter largely predominating, I must record that personally it proved, in perhaps nine cases out of ten, a loss rather than a gain. The additional breeding was more than counterbalanced by the loss of bees untimely called abroad to forage out of season.

*Precision in Bee Terms.*—I am always pleased to be checked when (and if) I use any vague, inappropriate or erroneous technical terms in writing. We all hear a number of strange words from non-keepers, and at times from the lips of members of our craft, which grate on our nerves. Thus a well-educated gentleman, who loves the bees, invariably calls a colony of bees a swarm, and I have heard him actually designate a swarm a *hive*. I read a leading bee-book lately where on two pages the poor worker bees were called *fellows* a dozen times over. I read a monthly bee-paper wherein these undeveloped female Amazons, or vestal virgins, are subjected to the indignity of having the male personal pronoun "he" frequently applied to them. So strong is custom and heredity that a frame hive is often designated a *skep*. I could multiply examples, but let these suffice.

Mr. Crawshaw would fain take me to task on page 39 of the "B.B.J." over the use of "brace" and "burr" combs, when, innocent that I am, I cannot cry *peccavi* like our mutual friend, to whom at times he proves so hard a task-master. The manuscript, written for page 24, contained the words "brace or burr combs," proving that I recognise a distinction and a difference between the terms. The printer, I note, turned these into *trace of burr combs*; but, alas, I can't blame him, because I feel the fault lay in my calligraphy. Brace combs are built to *brace* or strengthen some constructive work, and there seems always to be a reason for their presence wherever found. Burr combs are generally found in such a variety of shapes, and in such unaccountable positions, that one wonders why so wise a creature as the bee wastes time, material, and labour on their apparently useless construction. (I will

deal with *thick syrup* next week.) While on this subject of terms, I may give a few more points. In a recently published pamphlet the word "Index" is used as a synonym for Preface. The illustrations are described as "actual photographs." We are told of the "physiological moment" when nectar yields best, of "carbolic acid damped on a cloth," &c.

Reverting again to Americanisms, I may mention that one author calls the worker bee a "little *fellow*," and on another page a "rascal." His roof is a "lid," his flightboard an "apron," and he speaks of the "Porter" "escaping bees." The word "rascal" in the mouth, or rather from the pen of Mr. Root, appears to be meant as a term of endearment! I rather like several of the colloquial expressions more commonly found in the "Review" than anywhere else; they are so expressive, even when they are not found in the dictionary. All the foregoing are not meant as criticisms—"to err is human." I remember once the late "W. B. C." rejoicing over a communication sent him, written by the horny hand of toil, full of minor inaccuracies, but replete with sound, good sense. Our present editors, I doubt not, will equally welcome all such—if there's *grit* in them.

---

#### OBSERVATIONS ON HIVES.

By L. E. Snelgrove.

(Continued from page 42.)

The wood commonly used and best adapted for hives is that of the Northern Pine (*Pinus sylvestris*), known as Red Deal. Its resinous character makes it very durable both in wet and dry positions. It is strong, easily worked, and permits of good finish. When well seasoned it does not twist or warp much. On account of its cheapness and durability it is much more used for general purposes in this country than any other wood. The best Red Deal comes from the Southern Baltic ports. That obtained from the Scotch fir and from Scandinavia is inferior.

Another excellent wood, the American Yellow Pine, is sometimes used in the construction of hives where a high degree of finish is desired. It is soft and light, and on account of its straight grain is easily worked and unlikely to warp. Being obtained from huge trees, large boards may be obtained free from knots. It is, however, comparatively non-resinous, and therefore not so durable in damp positions as Red Deal. Although it takes glue well it is not tenacious of nails—an important point for the hive-maker to consider. On the whole, it is inferior to Red Deal for hive construction, and it is also more expensive.

White Deal, the wood of the Spruce Fir,

is sometimes used for hives. It is cheap, light, and strong, closely grained and therefore elastic. It is nearly non-resinous, and holds well to glue but not to nails. Owing to its woolly sap-wood and hard knots it is very difficult to smooth. The American variety is usually full of knots, and therefore liable to twist and warp. White Deal decays with comparative rapidity in wet situations, and therefore, while good enough for packing-cases, it is quite unsuitable for bee-hives.

Speaking of packing-cases reminds me that the wood obtained from them is frequently recommended for home-made hives. The use of such wood, however, usually entails waste (as many unsound pieces have to be rejected), the inclusion of boards of unsuitable width and thickness, extra and unpleasant labour, and at the best hives which are of inferior material and displeasing to the eye. It is usually no dearer to buy new wood for hive-making, but the novice should always begin by purchasing a good standard hive from a maker.

For the man who makes his own hives the best plan is to purchase wood direct from the saw mills. For very little extra cost he can have it machine-planed and sawn into lengths to suit his requirements. All wood used for hives should be planed on both sides. If the boards are not smooth on the inside they are not only unsightly but difficult to clean.

The thickness of the wood requires some consideration. Extremes of heat and cold cause cessation of work in the hive, the former by driving the bees outside to cool themselves, and the latter by reducing them to inanimation. Thick hive sides cannot prevent these effects in long periods of great heat or cold, but they can greatly retard them. When variations of weather are not prolonged, however, thick walls conduce to an equable temperature within a hive. While it is necessary then to guard against the effects of sudden frosts, especially when the brood nest is expanding, and sometimes when the bees have entered the first section-rack, yet many people of experience prefer that the hive walls be not so thick as to prevent the beneficent warmth of the spring sun from quickly reaching the interior of the hive. This warmth assists the bees when they move the cluster, and stimulates them to an early and natural activity. Many of the cheaper hives are made of  $\frac{1}{2}$  in. wood planed to  $\frac{3}{8}$  in. I have seen some of even thinner material. They have the advantage of being light to handle, but, on the other hand, they afford too little protection to the bees, they cannot be well jointed, and the sun soon warps and cracks them.  $\frac{3}{4}$  in. wood, planed to  $\frac{5}{8}$  in. is very

suitable, but hives made of it are somewhat heavy. Those of thicker wood are of course very heavy and unnecessarily expensive.

The ideal thickness is  $\frac{1}{2}$  in. prepared on both sides. This is the minimum consistent with strength, weathering qualities, and suitable conditions of temperature, whether for single-walled or "W.B.C." hives.

Hives made of straw and wood combined are picturesque, and may be well ventilated, but they have no other advantages, and do not wear so well as those made of wood only.

(To be continued.)

## BLURTS FROM A SCRATCHY PEN.

CONTINENTAL WANDERINGS.

(Continued from page 44.)

"Rucher Ecole," you will notice, is the advertisement the signboard gives, underneath of which we stood in our last adventure. That is the "Hive School," which is to Paris and France what our Apiary at the Zoo is to London and England—a school where minds infant in matters apicultural may be trained. My first thought was to draw some comparison between the two institutions, but some wiseacre forefather has declared that "comparisons are odious." Well, yes, they are if they reveal to us some ugly little habit or frequent failing that we knew not, or were wilfully blind to. Yet comparisons are the grading of our actions; they put the value on them and say if they are equal to our competitors. But in this case it is obvious that no such setting of the one against the other is possible. We are but as of yesterday. The *Rucher Ecole* was established in 1886 by Monsieur Hamet, former editor of the journal which is akin to ours, *l'Apiculture*, helped and aided by General the Marquis of Nantpoul, on ground given for the purpose. So they should have the experience and wisdom of age, which no doubt they have: Yet, methinks, taking this school as a standard, English bee-keeping is well to the front, both as to scientific knowledge and the means and system of inculcating that knowledge.

Paris lacks not for breathing spaces—lungs to purify the city's atmosphere. Even from the very centre of that city, commences the Jardin des Tuilleries, which, with the Champs Elysées and the Bois de Boulogne, forms a course following somewhat the windings of the river along which the air from distant fields may enter. And what the Jardin des Tuilleries is to Paris of the right side, so is the Jardin de Luxembourg to the left. Parisians live in the open air in summer time, and they rejoice and revel

in the possession of these playgrounds, but if there is one spot beloved by *maman et les enfants*, and haunted by the *bonne*, it is the Luxembourg. To have established an apiary there one would have thought meant to court trouble, but M. Sevalle assures us they have had no complaints. Let me repeat his own words, they are refreshing in their naïveté: "Our dear bees," he says, "do not object to the society of human beings; on the contrary, they are even quieter than elsewhere. They are so tame that we never use a veil for our manipulations, whatever they may be." Some time since I raised the discussion as to whether the neighbourhood of polite society softened the temper of bees. Here would appear to be confirmatory evidence. And this experience

us. One, of which he was vastly and truly proud, was a manuscript treatise on bee-keeping in four volumes, with marvelously exact pen-and-ink reproductions of plates, a copy of an older treatise which bore the date MDCXC. A visit to an appliance manufacturer, and further "bee chat," interested us, and we learnt that France is not agreed as to a standard frame. In one part they use our size, but in the South and West, where the forage is abundant, they prefer a larger one—say, about 15in. square. But as we moved about we found each country using a size adaptable to its needs. In Italy there were even larger frames.

In the Faubourg St. Antoine an *épicerie* had displayed a very good show. He had honey in the bottle, in the section,



A PARISIAN HONEY MERCHANT.

agrees with reports from our own Zoological Apiary. We have yet to learn the name of the first person who has been stung.

But to return to the Luxembourg. Here, too, they hold classes and instruct pupils. M. Sevalle tells us that they have an average of fourteen new pupils each year. "Who," to quote him again, "not only acquire useful knowledge about bees, but subsequently spread the knowledge over France."

It would, indeed, have been a discourtesy to have visited Paris and not to have paid our visit to *l'Apiculture*, and you will know without my telling that our reception was cordial. We spent a pleasant half-hour in bee chat with Monsieur d'Autemarche, in the absence of M. Sevalle, who, unfortunately for us, was away in the provinces. It was sufficient that we bore Mr. Cowan's introduction to make him open his treasures to

and even in skeps, or rather half-skeps or caps, as we should call them, these half the capacity of the real article had been worked out, and as an attraction turned so that the public could see. The proprietor willingly permitted us to "snap" his window, and here behold it. The half-skeps are much in evidence in the centre. We discovered another *marchand de miel*. He was vending it in treacle-tapped barrels, "Honey drawn from the wood." You will see we "snapped" him and his dog.

"Les Halles" is not a place every tourist visits when in Paris. It is reserved to the *habitué*. It is, say, Billingsgate, Smithfield and Covent Garden united. As we learnt to our sorrow, you may discover there, too, much of the mysteries of French cuisine. "Les dames" are well known for their volubility, and it is said in times of war for their proficiency with torch and petro-

leum can. Of their number they elect one annually for her beauty. Her title is Queen of Les Halles, and on her coronation day she has audience with the President, who salutes her with a kiss on both cheeks. Fortunate President! Well, in our wandering about "Les Halles" we espied transfixed on skewers certain glutinous objects, semi-transparent, flat as to mouth, with legs long, sinewy and tipped as with fingers. Has the "frog-eating Frenchman" then survived the Nelsonic era? We thought not, but here was unmistakable evidence that he still existed. Sadly we sought our hotel and prayed our hostess, by all the love she bore us for our patronage, to be true to us, and not permit that *we* should incur such an

## CORRESPONDENCE

*The Editors do not hold themselves responsible for the opinions expressed by correspondents. No notice will be taken of anonymous communications, and correspondents are requested to write on one side of the paper only and give their real names and addresses, not necessarily for publication, but as a guarantee of good faith. Illustrations should be drawn on separate pieces of paper. We do not undertake to return rejected communications.*

### " ISLE OF WIGHT " DISEASE.

[8948] I have been preaching heresy in connection with "Isle of Wight" disease so long that I cannot but feel some

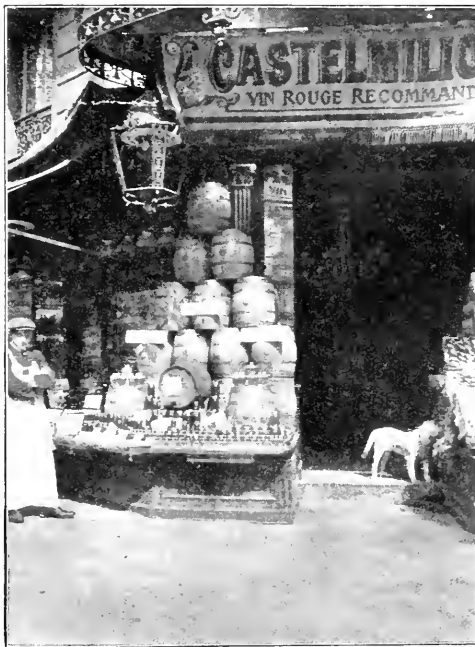

SELLING HONEY FROM BARRELS.

epithet. A faint and ghastly smile stole over her countenance. "*Messieurs que voulez-vous? Last night's dinner?*" We heard no more. Enough! Horror-stricken, we fled. Now we know better than ask questions as to our dinner—but it was very nice.—JNO. SMALLWOOD.

(To be continued.)

### BEE PICTURES AT HYDE.

Mr. J. C. Bee Mason will appear twice nightly at the Theatre Royal, Hyde, for one week, commencing March 2nd, when he will deliver a brief lecture and show his latest film, "The Bee Master."

satisfaction at finding such powerful adherents as have come to the front in the current issue of the "B.B.J.," and since the time seems ripe for a gathering together of forces in order to drive home what I have always believed to be the sound common sense view of the matter, not only to the minds of the rank and file, but also to the "official mind" mentioned by Mr. Campbell, I may perhaps briefly recapitulate the arguments I have used against burning as a remedy.

In Vol. XL., p. 374, I made it plain that infection is so frequently far advanced in the whole apiary before it is recognisable in any one stock that to destroy that stock alone would be useless.

On p. 15 of last year's volume I drew attention to the undoubted cases where temporary "cures" had been effected, and colonies which would have been doomed under the official system had given a good surplus. Since then I have over and over again had convincing evidence that it is possible to temporarily cure every stock suffering in the spring, providing the queen is good enough to build up the colony with reasonable rapidity. And all that is necessary is to remove the old stores.

On p. 165 I invited an advocate of burning to say where bees are to come from when all are burned, which would be the logical outcome of burning, having in view the already undisputed facts of the case. I never received a reply. On p. 354 I invited the advocates of the destruction theory to record their results. None to hand so far.

The whole truth of the matter is, burning nowadays is locking the door after the steed is stolen. Had every colony in the Isle of Wight been destroyed the moment the first case occurred the trouble could have been ended that way. But one could hardly have imagined at the time what the strange symptoms portended. Once it reached the mainland, burning became a useless proceeding.

Miss Betts's suggestion (page 56) as to the non-importation of other than immune bees is good—if only it were reasonably possible to be sure of their immunity; and to follow Mendelian methods is the proper course, if immunity proves to be a character of some yet-to-be-discovered race amenable to the Mendelian law. One must always bear in mind that only certain characters appear to conform to this law. Since there is a rust-proof strain of wheat which proved to follow the law, it is reasonable to hope that it may be the same with bees.

There is a hint in Miss Betts's letter which holds what may yet prove to be the true solution of the difficulty. From what district did the imported stocks come? Surely if we can discover that we may discover the place where we are to get immune bees.—HERBERT MACE.

#### BEE ASSOCIATIONS AND THEIR WORK.

[8949] As my letter has been represented as an attack on the Norfolk B.K.A., I write to re-affirm that such is not the case, and I thought I had already made this sufficiently clear. My criticism was intended impartially for all Associations whose "advantages" do not exceed those I mentioned. The only serious comment on local matters concerns the cost of the "Annual Report," regarding which my

views were already known to the Hon. Secretary and the Committee; and here I did not reserve my strictures for them. Nothing that I have so far read makes me think that our Association needs commiseration or condolence from any other. We have a very live secretary, who does not require to be "pinched." He is a born organiser, and works wonders with the materials at his disposal.

As showing that there is no personal animus, I may add that early in the year I told him of my sorry sermon on the "Advantages of Joining a Bee Association," and of my intention to write to the JOURNAL, if I could work myself up to it. Having unburdened my soul, I gave him a précis of my letter, and on both occasions I asked him to understand that my remarks were quite impersonal, and trusted that he would not join the band out for my scalp. My comments were made in good faith, and if they have caused irritation in any quarter I express sincere regret.

I am pleased that the consequent discussion is lively, and hope it will so continue. With the Editors' permission I hope to come in at the finish.—W. E. MATTINSON.

[8950] Will you kindly allow me space for a few comments on the remarkable effusion from the pen of Rev. W. Mattinson under the above heading? "I write with no ill-will, rather the reverse," he says, and then proceeds deliberately to pen a bitter attack on Associations. "Save me from my friends, particularly parsons," is likely to have been the comment of the Hon. Secretary of Norfolk B.K.A.! I have never come across, either in English or foreign bee literature, anything more alien to the cheery and kindly spirit of the genuine bee-keeper. He speaks of "continuous membership in one or other of two County Associations." It would seem as though he had made one of them too hot to hold him, nor am I surprised, if the attitude now taken up by him has been his normal one. A man holding such views would be blackballed by most Bee-keepers' Associations, and deservedly so. Unlike Balaam, he appears to have been invited to bless, yet had not sufficiently the courage of his convictions to speak out, but must needs do his cursing by the pen. He is not even logical, but continually begs the question, and makes several statements without the shadow of a foundation. I have not the patience to deal with his points seriatim, but the fallacy of each single one is obvious enough. At least let me refer to No. 13, in which he sneers at the unselfish spirit of the bee-keeper. Well, this comes

ill from a parson, though I am bound to say that it harmonises with my own experience of some of the clergy as members of Associations, however brilliant the exceptions may be. I am aware that the Editors do not hold themselves responsible for the opinions of contributors, but is it not rather rough on Hon. Secretaries of Associations to publish an article like this? I cannot imagine anything more calculated to prejudice people against Associations, especially cottagers, many of whom read the "Journal," and might attach some weight to the opinions of a parson. Hon. Secretaries have a difficult enough task as it is to maintain their membership, and I, for one, resent deeply a malicious attack on our work, a thankless task for the most part, an attack which plays into the hands of malcontents and slackers, of whom there are enough and to spare among the bee-keepers of every county. It is a matter which concerns the B.B.K.A. itself equally with the daughter Associations, and as a member I venture to hope that the Secretary will support me. Silence may be "golden" enough, as a rule, but there are occasions when opponents at any rate hold that "gives consent."—F. H. FOWLER, Hon. Secretary, Gloucestershire B.K.A., Barnwood Vicarage.

#### DOES IT PAY GARDENERS TO KEEP BEES?

[8951] I send a cutting from the *Daily Sketch* which may interest your readers:—"A striking evidence of the remarkably mild weather is the very advanced state of the bees. The bee expert of Chivers and Sons, the fruit growers, of Histon, Cambridge, who are the largest bee-farmers in the country, reports that the advanced state of the brood clearly indicates that the bees were laying so far back as December, an astonishingly early date, seeing that in the average winter they do not begin until the end of January.

"This early breeding is welcomed by fruit-growers, as it will greatly strengthen the hives, and enable the bees to begin working on the very earliest blossoms."

The interesting inference to be drawn from it is that it appears to be an unassailable point to put before market gardeners, and all who have gardens either for a living or hobby, as the case may be. Even if Messrs. Chivers are or are not the biggest bee-keepers in England, we do know they are one of the leading firms of jam-makers (who grow their own fruit), and if it pays them it will in proportion pay others to keep bees.—JOHN LAMBERT, Pool, near Leeds.

#### BEES DO PAY.

[8952] Having seen a letter in your paper on "Do Bees Pay?" I thought my experience in bee-keeping would be interesting to some of your readers. I started with three driven lots in August, 1912, without any knowledge of bees whatever. These I fed up with 36lbs. of sugar. In the spring, 1913, I fed them again. On the 7th May a swarm came off which I sold for £1. During the honey flow I took 160 sections, of which I sold £2 10s. worth, and kept the remainder for my own use. I have recently sold the wax for 2s. 6d., this bringing the total sum to £3 12s. 6d. In August, 1913, I purchased six more driven lots for 3s., which I united, forming two stocks, and fed them up for the winter. They now give every promise of making excellent stocks this spring, one lot having two frames full of sealed brood, the other one frame. Would you kindly tell me if this is a fair year's work for a novice? My friends say it is excellent. Wishing you and your paper every success.—A NOVICE, Frome.

[A good beginning, but you should have made more out of your sections if good ones.—Eds.]

#### BEE-NOTES FROM DERBYSHIRE.

##### A WORD OF WARNING.

[8953] February 3rd was really a beautiful day. The bees were flying freely about noon, and I took the opportunity of the warm weather to take just a peep under the quilts of each stock. I may say that all my stocks were well fed up for the winter before the beginning of October, some with syrup and some with natural stores—heather honey chiefly. What I found upon this first peep of the year induces me to pen these few lines, hoping they will be of benefit to fellow bee-keepers. I was really not very much surprised to find that most of my stocks were getting perilously near the top bar. The winter here has been so mild that there has been little inducement to the bees to cluster together. Every now and again they have been able to take flight, and the result of such open weather has been a greater consumption of winter stores than usual. In my case, although my bees were not yet short of stores, I have judged it the wisest course to give each stock a cake of candy in order to be on the safe side. I am of opinion that during the next few weeks many stocks will die through starvation unless fed, and I would sound a note of warning. Do not be too sure that because your bees were well fed up for the winter they are safe now, but make assurance doubly sure by giving them at once that cake of

candy. The winter has not been normal, having been too mild, and mild winters mean lost stocks.—D. Wilson.

#### EARLY FORAGERS.

[8954] As I have not seen any report in the "B.B.J." of the bees making a start, I thought you would like to know that mine were busy carrying pollen on February 4th and 5th; both days were sunny, and the temperature on the 5th was 61deg. Fahr. in the sun. It was very interesting indeed to watch them carrying in the first pollen, but it would be more interesting to know where they got it from. The aconite would be flowering before this, but I doubt whether many are grown about here, and the crocus shows no sign of flowering yet; at least, mine do not, and they were planted in October and have been through the ground for weeks. These bees were carrying pollen on November 5th, and drones flying from one hive (see "B.B.J." Nov. 13, 1913, page 456), so they have had a very short winter, but, alas! it is now windy, cold, and raining, and no bees are to be seen.—W. P. L. Baldock, Herts.



*Apiary Accounts* (p. 37).—As Mr. Smallwood takes his seat so squarely upon the stool of repentance, he may consider himself fully forgiven for his metaphorical references to the Dons Quixote who ride full tilt into mares' nests. It would, however, be well to restate the accounts accurately for the benefit of those bee-keepers who desire a model. But there is one aspect of such accounts to which I should like to draw attention, and this is the regarding of a credit balance as profit. Profit it may be, but gross profit. The true view of it is expressed by Mr. Carver (p. 48), where he states it as a return for work done. This is as it should be, since labour is a first charge upon such profit, and, to my mind, any question of the occupation being profitable should consider the time employed in the occupation. A practical consideration of this might easily lead to the adoption of better methods and shorter cuts. Or it might be found that the time could be more profitably employed in some other avocation. I am speaking commercially, of course, but accounts are essentially commercial things. It is true that there is pleasure in the work, but so should there be in every occupation, certainly in an occupation of

one's choice. Happy indeed is the man whose work is his hobby. However pleasurable the work, the pleasure is usually gilded by some addition to income. And just so soon as this occurs, the bee-keeper is no longer an amateur, pure and simple, but a professional. He should therefore ask himself: "Am I keeping more stocks than I need to gratify my love of bees, or, on the other hand, am I justified by the return for my labour in keeping a few more?"

"*Isle of Wight*" Disease (p. 37).—Mr. Campbell's interesting letter is, I think, in harmony with modern beliefs on the general subject of disease. At the same time he appears to undervalue preventive and curative methods, which have in analogous epidemics justified themselves. There is a natural tendency to immunity, and our disregard of this may lead, may have led, to increased susceptibility. At the time of the "Isle of Wight" outbreak I urged that surviving stock should be devoted to increase. But, alas! there appear to have been no survivors, and, much as one would wish to believe the contrary, it seems as if our race of bees cannot face this destroyer. Let us hope this will be disproved. Mr. Illingworth seems unduly disturbed by Mr. Campbell's theorising, and is, indeed, confronted by existing belief in the immunity of certain races to foul brood, and the claim for at least one race as immune to "Isle of Wight" disease. Without pretending to adjudicate upon such claims, I would point out that there is at least available the assertion which he demands. With reference, however, to his penultimate paragraph (p. 49), I suggest that the crudest examination of the abdominal contents of a bee suffering from "Isle of Wight" disease will convince him that there is a tremendous distinction between the disease and "spring dwindling," or even ordinary constipation. In an advanced state the structures will be found unspeakably ruined.

*Huber's Hive* (p. 43).—Is there no doubt as to the authenticity of the hive attributed by the Rucher Ecole to the blind master? It is not quite like the old leaf hive which I remember in the bee museum at Zug, which I was assured was the veritable hive of history. Was there more than one hive, or is this a copy? For all I know, Huber's hives may be as plentiful as pieces of the true Cross.

*Bee Associations* (pp. 35, 45).—Mr. Mattinson would put these institutions into the melting-pot of criticism, and why not? Are they true metal, and are they justifying their existence? Do they cover the ground? Is the membership maintained, and are the members satisfied? Very pertinent questions these. Let the Associations arise and answer fairly.



They should be capable of doing so. They have existed long enough to know. Whether Mr. Mattinson's plea for the extinction of the weaker bee-keeper is sound or not; whether the Associations should devote their attention to the capable; whether the travelling experts and lecturers do good and needed work; whether Mr. Mattinson takes too commercial a view of the question; here at least are the makings of a pretty discussion, and we may hope that Mr. Mattinson's proposals will be fully criticised by those who have real practical experience of Association work. The secretaries start at least with the advantages of optimism on their side. Is there anything to be said on the other?

*A Word for the Italian Bee* (p. 47).—It is very easy to deceive oneself when comparing races. At least, special and careful observation is essential to the arriving at just conclusions. As a queen-breeder I have obliged myself to take such note, and one vital point is the age of the queen. Thus, stocks of the same strain may give very different results owing to a variance in this factor. In the Italian strain, which I once possessed, I found the queens were shorter lived than those of my English bees, which were superseded at longer intervals. Now, if one may suppose a variety having the habit of supersedure, its colonies would usually start the year with the advantage of young queens. But whether such automatic advantage outweighed other disadvantage would be a matter for the bee-keeper to decide. There is no doubt that the Italian bee does not excel as a "comb-honey" bee, but the owner might do well to turn his attention to extracted honey. On the other hand, if he will re-queen his stocks methodically he may go a long way before finding a better bee for all-round work than the common English bee.



[8907] *A Novice's Queries*.—I should be greatly obliged if you would give me information on following points:—(1) Is it necessary for queen-excluder to completely cover brood-frames? When my shallow-frame super is on it is possible for the queen to get up into it past the edges of excluder. (2) In this district we do well if we get two supers full of honey. As a rule, when the first is nearly full and one puts it upon another super, the bees store a little honey in every comb, making a lot of extracting. Could I work with one shallow-frame super, lifting full combs out and replacing with empty ones? Also

working empty ones to middle before lifting any out at all. How often is it permissible to examine shallow-frame supers? I may say I can sell my honey immediately, so there is no fear of it fermenting if I extract it while uncapped. I know I could have a larger yield if I extracted whilst unsealed. Our season is so varied that one might have a super full one day and empty next (approx.) Please tell me what to do, as the last two seasons I have lost my harvest through waiting for honey to be capped previous to extracting. (3) In uniting, does it matter about removing a queen if they are both of same importance? I have been told bees will settle it themselves. (4) In uniting a swarm to a stock has one to flour both stocks? I want honey, as I have as many stocks as I can find time to give proper attention to. Suppose I have a swarm, I would look through my supers, and if one was empty I might infer the swarm came from that hive. Should I lift supers off, flour bees, and throw the swarm in at entrance? What about the queen-cells? (5) Will you give me a method of re-queening without the trouble of killing the old queen? Is Snelgrove's book on that theme? (6) Will you have an article in "B.B.J." soon on how to make a cheap hive (makeshift)? (7) Can I practise stimulative feeding over supers? I mean between blossom and clover flows. I shall be so obliged if you will give me an answer in "B.B.J."—*INQUISITIVE*.

*REPLY*.—(1) The excluder should cover the whole of the frames. (2) Under the circumstances you might do as you suggest. An examination twice a week will not hurt the bees. (3) The bees will settle the matter, but it is best to remove one queen and cage the other in case of accidents, as it is quite possible for both queens to get killed. (4) You must not do as you suggest. To locate which hive the swarm issued from, take a few bees from the swarm in a cup, flour them, and when released watch which hive they return to. You can then cut out all queen-cells and return the swarm without flouring the bees. (5) There is no safe method of doing this. With "Snelgrove's Method" you have to remove the old queen. (6) Probably. (7) No.

[8908] *Source of Pollen—Feeding in Spring*.—During the recent mild weather my bees (I have only one stock) have been flying constantly. I have been unable to discover whether or not they found anything, as to all appearance their journeys were futile. To-day (February 10th) my heart was gladdened to see them bringing in loads of orange-coloured pollen.

Bee-keeping has done wonders for me, although I only started last year. I never watched for spring as I have done this year; never took such interest in the

trees and the birds—those signs of re-awakening Nature—as I have done this year. I also find great interest in gardening, and I look daily to see how my plants are progressing, for I grow them all for my bees. The friend who sold me my stock so cheaply sold, or rather gave me, new sources of enjoyment which perhaps he never imagined.

May I ask two questions? (1) What do you think is the source from which my bees are getting pollen, and will they be also obtaining nectar? (2) The candy I gave has not been eaten. Do you think I made it wrongly? It was very hard. I have a frame of food of which I robbed my bees last summer. When shall I return it to them, please?

Thanking you for past favours, and wishing our BEE JOURNAL continued success.—NOVICE, West Riding.

REPLY.—(1) Bees are evidently working upon winter acornite. (2) If the candy is too hard the bees will be unable to eat it. You had better give them another cake. (3) You can put the comb of food in about April.

## Bee Shows to Come.

A nominal charge of 2s. 6d. is made for notices (not exceeding 7 lines) in this column, 10 lines charged 3s. 6d., up to 15 lines 5s., which covers cost of insertion from order till date of show. Cash should accompany orders for insertion.

June 9th-11th, at Malvern.—The Herefords and Worcs. Agricultural Society's Malvern Meeting. Twelve classes for Honey, &c. Good prizes; small entry fees.—For schedule apply, Mr. A. Elliott, Hon. Secretary's Department, Cusop, Hereford.

## Notices to Correspondents

W. E. F. W. (Falmouth).—*Honey and Diabetes*.—(1) Persons suffering from diabetes can use honey without ill effects. (2) We have heard of one or two cases of "Isle of Wight" disease in Cornwall.

F. B. (Welling).—*Preventing Swarming*.—(1) Yes. (2) Do not clip the queen's wings, but use a "Brice" swarm-catcher for about a fortnight during the swarming season.

R. P. (Cardiff).—*Buying Swarms*.—(1) A swarm will cost anything from 15s. upwards. (2) Keep to British bees.

J. E. J. (Pontardulais).—*Symptoms of Disease*.—It does not follow that all the bees die in five weeks. In some cases signs of disease are intermittent. You will find it is "Isle of Wight" disease, not paralysis.

### Suspected Disease.

H. L. (Gillingham).—Bees died from "Isle of Wight" disease. You can use the honey for human consumption, but on no account must you let other bees get to it.

J. B. (Kinross-shire).—We regret bees are too dry for us to state cause of death.

H. Y. G. (Hertford).—Bees were badly packed and were crushed flat in post. It was therefore impossible to examine them.

D. J. M. (Wales) and L. T. (Moseley).—Bees have died from "Isle of Wight" disease.

NOVICE (Lincs.).—The bees have died from starvation. Do not trouble to boil the frames, it is cheaper and better to buy new ones. The combs also should be melted down and not used again.

W. E. W. (Wrexham).—The bees, being improperly packed, were so crushed that we could do nothing with them. The letter also was in an abominably messy condition.

A. E. C. (Polegate), GERTIE (Kew Gardens), R. (Bromsgrove), E. G. (Brentwood), K. W. W. (Sussex), and G. E. M. (Countesthorpe).—The bees have died through "Isle of Wight" disease.

H. H. (Colchester) and A. E. R. (Saffron Walden).—The dead bees were too decomposed for examination.

F. H. B. (Saffron Walden).—Do not use the stores for other bees, as those sent were affected with "Isle of Wight" disease.

P. E. (Fareham).—(1) No. (2) The bees are too dry for us to say if diseased, but it would be unwise to risk harming others by using the stores.

A. C. (Lanes.).—(1) The bees have "Isle of Wight" disease. (2) British bees.

### Special Prepaid Advertisements.

Two Words One Penny, minimum Sixpence. Orders for three or more consecutive insertions entitle advertisers to one insertion in "The Beekeepers' Record" free of charge.

Trade advertisements of Bees, Honey, Queens, and Bee goods are not admissible at above rate, but will be inserted at 1d. per word as "Business" Announcements, immediately under the Private Advertisements. Advertisements of Hive-manufacturers can only be inserted at a minimum charge of 3s. per  $\frac{1}{2}$  in., or 5s. per inch.

### PRIVATE ADVERTISEMENTS.

FOR SALE, one 56lb. tin and three 28lb. of good extracted Essex honey, at 60s. per cwt.; also 11lb. beeswax, at 1s. 6d. per lb.—T. COLLEY, Thakes Farm Radwinter, Essex. v 62

At least 100 swarms wanted, May, June, large or small lots.—NEWBIGGING, Olvington, Lanarkshire. v 66

PURE Lincolnshire honey, light, 28lb. tins, 15s.; 58s. per cwt.—F. W. GELDER, Sturton, Lincoln. v 64

THREE W.B.C. hives, in good condition, 12s. 6d. each, two with both section and shallow crates.—2, Pleasant Villas, Eastwood, Leigh-on-Sea. v 63

WANTED, strong, healthy stock of bees; price and particulars.—HOLTON, Henwick. Newbury. v 61



**BRITISH BEE-KEEPERS' ASSOCIATION.**

The monthly meeting of the Council was held at 23, Bedford Street, Strand, London, W.C., on Thursday, February 19th. Mr. W. F. Reid presided. There were also present: Miss Gayton, Miss Sillar, Messrs. C. L. M. Eales, E. Watson, R. H. Attenborough, T. Bevan, J. Smallwood, O. R. Frankenstein, J. B. Lamb, and Sir Ernest Spencer (Association representatives), G. W. Judge and G. Bryden (Crayford), G. S. Faunch and G. R. Alder (Essex), D. Seamer (Lincolnshire), Rev. F. S. F. Jannings (Yorkshire), A. Willmott (Hertford), F. W. Harper (St. Albans), and the Secretary, W. Herrod.

Letters expressing regret at inability to attend were read from Messrs. T. W. Cowan, G. J. Flashman, A. Richards, A. G. Pugh, W. T. Sanderson, and Col. H. J. O. Walker.

The minutes of the Council meeting held on January 15th, 1914, were read and confirmed.

The following new members were elected:—Mrs. Pennington, Miss B. S. Macmichael, Miss E. Weston, Mr. D. Seamer, Mr. W. H. Carter, Mr. W. Finch, Mr. W. E. Carter, and Mr. A. Ross.

The following Associations nominated representatives to the Council, and the same were accepted: Glamorgan, Mr. F. Gravit; Essex, Mr. G. S. Faunch; Devon, Mr. A. McCullah; Northumberland, Mr. W. J. Sanderson; Olney, Rev. G. F. Sams; Hereford, Rev. J. W. Turner; Herts., Mr. A. Willmott.

The report of the Finance Committee was presented by Mr. Smallwood, who stated that the payments into the bank for January amounted to £40 4s., the bank balance being £228 15s. 3d. Payments amounting to £29 16s. 9d. were recommended.

The final examination was fixed for May 29th and 30th. Mr. D. M. Macdonald was appointed examiner.

The annual report was presented and passed as amended.

Mr. Reid having to leave on urgent business, Mr. Lamb was voted to the chair.

Arrangements were made for the annual meeting to be held at the Lecture Hall, Zoological Gardens, on March 19th, 1914.

A letter was read from Mr. Judge, and it was resolved to get the name of the Association enrolled in the lists of Scientific and Agricultural Societies.

The report of the Examining Board was presented by Mr. Lamb, and it was re-

solved to grant the expert certificate (final examination) to Mr. H. Goude.

The report of the Exhibitions Committee was presented by the Secretary, and it was resolved that the W. Broughton-Carr Memorial Gold Medal be awarded at this year's Royal Show, the conditions to be as follows:—A first prize to count 3 points, second 2 points, third 1 point. In case of a tie the competitor having the largest number of highest awards shall obtain the medal. No exhibitor shall take the medal for two consecutive years. The points to be awarded in all classes, except those for appliances, and classes 605, 606, and 607.

Mr. Wilson applied for arrangements to be made for him to take the Special Lecture test at some future date. The matter was referred to the Examination Committee.

A letter from Mr. Sanderson, *re* payment from Development Fund for Northumberland, was referred to the Development Fund Committee.

Unanimous resolutions passed at the annual meetings of the Herefordshire, Crayford, Northumberland, and Glamorganshire Associations, asking the Council to get the Bee Diseases Bill re-introduced this session, were received.

The Expert's report of the Crayford Association was received.

It was resolved to grant the sum of £5 towards the prize fund at the British Dairy Farmers' Show, 1914.

**SPECIAL NOTICE.**

A private lantern lecture and microscopical demonstration, with special reference to "Isle of Wight" disease, is being arranged to be given in London by an experienced investigator, on March 5th, at 2 p.m. Stained, and, if possible, "fresh" preparations will be shown. Will those who would like to attend please communicate with me at once, stating the amount that they are prepared to contribute towards the cost of same? Only a limited number can be accommodated.—W. HERROD, 23, Bedford Street, Strand, London, W.C.

**W. BROUGHTON-CARR MEMORIAL FUND.**

	£	s.	d.
Amount already acknowledged	14	9	0
D. Hancox .....	0	5	0
F. H. Hagley .....	0	5	0
H. Goude .....	0	2	6
T. W. T. ....	0	2	6
D. Wilson .....	0	2	6
	<b>£15</b>	<b>6</b>	<b>6</b>



## WINTERING BEES.

(continued from page 64.)

About the middle of October the full complement of stores should be made up by rapid feeding, so that the stock has about thirty pounds well sealed over. The stores should be sealed as far as possible, though a little unsealed will do no harm, as it will be used up first. The novice experiences difficulty in gauging the weight of food in the combs. If eight combs are well filled, there will be sufficient. To give an idea of what the combs should be like, I give photographs. Fig. 2, taken last autumn, of five combs from a stock of mine just before it was wintered down. No. 1 shows the outside comb, which contained seven pounds of food. Numbers 2, 3, 4 and 5 are of the combs in rotation, and of the side nearest the centre of the hive. No. 2 contains a little over six pounds; No. 3, five and three-quarter pounds; No. 4, five pounds; No. 5, four and a half pounds. The other five combs were in the same condition, so this stock had about fifty-six pounds of stores. An examination of No. 1 shows very clearly the extent of the brood-nest on the outside comb, and how, when breeding for the season ceases, these cells are taken advantage of for the storage of food for the winter. The supply of farinacious food in the shape of pollen should not be neglected—one or two combs should contain a supply of this; if absent, it may be procured from other stocks that can spare it, or a supply can be given by mixing Symington's pea flour with honey to a stiff paste, and forcing it into some of the empty cells with an ordinary dinner knife by a spreading motion, as when putting butter on bread. Having made the food supply all right, the final packing must be completed. It has been truly said that the best packing for wintering is "to pack with bees," and if the above instructions are carried out the combs should be crowded with young bees. A couple of balls of naphthalene, split in half, should be placed on the floor-board inside the brood chamber, as far away from the entrance as possible. Bees do not like the smell of naphthalene, therefore the balls are split so that the flat side prevents them being rolled out, and they are

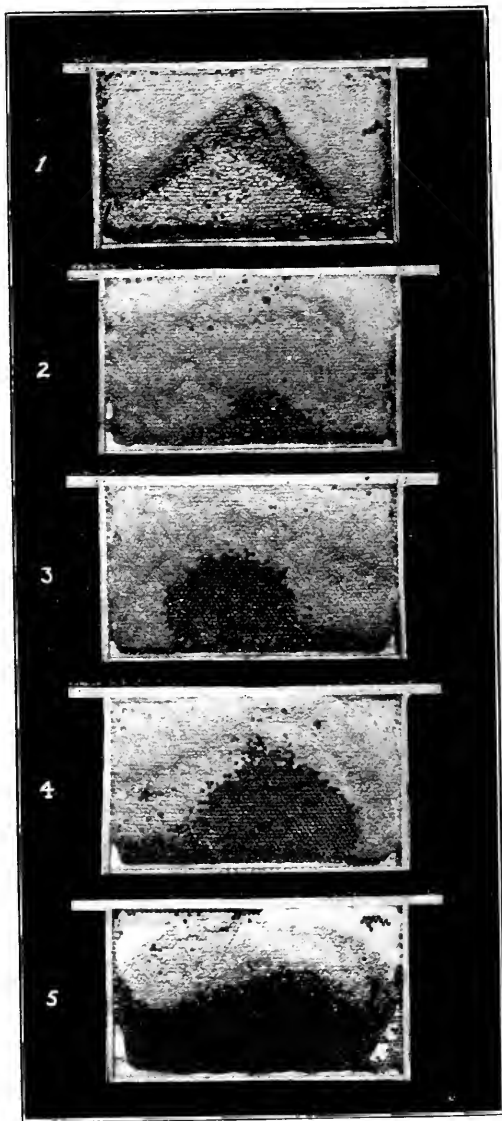

FIG. 2.

placed in the furthest corners for the same reason. My own practice is to wedge the naphthalene between the top bars for wintering (Fig. 3). A passage-way for the bees must be provided over the tops of the frames—the bees cluster at the top of the combs—and in cold weather they will not go down and under to get to food combs when the supply is exhausted where they are clustering, but they will pass over the top; therefore, unless this bee-way is given, it is quite possible for them to die of



FIG. 3.



FIG. 4.

starvation although food is within easy reach. A couple of pieces of wood, about three-eighths to half-inch thick and seven inches long, are required. These are obtained by cutting either elder or hazel shoots from the hedgerow—they are smooth and regular in size, and excellent for the purpose. These should not be placed exactly parallel with each other, but one beyond the other (Fig. 3), taking care that the ends do not come too near the side of the brood chamber to hold up the quilt, so allowing the bees to escape. The tops of the frames should not be cleaned for wintering, as the small pieces of comb and propolis help to form a winter passage.

If it is a W.B.C. between the brood outer case should be filled with chaff or this harbours insects, litter when cleared air space, being a either heat or cold, good quilt, made of with a feed-hole cut placed in position. back, and a one-in a glass-topped I would do this forms a good for noting the condi-supply, but for ascer-



FIG. 5.

hive, the space chamber and the left empty, and not other material, as and also makes a out in the spring—the bad conductor of is quite sufficient. A ticking or calico, in it (Fig. 4), is now The flap is turned pound cake of candy box put on (Fig. 5), with each stock, as it barometer—not only tion of the food taining the condition

of the stock in the spring time, especially in the South of England, where very often the bees build up so strong that they require more room before the weather allows the bee-keeper to examine them. In the cherry orchards in East Kent I have taken off racks of full sections the first week in May. When the bees require more room they will build comb in the candy-box (Fig. 6); as soon as this is seen a super should be placed on at once, so that surplus will be gathered which would have been lost but for the tell-tale box. Fig. 7 shows comb built in a box beside unconsumed candy. It should be borne in mind that, at times, bees will consume well-made candy in preference to their own stores. If it is known that a stock is short of stores, a large cake of, say, four pounds of candy should be given. The candy used after

Christmas should have a little pea meal mixed with it. By using the glass-topped box over the calico quilt there is no need to disturb the bees to see if the candy is consumed, or when replenishing it, which is the case if it is moulded in a saucer and put under the quilt.

Extra quilts of some warm material, such as felt or house flannel (Fig. 8), are now used to wrap down. A bag filled with chaff or cork dust does very well—failing these, neatly-folded newspapers make warm coverings. Avoid the use of guano bags and cast-off wearing apparel.

The quilts used must be perfectly dry; also sprinkle a little powdered naphthalene amongst them, to keep out moth, ants, and earwigs.

It will be necessary to secure the roof so that it does not blow off. The practice of using bricks or stones has three disadvantages—first, the moisture collects underneath them, so that in course of time a plain wooden roof, or one covered with calico, will rot; the bad effects can be seen right through the summer after the bricks or stones have been taken off (Fig. 9) by the mark left through the confined damp, while in many cases the damage is intensified by their remaining on continuously. When on tour I have frequently seen holes in roofs through the rotting of the wood. Only this winter I came across the case illustrated at Fig. 10, which speaks for itself. Secondly, the lifting off and putting on of the weights disturbs the bees, and causes them to consume more food than is good for them, which, in their confined condition, may cause dysentery; thirdly, with weights only, the hive is often blown bodily over by a gale.

Of all methods, Fig. 11 is the best—it is impossible for the roof to blow off or the hive to be blown over, the weight is easily taken off or put on, and there are no knots made tiresome to untie by varying climatic conditions. Procure a stout

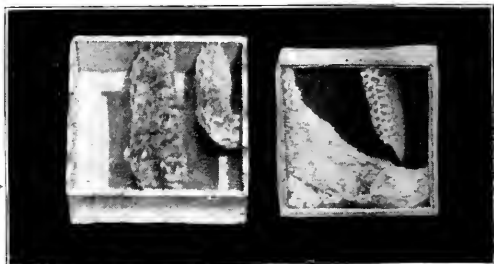

FIG. 6.

FIG. 7.



FIG. 8.



FIG. 9.

stake eighteen inches long, bore a half-inch hole through it about a couple of inches from the top, drive this down at one side of the hive, thread a strong piece of cord through the hole, and tie a knot on one end so that it will not slip through, pass the cord over the hive roof, and tie a brick on the other end so that it clears the ground, thus obtaining the advantage of all its weight yet it clears the hive, preventing it knocking against the side and disturbing the bees, with the result detailed above. Open the entrance six inches, and all is complete.

The bees should be disturbed as little as possible during the winter. About once every month gently lift off the roof and look to see if the supply of candy is gone; if it is, put on another cake. On fine days the bees will fly to void their fæces and clear out the dead—that is the best time to replace candy. In the very cold

weather the entrance should be raked clear of dead bees each week, by means of a piece of wire, hooked at one end, used very gently—if this is not done, an accumulation of dead bodies may block up the entrance and suffocate the living inmates. If snow falls, it should be swept from the roof, as melting snow percolates through the smallest crevice. It should also be cleared from the alighting board, and the



FIG. 10.



FIG. 11.

extended alighting board reared in front (Fig. 12. see page 89) to prevent the bees being attracted out to their death by the light from the snow being reflected into the hive.

Keep a watch for blue tits and mice—the former obtain food by tapping on the alighting board and attracting bees outside; the latter will eat away the entrance slides to obtain admission to the hive.

## CORRESPONDENCE

The Editors do not hold themselves responsible for the opinions expressed by correspondents. No notice will be taken of anonymous communications, and correspondents are requested to write on one side of the paper only and give their real names and addresses, not necessarily for publication, but as a guarantee of good faith. Illustrations should be drawn on separate pieces of paper. We do not undertake to return rejected communications.

### "ISLE OF WIGHT" DISEASE.

[8955] Does not the whole present discussion on "Isle of Wight" disease and the proposed methods of coping with same turn on the question: "Is this disease infectious or merely contagious?" If it is *infectious* then no amount of wholesale destruction of diseased stocks can stop the plague now that it is so widespread. Like influenza amongst ourselves, it has come to stay, and the only hope of salvation lies in the discovery of partially or totally immune stocks or strains of bees which may survive the coming holocaust! In that case, as Mr. Mace and his followers suggest, the sooner the world is scoured for immune strains the better; such strains

already exist in Australia if the information supplied to our Board of Agriculture is correct (see 1912 Report on "Isle of Wight" Bee Disease, pp. 51 and 52, also pp. 128 and 129). As to whether any British strains have yet become strongly resistant is a question. Mr. Stapleton, who has wrestled with the disease in Cornwall since 1904, wrote hopefully some time back in the "B.B.J." of his own work along the lines of immunity.

At the same time it must be admitted that so far the preponderating weight of evidence collected is in favour of *Nosema apis* ("Isle of Wight" disease) *not* being infectious, but rather that it needs an agent other than air to convey it from diseased to healthy stocks. Further, it has been demonstrated that apart from favourable conditions the spores of *Nosema* lose their virulence comparatively rapidly.

This makes a very strong case for the "orthodox" party, who demand compulsory destruction, and it is at least desirable that immunity enthusiasts should confine their experimental importations to districts where the disease has long been rampant. The crying need of the moment is total prohibition of the transference of bees from diseased to healthy districts.—  
H. E. SCROPE VINER.

## "ISLE OF WIGHT" DISEASE.

[8956] I feel that I owe an apology for trespassing once more on the Editors' patience and that of the readers of this JOURNAL; but it occurs to me that one or two observations might be of use to inquirers. First, then, I may inform Mr. Illingworth that I have it from two sources that this disease is already less virulent in North Berks and South Oxon, where previously it was probably at its worst; and as I see by to-day's papers that it has just broken out with exceptional fury in a hitherto "clean" part of Norfolk, this would seem to support my view that ultimate salvation *may* lie in immunity—though, of course, we shall need to examine our premises carefully before we can even begin to think of drawing conclusions. Above all, we must have more certain news of the condition of things in Berks and Oxon.

My second point is this. Having formerly kept bees in North Berks (where foul-brood is a permanent terror), I began some experiments in what I may call excessive out-breeding, importing queens from Norway, Germany, Austria, Russia, and Greece, but confining myself always to the black race. The German queen was imported in 1909, and, as I mentioned in a former letter, her progeny evinced distinct powers of resistance to foul brood—though they went under later when "Isle of Wight" disease took hold. In 1912 this latter disease had swept every bee in the district away, except in my apiary, where, if I remember rightly, only two stocks out of eight succumbed. In July of that year I introduced the Greek queen; and the following year all my hives were wiped out with the exception of her stock, which took the disease mildly but recovered. Being resident abroad at the time, I had to leave matters in the hands of my gardener; but on returning last summer I certainly found the Greek stock in good fettle.

Some interesting points, arising out of these observations, offer themselves for our consideration. Was my comparative immunity in 1912 due to out-breeding? If so, why did it not hold good through 1913? May this have been due to the inability of my bees to fight *both* diseases at once? Again, why did the Greek stock survive, seeing that it was pure and therefore unaffected by out-breeding? I would point out that, since bees in Greece can gather stores practically all the year round, they are never fed artificially; and two correspondents in this JOURNAL lately put forward the suggestion that we have weakened the stamina of our bees by giving unnatural food. This may not be the reason—I hope it is not, for, as I myself pointed out, if it is, we may as well give up keeping bees—but it requires

consideration. It may be that "Isle of Wight" disease does not greatly affect Greek bees; in fact, Greece *may* be the immune country we are looking for.

I trust the readers of the "B.B.J." will not, on the strength of this letter, make a wild rush to import Greek queens! We know so little that they will very probably be disappointed and blame me! Besides, the Greek method of sending queens is very primitive and likely to cause much anger on the part of the recipients! I am at present taking steps to rectify this; and I propose to continue my experiments in this district, where they will not be complicated by the presence of foul brood.

There is one other point, which, however, has nothing to do with the question of disease. A correspondent recently mentioned, among honey-bearing plants of February, what he believed to be *Saxifraga crassifolia*. I think he refers to *S. speciosa*, which I notice opening in my garden; but as "fatness" is certainly the most characteristic quality about its leaves, I regard his specific name as a happy notion. *S. cordifolia* much resembles *S. speciosa*. There is a patch of it in Kensington Gardens; but I observed no sign of blossom there on the 9th inst.—H. CAMPBELL, Pulham St. Mary.

## SUNDRY HERESIES ABOUT BEES.

[8957] The two letters which I wrote on "Delusions about Bees," over a year ago, drew upon my devoted head such a scathing rebuke from an anonymous correspondent, who professed to write from a village in Inverness-shire, that I have never since felt able to write any more about bees. I feel comforted, however, to read that some others have been able to repeat my observations.

I expressed the opinion that the mating of the queen did not always take place in the blue ether, as described by Maeterlinck and others, and I mentioned that on one occasion I had seen the queen and drone in copulation on the porch of a hive. I stated that "Swarthmore" and others had also seen the mating of the queen; but a "village bee club (somewhere in the County of Inverness), after carefully debating the whole affair," had come to the conclusion that my observation of this queen and drone was "a delusion which could not have entered the head of any but a bee-keeper in the chrysalis stage." I felt grateful to Mr. Geo. Steventon when he wrote in the "B.B.J." for 4th Dec. that he also had been able to witness the mating, and that it took place within a few feet from the hive. Is Mr. Steventon also in the chrysalis stage? An Irishman, convicted on the evidence of two eye-witnesses of having



stolen a cow, is said to have declared that he could produce hundreds of witnesses who had not seen him steal the cow. There are millions of people who have not seen the mating in the neighbourhood of the hive, but the numbers who have not seen it occur in the empyrean are beyond computation.

In discussing the oft-repeated statement that worker bees live only six weeks in the working season, I produced detailed evidence that bees of a queenless stock at Lurebost in this island had lived through July, August, and September, those months being the height of the season with us. Some other writers in the "B.B.J." corroborated my statement so far as queenless bees were concerned, but it was pointed out that broodless bees did not "live laborious days. They gather nectar, and, to a certain extent, build comb, but they have no brood nursing, no chyle-forming, and no excessive waste of tissue." I had said that those bees had built as much comb, gathered as much nectar, and filled as many cells with pollen as one could have expected in such a season as 1912. Six months later this criticism of my letter appeared in a Government publication in this form: "It is well known that broodless and queenless bees live much longer than the bees of a normal stock, but that they quickly wear out if brood is given them to rear. The secretion of brood-food is apparently very exhausting." Is it not, however, even better known that the secretion of brood-food is not under the control of the bee, but is a function of its age? Young bees cannot help the production of brood-food, and older bees can produce it only with great difficulty, if at all. The life of the older bees, who are foragers only, cannot, therefore, be shortened in any degree by the production of "chyle." I might perhaps mention in passing that another Government publication on bees declares that wax-production is the most wearing work that a bee has to face.

There has been a good deal of further talk on the age of bees since I was castigated. G. M. Doolittle has been advocating the selection of stock for longevity, and Mr. Macdonald has made favourable comment. Mr. Crawshaw has been at it (page 19), and now Mr. Desmond informs us (page 47) that he knows of black bees which lived through May, June, and July in a prosperous colony rearing brood at the normal rate.

The probability is that bee-keepers know the age of their queenless bees, but do not know how old are the foragers in normal stocks. Owing to the fact that I live "in the principal village of a remote island in the Outer Hebrides," I have very unusual opportunities for making bee

observations, and I might mention that I have clear proofs that some black bees, born not later than September 10th, 1912, were still alive and working on July 10th, 1913—just ten months—and this in a stock with a fertile queen. In view of possible criticism from Inverness, I have had the observations attested by a Justice of the Peace.

My assertion that unhatched queens are at least sometimes destroyed by the bees, and not by the queen first hatched, has not been discussed in Britain, but has given rise to some misunderstanding of my meaning in Italy and America. Mr. Dadant, in the *American Bee Journal*, notes that: "In *L'Apicoltore Moderno* Miss Fleischman criticises the statement made by J. Anderson in the 'B.B.J.' that young queens, newly born, destroy other queen-cells. She has never seen this take place, although she has often watched. We can, however, vouch for the correctness of Mr. Anderson's assertion. Young queens which have been confined to their cells by the bees are very lively, and when freed are exceedingly eager to destroy other queen-cells." Now my statement was very much to the same effect as that attributed to Miss Fleischman, so there is a misunderstanding somewhere. The curse of Babel is upon us. Either Miss Fleischman did not understand my English or Mr. Dadant's polyglot knowledge is for once at fault.—JOHN ANDERSON, Stornoway.

#### A WORD FOR THE ANTI-SKEPPIST.

[8958] The arguments of your correspondent, Mr. Chas. H. Heap, against the use of the skep are a bit too weighty for Mr. Crawshaw to combat them with success. The latter gentleman has had to resort to some special pleading to uphold the stand he has taken in defence of the skep, and I notice of late an inclination to "hedge." In his statement (November 13th, page 450), "I see no difficulty in fitting a skep with two or perhaps three frames," &c., he comes perilously near throwing the ordinary skep (over which all the controversy has centred) overboard. If two or three frames would be an improvement, why not go further and put in the full complement, and thus secure all that is asked for—a movable frame-hive? No one, I presume, would object to skeps, or even to "the box or barrel-hive of New Zealand or Timbuctoo," which our friend refers to, provided they were fitted with movable frames.

Mr. Crawshaw seems to enjoy giving "New Zealand box-hives" a quiet thrust now and again, but the reason for doing so is rather obscure. However, New Zealand bee-keepers can well afford to smile

at these jokes, seeing that the abolition of box-hives and skeps (we had these latter contraptions with us) has been the salvation of commercial bee-keeping in this country.

At the close of the communication referred to, Mr. Crawshaw says: "I am only concerned with the endeavour to fairly discuss the serious skeppist, and not anyone given to playing the fool with bees." If by "serious" is meant "determined," a person determined to make the most out of his bees, then a "serious skeppist" is hardly conceivable. When a skeppist becomes "serious" with regard to bee-keeping he would cease being a skeppist, and go for frame-hives.

Say what one will, no special or other pleading can stand its ground when opposed to experience.—I. HOPKINS, Auckland, New Zealand.

---

#### THE SOUTH AFRICAN BEE JOURNAL.

[8959] I notice in the "B.B.J." of Jan. 29th and the *Record* for February that "D. M. M.," in his Extracts and Comments, draws attention to the fact that the *South African Bee Journal* "has gone over to the great majority," but that the S.A. bee-keepers still have a rallying point in the *South African Poultry Magazine*, edited by Mr. G. S. Oettle. In the latter particular Mr. Macdonald is under a delusion as to the exact position of affairs. The S.A.B.K.A. now has for its official organ *The Farmer's Weekly*, as will be seen from the following letter quoted from that paper of December 17th, 1913:—

##### "AN OPEN LETTER TO THE MEMBERS.

"To the Members of the South African Bee-keepers' Association, the Western Province Bee-keepers' Association, and the Natal Bee-keepers' Association.

"Will the members of the above-mentioned Associations please note that the *S.A.B.K. Journal* has been discontinued and that in future the official notices of the above Associations will appear in the columns of *The Farmer's Weekly*, who have agreed to act as our official organ. A copy of *The Farmer's Weekly* will accordingly be sent post free each week to every paid-up member.

"The honey depôt at Johannesburg is still being continued, but just at the moment there appears to be a glut in the market. In this connection we would like to say that we consider the retail price of honey far too high, and if the market is to be extended we think that this will have to be altered. Two-and-sixpence per lb. is prohibitive to many people, and this is the price at which our first-grade honey is being retailed in many stores in the

Witwatersrand area. In fact, we have come across instances where even third-grade honey has been sold at the same figure. We suggest to the producers that it might be possible to modify this state of affairs by taking advantage of the agricultural parcels post. Why not maintain modest advertisements in the public Press offering first-grade honey, say, at 1s. 6d. per lb. post free to any address in the Union, and thus deal direct with the consumers? Dark honey, of course, could be sold for a good deal less, and in this way it might be possible to widen the market for honey very considerably. Should the experiment prove successful, it would, no doubt, be an easy matter to decide on some cheap but strong material, out of which to make special receptacles for the purpose of transporting small quantities of honey in this manner. Who will lead the way?

"It is earnestly hoped that members will continue to help us as of yore, by the contribution of articles of general interest to bee-keepers, and everything intended for publication should be sent, as previously, to Mr. S. St. L. Northcroft, 51, Fourth Street, Boksburg North, this gentleman having very kindly consented to continue to act as our Honorary Editor."

Mr. S. St. L. Northcroft is still acting as Honorary Editor of the Bee Column. In spite of hard times, the Central Committee of the S.A.B.K.A. and the Hon. Secretaries of the Western Province and Natal B.K.A. are striving hard against "fearful odds" to keep things going and help on the industry, and are doing good work.—M. DAGMAR SILLAR, Representative for South Africa.

---

#### WARNING AGAINST STARVATION.

[8960] I was much interested in the Bee Notes from Derbyshire in last week's "B.B.J." (page 77), but am sorry to say the warning was too late in my case; I am therefore anxious that others should read it and make sure their stocks are well supplied. My four hives were prepared for winter with plenty of their own stores, and I considered they would have enough to last till spring, but on a beautiful day in the beginning of this month, when bees were flying, I noticed that none issued from one of my hives, and on examining it found the whole lot had died of starvation. When I made further examination I was surprised to find another so far gone that nothing would save them. It is only my second winter of bee-keeping, and, thanks to the "B.B.J." and kind bee-keeping friends, I have not had to learn much by this sort of experience.—G. G. LEWIS, Acton, W.

## "I.O.W." DISEASE.—A CORRECTION.

[8961] At the end of my "Jottings," in "B.B.J." of February 12th, I failed to make my meaning quite clear. I said: "The combs (from hives in which the bees had died of 'Isle of Wight' disease) should either be destroyed at once or temporarily placed where they cannot by any possibility be reached by the bees." I ought to have added, "Until they can be properly dealt with."—CHAS. H. HEAP.



FIG. 12.

SEE "WINTERING BEES," PAGE 85.



## EXTRACTS AND COMMENTS.

By D. M. Macdonald, Banff.

*Bees and Poultry.*—The first issue of *Gleanings* for this year is a special one, dealing mainly with poultry as a "side-line" to go with bees. The Editor sums up: "Some interesting evidence is produced, showing that the combination of bees and poultry goes well together. When the work is most active among the chickens in the winter and early spring the bees are dormant, requiring little or no attention; and when the work is most pressing among the bees, in the late spring and summer and fall, the conditions are such that the chickens can, to a large extent, find their own food. We know of numbers of people who run a small farm in connection with bees, where they have a large number of poultry, and the whole combination, if not remote from a market, will yield good returns." One writer says: "The combination of bees, poultry, and, I may add, an orchard, is an ideal one. Each business has its own distinct season. The incubating and breeding of chickens is practically over before the busy season with the bees begins. Another advantage of the combination is that the same land can be

utilised for all three. Then the poultry fertilise the land, bees fertilise the fruit, and the blossom furnishes nectar to the bees."

*Bees in Buildings.*—The *Bee-keepers' Review* gives prominence to what they call a new method of bee-keeping. Acting on the well-known principle that bees will occupy overhead space, and thus check swarming, he gives them only eight frames in the lower body-box, and then tiers up. He believes that this residence and store-room is the most ideal imitation of "the hollow tree—the natural home of the bee." Two eight-frame bodies, and then the surplus chambers. These hives he places in spare rooms, garrets, and in the out-houses on his farm. He manages them with two visits in course of the honey-season—one to place on supers, the other to take them off and secure the honey: which system he considers is as near an automatic mode of managing bees as one will get in this world. He set up a hive for a neighbouring school teacher, who went off on vacations, leaving the bees to manage themselves; and on her return she got "over one hundred and fifty pounds of honey." Another neighbour visited Europe, and, although the house was shut up, the bees stored over 100lbs. before he returned. These are only samples. There are hundreds of these outfits in Grand Rapids, some of which have yielded 200lbs. surplus—and there has been no swarming. We are promised a continuation of this article.

*Levelling Hives.*—I wish bee-keepers would take a little trouble and level their hives, or that the manipulator were blessed with some appreciation of the value of perspective. Take for example several specimens of the photographic art reproduced in two issues of the *American Bee Journal*—December and January. When I looked at the centre hives on page 406 I almost held my hands to steady those "eight-deckers." I felt no such sensation on looking overleaf at the hive with the same number of bodies that yielded 224lbs. surplus. Neither did I feel any thrill when I looked at Mr. Bartlett's apiary, on page 417. I felt pleased, however, that the owner seemed to have a firm grip of the 210-pounder, on page 421. Grandpré and its surroundings, pp. 18 and 19, look as solid and steadfast as the everlasting hills, but Dr. Miller's house, on page 11, looks as if it were about to fall back.

Even when not preparing to have one's apiary photographed, it is advisable to re-level every individual hive some time during spring before the busy season sets in. A line of hives all at sixes-and-sevens looks bad, whereas a smart setting up gives a pleasantly taking appearance to the whole collection. Grace and utility

both claim that this periodic re-arrangement should be attended to every spring.

*Thick Syrup.*—Mr. Crawshaw, on page 58, thinks (by the way, that seems a favourite expression of his when dealing with my contributions of late)—he *thinks* I am wrong about the 2½ to 1 for thick syrup, but he tries to drop me gently by surmising that I “misunderstood” Dr. Miller and Mr. Root. Let me appeal to Caesar! On page 4, *Gleanings*, 1910, Dr. Miller wrote, “I have fed barrels of sugar for winter use, but always *two and a half to one.*” On page 207 of same volume Mr. Root writes much in praise of thick syrup, feeding late for winter, of which I quote one sentence: “By giving the thick syrup, *two and a half to one*, comparatively late in the season, the bees are given *the very best feed.*” He repeats this advice on page 711 in an editorial: “At this time of the year (late autumn) do not give any syrup thinner than *two and a half* parts of sugar to one of water, boiling hot; and it should be well stirred.” In the same volume quite a number of the leading contributors cordially support this advice, among them being Messrs. Holterman, Crane, and Doolittle. One even advocates three to one! If these can make “barrels,” “thousands of pounds,” “tons” of sugar into syrup, the “very best of food” for bees in winter, why should I not advocate a trial of it in this country without needless comment following?

*Errata.*—For “Darwin.” on page 2, please read *Hurley*.

## Bee Shows to Come.

A nominal charge of 2s. 6d. is made for notices (not exceeding 7 lines) in this column, 10 lines charged 3s. 6d., up to 15 lines 5s., which covers cost of insertion from order till date of show. Cash should accompany orders for insertion.

**June 9th-11th, at Malvern.**—The Herefords and Worcs. Agricultural Society's Malvern Meeting. Twelve classes for Honey, &c. Good prizes; small entry fees.—For schedule apply, Mr. A. Elliott, Hon. Secretary's Department, Cusop, Hereford.

**July 8th, at St Albans.**—Honey Show of the St. Albans B.K.A., held in connection with the Elstree and Boreham Wood Horticultural Society, at Aldenham Park. Open class for extracted honey. No entry fee. Liberal prizes. Judge, Mr. W. Herrod. Schedules from Mr. R. H. Attenborough, Alderham, Herts. **Entries close July 6th.**



A. J. T. (Ilkeston).—*Old Bec Book.*—If in a good state of preservation, your book is worth about 5s.

G. F. D. (Holstein, Germany).—*Rendering Old Combs.*—(1) No, it will do no harm to melt the old combs containing dead bees as all the waste matter will remain at the bottom of the cake of wax, and this can be scraped off when cold.

NOVICE BEE-KEEPER (Cardiff).—*Feeding Stock Short of Stores.*—You can make the stocks safe by giving to each a 1lb. cake of candy in a glass-topped box; when this is consumed, give another. The candy should be put on at once.

WOLVERHAMPTON.—*Honey Sample.*—We can taste nothing but burnt sweet in the sample sent.

T. A. E. (Dawlish).—*Weight of Stock in Skep.*—It would be a better plan to buy swarms than bees in skeps. We cannot say what weight they should be, as so much depends upon the size of the skep.

W. H. W. (Haydon Bridge).—*Dead Queen.*—The queen is fertile, but is an indifferent one.

G. F. J. (Llaafachreth).—*Dealing in Swarms.*—(1) Yes, it is profitable. (2) Certainly, if carefully worked. (3) Advertise now, and get your orders booked.

SOLAR (Atherstone).—*Making a Solar Wax-Extractor.*—(1) Yes, there should be two sheets of glass in the lid with a space ½ in. or ¾ in. between. (2) No. (3) Plate-glass would be best, but it is too expensive for the purpose.

W. E. G. (Dulwich).—*Age of Queen.*—We should say it is a 1913 queen.

R. E. (Toom).—*Addresses Wanted.*—We regret we do not know the name of nurserymen in the district you mention.

T. BROUGHTON (Balham).—*Honey Sample.*—You could hardly expect a bottle of honey to travel safely through the post simply wrapped in a piece of brown paper. We received fragments of glass only.

### Suspected Disease.

C. P. S. C. (High Wycombe), Miss KAYE, H. B. GARDINER.—We regret to say the bees are affected with “Isle of Wight” disease.

C. A. (Enfield).—From your description we fear the stock is affected with “Isle of Wight” disease.

W. E. (Newport).—The bees have died of “Isle of Wight” disease. The honey can be used for human consumption, but on no account let other bees have access to it.

FRANCIS (Torquay).—The bees are badly constipated.

I. W. J. (Notts).—“Isle of Wight” disease has caused the death of your stocks.



REVIEW.

*How to Prevent Swarming*, by A. H. Wilkes (published by the author at Lichfield Road, Four Oaks), price 1s. 1d. post free.—We have received a copy of the above booklet on the "Prevention of Swarming." In it the author describes his difficulties with swarming and how he overcame the same. The reading matter is made clear by numerous illustrations and drawings, also by the author.

WHITBY AND DISTRICT B.K.A.

ANNUAL MEETING.

The annual meeting of the Whitby and North-East Yorkshire Bee-keepers' Association was held in Hood's Café, Whitby on Saturday, February 21st, when the chair was taken by Mr. T. Hood, who presided over a fairly good attendance of members. The Rev. the Marquis of Normanby was re-elected to the position of president of the association. Mr. Pinkney, who was re-elected secretary with the assistance of Mr. L. H. Smailes, said that during the year the work had been carried on in a more or less satisfactory manner, a number of lectures having been delivered in the district. The work, too, had been carried on most inexpensively. If the County Council would come to their aid with a grant they might be able to do more propaganda work than they had been able to do on the small subscription list the Association had. It was agreed to remit to the committee as a strong suggestion that the annual show be held about the second week of September. The committee were further recommended to have the schedules out in July. It was moved that there should be a class for cottagers, three hives, the rental of the cottage not to exceed £10 a year.

Mr. L. S. Crawshaw gave an interesting address on the subject of "Preparing for the Expert Examinations," and, as the holder of a first-class certificate, and as an examiner, he was most able to deal with the subject. This he did in a very interesting manner, holding out encouragement to try for the examinations, and giving many hints as to how to go about the preparation. Very many more beekeepers, he said, were qualified to pass this examination than they knew themselves.

The Chairman moved a hearty vote of thanks to Mr. Crawshaw for his most interesting lecture.

Mr. Pinkney seconded. The lecture

was a most pointed one, and gave them a lot to think about. They now knew what they had to face.

Mr. Burn supported, and the vote of thanks was heartily accorded.—C. W. Pinkney, Hon. Sec.

SHEFFIELD B.K.A.

An illustrated lecture on "Diseases and Enemies of Bees" will be given by Mr. W. Herrod, F.E.S., on March 21st, at 8 p.m., in the rooms of the Literary and Philosophical Society (St. James' Chambers), Church Street, Sheffield. All interested in bees will be welcomed.

BEE PICTURES AT EXETER.

Mr. J. C. Bee-Mason will be at Theatre Royal, Exeter, for one week commencing March 16th. Every evening and at matinées daily at 3 p.m. he will show his celebrated films, "The Bee Master," "Life of the Bee," and "A Modern Bee-Farm."



SECTIONS FOR THE SHOW BENCH.

I, rashly as I now think, undertook away back in last August to deal with the preparation of sections for the show bench. I postponed tackling the subject month after month, feeling it was too deep, too high, and too wide for me. Entering fully into it, would require the whole space of this issue of the JOURNAL, and so I feel that what I am now about to say will only be mere "heads" of the whole discourse, some "texts" for several sermons. If I could but induce some of our leading prize-takers to fill out and amplify each head by giving us their opinions, experiences, and conclusions, I would feel that I had done a good work, and one for which I would deserve the thanks of the fraternity.

I proceed to fix up my "pegs"! They are not isolated ones, but set in a series, a row or chain of pegs, and then another, and another. One set will be "fixed to" the bee-keeper, second to the bees, and yet a third to the surroundings, the adjacent area, the locality. The bee-keeper must select the very finest sections chosen from his pile of several hundreds. None showing the least fault or defect should be selected. Wood should be as fine, white, and smooth as it can be had, with no roughness at edges or selvages at bee

space. The two bee-way ones are undoubtedly best, as with them there will be fewer pop-holes, less thinning down at corners, and the finish will be more uniformly level. The very finest and lightest foundation should be used, only full sheets being permissible. It should be fixed perfectly true and given no chance to sag or buckle, and set so truly perpendicular that there will be no connection with the dividers. Fix up the sections perfectly square. Let there be no bias and no acute angle. The rack, too, should be a true and exact square, and in making it up the sections should be pressed close together, with, of course, a divider between each row. Care must be taken that these are fresh and clean, and that they show no signs of buckling. They should not require pressure in being put in position. Springs should be used to tighten the sections together to avoid propolis. The racks should cover the entire space above frames in order that there will be no loss of heat. In all the handling be scrupulous in having hands thoroughly clean, so that there may be no suspicion of a thumb mark. If baits are used, and the advantages are questionable, place them in outside rows, where it will not matter if they are not completed. A better plan would be to have on a box of shallow frames until the flow is fully on and the bees are strong in numbers; then withdraw it and replace it by a fresh section-rack, when bees are likely to start the sections right off.

Don't leave the sections on long, but remove as soon as all cells are sealed, to insure clean comb and untarnished white capping. In removing, use a minimum of smoke, and avoid material with any strong odour in charging the smoker. I do not like the use of the carbolic cloth in carrying out this manipulation as it is so liable to taint the honey. Endeavour to clear out the bees as quickly and quietly as possible, and so insure that there will be no pinholes in capping. Carefully clean up the sections as soon as taken off the hive, and when they are scraped, glazed, and laced, wrap them up until they are required for the show. Personally I prefer prepared cases for the show table. They are very neat and clean, and have as attractive an appearance as hand-laced ones, while they have the added advantage that the judge can easily remove them to examine comb surface and test the flavour of their contents. It is pleaded for the lacing that more character is shown; and that the dozen exhibited convey more the character and individuality of the bee-keeper. That is so only to a certain extent. Avoid overlacing, and don't attempt faking. Choose worker-cell foundation, and fix it true, so that there may be no slanting of the rows.

Insure that the hive is perfectly level. Use queen-excluders below sections. Wrap up surplus chambers very carefully.

I have given so much space to the bee-keeper that I have left little for the bees. Undoubtedly, Black bees are best for sections, with Carniolans a good second. Of these certain strains are much better cappers, and use less propolis. Swarms, as a rule, supply the finest and cleanest sections. They work with such a will, while their brood-combs are so clean and fresh that they give the whitest finish. Combs must be drawn out very quickly, and the quicker they are filled and sealed the better. To aid this, secure them when a full flow is on, if possible, when it is at its height, and if the weather is uniformly good success is all the more certain. Both white clover and sainfoin are copious yielders, at a time when few other sources are available, hence they are important factors in securing prizes.

Location is undoubtedly an important third aid, but in a certain way it works evil on the show bench. Some judges acquire a taste for certain kinds of honey found only in limited areas, and display a preference detrimental to more important staple honey sources. In another way, location greatly aids the production of first-class samples simply because more favourable weather conditions have prevailed in certain counties.

---

## HOMES OF THE HONEY BEE.

### APIARIES OF OUR READERS.

We have pleasure in illustrating this week the charmingly picturesque apiary of the Hon. Rosamund Batesman Hanbury, a very capable lady bee-keeper, who is well known in the County of Suffolk. She writes a short account of her bee-keeping as follows:—

"Bees have been a great source of interest to me. My first hives in my present apiary were given me, and in those days numbered several skeps, and also some observatory hives. A well-known bee-keeping friend strongly advised me to go in for standard hives and work them on a proper system, so one year, with his assistance, the whole of my ten or twelve stocks were transferred to standard hives.

"It was an expensive outlay, but has been a success. I learnt how to wire the frames for foundation, and more about feeding the bees and the care of the hives, so now things run smoothly, and it is easy to interchange sections and frames in the different hives. My assistant, George Saunders, is becoming quite scientific, and takes charge of the apiary and makes all the wax and mead I require. In 1911 we had a record year. From hives Nos. 1, 2, 3, and 4 we took respectively 80lbs., 56lbs., 76lbs., and 41lbs. of honey; from hives Nos. 8, 10, 12, and

13, 104lbs., 44lbs., 75lbs., and 78lbs., our great success being hive No. 7, which yielded 172lbs.—I believe the second best return in the County of Suffolk that year.

“Considering the quantity of honey consumed, one wonders that this industry is not more developed in this country. I have found great advantage in belonging to the Bee-keepers' Association and in taking the BEE JOURNAL, and the visit of the County Expert is always an encouragement and very useful. My bees live in hives that are painted different colours, and are quite a feature in their corner of an old-fashioned garden.” -

and name and address of my apiary, in order that firms might be able to convince customers that they were buying a good article (I find a great number of towns-people are very ignorant as to what honey should be like), but the firms almost invariably order the honey without the label. I think the fear is that customers may order honey direct. I might say I am speaking mostly of sections. The best way to get a market is to keep one's eyes and ears open, deal squarely, and be persevering in canvassing. The most unlikely places, I might say, many times turn out best.



APIARY OF THE HON. ROSAMUND HANBURY, BROME HALL, EYE, SUFFOLK.

## CORRESPONDENCE

*The Editors do not hold themselves responsible for the opinions expressed by correspondents. No notice will be taken of anonymous communications, and correspondents are requested to write on one side of the paper only and give their real names and addresses, not necessarily for publication, but as a guarantee of good faith. Illustrations should be drawn on separate pieces of paper. We do not undertake to return rejected communications.*

### BEE ASSOCIATIONS AND THEIR WORK.

[8962] I have seen it repeatedly stated by correspondents in "B.B.J." that successful honey-showing is a means to a ready market for the disposal of honey. (See "B.B.J.," pp. 55 and 66, as recent instances.) I have certainly not found it so and can hardly point to the single customer obtained by this means. I had a label printed with a list of my successes

I put great value on the importance to any bee-keeper of trying for the expert's certificates. Many things are learned that bring one closer into touch with nature; the infinite beauty, delicacy and adaptability of insect life, and especially, of course, advanced knowledge of the bee-keeper in relation to the bee. I am of the opinion that all Bee-keeping Associations should give to cottagers, and to other members desiring it, a copy of "Modern Bee-keeping." This, at least, they would have always with them, even though the expert failed to pay his intended visit, and might lead to a desire for a more extended knowledge.

I can sympathise with Mr. Mattinson in his lecturing predicament, as I was once put into the same position, through an argument on the advantages of Bee-keeping Associations to cottagers. One man said in the company, "What are the advantages to me?" I must confess I hummed and hawed a bit, and was somewhat relieved when the discussion drifted into another channel.

I am, for the first time, using some W.B.C. hives of Standard pattern, and find that many bees lose their lives by getting capsized in the wind on the hive roof, and sticking there in the wet, which is so often present in showery weather. If the roofs had more slope this would be avoided, as, though the bees are often out after water now, they can make but little of it when they suddenly find it in this manner. I had occasion to lift several body-boxes on to fresh floor-boards in November, and found in every case the cluster extended to the floor-board, though the work was done on cold evenings, a small ring of bees on the board marking the point of contact—a thing I have never noticed in print.—  
J. G. NICHOLSON.

### BEE ASSOCIATIONS AND THEIR WORK.

[8963] I have enjoyed reading your correspondent, "Northumbrian Bee's," comments on "Bee Associations and their Work" (page 65). His opinions and mine have a great deal in common. But it is not his general views to which I am going to draw attention, but rather to one point which has come out in his comments on Mr. Mattinson's letter, and as it rather concerns me I feel the opportunity must not be allowed to slip by. Your correspondent says he has the honour to "belong to four County Associations." Now, of course, he does not say, but in the absence of information one can only presume, that he offers his subscription to whatever County Associations he fancies: they gladly accept the coin, and he becomes a member in every sense of the word. If such be the case, I feel there is something wrong, as a loophole is at once given, which will account in many ways for the unpleasantness among members, and to which the paucity of membership in our County Associations can be attributed. I was asked by a friend in a neighbouring county if he could join our Association. I replied I did not think so, adding, if he could I did not think it would be right.

My idea—right or wrong—of county organisations is that they should be confined strictly to the county. We have our County Show, with special classes for members, &c., with medals, specials, &c., offered as inducements to members to exhibit their produce. And of what use are these classes and privileges if (and as mostly happens with those who want to join the County Associations from the outside) these "professional" members, who are members only for what they can get, come in and take off all the cream, leaving only the skim milk (and not much of that) for those who do all the spade work during the year? To join an adjacent County

Association to obtain expert help and advice is quite right, but I think it should stop there.

I hope your correspondent, Mr. Mattinson, will not think I am referring to him in the above remarks—it is the system, on which I should like to hear other opinions.  
—R. LITMAN, Castle Cary.

### PLANTING FOR BEES.

[8964] I often wonder why more flowers are not planted in the garden for bees. Although one cannot tell how much one's own bees are the gainers, it is better to cultivate the plants that they patronise than those they do not, and who does not like to see their bees near home in showery weather? I believe, however, that bees differ in their choice for blossoms. Some that are spoken of as good honey flowers my bees will not work on at all, while others not often mentioned they revel in.

I am interested in getting some of the noted American bee-plants, and a friend in Indiana has promised to send a few roots of "Spanish needle," which is a splendid yielder in many parts of his State.

But there is one plant that deserves to be grown a good deal in England. I refer to "sweet clover," which is becoming extremely popular in America, and in Ohio it is one of the principal sources of honey. At one time this was thought to be only a wild weed, but now whole fields are planted; as it is supposed to be an exceedingly fine food for cattle, horses, and pigs. A little patch of seed I sowed last March sprang up, and grew till the plants reached the height of 6 feet, and resembled a small bush for sturdiness and size near the earth. I should think it ought to yield well in a dry season, as the roots go down quite a long way, and when established it is an effort to pull them up. There are three varieties, the yellow and the white, which blossom every year after the first; and the yellow kind that blooms the same year as sown.

A farmer friend has promised to devote a corner of one of his fields to "sweet clover," and I am anxious to see the result; because I think it would do well if it once got a good start. If any bee-keeper would like to sow a little of this seed, and will enclose stamps for postage, I will send a packet of each variety as long as the supply lasts.

With best wishes for a good season.—  
A. H. BOWEN, Coronation Road, Cheltenham.

### EARLY POLLEN PLANTS.

[8965] To those bee-keepers who have recently asked questions about early pollen gathering the following list of plants from



which bees gather pollen in the first three months of the year may be of interest:—

*January.*—Hazel, *Chimonanthus fragrans*.

*February.*—Hazel, alder, *Chimonanthus fragrans*, snowdrop, winter aconite, crocus, gorse, coltsfoot, a shrubby Chinese honeysuckle with small white fragrant flowers.

*March (beginning).*—Hazel, alder, *Chimonanthus fragrans* (these three are now nearly over and do not provide much pollen), Chinese honeysuckle, snowdrop, winter aconite (these two also nearly over), crocus, and gorse.

*March (middle).*—A little of those

extended also by inference. We might infer, for instance, that bees which gather pollen from yew might also gather it from the various kinds of trees commonly lumped together under the name cypress; or that gathering it from English elm, they also gather it from the wych elm.—H. A. G., Norfolk.

PROLIFIC STOCKS.

[8966] The photograph of honey which I send represents the surplus from two stocks which are located at an out-apiary. The total amount taken from these hives last year was 376lbs., which is rather an exceptional "take" for this district, and is

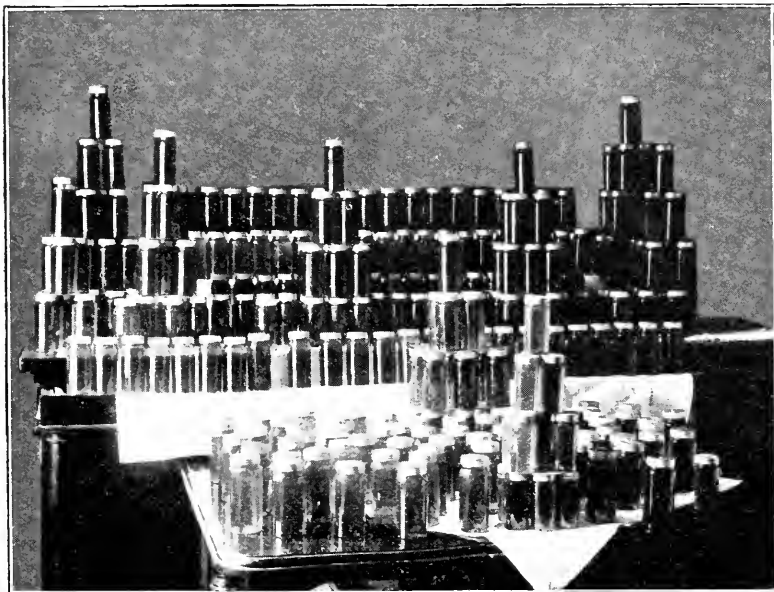

SURPLUS GATHERED BY TWO STOCKS OF BEES.

flowers in bloom at the beginning of the month, and, in addition, violets, the bird's-eye speedwell (*veronica*), arabis, peach (just beginning), wallflowers (a few), yew, crocus, sallow (very little yet), English elm (*Ulmus campestris*), and gorse.

*March (end).*—Chinese honeysuckle, crocus, violets, bird's-eye speedwell, arabis, peach, wallflower, sallow, white willow (just beginning), English elm, *Berberis aquifolia*, *laurustinus*, yew.

Most of these it will be seen are shrubs or trees.

The above list is composed solely of plants and trees from which I have observed bees actually gathering pollen. No doubt the observation of other bee-keepers could greatly extend it. I could easily enlarge it myself by adding those flowers on which I seem to remember seeing bees pollen-gathering before I started making notes on the subject. It might be

accounted for by the fact that within a few hundred yards of the bees there was a fine field of sainfoin for forage. When removing the honey at the end of the season (about the end of July or first week in August) there were so many bees that I had to divide each of the colonies to find room for them, and the four stocks are at the present time doing well; they have not been fed, having harvested quite sufficient to carry them through the winter. The bees are first cross Italians, and I have had as many as six racks of shallow-frames on the hives at one time. My average take from colonies in this position is about 100lbs. in a fair season.—E. WATSON, St. Albans.

PRECISION IN BEE TERMS.

[8967] For pleasure and instruction I never miss the chance of reading Mr. Macdonald's very valuable contributions.

His remarks (p. 72) on "Precision in Bee Terms" are good-natured and necessary, but has he not used an "erroneous term" in writing of the worker bees as "undeveloped female Amazons"? As Amazons, these bees are very fully developed, though that is not my point. Many scores of times I have been assured that a worker is an "undeveloped female." A worker is a female neither neuter nor hermaphrodite, and is no more an undeveloped female than is the queen, which is by implication a fully developed female. The queen has her reproductive organs developed, but not the organs for foraging and nursing—perhaps, we may add, for home defence. The workers have organs for nursing, foraging, and home defence developed, but not fully those of reproduction; and the "mothering" instinct, so distinctive in the female sex, is manifested in them far more than in the queen.—S. J., Glos.

#### NOTES FROM ALLAN VALE.

[8968] My baby nucleus hive was a failure last summer. I made it up in July and the queen flew out and returned mated. The next day, whilst removing the piece of excluder which had kept her in until the afternoon, I did not notice that she had wedged herself in attempting to get out, and so unfortunately I injured her, so that she died. This was annoying, as I have no doubt she was going out for a second flight.

"*Isle of Wight*" Disease.—I am sorry to say this fatal malady is now in my neighbourhood, not a quarter of a mile away. As I expected, the hives that were sent to the heather last autumn by some of my neighbours appear to have returned infected. It is strange how little we seem to know of this disease. Is it caused by a microbe, or is it that the diseased state of the bees favours the development of the microbe? Is it possible that a microbe has been imported from abroad and the cross with some of our British species has produced a hybrid of an especially prolific type? I was told by a bee-keeper the other day about a man whose bees were dying with "*Isle of Wight*" disease. He tried all sorts of remedies without success. At last he said, "Well, anyhow, they are dying; it is kill or cure," so he gave them a dose of jalap; I do not know in what proportion, but I suppose in syrup. At any rate, the result was the bees speedily recovered (apparently).

A new bee-flower suitable for a small garden that I had last summer was 10ft. high, the flower-head stretched out to 7ft., whilst it was 6in. round the foot of the stem. It is a biennial, and belongs to the Hemlock species. You might have seen quite a happy family of bees, flies and

honey-wasps on mine last summer. The flies seemed to know that the honey-wasp would not harm them. But as soon as one of another species came along they were off at once.

Anybody who is troubled with grass growing up in front of their hives might try the following plan:—Get a piece of common roofing felt, such as is used under slating, lay a strip of this down in front of the hive after having first cut the grass short. A piece of felt will last, used in this way, for a year, and not only has it the advantage of preventing the grass from growing, but it also helps the bees that fall on it to rise easily, and, again, you can see if they have thrown out queens in the swarming season.—HUMBLE BEE.

#### THE FLOWERS OF MARCH.

[8969] Leonard Blomefield, who kept observation for many years at Swaffham Bulbeck, in Cambridgeshire, gives the following average dates of flowering for some of the more important March bee-plants: Marsh Marigold, March 5th; Peach, 13th; Coltsfoot, 14th; Willow, 19th; Almond, 28th; Gooseberry, 29th; Ground-ivy, 30th.

This year is likely to be an early one. For example, Blomefield's date for the gooseberry to come into leaf is March 12th. It is almost a fortnight earlier this year, and may be in blossom by that time. Those interested in maintaining the utility of the bee should examine the gooseberry blossom, when they will find that the stamens open some hours before the stigma is ready to receive pollen. So the bee may brush off all the pollen of a blossom before the stigma is receptive, and then it can only be fertilised by another bee coming with strange pollen. It is not a very marked case of adaption for cross-fertilisation, but an experiment carried out at Newton Rigg Farm School, Westmorland, in 1910, showed that where there were no bees there were no gooseberries, while the next bush, to which bees were admitted, "carried an abundance of fruit." If any reader is experimenting this year he must remember, as they did not at Newton Rigg, that the netting put on to exclude bees may do other harm besides, by excluding air and sunshine, and the birds with their keen eye for caterpillars. Both bushes ought to be covered with the same kind of netting for the week or more they are in blossom, and one of them only uncovered for a few hours to let the bees in. An experiment of this sort might produce a very striking object lesson for the sceptical. The Indian or American currant, as it is impartially called, is already showing its colour, and will soon furnish welcome work for the bees. Black-

thorn is coming on, almond and ornamental plum are opening, and some very early pears need only a touch of sunshine to welcome the bees.—G. G. D., Glos.

#### EXPERIENCE WITH "ISLE OF WIGHT" DISEASE.

[8970] I herewith enclose an account of the operations in my apiary during the season of 1913.

During the summer of 1912 I imported some queens from the mainland, and was unfortunate enough to find at the end of the season that I had "Isle of Wight" disease among my stocks; as a consequence I lost all my bees, twelve stocks in all.

While the bees were ailing I tried several advertised cures conjointly, but found that tinkering to cure was useless, so I destroyed all remaining bees, combs, and fittings, and after going over the hives with a painter's lamp, and then using a disinfectant, I determined to make a fresh start. At the beginning of 1913 I bought three stocks of healthy bees, two of which were in skeps and one in a frame-hive. I started feeding early in February, and kept a plentiful supply of syrup on each until the honey-flow set in. The result was that my bees started swarming in May, and by the end of the month I had three swarms. As each swarm came off I gave it a jar of syrup and kept a supply on the old stock as well. At the end of the season I had by natural swarming ten swarms, the three original stocks, and one nucleus. They worked out one hundred and twenty sheets of foundation (full brood) and gave me 400lbs. of honey. Since packing down for winter I have only visited the bees twice, and have given no food until last week, when, on making my second examination, I found a few stocks getting low in stores, and one stock defunct through clustering away from the food and lack of coverings.

I have not noticed the slightest sign of "Isle of Wight" disease recurring among my bees, and I believe I have got rid of it altogether. I do not think there is much danger of the disease recurring if there are no diseased stocks within the radius of flight, provided disinfection has been thoroughly carried out.

I send you this account merely to raise the hopes of despondent bee-keepers who are suffering through the ravages of "Isle of Wight" disease, hoping that it may give them courage to start afresh. I was so disappointed by the loss of my bees that I had almost given up hopes of ever keeping them again. However, as "hope springs eternal in the human breast," I intend to carry out my plan to secure the greatest amount of honey and increase in

bees during the coming season by liberal feeding right up to the honey-flow.

My motto for success in bee-keeping is—feed continuously so long as the weather conditions are favourable. I conclude by wishing the "B.B.J." and its worthy Editors success, and long life to promote bee-keeping.—J. J. MOUNTON, Isle of Man.

#### ILOWITIS!

[8971] Doubt and controversy are still hovering about this dread disease. Some say, "Burn 'em"; some say, "Don't"; some say, "Give 'em physic"; others, "Leave them alone," and still the bees keep dying.

More than one correspondent has asked for information as to whether the disease has run its course and is dying out in any of the places where, during the past few years, it has been so rampant. Writing so far as my knowledge is concerned, its ravages are as evident as ever, and no stock which has once contracted the disease actually recovers, although an improvement does set in sometimes sufficient for the stock to gather a surplus during the summer, but as a rule it has to be written off before the spring comes.

Why the designation, "Isle of Wight" disease? I don't think the description fair. I do not think that the disease originally started in the island for at about the same time as the outbreak occurred in the island I was called to see a stock which was showing unusual symptoms, at Churt, in Surrey. Fortunately for Surrey, perhaps, I did not realise the nature of the complaint, but put it down to paralysis, a known disease amongst bees. The insects displayed all the characteristic symptoms which are now so familiar with us. Its history: an imported Italian stock arrived in Hampshire in July, was taken to Churt in the same month, and in September was in a wretched condition.

Is it of revenge to the Isle of Wight bee-keepers, who so prominently brought this disease to the notice of the public, that the name "Isle of Wight" is so persistently tacked on to the disease? Those bee-keepers, according to Mr. Mace, in "B.B.J.," February 19th, are to bear the blame for wafting the spores to the mainland, when in my opinion the spores were there already, but not recognised. Another case came under my notice in 1908. I was visiting a bee-keeper who lived miles from the beaten track, and well away from any other apiary, when I noticed the same symptoms as those displayed by the bees at Churt, in a stock in this apiary. The bee-keeper declared that he had had no dealings with any other bee-keeper, either in appliances or bees, for years. *Whence*

did this stock receive the infection? From the Isle of Wight? "I ha'e ma doots."

From that year the disease spread with alarming rapidity all along the hill-tops, and in the valleys in the following spring, a visit being made to my own apiary. Poor Surrey was visited at about the same time, and now in many an apiary once alive with the merry hum and bustle of the bees, silence reigns supreme.

Who amongst us shall arise and declare "Eureka!"?—HANTS BEE.

#### "ISLE OF WIGHT" DISEASE.

[8972] On page 76 of BEE JOURNAL, Mr. H. Mace says that every stock suffering from "Isle of Wight" disease in the spring can be cured temporarily, simply by removing the stores. Most of us would like to know how long does the cure last, and how can a cure be possible by such simple means when, as Mr. Crawshaw says, on page 78, that the structures of the internal organs of a bee suffering from "Isle of Wight" disease are unspeakably ruined? I have practised destruction of diseased stocks before robbing starts, and seem to have met with some measure of success in preventing the spread of the disease through my apiary. If that is so or not, I will send a full report later on, but I do not wish to crow too soon.—H. W., Kent.



*Long-lived Bees* (p. 48).—This subject is far from being unprofitable or uninteresting. I do not know the conditions under which Mr. Desmond's bees worked last year, but if the seasonal conditions were anything like our own, it may be that he condemns the hybrids too readily. On the other hand, if his stocks continued to gain whilst the hybrids lost weight, his criticism is probably just. But in such comparison the age of the queen should never be overlooked. So much centres upon the queen that her record should be closely scanned. Many artificially-reared queens are not worth hive room, although the stock from which they come may be the best. But prolificness alone is insufficient merit. Personally, I prefer a self-contained strain which will respond readily to a little stimulation. With such a strain the bee master can get his bees when he wants them. But the bees should be hardy to stand early stimulation. Last autumn I packed up a tiny nucleus which so far is all right. Whether it will stand the strain of brood-rearing remains, however, to be seen.

*Re De-queening*.—"D. M. M." would make reservations as to the infallibility of this queen-substitution. But will he not tell us what the reservations are? I am supposing that the A. C. Miller smoke method of introduction is in question. Anything that comes from Mr. Miller's pen is not to be lightly dismissed. Judged by his writings, he appears a methodical observer, who acquires his data at first hand. He deserves to be more widely known than he is, at any rate in this country. It is this first-hand observation which is so valuable. But it demands its own price, and is generally its own reward. Almost anyone can theorise, or quote recognised authorities. Half the bee books ever written exhibit the follow-my-leader spirit, which labels their authors leaders of the blind.

*Up a Gum Tree* (p. 50).—"D. M. M." says that the great, grand, glorious, &c., gum tree is more valued for its honey in Australia than here. But does it exist here in sufficient numbers, or yield honey to such an extent, as to be considered at all? Or is "D. M. M." merely disparaging the imported honey? In this I should agree, as I do not like such samples of Australian honey as I have tasted. But I own to prejudice, and considerable ignorance. I am not sure that I should recognise "gum honey." In fact, I admit that I thought the principal bee-keeping use of the gum-tree was to make the type of hive which gives Mr. Hopkins bad dreams.

*A Swarm in January* (p. 59).—This is not, as might reasonably be supposed, in the Antipodean summer, but in our own rather summer-like winter of 1913-14. "A swarm in Jan." arouses speculation as to the rest of the couplet. "The season has begun" is obviously untrue, apart from its vulnerability to other criticism. "Surprises any man" seems reasonable. My own view of this occurrence is that it was simply due to the unusual weather, which has already effected queer things. The other day, so I read, before the sun had dried the roads, a motor-bus came skidding along from side to side, followed by another gyrating Jumbo. "Ow," said the conductor, "it's the spring wot's got in their blood, they's as frisky as—little cocksparrows." Well, if buses, why not bees? The probability is that scout bees brought home strange reports of the progress of things, and were chased out of the hive as little liars by the rest of the bees *en masse*. Then they discovered that there was something in the idea, and had a flutter on their own. The queen, being older and more experienced, quickly discovered the error, and in her haste, and her flustered annoyance at their frivolity, got

back into the roof. I give this explanation for what it is worth, as it is quite likely that the bees are queenless.

*Wiring Frames* (p. 68).—Will Mr. Harris give us his reasons for wiring as he does? My own wiring is similar, but I use three wires of thinner gauge, and imbed from one side of the foundation in the usual way. I like the third wire, as it supports the comb where weakest, and centralises the bottom of the sheet. There is a slight tendency of the "soldering" wax to pull the sheet as it contracts, which I have not seen mentioned previously. Perhaps this only occurs where much wax is used. I solder with the usual can and do not consider it wasteful. This tip of warming the sheets before imbedding is good, though rather suggestive of winter nights. I believe that if the fixed foundation were warmed just before inserting the frames in the hive, and any slight bulges fingered flat on a wet wiring board, there would be fewer buckled combs. I usually look over my foundation a day or two after insertion, in case —.



[8909] *Various Queries*.—I bought a hive of bees at a sale last October. I was told they had sent off a swarm the same season, so they have a new queen, and seem to be a strong healthy stock. They have been out foraging in great numbers on every favourable day lately, and I have noticed them carrying in pollen from crocuses in my own garden. But the hive is a very old one and it will either have to be repaired or destroyed. I have ascertained by measuring from end to end of a frame (over the quilts) that the top bars are 17in., so I presume they are standard frames. I have made a new hive from the illustration of a "W. B. C.," given in the Bee-keepers' Guide Book, and I wish to transfer the bees to it as early as possible. (1) When can I do so? (2) If the frames prove to be not of standard measurement, what shall I do? (3) I have left the queen-excluder on all winter (there is a quilt between this and the frames), and have fed with candy over the excluder. Have I done right, or should I remove the zinc to continue feeding? I am doubtful whether all the bees have easy access to the candy. (4) With reference to the new hive, should it be painted inside, or merely treated with recipe No. 9 or 10 given in the "Guide Book"? (5) How long shall I go

on feeding with candy, and is it necessary to give artificial pollen? (6) Is it possible to get both a swarm and moderate return of honey (given a good season)? I am sorry to trouble you with so many queries, but I am very eager to become a competent bee-keeper, as I wish to teach the subject to my school children in conjunction with school gardening. I shall be very grateful for a reply to the above in the "B.B.J."—S. T., Derby.

REPLY.—(1) On a fine, warm day in April. (2) From the measurement given the frames are standard size, so you will have no difficulty. (3) The excluder zinc should only be on the hive when it is supered; you should take it off at once. (4) Paint the outside of the hive only, and do not put anything on inside. (5) Till the end of March. As you say the bees are carrying in pollen, there is no need to give an artificial supply. (6) It is not impossible, but improbable that you can increase and get surplus honey.

[8910] *Working for Sections*.—Our honey-flow is very short here, fruit blossom lasting two or three weeks. I work solely for comb-honey. Would you recommend the following?—When the bloom begins to show, take two strong lots next to each other, and fill one hive full of sealed brood taken from both, leave one queen, cut out any queen-cells there may be (preparatory for swarming) and put on two racks of sections. Move away the other hive with the other queen to a new stand, and place the doubled hive so as to receive all the flying workers of both. By the time the bees have made cells and raised a new queen, the honey-flow is over, for there would be no risk of swarming.—T. O. B., Culltin.

REPLY.—Yes, your suggested plan would work all right, but personally we should put on one rack instead of giving two at the same time.

[8911] *Fumigating Combs Containing Stores*.—Please let me know through the "B.B.J." if the following method has been tried with frames containing stores from stocks that have died through "Isle of Wight" disease. Make an airtight box and fumigate with formalin for eighteen to twenty-four hours. If I tried this plan would the stores absorb the gas and become poisonous? How much formalin would you recommend to be used to each cubic foot? If the above has been tried could you let me know results?—J. W. H.

REPLY.—It is impossible for the fumes to enter the food, especially when it is sealed over. The only safe plan, however, is to burn the combs. The honey is quite fit for human consumption but not for bees.

## Bee Shows to Come.

A nominal charge of 2s. 6d. is made for notices (not exceeding 7 lines) in this column, 10 lines charged 3s. 6d., up to 15 lines 5s., which covers cost of insertion from order till date of show. Cash should accompany orders for insertion.

**June 9th-11th, at Malvern.**—The Herefords and Worcs. Agricultural Society's Malvern Meeting. Twelve classes for Honey, &c. Good prizes; small entry fees.—For schedule apply, Mr. A. Elliott, Hon. Secretary's Department, Cusop, Hereford.

**June 30th to July 4th, at Shrewsbury.**—Royal Agricultural Society's Show. Bee and Honey Section, under the direction of the B.B.K.A. Prizes arranged in groups of counties for Associations affiliated to the B.B.K.A. Schedules from W. Herrod, 23, Bedford Street, Strand, W.C. Entries close May 30th.

**July 8th, at St Albans.**—Honey Show of the St. Albans B.K.A., held in connection with the Elstree and Boreham Wood Horticultural Society, at Aldenham Park. Open class for extracted honey. No entry fee. Liberal prizes. Judge, Mr. W. Herrod. Schedules from Mr. R. H. Attenborough, Alderham, Herts. Entries close July 6th.

## Notices to Correspondents

**Izon (Kent).**—*Starting Bee-keeping.*—(1) British bees. (2) "Wilkes'" excluder is best, as it does not hinder the bees so much when working.

**G. H. (Buxton).**—*Hive for Beginner.*—Get a "W.B.C." hive, it cannot be beaten as an all-round utility hive.

**E. K. H.**—*Bee-forage.*—It will be best to work for sections on the bean pasturage.

**BRITISH COLUMBIA.**—*Bee-keeping in Canada.*—(1) Bee-keeping is a profitable undertaking in British Columbia, see "B.B.J." November 13th, 1913. (2) Write to Mr. Dundas Todd, 1260, Oxford Street, Victoria, B.C., who will give you all particulars.

**H. A. C. (Ealing).**—*Varieties of Bees.*—(1) The bees are Italians. (2) If you study the subject beforehand, no doubt you would be able to rear queens successfully. (3) Fertile queens are worth anything from 3s. 6d. to 50s., virgins 1s. 6d. to 4s.

**Y. D. B. (Oundle).**—*Re-arranging the Apiary.*—(1) We should advise you to stick to your own bees for the present, in view of the risk of introducing disease. (2) In the "W.B.C." you have the best type of hive to use.

**W. C. (Long Eaton).**—*Transferring from Skeps to Frame-hives.*—(1) You should

buy the "British Bee-keepers' Guide Book," on page 149 of which you will find the method of doing this fully described. You should also join the Notts Bee-keepers' Association. The Hon. Sec., G. Hayes, Mona Street, Beeston, will send particulars if applied to.

**NOVICE (Caerphilly).**—*Renewing Brood-combs.*—(1) Your question is not quite clear. If the combs are at all unsatisfactory, it will be best to melt them down and use foundation in new frames. You should on no account manipulate the bees yet, it is too early in the year for this. (2) Re-queen as early as possible in April, and contract the bees on to the number of combs they cover.

### Suspected Disease.

**G. L. (Dunstable).**—From your description we are afraid your bees are suffering from "Isle of Wight" disease.

**D. L. (Finchfield Road).**—On no account must you use the old combs. Burn everything movable in the hive and scorch the latter with a painter's lamp. Start afresh on new ground if possible.

**A. J. C. (Pudsey) and W. H. (Parkeston).**—We do not find any trace of disease in bees sent.

**C. KEMP, C. E. (Sedgley), O. W. B. (Tamworth), H. C. (Worth), PERPLEXED (Carlisle), A. B. (Warwicks.), G. A. H. (Hinckley), P. E. (Fareham), BEGINNER WITH BEES, W. J. (Llandaff), W. H. (Streatham), P. W. DIX, and A. BONELL.**—The bees have died from "Isle of Wight" disease.

**W. J. P. (Plumstead), J. G. (Bearsden), ANXIOUS (Cockermouth), and J. L. (Merton).**—The bees were too dry for us to determine cause of death.

**J. B. (Huddersfield).**—There is every sign of "Isle of Wight" disease. Do not use the combs again, better burn them.

**R. T. (Devonport).**—There is no sign of disease in bees sent.

**W. L. S. (Chatham).**—The bees have died of "Isle of Wight" disease. See reply to "D. L." above.

**D. N. (Wishaw).**—Bees have died of "Isle of Wight" disease. The honey can be used for home consumption but not for other bees.

**G. H. (Derbys.).**—The bees were too decomposed for examination.

**C. HOPKINS.**—It is "Isle of Wight" disease. You have done all possible to mitigate chance of it recurring. Start again with a couple of stocks on fresh ground.

### Honey Samples.

**H. S. (Shipley).**—A good heather blend honey worth 1s. per lb. retail, or 9d. to 10d. in bulk.



**BRITISH BEE-KEEPERS' ASSOCIATION.**  
THE ANNUAL MEETING.

The B.B.K.A. annual meeting and half-yearly conversazione will be held in the Lecture Hall, Zoological Gardens, Regent's Park, on March 19th. The annual meeting, for members only, will commence at four o'clock, and the conversazione at 5.30. Tea will be provided and all interested in bee-keeping are cordially invited to attend. Mr. T. W. Cowan will give the concluding part of his lecture on "Bee-keeping in Other Countries," illustrated by lantern slides specially prepared for the occasion, and Mr. W. Herrod will lecture on "How to Manage Home and Out-Apiaries, including the Prevention of Swarming." A most interesting evening is expected, and it is hoped that members will endeavour to attend and will bring friends with them.

**NORTHANTS. B.K.A.**  
ANNUAL MEETING.

The thirty-first annual meeting of the Northamptonshire Bee-keepers' Association was held in the All Saints' Church Buildings, Northampton, on Saturday, February 28th.

The Rev. H. C. Holmes (Rector of Thorpe Achurch) was in the chair, and among those present were bee-keepers from all parts of the county.

The report, presented by the secretary, stated that the balance of the Society was now £4 5s. During the year a set of fifty lantern slides had been purchased at a cost of £2 13s. 9d., and were available for lectures anywhere in the county. Last season was not a good one for the majority of bee-keepers, though good takes of honey were reported in various parts.

During last year fourteen demonstrations were given by experts at horticultural and other shows, and five candidates presented themselves for examination for experts' certificates. Four were successful.

The dreaded "Isle of Wight" disease had made its appearance in different parts of the county, and the hope was expressed that bee-keepers suspecting its presence would at once notify the secretary.

The balance-sheet showed that the subscriptions during the year had amounted to £25 18s. 6d. and the total receipts to £50 16s. 4d. The expense had been £55 11s. 4d.

Both report and balance-sheet were adopted.

It was decided to hold the annual show in Abington Park, Northampton, about the middle of August, and to invite Mr. W. Herrod to again act as judge. It was decided this year to divide the honey in one of the open classes between Weston Home and Brixworth Workhouse.

The choice of president was left to be made at a subsequent date by the committee. The following were elected vice-presidents: Earl Spencer, K.G., Sir A. de Capell Brooke, Bart., Mrs. Eykyn, Mrs. Irene Osgood, Mr. H. Manfield, M.P., Mr. C. W. Phipps, Mr. T. G. Paget, and Mr. A. R. Steele.

The hon. secretary (Mr. R. Hefford), hon. stewards (Mr. R. Brawn, Kings-thorpe, and Mr. W. T. Munn, Northampton), and the hon. treasurer (Mr. G. E. Atkins) were re-elected.

The following form the committee: Messrs. J. R. Truss, F. Old, C. J. Burnett, A. Hiscock, C. E. Billson, W. H. Chambers, G. Page, J. Bubb, W. Osborn, O. Orland, G. Mason, Rev. J. P. Friend, and E. Thompson.—R. HEFFORD, Hon. Sec.

**DEATH OF A GOOD BEE-KEEPER.**

The older readers of this JOURNAL will learn with regret of the death of Mr. J. W. Jacomb-Hood, Chief Engineer of the London and South-Western Railway, on the 6th inst. His love for bee-keeping was manifest in the trouble he took while district engineer to induce the Company's country staff to keep bees. He was formerly, I believe, an active member of the Surrey B.K.A., and when transferred to Exeter he was largely instrumental in the revival of what is now the Devon B.K.A. in 1897, when his skill as practical expert and lecturer was invaluable.

On his removal to London to take up the absorbing duties of Chief Engineer, Mr. Jacomb-Hood had to part with his apiary, but to the end his heart retained a warm corner for bees and bee-men. He was a genial and agreeable companion, and will be widely regretted. His death occurred in the hunting field near Dulverton, Somerset, where he was taking holiday.—H. J. O. WALKER, Lieut.-Col., Leeford, Budleigh-Salterton.

**HONEY IMPORTS.**

The value of honey imported into the United Kingdom during the month of February, 1914, was £2,273.—From a return furnished to the BRITISH BEE JOURNAL by the Statistical Office, H.M. Customs.



### HOW TO MAKE AND STOCK AN OBSERVATORY HIVE.

Most novices are very keen to see bees at work, and for this purpose purchase so-called observatory hives to place in the garden. These are only ordinary hives with a glass panel on two sides, and sometimes one in the back as well, over each of which is fitted a hinged shutter. All that can be seen in such hives are the underside of the abdomen of the bees, and their feet, as they run to and fro over the glass, the ends of the frames, and at most one side of two combs.



FIG. 1. OBSERVATORY HIVE IN A WINDOW.

These panels are worse than useless, as they make the hive much colder than if it was made of solid wood. The only satisfactory observatory hive is one in which, when the frames are in position, each side of every comb is visible with the bees working upon them, and which can be examined at any time either night or day without disturbance. The ideal place for an observatory hive is inside a room. Fig. 1 shows my own fitted on a stand inside a window of my den, the entrance as seen being cut through the wooden sill, while the brick sill forms an alighting place for the bees. In most houses this can be done in either a lower or upper window, so that the bees can be seen, as mentioned above, night or day. It is most interesting to watch their operations during the latter period. If there is no room indoors, or the windows are inconvenient, then a shelter out of doors will have to be



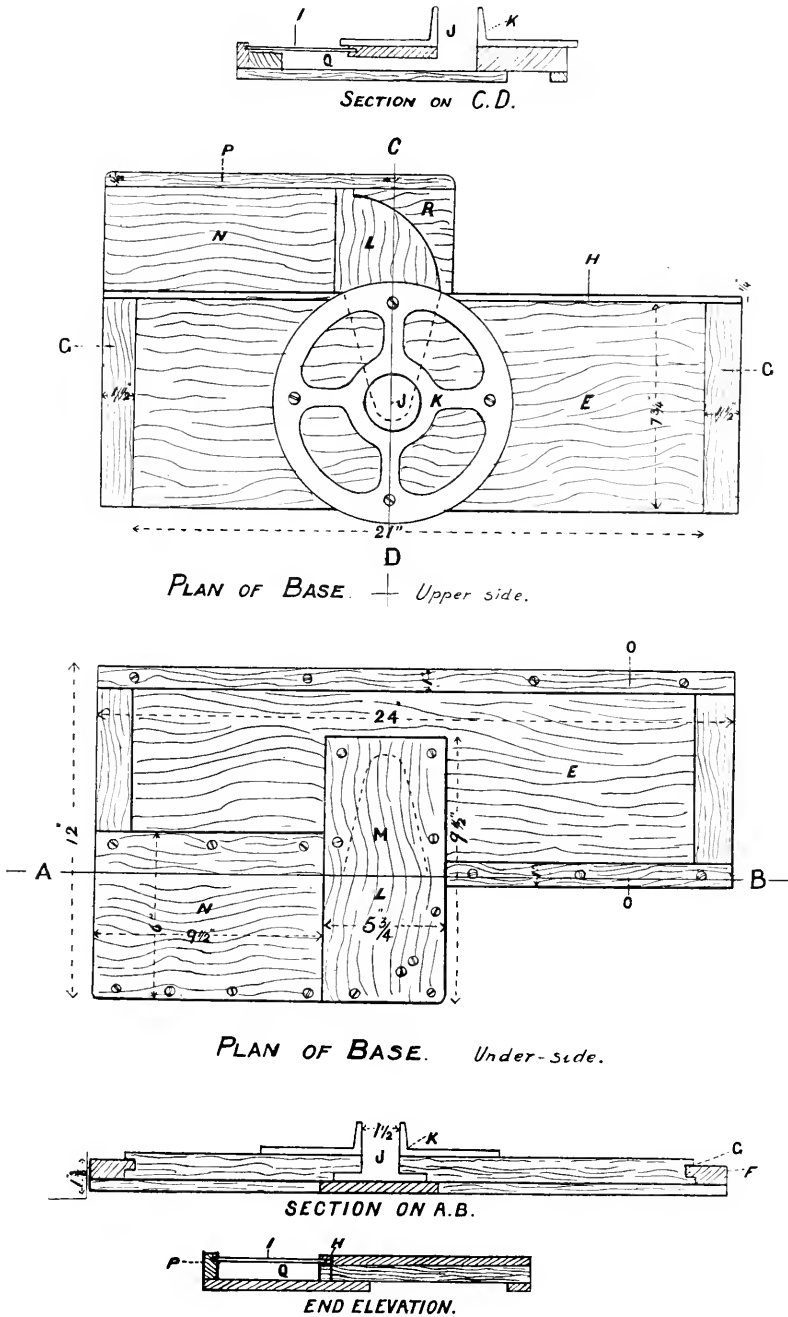

Fig 2.

A. B., Longitudinal Section; C.D., Cross Section; E., Baseboard; F., End Cleat; G. Rebate; H., Grooved Strip; I., Glass; J., Entrance Hole; K., Turntable (lower half); L., Underboard for Tunnel; M., Line of Tunnel; N., Underboard for Tunnel; O., Under Strips; P. Grooved Strip; Q., Tunnel; R., Corner Stop in Tunnel.

constructed for it to stand in, or an outhouse may be utilised, but in this case night observation is not so convenient.

I am convinced that if these hives were not so costly many more bee-keepers would possess one; therefore, I will endeavour to explain, and illustrate by drawings, as simply as possible, how I made my own, so that any amateur carpenter bee-keeper may make one, from which unlimited pleasure will be derived.

There are three forms of observatory hives, viz., Three Frame, Six Frame, and Single Frame or Unicomb. The latter is used for exhibition purposes only, and bees should not be kept in such hives for longer than a week at a time; later on I will give instructions how to make one of these. The one mostly used is that holding three frames, and if I give the dimensions and method of making this, it will serve for the six frame as well, as, for the latter, it is only necessary to make the base and bottom boards the extra length necessary to accommodate the other three frames, taking care to make the entrance tunnel in the centre.

The first consideration is the material. Oak should not be used. It is too hard and close in the grain, is difficult to work, and a good conductor of heat and cold; therefore does not maintain an even temperature. Mahogany looks very nice, but is expensive, and, being short in the grain, splits very easily. Yellow pine will be the best for the novice to use, as it is easy to work, contains few knots, and, being porous, it is a bad conductor of heat or cold. Failing this, nice soft white deal, as free from knots as possible, may be used.

The base board (Fig. 2) should be made first. A piece of wood is prepared so that it finishes 2 in. long,  $7\frac{3}{4}$  in. wide,  $\frac{7}{8}$  in. thick (E); on to each end of this a piece of wood  $7\frac{3}{4}$  in. long, 2 in. wide,  $\frac{5}{8}$  in. thick is fixed, with the grain running in the opposite direction, by means of a groove  $\frac{1}{2}$  in. deep and  $\frac{5}{16}$ ths of an inch in the base board, and a lip of the same dimensions on the small piece, glued in, section shown at F. This prevents the base board from warping, and leaves a rebate of  $1\frac{1}{2}$  in. by  $\frac{1}{2}$  in. at the top (G), which makes it look neater. On the edge of the base board a piece of wood 24 in. long,  $\frac{1}{4}$  in. thick and  $\frac{7}{8}$  in. wide (H) is glued and nailed. A groove  $\frac{3}{8}$  in. wide and deep and  $\frac{3}{8}$  in. from the top, is ploughed the whole length, for the reception of the glass to cover the tunnel. An entrance hole  $1\frac{1}{2}$  in. in diameter (J) is now bored in the centre, over which is screwed the bottom half of the turn-table, which is a brass wheel having a cone standing up in the centre 1 in. high and  $2\frac{1}{4}$  in. wide at the base, tapering to  $1\frac{7}{8}$  in. at the top (K). This can be purchased for about 10s. 6d., or one can be turned out of hard wood, such as oak or ash. The brass one is the best, as it is firmer, looks neater, and works smoother. If a wooden one is used, it must be kept well polished on the working surfaces with black lead or French chalk. On the underside of the board an entrance  $\frac{3}{8}$  in. deep is cut, commencing 3 in. wide at the edge of the board, and tapering to the entrance hole, as shown by the dotted line at M. On the underside a piece of wood (L),  $9\frac{1}{2}$  in. long,  $5\frac{3}{4}$  in. wide and  $\frac{1}{2}$  in. thick, is screwed so that it reaches  $5\frac{1}{2}$  in. on to the base board and covers the entrance hole and tunnel which has been cut.

Butting on to the side of this a piece of wood (N),  $9\frac{1}{2}$  in. long, 6 in. wide and  $\frac{1}{2}$  in. thick, is screwed. On either edge, at O, pieces of wood 1 in. wide and  $\frac{1}{2}$  in. thick are screwed, so that the base will stand level. On the upperside of base, at P, is glued, and then screwed from the underside, a piece of wood  $14\frac{1}{2}$  in. long,  $\frac{1}{2}$  in. wide and  $\frac{7}{8}$  in. thick, in which a groove  $\frac{3}{8}$  in. deep and wide and  $\frac{3}{8}$  in. from the top is cut, to correspond with that at H, to make the tunnel (Q), and also to fasten the pieces of wood, L and N, securely together. A piece of wood (R),  $\frac{5}{8}$  in. thick, is cut to shape, glued in, and screwed fast from the underside, as shown, to stop up that end of the tunnel. Pieces of  $\frac{3}{16}$ ths of an inch plate glass, cut to fit into the grooves provided for the purpose, complete the tunnel. These should be about 2 in. wide, so that if, for any reason, the bee-keeper wishes to catch bees when they are passing along the tunnel, they can be moved easily. If all glass is used, moisture often condenses on the underside, hindering the view; to prevent this it is advisable to have two or three strips of perforated zinc alternating between the glass slips for ventilation. The floor of the tunnel should be painted white, so that the bees can be seen easily.

*(To be continued.)*

**BLURTS FROM A SCRATCHY PEN.**

CONTINENTAL WANDERINGS.

(Continued from page 75.)

Astigmatism is a defect of vision which prevents its victims from seeing clearly even their most immediate surroundings. Sometimes it arises from corporeal infirmity, but at other times even

infirmity, for we wanted to give readers a photograph of the Luxembourg Gardens apiary (I wonder if anybody recognises that central figure?), showing the grouping of the hives and the clinging, ereeping ivy hedge which at once gives privacy and watches and wards passers-by against the attacks of viciously-disposed bees. It is,



EXPERIMENTAL APIARY, PARIS.

the most acute of vision will suffer from an attack, especially if there is an obstructing reason, and in this instance I rather think it was the latter cause which prevented *our friend* the gendarme from

indeed, very prettily situated in one of the most picturesque parts of the "Jardin." We should have liked to have seen the hives themselves more widely spaced. They seemed much too crowded

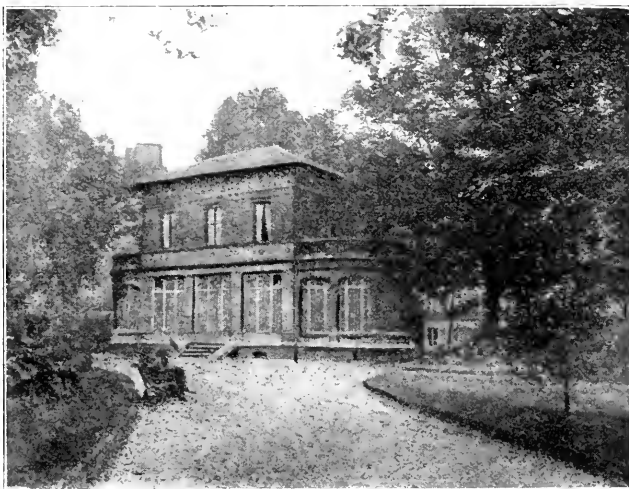

THE LECTURE PAVILION.

seeing three individuals of English appearance who suspiciously moved about midst the shrubs and trees, snapshotting now here and now there. It must have been a very severe attack indeed which had so blinded him, but we callously gloried in his

together, in view of possible outbreaks of disease. But we were not out to grumble, nor to look for faults, either with the candle of Diogenes or with a microscope. It suffices that apiarists have worked here: clever men, they have here studied and

made observations from which knowledge has been gained for which the bee-keeping world has been grateful. If they have not felt the want of more elbow-room it has no concern with us. But there, I have always understood it is an Englishman's privilege to grumble at everything which is not to home pattern. Our own apiary

worker, and drones, similar to those we possess, on the table. This is the theatre, where the lectures are given, where the classes are taught. The figures are Monsieur Sevalle in the centre, his assistant on the right as you look at the picture, and Mr. Herrod on the left. An irreverent person has asked why there are

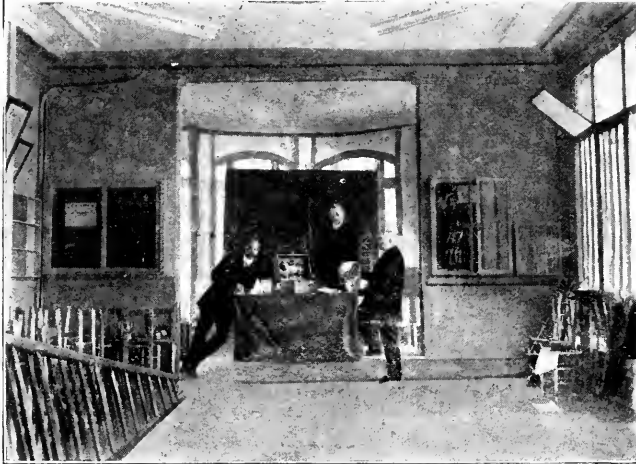

INTERIOR OF LECTURE PAVILION.

at the Zoo—No! I won't compare; I said in my last I would not.

With your back to the apiary proper, if you look "eyes left" you will see the lecture-hall of the school. This also we are enabled to reproduce. A plain build-

palisades in the room. Lest another should make the same mistake, let me hasten to inform you they are stacked-up chairs.

Monsieur Sevalle is great at fruit-growing in his home at Issart-le-Roi. The pears

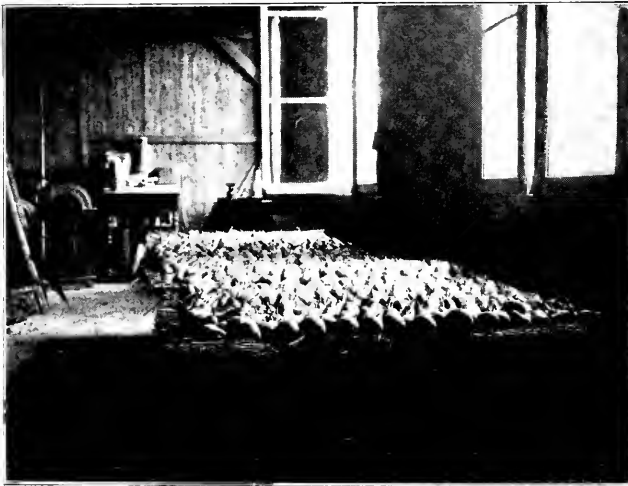

"WILLIAM" PEARS.

ing, as you may see, with nothing outwardly to attract attention. Interiorly also, as shown in the other photograph, it is very simple. A few charts of bee-keeping, a few pictures interesting to the fraternity on the walls, and models of queen,

we know by the name of "Williams" he produces in great numbers. Here we have a little "interior." Just one of his fruit rooms; all those round-looking objects you see on the staging are these beautiful pears, wrapped each in paper

bags to be sent to the Paris markets. In another room we note his cider and wine press, which, with a little adaptation, serves for a wax press. With such a powerful machine the very last morsel of wax is squeezed out.

We did a heavy day's work in Paris that day, and of course it was necessary to recuperate exhausted nature at the usual hour of lunch. There are some very agreeable restaurants in Paris, such as the "Duvals," somewhat after the style of our "Lyons," where you can, according to advertisement, dine cheaply and well. So we wandered into one of these. Of the repast I will say but little. It was quite satisfactory. But, like our own bees, the sting was in the last section. We had arrived at the cheese. On the menu was enumerated, among others, "Fromage Cheshire." Having a curiosity to see what concoction they would serve up in France for our English cheese, incautiously I requested a portion of "Fromage Cheshire," pronouncing it English fashion. You should have seen the look of indignation on the face of the waitress. "Monsieur," she almost screamed, "il n'est pas fromage Cheshire, il est fromage *Shuyshire*." I felt very humbled. I had come a long way to be taught how to pronounce "Cheshire cheese."—JNO. SMALLWOOD.

(To be continued.)

DEATH OF MR. A. SCHROEDER.

It was with deep regret that we received notice of the death, on February 17th last, of Mr. Alex. Schroeder, of Trieste, a reader and contributor to the "B.B.J." for many years. Mr. Schroeder was fond of travelling, and always managed to find out bee-men in whatever country he visited. An account of his visit to Roman bee-keepers appeared in "B.B.J." of June 23rd, 1910, and in January last year, at the close of a tour round the world, he described some Japanese apiaries he had seen while in Japan. He was in the sixty-fourth year of his age.

CORRESPONDENCE

The Editors do not hold themselves responsible for the opinions expressed by correspondents. No notice will be taken of anonymous communications, and correspondents are requested to write on one side of the paper only and give their real names and addresses, not necessarily for publication, but as a guarantee of good faith. Illustrations should be drawn on separate pieces of paper. We do not undertake to return rejected communications.

BEE LITERATURE FOR SCHOOLS.

[8973] It is a hobby of mine to collect bee-books. Thus, when the other day a booklet, entitled "A Worker on the Wing," was put into my hand, it was eventually placed upon my bookshelf. When, however, I found time to examine it, I decided that it must take its place among the unrelia- bles of bee-literature. It is published by Messrs. Dawson and Watson, Ltd., of Manchester, and is one of a series of books intended for use in schools. It has evidently been written by someone who is no bee-keeper, who possibly has never seen the interior of a hive, and who certainly is totally unacquainted with present-day apian science. It sounds some-



M. SEVALLÉ'S CIDER AND WAX-PRESS.

thing like a twentieth-century repetition of the heresies of Huish.

Bees are made to carry on conversations in every-day English. This is, of course, an old trick, but it is questionable whether it has not been worked to death by now.

I find that, starting with a swarm in May, another (presumably a maiden swarm) is thrown off at some later time, and that towards the end of the season, this maiden swarm is sufficiently advanced to allow of the owner taking out quite a large quantity of honey, and leaving enough for the needs of the bees during the coming winter. A most amusing part about it is that this swarm is led off by a virgin queen, leaving the old queen in the hive. Then the method of taking honey is one which I would not like to suggest

should be incorporated in the next batch of "Hints for Novices." To quote verbatim:—

"Well, one wet day in autumn, when all the bees in the new hive were at home, they heard someone moving about outside, and presently some strong smelling smoke came into the hive. The bees did not like it, so they rushed to the door, but found the doorway stopped up with clay. A pipe was stuck through the clay and Mr. Brown was puffing in tobacco smoke to make the bees go to sleep."

Surely Mr. Brown's name ought to go down to history as one of the present-day leaders in apiculture.

This is how Mr. Brown hived a swarm:—"He made sure at once that the *young queen* was amongst them, and then turned the hive over quickly on to the bench, so that the bees were underneath it. For a little while he kept the hole where the bees go in stopped up with grass, so that the bees could not get out before they had time to become used to their new home."

Another extract might have been written more than a century ago:—

"The master of the garden in which we live calls it pollen. Out of this, too, some of the bees make the wax-boxes which are used to store our honey."

Shades of Huber! Wax made from pollen! This in the twentieth century!

The rest of the book is more or less on a level with the extracts already quoted. If children may not be taught something better than this, then leave Nature study alone in schools, at least so far as it refers to bees.—D. WILSON.

#### PLANTING FOR BEES.

[8974] Would you kindly allow me a little space to say that as a consequence of my note under the above heading, which appeared in last week's BEE JOURNAL, I have been inundated with applications for "sweet clover" seed, and for particulars as to how it ought to be planted. I have had a difficulty to mete out the seed, and make it last; but a little more is coming over, and then I can send to those who still want to plant some.

The seeds ought to be sown very thinly in drills, and covered with fine soil, in which a little lime or road dust has been mixed: for it thrives best in soil containing most lime. When the plants have grown sufficiently they should be transplanted to about 1 foot apart, as the growth is so luxuriant in good soil that plenty of room is necessary. A few sticks are useful to support the plants when they reach the height of 2 feet and over.

The blossoms, which are small, appear first at the tip of the main stem, and then from the off-shoots, while the white variety is the quickest to bloom, and also the hardiest. I should be glad if you will insert the above hints, because it was impossible for me to write personally to all the bee-keepers who applied for seed.—A. H. BOWEN, Coronation Road, Cheltenham.

#### IS "ISLE OF WIGHT" DISEASE A NEW COMPLAINT?

[8975] In view of the recent discussion as to the origin and spread of the "Isle of Wight" (?) disease, it may be interesting and perhaps instructive to BEE JOURNAL readers if you would print the two following extracts:—

*Editorial*, "B.B.J.," August 1st, 1881: "We have heard of many cases of what appears to be paralysis of the wings of bees, which threatens to decimate the hives to which they belong, hundreds lying about the apiary, rendering it impossible to walk about without treading some to death. There is no dysentery or abdominal distension, and the bees take food when offered, but cannot fly. There is no appearance such as one would expect from poisoned food, nor is there any deficiency of food in the hives. The bees come out to take their flight and fall to the ground, and are unable to rise again. It appears to be worst in the morning after a previous day's confinement at home through wet or cold weather. Can anyone throw any light upon the cause of the malady?"

*Correspondence*, "B.B.J.," August 1st, 1882: "I send with this some hybrid bees, which are affected with some sort of disorder which I cannot make out. It does not appear to me to be dysentery, as they do not void their excrements either in the hive or on the alighting-board, but crawl out (and are dragged out by the other bees) swollen and distended, as you will see. They seem more than half paralysed, cannot fly, but drop down off the floor-board in large numbers. What is the disease? . . . What I send do not represent the whole mortality. If continued at its present rate of course the hive *must* dwindle away and die out. . . . *The swollen dead bees, when squeezed, throw out a large quantity of pollen (bee-bread) or honey, with which they seem to have been gorged and unable to get rid of it, as if suffering from obstruction of the bowels.* I estimate that during the last month as many bees as would make a fair swarm have died out of this hive. . . . The bees from my diseased hive, when put into a fresh hive with clean, empty combs, continued

to die off as before, until all had died."—  
W. A. WITCOMBE, Docks, Bridgwater.

### BEE-KEEPING ACCOUNTS.

[8976] May I be allowed, through your columns, to thank Mr. T. Meech for his kind assistance (8931, pp. 46-7) *re* apiary accounts. It has been a great help to me, and I found through my want of experience that I lost just 14s. my first year. But my third—that is, last year—in spite of a mild form of "Isle of Wight" disease, was much more satisfactory, although one stock was so reduced that it gave no surplus.

Is it necessary or advisable to wire shallow frames, not broad ones, but ordinary width? They would be used as brood combs and for extraction.—A NOVICE.

[All combs in frames should be wired, especially those which are going to be extracted.—Eds.]

### BEE ASSOCIATIONS AND THEIR WORK.

#### WHAT IS A PROFESSIONAL BEE-KEEPER?

[8977] Mr. Litman (on page 94 "B.B.J.," March 5th) has raised a point that I confess never occurred to me. I gather there are some "professional" (?) members whom he suggests join Associations simply for the purpose of getting cheaper entry fees, and then doing their best to sweep the board at shows. If this is his idea there may be such, but it was not for this reason I joined any Association. I only mentioned the number I belonged to first as a protest against Mr. Mattinson calling subscribers to Associations fools, and secondly, to make my point against his absurd idea of reducing subscriptions to the vanishing point, thereby making Associations useless from want of a working capital.

How I became a member of so many is very simple. At one time my county was joined on to another; when they separated I continued to be a member of both. The hon. secretary of another neighbouring county has helped me a great deal at various times, and noticing in the report of his Association that there were "members outside the county," I asked if I might become one of them. In the same way another friend who assists me a great deal lately started an Association, and I joined his. "One good turn deserves another," or, "Every little helps," call it which you like. Once only, several years ago, I sent honey to a show in a neighbouring county. I took two firsts in Open Classes, and only a second,

v.h.c. and h.c. in Members' Classes, so even then I did not take the cream from the county members. Since then, as I do a certain amount of expert touring and lecturing, &c., I have given up showing.

By Mr. Litman's use of the word "professional" member, I take it he means the man who makes a profession of showing? Is there any harm in this? I know several very keen exhibitors, and if one gets beaten it's "Aye, but wait till next year, I'll see if I cannot beat him next time." What better spirit can competition evoke than this? Far better than grumbling and calling the other man a "professional." Where there is competition the standard is bound to go up. The more a man shows, the higher the standard of excellence he sets himself, as he learns what is required before he can hope for success; but even then the most experienced may be knocked out by a novice who has luck with his crop and the pluck to show it. Too many novices hang back from showing, so much so that "Novice Classes" have often to be made for their encouragement. One can only be beaten, and it's not a case of broken bones! "If at first you don't succeed try, try, try again" is a wise old saw, and applicable to the honey show bench.

I noticed in last "B.B.J." the old discussion on "Precision in Bee Terms" crop up again. I suggest "professional" as applied to bee-keepers be defined by some of our authorities. Personally I always thought a professional was one who was paid for his services. I am a First Class Expert, but tour around when my services are required for nothing but love of the work and to try and help brothers in the craft. Am I a professional? Is a regular exhibitor in Open Classes a professional, and as such is he to be debarred from showing as a member at an Association show? That is the crux, I fancy, of the point raised by Mr. Litman.—NORTH-UMBRIAN BEE.

### WIRING FRAMES.

[8978] In answer to Mr. Crawshaw (page 99), I may say "Nothing succeeds like success." I *always* get perfect combs, and that is my only reason for wiring in the way I do. I use foundation ten sheets to the pound, and, as a rule, fix in the foundation just when wanted. One little "tip" I omitted. I dust the wiring-board with ordinary wheat-flour, for every three or four frames wired, as the wax, being softened, would otherwise stick to the wiring-board. Another point, the wax being soft, the wires make a firm attachment to the foundation, though now and again a wire does not seem to do so; or I

may press the embedder too hard and the wire cuts through. In that case I run the "soldering tool" along the wire. If when warming the foundation it buckles a bit, it is quite easy to flatten it on the wiring-board before using the embedder.

My experience is that it is when the foundation "sags" and touches the bottom bar that the combs bulge or buckle, for, even with the stout wires I use, the weight of the combs and the warmth causes the wires and combs, too, to sag slightly. I have made *many* experiments during my eighteen or nineteen years of bee-keeping, and once again I say emphatically that well-made frames only need two wires.

It takes me one hour to wire thirty frames. I prefer the feather as a soldering tool, because it makes a *real* attachment to both the wood and foundation. I have yet to see any faults; waterfowl wing feathers are slightly spoon-shaped at the tips and are very stiff, and with a small glue kettle over a stove lamp the attachments are done quicker and neater, and with half the wax than with a can.—A. HARRIS, Wavendon.

---

#### "THE BAZAAR, EXCHANGE AND MART."

An interesting announcement is made by *The Bazaar, Exchange and Mart* to the effect that, commencing on the 21st of Feb., it has issued one of its three weekly editions, the Saturday, at a penny, to meet the demand for a cheap paper of that character. The *Bazaar* has been a great public favourite for the past forty-six years, and its new development should greatly increase its popularity. The Wednesday and Friday editions still remain at 2d.

---

#### WEATHER REPORT.

WESTBOURNE, SUSSEX.

February, 1914.

Rainfall, 4.77 in.	ture, 30 on 17th,
Above average, 2.78 in.	19th, 26th, and 27th
Heaviest fall, .59 on 7th.	Minimum on grass, 20 on 19th.
Rain fell on 17 days.	Frosty nights, 6.
Sunshine, 90.7 hrs.	Mean maximum, 48.6.
Above aver., 1.3 hrs.	Mean minimum, 36.7.
Brightest day, 27th and 28th, 8.5 hrs.	Mean temperature, 42.6.
Sunless days, 5.	Above average, 4.2.
Maximum temperature, 52 on 1st and 14th.	Maximum barometer, 30.175 on 28th.
Minimum tempera-	Minimum barometer, 28.607 on 22nd.
	L. B. BIRKETT.

## Bee Shows to Come.

*A nominal charge of 2s. 6d. is made for notices (not exceeding 7 lines) in this column, 10 lines charged 3s. 6d., up to 15 lines 5s., which covers cost of insertion from order till date of show. Cash should accompany orders for insertion.*

**June 9th-11th, at Malvern.**—The Herefords and Worcs. Agricultural Society's Malvern Meeting. Twelve classes for Honey, &c. Good prizes; small entry fees.—For schedule apply, Mr. A. Elliott, Hon. Secretary's Department, Cusop, Hereford.

**June 30th to July 4th, at Shrewsbury.**—Royal Agricultural Society's Show, Bee and Honey Section, under the direction of the B.B.K.A. Prizes arranged in groups of counties for Associations affiliated to the B.B.K.A. Schedules from W. Herrod, 23, Bedford Street, Strand, W.C. **Entries close May 30th.**

**July 8th, at St Albans.**—Honey Show of the St. Albans B.K.A., held in connection with the Elstree and Boreham Wood Horticultural Society, at Aldenham Park. Open class for extracted honey. No entry fee. Liberal prizes. Judge, Mr. W. Herrod. Schedules from Mr. R. H. Attenborough, Alderham, Herts. **Entries close July 6th.**

---

## Notices to Correspondents

*Letters or queries asking for addresses of manufacturers or correspondents, or where appliances can be purchased, or replies giving such information, can only be inserted as advertisements. The space devoted to letters, queries, and replies is meant for the general good of bee-keepers, and not for advertisements. We wish our correspondents to bear in mind that, as it is necessary for us to go to press in advance of the date of issue, queries cannot always be replied to in the issue immediately following the receipt of their communications.*

J. A. C. (Wimborne).—*Honey and "Isle of Wight" Disease.*—The honey is quite wholesome for human beings, but should not be used for other bees.

G. A. H. (Leicester).—*"Isle of Wight" Disease in Wells Hive.*—You cannot yet be sure that the bees in the other part of the hive have not contracted the disease. If they do not develop it they will be a valuable stock, as they must be immune to the infection.

TRAVELLER (Westmorland).—*Bee-keepers in Belgium.*—Write to M. Wathelet, Directeur de Rucher Belge, Prayon-Trooz, Belgium, who will be able to supply the information you require.

G. P. (West Bromwich).—*Spreading the Brood.*—(1) No, too early. It is a risky operation and should not be attempted by anyone not experienced, as judgment is required in determining suitable condition of the colony, weather, &c.





## SOMERSET B.K.A.

## ANNUAL MEETING.

The annual general meeting of the Somerset Bee-keepers' Association was held on Saturday, February 28th, at the "School of Science and Art," Weston-super-Mare. Mr. T. W. Cowan, F.L.S., F.G.S., one of the vice-presidents, presided. There was a fairly good attendance of members, representing nearly every branch of the Association.

The Hon. Secretary, in reading his report for the past year, stated that the season, from a honey point of view, had been an excellent one, many exceptionally large "takes" being reported from different parts of the county, and the quality of the honey had been much above the average. Unfortunately, notwithstanding the fine season, "Isle of Wight" disease had spread considerably in certain areas. Bee-keepers had experienced severe losses from this cause in many districts, more especially along the north and north-west borders of the county. The great importance of regulating the indiscriminate trade in bees and queens was strongly emphasised. The Association had added nearly seventy new bee-keepers to its membership, which now numbered nearly 500.

The statement of accounts was brought before the meeting showing a balance in hand of £17 5s. 8d.

The report and balance-sheet were unanimously approved and adopted.

Lady Smyth was re-elected President of the Association; all the Vice-Presidents were unanimously re-elected, and in addition, Mr. E. Jardine, M.P. and Mr. H. Perham. Mr. R. G. Harris was re-elected Honorary Auditor. The following were elected members of the Council: Mrs. Carpenter, Miss R. Sheppard; Messrs. L. E. Snelgrove, S. Jordan, T. Jones, F. W. Owen, J. Charlton, J. W. Brewer, W. J. Lang, W. Brooks, J. Hutchieson, W. H. Jarvis, B. Boothroyd, J. Brown, G. H. Tatham, W. A. Withycombe, J. H. Burton, and Lieut.-Colonel H. F. Jolly as Chairman. Mr. L. Bigg-Wither was re-elected Honorary Secretary and Treasurer. Lieut.-Colonel H. F. Jolly and Mr. J. H. Burton were appointed as delegates to the British Bee-keepers' Association.

Medals and Certificates of Merit won by members at the annual show were presented by the Chairman. The British Bee-keepers' Association Intermediate Expert's Certificate was gained by Mr. J. A. Hutchieson, and the Preliminary Certi-

ficates by Mr. F. W. Owen and Mr. F. Harris.

The Honorary Secretary was asked to write to the President of the Board of Agriculture and Fisheries urging the vital importance of re-introducing and passing the Bee Diseases Bill as soon as possible, as both the bee-keeping industry and that of fruit-growing were suffering through want of this legislation.

After tea, at which about forty members and friends were present, Mr. L. E. Snelgrove, B.A., gave a most interesting and instructive lecture in the Science Theatre on "The Chemical Composition of Honey, means of Recognising its Purity and detecting its Adulteration." The lecture was illustrated by a large number of chemical experiments, honeys containing different pollen grains were shown under the microscope, and the use of the polariscope in detecting the presence of glucose and cane sugar was graphically demonstrated.

Mr. J. W. Brewer, in proposing a hearty vote of thanks to the lecturer, said that it was gratifying to hear something new in bee-keeping. He congratulated Mr. Snelgrove on the success of his experiments, remarking that no one but an expert teacher could have so lucidly explained so difficult a subject—a subject about which so little was known by the average bee-keeper.—L. BIGG-WITHER, Hon. Sec.

## NOTTS B.K.A.

The annual general meeting of this Association was held in the People's Hall, Nottingham, on Saturday, March 7th, at 3 p.m., with the Deputy Mayor (T. Ward, Esq.) presiding over a large assembly of members and friends.

The minutes of the previous meeting were read and confirmed.

The annual balance-sheet was next submitted, and was unanimously adopted, great satisfaction with same having been expressed.

The whole of the officers who served for 1913 were most heartily thanked for their services and re-elected for 1914.

A discussion arose at this point with regard to *microsporidiosis*, or "Isle of Wight" disease, which became interesting in several ways, and no doubt information would be found by those who sought it. It was pointed out how very serious the disease was, and that as it had shown itself in several places in the county it was necessary to be on the alert, and for every bee-keeper to do all he could to prevent its spreading. Members were advised not to purchase, during this season at least, any queens, stocks, swarms, or driven bees

outside the county, but to get all required from those within it.

Mr. Pugh proposed a hearty vote of thanks to the Deputy Mayor for presiding over the meeting. Mr. Ellis seconded, and it was carried with acclamation.

Mr. Ward, in reply, said how pleased he was to be able once more to be with them because he saw that they were doing all they could as an Association to push forward the industry of bee-keeping, and anyone could see on carefully scanning the report and the balance-sheet what a large amount of work had been done for the money expended.

The meeting was then adjourned for tea, to which about 120 members and friends sat down. After tea the prizes and medals were distributed to those winners who were present.

The Chairman then called upon Mr. Pugh to give his lecture on "Judging Honey." This proved to be, as was expected, a very interesting address, and called forth considerable discussion, which must have been very helpful to those privileged to hear it.

It was resolved: "That a resolution be sent from this meeting urging the Government to press forward the Bee Disease Bill, as it was felt to be most urgently needed."

A very successful meeting was brought to a close with the usual prize drawing.—  
GEO. HAYES Hon. Sec.

#### BEES ON THE BIOSCOPE.

Mr. J. C. Bee Mason will appear every evening at the Alexandra Theatre, Stoke Newington, London, N., for one week, commencing March 23rd. He will show "The Life of the Bee" and "The Bee Master," giving a short introductory lecture before each subject.



#### CHECKS TO SWARMING.

Those much troubled with undesired swarming might try one or other of the following plans to check it. Confine the queen to two or three frames at the side or back of a hive, keeping her there for about a week. During that time destroy any queen-cells which the bees may have started. Then by removing the queen-excluding dummy or division-board she will have the whole range of frames once again to keep her employed egg-laying, and the bees, then finding a queen pre-

sent will desist from all attempts at preparations for swarming.

The second plan, I think, is practised by Dr. Miller. Instead of caging the queen he simply places her in a nucleus above the frames of the body-box. She goes on laying in the two or three frames without any cessation, thus keeping up the population steadily. In about seven days he examines the brood body, cutting out all queen-cells which may be in progress. He then unites his nucleus with the main body, thus making a strong force of bees, generally content to go on storing without any thoughts of swarming. The late Capt. Hetherington, a thousand colony man, practised this system of management and found it at least a check to over much swarming year after year.

*How to Diagnose Queenlessness.*—In spring it is generally possible to tell when a hive is queenless by one or other of several fairly conspicuous signs. Attempts at robbing are very frequently made on a colony which has lost its queen. Coupling this agitation with a past sluggishness in working is a pretty patent index. Such a hive, if watched occasionally, may show a fair amount of pollen being carried in, but the loads in the baskets are small, as a rule. An additional and perhaps a better sign may be found in the fact that the bees are flying and walking near the entrance in a lethargic way. There is a want of energy, a tired-like appearance about them, never seen in a colony actively breeding. The latter dart in and out as busy as bees, while the workers of the queenless lot crawl in or linger and loiter before finally making their way in at the entrance. A "queen-right" colony is certain to show *débris* dropped about the doorway or on the ground in front of the flight-board, while a queenless lot rarely shows any. On spreading the frames apart, those without a queen will show almost every frame a solid mass of sealed honey. No larvæ can be seen in even the centre frames, no capped brood can be detected anywhere. Even the most cursory glance inside such a hive will show that all is not well, and that the keeper's aid is urgently required to save disaster.

*Propolised Frames.*—In going out and in among bee-keepers one discovers all kinds of frames, and several kinds of frame-rests. Where propolis is abundantly carried in by a strain of bees inclined to propolise heavily, the frame-rest is a most important part in the hive, for on it largely depends successful handling of the interior fittings. Where the lugs of top bars rest solidly on a flat surface, the point of contact frequently is fixed as firmly as if both were one piece. To conquer this some manufacturers sink the

piece, all but a narrow ledge, between the two walls, thus affording only a small space for the ends to rest on. Sometimes a simple knife-edge only is afforded, but, the wood being soft, this rest is not strong enough, and as a consequence the heavy weight of supers presses it down so much that the bottom space below frames becomes too cramped, thus lessening the free movement of the workers. To remedy this we have the metal rests, which should go with the metal ends, known as the "W.B.C." The metal spacers, resting on the thin edge of these supports, afford little or no opportunity for propolis-ing, therefore such frames yield freely and without any jar when they are being withdrawn. In the case of heavily propolis-ed frames a considerable pull is required, and at times they must be parted by a violent wrench brought about by a chisel or screw-driver. The vibration thus caused annoys the bees and makes them irritable. With easily-parted frames everything passes off amicably. Beginners should take the hint and see that their frames are resting on a narrow ledge of wood or a tin girder affording little opportunity for propolis-ing.

*Moving Short Distances.*—Every spring it is necessary to shift many hives about from one corner of the apiary to another. After a good long spell of wintry weather, when bees have been kept in for several weeks together, little more is required than to lift the hive bodily, as quietly as possible, and plant it down on the new site. When spring arrives, the bees, on looking out for the first time, will simply accept the situation as if it had always been their position, and there will be no loss and no intermixture of flying workers. A cold spell in early January or February might be selected as the best time to carry out this operation. If left until later in spring, something must be done to inform the bees that their site has been changed, and that on taking their first spring flight they must mark the new location; for bees do not so much mark their own hive as such, but associate it with other marked surroundings. A good smoking so confuses them that on issuing they take new bearings. The same good follows a drumming or very rough handling, and few return afterwards to the old site. If moss or grass is packed fairly tightly into the entrance so that the bees may have some trouble or worry in providing an exit, they generally mark the hive on taking flight. This last is a simple plan, and any who may have tried it in spring shifting might record their results.



*The Editors do not hold themselves responsible for the opinions expressed by correspondents. No notice will be taken of anonymous communications, and correspondents are requested to write on one side of the paper only and give their real names and addresses, not necessarily for publication, but as a guarantee of good faith. Illustrations should be drawn on separate pieces of paper. We do not undertake to return rejected communications.*

### " ISLE OF WIGHT " DISEASE " CURES."

[8979] It is to be hoped that those who reported cures of the "Isle of Wight" disease last year will not forget to announce whether their bees remain cured or have suffered a relapse. I have skimmed through a part of last year's files of "B.B.J." and extract very briefly the following of the more confident reports of cure. Mr. James Lee, in the issue of June 19th, reports having saved twenty-six colonies in a thirty-five apiary attacked, by moving the bees into clean hives, searched and painted with Ayles' solution. September 4th, "K.C.A.P.," North Herts, hived a swarm on foundation, which contracted the disease, and then evidently recovered. September 11th, J. H. Meyer, Fulham, washed a hive with Lysol, vaporised with the same through a perforated floor-board and medicated syrup with the same. He writes: "To-day the survivors are all working, and I have not seen more than a dozen dead bees outside the three hives. I am convinced the stocks will all recover."

Then there is the Kentish treatment with quinine. In spite of one captious critic, I thought that Mr. Wigley's evidence of its efficacy was very good. It was this ("B.B.J.," June 12th): Ten stocks packed for the winter. Lost three with natural stores and two with half natural and half medicated syrup. Saved five on medicated stores only. And on July 17th Mr. Wigley writes again: "A remedy to have any practical value must be effective enough to pull diseased bees through an attack, in spite of an infectious environment, which it would be impossible to disinfect. No effort was made, therefore, to destroy the spores in the brood-combs . . . it was primarily intended to kill the developing parasite within the bee. That my stocks have survived and are increasing strongly, in the midst of disease, is due, in my opinion, to the quinine sulphate."

In another number (August 28th) I find a further testimony to the efficacy of

quinine. "F. C.," Oxford, writes: "This treatment has checked the ravages of the disease in my apiary, and with perseverance I am hoping to eliminate it altogether." I expect that a great many bee-keepers have wintered stocks this year on syrup medicated with quinine. Others, perhaps, have medicated with Bowen's remedy. What is the result? Perhaps it is a little early to report yet, but the really useful accounts of "Isle of Wight" cures for this year will, I think, be those that were administered in 1913, and have proved efficacious ever since.—G. G. DESMOND, Sheepscombe, Glos.

#### FIGHTING BEE DISEASE.

[8980] The news of the dropping of the Bee Diseases Bill will come as a blow to many. However, this is not the time to despond over it. The question of bee diseases is still of primary importance, and as we bee-keepers cannot at present get compulsory powers to help us it is evident that we shall have to see what we can do to help ourselves. This being admitted, the question is how to do it.

In the past very good work has been done, but by comparatively few men. The point I want to make is that we can best make headway against bee disease by *each* bee-keeper taking an interest in it, and by every bee-keeper doing all he, or she, can to fight it. Even though the all be only very little it will help. I understand that the Gloucestershire B.K.A. has set up a Special Disease Committee. Very good. This is on the right lines. It now remains for the Gloucestershire bee-keepers to loyally support that committee and do the best they can to help it to make itself effective.

I feel sure that the sooner every bee-keeper realises that it is his definite duty to assist the bee-keeping community in its fight against disease in some way or another the sooner we are likely to be able to make rapid headway.—R., Gloucester.

#### DR. MILLER INTERVENES.

[8981] Too bad, two such nice boys as D. M. Macdonald and L. S. Crawshaw should fall to quarrelling about a little thing like sugar syrup. "D. M. M.," you tell "L. S. C." that I've fed a few thousand pounds of syrup made of 2½ lbs. of sugar to 1 pint of water, with no trouble from crystallisation. "L. S. C.," please remark to "D. M. M.," in a gentlemanly way that when I used such heavy syrup I added an even teaspoonful of tartaric acid for each 20lbs. of sugar.—C. C. MILLER, Marengo, Ill., U.S.A.

#### REPORT FROM SOUTH WESTMORLAND.

[8982] We are totally free from disease in this part of South Westmorland, which is something to be thankful for, but I should like to appeal to my fellow bee-keepers to keep hives, &c., in better order. I have got a good number of our local men to join the Lancashire B.K.A., but many keeping a few hives will not be persuaded to join at any price. They are the offenders. During the past season I had the opportunity of going through many hives, and whilst some were well tended others were abominably neglected. Anything was thought good enough for quilts, old manure bags, rugs, &c.; in fact, I got the impression that when things could not possibly be used for any other purpose than the bees had their innings. In one instance the hive had no roof, and the rain had percolated through all coverings. In a case like this it is surprising if disease does break out? I once more appeal for better attention.

In my opinion, we are going to have an early season. My bees have been carrying in pollen for some considerable time, chiefly from hazel, snowdrops, and aconite. Owing to absence of frost the above have been available for some weeks. The gooseberry will be in flower shortly, and with that the season may be said to have commenced in earnest.

We had a poor season in 1913, and are hoping for the opposite this year. Stocks have consumed a large amount of stores this winter owing to the mild weather. I have examined many during the past week or so, and the majority were nearly foodless. Fully 70 per cent. had to be provided with candy, although the owners had fed 20lbs. per hive on an average. I think the best plan is to not feed so liberally and then give candy in early February if necessary. The candy made by amateurs, as a rule, if put on hives over winter, generally turns out more suitable for scotching cart wheels than anything else. Of course, that made by reputable firms is all right, but the majority of people prefer to make their own. Some bee-keepers give too much, as they do not take the trouble to ascertain what food is already in the hive previous to feeding, with the result that many stocks have from 30lbs. to 50lbs. or 60lbs. of food to face winter with. Of course, this is a better fault than under-doing the thing, but the usual result is this: If the winter turns out very severe with the accompaniment of slender inroads into stores, then the combs are absolutely blocked with food in spring, which makes them unavailable for brood-raising. The remedy is obvious, more careful observation is needed.

I will conclude with wishing all readers

and yourselves a very successful season. I would like to impress upon readers the necessity of providing clean quilts in spring. It is so important if we mean to combat disease. Lastly, let me ask all bee-keepers to join their County Associations. The subscriptions are nominal and the advantages numerous.—FRED NEWSHAM.

### “ISLE OF WIGHT” DISEASE.

#### A PESSIMISTIC VIEW.

[8983] I am sorry to note that there seems to be no one able to give any hopeful reply to Mr. Illingsworth's question *re* the abatement of the above disease. In this neighbourhood second and third attempts have been made to re-stock, but all to no purpose. Out of thirteen colonies established last summer I now have only two alive. Doubtless there are very few places that can present a blacker picture than this district. Before the “Isle of Wight” disease appeared we could count our colonies by hundreds, and now not one colony remains of the original stock: and not only so, but many lots imported from other districts have gone the same way. Absolutely healthy bees, completely new hives, and entirely new situations, all have failed to make the slightest difference: in fact, it is most curious to relate, but one of the two remaining lots mentioned above was a truant swarm which lived itself in combs on which bees had died of the disease. They are still on the site of the old apiary, which was entirely wiped out, whereas every stock in a new apiary I started under conditions as above has succumbed. Now a word as to cures. I trust that bee-keepers will not waste their money on such things. There never has been a cure found as yet, and I will go further, and affirm that this disease never will be cured by disinfectants and medicines.

As regards an Act of Parliament, I do not glean much comfort from that idea, though I would welcome anything of really a practical nature, but what is such an Act going to do beyond the enforcing of the destruction of certain appliances, &c.? Will such an Act discover and utterly destroy all the old haunts of the bees, such as hollow trees, roofs of buildings, &c.? Hundreds of such places now exist where disease has done its work and left no marks by which an inspector might track it. My firm conviction is that legislation is absolutely useless to deal with “Isle of Wight” disease, and as to any other diseases, bee-keepers worthy of the name can combat them without the aid of such an Act. I express this view after over twenty-five years' experience, and not as one who has never seen foul brood, &c., but as having had my full share of experi-

ence on those lines, and if I had the powers of the B.B.K.A. I would never honour one with an expert certificate who needed an Act of Parliament to enable him to combat foul brood. I observe with regret that modern bee-keepers seem to be craving a lot of “mothering,” which those of the old school did not need, and did exceedingly well without. Foul brood did not trouble them, their very methods kept it at bay, even if it existed to any extent. Modern methods developed it, and gave it every chance, and it is very unfair to now turn on the skeppist and seek to abolish his skeps, when, after all, it is he who has proved the man, in that for centuries he kept bees profitably without crying for State-aid.—OWEN BROWNING, King's Somborne, Hants.

### PROGRESS OF “I.O.W.” DISEASE.

[8984] In the January 1st issue of the “B.B.J.,” Mr. Illingsworth enquires as to the progress of the so-called “Isle of Wight” disease in this country, and asks for an answer to the question: “Is it any use making another start next year? If not, how long must elapse before I can recommence bee-keeping with any hope of success?” I should imagine that there are few absolutely uninfected districts, but am sure it is wise for all to take as much care as if the disease were on the spot. The latest report issued by the Board of Agriculture on “Isle of Wight” disease answers the latter questions on pages 127 and 128. After advising that all infected hives should be thoroughly scorched out with a painter's blow-lamp, and the surrounding ground disinfected, the advice is given that “When the disease visits an apiary bees should not be imported into it, at any rate, not from a non-infected district, until the disease has run its course. If it is considered desirable to introduce fresh stocks, they should be obtained from an infected area, since, if they have survived an attack they may be to some extent immune. In all cases where it is desired to restock an apiary, we advise that some months should be allowed to elapse between the death of the last stock and the importation of fresh bees.”

In view of the numerous references as to the possibility of an immune race of bees developing, it has surprised me that so little has appeared in print on the subject. We are told that there is little hope of a drug cure and various authorities confirm this view. Dr. Zander thinks that a bee suffering from *Nosema apis* never recovers. The apparent cures reported from time to time are thought (page 3, further report) to be due to the sugar syrup, in which the drug is conveyed to the

insect, which acts as a purgative, the process eliminating from the bowels large numbers of bacteria and any free *Nosema* parasites. The statement is made that although treatment by feeding undoubtedly effects temporary improvement, no examples of a permanent cure have come to the notice of the investigators. A much more hopeful tone is noticeable when immunity is spoken of.

Page 39: "There is little evidence that treatment by any of the remedies which have been suggested results in permanent cure, though amelioration of the symptoms, for a time, not infrequently occurs. Prevention is, therefore, the only satisfactory method of controlling the disease."

Page 128: "Maasen's observations show that partially immune stocks and apiaries are common in Germany, and we have investigated at least one partially immune apiary in this country. We think good results might be obtained if attempts were made to build up apiaries from stocks which show well-marked resistance to the disease, infected apiaries, or from stocks known to be partially immune."

Page 39. Further report: "Some of the experiments seemed to indicate that partially immune stocks exist, which can only be made to suffer from the disease with difficulty."

In this connection perhaps it would be well to mention a case in my own apiary, which is in the centre of a badly infected district. In 1912 I had one nucleus which did not build up satisfactorily, though aided as far as possible. On several occasions during late summer and autumn I noticed numerous spots of excrement on my clothing after examining this nucleus, and came to the conclusion that they had contracted the disease and would not survive the winter. However, they came out fairly strong, built up into a good stock, and stored as much surplus as any stock I had, showing no further symptoms of the disease. To me this looks like a case of at least partial immunity. No further cases have occurred, and there were none previously.

On page 29 (further report) mention is made of the peorime disease of silkworms, which is caused by *Nosema Bombycis*, an organism closely allied to *Nosema apis*. This disease caused immense damage to the silk industry of France, in the middle of the nineteenth century, and threatened its extinction. Experiments were conducted over a period of twenty years, but no drug cure was discovered. "The method which saved the silkworm industry was the destruction of diseased insects, and reproduction from healthy moths."

In conducting the above-mentioned experiments the investigators had the advantage

over us in that the mulberry leaves, upon which silkworms are fed, are easily medicated, and the poisonous nature of the drug need only be considered in relation to its effect on the silkworm. *N. Bombycis* has the ability to invade every tissue of the host, but *N. apis* is largely confined to the digestive tract. "When the parasite can penetrate every tissue, so that it is diffusely infiltrated throughout the host, the damaging capacity is enormously greater than where the parasite is localised." Now, although *Nosema* has been found in the malpighian tubes on one occasion, and several times in the hæmocœlic fluid, we are in a better position to fight the disease than were the silkworm men.—H. H. BROOK.

(To be continued.)

## NECTAR-PRODUCING PLANTS AND THEIR POLLEN.

By Geo. Hayes, Beeston.

RAGWORT OR RAGWEED.

(*Senecio Jacobau.*)

No. 29. NAT. ORD. COMPOSITE.

(Continued from page 53.)

In the autumn of each year one often sees in the columns of our JOURNAL, amongst answers to correspondents, *re* samples of honey, such a reply as this: "A good sample of honey, spoilt by ragweed."

Whenever I see such replies, they remind me of an experience of my own. Some years ago we had a bad honey season, but a glorious autumn, and towards the latter end of September I went to tidy up an apiary and prepare the bees for winter after extracting. Some shallow frames had some time previously been put on to two of the stocks to be cleaned out, and were left there for me to remove, but I found three or four combs in each had, during the interval been partly filled and sealed over. I extracted this honey, and found it to be the most beautiful golden colour imaginable, and perfectly bright and clear. I thought to myself, this will be a treat for those in the house. During the extracting, it occurred to me that the odour was peculiar, and not at all enticing, except to induce one to investigate as to the cause, and this I did, and tasted the honey—but Ugh! I was very glad to get rid of it quickly. I have at different times tasted peculiar honey, but even paraffin honey had to give place to this, for I always consider it the most nauseous I ever tasted. It must have been entirely from ragwort flower. Of course, we gave it back to the bees in fool, as we concluded it was

a pity to rob them of such nice-looking honey, and evidently they were not fastidious in their taste.

From this it will be seen that at times this flower is too abundant for the bee-keeper, but if the honey was not so objectionable its beauty both of foliage and flower would soon make it a favourite, because it yields both pollen and nectar freely, and is therefore often very useful to the bees. For this reason I consider it should find a place in our list.

This plant is called Rag-wort—and “wort,” of course, means “plant”—and Rag-weed, from the fact that its leaves are very much cut up and raggy, which vary in different soils, the leaf segments or divisions being much finer in dry, poor soil, whereas a damp soil develops rank foliage, which is not so cut up. In some districts it is called Stammer-wort, which would seem to indicate that its medicinal properties are good for those having such an impediment in their speech. In this district its appellation is “stinking nanny,” so-called because of its odour; it is generally considered to make a soothing and healing wash for wounds and sores.

The generic title, *Senecio*, from *Senex* (old man), was given to it by Linnaeus because the seed heads, with their white crown, have the appearance of an old man’s grey head. *Jacobeus*, its specific title, reminds us of medieval times, when flowers were named after the Saint on whose day they were mostly to be found in bloom. *Jacobeus*, which is Latin, is

equivalent to James in English; and in some parts the plant is called St. James-wort. Among other names this plant bears in different districts are Ben-weed, or Bin-weed, Boliam, Canker-weed, Fellon-weed, Keddle Dork, James’s-, or St. James’s-weed, Stagger-wort, or Staver-wort, and “Yellow-taps.”

The flower is a deep yellow, bordering on orange near the centre, and is of the daisy type; the flower-heads, rather large in a handsome compact terminal corymbs. There is also an aquatic species (*S. aquaticus*, water-ragwort), which does not differ much from the one under consideration. This genus embraces the very lowly grousel and also the highly-prized cinerarias of the florist.

The pollen grain is a dull yellow in colour by transmitted light. The form is oval with three depressions or grooves running equidistant from end to end, the whole being covered with spines. When dry, it is as seen at No. 1, and its enlargement, No. 2, being a cross section

through the middle, and measures  $\frac{1\frac{1}{2}}{1000} \times \frac{1}{1000}$  in. When placed in water it assumes a spherical form, as shown at No. 4. When extracted from honey it is spherical in form, but it has then developed a number of processes and pseudo-process at irregular intervals over its surface; these are generally in great profusion. The grains now measure on the average  $\frac{1\frac{1}{2}}{1000}$ .

(To be continued.)

Dry.

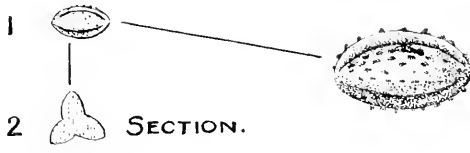

From Formalin.



In Water:



From Honey.

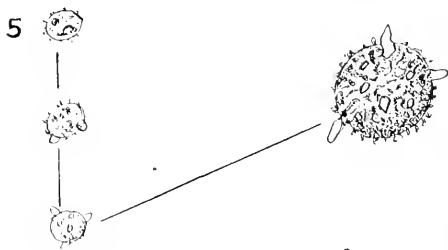

POLLEN OF RAG-WORT.



*Precision in Bee Terms* (p. 72).—The gentleman who calls a colony "a swarm," or a swarm "a hive," is not without justification, as these terms were used thus in the old days. A popular dictionary, which I have before me, gives as *one* of the meanings of swarm, "A body of bees united and permanently settled in a hive"; and of hive, "A swarm of bees inhabiting a hive." Still, that is not how we use the terms. "D. M. M.'s" explanation of the mishap to his "copy" is so obviously true that I might almost have detected the original beneath the printed disguise, and I hasten to make what "our mutual friend" would call the *amende honorable*. In this matter "D. M. M." has my sympathy, for such mishaps are not unknown to me, although invariably due, I fear, to a cramped and crabbed "fist." I am sure we both owe much to a long-suffering staff, and must endeavour to improve. For terminological accuracy is to be greatly desired, when dealing with a technical subject. Mr. Bullamore put the matter quite admirably in "B.B.J.," February, 1911, when he wrote, "A loose style of expression in the columns of a scientific journal usually gives rise to trouble." A little more accuracy, gentlemen, is the plea that I would constantly make, even "in jesting guise, for ye are wise, and ye know what the jest is worth." And may I couple with this, a plea for originality. A little more individual research, a little more actual experiment, a little more reference to the bee itself, and a little less sheltering behind authorities, however renowned. Knowledge is continually increasing, and the spirit of the true scientist, whilst essentially critical, is ever ready to abandon old theories in the face of new facts. A little more originality, gentlemen, please! Do not be disturbed by criticism, but get at the truth.

*In Friendship's Name* (p. 73).—*Nom d'uné plumé griffonnanté, c'est à diré*. In justice to our French friends, if Mr. Smallwood will allow me the correction, I think that a fairer translation of *rucher école* would be "apiary school." The French word for "hive" is *ruche*. I note also that our mutual friend recently took rather poetic license with our friends the butcher, the baker, the candlestick maker. Not that these liberties and fraternities detract in any way from his racy account of the Grand Tour of Bee-keeping.

*Wintering Bees* (p. 82).—This beautiful set of combs is enough to make some of

us sour with envy. Still, we have the consolation of knowing that they contained but a paltry half-hundredweight of honey for the bees to winter upon! I fear that some of us would have desired to share that with the bees, if, only for the ostensible purpose of giving them lodging as well as board. I have always thought that the "Guide Book" erred on the right side in the amount of winter stores, but 56lbs.! Mr. Herrod. Far be it from me to boast, but I have a tiny stock, a nucleus which I was obliged to pack up last autumn, a double handful of bees on a few pounds of honey in shallow-frames, and, so far, all is well with it. But it has been an exceptional winter, and I must not crow too soon. Of course, it cannot build up as the well-provided stock described will no doubt do, but I am waiting to see what happens.

*Infectious or Contagious* (p. 85).—There is little doubt that the disease is contagious, as evidence points to its being carried by the bee-keeper; and that makes the Board of Agriculture dictum on hive disinfection rather surprising. Disinfection may appear to be unnecessary, but it is not a difficult business, and bee-keepers would do well to take the precaution. On ordinary sanitary grounds alone some cleansing is advisable, and in the event of recurrence of the disease the bee-keeper will not have the worry of self-reproach. But "Isle of Wight" disease has taken hold in so devastating a fashion that if not actually infectious in the sense of being air-carried, the results are very similar. There is, however, so much pulling about of hives and going to and fro amongst bee-keepers that it is difficult to form conclusions. In this connection I note that the Diseases of Bees Bill is not to be re-introduced by Mr. Runciman. In view of the controversial discord raised by the proposal, one hardly knows whether to be glad or sorry.

#### TRADE CATALOGUES RECEIVED.

Jas. Lee and Son Ltd. (Head Office and Power Works, George Street, Uxbridge, Middlesex; Showroom, 10, Silver Street, Holborn; Bee Farms, Fulbourne and Wilbraham, Cambridge).—Messrs. Lee and Son again issue a most comprehensive list of bee goods. We are pleased to note that every article illustrated or listed is of practical utility, instead of including, as is often the case, many articles and nick-nacks which are of no value, except to fill the pocket of the manufacturer at the expense of the inexperienced beginner. A firm of such long standing is so well known that it would be futile for us to waste space repeating that which is familiar to all bee-keepers. Messrs. Lee and Son combine good workmanship with the



lowest possible price, as a perusal of their catalogue, which can be had free upon application, will show.

R. Steele and Brodie (Wormit Works, Wormit, Scotland).—This northern firm show progress in their excellent catalogue, which is neatly got up and well illustrated. We notice with regard to one appliance that it is wrongly named right through the catalogue with one or two exceptions, *i.e.*, the section *rack* is called a *crate*. With the correction of this error the catalogue would be perfect. We can personally recommend all bee-keepers in the North to put themselves in the hands of this firm, especially when requiring appliances for the gathering and extracting of heather honey. Their motto is "Straight dealing. A good, honest article at the lowest possible price." Messrs. Steele also manufacture poultry appliances, and a post-card to them will bring either catalogue post free.

A. H. Wilkes, Lichfield Road, Four Oaks, Birmingham.—Again this firm issues a most complete catalogue. As an inventor as well as manufacturer, the principal is well known. All forms of free-way goods are listed, and a marvel of cheapness is a rapid-feeder, holding one quart, at 1s. A perusal of this list, post free on application, will repay those interested in bees.

## QUERIES AND REPLIES.

[8912] *Preventing Disease*.—(1) I believe that in the *immediate* neighbourhood we are free from "Isle of Wight" disease, although there are suspicious cases not far away. Can anything be done as a *preventive*, and, if so, what? Even if nothing is a sure preventive perhaps you can suggest what would be, or might be, helpful towards warding it off, *e.g.*, to thoroughly disinfect hives and then transfer bees from present hives to them. Would that be any good? (2) In view of the mild weather is it too early to start stimulative feeding? (3) I have a patch of garden about 15ft. square in front of my hives, which I could easily spare for planting with flowers, shrubs, &c., for the bees. Would it be worth my while to do so, and if so with what plants?—E. S. L., Notts.

REPLY—(1) All you can do is to provide a drinking fountain in such a position that the bees do not fly over it, and so contaminate it by dropping excreta. The fountain should be washed with a disinfectant twice per week, and a little salt added to the water. Under ordinary conditions hives should be cleaned and dis-

infected. (2) Yes, wait till April. (3) Yes, plant Arabis, Limnanthes, Wallflower, and Borage.

[8913] *Ventilating Hives*.—As a constant reader of your paper, I shall be very glad of your advice in the following difficulty. Liking the idea of bottom ventilation, as described by Mr. Wigley, on page 316 of the "B.B.J.," I adopted it with the addition of a frame near the top for the brood-chamber to rest upon. I had a further reason for adopting such a plan, for I saw it would enable me to also have a bottom feeder (an idea I got from *Gleanings*). But now a much more experienced bee-keeper than myself tells me that if I leave so much space below the brood-chamber the bees will, in the spring or before the door is left open for ventilation, fill it with comb. Is he right, and if so can I overcome the difficulty by inserting a box of shallow frames after removing the feeder at the beginning of winter? It seems to me that pushing in the frame in the winter or drawing it out in the early summer would work havoc among the bees. I suppose excluder would have to be used above the box to keep the queen above it?—JNO. REID.

REPLY.—If you do as you suggest there will be no trouble; you should place an excluder between.

[8914] *Disinfecting Dividers and Combs*.—Will you kindly inform me through the JOURNAL:—(1) The best method to disinfect tin dividers; also (2) if brood-combs which have been away from the hives for a year and sprayed twice with carbolic acid will be free from foul brood germs?—J. R. M.

REPLY.—(1) Wash the dividers with a 10 per cent. solution of formaldehyde (2) If the combs have been in a diseased stock do not attempt to use them, but melt them down. If hive was healthy they will be all right to use.

[8915] *Too - Early Manipulation*.—Would you please give me your opinion through your valuable "B.B.J.," which is always a great help and a delight to read. I examined my bees on March 1st, it being a lovely day, the temperature 62degs. I had them indoors when the quilts were removed. I took two frames of honey from them, which were not covered by bees, leaving six. I found a good patch of brood on one frame sealed and unsealed. When I saw brood I packed up again. Will the hard frost we are having do unsealed brood any harm when the bees become dormant in cold weather? I may say bees did very well here last summer. I transferred a stock from a skep to a frame-hive in eight days. The queen was laying in frames on the second day. Bees in the skep were full to overflowing, two large clusters clinging to the

sides of the skep, which was inside a box-hive. A new queen was successfully introduced on the tenth day to frames after removing old queen.—J. HESLOP.

REPLY.—It was injudicious of you to open the hives so early. The bees will be able to take care of what little brood they have, even if it freezes.

## Bee Shows to Come.

A nominal charge of 2s. 6d. is made for notices (not exceeding 7 lines) in this column, 10 lines charged 3s. 6d., up to 15 lines 5s., which covers cost of insertion from order till date of show. Cash should accompany orders for insertion.

**June 9th-11th, at Malvern.**—The Herefords and Worcs. Agricultural Society's Malvern Meeting. Twelve classes for Honey, &c. Good prizes; small entry fees.—For schedule apply, Mr. A. Elliott, Hon. Secretary's Department, Cusop, Hereford.

**June 30th to July 4th, at Shrewsbury.**—Royal Agricultural Society's Show. Bee and Honey Section, under the direction of the B.B.K.A. Prizes arranged in groups of counties for Associations affiliated to the B.B.K.A. Schedules from W. Herrod, 23, Bedford Street, Strand, W.C. **Entries close May 30th.**

**July 8th, at St Albans.**—Honey Show of the St. Albans B.K.A., held in connection with the Elstree and Boreham Wood Horticultural Society, at Aldenham Park. Open class for extracted honey. No entry fee. Liberal prizes. Judge, Mr. W. Herrod. Schedules from Mr. R. H. Attenborough, Alderham, Herts. **Entries close July 6th.**

**July 24th and 25th, at Cardiff.**—The Glamorgan B.K.A., in connection with the Cardiff and County Horticultural Society's Show, in the Sophia Gardens, Cardiff. Open classes include:—Collection, Gift Sections, Beeswax, &c. Schedules from W. J. Wiltshire, Maindy School, Cardiff.

## Notices to Correspondents

FREDA (Oundle).—*Re-arranging the Apiary.*—We are sorry you carried out your own idea, and asked our advice afterwards. We are always ready and willing to assist our readers and have no axe to grind, and so could have saved you trouble. We repeat our advice: Stick to the "W.B.C." hives and British bees. Work up again from the lot in the make-shift hive. You will be no better off on the different points you mention if you purchase the hive of bees you suggest. The Brice swarm-catcher is good, and may be obtained from Messrs. Jas. Lee and Son. You could not keep the Carniolans pure, therefore would be unable to guarantee them if even there was a demand for swarms. With regard to

your second lot of queries, we reply to them briefly as under:—(1) The question of veils and bee-dress for women, was dealt with fully in the "B.B.J.," for December 11th, 1913. (2) The syrup is quite good to use. (3) Candy is too hard. (4) Use the sections in the ordinary way. (5) Scorch inside of hive with painter's blow-lamp. (6) Metal dividers are best. (7) South-east. (8) Close the entrance, and two persons can easily carry the hive; the bees will not be disturbed. (9) Do not give syrup food until April. (10) Use syrup, not honey.

NOVICE (Notts).—*Disinfecting Hive.*—(1 and 2) We prefer to use carbolic acid, as recommended in "British Bee-keepers' Guide Book." (3) If the bees have enough sealed stores to last until April you need not give candy again, but start to feed with syrup then.

G. S. (Bisley).—*Preserving Combs in Spirit.*—Both can be done in a 10 per cent. solution of formaldehyde.

J. G. (Wadhurst).—*Re-starting with Bees.*—(1) Yes, in a small way. (2) Spray it with petrol, and burn the grass. (3) Start with stocks of bees if you want to get any honey. (4) Sorry we cannot.

SILLIW (Catford).—*Re-stocking Hives.*—We see no reason why you should not try one stock again.

W. S. (Ilford).—*Discoloured Combs.*—The comb is simply discoloured through being bred in; it is not a sign of disease.

### *Suspected Disease.*

HANDLEY (Chester).—Both lots of bees have died from "Isle of Wight" disease. No. 1 are Blacks; No. 2 Italian hybrids.

J. G. (Beardsden), W. G. (Milford), and Mrs. A. P. H. (Ilminster).—Bees have died from "Isle of Wight" disease.

J. S. (Battlebridge).—We fail to find any symptom which enables us to state cause of death.

### Special Prepaid Advertisements. Two Words One Penny, minimum Sixpence.

Orders for three or more consecutive insertions entitle advertisers to one insertion in "The Beekeepers' Record" free of charge.

Trade advertisements of Bees, Honey, Queens, and Bee goods are not admissible at above rate, but will be inserted at 1d. per word as "Business" Announcements, immediately under the Private Advertisements. Advertisements of Hive-manufacturers can only be inserted at a minimum charge of 3s. per  $\frac{1}{2}$ in., or 5s. per inch.

### PRIVATE ADVERTISEMENTS.

SIX good stocks bees, in nearly new bar-frame hives; also sundry appliances.—Apply, WEAVING, Poultry Farm, Chipping Norton. v 14

A BARGAIN.—Thirteen W.B.C. body boxes, 1s. each; twenty W.B.C. shallow boxes, 9d. each;  $\frac{1}{2}$  gross metal ends, 1s. gross; twenty-six excluders, zinc 3d. each; full particulars stamped envelope, J. YOUNGER, 29, Newmarket-road, Cambridge. v 13

TYPEWRITER, No. 8, Remington, brief carriage, clear writing, very reliable, perfect, cost £23, sell 80s.; approval; great bargain. Wakefield, Newhall Hill, Birmingham. v 11



BRITISH BEE-KEEPERS' ASSOCIATION.  
ANNUAL MEETING.

The annual general meeting of members was held in the Lecture Hall of the Zoological Society of London, Regent's Park, London, on Thursday, March 19th, 1914, when Mr. T. W. Cowan presided over an attendance larger than in 1913. Many had travelled long distances to be present.

The minutes of the previous annual general meeting, held March 27th, 1913, having been read and confirmed, the Chairman said: I presume you have all received a copy of the Report for 1913. You have just heard the minutes read of the last meeting, which is a very full report of what occurred. I do not think I need say much this time, except that the Report is quite as favourable as it was last year, and we find that in almost every item we have made progress. To begin with, we started with forty-six affiliated associations, we had forty-five in 1912, and we have now forty-six. The membership has increased by three, which is very satisfactory considering there is so much disease about, and that so many members have been obliged to give up keeping bees. That we have not gone down in membership is very encouraging. With regard to finance we have made progress; the total amount in hand last year was £408 7s. 1d. against £374 17s. 10d. in 1912, an increase of £23 9s. 3d., which is very good. At the bank we have a balance of £193, while in the previous year we had only £119. When we can do that in spite of a bad season and great mortality amongst the bees I think it is very satisfactory. With regard to the Development Fund Grant, the work has been carried on and in the Report you will see all that has been done; the lectures have been satisfactory and the attendance good all round. There is another very favourable point to which I should like to draw your attention, *i.e.*, the Experts' Report. At Swanley, in 1912, the bees were all right, and I am pleased to find in this year's report that they still continue healthy, and that they have come through the winter in good condition, with no sign of "Isle of Wight" or other disease. This is very good after being decimated by "Isle of Wight" disease several years ago. With regard to legislation we are no further forward than last year. The Bill was introduced again, and it was really talked out, the Government

being obliged to drop it and give preference to other bills of more importance. They cannot take up a Bill that has to be discussed and carried through. At any rate, a great many bee-keepers have given up bee-keeping, as they seem to think that it is no use until there is legislation. All we can do is to keep bombarding the Government. (Applause.) We must keep on worrying them as we have done before until we do get it. I was at a meeting in Somerset the other day and members were all very keen to have an Act, and very wrath with the Government for not passing the Bill. This Bill is a very small matter compared to the Home Rule Bill and others that the House of Commons have in hand. We must hope for better days for bee-keepers. I think, however, that on the whole the Report is a very favourable one, and I propose that it, together with the balance-sheet, be adopted.

General Sir Stanley Edwardes seconded the motion, saying he had much pleasure in seconding the adoption of the Report and balance-sheet, which were both very satisfactory, and left nothing for them to criticise. He must confess he had hardly anything to say on the subject, but hoped that the Bill which has been before Parliament may get better luck next time. The proposition was carried unanimously.

Mr. Bocoek proposed a vote of thanks to the retiring Council and officers. They were all business men who devoted a great deal of time to the management of affairs of the Association, and it gave him great pleasure to propose a hearty vote of thanks to them for their zeal and labour.

Mr. Illingworth seconded the proposition and it was carried with acclamation.

Mr. Reid said he had much pleasure in proposing the re-election of the President and Honorary Vice-Presidents, Treasurer, Auditor, Analyst, Solicitor, and Foreign Corresponding members. This included a number of people who reflected great credit upon the Association. The Hon. Treasurer had been very active, there was a great deal that the Auditor had done for which they ought to be especially thankful. Two sets of accounts had to be dealt with, as the Development Fund necessitated the keeping of separate books: these had to be audited and presented to the Board of Agriculture. The Board arrange set forms to meet their requirements, and they had to keep these accounts, accordingly they were extremely grateful to the Auditor. They had not troubled the Analyst very much, but at any time questions might arise of the greatest importance, when of course they would go to him. It was a very good sign that they had not had to trouble him, and it showed that there was not much adulterated honey. The Solicitor

also had not been troubled much, but they were very grateful to him for keeping them in the right path. It was important for them to keep straight, so that they should not be called upon to answer for any misdeeds in the future.

Mr. Pugh seconded the resolution, and it was carried unanimously.

Mr. Judge said that he thought the name of Dr. Annie Porter should be added to their list of hon. members as they all knew she had worked hard in the investigation of *Nosema apis*, and he thought it would be a favourable opportunity of showing their appreciation of her efforts to assist bee-keepers by finding a remedy for the disease which was so disastrous to the industry.

Mr. Bocoek seconded Mr. Judge's proposition, adding that Dr. A. Porter had been working on the "Isle of Wight" disease since 1904, some considerable time before the Government investigated the disease. During the whole of the time since that year her efforts had been devoted to finding a cure; those efforts, he regretted to say, had not yet met with great success, but she was still persevering. He thought that it would be a good thing if they were to elect her as an hon. member, and that it would tend towards the advancement of bee-keeping.

The resolution was carried.

Mr. Judge proposed the election of the Council *en bloc*, as printed.

Rev. F. S. F. Jannings seconded, and it was carried.

Mr. Illingworth moved: "That in view of the continued and widespread ravages of 'Isle of Wight' disease, and the great loss thereby inflicted on bee-keepers, fruit-growers, and others, this annual general meeting of members of the B.B.K.A. urges the Board of Agriculture to continue its (valuable) investigations of the disease with a view to discovering a cure. A copy of this resolution to be sent to the Board of Agriculture."

Mr. Rogers seconded, and it was carried. This concluded the business of the meeting.

The monthly meeting of the Council was held immediately after the annual meeting. Mr. T. W. Cowan presided, and there were present Miss M. D. Sillar, Messrs. A. G. Pugh, C. L. M. Eales, R. H. Attenborough, J. Smallwood, W. F. Reid, E. Walker, E. Watson, T. Bevan, General Sir Stanley Edwardes, Sir Ernest Spencer, and Col. H. J. O. Walker; Association representatives D. Seamer (Lincolnshire), G. S. Faunch (Essex), G. J. Flashman (Barnet), F. W. Harper (St. Albans), Rev. S. F. Jannings (Yorkshire), G. W. Judge and G. Bryden (Crayford), W. W. Falkner (Leicestershire), and the Secretary, W. Herrod.

Letters expressing regret at inability to attend were received from Miss Gayton, Capt. Sitwell, Rev. G. H. Pratt, and Mr. J. Waterfield.

The minutes of Council meeting, held February 19th, 1914, were read and confirmed.

The following officers were elected:—Chairman, Mr. T. W. Cowan; Vice-Chairman, Mr. W. F. Reid. Finance Committee, Messrs. R. H. Attenborough, T. Bevan, C. L. M. Eales, J. B. Lamb, A. Richards, J. Smallwood, E. Walker, and Sir Ernest Spencer. Exhibition Committee, Capt. Sitwell, Messrs. T. Bevan, O. R. Frankenstein, A. G. Pugh, E. Watson, E. Walker, and Miss M. D. Sillar. Publication Committee, Messrs. T. Bevan, C. L. M. Eales, J. B. Lamb, W. F. Reid, and J. Smallwood. Board of Examiners (for Paper Work, First and Second Class Examinations), Messrs. T. W. Cowan, D. M. Macdonald, W. F. Reid, and Col. H. J. O. Walker. For Lecture Test, Messrs. T. W. Cowan, C. L. M. Eales, W. Herrod, J. B. Lamb, D. M. Macdonald, W. F. Reid, A. Richards, E. Walker, Sir Ernest Spencer, and Col. H. J. O. Walker. Emergency Committee, Messrs. J. B. Lamb, W. F. Reid, and Sir Ernest Spencer.

The financial report was presented by Mr. Smallwood. The receipts for the month of February were £23 4s. 9d. The bank balance at the end of February was £221 13s. 9d. It was resolved that payments amounting to £40 13s. 9d. be made.

The dates of Council meetings for 1914 were arranged for the third Thursday in each month, excepting August, when there will not be a meeting, in July when the meeting will be at the Royal Show, Shrewsbury, on July 2nd, and in October, when it will be held on the 22nd (Thursday) in Dairy Show week.

The following new members were elected:—Rev. E. A. Woodruffe, Dr. H. H. Corbett, Mr. J. Anderson, and Dr. C. Royds Jones.

The following nominations of representatives from affiliated Associations were received and accepted:—(Suffolk) Mr. H. G. Garratt, (Nottinghamshire) Mr. G. Hayes, (South Staffordshire) Mr. R. Talbot-Clayton, (Cheshire) Mr. G. Garratt, (Somerset) Col. H. F. Jolly.

A resolution unanimously passed at the annual meeting of the South Staffordshire and District Association urging the Council to get the Bee Diseases Bill re-introduced into Parliament was received.

Next meeting of Council, April 16th.

#### RANDOM JOTTINGS.

*By Charles H. Heap, Reading.*

THINGS TO AVOID IN SPRING FEEDING.

With the approach of April, many bee-keepers are seriously turning their thoughts to spring feeding. It is an im-

portant subject, for upon it, often later in the season, success, to a large extent, depends. Unfortunately, the work is not always carried out with sufficient thought and care. In this event the feeder becomes a hindrance rather than a help to breeding, by allowing the escape of a great deal of heat generated, not only at the expense of food, but of the vitality of the bees as well. During last year a long correspondence took place in the "B.B.J." on slow feeders. The great concern of the writers was to secure an instrument that would not allow the syrup to leave the vessel too freely; but no thought whatever appeared to be given to the equally important desideratum—the conservation of every possible degree of heat. While breeding is actively in progress, the bees have to maintain a temperature of over 90deg. Fahr., and it, therefore, follows that when the cluster of bees is comparatively small no effort should be spared by the bee-keeper to prevent the unnecessary escape of heat. Far too often feeders are not only a means by which food is furnished, but a means by which heat is effectively drawn from the brood-chamber. Factory-made articles as well as improvised feeders, are faulty, not only in being draughty but in presenting too large a surface to act as a conductor from the hive of heat which is required in building up a strong colony.

*Successful Stimulation Experiment.*—Another mistake is to slash in the quilts holes from 4 inches to 6 inches in diameter. These are far too large. For stimulative spring feeding a hole large enough to admit the easy passage of two bees abreast through the quilts to the syrup is, in my opinion, all that is needed. I came to this conclusion two years ago, as the result of a successful and unpremeditated experiment in slow feeding. On visiting some bees I had six or seven miles from home, I discovered that one colony was running short of food, and, moreover, needed stimulation. As I had no feeder at hand I took a lever-lid tin with a capacity for 12lbs. of syrup, and put in 5lbs. or 6lbs. of flour candy, which had become dry, and filled the tin with cold water. After stirring to get as much candy melted as possible, I made a tiny hole in the centre of the lid and inverted the can in such a way that the hole in the lid corresponded with a small hole the bees had gnawed through the quilts. When I visited the apiary a fortnight later, I found the can empty and a fine lot of brood in various stages of development. This gave me an idea for a new kind of slow feeder, which I hope to test this spring.

*Disease Germs in Honey.*—Some bee-keepers use honey of an inferior quality

for spring feeding; but the greatest care should be taken always to ascertain whether the honey is the product of a diseased stock. Honey, as every bee-keeper should know, is a vehicle by which the germs of all the well-recognised bee-diseases may be conveyed to a healthy colony. Consequently, when there is the slightest suspicion of disease, or when the honey is from an unknown source, water should be added to it, and the whole thoroughly boiled. I have at times fed doubtful honey, but before doing so boiled it for at least an hour. While the spores of some disease-producing organisms are easily destroyed others will stand somewhat prolonged periods of boiling. This is especially the case with foul brood. It must not be supposed that because honey is several years old it is safe to use on that account. The spores of foul brood will maintain their vitality for many years, while those of *Nosema apis* are able to survive for several years in honey under varying conditions.

*The Vitality of Nosema Spores.*—Last autumn the investigators of the Board of Agriculture and Fisheries carried out some experiments with honey taken from the brood-chambers of hives in which the bees died in the autumn of 1911, from "Isle of Wight" disease. Two samples of honey were used. One sample was in a liquid form. It had twice granulated, and had twice been liquefied through standing in an attic in a position where it received through a skylight sunbeams for several hours daily. The other sample had been placed in a cool, shady position, and had remained in a granulated condition almost from the time it was extracted in January, 1912. Last October the liquid honey was given to 400 bees, all of which died. A few of the bees showed signs of *Nosema*, and there was a great deal of dysentery among them. The granulated honey was also supplied to 400 bees, of which only thirty or forty were surviving on December 15th. The stock, however, lived much longer than that to which the liquid honey was fed. Out of a colony of 400 bees fed with fresh honey from uninfected sources about 300 were alive on December 15th. A few of the bees fed with the honey taken from the hives in which the bees had died were found to contain young *Nosema* meronts. Both samples of honey contained some *Nosema* spores, but the majority appeared somewhat lifeless.

These experiments are exceedingly interesting, as they show that *Nosema* spores are capable of retaining their vitality in honey for at least two years, and though at the end of that time some were "somewhat lifeless" they were capable of producing disease.



### HOW TO MAKE AND STOCK AN OBSERVATORY HIVE.

(Continued from page 104.)

The next portion to make is the brood chamber (Fig. 3). For the bottom a piece of wood (J), finishing 21in. long,  $7\frac{1}{2}$ in. wide, and  $\frac{3}{4}$ in. thick, is required. In the centre a hole (H and M),  $1\frac{1}{2}$ in. in diameter, is cut, to take the cone of the upper half of the turntable (I). This is tapered to fit over the lower half, K (Fig. 2); when screwed fast to the bottom of the brood chamber, and put in position, the top cone fits over the lower one, so that the top edges of both cones are level; M (Fig. 3) the faces of the brass or wood turntable come into contact, so that the brood chamber can be revolved, even when the bees are passing in and out, without injuring them. Another hole, for feeding (N),  $1\frac{1}{2}$ in. in diameter, is bored, with the centre 3in. from the inside of the end. On the side of the bottom (Q) a bracket, 8in. at its longest part and 6in. at its shortest,  $1\frac{1}{2}$ in. wide and  $\frac{3}{4}$ in. thick, is glued and screwed (P) through the curved portion of the bracket. Another hole (O),  $1\frac{1}{2}$ in. in diameter, with the centre  $3\frac{1}{2}$ in. from the centre of the one (N), is bored for the feeding stage. A connecting passage  $\frac{3}{8}$ in. deep is cut on the underside of the bottom, as indicated by the dotted lines between the holes, N and O. This allows a free passage for the bees from the hive to the feeder. A piece of wire cloth or perforated zinc is tacked on the bottom so that it reaches  $\frac{1}{2}$ in. beyond the holes and the passage sides. This prevents the bees from escaping, and forms a floor to the passage. It also helps to ventilate the hive. Two pieces (K), 27in. long,  $5\frac{1}{2}$ in. wide and  $\frac{3}{4}$ in. thick, form the ends. These are lock jointed into the bottom (O) End Elevation Outside (Fig. 4), glued, and screwed with three long screws (Q) from the underside, so that the inside measure is  $17\frac{1}{16}$ in. A piece, P (Fig. 4),  $18\frac{5}{8}$ in. long,  $1\frac{5}{8}$ in. wide and  $\frac{1}{2}$ in. thick, is lock jointed (E), glued, and screwed into the ends at the top. Six blocks, G (Fig. 3) and H (Fig. 4),  $8\frac{1}{4}$ in. long,  $1\frac{1}{2}$ in. wide and  $1\frac{1}{4}$ in. thick, are screwed from the inside only, not glued, S (Fig. 3) and R (Fig. 4), up the centre of the inside of the end, G (Fig. 3) and H (Fig. 4), so that a space above the top one and between the others of  $\frac{1}{2}$ in. is left to carry the lug of the frame. At one of the front corners of the top block a rebate is made, I (Fig. 4), to carry a clinical thermometer for observing the temperature. A couple of tin clips, as shown, tacked round, will hold it in place and allow it to be put in or taken out from the top for cleaning. In this position it is visible from the outside when the glass frame is in position. A couple of holes about  $1\frac{1}{2}$ in. in diameter are bored through the end at U (Fig. 3), and covered with perforated zinc on the inside. The position allows air to pass in over the frame ends. On the outside, ventilators, A (Fig. 4), which can be opened or closed, are screwed. To steady the frames, and also to hold the blocks secure, round head brass screws, R (Fig. 3) and C (Fig. 4), are put in. These should be long enough to go into the frame end about  $\frac{1}{16}$ in. Frames to hold the glass, T (Fig. 3), are made next. These should be  $1\frac{1}{2}$ in. wide for the sides and  $\frac{5}{8}$ in. for top and bottom, so that they do not obstruct the view; the thickness is 1in. These frames are mortised and tenoned together, one being 25in. long by  $17\frac{1}{16}$ in., F (Fig. 4). The others must be  $\frac{1}{2}$ in. shorter, *i.e.*,  $24\frac{1}{2}$ in. long by  $17\frac{1}{16}$ in. wide, so that the frame will fit under the cross piece, P (Fig. 4). Grooves to take the glass, L (Fig. 3), are now ploughed on the inside. These must be wide enough to take the glass used. Twenty-one ounce ordinary glass is the least expensive, and will do very well if carefully chosen free from defects;  $\frac{1}{8}$ in. plate glass is the best, but, of course, is expensive. The outside edge of both grooves should be  $\frac{1}{2}$ in. from the face, T (Fig. 4), or, in other words, the thickness of the wood from glass to the outside of the frame is  $\frac{1}{2}$ in. The space between the glasses will vary according to the thickness of the glass used. The bottom rail mortises

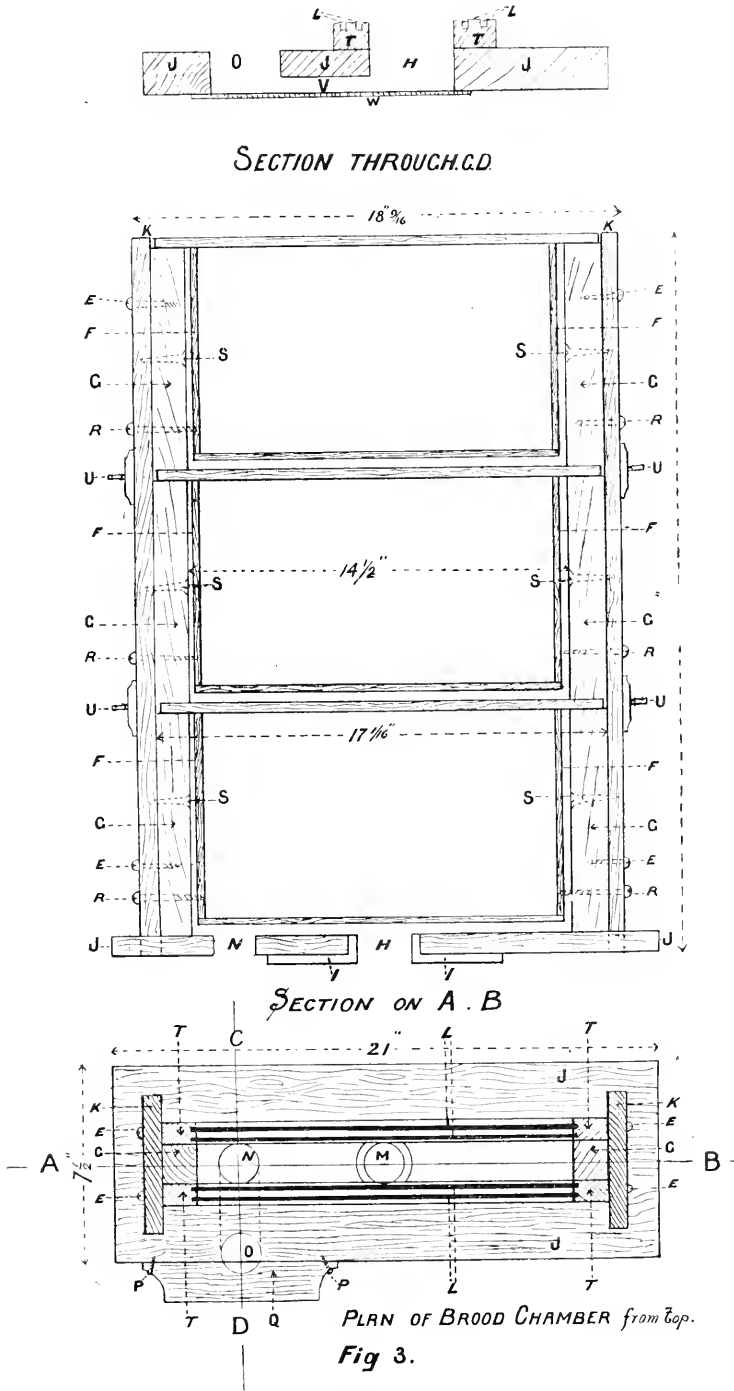

A.B., Longitudinal Section; C.D., Cross Section; E., Glass Frame Screws; F., Frame; G., Blocks; H., Entrance Hole; I., Turntable (upper half); J., Bottom; K., End Upright; L., Glass; M., Entrance Hole; N., Entrance Hole to Feeder; O., Feed Hole; P., Bracket Screws; Q., Bracket for Feeder; R., Frame Screws; S., Block Screws; T., Frame for Glass; U., Ventilators; V., Passage to Feeder; W., Perforated Zinc Bottom to Passage.

are pinned with wood; the top ones should be fastened with screws, so that they can be taken out to remove and replace the glass for cleaning the inside surfaces. The frames are secured by round head brass screws through the end, E (Fig. 3) and B (Fig. 4).

(To be Continued.)



*The Editors do not hold themselves responsible for the opinions expressed by correspondents. No notice will be taken of anonymous communications, and correspondents are requested to write on one side of the paper only and give their real names and addresses, not necessarily for publication, but as a guarantee of good faith. Illustrations should be drawn on separate pieces of paper. We do not undertake to return rejected communications.*

#### "ISLE OF WIGHT" DISEASE.

[8985] A few months ago you were kind enough to publish in your columns an article which I contributed, entitled "A Model Apiary."

I now regret to have to record the melancholy fact that some disease—most probably "Isle of Wight"—has decimated this "humming village" of thirteen stocks, not one being left.

This apiary produced a large surplus of honey during last season, but towards the end one stock showed signs of disease, and upon some of the bees being sent to the Editors of "B.B.J." for examination it was pronounced to be "Isle of Wight" disease. The stock was promptly "sulphured," the bees, combs, and frames burned, and the hive scorched and put aside. The twelve stocks remaining, which were strong and vigorous, were fed with medicated syrup, and afterwards neatly packed up for winter. On one of the sunny days of January my friend went to the apiary, but as he did not see any bees flying he peeped into one of the hive entrances, and he then saw some dead bees on the floor-board. On examining more closely he found eleven stocks dead, the twelfth having a mere handful of bees alive; these few were subsequently killed, and a bonfire of bees, combs, and over a hundred frames were burned. The ground upon which the apiary stood has been covered with lime and every precaution taken to disinfect it.

My friend intends making a fresh start; two members of our local Association having presented him with two stocks of bees, and he has ordered a stock from a well-known bee-appliance manufacturer.

There are one or two deductions perhaps to be drawn from the foregoing, viz.:—"Isle of Wight" disease is no respecter of persons; it attacks the well-kept apiaries with the same virulence, as it does those of the go-as-you-please class, and thus disproves the contention I have heard made by some bee-keepers that the disease only attacks ill-kept stocks. Before

I close I should like to ask a question relating to honey taken from hives of bees which have died of "Isle of Wight" disease. (1) Has it been scientifically proved that such honey is harmless for human beings? (2) Would it not be better for all such honey to be sterilised by bringing it up to a certain fixed temperature?

These questions have agitated my mind for some time for the following reasons: "Isle of Wight" is a disease of the intestines, and if the germs of disease are in the honey, is it impossible for them to find a sympathetic spot in the intestines of some human beings, especially delicate people? And I constantly read in the "B.B.J." enquirers' column that "The honey is safe, or fit, for human consumption, but must not be given to bees."

No doubt you and your scientific readers are able to give solid proof of the immunity of human beings from diseases of bees, and if such proof appears in the "B.B.J." it will allay any nervousness which may exist among those enlightened people who use honey as a regular article of food.—ALFRED EDGE, Bridgnorth.

[See reply to L. K. (Ruabon) page 130.—Eps.]

#### "ISLE OF WIGHT" DISEASE "CURES."

[8986] Replying to Mr Desmond's inquiry (page 113) in last week's "B.B.J." *re* the above, I am sorry to say the "cure" I reported in September last did not prove to be permanent. A few days after I wrote I took off another rack of sections almost as well filled as the first, and later, when I packed the bees up for the winter they appeared to be well and strong, and had plenty of stores. As the weather was mild they continued flying almost daily until Christmas, but about a week before that date they were beginning to drop about again, and they finally died out about a month ago, having still 30lbs. of honey in the hive. Three neighbours whose bees also apparently recovered in the spring report the same ultimate result as myself, only their stocks died earlier.—K.C.A.P., North Herts.

#### POLLEN MITE AND "ISLE OF WIGHT" DISEASE.

[8987] In my opinion the cause of the "Isle of Wight" disease is a tiny mite in the pollen, very much resembling the *Rhizoglyphus agilis*, better known as the "Bulb Mite." This mite has a rather extended life history. The larva, on hatch-  
(Correspondence continued on page 128.)



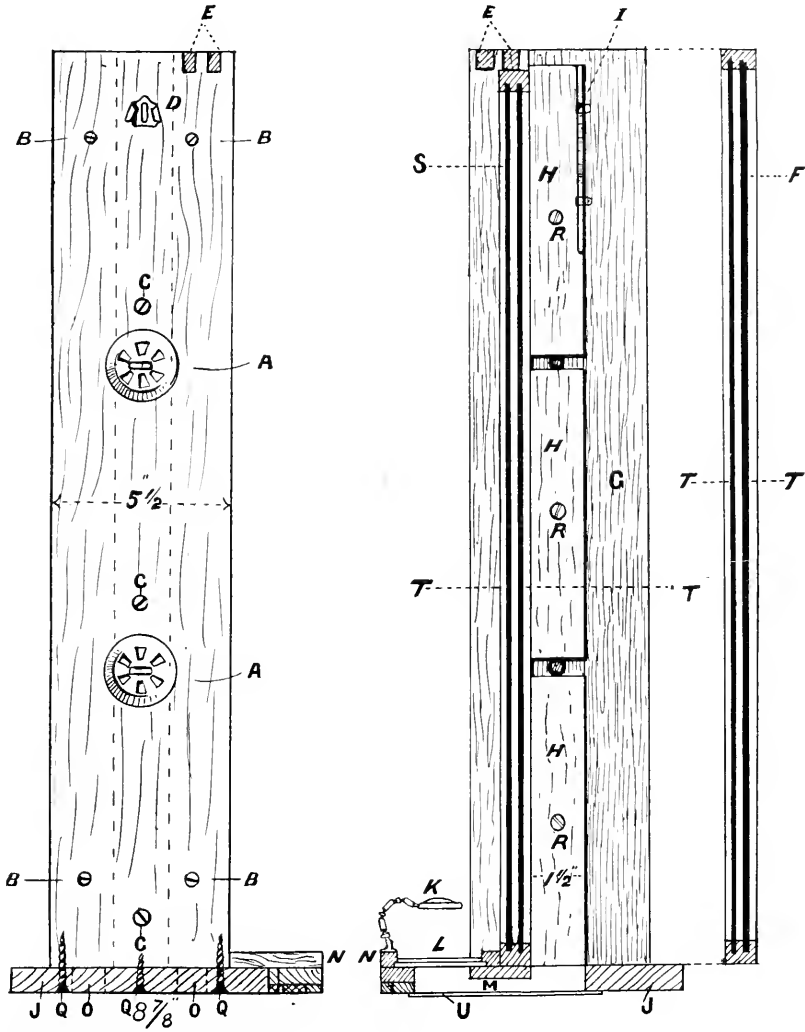

END ELEVATION, outside. END ELEVATION, inside.

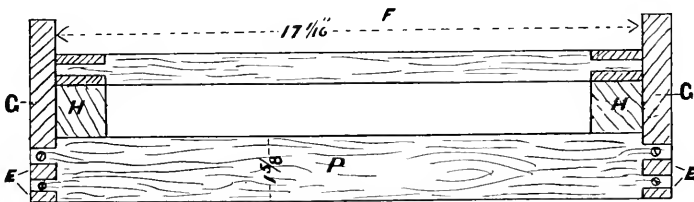

Fig 4. PLAN OF TOP OF BROOD CHAMBER.

A., Ventilators; B., Glass Frame Screws; C., Frame Screws; D., Fastener Catch; E., Lock Joints; F., Long Glass Frame; G., End Uprights; H., Blocks; I., Thermometer; J., Bottom; K., Ball Jointed Lens; L., Opal Glass and Glass in Feeder; M., Feed Hole Tunnel; N., Feeding Stage; O., Lock Joint of End Uprights; P., Top Cross Brace; Q., Screws; R., Block Screws; S., Short Glass Frame; T., Wood Left Between Glass and Outer Edges; U., Perforated Zinc.

ing from the egg, has six legs, and after feeding for a short time it moults and becomes a nymph with eight legs. The nymph probably moults twice before it becomes a perfect insect sexually. There is also a *hypopus* stage in the life of some of them, which stage is developed for the spread of the species, and during which the *hypopus* possesses suckers by which it can adhere to flying or passing animals. All the stages can be found in a hive with "Isle of Wight" disease, and also in the intestines of the diseased bee. The hatching eggs are responsible for the destruction in the intestines of the bee.

The perfect insect itself is easily destroyed. A few puffs of tobacco smoke will make it insensible and allow a half-hour's examination. The *Hypopus* is non-active, and may also be seen with a good lens. The eggs are very, very small and numerous, and seem to be able to resist any drug which may be administered to the bee with safety. The removal of the pollen will, of course, arrest the infection, but it will be found that those bees showing signs of the disease have lost their ability to take food.—G. W. GRANT.

#### THE FIRST HUMBLE BEE.

[8988] I saw my first humble bee this year on March 21st, a beautiful day, with hailstorms between bursts of bright sunshine. The willow has been in bloom for a week, and the bees are now busy on it. Last year I saw the first humble bee on March 31st. Then, as now, it was *Bombus terrestris*. I do not find that *B. pratorum*, Mr. Sladen's "early nesting humble bee," is the first to appear. The flowering currant is just out, and shortly will entertain many wild bees.—G. G. DESMOND, Sheepscombe, Glos.

#### PROGRESS OF "ISLE OF WIGHT" DISEASE.

(Continued from p. 116.)

Page 73: "It is known that in certain other protozoal diseases that the newer the parasite is to the host the more deadly it is found to be. Also it has been shown that after a time the host acquires the power of tolerating the parasite to a greater or less extent. Arguing by analogy with *N. Bombycis*, which is fatal to silkworms in practically all European cases, it would seem probable that *N. apis* has been a parasite of bees for a longer period than *N. Bombycis* has of silkworms. If such be the case, there is then the possibility of an immune race of bees developing; and, indeed, certain experiments in cross infection have shown that some bees may feed on honey containing thousands of *Nosema* spores, and yet be unaffected by them."

In the portion of the report dealing with the history of the disease, substantial evidence is brought forward, pointing to the

fact that the disease is no new one, but that it has been endemic in various parts of the country for many years, and that the numerous cases of bees dying during winter, the reason for such being put down to the inability of the bees to reach stores during cold spells, to dysentery, &c., were really due to *Nosema apis*. Spring dwindling is also attributed to the parasite. Further evidence supporting the case for the possibility of acquiring immunity lies in the fact that we have no other insect that can do for us what the hive-bee does in the way of fertilising fruit blossom. Humble bees and other insects do visit them, but at the season of bloom they are not present in sufficient numbers to perform the work efficiently. In many parts of the world it has been found necessary to establish apiaries on fruit farms in order to provide for the blossoms being properly fertilised. In view of this, it does not appear likely that it is part of Nature's plan to allow of the extermination of the hive bee. In a state of Nature, the continuance of the race could only be provided for by some bees acquiring the power to resist the disease and reach a state of immunity—"The survival of the fittest."

But we can do something at any rate to assist our bees by seeing to it that the conditions under which they live are favourable. They cannot flourish in damp hives, and therefore it is necessary to see to it that roofs are watertight. Bad stores are a fruitful cause of trouble, predisposing bees to disease by overtaxing their digestive systems and so weakening their resistant powers. Reference is made on page 28 to a statement made by Mr. Beuhne, of Australia, to the effect that "he had an instance of bees falling out of a hive in a short time after he had given them a comb of mouldy pollen." Mouldy combs are frequently found on the outside of the brood-chamber in the early spring, and these outside combs are usually stored with pollen. If these are left in the hive the bees will, if strong, clean them up, but to do this they are compelled to tear down the cell walls in order to remove the pollen and take the mouldy mass into their mouths for removal from the hive. This can have none but a prejudicial effect upon health. It is a good plan, whenever a poor comb is found during an examination, to work it to the side of the brood-chamber and remove it in spring.

The plan provides for the systematic renewal of the combs and ensures that if any of the combs are spoiled by mould, it is those of the least value.

Plenty of warm wraps are necessary in winter and spring, but "the best packing for bees is bees."

To produce heat bees consume honey and hang in a cluster. In a healthy con-

dition they have the ability to retain their excreta in the bowels for a considerable time and until a warm day provides an opportunity for flight. A large cluster of bees can reach and maintain the necessary temperature with less individual consumption of stores than is the case with a small cluster, consequently there is a smaller quantity of residue in their bowels, and they will pass through hard weather better and live longer in the spring. Bees in a small cluster are compelled to consume large quantities of honey in order to produce heat. The increased quantity of residue causes a strain on their bowels, which frequently culminates in dysentery, and is, in any case, bound to result in a lowered vitality. In this condition they contract disease quickly. In conclusion, I will re-quote from the report the statement that "We think good results might be obtained if attempts were made to build up apiaries from stocks which show well-marked resistance to the disease."

In doing this let us see to it that queens are reared in none but strong colonies and only when honey is coming in, thus ensuring that the embryo queens will be well fed during their larval stages. A poor queen means a poor colony.—  
H. H. BROOK.

#### BLURTS FROM A SCRATCHY PEN.

CONTINENTAL WANDERINGS.

(Continued from p. 107.)

We should have liked to have stayed longer in Paris. Even from an apicultural point of view we were obliged to hurry over our work. As all the world knows, our junior editor has but very short intervals which may be devoted to relaxation. Therefore our tour was necessarily mapped out, so many days here, so many days there, and we had still Italy, Switzerland, and Belgium to visit. Therefore the evening of Tuesday saw our movement farther south. We were in light marching order, our impedimenta of the smallest, just as much as we could cram into a moderate sized valise, plus portable camera and photographic apparatus. Therefore we contemned the need of taxis. Should I ever go the "Grand Tour" again, I would consider even halving this baggage. Was it not General Gordon who said that a hair brush, soap, and a razor were the only necessities even for a world's tour.

The "Gare de Lyon"! Now we begin to recognise that we are not on an island. From this point you may commence and, scarce leaving train, may travel Europe, Asia, aye, even Africa. The departure boards at our English stations indicate that from where you may at the moment be situated you can reach the North of Scotland or even Dublin town, but at the Gare de Lyon you read that the

train from platform number so-and-so starts for Geneva, and from the next to Rome, Naples, and Brindisi. Verily, the world is but small after all.

Our next main halting-place was Rome, yet it is a long journey to take without any break, therefore we arranged sundry halts en route. We left Paris, as I said before, in the late evening; in the early morning as the day began to break we could see the snow-capped mountains on our right, the Jura Alps, which nestle around Geneva. We crossed the frontier via Mont Cenis and its seven miles tunnel. Modane was a station divided against itself, on the one side French officials, on the other Italian; nay, even the time of day would not agree, for the face of the Italian clock would insist on brazening out that the French clock, which stared it full in the face, was an hour late. We who hailed from Britain believed neither, we knew that both lied.

And so we invaded Italy, but with very peaceful intention. We descended on the fat plains of Lombardy. Shades of ravaging Gauls of bygone days, now I appreciated how and why you had broken through those mountain fastnesses for spoils of war. Land of plenty now at peace. Land of grapes and olives, of wine and oil and honey. Fat oxen tilled the soil or dragged loads at their own lazy gait. Here fields of maize and flax or buckwheat, there bamboos growing as the osier does with us. Until the afternoon we travelled through the same unceasing abundance. Why do Italians leave their beautiful lands for our rugged shores?

Our resting-place for the night was Turin, city of colonnades and piazzas. We were "a day's march nearer Rome," and the next morning early we were away betimes; we wanted to visit Pisa to see its leaning tower and its cathedral in our hurried flight, for, perforce, it was almost that. In the grey of almost the only rainy afternoon we endured we saw Genoa and sped onwards. At first we met the Mediterranean. "There shrinks no ebb in that tideless sea." As the rays of the rising sun pierced the mists of the morning, the ruined arches of the great aqueduct told us we were nearing the Eternal City. We were speeding through the level Campagna and wondered if in the history of Rome those ruined towers that we saw so frequently had taken any part. We were brimful of romance and poetry and so we passed the ancient walls and entered Rome.

O Rome! Rome! I have dreamt of thee since my schoolboy days. I have suffered pains and punishments because I found it difficult to learn thy Latin. I have mentally pictured thy streets with marching brass-helmeted legions, chariots accompanying. I see thy toga-clad

senators. I hear Cicero declaiming "O tempora! O mores!" I hear—

"Hotel! Hotel! Hotel! This ees de English Hotel! Voiture for Hotel de Londres! Any baggage! I am the English Guide!" and a thousand other shouts from lungs of brass.

Really, that last night's travelling must have sent me to sleep. I have been dreaming. This Babel and confusion cannot be old Rome, it must be some up-to-date city of pleasure.

We had already arranged for our residence. Our words were few, but were to the point. Some people might have called them English swear words.—J. SMALLWOOD.

(To be continued.)

#### LECTURE ON BEE-KEEPING.

On March 30th, a lecture on "A Year's Work in the Apiary" will be given by Mr. W. Herrod, at 8 p.m. in the Christ Church Schoolroom, Woodside Road, Longlands, Sidcup. The lecture is organised by the Crayford and District B.K.A., and the Secretary hopes that all members will endeavour to be present, and will bring friends.

#### TRADE CATALOGUES RECEIVED.

E. H. Taylor (Hive Works, Welwyn, Herts).—This well-known firm is again to the fore with a well-got-up list of bee-appliances for large and small apiaries. Everything that the bee-keeper can possibly require is listed, and in most cases illustrated also. The Hints on Successful Bee Management will be found handy by the novice, who is frequently in need of a reminder as to when and how to perform the necessary work in the apiary. Mr. Taylor makes a feature of poultry appliances, a comprehensive list, well illustrated, of these is added to the bee goods catalogue. There are many other items shown connected with bees and gardens. The catalogue, forming a useful book of reference, can be had post free on application.

## Bee Shows to Come.

A nominal charge of 2s. 6d. is made for notices (not exceeding 7 lines) in this column, 10 lines charged 2s. 6d., up to 15 lines 5s., which covers cost of insertion from order till date of show. Cash should accompany orders for insertion.

**June 9th-11th, at Malvern.**—The Herefords and Wores. Agricultural Society's Malvern Meeting. Twelve classes for Honey, &c. Good prizes: small entry fees.—For schedule apply, Mr. A. Elliott, Hon. Secretary's Department, Casop, Hereford.

**June 30th to July 4th, at Shrewsbury.**—Royal Agricultural Society's Show. Bee and Honey Section, under the direction of the B.B.K.A. Prizes arranged in groups of counties for Associations affiliated to the B.B.K.A. Schedules from W. Herrod, 25, Bedford Street, Strand, W.C. Entries close **May 30th**.

**July 8th, at St Albans.**—Honey Show of the St. Albans B.K.A., held in connection with the Elstree and Boreham Wood Horticultural Society, at Aldenham Park. Open class for extracted honey. No entry fee. Liberal prizes. Judge, Mr. W. Herrod. Schedules from Mr. R. H. Attenborough, Aldenham, Herts. Entries close **July 6th**.

**July 24th and 25th, at Cardiff.**—The Glamorgan B.K.A., in connection with the Cardiff and County Horticultural Society's Show, in the Sophia Gardens, Cardiff. Open classes include:—Collection, Gift, Sections, Beeswax, &c. Schedules from W. J. Wiltshire, Maindy School, Cardiff.

## Notices to Correspondents

**L. K. (Ruabon).**—Honey and "Isle of Wight" Disease.—No instance has been discovered in which honey from stocks dead from "Isle of Wight" disease has been harmful to human beings. We would, without hesitation, eat such honey ourselves. One eminent scientist tried in this way to "poison" himself with *Nosema apis*, as an experiment, but without success. There is no doubt that it is harmless to human beings.

#### Suspected Disease.

**H. M. E. (Enfield).**—Send the dead bees to us for examination.

**J. T. (Baildon) and M. H. (Lowestoft).**—The bees have died from "Isle of Wight" disease.

**Q. S. (Mindrum).**—It is "Isle of Wight" disease, but there is no reason why you should not start again.

**TROUBLED (Thorby).**—The bees were too decomposed for us to determine cause of death.

**SCOTIA (Ayrshire).**—It is "Isle of Wight" disease, the only course you can safely follow is to destroy the infected bees.

**G. C. E. (Ayr).**—There are signs of "Isle of Wight" disease in the bees sent.

**J. B. (Falfield).**—We are sorry, but the bees are too decomposed for us to be able to form an idea as to cause of death.

#### Honey Samples.

**H. H. B. (Ottery St. Mary).**—The honey contains a little ragwort, but we do not consider it objectionable; on the contrary, it is not a bad honey.

**W. H. (Teals).**—A fairly good sample.

### Special Prepaid Advertisements.

**Two Words One Penny, minimum Sixpence.** Orders for three or more consecutive insertions entitle advertisers to one insertion in "The Beekeepers' Record" free of charge.

Trade advertisements of Bees, Honey, Queens, and Bee goods are not admissible at above rate, but will be inserted at 1d. per word as "Business" Announcements, immediately under the Private Advertisements. Advertisements of Hive-manufacturers can only be inserted at a minimum charge of 3s. per  $\frac{1}{2}$  in., or 5s. per inch.

#### PRIVATE ADVERTISEMENTS.

**B**EEES.—Seven good stocks, new hives; also all appliances, to clear.—MISS SARGEANT, Bank-street, Braintree.

# Editorial

## BRITISH BEE-KEEPERS' ASSOCIATION. CONVERSAZIONE.

At the conclusion of the annual meeting, reported last week, the members and friends assembled in the Lecture Hall, where light refreshments were served. At six o'clock Mr. T. W. Cowan gave his "Special Lecture" on "Bee-keeping in Other Countries," dealing with those countries which he had not time to include in the lecture given on the same subject in March, 1913. The large audience

attention to a venerable gentleman in the foreground, who is explaining the advantages of the moveable comb-hive. This is M. Kandratief, who did so much to popularise the Dadant hive in Russia, which in this picture he is pointing to during his discourse.

In the lecture, which I gave in March of last year, I made a brief allusion to what the Swiss call "race breeding," which had by means of constant selection produced such good results. It was not possible in the time at my command to go into details or show you any of the stations in the mountains where queen-rearing is being carried on. I am pleased now to be able to show you views of some of these places, so that they will give you an idea



MATING STATION, BRUGGEN, SWITZERLAND.

assembled listened with the greatest interest to Mr. Cowan's address, which was rendered more enjoyable by the splendid lantern slides specially made for this lecture by Mr. A. H. Cowan. Eighty-nine were shown, and we regret that only a few of these can be illustrated in our pages, as the photographs were of such excellence and general interest that it was difficult to make a selection. Mr. Cowan said:—

The picture before you, which gives the title of my lecture, is an allegorical one, and represents a typical apiary in a Russian village situated amongst picturesque surroundings with the village church in the background. You will notice the trunks of trees which are used as hives covered by ridge roofs, and on the left the peasant proprietor paying serious

of the work connected with rearing queens by selection. The Swiss believe, with very good reason, that "every land has the best bee," which, in other words, means that the common bee of the country is best suited to that country.

With the object of deciding which race to cultivate, the opinion of the members of the Swiss Bee Association was taken in 1907, with the result that of the 3,400 members:—76 per cent. favoured the Common Black; 5 per cent. Carniolans; 3 per cent. Italians; and 15 per cent. cross breeds.

This overwhelming majority in favour of the common bee decided the Society to go in for pure-race culture. You must not imagine that this breeding by selection

is a very simple process, within the capabilities of every bee-keeper, for there are several factors which must be taken into consideration. There are two types of native bees: (a) The reddish-brown and (b) the brown-black, and it is recommended that these should not be crossed. The lighter coloured bees are found in districts rich in potash, such as south of the Alps and at the foot of the Jura. Then Dr. Kramer says that such factors must be taken into consideration as the food, age of the queen, the mating, the season, as well as the strength of the colony. For the purpose of this breeding and obtaining fertilisation by drones from selected colonies, queen-rearing and mating stations are established in isolated places in the mountains. I will now show you a series of these containing nuclei, so that you may form some idea of the work that is being done. The following pictures show some of the apiaries in the valleys where queen-cells are produced. They are then placed in the nuclei and taken to the mountains for mating with selected drones, which are taken there for the purpose. It is evident that at these elevations, where bees are not kept, the queens on flying must mate with drones brought there. The next picture shows a motor-car laden with nuclei going to the stations for mating. All those undertaking this sort of queen-rearing meet frequently for comparing notes and instruction, and, among other things, learn how to make nuclei and other appliances for the purpose, as you will see in the picture before you.

In my last lecture, when speaking of the work of Dr. Zander, who was the first to bring to notice *Nosema apis*, and point out its extreme danger, I showed you views of the laboratory and experimental apiary at Erlangen, and now I am pleased to be able to present you with his portrait. All the investigations of Dr. Graham-Smith and the others associated with him have fully confirmed Dr. Zander in his statements regarding the disease which is still so prevalent in this country.

#### HOLLAND.

Bee-keeping in Holland is principally carried on in skeps, although there are advanced bee-keepers who use frame-hives. There are 120,000 bee-keepers; most of them own round straw skeps, although there are also 3,000 square skeps and frame-hives. There are two forms of skeps used, namely, round ones similar to ours but larger and higher, as seen in the picture of an apiary at Amerongen, and square ones, the picture before you showing the men at work plaiting them. The principal bee-keeping districts are in the province of Drenthe, Gelderland, and North Brabant, as far as the most southerly boundary. Most of the

frame-hives are found in North Brabant, although there are a few in other districts, the picture before you showing the apiary of Herr Van Os, at Leersum. To the east, along the German frontier, are extensive moors yielding an abundant supply of heather honey. German bee-keepers frequently transport their skeps in the autumn to these districts to take advantage of the heather. It cannot be said that bee-keeping is thriving, because the cultivation of buckwheat, one of the principal honey sources, is diminishing from year to year, and a large part of the heath districts have been brought under cultivation. There is a Bee-keepers' Association (*Vereniging tot besordering der bijenteelt*), and also an instructor, who gives courses of lectures. The Association, which has 6,200 members, received a yearly grant from the Treasury of 4,000 francs, and the bee-keepers are permitted to obtain their sugar, for feeding in spring and autumn, free of duty.

There is a curious custom still prevailing in Holland, for every year, on the second Tuesday in July, a bee market is held in Veenendaal (Province of Utrecht). Only bees in straw skeps are brought to this market, and generally from 3,000 to 4,000 of them are to be seen. Bee-keepers from all parts of the country come to buy or sell their skeps of bees at from 2 to 3½ francs a skep. In the spring they are worth 4 to 4½ francs, and in the autumn 6 to 7 francs. Honey sells at 30 to 40 centimes a pound for the best qualities and 18 to 25 centimes for inferior ones.

#### AUSTRIA-HUNGARY.

By referring to the map, you will see that these countries are in parts very mountainous, and are therefore extremely well adapted for bee-keeping. In Austria this is carried on very much in the same way as it is in Germany, for similar hives and bee-houses are used, as you will notice in the pictures. The country is very productive, and there are large districts where bees do very well. In recent years the horizontal system, such as we employ, has been introduced, and is being taken up more and more. Bohemia and Moravia are mountainous, and both in the plains (where fruit is cultivated) and in the mountains there is plentiful pasturage for bees. There are also many bee-keepers in Southern Austria and Tyrol. In Hungary there are also many mountainous districts, so that bee-keepers are able to take their bees to higher pastures when the flowering in the valleys is ended, and in this way the honey season is prolonged.

It is estimated that there are 1,765,213 colonies of bees kept. Most of these are in small boxes, and one sees piles of them frequently under the eaves of the peasants' houses, or under shelters in their gardens.

In Carniola, where the pasturage is scanty, the peasants derive their profit from selling their bees to dealers, who every year send a large number of colonies to other countries. Carniolan bees are noted for their mild temper and excessive swarming, which is probably a habit acquired owing to the very small hives used. In the Banat district there is a race of bees very similar to Carniolans. In Galicia, which is most favourable for bee-keeping, there are 230,000 colonies. Hungary and Bukovina have also rich pasturage, the Carpathian Mountains abounding in lime trees, and to the south there are extensive fields of melon. One of the best trees is the acacia, which furnishes a beautiful white honey of excellent

same plan as those I mentioned in Switzerland. The Bee-keepers' Association is under the patronage of the Emperor Francis Joseph, who contributes 200 kroner from his own purse towards its funds.

#### BALKAN PENINSULA.

Entering Servia by Belgrade, we find we are in a mountainous and romantic country, and that bee-keeping is extensively carried on, more particularly in the north-west. I am able to show you a number of the leading apiaries, and you will see that the parish priest, or "Papa," as he is called, figures in most of them, as the clergy, as a rule, take a leading part in the industry. Cultivated plants are scarce, but, on the other hand, the



APIARY AT MONASTERY ST. PANTELEIMON, SERVIA.

flavour and aroma. There are also several varieties of betony that yield nectar in abundance. Owing to the duration of the flow in this part of the country, the larger Berlepsch hives are in greater use, and many bee-keepers practise migratory bee-keeping. The Government makes a grant of 10,600 kroner to the Bee-keepers' Association and 1,400 kroner for the School of Bee-keeping. The Bee-keepers' Association, with its branches, numbers 12,680 members, all of them receiving the official organ, *Bienen Vater*. Instructors travel to all parts of the country, and in the laboratory attached to the school scientific investigations are carried on. They also have an experimental apiary, in which I see last year they lost thirty-two colonies, so that it is not only in this country that losses occur in experimental apiaries. There are observation stations on the

mountain flora is abundant, the acacias and *gleditchias* being extensively distributed. The common hive, "truka," is conical and made of plaited basket work, generally plastered over with clay, as you will notice in the pictures before you. Modern bee-keeping, however, is rapidly spreading, and the horizontal hives are taking the place of skeps. In the view of the monastery of St. Panteleimon you may see two skeps suspended from the trees, these being for the purpose of catching swarms. There are 185,000 colonies of bees in Servia, and schools as well as experimental stations at Yagodina and Krasnigeva. One of the largest bee-men is M. Marchulya, near Belgrade, who owes 1,400 colonies, fifty of them being in frame-hives. Pastoral bee-keeping is also carried on, the picture before you showing a family occupied in this pursuit.

## ROUMANIA.

Following the River Danube from Belgrade, we enter Roumania, where to the east of the Carpathian Mountains we find a fertile plateau. The hives (called "stup" or "ulei") used here are either hollowed out of trunks of trees or upright boxes made of boards, generally covered with a loose lid. It is seldom that one encounters the Balkan skep in Roumania, although it is common in the other States. There are 310,000 colonies spread over the country, and the Apicultural School is situated in the mountains. The principal hive used in this apiary is of the Dadant pattern, which is making its way gradually all over the country, although several other types

there are several bee-keepers who have taken to modern methods. As you will have seen, from the map I showed you, parts of the country are very mountainous. The pasturage, however, is good, there being acacias and lime trees in abundance, besides the regular mountain and alpine flora. The common Bulgarian hive, called "kosch," is made of coarse basket work of thin lathes, and the peasants kill the bees in the autumn to get the honey. Small swarms and weak lots are left to their fate, many of them perishing from starvation during the winter. Those using modern hives are able to obtain an average of 50 kilos of honey per hive, and the total produced yearly is said to be 1,000,000 kilos. The

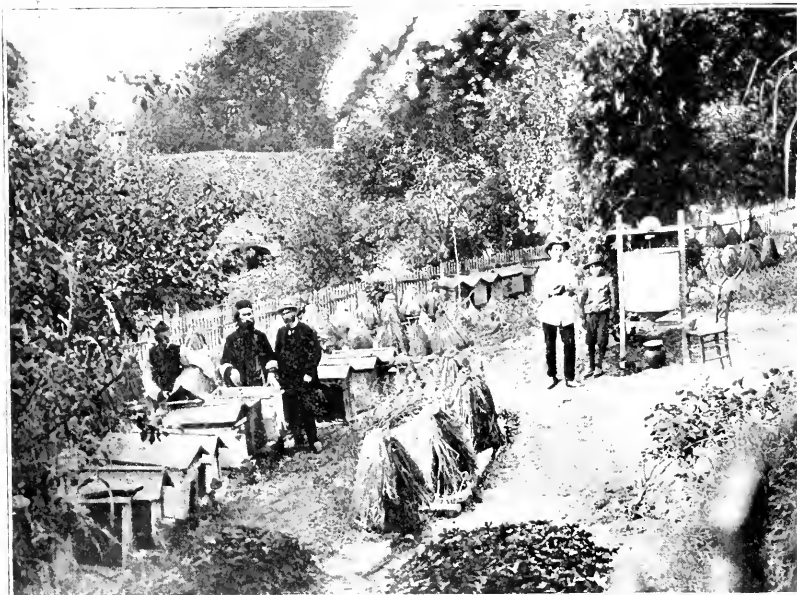

APIARY OF M. J. PAFOVITCH, PETCHENOVATZ, SERVIA.

of hives are also in use. One of the largest bee-keepers and pioneer of modern methods is Prince Stirbey. On his property at Buftea he has 420 colonies of bees. In a large bee-house there are 220 colonies. This house is provided with water-heating apparatus, so that in winter the temperature is never allowed to get below 40 degs. Fahr. In cold, damp springs the temperature is increased so as to enable the colonies to develop more rapidly. In addition, there is an annexe to this house, in which are placed during winter 120 colonies. These are all in horizontal hives, and are brought outside during the summer months. In another annexe there are eighty skeps.

## BULGARIA.

Bee-keeping, which has been backward in this State, is just now waking up, and

bee of the Balkans is called "Ptschela," and is very similar to the Carniolan bee. The Government has two model apiaries at Sofia and Tewfic, both furnished with modern horizontal hives. One of the leading bee-keepers is M. Watchkoff, of Souhindol, who has a large apiary, consisting almost entirely of Dadant hives. The Association of Bulgarian Bee-keepers was founded in 1899, and has for its organ the magazine called *Ptschela*. All these countries of the Balkan peninsula have suffered from the war, and I am sorry to say that some of my correspondents are no more, as letters have been returned marked "not known" or "left, no address," which makes it melancholy to contemplate the results of war in a country.

(To be continued.)



**SHEFFIELD AND DISTRICT BEE-KEEPERS' ASSOCIATION.**

A large number of bee-keepers and their friends assembled at a meeting of the Sheffield and District Bee-keepers' Association, held on Saturday, March 21st, in the rooms of the Literary and Philosophical Society, Sheffield. Mr. E. Howarth, F.R.A.S., F.Z.S., presiding, to hear a lecture by Mr. W. Herrod, on "Diseases and Enemies of Bees," illustrated by lantern views. The audience were very much interested in the subjects, as was indicated by the number of questions asked. These were promptly and satisfactorily disposed of by the lecturer. A hearty vote of thanks was accorded to Mr. Herrod for the very able way in which he delivered the lecture, and also to Mr. Howarth for presiding at the meeting.—W. GARWELL, Hon. Sec.

**ERRATUM.**

We omitted the name of the Rev. E. A. Woodruff-Peacock, L.Th., F.G.S., F.L.S., &c., from the list of new members of the B.B.K.A. in our last issue.



*The Editors do not hold themselves responsible for the opinions expressed by correspondents. No notice will be taken of anonymous communications, and correspondents are requested to write on one side of the paper only and give their real names and addresses, but not necessarily for publication, but as a guarantee of good faith. Illustrations should be drawn on separate pieces of paper. We do not undertake to return rejected communications.*

**SUNDRY HERESIES ABOUT BEES.**

[8989] I have been looking every week in the "B.B.J." for a reply to Mr. Anderson's letter of February 26th, page 86, and as nobody seems inclined to criticise the statements, I venture to give my experience on the subject. I had the pleasure of meeting Mr. Anderson at the Honey Show at Aberdeen last August, and can quite believe he saw the queen and drone on the porch of the hive as stated in his letter; but it is quite possible, and likely, that the first part of the act took place in the air some little distance from the hive and that both dropped together on the porch.

I have seen scores of virgin queens flying, but never yet saw a drone taking any notice of a queen, either in or on the hive. Young queens behave in much the same manner as young workers, and can easily be seen flying near the hive

marking the place. I have more than once caught a young queen on the wing a few yards from the hive. As to the necessity of making very careful observation, the following incident will show:—At the Aberdeen Show last year I had a "Nicolson" Observatory Hive stocked with bees on view. On the day preceding the show the bees were put in along with the comb, on the edge of which I had grafted three queen cells for illustration. During the show Mr. Anderson, if I mistake not, pointed out that the queen was tearing down a queen cell. This was very interesting to me, as I knew the condition the queen cells were in, and could not see what purpose it would serve the queen to tear them down. However, little could be seen of the actual destruction at that particular time, as the bees were evidently busy round that cell; but later on, when the bees began to cluster near the centre of the comb and leave the cell exposed, I observed it was the top of the cell that had been torn open, as this had no doubt been damaged when the bees were repairing the broken edge of comb and attaching the cell, which they can do very nicely. The cells in this instance were all empty, the queens having hatched, but as the capping had been left only partially cut off, the bees had sealed it again in place, and it looked like a ripe queen cell. The sealing up of an empty queen cell often takes place about the time a cast is expected, and I am inclined to think that novices often leave an empty queen cell when they cut out all save one to prevent after swarms, which it certainly does, but leaves a queenless stock. By holding the cell up to the light its emptiness will be revealed.

Mr. Anderson's assertion that unhatched queens are sometimes destroyed by the bees, and not by the queens first hatched, is quite correct, as can sometimes be proved by inserting a few queen cells in a nucleus, when some of these may be torn down before any of the queens hatch.

So far as I have observed, a queen cell containing an unhatched queen is always attacked by the queen, or by the workers at the instigation of the queen, or by the workers themselves, at the side of the cell first where it is soft, and after the young queen has been dispatched the cell is ripped down and the contents emptied.

I quite agree with Mr. Anderson that many bees live longer than six weeks, some even six or even eight months, and perhaps in a very rare instance for ten months, as he points out in his own case; still, when we consider the average length of life of a worker bee in the height of the season, I think six or eight weeks will be about the limit. Mr. Anderson will

get a good illustration of this if he takes a cast, which will contain many young bees, and removes all the young brood before it hatches; six or eight weeks later only a small percentage of the original stock will remain.—ALEC. LOW, Aberdeens.

#### “ ISLE OF WIGHT ” DISEASE CURES.

[8990] I noted the request of Mr. Desmond (8979) in your issue of March 19th, relative to the above, and as he refers to my letter published in the JOURNAL on June 19th last year, and to enable those interested in this subject to follow my reasoning, I must perforce refer to this communication, and also to my correction in the following issue (page 252).

The pestiferous lot of diseased colonies referred to in paragraphs 2, 3, and 4 (page 245) were, up till quite recently, in the same condition as there described; the small apiary of fifteen colonies, par. 4 (not ours) close to the above-mentioned diseased stocks, were treated with Ayles' Cure throughout the summer, in some cases three times, and each time the hives were burnt with a painter's blow lamp before transferring. Results: the disease was checked, and checked only. The stocks gradually succumbed until in late autumn not one was left alive.

The thirty colonies referred to in par. 5, and situated at Wilbraham, about three miles from our home apiary, were already affected on June 19th. The treatment followed was the same as in the case of the fifteen stock apiary, but results are a trifle better, four colonies being alive, two of which are very strong and up to date show no sign of disease. The disease (page 245) which was checked in those affected colonies, reappeared in September and they were destroyed; the others, excepting the four mentioned above, died during the winter.

I now come to the home apiary, par. 5, page 245. I had at this date fifty stocks in splendid condition, producing at the end of the season a good crop of honey. The disease appeared in the early autumn; six I destroyed, and three died during the winter, leaving at the present moment forty-one colonies. Amongst these there are ten showing signs of the disease, some of which, I believe, had it in a mild form in early winter, the remaining thirty-one, so far as one can tell at present, are in a healthy condition.

In judging results one must consider the condition of colonies in the neighbourhood. Taking in a radius of ten miles from Fulbourne, a southern section embracing seven or eight villages, I have been told on good authority and partly from observation that it is difficult to find a single colony of bees alive (I knew of apiaries within this section ranging

from 150 colonies downwards). In the immediate neighbourhood of Fulbourne, apart from our own, the colonies still alive can be counted on the fingers of one hand. Ayles' Cure, I believe, has done some good, more as a preventive than as a cure (in my experience). Within the radius given I know there are several districts where no disease has been seen.

I am now trying another remedy which has been alluded to in the JOURNAL, and whatever the result I will, if desired, report it. With Mr. Desmond I appeal to those other bee-keepers who have reported cures to give results of their experiments.

JAMES LEE, Fulbourne, Cambs.

#### WINTERING BEES.

[8991] Apparently it has not occurred to Mr. Crawshaw (page 118) that it *might* be a stock of Banats for which Mr. Herrod intended the almost ideal combs illustrated on page 82.

Black stocks, strong numerically and physically, tucked in snug and warm, and with about 30lbs. of well-matured stores, will invariably be found “ in the pink ” at the spring examination; but Banats—well, there seems to be no limit to the amount of food they can consume, provided it is supplied to them. In Cumberland they cannot, or will not, gather anything near their own requirements for winters like the last two have been. One stock, which was exceptionally strong both in 1912 and 1913, could not in either year be prevailed upon to store an ounce of honey in the racks of fully drawn-out sections I gave to it. Last September I found the stock had only about 30lbs. of honey in the brood-frames, and guided by the experience of the previous winter, I fed them up rapidly until there was about 50lbs. of stores in ten frames. Seeing brood cast out on February 14th, I looked in and found a very bare cupboard, and put on 8lbs. of candy, all of which had disappeared on March 13th, and had to be renewed. They are thus nearing 66lbs., with a month still to go. I may have got hold of a bad lot, because I find laziness and abnormal appetite are only two of their faults, and I should be glad to hear how other bee-keepers have fared with this particular strain.

As a contrast, I have a small driven lot of blacks put on empty combs in a John West's salmon-box (which just takes six frames) early in October, and supplied with three quarts of syrup and 8lbs. of candy, and they were doing nicely on the 13th inst., when I gave them another 4lbs. of candy in case they ran short. A further eight stocks of blacks which went into winter quarters with not more than 30lbs. of stores each are all well provisioned.—JOHN STEEL, Carlisle.

## "ISLE OF WIGHT" DISEASE.

[8992] Surely your correspondent (8983) on page 115, who takes such a pessimistic view of bee-keeping under modern conditions, and affirms the ineffectiveness of any of the so-called cures or remedies for *microsporidiosis*, would do well to be thankful for small mercies.

He has acquired, by chance, a swarm that is so immune from infection that it still thrives in a hive and on the combs lately vacated by diseased bees, which have died out.

He might increase from this colony and endeavour to re-stock his once flourishing apiary with a disease-resisting strain of bees, and so prove that this is the one way to combat the spread of this scourge.—R., Lancashire.

[8993] With regard to Mr. O. Browning's letter in last week's "B.B.J." (8983), I am not sure that he is such a pessimist after all. Of course, bees *may* become extinct, as other creatures have done, but I do not think Mr. Browning holds this view. He apparently believes either that bees will become immune, or, like some bee-keepers I have met, that the disease will disappear altogether from some mysterious cause before many years have passed.

Now it is well to look facts in the face, even at the risk of being dubbed a pessimist, and to remember that human diseases seldom, if ever, die out mysteriously, and that many have long been with us, and are still, in spite of much effort and research, neither preventable nor curable. Hope is held out to us along four different lines: (1) Immunity; (2) legislation; (3) prevention; (4) cure.

Let us take them in that order. The search for an immune race is worth while if one can be discovered. But what is immunity? Does it mean that the immune bee cannot have the disease at all, or that it has it, but is not seriously affected by it, as is the case when I have an ordinary cold in the head? If the former, well and good, but if the latter what awful havoc would result, supposing that I, living in a diseased area with my immune bees, were to move into a clean area taking my bees with me! I should be all right, but all my neighbours' bees would immediately succumb!

I have never been opposed to legislation, but while it would have been excellent when the disease was still confined to the Isle of Wight, I see little use in it now. I suspect that the first outbreak in my own apiary may have been due to some unglazed sections from a diseased apiary some miles off being exposed for sale in a shop quite near to where I keep my

bees. There is also a natural drinking supply close to my apiary which may have become contaminated. Will any Parliamentary Bill do away with either of these possible sources of infection?

Prevention seems difficult, if not impossible, in view of what has just been said and also of further arguments, which might be brought forward. My own hope lies in the discovery of a cure. It does not seem unreasonable to look forward to the time when, by the addition of some specific to the bees' food, the germ which causes the disease will be either checked in its development *after* it has entered the bee's body or entirely destroyed.

I know that some human diseases are still incurable, but yet I have hope. The cure is more likely to be found by skilled scientific investigators than by practical bee-keepers, but the experiments of both should go on.

It is not so easy to carry out the advice quoted by Mr. Brook from the Board of Agriculture's Report (page 129). There are no bees to be had in this district. I only know of two surviving stocks. Their owners are naturally unwilling to part with them, and, of course, will have no swarms for sale.

An interval of at least three months did elapse before I attempted to re-stock my apiary, but perhaps it was not long enough. Anyhow, the new bees are either dead or dying. Returning to Mr. Browning, I do not see why we should not receive State aid. Some other countries fare much better than we do in this matter. Such assistance might usefully be applied to the search for an "immune" bee, and to the establishment of queen-rearing and mating stations such as exist in Switzerland.

Both the correspondents who do me the honour of referring to my previous letters or the above subject make the same curious mistake in the spelling of my name. I will forgive them this time if they promise not to do it again!—L. LLLINGWORTH.

## FLOWERS OF APRIL.

[8994] Laurustinus has been attractive to the bees since January, and still has plenty of fresh blossom. On every fine day I have seen the bees coming home with the tiny white pellets that signify a visit to this shrub. I have never seen full corbiculae of laurustinus pollen, from which I infer that the nectar is so generous that the honey-sac is full before the legs are loaded. But I wonder whether this shrub is entirely wholesome. I have sometimes found foragers dead among its blossoms.

The main crop of gooseberry blossom is evidently to be an April one this year; then will come black currant, red currant,

and raspberry. We shall have pear blossom, upon which I have usually seen many species of *Andrenidae* more busy than our brown bees and Italians, and apple blossom, which gives some bee-keepers not only abundant brood but surplus. Horse-chestnut is good, especially, I think, the pink kind. Sycamore is better than either, and when it blossoms in fine weather makes a decided honey-flow. The common laurel is on the verge of opening, and will bring in supplies during the first week. Blackthorn and garden plum are nearly ready, the cherry, too, coming into that category. With fine weather, the bees will be self-supporting, but at the least falling-off from the ideal in this respect we shall have to watch them with a hand on the feeding-bottle.

There are few garden flowers for which we need be more grateful than the "snow-upon-the-mountain," sometimes called "welcome-home-husband-though-never-so-drunk," because, I suppose, it makes such a good beacon into one's garden gate when the legs are tempestuous. I have never decided whether its proper name is arabis or alyssum. The single variety is the best in every way, chiefly for the fact that it is earlier in bloom than the double. I don't see why it should not be planted by the acre in a limestone country, being made, a little at a time, to blossom along miles of dry wall by the public roads. It would be a great delight to the traveller, and I am sure no one would seriously interfere with it.—G. G. D., Glos.

#### TESTING SUGAR.

[8995] As no doubt many readers are anxious at times to know whether the sugar they feed their bees with is made from beet or the cane, I have much pleasure in sending a simple test, which differs from that mentioned on p. 44 of the current volume of the "B.B.J.," inasmuch as one has not to wait a week or so to know the result, but can tell in a minute. The test is this: Apply a lighted match to a corner of a piece of sugar. The sugar will melt and drop. If the drops are of a red colour the sugar is made from beet, but if the drops are clear you may safely infer the source is cane. Perhaps other readers may be able to furnish further tests, as in view of preventing disease it is absolutely necessary to feed with pure food. My experience of buying sugar is that the grocer will say anything is cane rather than lose an order.—FRED NEWSHAM.

#### STARTING IN A SMALL WAY.

Mistress: "Well, James, I'm going to start bee-keeping." James: "Bees is nasty, troublesome things, ma'am." Mistress: "Oh, but I shall start in a very small way—just a pair to begin with."



[8916] *Disinfecting Section-racks.*—I have some section-racks from stocks which have had the "Isle of Wight" disease. I have carefully and thoroughly scraped them all over inside and out with a steel scraper. Is it possible or necessary to disinfect them in any way, as they will be used on the same hives again this year? I am under the impression that it is impossible to destroy the spores of this disease, except by burning.—A NOVICE.

REPLY.—You must scorch the wood with a painter's spirit-lamp. No disinfection but fire is absolutely safe, as it is so difficult to kill the spores.

[8917] *Moving Bees.*—I should be glad if you could advise me on the following matters through the "B.B.J.":—(1) Would it be safe for me to remove my three hives of bees to another garden about 300yds. from the present standing ground? (2) I purchased some honey, which is now granulated. Should I be doing right in using this for spring feeding rather than giving the bees medicated candy?—W. HAYNE, Cornwall.

REPLY.—(1) Quite safe. (2) Use syrup instead of the honey; it is safer in view of the possibility of introducing disease into your healthy stocks.



*Making Soft Candy* (p. 70).—I never have any difficulty with this matter, and although I believe that I first drew attention to the use of the thermometer for the purpose, I generally use the recipe which is to be found in Webster's book, a volume which, in common with many beginners, was the first bee book I read. In this recipe, 10lbs. of sugar are added to  $1\frac{3}{4}$  pints of water, and brought slowly to the boil, when the boiling is hastened. After boiling has proceeded for a few minutes, the syrup rises, and an obvious change takes place. When it has subsided, rapid boiling is continued for three minutes, when the candy is done. I have discovered that it is important to leave the finished syrup in the pan as long as possible after withdrawal from the stove. This ensures a finer grain. It should, however, not be allowed to begin crystal-

lisation before the cooling process is undertaken. A spoonful of cream of tartar and a little salt may be added, but perfect candy can be made without. A little honey or a crushed piece of perfect candy may be added after withdrawal, but none of these things are absolutely essential. They do help, however. A *Primus* stove is ideal for the work.

*Sundry Heresies* (p. 86).—Mr. Anderson labels himself a heretic, but I trust he is not puffed up with false pride. For it is quite fashionable to be heretical in these days of free speech, when there is nothing "at stake." But let him not be unduly cast down; perhaps the scoundrel from Inverness, wrapped in his cape of anonymity, will fall into the carefully attested trap, when the Justice of the Peace may be really needed. As a heretic of sorts myself, I welcome Mr. Anderson's return. Whether criticism be aroused or not, direct observation is of real value, and it is a great thing to make discovery. So if anyone, whether anonymous or not, falls foul of the conclusion, let Mr. Anderson remember that he is merely paying the penalty of greatness.

*Go to the Anti, Consider his Ways* (p. 81).—Mr. Hopkins may be right in supposing that the writer is unable successfully to refute the arguments of the anti-skeppist. So far, however, there is little or no argument to refute. However, by the time this is in print, I presume Mr. Hopkins will have seen my further reference to the *bogenstulper*, which will perhaps make the matter as clear to him as I trust it is to Mr. Heap. I bear no particular grudge against the New Zealand box-hive, but such description of this as I have seen shows that the English skep is its superior, and that argument based upon experience in the one country does not necessarily apply to the other, which was the point I wished to make. I am not aware that Mr. Hopkins himself was violently opposed to the skep until he went to New Zealand. But I am not solely concerned with the "commercial bee-keeper," nor with comparative profits of alternative methods. I have defended the skep against wild accusation of responsibility for disease, and further iteration would appear useless, and merely tending to encourage vociferate opinion. Facts, and a true interpretation of them, are what we want, whatever the trend. There is not wanting, however, evidence that the skep produces satisfactory profit, labour properly considered, and that it has justified its existence during the recent wave of disease. I do not propose to argue the point *ad nauseam*, but I shall be very glad to hear from anyone holding either opinion who has evidence, not opinion, to offer in the hope that we may obtain a fair and unbiassed

knowledge of the merits or demerits of the skep.

*Bees, Poultry, and Fruit* (p. 89).—I am able to endorse the advantages of this combination, as I run my bees and poultry together in a tiny orchard. "D. M. M.," however, omits the addition of bees to the diet of the birds, some of which develop a liking for drones. They usually, and wisely, leave the workers alone. There may be a loss of mating queens, but I have not felt this. However, to avoid the possibility, I place the mating-boxes outside. The birds love a piece of drone comb full of brood, and whenever this occurs without my authority, I cut the dainty out for their delectation. Empty hives form regular traps for earwigs, which go to swell the same crop. To get the best results from the fruit, adjacent trees of the same variety should be planted to ensure cross fertilisation in any favourable interval, however short. Many failures to set the fruit are traceable to neglect of this precaution to plant alike trees. Small fruit such as currants cannot well be grown as the poultry pluck the fruit. Moles should be rigidly excluded, as their operations enable the birds to dig holes in the ground.

*Thick Syrup* (p. 90).—I am sorry "D. M. M." should find fault with my thinking. But surely he is responsible, having specially advocated the habit! It is difficult to please in an endeavour to steer between dogmatism and over-caution. But the fact is that I do not assert that "D. M. M." is "wrong," only that he is hasty, or careless, or ill-advised in "advocating" what he has not himself tried. "D. M. M." does not perhaps realise that he is regarded by many as an authority, so that his quotation of authorities without detailing their methods is misleading. I am aware of a method by which 2½ lbs. of sugar to the pint can be used, but it requires special precaution. "D. M. M.," however, gives no such precaution, and under ordinary conditions, and in the hands of the ordinary beekeeper, I think the proportions inadvisable for reasons stated. I should attach more weight to "D. M. M.'s" contention were he to say, I have myself used these proportions. Here I am once again pleading for accuracy and practical test. I may be over-cautious, but the question often arises with me, as to what can be safely advocated, and I hope that my comment is neither needless nor unjustified if it prevents some beekeeper from carelessly plunging into trouble.

N.B.—Since writing the foregoing, I note Dr. Miller's letter, which is directly to the point, and I have heard from the originator of the "2½" method. Incidentally I note that "Cheshire" states that

3 lb. of sugar may be added to the pint of cold water, but neither of these methods is the ordinary process which the ordinary bee-keeper would understand "D. M. M." to advocate.

#### AN UNFORTUNATE BEE-KEEPER.

A hard case has just come to our notice—one of many such—of a gardener sixty years of age, who was taken ill six years ago with consumption and had to give up his work. He is still on the sick list, and the doctor will not sign him off. He is getting 3s. 6d. a week from his club and has to depend for a living on his bees and poultry. "Isle of Wight" disease has broken out in his apiary, and already he has lost several colonies. He expects that the remaining seventeen will ultimately succumb to the disease, and in the interest of his neighbouring bee-keepers he is ready to destroy them directly they show the first signs of the disease. This loss will seriously affect him, as the greater part of his income will be gone, and he thinks that there may be some well-to-do bee-keepers who might be able to spare a swarm or two of bees without inconvenience to themselves to enable him to start again. As the case is well known to us as a deserving one, we hope there may be someone who would comply with this request. Any letter addressed "W. C. S.," care of this office, will be forwarded to him.

## Notices to Correspondents

- F. V. B. (Hammersmith).—*Converting Nectar into Honey.*—(1) The cane sugar of nectar is converted into the grape sugar of honey in the honey sac. (2) Bees do not inject formic acid from the sting into the cells.
- E. T. (Skipton).—*Painting Floor-board.*—(1) It will do no harm. (2) No, certainly not. (3) The address you sent to was quite right; no doubt you will hear from the advertiser very soon. If not write us again.
- D. S. (Gullane).—*Making Soft Candy.*—(1) The candy is all right; the small granules you notice are caused by some of the candy getting too dry for the bees to eat. (2) Do not start syrup feeding until about the end of April. If there are plenty of stores you might uncap a little instead of feeding. (3) Put the pea-flour in the candy, the bees will then take it.
- E. J. W. (Sussex).—*Stocks Found Dead in Spring.*—We are sorry we cannot

give an opinion without more particulars. The moving might cause it.

S. (Yorks).—*Good District for Bees.*—Yes, Somerset is a good county.

G. C. (Oxon).—*Colleges for Scientific Bee-keeping.*—There are no colleges such as you name in this country.

W. P. B. (Harrogate).—*Granulated Honey in Combs.*—The bees will clean out the combs if given to them instead of syrup.

INTERESTED (Burton).—*Bees Near Houses.*—No doubt the bees were short of stores, which made them excited, and they were endeavouring to collect food near the house. You did right to put out the candy. Yes, if you can give pea-flour it will help them.

A. L. S. (Wheatley).—*Honey from Diseased Stock.*—The honey is harmless for human consumption, but unless it is from supers, it would not be worth while extracting it, as honey from old brood-combs is not suitable for eating. Best burn combs and honey.

#### Suspected Disease.

H. P. (Buntingford).—It is useless sending bees for examination wrapped in paper and posted in an ordinary envelope. Yours arrived in the same condition as those in photograph on page 22 of "B.B.J.," for January 15th last, when we gave full instructions as to how to send specimens.

ITALIANS (Hinckley).—The bees have "Isle of Wight" disease and should be destroyed at once.

ANXIOUS (Whalley).—We cannot trace any disease. The staining is only normal when bees take a cleansing flight.

SUFFOLK (Leicester).—Both lots of bees were too decomposed for examination.

MEL. (Cardigans).—The bees have died from "Isle of Wight" disease. They are Carniolans.

W. F. S. (Weybridge), E. BOTTOMLEY, DOUGLAS (Durham), H. G. Y. (Alton), and R. O. (Lower Kirby).—The bees have died from "Isle of Wight" disease. Burn combs, &c., and well disinfect the hives before using again.

M. C. C. (Wisbech) and ENA (Leicester).—The bees were too dry for examination.

H. J. S. (Lurgan).—There is no disease so far as we can see.

P. X. (Tewkesbury).—All outward signs of "Isle of Wight" disease appear in several of the bees sent.

K. R. (Wimbledon).—(1) The bees are too dry for us to be able to state cause of death. (2) You can use the honey for home consumption, but it would be unwise to use either it or the combs for other bees. The hives should be thoroughly disinfected before re-stocking.

## Editorial

### BEE-KEEPING IN OTHER COUNTRIES

Lecture by Thos. W. Cowan, F.E.S., &c., given at the B.B.K.A. Conversazione March 18th, 1914.

(Continued from page 134.)

#### RUSSIA.

As early as the thirteenth century the production of honey and wax in Russia appears to have been a prominent rural industry. At that time apiculture was regarded as of great importance, and the products of the bee-keeper were not only

is so abundant that large quantities of honey are obtained from it. Viatka, Kazan, Penza, Ufa, and the slopes of the Ural Mountains are rich in forests. But it is principally in Little Russia and the Caucasus that bee-keeping is most flourishing, it being the principal industry of a considerable number of the population. In Little Russia there are peasant proprietors who own as many as a thousand colonies in modern and old-style hives. In the Government of Ekaterinoslav it is said that there are four hives to every inhabitant. In the Government of Kazan, which is populated by Russians and Tartars, there are more than 400,000 colonies. The Tartars have not adopted the frame-hive to any great extent. In many of the other Governments bee-keeping is equally prosperous. In Woronetz



APIARY OF I. ABAKOU'NOF, RUSSIA, SHOWING LOG HIVES.

consumed at home but were exported to Western Europe. In the sixteenth century Russian wax was exported to England from the White Sea, being shipped from Archangel. The trade flourished till the eighteenth century, when the imposition of duties by Peter the Great caused the bee-keeping industry to decline.

At the present time bee-keeping is practised throughout Russia and in many parts of Siberia, except where, owing to climatic conditions or absence of vegetation, it is impossible to keep bees. In the west, the Baltic provinces and Finland, there are large tracts of lime forests, which yield abundantly. In the Government of St. Petersburg, round Lake Ladoga, *Echium vulgare* (Viper's bugloss)

and Poltava there are more than 300,000 colonies in each. The largest number of colonies are kept by the clergy, for here, as in the Balkan States, ecclesiastics take a great interest in bee-keeping. The total number of colonies kept in Russia is stated by M. Dernoff, the editor of *Ptschelovodnaya Gisa*, to be 6,309,043, and there are 339,110 apiaries. Of these, 5,115,900 are fixed comb-hives and 1,193,143 frame-hives.

In Russia peasants use honey extensively instead of sugar, and a large quantity is made into a beverage called "miod," a kind of light mead, which is much used. The churches also make a heavy demand on wax for tapers, it being essential that these be made of pure beeswax. The

amount of honey sold per annum is 1,987,447 pounds, of the value of 12,000,000 roubles (£1,200,000) and of wax 234,527 pounds, realising 8,000,000 roubles (£800,000).

Bees are bred in two different ways—in the wild and domestic state. In the former way, a swarm of wild bees settles in the hollow of a tree, generally prepared beforehand. Sometimes hollow pieces of timber are fastened to the trees and the wild bees hive therein. The peasant bee-keepers generally employ hives made of well-hollowed trunks of trees, called "kolodka," such as you see in this picture. These can be used either upright or horizontally, this last position being universally adopted in the Caucasus. Cross bars are

apiary or "pasieka," belonging to M. Kandratief, of St. Petersburg, showing Dadant hives on his property at Ploussa. The next is that of the Brothers Tehernevi at Vratza. The "zemstvos" encourage bee-keeping among the peasants, and I am able to show you the model apiary belonging to the Kazan zemstvo. The local authorities of most of the Governments in Russia encourage bee-keeping, and many have schools and model apiaries. There are also floating apiaries, which pass up and down the rivers for the purpose of exhibiting modern hives and teaching modern methods to the peasants in the different towns at which they stop. The following pictures show one of these starting from Moscow and



APIARY OF M. KANDRATIEF, PLOUSSA, RUSSIA.

fixed in these hives to sustain the combs. There are also upright hives made of boards, and boxes having bars only; these are called "lineietchni." Many bee-keepers now use frame-hives called "ramotchni." In the common hives honey is often taken by killing the bees and raking out the honey, wax and bees in a mass. This is called "sirtsevoi" or "bochechnoi," and cannot be used for food, but is sent to factories to be prepared. Another way is to drive the bees out or stupefy them and cut out the combs, which are then crushed and strained. This plan is called "podreznoi." The bar-hives and frame-hives are worked with supers as with us. There are many frame-hives in use, the Dadant pattern being the most in favour. I will now show some of the apiaries containing the different styles of hives. The first is a modern

working along the river to Kalouga. There are not only hives with live bees on board, but there is a museum as well as a reading-room. Lectures are given and sometimes quite a large audience assembles, as you may see in the picture before you.

There are 200 Bee Associations in the country, and literature on bees is considerable, as the Russians are great readers and like to keep themselves informed of what goes on in other countries. Several European bee-books have been translated into Russian, and it will give some idea of their desire to read up-to-date foreign works when I tell you that the "British Bee-keepers' Guide Book" has passed through three editions and a fourth is now in preparation. Two editions of "Waxcraft" have already appeared, as well as "The Honey Bee."



There are also seventeen bee papers, one of them *Ptschelovodnaya Gisu*, edited by M. Dernoff, appearing twice a month. The Government encourages bee-keeping by making an annual grant of 80,000 roubles.

But the most interesting, because so different from those of any other country, are the "pasiekas," or apiaries, in the Caucasus. You will have seen on the map of Russia, which I have shown you, that Caucasia is divided into two parts by the Caucasus mountains, which stretch from the north-west extremity to the south-east. There are some fertile tracts, but a great part of the alluvial flats is covered with salt pools and marshes, which make the soil unfit for cultivation.

This is the typical bee of South Caucasus, and is known as the "Leucoran bee." These bees are bad tempered and great robbers. On the other hand, the bees from Tiflis, Nucha, and the Caucasian mountains are dull grey, and are gentle, splendid workers, and the queens good layers, the bees enduring the most severe climate with outdoor wintering. The bees of North Caucasus are crosses between the grey bees and those of Persia, and are of a light colour but not as good-tempered as the pure mountain race. M. Gorbatcheff says that a study of these bees has shown that they have long tongues (6.66 mm.) and are therefore able to fertilise red clover, and collect nectar from it. M. Klengen, the manager of the



APIARY IN LEUCORAN, GOV. OF BAKU, CAUCASUS.

The mountains extend for a distance of 700 miles and branch in different directions, one branch linking the main chain with Mount Ararat in Georgia. The climate here is mild and vegetation very vigorous. Fine forest trees clothe the mountain slopes, and lower down all the finer fruit trees are found growing in abundance, whilst an endless variety of shrubs and flowers, all supplying good pasturage for bees, are found in the valleys.

Much has been said and written about Caucasian bees, some praising them and others giving them a bad character. This is owing to there being two distinct races of bees in the Caucasus. My correspondent, M. Gorbatcheff, tells me that the golden banded bees of Erivan, Kars, and Leucoran originated from Persia.

estate of the Grand Duke Michael in the Government of Orel, corroborates this fact.

The following pictures show some of the typical apiaries in Leucoran, Elizabethpol, Tiflis, and Daggestan. It will be seen that, besides the hollowed trunks of trees, clay cylinders are used, and also skeps covered with a coating of clay. Some are protected with a covering of reeds, or straw. In old homesteads one frequently finds bees in long boxes put in a pile in some corner, and Caucasians do not mind crowding hives together. Here is a picture of such an apiary, and another showing hives of the old and new style, the old upright hives being protected against the wind by means of long stakes placed in a slanting position. There are some modern hives kept in

North Caucasia, the picture before you showing quite an extensive modern apiary. The last picture which I show you illustrates the manner of transporting bees in the mountains in a bullock cart. This is done to take advantage of the later flora in the higher districts.

(To be continued.)

### OBSERVATIONS ON HIVES.

By L. E. Snelgrove.

(Continued from page 73.)

The general features of wooden hives present some variety which deserves attention. They are all distinguished from

and placed on a spare floor, while the scrubbing-brush and some mild disinfectant are applied to the floor. This practice, combined with that of simultaneously renewing the first quilt, is an important precaution against disease, and is said to be the proper preventative of *Braula ceca*, whose eggs are laid chiefly on the floor-boards.

In many of the best hives the legs are attached to a frame which is separate from the floor-board. I have always failed to see the advantage of this. It makes for unnecessary complication, instability in rough weather, and superfluous interstices. It should be remembered that these form good harbours for insect and other pests.



APIARY IN GOV. OF TIFLIS, CAUCASUS.

the oldest forms of hives in that they can readily be divided into separate parts. The more this can be done, within certain limits, the better.

Hives with stock-boxes fixed to the floors are occasionally met with in some apiaries. Novices make them because it is easy to nail boards to the bottom of a box and so form a floor. I have known such floors to be extended to form flat alighting-boards. Hives with such fixed floors are an abomination. They do not permit side and back ventilation, so necessary in swarming time, nor do they conduce to cleanliness. A wise bee-keeper makes it a practice to clean his floor-boards every spring and autumn. This can be done in two or three minutes when the floor and the stock-box are separate. The stock-box is gently lifted off in the cool of the evening, without disturbance,

The outer casing or "lift" of a hive above the stock-box should always be movable. It is fixed to the stock-box in some home-made hives, and in others it forms part of a very deep roof.

In the former case it is an obstacle to the free manipulation of the frames, and it also interferes with the light. When a super is being placed on such a hive there is some probability of letting it down with a bump, especially if, as is usually the case, there is no room for the hands. Insertion of the super clearer and removal of the super are difficult for the same reason.

For convenience of working there should be one movable lift for each super used, or at least one for every two supers.

The provision of a combined roof and lift is bad because of the extra weight which has to be lifted every time the

hive is opened, and also because of the necessity of using only precisely cut quilts. Should these not be accurately placed the roof does not "go down," and the necessary readjustment of the quilts often entails the escape of angry bees. This difficulty of quilts arises in all hives which have not a separate outer case above the stock-box. There is no space into which the edges of the quilts can be tucked, and therefore materials of irregular shape and size cannot easily be utilised. Many of the so-called single-walled hives, in which the lifts are the supers held in position by plinths, are draughty because of the

impossibility of completely covering the ends of the frames. The draughts become serious if, as often happens, a small portion of material accidentally gets between the outer boards of the supers.

The lifts of a "single-walled" hive should be constructed on the telescopic plan, for then each is larger than the one below, and the lowest is larger than the stock-box. This gives room for the easy manipulation of the supers, and permits of the folding of the quilts over their edges.

(To be continued.)



### HOW TO MAKE AND STOCK AN OBSERVATORY HIVE.

(Continued from page 126.)

The super (Fig. 5) is made so that it will take either sections or a shallow frame. The bottom is made 2 in. long, 6½ in. wide, and ½ in. thick. The ends (A) are screwed on from the underside (B), so that they are 17<sup>1</sup>/<sub>16</sub> in. apart. Grooves are cut in the ends on the inside, as indicated by dotted lines, E, to take the glass, F. The inside ones are 2 in. apart, and the space between the two is ¼ in. The glass must be cut very straight, so that it fits on to the bottom and up to the top without grooves. A slotted hole, as shown at C, is cut, with projections 4½ in. from centre to centre, to carry the sections and allow the bees to enter them. On the bottom of this (D) a piece of excluder zinc is let in level, and tacked fast. The top is 2 in. long, 6½ in. wide and ½ in. thick, with a couple of ventilating holes (G) 1½ in. in diameter bored through. When sections are used, a block of wood (H), 17<sup>1</sup>/<sub>16</sub> in. long and 1¾ in. square, is fastened by means of round head brass screws (I). The holes at G are bored right through this, as indicated by the dotted lines. When sections are in use, an ordinary spring block at the end wedges them tightly together. If a shallow frame is used, then the block, H, is removed, and two blocks (J), 5½ in. long, 2 in. wide and 1¾ in. thick, are fastened inside by means of the round head screws (K). The super is fastened to the brood chamber, and the top to the super, by means of universal fasteners, D (Fig. 4) and L (Fig. 5). To make the super fit snugly on to the brood chamber a piece of thin, soft leather should be glued on to the top edges, as shown in plan of top (Fig. 4). The last part to make is the feeding stage (Fig. 6). This is constructed so that it can be used for ordinary feeding, or for watching the tongue action of the bee when taking food. A small frame (E) of ½ in. wood, 6 in. long by 3½ in. wide, outside measure, is made by lock jointing the corners (F). A piece of opal glass (G), with a hole (H) 1½ in. in diameter, is let into a rebate on the underside, so that it is quite level with the wood. This is fastened by two screws (P) over the hole in the base left for it, as shown in Plan of Feeder. If, for ordinary feeding, a small bottle is inserted over this hole, for observation purposes a piece of glass (M), 3 in. by 2½ in., is placed inside, with a shaving of wood between it and the opal glass at either end, to allow a space so that when a small quantity of syrup is poured in, it is imprisoned, compelling the bees to push their tongues over the top of the opal glass to obtain it, when the action can be observed by means of a ball-jointed lens, K (Fig. 4), fitted at N (Figs. 4 and 6) by means of a couple of screws. To hold the glass from slipping, a couple of pieces of watch spring, O (Fig. 6), 2½ in. long, are pushed in across the narrowest part. The whole arrangement is shown very clearly in the End Elevation Inside (Fig. 4).

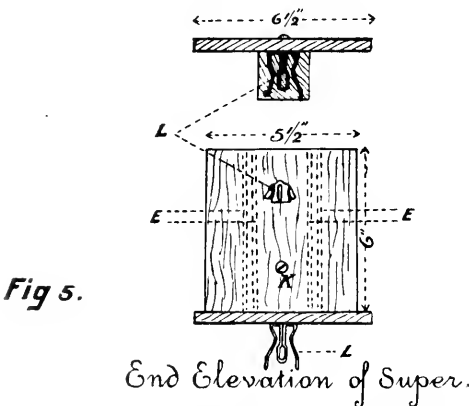
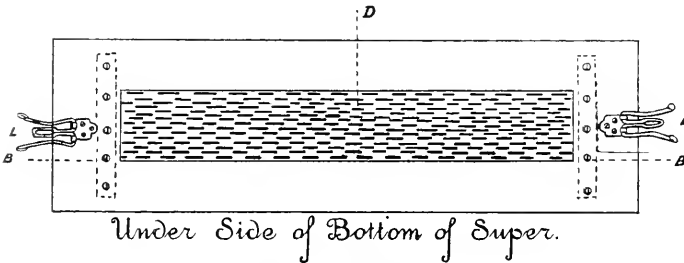
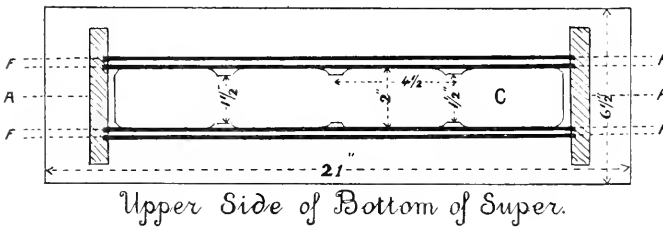
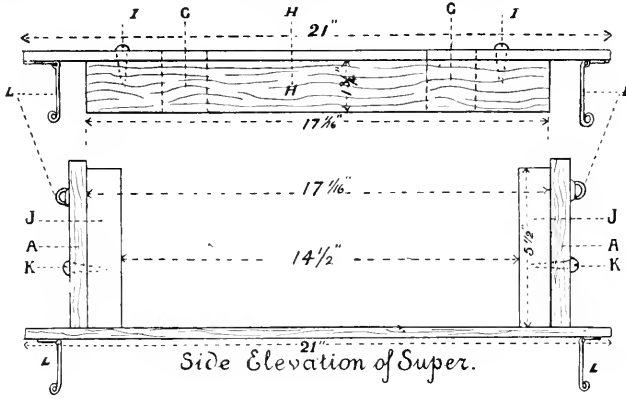

- A. Ends.
- B. Screws in End.
- C. Hole for Excluder.
- D. Excluder.
- E. Dotted Lines Indicating Grooves.
- F. Glass.
- G. Ventilation Holes.
- H. Top Block.
- I. Screws.
- J. Frame Blocks.
- K. Block Screws.
- L. Fasteners.

**Fig 5.**

- It now remains to make the four shutters. These should be of  $\frac{3}{4}$  in. wood, with a piece  $1\frac{1}{2}$  in. wide cleated on the ends to prevent warping. They are then planed to fit in their respective places. A small piece will have to be cut off one to allow it to go over the feeding stage. They should be made to go easy, so that they will fit nicely, after being covered by glueing green baize over them, taking care to make the joints of the baize on the inside of the shutters, so that they will look neat on the front side. They are fastened in position by means of a brass button on either side, a small notch being cut in the wood to form a catch.  
(To be continued.)

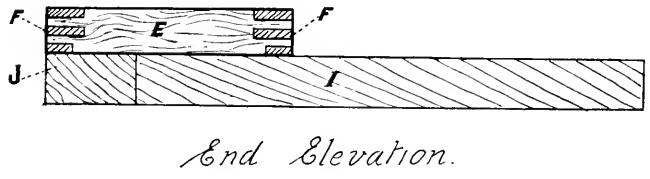
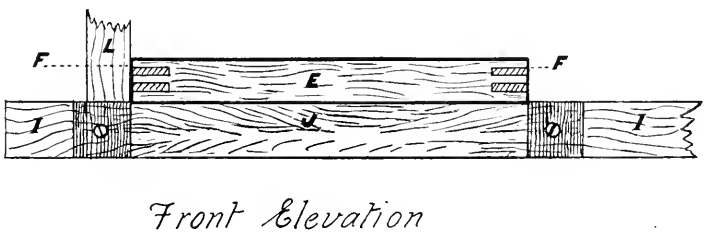
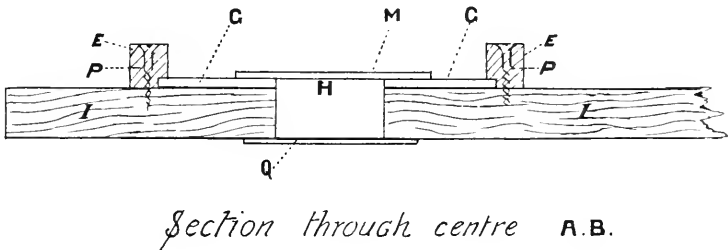
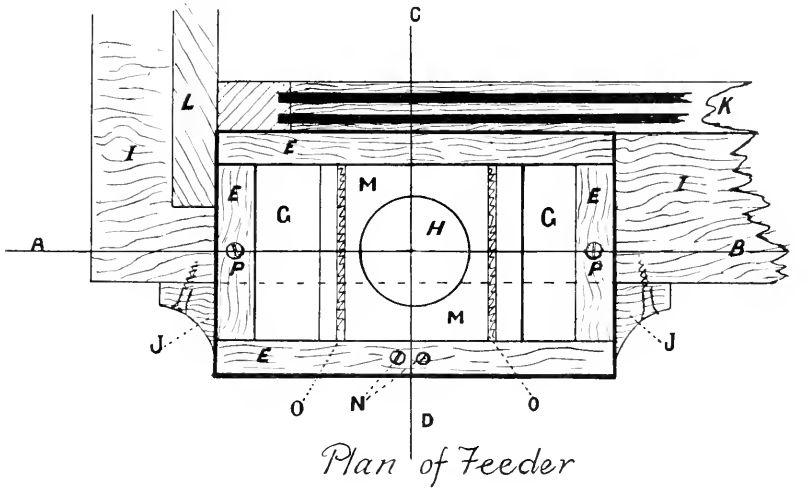
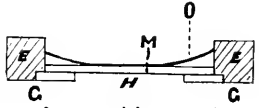

Fig. 6.  Section through C.D.

A. B., Longitudinal Section; C.D., Cross Section; *r.*, Frame; F., Lock Joints; G., Opal Glass; H., Feed Hole; I., Base; J., Bracket; K., Glass Frame; L., Upright End; M., Glass; N., Place to Fasten Lens; O., Springs; P. Screw to Fasten Frame; Q., Perforated Zinc.



*The Editors do not hold themselves responsible for the opinions expressed by correspondents. No notice will be taken of anonymous communications, and correspondents are requested to write on one side of the paper only and give their real names and addresses, not necessarily for publication, but as a guarantee of good faith. Illustrations should be drawn on separate pieces of paper. We do not undertake to return rejected communications.*

#### DO BEES HEAR?

[8996] In the *BRITISH BEE JOURNAL* (March 6th, 1902) an article appeared on page 96 entitled, "Can Bees Hear?" by W. A. Varian. Varian says there: "Tap or drum on the side close to them with a switch or the handle of your knife." How is this meant? What does Varian mean by "the side"? Does he mean the side of the hive, straw skep, or wooden hive? If he really means a drumming on the *wooden* hive side it is possible that the bees do not *hear* the sound, but feel the vibrations of the *ground*, which very likely is effected by the drumming. Is there a possibility that this may be true?

You would oblige me very much if you would be so kind as to give me an answer about this. I am just writing about the problem whether the bees can hear or not. Many thanks beforehand.—Prof. V. BUTTEL-REEPEN, Zoologist, Oldenburg.

[Reading the article through it appears that the writer means that he places a wooden hive a foot from the bees and raises the edge nearest the bees on two small stones. This side is where the tapping takes place, and Mr. Varian thinks that the movement of the bees shows them to be susceptible to sound. On the other hand it is quite possible that they feel the vibration caused by the tapping, which induces them to rush for shelter in the hive.—Eds.]

#### BEE ASSOCIATIONS AND THEIR WORK.

[8997] Your decision not to insert my lengthy reply on the above subject, owing to lack of space, is not to be wondered at. In the circumstances, I would like to emphasise the fact that there was no more intention of injuring Associations by my candid criticism than there was on your part in publishing it. Except from a debater's standpoint I should have been pleased to have been shown to be wrong in every particular.—W. E. MATTISON, Horsey Vicarage, Great Yarmouth.

[Having a personal acquaintance with the Rev. W. E. Mattison, we are satisfied that his original letter was evoked by the circumstances stated therein; that it is

obvious he has no personal interest in decrying Associations, nor has he anything to hope from them. On the contrary, he has all through his bee-keeping career given his services freely to others, and has been for the past two seasons an Hon. Expert for the Norfolk B.K.A. (now first class), and has been asked to continue in that office, though his resignation was tendered. Our sole reason for not publishing his reply is that the letter has aroused so much interest that it would take several issues of the "B.B.J.," to print all the replies received, therefore, to be fair to all we have stopped the discussion, as we are overcrowded with other matter.—Eds.]

#### ESSENCE OF CINNAMON FOR "ISLE OF WIGHT" DISEASE.

[8998] Will you oblige by asking some bee-keepers in districts affected with "Isle of Wight" disease to try essence of cinnamon, 3 drops to the pint of syrup, as a cure?

I am trying it as a preventive, but we are still free, and hope to remain so. I have asked the Board of Agriculture to experiment with it, but would much like some sufferers to try it with selected stocks. It is most potent in certain diseases, and the bees take it well. Its scent alone is said to be effective in certain diseases of man.

It should be the true essence of cinnamon, and the drops are best added to the sugar first, as they mix more readily thus.—H. E. BALCH, Somerset.

#### "ISLE OF WIGHT" DISEASE CURES.

[8999] As I was one of those referred to by Mr. Desmond in your issue of March 19th I have pleasure in sending a report of the result of my experiment with the "Kentish" treatment for "Isle of Wight" disease. The three diseased stocks which I reported cured last August have wintered well, and at the present time are breeding vigorously, despite the recent demise of two neighbouring apiaries from "Isle of Wight" disease. One stock, however, in an out-apiary, contracted the disease and died in the winter, leaving full stores. These bees, I must admit, did not respond to the treatment, of which, owing to distance, &c., they did not receive their full share, but it is an indisputable fact that so far as my bees are concerned quinine has worked wonders. May I remind all interested that Mr. Wigley recommended 60grs. of sulphate of quinine in  $\frac{1}{2}$ oz. of water containing 2 drops of sulphuric acid, to be added to every gallon of sugar syrup, cost of quinine ready mixed, 1s.—F. C., Oxford.

A SIMPLE SLOW-FEEDER.

[9000] Referring to "Stimulation Experiment in "Random Jottings," in BRITISH BEE JOURNAL, March 26th (page 123), I may mention an experiment I have tried and found useful. Procure a large-mouthed bottle, make a hole in the cork, the size of a large goose-quill, insert the quill from the underside of the cork, and make secure with sealing wax, if necessary. Make a darning-needle red hot and pass it twice through the quill (that is two holes) about a quarter of an inch or rather more from the closed end of the quill. The large end of the quill should be level with the cork. For use, fill the bottle with syrup, insert the cork with quill, reverse the bottle and pass it through a small hole in the quilt between two frames, so that the holes in the quill may be free from the comb on either side. There is no disturbance, or loss of heat. It is certainly a slow feeder and easily made.

I have been a bee-keeper for nearly fifty years, and have recently lost about seventeen stocks from "Isle of Wight" disease, having only one left.—FREDK. WHEATLEY.



[8918] *Surplus from Swarms.*—I am commencing bee-keeping this year. I have four Abbott's "W.B.C." hives, and have made arrangements to buy four swarms in May, two of which will be kept in my garden, and two in a garden two miles distant. My intention is to get a rack of sections (if possible) from each hive, and then to put on shallow frames (if season permits), so as to get the foundation drawn out in readiness for the following year. I am told, however, that the honey in the shallow-frame boxes will be useless, as it will not be capped. (1) Is this so, and if so, is the quantity likely to be so much as to make it inadvisable to use shallow-frames this season? (2) Could frames of sections ("W.B.C.") be taken out as completed and returned with new sections fitted with foundation? Also could section-frames be placed in shallow-frame box, or is the space below great enough to induce comb-bulking there? —ARTHUR TUCKER.

REPLY.—We are afraid you are "counting your chickens before they are hatched." It is unusual for swarms to give surplus. If you get a rack of sections filled and sealed from a swarm the first season you will be lucky, to say nothing of getting shallow combs as well. Unripe honey can be extracted and ripened in an

open vessel, therefore if you can obtain any in shallow combs it will not be wasted.

[8919] *Queen-rearing.*—I think of rearing a few queens this summer. Would the following method be suitable?

Stimulate a strong hive to swarm early, then after it has swarmed divide the parent stock into nuclei, giving a queen cell to each. If you think the method all right, how soon after the stock has swarmed will it be ready to divide into nuclei; also, must you have a separate nucleus hive for each queen you want to rear?—T. O. D., Wellingboro'.

REPLY.—The method you propose is all right, providing you pay attention to selection in the stock allowed to swarm, and that you do not lose the swarm. You should divide the same day the swarm issues, and provide a separate nucleus hive for each queen to be reared.

[8920] *Early Examination.*—Please answer me the following questions:—(1) I had a look at my bees on March 21st, and found they had not many stores left, so I gave a 2lb. box of candy with pollen, which, on March 29th, was nearly empty. Shall I, after they have emptied it, start to feed with syrup, and how many of the holes should be turned on? (2) Where could I obtain the editions January 1st and 8th of "B.B.J."?—H. C.

REPLY.—(1) You did wrong; it is much too early to examine bees yet. (2) It will be best to put on candy until the end of April. (3) You can obtain them from this office, 1½d. each.

## Bee Shows to Come.

**June 9th-11th, at Malvern.**—The Herefords and Worcs. Agricultural Society's Malvern Meeting. Twelve classes for Honey, &c. Good prizes; small entry fees.—For schedule apply, Mr. A. Elliott, Hon. Secretary's Department, Cusop, Hereford.

**June 30th to July 4th, at Shrewsbury.**—Royal Agricultural Society's Show. Bee and Honey Section, under the direction of the B.B.K.A. Prizes arranged in groups of counties for Associations affiliated to the B.B.K.A. Schedules from W. Herrod, 23, Bedford Street, Strand, W.C. **Entries close May 30th.**

**July 8th, at St Albans.**—Honey Show of the St. Albans B.K.A., held in connection with the Elstree and Boreham Wood Horticultural Society, at Aldenham Park. Open class for extracted honey. No entry fee. Liberal prizes. Judge, Mr. W. Herrod. Schedules from Mr. R. H. Attenborough, Aldenham, Herts. **Entries close July 6th.**

**July 24th and 25th, at Cardiff.**—The Glamorgan B.K.A., in connection with the Cardiff and County Horticultural Society's Show, in the Sophia Gardens, Cardiff. Open classes include—Collection, Gift, Sections, Beeswax, &c. Schedules from W. J. Wiltshire, Maindy School, Cardiff.

**July 23rd, at Bath.**—The Annual Show of the Somerset Bee-Keepers' Association, in connection with the Larkhall Horticultural Society. Seven Open Classes. Schedules from J. W. Brewer, Glen Lynn, St. Saviour's Road, Bath. **Entries close July 18th.**

## NOVELTIES FOR 1914.

## NEW SUPER-CLEARER.

We have much pleasure in introducing to our readers a new super-clearer invented by Mr. F. W. Watts, 136, Goodrich Road, East Dulwich, whose ingenious mind has evolved many small appliances for the benefit of the craft. There have been many complaints during the past few years of the "Porter" bee-escape not working properly, no doubt owing to the faulty adjustment of the springs. This tiny appliance will undoubtedly efface all this difficulty, as it works with aluminium drop plates which are so nicely adjusted

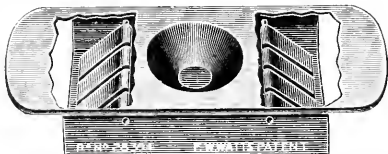

that a bee can push its way under and get out, but which drop back immediately into their place, effectively preventing the bee's return. It also completes the work much more expeditiously than the old form. Mr. Watts has given the appliance a thorough trial before placing it on the market. It was shown at the Conversation of the British Bee-keepers' Association in March last, and favourably commented upon by those present. We predict a large sale for this useful appliance, which can be obtained at 6d. from all dealers.

## BEE-PICTURES AT SUNDERLAND.

Northern bee-keepers will be pleased to hear that Mr. J. C. Bee Mason is to appear at the Theatre, Sunderland, for one week, commencing April 13th. He will show the "Life of the Bee," "Bee-farming," "Dutch Bee-keeping," and "The Bee-master," giving a short descriptive address before each film. The whole series will take three-quarters-of-an-hour to exhibit.

## Notices to Correspondents

- G. H. L. (Petersfield).—*Restarting Bee-keeping*.—We are sorry we cannot accede to your wishes regarding the above; all the information you ask for has been repeated over and over again in our columns. We fear you do not read as much as you should, or you would have seen all you want to know.
- A. G. ARWELL (Borden).—*Hants B.K.A.*.—The Hampshire B.K. Association is in a moribund condition. See letter in "B.B.J." of February 12th (page 68), as to starting it afresh. You had better

communicate with the writer, Mr. A. Hardy, Palace House, Bishop's Waltham, Hants.

- K. P. (Marlborough).—*Brice Swarm-catcher*.—The Junior Editor has used the "Brice" swarm-catcher for years, and finds it quite satisfactory. It will fit any hive the porch of which is movable, as it is necessary to take the latter off. See illustrations "British Bee-keepers' Guide Book," pages 22-23.
- F. P. (Histon).—*Combs from Diseased Stock*.—We should not use the combs, but melt them down. It is impossible to disinfect them thoroughly by spraying.
- HONGE (Wainfleet).—*Honey Sample*.—(1) The honey is worth about 56s. per cwt. (2) If you will give us the date of "B.B.J." in which the letter appeared, so that we can refer to it, we will reply to your enquiry.
- R. W. H. (Sudbury).—*Mead Sample*.—Your sample is not mead but vinegar.
- H. A. C. (Ealing).—*Variety of Bees*.—The bees are Italians, as stated. They may be Sladen's or any other breeder's, but this does not alter the fact. We know the gentleman named, and if he tells you they are Sladen's strain you can take it they are.
- E. M. R. (Salop).—*Price of Queens*.—The figure is quite correct, but this, of course, refers to special breeds or strains.
- A. S. P. (Abbey Wood).—*Variety of Bee*.—The specimens you send are hybrid Ligurians.
- FREDA (Oundle).—*Preventing Disease*.—(1) Bees living in a wild state are just as liable to disease as those in hives. (2) Glass quilts, where used, are kept on the hives during the whole year.
- COTTON YARN (Bolton).—*Danger of Introducing Disease*.—There is no danger in using "Weed" foundation made in this country.
- BEE-KEEPER (Montgomery).—*Honey Samples*.—No. 1 is from clover; No. 2, a heather blend; and No. 3 from mixed sources.
- Suspected Disease*.
- G. M. R. (Saffron Walden).—(1) The bees have died of "Isle of Wight" disease. (2) You might start again this spring with bees bought in the neighbourhood.
- A. E. K. (Eufield), DEAN FOREST, S. J. S. (Hereford), and ESPEREJULO.—The bees died of "Isle of Wight" disease.
- W. J. W. (Plymouth).—Bees marked No. 1 have died of "Isle of Wight" disease; No. 2 were too dry for examination.
- J. W. L. (Glam.).—Bees were too dry for examination.
- H. G. (Great Baddow).—The comb contains chilled brood only.
- INQUISITIVE (Barnsley).—So far as we can see, death was caused by chill.



## Editorial

### REVIEW.

*Some Minute Animal Parasites; or, The Unseen Foes in the Animal World*, by H. B. Fantham, D.Sc., and Annie Porter, D.Sc. (London: Methuen and Co., Ltd., price 5s. net.).—The object of this book is to give a popular account of the life-histories of some of the microscopic protozoal organisms that produce diseases in man and others of the higher animals, as also those of insects, including bees. Diseases both of men and animals are subjects that have been more carefully

bodies which may have been expelled from the body of a former host, are pointed out. In the first chapter we get a very good idea of the life-history of Protozoa and their danger, while in subsequent chapters parasites in relation to specific diseases, such as sleeping sickness, yellow fever, and some cattle diseases, are dealt with. What, however, will be of special interest to the bee-keeper is Chapter XI. on *Microsporidiosis*, bee and silkworm diseases. After briefly describing the fatal disease—pebrine—which was first identified by Pasteur with the animal parasite *Nosema bombycis*, the authors take up the question of the "Isle of Wight" disease, which is caused by a similar protozoan to which the name of *Nosema apis* had already been given by Dr. Zander, who was the first to draw



APIARY OF PH. BALDENSPERGER, JAFFA.

studied of late years, and the present book is the outcome of the attempts of the authors to satisfy the demand for a simple but scientific account of the minute parasites that produce these diseases. After describing the lowest forms of the life of these single-celled animals, which are known as *Protozoa*, or primitive living animals, the authors show that the situations in which they are found depend largely on their mode of life. Some are so degenerate that they have become parasites, deriving their nourishment from the body of the living animal to which they have attached themselves. The ways by which the parasitic Protozoa gain access to their hosts and are spread from animal to animal are described, and the danger arising from the spores or resting

the attention of bee-keepers to the danger of the disease caused by this parasite. The life history of the parasite and its action on the bees is given in some detail, and the illustrations help to render the descriptions more clear. We can quite recommend the book for perusal by those wishing to be better acquainted with these minute animal parasites, which are the cause of so many serious diseases.

### BEE-KEEPING IN OTHER COUNTRIES

Lecture by Thos. W. Cowan, F.E.S., &c., given at the B.B.K.A. *Conversazione*, March 18th, 1914.

(Continued from page 144.)

I could show you some apiaries in other countries, but think I ought to leave off now, as there is another lecture to be

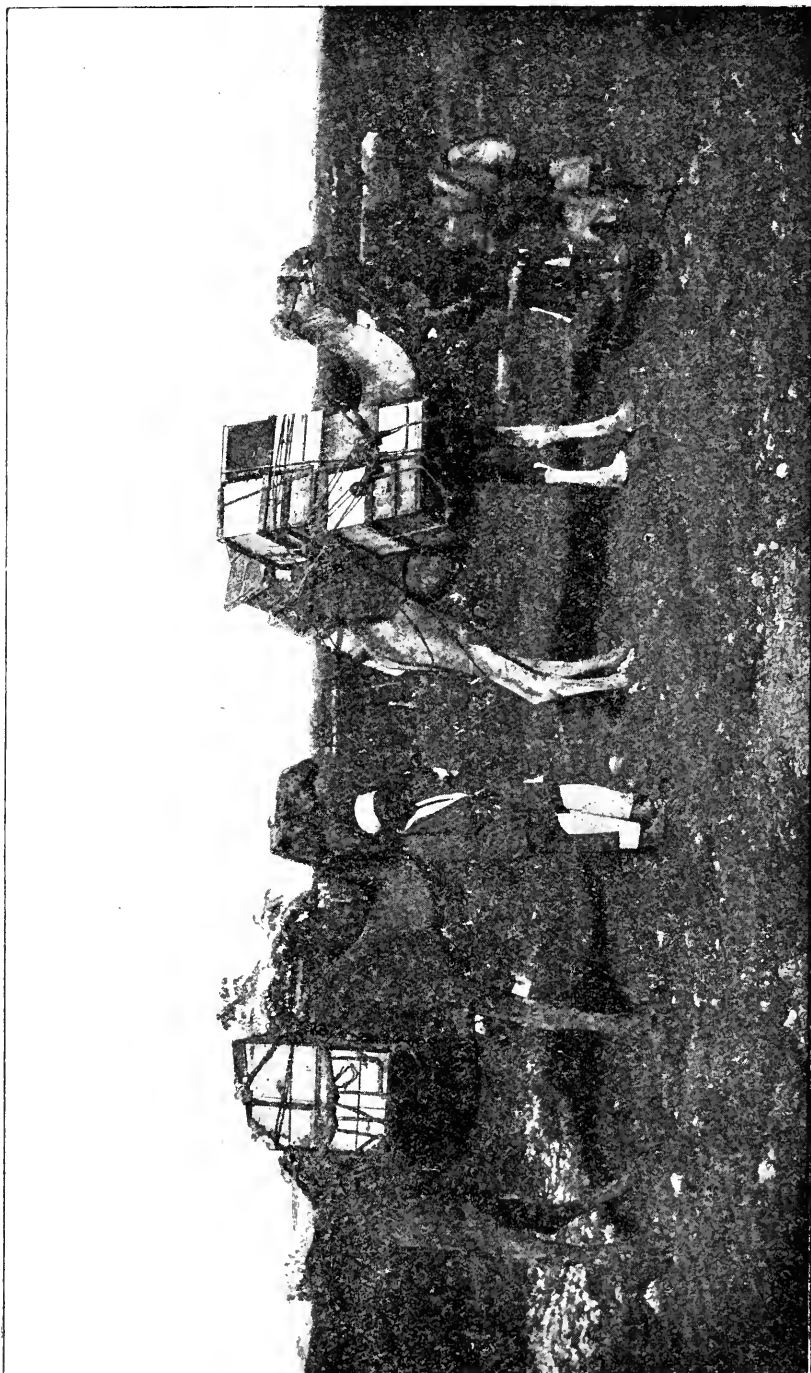

TRANSPORTING BEES ON CAMELS IN PALESTINE.

given by Mr. Herrod, and I do not wish to encroach on his time. (Go on.) As you seem to wish me to go on I will get through the remainder of the pictures as rapidly as possible.

#### PALESTINE.

The picture before you is that of a district in Palestine from which at one

time a good many "Syrian" and "Holy Land" bees were obtained. These bees, you will remember, had bright golden bands similar to those of Cyprian bees, but were said to be better tempered. In the picture you see the historical Solomon's pool, and it was here that Mr. Bakdensperger, father of the present Ph.

Baldensperger, started bees so long ago as 1850. Beyond the pool is an arch of the castle, in which are piled clay cylinders used by the natives as bee-hives. The following pictures show the apiaries of Mr. Ph. Baldensperger at Jaffa, where the queens were bred for export. In one showing the City of Jaffa (formerly called Joppa) in the background, you will see him with his family and Arab assistant preparing queens for shipment, in a quite up-to-date apiary, and in the next the boxes containing the queens, laden on camels for transportation to the shipping station. The roads in Palestine are not

following pictures show the neat and quite up-to-date Nogogaki apiary at Okucho, in which you will see not only modern frame-hives, but also an extractor and honey-ripenner, and the method of queen-rearing in the small boxes hung round the walls. We know what a progressive country Japan is, but I think the following picture (see p. 154) will be a surprise to you, and should be an example to us all. It represents a meeting of the Japanese National Bee-keepers' Association at Gifu in 1912, when 600 bee-keepers were present. It is a fine sight, and all those in the group appear anxious to learn something about bee-

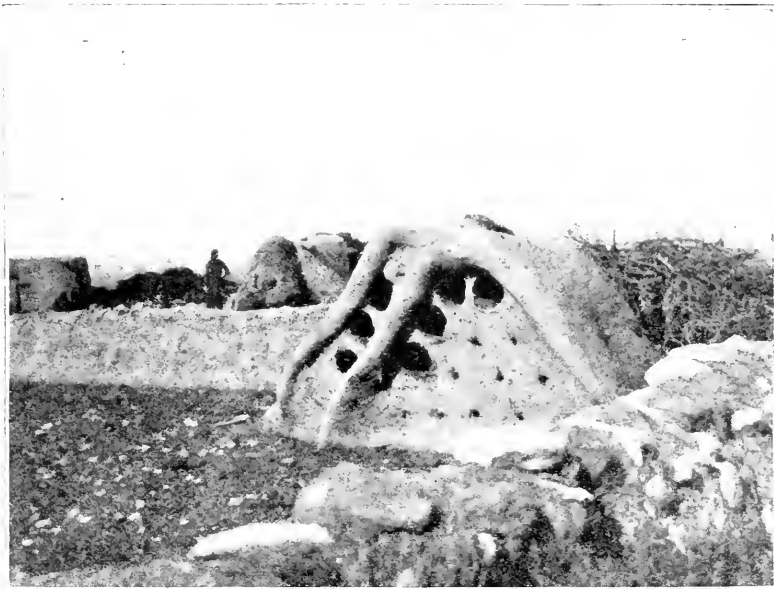

MUD HIVES AT JEZREEL, PALESTINE.

as good as ours, and in some places there are simply tracks, so that a good deal of the traffic has to be done with camels, and the picture before you gives a good idea of the method of travelling in that country. The next view is that of an Arab apiary in Jezreel. The hives are merely clay cylinders stacked together and plastered over with mud. The bees are hived in these cylinders, which are closed at the ends, small holes being left for the bees to go in and out. To get the honey the ends are taken off and the bees driven back with smoke, the combs being cut out and the coverings replaced. This is quite a typical Arab apiary, and there are many such in different parts of the country.

JAPAN.

We will now pass over to Japan, and although modern bee-keeping there is quite in its infancy there are a certain number of progressive bee-keepers. The

keeping. I wonder in what other country such a gathering could be got together?

(To be continued.)



NEW ZEALAND "HEATHER" HONEY.

I have recently had submitted to me a document recording the doings of a Conference of Dominion Bee-keepers, held last season in Wellington. At this gathering a new "National Bee-keepers' Association" was formed, and all on this side will rejoice that they have been able to inaugurate an organization "for the purpose of improving the condition of bee-

keeping, and the honey market in particular. The fostering of the export trade is one of the leading planks in the platform of this new society. Small exports to this country are no new thing, but they aim at big things in the future. Hon. R. H. Rodes, who formally opened the Conference, gave the information that last year they sent us 135 tons, or, in Customs parlance, 302,400lbs. of honey. Many in this country will be pleased if the bulk of our imports, to the value of from £30,000 to £60,000 annually, representing possibly well on to 5,000,000lbs. of honey, should come to us from the beekeepers of Greater Britain rather than from foreign sources. In view of what I

it with what two subsequent speakers said in regard to the honey they considered good enough to substitute for the produce of our heather hills. No less an authority than the President assured us that they have already been playing this game. He says, "*They had found that ti-tree honey would probably sell as well as New Zealand heather honey. It was of a similar flavour to the Scottish heather honey,*" and he again informs us that amongst other places this ti-tree honey went to *Glasgow*. I lay emphasis on this further statement.

Another speaker, apparently without a blush or suffering from any qualms of conscience, declared that "So far as dark honey was concerned, he thought if it

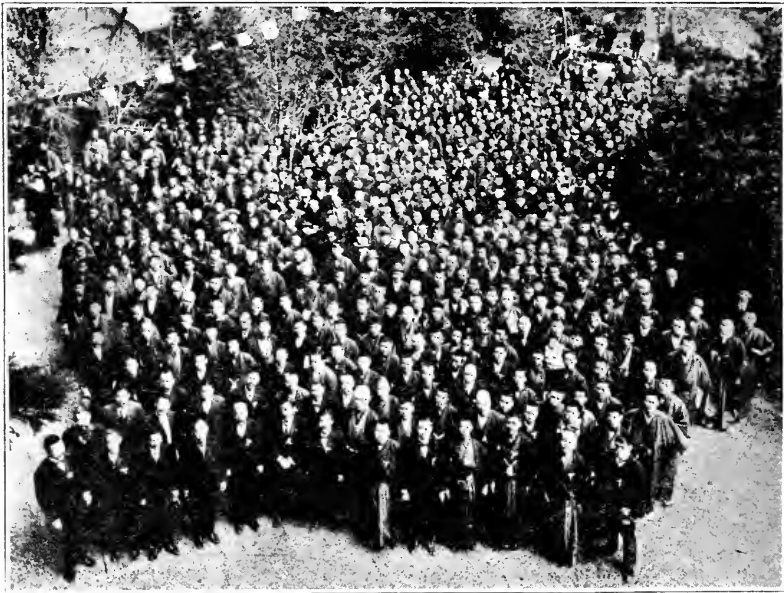

GROUP OF JAPANESE BEE-KEEPERS.

have to say later, I would add that New Zealand sends us some of our finest imported honey, which often sells at the highest price, after the home supply.

Now, readers might turn with me to the dark side of the picture, and note that a honey—"a poor third or fourth grade"—is found in quantity over considerable areas of North Island, which Mr. Hopkins, in an article read at the Conference, designates "unextractable" honey. Ordinary centrifugal force cannot part it from the combs; and, like our Highland heather honey, the combs have to be put under pressure, thus destroying them, before it can be put on the market. Several sources for this thick gelatinous product have been named, but Mr. Hopkins says, "I have no doubt the manuka or *ti-tree* is one of the sources." I wish to emphasise this statement, and connect

were sent to Scotland, labelled *New Zealand Heather Honey*, it would sell well!" Now, note this is some of their cheap honey, too dark to sell profitably at home, the very honey which Mr. Hopkins characterises as a third or fourth grade, and *poor* at that. Yet these sapient beekeepers from the back woods of New Zealand presumably propose to launch it on our home market to be sold at the highest price.

I have another choice tit-bit to reproduce on the authority of their own organiser. Several speakers gave the "West of England" and the "West of Scotland" as the best market, and Bristol, Liverpool, and Glasgow were specifically named. Mr. Lysnar, the organiser for the Bristol and Dominion Producers' Association, let the cat out of the bag when he made the following statement: "All enquiries go to

show that there is a better and more reliable market in the Western cities than there is in London. There are *too many associations* in London, which assist the Londoner, but are detrimental to the producer; but these organisations do not exist to the same extent in the West." I think this is a gem which should duly receive the close attention of the BEE JOURNAL, and also in marked degree that of the British B.K.A. I think, too, this nefarious proposal to substitute cheap, inferior honey for the choice produce of our heather hills should engage the close attention of all interested, not only in heather honey, but good honey of any kind. We have heard in the past of "barrels of heather honey at 3½d. per lb." Our best and most competent judges declared that it differed entirely from real heather honey in colour, consistency, flavour, and aroma, and under a powerful microscope the pollen grains were proved to belong to no known plant in this country.

If this new invasion, so brazenly heralded, is of a similar nature, I can promise the promoters a lively time. The Board of Trade will have samples in their possession as soon as procurable. Eminent analysts will test honey, and our leading judges will sit in judgment on its quality. But before taking any such steps we will ascertain what effect sweet reasonableness may have on the Government of New Zealand, the leading bee-keepers in the Dominion, and the sane members of the new Association. We want only justice and fair dealing.

the field when plum, pear, and apple are in bloom, for at this season few other insects are about to carry out the work of cross-fertilisation of the blossom.

This is where the Banat scores. At a conservative estimate there are now (early April) twice as many flying workers in my Banat hives as in my strongest British hive. Of course, for Northern bee-keepers—and late districts in general—this is a positive disadvantage; as your correspondent laments, stores are used up in producing a large force of workers before there is forage for them, but hereabouts, where the countryside is usually white with blossom by Easter, the advantage of early breeding can hardly be over-estimated.

Then as to surplus collection, a good stock, properly managed, will fill out at least three 30lb. supers, say, one fruit and two clover honey, with another 30lb. of winter stores, but there must be *ample* ventilation—a 4in. floor-board ventilator, wedges between each storey, and the outer case acting as a chimney, will not be too much throughout an average summer. Incidentally, I would remark that probably most of the troubles experienced by those who try foreign races (such as excessive swarming) are really caused by their own neglect to give plenty of ventilation, the bees *must* swarm or suffocate!

Another point for Banats—their defence of stores against robbers! The British bee is a poor hand at this, needing a contracted entrance—just when the weather is most oppressive, too!—to assist her in "repelling boarders," but let the word go round that there are strangers in a Banat hive, instantly the guards are filled with a veritable Berserker fury, they rush about uttering a peculiar and quiet awe-inspiring note, and the intruders are promptly seized and expelled, being, indeed, nearly torn to pieces in the process. For all this, Banats are easy to handle and quiet on their combs during manipulation.

To sum up, I plump for Banats because:—They breed early; they resist foul brood; they give a good surplus, and are unequalled at stores defence.

Do any readers know an importer of these bees? I tried unsuccessfully to find one last year.—H. E. SCROPE VINER, Overbury Fruit Farm, Worcestershire.



*The Editors do not hold themselves responsible for the opinions expressed by correspondents. No notice will be taken of anonymous communications, and correspondents are requested to write on one side of the paper only and give their real names and addresses, not necessarily for publication, but as a guarantee of good faith. Illustrations should be drawn on separate pieces of paper. We do not undertake to return rejected communications.*

**BANATS—THE FRUIT-GROWERS' BEE.**

[9001] Your Carlisle correspondent (page 136) gives Banat bees a very bad character in BEE JOURNAL for April 2nd. Least readers should be unduly prejudiced thereby, may I give my experience of them? I have kept Banats for four seasons, and each year they have come out ahead of either Italian hybrids or British bees for all-round usefulness.

Being a fruit-grower, I need a bee that breeds *early*, so putting a strong force in

**"HOPE ON, HOPE EVER."**

[9002] Mr. Owen Browning certainly writes very pessimistically in his article (8983) in the "B.B.J.," March 19th last.

For the benefit of those who have not had any experience with this horrible "Isle of Wight" disease, may I suggest

some points which Mr. Browning appears to have neglected?

I think it is generally accepted that "Isle of Wight" disease is usually caught by the bees of one stock consuming the honey from a hive where the bees have had "Isle of Wight" disease. Yet Mr. Browning tells us that a swarm entered a hive where the bees had died of the disease. Would it not have been safer to close that hive, or take it away, and thus prevent any bees robbing it, or a swarm entering it? For what is the use of clean hives, &c., if a diseased set of combs is left exposed?

Then, on the subject of cures, Mr. Browning writes rather positively. Last year I saw several stocks affected with "Isle of Wight" disease, and saw them apparently cured, for they gathered a good surplus, and some threw swarms which did well also. The method of cure was very thorough. As soon as the disease was seen, every stock in the apiary was transferred into clean hives which had been dressed with Ayles' "Isle of Wight" cure. Those stocks which had shown signs of "Isle of Wight" disease were only allowed to remain in these hives for a fortnight, when they were again transferred into clean, dressed hives as before. Not only were the stock boxes and floors disinfected, but everything was thoroughly cleaned and disinfected, and new quilts were supplied. The combs which had no brood in were dipped in Izal and replaced. At the end of the season there was no trace of "Isle of Wight" disease in the apiary.

When infectious or contagious diseases appear in a human habitation every care is taken to burn or thoroughly disinfect everything that has been near the disease. Surely if this precaution was taken by beekeepers it would at least lessen the chance of the malady spreading.

In conclusion, may I second Mr. Desmond's request for particulars of those stocks which were apparently cured last year?—L. G. COPLESTON, Cambridge.

#### SPRING FLOWERS—AND WINDS.

[9003] "Snow-upon-the-Mountain," referred to by "G. G. D.," *Glos.* (8994), is *Arabis*—not *Alyssum*. The double variety, though more splendid and therefore commoner in gardens, is of no bee-value; but the single (*A. albida* and *A. a. variegata*) is one of the most useful flowers we have. It is such a strong grower that I imagine it could well be left to look after itself; no weed is likely to stand much chance against it. But I suggest that its cousin, *Aubrietia*, be planted as well along roadsides, wherever a steep, open bank or wall offers. It is equally sturdy and even more

attractive to bees, while its purple cascades would certainly brighten up our landscapes.

I think, also, the blue *Anemone* (*A. ap-penina* or *A. blanda*) might be tried on the sunward side of hedges. As it is in full leaf long before the earliest weed begins to wake, I cannot fancy it would be likely to get choked. I have seen it thrusting through a thick mat of *Arenaria balearica*, which is warranted to kill most things!

But it must not be planted along frequented roads—it attracts humans as much as bees!

May I also draw attention to *Coronilla glauca*? This is a small leguminous shrub with yellow flowers, on which the bees are very busy just now. There is one in this garden that has been in flower continuously since the end of June—and probably longer: not just a few blossoms now and then, but sheets of them the whole time. I fancy the bees visit it for want of better things, as they only began to attend to it in February.

As regards wind, I recommend beekeepers to sprinkle a little fine sand on the alighting-board before covering it with the last coat of paint. It should be put on while the second coat is still wet, and immediately before the third coat is added any loose grains should be dusted off. We have had rather blustering south winds lately, and I notice that two of my hives so treated have scarcely lost a bee, whereas three untreated hives close beside them showed deplorable results—chilled bees lying thick all round. For a moment I thought it was "Isle of Wight" disease, until I saw that almost every bee was loaded with pollen—so many bees are swept off the board as they close their wings on alighting; whereas the sand gives them a firm grip. I recommend this to the notice of hive manufacturers.—H. CAMPBELL, Pulham St. Mary.

#### ANOTHER ADVOCATE OF SKEPS.

[9004] I like Owen Browning's letter (page 115), pessimistic although it is; I would put my shoulder to his in defence of the skeppist. In my garden are eight hives—seven bar frames and one skep. I would as soon see them the other way about. The bees are direct descendants from those which inhabited straw skeps forty-five years ago, and never had anything wrong with them until their late owner was induced to try the new hives.

The second season he was cleaned out with disease, only two stocks in skeps just managing to come through, and his verdict, after fifty years' experience, was: "The new hives are fine for getting at the honey, but bad for the bees." His method of management was to have good skeps, roofed with straw in winter; a

little syrup in shallow tins at the entrance when the weather was mild in spring; unsold surplus stocks done away with in the smoke-pit. The bees always paid with him.—J. S. L., Perth.

### IMMUNITY TO "ISLE OF WIGHT" DISEASE.

#### A PROMISING STRAIN.

[9005] With reference to the above, I have a very likely strain of British Golden, crossed once with a brown drone, which has survived now three years, in direct contact with stocks affected with "Isle of Wight" disease. In this period, for two years, the bees were under exceptionally bad conditions, as last June owing to a bad attack of "foul brood" they only covered about three frames. They are working in great earnest every fine hour, in the cold winds of late. I should be glad to hear of any one willing to exchange or sell about May two virgin queens of the same strain, viz., British Golden. With a diseased stock of native bees there seems to be decided change for the better, and I am hoping to save them by squeezing the juice of a lemon in a quart of syrup; but one wants warm weather to destroy all affected bees as they come out, as only by this, in my opinion, can we hope to counteract the disease at all. Among other precautions to take, I think we must now avoid the orthodox method of giving pollen in the open air. I find a small hole in first quilt, with a matchbox or some such article, containing a small quantity of pea-flour, placed over the hole answers well, and the bees can get at it whatever the conditions are outside.

*Optimistic view of "Legislation"* (page 115). I was surprised to read of anyone possessing such a long experience in bee-keeping expressing such views of the Act as your correspondent, Mr. Browning does. I have no doubt that an inspector who knew of such infectious haunts as are mentioned in his letter, would make some attempt to destroy all possibility of infection. The very fact of the definition of "bee-keepers" used by your correspondent, leaving so many hundreds, however "unworthy," but still "keepers," outside the definition, shows that the Act is a serious necessity. No one wants legislation to "combat" bee diseases in its technical meaning, but it is useless attacking disease unless we have the right to supervise or advise both the ignorant and careless. Modern bee-keepers, as agitators for this reform, are only too anxious to do the "mothering," which the old school bee-men neglected. Foul brood did not trouble the latter, they understood not its dangers, and however

effective their plan of eliminating disease may be, their barbarous methods are none the more excusable; the bee, although domesticated and owned, does not forfeit the right to live, and modern, humane methods are the nearest approach to protecting it, to say nothing of the extra facilities these methods give for the study of a very pleasant and profitable pastime. My opinion is that modern methods have not developed disease, but have brought it to light, consequently furnishing some chance of stamping it out; this applies, at any rate, to foul brood.—A. H. HAMSHAR.

### APPRECIATION.

A correspondent writes as follows: "I may add that I always read the JOURNAL with interest: what I specially like about it is the spirit in which the work is carried on. The traditions of the headquarters staff seem to be those of kindness and helpfulness. Wishing you all success. Yours sincerely—E. N."

### WARWICKSHIRE B.K.A.

The annual general meeting of the above will be held in the Grand Hotel, Birmingham, on April 23rd, after which an illustrated lecture on "A Year's Work in the Apiary" will be delivered by Mr. W. Herrod, F.E.S. The chair will be taken at 5.30 p.m. At the conclusion of the lecture Mr. Herrod will be pleased to answer any question relating to bee-keeping. All interested in bees and bee-keeping are invited to be present.—J. NOBLE BOWER, Hon. Secretary.

### HONEY IMPORTS.

The value of honey imported into the United Kingdom during the month of March, 1914, was £2,465.—From a return furnished to the BRITISH BEE-KEEPERS' JOURNAL by the Statistical Office, H.M. Customs.

### BLURTS FROM A SCRATCHY PEN.

ROME.

(Continued from page 130.)

But, all considered, what was the use of wasting good old Saxon on the *Populus Romanus*? Little would they appreciate it. Better by far to keep our breath to cool our—no, not our "parritch." We should get none of that here, and macaroni is but a sorry substitute for "the chief of Scotia's food." Keep our breath until we visit some of the roof apiaries here. We shall want it.

Oh! these hotel touts. In all Continental towns what a nuisance they are.

To escape this crowd perforce it was necessary to drive to our hotel.

And we are actually traversing the streets of Rome! Rome that I have longed of all cities of the world to see, save, perhaps, one other in Palestine. What are my feelings? Of what am I thinking? Scarce can I tell; I cannot fit the pieces harmoniously together. Thirty centuries of history are around me. Carthage and Athens, and even her more modern rival, Constantinople, have faded away and almost gone, and still the "Eternal City" remains. That slave-built Coliseum frowns on us, grey and savage, and cruel as ever, grim in its naked unornamented walls. There Britain's sons were dragged, prisoners of war, to fight to the death for the amusement of an idle crowd.

"Butchered to make a Roman holiday." From yonder majestic Vatican wandered a great Pontiff. In these very streets he saw the Saxon children exposed as slaves. To the dark-haired Roman their fair skin was marvellous. *Angli*, their owner called them "Not Angli, but angels," was the Pope's reply, and the legend says he could not rest until his missionaries had visited the white-cliffed Albion. What of Rome of to-day? Its palaces are built of Carrara marble, dazzling in their whiteness, while the crowds who throng the streets are still of every race and every clime; but it is as the vintage of to-day occupying the amphora, the earthen wine bottles, of old Rome. The times seem out of joint. There is a solecism somewhere.

Pardon my meanderings, but the occasion must be the excuse. There has been much ink slung in an American bee journal recently as to whether bees could be kept to advantage in a city. Here, within the very walls of Rome, the question has been solved, and successfully, too. Of course, Rome is a city different from any other. First, it is a real garden city. Every palace has its garden, every residence of its citizens has its court, where, in the shade, they may escape the mid-day sun. There are few cities, too, which have so many public parks and pleasure grounds, and so many fountains of running water. The acacia and the begonia, and a hundred other nectar-bearing trees and shrubs unfamiliar to the barbarian eye, crowd everywhere within the flight of bee; also the buckwheat and the trefoil are near at hand. So there is no dearth of forage, as in many capitals.

Yet it would be marvellously difficult to conduct an apiary of any size mid such a mass of men on *terra firma*, and there comes in the advantage which the sunny South has over the rugged North. We

superimpose on our walls ugly, pyramid-like masses of slate or tiles. In Rome the roofs are flat, so that in the cool of the evening the inmates of the house may sit and enjoy the breeze from the not distant sea. Here, then, the Cavaliere Antonio Constantini has established his bee-farm, seven storeys high, on the top of his house in the Viccolo Brunetti—

"Far from the madding crowd's ignoble strife."

We came to know him in this fashion. We carried letters of introduction to our worthy host of the *Hôtel de l'Europe* (a to-day Senator of Rome). The hotel proprietor was soon forgotten in the friend, and all the sights of the ancient city were accessible to us. "Out of the fulness of the heart the mouth speaketh." It was not long before it was discovered that we were bee enthusiasts, and scarce was it known before a special messenger was dispatched to the Cavaliere. We are all bee-keepers. Is it necessary to say that the invitation to visit him was cordial?—J. SMALLWOOD.

(To be continued.)



#### EXTRACTS AND COMMENTS.

By D. M. Macdonald, Banff.

*Spraying Bloom.*—"Please tell this to your neighbours. Tell it to the editors of all the papers. Proclaim it from the housetops. Let everybody know that to spray a tree while in bloom is liable not only to injure the fruit and thus help to destroy the crop, but also kills the bees. This fact should be placed before each school teacher, and kept on the walls of each schoolroom of the State. Let us make it strong. Tell every teacher in your county to write on the blackboard in capitals: 'Never spray fruit while in bloom.'"

The above is from *Gleanings'* special fruit number. Another contributor tells when to spray. "The first spraying should be done when the buds are dormant, the second when they are nearly formed, the third, and practically the most important, when the petals are falling off; the fourth ten days after, and the fifth about July 1st." A badly affected orchard was thus cured, and a perfect foliage secured, while practically every tree was heavily laden with perfect fruit, and the crop was enormous. This from a lot of worn-out, run-down trees, previously yielding but a scanty crop of wormy and ill-shaped fruit. By the



way, some credit should also be given to the fifty "swarms" of bees placed in the orchard to pollinise the blossoms.

*Standardisation.*—A movement in favour of making hives and bee-keepers' supplies a standard size seems to be making good headway in the States and Canada, and manufacturers are aiding by adopting the same styles and sizes. This is as it should be. The consensus of opinion favours the ten-frame hive in preference to the hitherto favoured eight-frame one. Messrs. Root state: "Just a few years ago the majority of hives sold were the eight-frame, now the ten-frame outnumbers the former by nearly three to one." The National Association are working in the same good cause, and are trying to standardise appliances as far as possible.

*Re-queening.*—"There are several things to be gained. A young laying queen in a colony will, as a rule, increase the vigour of the bees, so they will both breed faster and gather honey more rapidly when it comes. I have often found such colonies among my best for surplus. Such colonies, if left to supersede their own queens, become often so reduced in bees that their surplus is likely to be much below the average. Again, such colonies are much less likely to swarm than those having old queens. Many swarm simply as a result of the superseding of old queens." That means three points in favour of the re-queened stock—less chance of swarming, breeding faster, which means a stronger force and more honey, which means more profit.

*One for Blacks.*—Mr. Byer, Canada, says: "I believe any claim that Italians are exempt from the ravages of American foul brood is mere twaddle. In my experience as an inspector, as well as in dealing with this disease in my own apiaries, Italians were more often affected than other races. I judged this to be caused by the Italians' well-known propensity for robbing." The claim of immunity has been controverted over and over again, and here comes Mr. Byer asserting that Italians were more often affected. Unquestionably, that is my own experience.

*Convention Groups.*—February *American Bee Journal* illustrates interesting groups of the Convention of Iowa beekeepers, and the Michigan Convention to the number of over 120 members. All sorts of men and women are shown as others see them, and they will well bear a look. Many fine types of both sexes are to be seen. How is it that we never see a group of bee-keepers in our bee newspapers on this side?

*Compound Words.*—The above paper and *Gleanings* have been conspiring to run a

number of these words into simple ones, mentioning *foulbrood*, *beekeeper*, *beesting*, as samples. ("Now, why it is I will not tell, But I do not like thee, Doctor Fell!") Then they proceed to write and print (amongst others)—White-clover, bee-tree, pure-food, machine-shop, hive-cover, ten-frame hive bee-papers, bee-sting, foul-brood, red-clover bees. Why? Consistency, thy name is neither Miller, Root, nor Dadant!

---

#### SUGGESTIONS FOR OBSERVATIONS ON THE ORDER OF BLOSSOMING OF DIFFERENT VARIETIES OF FRUITS AND EXPERIMENTS IN THEIR POLLINATION.

1. Note the order of blossoming of different varieties of apple, pear, but more particularly of cherry and plum; also note the length of time the different varieties are in flower, with the object of seeing which varieties are in flower about the same time for cross-pollination.

2. In order to test which varieties are self-fertile and which are self-sterile, enclose trusses of unopened flowers in paper or muslin bags and tie the bag at base. When the tree is in full flower open bags, pollinate blossoms with pollen of the same variety by dusting stigmas either with pollen of anther held by forceps or by camels' hair brush, remembering to sterilise the brush by dipping in methylated spirits and allowing to dry before using with another variety. After pollination replace bags, label with date, approximate number of flowers, and what has been done.

3. An interesting experiment is to place bags over three trusses of unopened flowers on a variety: (a) leave alone to see whether any fruit will develop with insects excluded; (b) pollinate with own pollen to see whether or no fruit will set and mature with pollen of the same variety; (c) pollinate with pollen of another variety to see whether a better result is obtained with foreign pollen than with its own. Each trial should be labelled and a careful record kept, examining them, say, once a fortnight, till mature, as many fruits that "set" fall before the fruit is ripe. The bags can be removed when all petals of the enclosed flowers have fallen—say a fortnight after pollination.

4. To find the best pollenisers, especially for shy-bearing kinds: The unopened blossoms to be bagged may be emasculated (by pulling out or cutting out the anthers before they shed their pollen); or, if the variety is self-sterile, they may be left untouched. The flowers that have been bagged are pollinated (when the tree is in full bloom) with pollen of another

variety. The approximate number of flowers pollinated should be noted on the label, together with name of pollen used, dates and notes from time to time till the fruit is mature. It may be advisable to thin the number of flowers or fruits to give them the best chance.

5. Notes may be made of the insect visitors that chiefly visit and pollinate the different fruit blossoms, the object being to get records from different parts of the country.

Observations and records of experiments should be sent to the Secretary of the National Fruit Growers' Federation, 2, Gray's Inn Place, Gray's Inn, London, W.C., to be tabulated and summarised; all contributors of careful observations to receive a summary of the season's observations when published, a copy of which will be sent to the Editor of this journal for publication.

## Bee Shows to Come.

**June 9th-11th, at Malvern.**—The Herefords and Worcs. Agricultural Society's Malvern Meeting. Twelve classes for Honey, &c. Good prizes; small entry fees.—For schedule apply, Mr. A. Elliott, Hon. Secretary's Department, Cusop, Hereford.

**June 30th to July 4th, at Shrewsbury.**—Royal Agricultural Society's Show. Bee and Honey Section, under the direction of the B.B.K.A. Prizes arranged in groups of counties for Associations affiliated to the B.B.K.A. Schedules from W. Herrod, 23, Bedford Street, Strand, W.C. **Entries close May 30th.**

**July 8th, at St Albans.**—Honey Show of the St. Albans B.K.A., held in connection with the Elstree and Boreham Wood Horticultural Society, at Aldenham Park. Open class for extracted honey. No entry fee. Liberal prizes. Judge, Mr. W. Herrod. Schedules from Mr. R. H. Attenborough, Aldenham, Herts. **Entries close July 6th.**

**July 24th and 25th, at Cardiff.**—The Glamorgan B.K.A., in connection with the Cardiff and County Horticultural Society's Show, in the Sophia Gardens, Cardiff. Open classes include:—Collection, Gift, Sections, Beeswax, &c. Schedules from W. J. Wiltshire, Maindy School, Cardiff.

**July 23rd, at Bath.**—The Annual Show of the Somerset Bee-Keepers' Association, in connection with the Larkhall Horticultural Society. Seven Open Classes. Schedules from J. W. Brewer, Glen Lynn, St. Saviour's Road, Bath. **Entries close July 18th.**

**August 26th, at Prestbury.**—Honey show, in connection with the Prestbury Flower Show. One class open to the kingdom. Several for those within 12 miles radius. Exceptional prize list. Schedules from A. H. Bowen, Coronation-road, Cheltenham.

### TRADE CATALOGUE RECEIVED.

*Abbott Bros.* (Southall, near London).—This old established firm issue a well arranged catalogue, which has been revised and brought up-to-date, illustrations being given of most of the articles listed. It is replete with every appliance required by the bee-keeper, and includes stocks, swarms,

and queens. Many "special" patterns of hives are illustrated, while the model "W.B.C.," which has gained premier honours at so many "Royal" shows, again occupies a prominent place. The excellence of the woodwork turned out by Messrs. Abbott is well-known, and all their goods can be relied upon to be equally satisfactory. The catalogue can be had post free on application.

## Notices to Correspondents

H. F. SWANN (Northants).—*Feeding in Spring.*—Bruise the cappings of the sealed food in the combs in order to induce the bees to eat it. They will need the food before the flowers bloom.

J. W. G. (Huddersfield).—*Buying Honey for Bee-food.*—It is no use wrapping honey in paper to send through the post. It should be properly packed to travel safely; only the sticky paper arrived here. In any case, do not buy honey for bee-food at present. It is too risky in view of disease.

FREDA (Oundle).—*Various Queries.*—(1) We cannot add anything to the advice already given—i.e., it would be best to stick to your own bees, and not buy from outside at present. (2) You must not shut the bees up in the Claustral hive. Transfer them any time now on a warm day, and then move them not more than one yard per day, when they are flying, until you get them to the new position. (3) The "Brice" swarm-catcher is good and has no disadvantages. (4) Certainly give the bees water in a proper fountain, rather than let them go to a pond to drink.

H. K. (Rugby).—*Bees Casting out Queen.*—The queen is an old one and has been rejected by the bees because she has been injured and cannot lay. No doubt this was done during the manipulations on the Sunday as mentioned.

### *Suspected Disease.*

L. J. B. (Northants) and J. H. DIXON (Cornwall).—The bees were too dry for us to be able to state cause of death. It would be best to melt the combs and well disinfect the hive before putting bees in it again.

R. L. (Castle Cary).—Bees show every indication of "Isle of Wight" disease.

J. B. (Nuneaton) and R. AULD (Bath).—Bees have died from "Isle of Wight" disease.

A. S. M. (Romford).—The bees are Carniolans, and are badly affected with "Isle of Wight" disease.

*Editorial*

**BEE-KEEPING IN OTHER COUNTRIES**

Lecture by Thos. W. Cowan, F.L.S., &c., given at the B.B.K.A., *Conversazione*, March 19th, 1914.

(Continued from page 153.)

The next picture is that of Ramon Gonzales in Haïti, and you will see that there, also, are quite advanced bee-

keeping in the United States of America, and in Canada is carried on very much on the same plan as it is here, only on a much larger scale, so that I need not devote very much time to it. However, I wish to bring before you a portrait of Mr.

AMERICA.

keeping in the United States of America, and in Canada is carried on very much on the same plan as it is here, only on a much larger scale, so that I need not devote very much time to it. However, I wish to bring before you a portrait of Mr.



MR. C. P. DADANT.

keepers. The hives in the apiary of M. Malherbe Pressor are on tall legs, and are arranged amidst tropical vegetation, and you will observe that the ladies and gentlemen are dressed in light tropical costumes. From Haïti we can go to India, and here are natives manipulating frames at the apiary of St. Joseph's College in Trichinopoly. The Hindoos who have charge of the apiary do not seem to mind the bees, as they go about with

C. P. Dadant, who is not only a prominent bee-keeper in America, but whose name is also well known in Europe, as he and his father have done much to popularise the horizontal frame-hive on the European Continent. Mr. Dadant is of French extraction, and has been a frequent contributor to European bee-papers, and it is through his influence that the movable comb-hive is so rapidly spreading over the whole of Europe.

(Applause.) I had the pleasure of meeting him last autumn in Switzerland, and he said that he would come to England before long and visit some of the bee-keepers in this country. Those who meet him will find that he is full of information. During the two days I spent in his company he did not cease to talk about bees, and find out all he could about them. While staying with Mr. Bertrand we had the opportunity of meeting Dr. Loris Melikov, of the Pasteur Institute, Paris, who had been sent by the French Government in view of legislation, to investigate foul brood, which was devastating Savoy. He came over from Evian to get what information he could, and we had several hours of very interesting conversation, being able to give him particulars of what had been done in Switzerland to combat this disease by means of legislation. The next picture is a view of the apiary of J. House, in New York State, and contains 350 colonies arranged in pairs on the slope of a hill. The following are views of the apiary building and rooms of the Massachusetts Agricultural College. Some of the largest bee-keepers are in California, and I am able to show you two apiaries belonging to Mr. Mendelson, of Ventura, one consisting of 500 colonies arranged in pairs on terraces on the side of a hill, and another of 1,500 Danzenbaker hives. The extracting house, as you will see, contains Cowan extractors driven by an engine.

In my last lecture, I described the system adopted in Gatinais of inverting straw-skeps and placing empty ones on them to obtain a large harvest of honey. I am now able to show you how some of the modern bee-keepers in that part of France have improved on the old plan by using wooden supers instead of straw skeps.

For all these pictures I am indebted to my son, who has prepared them for me. Many of them, especially those of bee-keeping in the Caucasus and in the Balkan States are interesting because so different from what we are accustomed to find in other parts of Europe. In conclusion, I would thank you for the kind and patient attention which you have given to my remarks. (Applause.)

Mr. W. Herrod then gave his test lecture for lecturer's special certificate, the subject being "How to Manage Home and Out Apiaries, including the Prevention of Swarming." He was listened to with great attention, and at the conclusion, the audience were requested to ask as many questions as they pleased. Numerous points were raised and promptly dealt with by the lecturer.

Articles of interest were then inspected, including some excellent photographs of bees and "Isle of Wight" disease brought by

Mr. G. W. Judge, a home-made wax-smelter by the Rev. F. S. F. Jannings, displaying again his inventive genius; a new excluder, sent by Mr. E. H. Taylor, of Welwyn, in which the greater bulk of the metal (as in the old pattern) is eliminated. This improvement will, no doubt, be welcomed by those bee-keepers who wisely use excluders. Mr. F. W. Watts also exhibited a new bee escape; this was very favourably commented upon and has already been illustrated in our pages.

[We are indebted to the Editor of *Apiculture Nouvelle* for the loan of block on page 152 of last week's "B.B.J."—Eps.]

#### BRITISH BEE-KEEPERS' ASSOCIATION.

The monthly meeting of the Council was held at 23, Bedford Street, Strand, London, W.C., on Thursday, April 16th, 1914. Mr. W. F. Reid presided. There were also present Messrs. C. L. M. Eales, A. Richards, A. G. Pugh, T. Bevan, J. Smallwood, O. R. Frankenstein, and H. P. Perkins; (Association representatives) G. S. Fauch, and G. R. Alder (Essex), G. J. Flashman (Barnet), G. Bryden, and G. W. Judge (Crayford), F. W. Harper (St. Albans), and the Secretary, W. Herrod.

Letters expressing regret at inability to attend were read from Miss M. D. Sillar, Messrs. T. W. Cowan, E. Walker, Sir Ernest Spencer, Colonel H. J. O. Walker, Captain F. Sitwell, and Rev. F. H. Fowler.

The minutes of Council meeting, held on March 19th, 1914, were read and confirmed.

The following new members were elected: Mrs. H. W. L. Waller, Mr. R. Talbot Clayton, and Mr. C. V. Bellamy.

The Manx Bee-keepers' Association applied for affiliation, and were accepted.

The following Associations nominated representatives to the Council, and the same were accepted: (Lincolnshire) Mr. D. Seamer, (Staffordshire) Mr. W. Valon, (Mid-Kent) Mr. J. C. Roberts, (Leicestershire) Mr. W. W. Falkner.

The report of the Finance Committee was presented by Mr. Smallwood, who stated that the payments into the bank for March amounted to £40 12s. 2d., the bank balance being £221 16s. 8d. Payments amounting to £20 7s. were recommended.

The report of the Examining Board on the lecture given by Mr. W. Herrod at the *Conversazione* on March 19th for the lecturer test was presented by Mr. W. F. Reid, and it was unanimously resolved to award him the certificate. Mr. Herrod was called into the room and warmly congratulated by the Chairman and

Council upon being the first to gain the honour.

The Secretary reported that Colonel H. F. Jolly, of Glenavon, Clifton Down, Bristol, had kindly offered as a second prize to the exhibitor gaining the second highest number of marks in the W. Broughton Carr Memorial Medal competition, a "W. B. C." hive, the same to be selected by the judges from the competitive exhibits at the show. It was unanimously resolved that Colonel Jolly be cordially thanked for his generous offer, and that the same be accepted.

Mr. A. G. Pugh brought forward the matter of arranging a judging competition. It was resolved that a class be arranged at the conversazione to be held October 22nd, 1914. Mr. C. L. M. Eales offered to present a first prize of one guinea, and Mr. O. R. Frankenstein a second prize of half a guinea; both gentlemen were heartily thanked for their generous gifts and the same were accepted. The arrangement of details was left in the hands of the Exhibition Committee.

Next meeting of Council May 21st, 1914.



HOW TO MAKE AND STOCK AN OBSERVATORY HIVE.

(Continued from page 146.)

The complete hive is shown at Fig. 7, where it will be seen that a large hand lens is fastened to the hive by means of a chain and hook, to prevent it being removed. This is very useful when examining the bees on the comb, or to get a better view of the inside of the cells. Fig. 8 (see p. 164) is a photograph of a six-frame observatory hive made by Messrs.

Jas. Lee & Son, to whom I am indebted for the loan of the photograph and permission to use the same. After studying the description and drawings for the three-frame observatory hive, it will be easy to understand from this illustration how to make room for the extra three frames.

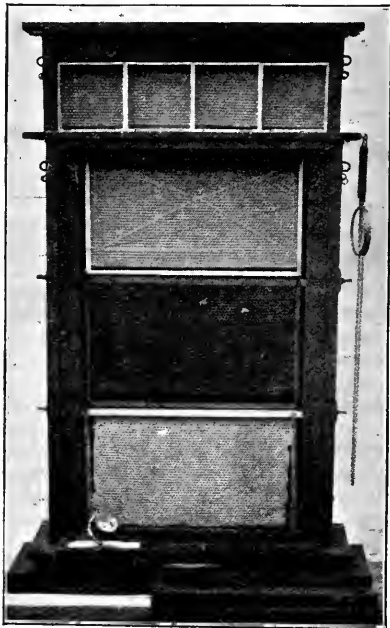

FIG. 7.

It is best to stock the observatory hive with a very small swarm or cast rather than with a nucleus. By the former method the combs are built evenly in the hive, and there is no fear of crushing bees on the bulging combs when putting in the glass frame, which often happens when built combs are used. The swarm or cast will locate the hive much better than a nucleus. It is inadvisable to try to run the bees into the observatory hive in the orthodox fashion. The entrance is too long and narrow to do this, and the bees will be a long time finding their way in. Put the three frames, fitted with foundation, into a nucleus box, with the entrance occupying the position of that of the observatory hive. Run the bees into this in the usual way. Give them food, and let them work for about four

days; then remove the box, and put the hive in its place. Take out the long glass frame and transfer the partly-built combs with the bees adhering, making quite sure the queen is on one of them. The glass frame is then worked gently into position and screwed fast. The hive should be kept dark by keeping up the shutters all along, only taking them off when watching the bees. If left off for

long periods the bees will not be so warm, and, as they object to light, they will coat the glass with wax or propolis. An entrance slide should be provided; this should be easy of access when looking at the bees, so that if it is required to catch a bee in the passage, it can be prevented from getting out. The bees should not be wintered in the hive, as they cannot cluster close enough together for the necessary warmth, and it is difficult to give them candy. Move the hive away and transfer them to a nucleus box, which can be well wrapped up to keep them warm. The scale of drawings is 3in. to the foot.

[*Errata.*—On page 124 (*British Bee Journal*, March 26), third line in first paragraph should read "In the centre a hole (H and M)  $2\frac{1}{4}$  inches in diameter is cut." On page 125, at right-hand side of block, Fig. 3, should appear the words "27 inches."]

#### THE GROWTH OF THE BROOD NEST AND BUILDING UP STOCKS.

Success in obtaining surplus honey from the bees depends not on rule of thumb methods, but upon understanding their habits and the numberless idiosyncrasies which they possess. There are probably very few bee-keepers who take the trouble

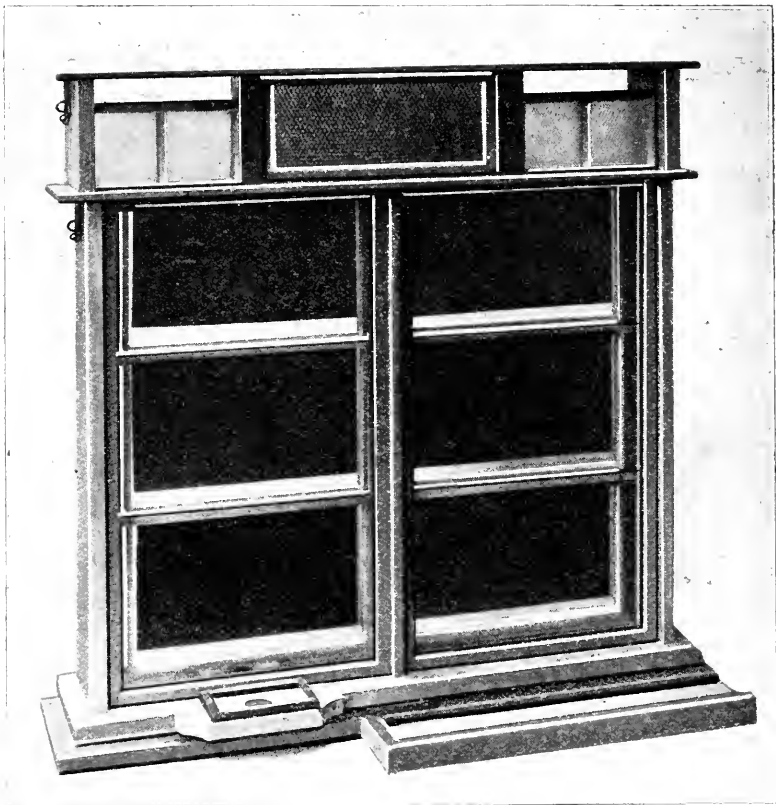

FIG. 8.

to observe the manner in which the brood nest spreads, and fewer still who make the slightest attempt to assist the bees to carry out this work to the best advantage.

There is a prevalent idea amongst bee-keepers that the queen always commences to lay in the centre of the comb; observation proves that nine times out of ten such is not the case.

Breeding commences about the last week in January, and the queen will commence to lay in the cells of those combs upon which the bees happen to be clustering at the time. Bees take cleansing flights on fine days during the winter months, and when they settle down again the position of the cluster is shifted to those combs which contain the most food, so that when breeding does commence, the bees may be located in any position in the hive. It will frequently be found that

breeding has commenced at one end of the combs, or even in the centre of the last comb but one. In such a case the expansion of the brood nest is restricted to one side only; to remedy this, move the combs containing brood so that they are the central ones of those occupying the hive. The division board—mistakenly called a dummy—is the most useful appliance to use for building up stocks. It is more efficacious than feeding; yet experience teaches me that it is rarely used. When incubating eggs, and rearing brood, heat is required, and if the bees have a large unoccupied area in the brood chamber to keep warm, as well as that where brood and bees are situated, it means that not only is energy and food wasted, but the numbers do not increase so rapidly as when they are confined by means of the division board to those combs which they are capable of covering. The use of this appliance releases a larger number of bees to go out foraging. The division board should not fit close down to the floor-board; a space of about three-eighths of an inch should be allowed, so that bees can pass freely underneath. It is advisable to keep a few frames fitted with foundation on the unoccupied side. These serve a double purpose—they help to keep the quilts snug and straight, and also prevent the bees wasting their energy in building drone comb in the empty cavity, which will happen if they are neglected for a time, and over-populate the combs to which they are confined. The bee-space under the division board will allow them to pass to the fitted frames, and carry out useful work, instead of swarming, or wasting time as stated above. The use of the division board means a little

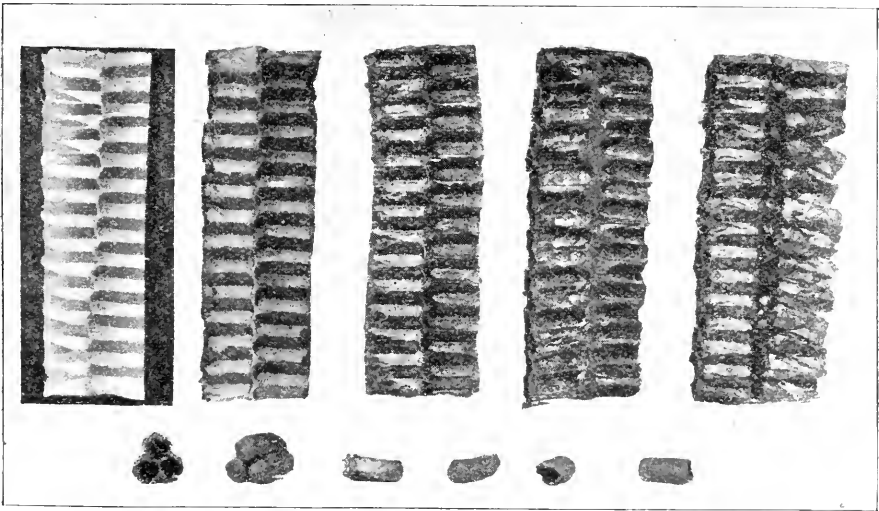

FIG. 1.

more labour and careful watching, but this is amply repaid by the rapid building up which results. It is the principle one would apply to a long room with a fire-place at one end. If it were going to be occupied by a few people only, a curtain or partition would be put across, so that the heat from the fire would be confined to the enclosed space. Another operation which should be carried out at the same time as the building up of stocks is the renewal of combs. This is not done frequently enough, and if it were practised more, I am certain disease would not be so prevalent. Constant breeding reduces the size of the cells, by the adhesion to their walls of the skins from the larvæ which are cast off when moulting, so that from old combs are produced diminutive bees, with reduced stamina and whose carrying capacity is lessened. Therefore, more journeys have to be made to obtain the same amount of nectar that is carried by the larger bees reared in new combs. The photograph (Fig. 1) shows very clearly the difference in combs of various ages. No. 1 is a newly-built one; No. 2 is one year old, showing the thickening of the cells during that period; No. 3, which is three years old, shows a further reduction in the size of the cells (when the comb was broken in two the left side cocoons remained intact); No. 4 is five years old—no explanation is necessary—while No. 5 is a three-year-old comb broken in two, showing the cocoons

on the right side slightly loosened and raised at their base; along the bottom are cocoons taken from a solar wax extractor after all the wax has been melted away; as will be seen, they retain the shape of the cell, and are very tough.

(To be continued.)



The Editors do not hold themselves responsible for the opinions expressed by correspondents. No notice will be taken of anonymous communications, and correspondents are requested to write on one side of the paper only and give their real names and addresses, not necessarily for publication, but as a guarantee of good faith. Illustrations should be drawn on separate pieces of paper. We do not undertake to return rejected communications.

### "ISLE OF WIGHT" DISEASE AND STRONG QUEENS.

[9006] I think we should all be grateful to Mr. Lee and others for sending us the sequel of what they believed last year was a successful evasion of our terrible enemy. Beyond the letters you have published I have had one from the Oxford gentleman, whose former report I alluded to, and that shows that the quinine treatment is at any rate not an absolute cure. I agree with Mr. Mace that colonies can be tided through the spring attack and made useful at any rate for one season, and with Mr. Brook on the importance of breeding queens of strong and clean constitution. But are Mr. Brook's postulates enough? He says, "Let us see that queens are reared in none but strong colonies and only when honey is coming in, thus ensuring that the embryo queens will be well fed during their larval stages." You might have all these factors, including the important one of "honey coming in," say, in July, and yet perhaps on account of the abundance of fresh pollen and the vitality of the early summer sunlight, May is very likely the best month for breeding really strong and healthy queens. I suppose Mr. Mace would not find it hard to add to his other heresies that a young queen could be over-fed and thus made flabby. Then we have seen that "Isle of Wight" disease can be temporarily checked by taking away the queen and thus giving the stock a rest from brood-feeding. Perhaps it is an essential to health that there should be an interregnum in every hive every year. We could give that without much loss to ourselves by removing the queen and letting her lay elsewhere for a fortnight and then reuniting under a new queen. That is a far point, but the immediate question is whether we are careful to breed only strong and healthy queens, and whether we know all the conditions necessary to that end.—G. G. DESMOND, Sheepscombe, Glos.

### "BOX-HIVES."

[9007] My reason for believing that the mention of "box-hives," especially in connection with New Zealand, acts in a peculiar manner on Mr. L. S. Crawshaw (page 38, January, 1914) is because he has previously gone out of his way in controversy with others to ironically refer to them. Mr. Crawshaw shows himself an evasive controversialist in trying to confine the meaning of the term "box-hives" as used by me to "cracker boxes," &c., without mentioning his own particular fancy—skeps—when he should know as well as I do that I have explained through the "B.B.J." on several occasions that right throughout Australasia the term is used comprehensively to cover all forms of immovable comb-hives, be they skeps, barrels, boxes, or any other article. Pray, Mr. Crawshaw, accept this explanation as final.

May I ask Mr. Crawshaw before closing whether he uses the *common* straw skep or not, and, if not, why not?—I. HOPKINS, Auckland, New Zealand.

### "ISLE OF WIGHT" DISEASE.

#### THE QUININE TREATMENT.

[9008] I regret that pressure of other work has prevented my replying before to queries concerning the results of the quinine treatment.

I give the facts, to date, briefly. Your readers may recall that the five stocks wintered solely upon medicated stores survived till the spring of 1913. These yielded a surplus of 154lbs. of extracted honey last summer, and at the same time increased to fifteen colonies. Signs were not wanting that the disease was present during the season in every hive, but in an insignificant degree till August.

The late summer and autumn of 1913—unlike that of the preceding year—was remarkable, here, for a prolongation of the honey-flow. Bees were gathering busily and breeding hard till mid-September. In August the disease reappeared badly in one colony. Remedial measures—quinine, disinfection, a new queen—failed to stay its inroads, and the lot were evanished. Brood-nests were found in September to contain quantities of natural stores: the medicated syrup was very slowly taken, and the stocks were at last packed down for the winter on mixed stores.

The mild weather that at first prevailed kept the bees active; rapid dwindling apparently took place; when the fortnight's frost came suddenly in January, the



weakened stocks were chilled to death. All had brood—queens had been laying till the last; most had a pile of bees on the floor-boards and a smaller number huddled over the brood. All had plenty of stores—partly medicated. Three stocks survived the frost. One was destroyed later, the other two failed to take down the medicated spring syrup, and died off within the last fortnight. The disinfected hives have been stored—in hopes of better days to come. A hundredweight of stores was taken from selected combs before they were burnt. It proves too bitter for use.

It is not safe to draw dogmatic conclusions on the material to hand, but for the past two winters stocks supplied with part medicated and part natural stores have died. I had determined to extract the natural stores before winter last season, but they were so mixed up with brood that, beyond removing a frame or two, it was quite impossible, and so history was left to repeat itself.—H. WIGLEY, Gravesend.

“IMMUNITY” AND “ISLE OF WIGHT” DISEASE.

[9009] “Isle of Wight” disease has been especially fatal in this parish. Where, a few years ago, one could count hives by the dozen, there are only three left, and these are direct descendants of bees that have succumbed to the malady. In the autumn of 1912 I obtained a small cast on three frames from an apiary near, which has since been wiped out. There was a mere handful of bees, but I fed them on syrup and candy, and they came through the winter well. They swarmed twice and also gave me a surplus of about 50lbs. of honey. Now, the first swarm that left the hive did not cluster, but I followed it and saw it enter one of a number of hives belonging to a farmer about 300 yards from here. His bees had previously all died of “Isle of Wight” disease, and he had left the hives standing out just as the bees had died in them. I would not claim the swarm, as I thought they would surely die. But the unexpected happened; the bees lived and flourished, and last Tuesday, the 14th inst., I got permission to inspect them and found them covering ten frames with drone brood nearly ready to hatch, so I guess they will soon swarm. I could see no sign of disease, and they are still in that same hive and nothing has been done to it since its former occupants died. I have the parent stock, and the second swarm, and they are both well and strong; in fact, I have supered the parent stock.

Your correspondent “H. A. G.” (page 94) gave a list of early pollen plants; the Cornelian Cherry (*Cornus Mās*) should also

be included. It flowers early in February, and on a fine day I have seen it literally covered with bees.—ELVEY E. SMITH, Southfleet.

QUERIES AND REPLIES.

[8921] *Decoy Hives*.—I should be glad if you could tell me through the “B.B.J.” if it is legal for a neighbour to put out hives or leave out hives with comb and honey for the purpose of catching other people’s swarms? I know where there are two diseased hives left out for this purpose, and I do not think it is at all right.—W. R., Sussex.

REPLY.—We agree with you. It is a shame that such a thing is allowed. Yours is one of the hundreds of cases which go to show how necessary it is to have legislation. At present there is no law to prevent your neighbour allowing his diseased hives to stand. If a swarm issues from your hives, so long as you keep it in view, you can follow and claim it. The only difficulty you might have is that such an unscrupulous person would probably swear that the hive was already occupied by bees.

[8922] *Moving Bees*.—*Honey Tea*.—(1) In queries and replies (8917) your reply is “quite safe.” In all books of instruction that I have read it states, “Hives can only be moved *one yard per day* at a time.” Which is right? (2) Will you also kindly tell me what is “honey tea” and how is it made?—New Forest.

REPLY.—(1) You have mixed up two conditions. When bees have been kept indoors for about a fortnight through bad weather, as in winter and early spring, they can be moved short distances, and will locate their new position. When they have been working and flying continuously for some time, then for short distances they must not be moved more than one yard per day, or many bees will be lost. (2) One large table-spoonful of honey in a breakfast-cup, which should be filled with boiling water. The tea should be sipped as hot as possible.

ECHOES FROM THE HIVES.

Two swarms came off in my apiary today (April 20th). This is very early for this part. My other stocks are in good condition.—H. SEAMARK, Willingham, Cambs.

The first swarm of the season came off on Sunday, April 19th (sure to be Sunday!). The bees are booming down here;

we have had a fortnight of glorious weather, with the fruit trees in full blossom. One colony has filled a super in the past fourteen days.—W. WOOLLEY, Evesham.

I am glad to report that my bees are in splendid condition, and very strong. All stocks (ten in number) came through winter well, and in most cases have built comb and stored honey in empty candy boxes. One stock in particular which I was changing to a clean hive yesterday (April 17th) I found so crowded on the ten frames that I gave the bees a super of sections and they were up working an hour afterwards, so I shall probably get some sections from the fruit bloom. All my stocks have 1913 queens, and are building up well, so I hope to have some early swarms.—J. BOWDEN, Witley, Surrey.

A glorious week for the bees. They are working on the plum blossom and berries, and we have had to put in forty frames of foundation to keep them from swarming. Four stocks are working up in shallow frames: the honey is dark and strong, but it is good stuff to raise brood for the raspberry bloom which is coming on.—R. BROWN AND SON, Somersham.



*Sections for the Show Bench* (p. 92).—Just why should two-bee-way sections be better than any other for the production of fine comb? There would seem to be no logical connection between increased bee-way and pop-holes. I should have voted for no-bee-way sections for the purpose, which perhaps simply goes to prove that each man succeeds best with the outfit he prefers. In other words, it is possible that there is no best section or best hive. But the no-bee-way section has, to my way of thinking, several advantages. There is no trimming of the wood for glazing, and no trimming can be so neat as the original plainness. It is much better to glaze close to the comb surface, the outside row of cells being better concealed. Of course such sections require greater accuracy of fixture, and more care in handling, but I think they are worth it. I don't like "show cases," nor do I think that they compare in finish with a finely-glazed section. If "D. M. M." were to see some specimens which are supposed to show off their contents year after year, he might agree. But "fancy" sections depend

more upon skill than style of section. Skill and care from beginning to end, with every now and then a dash of luck to out-distance skill and care. "Bottom starters" are a great help in the production of show sections, and I should like to add a good word for section frames, which certainly keep the sections cleaner and "squarer" than the ordinary rack. "D. M. M." writes of selection from several hundred sections. Ah, me! we are not all so favourably placed. What of the small bee-keeper with one or two hives, who yet would like to compete on the show bench? To him I would suggest, take your strongest stock or stocks, and give them every encouragement up to fruit bloom. Then super with a set of fully drawn-out-shallow worker-combs. If these fill up, place a super of shallows (foundation) under, to catch the Sycamore honey. When the clover opens, place the section-rack between these shallow supers. The new combs will separate the sections from the brood-nest, and keep them cleaner. Then, if your luck holds, you may get some show sections. But see that there is some drone comb in the brood-nest at the extreme outside, and don't use an excluder. Don't rely upon swarms to give surplus, but should the stock swarm during clover bloom, return the swarm after taking away all the queen-cells and most of the brood-combs, replacing these with two or three sheets of foundation, and returning the supers as before. Better see if some of the sections are not done to a turn at the same time, but do not blame the writer too severely if the bees should not have touched them. That would certainly be their own fault, perhaps in a misguided endeavour to live up to Mrs. Comstock's maxim, that "bees do nothing invariably." I can only say that I have not found this maxim entirely true. My own bees are invariably very busy.

*Precision in Bee Terms* (p. 96).—When you come to think of it there is a good deal in the contention made by "S. J." that the worker is not an "undeveloped female Amazon." Amazon, if you like, which would appear to imply female, but not an undeveloped Amazon—rather the contrary! But is she comparatively undeveloped? Is she not rather more developed than the full female, who would appear to have lost the arts in the development of a process? She is no less a female than the full queen, and can take her place on occasion, although her powers are beyond question limited. But she is much more developed in other ways, as might be expected from her longer period of growth. It is true that the shorter period of the queen can be accounted for by evolutionary theory, but even this implies some guesswork. And

what of the drone, whose period is still longer, and whose development in some respects is even greater? Again, what shall we substitute for the generally accepted description? "S. J." does not make any suggestion, and it would seem that one is needed.

*Cure of Colony or Individual* (p. 98).—There appears to be some confusion of idea here as to what constitutes a cure. It is, of course, impossible to cure a bee whose internal structure is seriously injured, and I doubt whether an individual bee can recover after being fairly attacked by the disease. But this is not to say that the progress of the disease in the colony cannot be checked, nor that those individuals which are still healthy, even though the germs be within them, cannot be helped to fight for their life. I believe that this can be done, so that a colony is eventually free from disease. Cures are either being mistakenly reported, or they prove this, and we may yet find the specific. But it is the colony which recovers, and not the individual bee.

*Wiring Frames* (p.110).—There is a difference to be observed in various makes of foundation. Some will sag or buckle, do what you will. The softer foundation appears to sag, and the older or harder to buckle. I came across a comb of my own the other day which illustrated the difference. This was only a half comb, two to the standard frame, and it had three horizontal wires, whilst the foundation had been waxed to the wood all round the three upper sides. But the sag was terrific, about the depth of a row of cells in some six inches of length. Not only had the wires been forced downward, but the foundation had settled somewhat upon each wire, making a crushed row of cells. Yet the buckle was only slight.

"*Isle of Wight*" *Disease* (p. 115).—Mr. Owen Browning's letter is labelled "A Pessimistic View," but this title hardly does justice to the spirit of his article. I take it that he is a believer in the opinion that the disease has occurred before, and that it has run a natural course, leaving bee-keeping to flourish once again. If this be true, and there appears little reason to doubt it, we may regard the future with more optimism. It is certainly true that foul brood and all the other diseases we know have not wiped bees out of existence, in spite of skeps, hollow trees, or frame-hives. Mr. Browning makes a call to all bee-keepers to be up and doing, and, in the absence of legislation, to help themselves by helping their weaker brethren to get rid of disease. And I would add a further appeal to all bee-keepers and dealers, not to ship bees from an affected area, and especially to disinfect all travelling boxes upon their return. I

think it would be better for dealers to send out unreturnable boxes, but for their own sake, and for ours, I trust that this appeal will not be disregarded.

TRADE CATALOGUE RECEIVED.

*E. J. Burr*, *Stroud Road, Gloucester*.—This well-known West of England firm of manufacturers issue a comprehensive list of appliances. They make a speciality of hives in the flat, and these can be had in half-a-dozen different patterns at very moderate prices, while bee-keepers who are fond of carpentry can buy well-seasoned boards ready cut and planed for making hives and other appliances. Bee-houses are also listed, and many other necessities for the apiary. The catalogue is well printed and illustrated, and can be had post free on application.

WEATHER REPORT.

WESTBOURNE, SUSSEX.

March, 1914.

Rainfall, 5.49 in.	Minimum temperature, 28 on 25th.
Above average, 3.27 in.	Minimum on grass, 18 on 11th.
Heaviest fall, .84 on 9th.	Frosty nights, 9.
Rain fell on 27 days.	Mean maximum, 49.4.
Sunshine, 105.1 hrs.	Mean minimum, 37.2.
Below aver., 38 hrs.	Mean temperature, 43.3.
Brightest day, 31st 10 hrs.	Above average, 1.5.
Sunless days, 5.	Maximum barometer, 30.243 on 31st.
Maximum temperature, 58 on 6th and 31st.	Minimum barometer, 28.603 on 20th.
	L. B. BIRKETT.

Notices to Correspondents

T. E. (Bath).—*Introducing Queen to Nucleus*.—It is not absolutely necessary, but advisable to cage the queen for twelve hours.

G. G. (Honiton).—*Duplicate Eggs in One Cell*.—(1) It is unusual but not uncommon. Often caused by a too prolific queen in a weak stock. The bees do not distribute the eggs, but eat them. (2) Do not remove the stored combs, but bruise the cappings of the cells near the brood, so that the bees will feed upon the honey.

NOVICE (Midhurst).—*Elongated Cells*.—The drawn-out cells you saw are odd

- drone ones, which are occasionally made amongst worker brood. Queen-cells always hang mouth downwards, and are about the size of an acorn.
- W. M. (Shepherdswell).—*Early Examinations*.—The words "if the weather is favourable" are the crux of the matter. This year the weather at the end of March was decidedly unfavourable. It is a matter of using discretion, as bees cannot be managed by rule of thumb methods.
- E. P. J. (Caerphilly).—*Cleaning Extracted Combs*.—Put them on the hive, and the bees will clean them.
- G. H. JONES (Llauberis).—*A Beginner's Questions*. (1) You could follow the plan you suggest, and it would work all right. If you carried the bees on your back they would travel safely. If you arrive home late, do not attempt to transfer the bees to a "W.B.C." hive, but leave them until the next day. (2) Bees collect a certain amount of food from early blooming flowers, and they also eat last year's stores. (3) Yes. (4) Buckwheat can be obtained from any corn dealer. It is very like onion seed, only larger. It is used as poultry food, also when ground into flour, a great deal in America and to some extent in this country, for making buckwheat cakes (a dainty which much resembles our pancakes): eaten with maple syrup they are delicious. (5) To make the hive warm. (6) An illustrated article on "How to Make a Solar Wax-Extractor" has been in type for some time, and we are only waiting an opportunity to print the same: we are so full up with matter that it is difficult to fit it in. Many thanks for your appreciative letter, we are receiving scores of similar ones.
- T. A. E. (Dawlish). *Uniting Weak Stocks*.—(1) Yes, it will be best to unite. (2) Capture and destroy one of the queens and cage the other.
- J. BEE (Cardonak).—*Making an Observatory Hive*.—There is a mistake, the hole should be  $2\frac{1}{4}$  inches.
- Suspected Disease.*
- F. V. W. (Norfolk).—(1) The bees are affected with "Isle of Wight" disease. (2) Yes. (3) You can start again immediately on fresh ground. (4) No, we think not.
- BACKWELL (Somerset).—(1) The bees are affected with "Isle of Wight" disease. (2) Are you a subscriber to our JOURNAL? If so it is curious that you address us at Henrietta Street as we vacated our offices there four years ago.
- H. J. D. (Danbury).—Bees were too dry for examination.
- W. H. (Christchurch).—We regret to say that the bees now sent show unmistakable signs of "Isle of Wight" disease.
- H. C. (Baikdon).—Bees and matchbox arrived smashed to pulp through improper packing.
- S. M. (Hindhead).—(1) Bees are badly affected with "Isle of Wight" disease, and should be destroyed at once. (2) They are hybrid Carniolans. (3) Under the circumstances there is no need to trouble; the combs should be burnt, otherwise your plan would work all right.
- H. G. S. (Cardiff) and W. J. B. (Hurstmonceux).—It is "Isle of Wight" disease.
- H. E. (Wolverley).—Bees are too dry for us to state cause of death; to avoid risk it will be well to burn the combs and scorch the hive before using again.
- M. C. C. (Wisbech).—Those now sent are just the opposite, being too wet and decomposed.

---

### Special Prepaid Advertisements.

Two Words One Penny, minimum Sixpence.

Orders for three or more consecutive insertions entitle advertisers to one insertion in "The Beekeepers' Record" free of charge.

Trade advertisements of Bees, Honey, Queens, and Bee goods are not admissible at above rate, but will be inserted at 1d. per word as "Business" Announcements, immediately under the Private Advertisements. Advertisements of Hive-manufacturers can only be inserted at a minimum charge of 3s. per  $\frac{1}{2}$  in., or 5s. per inch.

---

### PRIVATE ADVERTISEMENTS.

**LIGHT HONEY**, 14lb., 31lb., 33lb. tins, 7d. per lb.; also two new hives.—HASTINGS, Welcombe, Stratford-on-Avon. v 84

**HEALTHY MAY SWARMS**, natural, 15s.—FRED IBBITT, Pleasant Cottage, Tempsford, Sandy. v 85

**TWO** very strong stocks, nine frames, healthy, complete, packed, 35s.—CHARLES DRAKE, Cleveland House Apiary, Chatteris. v 85

**PURE LINCOLNSHIRE HONEY**, in 28lb. tins, 7d. lb.; sample, 3d.—WAIN, Thorpe Bank, Wainfleet. v 65

**GRAND** healthy stock, 1913 queen, ten frames, W.B.C. pattern hive, 30s.—ANDERSON, 11, Church-place, Amman. v 66

**SWARMING SEASON**.—Healthy May swarms, 15s.; 8-frame colonies, 24s.; book now.—BOWEN, Cotswold Apiarist, Cheltenham. v 82

**FOR SALE**, 1 cwt. good quality honey, in 28lb. tins, price 8d. per lb., delivered on rail.—W. P. J., Cornish Hall End, Braintree. v 78

**TWO** stocks of bees for sale, guaranteed healthy, 21s. each; box to be returned; enclose stamp.—HANSON, 24, Triangle, Ilkeston. v 80

**SWARMS**, from bar framed hives, during May and June 15s., cash with order.—J. REAVELEY, Starbeck, Harrogate. v 78

**SWARMS** for sale, 1913 queens; four new W.B.C. hives, 14s. 6d.—BOWDEN, Broomhill, Witley, Surrey. v 75



---

 REVIEW.
 

---

*L'Ape e la sua coltivazione*, by A. De'Rauschenfels (Milan: Ulrico Hoepli, price 8.50 lire. = 7s.).—This is a second edition of this manual by the late editor of *L'Apicoltore*, revised by the present editor of that paper, Signor V. Asprea. The volume before us has been considerably enlarged, and has now 463 pages 9½ in. by 6½ in. It also contains 116 figures and sixteen portraits, instead of the sixty-six figures in the former edition. The natural history has been ably treated and the illustrations from Cheshire's "Bees and Bee-keeping," add to the interest of this chapter. It is a pity, however, that the old figure showing the wax scales has not been discarded for one showing these scales in their correct positions. The practical part of the work is quite up to date, and we congratulate the editor in bringing out such a useful book, and can recommend it to those of our readers who know the Italian language.

---



---

 TO OUR READERS.
 

---

We would like to call the attention of readers to the fact that the work at the Experimental and Educational Apiary of the British Bee-keepers' Association commences on May 8th. All those desirous of attending these lectures (for which free tickets of admission are given to the Gardens) should apply at once to the Secretary. Members of Associations affiliated to the B.B.K.A. should bear in mind that they can obtain tickets of admission to the Zoological Gardens at half-price (6d. each) upon forwarding an application and the cash for the number required, to the Secretary B.B.K.A.

We would also direct the attention of exhibitors to the generous offer made by Colonel F. H. Jolly of an extra prize in the W. Broughton Carr Memorial Competition, at the Royal Show, Shrewsbury, June 30th to July 4th.

---

 LEICESTERSHIRE B.K.A.
 

---

 ANNUAL MEETING.
 

---

The annual meeting of the Leicestershire and Rutland Bee-keepers' Association was held at the Higheross Coffee House on April 4th, Mr. H. M. Riley presiding over a good attendance.

On the proposition of Mr. Spencer, seconded by Mr. Earp, the annual report and balance-sheet were adopted. The Rev. H. J. Anderson proposed, and Mr. Meadows seconded, a vote of thanks to the retiring officers, which was heartily accorded.

Lady Levy was re-elected President for

the ensuing year, and the Vice-Presidents were also re-elected. Mr. W. K. Bedingfield was elected Chairman, Mr. E. J. Underwood Vice-Chairman and Auditor, Mr. H. M. Riley Treasurer, and Mr. J. Waterfield Secretary.

A resolution was passed urging upon the Government the necessity of proceeding with the Bee Diseases Bill at the earliest possible date. Tea was then taken, after which the annual prize drawings took place, and Mr. G. Hayes, of Nottingham, gave a lecture on "Honey, its Granulation and Density."—J. WATERFIELD, Hon. Sec.

---

 LINCOLNSHIRE B.K.A.
 

---

The annual meeting of the Lincolnshire Bee-keepers' Association was held at Boston, on March 27th, Ald. J. Eley (Deputy Mayor) presiding.

Captain J. H. Hadfield, Hon. Secretary, submitted the twenty-fourth annual report and financial statement. The total receipts, including last year's balance, amounted to £203 3s. 3d., and the expenditure to £166 17s. 2d., leaving a balance of £36 6s. 1d. On the whole, 1913 was a favourable year for bee-keepers, and some excellent honey was gathered, for which there was a ready sale.

The report was adopted. On the proposition of Mr. J. G. Robinson (Sibsey), seconded by Mr. T. R. Catchpole (Stickford), the following officers were re-elected: Hon. Treasurer, Mr. H. C. Bentley, Louth; Hon. Auditor, Mr. G. Booth Walker, Wainfleet; Hon. Librarian, the Rev. C. H. Murray, Partney; Hon. Secretary, Captain J. H. Hadfield; Committee, Dr. Carline (Chairman), Dr. Percy Sharp (Vice-Chairman), Messrs. C. Laywood, A. K. Maples, S. Maudson Grant, W. J. Mouncey, and C. H. Marshall, with the addition of Mr. Roper, Thorpe-on-the-Hill. Mr. D. Seamer (Grimsby) was elected the delegate to the London meetings of the British Bee-keepers' Association. It was decided that the next annual meeting be held at Alford.

Discussion took place on the dropping of the Diseases of Bees Bill in the recent session.

On the proposition of Mr. W. Ion (Healing), seconded by Mr. F. W. Frusber (Crowland), a resolution was passed regretting the dropping of the Bill, and urging that every endeavour should be made to obtain the re-introduction of the measure in the present session of Parliament, and the hon. secretary was requested to send the resolution to the Board of Agriculture and Fisheries.

Medals awarded by the Association were presented to Messrs. T. W. Swabey, W. Patchett, C. H. Marshall, and D. Seamer.

The meeting was followed by a lantern lecture on "A Year's Work in the Apiary," delivered by Mr. W. Herrod.



THE GROWTH OF THE BROOD NEST AND BUILDING UP STOCKS.

(Continued from page 166.)

When manipulating, the bee-keeper should make a practice of always placing bad combs so that they are the outermost ones in the brood chamber—by bad combs I mean those which have small cells through being old, pollen-clogged ones, as Fig. 2, where all the breeding cells are filled with pollen, those which are twisted or contain an excessive amount of drone comb, or which are, from any cause whatever, not desirable. During the winter and early part of the year these are emptied of food by the bees,

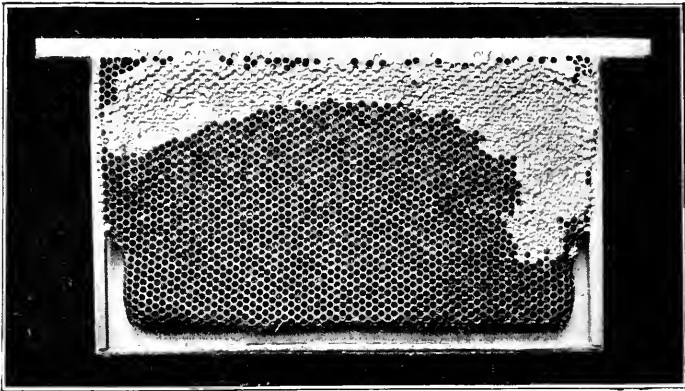

FIG. 2.

so that, when closing up with the division board, these combs are taken out. I would here give a word of warning: never keep useless combs on hand, either when removed as stated above or in the case of a colony which has died out through any cause other than disease, when, of course, they should be burnt. Break them up *at once*, so that the temptation to use them again at a busy period of the year is removed. If these combs containing dried pollen are used, a great deal of labour

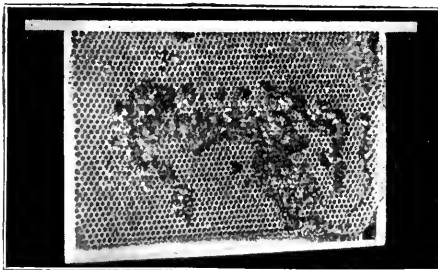

FIG. 3.

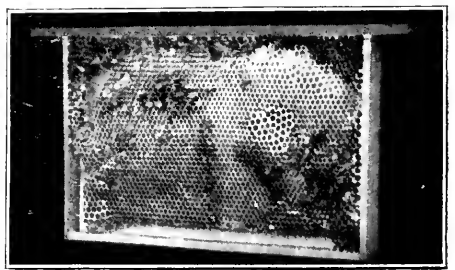

FIG. 4.

is put upon the bees. They will certainly clear them, as shown in Fig. 3, but their time would be more profitably spent in brood-rearing; not only so, but they often build drone comb in the torn down portion, as is shown at Fig. 4, which is an actual photograph of Fig. 3 after it had been in the hive. It is much better to give full sheets of foundation than combs, as the bees build them out quickly, and the

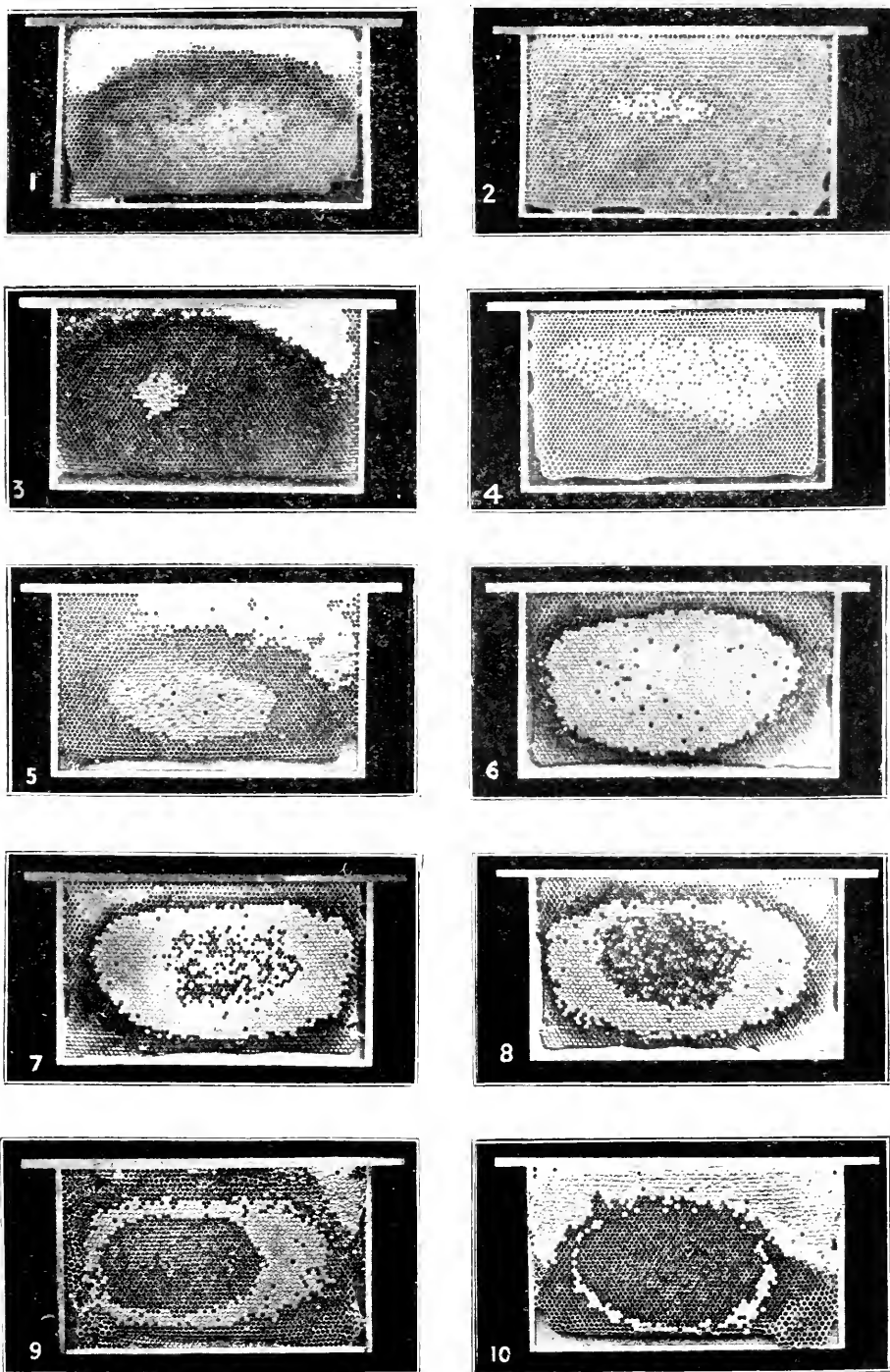

FIG. 6 (See page 174.)

queen prefers to lay in new comb rather than old. At least two full sheets of foundation should be given to each stock every season after the second year.

The first work then is, as shown at Fig. 5 (page 174) to close the bees on to the number of combs they cover (in this case, five); if there is a shortage of food, it will

be necessary to feed slowly; if, as at No. 1, Fig. 6, there is an abundance of food and plenty of room for the queen to lay, it is only a matter of wrapping down warmly and giving more combs as required. The brood nest can be enlarged more rapidly by a little judicious manipulation. The work I am now going to describe *should only be done when those combs in the hive are absolutely crowded with*

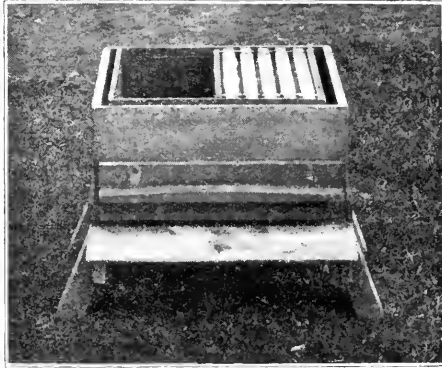

FIG. 5.

*bees*, or a great deal of harm will result. An examination may reveal the fact that, instead of the brood being in the centre of the combs, as Nos. 1 and 2, Fig. 6, it is at the end of each of the three central ones, as No. 3; if so, the centre comb should be reversed, so that a portion of the brood is removed to the other side of the hive, when the queen will pass backwards and forwards in the cluster of bees, which has now been enlarged by their spreading to keep the brood warm, and will deposit eggs as she goes, so that the combs are filled, as at No. 4. Then from time to time, under the conditions given in italics, a new comb or sheet of foundation is placed in the centre until the stock is brought up to full strength, *but on no account should more than one comb be given at a time.*

The careful observer will notice that the brood patches in the combs extend in circles, *i.e.*, as the cluster of bees expands and they are capable of brooding over more eggs and larvæ, the queen deposits eggs at the outer edge of the patch. The illustrations (Fig. 6) show this very clearly—No. 1, the first brood patch with the larva unsealed; Nos. 2 and 3, the oldest larva in the centre sealed over; No. 4, the patch extended, showing the growth of the larva outside the sealed area; No. 5, more of the centre sealed over; No. 6, a large patch sealed over; at No. 7 the bees have commenced to emerge from the centre, while, in No. 8, the centre is nearly clear and eggs laid again in many of the cells; in No. 9, the larva can be seen in the centre, the cells containing eggs and at the outside sealed brood; in No. 10, nearly all the bees have emerged; the repetition of the circle is shown in Fig. 7. Nos. 11, 12 and 13, while at No. 14 is seen an excellent specimen of the circles; No. 15 is a photograph taken against very strong sunlight to show how the bees arrange the food supply, honey at the top of the combs, in a semi-circle; between food and brood the dark cells show the situation of the pollen. If, when feeding for building up, there is a shortage of pollen, a substitute should be provided by placing very fine pea flour on shavings or chopped hay in a box outside, but sheltered from the wet. No. 16 shows the brood patch restricted by too much food in the combs. In such a case the bees can be stimulated and the patch increased by bruising the cappings covering the food with the thumb nail for about  $\frac{3}{4}$  in. all round the brood; this induces the bees to take the food and feed the queen more liberally, so that she lays eggs in the room provided by the bees emptying the cells. The practice followed by some of bruising the food cappings at the top of the comb is useless; stimulating the bees under these conditions is of no avail, unless, at the same time, room is provided for the queen to lay. No. 17 shows an ideal brood patch, which can be obtained on eight combs out of ten if the above details are carefully followed; such patches mean the issuing of thousands of workers at the right time to take advantage of the honey harvest.



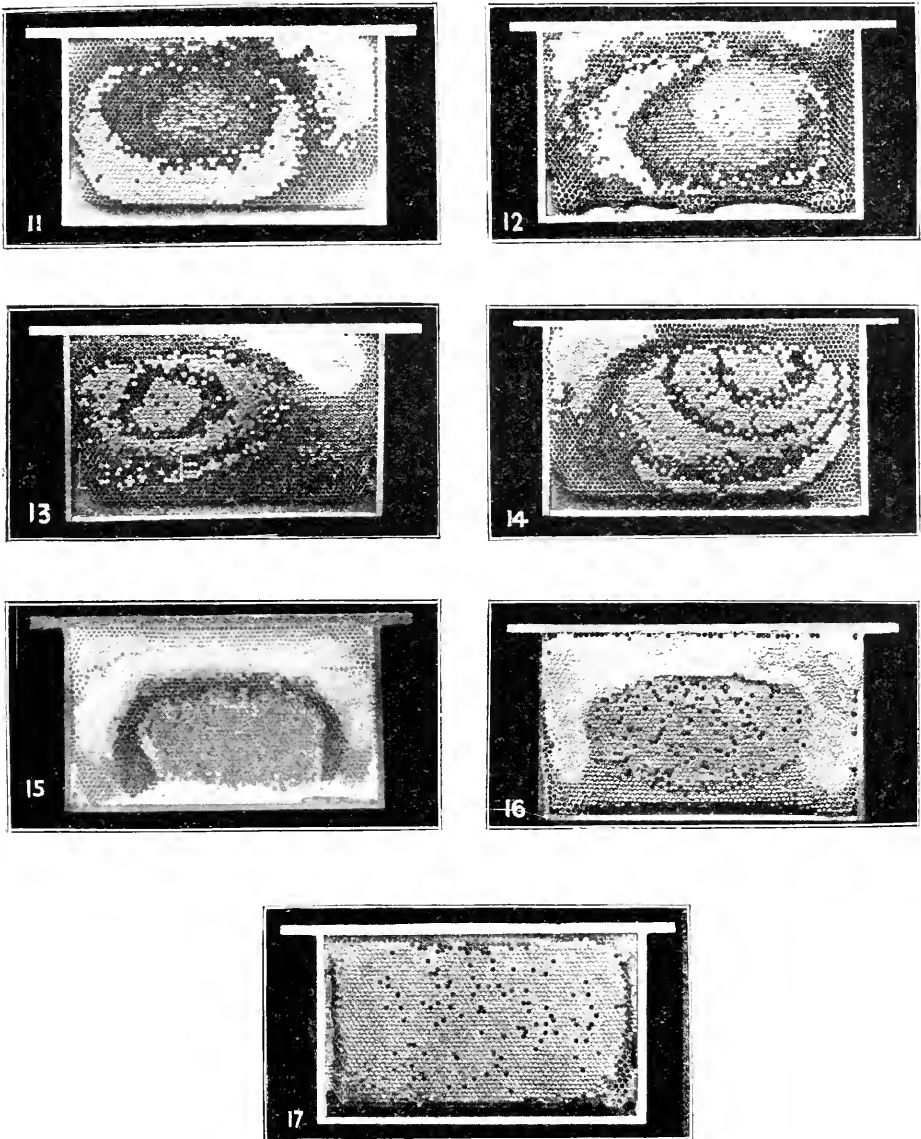

FIG. 7.

**BLURTS FROM A SCRATCHY PEN.**

CONTINENTAL WANDERINGS.

(Continued from p. 158.)

Even if we had the proverbial "bee in bonnet," it follows not that we possessed the abnormal energy of that youth who carried

The banner with the strange device "Excelsior."

for which reason five persons mounting seven stages by means of 140 steps found some difficulty. When we came in view of the blue sky we had but little breath, and yet the climb was worthy of the trouble. We had the view of the seven hills around

us. But let that rest—we came to see the bees. The first thing that struck us was the completeness of such an apiary right up in the skies. Here were carpenter's shop, extracting house, and about seventy hives all arranged methodically and systematically—a model, in fact. You will not be able to gather much from the pictures with this article as to its completeness. Space in our JOURNAL is limited, but in the rear of the hives, where you see "a consultation," there are these edifices. Looking at this illustration and at the first, which shows the proprietor himself, you will notice the

difference in shape of the hives to those of our pattern. In Italy, the majority use frames  $27 \times 46$  c/m, say  $9\frac{1}{2}$  in.  $\times$  18 in. It was the month of August, and at that time at home beekeepers are looking to the conclusion of the season, but here were the immense frames crammed from top to bottom with brood, and the bees hanging out at the entrance of the hive. Naturally, we needs must have a peep inside. As all the world knows, Italian bees are well known for their gentle disposition, a whiff of smoke from a cigarette, in this case, being sufficient to subdue them. Old toughs, as perhaps two of the party may be called, might be excused for the foolhardiness of not using veils, but it was astonishing to the natives when Mrs. Herrod, too, discarded the superfluity. Of course being

We were much obliged to the Cavaliere Constantini for his extreme courtesy, and welcome. He is very entertaining, quite at home with "bee chat" all over the world. Many leaders in our craft from countries far away have mounted those cruel stairs to visit the "roof apiary," martyrs to science, and it is one of the things that puzzles me how he has the energy to ascend and descend all the appliances necessary, and the produce which such a large bee-farm necessitates.

We had arranged, in our scamper through Europe, to include Naples, so from Rome we took an early morning train, and now we saw the Blue Mediterranean in all its glory, in all its brightness. What wonder the ancients romanced the history of their deities, of their loves, their hatreds, and their lives round these

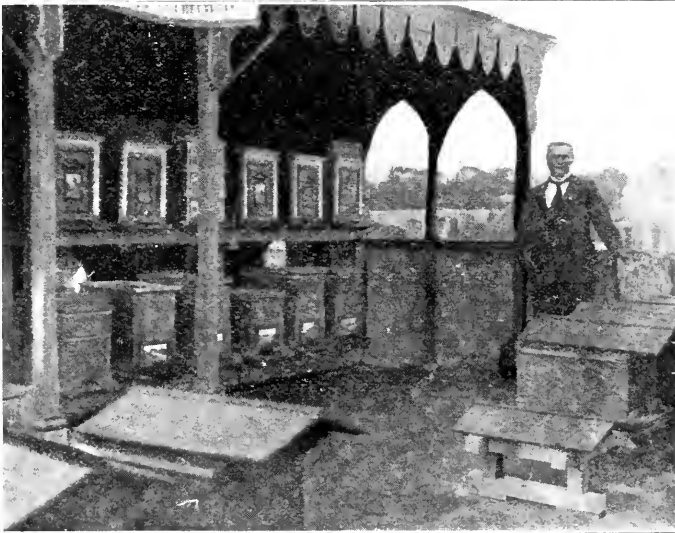

THE PROPRIETOR.

their native vice, swarms are frequent, and their aspirations are not so exalted as their owner, for they have a habit of seeking after things of earth, earthly. They frequently descend into the gardens of an old monastery, which lies below, a possible excuse being that there is nothing above them, unless peradventure they visited the planet Mars. Disease is practically unknown. In years gone by one hive was afflicted with foul brood, *la loque*, this happening to be an importation from a foreign apiary. It was promptly stamped out with fire and brimstone. This apiary pays well; the Cavaliere sends nuclei and queens to many parts, and he has a market at hand for all the honey gathered. He supplies all the hotels with it. Such honey as we tasted was full in flavour and aromatic, but it had a slightly astringent taste, which the tonsils feel. Its colour is rather a deeper olive-brown than is our honey.

soft seas, where the storm never seems to blow in anger.—JNO. SMALLWOOD.

(To be continued.)

## CORRESPONDENCE

The Editors do not hold themselves responsible for the opinions expressed by correspondents. No notice will be taken of anonymous communications, and correspondents are requested to write on one side of the paper only and give their real names and addresses, not necessarily for publication, but as a guarantee of good faith. Illustrations should be drawn on separate pieces of paper. We do not undertake to return rejected communications.

### THE BEE DISEASES BILL.

[9010] So much has been said in your pages, both pro and con, ament the Bee Diseases Bill that I anticipated complete

harmony amongst bee-keepers, both *large* and small, long before this, but the gods decree otherwise, and the latest information from the Secretary of the Board of Agriculture is about the last Parliamentary straw to be laid on the backs of the long-suffering bee-keeper. I understand from the bee-keepers' column in a local newspaper, the Bill is not to be introduced during the next session *because of opposition from large bee-keepers*. Did one ever hear of such legislation? Up to the moment of reading this "latest information." I was under the impression that the Bill, as published, was

rule, and yet the Bill, we learn, is blocked by the *big* bee-keepers.

I cannot imagine *any unselfish* or *unprejudiced* bee-keeper offering opposition to the Bill. Time after time I see in operation means of spreading disease wholesale, and am powerless to prevent it.

I will give two common, everyday examples where an Act would not only be a safeguard but a blessing. For the first I will take the case of a workingman who saves his hard-earned cash and invests it in bees; then by some other person's carelessness disease is introduced: the hard-



BEEES ON A HOUSE-TOP. IN CONSULTATION.

intended for the benefit of *all* bee-keepers, both *small* as well as large, but alas! I was evidently labouring under a delusion. It appears that *might*, which ages ago was always *right*, is again to assert itself, and legislation on matters apicultural, at any rate, is only to be on the side of the great and mighty in future. I wonder if Mr. Lloyd George heard the learned and Right Hon. President of the Board of Agriculture giving this information for bee-keepers!

I am glad to know that in spite of disease on every side we still have *large* bee-keepers among us, but taking the number of bee-keepers throughout the area the Bill would cover, I suppose that *small* bee-keepers are in the majority in the proportion of something near 1000 to one! In these democratic days one would very naturally expect majority to

working bee-man is quickly and practically ruined through no fault of his own, and there is no power to prevent it.

Again, if a person has an enemy and owes him a grudge and punches him on the nose there is two months' imprisonment staring him in the face; or if the person steals from his enemy there is a possibility of penal servitude ever before him, but under present conditions, if the enemy happens to be a bee-keeper there is a *legitimate*, safe, and sure way of wreaking a terrible vengeance. The person, if he happens to be a near relative of Ananias, obtains for "scientific purposes" a stock suffering from "Isle of Wight" disease, places it near his enemy's apiary, then retires to "wait and see." Surely and *legitimately* comes extermination and revenge!

Such imaginary instances would never, under an Act, become real or possible.

Only a few days ago I was at a public auction where a number of empty hives, supers filled with drawn-out combs, section-racks, and other bee-paraphernalia, brought straight from an apiary where the bees had died from "Isle of Wight" disease, were offered for sale. The bee-keepers there got to know where the articles came from and kept clear, but a general dealer bought the lot and goodness only knows where the things will ultimately get to, and what will be the result.

This is only one of many cases where the dread disease is being scattered north, south, east and west by careless and unscrupulous persons, while the small bee-keepers can only look on and sigh.

Much time, labour and money is being expended by our best and most unselfish scientists and bee-keepers in trying to eradicate the terrible scourge, but to what purpose so long as cases like the one quoted above are occurring without let or hindrance. Scores of *small* bee-keepers have had their apiaries wiped out, and a means of augmenting their small incomes gone, simply and solely through such conduct on the part of others.

Now what would small farmers do if any number of them were allowed to traffic in material which had been in contact with such highly contagious diseases as anthrax, foot-and-mouth disease, &c.? Picture for a moment the result. Agriculture would soon be where apiculture now is: on the highway to total destruction. Supposing there was no legislation to deal with the diseases of animals and the *small* farmers were losing their stock and being ruined, but all the while crying for Parliamentary protection, and after several attempts to get their Bill before the House were told by the President of the Board of Agriculture that they could not be considered for some time, as the big farmers, who, up to then, had escaped disease, were against the Bill. How ridiculously absurd the whole procedure would become! The same reasoning applies to apiculture. How ridiculous (and selfish) is the position of opponents to the present Bill. I sometimes think that a lot of opposition is "party politics"; a great many oppose the Bill, not because it is a Bill, but because of feeling between them and the promoters of it—the B.B.K.A. It seems a pity that such a spirit should ever enter the hearts of bee-men, but I suppose there always has been, and always will be, in all large bodies, a few of the never-have-been-and-never-want-to-be-satisfied type.

I firmly believe that most of the opponents to the present Bill have not the slightest knowledge how the various orders

of the Board of Agriculture are executed. The orders are worked through the different local authorities as smoothly as it is possible to imagine. Though the powers of the inspectors are surprisingly great during my years of experience in carrying out the orders of the Board of Agriculture relating to the contagious diseases of animals, I have not met with a single case of obstruction. Agriculturists are always ready to give all the information and render what assistance they can.

The opponents of the Bee Bill, who say it is harsh, and imposes too stringent regulations on apiculture, ought to read some of the orders of the Board of Agriculture relating to cattle, which look terribly formidable owing to the legal phraseology, and then see those orders executed, they would, I am sure, change their opinions and support the Bee Bill.

I am afraid I shall take up too much of your valuable space by writing more, but more on behalf of the *small* bee-keepers remains to be said and done to secure for them that protection they sorely need, and which only the law can give.—JESSE JOHNSON, Stafford.

## BANATS.

### THE FRUIT GROWERS' BEE.

[9011] I thank Mr. H. E. Scrope Viner for his reply to my letter (page 153), as I was anxious to learn a little more about Banat bees, my own experience of them being so disappointing.

I admit that under certain conditions they are fairly easy to handle, but I have found them somewhat treacherous, particularly in damp weather, when, although clustered beautifully on a comb, under examination they will rise in a cloud in an instant without any apparent cause, and on two occasions I have known at least three-fourths of the stock to take wing.

They may be a satisfactory investment in a suitable district, but after giving them a very careful trial I am convinced they are not sufficiently hardy for the erratic climate of this country. North Cumbrian fruit growers cannot credit them with any advantage over the home article, as, although they breed very quickly in the spring, the bulk of the blossom is past before the weather is warm enough for them to venture forth. On Saturday last the weather was beautiful, fruit blossom was in abundance, but for every Banat leaving the hive on nectar bent I could see five Blacks issue from the next stock, although the Banat stock is much the stronger.

Ventilation of all descriptions has been tried, yet, in the middle of last year's honey flow, when every available Black

bee in the apiary was afield, I found the Banats idly hanging like a swarm from the alighting board, with barely a handful of bees in the section rack, although the ventilation was almost "open-air treatment."

I accept Mr. Viner's assurance regarding their creditable defence of stores, as mine have never gathered any stores to defend; but sometimes when I am working amongst them, they do not disguise their desire to reduce the membership of the C. and W.B.K.A., and one of my friends declares they know the click of his garden gate and come down the path to meet him.

In a suitable temperature they may keep other bees from entering their hives, but under a sudden cold snap in autumn I feel they would stand little chance of holding their own against their Black neighbours. I do not remember ever seeing a Black bee in a stock of Banats, which is doubtless due to the warlike spirit Mr. Viner mentions, but when packing up last autumn there was any quantity of Banat bees in each of the nine hives in my Scotch apiary.

I do not wish to unduly condemn Banats. By all means let South-country men retain them if they can do so profitably. They are pretty little insects, and I should have liked to see them a success, but I think Border bee-keepers will be well advised to leave them alone.—JOHN STEEL, Carlisle.

#### SKEPS AND "I.O.W." DISEASE.

[9012] As the writer of "Cappings of Comb" (page 139) refers to the merits of skeps, and asks for the experience of other bee-keepers, it may be interesting to mention that I have seen skeps and boxes of bees that have stood for a season or two close to hives that have suffered from "Isle of Wight" disease and have apparently not contracted it. The former are still doing well. Again, I saw skeps in a similar position three years ago which eventually died of "Isle of Wight" disease. Although the skep is often condemned ignominiously, largely because the honey taken is not in the best marketable form, it will be surprising to many to know that in the hands of a skilled bee-keeper over 90lbs. of surplus honey has been taken from one skep.

I would also like to refer to my experience with Italian and hybrid Italian bees situated in close contiguity to bees which have succumbed to *Nosema apis*, or "Isle of Wight" disease. Some Italian stocks which have been surrounded by disease for two or three years have shown no signs of infection. The hybrids, too, have stood the test well in the same district. In another district I saw a

hybrid stock standing a very short distance from a stock that died. The former was free for two years, but now is in the "crawling" stage. Referring to the various so-called remedies, I do not think from experience I can say we have a definite cure for "Isle of Wight" disease. Much can be done in the way of prophylactic treatment and changing bees to new combs and hives properly disinfected. I am inclined to think that if the queen and young bees only are put on to fresh combs we have a remedy for a considerable period. I have tried this method by moving the infected stock to a fresh position, to let the flying bees return to a hive prepared for temporary use. The queen and young bees left on the combs, after slightly shaking them, were transferred into a new hive, with healthy combs or foundation, and were fed with medicated syrup and the combs sprayed with Izal solution. The hive was then isolated for a time, and the old combs and fittings with bees were destroyed. The new stock made as related apparently recovered.—A. W. SALMON, East Finchley.

#### EARLY SWARMS.

Just a line to let you know that I had a 4lb. swarm on Sunday, April 19th, which is very early in this district.—J.S.O. BERRY, Llanrwst, North Wales.

It may interest your readers to hear that a swarm sent to a gentleman last June gave a good surplus, and has already sent off a strong swarm (April 18th). The owner resides in a district where the "Isle of Wight" scourge has wiped out most of the bees.—DAVID HANCOX, Oxon.



[8923] *Moving Bees.* I am starting bee-keeping this season, and shall be much obliged if you will give me your opinion on the following:—(1) I shall have the bees (one stock) early in May, but shall probably be moving from my present house in June. Is it possible to move the bees to a garden within a mile of my present one? I have heard that you cannot do this, as bees will return to their old haunts. (2) Is there a branch of the B.B.K.A. anywhere in this neighbourhood?—F. W., Leigh-on-Sea.

REPLY.—(1) Although bees fly two miles in search of food, we do not think you would lose many if you moved them a mile. Another plan would be to take them to some friend's garden more than

two miles away, let them stay there for a week, then move them to your new garden. The bees would then locate their new position. (2) The Secretary of the Essex Bee-keepers' Association is Mr. G. R. Alder, 176, Hainault Road, Leytonstone.

[824] *Preventing Drone Comb Building.* Last season I had an abnormal quantity of drone-cells built on worker foundation brood frames. Do you think I could prevent a repetition of this by close spacing frames for a few days, then altering same to usual spaces?—G. A. HALL.

REPLY.—Yes, you can stop the bees building drone-comb in the way you suggest.

## Notices to Correspondents

A lady correspondent living at Harefield, Hants, requires a capable bee-keeper to attend to her two hives. If any reader living in that district would like to communicate with her we shall be pleased to forward letters. Address "M. F." care of "B.B.J." Office.

H. CROWTHER (Berks).—*Cleaning Metal Appliances.*—Wash them with Fels-naphtha soap first, and afterwards in a 10 per cent. solution of Formaldehyde.

BEE LOVER (Teignmouth).—*Strange Behaviour of Bees.*—We are afraid the excitement was caused by the carbolic acid solution being too strong, or it may be that the bees are queenless.

W. B. (Shrewsbury).—*Wild Bees.*—The Bees are a species known as *Andrena fulva*.

C. S. KUSEL.—*Drone-breeding Queen.*—The queen is about three years old, and has evidently lost her fertility.

W. T. FIELD (Baildon).—*Badly-packed Sample.*—With much trouble we have managed to wash your letter sufficiently to be able to read it. If you will not take a little trouble to pack honey securely (not in a cardboard box) you must not blame us for our inability to help you. The parcel arrived in a disgusting mess.

### *Suspected Disease.*

G. J. L. (Ross).—It is foul brood of long standing.

DOVEDALE (Derbyshire) and F. (Hagley).—Bees have died of "Isle of Wight" disease.

E. A. COTTAGE and G. H. (Colchester).—The bees were too dry for us to diagnose the cause of death.

F. D. WESTON.—(1) There is no disease in bees sent. (2) You can do nothing more.

J. R. TAYLOR.—The bees are hybrid Ligurians, and have died of "Isle of Wight" disease.

## Special Prepaid Advertisements.

Two Words One Penny, minimum Sixpence. Orders for three or more consecutive insertions entitle advertisers to one insertion in "The Beekeepers' Record" free of charge.

Trade advertisements of Bees, Honey, Queens, and Bee goods are not admissible at above rate, but will be inserted at 1d. per word as "Business" Announcements, immediately under the Private Advertisements. Advertisements of Hive-manufacturers can only be inserted at a minimum charge of 3s. per lin., or 5s. per inch.

### PRIVATE ADVERTISEMENTS.

ITALIANS, strong 10-frame stocks, 1913 queens, guaranteed healthy, package free, 25s. each.—OLIVER KNIGHT, 4Pney, Stonehouse, Glos. v 12

TWO Lee's Coronation hives, new; 500 2-way plain sections; a quantity of secondhand section racks, travelling crates, and honey tins; offers or exchange.—J. COOPER, 45, Bunyan-road, Hitchin.

PRIME May swarms, 15s.; strong 8-frame colonies, 24s.—BOWEN, expert, Cheltenham. v 99

A BARGAIN; seven W.B.C. body boxes, 1s. each; one gross metal ends, 6d.; ten shallow boxes, 9d. each; four shallow boxes, with drawn out frames, 2s. od. each; twelve section racks, with metal dividers, 1s. each; eight queen excluders, 3d. each; full particulars, stamped envelope.—J. YOUNGER, 29, Newmarket-road, Cambridge. v 100

FOR SALE, extractor, chain gear, good condition, standard, shallow, or sections, 19s., f.o.r.—W. J. OWERS, Barrington-road, Horsham. v 2

WANTED, one healthy stock of bees, on standard frames, cash.—W. TAYLOR GARDNER, 4, Chilton-road, Richmond, Surrey. v 7

MICROSCOPE, Powell and Lealand, various accessories, and over 100 objects; full particulars on application; price 27 the lot.—H. COPPEARD, 12, King's-avenue, Greenford Park, Middlesex. v 8

TWO stocks of healthy bees, in W.B.C. hives, with all accessories, and three spare W.B.C. hives, accessories, and honey extractor; particulars on application; owner giving up bee-keeping.—Apply, Box A., "B.B.J." Office, 25, Bedford-street, Strand, W.C. v 89

SELL, Thould and Hutchinson portable cesspool pump, with all fittings, used once only, cost £3 10s.; offers.—"PUMP," "B.B.J." Office, 25, Bedford-street, Strand, London, W.C.

BLACK net manipulating screen, 40ft. long, canvas bottom taped hooks top edge, only used twice, £1; foundation mills, two brood, 9in. and 10in; super, 6in, ditto, flat bottom, brass rollers, 10in; thicknessing mill, 10in; drone mill, 6in; the lot, all usable, £3.10; copper water jacketed melting tank, 14in. by 11in. by 11in, £2; weight and scales, copper pan, 11in. by 12in, P.O. pattern, 7s. 6d., 1lb. missing; 150 "Bee Journal," 1912-13-14; "Poultry," 32 copies, 1913; what offers?—Box XX., "B.B.J." Office, 25, Bedford-street, Strand, London, W.C.

WANTED, natural swarms, guaranteed healthy, goldens preferred.—WIGGINS, 1, Swindorby-road, Wembley. v 6

TYPEWRITER, No. 4, Smith Premier, double keyboard, last a lifetime, perfect, 80/-, bargain; others, all makes, from 40s.; on approval. Illustrated lists free.—WAKEFIELD and CO., Newhall Hill, Birmingham. v 94

TYPEWRITER, No. 8, Remington, brief carriage, clear writing, very reliable, perfect, cost £25, sell 80/-. Approval; great bargain.—WAKEFIELD, Newhall Hill, Birmingham. v 95

WANTED, three or four frames healthy Carnolians or Banats, 1913 Queen; state price.—ASHKETTLE, Whittington College, Highgate, London. v 5

FOR SALE, swarms from bar frame hives, until May 20th, 17/6; after, 15/- each; second swarms, 10/-; guaranteed healthy.—J. W. WILKIN, Pymoor, Ely, Cambs. v 4

EARLY swarms wanted.—Price per lb., delivered, to Mr. H. TILLEY, Bee Farm, Dorchester. v 3

# Editorial

## REVIEWS.

*Jahrbuch über die Faulbrutversicherung des Vereins schweitzer Bienenfreunde pro 1913*, by Fr. Leuenberger, Bern.—This is the report for 1913 respecting the work carried on against foul brood, and shows the value of inspectors, and the advantages that have resulted from legislation. The number of compulsorily insured members of the Association has risen by 343, and is now 9083. The number of colonies insured has increased by 7121 during the year, and is now 122,327. It is satisfactory to read that the number of cases of foul brood has diminished. There were 114 in 1912, and only 92 last year. Compensation paid only amounted to 2080.25 francs, the lowest since compulsory inspection was instituted. In six cantons foul brood has been entirely exterminated, and there was not a single case last year. In canton Lucern it has been reduced to 2 per cent., Appenzell 2.5 per cent., Unterwalden 3 per cent., and Valais 10 per cent. Altogether the average for all the cantons is 0.8 per cent., a very fine result indeed, and strong evidence of what can be done under compulsory powers. Valais still shows the largest percentage of cases, and this is accounted for by the fact that foul brood had for years become endemic in that canton, owing to no measures having been taken to combat it. The 92 apiaries in which foul brood was found in 1913 had 154 (18 per cent.) of the stocks affected. Of these 110 were destroyed, and 44 cured by the artificial swarming method.

In diagnosing the disease Dr. Burri, with his assistant, Dr. Morgenthaler, found 23 cases of dead brood free from bacteria, 14 cases of strong-smelling foul brood (*B. alvei*), mostly associated with sour brood (*Streptococcus apis*), and 33 cases of odourless foul brood (*B. Burri*). There has been no call on the Government for financial help, as the insurance of 5 centimes per colony has not only been amply sufficient to pay all expenses, including compensation, but has left a balance to the good of 3169.35 francs. We can only congratulate the Swiss bee-keepers on what the Association, under the management of M. Fr. Leuenberger, had been able to accomplish with the powers which legislation has given them. What a contrast this is to what is happening in this country, when a few clamant bee-keepers are able to hinder legislation which would benefit thousands of those engaged in the industry, and by their opposition are promoting the spread of disease in the country.

*Langstroth on the Hive and Honey Bee*, 1853 (Published by the A. I. Root Co., Medina, Ohio, price \$1).—This is a reprint of the famous old original edition of this book, which appeared in 1853. It has a preface by C. P. Dadant, otherwise it is a reproduction in paper and binding, with all the original illustrations just as it appeared in 1853. There are not many old books worth reproducing, but we are quite sure that anyone who obtains this work will be delighted with it. It is charmingly written, and more like a story than a manual, although the practical side is always kept in view. To Langstroth we owe the practical movable comb hive, and his hive is still extensively used. His accuracy of observation is noticeable in this book, and the reader will be surprised to find that he had already mentioned many things that are brought out now as new ideas. We are pleased to recommend the work, and certainly think that no bee library should be without it.



## INTERESTING AND USEFUL FACTS.

1. For cleaning up any articles that are daubed with wax, use a cloth saturated with benzine. Benzine will dissolve wax much as water will dissolve sugar.
2. Sulphuric acid will cleanse or clarify beeswax that is brown or nearly black, bringing it back to the nice bright yellow generally seen in foundation.
3. Wherever salt keeps well there comb-honey may be best preserved from deterioration. Wrapped up in waxed paper and sealed in a tin case it keeps well for a full year.
4. Nine times out of ten a robbing boom is caused by gross carelessness on the part of the apiarist, and its inception in the tenth case is easily preventable.
5. If you must catch a queen by the legs do so gently, but it is better to seize her by the wings, and best of all to catch her by the thorax. Never seize her by the abdomen.
6. In after dequeening a colony to start queen-cells, the best time to break it up into nuclei is ten days after the withdrawal of the queen, because all cells are then sealed.
7. In looking for eggs, turn your back to sun or brightest light, raise comb about height of chin, thus throwing the rays into the cells at an angle of about 45deg.
8. A correct bee-space is represented

by a scant quarter of an inch; any addition to this will mean brace or burr combs, and other nuisances in the hive.

9. When a hive has lost its mother bee and failed to provide her with a fully fertilised successor, that colony is doomed to extinction, unless man aids.

10. Dr. Millar lately stated, "I don't believe I ever gained by stimulative feeding (in spring), and I am sure I have lost by spreading the brood."

11. Young queens will stand a journey through the mails much better than older ones. In other words, a queen who has just begun to lay travels better than one six weeks or over.

12. Have you ever observed that exposed honey just off the hives will attract robbers much sooner than that which has lost the hive warmth? The odour is more pronounced.

13. Since acquiring Dr. Phillips' book on "Treatment of Bee Diseases," an extensive bee-keeper says, "I have invested in a gasoline torch and follow the disinfecting direction to the letter."

14. One pound of wax turned into comb can store over 30lbs. of honey, and it is estimated that 1lb. of wax is moulded into forty or fifty thousand worker-cells.

15. I have found queens to lay over 3000 eggs a day. These, I find, weigh 3900 grams, while the queen only weighs .2299 grams. Thus, in twenty-four hours, she may lay well over her own weight of eggs.

16. Levenhoek actually counted 12,000 facets in the eye of a dragon-fly, while some butterflies have over 17,000. There may be as many as 25,000 in a single compound eye.

17. The single copulative act of the drone may convey millions of spermatozoa to the spermatheca of the queen, more than enough to last her all the period of a long life.

18. By inference, we might safely conclude that queens raised in strong colonies would turn out the most prolific, and experience confirms the truth of the surmise.

19. Honeycomb is wonderfully delicate, the wall of a new cell being only about  $\frac{1}{10}$  of an inch in thickness, yet it combines great strength with the least expense of material and room.

20. The base of each cell forms one-third of the base of each of three opposite cells. One side thus braces the other, and adds very much to the carrying strength of the comb.

21. The practice of clipping off a part of the queen's wing is very old. The oldest bee-book advises it in order that swarms may not fly away and be lost to their owner.

22. For about two weeks after the young worker emerges from the cell she is almost

exclusively engaged inside the hive, after which she collects pollen, and later gathers honey.

23. Contrary to what is often stated in bee-books, queenless bees *do* gather pollen, but a truer index is watching how they do it. Queenless bees loiter; queen-right bees are all energy.

24. A dry season is a honey season, yet where there is a long protracted drought flowers forget to secrete nectar, and bees working hard carry in only dribbles.

25. While bees may at times forage three or four miles from home, yet they very seldom do, and it may be a safe guess to say the bulk of the surplus is collected within the one-mile limit.

26. *Bars* were used centuries ago in Greece. Délla Rocca, in a work published in 1790, describes bars as used by him. Schirach used something similar in his hives.

27. Major Munn (England) was really the first to use a full frame in his hives; while he published his book in 1843 he puts it on record that he used frames in 1834.

28. While this is undoubtedly so (honour to whom honour is due), the real inventor of the modern movable frame was the Rev. L. L. Langstroth, "the father of American bee-keeping."

29. One of Langstroth's "axioms" was—"Bees, when frightened by smoke, fill themselves with honey, and lose all disposition to sting, unless they are hurt."

30. Another was—"If your stocks are strong, you will show that you are a *bee-master* as well as a bee-keeper, and may safely calculate on good returns. *Keep your stocks strong.*"

31. Counting the number of facets in the compound eye of a queen bee, Cheshire found 4,920; in that of a worker 6,300 facets; while in the eye of the drone they numbered 13,090.

32. Bees sometimes work by moonlight! Langstroth, page 7, says: "We have known bees to gather honey from the tulip trees on very clear moonlight nights. Australian bees work by moonlight."

33. By having a hive furnished entirely with worker-comb we can so nearly prevent the production of useless drones, that it is safe enough to call it a complete remedy.

34. A single colony, doubling every year, would, in ten years, increase to 1,024 colonies, and in twenty years they might number over 1,000,000! Who says "Bees don't pay!"

35. Novices should not try introducing virgins until they become expert in the business of queen-rearing. Unhatched cells are more easily dealt with and more uniformly successful.





By "Nemo."

*How to Disencumber Bees of Parasites (Braula Caca).—*The following method is given in *Leipziger Bienenzeitung* to rid the bees of parasites which have attached themselves to their backs and live at their expense, and which, owing to their relative large size, must weaken as well as torment them. Purchase a pennyworth of camphor and spread it on a piece of cardboard, which can in the evening be slipped into the hive on the floor-board under the bees. Next morning a number of parasites will be found on the cardboard. In three nights the writer says he found 373 parasites dead. He recommends the camphor to be in good-sized granules so that bees should not be able to remove it.

*The Use of Propolis.*—This substance has not been used as a medicament, but we read in the *Bulletin de la Société d'Apiculture de la Somme* that a German bee-keeper has mentioned a fact which will cause some to be sceptical, but which will be promptly tried by a good many others. He says that he had soft corns which caused him excruciating pain. He had tried all the plasters which were advertised as infallible, but all in vain, and at last tried propolis, which he says completely got rid of the corns. The following is his prescription: Soften the propolis by rolling it between the fingers, then spread it on very thin leather, warm the plaster over the flame of a candle, and apply it to the corn. In from one to two weeks a complete cure is effected.

The same journal says that if one has an abscess there is no better remedy than a plaster of honey. Mix a dessert-spoonful of honey with the yolk of an egg and two spoonfuls of rye flour. Spread this ointment on a piece of linen and apply it to the abscess. The matter is drawn out by degrees and the pain diminishes. It is recommended to renew the plaster every two hours.

*A Cure for Bee Stings.*—Writing in the same journal, M. Léon Tridon says that for ten years he has used a simple and cheap remedy for bee stings, which is perfectly harmless and infallible. He has recommended it to his friends, who, like him, are well satisfied with it. This remedy, which removes pain and swelling, is simply Eau de Javel, or sodium hypochlorite. The sodium of this product, when it comes in contact with an acid,

absorbs the hydrogen of this acid atom for atom, and forms a neutral salt which is consequently harmless. When stung, after having removed the sting, apply the soaked cork from the phial containing the Eau de Javel to the affected part. The effect is immediate, and as a result there is no pain or swelling.

*The late Alexander Schröder.*—Allusion was made in the "B.B.J." for March 12th last to the death of this correspondent, which took place on February 17th last. Most of the papers have also made allusion to it, but one of the best notices appears in *Illustrierte Monatsblätter*, to which paper Mr. Schröder was a regular contributor, and whose last article appeared in the January number of that journal.

Alexander Christian Schröder was born in Trieste on November 21st, 1850. His father when quite young came to Trieste, where in due time he founded a mercantile establishment which at the present time is one of the largest in the city. Mr. Schröder entered his father's business after he had studied in the Lausanne University and undergone a business training in London and Liverpool. When he took over the management of his father's business he further extended it by taking on several large international agencies. Thus he became the representative of the Orient Line, of Hamburg; the P. and O. Company, London; director of the North British Mercantile Company in Trieste; director of the Cunard Line in Trieste, and Consul of the Republic of Venezuela. His love of nature and natural history led him to take an interest in bees and agriculture, and he was for many years a member, and latterly President, of the Agricultural Society in Trieste.

He commenced bee-keeping in 1874 and established an apiary on his property. Here he spent many hours of a very busy life, and had from fifty to sixty colonies, which he up to the last managed entirely himself. He was in correspondence with most of the leading bee-keepers, and was the first to introduce Cyprian bees into Austria. He was a frequent contributor to European bee papers, and being a good linguist was able to keep them well informed of what was going on in the bee-keeping world. He could speak five languages—namely, English, German, French, Italian, and Slavonic. He was fond of travel, and every year undertook a long journey, accompanied by his wife, and in this way he had visited Palestine, Northern Africa, and two years ago made the tour of the world, travelling over India, Japan, the Pacific Ocean, all through America to England, France, and back through Vienna to Trieste. In all lands he took an interest in bees, and

as a result an illustrated article of his on bee-keeping in Japan appeared in the "B.B.J." of Jan. 2nd, 1913, page 5. Another account of his visit to Roman bee-keepers appeared in the "B.B.J." of June 23rd, 1910. Latterly he suffered from diabetes, and last year he had two severe attacks of bronchitis, and although he thought that he had completely recovered and was planning another long journey, his article to the *Illustrierte Monatsblätter*, sent in December, was the last, and in the night previous to his contemplated journey he ruptured a blood-vessel, which caused his death. He was a fine type of man, and bee-keepers throughout the world will mourn his loss.



*The Editors do not hold themselves responsible for the opinions expressed by correspondents. No notice will be taken of anonymous communications, and correspondents are requested to write on one side of the paper only and give their real names and addresses, not necessarily for publication, but as a guarantee of good faith. Illustrations should be drawn on separate pieces of paper. We do not undertake to return rejected communications.*

### BANATS.

#### THE FRUIT GROWERS' BEE.

[9013] After reading Mr. Viner's letter (page 155) I have come to the conclusion that he possesses a quiet strain of Banats. Through the recommendation of the late Mr. C. N. White I purchased seven Banat queens from a friend of his in that country. I sold five of these to friends, so that they might give them a trial. Their experiences and my own are exactly the same. Only one queen seemed to go ahead as far as the outward appearance of the hive was concerned, as bees were coming out in dozens.

I prepared a rack with drawn-out sections and put this on, lifted the body-box  $\frac{3}{4}$  in. off floor board for ventilation. When I looked in at the top of the rack a week later not a single Banat was up, although in my other stocks some had finished two racks.

I intended after this set-back to introduce new blood into my apiary, so I purchased nine Black queens from a well-known dealer. I used his Free Way cage, which is a very handy article for introducing queens. Out of nine queens I had one failure, and this was the Banat stock. I found the queen dead at the bottom of the alighting board. The only compensation I get from this stock is in being well stung nearly every time I open the hive. I had a look through my hives on the

16th ult., and the Blacks were in the pink of condition—eight to nine combs full of sealed brood, and also a lot of young bees.

I packed down eight stocks last autumn, each colony having between 40lb. to 50lb. of sealed stores, so to make things better I put on four 2lb. cakes of candy on each. In the second week of January I peeped in to see how the stores in each were going on: the Blacks had plenty, but the Banats were on the verge of starvation. I put 6lb. more candy on there and then, and now they want more, so I have finally made up my mind to let them go. If anyone is thinking of commencing bee-keeping my only word of warning is to "keep off Banats."

I quite agree that the climatic conditions have a lot to do with these things, as we do not have the same amount of heat in North Cumberland as in the South of England. On Sunday, for every Banat seven or eight Blacks were coming out. The latter are a hardier bee, and easier to handle. I never could unite a Banat stock with another race, as they would kill all the other bees. This is a big fault, because in the autumn, when you want to unite you cannot use Banats for this purpose.

My conclusion is, give me the Blacks of a good reliable strain, and then I will be satisfied.—NORTHERN BEE-KEEPER, Carlisle.

### "ISLE OF WIGHT" DISEASE.

[9014] My promised report on the progress of "Isle of Wight" disease in my apiary is unfortunately not one of great success. No treatment having proved to be a cure, I am only giving briefly those points that may be of interest. The disease started last August. I had thirty stocks at that time, and have up to the present destroyed fourteen. In every case these were destroyed before robbing started.

No Black stock has shown any resistance to the disease, and every stock that had a high death-rate in the winter has since shown infection strongly, and is now gone. I had four half-bred Sladen's "Goldens"; they showed no resistance, and three of them are gone. I had only one stock of pure Italians; these appear perfectly healthy, and are going ahead well, although they have had diseased stocks on both sides of them. Of five half-bred nuclei reared from this stock two became infected in January; one I destroyed. The other was in an isolated position and I left it, and at the present time it is still going on, and has shown more resistance to the disease than any other lot I have seen. My strongest stocks with most natural stores went first. Those that have survived seem to be stocks that were fed up with most syrup medicated with Naphthol Beta.

Two stocks of driven bees with only medicated stores have wintered well, and are up in the shallow frames. Since the present fine weather set in there have been no fresh cases.—H. WATTS, Bearsted, Kent.

MOVING BEES.

[9015] "D. M. M." was writing on this subject some little time back, and asked for opinions on the relative merits of "drumming," &c.

I stocked an observatory hive about a fortnight ago, and placed some loose grass before the entrance, which remained for two days. As far as I could judge no bees returned to the original hive. I tried the same idea last year with a rather weak stock in the middle of summer, but in this case it was not a success, so many returning to the former position as to render the stock an easy prey to wasps. I have, however, found grass at the entrance a useful complement to "drumming," and with the two have moved a full stock in the middle of the honey flow with indubitable success.

The whole question depends on the time of year and weather, for we sometimes get January weather in July, and occasionally swarms (I know of three within three miles in April!)—G. S., Bisley.

"ISLE OF WIGHT" DISEASE CURES.

A CURIOUS INCIDENT.

[9016] I must say Mr. Wigley's letter in last week's "B.B.J." gave me a shock, and it appears that the dreaded disease germ is still triumphant over drugs; however, my bees still live and prosper. The badly affected stock of last July, which I consider cured, gave a swarm on Sunday, April 19th, and the incident is worth recording. It appears that as the bells of the parish church were ringing for evensong the bees left the apiary and made straight for the church, distant a quarter of a mile away, and clustered just above the door, where they remained till Monday evening, when I recovered them. Can the bells have affected the swarm, or were they in their way returning thanks for a good recovery to health?—F. C., Oxford.

CINNAMON FOR "I. O. W." DISEASE.

[9017] I wish to congratulate Mr. H. E. Balch on his discovery of this new remedy (essence of cinnamon). My bees were badly affected with "Isle of Wight"

disease. Fortunately I noticed your correspondent's letter in the BEE JOURNAL of April 9th. I immediately tried his remedy, and there was apparently an improvement in three days; in a fortnight the bees were quite well and breeding vigorously. I am certain this remedy will prove a blessing to bee-keepers in the future.—S. WHITTINGTON, Yeovil.

BANATS.

THE FRUIT GROWER'S BEE.

[9018] Mr. Steel's second letter makes it clear that he and I have struck two totally distinct strains of Banat bees; this is shown by his concluding remark that Banats are "pretty little insects." No one would make that remark about mine, as, to the casual observer, they are indistinguishable from British bees, though like Carniolans they show light rings between the abdominal joints. Mr. Cowan, in his interesting paper on bee-keeping in other countries, points out that Caucasian bees are divided into two varieties, the one plain in appearance but industrious, the other pretty but vicious and unprofitable. Apparently Banats follow the same rule; it is for those who desire in their bees the excellent qualities I have previously described to see to it that they obtain the right strain.—H. E. SCROPE VINER.

BANAT BEES.

[9019] I have kept Banats for many years, and I find that they are a most hardy, energetic race, much resembling Carniolans, but without their propensity for swarming. Good winterers, consuming little winter stores, they come out strong in spring and build up rapidly. They are good disease resisters, and in a pure state very good tempered. Queens of this race mated with natives produce excellent honey gatherers, the honey having beautiful white cappings. I think there are two varieties of them, yellow and grey, but I have never tried the yellow; my experience is with the grey variety, with queen direct from Banat, Hungary. The only fault I have to find with them is that when crossed with natives they are not so good tempered as in a pure state, but they are no worse than the natives run. When crossed with natives they very much resemble them in colour; in fact, there is little difference, except in their habits at home. I still hope to hear others' experience with them, good or bad.—O. KNIGHT, Glos.

## BLURTS FROM A SCRATCHY PEN.

CONTINENTAL WANDERINGS.

*(Continued from p. 176.)*

For the town itself it was in part a disappointment, in part a pleasure. We wandered along the edge of the bay, longing to get a clear view, but the long succession of steamers discharging and loading, with their smoke and odour, reminded us of a third or fourth shipping port in our own country. We had reached at last the end of the funnels and their noxious smokings, and we stood where Vesuvius lay in full view across the bay. Casually the writer remarked, "That is smoke issuing from the crater"; but a reply came in a soft, boyish voice in most perfect English, "No! that is not smoke, that is the mist on the mountain." And so we made the acquaintance of our



OUR LITTLE GUIDE.

boy guide, Angelo Bava, a typical Italian face, good-looking (and it is wonderful what beauty, both male and female, you see in Naples), and intelligent. We chatted with him, and found that although scarcely fifteen he spoke several languages well. He was trying to support his widowed mother and younger brothers and sisters. His ambition was to graduate as a guide and to visit England.

We were in the best of hands. From the terrace of the "Castello Nuovo" he showed us where we could get the best view across the bay, photographing the Mount, so calm at the moment, and the wicked-looking grey Italian men-of-war as they lay in the middle distance.

Castello Nuovo, one of the typical dungeon fortresses of the middle centuries.

At its gate they show you the cannon-ball, still caught in the massive iron-work, its strength spent ere it could pass through. It has its chapels, each with a masterpiece of art—painting, sculpture, or carving. What chapel in Italy has not got such? In the dungeons beneath we found the guillotine, and mummied to skin and bones were three of its victims, a dignitary of the Church, a knight, and a lady. We had the curiosity to notice how cleanly the knife had passed through bone and sinew. In the third case the victim had been specially honoured by being tri-sected; and then we wandered to the Church of St. Januarius, world known for its annual miracle, and so unto the town.

One is immediately reminded of what we read of in Old Spain, of the towns where Moorish invaders once held sway. We think of the Alhambra of Ferdinand and Isabella, of the long struggle twixt Cross and Crescent, with the Romanesque legends so interwoven in the real history. For here in Naples we have the same lofty arches, made at once to admit light in full volume and yet to give shade; and then we wandered into the shops and made our purchases, souvenirs of our visit.

In the soft cool of the Italian evening we took train back to Rome. A day enjoyably spent, a day long to be remembered; indeed, never to be forgotten, and for this we owed much to our boy guide.—  
Jno. SMALLWOOD.



*Successful Stimulation* (p. 123).—A small hole through the quilt is admirable if it occurs in exactly the right place. In Mr. Heap's case the bees made the hole, and the bee-keeper himself could not have located it more satisfactorily. But such a hole might not be invariably open, unclosed by a top bar. I have found nothing more satisfactory than the carpet quilt which I illustrated in the "B.B.J.," March 22nd, 1906. This has a 2in. round hole placed 3in. out of centre of the quilt. This gives four positions in which the feed-hole may be used, and the hole usually taps two seams, whilst the actual passage is not large. Two squares of carpet are used, and they can be placed with the holes coincident or otherwise. If desired a disc of thin wood, having a notch in one side, may be used to give access to one seam only. I find the quilts perfectly satisfactory after years of wear, as the material is far superior to that

usually employed. It does not become torn by attachment to the top bars, and the bees do not attack it, but gradually glaze it with propolis or wax. Read the article to which I refer and try them.

*Pollen Mites and Disease* (p. 126).—Mr. Grant's theory of the pollen mites being the cause of "Isle of Wight" disease is hardly supported by ascertained fact, but no theory should be dismissed without consideration. It will, therefore, be much to the point if he will give the data upon which he bases his conclusion, and state how he disposes of the following objections, particularly No. 4:—(1) The pollen mite is ubiquitous, *i.e.*, it exists in districts where "Isle of Wight" disease is unknown; (2) *Nosema apis* has been authoritatively specified as the cause; (3) Honey in which *Nosema* spores exist is said to produce the disease (see p. 123); (4) The digestive tract of the bee would not appear to be the normal habitat of a larva having legs.

*Nature's Plan* (p. 123).—Mr. Brooks' statement as to the working of "Nature's plan" is not quite so clear as we would like. He does not attempt to give the steps in the beneficent chain by which the disease is checked, apart from pointing to the survival of the fittest. No doubt the fit may survive, but other creatures have become extinct, and a bare statement of the dependence of the fruit crop upon the bees hardly covers a tremendous supposition of special intervention or plan for their preservation.

*Hive Roofs and Mouldy Combs* (p. 128).—Perhaps an even more important point in hive roofs than absolute watertightness is ventilation. Have them watertight by all means, but more evil arises from slight internal moisture than from slight leakage, and mouldy combs more readily result. But in a natural brood-nest pollen is not, I think, usually found in the outside combs, and where this occurs in the frame hive it may be due to derangement of the combs.

*Sundry Heresies* (p. 135).—Mr. Alec Low's method of arriving at the age of worker bees is unsound, in that the age of the bees is first of all indefinitely known, and, second, that highly artificial conditions obtain in the constant removal of all brood from an undersized stock having a vigorous young queen. A much better method of investigation is to insert into a strong stock a comb of brood of another race and to leave it undisturbed. The test is much more accurate if no other bees of the inserted race occur in the same apiary.

*Banatical Banter* (p. 136).—In response to Mr. Steel's humorous suggestion that the set of show combs was intended for Banat bees, I must say that the possi-

bility certainly did not occur to me in view of Mr. Herrod's well-known liking for our own bees. In any case, on Mr. Steel's own showing it is unlikely that such bees as he describes would have produced such a set of combs, whatever their own needs. I should advise him to get rid of the hungry little beggars or compel them to hant. I do not know whether they are able to support themselves by the exertions of their neighbours, but I have sometimes thought that certain foreign races would not make so good a showing as they do if there were not plenty of native bees for them to rob!

*Starting in a Small Way* (p. 138).—This story reminds me of the well-known tale of an illiterate town councillor who opposed the proposal to purchase a number of gondolas for a public lake, on the grounds of economy, there being several small islands where a suitable couple might very well breed!

*Do Bees Hear?* (p. 148).—Prof. Butteler-Reepen might try the Varian Experiment with a modification to eliminate the vibration. The hinder edge of the box might be supported on a long pole making contact with cushioned supports only at its ends; the front edge of the box might be supported by a rod making contact with the ground *behind* the bees. Now if the bees still travel towards the box it may be supposed that the direction from which the vibrations come has not attracted them. There is, however, the possibility that the bees see the movement of the hand, and are thus attracted by sight to the shade of the box. The removal of the front side of the box might help to eliminate this objection. Personally I have no doubt that bees hear. After all, hearing is but the sensing of certain vibrations. It does not, however, seem reasonable to suppose that the bees are thus unconscious of the many and varied sounds which they themselves emit. No one, for instance, who has ever teased a bumble bee can reasonably conclude that it is unconscious of its own note of annoyance, any more than, apart from other evidence, a dog is unconscious of its own growl. This is not to say that the range of hearing coincides with our own, any more than does the range of sight.

*A Simple Slow Feeder* (p. 149).—This idea ought not to be missed. Many a tiny cluster could be fed without disturbance in this way by those who care to bother with small lots, and a strong lot would have the feed close at hand and already warmed. It would be well to wrap up the bottle in any case to slow the circulation. The hole in the quilt would be so tiny that if made with a small marine spike it would probably close up again.

## NOVELTIES FOR 1914.

## NEW QUEEN EXCLUDER.

The illustration below represents a new excluder designed and registered by E. H. Taylor, of Welwyn, Herts, to overcome the difficulty of bee-keepers through their bees not taking to the supers when the ordinary old pattern of excluder zinc is used, and also to meet with the objection of bent and distorted wires. Every other bridge piece is cut away, and spaces between the rows of openings considerably reduced, which gives about fifty per cent. freer access to the supers by the bees. The excluder is made of stouter zinc than the ordinary, to prevent the likelihood of bending when removing from the

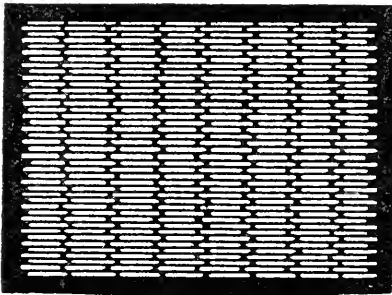

E. H. TAYLOR

hive. A good plan before placing excluders on a hive is to vaseline them first, which prevents the bees from propolisising them down, or the super placed above being fixed to them. Price and full particulars of this useful excluder may be obtained from E. H. Taylor, Welwyn, Herts.



[8925] *A Beginner's Queries.*—As a new recruit to the ranks of bee-keepers, I should be grateful for answers to the following:—

(1) A few days ago I got a stock of English bees, and at different times I have observed them expel a sort of white grub, or larva of some kind, in appearance pearly white,  $\frac{3}{8}$  in. to  $\frac{1}{2}$  in. long, back shiny, and not unlike a bee in shape; underside, impression of, rather than perfect legs (six). Please tell me what they are.

(2) Are the slats of the Rymer board placed at right angles to the frames?

(3) Is it expedient to use it between any frames except the deep ones?

(4) How can I prevent ants invading the hives. Are the iron shoes which hold paraffin successful? It seems to me they would make the hive unnecessarily high.

(5) I intend doubling the brood chamber. When should I do it?

(6) My bees, when they arrived last Thursday, were on eight combs and had two new frames with foundation. To-day I have examined them, and found one of the new foundations drawn out beautifully. Should I take that out and give them another frame to draw out?

(7) When I double the brood chamber, what would be the result if I introduced a wire queen excluding dummy in the half of each chamber, and had two queens, that is, a queen to each double lot of five frames? I suppose the bees would swarm. Would this happen if I provided ample ventilation by raising the brood chamber, &c.?

(8) I want to plant a new hedge. Can you suggest a hedge that would be of use to the bees?

(9) Shall I write to the Secretary at Croston for information about joining the B.K.A.? I know his address.

(10) Are two holes ( $\frac{1}{8}$  in.) sufficient for syrup-feeding just now? My bees have taken, through the two holes, a little more than  $\frac{1}{4}$  pint since Thursday (four days). Is that enough?

I am sorry to ask so many questions. I have never known a bee-keeper, and my nearest bee-keeping neighbour is two miles away. My chief sources of information have been the B.B.K. Guide Book and the JOURNAL and RECORD for the past nine months.—B. SERGEANT.

REPLY.—(1) They are wax moth grubs. (2) Yes. (3) No. (4) Use powdered naphthaline under the lugs of the frames. (5) At the end of May. (6) No, let it remain. (7) Do not try it. (8) Sorry, we cannot. (9) Yes. (10) Two holes a little more than the diameter of a pin—not  $\frac{1}{8}$  in., as all the syrup would run out of the latter. They have not taken too much.

[8926] *Removing Swarm Catchers.*—I propose fitting two hives with Cashfield's swarm catchers. In the event of these swarming and my not requiring increase of stocks, what should I do? If left to themselves would the swarm return to the hive and destroy the old queen (or leave the queen and destroy the queen cells), or must this be done for them, and the bees allowed to run in in the usual way before they will settle down again? The two hives I propose fitting have 1913 queens, very prolific, one an Italian direct from Italy, and the other evidently a hybrid (the progeny look like hybrids).

These hybrid bees already cover thirteen frames, and there is one super of shallow frames on. My bees, in common with all others in this district, had swarming fever badly last year, and in the incessant manipulation I lost all my three queens in the middle of the honey flow. I do not want this to occur again.—H. W. DALTRY, Newcastle, Staffs.

REPLY.—It is impossible to say exactly what would happen if you left the bees alone. If the bees swarm take off the catcher, cut out all queen cells, and return the swarm after having given an extra super.

[8927] *Ventilating Hives.*—Will you be kind enough to tell me whether the following is a correct interpretation of instructions for ventilating hives, as described at bottom of page 63, "Outer cases, &c.," in Coronation edition of Bee-Keepers' Guide Book:—(1) "Raise front of body-box 1in. by means of wedges" ? The front of the body-box will then be 1in. higher in front than behind, and all combs in body-box and supers will therefore slope 1in. toward back. (2) The outer case is raised so that bees may enter all around (or leave), and when cases are crossed as in Fig. 40, page 64, bees may go in and out at corners. (3) How are the bees controlled when putting on or taking off racks? (4) Is it desirable to subdue bees with smoke whenever anything is done to them, such as raising the body-box, &c.? (5) Does frequent subduing tend to make bees savage?—T. B., Barnstaple.

REPLY.—(1) You could raise the back legs 1in. also, in order to make it all level. (2) That will not matter. (3) By the ordinary subjugators, smoke, or carbolic cloth. (4) Yes. (5) Not if it is done judiciously.

## Bee Shows to Come.

**June 9th-11th, at Malvern.**—The Herefords and Wores. Agricultural Society's Malvern Meeting. Twelve classes for Honey, &c. Good prizes; small entry fees.—For schedule apply, Mr. A. Elliott, Hon. Secretary's Department, Cusop, Hereford.

**June 10th and 11th, at Waltham Abbey.**—Essex Bee-Keepers' Association Honey and Appliance Show, in connection with the Essex Agricultural Society's Annual Show. Judge, Lecturer, and Examiner of Candidates for B.B.K.A. Preliminary Certificate, Mr. W. Herrod. Schedules from G. R. Alder, 176, Hainault-road, Leytonstone. **Entries close May 31st.**

**June 10th and 11th, at Lichfield.**—The Staffordshire Bee-Keepers' Annual Exhibition, held in connection with the Staffordshire Agricultural Society's Show. Open classes. Liberal prizes. Judge, Mr. A. G. Pugh, Nottingham. Schedules from Claude R. Forse, Hon. Sec., Trentham, Stoke-on-Trent. **Entries close May 31st.**

**June 10th to 13th, at Portsmouth.**—Hants B.K.A., Bee and Honey Show. Liberal prize schedule now ready. Write, E. H. Bellairs, Hon. Sec., Hants B.K.A., Christchurch.

**June 30th to July 4th, at Shrewsbury.**—Royal Agricultural Society's Show. Bee and Honey Section, under the direction of the B.B.K.A. Prizes arranged in groups of counties for Associations affiliated to the B.B.K.A. Schedules from W. Herrod, 23, Bedford Street, Strand, W.C. **Entries close May 30th.**

**July 8th, at St Albans.**—Honey Show of the St. Albans B.K.A., held in connection with the Elstree and Boreham Wood Horticultural Society, at Aldenham Park. Open class for extracted honey. No entry fee. Liberal prizes. Judge, Mr. W. Herrod. Schedules from Mr. R. H. Attenborough, Aldenham, Herts. **Entries close July 6th.**

**July 24th and 25th, at Cardiff.**—The Glamorgan B.K.A., in connection with the Cardiff and County Horticultural Society's Show, in the Sophia Gardens, Cardiff. Open classes include:—Collection, Gift, Sections, Beeswax, &c. Schedules from W. J. Wiltshire, Maindy School, Cardiff.

**July 23rd, at Bath.**—The Annual Show of the Somerset Bee-Keepers' Association, in connection with the Larkhall Horticultural Society. Seven Open Classes. Schedules from J. W. Brewer, Glen Lynn, St. Saviour's Road, Bath. **Entries close July 18th.**

**August 26th, at Prestbury.**—Honey show, in connection with the Prestbury Flower Show. One class open to the kingdom. Several for those within 12 miles radius. Exceptional prize list. Schedules from A. H. Bowen, Coronation-road, Cheltenham.

**September 1st, at Deddington.**—Honey show in connection with Deddington Horticultural Society's Show, to be held in the Castle Grounds. Open classes for honey. Schedules from H. J. Harnsworth, Deddington, Oxon.

**September 2nd, at Lancaster.**—Agricultural Show. Premier Honey Show of the North. 15 classes; £20 in cash prizes, silver cups and medals value 15 guineas, and other specials. Send for schedule (Honey) to Robert Gardner, solicitor, 69, Church-street, Lancaster. **Entries close August 19th.**

## Notices to Correspondents

W. MILLIGAN (Mollinsburn).—*Removing Combs.*—No, leave the combs alone for the present. There is bad weather still to come before the honey harvest, and they will need all their stores.

"STANWELL" (Staines).—*Returning a Swarm.*—Your method is all right for an inexperienced bee-keeper.

F. G. P. (Cheshire).—*Unsatisfactory Queen.*—There are several possible reasons for the state of your hives. It may be a case of "Isle of Wight" disease, the queen may be a drone breeder, or she may have been injured in some way. A laying worker would account for the eggs being so plagued.

VERY NEW BEE-KEEPER. — *Swarming Queries.*—We should advise you to make an artificial swarm by taking away one comb with queen and bees, as advised in British Bee-keepers' Guide Book.

M. G. (Tunstall).—*Race of Bees*.—The bees sent are of the ordinary English variety.

F. G. (Penrith).—*Clover Seed*.—The seeds enclosed are Bokhara Clover. It is a trifolium species, and may be sown at any time and in any good soil.

R. L. L. (Devon).—*Disinfecting Hives*.—The use of a painter's blow-lamp is the most effectual way of disinfecting. It is used on the inside of the hive, and if done carefully will not spoil the appearance of the hive. In any case we would rather have this than run risks by using any other method of disinfection.

BEGINNER (Swanwick, Hants).—*Leaving on Swarm Catchers*.—(1) You could leave them on until the end of May. (2) Bait sections are those saved over from last year, and which contain a little honey. (3) Wigley's Quinine Cure was described in the "B.B.J." of June 12th, 1913.

C. B. (Malden).—*Making Artificial Swarm*.—(1) You could leave a queen-cell in the stock if there is one, the bees will not tear it down. (2) You had better not run any risk, but melt them down.

FREDA (Oundle).—*Using a Swarm-catcher*.—(1) The Brice swarm-catcher can be fixed to any hive with a movable porch. It should be put on the hive when the bees show signs of swarming. Experience will teach you to know the signs of an inclination to swarm some time before the bees issue. (2) Yes. (3) You gave far too much syrup, and it is well you have left off. (4) We warned you against this hive. If people ask our advice and, when it is given, do the opposite according to their own idea, they alone are responsible for any consequent disappointment.

#### *Suspected Disease.*

NOVICE (Staffs.).—We find no trace of disease in bees sent, therefore the combs may be used again.

H. C. (Baildon), G. M. E. (Southsea), and P. H. (Downe).—The bees have died of "Isle of Wight" disease.

M. E. B. (Southwell).—The bees were too dry for us to determine cause of death.

W. S. (Ilford) and W. H. (Christchurch).—The bees are affected with "Isle of Wight" disease. They should be destroyed and the hive thoroughly disinfected. The ground should also be dug over.

H. Q. (Sligo).—(1) The bees are badly affected with "Isle of Wight" disease; (2) Banats are a race of bees from Hungary.

**Special Prepaid Advertisements.**  
**Two Words One Penny, minimum Sixpence.**  
Orders for three or more consecutive insertions entitle advertisers to one insertion in "The Beekeepers' Record" free of charge.

Trade advertisements of Bees, Honey, Queens, and Bee goods are not admissible at above rate, but will be inserted at 1d. per word as "Business" Announcements, immediately under the Private Advertisements. Advertisements of Hive-manufacturers can only be inserted at a minimum charge of 3s. per  $\frac{1}{2}$  in., or 5s. per inch.

#### PRIVATE ADVERTISEMENTS.

**WANTED**, strong stocks of bees, in skeps, cheap, guaranteed healthy.—C. S. KESSEL, Melbree, Allerton, Liverpool.

**WANTED**, young man used bee hive, poultry house, and similar work, quick, steady, machines and bench, regular if suitable; state wages required.—Box XXX., 56, "B.B.J." Office, 23, Bedford-street, Strand, W.C.

**CAMERA**, half plate Sanderson, fitted Aldis C/177 lens, case, tripod, &c, in perfect condition, £4; would accept two swarms part exchange.—STEIN, Colham Green, Uxbridge. v 18

**HEALTHY SWARMS**, end of May and June, 15s. each; booked in rotation, cash with order.—E. LANG, 124, Canterbury-street, Chorley, Lancashire. v 22

**FOR SALE**, guaranteed healthy stocks of bees, on eight frames, free on rail; travelling boxes to be returned, at 22s. 6d. each.—JOS. ROWLAND, Holbrook, Derby. v 26

**SUPERIOR** English honey, 68s. cwt., tins included; also Radant's weed, frames, sections, healthy bees and sundries; stamp.—HUNT, Quarry-rd, Somercotes, Alfreton. v 39

**SWARMS** Natives, from bar frame hives, 15s.—MISS GRACE, Terrick, Kington, Worcester.

**HEALTHY** natural swarm, sent on three frames, 13s. 6d., box free.—MULLEY, Upton-on-Severn. v 25

**OAK** ferns, 3d. each, 2s. 6d. dozen; beach ferns, 4d. each; would exchange joiner's tools, or optical goods.—F. MORLEY, Birst with, Leeds. v 23

**W.B.C. HIVE**,  $\frac{1}{2}$ lb. section wax, sixty sections, ten standard frames, sixty-six metal ends, all new, two section racks, smoker, lot 12s.—DRAKE, 15, Seaforth-avenue, New Malden. v 21

**BEST** quality granulated dark honey, in bulk, 6 $\frac{1}{2}$ d., on rail.—TOWNSEND, Lydbrook.

**PARTY** going abroad.—For sale, five Simmin's Conqueror hives, stocked hybrid White Star bees, best hive for honeycomb production, all healthy, no disease in district, price £12.10 for five.—Apply, THOMSON, 20, Easwald Bk., Kiltbarchan, West Renfrewshire, Scotland. v 16

**WANTED**, books on bees.—Maeterlinks buy cheap, or exchange hives, bicycle lamp, expanders, &c.—Write, H., Craven Arms Post Office, Salop. v 30

**TWO** Lee's Coronation hives, new; 500 2-way plain sections; a quantity of secondhand section racks, travelling crates, and honey tins; offers or exchange.—J. COOPER, 45, Bunyan-road, Hitchin.

**SELL**, Thould and Hutchinson portable cesspool pump, with all fittings, used once only, cost £3 10s.; offers.—"PUMP," "B.B.J." Office, 23, Bedford-street Strand, London, W.C.

**WANTED**, natural swarms, guaranteed healthy, goldens preferred.—WIGGINS, 1, Swinderby-road, Wembley. v 6

**TYPEWRITER**, No. 4, Smith Premier, double keyboard, last a lifetime, perfect, 80/-, bargain; others, all makes, from 40s.; on approval. Illustrated lists free.—WAKEFIELD and CO., Newhall Hill, Birmingham. v 94

**TYPEWRITER**, No. 8, Remington, brief carriage, clear writing, very reliable, perfect, cost £23, sell 80/-, Approval; great bargain.—WAKEFIELD, Newhall Hill, Birmingham. v 95





### HANTS AND ISLE OF WIGHT B.K.A.

The annual general meeting of the Hants and Isle of Wight Bee-keepers' Association was held at Southampton on May 9th, presided over by Mr. E. H. Bellairs, Hon. Sec. An encouraging number of members were present, and a very pleasant meeting was enjoyed. The accounts showed a balance in bank of £35 12s. On the resignation of Mr. Bellairs, Mr. F. D. Hills was elected in his place, and the following committee were appointed:—Miss Minns, Miss Martin, Rev. A. A. Headley, Messrs. T. Giles, W. B. Green, H. M. Cooper, D. E. Alexander, — Elliott, E. J. Morgan, and A. F. Hardy, librarian, to succeed Rev. W. E. Medlicott, who retires. As a slight recognition of his devoted services on behalf of the H.B.K.A. since 1883, when the Association was founded by him, Mr. Bellairs was elected a Vice-President, and it is only regretted that eye trouble, and engagements in connection with the Bournemouth Hospitals, of one of which he is chairman, have compelled him to fall out of the active work of the H.B.K.A. Mr. Bellairs has a fine record as a lecturer, having in his younger days travelled the country over, and he is an expert of no mean order.

The Association will hold demonstrations and give free lectures at the Royal Counties Show at Portsmouth in June, advertisement of which appears in the "B.B.J."—F. D. HILLS, Hon. Sec.

### SURREY B.K.A.

#### ANNUAL MEETING.

The annual general meeting of the above Association was held at Marden House, London Road, Redhill, on April 25th. Mr. Wm. Welch, J.P. (Cranleigh), occupied the chair.

The report for the past year expressed sincere regret at the death of the late Sir Wm. Vincent, Bart., J.P., C.A., who was for many years one of the vice-presidents of the Association. The number of members for the year ending March 31st, 1914, was 323. The grant of £150 from the Surrey Education Committee in aid of technical instruction in bee-keeping had been renewed. From the returns of the six paid qualified experts it appeared that 320 stocks were found dead. The number of apiaries visited was 220, and the stocks examined 1,051. The bee season of 1913 was much more favourable for bee-keeping than for some years past: much less disease appeared, and where stocks had received skilful and necessary

attention they were very prolific, gathering in many instances considerable amounts of honey of exceptionally good quality. Lectures and demonstrations were given at several schools in the county, and also at flower and agricultural shows. The accounts showed an excess of special expenditure over income of £28 3s. 9d., whilst on the general side there was a balance in hand of £11 1s. 5d. The balance-sheet showed the excess of assets over liabilities of £182 6s. 8d.

Mr. Hamshar seconded the adoption of the report and accounts, and the motion was carried.

A vote of thanks to the retiring Executive Council, Joint Committee and officers was accorded, on the proposition of Mr. Silver, seconded by Mr. Hamshar, and the following were elected on the Executive Council for the ensuing year, proposed by Mr. Page and seconded by Mr. Hamshar: Lient-Col. J. A. C. Younger, Messrs. Archbald Seth Smith, R. C. Blundell, F. S. Fletcher, G. C. Halahan, W. E. Hamlin, A. T. Hedger, J. Kaehler, J. W. Lewis, W. F. Reid, E. J. Stevenson, E. Walker, A. Watkins, T. H. E. Watts-Silvester, M.A., M.R.C.S., and F. B. White.

The meeting concluded with a vote of thanks to Mr. Seth Smith, proposed by the Hon. Secretary, and seconded by Mr. Overton.

### NORFOLK B.K.A.

Dr. D. Wardleworth (Sheringham) presided over the annual meeting of the Norfolk Bee-keepers' Association at the Settlement House, Norwich, on Saturday, April 25th.

Lady Hastings was again elected president, and other officers were appointed.

The Chairman said that the report of the expert from Hunstanton showed that there was a tremendous lot of foul brood, and that the district was absolutely ravaged with "Isle of Wight" disease. The stocks were dying in all directions.

Submitting his own report, Dr. Wardleworth said that last year out of 205 stocks only four had foul brood, and there was practically no "Isle of Wight" disease. There was a different tale this spring. Every single apiary, with a few exceptions, had been visited by "Isle of Wight" disease. He himself had lost seven stocks out of nine. He personally thanked all the officers and experts for their work. As for the examination results, they were very satisfactory indeed. There were five entries for the third-class certificate, and all passed. It was hoped that the experts of last year would strengthen their position by taking a second-class examination next November. There were two entries for the first-class certificate last May, and the Rev. W. Mattinson was successful.

Discussing the balance-sheet, the Chairman said they had a balance of something like £6 or £7 in hand. They had had a considerable number of new members, about thirty, which was, he considered, extraordinarily good.

Dr. Wardleworth and Mr. Basil Cozens-Hardy were again appointed representatives to the British Bee-keepers' Association.

The Chairman explained that by way of inducing members to send in their subscriptions early, three hives of the value of £1 each would be drawn for from the names of those subscribers.

The winners were Mr. Moulton, Mr. Ling, and Mr. Page.

Mr. H. Bond moved a vote of thanks to the hon. secretary and treasurer (Dr. Wardleworth), who, he said, had done valuable service to bee-keeping in North Norfolk and throughout the county.

Mr. J. T. Brown seconded the motion, which was carried with enthusiasm.

Dr. Wardleworth acknowledged the vote.

It was intended that a lecture should be given by Mr. W. Herrod, F.E.S., on the advantages of modern bee-keeping. The Chairman said that owing to illness Mr. Herrod was unable to come to Norwich.—*Communicated.*

#### WEAR VALLEY AND DISTRICT BEE-KEEPERS' ASSOCIATION.

In connection with the above Association an interesting lecture was given at Crook, Co. Durham, on Saturday, May 2nd, by Mr. R. Casson, Darlington; the subject being "Transferring and Artificial Swarming."

Captain Stobart, of Etherley, was in the chair.

As a result of the lecture a number of new members joined the Association.—**W. S. WATSON**, Hon. Sec., Southview, Wolsingham, Co. Durham.



#### HOW TO MAKE AND USE A SOLAR WAX EXTRACTOR.

On account of the trouble entailed in the melting of wax by steam a great deal of money is wasted by bee-keepers in this country. Beeswax is one of the most valuable assets the bee-keeper possesses, and it will pay to save even the smallest scraps of comb for melting down.

The method that gives the least trouble and produces the finest wax without loss of aroma is the Solar Wax Extractor, which is easily constructed. The material being inexpensive, time is the only serious outlay. It is cheap to work, as the sun provides fuel without cost.

When made, the extractor should be placed in such a position that, after dealing with the last stock, the bee-keeper must pass it, and any pieces of comb removed during the manipulation may be placed in it and melted at once, so that they are not wasted and do not lie about to provide food for and breed wax moths.

The idea of the extractor is to attract and retain as much of the heat of the sun as possible, and for this purpose it is made very much like a garden light. The main portion, No. 1 (Fig. 1), is made of an outer shell  $\frac{3}{4}$  in. thick, the sides (A) being outside measure 2ft.  $1\frac{1}{2}$  in. long,  $12\frac{3}{4}$  in. deep at one end, and  $2\frac{3}{4}$  in. at the other. One end (B)  $2\frac{1}{2}$  in. deep,  $14\frac{1}{2}$  in. long, and the other (C)  $12\frac{3}{4}$  in. deep,  $14\frac{1}{2}$  in. long, so that, when these are nailed inside the sides, it gives an outside width measurement of 16in. The bottom,  $\frac{3}{4}$  in. thick, is now nailed across the narrow way, giving an outside depth measure of  $13\frac{1}{2}$  in. at one end and  $3\frac{1}{2}$  in. at the other.

The inside, except the bottom, is now lined with thick felt, which is turned over the edge to the outside, tacked down, and then cut level with the outside edge of the wood, so that when the glass frame is closed it is quite airtight. Over this, with the grain running in the opposite direction to that of the outer case, to prevent warping, but with the edges level with same, so that they do not interfere with the felt bed, a  $\frac{1}{2}$  in. wood lining is well nailed (D).

The glass lid (No. 2) is made next; the two sides measure 2ft.  $6\frac{3}{4}$  in. long, 2in.

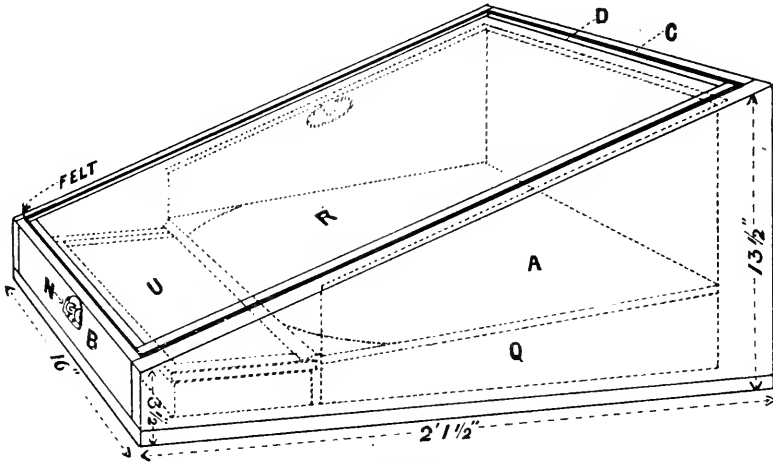

No. 1.

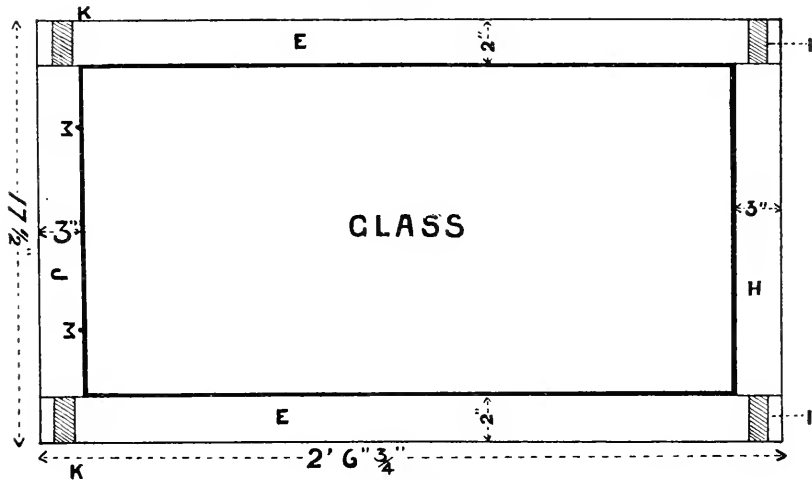

No. 2.

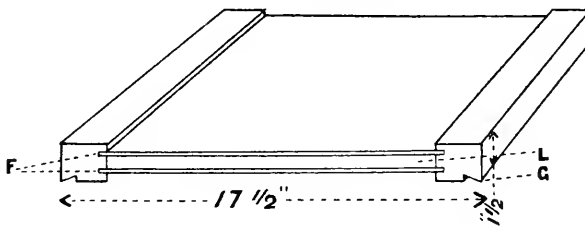

No. 3.

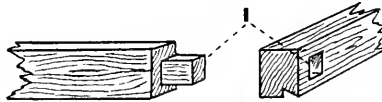

No. 4. C

Fig. 1.

wide, and  $1\frac{1}{2}$  in. thick. They are grooved for the glass, as shown at F (No. 3), so that the two sheets of glass will have a space of  $\frac{1}{2}$  in. between them. They are

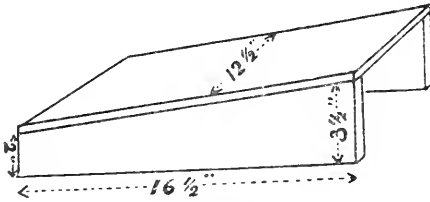

No. 5.

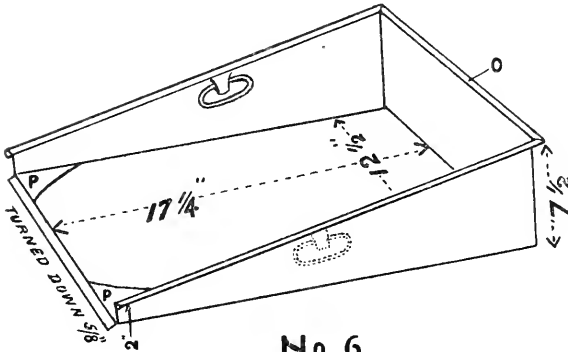

No. 6.

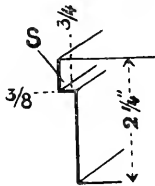

No. 7.

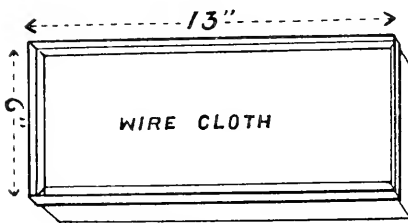

No. 8.

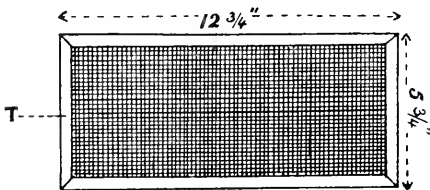

No. 9.

Fig. 2.

also throated (G), to prevent the wet getting to the felt. The top rail (H) is cut 17 1/2 in. long, 3 in. wide, 1 1/2 in. thick, and has the two grooves to accept the glass. It is morticed and tenoned together. I (Nos. 2 and 4). The bottom rail (J) is made by morticing and tenoning K, a piece of wood 17 1/2 in. long, 3 in. wide, and 1/2 in. thick, right in the centre, so that the glass sheets will slide into the grooves at the top and bottom of it, L (No. 3). The four corners are glued and fastened with wood pins, so that the outside measure of the frame is 2ft. 6 3/4 in. by 17 1/2 in. To hold the top sheet in position a couple of tacks, M (No. 2), are driven in while the bottom sheet is held, and the frame made level by fastening with brass screws a piece of wood 13 1/2 in. long, 2 1/2 in. wide, and 1 1/2 in. thick. This, of course, is taken off to put in the glass. A couple of sheets of 21oz. glass completes the lid, which is hinged at the top outside with a pair of box hinges, so that it projects beyond the body (A) 1 3/4 in. top and bottom and 1/4 in. on either side. It is fastened by a universal fastener (N) at the bottom.

The inside is fitted by making a sloping platform of 1/2 in. wood, as shown at No. 5 (Fig. 2), and Q (No. 1, Fig. 1 dotted lines), this carries the tin-holder (No. 6, Fig. 2) and R (dotted lines, No. 1 Fig. 1), made as shown, the top edge O (No. 6, Fig. 2) is rolled over a 1/4 in. wire, to do away with sharp edges, while, to make the wax run off at the centre, raised pieces of tin (P) are soldered in. The tin wax tray (No. 8), is now made 13 in. long, 6 in. wide, and 2 1/4 in. deep, outside measure. The top edge is shouldered as shown (S, No. 7), to carry the wire cloth strainer (No. 9); the latter is edged with tin (T) to make it firm.

This is placed at U (No. 1, Fig. 1), so that when the combs to be melted are placed in the tin (No. 6), the lid closed, and the extractor put so that it faces the sun, the double glass and the bright tin attract the heat, so that the wax is melted and runs down the slope on to, and through, the wire cloth, which strains out the large pieces of foreign matter, into the tin tray. When cool the square cake of wax can be lifted out.

It is a mistake to place too much material at one time in the tin holder, for, by so doing, the melted wax from the top combs runs through and coagulates those at the bottom in a mass, which will take a long time to melt. Only sufficient combs to cover the bottom of the holder should be placed in at one time, and when all the wax is melted away the dross should be scraped out before putting in another batch. The method of filling is shown in illustration below.

The extractor should be painted black to attract the heat, and it should stand on bricks to prevent rotting of the wood by damp.

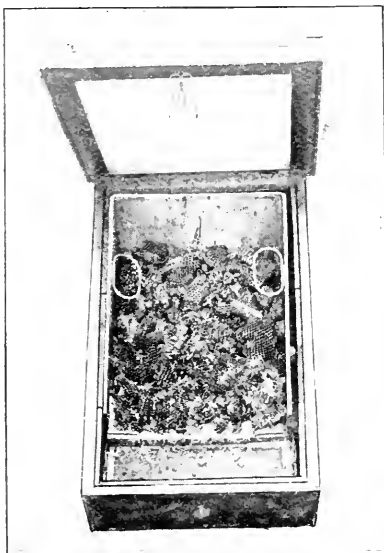

SOLAR WAX EXTRACTOR.



*The Editors do not hold themselves responsible for the opinions expressed by correspondents. No notice will be taken of anonymous communications, and correspondents are requested to write on one side of the paper only and give their real names and addresses, not necessarily for publication, but as a guarantee of good faith. Illustrations should be drawn on separate pieces of paper. We do not undertake to return rejected communications.*

**THE QUEEN AS ARCHITECT.**

[9020] To get baits for the section-rack I put a home-made frame of six sections in the brood-nest. The slots in the guard were made too wide and the cells on the comb facing them have been drawn out and filled with drone grubs in worker foundation. It is a very common experience, but does it not make us wonder whether we know all about the

queen's and the bees' control of sex? The queen commonly lays in new cells when they are scarcely half built, and one would think that in such a case she would go over a worker comb and fill it automatically with worker eggs. It would seem that in the case I have described, when she came to a part of the comb that was farther away from the next comb than the rest, she immediately altered her eggs from worker to drone, as though she knew that here was a place where drone grubs could be reared. The frame of sections was put in at the back of the last frame on April 19th, and the sealed drone-brood found on May 3rd so that it is not certain that the cells were not drawn out before the eggs were laid. It would be interesting to settle this point by an experiment in an observatory hive or by taking more careful note.—G. G. DESMOND, Sheepscombe, Glos.

**BEEES IN THE SOUDAN AND IN MADEIRA.**

[9021] Mr. G. Walter Grabham, M.A., F.G.S., geologist to the Government of the Sudan, who has recently been exploring some hundreds of miles across the desert between Khartoum and the town of Gallabat, on the Abyssinian Frontier, gives an account of the district which will probably interest readers of your journal.

With many camels and numerous attendants, Mr. Grabham crossed two rivers, or rather, river-beds at this dry season, where all the fish and huge alligators—one of the latter measuring in length 12ft. when shot by Mr. Grabham—seemed to be concentrated in scattered pools until the rainwater from the Abyssinian uplands again descends to replenish the streams and revive the country.

Meanwhile, all kinds of creatures arrive at night to drink at the remaining pools, such as antelopes, water-buck, leopards, &c., and many of these remain and contribute to the sustenance of the voracious reptiles which lie in wait for them.

In one stretch across the desert the geologist's party came across a well out

of which they hoped to assuage their thirst and water their camels, but the surrounding rocks were full of wild bees, and though the well was covered over they had found a way in and had rendered the water undrinkable with a scum of their drowned ones on its surface.

"They came swarming upon us in great numbers," Mr. Grabham writes, "to drink the water from our sweating faces, and it was no agreeable matter to have these unwelcome creatures crawling at one's eyes, nose, and mouth in search of moisture. We sought in vain the shelter of a rest-hut, and only obtained relief at length by lighting fires and sitting in the smoke."

I am sending for appliances to transplant some of these colonies to Khartoum, for the bees are naturalised to the climate, and store excellent honey. From 10 a.m. to 3 p.m. not a bee ventures forth in the extreme heat. Some of your readers may know something of this species of African bee, and of its subsistence in those desolate regions.

Madeira presents a veritable contrast to the conditions indicated above. Our bees swarm early in the year; the food supply is perennial, and there is no hibernation. The little creatures, nevertheless, store in summer with a feverish activity, as though inspired with a groundless apprehension of coming winter. My honey here (300ft. above the sea-level) is good, though dark-coloured and aromatic, but I have another apiary at my mountain home 2,000ft. higher, where there are tracts of bilberry and wild flowers with *Thymus micans*, &c., in abundance, and the honey yielded in that district is delicately flavoured and highly esteemed.

Many years ago I brought to the island a colony of yellow Ligurians, and watched their work with interest. They collected farther and farther from home until at length I observed my yellow-striped friends feeding on a Rosemary hedge two miles away, and these well-behaved little creatures were never found guilty of the depredations in the vineyards and fruit gardens which attach to the local species. But my breed is merged in the native strain and is now hardly distinguishable from them. "They have seen the daughters of the land that they were fair, and have taken wives of all they chose."

A few years ago also I brought over a strong colony of Carniolans, which, after a captivity of five days, were let loose in my garden, and were seen returning to their hive pollen-laden in less than seven minutes! With another colony I was not so fortunate, for, the voyage being unusually protracted, my food supply fell short and my little friends ate

greedily of the syrup of orange marmalade and died by hundreds—no doubt with excruciating stomach aches.

I have written elsewhere on hybridisation and fertility, and my bees are still a constant solace and interest to me.—MICHAEL GRABHAM. M.D., F.R.C.P., Madeira.

### IS "ISLE OF WIGHT" A NEW DISEASE?

[9022] After all that has been said about the "Isle of Wight" being a new disease among bees, no doubt many of your readers were surprised on reading Mr. Withycombe's (8975) question in your March 12th issue—"Is it a new disease?"

Although I am a novice myself, my adviser, Mr. J. J. Adamson, who is an expert of over twenty years' experience, firmly believes it is not a new disease, and is most emphatic whenever I bring up the subject. Want of proof, in face of the many and widespread calamities, has prevented me from writing you before, making the same suggestion.

Incidentally, whilst perusing one of my books, I have found what I consider is proof that the disease is not new.

If any of your readers have a copy of "Bevan on the Honey Bee," on reference they will find a special chapter devoted to "Diseases of Bees," page 203. On page 209 it is the *first* subject dealt with, and presumably it was in the author's opinion the most important one. I give below an extract:—

"In the winter of 1782-3 a general mortality took place among the bees in this country, which was attributed to various causes: want of honey was *not* one of them, for in some hives considerable store was found after the bees had gone. Some were of opinion that it arose from the preceding being a bad breeding year, and thought that the bees died of old age. Others attribute it to the moistness of the spring of 1783, which rendered the providing of pollen difficult, for without pollen no brood can be raised. The difficulty of collecting pollen was ascribed to the continual closing of the flowers over the anthers, and the washing away of the pollen by the frequent showers after they did burst.

"The fatal influence ascribed to the wetness of the spring 1782 seems to be improbable; though it may have affected the quantity of bees bred, it was not likely to put a stop to their breeding altogether, and the young bees ought, at any rate, to have escaped the desolating evil, if it were from old age alone; yet wherever the mortality made its appearance, every bee became its victim.

"A similar incident occurred amongst the wasps in the year 1824, &c., &c., &c. In both cases it seems probable that the mortality arose from some unfavourable circumstance at the breeding season *with which we are unacquainted*. I am not aware that it has been attributed to any specific distemper of an epidemical nature.

"Mr. Knight noticed a similar occurrence as to wasps in the year 1806, and in 1815 Spence and Kirk both made the same observations."

This should be very interesting and encouraging to all bee-keepers, as, in my opinion, "Isle of Wight" disease is a passing plague, and will shortly leave us for another—and may we hope?—long period.

I am enclosing view of part of our apiary, which is situated about  $2\frac{1}{2}$  miles from the centre of Birmingham. I would further add (if I dare) that we have, so far, been free from the disease.

I should like to invite friendly criticism on the above, which is referring to over 100 years ago.—FRED A. CLARK.

#### BEE-KEEPING IN NEW ZEALAND.

*By an ex-London Clerk.*

After eighteen years' service as clerk in one of the large West End Stores, my health broke down, and I was ordered a long sea voyage, and decided to go to New Zealand. Although I intended adopting an outdoor life when arriving I found the general run of farming was much too strenuous for me to venture until I had got stronger, so within a week of landing I was again at the desk in a large warehouse in Wellington. I arrived in New Zealand in the early spring, and as the summer came on with its glorious sunshine day after day, I was daily more and more convinced that, come what may, I would not be content to be cooped up within four walls when God's fresh air and sunshine were to be enjoyed outside, and would get either on a fruit farm or sheep station at the earliest opportunity.

After about three months I went to lodge with a man (also a Londoner) who had kept a few hives of bees at Teddington, and had just bought three box-hives. Up to that time I don't know that I'd ever seen a bee, and certainly couldn't have identified one had I seen it alight anywhere, and I had to enquire how they stung, whether it was by a bite or otherwise? (I know now). My friend transferred the bees to a movable frame-hive, I standing at a very respectable distance away with a lace curtain all over me, also leggings and kid gloves. I was much interested in the operation, and more so when about a week later I was shown how the bees had made solid combs of the pieces tied in the frames, and I very soon

became fascinated with the continual movement in the front of the hives, and used to sit (with a veil on) for hours watching the bees.

One day my friend suggested that bee-keeping was the life to suit me, and although I thought little of it at first, the idea gradually became uppermost in my mind, and I started saving all I could to start in a sufficiently large way to make my living.

After an interview with the Government Apiarist, I decided to try and get with a commercial bee-keeper for a season, as practical experience is absolutely necessary if one is going to start in a large way at once. I was fortunate enough to get with the largest and most successful bee-keeper in the Dominion, who at the time I was with him had eleven out-apiaries, totalling 1,300 hives with an output of over 30 tons of honey. Here I learnt how to make increase, control swarming, queen-rearing, comb foundation making, and the general manipulation from the first opening of the hives in the spring until they were closed down for the winter. This man ran his apiaries for extracted honey alone, using twelve-frame hives, and all full-depth supers, the latter having ten frames wide spaced to allow for deep combs. To facilitate uncapping, and to keep down swarming in which the large-sized hives help considerably, he pushes the first super forwards, leaving about  $\frac{3}{4}$  in. space at the back of the brood-chamber, which not only ventilates the hives but also is used as an extra entrance and exit—another big consideration. I of course do the same and find this method answers admirably, but many bee-keepers here who saw my hives so placed for the first time were much surprised, and wanted to know how about the rain beating in, and if it would not start robbing. The rain can only get on to the rabbit, and the end of the hive, and if very heavy rain comes the water would run on to the bottom board and out at the entrance. As regards robbing, the space is opened only when the honey-flow is starting, and is closed again when the first lot of honey is taken off, so there is no danger on that score, and although I have been compelled to leave the space open after the flow is over, I have never had a case of robbing from that cause.

It is now my fourth season as a bee-keeper "on my own," and although we have had a sequence of three poor ones I am quite happy in the choice of my means of earning my living. The following will show what can be done here:—First season. Spring count, seventy-five colonies; surplus,  $5\frac{3}{4}$  tons. Second season (worst summer for thirty years). Spring count, eighty-four hives:  $2\frac{3}{4}$  tons. Third

season. Spring count, seventy hives, 3 $\frac{3}{4}$  tons. Fourth season, Spring count, eighty-five (six weeks' bad spell, November and December); I expect about 4 tons, am now making final extraction.

All through the Dominion are Bee-keepers' Associations; all except one are affiliated with the National Association, which is fast assuming a very strong position, and is formed for the purposes of increasing the interests of all concerned in the industry, and for promoting a systematic course of advertising, what honey is as a food and why a great deal more should be eaten, also to place before the Government any matters that are considered necessary for the general interest of bee-keepers.

petrol and kerosene tins which weren't always properly cleaned, and the result was the honey was tainted.

All honey now put up for export must conform to the Government regulations, which are few tins and cases of a uniform size, and all honey must be graded by a Government expert before being shipped, which will ensure that nothing of an inferior quality can pass, except it be branded as such. One parcel sent last year realised £46 10s. per ton, and honey from this district fetched from £40 to £44 10s. per ton, and I think that when the home merchants know they can rely on our honey those prices will be improved upon.

I often wish I had come across a bee-



MR. F. BAINES' APIARY.

We have a splendid Agricultural Department, the Director of which is most anxious to assist the bee-keeping industry. Recently the Apiary Inspectors were supplied with motor-cycles, which enable them to give about four times as many visits as they were able to before, and now that their powers are increased by the recent amendments to the Apiaries Act we believe we can see the elimination of foul brood in sight.

We of course produce a great deal more honey than is consumed here, and up to about two or three years ago bee-keepers were compelled to accept whatever they could get, in some cases as low as 2 $\frac{1}{2}$ d. per lb. for best clover honey.

However, that is now at an end, as we have succeeded in finding a payable market in England, which has been made difficult owing to careless bee-keepers sending their honey badly packed in old

book or journal when in England, it would have, I'm sure, set me thinking whether I wasn't a fool to stay at the desk, ruining my health when there was an industry so pleasant and profitable to be had, and although I don't think it is quite so profitable at home as here on account of the climate I feel sure much better health can be obtained by it than sitting at a desk.

Things may be different now, it being eight years since I left England, but I never met a man who could "talk" bees in the Old Country; those who kept them in the country places I visited simply said they had some bees, and there the matter ended, consequently the most interesting industry in the world of Nature passes by unknown to many.

I can only hope this article will catch the eye of a few men situated as I was, and will set them thinking, and thus lead them to find out more about bees, and



perhaps join an Association where the foundation may be laid for building up of a free and fresh air life from which they will look back on the office conditions as a nightmare.

The accompanying photographs are connected with a field day of the South Taranaki Bee-keepers' Association, held at the apiary of the President, Mr. Fred C. Baines, at Te Roti, which was attended by about seventy people, including a Government Apiary Instructor.

The proceedings opened with a demonstration of taking the honey off the hives, the combs being taken direct to the honey-shed, where the whole process of uncapping and extracting was shown. This to many of the visitors was a very great surprise, particularly when the combs were taken from the extractor clean and intact. Mr. Baines uses a steam-heated knife, also a capping melter of his own design, both of which were highly commented on by the professional bee-men and the Government Apiarist. He also uses a four-frame extractor, driven by a one horse-power benzine engine; the latter doing service in the winter in driving the small circular saw, whereby he is able to make all his hives, frames, and appliances.

How to wire the frames for fixing foundation was next shown, which was interesting because Mr. Baines, instead of using the ordinary embedder, uses a soldering-iron with the point bent over and grooved, which, after being heated over a stove, runs along the wires, resulting in just the walls of the impression being melted, and making a splendid job.

The Government Instructor then showed how to manipulate a hive of bees, handling frames, &c., and the various stages of the bee from the egg to the fully-grown bee eating its way out were very keenly followed.

A lady bee-keeper then showed "how it could be done," this lady having twenty colonies, and is buying 100 more for next season.

## Bee Shows to Come.

**June 9th-11th, at Malvern.**—The Herefords and Worcs. Agricultural Society's Malvern Meeting. Twelve classes for Honey, &c. Good prizes; small entry fees.—For schedule apply, Mr. A. Elliott, Hon. Secretary's Department, Cusop, Hereford.

**June 10th and 11th, at Waltham Abbey.**—Essex Bee-keepers' Association Honey and Appliance Show, in connection with the Essex Agricultural Society's Annual Show. Judge, Lecturer, and Examiner of Candidates for B.B.K.A. Preliminary Certificate, Mr. W. Herrod. Schedules from G. R. Alder, 176, Hainault-road, Leytonstone. **Entries close May 31st.**

**June 10th and 11th, at Lichfield.**—The Staffordshire Bee-keepers' Annual Exhibition, held in connection with the Staffordshire Agricultural Society's Show. Open classes. Liberal prizes. Judge, Mr. A. G. Pugh, Nottingham. Schedules from Claude R. Forse, Hon. Sec., Trentham, Stoke-on-Trent. **Entries close May 23rd.**

**June 10th to 13th, at Portsmouth.**—Hants B.K.A., Bee and Honey Show. Liberal prize schedule now ready. Write, E. H. Bellairs, Hon. Sec., Hants B.K.A., Christchurch.

**June 30th to July 4th, at Shrewsbury.**—Royal Agricultural Society's Show, Bee and Honey Section, under the direction of the B.B.K.A. Prizes arranged in groups of counties for Associations affiliated to the B.B.K.A. Schedules from W. Herrod, 23, Bedford Street, Strand, W.C. **Entries close May 30th.**

**July 8th, at St Albans.**—Honey Show of the St. Albans B.K.A., held in connection with the Elstree and Boreham Wood Horticultural Society, at Aldenham Park. Open class for extracted honey. No entry fee. Liberal prizes. Judge, Mr. W. Herrod. Schedules from Mr. R. H. Attenborough, Aldenham, Herts. **Entries close July 6th.**

**July 14th to 17th, at Hawick.**—Scottish Bee-keepers' Association, Exhibition of honey, wax, and appliances, in connection with the Highland and Agricultural Society's Show. Open to all British bee-keepers. Liberal prize-money. Write for schedules to A. Aikman Blair and John L. Gibson, joint secretaries, 176, Bruntsfield-place, Edinburgh.—**Entries close 7th July.**

**July 24th and 25th, at Cardiff.**—The Glamorgan B.K.A., in connection with the Cardiff and County Horticultural Society's Show, in the Sophia Gardens, Cardiff. Open classes include:—Collection, Gift, Sections, Beeswax, &c. Schedules from W. J. Wiltshire, Maindy School, Cardiff.

**July 23rd, at Bath.**—The Annual Show of the Somerset Bee-keepers' Association, in connection with the Larkhall Horticultural Society. Seven Open Classes. Schedules from J. W. Brewer, Glen Lynn, St. Saviour's Road, Bath. **Entries close July 18th.**

**August 26th, at Prestbury.**—Honey show, in connection with the Prestbury Flower Show. One class open to the kingdom. Several for those within 12 miles radius. Exceptional prize list. Schedules from A. H. Bowen, Coronation-road, Cheltenham.

**September 1st, at Deddington.**—Honey show in connection with Deddington Horticultural Society's Show, to be held in the Castle Grounds. Open classes for honey. Schedules from H. J. Harmsworth, Deddington, Oxon.

**September 2nd, at Lancaster.**—Agricultural Show, Premier Honey Show of the North. 15 classes; £20 in cash prizes, silver cups and medals value 15 guineas, and other specials. Send for schedule (Honey) to Robert Gardner, solicitor, 69, Church-street, Lancaster. **Entries close August 19th.**

## WEATHER REPORT.

WESTBOURNE, SUSSEX.

April, 1914.

Rainfall, 1.80 in.	Minimum temperature, 31 on 8th.
Above average, 1.3 in.	Minimum on grass, 23 on 8th and 9th.
Heaviest fall, .40 on 5th.	Frosty nights, 3.
Rain fell on 11 days.	Mean maximum, 58.3.
Sunshine, 243.7 hrs.	Mean minimum, 40.8.
Above aver., 65 hrs.	Mean temperature, 49.5.
Brightest day, 28th 13.2hrs.	Above average, 3.3.
Sunless day, 1.	Maximum barometer, 30.575 on 26th.
Maximum temperature, 72 on 20th and 29th.	Minimum barometer, 29.458 on 7th.
	L. B. BIRKETT.

## ECHOES FROM THE HIVES.

Bees in this district seem to be going strong. I have taken a swarm which issued from a hive that has filled a rack of sections sufficiently full to warrant giving the second. The fruit blossom is particularly fine, the bees are just commencing work on the apple. "Isle of Wight" disease has not disappeared yet, but I have only seen one case, and that was where a man increased too much, and the weaker lots succumbed. This is certainly an excellent opportunity for rapid building up with a view to increase where apiaries have been depleted through "Isle of Wight" disease.—Geo. STEVENTON, Bisley.

## Notices to Correspondents

CARNIOLAN (Stanford).—*Vicious Bees*.—

(1) Very likely. (2) All hybrids are vicious. (3) Yes. (4) No, she would most probably be lost. (5) Yes.

S. A. S. (Uxbridge).—*Wrongly-built Cells*.—Because the foundation used was made the wrong way about.

A. P. W. (Alfriston).—*Dutch Bees*.—(1) They can be had from Mr. J. C. Bee Mason, 27, Ashted Road, Upper Clapton, London, N.E. (2) We cannot say from personal experience.

NEWTON BY MIDDLEWICH (Cheshire).—*Various Queries*.—(1) You can remove the rust spots from your ripener by using "Vim" or "Monkey Brand" soap. (2) No doubt she was a deposed queen, and the bees had reared a young one to take her place, which is now heading the colony. (3) No, it is not at all suitable. Cane sugar should be used at all times. (4) Two bee-way sections are best.

MRS. D. H. STUART.—*Superfluous Drone Brood*.—(1) It is useless to cut out drone comb as you suggest, as the bees will only build it up again. You should close-space the frames to prevent drone-rearing. (2) Continue the feeding giving about  $\frac{1}{4}$  of a pint every third night until about the end of May.

D. M. (Polton).—*Wild Bees*.—(1) It is not a humble bee but a species, *Andrena fulvia*. (2) We are pleased to hear that your bees are now doing well.

H. T. (Worsley).—*Preventing Swarming*.—(1) Your plan will doubtless be successful. (2) About a fortnight or three weeks.

A. M. D. (Witley).—*Bees and Laurels*.—The bees are gathering nectar which is secreted by the laurels.

R. H. C. (Berkhampstead).—*Attempted Swarming*.—(1) The bees were attempting to swarm, but evidently the queen did not come out. It is possible, though not probable, that she is unable to fly. (2) It does not matter which way they run.

### Suspected Disease.

A. D. (Notts).—(1) There is no sign of disease in the bees sent, they have overladen themselves apparently, and died from exhaustion.

A. J. C. (Loughborough).—The bees have been chilled; there is no disease.

Pux (Birmingham) and ANXIOUS (Wisebeck).—The bees have died from "Isle of Wight" disease.

W. D. T. (Kilmarnock).—(1) The bees have evidently died through chill. (2) They are British bees. (3) We find no trace of "Isle of Wight" disease. You can do nothing but destroy the affected stock if it breaks out, there is no known cure.

### Special Prepaid Advertisements. Two Words One Penny, minimum Sixpence.

Orders for three or more consecutive insertions entitle advertisers to one insertion in "The Beekeepers' Record" free of charge.

Trade advertisements of Bees, Honey, Queens, and Bee goods are not admissible at above rate, but will be inserted at 1d. per word as "Business" Announcements, immediately under the Private Advertisements. Advertisements of Hive-manufacturers can only be inserted at a minimum charge of 3s. per  $\frac{1}{2}$  in., or 5s. per inch.

### PRIVATE ADVERTISEMENTS.

A FEW good section racks, complete, with dividers, follower, and wedge, 1s. 6d. each.—WOODLEY, Beedon, Newbury.

STRONG swarms for sale, 15s., carriage and box free.—NORRIS, Barracks, Cashel, Tipperary. v 48

HEATHER honey.—Several dozen fine quality screw cap, 12s. doz.—EDWIN GLOSSOP, Ambergate. v 49

ENGLISH BEES.—Several strong stocks, on wired standard combs, guaranteed healthy, 20s., 25s., 30s. each; travelling boxes to be returned.—CASS, Flaxley-road, Selby. v 51

EIGHT W.B.C. hives, joiner make, nearly new. 8s. each, a bargain; one observatory hive, for three stocks, well made, £1.—MARCH, builder, Horsford, Norwich. v 47

CAMERA,  $\frac{1}{4}$  plate Klito, folding model, R.A. lens, auto shutter, A release, one double dark slide, as new, 19/-; Wonder honey extractor, takes standard or shallows; exchange for swarm, or offers.—F. B. L., 82, High-street, Hythe. v 46

FOR SALE, five splendid stocks Scotch bees, healthy, 1913 queens, 30s. each, or with good secondhand hives, 40s. each, f.o.r., cash.—GEO. W. PAISLEY, Wayside Apiary, Newport-on-Tay. v 42

WANTED, healthy bees; also honey; price, carriage paid.—HATT, 280, Broadway, Bexley Heath. v 31

SIX beehives, 10s. each; particulars.—E. BURTON, Hatfield, Doncaster. v 32

WANTED, natural strong swarm of Carniolans or Italians, guaranteed healthy.—CHEESMUR, Cuff's Cottage, Worth, Sussex. v 33

SEVEN beehives, standard frames, complete, nearly new, £5 the lot; various appliances thrown in, or 16s. separate, free on rail.—APPLETON, Leigh Sinton, Malvern. v 34



---

 THE ROYAL SHOW.

Those intending to exhibit at the Royal Show at Shrewsbury on July 30th must note that the entries close on May 30th, therefore they should be sent in at once to the Secretary, B.B.K.A., 23, Bedford Street, Strand, W.C.

In addition to the usual valuable prizes the W. Broughton Carr Memorial Gold Medal and the "W.B.C." hive offered by Col. T. H. Jolly are further inducements to compete, apart from the valuable asset of prize cards when marketing.

---

## LECTURE ON "ISLE OF WIGHT BEE DISEASE."

There are a few people who pride themselves on being large bee-keepers—or, shall we say, large "possessors" of bees?—whose sole object is to get as much out of the bees with as little trouble as possible. They do this without the slightest consideration for the welfare of other bee-keepers, especially of the cottager, whom they look upon as a parasite on the monopolist who ought to be driven out of existence, and have evidently taken as their motto the advice given by the avaricious man to his son when sending him out into the world, "Get money, get it honestly if you can, but *get it*."

Some make not the slightest endeavour to do good for the craft, but use every means of thwarting progress because it might touch their own pocket, while others are "Agin the Government" on personal grounds owing to its refusal to give them publicity or employment on account of their incapacity as either teachers, writers, or practical bee-keepers, their knowledge being limited to their ability and audacity in copying the work of others to pass off as their own.

Very different is the attitude of others, amongst these Mr. C. H. Boccock, of The Elms, Ashley, Newmarket, one of the *largest bee-keepers in the country*, by whose energy a treat was supplied to those attending a special lecture on the above subject given in the offices of *The British Bee Journal* on March 5th by an

eminent bacteriologist who has devoted years to study and research of "Isle of Wight Disease." Much useful information was given, and we print below an epitome of the lecture, which was illustrated by lantern slides. After the lecture demonstrations of the various forms of the parasite *Nosema apis* were given, both fresh and stained microscopical preparations being shown, which preparations contained all the salient forms illustrated by the lantern slides used during the lecture. We were much impressed by the vast amount of continuous research work that must have been done by the lecturer, and the readiness with which every question was answered, and each of the microscopes kept supplied with a succession of specimens for observations. Our one regret is that we cannot give illustrations of the specimens or yet one-half of the information imparted by the lecturer, both during the lecture and by answering questions after. A hearty vote of thanks to the lecturer and to Mr. Boccock for his unselfish labour in providing the means of obtaining a practical knowledge of the disease concluded a most useful and instructive afternoon.

---

Ladies and Gentlemen.—A consideration of the minute animal parasite, *Nosema apis*, that has been responsible for so much destruction among our little velvet-coated friends, the honey bees of Great Britain, must be of interest to all bee lovers. The life history of the tiny organism that causes the badly named malady, popularly known as "Isle of Wight" disease, will be set forth here in as simple a manner as possible. Every subject has a certain number of terms that are in constant use. These will be reduced to the smallest possible limits, and will be explained, and the explanation repeated, a procedure that it is hoped will be acceptable. At the close of the lecture, it is hoped that all will be able to stay and see specimens that have been brought, as they include practically every form of *Nosema apis*, the cause of "Isle of Wight" bee disease, better termed *microsporidiosis*.

In the first instance, it is necessary to point out that there is more than one disease among bees, and that in the experience of workers on the subject, deaths among bees have often been diagnosed as being due to "Isle of Wight" disease that are not attributable to *Nosema apis* at all. Starvation, paint fumes, chemical

vapours due to disinfectants used in cleansing hives, ordinary dysentery—due to feeding on fermented pollen—foul brood, and in some cases other minute animal parasites have been responsible for the deaths of the bees, supposed to be the victims of *Nosema apis*.

Again, the symptoms of bee diseases have an extraordinary resemblance to one another, and there are practically no external signs which serve to distinguish the victim of "Isle of Wight" disease from the bee stricken to death with dysentery. This can be easily understood if the very small range of expression of the bee's feelings is remembered. It cannot express its sufferings by voice or sound; it cannot indicate the seat of the trouble, nor can it apply remedies. The only thing of which it is capable, when it is stricken by disease, is to cease its active flight and to utilise the feeble energy left it in crawling sadly to the top of a blade of grass or other vegetation near the hive, whence it endeavours to launch itself into the air and thus gain the alighting-board. Thus, practically whatever may be the cause of the trouble, the symptoms are the same.

The disappearance of bees from the hive, without the presence of many dead bees within or around it, has often been described as a mystery. The solution of the mystery is often found when it has been possible to find the favourite drinking place of the bees. Incidentally it must be borne in mind that bees often prefer stagnant water that is somewhat warm to perfectly fresh and clear but cold, water. A visit may now be paid in imagination to a secluded drinking place of bees in a district where "Isle of Wight" disease (better called *microsporidiosis*, since it is produced by tiny spore-forming animals) is rampant. Drinking at this spot are a number of bees. Many are seemingly healthy, but among them there are infected bees. They drink greedily, but when a newcomer alights near one of the infected members, should the abdomen of the latter be slightly touched, almost instantly a quantity of semi-digested food forming the feces of the bees is discharged. Some feces enter the water, other particles bespatter the neighbouring bees, yet other portions foul the soil, where they dry rapidly, become powdery, and may be carried by the wind to adjacent flowers or foliage, or into the water. The feces naturally contaminate the water, but do not render it offensive to other bees, who continue to drink the water greedily. Those soiled by the infected bee proceed to cleanse themselves and their neighbours, and their very cleanliness is fatal to them, for by the cleansing processes, as equally by means

of the fouled water, they absorb the seeds of disease into their food canals.

If a tiny particle of the excrement of a heavily-infected bee is examined under the microscope, and magnified about 1,000 times, mingled with the partly digested pollen a number of tiny oval bodies with a shining appearance, and looking very like rice grains (though actually about  $\frac{1}{10000}$ th size), are seen. These small, oval bodies can resist both high and low temperatures, and can live for a very long time. They are called spores, this name being given them partly on account of their small size and great powers of resistance. Spores of the parasite *Nosema apis* are found in the feces of infected bees, and as the latter are unable to take their usual cleansing flights, defecation occurs within the hive in many cases, and thus honey, pollen, and wax become contaminated and infective to bees that feed on them or work on the soiled foundation or combs. Drones also can become infected and act as perambulating dispensers of disease, their roving habits being well known. Protected probably by their odour, they seem to be tolerated in any hive they choose to visit, and drones coloured artificially have been observed and found to visit several hives in the course of a few hours. Queens likewise become victims of the disease, and die of it. Larvæ also can become infected, either by being fed on already infected food or by receiving the infection from their nurses, when they are being fed by them. To sum up, the infection of individual bees is brought about chiefly by means of infected food and drink.

The infection of new stocks can result from the entrance of infected individuals, but the disease also can be spread from stock to stock by the wind. This is particularly the case when the hives are at different levels. If the first infected one is at a higher level than some others, and the wind blows from above downwards, then dust containing spores of the parasite is carried by the wind and deposited on the foliage or ground intervening between the two sets and also on the lower hives. Some of the spores thus are carried into positions where they can easily reach the hitherto uninfected stocks. This process is aided when a high wind carries the spores into puddles at which the bees drink, or deposits the dust on or in the hive in such positions that the bees proceed to clear it away. Robbing is a fertile cause of spreading; also wasps, ants, and other bee enemies aid in spreading *Nosema* spores, which, in many cases, pass unharmed through their bodies. Causes of spreading such as the last-named can be controlled to some extent, but there is one source of infection that no bee-keeper can

guard against. Some bees, fortunately for themselves, but unfortunately for their neighbours, have acquired a certain amount of immunity to the parasite, which can live and multiply within them, but does not affect them seriously, so that they live about as long as ordinary, healthy bees. These bees, which are called parasite carriers, are veritable flying reservoirs of disease, to be placed in the same category as the unfortunate men and women who, while healthy themselves, spread typhoid fever wherever they go. Against the parasite carrier no precaution can be taken, and many an apparently mysterious outbreak in a hitherto unaffected district is due to the agency of the parasite carrier.

Having thus briefly indicated the main ways by which disease is spread, the series of events within the bee may now be considered.

When the tiny spores of the parasite enter the bee, usually with the infected food or drink, they pass unchanged through the œsophagus and enter the honey stomach. As a rule, nothing happens to them there, and they pass through the stopper into the chyle or digesting stomach. Here the powerful digestive juices of the bee are at work, and under their influence the spore coat becomes softened. Then part of the spore contents, in the form of a long, thin, elastic thread, called a polar filament, is shot from the spore, and serves to anchor it to the wall of the chyle stomach. When anchored, one very tiny, active germ creeps from each spore and proceeds to move actively over the wall of the gut by pushing out one portion of its body and withdrawing another. Thus it gradually progresses by means of these protrusions, called pseudopodia. This wandering form of the parasite is called a planont, a word meaning wanderer, and just so long as it wanders about it is termed a planont.

After a time the planont ceases to wander, and gradually insinuates itself into one of the large digestive cells or pierces between them and reaches the body cavity lying beyond. The first case is far more common than the second, and so will be considered in detail. The tiny planont, or primary infecting germ, consists of two parts: (1) The body substance that breathes, feeds, and excretes, termed the protoplasm, and (2) a more or less central controlling part, termed the nucleus, that regulates the various processes of the protoplasm, and, in addition, initiates and controls the multiplication or increase in numbers of the organism. When the planont has penetrated a digestive cell, it loses its irregular shape and becomes more or less rounded. For a short time it grows steadily, feeding on the living sub-

stance around it, and destroying the cell substance as it does so. Then the controller, or nucleus, begins to divide into two, and when two nuclei are thus formed, the division of the body substance follows, so that now two parasites exist, where before there was but one. Each grows quickly, and then divides again, and the division is repeated so rapidly that soon the cell becomes crowded with the young parasites. Each of the dividing forms is called a meront, and a very large number of meronts can be produced from one planont. Thus, when a number of spores is swallowed by a bee, the number of meronts may become enormous in a very short time. In fact, many bees die from the effects of the meronts upon them and thereby cut short the life of those parasites that have not progressed beyond the meront stage. The meronts do grave damage to the bee's food passage in two ways. It must be remembered that the bee forms its digestive juices in a somewhat peculiar way. The chyle stomach of the bee is lined by large cells shaped somewhat like a round-headed nail. They have a large globe-shaped head, which faces the gut cavity, and a stalk, containing the nucleus, that nearly touches the muscle layers of the bee's food passage. When there is little or no food in the chyle stomach, these large cells secrete digestive juice, which forms a number of droplets within them. But when food enters the chyle stomach, instead of the droplets of digestive juice being discharged, the rounded head of each cell containing them is cast off bodily, and until it bursts the digestive fluid is not set free. As the stalk of the cell containing the nucleus of it is left behind, a new head is soon grown, ready to form more digestive juice as required. But if a *Nosema* parasite has gained access to the cell, not only does the cell use its energies in trying to check the parasite, but it also loses the power of forming digestive juice, and gradually dies. Further, the nucleus becomes weakened, and even destroyed, so that new digestive cells are no longer formed. Thus, not only do the digestive juices of the bee fail for a time, but the bee becomes incapable of forming more, and any new food taken, instead of serving as nourishment for the body, merely acts as a mechanical irritant to the already injured food passage.

(To be continued.)

---

#### HONEY IMPORTS.

The value of honey imported into the United Kingdom during the month of April, 1914, was £4,747.—From a return furnished to the BRITISH BEE JOURNAL, by the Statistical Office, H.M. Customs.



*The Editors do not hold themselves responsible for the opinions expressed by correspondents. No notice will be taken of anonymous communications, and correspondents are requested to write on one side of the paper only and give their real names and addresses, not necessarily for publication, but as a guarantee of good faith. Illustrations should be drawn on separate pieces of paper. We do not undertake to return rejected communications.*

#### WHAT IS PURE HEATHER HONEY?

[9023] Can you, Messrs. Editors, or any of the readers of the "B.B.J.," give a definition of the standard of heather honey? What per cent. heather should exist in it? Can any action by an Inspector of Foods and Drugs under the Act be taken in this respect? *i.e.*, is it any use calling his attention to the question? The reason I ask is because a quality of honey, which may be good as it stands, is labelled and sold as "pure heather honey," whereas it is obvious from colour, taste, and aroma, that it is nearly all clover with a trifling per cent. of heather mixed in it. In this district is produced one of the finest heather honeys obtainable, and we bee-keepers here feel we have a great grievance when any sort of honey can be labelled pure heather without our having any means of redress. Seeing that the price of pure heather honey is 50 per cent. greater than that of clover, it is plain that there is a substantial gain in wrongly describing a cheaper grade of honey as "pure heather," and it also reacts unfairly on the price of the real thing.—CAMPBELL R. PINKNEY.

#### EARLY SURPLUS.

[9024] On the 6th inst. I took 30lbs. of surplus honey from one of my stocks, and have six or seven stocks with even more ready, all in shallow frames. This seems to me very early, and I think it may be of interest.—W. F. F., Ilford.

#### PLANTING HEDGE AND PROVIDING WATER FOR BEES.

[9025] In reply to the query (8925, No. 8), on page 188, would not the American Flowering Currant be good for bees? It makes a fine hedge, and the clipping does not seem to interfere with its flowering.

A suggestion as to a drinking place for bees occurs to me. Any tub or deep vessel in which the water would not dry up, with some plants of Frog-bit (*Hydrocharis*) floating in it. My bees frequent a tub and stand on the Frog-bit leaves to drink. One could in this way add cinnamon or any other substance to the drinking water. I could supply a limited number of Frog-bit plants to any fellow bee-keepers who wanted them.—IDA H. JACKSON, The Godolphin School, Hammersmith, W.

*Sugar v. Honey.*—"Science shows that honey contains mineral salts—salts of iron, potash, lime, phosphates, &c., and that these are *indispensable* to the formation and maintenance of living organisms. Since sugar is almost entirely deprived of these salts, bees fed almost solely on sugar must necessarily deteriorate." It is often contended that bees subsist best on sugar syrup during winter, and I rather subscribe to the doctrine, but the case is entirely different when we come to deal with breeding and the building up of tissue. Here the above salts present in honey are lacking in sugar syrup.

*Longevity.*—It has often been observed and commented on that a stock of bees where breeding is kept up at an abnormal rate lags behind in the race for the first rank in honey-surplus. I know that repeatedly Italians boiling over with bees and covering eighteen standard frames yielded infinitely less super honey when working at the heather than the Blacks did, with apparently a much smaller force of bees. I am inclined to attribute this curious result to somewhat kindred causes as are named by a recent writer in *Gleanings* under the above heading. His contention is embraced in the following three propositions:—(1) A good queen may easily lay sufficient eggs to build up rapidly and keep a colony strong, but the bees produced may be a little below the average in length of life. (2) A colony of average strength may produce good results, because the bees live a little over the average, and such a colony will be really strong in working force, while only fair in young bees. (3) A colony may be of average strength and produce an average crop of honey because the death-rate may equal the rate of increase. There is certainly food for thought here. If "longevity" is possible, how can we best secure it in breeding our queen-mothers?

*Points in Queen-rearing.*—Eliminate queens whose progeny show bad temper, all heavy propolisers, those given to superfluous swarming, bad winterers, defective cappers, queens yielding soft bees; don't breed for beauty alone, because it is only skin-deep. I never saw a hive of bees that had *all* the good qualities in perfection with none of the bad. All honey-producers know that there is a great difference in the production of honey from different colonies headed by queens bred from the same mother, and this difference cannot always be accounted

for, even by the most experienced apiarists or queen-rearers. Bees are only like other animals or humans in this respect. Perhaps in the case of queens a good deal depends on the age of larva selected, and, as one writer lately suggested, on the size of the cell, or, alternatively, I would say, on the nature of the feeding. Parliament is now enacting a law to secure *pure* milk for the infant generation!

*Motor-boat Transit.* — Our American cousins have gone one better than anything I have heard of on this side. "In Florida the prevailing means of going to and from yards is a gasoline launch. One of the great advantages is smoothness of running." Even there they have drawbacks, for unfortunately most of the good

such a way that they will get a supply of nectar and flour, both on the same trip."

*College Bee-keeping.* — "Educational work of this kind is coming to be recognised more and more, not only in our public schools, but also in our agricultural colleges, the two most prominent being Amherst, Mass., and Guelph, Canada." On this side we are advancing on the same lines. *Propos* of this endorsement it may be advisable to state that my appointment over a year ago as Instructor and Lecturer in Bee-keeping in Aberdeen Agricultural College never matured, owing to the Board of Agriculture withholding sanction for the expenditure, because they were not consulted in the early stages. Sanction has, however, now been obtained.



NEW ZEALAND BEE-KEEPERS.

A Field Day of the South Taranaki Bee-keepers' Association, held at the apiary of the President, Mr. F. C. Baines, at Te Roti, New Zealand.

locations are remote from rivers, bays, and lakes.

*Natural v. Artificial.*—Messrs. Root have been investigating the question of pollen derived from natural sources compared with that supplied in the shape of flour, &c., and unhesitatingly declare in favour of flower-pollen as against flour-pollen. One of their operators favours the idea that we might be able to get practically the same result if we could feed both at the same time. "Thin nectar should be fed to the bees in

but I had previously withdrawn my name owing to the prolonged delay. The appointment is likely to be advertised soon—and I wish it to be known amongst bee-keepers that my name will not be available as a candidate.

*Larva for Queen-cells.*—Professor Baldwin, the new "Associate" Editor of *Review*, supplies the following useful hints: "For lifting the young larva from the worker-cell, have the smaller end of the cell-grafting needle slightly coated with royal jelly, then a very slight contact with

the tiny larva will be sufficient to adhere and draw it up with the needle. If you don't get it up at the first attempt, let that one go, and try a new cell." It is becoming more and more a confirmed truism amongst queen-breeders that the younger the larva transferred the better is the guarantee that the resulting queen will be a thoroughly reliable mother, other things being equal.

## QUERIES AND REPLIES.

[8928] *Artificial Increase.*—I shall be much obliged if you will advise me in the "B.B.J." if the following would be a successful plan of increasing my stocks? I have four strong colonies of English bees, and propose, when the honey-flow is well on here, taking a frame or two with bees out of each hive and starting a fresh colony, putting in an Italian queen. How soon could the queen be put in, and would she have to be caged?—G. W. L., Hereford.

REPLY.—You must not do as you suggest, but adopt the following plan. As soon as all the combs are crowded with bees, take from each of three hives two combs of brood, brushing back the bees. Move No. 4 hive ten yards away, and put the new hive with the six combs of brood, and four frames of foundation in its place, to get the flying bees. In twenty-four hours introduce the Italian queen by caging. If the plan you suggest was followed you would get only a few bees to stay, and they would probably fight. Where the combs are taken out put in fresh frames fitted with foundation.

[8929] *Various Queries.*—I shall feel obliged if you will answer the following questions in "B.B.J.":—(1) I have twelve partly filled sections of last year's honey. Can I return them to the hive this season to be filled and sealed? (2) There is wax-moth in my hive, also a small kind of maggot living on the top of the frames. I placed a piece of wood under the quilt to allow bees to clear them away, which they started doing as soon as I raised the quilt. Have I done the right thing? (3) My bees are not increasing in number. I do not know the age of the queen. Could I introduce a young queen on one side, divide the hive in the middle, and leave the old one on the other side? (4) I have noticed many humble bees with every sign of the "Isle of Wight" disease. Is it known if these bees are suffering from it too?—NOVICE, Wimbledon.

REPLY.—(1) Yes, if not granulated. (2) Take away the wood and use either Naphthaline or Apicure in the hive. (3) Remove the old queen altogether, and twelve hours later introduce the young one. (4) It is quite possible.

[8930] *Suspected Laying Worker.*—I shall be obliged if you will tell me in an early issue of your JOURNAL whether one of the Italian bees I forward is a fertile worker. A neighbour's hive was found to be queenless this spring, and yet eggs have been laid in patches and drones hatched for over a month now. We have carefully gone over the frames and caged for your inspection what seemed to us the likely layers. Is there any danger of the bees in such a hive rejecting a fertile Italian, supposing we have failed to find this wrong-doer? Thanking you in anticipation.—GEO. P. WALKER.

REPLY.—It is impossible for us to say if any of the workers are fertile or not, as we have not the time to make dissections. The only way to get the bees to accept a fertile queen will be to cage her on a comb of normal unsealed brood from another stock.

[8931] *Novice's Queries.*—I shall be very grateful for answers to the following:—(1) Can you tell me why the bees I am enclosing have been expelled from the hive? (2) On the 22nd April I found the brood-nest in the hive was full of brood, and put a rack of shallow frames on, hoping the queen would lay in them but she did not, and the bees in a few days had filled them with honey. Did I do wrong in putting in the shallow-frames?—A. M. S., Kettering.

REPLY.—(1) The bees are drones, which have been killed off on account of the cold weather. (2) You did quite right, which is proved by the surplus obtained.



*Hope on, Hope Ever* (p. 155).—Mr. Copleston might have given us the rest of Gerald Massey's line to encourage us in our hope that this dread disease is really passing. I cannot turn to it at the minute, and I am not quite sure how it goes, but I think it is thus: "After darkest night comes full of glad some day, the laughing sunshine." And that is just what we want to be assured in our depressed moments. But if ever there was a



class inclined to hope, it is agricultural, and of all its individuals I think the bee-keeper is the most consistently optimistic. He is always hoping for a better season, buoyed up, no doubt, by happy memories. Hope on, brother, hope ever, and good fortune attend your onward way.

*Sanded Alighting Boards* (p. 156).—May I endorse what Mr. Campbell says about the usefulness of these? There are other and more elaborate devices towards the same end, but the sanded board is simple, cheap, and effective. The only objections are that moisture, dew, perhaps, appears to collect upon them at times, and that they get rather dirtier than the plain board. They are particularly useful where the entrance is unprotected by a porch. Is there, however, any reason why hives should not be fitted with much larger porches, removable at will? I think that a device which would be at once porch and swarm-catcher might fill a want. A kind of claustral chamber adapted to take frames, and fitted with removable fronts. The lower portion of the front could be fitted with excluder, or this might be entirely closed, and, of course, opened so that the bees could fly straight into the annex.

*Box Hives* (p. 166).—Mr. Isaac Hopkins may be right in styling me evasive in controversy, but he is certainly not justified by the material upon which he bases his accusation. At least, I had no intention of evading any portion of the issue. My confidence in the strength of the case is too great to cause me either to resort to such childish methods, or to indulge in personal abuse of my sincere opponents. I certainly did not limit the term "box-hives" to cracker-boxes. My actual words were "cracker-boxes or any old thing that comes first to hand." Now, will Mr. Hopkins kindly understand that as including his barrels and boxes, and any other base vessel he cares to mention. But I particularly request him not to include the skep in his condemnation of such "hives." There is a dividing line which is too strongly marked to be over-ridden by careless generalisation, and no amount of misused language can make a basket into a box. It is my fault that I do not remember the explanation to which Mr. Hopkins refers, and I shall be glad to have chapter and verse. But I am not without grounds for supposing that all colonials do not adhere rigidly to the explanation. This is the case so recently as January, 1914, and if Mr. Hopkins will turn to the "B.B.J.," page 4, he will find the following by a writer with a name singularly like his own: "Immovable comb hives . . . be they skeps or box-hives." The writer proceeds to make especial reference to "the latter"! And

that I will leave Mr. Hopkins to explain away as best he may.

*Skeps* (p. 166).—Mr. Hopkins asks me particularly whether I use the "common straw skep." Now, I do not know what trap Mr. Hopkins has ready for me, but I will answer him as fully as possible, and let him develop whatever argument he wishes. I have no colonies in skeps to-day, but I have often possessed them, and I expect shortly to have some more. Such skeps as I am able to obtain are of the "common" type. The bees are usually worked into frame-hives under my methods, but they invariably spend one winter at least in their original domicile. I have no winter losses with them, which is not always the case with the frame-hives, and they form a useful reserve. I transfer them as soon as convenient, because I am primarily a frame-hivist, and my methods are those of my class. I am a frame-hivist because, if I may say so, I am sufficiently intelligent to be able to appreciate the advantages of the frame-hive, and I personally find the frame-hive more profitable than the skep. The skep is not, however, without important advantages, even to me. Now, if that is not the full answer which Mr. Hopkins requires I shall have pleasure in adding to it, but it will, no doubt, be sufficient text for his purpose. I have already stated my belief that the skep is adapted to the needs of the common skeppist, or it would hardly have survived the competition of the frame-hive. It could, I think be easily adapted, as I have already suggested, to the requirements of the purists. But the fundamental error these worthy gentlemen make, is to speak as though the skep were managed on the lines of the frame-hive. It is not.

---

#### OBSERVATION BIRD NESTING-BOX.

The man who is fond of bees is generally fond of birds too. It is natural that he should be so, as he has in him the love of living things. He is also an admirer of work.

Great was the wonder caused by the first observation hive, which made it possible for all the world to see everything that passed among the combs. It showed us the life of the bees, and everybody, even school children, can tell you at least something about bee life.

The science of bird observation, however, has not yet attracted the man in the street, or rather let us say, the man in the apiary, and as far as he at least is concerned, the secret of nest-building has rested with the birds themselves. True, we know how birds' nests are made, of what materials they are composed, and at what season of the year they are built. There are books that tell us all this—the

writers of the books have learnt all that they know by much patient waiting and the camera to aid them.

To the ordinary man, however, who has neither the patience nor the time to make observations of this nature, the bird life of his garden or his apiary passes unnoticed. All this is now altered by the invention of the "Observation" bird-box, by Mr. S. W. Abbott, of the well-known firm of Abbott Bros., Southall.

By its aid the whole process of nest-building and rearing the young can be most minutely examined, and the home life of the birds passes beneath our eyes. The construction of the "Observation" box is exceedingly simple; in form somewhat resembling the more ordinary form of nest-

Many different kinds of birds build in the "Observation" box; among the common kinds are the robin, tit, sparrow, and the wren, and as each of these builds a different form of nest, there is always something fresh and interesting to watch. The boxes can be obtained from Mrs. Wilfred Mark Webb, Odstock, Hanwell.

## Bee Shows to Come.

**June 9th-11th, at Malvern.**—The Herefords and Worcs. Agricultural Society's Malvern Meeting. Twelve classes for Honey, &c. Good prizes; small entry fees.—For schedule apply, Mr. A. Elliott, Hon. Secretary's Department, Cusop, Hereford.



VIEW OF OBSERVATION BOX IN USE IN THE OPEN. THE ENTRANCE IS FROM OTHER SIDE OF FENCE.

ing-box, it is provided on the top with an aperture or eyelet through which the observer can see clearly the whole interior of the box. The birds are not in the least disturbed by being observed, because they are unconscious of it. The opening and closing of the aperture is silent and unseen. In this way the nest can be observed from the first straw or bit of moss until, at the end of the breeding season, the young birds leave it.

The illustrations show very clearly how the box is fitted on to the inside of a shed or fence, which shields the presence of the observer from the birds as they approach it from the front. It is provided with a large hole in front to correspond with another hole cut through the fence or shed to which the box is fixed to give ingress to the birds. By regulating the size of this hole one can attract different species, some birds preferring a large and some a smaller hole.

**June 10th and 11th, at Waltham Abbey.**—Essex Bee-Keepers' Association Honey and Appliance Show, in connection with the Essex Agricultural Society's Annual Show. Judge, Lecturer, and Examiner of Candidates for B.B.K.A. Preliminary Certificate, Mr. W. Herrod. Schedules from G. R. Alder, 176, Hainault-road, Leytonstone. **Entries close May 31st.**

**June 10th and 11th, at Lichfield.**—The Staffordshire Bee-Keepers' Annual Exhibition, held in connection with the Staffordshire Agricultural Society's Show. Open classes. Liberal prizes. Judge, Mr. A. G. Pugh, Nottingham. Schedules from Claude R. Forse, Hon. Sec., Trentham, Stoke-on-Trent. **Entries close May 23rd.**

**June 10th to 13th, at Portsmouth.**—Hants B.K.A., Bee and Honey Show. Liberal prize schedule now ready. Write, E. H. Bellairs, Hon. Sec., Hants B.K.A., Christchurch.

**June 30th to July 4th, at Shrewsbury.**—Royal Agricultural Society's Show, Bee and Honey Section, under the direction of the B.B.K.A. Prizes arranged in groups of counties for Associations affiliated to the B.B.K.A. Schedules from W. Herrod, 23, Bedford Street, Strand, W.C. **Entries close May 30th.**

**July 8th, at St Albans.**—Honey Show of the St. Albans B.K.A., held in connection with the Elstree and Boreham Wood Horticultural Society, at Aldenham Park. Open class for extracted honey. No entry fee. Liberal prizes. Judge, Mr. W. Herrod. Schedules from Mr. R. H. Attenborough, Aldenham, Herts. **Entries close July 6th.**

**July 14th to 17th, at Hawick.**—Scottish Bee-keepers' Association. Exhibition of honey, wax, and appliances, in connection with the Highland and Agricultural Society's Show. Open to all British bee-keepers. Liberal prize-money. Write for schedules to A. Aikman Blair and John L. Gibson, joint secretaries, 175, Bruntsfield-place, Edinburgh.—**Entries close 7th July.**

**July 24th and 25th, at Cardiff.**—The Glamorgan B.K.A., in connection with the Cardiff and County Horticultural Society's Show, in the Sophia Gardens, Cardiff. Open classes include:—Collection, Gift, Sections, Beeswax, &c. Schedules from W. J. Wiltshire, Maindy School, Cardiff.

**September 2nd, at Lancaster.**—Agricultural Show. Premier Honey Show of the North. 15 classes; £20 in cash prizes, silver cups and medals value 13 guineas, and other specials. Send for schedule (Honey) to Robert Gardner, solicitor, 69, Church-street, Lancaster. **Entries close August 19th.**

## Notices to Correspondents

**J. D. (Kent).**—*Transferring Bees from Skep to Frame-hive.*—(1) Leave the skep on top of frames until the combs below are worked out and have brood in them. You can then get the queen

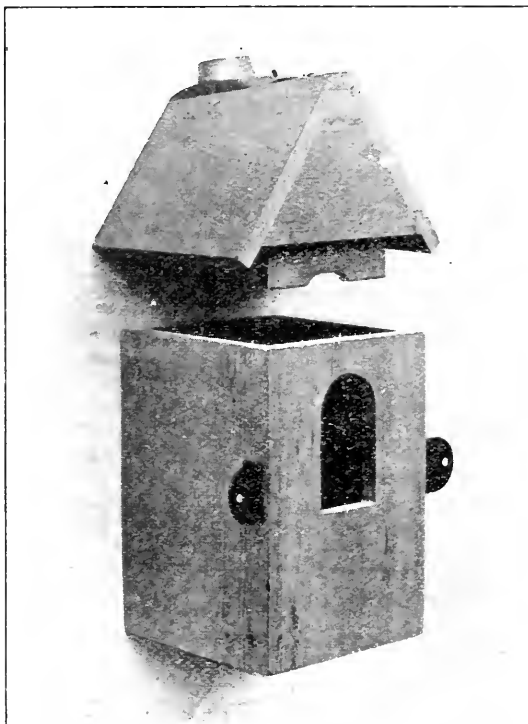

FRONT VIEW OF THE OBSERVATION BOX.

**July 23rd, at Bath.**—The Annual Show of the Somerset Bee-keepers' Association, in connection with the Larkhall Horticultural Society. Seven Open Classes. Schedules from J. W. Brewer, Glen Lynn, St. Saviour's Road, Bath. **Entries close July 18th.**

**August 26th, at Prestbury.**—Honey show, in connection with the Prestbury Flower Show. One class open to the kingdom. Several for those within 12 miles radius. Exceptional prize list. Schedules from A. H. Bowen, Coronation-road, Cheltenham.

**September 1st, at Deddington.**—Honey show in connection with Deddington Horticultural Society's Show, to be held in the Castle Grounds. Open classes for honey. Schedules from H. J. Harmsworth, Deddington, Oxon.

below, put an excluder between the skep and top of frames for three weeks to allow the brood to hatch out: then drive the bees from the skep and put a proper super in its place. (2) The larvæ is that of a worker killed by cold.

**J. E. (Bromsgrove).**—*Bees Re-queening Themselves.*—The bees have evidently superseded the old queen. Leave them alone, they will be all right now.

**ANXIOUS ONE (Devon).**—*Suspicious Mortality Among Bees.*—(1) We do not think the symptoms were caused by the sugar. (2) Yes. (3) You might spray

the combs with a 10 per cent. solution of formaldehyde. We fear from what you say that the bees are suffering from "Isle of Wight" disease, therefore, any combs that you suspect of coming in contact with them since October should be burned.

E. J. S. (Kew).—*Peculiar Coloured Honey.*

—(1) The honey is mainly from limes. (2) Certainly. (3) It is quite suitable for making mead.

C. PAIN (Dorset).—*Dead Young Bees in Cells.*

—The bees are drones which have either been allowed to die on account of the cold spell we have had lately or there is a laying worker or a drone-breeding queen in the hive.

J. W. (Meols).—*Dead Drone.*

—(1) Yes, the drone has mated a queen. (2) It would rather point to a swarm having issued some time ago without your knowledge.

J. H. W. (Andover).—*Suspected Queenlessness.*

—(1) No, but the queen is an old one. (2) It is pollen which has become mildewed.

E. M. P. (Guernsey).—*Failing Queen.*

—The queen is an old one, so she is laying but few eggs. We see no reason why the virgins reared by the stock should not be all right.

A. G. C. (Torquay).—*Honey Samples.*

—Both samples are very good, of the two that marked 7 is the better. They are certainly good enough to sell.

#### *Suspected Disease.*

J. J. W. (Glos.).—It is foul brood. Use Apicure.

F. E. C. (Essex).—(1) If you destroy the four stocks, as you suggest, you are adopting the only plan of checking the spread of "Isle of Wight" disease. (2) In the slight cases, Apicure will effect a cure.

W. A. H. (Bilston).—The bees have died from "Isle of Wight" disease. Destroy all combs, &c., following the instructions for disinfection so frequently given in our pages.

C. W. T. (Hull).—(1) The symptoms are those of "Isle of Wight" disease. (2) There is no known cure. (3) Yes.

J. A. E. (Norfolk).—The bees have "Isle of Wight" disease.

H. T. L. (Sussex).—(1) The bees marked No. 1 are apparently quite healthy. (2) Symptoms of "Isle of Wight" disease.

DORKING.—The bees were too dry for examination.

M. B. (Southwell).—We regret to say there is every sign of "Isle of Wight" disease in the bees sent.

B. C. W. (South Norwood).—There is no disease, the bees are drones cast out on account of the cold weather.

A. M. (Ponder's End).—It is "Isle of Wight" disease.

## Special Prepaid Advertisements.

Two Words One Penny, minimum Sixpence.

Orders for three or more consecutive insertions entitle advertisers to one insertion in "The Beekeepers' Record" free of charge.

Trade advertisements of Bees, Honey, Queens, and Bee goods are not admissible at above rate, but will be inserted at 1d. per word as "Business" Announcements, immediately under the Private Advertisements. Advertisements of Hive-manufacturers can only be inserted at a minimum charge of 3s. per lin., or 5s. per inch.

## PRIVATE ADVERTISEMENTS.

ADVERTISER will start capable person (any class) with swarm, and, if required, two frame hives and accessories; repayment by sale of one healthy May swarm (advertiser to bear all expenses of sale) and 3½ per cent. on amount expended each year (beginning next year) till expenditure repaid. Receipted bills of expenditure shown to bee-keeper.—Write, stating experience (if any), to S. OUSELEY, 58, Waldemar-avenue Mansions, Fulham, S.W.

MAY SWARMS, 15s.; June swarms, 14s.; three frames nucleus, 12s. 6d.; four frames nucleus, 15s.; cash with order.—J. REAVELEY, Starbeck, Harrogate. v 70

COWAN extractor, cost 50s., for 20s.; two Langstroth American hives, with new brood frames, 3s. 9d. each; all carriage forward.—HEATON, Eastview, Methwold, Norfolk. v 71

FOR SALE, swarms, from frame hives, guaranteed healthy, 15s. each.—J. M. WILKIN, Pymoor, Ely, Cambs. v 72

NATURAL SWARMS, guaranteed healthy, 3s. per lb. until the 15th of June; swarm boxes returnable.—DENNIS, Brownsover, Rugby. v 54

SEVERAL strong, healthy swarms, on four and five frames, wired, 14s. 6d. and 15s. 6d.; packed in boxes free.—MULLEY, Upton-on-Severn. v 76

MAY top swarms, from guaranteed strong, healthy stocks, "I.W.D." unknown in district, packed, f.o.r., 12s. 6d.—D. HARRISON, New Garden Nurseries, Whitby. v 74

THREE good hives, with section racks, shallow frames, dummies, &c., all clean and ready for use, 5s. each.—UTTLEY, Bamford-road, Didsbury, Manchester. v 73

LEAVING Derbyshire, going South.—Have no end hives and other appliances to sell, cheap, namely, best modern hives, geared extractor, ripener, body boxes, crates, shallow frames, sections, bargain for somebody, no disease, opportunity for starting.—BRYDEN, Buxton, Derbyshire. v 69

SWARMS, 15s.; 10-frame hive, 35/-; 7-frame ditto, 23s.—MISS GRACE, Terrick, Kington, Worcester. v 68

HEALTHY swarms, 13s.; second, 10s.; safely packed.—H. W. GLOVER, Biggin, Hulland, Derby. v 67

SIMMINS' "Double Conqueror," nearly new, extracting, new frames.—MANLEY, Besselsleigh, Abingdon. v 66

BEING compelled to reduce my apiary, I offer strong stocks, 25s. to 30s.; double Simmings' hive, sound condition, 25s.; W.B.C., 10s.; W.B.C., 5s.; combination, one lift, 6s.; combination, two lifts, 7s. 6d.; single walled, three lifts, 6s.; seen by appointment.—H. W. BROOK, Polygon, Bowdon, Cheshire. v 65

BEAUTIFUL queens, from my Cotswold apiaries, Native, 5s.; Golden, 5s. 6d.; crowded 8-frame colonies, for early June delivery, 24s.; book now.—BOWEN, Apiarist, Cheltenham. v 64

PRIME natural swarms, from healthy stocks, fine strain English Blacks; particulars, stamp for reply.—NORTH, Cressing, Braintree, Essex. v 63



## A GOLDEN WEDDING.

The greatest gift which an all-wise Creator can bestow on man is a good and wise helpmate, the valiant woman of whom the Canticles sing that her value is unappreciable. When He had created man, as the complement of His work, He saw that "it was not good for man to be alone," and therefore He bestowed on him a partner in his sorrows and his joys, and neither riches nor title nor power can measure against the worth that a good wife is to her husband.

And for the woman, what higher bliss does she ask than the affections of a good man, and the loving and caring for her children to train their minds in the way they should go.

So bound up together in mutual happiness it is natural that fit expression should be found to tell the number of years that pass by. We speak of a silver wedding as representing twenty-five years of married life, and many are proud that Heaven has so blessed them. Yet even to some few double that term of years is given, and this as the higher merit we call the golden wedding. There are not many who stay thus long. Is it presumptuous to think that such an extended period is given as some reward for a blameless life? We know not, but this we do know, that without the calm, quiet virtues of a life most aptly described by the adjective Christian there is almost an impossibility of it happening. And now the time has arrived when we can celebrate the fifty years of wedded life of Mr. and Mrs. Cowan. Often in the past must they have had expression given to them of good wishes for many years, but now is there one who reads this article who would not wish to convey to them heartfelt wishes for happiness until the very utmost term which Providence can give them?

It is difficult on such an occasion as this not to write about the sterling virtues of Mr. and Mrs. Cowan. These are well known to all, but we also know that nothing would give either of them more pain than to dwell on such a theme. So let that pass. But by his works ye shall know him—world-wide as Mr. Cowan's reputation is, full as his mind must be of the various matters in which he still concerns himself, yet he could write "We are visiting some of the places Mrs. Cowan and I visited when we were first married, and are able to show the places to our children. Yesterday, the 19th, was

our golden wedding day." And again, "We have had so many congratulations from quarters that I never thought would be likely to notice it." That he could write at such a moment so simply and unaffectedly reveals a serene and happy mind which is much to be envied.

We do not ask our readers' permission to tell Mr. and Mrs. Cowan (we know we have it without asking) that we all hope they will be spared for many years to enjoy in each other's company the rest which they have so well earned.—W. HERROD.

## BRITISH BEE-KEEPERS' ASSOCIATION.

The monthly meeting of the Council was held at 23, Bedford Street, Strand, London, W.C., on Thursday, May 21st, 1914. Col. H. J. O. Walker presided. There were also present: Messrs. C. L. M. Eales, J. Smallwood, J. B. Lamb, R. H. Attenborough, and H. P. Perkins (Association representatives), G. R. Alder and G. S. Fauch (Essex), D. Seamer (Lincolnshire), W. Young (Olney), G. J. Flashman (Barnet), G. W. Judge (Crayford), W. T. Saunderson (Northumberland), and the Secretary, W. Herrod.

Letters expressing regret at inability to attend were read from Miss Gayton, Miss Sillar, Messrs. T. W. Cowan, W. F. Reid, E. Watson, W. M. Vallon, F. W. Harper, and Col. H. F. Jolly.

The minutes of Council meeting held on April 16th, 1914, were read and confirmed.

The following new members were elected:—Miss S. Ouseley, Mr. A. G. Gambrell, Mr. F. W. Sibley, Mr. G. W. Kirby, Major W. J. R. Wingfield, Mr. W. Schröfel, Mr. G. S. Fletcher, Rev. H. W. Harcourt, Mr. J. L. D. Williamson, Mr. D. Jones, and Mr. G. J. L. Slater.

The Berkshire Association nominated Mr. A. D. Woodley as their representative, and the same was accepted.

The report of the Finance Committee was presented by Mr. Smallwood, who stated that the payments into the bank for April amounted to £18 9s. 4d., the bank balance being £219 19s. Payments amounting to £10 6s. 2d. were recommended.

May 19th being Mr. T. W. Cowan's golden wedding day, it was resolved unanimously that the following telegram be sent:—"Council of British Bee-keepers' Association send cordial congratulations to Mr. and Mrs. Cowan on occasion of celebration of their golden wedding."

Preliminary examinations were arranged for Swanley and Waltham Abbey.

The Essex Association applied for Mr. W. Herrod to judge at their show on

June 10th, and the appointment was sanctioned.

A letter was read from the South African Bee-keepers' Association *re* insurance, and the Secretary was instructed to deal with the matter.

Medals were granted for the Grocers' Exhibition at the Agricultural Hall, Islington.

The matter of syllabus for the Bacteriological Examination was discussed and the Secretary was instructed to write to Mr. Reid on the matter.

Next meeting of the Council, June 18th, at 23, Bedford Street, Strand.

### LECTURE ON "ISLE OF WIGHT" BEE DISEASE.

(Concluded from page 203.)

Meronts, when few in number, are usually oval or rounded, but when numbers of them are present, mutual compression occurs, with the result that many variations in appearance and size are seen. Sometimes the division of the nucleus is twice repeated before the separation of the body substance occurs, so that a meront with four nuclei is found. This form is common in some bees, less usual in others. At times, one nucleus of a meront with two nuclei may divide before the other, so that three nuclei occur, while an unequal number of divisions may result in five or seven nuclei in a string. In yet other cases, especially when the original meront formed between cells, a very large meront with numerous nuclei is produced.

Meronts do not remain as such indefinitely. Sooner or later, either as a response to the necessities of the animal itself or as a result of the reaction of the host upon the parasite and the diminution of its food supply, the organism prepares for life outside its present host. With this end in view each meront proceeds to modify its form, so that it can resist to the uttermost any disadvantageous circumstances that it may encounter during the period that intervenes between it leaving one host and entering the next. These changes that lead up to spore formation are termed sporogony.

Each uni-nucleate meront is destined ultimately to become one spore, but before the spore is fully formed the meront undergoes changes, both in its body substance and in its nucleus. A meront undergoing these changes becomes a spore-mother-cell or sporoblast. First it concentrates its body substance and becomes more or less oval. Two cavities, or vacuoles, form in it, one at each end. The first is known as the polar capsule, the

second as the posterior vacuole. The body substance, now called the sporoplasm, forms a girdle-like ring at the middle of the spore. Then a number of divisions of the nucleus occur, whereby five nuclei result. Two of them become threadlike and control the formation of the sporocyst, or spore-coat. One regulates the polar capsule and the remaining two are the nuclei of the sporoplasm. Meanwhile the sporocyst has been steadily thickening, and thus the ripe spore, with which the life-history of *Nosema apis* commenced, is reached again.

It is not an easy matter to see all the above described structures in a spore at one time. While these structures are attaining their final form, the spore-coat is steadily thickening and becoming very opaque. The result is that the processes going on within the spore can only be seen by the use of strong reagents, which make the spore-coat more or less transparent, and thus allow of a view of the interior and of the penetration of stains as the case may be. Also, as soon as the nuclei of the spore-coat and polar capsule have fulfilled their function, they begin to degenerate. Thus it is not always easy to obtain spores showing all five nuclei well at the same time. They may not have developed on the one hand, or, alternately, some, having fulfilled their function, are in process of disintegration.

When a bee dies all the forms of *Nosema apis* except the spores die also and decompose within a very short time, with the result that it is often with the utmost difficulty that meronts can be detected in a bee. Also, it is usually almost impossible to gauge the intensity of infection from examination of specimens that have been dead several days. Again, it not infrequently happens that defæcation is caused in collecting bees for transport for examination, a fact that increases the difficulty of diagnosis. Consequently it is necessary to have a number of bees—about fifty is desirable—in order that some specimens may be in the condition best suitable for examination, and to increase the possibility of finding spores of the parasite. It is important to emphasise the necessity of microscopical examination of bees before they can be said to be suffering definitely from "Isle of Wight" disease. Sometimes change of diet has a temporary effect in checking disease. In such cases, the main source of spores has been found to be the pollen and honey contained in the combs in the hives. The removal of the natural stores and the substitution of artificial food has thus removed the source of supply of the disease. Consequently, fewer re-infections and new infections *via* food have occurred, and a temporary recovery of condition of the

stock results. Most unfortunately, this rally is usually followed by a fresh outbreak, when the time necessary for the spore formation of *Nosema apis* in the already slightly infected bees has elapsed.

Numerous attempts at curative measures have been made during the last few years by the discoverers of the agent of "Isle of Wight" disease in British bees. Many have proved to be of no use, others give temporary relief. In one case a stock under treatment has survived two winters, but is in an enfeebled condition at the present time, as re-queening cannot be adopted for fear of introducing an infected queen to the stock. However, other experiments are in progress with the same drug, and it is hoped that they may be of service in the future. Neither time, trouble nor expense has been spared by the scientists engaged thereon, and to no one would it be a greater gratification than to them to be able to announce a cure for the disease. The hearty co-operation of the practical bee-keeper in the apiary and of the practical scientist in the laboratory is essential to the success of any scheme of tests calculated to be of service in combating bee disease.

Finally, a word may be added with regard to the races of bees and certain ideas prevalent as to their disease-resisting powers. From the examination of numerous stocks and strains of bees, it does not seem possible to pick out any special variety of bee as being more resistant to *Nosema apis* than others. British Blacks, Italians, hybrids, all alike fall victims. But there seems a possibility that some bees can acquire a certain amount of immunity to the *Nosema*, just as cattle can become "salted" with regard to other parasitic diseases. For this reason the history of the strains of bees, both healthy and diseased, is of importance in deciding whence bees shall be obtained for re-stocking. At the same time it must be remembered that the British climate may not be well suited to bees imported from abroad.

Unfortunately, most of the Continental countries have the same difficulty as England with regard to *microsporidiosis*. The importation of stocks of bees, and even of queens, from the Continent does not seem particularly wise, having regard to the widespread character of the disease. It is sincerely hoped that by systematic examination of stocks in the British Isles a race of relatively immune bees may be found, or that some means of increasing the powers of resistance of the bees will be discovered. For the present, the more thoroughly the disease is investigated by competent workers the more likely it is that the desired end will be attained and disease be banished.



By "Nemo."

#### *Instruction in Advanced Bee-keeping.*—

There is to be a course of instruction in the scientific branches of bee-keeping in connection with the Royal Horticultural Society in Berlin-Dahlem, from June 2nd to 13th, 1914. This course is intended only for expert bee-keepers, and not for beginners. Its object is to instruct in special branches of the study. Every student must bring with him a microscope with objectives 3, 7 and 1/12 oil immersion, and illuminating apparatus. These can be hired for the course on payment of 5 marks. The instruction takes place daily from 9 a.m. to 2 p.m., and embraces the following work:—

- (1) Introduction to microscopy, preparing microscopic objects of the anatomy of the bee.
- (2) Diagnosing bee diseases, microscopic examination and preparing sections.
- (3) Study of technical bacteriology, preparing culture media, staining processes, obtaining pure cultures of *Bacillus larve*.
- (4) Producing micro-photographs.
- (5) Preparing lantern slides.

The course of instruction will be conducted by Dr. Küstenmacher. Candidates for taking part in this instruction must apply to the Director der Königlichen Gärtnerlehranstalt, in Berlin-Dahlem. The subscription for the course is: For Germans, 18 marks; for foreigners, 36 marks; 5 pfennigs must be added for postage. Orders to be made payable to the Kasse der Königliche Gärtnerlehranstalt, Berlin-Dahlem, Post Steigltz.

#### *How often should Combs be Renewed.*—

There is a difference of opinion with regard to the necessity of renewing combs, some thinking old combs quite as good as new ones. In view of eradicating bee disease, Dr. Zander even recommends that all the combs in a hive be renewed every two years. M. Weigert has been carrying out experiments with the object of arriving at a satisfactory conclusion, and gives his views in the *Leipziger Bienenzeitung*. He says new combs are deficient in strength, and consequently are liable to be damaged during manipulation. Old combs are, however, much heavier than new ones, and contain the remains of the cocoons, many layers accumulating after a time. A new comb 17 by 21 centimetres and 25 millimetres thick weighs 22 grammes, and

10,000 worker cells in an empty comb weigh 65 grammes. A comb of this size completely filled with brood will weigh 125 grammes, and a similar comb of sealed honey weighs from 2lbs. to 3lbs. M. Weigert says that from long practice he has come to the conclusion that either by cutting out combs in straw skeps or removal of frames in movable comb-hives, it

is advisable to renew the combs every four years. This applies to all combs. In general, old combs can be used for surplus so long as they are in good condition, and retain the characteristic wax odour. He recommends more frequent renewal of combs in districts where disease is prevalent, and in this respect he agrees with Dr. Zander's recommendation.



### THE HIVING AND TREATMENT OF NATURAL SWARMS AND CASTS.

The term "swarm" is very often used erroneously by bee-keepers. Many times do we hear bee-keepers speak of the *swarms* of bees they have in the garden in the winter months. The following definition will probably help to abate the use of wrong terms. A "swarm" or "cast" is a cluster of bees and their queen only. A "colony" consists of bees, queen and combs, with food and brood. A "stock" includes the latter, together with the home in which the bees are living.



FIG. 1.

Swarming is the result of overcrowding, and is nature's method of increasing the number of stocks. Under normal conditions the queen commences to lay about the last week in January, only a small patch of cells being occupied at first. As the spring approaches, the growth of the brood nest is regulated by the clustering capacity of the bees the more bees, the quicker its growth, as a larger space can be kept warm. About May or June the hive becomes overcrowded, and it is then that the bees prepare to relieve the congested condition of the hive by swarming, and with this object in view, from four to a dozen queen cells will be built. The first outward indication of this preparation is a small cluster of bees hanging at the entrance towards evening; in a few days the cluster will remain all day long, as at the skep (Fig. 1). That the same condition will occur in a frame hive if not properly managed is seen in (Fig. 2). At this period very little

work is done beyond attention to the brood. When the most advanced princess is due to emerge from the cell in about three days' time, providing the weather is warm and fine, the swarm, consisting of from fifteen to twenty-five thousand old bees and the old queen, issues from the hive, the time chosen being generally between the hours of 10 a.m. and 4 p.m. If, when the above stage of preparation is reached, cold or wet weather occurs, then swarming is checked for a time; the bees often destroy the queen cells, and do not attempt to swarm for ten or twelve days. Before they issue each bee forming the swarm takes into its stomach sufficient food to last it for four days, the reason for this being obvious, when we consider that the natural home of the bee is in a hollow tree, devoid of combs or food; therefore nature has ordained that they shall be able to carry sufficient food for wax secretion and to last them until combs are built and stored with food in the new home.

The bees pour out of the hive and circle round in the air, making a contented



and musical hum, which the experienced bee-keeper can detect, even when many yards from the hives. Eventually they settle in a large cluster (Fig. 3).

It is a mistake to imagine that the queen leads the swarm; by numberless observations at the hive entrance, I find that the queen comes out when about half the



FIG. 2.

bees constituting the swarm have issued. The same thing applies to the clustering, or, as the old-fashioned bee-keeper called it, knitting; it is the workers who pitch upon the spot where this is to take place, and not the queen. This can easily be put to a practical test by watching the entrance of the hive from which a swarm is issuing, catching the queen when she comes out on the alighting board, and placing her in a match-box, which is put in the pocket for warmth; the workers will cluster in the usual way, until they discover the absence of the queen, when they return to the hive. The bees themselves often demonstrate this involuntarily, when, for some reason, the queen is unable to fly, they will come out and cluster for a short time, and then return as (Fig. 4). In the majority of cases swarms do not go very far before clustering. Occasionally they show a disposition to abscond by taking a long flight: if they show signs of restlessness and a disinclination to settle, mounting higher and higher in the air, it will be necessary to adopt some plan to bring them down. The old-fashioned and superstitious method of tanging by beating on the frying-pan with the door key, (Fig. 5) is useless, yet it is astonishing how many people, even amongst the better class, believe in it, and will attribute the frequency with which swarms issue on a Sunday morning to the metallic music of the church bells. That Sunday is a favourite day for swarms to issue is a well-recognised fact, the probable reason being their love of quietness and non-interruption in their work, hence their frequent choice of the quietest day of the week on which to swarm. An amusing instance of the credence given to these fallacies occurred some years ago, soon after my appointment at Swanley College. A swarm of bees settled on the railway embankment near the station, and three railway porters took it in turn to ring the station bell close to them for an hour, while I was sent for from the college to hive the swarm. The origin of tanging was as follows: Years ago, before sugar was known, our forefathers were more sensible than we are to-day, for nearly every cottager kept a few stocks of bees to produce a sweetening agent, more wholesome than the sugar used to-day. The bees were allowed to increase by natural swarming. The law with regard to

bees constituting the swarm have issued. The same thing applies to the clustering, or, as the old-fashioned bee-keeper called it, knitting; it is the workers who pitch upon the spot where this is to take place, and not the queen. This can easily be put to a practical test by watching the entrance of the hive from which a swarm is issuing, catching the queen when she comes out on the alighting board, and placing her in a match-box, which is put in the pocket for warmth; the workers will cluster in the usual way, until they discover the absence of the queen, when they return to the hive. The bees themselves often demonstrate this involuntarily, when, for some



FIG. 3.

bees themselves often demonstrate this involuntarily, when, for some reason, the queen is unable to fly, they will come out and cluster for a short time, and then return as (Fig. 4). In the majority of cases swarms do not go very far before clustering. Occasionally they show a disposition to abscond by taking a long flight: if they show signs of restlessness and a disinclination to settle, mounting higher and higher in the air, it will be necessary to adopt some plan to bring them down. The old-fashioned and superstitious method of tanging by beating on the frying-pan with the door key, (Fig. 5) is useless, yet it is astonishing how many people, even amongst the better class, believe in it, and will attribute the frequency with which swarms issue on a Sunday morning to the metallic music of the church bells. That Sunday is a favourite day for swarms to issue is a well-recognised fact, the probable reason being their love of quietness and non-interruption in their work, hence their frequent choice of the quietest day of the week on which to swarm. An amusing instance of the credence given to these fallacies occurred some years ago, soon after my appointment at Swanley College. A swarm of bees settled on the railway embankment near the station, and three railway porters took it in turn to ring the station bell close to them for an hour, while I was sent for from the college to hive the swarm. The origin of tanging was as follows: Years ago, before sugar was known, our forefathers were more sensible than we are to-day, for nearly every cottager kept a few stocks of bees to produce a sweetening agent, more wholesome than the sugar used to-day. The bees were allowed to increase by natural swarming. The law with regard to

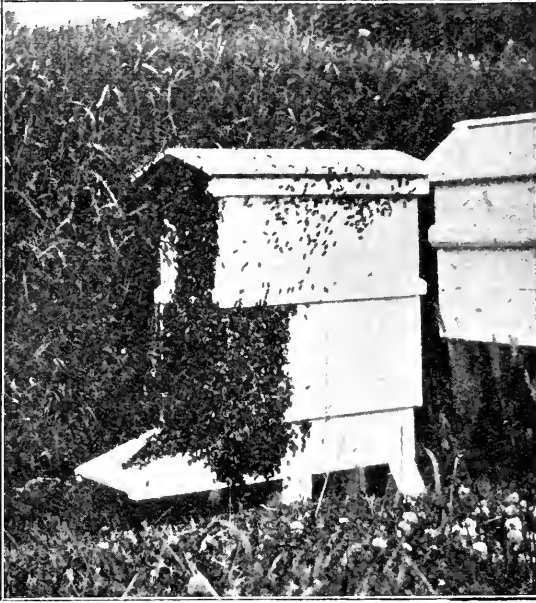

FIG. 4.

a swarm is that, if it is kept in view by the owner of the stock from which it issued, he retains ownership, and may follow it anywhere; if he does not see it issue, or loses sight of it, then his claim to it lapses. Therefore, in order that the neighbours might know whose bees were swarming, tanging was carried out to establish ownership. It has no effect upon the bees; therefore, instead of wasting time and annoying people by making an abominable noise, advantage should be taken of our knowledge of the bees' habits. They object to damp, and very rarely fly when it is raining; therefore, the use of a garden syringe to spray water amongst them will make them settle.

(To be continued.)

## CORRESPONDENCE

The Editors do not hold themselves responsible for the opinions expressed by correspondents. No notice will be taken of anonymous communications and correspondents are requested to write on one side of the paper only and give their real names and addresses, not necessarily for publication, but as a guarantee of good faith. Illustrations should be drawn on separate pieces of paper. We do not undertake to return rejected communications.

### ROSS-SHIRE NOTES.

[9026] Bees are in good condition here and securing some honey from the May blossom, although not enough to exist on. Stores are running short in most hives, and feeding is necessary to carry our strong colonies progressively onwards to the opening of the main honey-flow. Clover heads can now be seen in the fields, but June must be well advanced ere much honey is available from this source.

*Banning Banats.*—I note from recent contributions that many have been unfortunate in their experiences with the Hungarian bee. Personally, I am highly pleased with mine—the handsome Golden variety of Banats. Last June I imported three Golden queens direct from Hungary,



FIG. 5.

and introduced them to nuclei formed by artificially swarming a strong stock of Carniolans. Although started as mere nuclei in mid-June, the Banat colonies were storing in two racks apiece by August, while the total yield from the parent stock and its three nuclei was 150 sections. As regards present condition, my best colony is a Carniolan, closely followed by the three Banat stocks, next a White Star Italian, English bees after them, and Swiss bring up the rear.

*Swarming.*—Here anticipation is decidedly preferable to realisation. A swarm secured previous to the honey-flow is more to be desired than one that comes off and perhaps "goes off" during the height of the season. Start with a powerful colony, shaking the bees off all but two frames of brood, and fill up the vacancy with full sheets of foundation. The removed beeless brood is placed *en masse* on a fairly good colony, and the queen allowed full run of both storeys. Later, when this doubled colony gets crowded with bees, shake it also on full sheets of foundation with only two combs of brood. This leaves two boxes of brood to be placed on yet another medium-strength colony, giving the queen full liberty. The three-storey hive, with its immense quantity of brood, soon overflows with bees, but instead of being shaken is divided into four colonies. The queen, with two combs of brood and the flying bees, forms one colony on the old stand, while the removed brood with all adhering bees can be used to make other three good colonies.

A fertile queen can safely be introduced to each young colony on the evening of the day succeeding the division, and supers given shortly after.—J. M. ELLIS, Ussie Valley.

LEGISLATION FOR BEE DISEASE.

[9027] I notice in recent numbers of the "B.B.J." that there are a number of large bee-keepers who are opposed to legislation for bee disease and cannot understand any man taking up such an attitude. If an Act of Parliament is the means of protecting and preserving bees in this country, unless, of course, they oppose it from selfishness, I think it is the duty of every man, not the bee-keepers only, to support such an Act. Bees fertilise fruit and flowers belonging to the rich and poor man alike, thereby bringing them to greater perfection and abundance, and thus everybody is directly or indirectly concerned in the work of the bee. If fruit and vegetables are plentiful they are cheaper, so the poorer classes benefit. I know this is taking a wide view, but suppose, for instance, cattle had no legal protection, and disease broke out and many died, would not the cost of living go up? Well, the same applies to the bees. I think myself that legislation is all important, as bees affect the wealth of the country in the same way as cattle.

I cannot understand why the members of Parliament should pass this Bill over, which indirectly affects many other industries. It is every man's duty to protect bees in the same manner as cattle are protected, be they his own or not, for the

welfare of the country.—WORKING MAN, Croydon.

BEES AND FRUIT-SETTING.

[9028] We are often told that the presence of hive bees is practically essential to the setting of apple, pear, and plum blossom. Owing to the fact that "Isle of Wight" disease has cleaned out all the stocks in this neighbourhood I was able to test this statement, and cannot find that it is upheld by experience. I was working in the garden most of the time the plum and apple trees were in blossom, and during the *whole time* kept a constant watch for bees. I did not see a single hive bee in the garden during the period they were out, but they were visited *very occasionally* by various species of wild bees and hover flies.

When the apple was well out I bought a weak stock of Carniolans, but did not see any of them, or any other hive bees, in the apple blossom. As the result we are led to expect that there would be very little if any fruit. Instead of this there is a record set of all three fruits, and I am very busy thinning them. A far larger proportion has set than I have ever seen before when I had as many as eight strong stocks.

If only we had some good rain there is a fair prospect of a bumper crop of all these fruits, which, I feel confident, are fertilised by the agency of the wind and not insects.—G. H. L., Petersfield.

[Your contention is not supported by experiments made by both practical fruit-growers and scientists.—Eds.]



[8932] *Various Queries.*—During the winter of 1912-13 I lost the whole of my bees through "Isle of Wight" disease. They all died before many bees commenced flying, and as I destroyed dead bees, &c., and disinfected hives, there were no outbreaks of disease among neighbouring bee-keepers as far as I am aware, although I have made numerous enquiries. On May 1st this year I bought a stock of bees and placed them in one of my old hives, in a different garden altogether. I scorched the hive thoroughly, and afterwards washed the whole with strong carbolic solution. The first week that I had bees

was very wet and cold, but it has improved a little during the last few days. Although there are plenty of wallflowers and apple trees in bloom the bees have not worked on them very much. (1) Can you suggest a reason for this? (2) Could you tell me the name of flower enclosed? One rather cold, wet day bees were very busy working on it. This district seems very satisfactory for pollen, and I am afraid the combs will soon become so filled with pollen that there will not be sufficient room for queen to lay eggs. (3) What is the remedy? (4) Is "white carbon" useful in keeping off attacks of foul brood? (5) Is there any trace of disease in bees sent? I picked them up from the front of hive, where they had been accumulating during the last few days. (6) What kind of bees are they? I trust your paper will continue to be as helpful to me as it has been in the past.—UN.Y.Y.Z., Notts.

REPLY.—(1) We should say the paucity of bees is the reason you do not notice them working. (2) The flower is *Sedum hispanicum*, a native of Southern Europe. (3) Remove the combs and replace with foundation. (4) No, it will asphyxiate the bees. Use naphthaline. (5) We find no trace of disease in the bees sent. (6) They are of the English variety crossed with Carniolan.

[8933] *Law Relating to Swarms.*—Yesterday (18th), at about 10.30, I had a fine swarm of Sladen's British Golden bees from a skep. I successfully "took" them after finding the queen on the ground and placing her in the skep; they appeared to settle down all right, and I shaded them well from a very hot sun. Three hours afterwards, while I was preparing the hive, the bees left the skep and made for a neighbour's hive about 50 yards away, standing (empty for one or two seasons) next to one full hive, and settled there. I obtained permission to follow them, and in the evening, after much trouble (the old combs being infected badly with wax-moth and their débris), was fortunate enough to get them into my own hive. Will you kindly say what is the legal position in such a case? Am I within my legal right in claiming them? And in the (perhaps improbable) event of being refused, what is the remedy? I fully expect more swarms, and if history repeats itself, in the case of the voluntary hiving, and does not repeat itself in the permission to "follow," what is to be done? Into the ethics of leaving hives with the object of "taking" stray swarms I need not go, as this has been so often done in your columns, but one need not wonder at the spread of disease amongst bees when such a course is pursued. The much needed Bee Diseases Bill would remedy this.—A. E. B., Leicester.

REPLY.—You will find the information you desire in last year's volume of *BRITISH BEE JOURNAL*, at the following dates:—February 20th, page 80; June 5th, page 227; July 24th, page 485; and January 1st, 1914, page 8.

[8934] *Clarifying Wax.—Covering Hive Roofs.*—(1) What is the process of cleaning or clarifying dark-coloured wax, with sulphuric acid? Also the market price of good-coloured wax? (2) Please recommend a good material for covering roofs. Would a coating of tar or calico be suitable, and if paint is used how many coats are required? (3) Average weight of first swarms?—D. E. F.

REPLY.—(1) The process of refining wax is dealt with fully on page 81 of "Wax Craft." Market price from 1s. 4d. to 1s. 6d. per lb. (2) Cover the roof with calico as lightly as possible and then give three coats of paint at four-day intervals. (3) Four to five pounds.

[8935] *Dutch Bees.*—On May 29th, 1913, I bought one of the swarms sent over from Holland, from which I had no fewer than four swarms, the last one issuing as late as July 30th. Everything possible was done to prevent it, but without result. As I do not want to have the same experience this year (I have already had two swarms) I am writing to your paper, of which I am a regular reader, to know if you can give me any advice. It appears to me that Dutch bees require different treatment to that given to our English bees.—K. E. LEE, Sussex.

REPLY.—The difficulty with Dutch bees is their great swarming propensity. In Holland the bees are kept in skeps and are encouraged to swarm as much as possible, the honey being obtained by sulphuring the bees at the end of the season. We are sorry that we are unable to advise you how to prevent it, beyond re-queening with an English queen.

[8936] *Using Swarm-catchers.*—(1) Can you tell me if leaving swarm-catchers on for two or three weeks will cause trouble through keeping the drones prisoners so long? (2) Are there drones in all the hives? I can only attend to my hives two or three times a week. (3) Where can I purchase tin cases for 1lb. sections?—J. D., Swanwick.

REPLY.—(1) The cover should be lifted each evening to liberate the trapped drones, so do this whenever possible. (2) There are generally a few drones in each hive, but the number can be kept down by the use of full sheets of worker base foundation. (3) Tin section cases are seldom used now, cardboard ones being much cheaper besides looking neater. Try

Mr. E. H. Taylor, Welwyn, who will, no doubt, be able to supply what you want.

[8937] *Rearing Italian Queens.*—I shall be obliged if you will answer me the following in your next issue of "B.B.J.":—Would pure Italian queens be raised by placing Italian queen eggs in a queenless stock of Black bees, or should they be raised in an Italian stock?—W. I. Grimsby.

REPLY.—Pure Italian queens would be reared from the eggs, even though they were placed in a Black stock.

## Bee Shows to Come.

**June 9th-11th, at Malvern.**—The Herefords and Worcs. Agricultural Society's Malvern Meeting. Twelve classes for Honey, &c. Good prizes; small entry fees.—For schedule apply, Mr. A. Elliott, Hon. Secretary's Department, Cusop, Hereford.

**June 10th and 11th, at Waltham Abbey.**—Essex Bee-Keepers' Association Honey and Appliance Show, in connection with the Essex Agricultural Society's Annual Show. Judge, Lecturer, and Examiner of Candidates for B.B.K.A. Preliminary Certificate, Mr. W. Herrod. Schedules from G. R. Alder, 176, Hainault-road, Leytonstone. Entries close May 31st.

**June 10th and 11th, at Lichfield.**—The Staffordshire Bee-Keepers' Annual Exhibition, held in connection with the Staffordshire Agricultural Society's Show. Open classes. Liberal prizes. Judge, Mr. A. G. Pugh, Nottingham. Schedules from Claude R. Forse, Hon. Sec., Trentham, Stoke-on-Trent. Entries close June 4th.

**June 10th to 13th, at Portsmouth.**—Hants B.K.A., Bee and Honey Show. Liberal prize schedule now ready. Write, E. H. Bellairs, Hon. Sec., Hants B.K.A., Christchurch.

**June 30th to July 4th, at Shrewsbury.**—Royal Agricultural Society's Show, Bee and Honey Section, under the direction of the B.B.K.A. Prizes arranged in groups of counties for Associations affiliated to the B.B.K.A. Schedules from W. Herrod, 23, Bedford Street, Strand, W.C. Entries close May 30th.

**July 8th, at St Albans.**—Honey Show of the St. Albans B.K.A., held in connection with the Elstree and Boreham Wood Horticultural Society at Aldenham Park. Open class for extracted honey. No entry fee. Liberal prizes. Judge, Mr. W. Herrod. Schedules from Mr. R. H. Attenborough, Aldenham, Herts. Entries close July 6th.

**July 14th to 17th, at Hawick.**—Scottish Bee-keepers' Association. Exhibition of honey, wax, and appliances, in connection with the Highland and Agricultural Society's Show. Open to all British bee-keepers. Liberal prize-money. Write for schedules to A. Aikman Blair and John L. Gibson, joint secretaries, 176, Bruntsfield-place, Edinburgh.—Entries close 7th July.

**July 16th and 17th, at Boston.**—Lincolnshire Bee-keepers' Association. Exhibition of Honey, Hives and Appliances. Open and county classes. Over £30 in prizes. Schedules and entry forms from Capt. J. H. Hadfield, Alford, Lincs. Entries close 13th June.

**July 22nd and 23rd, at Cardiff.**—The Glamorgan B.K.A., in connection with the Cardiff and County Horticultural Society's Show, in the Sophia Gardens, Cardiff. Open classes include:—Collection, Gift, Sections, Beeswax, &c. Schedules from W. J. Wiltshire, Maindy School, Cardiff. Entries close July 18th.

**July 23rd, at Bath.**—The Annual Show of the Somerset Bee-keepers' Association, in connection with the Larkhall Horticultural Society. Seven Open Classes. Schedules from J. W. Brewer, Glen Lynn, St. Saviour's Road, Bath. Entries close July 18th.

**August 26th, at Prestbury.**—Honey show, in connection with the Prestbury Flower Show. One class open to the kingdom. Several for those within 12 miles radius. Exceptional prize list. Schedules from A. H. Bowen, Coronation-road, Cheltenham.

**September 1st, at Deddington.**—Honey show in connection with Deddington Horticultural Society's Show, to be held in the Castle Grounds. Open classes for honey. Schedules from H. J. Harmsworth, Deddington, Oxon.

**September 2nd, at Lancaster.**—Agricultural Show. Premier Honey Show of the North. 15 classes; £20 in cash prizes, silver cups and medals value 13 guineas, and other specials. Send for schedule (Honey) to Robert Gardner, solicitor, 69, Church-street, Lancaster. Entries close August 19th.

## Notices to Correspondents

\* \* \* Can any reader assist a correspondent who wishes to find a suitable locality for settling as a bee-keeper in the South of England? He would prefer a fairly high situation, with bracing air, moderate rent, and where nice social society could be met with. Nearness to the sea would be an attraction. Anyone knowing of such a place will greatly oblige by writing W. R. Bryden, Buxton, Derbyshire.

W. J. (Forfar).—*Rendering Wax.*—The proportions as advised in "Wax Craft" are 1½oz. of sulphuric acid to every gallon of water used.

C. G. (Elham).—*Using Swarm-catcher.*—The swarm-catcher should be put on at once and should remain for about a fortnight or three weeks.

NOVICE (Caerphilly).—*Bees and Neighbours.*—Unless you can prove that your neighbour's bees are a nuisance and a source of danger you cannot compel him to move them. Why not try peaceful persuasion? If you deal tactfully with him, no doubt he will try to meet your wishes.

W. SAXBY (Norfolk).—*Immature Bees Cast Out.*—(1) The bees are malformed owing to want of food. (2) Write to Secretary of Norfolk B.K.A., Dr. Wardleworth, St. Nicholas, Sheringham.

C. R. P. (Whitby).—*Bees Refusing Syrup.*—We can find nothing in the sugar which should cause the bees to refuse the syrup.

H. CROWTHER (Berks).—*Dead Queen on Alighting Board.*—The queen is a very old one and has evidently been superseded.

A. H. H. (Bramley).—*Queen Ceasing to Lay.*—We should say the queen must have been injured in some way.

#### *Suspected Disease.*

WORKER BEE (Oxford).—(1) The bees are affected with "Isle of Wight" disease. (2) Use Apicure for foul brood.

BEGINNER (Bletchley).—No, there is no disease apparently. The bees are simply gorged with food.

H. S. (Congleton).—The bees were too dry for examination.

T. H. (Uttoxeter).—There is no disease, the brood is quite healthy.

BEGINNER (Herne Hill) and W. SCOTT.—Bees have "Isle of Wight" disease.

W. H. (Christchurch).—Both lots show unmistakable signs of "Isle of Wight" disease.

H. W. (Wickham) and H. DEVIZES.—The bees arrived in such a sticky mess that it is impossible to form any idea as to cause of death.

F. M. (Norfolk).—There is no trace of disease. The bees are apparently quite healthy.

#### **Special Prepaid Advertisements.**

**Two Words One Penny, minimum Sixpence.** Orders for three or more consecutive insertions entitle advertisers to one insertion in "The Bee-keepers' Record" free of charge.

Trade advertisements of Bees, Honey, Queens, and Bee goods are not admissible at above rate, but will be inserted at 1d. per word as "Business" Announcements, immediately under the Private Advertisements. Advertisements of Hive-manufacturers can only be inserted at a minimum charge of 3s. per  $\frac{1}{2}$  in., or 5s. per inch.

#### **PRIVATE ADVERTISEMENTS.**

STRONG stocks, eight and ten frames, 30s. and 35s.; nuclei, three frames, 12s. 6d.; a few swarms, 15s.—MRS. WATSON, Morcott Grange, Uppingham. v 78

WANTED, sections of honey.—Price and quantity to COWELL, Station-road, Sheringham, Norfolk. v 84

80 LB. pure extracted English honey, granulated will accept 7d. lb.; honey extractor, two cages, treacle tap, excellent condition, 14s.—LEETE, The Apiaries, Therfield, Herts. v 83

FOR SALE, June 15th, ten to twenty stocks of bees in hives, consisting of floor-board, brood box, outer case, lift, roof, painted, seven Italian 1914 queens, the remainder black, guaranteed healthy on despatch.—ASHWORTH, Heytesbury. v 80

TWO Simmins' "Conqueror" hives, one W.B.C., 12s. each; two Lee's improved, 6s.—TAYLOR, 137, Keldgate, Beverley. v 86

FOUR Simmins' "Conqueror" hives, 6s. each; eight single and double walled hives, 4s. and 5s. each; all thoroughly clean and ready for use, scorched with painter's lamp.—LOXLEY, Northfield, Birmingham. v 87

ONE dozen W.B.C. hanging frame section racks, 2s. 3d.; one dozen shallow frame supers, all new, 1s. 9d.; several good hives, 5s.—W. WOODS, Normandy, Guildford. v 89

CAMERA, Magazine, twelve plates, R.R. lens, perfect condition, cost 31s. 6d., sell 15s.—33, Isla-road, Plumstead. v 88

BEAUTIFUL Sladen's golden queens, from the Cotswold Hills, 5s. 6d.; vigorous Natives, 5s.; grand 8-frame colonies, with young queens, 24s.—BOWEN, Cotswold Apiaries, Cheltenham. v 90

FIVE stocks of bees, five empty hives, all W.B.C., guaranteed healthy, £10 the lot, or can be divided; solid mahogany observatory hive, awarded two firsts Royal, first Lincolnshire Shows, £4, or nearest offer.—GOODBURN, Oakham. v 92

STRONG swarms for sale, 15s., carriage and box free.—NORRIS, Barracks, Cashel, Co. Tipperary. v 96

WANTED AT ONCE, young man for a bee and poultry farm in Suffolk, for general work, not an expert, and not afraid of work. If with a good knowledge of one branch the other will be taught; wages, 25s. per week.—HEROD, "B.B.J." Office, 23, Bedford-street, Strand, W.C.

GOOD, strong, healthy swarms, 10s. each, or 2s. 6d. per lb., cash with order.—WHITTING, Manea. v 98

WANTED on approval, strong stock, on six to eight standard frames, 1913 queen, in new or secondhand W.B.C. hive.—ARCHER, Holme-avenue, Newcastle-on-Tyne. v 97

FIRST-CLASS expert offers services and tuition in exchange for holiday and expenses Whit-week.—WILSON, Apiary, Belper. v 95

TO CLEAR, five 28lb. tins good granulated honey, dark and medium, 50s. the lot, tins free, carriage forward; samples, 3d.—A. LEE, Eastleigh, Bideford, North Devon. v 94

FOR SALE, outbuildings, substantially built, good as new, bolted in sections, size 14ft. long, 9ft. wide, 10ft. high, f.o.r., price £7 10s.—STAPLEY, Potton. v 85

MAY SWARMS, 15s.; June swarms, 14s.; three frames nucleus, 12s. 6d.; four frames nucleus, 15s.; cash with order.—J. REAVELEY, Starbeck, Harrogate. v 70

FOR SALE, swarms, from frame hives, guaranteed healthy, 15s. each.—J. M. WILKIN, Pymoor, Ely, Cambs. v 72



---

### MEETING OF BEE-KEEPERS AT BRAMHALL, CHESHIRE.

A meeting of local bee-keepers took place in the Council Schools, Bramhall, on Saturday, May 23rd, for the purpose of having a discussion about bees and bee-keeping. Over forty enthusiasts turned up, and a most enjoyable afternoon was spent. The Rev. S. Young presided, and was an admirable chairman. He briefly introduced Mr. E. W. Franklin, Hon. Sec. of the Cheshire Bee-keepers' Association, who opened the discussion by giving a short address on "A Year's Work in the Apiary." For an hour afterwards various points were raised and questions asked, all of which were dealt with either by Mr. Barlow, the C.B.K.A. expert, who is at present touring in the district, or by Mr. Franklin. At the close of the meeting the Chairman cordially thanked Mr. Franklin for coming and meeting them that day. Mr. Bradburn, the local Secretary, who had arranged the meeting, was also heartily thanked for all his trouble.

---



*Heather.*—One Southerner, through the office, enquires how he can grow heather. If he means that he desires to establish plants over a wide area to feed his bees and gather surplus from the bloom, I would endeavour to dissuade him from entertaining such an elusive hope of securing heather honey. Calluna, Tetralia, and Cinerea can be grown successfully, however, in small clumps. The best way of establishing plants is to bring home large sods containing well-rooted growths which have shown rich bloom, and these can be transplanted, or rather, transferred to the new site, either in autumn or spring. Most heaths can also be grown from seeds. I have done a little in this line by gathering well-ripened seeds and carefully guarding them up to the stage of small-rooted growths, when they will take care of themselves; but the process is slow and at times rather uncertain,

owing to the "dorty" habits of the plants. A gentleman near Aberdeen has a very fine collection of all kinds of heaths, among them some lovely "Cape" ones. They form beautiful clumps, and flower well, many being in successive bloom from June up to the end of August. They are visited extensively by bees, wild and tame, but all over the amount of honey obtained would not amount to much. The specimens I grew were rarely visited by bees, owing to the fact that acres, or rather square miles of the plant, bloomed in profusion within easy reach of the hives.

*Acid in Wax-extracting.*—"W. J. O." enquires about paragraph two on page 181, and his note has been forwarded to me. I do not think it injures the wax in any way for future use in comb-foundation, and I believe most, if not all, manufacturers use it extensively in rendering the darker waxes and giving them a brighter colour. The fact is, the wax being lighter than water, floats, sediment being generally heavier than wax or water falls below the cake, while acid sinks down to the bottom. Being volatile, too, it soon evaporates or floats away in the atmosphere. For certain uses acid does injure wax, making it harder and more brittle, and as a consequence purchasers who use it for art purposes stipulate that it must not be rendered with the aid of acid. Messrs. Root, who convert tons of wax into foundation, use it freely, thus proving that they have no doubt it is an aid in securing pure foundation. While this is the almost universal opinion and practice, it is fair to state that a few hold the opposite opinion and contend that it should not be used, simply, I think, because in the hands of the amateur it is generally overdone. That introduces the second point in the query. What quantity should be used? I can best answer this by making two short quotations, the first from "Advanced Bee-keeping," and the second from the "A.B.C.": "For some mysterious reason, sulphuric acid will cleanse, or clarify, beeswax that is brown or black, or almost any colour, bringing it back to a nice bright yellow. Acid is added at the rate of about one pint of acid to twelve gallons of water." "On an average," says the "A.B.C.," "we use three quarts of acid to eighty gallons of water for 1,500lbs. of wax. Soon after this is poured in the boiling wax will be seen to grow lighter. After twenty-four hours the acid will have settled to the bottom by reason of its greater specific gravity." "Wax Craft" gives the formula of "one-and-a-half ounce of sulphuric acid to every gallon of water"; and further informs us that "Some manufacturers expedite the refining process by adding tartar and borax to the water, the

proportion being 50 parts (by weight) of water, and 40 of wax to 1 of refined tartar and  $\frac{1}{2}$  of borax."

*Bee Disease.*—It is sad to hear men call out "Peace, peace!" when there is no peace. Two fresh communications reached me last week, one from the South of Scotland and the other from further North than here. The last writer has lost over 120 stocks during the past two seasons, and some of the hives were re-stocked again and again. Now he has not a living bee. The other is aged seventy, and his pathetic words, "I do wish I could keep my bees in my old age," impressed me very much. To one who loved them, as he has done for many years, their loss will be a great blank, as hitherto they have not only paid very well but also proved an unending solace and delight. At present a few stragglers only remain, and if these go, as they will, it means in all a loss of "two hundred and sixty stocks, and all neighbours' bees also." His query to me is, "Do you know of any cure having been found?" to which my answer is an emphatic "No," and I would add, neither does any other man. I pray for the day when one can be found, and I welcome all attempts at discovering a cure; but in spite of advertised nostrums, palliatives, "remedies," and so-called "cures," I whole-heartedly endorse the Editor's repeated statement that *there is no known cure*. The two gentlemen mentioned above (and in Scotland there are hundreds of others) have tried everything hitherto boomed and found their labour vain.

---

## RANDOM JOTTINGS.

*By Charles H. Heap, Reading.*

### THE IMMUNE BEE CHIMERA.

Many pages of the BEE JOURNAL have been occupied during the past six months with articles on bees and immunity from "Isle of Wight" disease. Judging from the airy fashion in which correspondents have written, none of them appear to understand or appreciate how difficult and complicated a subject immunity from disease really is.

All this talk of an immune bee has arisen from some remarks on building up apiaries (which may be subject to revision as the result of further experience) made by Dr. G. S. Graham-Smith and Mr. G. W. Bullamore in Section X. ("Treatment and Prevention") of the Board of Agriculture's "Report on the 'Isle of Wight' Bee Disease," May, 1912. They say, "Maassen's observations show that partially immune stocks and apiaries are

common in Germany, and we have investigated at least one partially immune apiary in this country." To this is added the thought that good results might be obtained if attempts were made to build up apiaries from stocks which show well-marked resistance to the disease in infected apiaries. Though I am no pessimist, I see no hope in this suggestion.

To those who find comfort in this particular passage in the 1912 Report, I would ask, Of what value is a partially immune stock? Such a stock is a constant menace to successful bee-keeping in a district, and for confirmation of this we have only to read twelve lines further. Beuhne is there quoted as saying that fifty stocks sent to him from an apiary free from paralysis developed this disease in a virulent form within a few days after being placed in his apiary. "In this case," comment Dr. Graham-Smith and Mr. Bullamore, "no doubt Beuhne's colonies were parasite carriers, and infected the new stocks." Either Beuhne was wrong in supposing the fifty colonies were disease free, or "paralysis" in Australia is a different disease from that with which we have to contend in this country.

Experience in my own and other people's apiaries shows that "Isle of Wight" disease does not develop to a degree that is noticeable in a few days, but requires weeks and more often months.

Let us return to the main point—immunity. Some animals under normal conditions are naturally immune to certain diseases, but under abnormal conditions may become infected. With these we need not concern ourselves, but we may notice the conditions under which an animal may become immune to a disease by which members of its species may be attacked. Briefly, the chief of these are (a) recovery from an attack of a particular disease; (b) inoculation with a mild form of disease; (c) injection of blood from an animal which has acquired immunity. In the case of bees it is obviously out of the question to resort to the methods *b* and *c*, so that we have to fall back upon *a*. Here we are confronted with a great difficulty, inasmuch as the worker bees can be of no value to us in the production of an immune stock. In the first place the bee while sick will plant the spores of the disease in the hive, either in the larvæ or in the honey and pollen it collects; in the second it will, during the breeding season, live only a few weeks, and in the third it cannot transmit any resistant powers it may by some lucky chance have inherited or acquired, because it is incapable of breeding.



Primarily, everything depends upon the queen. Supposing she is the mother of a colony of disease-resisting workers, how can the perpetuation of these qualities be guaranteed? If young queens are raised from her eggs, is it not likely that they will seek partners from other hives, which would probably destroy in the workers the peculiar qualities shown by their predecessors? On the other hand, if the princesses mated with the male progeny of their mother the stamina of the resulting workers might not be good. In season, as we all know, the mating of virgin queens cannot be controlled, and if reared out of season to get them mated is very difficult. There is also the drawback that out-of-season queens are not always so robust as those raised during the swarming period.

It is, of course, possible that a bee able to resist the present virulent strain of *Nosema apis* may be evolved, but those of us who have no expectation of living until the year of grace 2014 or 2114 may as well turn the "W.B.C." hives we have been so proud of into chicken coops, dog kennels, or fire wood. No variety of *Apis mellifica* capable of resisting the species of *Nosema* with which we are familiar is known, and without some legislative enactment the present generation of apiculturists cannot reasonably hope, in the British Isles, to keep bees with pleasure or profit. Nature by a process of exhaustion will in time eliminate the disease; but she can in the meantime be greatly helped or hindered by man. By the importation of bees into disease-ridden districts, as in Norfolk, for example, she is being hindered, whereas the universal destruction of diseased and suspected stocks would help her enormously.

welcome rains of late have improved matters greatly, and the sainfoin appears to be in excellent condition as far as blossom goes.

I do not remember a spring when colonies have built up so quickly as this one, due, I think, to the liberal amount of honey left in the hives last autumn, the young queens and the warm spells of weather during which honey and pollen were gathered so plentifully.

In the vale around Cheltenham there has been quite a honey glut from the early blossoms, and several stocks have filled a section-rack: the honey is of excellent quality, though not of the delicate flavour belonging to that which is gathered from sainfoin. I often wonder why so much fuss is made about the prevention of swarming! In my experience bees that are prevented from swarming year after year, and are not requeened each autumn, certainly deteriorate, becoming weaker and weaker each season, until they are no longer profitable to the apiarist.

A colony that swarms is a prosperous colony, and it is an easy matter to hive the swarm on the old stand, shifting the supers from the old to the new hive.

This procedure makes very little difference to the honey yield, while it gives a useful increase with a young queen. There are still a good many skeppist beemen in our Cotswold villages, and at driving time I am always struck by the vigorousness and healthiness of the bees. They swarm and cast regularly every year, and they always do well both in the hands of their owner and in mine, when established on drawn-out combs with some honey besides to carry them through the winter.—A. H. BOWEN, Cheltenham.

#### NOTES FROM DERBYSHIRE.

[9030] Up to the present I have not heard of many early swarms in this neighbourhood, but Derbyshire never is early in such matters so far as my experience goes. I have seen some exceptionally weak stocks this spring, and some on the other hand which have come through the winter well. Of my own I have had to super five to guard against swarming. I have never done this before at such an early date, and have visions of supers of honey from fruit blossoms. Bees have been working hard on plum and pear bloom, but now that apples are in flower the weather has chosen to change, and unless it becomes warmer my fruit blossom honey will remain visionary only. Usually my only surplus locally is from clover and the limes.



The Editors do not hold themselves responsible for the opinions expressed by correspondents. No notice will be taken of anonymous communications, and correspondents are requested to write on one side of the paper only and give their real names and addresses, not necessarily for publication, but as a guarantee of good faith. Illustrations should be drawn on separate pieces of paper. We do not undertake to return rejected communications.

#### A COTSWOLD BEE NOTE.

[9029] The outlook for a good honey season in this locality is fairly bright. The

To-day (May 2) being rather finer than the past few days, I have made arrangements for commencing queen-rearing by splitting one of my strongest stocks and taking a few frames and the queen to an out-apiary. The dequeened portion will be tried with larvæ in cups. Drones are now in the hives, so the time is quite opportune.

From time to time the question crops up as to the suitability of heather honey as a winter food for bees. I have before expressed my opinion that it is a good winter food. This season I have taken special notice, and I am able definitely to state that the stocks which went to the heather last August have wintered better,



HOME-MADE OBSERVATORY HIVE.

with less consumption of stores, and have come through stronger in bees than those kept at home and fed up on syrup. As a consequence, they are now ready either for supering or dividing, whilst the others are having to receive special attention to get them ready for the clover-flow. Perhaps if other bee-keepers would give their experience of heather stores during the past season we should go a long way towards settling the vexed question once and for all.

I should like (if the Editor will allow) to add a note of personal thanks for the instructions given in recent numbers of "B.B.J." for making an observatory hive. Although I do not claim quite to come under the head of 'Novices,' I found the

article most helpful, and was waiting each time for the next contribution. I am not a "Cræsus," and so have never been able to afford an observatory hive before, having always had something else to do with my money. But now, with the Editor's help, the expenditure of a few shillings, a little labour, and a little ingenuity, I am set up for a time. My hive is only made of deal, enamelled white, but next winter I intend to make another in mahogany.—D. WILSON.

#### BLURTS FROM A SCRATCHY PEN.

SUNDAY AT THE ZOO WITH THE PIOUS BANATS.

Bother those Banats! They have robbed me of the day of rest which most people expect to get once in every week, and have spoiled my Bank Holiday.

It happened like this: Our latest importation to the Zoo was a colony of these wretches. Strong? I should think they were! They crushed each other to suffocation on ten frames, they crowded into the section-rack, and they crowded out on to the alighting-board. If 5,000 bees nearly equal a pound there must have been ten or twelve pounds.

But my tale commences really on the eve of the Sabbath. It so happens that the writer is the nearest available expert to our apiary at the Zoo, in case of emergencies, and was actually on the point of starting for an appointment when the telephone rang. "Come to Zoo immediately, bees have swarmed," was the excited message. Of course, appointment had to be put off—nuisance No. 1.

But Banats never act like any other bees, they are a superior race and cannot be expected to. So after hurrying at all possible speed, I found that they had altered their mind and decided not to leave their hive that day, therefore they had returned to it again. Eager to keep previous appointment, I could only prepare a home for them, and bitterly think of the morrow.

My dreams were of obstinate bees. In the morning I had a foreboding of coming trouble, and at about the tenth hour wended my way once more to the Zoo.

I remembered that when on tour in Westmorland one very worthy Vicar of a parish there related to me, as his serious belief, that the bees were attracted to swarm by the ringing of the bells of the village church. "It is the only holiday they get, and to shame Christians they rush out when they *hear* the church bells ring." I am not quite prepared to accept

his teachings on these points either as to acoustics or theology, but this I do know, that scarcely were the bells in the numerous surrounding steeples clanging their harmony when pell-mell in their thousands out came the swarm. To bee-keepers I need not describe their gyrations, but instead of settling themselves down on one of our infinite selection of handy and available small trees, they preferred rather to form their bunch high up in a tree, from whence they could obtain a glimpse of the spire of the nearest church. Am I wrong in assuming there was pious method in their madness?

When I began to recognise the point they were making for I am afraid my ejaculations were not in consonance with a patient spirit. I would have disturbed their religious aspirations, but I was helpless, nor syringe, nor dust, not even a shot-gun were available. No, I could not even find an old pan and key as a counter-clang. I must submit to my fate.

At last, behold them! hanging grape-like from a branch, another series of branches just under them, which had to be pushed through to get at them. The nearest ladder was at the other extremity of the gardens. Sunday morning, and no workmen about! A kindly keeper consented to help, so away we trudged, and returned carrying shoulder high a twenty-five rung ladder. Oh, horror! There was no branch which would bear the weight. We reared it against the framework of the aviary, where the mutton-eating (Kea) parrot lives, but one-third of the ladder projected into space, and still the swarm hung ten or fifteen feet above my head.

Oh, for one of the wonderful swarm-catchers invented by Cheshire. There they hung, dangling above, and I below, like the old illustrations we used to see in Æsop's fables of the Fox and the Grapes, but there the simile ended, for I meant to have that swarm.

Procuring a skep and a pole of some dozen feet, it was easy to nail the inverted skep to the latter, and thus equipped I mounted my ladder, and now the fun began. Forcing between the intermediate branches, I gave a thrust and shake, and immediately from the clouds, as it were, descended an avalanche of bees on my head and shoulders. From a safe position a crowd of visitors were watching my performance. The gentler members shrieked when they saw a portion of the swarm transferred from the tree to myself, but a couple of slight punctures were the extent of my wounds.

Again another attempt, and this time with better success. I had gathered the bulk, with the queen, and in the orthodox fashion let them remain under the tree in the skep, and felt it a fitting opportunity to adjourn for refreshment and rest.

It was in the evening I returned, and my friend the keeper met me. "Sir, the bees have shifted." "Where to?" of course, I asked. "In the old place on the tree," he replied. So the whole of my Sunday labour was in vain. Banats *cannot* act as other bees!

However, the work had to be commenced again, so I grasped my weapon and mounted the ladder. The rain was pouring down. I gave a vigorous push, shake, and again I had the swarm and another shower-bath of rain and bees.

With dignity and calmness, skep at the end of the pole, I marched to the hive I had prepared, and lest there should be any escape this time, threw them on the top of the bars and covered down.

Ere this, my keeper friend had left me. The rain was a deluge. It was dusk. I was all alone in the Zoo. The lions roared in the distance, the elephants trumpeted, the wolves howled, and the great baboon, within a few yards of me, barked. It was a weird experience. I am not nervous, but I thought something might happen, and the BEE JOURNAL would get no "copy."

Bother the Banats! Still, if they had been hybrid Italians that rain of bees might have been more acute in its attention to the writer.

(That swarm is now comfortably settled in six frames.)

J. SMALLWOOD.

## NECTAR-PRODUCING PLANTS AND THEIR POLLEN.

By Geo. Hayes, Beeston.

### SAINFOIN.

(*Onobrychis sativa*.)

NAT. ORD. LEGUMINOSÆ.

The name of this flower is sometimes spelt Saint-Foin, and, according to Plunkett and Hill, it was first given to Lucerne (*Medicago sativa*), and that of Lucerne to an onobrychis, our present Sainfoin. There does not appear to have been a Saint Foin, nor is there, so far as I can learn, any reason for ascribing to this plant the divine properties it once held. The name is derived from the French *sain*, wholesome, and *foin*, hay.

The generic name comes from the Greek "ones," the ass; and "brycho," to bray; the plant being a favourite food of asses. Besides the names already given, this plant is known in some localities as "Cocks-head," from the shape of the flower-head; also Fodder-grass or French-grass. This plant is believed to be indigenous in southern and eastern England, but is rarely found in its wild state, except on dry, chalky soils.

It is grown extensively in the Southern counties for fodder, and on the shallow, chalky soil its endurance is remarkable. Its long, tapering roots descend into the fissures of rock, breaking it up and rendering the ground deeper and better for cultivation.

Sainfoin commences to bloom soon after the fruit blossoms fall, and will—if left—continue to do so for some weeks, as the blooms do not all open simultaneously. It is a perennial and grows to a height of from 9 to 18 inches, according to conditions of soil and position. The leaves are serrated and spring alternately from a branching stalk,

at the end of which the flower-spike is borne. The flowers are of the papilionaceous type, that is, like the pea, and of a pale pink colour. Like the clovers, the lower blooms open first and continue upwards to the end of the spike, and in this way the blooming may be prolonged for several weeks.

In some districts in the South this is the only flower on which reliance can be placed for surplus. The honey from this source is esteemed by some connoisseurs as superior to that from white clover, whilst others prefer the latter.

Notts. bee-keepers know very little about this flower from close acquaintance, for I have only seen it growing naturally in this county in one district, and then it was very thinly distributed amongst other plants and grasses.

The pollen grain is easy to recognise, being of a different form to any we have studied, and, like the Lime and Heather grains, stands out distinctly from the rest. Its colour by reflected light is a golden-yellow with a tinge of green, but by transmitted light appears much paler.

The form, of the grain, when dry, is shown at Fig. 1, and its enlargement, whilst Fig. 2 is a cross-section, and measures  $\frac{2}{1000} \times \frac{3}{1000}$  in.

When placed in water it assumes a spherical form, the extine or outer covering being clearly seen distinct from the intine and fovilla; but no processes are formed. This is seen at No. 3. In this condition it measures  $\frac{1\frac{1}{2}}{1000}$  in. diameter.

In honey its original form is not altered,

being the same as when dry, except that it becomes very transparent and measures slightly over  $\frac{2}{1000} \times \frac{3}{1000}$  in.

When extracted from honey, I find it first assumes a spherical and afterwards an ellipsoidal form, the ends of which are slightly flattened; with processes breaking out at irregular intervals, as seen at Figs. 4 and 5, and measures in the last stage  $\frac{2}{1000}$  in  $\times$   $\frac{3}{1000}$  in. These grains have a tendency to break up when extracted from honey.

### Dry.

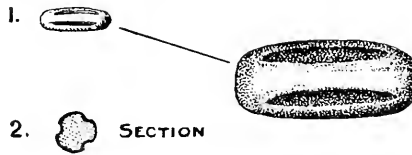

### In Water.



### In Honey.



### From Honey.

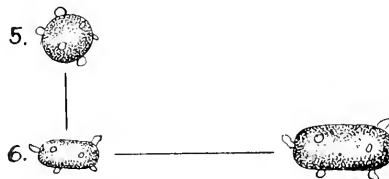

**QUERIES AND REPLIES.**

[8938] *Stocking Observatory Hive.*

—I have had one stock of bees since autumn, which is doing fairly well. Being desirous of seeing more of their work and life, I have made an observation hive according to instructions given in the *Bee Journal*. This I have placed inside a greenhouse 20 yards distant from where the stock now stands. With regard to stocking, my plan is as follows:—(1) To transfer three frames with bees, brood and honey from No 1 stock; (2) Give No. 1 one new frame of foundation and close up with the dummy (have already taken out 2 of 10 old frames and substituted new, which are all drawn out); (3) Follow up with another frame if there is time before the honey flow comes on; (4) Give new queen either to No. 1 or to observation hive, so as to keep on building up; (5) In the event of the observatory hive doing well, I presume I could give a frame of brood, or bees off same, to No. 1, so as to ensure full strength and secure some surplus. Do you think this would succeed, or would too many bees go back to No. 1 hive? Again, how could I, at once determine whether the Queen was left in No. 1 or transferred to new? Although I have examined the frames three times I have failed to observe the Queen.  
—J. BEE.

REPLY.—We are not clear as to what you mean, whether you are using the observation hive and call it No. 2, or another hive. The best plan will be to take a couple of combs of brood and one of food from the strong stock without the queen, and put them into the observation hive with one frame of foundation. Let the bees run a queen, which will be interesting to watch.

[8939] *Bees not entering Supers.—Moisture in Hive.*—(1) I purchased a stock of bees on six frames in the early part of the season, and as all frames were well covered and the queen seemed to be laying well, I gradually increased to ten. These were filled as I put them in, but when I placed two more frames in the bees started to fill them with honey. On the advice of a friend I put a rack of sections on, but though this was done a week ago the bees have not started on them yet. Do you think I have done right? (2) I have noticed in the mornings that the floor board seems to be covered with moisture, which probably is

due to the hive sweating, although I have not noticed any on the sides of the hive when I have taken the roof off. I have also noticed mouldy pollen in some of the combs, do you think that there is sufficient ventilation? For quilts I have a piece of American cloth, and a piece of sacking folded in four thicknesses.—  
ANXIOUS NOVICE, Kent.

REPLY.—(1) The bees will go into the super when ready. (2) Take off the American cloth quilt and put calico in its place. The damp is caused by the non-porous covering.

[8940] *A Beginner's Queries.*—On May 24th I took from a very strong stock two frames full of brood and honey, on one of which there was a queen-cell sealed over. These I put into a clean hive one yard away, and filled both empty spaces with sheets of foundation. (1) Have I done right? and how long will the queen be before she hatches out? (2) How much methylated spirit should be put to half an ounce of Naphthol Beta? (3) How much honey will a shallow-frame hold well filled?  
—BEGINNER, Notts.

REPLY.—(1) You did quite right if the cell was sealed. You may expect a queen to emerge in about seven days. (2) Three-and-a-half ounces. (3) Five to six pounds.

**A VAGRANT.**

The humble bee  
No skep has he,  
No twisted, straw-thatched dome;  
A ferny crest  
Provides his nest,  
The mowing grass his home.

The crook-beaked shrike  
His back may spike,  
And pierce him with a thorn;  
The humble bee  
A tramp is he,  
And there is none to mourn.

O'er bank and brook,  
In wooded nook,  
He wanders at his whim;  
Lives as he can,  
Owes naught to man,  
And man owes naught to him.

No hive receives  
The sweets he gives,  
No flowers for him are sown;  
Yet wild and gay  
He hums his way,  
A nomad on his own.—From *Punch*.

## THE NYASA BEE.

*Continued from Vol. 41 (page 348).*

Owing to the kindness of the Rev. Kendall, of Buluwayo, Southern Rhodesia, I have been able to compare workers and drones of his Rhodesian bees with those of the Nyasa bee. I have not found any remarkable difference between them in colour nor shape, that could not be attri-

buted to the formalin in which they were preserved or to age. Perhaps the silver bands along the lower rings of the abdomen were less pronounced with the Rhodesians than with the Nyasa bee, but this might be due to the Rhodesians sent being somewhat older.

foundation." worked out irregularly all over. This irregularity, though conspicuous to our eyes, has not inconvenienced the bees in the very least. Perhaps one of your readers will give the reason why this smooth foundation is not worked out so regularly as ordinary comb.

Anyhow, by giving bees such smooth foundation, a good substitute for

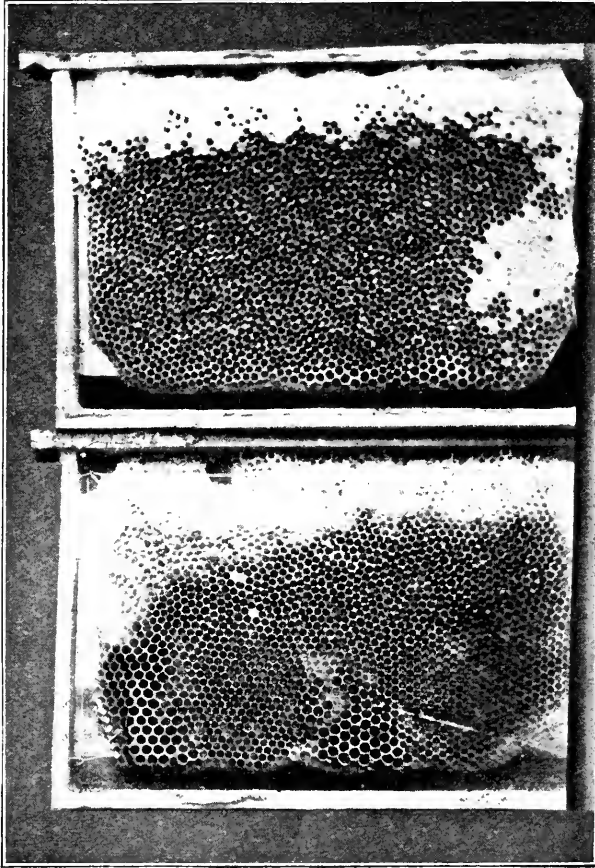

COMBS WORKED OUT ON SMOOTH FOUNDATION.

In a previous letter I wrote about home-made "smooth foundation." I now enclose two photographs of comb worked out on such foundation, bred in, and filled with honey. One represents a half sheet of smooth foundation given to the bees, worked out irregularly on the foundation, and worked out regularly underneath it. The other is a whole sheet of "smooth

bought foundation is given, at a much less cost, and easily made by any beekeeper.—L. W. J. DEUSS.

## Bee Shows to Come.

*A nominal charge of 2s. 6d. is made for notices (not exceeding 7 lines) in this column, 10 lines charged 3s. 6d., up to 15 lines 5s., which covers cost of insertion from order till date of show. Cash should accompany orders for insertion.*

**June 9th-11th, at Malvern.**—The Herefords and Wores. Agricultural Society's Malvern Meeting. Twelve classes for Honey, &c. Good prizes; small entry fees.—For schedule apply, Mr. A. Elliott, Hon. Secretary's Department, Cusop, Hereford.

**June 10th and 11th, at Waltham Abbey.**—Essex Bee-Keepers' Association. Honey and Appliance Show, in connection with the Essex Agricultural Society's Annual Show. Judge, Lecturer, and Examiner of Candidates for B.B.K.A. Preliminary Certificate, Mr. W. Herrod. Schedules from G. R. Alder, 176, Hainault-road, Leytonstone. **Entries closed.**

**June 10th and 11th, at Lichfield.**—The Staffordshire Bee-Keepers' Annual Exhibition, held in connection with the Staffordshire Agricultural Society's Show. Open classes. Liberal prizes. Judge, Mr. A. G. Pugh, Nottingham. Schedules from Claude R. Forse, Hon. Sec., Trentham, Stoke-on-Trent. **Entries close June 4th.**

**June 10th to 13th, at Portsmouth.**—Hants B.K.A., Bee and Honey Show. Liberal prize schedule now ready. Write, E. H. Bellairs, Hon. Sec., Hants B.K.A., Christchurch.

**June 30th to July 4th, at Shrewsbury.**—Royal Agricultural Society's Show. Bee and Honey Section, under the direction of the B.B.K.A. Prizes arranged in groups of counties for Associations affiliated to the B.B.K.A. Schedules from W. Herrod, 23, Bedford Street, Strand, W.C. **Entries closed.**

**July 6th, at St Albans.**—Honey Show of the St. Albans B.K.A., held in connection with the Bistree and Boreham Wood Horticultural Society, at Aldenham Park. Open class for extracted honey. No entry fee. Liberal prizes. Judge, Mr. W. Herrod. Schedules from Mr. R. H. Attenborough, Aldenham, Herts. **Entries close July 6th.**

**July 14th to 17th, at Hawick.**—Scottish Bee-Keepers' Association. Exhibition of honey, wax, and appliances, in connection with the Highland and Agricultural Society's Show. Open to all British bee-keepers. Liberal prize-money. Write for schedules to A. Aikman Blair and John L. Gibson, joint secretaries, 176, Bruntsfield-place, Edinburgh.—**Entries close 7th July.**

**July 16th and 17th, at Boston.**—Lincolnshire Bee-keepers' Association. Exhibition of Honey, Hives and Appliances. Open and county classes. Over £30 in prizes. Schedules and entry forms from Capt. J. H. Hadfield, Alford, Lincs. **Entries close 13th June.**

**July 22nd to July 24th, at Bradford.**—Great Yorkshire Show. Classes for hives, honey, &c. Good prizes. For schedules and forms of entry (stating department), apply, The Secretary, Great Yorkshire Show, Blake-street, York. Telegrams, "Yas, York." **Entries close June 13th.**

**July 22nd and 23rd, at Cardiff.**—The Glamorgan B.K.A., in connection with the Cardiff and County Horticultural Society's Show, in the Sophia Gardens, Cardiff. Open classes include:—Collection, Gift, Sections, Beeswax, &c. Schedules from W. J. Wiltshire, Maindy School, Cardiff. **Entries close July 18th.**

**July 23rd, at Southwell.**—The Notts. Annual County Show, in connection with the Southwell Horticultural Society. Open class for single jar extracted honey. Schedules now ready from G. Hayes, Mona-street, Beeston, Notts.

**July 23rd, at Bath.**—The Annual Show of the Somerset Bee-Keepers' Association, in connection with the Larkhall Horticultural Society. Seven Open Classes. Schedules from J. W. Brewer, Glen Lynn, St. Saviour's Road, Bath. **Entries close July 18th.**

**August 26th, at Prestbury.**—Honey show, in connection with the Prestbury Flower Show. One class open to the kingdom. Several for those within 12 miles radius. Exceptional prize list. Schedules from A. H. Bowen, Coronation-road, Cheltenham.

**September 1st, at Deddington.**—Honey show in connection with Deddington Horticultural Society's Show, to be held in the Castle Grounds. Open classes for honey. Schedules from H. J. Harnsworth, Deddington, Oxon.

**September 2nd, at Lancaster.**—Agricultural Show. Premier Honey Show of the North. 15 classes; £20 in cash prizes, silver cups and medals value 13 guineas, and other specials. Send for schedule (Honey) to Robert Gardner, solicitor, 69, Church-street, Lancaster. **Entries close August 19th.**

**Sept. 5th, at the Club Room, North-road, Kew.**—Honey Show of the Richmond and District Bee-Keepers' Association. Open classes for honey and wax. For schedules, apply Hon. Sec., Mr. J. G. Romer, 234, Kew-road, Kew-gardens. **Entries close Aug. 23th.**

## Notices to Correspondents

**LIGURIAN (Birmingham).**—*Dividing Stocks.*—You will find full directions for this on page 93 of the "British Bee-keepers' Guide Book." We cannot take up space describing this simple operation.

**ROXA (Watling Street).**—*Italian Virgin Queens.*—We do not know where you can obtain pure Italian virgin queens. No doubt an advertisement in our columns would bring you what you want.

**H. G. (Devon).**—*Disinfecting Hives.*—The best method of disinfecting is by scorching the inside of hive with a painter's blow-lamp.

**NOVICE (South Shields).**—*Honey from Suspected Stock.*—The honey is quite fit for human consumption.

**BETA (Lancs.).**—*Beet Sugar for Bees.*—No; only pure cane-sugar should be used. The best kinds for the purpose are either white crystals or crushed lump.

**C. W. H. (Maidstone).**—*Supering Stocks.*—(1) Put on another super. (2) The medicine will do them no harm. (3) Are you sure they are fighting, or are they killing drones?

**J. B. (Plumstead).**—*Disinfecting Hives.*—The hives should be disinfected by scorching them with a painter's blow-lamp.

J. S. (Kettering).—*Weak Swarms*.—It is impossible for us to answer your question. All you can do is "wait and see."

G. R. (Dorset).—*Queen Cast Out*.—The queen is an old one, and the bees have evidently rejected her.

F. C. W. (Ilford).—*Bunat Bees*.—(1) These are a race of bees native to Hungary. (2) We cannot say from personal experience.

#### *Suspected Disease.*

E. O. (N. Wales).—There is no trace of disease; the bees have died from starvation.

J. H. B. (Plymouth).—It is a case of "Isle of Wight" Disease.

VERONICA (Devon).—The bees have "Isle of Wight" disease.

ANXIOUS (Rock Ferry).—There is no trace of disease. The bees are chilled.

W. M. (Enfield).—The bees were too dry for us to give an opinion as to cause of death.

RETLAW (Ponteland).—We should not advise you to risk using sections which have been on a diseased stock, even though the bees have never worked in them. Better burn the lot than risk infection.

#### **Special Prepaid Advertisements.**

**Two Words One Penny, minimum Sixpence.**  
Orders for three or more consecutive insertions entitle advertisers to one insertion in "The Beekeepers' Record" free of charge.

Trade advertisements of Bees, Honey, Queens, and Bee goods are not admissible at above rate, but will be inserted at 1d. per word as "Business" Announcements, immediately under the Private Advertisements. Advertisements of Hive-manufacturers can only be inserted at a minimum charge of 3s. per  $\frac{1}{2}$  in., or 5s. per inch.

#### **PRIVATE ADVERTISEMENTS.**

**SUPERB** Cotswold queens, bred for honey from highest yielders, prolific and vigorous, 5s. by return mail.—BOWEN, honey specialist, Cheltenham. v 5

**4-FRAME** nuclei, Carniolan hybrids, brood in all frames, with young laying queen, 17s. 6d. each.—EVERETT, expert, Rosebank Apiary, 40, Linden-street, Leicester. v 2

**FEW** healthy June swarms, with 1913 queens, 12s. 6d. and 15s.—SPEARMAN, Andoversford, Glos. v 10

**HEALTHY** swarms, 13s.; second, 10s.; safely packed.—H. W. GLOVER, Biggin, Hulland, Derby. v 67

**LEA'S** steam-heated uncapping knife, only used one season, 25s.; electric embedding apparatus, 4s. 6d.; three new section racks, with dividers, 1s. 6d. each; a few used, 1s.—BLACKBURN, Hoo, Minster, Thanet. v 11

**FOR SALE**, two healthy stocks of bees, price 30s. each or nearest offer.—R. LAW, 70, Bentley-road, Doncaster. v 8

**FOR SALE** owing to removal.—Nine W.B.C. hives, three and four lifts each, brood chambers and frames, clean, and in splendid order, 7s. 6d. each; sixteen racks of shallow frames, eight each drawn combs, 4s., or offer; six W.B.C. hanging section racks, 3s., as new; one ripener, 150lb., and two strainers, 7s. 6d.; Cowan extractor, first-rate machine, 30s.; wax extractor, 4s.; uncapping tray, 2s.; heater and knives, 5s.; observatory hive, 6 frame, 10s.; sell whole, or part; inspection invited.—HART, Park Farm House, Brigadier-hill, Enfield. v 7

**READY** for immediate despatch, strong guaranteed healthy swarms, 14s. 6d.—Caroline Cottage, Winchelsea-road, Hastings. v 6

**FEW** strong swarms; also small swarms, 1914 queens; particulars, stamp reply.—NORTH, Crossing, Braintree, Essex. v 4

**EXCHANGE**, Dollond's day or night telescope, 1 $\frac{1}{2}$  in. objective, for binoculars or barometer.—NICHOLSON Langwathby. v 3

**SWARMS**, 15s.; queens, 1915, 4/-; 1914, 5s.—MISS GRACE, Terrick, Kington, Worcester. v 1

**HAVE** a healthy Dutch queen to spare, this year's, fertile, 4s.—GEO. LEDGER, Weybridge. v 12

**WANTED**, sections of honey.—Price and quantity to COWELL, Station-road, Sheringham, Norfolk. v 84

**FOR SALE**, June 15th, ten to twenty stocks of bees in hives, consisting of floor-board, brood box, outer case, lift, roof, painted, seven Italian 1914 queens, the remainder black, guaranteed healthy on despatch.—ASHWORTH, Heytesbury. v 80

**FOUR** Simmins' "Conqueror" hives, 6s. each; eight single and double walled hives, 4s. and 5s. each; all thoroughly clean and ready for use, scorched with painter's lamp.—LOXLEY, Northfield, Birmingham. v 87

**WANTED AT ONCE**, young man for a bee and poultry farm in Suffolk, for general work, not an expert, and not afraid of work. If with a good knowledge of one branch the other will be taught; wages, 25s. per week.—HERROD, "B.B.J." Office, 23, Bedford-street, Strand, W.C.

**GOOD**, strong, healthy swarms, 10s. each, or 2s. 6d. per lb., cash with order.—WHITTING, Manea. v 98

**MAY SWARMS**, 15s.; June swarms, 14s.; three frames nucleus, 12s. 6d.; four frames nucleus, 15s.; cash with order.—J. REAVELEY, Starbeck, Harrogate. v 70

**NATURAL SWARMS**, guaranteed healthy, 3s. per lb. until the 15th of June; swarm boxes returnable.—DENNIS, Brownsover, Rugby. v 54

**SMITH PREMIER** typewriter, standard double keyboard, very reliable, beautiful writing, perfect condition, cost £23, accept 60s., worth double.—WAKEFIELD, Newhall Hill, Birmingham. v 61

**FOR SALE**, one stock of healthy bees, strong, price 30s. cash.—J. WINSTANLEY, Kirkham, Lancashire. v 52

**A FEW** good section racks, complete, with dividers, follower, and wedge, 1s. 6d. each; lace paper, neat pattern, 6d. 100, post free; lace bands, 2 $\frac{1}{2}$  in. and 3 in., 100 1s. 2d., post free, finest quality.—W. WOODLEY, Beeton, Newbury.

**SELL**, Thould and Hutchinson portable cesspool pump, with all fittings, used once only, cost £3 10s.; offers—"PUMP," "B.B.J." Office, 23, Bedford-street, Strand, London, W.C.





## ERRATUM.

We regret that an error appeared in BEE JOURNAL of May 21st, page 201. On line two the date of the opening of the Royal Show should read June 30th, not July as printed.



The Editors do not hold themselves responsible for the opinions expressed by correspondents. No notice will be taken of anonymous communications, and correspondents are requested to write on one side of the paper only and give their real names and addresses, not necessarily for publication, but as a guarantee of good faith. Illustrations should be drawn on separate pieces of paper. We do not undertake to return rejected communications.

## THE IMMUNITY CHIMERA.

[9031] Mr. Heap (page 222, "B.B.J.," June 4th) is far too despondent in this matter. His three categories of immunity not only fail to exhaust the subject, but they scarcely touch it. They all bear upon inoculation, and therefore make it easy for Mr. Heap to say that immunity must fail as soon as a new generation of worker bees appears.

Suppose, however, that a worker bee acquired by ingestion or miraculous gift an anti-microbe eager to feed on *Nosema apis*, capable of existing in small numbers without its special food, and also able to multiply rapidly when the need for it arose. That anti-microbe might easily be just as transmissible from worker-bee to worker-bee or larva as *Nosema apis* itself. The same could be said of a mere ferment acting as an immediate poison to the planouts of "Isle of Wight" disease in the folds of the chyle stomach. Not only worker-larvæ, but drone-larvæ and young queens could take this anti-toxin or what not, and thus immunity arising in a worker could go to the fountain-head of a new stock.

It is not necessary to discuss the case of a queen developing an immune constitution, though Mr. Heap is despondent about that also. Her daughter might make an

alliance, he says, that would cancel the immunity. She would be more likely not to, because the drones of her hive would *ex hypothesi* be stronger than the disease-racked drones of the neighbourhood. And they might even meet non-immune virgins and render their progeny immune.

So much for the *a priori* argument. What of the actual facts? Dr. Maassen said that *Nosema apis* could be found in every hive in Germany and (page 21 of our second Governmental report) that by keeping a stock in cold confinement the disease could be apparently spontaneously developed. Does not that point to a widespread immunity at that time, that could only be upset by very unfavourable conditions? Then, who has not seen of late years many degrees of susceptibility in stocks, some of them closely approaching the ideal of immunity? I know a stock that has assisted at the robbing of eight hives, seven at least of them emptied by "Isle of Wight" disease. Some of those robberies were before the winter, some since, but the robbing stock (which I have christened "Old Immunity") still goes on without sign of infection. Perhaps it will die, but it is capable of leaving vigorous progeny with even less proclivity to disease. It is only a case out of many. I believe that the disease will run till every hive in the land will yield at call a specimen or so of *Nosema apis* for the microscopist, while the disease in its full virulence will be no more common than malignant dysentery has been in the past. —G. G. DESMOND, Sheepscombe, Glos.

## IMMUNITY AND "I.O.W." DISEASE.

[9032] Some of Mr. Heap's remarks in "Random Jottings" in the "B.B.J." of June 4th (page 222) seem to call for comment. Attempts have been made to produce disease-resisting wheat, potato, &c., and a certain amount of success has been claimed for these experiments, and so experienced a queen-breeder as Mr. Sladen had hopes of being able to produce a strain of bees capable of resisting foul brood. This power of resistance, if it is not technical immunity, does not necessarily appear to depend on any of the three causes (a), (b), and (c) enumerated by Mr. Heap.

In this badly-infected district there are a few stocks (not mine, unfortunately) which have remained healthy throughout. Are we to suppose that all these, though in some cases situated quite close to others that have died, have never come into contact with infection? If, on the contrary, they possess special powers of resistance, are they not worth breeding from? This seems the only practical thing to do, for

we may have to wait twenty years for legislation, and perhaps even longer than that before a cure is found.

As to the difficulty of mating our queens with drones also possessing powers of resistance to "Isle of Wight" disease, is not the problem already solved in badly affected areas, for if we can persuade bee-keepers not to import from outside, are not all surviving bees in such an area, whether queens, drones, or workers, possessed of some resistive power?

If this is not enough, cannot the B.B.K.A. step in and help us? The mating of selected queens and drones is secured in Switzerland by taking both up to an altitude at which no other bees fly, and several public mating stations are maintained to which members of the Swiss Association can send their queens. Though we have not all the advantages provided by the Alps, surely there are some high altitudes in this country which could be employed for a similar purpose.

Our native bee possesses many good qualities. Would it not be better if the B.B.K.A. turned its attention, like the Swiss Association, to the improvement of the native race instead of teaching people to keep bees who are not already bee-keepers, at a time when bee-keeping is so precarious?

If there are no funds available for the purpose I have suggested, may I propose that a special fund should be raised to start an Experimental Apiary and Mating Station in a suitable position, to be devoted entirely to the improvement of the native bee without intermixture with foreign races. I would promise to contribute my mite.—L. ILLINGWORTH.

#### QUEEN-REARING EXPERIENCES.

[9033] Now that the queen-rearing season is upon us I should like to give two methods of my own, which, though perhaps not altogether original, may be of interest to other readers:—(1) From a very strong hive having a choice queen take away the latter with two frames of bees. This leaves a strong stock which rears a good number of queen-cells, and, in the ordinary course of events, would go in for after swarming. On the third day undesirable cells which are sealed over may be destroyed. The first queen will be hatched out in twelve days or so, and shortly afterwards, if an ear be put to the side of the hive, other queens kept in their cells may be heard crying. At the end of fifteen days all the queens will have matured, and may then be taken from the cells in which they have been confined. I have obtained as many as ten

fine virgins at once in this manner, and the method requires practically no skill in manipulation.

(2) I have also been very successful in hatching queen-cells in an ordinary hot-water tank incubator, with a large moisture tray, the machine being run at about 96deg. Fahr. (on one occasion, through an accident, I had a drop of 20deg. for a time, but cells hatched nicely). I found the cells which were inserted immediately after sealing over hatched just as well as those put in in a more advanced stage. Of course the cells should be caged; I myself used a multiple cage with two dozen compartments. The cells should be taken away after the queens hatch, otherwise they may form death traps. It is preferable to use the queens as soon as possible, I found a heavy mortality if they were kept a few days in the incubator.

It would be interesting if those bee-keepers who have tried a plurality of laying queens in one hive would give us an account of their experiences and difficulties. The only time I tested Alexander's statement that two queens will not fight if they can possibly avoid one another, was on an occasion when I had two superfluous old Black queens, and these two certainly fought with determination.—  
APICULTEUR.

#### CONTROLLING PROLIFIC QUEENS.

[9034] It is a common remark from those who decry foreign races of bees: "Oh yes, we know your Italian, Carniolan, Banat queen—as the case may be—gives you an enormous force of workers, but what is the use of that? All this extra energy is used up in maintaining a huge brood-nest, so your surplus is not augmented by them to any extent, and instead swarming in and out of season is produced to an intolerable degree."

The indictment is perfectly true where no attempt to regulate the queen's breeding proclivities is made, and for the *laissez faire* bee-keeper who puts supers on in spring and takes them off in autumn with very little attention to his bees between whiles, no doubt the dogged Britisher is the best bee, *her* brood-nest can safely be left to take care of itself!

But you, dear reader (as the ancients have it), who are justly proud of the eighteen or twenty frames packed with brood by your beautiful alien queen—be-think you! Time is fleeting, *clover* is coming into bloom, your main forage crop on which depends the super record of your stocks. Twenty frames of May brood are excellent preparation for a bumper in-gathering; the same number in July

spells only a multitude of hungry mouths whose owners can never gather surplus, but only consume it. There must be a point at which limitation of the brood-nest is highly desirable, and that date may, I think, be taken as about a month before the main honey-flow declines. Mid-June, then, will be about the right time in clover districts for "throttling-down" our prolific queens; all that is necessary is to place a queen-excluder between the two brood-boxes (presuming the stock has been doubled), making sure that the queen is in the lower one. While finding her it is best to put the older brood-combs and any empty ones in the lower box, young brood, drone, or full honey-combs above; trapped drones can be given passage way by wedging up the upper box or leaving a corner of the quilt turned back, which also gives needful ventilation to the hive.

The queenless body-box is, moreover, an ideal nursery for queen-cells where it is desired to raise selected queens for re-queening swarms or artificial increase.—  
H. E. SCOPE VIXER, Overbury, Worcs.

A REPORT FROM SCOTLAND.

[9035] I am a little late in sending you a report as to how bees wintered in this district, also progress made since early spring, but better late than never. Stocks in general wintered very well, we having had so many fine days from November until March that bees were often to be seen out, with the result that those who packed up for the winter with an ordinary supply of stores found, on examination in early spring, that more stores had been consumed than is usual, no doubt owing to the mild weather. I had to put standard frames of heather honey into every one of my stocks, in some hives as many as four. I did not feed one with syrup, but returned to them the fruits of their labours in the autumn. I was told by an old bee-keeper here that I did wrong, as I should have run that honey, then fed with syrup; perhaps I may be wrong, but not even the oldest bee-keeper here will convince me that I am. I think if less unnatural food was given, bee-keepers would have much better stocks. I have also read somewhere that bees do not winter well on heather honey; then why is heather honey so highly valued for medicinal and household purposes? Why are bees sent to the heather if not to gather stores for their winter's keep? I fancy those bee-keepers who say that bees do not winter well on heather honey don't give them the chance. My own bees have wintered exceptionally well on heather honey, and I shall have no hesitation, should this year give a return like last, of

wintering all my stocks on it. Bee disease is still raging. A week ago, when walking up at Clydeside, I noticed close to the road a very pretty cottage, which had at the side some eight frame-hives. It being a beautiful evening, I knew bees would still be working, and wondering what kind of bees he stocked, I went in and found the owner working amongst his roses. He very sadly informed me that he had not a bee left, six stocks having died out during the winter. I have promised him a swarm, but up to time of writing have had only two, one of which I lost, and the other I returned, as it was small. So far I have escaped this plague, all stocks are healthy and strong, most of them working on supers. A neighbour of mine had four swarms on May 24th, from four stocks; all issued on Sunday, when the church bells were ringing. This is very good for this district, where swarms are much later as a rule. Wishing the "B.B.J." and all readers a "bumper" year.—  
W. C. B., Blantyre.

HEATHER HONEY.

[9036] I shall be glad if some kind reader of the "B.B.J." will give me some hints on the following points with regard to heather honey. (1) What condition is it necessary for stocks to be in for taking to the moors? (2) What is the best method of packing the hives in order to ensure safe arrival? (3) I should be grateful for a few particulars as to supering for sections. Is drawn out comb necessary? (4) When is the best time for taking bees to the moors? Any other hints on points not mentioned above will be greatly appreciated.—  
HEATHER HONEY, Lincs.

WEATHER REPORT.

WESTBOURNE, SUSSEX.

May, 1914.

Rainfall, 1.17in.	Minimum temperature, 33 on 26th and 27th.
Below average, .83in.	Frosty nights, 0.
Heaviest fall, .28 on 3rd.	Mean maximum, 60.4.
Rain fell on 12 days.	Mean minimum, 43.8.
Sunshine, 222.3 hrs.	Mean temperature, 52.1.
Below aver., 7.5 hrs.	Above average, 0.2.
Brightest day, 18th 7.5 hrs.	Maximum barometer, 30.359 on 20th.
Sunless day, 1.	Minimum barometer, 29.514 on 7th.
Maximum temperature, 74 on 21st and 22nd.	
Minimum on grass, 24 on 26th.	

L. B. BIRKETT.

## HELPFUL HINTS FOR NOVICES.

By W. Herrod.

### THE HIVING AND TREATMENT OF NATURAL SWARMS AND CASTS.

(Continued from page 216.)

If a syringe is not obtainable then a good substitute is to throw handfuls of earth, or, better still, fine sand, amongst them. Occasionally the bees rise so high that the use of either of these is impossible; in such a case the vibration caused by discharging a gun beside them will bring them down.

As soon as all the bees have settled to the cluster they should be hived into some receptacle and allowed to remain until the evening, when they can be put into their permanent home. It is well to keep a straw skep for this purpose, although a box, wooden pail, or other article of a similar nature may be used. If it is possible to hive the swarm without shaking this should be done; in no case should the bees be brushed to get them into their temporary home. A swarm weighs from three to five pounds, and as there are five thousand bees in a pound it will be seen that there are anywhere from fifteen to twenty-five thousand bees in a swarm, and as these do not all sit facing one direction, if brushing is resorted to some will be



FIG. 6.



FIG. 7.

stroked the wrong way, their tempers will be upset, and the operator will suffer from the use they will make of their protective weapon.

I will describe and illustrate several methods of hiving a swarm, then no matter what position the swarm occupies it will only be a matter of following or adapting the principles laid down. In dealing with swarms it is necessary to remember that bees always travel up hill, and will enter a dark or semi-dark chamber more readily than one to which the light has free access. Much trouble will be obviated and time saved if these two facts are borne in mind.

The first method given is that of shaking. The bees settle as in Fig. 6; to make them cluster close and reduce their excitement, cool them with a fine spray of water; the skep is then held under the clustering bees, and they are dislodged by a sharp vigorous shake of the branch upon which they are resting and fall into it (Fig. 7); the skep is then turned the right way down as near the position occupied by the cluster as possible. A board should be used to stand the skep on to keep them from the damp ground, and ample ventilation provided

by propping up one side of the skep five or six inches; a brick or large stone can be used for this purpose, as illustrated. Instead of turning the skep over rapidly, so spilling the bees on the ground and crushing a number of them, it should be turned slowly so that the bees may run to the top and cluster. (Fig. 8) shows this being done, (Fig. 9) shows the skep being shaded with a damp sheet, while (Fig. 10) illustrates the use of an umbrella for the same purpose. This shading is very necessary, as if the sun is allowed to shine fiercely on the receptacle in which the swarm is hived, the extra heat added to that generated by them in the excitement



FIG. 8.



FIG. 9.

of swarming makes it unbearably hot, and may cause them to come out and abscond. Hay, grass, or leafy branches of trees put over them and sprinkled with cold water from time to time will serve the same purpose. The clustering swarm will at times be out of reach in the branches of a high tree; it may then be hived in the following way. Stick the tines of a very long-handled hayfork through the top of a skep, put it right up under the bees (Fig. 11), then by a sharp upward jerk dislodge them



FIG. 10.



FIG. 11.

into it and lower carefully. A curious position for a swarm to settle is shown at (Fig. 12). The writer was working amongst the bees when a swarm came off and settled on his hand; it weighed five pounds, and remained for about half an hour,

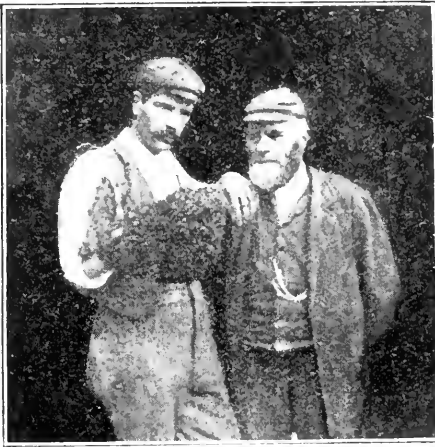

FIG. 12.



FIG. 14.

while a photograph was taken; it was then hived. Only two stings were received, and those were caused by crushing bees between the fingers. The only discomfort was the irritation caused by the sharp claws of those bees attached to the flesh;

their close adhesion and the weight they had to sustain caused their sharp claws to penetrate the skin so that minute pustules of blood formed under the skin. (Fig. 13) shows a swarm clustering in what to some would appear an awkward position, yet remembering the two points mentioned before it is quite an easy matter to hive it. This swarm reminds me of an old man who lived in the Huntingdonshire fens, and had kept bees for forty years, whom I was sent to help. Upon my arrival he expressed his regret that I was not with him an hour sooner, as he had had great trouble with a swarm that had settled on a gooseberry bush. Upon expressing my surprise that such a lowly position should be a source of trouble, which I could quite understand had it been at the top of a very high tree, he said, "Well, you see, I had to dig such a big hole to get the skep under to shake them in." I went down the garden, and sure enough there was the hole as stated. "Forty years a bee-keeper, and yet he didn't know that bees travel up hill." The method of hiving from such a position is to make a tripod of three stakes and put the skep above (Fig. 14), or the skep may be held with one edge touching the cluster to let them run in (Fig. 15).

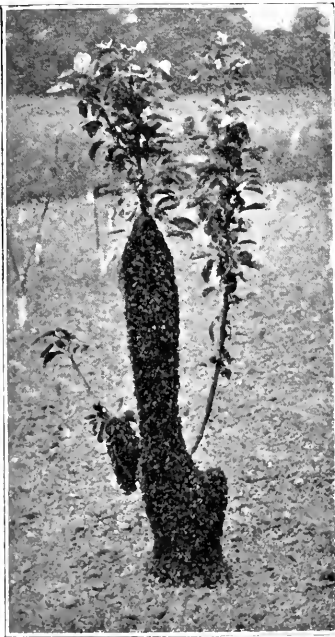

FIG. 13.

If left entirely alone the bees will gradually run into the skep. At times circumstances arise which make it necessary to hurry them a little; this can be done by means of the smoker, but it must be used

springly and judiciously at the bottom of the cluster (Fig. 16) or the bees will rise again. A better plan is to use a carbolie cloth, tying it just below the cluster



FIG. 15.



FIG. 16.

and moving it up as they retreat from it. Swarms in the middle of a holly, privet, or thorn hedge can be hived by placing the skep above them.



FIG. 17.

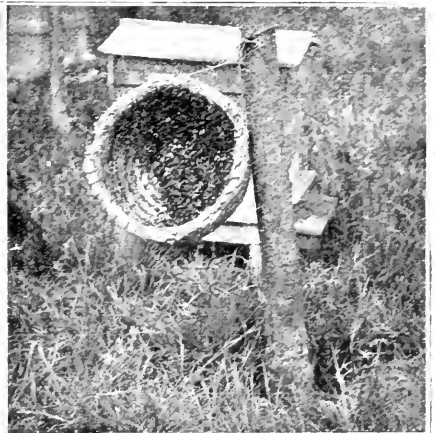

FIG. 18.

If the cluster is on the bole or a thick branch of a tree, or on a post, then the skep should be fastened by means of string so that one edge is just above the topmost bees, and propped off at the bottom by means of a stick (Fig. 17), when they will gradually enter as they have done in (Fig. 18).

*(To be Continued.)*



## QUERIES AND REPLIES.

[8941] *Smooth Foundation.*—On page 228 of last week's "B.B.J." a writer compares combs made naturally and those drawn-out from "home-made" smooth foundation. I should be very much indebted to you if you let me know through your "Queries and Replies" column:—(1) What smooth foundation is? (2) How it can be made at home? (3) Where I can get the appliances and the cost? Wishing you and your JOURNAL the best of success.—F. N. C. MOV.

REPLY.—(1 and 2) Smooth foundation is made by dipping boards into a deep tank of molten wax several times, and then stripping off the sheets of wax. Instructions for making it were given by Mr. Deuss in "B.B.J." July 24th, 1913. (3) It would not pay you to try and make it, especially as foundation made with the base of worker-cells can be procured so cheaply, and far better combs are obtained by its use. A "Rietsche" Foundation Press for making larger quantities would cost about 20s. to 25s.

[8942] *A Beginner's Queries.*—I shall be grateful if you will kindly answer the following questions:—(1) Two swarms, hived a fortnight ago on six standard frames of full-sized sheets of foundation, have worked so well that a few days ago an extra frame was given to each colony, and is nearly filled with honey. Should extra frames be given as required? (2) Would there be a risk of the brood being chilled? (3) Could a section rack be put on before the young bees are flying? (4) Two swarms covering two frames, though three are given, have pulled out foundation, but no stores of honey are visible though the queens are laying, the swarms being hived a week ago. Should these swarms be fed?—BEGINNER.

REPLY.—(1) Yes. (2) Not if you wait until the combs are crowded with bees. (3) Yes. (4) Yes, feed without delay.

### TRADE CATALOGUES RECEIVED.

*E. J. Burt, Stroud Road, Gloucester.*—A very neat catalogue and an improvement in size from 24 pages last year to 40 this year. Every branch of apiculture is catered for. Particulars should be noted of that very necessary requisite in the apiary, a Bee House, which Mr. Burt

lists and supplies. A new feature is the "Pratley Uncapping Tray," which bee-keepers will find a great boon, preventing the necessity of cleaning up a lot of spilt honey, which is the case when makeshift trays are used. The catalogue is post free.

A. W. Gamage, Holborn, London, E.C., send us their catalogue, with which is included poultry appliances, which, no doubt, our readers will find useful, as many bee-keepers are poultry-keepers also. The catalogue is an improvement on any hitherto issued, being thoroughly practical, and reflects the improvement which we understand has taken place since the appointment of a new manager in this department. Messrs. Gamage send the catalogue gratis on application.

## Bee Shows to Come.

*A nominal charge of 2s. 6d. is made for notices (not exceeding 7 lines) in this column, 10 lines charged 3s. 6d., up to 15 lines 5s., which covers cost of insertion from order till date of show. Cash should accompany orders for insertion.*

**June 11th, at Malvern.**—The Herefords. and Worcs. Agricultural Society's Malvern Meeting. Twelve classes for Honey, &c. Good prizes; small entry fees.—For schedule apply, Mr. A. Elliott, Hon. Secretary's Department, Cusop, Hereford.

**June 10th and 11th, at Waltham Abbey.**—Essex Bee-Keepers' Association Honey and Appliance Show, in connection with the Essex Agricultural Society's Annual Show. Judge, Lecturer, and Examiner of Candidates for B.B.K.A. Preliminary Certificate, Mr. W. Herrod. Schedules from G. R. Alder, 176, Hainault-road, Leytonstone. **Entries closed.**

**June 10th and 11th, at Lichfield.**—The Staffordshire Bee-Keepers' Annual Exhibition, held in connection with the Staffordshire Agricultural Society's Show. Open classes. Liberal prizes. Judge, Mr. A. G. Pugh, Nottingham. Schedules from Claude R. Forse, Hon. Sec., Trentham, Stoke-on-Trent. **Entries closed.**

**June 10th to 13th, at Portsmouth.**—Hants B.K.A., Bee and Honey Show. Liberal prize schedule now ready. Write, E. H. Bellairs, Hon. Sec., Hants B.K.A., Christchurch.

**June 30th to July 4th, at Shrewsbury.**—Royal Agricultural Society's Show, Bee and Honey Section, under the direction of the B.B.K.A. Prizes arranged in groups of counties for Associations affiliated to the B.B.K.A. Schedules from W. Herrod, 23, Bedford Street, Strand, W.C. **Entries closed.**

**July 8th, at St Albans.**—Honey Show of the St. Albans B.K.A., held in connection with the Elstree and Boreham Wood Horticultural Society, at Aldenham Park. Open class for extracted honey. No entry fee. Liberal prizes. Judge, Mr. W. Herrod. Schedules from Mr. R. H. Attenborough, Aldenham, Herts. **Entries close July 6th.**

**July 14th to 17th, at Hawick.**—Scottish Bee-keepers' Association. Exhibition of honey, wax, and appliances, in connection with the Highland and Agricultural Society's Show. Open to all British bee-keepers. Liberal prize-money. Write for schedules to A. Aikman Blair and John L. Gibson, joint secretaries, 176, Bruntsfield-place, Edinburgh.—**Entries close 7th July.**



**July 16th and 17th, at Boston.**—Lincolnshire Bee-keepers' Association. Exhibition of Honey, Hives and Appliances. Open and county classes. Over £30 in prizes. Schedules and entry forms from Capt. J. H. Hadfield, Alford, Lines. **Entries close 13th June.**

**July 22nd to July 24th, at Bradford.**—Great Yorkshire Show. Classes for hives, honey, &c. Good prizes. For schedules and forms of entry (stating department), apply, The Secretary, Great Yorkshire Show, Blake-street, York. Telegrams, "Yas, York." **Entries close June 13th.**

**July 22nd and 23rd, at Cardiff.**—The Glamorgan B.K.A., in connection with the Cardiff and County Horticultural Society's Show, in the Sophia Gardens, Cardiff. Open classes include:—Collection, Gift, Sections, Beeswax, &c. Schedules from W. J. Wiltshire, Mandy School, Cardiff. **Entries close July 18th.**

**July 23rd, at Southwell.**—The Notts. Annual County Show, in connection with the Southwell Horticultural Society. Open class for single jar extracted honey. Schedules now ready from G. Hayes, Mona-street, Beeston, Notts.

**July 23rd, at Bath.**—The Annual Show of the Somerset Bee-keepers' Association, in connection with the Larkhall Horticultural Society. Seven Open Classes. Schedules from J. W. Brewer, Glen Lynn, St. Saviour's Road, Bath. **Entries close July 18th.**

**August 4th, 1914, at Bridgnorth.**—Annual Show of the Bridgnorth and District Bee-keepers' Association. Held in connection with Hampton Load Horticultural Society. Open gift class single 1lb. jar extracted honey. Prizes, 7s. 6d., 5s., 2s. Schedules from J. S. Lawton, Oldbury Wells, Bridgnorth. **Entries close July 25th, 1914.**

**August 26th, at Prestbury.**—Honey show, in connection with the Prestbury Flower Show. One class open to the kingdom. Several for those within 12 miles radius. Exceptional prize list. Schedules from A. H. Bowen, Coronation-road, Cheltenham.

**September 1st, at Deddington.**—Honey show in connection with Deddington Horticultural Society's Show, to be held in the Castle Grounds. Open classes for honey. Schedules from H. J. Harmsworth, Deddington, Oxon.

**September 2nd at Stoke Park, Guildford.**—Annual Exhibition of honey, wax, appliances, &c., will be held by the Surrey B.K.A. in connection with the Guildford and West Surrey Agricultural Association. Eighteen classes, five open to all. Many medals. Schedules from F. B. White, hon. secretary, Marden House, Redhill, Surrey. **Entries close 24th August.**

**September 2nd, at Lancaster.**—Agricultural Show. Premier Honey Show of the North. 15 classes; £20 in cash prizes, silver cups and medals value 15 guineas, and other specials. Send for schedule (Honey) to Robert Gardner, solicitor, 69, Church-street, Lancaster. **Entries close August 19th.**

**Sept. 5th, at the Club Room, North-road, Kew.**—Honey Show of the Richmond and District Bee-keepers' Association. Open classes for honey and wax. For schedules, apply Hon. Sec., Mr. J. G. Romer, 234, Kew-road, Kew-gardens. **Entries close Aug. 28th.**

**A NOVICE (South Devon).**—*Drone Brood in Shallow Frames.*—Be careful to get the queen below and then put on an excluder zinc. From time to time lift off the quilts and allow the drones that have emerged to escape. Or a better plan would be to get the queen below, and sacrifice the few combs containing drone brood by cutting them out and replacing with foundation.

**E. M. P. (Guernsey).**—*Dead Queen.*—The queen sent is a virgin.

**F. H. TREWEEKS (Pembroke).**—*Using Swarm-catcher.*—It would certainly hinder the bees working a little.

**NOVICE (Norwich).**—*Honey Sample.*—(1) The honey is quite pure, from clover. (2) We very much doubt if it is pure cane. (3) The bees were too dry for us to determine the cause of death.

**J. McKINNON (Bute).**—*Wild Bees.*—The species is *Andrena*, a wild bee common in this country.

**Scor (Stirlings).**—Evidently the bees have been fighting.

**M. R. (Minster).**—*"English" Honey.*—The honey is foreign, and a bad sample at that.

**C. H. NOEL (Salisbury).**—*Honey Prices.*—Much will depend on the season, already sections are on the market. Sections should fetch at least 10s., and if very good 11s. or 12s. per dozen wholesale. Retail price would be about 1s. to 1s. 3d. each.

*Suspected Disease.*

**X. Y. Z. (Ludlow).**—There is no appearance of disease in bees sent.

**AMATEUR BEE-KEEPER.**—Odd cells are of no use for examination. Please send a piece of comb about 3in. square.

**E. GRIFFIN (Slough).**—The bees have every appearance of being affected with "Isle of Wight" disease.

**BATH (Grosvenor).**—(1) The bees were too dry for examination. (2) "Isle of Wight" disease.

**W. R. (Berwicks).**—We regret to say the bees are undoubtedly suffering from "Isle of Wight" disease.

**BONIFACE (Devonport).**—We are sorry to say it is a case of "Isle of Wight" disease, for which at present there is no known cure. You have done all that is possible by way of disinfection, but it will be best to destroy the bees, burn the combs, and disinfect the hive by scorching with a painter's blow-lamp.



**M. R. (Thanet).**—*Sugar Boiler's Thermometer.*—You can obtain this from Messrs. E. Skuse, Ltd., Ashmore Works, Harrow Road, London, W. The price is 7s. 6d.

**Special Prepaid Advertisements.****Two Words One Penny, minimum Sixpence.***Orders for three or more consecutive insertions entitle advertisers to one insertion in "The Beekeepers' Record" free of charge.**Trade advertisements of Bees, Honey, Queens, and Bee goods are not admissible at above rate, but will be inserted at 1d. per word as "Business" Announcements, immediately under the Private Advertisements. Advertisements of Hive-manufacturers can only be inserted at a minimum charge of 3s. per  $\frac{1}{2}$  in., or 5s. per inch.***PRIVATE ADVERTISEMENTS.****B**LACK, also Italian (White Star) hybrid prime stocks for sale, absolutely free from disease. May swarms, well built up on combs.—VINCENT, 132, Croydon-road, Anerley, S.E. v 37**L**ARGE Solar wax extractor, 10s. 6d.; Meadow's Raynor honey extractor, gearing chain, and cover, cost 47s. 6d., take 35s.; Brice's observatory hive, made by James Lee, cost 22s. 6d., accept 10s. 6d.; all in perfect condition; particulars, 1d. stamp.—W. JOCKMAN, T.C.F., Cherryhinton Post Office, Cambridge. v 15**C**ERTIFICATED expert wanted, for a few weeks, in Cumberland.—Apply, G. W. AVERY, Wetheral, Carlisle. v 18**W**ANTED, healthy stock or two, 4lb. swarms; exchange good Tremlett banjo, No. 1407, good leather case.—POSTMASTER, Crowborough, Sussex. v 25**Y**OUNG MAN seeks work as bee man, carpenter by trade, willing to learn to drive car if needed.—Box X., "B.B.J." Office, 23, Bedford-street, Strand W.C.**S**UPERSEDING entirely with Italians, sell good native queens, 2s.; old and poor ones destroyed.—GORDON, Expert, Lonscale, Threlkeld, Penrith. v 16**E**NGLISH HONEY, 7s. 6d. dozen; sample jar, 1d.; Dadant's weed, ten sheets, 5lb., 10s. 9d.; wax, 1s. 6d.; stamp.—HUNT, Quarry-road, Somercotes, Alfreton. v 39**A** FEW of a very fine strain of specially bred queens for sale, from a district that has been devastated by "Isle of Wight" disease, and from stocks that have proved perfectly healthy, excellent honey stagers and good comb builders, pure, fertile, 10s. 6d. each; every queen tested, no unfertiles sold; safe arrival guaranteed.—E. HOWARD COLLINS, Harewood Apiary, Chalfont St. Giles, Bucks. v 30**W**ANTED, secondhand books on bee-keeping, cheap.—"BOOKS," "B.B.J." Office, 23, Bedford-street, Strand, W.C. v 29**P**ERFECT sections, 10s. per dozen, carriage forward.—Apply, MISS GORDON, Wethersfield-place, near Braintree, Essex. v 28**J**UNE SWARMS, from frame hives, guaranteed healthy, 15s.—THOS. ORMESHER, Westhead Apiary, Ormskirk, Lancs. v 27**C**HAPMAN honey plants, Borage, 3d. per score, post free.—STEVENS, Churchill, Oxfordshire. v 25**S**TRONG, healthy nuclei, with 1914 queens, four frames, 15s.; six frames, 20s. each, guaranteed healthy, no disease of any kind in the district.—A. SHARP, Halstead Farm, Barrowford, Lancashire. v 23**100** LB. clover honey, granulated, screw cap jars, 7d. lb. for cash.—JONES, printer, Wellington, Salop. v 22**S**ALE, or exchange, hives and appliances, cheap, 27, Churchill-road, South Croydon. v 36**F**OR SALE, grand stocks Scotch bees, healthy, 30s. each, or in good secondhand hives, 40s. each, F.o.r., cash.—GEO. W. PAISLEY, Newport-on-Tay. v 45**F**OR SALE, strong stock bees, ten frames, 25s.—PUTT, 62 Exeter-road, Croydon. v 14**F**OR SALE, Rymer heather honey press and drawer, no stand, unused, 40s., or offers; large uncapping tray, with hot water chamber under, 7s. 6d.; also extra large Gerster's wax extractor, 7s. 6d.—"BUMBLE," "B.B.J." Office, 23, Bedford-street, Strand W.C.**F**OR SALE, good uncapping tray and heather bars; particulars.—HERROD, "B.B.J." Office, 23, Bedford-street, Strand, W.C.**A** COUPLE of good stocks, on wired combs, just ready for supering, 40s. each, cash with order.—"BUMBLE," "B.B.J." Office, 23, Bedford-street, Strand W.C.**G**UARANTEED healthy natural swarms.—Apply, THE APIARY, Northwood, Siddington, Chelford, Cheshire. v 19**S**TRONG healthy stocks, ten frames, £1 each.—WHEELER, Elmhurst, Shamley Green, Surrey. v 42**N**EW 14lb. tins, with handles, 5s. dozen; good W.B.C. hives, 11s. 6d. each; geared extractor, 17s. 6d.; ripener, 7s. 6d.; four frame nucleus, 15s. 6d. each.—J. BOWDEN, Broomhill, Witley, Surrey. v 35**T**AYLOR'S 28s. honey extractor for sale, price 18s., good as new; also a few empty standard frame hives, with twelve standard frames, price 2s. 6d. each; W.B.C. hives, with frames, 3s. each; no disease.—W. PRINGLE, 2, Commercial-square, Winton, Blaydon-on-Tyne. v 38**L**ADY would like to work on bee farm July, August, with or without board; terms.—STUDENT, "B.B.J." Office, 23, Bedford-street, London. v 43**S**WARMS of Dutch, Italian, British Golden, prolific, Sladen's strain, and Native Blacks, for sale.—Apply, MAJOR MAXWELL, Glenlair, Dalbeattie, N.B. v 31**R**EADY for immediate despatch, strong guaranteed healthy swarms, 14s. 6d.—Caroline Cottage, Winchelsea-road, Hastings. v 6**W**ANTED, sections of honey.—Price and quantity to COWELL, Station-road, Sheringham, Norfolk. v 84**F**OR SALE, June 15th, ten to twenty stocks of bees in hives, consisting of floor-board, brood box, outer case, lift, roof, painted, seven Italian 1914 queens, the remainder black, guaranteed healthy on despatch.—ASHWORTH, Heytesbury. v 80**A** FEW good section racks, complete, with dividers, follower, and wedge, 1s. 6d. each; lace paper, neat pattern, 6d. 100, post free; lace bands, 2 $\frac{1}{2}$  in. and 3 in., 100 1s. 2d., post free, finest quality.—W. WOODLEY, Beedon, Newbury.**S**ELL, Thould and Hutchinson portable cesspool pump, with all fittings, used once only, cost £3 10s.; offers.—"PUMP," "B.B.J." Office, 23, Bedford-street, Strand, London, W.C.**W**ANTED, the following: Cloth editions "British Bee-Keepers' Guide Book," 1st, 3rd, 4th, 5th, 7th.—HERROD, "B.B.J." Office, 23, Bedford-street, Strand, W.C.



### SURREY B.K.A. SHOW.

As the Guildford and West Surrey Agricultural Association, with which the annual exhibition of the above Association is to be held, has been obliged to change the date of its show from September 2nd to September 9th, will intending exhibitors please note the alteration in the date of the Surrey B.K.A. show to September 9th? Entries now close on August 31st instead of August 24th.

### BEE-KEEPING IN CANADA.

The conditions for bee-keeping in this part of Canada are very different to those found in the Old Country. This year, for instance, the weather was not mild enough for the bees to be brought out of the cellar until April 16th. To-day, May 27th, two colonies have half filled their first extracting super with honey mainly from dandelion. These two colonies were wintered out of doors, packed in shavings, with two others in a wintering case, and experienced a long period of below zero weather in February, with drops to 30deg. below and less some nights. The honey-flow from white clover and alsike clover, usually by far the greatest of the season, will not begin for two weeks. It will be supplemented in July by a flow from sweet clover, and will be succeeded in August by a flow from buckwheat, and in September from golden rod and aster. In an apiary in the bush over a hundred miles north of Ottawa, 160lbs. of honey per colony were got last year, mainly from willow herb (*Epilobium angustifolium*), a plant that produces a very light honey with a superb spicy flavour. The willow herb remains in bloom from early July until frost, and is said to produce a good crop every season.

The wholesale price of honey in Ontario is 10c. to 12c. per lb.—almost as high as in England.—F. W. L. SLADEN, Apiculturist, Central Experimental Farm, Ottawa, May 27th, 1914.

### HONEY IMPORTS.

The value of honey imported into the United Kingdom during the month of May, 1914, was £5,416.—From a return furnished to the BRITISH BEE JOURNAL, by the Statistical Office, H.M. Customs.

### OBSERVATIONS ON HIVES.

By L. E. Snelgrove.

(Continued from page 145.)

The general appearance of a hive is important: the joy of bee-keeping is greatly enhanced if the apiary is comprised only of hives that are well designed, tastefully arranged and kept scrupulously clean. Such hives add charm to the most beautiful garden, and are, therefore, a constant source of pleasure to visitors as well as to the bee-keeper. Elegance in the design of a hive may be obtained without extra expenditure. The shapes and dimensions of all parts should harmonise. The legs should be of proportional length and thickness and suitably splayed, the length and breadth of the whole hive the same, or nearly so; the height no greater than is absolutely necessary; the roof a mere cap with pleasing slope; the alighting-board wide and only slightly sloped; and the porch light and of simple design. The cheaper kinds of hives are sold without legs, and some beekeepers do not object to this. Such hives, however, placed on the ground or upon pieces of wood or brick, are easily invaded by obnoxious insects, especially ants and earwigs, while moisture, which is always being drawn upwards from the ground by capillary attraction, makes them damp and unhealthy. Beekeepers who have worked hives placed on the ground certainly know what it is to have a "back-ache." This trouble may be avoided, however, if the legless hives are placed on stout rafters, which are affixed to stakes driven into the ground and made exactly level. The hives are then also level, an important point in the production of comb-honey. This plan, however, is not to be commended, for it is difficult to change the relative position of the hives during the summer if this becomes necessary, and unless there is considerable space and dissimilarity between them the bees visit neighbouring entrances promiscuously. I once kept an out apiary, consisting of a row of twelve hives all of the same pattern and colour. Having occasion to destroy two of the stocks on account of foul brood, and having replaced the cleansed hives in their places, I was dismayed the next day to see as many bees entering the empty as the full ones. The hives were two yards apart, but their similarity had confused the bees, with the result that the disease gradually appeared in almost all the stocks in the row. It is therefore good economy to provide all hives with legs. Their height should be such as will enable one to manipulate the brood nest without stooping unduly, and the body of the hive should be sufficiently far from

the ground to be clear of the dirt which is splashed upwards in a storm. The legs should not be so high as to render the hive unstable in a wind or to make the uppermost supers higher than the elbows of the manipulator.

Bearing these points in mind, the most suitable height of the floorboard from the ground is about 12in. Allowing 2in. for iron feet, this leaves 10in. for the length of a leg.

Illustrations of old hives show that the legs were often considerably longer than this, but then supers were not always tiered as they are now, and although brood nests were more conveniently handled, the short bodies and long legs remind one of certain types of caricature. Equally objectionable are the extremely short legs supplied with large hives now-a-days by some makers where elegance is sacrificed to economy. I have seen modern hives whose floors were not more than 6in. from the ground.

To give stability each leg should be splayed outwards in two directions. The amount of splay desirable depends upon the length and thickness of the leg and of the mode of attachment to the joist. In most hives with hanging frames the weight is transmitted vertically through

the joists. The vertical line through the centre of gravity of a joist should therefore fall just within the inner edge of the base of the splayed leg. This will permit two legs, with the joist in position, just to stand without toppling over. Should the splay be greater than this the weight of the hive exerts a continuous movement tending to tear the legs from the joists. Should it be less, the greatest desirable stability is not attained. For a leg of 12in. length and  $2\frac{1}{2}$ in. square, fitted with joists 3in. by  $1\frac{1}{2}$ in., the splay should give a slope of 1 in 6 from the vertical. This may easily be obtained by setting a bevel to 80 degrees and marking in opposite directions from a given point on a corner of the leg till the bevel marks meet at the opposite corner.

If cut off in the plane of these marks the leg will slope in two directions. The joist should be let into the leg at right angles to a cut surface. Screws should be used for fixing so that the legs may readily be removed if necessary.

Heavy iron nails or dowels partly driven into the bottom will prevent decay, but it is better to use the ant-proof feet made for the purpose and sold by all appliance dealers.

*(To be continued.)*



### THE HIVING AND TREATMENT OF NATURAL SWARMS AND CASTS.

*(Continued from page 237.)*

The next position is that of a swarm which settled on a thorn bush growing at the foot of a bank which came close to its branches, so that it was impossible to get a skep underneath (Fig. 19). The skep was placed so that it rested on the bank with the top edge touching the bees (Fig. 20), where they are seen just commencing to enter. At (Fig. 21) about half have gone in, at (Fig. 22) very few remain, while (Fig. 23) shows that all have passed inside.

Sometimes a swarm will cluster on a branch of a tree or hedge that is of no value. In such a case the branch may be cut off with a sharp knife or parrot-nosed pruning shears (Fig. 24), and laid on a board in front of the prepared frame hive, when they will run in, as shown at (Fig. 25).

Again (Fig. 26) shows a curious position and formation of the swarm. It reached from the branch to the ground, measured two feet in height and width and three inches in thickness; the method of hiving is illustrated at (Fig. 27). The skep was placed on the ground a little way off and propped up with a stone; the bees were then dislodged by passing a piece of wood along the underside of the branch. When they fell to the ground a few were guided towards the skep, when the whole lot ran in without the slightest trouble. Two methods of dealing with a swarm on the hand (Fig. 28) are shown, at (Fig. 29) it has been shaken into a skep, and at (Fig. 30) it is being allowed to run into a frame hive. What bee-keeper has not

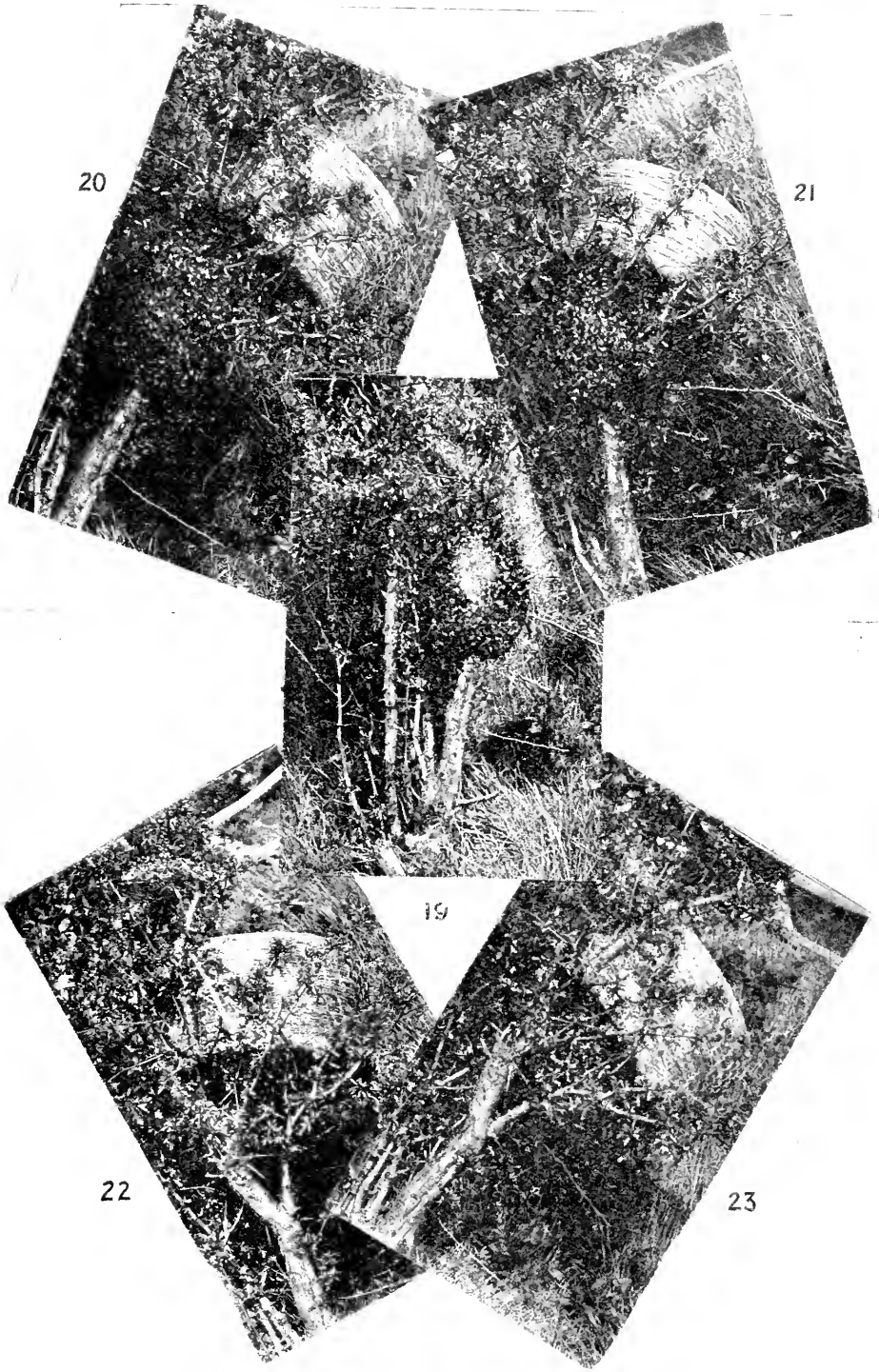

had the annoying experience of seeing one of his fine swarms go into some cavity in a tree or building, as, for instance, the flue of a chimney with the bottom bricked up? In many such cases I have secured the bees by taking a comb or brood

from a stock and lowering it by means of string tied to one of the lugs so that it touched the cluster. It was allowed to remain for an hour or so, and then hauled up with the queen and bees attached, as their natural instinct caused them to cluster on the brood to warm and protect it.

In large apiaries it not infrequently occurs that two or more swarms come out at the same time and join together. Where this occurs they may be hived into a



FIG. 24.



FIG. 25.

frame hive, with sufficient supers placed upon it to accommodate them, when a good surplus will be obtained. If they are required for sale purposes then it will be necessary to separate them. This is easy of accomplishment. In two cases I have had to deal with four swarms joined together; in each case it was necessary to separate them, and I proceeded as follows. A large sheet was spread upon the ground, a skep placed at each corner, and propped up on the side facing the centre



FIG. 26.



FIG. 27.

of the sheet. The bees were brought up by skepfuls and shaken down in the centre of the sheet. A careful examination was made until all four queens were found; one was placed in each of the four skeps, and then the bees were guided by means of a yucca brush so that an equal portion went into each skep. The work was carried out in the evening. No fighting took place, nor were any of the queens killed.

Bees living in trees, etc., under natural conditions, before they swarm send out

scouts to find a new location, and no doubt some of my readers may have had or will have experience of this. An empty hive standing in the garden is visited for a week or ten days by a number of bees, who are busily engaged in cleaning it down. The owner is surprised at this, but he is quite astonished when one day he finds the hive fully populated. The bees seen first were the scouts, and when the swarm issued it was piloted straight to its new home. If the bee-keeper is



FIG. 28.



FIG. 29.

away from home during the day time he can take advantage of this natural trait by putting out a decoy hive, *i.e.*, a hive fully fitted as for the hiving of a swarm. If the bees swarm during his absence the chances are that they will take possession of the new hive and so save loss. It is not playing the game, but very mean, for those who do not own bees to put out decoy hives to make a cheap start, which is done at times.

Another effective method of getting swarms to settle is the dead decoy, which is made by threading a number of dead bees on cotton and hanging them in a cluster on a tree (Fig. 31).

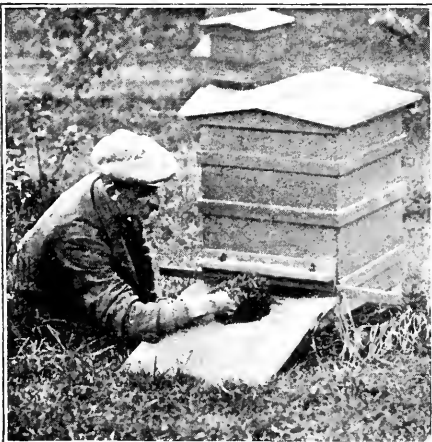

FIG. 30.

#### HUNGER SWARMS.

These issue in March, and instead of being the sign of an abnormally early season, as so often stated with much gusto by the daily papers, shows bad bee-keeping. The stocks are packed down with insufficient food to last them until a natural supply can be obtained from the flowers. They are not supplied with candy during the winter and early months of the year, so their food supply being exhausted in March they come out on a fine day in the form of a swarm to try and find a provisioned home. Hunger swarms are small (Fig. 32); they are very restless and move from place to place very rapidly, and will settle almost anywhere. They should be



FIG. 31.

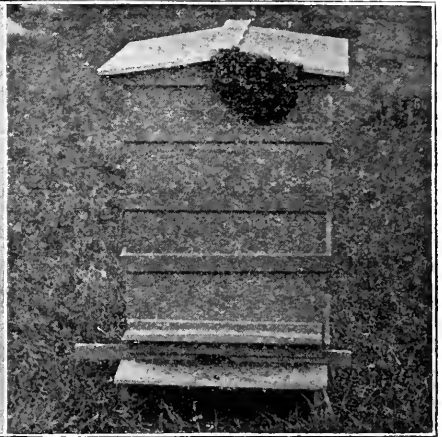

FIG. 32.

captured as quickly as possible, hived back into their old home, and supplied with warm syrup in a bottle-feeder. The feeding must be kept up until a natural supply is obtainable.

*(To be Continued.)*

## CORRESPONDENCE

### SUCCESS AT THE HEATHER.

“Tis not in mortals to command success,  
But we’ll do more—deserve it.”

[9037] May one who until lately was a comparative novice at that annual event known amongst some bee-keepers as “going to the heather” venture upon a few words of advice to those who may be, like he himself was a few years ago, anxious to go, but lacking knowledge and experience of the best ways of carrying out the operation. It may sound somewhat of a paradox to say that “success at the heather” is not gained there, but in the more prosaic apiary at home. Like other achievements which are at all desirable, it must be prepared for months in advance. It is not a mere matter of taking bees to the moors, placing them in the most favourable situation, and then trusting to luck. We learn from our successes; possibly we learn more from our failures. What I here wish to teach is the result, as much of failure as of success.

Most bee-keepers have had one harvest of honey before the time arrives for the annual migration to the heather. Although

perhaps the most glorious event in the bee-keeper’s calendar it is not to be entered upon lightly and without due consideration. Success may come even to the foolish, but the experiment is most likely to end in dire and dismal failure. Remember that from early spring you have been working your stocks to their utmost extent, stimulating the queen to the limit, and that now the harvest of lowland honey is over both queens and stocks are ready for a rest. But if heather honey is to be obtained no rest may be allowed. Strict necessity requires that any hive taken to the moors must be a mass of brood from back to front. For it is the quantity of brood taken, rather than the number of bees, that is to determine success or failure. How is this to be obtained? As soon as the clover flow is over, requeen at once. This is not a treatise on requeening, or queen rearing, but by any method you can, see that a young queen is at the head of each stock, and by gentle stimulation if necessary make sure that she is laying to her fullest capacity. The presence of a young and vigorous queen puts new life into the stock as well as assuring combs solid with brood. This, then, is the first essential, and must be thought out not the night before the great event, but months in advance. Although moderately strong stocks may be taken with a view to obtaining winter food, it is only the very strongest that will



give surplus at a time when the natural propensity of the bees is to reduce the brood nest and begin to cluster.

Perhaps next to having stocks fit to take, the chief essential is to have suitable hives to take them in. There are many hives on the market, all equally good for standing in the home apiary, but possessing all sorts of defects when it comes to travelling with them. The essentials of a good heather hive are that it shall be easily shut up ready for a journey, that when closed there shall be ample ventilation for bees so that combs do not break down with the heat, that it shall ride easily on a conveyance without any suspicion of top-heaviness, and that it shall pack easily along with others.

If then the reader desires to take his bees to the moors he must see that his hives possess these essential features at once. A hive for the moors ought not to stand on legs, for when loaded on a dray these make the hive top-heavy and cause a considerable amount of swinging. Instead of legs stout plinths about 4in. deep under the floor-board are all that is necessary. The entrance should be such as can be closed in a minute with perforated zinc and yet will give the bees ample ventilation, and perhaps more important still, it should run the whole length of the hive. Double-walled hives—that is, hives with interior chambers loose, such as the "W.B.C.," although perhaps the best for home use, are difficult to pack securely, and should not be taken. All supers should be contained in the outer case; sections can be easily accommodated in the "W.B.C." hanging frame, and the supers containing them will then be found to be interchangeable with supers of shallow bars. In packing, a piece of cheesecloth or coarse sacking may be laid over the brood chamber or even over the supers, and another super jammed down tight will hold all secure. Nails or screws through the plinths complete the packing.

Combs should also receive attention. Novices are regularly being warned to nail all frames and to wire all foundation. If this is necessary for the home apiary, it is doubly needful when it comes to transporting stocks. If this little piece of advice be neglected the would-be traveller will possibly find himself, as Pettigrew says, "A hive the poorer but a thought the richer." Have by a supply of drawn-out shallow bars, and if possible sections also, because, although bees will draw out foundation at the moors they seem to do it with reluctance, and much valuable time may be saved by having combs ready. These they will fill at times when they will not look at foundation.

Now as to transporting bees to the heather. Close all hives the night

previous to the journey, and if possible travel during the night or early morning, so as to have the stocks on their new stands before the heat of the day. Even the method of transporting stocks needs careful consideration. I am of the opinion that a light motor-lorry is the best means, and intend to try it as soon as possible. Failing that, choose a four-wheeled spring dray. On no account take an ordinary two-wheeled vehicle. Accidents happen to horses at times, and if the animal honoured by your choice to convey you and the bees to the moors chooses to lie down on the way, well, a two-wheeler goes down with it, whilst a four-wheeler may be trusted to remain as a rule in stable equilibrium. Look well after the horse, and see that he is capable of doing his work in the time allotted for it, or, if prolonged rests have to be made on the road, the bees may suffer. I write from experience. I once hired a horse which appeared to be splendid. He went well on the level, but when he came to the hills he refused to go, and no amount of persuasion could induce him to pull. He had to be taken out, and I had an up-hill journey of several miles to the moorland farm to get another. Result—a stock damaged (my best stock, by the way), my temper gone for the week. When I examined that horse I found he had sore shoulders. Such details as here pointed out make for success. Leave nothing except the weather to chance, and then if that is favourable you will be rewarded by a bumping harvest.

Pack your hives carefully on the dray, a few turns of rope will hold them secure, and then drive. If you have such faith in your packing that you need not look behind to see if bees are coming out, then so much the better.

On arriving, unpack the hives from the dray, place on their permanent stands, which may have to be of the makeshift variety, such as a few stones, and then, before loosing the bees, see that the horse is taken out of the field. Make everything secure; see that there is ample room for bees to work and that all is packed up warm. Success in the shape of good supers of honey may not come, but it pays me to take for winter stores only. One more thought—a queen excluder is scarcely necessary, as the brood nest is now contracting.

D. WILSON.

#### LINSEED AND "I.O.W." DISEASE.

[9038] May I suggest linseed as a remedy for "Isle of Wight" disease? It is not, of course, intended to kill the parasite, but to strengthen the bee against it. It is well known that linseed improves

the coat and skin of animals. It is also an old remedy for colds; and I suppose its effect is in healing the mucous membrane. If this is so, may it not strengthen the internal skin surface of the bee and so prevent the parasite from entering the body, as we are told, by the bacteriological lecturer reported in your issue of May 21st, that it does by "insinuating itself into one of the larger digestive cells, or piercing between them, and reaching the body cavity lying beyond." That this proposed remedy is not altogether improbable would seem to follow from what the lecturer further said, namely, that some bees "have acquired a certain amount of immunity to the parasite, which can live and multiply within them, but does not affect them seriously."

I have tried linseed flour in candy (not for the cure of disease), and the bees seem to prefer it to pea-flour. Linseed is difficult to grind; probably some of the oil should be extracted first, and then the broken seed dried before it is ground and sieved. It may be said that we cannot continue the feeding of linseed; but I think, if it is effective, all that would be necessary would be to give it during the important breeding seasons—say, two months in spring and one month in autumn. It is only intended as a remedy for the bee reared wholly or partly on it from the egg, and not for the fully-developed bee.

I should like to find fault with Mr. Heap (page 222, June 4th) when he implies that the immune bee is a chimera, and says the "universal destruction of diseased and suspected stocks would help her (Nature) enormously." I am not altogether opposed to legislation in regard to bees, but if we are to destroy stocks of bees as the Board of Agriculture destroys pigs, we may be no nearer to the immune bee at the period Mr. Heap mentions. I believe immunity is the only proper policy to aim at, and that it is not difficult to attain; and to this end only badly diseased stocks should be destroyed. If partly diseased and even "suspected" stocks are to be destroyed, how is the immune bee to arise?—T. T. TAYLOR, Beverley.



[8943] *Beginner's Queries.*—(1) Is it a sign of anything wrong to find dead bees scattered on the ground before the alighting-board? The stock is a strong and active one with 1913 queen, covering ten frames and working in a first super. I do

not notice any other suspicious sign, such as bees loitering on the alighting-board with wings extended, or voiding excrement on and about the hive. (2) How long should it take such a stock to draw out ten shallow frames in a super (full sheets), having regard to season and locality? (3) Is it wise, after work has been commenced in a super, to disturb the bees by examining the brood-frames? The bees are building comb between the bottom of shallow-frames and the queen-excluder. (4) Can this be prevented or does it not matter? (5) Do bees ever tear down the edges of sheets of foundation (shallow frames) if the sheets do not extend right across? This is my first season, and perhaps I am inclined to be over-anxious about my one stock.—S. TWIGG, Derby.

REPLY.—(1) The symptoms point to "Isle of Wight" disease. (2) It is difficult to say, from a week to a fortnight, when they commence work in them. (3) No. (4) If the supers are made to the right size this ought not to be. Let them alone now. (5) Bees will tear down foundation at times for various reasons. Don't worry, it will be all right.

## Bee Shows to Come.

*A nominal charge of 2s. 6d. is made for notices (not exceeding 7 lines) in this column, 10 lines charged 5s. 6d., up to 15 lines 5s., which covers cost of insertion from order till date of show. Cash should accompany orders for insertion.*

**June 30th to July 4th, at Shrewsbury.**—Royal Agricultural Society's Show. Bee and Honey Section, under the direction of the B.B.K.A. Prizes arranged in groups of counties for Associations affiliated to the B.B.K.A. Schedules from W. Herrod, 23, Bedford Street, Strand, W.C. Entries closed.

**July 8th, at St Albans.**—Honey Show of the St. Albans B.K.A., held in connection with the Elstree and Boreham Wood Horticultural Society, at Aldenham Park. Open class for extracted honey. No entry fee. Liberal prizes. Judge, Mr. W. Herrod. Schedules from Mr. R. H. Attenborough, Aldenham, Herts. Entries close July 6th.

**July 14th to 17th, at Hawick.**—Scottish Bee-keepers' Association. Exhibition of honey, wax, and appliances, in connection with the Highland and Agricultural Society's Show. Open to all British bee-keepers. Liberal prize-money. Write for schedules to A. Aikman Blair and John L. Gibson, joint secretaries, 176, Bruntsfield-place, Edinburgh.—Entries close 7th July.

**July 16th and 17th, at Boston.**—Lincolnshire Bee-keepers' Association. Exhibition of Honey, Hives and Appliances. Open and county classes. Over £30 in prizes. Schedules and entry forms from Capt. J. H. Hadfield, Alford, Lincs. Entries closed.

**July 22nd to July 24th, at Bradford.**—Great Yorkshire Show. Classes for hives, honey, &c. Good prizes. For schedules and forms of entry (stating department), apply, The Secretary, Great Yorkshire Show, Blake-street, York. Telegrams, "Yas, York." Entries closed.

**July 22nd and 23rd, at Cardiff.**—The Glamorgan B.K.A., in connection with the Cardiff and County Horticultural Society's Show, in the Sophia Gardens, Cardiff. Open classes include:—Collection, Gift, Sections, Beeswax, &c. Schedules from W. J. Wiltshire, Maundy School, Cardiff. **Entries close July 18th.**

**July 23rd, at Southwell.**—The Notts. Annual County Show, in connection with the Southwell Horticultural Society. Open class for single jar extracted honey. Schedules now ready from G. Hayes, Mona-street, Beeston, Notts.

**July 23rd, at Bath.**—The Annual Show of the Somerset Bee-Keepers' Association, in connection with the Larkhall Horticultural Society. Seven Open Classes. Schedules from J. W. Brewer, Glen Lynn, St. Saviour's Road, Bath. **Entries close July 18th.**

**August 4th, 1914, at Bridgnorth.**—Annual Show of the Bridgnorth and District Bee-Keepers' Association. Held in connection with Hampton Load Horticultural Society. Open gift class single 1lb. jar extracted honey. Prizes, 7s. 6d., 5s., 2s. Schedules from J. S. Lawton, Oldbury Wells, Bridgnorth. **Entries close July 25th, 1914.**

**Aug. 6th, at Bromham Park, Bedford.**—Honey show in connection with Biddenham and Bromham Flower Show, to be held in Bromham Park, near Bedford. Open classes for honey. Schedules from A. Henman, Bedford-road, Biddenham. **Entries close July 30th.**

**August 26th, at Prestbury.**—Honey show, in connection with the Prestbury Flower Show. One class open to the kingdom. Several for those within 12 miles radius. Exceptional prize list. Schedules from A. H. Bowen, Coronation-road, Cheltenham.

**September 1st, at Deddington.**—Honey show in connection with Deddington Horticultural Society's Show, to be held in the Castle Grounds. Open classes for honey. Schedules from H. J. Harmsworth, Deddington, Oxon.

**September 2nd at Stoke Park, Guildford.**—Annual Exhibition of honey, wax, appliances, &c., will be held by the Surrey B.K.A. in connection with the Guildford and West Surrey Agricultural Association. Eighteen classes, five open to all. Many medals. Schedules from F. B. White, hon. secretary, Marden House, Redhill, Surrey. **Entries close 24th August.**

**September 2nd, at Lancaster.**—Agricultural Show. Premier Honey Show of the North. 15 classes; £20 in cash prizes, silver cups and medals value 15 guineas, and other specials. Send for schedule (Honey) to Robert Gardner, solicitor, 69, Church-street, Lancaster. **Entries close August 19th.**

**Sept. 5th, at the Club Room, North-road, Kew.**—Honey Show of the Richmond and District Bee-Keepers' Association. Open classes for honey and wax. For schedules, apply Hon. Sec., Mr. J. G. Romer, 234, Kew-road, Kew-gardens. **Entries close Aug. 28th.**



**RED MOUNT (Lynn).**—*Fermented Honey.*  
—So long as you boil the honey it will be quite safe to feed the bees with it.

**C. H. M. (Lincs).**—*Observatory Hives.*—(1) The measurements given are perfectly correct. You will notice that one of our correspondents has already completed an observatory hive from the description. (2) The thermometer is for the purpose of recording the temperature in hive. (3) No, it is not unusual

to have a filled shallow-frame weighing 5lbs. to 6lbs.; we have had heavier ones still. The statement refers to eight combs per super.

**W. A. S. (Derbyshire).**—*Dead Larva Thrown Out.*—Without seeing them it is difficult to form an opinion. We should say that, having given up all idea of swarming, the bees are casting out drone larvae, which often occurs.

**W. A. M. (Norwich).**—*Name of Insect.*—The insect is a Mason bee, which is very common in this country.

**G. A. H. (Hinckley).**—*Bees Eating Holes in Foundation.*—It is generally caused by the foundation being too old and hard. They will also do it if too much soda has been used for lubricating the machines.

**J. B. (Stonehaven).**—*Disinfecting Appliances.*—Use a painter's blow-lamp, or wash with a solution of Calvert's No. 5 carbolic acid, 2 parts; water, 5 parts.

**R. S. (Castle Cary).**—*Wild Bee.*—Andrena, a species common in this country. (2) We use perchloride of mercury. Get a bottle of tabloids and follow instructions on bottle.

**H. J. H. (Winchester).**—*Lost Swarm.*—You have done all that was possible, as although room in advance of their requirements is given, bees will at times persist in swarming.

**A. H. B. (Newport Pagnell).**—*Defective Queen.*—So far as we can see, the queen is all right, there must have been some internal injury to account for her failing to lay. Why did you not complain to the dealer in question? He would have replaced her.

**G. H. L. (Petersfield).**—*Carniolan Bees.*—(1) The bees are pure bred Carniolans. (2) They show signs of "Isle of Wight" disease. (3) Close space the frames, to prevent drones from hatching.

**FULL SHEET (Gloucesters).**—*Dead Drones.*—The drones are being killed off by the workers.

**Bosco (Birmingham).**—*Feeding Swarm.*—Yes, you have done quite right. Continue feeding for another week.

*Suspected Disease.*

**R. L. L. (Devon).**—(1) It is the brood of a laying worker. (2) The brood is chilled only. (3) There is no other way. (4) They might possibly do so, but it is not probable.

**H. W. (Potterne Wick).**—It is a case of "Isle of Wight" disease.

**C. L. H. (Exeter), A. T. J. (Manningtree), and A. S. (Leighton Buzzard).**—The bees are suffering from "Isle of Wight" disease.

**FISHPODS (Bristol).**—The bees were too dry for us to determine the cause of death.

T. H. D. (N. Devon).—There is no disease, only pollen, in the comb sent.

B. J. (Colchester).—We can find no trace of disease in the bees.

TEMPLECOMBE.—Regret to say it is "Isle of Wight" disease.

QUEEN CAMEL.—No disease.

G. McN. (Leshmahagow).—It is "Isle of Wight" disease. There is no fee.

JINGO (Glos.).—Bees have "Isle of Wight" disease. There is no known cure.

H. E. W. (Sevenoaks).—Bees have "Isle of Wight" disease. Yes, it is quite possible for it to develop in the time stated.

### Special Prepaid Advertisements.

Two Words One Penny, minimum Sixpence.

Orders for three or more consecutive insertions entitle advertisers to one insertion in "The Bee-keepers' Record" free of charge.

Trade advertisements of Bees, Honey, Queens, and Bee goods are not admissible at above rate, but will be inserted at 1d. per word as "Business" Announcements, immediately under the Private Advertisements. Advertisements of Hive-manufacturers can only be inserted at a minimum charge of 3s. per  $\frac{1}{2}$  in., or 5s. per inch.

### PRIVATE ADVERTISEMENTS.

PRINTING PRESS, metal type, accessories, 10s., bargain; particulars.—W. WEBSTER, 291, Normanton-road, Derby. v 47

5S. OFFERED for cast, not under 2lb.—WILLIAMS, Palmouth-avenue, Highams Park. v 58

THREE BEE-HIVES for sale, in good condition; giving up the business reason for disposal; bargain.—H. MORRISON, King's Hut, Hunter's Quay, Argyllshire. v 46

WANTED, secondhand wax extractor, honey extractor, uncapping tray; all particulars.—FRASER, Melton Cottage, Balbirnie-street, Markinch. v 49

CASH OFFERS wanted for natural May swarms, on new wired frames, guaranteed healthy by expert.—JOHN BRAY, Covenham, Louth, Lincolnshire. v 50

CHAPMAN'S Honey Plants, strong plants, 3d. per score; seed, 3d. per packet.—W. KING, 20, Moy-road, Cardiff. v 51

SMITH PREMIER TYPEWRITER, Standard double keyboard, very reliable, beautiful writing, perfect condition, cost £25, accept 60/-, worth double.—WAKEFIELD, Newhall Hill, Birmingham. v 54

EXTRACTOR, Lee's, 27s. 6d., used once, perfect, 18s. f.o.r.—SCHOOLMASTER, Bampton Aston, Oxon. v 55

VIRGIN QUEENS, 2s. each, swarm raised; best honey strain, and very prolific; disease unknown. HORSBROFT, certificated apiarist, 207, Coventry Road, Ilford. v 57

CERTIFICATED expert wanted, for a few weeks, in Cumberland.—Apply, G. W. AVERY, Wetheral, Carlisle. v 18

A FEW of a very fine strain of specially bred queens for sale, from a district that has been devastated by "Isle of Wight" disease, and from stocks that have proved perfectly healthy, excellent honey storers and good comb builders, price, fertile, 10s. 6d. each; every queen tested, no unfertiles sold; safe arrival guaranteed.—E. HOWARD COLLINS, Harewood Apiary, Chalfont St. Giles, Bucks. v 30

PERFECT sections, 10s. per dozen, carriage forward.—Apply, MISS GORDON, Wethersfield-place, near Braintree, Essex. v 28

JUNE SWARMS, from frame hives, guaranteed healthy, 15s.—THOS. ORMESHER, Westhead Apiary, Ormskirk, Lancs. v 27

CHAPMAN honey plants, Borage, 5d. per score, post free.—STEVENS, Churchill, Oxfordshire. v 25

STRONG, healthy nuclei, with 1914 queens, four frames, 15s.; six frames, 20s. each, guaranteed healthy, no disease of any kind in the district.—A. SHARP, Halstead Farm, Barrowford, Lancashire. v 23

100 LB. clover honey, granulated, screw cap jars, 7d. lb. for cash.—JONES printer, Wellington, Salop. v 22

FOR SALE, grand stocks Scotch bees, healthy, 30s. each or in good secondhand hives, 40s. each, f.o.r., cash.—GEO. W. PAISLEY, Newport-on-Tay. v 45

A COUPLE of good stocks, on wired combs, just ready for supering, 40s. each, cash with order.—"BUMBLE," "B.B.J." Office, 23, Bedford-street, Strand W.C.

GUARANTEED healthy natural swarms.—Apply, THE APIARY, Northwood, Siddington, Chelford, Cheshire. v 19

A FEW good section racks, complete, with dividers, follower, and wedge, 1s. 6d. each; lace paper, neat pattern, 6d. 100, post free; lace bands, 2 $\frac{1}{2}$  in. and 3 in., 100 1s. 2d., post free, finest quality.—W. WOODLEY, Beedon, Newbury.

SELL, Thould and Hutchinson portable cesspool pump, with all fittings, used once only, cost £3 10s.; offers—"PUMP," "B.B.J." Office, 23, Bedford-street, Strand, London, W.C.

WANTED, the following: Cloth editions "British Bee-keepers' Guide Book," 1st, 3rd, 4th, 5th, 7th.—HERKOD, "B.B.J." Office, 23, Bedford-street, Strand, W.C.

DIRECT from F. W. Sladen's original extra golden bee stocks.—British golden virgin queens, 2s. 6d. each, three for 5s. 9d.; apiary free from "I.O.W."—CREWES, Apiary, Warmingham, Surrey. v 20

STOCKS of Bees for sale, never had disease of any kind in apiary.—WEAVER PRICE, F.R.H.S., Brecon, South Wales.

### BUSINESS ADVERTISEMENTS.

HOW TO PREVENT SWARMING.—A certain method, fully explained, with illustrations from life, of bees and their work, price 1s., postage 1d., from all dealers, and the author, A. H. WILKES, Lichfield-road, Four Oaks, Birmingham.

### CHOICE, PROLIFIC, FERTILE.

English Queens, excellent strain, safe arrival guaranteed, every Queen tested, 5s. each.

Wilkes, Lichfield Road, Four Oaks, Birm.  
Established 1892.

COMFORTABLE APARTMENTS for Brother Bee-keepers visiting Douglas. Terms: Tea bed, and breakfast, 3s. 6d.; or full board, 5s. per day.—HORSLEY'S, Merridale House, top of Castle Drive, Douglas, Isle of Man.

NEW Super-Clearer (patented), combining reliability and rapidity. See "B.B.J.," April 9th. Order at once from your dealer, 6d. each, or from F. W. WATTS, 132 Goodrich Road, East Dulwich. v 87



### THE ROYAL SHOW.

We take this last opportunity of drawing our readers' attention to the Royal Show, at Shrewsbury, which opens on Tuesday next. The show promises to be one of the largest in recent years. In the Hives and Honey Department there are more entries than at any since the Lincoln Show of 1907. The annual show at Shrewsbury is noted all over the country, especially for its horticultural section, and also until lately for its honey section. No doubt the town will be able to do justice to its reputation, and we advise as many of our readers as possible to pay the show a visit. It is educative to the majority of bee-keepers to visit a large show, representative of the best and most experienced exhibitors in their ranks. We are looking forward to increasing our already large number of bee-keeping friends as well as to renewing acquaintance with old ones. Whatever you miss at the show, don't fail to pay a visit to the "Hives and Honey Department."

### ST. ALBANS AND DISTRICT B.K.A. SHOW.

We would call our readers' special attention to the show to be held under the auspices of the St. Albans and District B.K.A. in Aldenham Park, on Wednesday, July 8th, 1914. A great deal of trouble has been taken by Mr. R. H. Attenborough to make it a success, and he deserves the support of all bee-keepers. There is an open class for a single jar of extracted honey, with liberal prizes and no entry fee, which is well worth the attention of bee-keepers in any part of the country. Those who reside in the vicinity should certainly pay a visit to this show. Not only to see the honey competitions, but the gardens and grounds of the Hon. Vicary Gibbs are famous throughout the country and well worth a journey of many miles to see. Cheap tickets are issued on the Midland Railway, and a motor-bus service to the entrance of the gardens will be run from Cricklewood, and the train at Radlett Station. All particulars can be obtained from Mr. R. H. Attenborough, Aldenham, Herts.

### IGNORANCE.

The following, taken from a Northern newspaper, June 5th, 1914, made us rub our eyes and wonder if we were living in the first or twentieth century. It is incredible that such trash should be printed in these enlightened days:—

#### "LOOKING AROUND.

"*How Skilfully She Builds.*"—Yesterday, I made incidental reference to the building of her cell by the bee, saying that there is nothing extraordinary in the beautiful six-sided achievement. 'Bee-keeper' wonders at my observation, 'having been taught from infancy to regard the bee's cell as one of the most marvellous achievements of instinct in the whole realm of nature.' But, really, there is not much in it. The bee, because of the form of its body, cannot help itself but make a six-sided cell, and 'Bee-keeper' will be persuaded that it is so, if he places as many pennies as possible around one penny, so that all touch the centre coin and each other. He will find that exactly six pennies can be thus placed around one penny.

"*Pennies, Cheeses, Full Moons.*"—'Bee-keeper' will find the same thing to be true, if he make the experiment with threepenny-pieces, sixpences, crowns, round plates, cheeses, and moons. Because every circle, great or small, admits around it exactly six circles of its own size, all being in touch with it and with each other. Now let 'Bee-keeper' fill up with wax the six triangular interspaces around the central coin, and thereupon remove this coin. He will find that he has made a hexagonal or six-sided cell as perfect as the bee. For bees hang in a cluster, packed together when making the comb, the cylindrical body of each bee being in touch with the six cylindrical bodies of other bees. Every bee thus placed covers its body with a layer of secreted wax, filling the interspaces with the same.

"*As the Muggers' Horse.*"—It follows from the foregoing explanation that each bee, on withdrawing its body from the wax, leaves, and cannot help but leave, a six-sided cell. From this it will be understood that the bee deserves no more credit for the making of its beautiful cell than does the earthworm for the round hole it makes on coming to the surface—no more credit than the mugger's horse deserves for describing a perfect circle by going round and round at the length of its tether."

And again, from *Farm, Field, and Fireside* we have the following:—

"Supposing a large number of drones to have hatched out it is sometimes desirable to trap them. This may be done by means

of a trap made of queen-excluder zinc, made to fit over the hive entrance. It should be put on in the middle of a fine sunny day when drones are flying, and prevents them from re-entering the hive without materially hindering the workers.

"Combs filled entirely with drone brood should be removed altogether, after shaking the bees back into the hive. They may be fed to chickens, who devour them greedily, and, indeed, I am not surprised, for following the example of some native tribes, I once boiled a lot of drone grubs and ate them. They are pure white, tasty morsels, with a rich nutty flavour, and if prejudice can be overcome would form a quite acceptable and luxurious dish.—Ivo."

Shades of C. N. White! it is enough to make him turn in his grave that such rubbish should be written above his personal *nom de plume*, and by which he was known for many years. Out of respect to the dead we would suggest that the present writer (we know not who he is) will have the decency to choose a *nom de plume* of his own.

#### BRITISH BEE-KEEPERS' ASSOCIATION.

The monthly meeting of the Council was held at 23, Bedford Street, Strand, London, W.C., on Thursday, June 18th, 1914. Mr. W. F. Reid presided. There were also present Miss M. D. Sillar, Sir Ernest Spencer, Col. H. J. O. Walker, Messrs. C. L. M. Eales, E. Watson, J. Smallwood, R. H. Attenborough, O. R. Frankenstein, J. B. Lamb, and H. P. Perkins; Association representatives, G. J. Flashman (Barnet), G. R. Alder, and G. S. Fauch (Essex), F. W. Harper (St. Albans), G. W. Judge, and G. Bryden (Crayford), Rev. F. S. F. Jannings (Yorkshire), and the Secretary, W. Herrod.

Letters expressing regret at inability to attend were read from Miss Gayton, Mr. T. W. Cowan, and Mr. D. Seamer. The minutes of Council meeting, held on May 21st, 1914, were read and confirmed.

The following new members were elected:—Miss E. B. Hampson, Miss D. E. Shakerley, Captain Basil J. Orlebar, Mr. A. L. Williams, Mr. A. B. Cloutman, and Mr. S. H. Smith.

The following Associations nominated delegates, and the same were accepted: Lancashire, Dr. W. Anderton; Yorkshire, Rev. F. S. F. Jannings; Northampton, G. Masom.

The report of the Finance Committee was presented by Mr. Smallwood, who stated that the payments into the bank for May amounted to £323 13s. 1d., the bank balance being £283 5s. 11d. Payments amounting to £325 5s. were recommended.

Reports were made by Mr. W. F. Reid

and Mr. J. B. Lamb *re* Bacteriological Examinations, but it was felt that there was not sufficient information before the Council to act upon at the present.

A letter was read from Mr. T. W. Cowan thanking the Council for their telegram of congratulation on the golden wedding of Mrs. Cowan and himself.

The matter of arranging the judging tests at the conversazione in October was kindly undertaken by Mr. O. R. Frankenstein.

Applications for Preliminary Examination to be held in Gloucestershire, Lincolnshire, Somersetshire, Glamorganshire, Worcestershire, and at the Royal Show, Shrewsbury, were received and granted.

Next meeting of Council, in the Hives and Honey Department, Royal Show Ground, Shrewsbury, Thursday, July 2nd, 1914.

#### ROYAL COUNTIES AGRICULTURAL SHOW.

##### BEE AND HONEY DEPARTMENT.

The above show, held on the Common at Southsea, on June 10th to 13th, was favoured with excellent weather conditions, which no doubt was responsible for attracting the record crowds visiting the show. Some excellent honey was staged, and considering the state of the bee industry in the Southern Counties, there was a good entry. The observatory hives shown by Mr. Geo. Boddie and Mr. H. M. Cooper attracted great attention, and about 500lbs. of honey was sold at a good price, in the selling classes. The bee tent attracted large crowds, which were evidently greatly interested in the lectures and demonstrations given under the auspices of the Hants. and Isle of Wight Bee-keepers' Association by Messrs. E. H. Bellairs, H. M. Cooper, and F. D. Hills, the Hon. Sec., assisted by Mr. F. W. Allinson. The Duke and Duchess of Teck, Sir H. Meux, and Sir Wm. Portal were among the distinguished visitors who spent some time at the demonstrations, and were evidently greatly interested. Mr. E. H. Bellairs judged the exhibits and made the following awards:—

*Collection of Hives and Appliances.*—E. H. Taylor, Welwyn.

*Observatory Hive, with Bees and Queen.*—Geo. Boddie, North End, Portsmouth.

*Complete Frame-hive (price not to exceed 20s.).*—E. H. Taylor.

*Cottage's Hive (price not to exceed 10s. 6d.).*—E. H. Taylor.

*Invention or Inventions calculated to be of use to the Bee-keeping Industry.*—No award.

*Display of Honey and Wax.*—1st, H. M. Cooper, Thorley, Isle of Wight; 2nd, F. D. Hills, Ivanhoe, Alton.

*Twelve Sections (not exceeding 2-lbs. each).*—1st, F. D. Hills; 2nd, H. M. Cooper; 3rd, Mrs. Henshaw, Eynham, Bitterne, Hants.

*Six 1-lb. Sections.*—1st, F. D. Hills; 2nd, Mrs. Henshaw; 3rd, H. M. Cooper.

*Single 1-lb. Section.*—1st, F. D. Hills; 2nd, H. M. Cooper.

*Single 1-lb. Jar of Extracted Honey.*—1st, A. H. Bowen, Cheltenham; 2nd, F. D. Hills; equal 3rd, E. J. Pannell, East Street, Havant, and H. M. Cooper.

*12-lbs. of Extracted Honey in 1-lb. or 2-lb. Vessels.*—1st, S. G. Leigh, Broughton, Hants; 2nd, H. M. Cooper; 3rd, E. J. Pannell.

*Beeswax.*—1st, H. M. Cooper; 2nd, Geo. Boddie.—F. D. HILLS, Hon. Sec.

spring to see whether the cure was permanent or not. The month of April revealed solid slabs of brood, which were a delight to look at, every cell containing an absolutely healthy grub. The stock developed into one of hurricane strength, and gave me almost 100 beautiful sections. The beauty of the bees, and the immense number were a marvel to all bee-keepers who saw them.

I should also say that every stock headed by a foreign queen proved healthy, and remained so up to the time of writing, despite the fact that they were all put into more or less affected hives. Let me turn to colonies headed by native or Black queens. I had only two swarms last year, both from natives. I noticed slight traces of disease in one of them, which failed to requeen. Now for the sequel. I introduced a Black virgin, which I got from a friend about a fortnight after the swarm issued. In due course she mated and commenced laying. You will observe they were treated almost similarly to the stock into which the Golden Italian virgin was introduced. More than three weeks elapsed from the removal of the laying queen until any eggs were deposited in either hive. The Golden Italian headed a colony of bees of which anyone might be proud, while this native Black is to-day at the head of a rotten and dwindling handful of bees. But I am not yet finished. The other stock of natives which swarmed, and which at the time appeared quite healthy, came out this spring in a worse and weaker state than the aforementioned, and was destroyed some time ago.

I have unfortunately still got seven stocks of Blacks, five of which are diseased, while every one of the twelve stocks headed by Italian and Carniolan queens is healthy and very strong.

The native bee has its good qualities and succeeds very well in districts free from disease, but where such abounds it is helpless and a source of contagion. In face of an experience such as mine, I consider it rank heresy to advocate sticking to Blacks under every condition.—CRUICKSHANK, Granton-on-Spey.



*The Editors do not hold themselves responsible for the opinions expressed by correspondents. No notice will be taken of anonymous communications, and correspondents are requested to write on one side of the paper only and give their real names and addresses, not necessarily for publication, but as a guarantee of good faith. Illustrations should be drawn on separate pieces of paper. We do not undertake to return rejected communications.*

### NATIVE v. FOREIGN BEES.

[9039] For the benefit of your readers I should like to give my experiences with native and foreign races of bees. I am located in a district infected with foul brood, and for a number of years my apiary has not been free from it. I have wasted gallons of Izal and tried every known specific to cure or check it, burning on an average three stocks every season, only to find the disease triumphant the following spring. I had often read of the greater immunity from disease of the Italian and Carniolan bee, so I determined to give them a trial. Two years ago I introduced several queens of both races. I put some of them into colonies which were more or less affected with the disease. One case is worthy of special mention. Into one stock very badly affected I put a Golden Italian queen which, owing to bad weather, was rather long in getting mated.

When brood appeared, I was gratified to see a uniform mass of pearly-white grubs without the slightest signs of disease. I closed down the hive strong in bees, with a sufficiency of stores, and waited with some anxiety the coming of the following

### FIGHTING "ISLE OF WIGHT" DISEASE.

[9040] "Isle of Wight" disease first appeared among my bees in August of 1911. I was rather alarmed at its first appearance, but later resolved to try and winter my stocks, some of which were Italian and some English. The English stocks all succumbed to the disease during the winter, but the Italians wintered well without any loss, and were

very strong and in fine condition. It was then that I resolved to test the resisting qualities claimed for Italian bees, and requeened every stock of native bees with a select tested Italian queen, which I got from a reliable queen-breeder, and for which I gave 10s. 6d. each. These stocks did well during 1912, and gave a splendid return of honey, and the disease did not reappear. To still further test their abilities I bought some stocks of native bees, and they developed the disease almost immediately. I at once deposed their queens, inserting in their place some specially selected Italian queens, for which I gave a high price. This seemed to put new life into them, and when the young Italians began working some five weeks later a crawling bee could scarcely be found. I at first used disinfectants, but have now given them up (except medicating the food when feeding them), as I find they are hardly necessary, though, of course, they do not do any harm. I also make a point of digging up the ground every fortnight, and spraying with Izal, which keeps the apiary in a healthy state. This present season the bees are better and healthier than ever, and some of the stocks gave me a rack of honey by April 26th, the earliest I have ever taken any.

It may also interest readers to know that this part of the county is very badly affected, and as I am expert to the Hunstanton, King's Lynn, and Docking districts of the Norfolk B.K.A., I have handled hundreds of diseased stocks in all stages, I, if anyone, ought to carry infection to my own bees. In several of the villages not a bee can be found, and I am convinced that it has to do with the bad state of our native bees. One enthusiastic bee-keeper boasted to me of the fact that there had been bees in his garden for over fifty years, and he had never bought or sold any stocks or swarms. This bee-keeper had lost all his stocks through "Isle of Wight" disease, and there is no doubt that inbreeding had made the bees very weak, and quite incapable of resisting disease.

My experiments lead me to believe that a good strain of Italian bees are the very best for disease resistance, though Carniolans are also good. I cannot speak very favourably of our English bees, as they seem helpless when attacked. I also believe in giving plenty of comb foundation, as this develops a good-sized bee. These stocks of mine have now stood the test for the last four years, and I have every confidence in saying that the cure of the disease rests entirely with the bee-keeper himself, and if a little time and trouble are taken by bee-keepers to see that they always have a good, young queen at the head of their stocks, I have no

doubt that the disease will gradually die out.

If any readers of this paper are visiting Hunstanton this summer I invite them to pay a visit to the "Model Apiary," when I should be only too pleased to still further explain my methods for keeping free from what up to the present has proved a most exterminating disease.—JULIAN E. LOCKWOOD, Hunstanton.

#### "ISLE OF WIGHT" DISEASE.

[9041] With a view to possibly assisting other bee-keepers, and that it may be of general interest in these troublesome times, and further in the hope that some other of your readers will give their experiences, I venture to set forth the visitation of this dreaded disease to my small apiary of nine stocks. Bees came through the winter exceptionally well, excellently stocked with natural food, and were all headed by prolific queens. Three weeks' very fine weather in April assisted breeding, with the result that by June 5th they had cast fourteen swarms, all so good that I could not detect the swarms from the casts. By June 7th, bees were well up in supers, but as all the surrounding bee-keepers were devastated by disease I kept a good look out. On that date I noticed some crawlers from a swarm cast on May 27th; the following day there were scores, and the next day they were so bad that we burned the lot in the evening. Those suffering from the disease had, however, whether by alighting drowsily on the wrong floor-board, or more generally by crawling up the legs of the hive, invaded their next-door neighbour—a magnificent swarm cast on June 4th. The crawlers were, of course, speedily expelled, and the floor-board covered with the slain, but the mischief was done, and on June 12th the second swarm showed unmistakable signs of disease. The day following there were numbers of crawlers, and as another stock was also slightly affected I stopped up both entrances in the evening, and removed them to separate localities, some 100 yards distant. They both ate their way out the next day, and some bees returned to their old stands, and no doubt it would be better to place old hives to receive and destroy them.

However, at the time of writing, no other stocks are affected. The stock slightly affected has recovered; the swarm continues to decrease, but as there is a quantity of brood I have a faint hope that it may supplement the casualties. In helping our little friends to fight this scourge we have one great asset. They are true sportsmen—or should we say sportswomen?—and if they must die they die fighting, game to the



last. My suggestion is that unaffected stocks must at all hazards be protected from the crawlers, and is it not a fair inference that the reason why whole apiaries are exterminated is largely because the hives are placed so close together?—H. R. YEO, Roughton Rectory.

#### SOMETHING LIKE A SWARM.

[9042] On Friday, 19th June, I was called to hive a swarm of bees at the residence of one of our members, H. Riley, Esq., West Lodge, Kew. I saw at once it was a monster, hanging so that I could reach it from the ground. I am not possessed of much muscular strength, and one shake brought so many bees in the skep that I was unable to hold it with one hand. I quickly got the other hand to it, and put it on the ground. I seized a box, about a foot square, lying close by, and shook that also full of bees, and threw them down at the propped-up skep entrance; also a second box full, before I had cleared the branch. I watered the swarm before hiving, and after it was in the skep; also cooled the outside with water, and left it well in the shade under the trees whilst I went home to fit up frames, &c., ready to hive the bees on later.

I had only been at home a quarter of an hour when a message arrived, "The bees are off again." I got them in a second time. When finally tied up in skep it weighed 15lbs. 8ozs. The skep, cheese cloth, and string, without bees, weighed 6lbs. 6ozs., leaving a total weight of 9lbs. 2 ozs. of bees.

Beg pardon, what did you say? Double swarm? "No such thing, marm," as the dustman told the lady when accused of stealing. There is only one stock in the walled-in kitchen garden; the swarm settled but a few feet away from the stock, the gardeners saw it issue from this only hive, and "rung it down." The weighing was done in the presence of Mr. and Mrs. Riley, also the gardeners, one of the maids, and your humble servant. "The British Bee-keepers' Guide Book" gives 5lbs. as a "good swarm." A thunder-storm was raging during the whole time of the second operation.—A. G. GAMBRILL, Richmond.



*Building up Stocks* (p. 174).—This article, by Mr. Herrod, with its wonderfully instructive photographs, has interested me greatly. I do not remember

to have seen such a set of photographs in any other journal, although observant bee-keepers must often have noted the conditions described. There is one point to which I should like to allude, and that is the placing of foundation between drawn combs. I have seldom experienced satisfaction with this method, owing to the extension of adjacent combs. Flat combs can be produced by inserting two sheets, and then withdrawing and reversing when drawn out, dressing off with a sharp knife the projecting portions of the adjacent combs. But this is messy work, and not to be recommended. I have finally overcome all my difficulties by placing a slatted divider on each side of the sheet of foundation. This gives a perfectly drawn comb without any neighbouring encroachment. If the dividers give gangway to the queen there is no hurry about their removal, and they may be left without disadvantage. There is, in fact, a hive constructed on these lines, having a divider between each comb. It is well to give only one sheet of foundation by this method, so that the queen may not be discouraged from passing over to the other half of the brood-nest. Much delay in this crossing might result in her supersedure.

*A Little Arithmetic* (p. 175).—It would be kinder to us in this, our busy season, if Mr. Smallwood would give us the answers to his problems at the time of stating. I have no doubt that many bee-keepers have, like myself, waked unrefreshed after struggling with his latest, "If five persons mount seven stages by means of 140 steps, how many steps were there?" It looks simple, but is it? If each stage consisted of 140 steps there is no doubt that, as Mr. Smallwood hints, they earned discovery by "the f'ithful 'ound"! But if the five persons took 140 steps it is obvious that each *étage* consisted of four steps, which is quite another "story"!

*Stop Thief* (p. 181).—(4) "Nine times out of ten, a robbing boom is caused by . . . the apiarist, and its inception in the tenth case is easily preventible." What does the latter sentence mean? A robbing boom is in progress, due to some unstated cause, and its inception is easily preventible. Rather late in the day, isn't it?

*Correct Bee Space* (p. 182).—(8) "Any addition to a scant quarter of an inch will mean brace or burr combs, and other nuisances." Not always, much depends upon where the space lies, and how accessible it is. For instance, below the frames, or outside the ends of close-ended frames. What is included in "other nuisances"? And what about *less* than a bee space? I find this far more troublesome. By-the-bye, "D. M. M.," did we not have a little friendly discussion as to the distinction between "brace" and

"burr," and are you not, by lending your countenance to the above, running some risk of renewed hostilities?

*Doomed to Extinction* (p. 182).—(9) I take it that these interesting extracts are quotations, but "D. M. M." labels them facts. As such they would seem to be open to exception. For instance, No. 9 dooms a colony to extinction, but there are several possible ways in which it might be saved. An entering swarm is perhaps inadmissible, but a stray queen might save it. And we are not without some testimony that bees in desperate case occasionally steal eggs. Probably these are gigger bees!

*Thickness of New Comb* (p. 182).—(19) I have just made some measurements, and these do not agree with the  $\frac{1}{16}$  in. given by "D. M. M." Not only is the piece of natural comb which I have measured much thinner than this, but there is a difference between the thicknesses of base and wall, and between "drone" and "worker." The latter difference can actually be seen when the comb is held to the light, and the measurements lead me to challenge the oft-repeated statement that there is considerable economy of wax in drone comb. The portions of wax were slightly flattened between parallel faces before measurement, without, however, being squeezed outward at all, the same pressure being applied in all cases. The readings were taken between the faces, and are as under: Drone wall, 4 thousandths of an inch; drone base,  $5\frac{1}{4}$  to  $5\frac{1}{2}$  thousandths; worker wall,  $3\frac{3}{4}$  thousandths; worker base, 4 thousandths. Of course, natural comb may vary, and some difference may be due to method of measurement. I do not, however, remember that these differences have been previously noted.

*Pro Bono Publico* (p. 182).—(26) "Bars were used centuries ago in Greece." Why, of course they were, wisely and well, let us hope. There, no doubt, the Roman invader received his "meed" at the hands of the fair maid of Athens herself, being only reminded of closing hours, as *bars* to complete happiness, by the regretful inscription, written by one of his comrades over the door, "*O tempora, O mores!*"

*Increase* (p. 182).—"A single colony doubling every year . . . in twenty years might number over 1,000,000!" I like that word "might." Why not say "would" at once and have done with it? I may add that if the apiarist manipulated four colonies a minute for an average of twelve hours a day without stopping for meals, and not working on Sundays, he would, or might, just get round in a year. Presumably he would no longer work for increase, and might take longer than I have allowed owing to the necessary alteration of his usual methods.

## QUERIES AND REPLIES.

[8944] *Superseding Queens*.—I purchased a stock of bees in skep in February last, which I have transferred to a bar-frame hive, as recommended in "Guide-Book." Yesterday morning I found a queen bee (apparently old) on alighting-board. What I, as a novice, would like to know is:—(1) When queen is superseded is there a young fertile queen in hive? or (2) has young queen not then emerged from cell?—G. THOMS, Paisley.

REPLY.—(1) There is a young fertile queen in the hive before the old one is cast out. At times the two will live together for some time.

[8945] *Finding Queen*.—(1) Is there any royal road to finding the queen in a swarm? (2) My bees swarmed in a thorn hedge on Saturday last. I only discovered them at 7 p.m., and tried to smoke them into a skep, but they rose and swarmed again on a clothes post. I had them all safe in a skep by 9 p.m. The next day I went through the hive, and, as I thought, destroyed all queen-cells but one. I placed queen-excluder zinc over the entrance, and then re-hived swarm, hoping thus to secure old queen, but all entered except about half-a-dozen drones. I had missed the queen. The bees remained in the hive till Thursday, when at 10 a.m. they swarmed again. I have again hived them with excluder zinc over entrance, and again missed the queen. I may say I have now on three occasions tried to secure an old queen by means of placing excluder-zinc over the entrance, but without success. I shall be glad of a word of advice from you. I don't doubt there will by this time be a young queen in the hive. (3) If I persist in returning the swarm to the hive do you think the bees will settle the matter for themselves and cease troubling, or is it more likely they may swarm again and decamp?—H. T., Eccles.

REPLY.—(1) No. (2) Our usual plan is to cover the hiving board with a white cloth and "spot" the queen as she runs up. This is not at all difficult if the bees are thrown down about a foot away from the entrance. A method we have seen adopted is to have a box or skep with a cover made of excluder-zinc into which the swarm is hived. When all the bees are in, the receptacle is turned up, the cover placed in position, and the bees smoked out, when they return to the hive leaving queen and drones behind. Quite possibly you missed one or more queen-cells, and

the old queen was lost on the first occasion. (3) The bees will probably settle down now. Give an extra super if you have not already done so.

[8946] *Swarming Queries.* Will you kindly give me further information on the following matter:—Mr. Herrod, in his "Helpful Hints" (May 28th), says that a swarm normally issues about three days before the first princess is due to emerge. Have I not read elsewhere that the swarm comes off when the first queen-cell is sealed? Which is right? If Mr. Herrod, and if I have rightly understood him, why does a cast usually issue nine days after the prime swarm? I do not understand how the first hatched queen can wait six days.—L. ILLINGWORTH, Brentwood.

REPLY.—Mr. Herrod is quite right. You do not appear to have taken into account the word "normally," or that "bees do nothing invariably." We have known bees under abnormal conditions to swarm when the queen-cells contained eggs only. At other times, when the weather is unfavourable, the young queens are prevented from emerging from their cells for several days. The young queen flies out for mating about the ninth day after the issue of the prime swarm. If the bees have not allowed her to destroy her sisters, a number of them rush out with her and form the cast.

[8947] *Artificial Swarming Trouble.*—I started with bees last August, fed them, and brought them safely through the winter. On May 21st I inspected my stock, which was on twelve frames, and found five queen-cells formed. I cut away all except one, and transferred six frames of brood and bees to another hive, filling up both hives with frames of foundation to make up twelve frames (as per "Guide Book"). On June 6th, I was surprised to see a swarm issue from the hive which contained only a queen-cell, and on looking inside the hive I found another queen-cell—two in all—one empty and the other with a nearly mature queen. I cut this out, returned swarm, and let alone for a week. Finding the bees not working well, I examined the hive again on the 12th, and found neither queen or brood. I therefore gave them a frame of brood in the first stages from the other hive, and they are now working better. (1) When should I look at them again? (2) Have I done right so far? (3) Was the queen (enclosed) that I found near the hive killed? (4) Is she a young one? (5) What is the breed of bees enclosed? (6) Have they died of any disease? (7) Is it usual to lose a lot of bees when examining? I use a carbolic cloth, and next day I find a lot of bees turned out dead, or

are they old bees? The other hive is well stocked now on about ten frames, but they are not working in the sections. (8) Is it because there is no honey about? And when may I expect honey, as time is getting away? (9) Will I get any surplus this year? Thanking you for any kind hint and information.—A NEW BEGINNER, Norwich.

REPLY.—(1) You may look at them any time now, and make certain that queen-cells are started. (2) Yes. (3) Yes, she was balled. (4) Yes, a virgin. (5) Bees are natives with a trace of Italian. (6) No. (7) Not if manipulations are properly carried out. You may be using too strong a solution of carbolic on cloth. Try a weaker solution. (8) That may be the reason, or the bees have not yet filled the brood-chamber and made up for the loss of bees taken to form the other stock. You cannot expect to take away bees to increase number of stocks and get any quantity of surplus as well. In most localities bees are storing honey now. (9) It is quite possible; much depends on the weather.

[8948] *Trouble with Neighbours.*—A lady six doors above us has been stung twice by my bees (of which I have two hives). Her husband has been complaining about them, and says they are too near. We have neighbours around us nearer, some of whom have children, and I have not had any complaints from them at all. Could you tell me if he can make me move them for so paltry a thing?—T. TOLLER, Wellington.

REPLY.—If they can *prove* the bees are a nuisance, no doubt they could get an injunction against you. Try a present of a few pounds of honey, it will often soothe and sweeten all irritation caused by the stings. Also insure with the B.B.K.A. against damage caused to third parties by your bees. The "worms" are larvæ of the wax-moth.

[8949] *Queen-rearing.*—In the BEE JOURNAL of June 11th, page 232, is an article on queen-rearing. Will you kindly give me some further advice in the BEE JOURNAL? I am a constant reader, and have never reared queens. If I remove the old queen, the bees will build several queen-cells. Must I protect the young queens before they are hatched? If not, I presume they would fight. When they are hatched what can I do with so many—say, ten or twelve? Could I make one big hive with divisions for each queen, or must they each have a separate small one? I presume they would have to be mated and introduced about September next. Could I put each queen on two frames, would that be enough? You will see by my ques-

tions that queen-rearing is new to me, and I shall be deeply grateful for your advice on the subject.—T. C. HONEY, Stratton.

REPLY.—To reply fully to your questions would require too much space. We would strongly advise you to buy a "British Bee-keepers' Guide Book," in which the matter is dealt with. Having got your queen-cells, they are cut out and placed in nuclei of three combs each. Messrs. Lee and Son supply a hive divided up for preserving a number of queens on two or three combs each.

[8950] *Novice's Queries*.—In May, 1913, I found a swarm of bees (about a mile from any house) in a copse on the farm. Though not knowing anything about bees, I was determined to try my luck, so I got a straw skep and hived the bees all right. A very short time after they swarmed again, and I put this lot in a double skep; soon after they swarmed again, and this time I put them in a wooden box, about 18in. by 12in. by 12in. The double skep I took for honey, 20lb. (destroying the bees). The single skep I saved for swarms, also the box. The single skep has swarmed twice, but the box has not swarmed. (1) Is it because they have so much room? I may say it was a small lot. I now have four lots of bees, two single skeps, one double, and one box. (2) Which lot would you recommend me to take for honey? (3) When bees swarm is it the old ones that come out? (4) Will you recommend a book for the beginner? I shall be looking out for answers next week. I have been taking the "B.B.J." about a month and found some useful information.—E. B. WYATT.

REPLY.—(1) Yes. (2) We cannot say without examination. See that those left have stores enough for winter. Can you not get someone to drive the bees instead of destroying them? (3) Yes. (4) "The British Bee-keepers' Guide Book."

#### TRADE CATALOGUE RECEIVED.

W. P. Meadows, Syston, near Leicester.—This well-known firm issue a catalogue which is replete with every appliance necessary for bee-keepers. Their reputation for the manufacture of tin goods, especially extractors, is world-wide, therefore any remarks on our part would be superfluous. That they have won prizes at the Royal Show for twenty-nine years speaks well for their workmanship. Not only are bee goods illustrated, but garden requisites and work benches, together with poultry appliances, are made by this firm. Catalogue post free upon application.

## Bee Shows to Come.

*A nominal charge of 2s. 6d. is made for notices (not exceeding 7 lines) in this column, 10 lines charged 3s. 6d., up to 15 lines 5s., which covers cost of insertion from order till date of show. Cash should accompany orders for insertion.*

**June 30th to July 4th, at Shrewsbury.**—Royal Agricultural Society's Show, Bee and Honey Section, under the direction of the B.B.K.A. Prizes arranged in groups of counties for Associations affiliated to the B.B.K.A. Schedules from W. Herrod, 23, Bedford Street, Strand, W.C. Entries closed.

**July 8th, at Aldenham.**—Honey Show of the St. Albans B.K.A., held in connection with the Bletre and Boreham Wood Horticultural Society, at Aldenham Park. Open class for extracted honey. No entry fee. Liberal prizes. Judge, Mr. W. Herrod. Schedules from Mr. R. H. Attenborough, Aldenham, Herts. Entries close July 6th.

**July 14th to 17th, at Hawick.**—Scottish Bee-keepers' Association. Exhibition of honey, wax, and appliances, in connection with the Highland and Agricultural Society's Show. Open to all British bee-keepers. Liberal prize-money. Write for schedules to A. Aikman Blair and John L. Gibson, joint secretaries, 176, Bruntsfield-place, Edinburgh.—Entries close 7th July.

**July 16th and 17th, at Boston.**—Lincolnshire Bee-keepers' Association. Exhibition of Honey, Hives and Appliances. Open and county classes. Over £30 in prizes. Schedules and entry forms from Capt. J. H. Hadfield, Alford, Lincs. Entries closed.

**July 22nd to July 24th, at Bradford.**—Great Yorkshire Show. Classes for hives, honey, &c. Good prizes. For schedules and forms of entry (stating department), apply, The Secretary, Great Yorkshire Show, Blake-street, York. Telegrams, "Yas, York." Entries closed.

**July 22nd and 23rd, at Cardiff.**—The Glamorgan B.K.A., in connection with the Cardiff and County Horticultural Society's Show, in the Sophia Gardens, Cardiff. Open classes include:—Collection, Gift, Sections, Beeswax, &c. Schedules from W. J. Wiltshire, Maindy School, Cardiff. Entries close July 18th.

**July 23rd, at Southwell.**—The Notts. Annual County Show, in connection with the Southwell Horticultural Society. Open class for single jar extracted honey. Schedules now ready from G. Hayes, Mona-street, Beeston, Notts.

**July 23rd, at Bath.**—The Annual Show of the Somerset Bee-keepers' Association, in connection with the Larkhall Horticultural Society. Seven Open Classes. Schedules from J. W. Brewer, Glen Lynn, St. Saviour's Road, Bath. Entries close July 18th.

**August 4th, 1914, at Bridgnorth.**—Annual Show of the Bridgnorth and District Bee-keepers' Association. Held in connection with Hampton Load Horticultural Society. Open gift class single 1lb. jar extracted honey. Prizes, 7s. 6d., 5s., 2s. Schedules from J. S. Lawton, Oldbury Wells, Bridgnorth. Entries close July 25th, 1914.

**August 5th and 6th, at Abington Park, Northampton.**—Northants B.K.A. Annual Honey Show. In connection with the Municipal Show. Special prizes for open classes, including one for single 1lb. jar. Entry free. Schedules from R. Hefford, Kingsthorpe, Northants. Entries close July 25th.

**Aug. 6th, at Bromham Park, Bedford.**—Honey show in connection with Biddenham and Bromham Flower Show, to be held in Bromham Park, near Bedford. Open classes for honey. Schedules from A. Henman, Bedford-road, Biddenham. Entries close July 30th.

**August 17th and 18th, at Cannock (Staffs.).**—Honey Show, in connection with Cannock Horticultural Show. Eight open classes. Good prizes. Schedules from hon. sec., John Bird, Glenmay, Cannock.

**August 18th and 19th, at Brighton.**—The Fourth Annual Show of the Sussex Bee-keepers' Association, in connection with the summer show of the Brighton, Hove, and Sussex Horticultural Society. Seven Open Classes. Liberal Prizes. Schedules from C. A. Overton, Beecroft, Crawley. **Entries close Aug. 10th.**

**August 25th, 26th, and 27th, at Newcastle.**—Northumberland Bee-keepers' Association. Exhibition of honey and wax, in connection with the Newcastle Flower Show. Nine open classes. Schedules and entry forms from R. H. Newton, 24, Grainger-street West, Newcastle, or Captain F. Sitwell Wooler. **Entries close August 20th.**

**August 26th, at Prestbury.**—Honey show, in connection with the Prestbury Flower Show. One class open to the kingdom. Several for those within 12 miles radius. Exceptional prize list. Schedules from A. H. Bowen, Coronation-road, Cheltenham.

**August 26th, at Chester.**—Annual Show of the Cheshire Bee-keepers' Association, in connection with Cheshire Agricultural Society. Several open classes. Good prizes. Schedules from T. A. Beckett, St. Werburgh Chams., Chester.

**September 1st, at Deddington.**—Honey show in connection with Deddington Horticultural Society's Show, to be held in the Castle Grounds. Open classes for honey. Schedules from H. J. Harmsworth, Deddington, Oxon.

**September 2nd, at Lancaster.**—Agricultural Show. Premier Honey Show of the North. 15 classes; £20 in cash prizes, silver cups and medals value 15 guineas, and other specials. Send for schedule (Honey) to Robert Gardner, solicitor, 69, Church-street, Lancaster. **Entries close August 19th.**

**Sept. 5th, at the Club Room, North-road, Kew.**—Honey Show of the Richmond and District Bee-keepers' Association. Open classes for honey and wax. For schedules, apply Hon. Sec., Mr. J. G. Romer, 234, Kew-road, Kew-gardens. **Entries close Aug. 28th.**

**September 9th, at Stoke Park, Guildford.**—Annual Exhibition of honey, wax, appliances, &c., will be held by the Surrey B.K.A. in connection with the Guildford and West Surrey Agricultural Association. Eighteen classes, five open to all. Many medals. Schedules from F. B. White, hon. secretary, Marden House, Redhill, Surrey. **Entries close 31st August.**



**A. E. W. (Bletchley).**—(1) Several days. Do not keep it airtight while ripening or moisture will not be able to get away. (2) Warm and dry.

**E. R. J. (Fleet).**—It is a Leaf-Cutter Bee. If you examine pocket you will find the cells constructed from the pieces of leaf. They show a preference for rose leaves.

**J. S. H. (Cophorne).**—*Dealing with Disease.*—Yes, it is "Isle of Wight" disease. Another queen would make no

difference. We are afraid your suggestion is impracticable. Your case shows the need for legislation, and the best thing you can do is to help all you can to get it. Dig over the ground and lime it, and it will be safe any time.

**ANXIOUS ONE (Notts).**—*Artificial Swarm.*—Bees are robbing. Close entrance to one bee space.

**C. L. (Derby).**—*Dead Drone.*—The drone has mated with a queen.

**T. O. B. (Guernsey).**—*Artificial Swarm.*—(1) The Vetch is a moderate bee flower. (2) July. (3) We cannot say, as the orders are taken in rotation.

**W. H. N. (Bungay).**—*Smell from Hive.*—It is impossible to diagnose disease by smell. Send us a piece of comb with brood in it, carefully packed in a tin box, and we will try to help you.

**A. P. (Tattingstone).**—*Renewing Combs.*—The best time to renew combs is in the spring. One comb only at a time should be put in between old combs. Renew at least two combs in each hive each year after the second.

**BEE NOVICE (Olney).**—*Drones in Skep.*—The bees are drones, and there are no means of getting rid of them, or yet limiting the number reared. This is one of the great drawbacks of the skep system of "possessing bees." Get a frame-hive, and keep them on up-to-date methods.

**C. H. M. (Lines).**—*Observatory Hive.*—You have not taken into consideration thickness of baseboard, from the *underside* of which the measurement is taken. The ends are lock-jointed into it. Substitute an incubator thermometer.

**J. J. N. (Launceston).**—(1) The bees have evidently requeneed themselves. (2) She will have been reared and probably mated.

*Suspected Disease.*

**G. T. (Helpringham) and LISBOX (Devon).**—Bees show symptoms of "Isle of Wight" disease.

**B. S. (Witton-le-Wear).**—Bees have "Isle of Wight" disease.

**F. W. W. (Ewell).**—*Odourless Foul Brood.*—Better treat as advised in "Guide Book," by shaking bees off combs, &c. Case is too bad for milder treatment.

**SEECHEM (Alnchurch).**—(1) It is sour brood; use Apicure. (2) So far as we can judge from particulars supplied, there is a laying worker. Probably the queens have died. We cannot say definitely without examining stock.

**A. B. (East Liss).**—No. 2 are suffering from "Isle of Wight" disease. The reason is the old bees are affected first. All the queens sent—11—are virgins. It is a large number from one cast.

**Special Prepaid Advertisements.**  
**Two Words One Penny, minimum Sixpence.**

Orders for three or more consecutive insertions entitle advertisers to one insertion in "The Bee-keepers' Record" free of charge.

Trade advertisements of Bees, Honey, Queens, and Bee goods are not admissible at above rate, but will be inserted at 1d. per word as "Business" Announcements, immediately under the Private Advertisements. Advertisements of Hive-manufacturers can only be inserted at a minimum charge of 3s. per lin., or 5s. per inch.

**PRIVATE ADVERTISEMENTS.**

**N**EW Super-Clearer (patented), combining reliability and rapidity. See "B.B.J.," April 9th. Order at once from your dealer, 6d. each, or from F. W. WATTS, 132, Goodrich-road, East Dulwich. v 87

**F**OR SALE, several clean 28lb. honey tins, in very good condition, only 5d. each; through removal.—CROWE, Central-avenue, Wigston, Leicester. v 84

**T**YPEWRITTEN lecture and fifty very clear slides on bee-keeping, 35s. Approval.—JULIAN LUCKWOOD, Hunstanton. v 85

**W**ANTED, sections; state lowest price and quantity.—CHURCH FARM DAIRY, Sheringham, Norfolk. v 85

**S**TRONG, healthy swarms, 10s. 6d.; with 1913 queens, 12s. 6d.; packed free.—SPEARMAN, Andoversford, Glos. v 82

**S**IX guaranteed healthy stocks, in skeps, ready to swarm, 18s. 6d. each; large, healthy swarms, from frame hives, 12s. 6d.; all the above for immediate dispatch.—Caroline Cottage, Winchelsea-road, Hastings. v 74

**S**UPERB nuclei, three frames, packed with bees, brood, honey, 15s.—APIARIST, 15, Pittville-street, Cheltenham. v 72

**F**OUR-FRAME nuclei, Carniolan hybrids, brood in all frames, with young laying queen, 17s. 6d. each.—EVERETT, expert, Rosebank Apiary, 40, Linden-street, Leicester. v 70

**F**OR SALE, Rymer heather honey press and drawer, no stand, unused, 40s., or offers.—"BUMBLE," "B.B.J." Office, 23, Bedford-street, Strand, W.C.

**F**OUR Simmins' "Conqueror" hives, in good condition. £2.—TAYLOR, Acacia House, Beverley. v 79

**F**INE pale new sainfoin honey, just off hives, 30s. per  $\frac{1}{2}$  cwt. tin.—A. M., c/o "B.B.J." Office, 23, Bedford-street, Strand, London, W.C. v 78

**S**UPERSEDING entirely with Italians, sell good native queens 2s.; old and poor ones destroyed.—GORDON, expert, Lonscale, Threlkeld, Penrith. v 16

**B**ARGAIN, Meadows' guinea extractor, 11s. 6d.; Brice's observatory hive, 10s. 6d.; two combination hives, 3s. 6d.; two gross W.B.C. metal ends, 9d. gross; full particulars 1d. stamp.—W. JOCKMAN, Cherryhinton Post Office, Cambridge. v 81

**B**EGINNER'S opportunity, owing to removal. Brand new W.B.C., nicely painted, healthy stock natives, combs, frames, excluders, feeder, smoker, veil, &c., all new in May. £2 10s.—103, High-road, Beeston, Notts. v 83

**W**ANTED, a complete comb of both a bad and mild case of Foul Brood.—HERROD, "B.B.J." Office.

**H**ARDY, Prolific Dutch Queens, 1913. 3s. Virgins (next week), 2s. Orders rotation.—PAUL Salisbury-road, Bexley. v 87

**W**ANTED, secondhand wax extractor, honey extractor, uncapping tray; all particulars.—FRASER, Melton Cottage, Balbirnie-street, Markinch. v 49

**S**MITH PREMIER TYPEWRITER, Standard double keyboard, very reliable, beautiful writing, perfect condition, cost £23, accept 60/-, worth double.—WAKEFIELD, Newhall Hill, Birmingham. v 54

**C**ERTIFICATED expert wanted, for a few weeks, in Cumberland.—Apply, G. W. AVERY, Wetheral, Carlisle. v 18

**A** FEW of a very fine strain of specially bred queens for sale, from a district that has been devastated by "Isle of Wight" disease, and from stocks that have proved perfectly healthy, excellent honey storer and good comb builder, price, fertile, 10s. 6d. each; every queen tested, no unfertiles sold; safe arrival guaranteed.—E. HOWARD COLLINS, Harewood Apiary, Chalfont St. Giles, Bucks. v 30

**P**ERFECT sections, 10s. per dozen, carriage forward.—Apply, MISS GORDON, Wethersfield-place, near Braintree, Essex. v 28

**J**UNE SWARMS, from frame hives, guaranteed healthy, 15s.—THOS. ORMESHER, Westhead Apiary, Ormskirk, Lancs. v 27

**C**HAPMAN honey plants, Borage, 3d. per score, post free.—STEVENS, Churchill, Oxfordshire. v 25

**100** LB. clover honey, granulated, screw cap jars, 7d. lb. for cash.—JONES, printer, Wellington, Salop. v 22

**F**OR SALE, grand stocks Scotch bees, healthy, 30s. each, or in good secondhand hives, 40s. each, f.o.r., cash.—GEO. W. PAISLEY, Newport-on-Tay. v 45

**A** FEW good section racks, complete, with dividers, follower, and wedge, 1s. 6d. each; lace paper, neat pattern, 6d. 100, post free; lace bands, 2 $\frac{1}{2}$ in. and 3in., 100 1s. 2d., post free, finest quality.—W. WOODLEY, Beedon, Newbury.

**S**ELL, Thould and Hutchinson portable cesspool pump, with all fittings, used once only, cost £3 10s.; offers—"PUMP," "B.B.J." Office, 23, Bedford-street, Strand, London, W.C.

**W**ANTED, the following: Cloth editions "British Bee-keepers' Guide Book," 1st, 3rd, 4th, 5th, 7th.—HERROD, "B.B.J." Office, 23, Bedford-street, Strand, W.C.

**D**IRECT from F. W. Sladen's original extra golden bee stocks.—British golden virgin queens, 2s. 6d. each, three for 8s. 9d.; apiary free from "I.O.W."—CREWES, Apiary, Warringham, Surrey. v 20

**S**TOCKS of Bees for sale, never had disease of any kind in apiary.—WEAVER PRICE, F.R.H.S., Brecon, South Wales.

**BUSINESS ADVERTISEMENTS.**

**H**OW TO PREVENT SWARMING.—A certain method, fully explained, with illustrations from life, of bees and their work, price 1s., postage 1d., from all dealers, and the author, A. H. WILKES, Lichfield-road, Four Oaks, Birmingham.

**CHOICE, PROLIFIC, FERTILE.**

English Queens, excellent strain, safe arrival guaranteed, every Queen tested, 5s. each.

Wilkes, Lichfield Road, Four Oaks, Birm.

Established 1892.

**C**OMFORTABLE APARTMENTS for Brother Bee-keepers visiting Douglas. Terms: Tea, bed, and breakfast, 3s. 5d.; or full board, 5s. per day.—HORSELEY'S, Merridale House, top of Castle Drive, Douglas, Isle of Man.

**N**EW Super-Clearer (patented), combining reliability and rapidity. See "B.B.J.," April 9th. Order at once from your dealer, 6d. each, or from F. W. WATTS, 132 Goodrich Road, East Dulwich. v 87



## REVIEWS.

*Bees as Rent-payers*, by Tickner Edwardes, price 6d.—The name of the author is so well known that it would be invidious for us to enlarge on his abilities. This work has been revised and enlarged, and contains many useful hints to the bee-keeper. It is intended mainly for the cottager, and contains more than double the amount of matter in the first edition. It can be obtained from this office, 7d., post free.

*My Natural Non-Swarming System*, J. Fairall, junr., Hellingly, Sussex.—Unlike many small pamphlets of a similar nature, this is wonderfully well written. Much care and thought must have been expended for many years in the practical experiments which have been carried out. There are no freak methods, the pamphlet is founded on sound orthodox principles. The only fault which we can find with it is its price, 1s. is rather a large amount to pay for such a small work. At the same time, we do not lose sight of the fact that every labourer is worthy of his hire, and certainly years of experimenting are worthy of some compensation. The book can be obtained either from the author or from this office, 1s., post free.

the royal visitors making many interested inquiries as to the manner and habits of bees.—A. G. GAMBRILL, Expert.



*The Editors do not hold themselves responsible for the opinions expressed by correspondents. No notice will be taken of anonymous communications, and correspondents are requested to write on one side of the paper only and give their real names and addresses, not necessarily for publication, but as a guarantee of good faith. Illustrations should be drawn on separate pieces of paper. We do not undertake to return rejected communications.*

## FUNGUS DISEASES OF BROOD.

[9043] I am anxious to find out whether any of the diseases of brood caused by fungi occur in this country, and should therefore be glad if any of your readers who may come across a case of disease in which the brood becomes mummified into hard lumps, would send me a sample of the diseased comb, to the address given, wrapped in clean paper and enclosed in a strong tin box, I will willingly refund postage.—(Miss) A. D. BETTS, Hill House, Camberley, Surrey.

## ANOTHER MONSTER SWARM.

[9044] In the BEE JOURNAL of to-day I notice a large swarm, 9lbs. 2ozs. of bees. Last Tuesday, June 16th, I had a monster swarm, which was 10lbs. of bees. It came from a sixteen-frame hive which had three lifts on, two full of honey. When I put this swarm in a ten-frame hive with foundation, it had eight shallow frames as well. This swarm filled the lot, and has now got the shallow bars ready to come off. When running in the swarm I picked five young queens out. Perhaps this will interest some of your readers.—W. MOUNTING, Southwell. June 25.

## A LITTLE ARITHMETIC.

[9045] If there is one thing I envy Mr. Crawshaw for it is his immense self-confidence (a word of five letters is often used to express this accomplishment). Poor ordinary mortals as are your readers and myself are always content to give a certain amount of poetic licence to writers in your JOURNAL. It would be painful were

## RICHMOND AND DISTRICT B.K.A.

The Richmond and District Bee-keepers' Association had a stand at the Flower Show which was held in the Old Deer Park, Richmond, on Wednesday, June 24th, at which there was a nice, tastefully arranged display of honey and bee flora from the neighbourhood. The royal visitors attending the show were their Highnesses the Duke and Duchess of Teck (who performed the opening ceremony), Her Majesty Queen Amelia of Portugal, and their Majesties King Manuel and Queen Augusta Victoria. Geo. Cave, Esq., K.C., M.P. (president of the Richmond and District Bee-keepers' Association), conducted the Duke and Duchess of Teck round the show. Later Queen Amelia was escorted round by His Worship the Mayor, Alderman Cook, and the Mayoress, to be followed later still by King Manuel and Queen Augusta Victoria, Alderman Bisgood being in attendance.

Mr. A. G. Gambrill, expert to the Association, had the honour of exhibiting bees to each of the three parties in succession,

it not so and in things not essential to require that everything should be *au pied de lettre*, or mathematically exact. Should Mr. Crawshaw desire the rate of progression up those historic steps calculated to a decimal fraction, I am sure he is quite at liberty to do it himself, and is very capable of it. I doubt if anyone else would care to see the working out of the figures. I am quite sure I should not in this hot weather.—JNO. SMALLWOOD.

#### CARELESS METHODS AND DISEASE.

[9046] I am pleased to see Mr. Herröd has told your readers in last week's BEE JOURNAL what a mean trick it is to put out decoy hives, but there is a much worse practice going on in this neighbourhood, and I daresay in other parts as well. Most of the bees here have died of "Isle of Wight" disease, and in several instances the owners (not always cottagers) have left the hives and combs where they stood for other people's bees to swarm into or to rob. Two persons in our district have thus restocked hives this spring. It is time we had legislation to stop exposing combs on

which bees have died, as it is a sure method of spreading disease, waxmoth, &c., and also encourages robbing.

Some bee-keepers lift their old skeps off the stands, knock the old combs out in the garden, and leave them there for everybody else's bees to examine.

Re immune strains of bees—I lost all my bees two years ago from "Isle of Wight" disease. Last year I started again with four swarms, three of which died from the same cause during the winter. The surviving stock was affected last autumn and early spring, but seem to have shaken it off now; and the bees are working in two supers, and I have taken off twenty-three finished sections already.

Early in spring I fed them with quinine syrup, in which a little salt was mixed; this may have helped them. Two strong stocks located in a hollow tree here have died of "Isle of Wight" disease, but at one cottage the bees in the garden died, while a lot in the house tiles are still alive. I hope we shall soon produce an immune strain, or find a reliable remedy for the disease, as it has nearly cleared this district.—P. E. GRINSTEAD, Sussex.



#### THE HIVING AND TREATMENT OF NATURAL SWARMS AND CASTS.

(Continued from page 246.)

##### PREVENTING SWARMING.

If increase is not desired the bee-keeper must by careful attention to his stocks try and prevent swarms issuing. This can be done by giving room a little in advance of requirements. If the bees have been confined on to a few combs by means of the division board they should have more combs or frames fitted with full sheets of foundation given, one at a time as they get crowded, until the full complement is reached. If in the meantime, although every precaution has been taken to prevent it, the bees persist in preparing for swarming by building queen cells, these should be cut out and destroyed. To do this effectively work systematically, by commencing with the comb nearest the side of the brood chamber; shake the bees back into the hive, and carefully examine the comb for queen cells or the commencements of them; each comb is taken in turn and treated in the same manner. It is impossible to do the work properly with the bees adhering to them; if this is attempted it is almost certain that a cell or cell base will be overlooked by being covered with the bees, the work will then be abortive. A super should be put on, and others added as required. The operation may need repeating in ten days' time, after which, as a rule, all desire to swarm disappears. Ventilation should also be given by raising the brood chamber about



an inch all round, with a block of wood at each of the four corners (Fig. 33) in a single walled hive. For a "W.B.C." hive it will be necessary to have the blocks long enough to raise both the outer case and the brood chamber. (Fig. 34) is tipped up to show the position of the blocks.

Another method of dealing with a stock that will persist in swarming after all preventive measures have been taken is to remove the combs of brood and distribute them amongst the other stocks and nuclei, or put them on the top of a medium one so that the emerging bees will strengthen it. They are replaced with frames fitted with full sheets of foundation, and a super put on at once. This extra work and taking away their brood will effectively prevent the bees attempting to swarm again.

In those cases where the bees have an abundance of honey remaining from the previous year, or through too liberal feeding in the spring enabling them to store food in the combs, or an early flow of nectar causing the same condition, the combs are clogged with food, the queen is prevented from laying, and the bees will prepare for swarming. This can be avoided by extracting some of the food and giving back the empty combs for the queen to lay in, at the same time putting on a super.



FIG. 33.

FIG. 34.

Old queens are more likely to cause the bees to swarm than young ones, therefore one of the many advantages of having young queens heading the stocks is that it minimises the chance of swarming.

#### RETURNING SWARMS.

This is easy of accomplishment, and is adopted where surplus and not increase is desired. First hive the swarm into a skep or box, then go to the hive from which the swarm issued and destroy the queen cells as already described. If one or more of the princesses have emerged, which happens sometimes and which is indicated by the vacated queen cells, they must be searched for and killed. An extra super is added, and the swarm hived back from the front in the usual way. The extra super is an absolute necessity.

#### HOW TO FIND WHICH STOCK HAS SWARMED.

Unless the swarm is seen to issue much time may be wasted in trying to find out which stock has swarmed by searching for the one depleted of a large number of bees, and which contains sealed queen cells, but no queen. Even then a certain amount of uncertainty exists, as more than one may have done so and the swarm absconded. To make quite sure, with the minimum amount of trouble, take a teacup full of bees from the swarm, cover it with the hand to prevent them escaping while they are carried some distance away, then dust them well with wheaten flour before

liberating. Marked white in this manner they return home instead of to the swarm, and the hive they enter can easily be located.

#### CASTS

are really second swarms, and issue about nine days after the first swarm. When the bees intend to throw a cast it is indicated by the piping of the virgin queens. Instead of the first princess to emerge being allowed to kill her sisters still in their cells she is prevented from so doing by the workers; she becomes angry and runs over the combs in an excited manner, stopping every few moments to pipe, which is a shrill note, "peep-peep." This is answered with a deep noted "pau-pau" from the imprisoned ones. It is interesting to hold a comb, see and hear this taking place as I have done many times. The free princess lowers her head and vibrates the body violently while making the piping note, which can often be heard several yards from the hive. Third and fourth swarms will sometimes issue; these were called in olden days "colts." When a swarm of the current year builds up strong enough to throw a swarm, the latter is called a "maiden swarm." Any number of virgin queens may issue with a cast; I have taken away as many as seven. If left alone these fight it out, and the fittest survives. Casts usually weigh from one to two pounds.

#### PREVENTING CASTS.

With the passing of the skep the idea of obtaining as much increase by natural methods as possible is being eliminated from the mind of even the most conservative bee-keeper. The drain on the population of the hive by numerous casts very often results in total extinction of the parent stock. Not only so, but if carried to excess the casts are so weak in numbers that they are unable to properly establish themselves, and eventually they perish before their owner obtains any return for the trouble expended upon them. If increase by natural methods is desired, then the first swarm only should be allowed to issue. This should be hived in the new hive, which is placed on the stand occupied by the stock from which it issued. In this way all the old flying bees are obtained from the parent stock, as bees locate position and not the hive; when they leave the old home the next morning to forage, they return, not to the original hive, which is now standing in a fresh position, but to the old location. This prevents all possible chance of a cast or second swarm issuing. Have no fear for the parent stock, as it will be entirely populated by young bees not more than a fortnight old, for they do not fly until they reach that age. When these young bees do leave the hive for their first flight, they return to the same position, for they have known no other.

Further, the continual emerging of the young bees which were sealed over at the time the swarm issued will increase the population, so they will have ample opportunity of working up strong enough for wintering after the young queen has been fertilised and commenced her maternal duties. For a few days after the change of position the entrance to the old home will show no signs of life. This does not point to anything being wrong, but is accounted for, as stated above, by the fact that for several days there will be no bees old enough to fly. By following this method not only is increase secured, but very often surplus as well. I know of one bee-keeper who obtained one year golbs. of honey from a swarm by adopting this method. Another danger which often arises is that casts are lost owing to the agility and restlessness of the virgin queen. Casts usually issue about nine days after the first swarm, and if the queen is heard piping it is almost a sure indication that a cast will issue. Casts can also be prevented by cutting out all the queen cells in the parent stock except the best one, so that only one princess will emerge. She will remain to head the stock, instead of leaving with a cast. If, through neglect on the part of the bee-keeper or by an oversight, casts come out, they should be returned to the hive, after cutting out all remaining queen cells and killing any princesses that have emerged; or, if not returned, two or three should be united together. In many cases the combs in the brood-chamber of a hive that has swarmed and remains queenless and broodless for a time are choked with honey. This will prevent the young queen from laying when fertilised, therefore the extractor should be brought into use, and two or three of the combs

extracted and put back into the hive the same evening. From this cause swarmed stocks are sometimes suspected of being queenless, but the provision of room by extracting quickly proves this to be wrong. The cause of casts issuing is but imperfectly understood by many bee-keepers. When we consider that swarming usually takes place between the hours of ten and four—also very often prematurely through intense outside heat raising the internal temperature unexpectedly to an abnormal degree, making the hive unbearable for its immense population—it will be seen that a large number of the old bees are out foraging at the time the swarm issues. When they all return the hive is still over-crowded, and, the swarming fever being upon the bees, a cast is the natural result. Another annoying feature about casts is that they issue at any time. They come out as early as six a.m. and as late as eight p.m. They also take not the slightest notice of climatic conditions, leaving the hive just as readily on dull days as upon bright ones, they will come out even when it is raining. Therefore, all things considered, casts should be prevented, as they are a drawback and not an advantage in the apiary.

#### HIVING SWARMS INTO FRAME HIVE.

The new bee-keeper usually undertakes this first operation in fear and trembling, very often doing the wrong thing in his anxiety to do right. We will suppose the swarm has been purchased, and has travelled some distance by rail. If bought by weight, the first thing to do when it arrives is to weigh it—travelling receptacle and all. When empty the latter is again weighed, and that amount deducted from the gross weight, when we have the net weight of the bees. Remember that bees lose weight in travelling on account of the food they have consumed before issuing being utilised. For instance, a five pound swarm will lose from half to one pound in weight; the price is based upon the weight immediately they are hived. After weighing, do not be in a hurry to liberate the bees, but place them in a cool place. If in a skep, they should be taken into a cellar or cool dark room, and allowed to remain with the scrim covering the mouth of the skep upwards until the evening. Towards the middle of the afternoon give food by inverting a bottle feeder (covered with a double thickness of muslin instead of the usual metal-cap) over the scrim cloth. This prevents all possible chance of the bees being hungry and consequently angry when liberated. About an hour before hiving, hang the skep the right way up; (don't place it on the ground or the bees will be suffocated); the bees will then cluster at the top, so that the covering can be removed without a lot of bees adhering to it. If in a proper travelling box the same procedure should be followed except that the box should be placed with the lid downwards so that it can be removed without bees adhering to it.

*(To be Continued.)*

---



---

#### “BLURTS FROM A SCRATCHY PEN.”

##### ITALIAN WANDERINGS

A Sunday we spent in Rome—a Sunday scarcely of rest, where there was so much to see and so little time to spend. We needs must hear the singing at Mass in St. Peter's in the early morning. The sweet religious chant, the soft flexions of which linger for ever, a visit to some of the old churches, and as restful a day as might be. We had been promised an audience of His Holiness, but the day was hot—so hot!—and at the last moment we were informed it was impossible for that reason.

And yet we did not think the heat so excessive. Keeping in the shade and wearing our lightest habiliments, we rather appreciated it. In the bright, clear

air, it was not as is our muggy, humid climate, when a thunderstorm is rumbling in the distance, nor even as on a frizzling July day. We were told we should catch malaria, the Roman fever. Verily we did fall victims to one fever. It was the fever to return again and see more of this beautiful city.

At Naples we had touched the “Ultima Thule,” the boundary of our wanderings. We were over eleven hundred miles from Bedford Street. It was a long way from our hearths and homes. Yet we were not sad. On the contrary, we should have liked to have stayed yet longer and gone a little farther on, say, to Africa, only another three hundred and eighty odd miles away—but we could not be allowed to. That daily grind, stayed only for a few short days to give us play time, was.

calling us. We needs must therefore homewards wend our way.

We had arranged that we should arrive in the evening at Bologna. *En route* we managed to visit Florence (Firenze as they recognise it). Those cities of ancient Italy! How one longs to spend more time in them. Of each volumes have been written, and could still be written. We saw the glories of its cathedral and churches, and sadly hurried on, sad, for we wished to see more. Between Florence and Bologna we had to pierce the Apennines. Tunnel after tunnel until their number reached forty-five, and the glimpses we had of sunshine between those shutters of darkness! Mountain peak and torrent, snow-filled ravine, and deep defiles, each with its tales of war, heroism and romance.

beetroot drawn by six or eight such lazy white oxen. You cannot hurry them, the driver, who is barefooted (it is cooler and saves shoe-leather), prods them with his long pole, uttering a grunt "Ugh," but no! they will not budge an inch faster. To the amusement of the natives we snapped a few examples at the cost of a small silver coin or two. And those women washing their linen in the stream, beating it on the flat stones, whoever saw the like of that, in this country? No self-respecting washerwoman would stand shin-deep in a stream over here with some ten or a dozen other acquaintances and wash their dirty linen in public. If there is no public laundry in our villages, I suppose the "wash-tub" and "dolly" are still in evidence.

Courteously we were met by Signor



A VILLAGE LAUNDRY.

The old university town of Bologna—to our shame—we only used as a resting place for the evening, for on the morrow in the early morning we had arranged to visit the apiary of Signor Piana, one of the most advanced and up-to-date queen-raising establishments in the north of Italy. Castel St. Pietro is the nearest railway station by which you can approach it. From thence you needs must take a vehicle, for there are still a few miles to travel by road.

Of course, now we were in rural Italy, and the village of Castel St. Pietro might easily have been mistaken for any of the thousand large villages which dot our England. But there were differences which at once disillusioned us. In no English village did one ever see—no, not in Norfolk itself—such a wain load of

Piana at the station. Now we were driven through fields, undulating and well cultivated. Not a foot of land seemed to escape cultivation. Fields of maize, of lucerne, of sainfoin, of buckwheat; vineyards, where the grapes hung in tempting bunches; orchards, now russet-brown and crimson-red, with ripening fruit, olive and chestnut and walnut trees. And, again, in the marshes the bamboo. The wheat was gathered in, but the poppies peeped through the stubble. Of hedges but few, the fences, perhaps a low stone wall. He who listed might gather fruit, or ear of maize. There was enough for all and to spare. At length one realised what was meant in the holy writings, "A land of milk and honey—of oil and wine. A land of fat beeves and oxen."

Absorbed in our surroundings soon we

arrived at Signor Piana's dwelling and bee-farm, but it would be useless to attempt to describe it at the tail of this article, I must keep it for my next.—J. SMALLWOOD.

## QUERIES AND REPLIES.

[8951] *Oil Beetles and Bees.*—My bees here are being very much troubled by oil beetles. These actually keep guard over the Canterbury Bells, Bird's-foot Trefoil, &c., and if an unwary bee does venture they spring upon it, with a view, I believe, of depositing their eggs on it, so that their young may be nurtured in the hive. Can I do anything to rid the garden of them? They creep into holes in the bricks at night, perhaps one might catch them then.—I. H. J.

REPLY.—The only way is to destroy the beetles, as a female has been found to contain as many as 5,000 eggs in her ovaries. The beetles lay their eggs just below the surface of the ground, and when the larvæ are hatched they climb upon the plants in their neighbourhood, and when bees alight near them they do their best to hook themselves on, and are thus carried to the hive, where they live at the expense of the bee.

[8952] *Beginner's Queries.*—I shall be greatly obliged if you will answer the following questions in BRITISH BEE JOURNAL. I have one stock of bees in skep, which I wish to transfer into a modern hive by means of driving and hiving as a swarm: (1) When may this be performed to the best advantage so as not to have a lot of brood destroyed? (2) How can I tell when the queen has ceased laying? (3) When is about the usual time for the queen ceasing to lay? (4) Would it be correct to drive about midday, when bees are flying, and driven bees in skep placed in position of old one? or should the bees be driven in the evening when few are on the wing, and then hived immediately? (5) If you advise transferring at end of honey flow how many frames would be needed for from 4lb. to 5lb. of bees? (6) How much syrup would they require to see them safely through winter?—BEGINNER, Horwood.

REPLY.—(1) This depends on whether you have spare drawn-out combs or not. If you have, about the middle of August. If not, you had better leave them till

next spring, and work down into a frame hive. (2) Only by examining combs, and noticing if there are eggs or brood. (3) This varies, all depending on the weather and amount of the bee flora. We have known them cease at the end of July, and at other times keep on till October. (4) We prefer evening. Either plan will answer. (5) Eight. (6) Feed until combs are full. This will take from 30lb. to 40lb. syrup.

[8953] *Removing Brood Combs.*—Thank you for your reply as to brood combs, but there is a point I do not quite understand:—(1) Do you think it too late to put new combs in now? (2) Ought I to remove the *outside combs* or those nearer the middle if I put in two new ones? I am not very experienced yet. (3) My hives now have sections on, will it do when they come off?—A. P., Ipswich.

REPLY.—(1) It is getting rather late, but you might do it. (2) Yes, cut away as many outside combs as possible without destroying brood, and feed bees if necessary. (3) It will be too late for the first method. Your best plan now will be to let them stay till spring, and follow second plan.

[8954] *Bees Working in Hive Roof.*—In one of our hives the bees are working at the top of the hive. Can you tell me the best way of getting them down into the sections again?—A. HIGNETT, Bath.

REPLY.—Give a puff of smoke through the ventilation hole, then take off roof, cut out the comb, and brush the bees off. Make all secure, so that they cannot escape again. The bees will fly back to the hive. They evidently need more room, give another section rack.

[8955] *Combs Built together.*—I have a stock which I purchased this year, the brood comb of which is all braced and irregularly built all over the bar, caused, as I am aware, through neglect. The bees are healthy and strong, and are working well. Would you mind telling me, through your valuable paper, the best way to introduce new foundation to the stock and at what time?—T. CHATTERTON, Horneastle.

REPLY.—You may place them on top of a brood box—a temporary box that will hold the frames will do—containing frames and foundation properly fitted, and allow bees to work down. When they have taken possession of the new frames, and there is brood in them, place a queen excluder between the two boxes, making certain the queen is on the new frames. In about twenty-five days' time you may take off the top box and remove

combs and honey. If you have used a temporary box for new frames, transfer them to the original brood box, after cleaning it thoroughly.

Another method would be to cut out as many of the old frames as possible early in the spring, and replace with new frames and foundation, as bees require more room. Do this each year, working the old combs to the outside of box until all are renewed.

[8956] *Various Queries.*—On June 15th my stock of bees swarmed owing to overcrowding. The swarm weighed 7lbs. I sold it for 2s. 6d. per lb. (1) Is not this a very large swarm, especially from a new stock of bees this year? The stock has also filled two racks of sections with lovely honey. It is a splendid year for honey here. A swarm I bought five weeks ago have filled one rack of sections as well as their brood chamber. (2) Does the Porter escape clear every bee out of the racks? Mine does not. I had to drive a really large quantity out with the smoker after the escape had been on twenty-four hours. The bees seem to be able to get back again. (3) Does it flavour or discolour the honey to have to use the smoker so vigorously? Thanking you for the valuable hints which are given week by week in the "B.B.J." I find them of great use.—M. WYATT, Knebworth.

REPLY.—(1) Yes, very good. (2) There is a fault somewhere, either in the escape itself or the board. There should not be more than half-a-dozen bees left. (3) Yes, too much smoke will give the honey a decidedly smoky taste, but is not likely to discolour it.

[8957] *Infection with "Isle of Wight" Disease.*—(1) Will you be so kind as to inform me of the *least time* in which infection of bees with "Isle of Wight" disease (so as to show symptoms of scores crawling, dislocation of legs, &c.) could take place when a healthy swarm is placed in an infected hive? The hive in question was supposed to be thoroughly disinfected and the swarm to be healthy, but the above symptoms were in evidence on the second day, and I should much like to know whether it is to be put down to hive or swarm. (2) Would you advise destroying the bees at once? (3) If so, how?—EAST SUSSEX, St. Leonards.

REPLY.—(1) We cannot say, it varies from a week to a fortnight. (2) Yes. (3) Pour in at top of hive a solution of cyanide of potassium, 1oz.; water, 1 pint. One-eighth of a pint of this solution

should suffice for one stock. Cyanide is a deadly poison, so be careful with it.

[8958] *Renewing Disinfectants.*—(1) When introducing queen to a queenless stock, or nucleus that has queen cells building, or built and sealed, is it right to tear down the cells or leave them? (2) How soon should a dose of apicure and naphthaline inserted in a hive diminish F.B. symptoms (actual dead larvæ, bacilli stage)? How soon should it abolish them? Will bees remove all spores?—F. G., Threlkeld.

REPLY.—(1) Destroy all queen cells. (2) From three weeks to three months; it depends on circumstances. The spores will break into life, become bacilli, and then be killed.

---



---

## PRESS CUTTINGS.

### MIXED HIVE.

BIRDS, HUMBLE BEES, AND HONEY BEES  
UNDER THE SAME ROOF.

A humble bees' nest brought to Portsmouth for the Royal Counties Agricultural Society's Show last month by a south country bee-master represented one side of a remarkable triangular partnership.

A modern wooden hive contained a nest of eight eggs of the great tit in the top and the humble bees' nest at the bottom, while the other part was used in an emergency to hold a swarm of honey bees, of which the great tit is an enemy. All went peacefully for two weeks. The honey bees were comfortably settled on the lower combs, and the young tits, having been hatched meanwhile, at length took wing.

But the honey bees tried to kill the humble bees, whose nest was removed. Thus the quaint treble partnership was finally broken up.—*Daily Mail*.

---



---

## Bee Shows to Come.

*A nominal charge of 2s. 6d. is made for notices (not exceeding 7 lines) in this column, 10 lines charged 3s. 6d., up to 15 lines 5s., which covers cost of insertion from order till date of show. Cash should accompany orders for insertion.*

---

June 30th to July 4th, at Shrewsbury.—Royal Agricultural Society's Show, Bee and Honey Section, under the direction of the B.B.K.A. Prizes arranged in groups of counties for Associations affiliated to the B.B.K.A. Schedules from W. Herrod, 23, Bedford Street, Strand, W.C. Entries closed.

**July 8th, at Aldenham.**—Honey Show of the St. Albans B.K.A., held in connection with the Elstree and Boreham Wood Horticultural Society, at Aldenham Park. Open class for extracted honey. No entry fee. Liberal prizes. Judge, Mr. W. Herrod. Schedules from Mr. R. H. Attenborough, Aldenham, Herts. Entries close July 6th.

**July 14th to 17th, at Hawick.**—Scottish Bee-keepers' Association. Exhibition of honey, wax, and appliances, in connection with the Highland and Agricultural Society's Show. Open to all British bee-keepers. Liberal prize-money. Write for schedules to A. Aikman Blair and John L. Gibson, joint secretaries, 176, Bruntsfield-place, Edinburgh.—Entries close 7th July.

**July 16th and 17th, at Boston.**—Lincolnshire Bee-keepers' Association. Exhibition of Honey, Hives and Appliances. Open and county classes. Over £30 in prizes. Schedules and entry forms from Capt. J. H. Hadfield, Alford, Lincs. Entries closed.

**July 22nd to July 24th, at Bradford.**—Great Yorkshire Show. Classes for hives, honey, &c. Good prizes. For schedules and forms of entry (stating department), apply, The Secretary, Great Yorkshire Show, Blake-street, York. Telegrams, "Yas, York." Entries closed.

**July 22nd and 23rd, at Cardiff.**—The Glamorgan B.K.A., in connection with the Cardiff and County Horticultural Society's Show, in the Sophia Gardens, Cardiff. Open classes include:—Collection, Gift, Sections, Beeswax, &c. Schedules from W. J. Wiltshire, Maindy School, Cardiff. Entries close July 18th.

**July 23rd, at Southwell.**—The Notts. Annual County Show, in connection with the Southwell Horticultural Society. Open class for single jar extracted honey. Schedules now ready from G. Hayes, Mona-street, Beeston, Notts.

**July 23rd, at Bath.**—The Annual Show of the Somerset Bee-keepers' Association, in connection with the Larkhall Horticultural Society. Seven Open Classes. Schedules from J. W. Brewer, Glen Lynn, St. Saviour's Road, Bath. Entries close July 18th.

**August 4th, 1914, at Bridgnorth.**—Annual Show of the Bridgnorth and District Bee-keepers' Association. Held in connection with Hampton Load Horticultural Society. Open gift class single 1lb. jar extracted honey. Prizes, 7s. 6d., 5s., 2s. Schedules from J. S. Lawton, Oldbury Wells, Bridgnorth. Entries close July 25th.

**August 5th and 6th, at Abington Park, Northampton.**—Northants B.K.A. Annual Honey Show. In connection with the Municipal Show. Special prizes for open classes, including one for single 1lb. jar. Entry free. Schedules from R. Hefford, Kingsthorpe, Northants. Entries close July 25th.

**Aug. 6th, at Bromham Park, Bedford.**—Honey show in connection with Biddenham and Bromham Flower Show, to be held in Bromham Park, near Bedford. Open classes for honey. Schedules from A. Henman, Bedford-road, Biddenham. Entries close July 30th.

**August 12th, at Wye, near Ashford, Kent.**—Kent Honey Show. 13th Annual Exhibition. Classes to suit all bee-keepers. Splendid prizes. One 6 guinea and two 5 guinea Challenge Cups; also two champion silver cups. A class for honey put up in short bottles, and a new class this year for best six photographs of bee life (taken by exhibitor); 2 silver medals for best exhibits of bee appliances. 25 different classes. Prize schedule and entry form free on application to Mr. Alfred Lepper, secretary Kent Honey Show, Scotton-street, Wye, Kent. Prize schedule and entry form will be sent to all exhibitors of last year without application.

**August 17th and 18th, at Cannock (Staffs.).**—Honey Show, in connection with Cannock Horticultural Show. Eight open classes. Good prizes. Schedules from hon. sec., John Bird, Glenmay, Cannock.

**August 18th and 19th, at Brighton.**—The Fourth Annual Show of the Sussex Bee-keepers' Association, in connection with the summer show of the Brighton, Hove, and Sussex Horticultural Society. Seven Open Classes. Liberal Prizes. Schedules from C. A. Overton, Beecroft, Crawley. Entries close Aug. 10th.

**August 19th, at Radstock.**—Honey show, in connection with the Radstock and District Horticultural and Fanciers' Association. Schedules from B. M. Clark, Fox Hills, Radstock.

**August 25th, 26th, and 27th, at Newcastle.**—Northumberland Bee-keepers' Association. Exhibition of honey and wax, in connection with the Newcastle Flower Show. Nine open classes. Schedules and entry forms from R. H. Newton, 24, Grainger-street West, Newcastle, or Captain F. Sitwell Wooler. Entries close August 20th.

**August 26th, at Prestbury.**—Honey show, in connection with the Prestbury Flower Show. One class open to the kingdom. Several for those within 12 miles radius. Exceptional prize list. Schedules from A. H. Bowen, Coronation-road, Cheltenham.

**August 26th, at Chester.**—Annual Show of the Cheshire Bee-keepers' Association, in connection with Cheshire Agricultural Society. Several open classes. Good prizes. Schedules from T. A. Beckett, St. Werburgh Chams, Chester.

**August 26th and 27th, at Rugby.**—Exhibition of the Warwickshire Bee-keepers' Association, in connection with the Warwickshire Agricultural Society's Show. Open and county classes. For schedules apply, J. R. Ingerthorp, Knowle, Warwickshire. Entries close August 17th.

**September 1st, at Deddington.**—Honey show in connection with Deddington Horticultural Society's Show, to be held in the Castle Grounds. Open classes for honey. Schedules from H. J. Harmsworth, Deddington, Oxon.

**September 2nd, at Lancaster.**—Agricultural Show. Premier Honey Show of the North. 15 classes; £20 in cash prizes, silver cups and medals value 13 guineas, and other specials. Send for schedule (Honey) to Robert Gardner, solicitor, 69, Church-street, Lancaster. Entries close August 19th.

**Sept. 5th, at the Club Room, North-road, Kew.**—Honey Show of the Richmond and District Bee-keepers' Association. Open classes for honey and wax. For schedules, apply Hon. Sec., Mr. J. G. Romer, 234, Kew-road, Kew-gardens. Entries close Aug. 28th.

**September 9th, at Stoke Park, Guildford.**—Annual Exhibition of honey, wax, appliances, &c., will be held by the Surrey B.K.A. in connection with the Guildford and West Surrey Agricultural Association. Eighteen classes, five open to all. Many medals. Schedules from F. B. White, hon. secretary, Marden House, Redhill, Surrey. Entries close 31st August.

## Notices to Correspondents

### *Suspected Disease.*

**Buzz (Threlkeld).**—Can find no outward signs of disease in bees sent.

**I. (Stourbridge).**—There are symptoms of "Isle of Wight" disease. We cannot say definitely, as there were too few bees, and you give us no particulars as to symptoms outside hives.

"ENQUIRER" (Tan-y-Bwlch).—There is no disease in the bees sent. It is probably starvation.

W. E. R. (Whitkirk).—Yes, bees have "Isle of Wight" disease.

C. P. (Stalbridge).—We regret to say it is a case of "Isle of Wight" disease.

S. S. S. (Hastings).—All the symptoms point to the stock being infected with "Isle of Wight" disease.

I. A. N. (Higham).—It is a case of "Isle of Wight" disease.

SOLWAY (Annan).—There is no trace of disease in the bees sent.

WEST CUMBERLAND.—The symptoms point to "Isle of Wight" disease.

C. T. (Aberdeen).—We can find no trace of disease in bees. The queen appears to be a hybrid Italian.

J. A. H. (King's Heath).—The bees have "Isle of Wight" disease.

### Special Prepaid Advertisements.

Two Words One Penny, minimum Sixpence. Orders for three or more consecutive insertions entitle advertisers to one insertion in "The Bee-keepers' Record" free of charge.

Trade advertisements of Bees, Honey, Queens, and Bee goods are not admissible at above rate, but will be inserted at 1d. per word as "Business" Announcements, immediately under the Private Advertisements. Advertisements of Hive-manufacturers can only be inserted at a minimum charge of 3s. per  $\frac{1}{2}$ in., or 5s. per inch.

### PRIVATE ADVERTISEMENTS.

THREE, four, and five frame nuclei, 15s., 17s. 6d., 20s., all this year tested Queens. May swarm on 8 frames, plenty of brood, 25s., cash with order, f.o.r. Boxes to be returned carriage paid. Inspection invited, by appointment.—J., 9, Sunnyside-rd, Hford. v 21

WANTED, first grade sections, any quantity, glazed and unglazed; also run honey. Deposit.—Address, "P.", "British Bee Journal" Office, 23, Bedford-street, Strand, W.C. v 17

MATING and travelling boxes, two entrances, 4s.; Dadant's Weed, ten sheets, 5lb., 10s. 6d.—HUNT, Quarry-road, Somercotes, Alfreton. v 18

STOCK of British bees, guaranteed healthy, price, including hive, 25s.—MARSHALL, Cumberland-road, Brighton. v 15

WANTED, good Solar wax extractor.—HIGGS, The Apiary, North Rode, Congleton. v 16

STRONG, healthy nuclei, with 1914 laying queens, with four frames brood, 15s.; six frames, 20s. each; ten frame stocks, ready for supering, 30s.; guaranteed healthy, no disease of any kind in the district.—A. SHARP, Halstead Farm, Barrowford, Lancashire. v 14

FOR SALE, extractor, cog-gearing, good condition, 15s.; two uncapping knives, Bingham pattern, 2s. 6d.; at Boston Spa.—Apply, COOPER, 27, Claremont-terrace, York. v 13

THREE strong stocks, in W.B.C. hives, extra hives and appliances, cheap.—FRY, 38, Sydenham Park, Sydenham. v 12

HEALTHY stocks for sale, 35s., 40s. each; three-frame nuclei, 15s. MORGAN, 93, The Avenue, Ealing. v 11

A FEW 8-frame stocks, 1914 queens, 30s. each, f.o.r., guaranteed healthy.—WILSON, Apiary, Belper. v 10

WANTED, Rymer honey boards, W.B.C. outer boxes. HALL, outfitter, Hinckley. v 8

5-FRAME nuclei, Carniolan hybrid, brood in all 5 frames, 1914 laying queens, 15s. each guaranteed healthy; boxes to be returned.—A. MAGSON, Kirkham, Lancashire. v 7

HARDY prolific Dutch queens, 1913, 2s. 9d.; on 3-frame nuclei, 13s. 6d.; naturally raised virgins, 2s.—PAUL, Salisbury-road, Bexley. v 5

1913 QUEEN for sale, 4s.—HURST, 31, Ellerton-road, Wandsworth Common, S.W. v 4

COWAN extractor, cost 50s., take 35s.;  $\frac{1}{2}$  cwt. ripener, 8s. 6d.; both Meadows's make, scarcely used; nine 28lb. honey tins, new, 4s. 6d.—PERCIVAL, 14, Chretien-road, Northenden, Cheshire. v 3

HIVES, sound, painted, no disease, two, W.B.C., three lifts each, 17s. each; eight single, two lifts each, 8s. each; twelve dozen shallow drawn combs, 4d. each; Solar wax extractor, 22in. by 16in., 8s.; three shallow frame show cases, 3s., or offer.—CARVER, Castle Cary. v 2

SEVEN strong hives, with standard and shallow body, and lift, 2s. 6d. each; also a Combination, with four bee-way, price 4s., or £1 the lot, with other things thrown in, dummies, dry sugar feeders, frames, smoker, &c.—W. PRINGLE, 2, Commercial-square, Winton, Blaydon-on-Tyne. v 1

WANTED, sections; state lowest price and quantity.—CHURCH FARM DAIRY, Sheringham, Norfolk. v 85

FOR SALE, Rymer heather honey press and drawer, no stand, unused, 40s., or offers.—"BUMBLE," "B.B.J." Office, 23, Bedford-street, Strand, W.C.

WANTED, a complete comb of both a bad and mild case of Foul Brood.—HERROD, "B.B.J." Office.

SMITH PREMIER TYPEWRITER, Standard double keyboard, very reliable, beautiful writing, perfect condition, cost £23, accept 60/-, worth double.—WAKEFIELD, Newhall Hill, Birmingham. v 54

A FEW of a very fine strain of specially bred queens for sale, from a district that has been devastated by "Isle of Wight" disease, and from stocks that have proved perfectly healthy, excellent honey storers and good comb builders, price, fertile, 10s. 6d. each; every queen tested, no unfertiles sold; safe arrival guaranteed.—B. HOWARD COLLINS, Harewood Apiary, Chalfont St. Giles, Bucks. v 30

FOR SALE, grand stocks Scotch bees, healthy, 30s. each, or in good secondhand hives, 40s. each, f.o.r., cash.—GEO. W. PAISLEY, Newport-on-Tay. v 45

A FEW good section racks, complete, with dividers, follower, and wedge, 1s. 6d. each; lace paper, neat pattern, 6d. 100, post free; lace bands, 2 $\frac{1}{2}$ in. and 3in., 100 ls. 2d., post free, finest quality.—W. WOODLEY, Beeton, Newbury.

SELL, Thould and Hutchinson portable cesspool pump, with all fittings, used once only, cost £3 10s.; offers.—"PUMP," "B.B.J." Office, 23, Bedford-street, Strand, London, W.C.

WANTED, the following: Cloth editions "British Bee-keepers' Guide Book," 1st, 3rd, 4th, 5th, 7th.—HERROD, "B.B.J." Office, 23, Bedford-street, Strand, W.C.

DIRECT from F. W. Sladen's original extra golden bee stocks.—British golden virgin queens, 2s. 6d. each, three for 6s. 9d.; apiary free from "I.O.W."—CHESTON CREWES' Apiary, Warlingham, Surrey. v 20

### BUSINESS ADVERTISEMENTS.

HOW TO PREVENT SWARMING.—A certain method, fully explained, with illustrations from life, of bees and their work, price 1s., postage 1d., from all dealers, and the author, A. H. WILKES, Lichfield-road, Four Oaks, Birmingham.





#### BRITISH BEE-KEEPERS' ASSOCIATION.

The monthly meeting of the Council was held in the office of the Hives and Honey Department, Royal Show Ground, Shrewsbury, on Thursday, July 2nd, 1914. Mr. A. G. Pugh presided. There were also present Miss M. D. Sillar, Messrs. H. Jonas, J. N. Smallwood, Association representatives; C. R. Forse and W. M. Vallon (Staffordshire), Rev. G. E. H. Pratt (Salop), A. McCullah (Devon), W. E. Richardson (Yorks), and Dr. W. Anderton (Lancashire), and the Secretary, W. Herrod.

Letters expressing regret at inability to attend were read from Messrs. T. W. Cowan, W. F. Reid, C. L. M. Eales, and O. R. Frankenstein.

The following new members were elected:—Mr. J. W. Hignett, Mr. W. Thorne, and Mr. R. Slimmand.

The report of the Finance Committee was presented by Mr. Smallwood, who stated that the payments into the bank for June amounted to £13 19s. 6d., the bank balance being £222 0s. 5d.

Applications for preliminary examinations were received from Norfolk, Northumberland, and Suffolk; these were granted and examiners appointed.

The report of the preliminary examination, held at Waltham Cross, was received, and it was resolved to grant the certificate to Miss Gladys Darrington.

The report of the Exhibitions Committee on the proposed judging competition by Mr. Frankenstein was read by the secretary. A minority report was read by Mr. A. G. Pugh, and after discussion it was resolved that the best thanks of the Council be given to the Committee for the work they had done, and that the matter be referred to them for further consideration.

This concluded the business of the meeting.

Dr. W. Anderton then rose and said it was the first meeting of the Council he had attended, and he felt it his duty to compliment the Council on the methodical and business-like manner in which the work was carried out.

The Chairman said he was certain he voiced the feelings of the whole Council of the B.B.K.A. in saying how pleased they were when the representatives of the affiliated Associations attended the meetings, and he extended a hearty welcome

to them. The sympathy of the Council was with those representatives who lived many miles away from London, and therefore were unable to attend. When the matter of having the Council meetings migratory was considered several years ago, it was found that it would be very inconvenient to hold them away from the office in London, where all the papers and documents are available for reference. At that time he suggested the idea of holding one Council meeting each year in the provinces at the town in which the Royal Show was held. Owing to being responsible for this alteration he had made it a point to be present each year at this particular meeting, and he was pleased to note that the idea had caught on, and that the attendance increased year by year. In the first year of the change, 1912, only five attended, in 1913 eight attended, while that day ten were present.

Next meeting of Council, Thursday, September 17th, at 23, Bedford Street, Strand, London, W.C.

#### THE ROYAL SHOW AT SHREWSBURY.

The "Hives and Honey" stand occupied an exceptionally good position this year. From the front stretched a wide avenue right across the ground past the "Horse Ring" to the stand of the Education Department. The exhibits were, as usual, excellent, and in goodly number, very few entrants being unable to send their exhibits. The lot of the judges was not at all enviable; not only were the exhibits all so good as to make it a difficult matter to decide which should take premier honours, but the weather was intensely hot. With such well-known exhibitors of "trophies" as Messrs. Pearman, Brown, and Dixon, and others, that class was a strong one. The class for mead secured a large number of entries this year, as did the wax classes also. The judging was undertaken by Revs. T. J. Evans and G. E. B. Pratt, and Messrs. W. F. Reid, and A. G. Pugh. Mr. Cartwright undertook the duties of steward.

Below we append a list of awards:—

##### HIVES AND APPLIANCES.

*Class 599.—Collection of Hives and Appliances, including Suitable Outfit for a Beginner in Bee-keeping.*—1st, W. P. Meadows, Syston, Leicester; 2nd, James Lee and Son, Uxbridge; 3rd, E. J. Burt, Stroud Road, Gloucester.

*Class 600.—Complete Frame-hire for General Use.*—1st, E. H. Taylor, Welwyn, Herts; 2nd, James Lee and Son; 3rd, W. P. Meadows.

*Class 601.—Complete and Inexpensive Frame-hive for Cottager's Use, price not to exceed 10s. 6d.—1st, E. H. Taylor; 2nd, James Lee and Son; 3rd, W. P. Meadows.*

*Class 602.—Honey Extractor.—1st, W. P. Meadows; 2nd, E. H. Taylor.*

*Class 603.—Observatory Hive with Bees and Queen.—1st, A. W. Simcox, Fallings Park, Wolverhampton.*

*Class 604.—Any Appliance connected with Bee-keeping, to which no prize has been awarded at a Show of the Royal Agricultural Society of England.—1st, James Lee and Son; certificates, B. Blackbourn, Minster, Thanet; F. W. Watts, 132, Goodrich Road, East Dulwich, S.E.*

#### HONEY.

Classes 605 to 607 confined to members of the Shropshire Bee-keepers' Association.

*Class 605.—Four 1-lb. Sections.—1st, E. Brookfield, Myrtle, Salop; 2nd, R. H. Elson, Wellington, Salop; 3rd, H. Henstock, Nesscliffe, Salop.*

*Class 606.—Four 1-lb. Jars of Extracted Light-coloured Honey.—1st, E. Brookfield; 2nd, H. R. Millington, Wistanswick, Market Drayton; 3rd, H. Hulme, Quatford, Bridgnorth; r.n. and h.c., H. R. Eddows, Grinshill, Shrewsbury.*

*Class 607.—Collective Exhibit of Honey and Wax.—1st, W. Shuker, Bridgnorth, Salop; 2nd, H. R. Millington; 3rd, E. Brookfield; r. and h.c., R. H. Elson.*

Entries in Classes 608 to 611 can only be made by residents in Cheshire, Cumberland, Derbyshire, Durham, Herefordshire, Lancashire, Leicestershire, Lincolnshire, Monmouthshire, Northumberland, Nottinghamshire, Rutland, Shropshire, Staffordshire, Warwickshire, Westmorland, Worcestershire, Yorkshire, the Isle of Man, Ireland, Scotland, or Wales.

*Class 608.—Twelve 1-lb. Sections.—1st, W. N. Helme, Weatley, Hereford; 2nd, R. Robson, Cheviot Street, Wooler; 3rd, J. G. Nicholson, Langwathby, Cumberland; r. and h.c., J. Pearman, Penny Long Lane, Derby; c., Studley Horticultural College, Warwicks.*

*Class 609.—Twelve 1-lb. Jars of Extracted Light-coloured Honey.—1st, J. Berry, Llanrwst, N. Wales; 2nd, T. A. Dennison, Stockton, Rugby; 3rd, W. Patchett, Cabourne, Caistor, Lincs.; r. and h.c., J. Pearman; h.c., M. W. C. Partridge, Cannock, Staffs.; c., F. C. Holmes and H. R. Millington.*

*Class 610.—Twelve 1-lb. Jars of Extracted Medium or Dark-coloured Honey.—1st, Studley Horticultural College; 2nd, W. Shuker; 3rd, T. A. Dennison; r. and h.c., W. H. Barlow, High Leigh, Knutsford.*

*Class 611.—Twelve 1-lb. Jars of Granulated Honey.—1st, A. W. Weatherhogg, Willoughton, Lincoln; 2nd, J. Pearman; 3rd, J. Berry; r. and h.c., Studley Horticultural College; h.c., W. Patchett; c., H. Hulme.*

Entries in Classes 612 to 615 can only be made by residents in Bedfordshire, Berkshire, Bucks, Cambridgeshire, Cornwall, Devon, Dorset, Essex, Gloucestershire, Hampshire, Herts, Hunts, Isle of Wight, Kent, Middlesex, Norfolk, Northamptonshire, Oxfordshire, Somerset, Suffolk, Surrey, Sussex, or Wiltshire.

*Class 612.—Twelve 1-lb. Sections.—1st, F. Bird, Little Canfield, Dunmow; 2nd, C. W. Dyer, Compton Crossing Newbury; 3rd, R. Brown, Somersham, Hunts; r. and h.c., W. J. Goodrich, Oxford Street, Gloucester; h.c., A. H. Bowen, Coronation Road, Cheltenham; A. MacCullah, Dun-chidock, Exeter.*

*Class 613.—Twelve 1-lb. Jars of Extracted Light-coloured Honey.—1st, S. G. S. Leigh; 2nd, G. W. Kirby, Knowle, Bristol; 3rd, D. Hancox, Deddington, Oxford; r. and h.c., A. H. Bowen; h.c., J. E. Swaffield, Libertus Villas, Cheltenham; c., A. MacCullah.*

*Class 614.—Twelve 1-lb. Jars of Extracted Medium or Dark-coloured Honey.—1st, C. E. Billson, Cranford, near Kettering; 2nd, G. W. Kirby; 3rd, R. Brown; r. and h.c., A. MacCullah; h.c., S. Sanderson, West Wrattling, Cambs.; c., F. G. Hales, Wellow, Bath.*

*Class 615.—Twelve 1-lb. Jars of Granulated Honey.—1st, A. H. Bowen; 2nd, F. Bird; 3rd, A. MacCullah; r. and h.c., L. Andrews, Millfield, Peterborough.*

#### MISCELLANEOUS OPEN CLASSES.

*Class 616.—Three Shallow-frames of Comb Honey, for Extracting.—1st, R. Brown; 2nd, F. G. Hales; 3rd, H. Henstock.*

*Class 617.—Six 1-lb. Jars of Heather Honey.—1st, W. Dixon, 27, Central Road, Leeds; 2nd, M. J. Lamboll, Chiddingfold, Surrey; 3rd, J. Berry; r. and h.c., G. Scott, Cumnock, Ayr, N.B.; h.c., W. Burn, Phoenix House, Whitby; c., J. Shaw, Mulgrave Apiary, Sandstead; J. Pearman.*

*Class 618.—Six Jars of Heather Mixture Extracted Honey.—1st, J. Berry; 2nd, F. C. Holmes; 3rd, J. Pearman; r. and h.c., J. Pearman.*

*Class 619.—Honey Trophy.—1st, J. Pearman; 2nd, R. Brown; 3rd, W. Dixon; r. and h.c., F. C. Holmes, Powis Castle Nursery, Welshpool; h.c., F. Newport; c., W. Dixon.*

*Class 620.—Bees Wax (not less than 2-lb.).—1st, W. Patchett; 2nd, R. Brown;*

3rd, J. Pearman; r. and h.c., J. Berry; h.c., Hyde and Fishwick, Lytham.

*Class 621.—Bees Wax (not less than 3-lb, the produce in shape, quality, and package suitable for the retail trade).—*1st, J. Pearman; 2nd, J. Berry; 3rd, A. MacCullah; r. and h.c., F. W. Frusher, Crowland, Peterborough.

*Class 622.—Honey Vinegar, 1-qt.—*1st, R. Brown; 2nd, G. W. Kirby; certificate, J. Berry; r. and h.c., J. Pearman.

*Class 623.—Mead, 1-qt.—*1st, J. Berry; 2nd, J. Thomson, St. Peter's Park, Paddington, London; certificate, J. Pearman; r. and h.c., F. C. Holmes.

*Class 624.—Exhibit of a Practical or Interesting Nature, connected with Bee Culture.—*1st, A. MacCullah; 2nd, W. Dixon.

*Class 625.—Exhibit of a Scientific Nature.—*1st, G. Steventon, Shaftesbury Lodge, Bisley; 2nd, D. Lindsay, St. Paul's Schools, Worcester.

W. BROUGHTON CARR MEMORIAL MEDAL.

1st, J. Berry, Llanrwst, N. Wales; 2nd, Col. Jolly's "W.B.C." hive, R. Brown, Somersham.

LANCASHIRE AGRICULTURAL SHOW.

We desire to draw readers' attention to the annual show of the Royal Lancashire Agricultural Society, to be held this year at Liverpool from July 30th to August 3rd.

Great inducements are offered to exhibitors, nine classes being open to the United Kingdom, with generous prizes, in addition to silver and bronze medals in County Palatine classes. The final date for closing entries is July 11th, and any bee-keepers having good honey will find it worth while to apply for schedules, which will be sent on application to the Secretary of the Society.

THE CROYDON AND DISTRICT BEE-KEEPERS' ASSOCIATION.

A general meeting will be held at the Y.M.C.A., North End, West Croydon, on July 13th, at 8 p.m. sharp, with the object of reorganising the above Association, when all members are cordially invited.—C. H. ROSE, Hon. Sec. *pro tem*.

WEAR VALLEY AND DISTRICT BEE-KEEPERS' ASSOCIATION, Co. DURHAM.

Under the auspices of the above Association a lecture was delivered at West-

gate, July 4th, by Mr. W. S. Watson, Wolsingham, Hon. Sec. of the Association. The subject, "Swarming and Re-queening," was listened to by an appreciative audience. Questions were asked after the lecture, and answered by the lecturer. Mr. J. Willan occupied the chair. A hearty vote of thanks was accorded the chairman and lecturer, the latter receiving an earnest invitation to visit Westgate again and give another address on bees.

BEE PICTURES IN LONDON.

Mr. J. C. Bee Mason is showing two films this week at the London Opera House, at 3.0 p.m. and 8.15 p.m. Subjects: "Bees and their Enemies" and "The Bee Master."



EXTRACTS AND COMMENTS.

By D. M. Macdonald.

*Rearing Queens.*—When best to do this is a moot point, and many hold that about swarming-time, when bees' thoughts are naturally inclined to queen cell construction, is best. Mr. Root recently uttered the following pronouncement on this subject: "An experienced queen-breeder who understands the art of feeding—that is, of stimulating—can rear just as good queens out of season as during the swarming or supersedure impulse"; and he quotes an experienced breeder, who rears thousands of queens, as follows: "I prefer to have no honey coming in, because then I have all the conditions under my control, and knowing these conditions I can raise the best of queens." Dr. Miller commends Mr. Greiner for advocating the period of natural swarming. The bee-keepers of Switzerland and Germany advise rearing queens during the time bees naturally swarm. In this country, in most seasons the time for successful queen-rearing is very limited, and very rarely do any of our queen-rearers postpone the operations until the close of the honey season.

*Moving Bees.*—*Gleanings*, June 1st, is a special issue dealing with this subject. I do not know that I can coin much from the mass of matter specially illuminating for bee-keepers on this side. They move a car-load at a time, and all the way from such remote centres as Florida and Ohio.

We can never accomplish anything similar, as we have no such extremes of climate. The aim in this particular case was not only to get a northern harvest and a southern one, but also to make increase on a large scale—four car-loads from one! They find that while in transit, as long as the train is moving bees are contented and comfortable. Resting long may produce disaster. The combs must not be heavy with honey, and the colonies must not be strong. A special car, suitably fitted up, is used, and an attendant travels along with the bees. In warm weather water is liberally used to cool the hives, and provision is made for occasional drinks being given. The whole question of transit in this country needs overhauling, and several features could be greatly improved, a great part of the success generally following a rail journey being more a question of luck rather than management.

*Apiculture Looking Up.*—This is going to be a good supply year. Reports show that a high-water mark has been reached. All manufacturers are having a bigger demand for goods than ever before. This shows that bee-keeping is looking up in spite of adverse conditions here and there. In America there has been an extensive demand for power-driven extractors, and queen-breeders report an enormous call for young queens.

*Swiss Bee-Keepers.*—What handsome, good-looking fellows (men and women, Dr. Miller) they have at conventions in Switzerland, judging by the fine photograph reproduced on the front page of the cover of the June *American Bee Journal*. Mr. Dadant's well-known features are easily spotted. Apart from one or two which have appeared in our journal, I have been unable to spot any prominent faces in the group.

*Wild Bees.*—"Our younger bee-keepers, both boys and girls, would find it well worth their while to collect and study the wild species of their neighbourhood. By exchanging and corresponding with each other this work might be made intensely interesting. Some 8,000 species have been described throughout the world, of which 2,000 belong to Europe. There are about 200 species in England, 400 in Germany." This, as a study, should prove of absorbing interest, if carried out systematically. I should think—but alas! I am no longer numbered in our "younger" bee-keepers!

*Bees' Olfactory Organs.* Several of our confirmed ideas regarding the sense-organs of bees have lately gone by the board. Dr. McIndoo, of the Bureau of Entomology, Washington, has been during the last three years devoting his entire time to a study of the olfactory sense in the honey bee, and his conclusion is that the view

that the antennæ carry these organs must be abandoned judging from the fruits of his observations. From his diagrams it may be judged that he would locate them in the wings, legs, sting, &c., but *not* in the antennæ! Quoting briefly we are told Groups 1 to 5 lie on the bases of the wings; groups 6 to 18 lie on the legs; groups 19 to 21 lie on the sting. Drones have an average number of 2,604 olfactory organs, 606 lie on all six legs, and 1,998 on all four wings. Workers have an average total number of 2,268 olfactory organs, 100 of which lie on the sting, 658 on all six legs, and 1,510 on all four wings. Queens have an average total number of 1,860 olfactory organs, 100 of which lie on the sting, 450 on all six legs, and 1,310 on all four wings. These *facts*, which appear quite fabulous, and have been attained as the fruits of long and patient labours in making mutilating experiments, appear in a contributed article in June *American Bee Journal*. At present all comment is withheld.

---

#### "BLURTS FROM A SCRATCHY PEN."

ROYAL SHOW, 1914.

It was all the fault of that wretch, the "Clerk of the weather," or of the Meteorological Office. It was not the fault of Shrewsbury. She, forsooth, had done all that a town could do. For months before she had been preparing. She had proclaimed that she meant to make *her* show a record. It should excel all previous Royal Shows. Invitations had been issued broadcast, and the Royal Agricultural Society had joined hands with her. French, German and Danish agriculturists were asked to come, aye, even South Africa, far as it is, sent a contingent. Then just at the very moment when everything depended on brilliant sunshine, the powers that rule the weather turned rogue, and spoiled all. Really if the people who pay the rates and who spend such a lot of money to get up a festival like this cannot have some control over those who make the rain it is high time there was some reform. Nor is this the only quarrel I have with these officials. They played "possum," they were tricky. Evidently the joke was to try to tempt as many to come as possible, and then to drown them, or nearly so. In the early days of the week, never was brighter sunshine, never warmer weather. So hot indeed that it is reported that many of the fat cattle and pigs fainted. Lest any member of the R.S.P.C.A. should be alarmed, let me hasten to tell him that first aid was immediately at hand. There were armies of "vets" and tons of medicine on the

spot, even including smelling salts, and "Eau de Cologne."

And then on the Wednesday, just as the tea was ready, down came the rain. "Not 'arf," as Cockneys say, but just in sheets which splashed and rebounded from the trodden meadow, while the lightning flashed and forked, from the zenith even to the horizon, and the thunder crashed and crackled. Oh! how that old river god who dwells in the Severn must have laughed to see the scattering of dainty dames and demoiselles clad in the most dainty and most light (avoirdupois) of costumes. And so the game went merrily on for an hour or more, when I suppose it was concluded that we had had enough for one day, and midst gorgeous pillows of crimson and gold old Sol retired to his rest.

Still the controllers of the weather were bent on mischief. The quaint old town, in expectation of the visit of the King on the morrow, had decked itself out right royally. Flags, and banners, and festoons, from Venetian masts had made the streets an archway through which peeped here and there the old houses, black-beamed and overhanging the pathways. All this preparation was allowed to proceed calmly until mid-day, and then! if it had rained in sheets the day before, to-day it was in avalanches of hail. The flags became as limp as bathing towels, and the poor banners hung disconsolate, gibbeted on their cross arms. As for the show field, it was for the moment transformed into a lake, with tents, and sheds, as isles in its midst. Again in the evening a short respite was given, but all night long the rain pelted on the roof of our camp and the grey morning gave but little hope. However, this much I will say of these much-reviled weather authorities—ere the King came all the rain clouds had been besomed and brushed over the hills and far away.

And about *our* Show. The entries were in excess of any previous year, and therefore there was a greater display. The extracted honey seemed to me superior to any I had met with on a show bench before, but I think I have seen better sections and shallow frames. For these there is excuse that it was perhaps impossible to get the best samples so early (relatively) in the year. The judges were capable and did their duty. But whoever heard of a judge giving satisfaction to everyone? Solomon officiating at a honey show would have been a horrid failure. Those who do not get prizes always think they ought to have had them, and would probably feel disposed to argue with the awarders of the honours, but for wise reasons they are not "get-at-able." He who is curious to know the fortunate

may consult our Journal, but as the verdict is given the case is finished.

Of "Bee Appliances" there was no end. All the usual manufacturers had *their* show. Messrs. Lee and Taylor, Burt and Meadows. Thank Heaven! there was nothing specially new to record. Poor amateur, how his heart must sink when he views that vast array. Are all these necessary? he queries. Well, not all. That neat little machine for making bees sting rheumatic folk, *that* he will not want. He can get plenty of Formic acid injections without its aid. But if I attempt to separate the essentials from the non-essentials I shall require an extra page, which I don't think our editor can spare me.

And now I have just one more sentence to add. It is as to the usefulness of these shows over and above the giving of prizes. I have had the pleasure of spending annually two or three days "camping out" at the show, and it is very noticeable how each year the number of intelligent enquiries increases. The brilliant crimson of the "Bee Tent," of course, is a striking landmark, and the lecturers attract a listening crowd. After the "Bee Chat" some of the questions asked show great observation, but it is when that is over enquirers, literally from all parts of the world, seek out the tent over which flaunts the banner whereon is emblazoned the queen bee, in search of information. The quiet, unostentatious way in which the work has been carried on these forty years is being rewarded. The number of beekeepers is increasing, the more numerous visits to the tent is one of the signs, and if only we, armed to battle against disease, were enabled to enforce the most elementary principles for preventing its increase, the years would be very few ere our prize list would need doubling.

JNO. SMALLWOOD.



*The Editors do not hold themselves responsible for the opinions expressed by correspondents. No notice will be taken of anonymous communications, and correspondents are requested to write on one side of the paper only and give their real names and addresses, not necessarily for publication, but as a guarantee of good faith. Illustrations should be drawn on separate pieces of paper. We do not undertake to return rejected communications.*

#### PEASANT HIVES IN ITALY.

[9017] I have been interested in Mr. Smallwood's articles on Italy, and wonder

whether he has come across any of the hives made from the hollowed out portion of a tree trunk, about 3 feet high and 2 feet in diameter, with a minute entrance. I regret that I have no photograph of one. Some years ago I was asked to introduce modern hives on Baron Franchetti's estates in Umbria. One English "W.B.C." hive was sent out by Messrs. Lee and was beautifully copied by a local carpenter, and now every farm on these large estates has "W.B.C." hives, and owners who understand how to manipulate them. The difficulty was to transfer the bees from the trunk hives into the English ones. The method I adopted was a rough-and-ready one, but proved quite effectual. The trunk hive was cleaved open with a hatchet. Then the best and straightest pieces of comb with brood were tied with wire into the brood frames, and as soon as the hive was thus fitted it was placed on the spot where the old trunk hive had stood. All remaining comb was removed and burnt at once. The Italian bees are very good natured, and, considering the nature of the work, I received very few stings. The bees store an immense amount of honey considering the shortness of the season, for, after the end of June, there is little nectar to be gathered, owing to the drought and heat. Shallow frames are used, as Italians will not eat honey-comb.—MAGDALEN MILLARD.

#### OBSERVATORY HIVE.

[9048] Two interesting things have happened this week. One is that I had been watching a ripe queen-cell which had been sealed over six days. I was called away for not more than half-an-hour, and on my return found the queen had just emerged. The hive was in a state of great excitement, and very strong, the seven sections filled but not quite sealed. Within ten minutes of my return to the hive the bees were swarming, and I took them easily from a laburnum tree outside the window.

A swarm was issuing from a strong stock in my apiary and seemed inclined to cluster on some pea-sticks, but were spread widely, and a big lot of bees on the wing. I was standing near the line of peas with a skep in my hand. I had been there perhaps five minutes, when I noticed I was the centre of attraction, and my right foot and leg were soon thick with bees. I kept still to see what would happen, when I shortly found the bees entering and hiving themselves in the skep in my hand an accommodating lot. Yesterday I found a wild swarm on the trunk of a tree in the wood here. I could not shake them, nor could I smoke them, as the smoke

filled the skep and so defeated the object of using it. I therefore got a couple of handfuls of bees into the skep, but without the queen, I fancy, and then hung the skep on a limb three or four yards away. I then climbed the tree and smoked the bees till they swarmed, and they at once hived themselves with the small lot in skep.—APRS.

#### MR. CRAWSHAW AND NEW ZEALAND BOX-HIVES.

[9049] I crave your indulgence once more in a final word with my friend on the fixed-comb hive question (p. 139). Mr. Crawshaw's last to reach me reminds me of the old saying, "Convince a man against his will," &c., which seems very apt in this case. He still persists in singling out "New Zealand box-hives" as though common boxes as domiciles for bees were an exclusive form of immovable comb hive used in this country. I have on several occasions informed Mr. Crawshaw that the term "box-hive" is used by New Zealand bee-keepers for convenience to cover in a general way all sorts and kinds of fixed comb receptacles, be they boxes, barrels, skeps, or anything else, not being movable frame hives. I may mention that the same term conveying a similar meaning is used throughout Australia.

It is somewhat amusing to find Mr. Crawshaw, in defence of the skep, saying it is superior to the New Zealand box-hives, which is really declaring that one evil is less than the other, and on that account the lesser evil should be put up with. I am astonished that a regular contributor to a journal representing British bee-keeping should say: "But I am not solely concerned with the 'commercial bee-keeper,' nor with the comparative profits of alternative methods." If, as I take Mr. Crawshaw's position to be, he is a teacher of bee-keeping, through his contributions, he should most decidedly be concerned with the working out of the most profitable methods of commercial bee-keeping. It must have been a slip of the pen, surely.—J. HOPKINS, Auckland, New Zealand.

#### A PROLIFIC COLONY.

[9050] Your remarks anent how to prevent casts induces me to write, as I find with some strains that it is not such an easy matter.

Last year, after the first swarms came out, I cut out all the queen-cells but one, with the result that in two of my hives the young queen was lost, presumably during her wedding flight, and I had to require later on. This year I did not

cut out the queen-cells, but in each case hived the swarm on the old stand, removing the parent hive to a new location: still a cast came out in spite of bottom ventilation and plenty of room overhead.

One of my stocks has had what seems to me a remarkable rate of increase. My notes for this stock are:—April 10th, section rack put on. April 19th, Combs drawn out, second rack put on. April 29th, swarmed: swarm hived on old location and given the two partly finished racks; no drones yet out. May 9th, young queen first heard piping in parent hive. May 13th, nine dead virgins thrown out. May 14th, cast, hived in fresh hive. Racks put on both parent hive and cast, also all three had bottom ventilation: nevertheless, all three swarmed again between 22nd and 29th June, and one cast, all of which I hived separately, so the increase in number of stocks is from one to seven in two months.

What surprised me was the fact of the dead virgins being thrown out, and yet a cast following the next day. Is not this very unusual?—C. R. J.



*Pure Heather Honey* (p. 204).—Mr. Pinkney's difficulty of designation is not quite easy to understand, nor is the need of a standard very apparent. For "pure" heather honey should surely contain no other honey in appreciable quantity, and an admixture should be described as a blend. Taking as a basis Mr. Pinkney's standard of comparative value—clover honey at 1s. and heather at 1s. 6d.—a half-and-half blend should be worth from 1s. 3d. to 1s. 4d. Such a blend is preferred by some to either pure article. Probably neither Mr. Pinkney nor myself, as heather men, entirely approve of such prejudices, but they exist, and common sense counsels the catering for them. Between the two extremes of pure honey we may then get blends in which either honey predominates, and these may be described as heather-clover or clover-heather, the first term indicating the preponderance. But who is to insist upon such classification, and how are offenders to be brought to book? Does not the problem resolve itself into one of energy on the part of the bee-keeper in order to educate the customer or the middleman, coupled with a willingness to cater for any definitely expressed preference?

*Weight of Comb* (p. 213).—There are some discrepancies in the figures quoted from the *Leipziger Bienenzeitung*. M. Weigert states that a new comb 17 by 21 c.m. and 25 m.m. thick (say 6.6in. by 8.3in. by 1, or 2750 cells) weighs 22 grammes (say  $\frac{1}{2}$  oz.) Allowing for the absence of capping, this appears about right, but he goes on to say that 10,000 worker cells weigh 65 grammes. On the same basis as the other the weight would appear to be about 80 grammes. Again, a comb of this size, presumably the smaller, completely filled with brood, is stated to weigh 125 grammes (say 4.4oz.), whilst filled with honey it weighs from 2lbs. to 3lbs. The difference is too striking to be credited offhand, so that M. Weigert must forgive us if we check results when opportunity offers.

*Hawthorn Honey* (p. 216).—In the past there have been several discussions as to whether the hawthorn yields honey or pollen. I had exceptional opportunity this year for observation, and wish to testify emphatically that bees do, at any rate in certain years, get considerable honey from this tree. All the bees observed by me were very busy obtaining nectar, and were not also collecting pollen. At this time the honey coming into the hives bore the unmistakable odour of the may-blossom, so that the fanning bees before the hives in the cool of the evening were steeped in the scent of the bloom as they hurried it to meet the grateful nostril of the bee-master. The honey itself is not so attractive in appearance, having a greenish colour, but it is much liked by certain of my acquaintance, and it is amazingly good stuff for growing bees. It quite atoned this year for the failure of the fruit bloom, due to the very unseasonable frosts which devastated my own district.

*Heather Honey for Winter* (p. 224).—As one of those who have certified the occasional ill results of wintering upon heather honey, I must this year confirm the experiences of D. Wilson (and W. E. B., p. 233). Those of my stocks which went to the moor wintered exceptionally well, and their average condition was better than the rest of the apiary. This does not in the least shake my previous statement, except so far as an admission that the honey may be all right in certain winters. Something may be due to weather or other conditions at the moor. It was a specially good heather harvest last year. It may even be that an unsatisfactory result is due to the admixture of other honey, but the fact remains, and I am not alone in experiencing loss from this cause. Similar experience may be found in old bee books. It should be borne in mind that there is

a distinct local difference in heather (*calluna*) honey itself, and difference of experience may be due to this cause.

*Controlling Brood-rearing* (p. 233).—May I suggest some modifications of Mr. Scrope Viner's recommendation, which experience leads me to believe are sound. Instead of weeding out the brood combs at the time advised, do so at the Spring examination. I do not get many poor combs, but if such exist I weed them out ruthlessly in the Spring. They are then light in honey, and the approved combs can be easily trimmed to fit one another if necessary. This "trimming" is not so advisable when the combs are heavy with new honey. Good provident bee-work is thrown away and the advantage of this uncapping is lost. In preparation for doubling I thereby make sure that the lower combs constitute a good set, and thus allow the bees to put their house in order for the year. Then instead of hunting for the queen through two storeys of a doubled stock I simply blow a little smoke in at the top to drive her down, allowing a sufficient interval for the daylight and the smoke to do their work, when the upper body may be raised, or an excluder slipped between the two bodies in the confident assurance that the queen will be downstairs.

*Shortage of Swarms* (p. 233).—W. C. B. is not alone in experiencing few swarms. It is not a swarming year. I have had two so far, and only one of the other thirty stocks has built cells, with what ulterior motive I am not prepared to say, but I doubt if they will swarm. My method of management does not encourage swarming. I give extra breeding room about fruit bloom, and reduce again about clover bloom, either by raising over excluder, or removal. But other beemen known to me, who encourage swarming, have not had their share of swarms this year, so that unless a change comes o'er the spirit of the hive, I am inclined to label 1914 as not a "swarming year."

*Capturing a High Swarm* (p. 235).—This picture reminds me of an early experience, when I light-heartedly attempted to reach a swarm with a skep nailed to a long rod. As a matter of fact the rod was three clothes props fastened together. Oh! yes, the skep just reached the swarm, though it swayed about dangerously. After some extraordinary fishing in mid-air, the swarm was "cupped," and the skep jerked upwards. Then things happened. One of the "props" was not so straight grained as it might have been, and down came the lot. However, the skep, plus what was left of the pole, was placed over one of the lots on the ground, and the best was

hoped for, the while other skeps were requisitioned. But it must have been the wrong lot, for shortly they were all back upon the almost inaccessible bough. No, not all, some were wasted. They would waste themselves upon me, regardless of the fact that I was doing the best I could for them. A misunderstanding, no doubt, in ignorance of the maxim that swarming bees never sting. When they were finally hived, I vowed, with uplifted swollen hands, never again! Fortunately my vow has not since been put to the test.

---

## Bee Shows to Come.

---

*A nominal charge of 2s. 6d. is made for notices (not exceeding 7 lines) in this column, 10 lines charged 3s. 6d., up to 15 lines 5s., which covers cost of insertion from order till date of show. Cash should accompany orders for insertion.*

---

**July 14th to 17th, at Hawick.**—Scottish Bee-keepers' Association. Exhibition of honey, wax, and appliances, in connection with the Highland and Agricultural Society's Show. Open to all British bee-keepers. Liberal prize-money. Write for schedules to A. Aikman Blair and John L. Gibson, joint secretaries, 176, Bruntisfield-place, Edinburgh. **Entries closed.**

**July 16th and 17th, at Boston.**—Lincolnshire Bee-keepers' Association. Exhibition of Honey, Hives and Appliances. Open and county classes. Over £50 in prizes. Schedules and entry forms from Capt. J. H. Hadfield, Alford, Lincs. **Entries closed.**

**July 22nd to July 24th, at Bradford.**—Great Yorkshire Show. Classes for hives, honey, &c. Good prizes. For schedules and forms of entry (stating department), apply, The Secretary, Great Yorkshire Show, Blake-street, York. Telegrams, "Yas, York." **Entries closed.**

**July 22nd and 23rd, at Cardiff.**—The Glamorgan B.K.A., in connection with the Cardiff and County Horticultural Society's Show, in the Sophia Gardens, Cardiff. Open classes include:—Collection, Gift, Sections, Beeswax, &c. Schedules from W. J. Wiltshire, Mandy School, Cardiff. **Entries close July 18th.**

**July 23rd, at Southwell.**—The Notts. Annual County Show, in connection with the Southwell Horticultural Society. Open class for single jar extracted honey. Schedules now ready from G. Hayes, Mona-street, Beeston, Notts.

**July 23rd, at Bath.**—The Annual Show of the Somerset Bee-keepers' Association, in connection with the Larkhall Horticultural Society. Seven Open Classes. Schedules from J. W. Brewer, Glen Lynn, St. Saviour's Road, Bath. **Entries close July 18th.**

**August 4th, 1914, at Bridgnorth.**—Annual Show of the Bridgnorth and District Bee-keepers' Association. Held in connection with Hampton Load Horticultural Society. Open gift class single 1lb. jar extracted honey. Prizes, 7s. 6d., 5s., 2s. Schedules from J. S. Lawton, Oldbury Wells, Bridgnorth. **Entries close July 25th.**

**August 5th and 6th, at Abington Park, Northampton.**—Northants B.K.A. Annual Honey Show. In connection with the Municipal Show. Special prizes for open classes, including one for single 1lb. jar. Entry free. Schedules from R. Heford, Kingsthorpe, Northants. **Entries close July 25th.**



**August 6th, at Madresfield, Malvern.**—In conjunction with the Agricultural and Horticultural Show. The Annual Show of the Worcestershire B.K.A. 5 open classes. Entry, 6d. each. Increased prizes. Schedules from George Richings, 2, Shubbery-terrace, Worcester. Entries close August 1st.

**Aug. 6th, at Bromham Park, Bedford.**—Honey show in connection with Biddenham and Bromham Flower Show, to be held in Bromham Park, near Bedford. Open classes for honey. Schedules from A. Henman, Bedford-road, Biddenham. Entries close July 30th.

**August 12th, at Wye, near Ashford, Kent.**—Kent Honey Show, 13th Annual Exhibition. Classes to suit all bee-keepers. Splendid prizes. One 6 guinea and two 5 guinea Challenge Cups; also two champion silver cups. A class for honey put up in short bottles, and a new class this year for best six photographs of bee life (taken by exhibitor); 2 silver medals for best exhibits of bee appliances. 26 different classes. Prize schedule and entry form free on application to Mr. Alired Lepper, secretary, Kent Honey Show, Scottou-street, Wye, Kent. Prize schedule and entry form will be sent to all exhibitors of last year without application.

**August 18th and 19th, at Brighton.**—The Fourth Annual Show of the Sussex Bee-keepers' Association, in connection with the summer show of the Brighton, Hove, and Sussex Horticultural Society. Seven Open Classes. Liberal Prizes. Schedules from C. A. Overton, Beecroft, Crawley. Entries close August 10th.

**August 19th, at Radstock.**—Honey show, in connection with the Radstock and District Horticultural and Fanciers' Association. Schedules from B. M. Clark, Fox Hills, Radstock.

**August 25th, 26th, and 27th, at Newcastle.**—Northumberland Bee-keepers' Association. Exhibition of honey and wax, in connection with the Newcastle Flower Show. Nine open classes. Schedules and entry forms from R. H. Newton, 24, Grainger-street West, Newcastle, or Captain F. Sitwell Wooler. Entries close August 20th.

**August 26th, at Prestbury.**—Honey show, in connection with the Prestbury Flower Show. One class open to the kingdom. Several for those within 12 miles radius. Exceptional prize list. Schedules from A. H. Bowen, Coronation-road, Cheltenham.

**August 26th, at Chester.**—Annual Show of the Cheshire Bee-keepers' Association, in connection with Cheshire Agricultural Society. Several open classes. Good prizes. Schedules from T. A. Beckett, St. Werburgh Chams., Chester.

**August 26th and 27th, at Rugby.**—Exhibition of the Warwickshire Bee-keepers' Association, in connection with the Warwickshire Agricultural Society's Show. Open and county classes. For schedules apply, J. R. Ingerthorp, Knowle, Warwickshire. Entries close August 17th.

**September 1st, at Deddington.**—Honey show in connection with Deddington Horticultural Society's Show, to be held in the Castle Grounds. Open classes for honey. Schedules from H. J. Harmsworth, Deddington, Oxon.

**September 2nd, at Lancaster.**—Agricultural Show. Premier Honey Show of the North. 15 classes; £20 in cash prizes, silver cups and medals value 13 guineas, and other specials. Send for schedule (Honey) to Robert Gardner, solicitor, 69, Church-street, Lancaster. Entries close August 19th.

**Sept. 5th, at the Club Room, North-road, Kew.**—Honey Show of the Richmond and District Bee-keepers' Association. Open classes for honey and wax. For schedules, apply Hon. Sec., Mr. J. G. Romer, 234, Kew-road, Kew-gardens. Entries close August 23th.

**September 9th, at Stoke Park, Guildford.**—Annual Exhibition of honey, wax, appliances, &c., will be held by the Surrey B.K.A. in connection with the Guildford and West Surrey Agricultural Association. Eighteen classes, five open to all. Many medals. Schedules from F. B. White, hon. secretary, Marden House, Redhill, Surrey. Entries close 31st August.

## Notices to Correspondents

H. HARTLEY (Huddersfield) and G. H. (Nantwich).—*Honey Samples.*—There is a little honey-dew in honey, hence green colour.

ANXIOUS ONE (Devon).—*Symptoms of Disease.*—(1 and 5) You might try the quinine, follow the instructions given on the bottle. (2 and 4) We cannot be certain it is the disease. If possible, send a few bees in a tin box. (3) No, they usually crawl about until they die.

PUZZLED (Sussex).—*Transferring Bees.*—(1) When there is brood in new combs make certain that the queen is on them, and then place a sheet of queen excluder zinc on the top. You should be able to release the top box by a screwing motion, replace it over the zinc, and in twenty-two or twenty-three days all the young bees will have left the cells, when it may be taken away. (2) Quite possibly. (3) No, only one. (4) Send a piece of comb with some of the cells, and we will try and help you. Pack in a tin box.

RODDAM (Alnwick).—*Double Swarm.*—(1) Not for two or more swarms to unite. (2) Yes, quite right. (3) Exactly as you would treat any other strong stock. Sorry we have not room for your letter.

J. D. (Swanwick).—*Coal Oil.*—It is creosote.

W. S. A.—*Swarm Suffocated.*—Under the conditions named, the bees would not live half-an-hour, as they would be unable to breathe. You should have placed the skep in the trap mouth upwards, then all would have been well.

BEE HIVE (Cardigan).—*Varieties of Bees.*—(1) Pure Italians. (2) No difference, except in colour, for the latter the yellowest are chosen to breed from. (3) A couple of days in the post. (4) No.

FREDA (Oundle).—*Trouble with Wasps.*—(1) If the hive is inside a room could you not fix a small porch and slides outside over the entrance? (2) The zinc, as suggested, should answer the purpose. It would be best to leave it until the honey-flow is over, or you notice the wasps are becoming troublesome. The width of entrance depends on strength of colony. If strong they would be able to defend from 2 to 3 inches. (3) Yes, if bees are still storing honey, and

need more room. (4) The honey should be extracted. If you have no extractor available, you may break the comb up and strain the honey from it. (5) We could not say without seeing it. Could you not have fixed the skep in some way, so that its lower edge touched the top of the swarm? (6) Insect was crushed in the post, but appears to be one of the wild bees—*Andrena*.

H. T. (Eccles).—*Ventilating Hive*.—(1) Yes. (2) It would be better to cover the feeding hole only, or cut a hole about 4 inches square, and place zinc over. You might also lift the front of the hive by means of small wedges. (3) Yes.

GARDNER (Hertford).—*Dead Drones*.—Yes, it has met a queen. (b) No.

A BEGINNER (Colerne).—(1) The symptoms are those of "Isle of Wight" disease. (2) They may occasionally. (3, 4, 5, and 6) It is not possible to say.

#### *Suspected Disease.*

G. C. (Ayr), L. W. (St. Germans), and R. E. (Llandudno).—Yes, it is "Isle of Wight" disease.

ANXIOUS (Stonchouse).—"Isle of Wight" disease.

F. A. K. (Shanklin).—Bees were covered with disgorged honey, but are healthy so far as we can see. It would be safer to keep them away from the others for a time.

Fivo (Bradford).—Bees have "Isle of Wight" disease.

S. H. B. (Chester) and A. H. W. (Tavistock).—Symptoms are of "Isle of Wight" disease.

W. J. (Falkirk).—Bees too dry for diagnosis, and you give no particulars as to symptoms.

### Special Prepaid Advertisements.

**Two Words One Penny, minimum Sixpen e.**  
Orders for three or more consecutive insertions entitle advertisers to one insertion in "The Beekeepers' Record" free of charge.

Trade advertisements of bees, honey, queens, and bee goods are not admissible at above rate, but will be inserted at 1d. per word as "B.B.S.-BEE" Announcements, immediately under the Private Advertisements. Advertisements of hive-manufacturers can only be inserted at a minimum charge of 3s. per  $\frac{1}{2}$  in., or 5s. per inch.

### PRIVATE ADVERTISEMENTS.

**T**ROPHY stand, including canopy, bottles, cases four sheets plate glass, &c., £2 10s.; photo, 2d.; new four-frame nuclei hives, roofs, canvas covered 4s. each.—ANDREWS, Rock-road, Peterborough. v 59

**Y**OUNG MAN requires situation as bee-keeper's assistant with experience, age 20.—Apply, ALBERT SYMONDS The Lodge, Lessness Park Abbey Wood, London, S.E. v 53

**F**OR SALE, pure English honey, light colour 60s. per cwt.; sample, 3d.—LAW, Cuckoo, Ashwell, Baldock Herts. v 31

**W**ANTED cheap, microscope slides of bees, private student subjects, price. Approval.—F. NEWSHAM, Milnthorpe. v 29

**W**ANTED, youth or young man, mechanical aptitude, learn drive White steam car and manage bees, gardening, pony; previous experience advantageous, but not necessary; five in.—GORDON, Lonscafe, ThreKeld, Penrith. v 28

**1914** SELECT English queens, 3s. 6d.; no disease district.—LOWE, Park-road, Chilwell, Notts. v 27

**T**HREE good stocks, with 1914 queens, healthy, packed free, 24s. each; take honey in exchange.—J. BOWDEN, Broomhill, Witley, Surrey. v 26

**S**IMMINS'S White Star Italians, strain practically immune from "I.O.W.," four-frame nuclei, 1914 queens, bred direct from Simmings' queens, 20s.; hive, 2s. 6d., returnable.—REV. ANDERSON, Glem Hall, Leicester. v 25

**W**ANTED, bees, or hives, in exchange for three pairs canaries, pair bullfinches, and two cock linnets.—PEGGRUM, Market-hill, Sudbury, Suffolk. v 22

**G**OOD swarm, on nine frames, for sale, 18s.; send box, no disease.—ANTHONY, 2, Longfield-terrace, York. v 24

**F**OR SALE, six healthy nucleus lots, four and five frames, 15s. and 17s. 6d. each.—Elmhurst, Bourdon-road, Anerley. v 23

**T**HREE, four, and five frame nuclei, 15s., 17s. 6d., 20s., all this year tested Queens. May swarm on 8 frames, plenty of brood, 25s., cash with order, f.o.r. Boxes to be returned carriage paid. Inspection invited, by appointment.—J., 9, Sunnyside-rd, Ilford. v 21

**S**TRONG, healthy nuclei, with 1914 laying queens, with four frames brood, 15s.; six frames, 20s. each; ten frame stocks, ready for supering, 30s.; guaranteed healthy, no disease of any kind in the district.—A. SHARP, Halstead Farm, Barrowford, Lancashire. v 14

**H**EALTHY stocks for sale, 35s., 40s. each; three-frame nuclei, 15s.—MORGAN, 93, The Avenue, Ealing. v 11

**W**ANTED, sections; state lowest price and quantity.—CHURCH FARM DAIRY, Sheringham, Norfolk. v 85

**F**OR SALE, Rymer heather honey press and drawer, no stand, unused, 40s., or offers.—"BUMBLE" "B.B.J." Office, 23, Bedford-street, Strand, W.C.

**W**ANTED, a complete comb of both a bad and mild case of Foul Brood.—HERROD, "B.B.J." Office.

**A** FEW good section racks, complete, with dividers, follower, and wedge, 1s. 6d. each; lace paper, neat pattern, 6d. 100, post free; lace bands, 2 $\frac{1}{2}$  in. and 3 in., 100 1s. 2d., post free, finest quality.—W. WOODLEY, Beedon, Newbury.

**S**ELL, Thould and Hutchinson portable cesspool pump, with all fittings, used once only, cost £3 10s.; offers.—"PUMP," "B.B.J." Office, 23, Bedford-street Strand, London, W.C.

**W**ANTED, the following: Cloth editions "British Bee-keepers' Guide Book," 1st, 3rd, 4th, 5th, 7th.—HERROD, "B.B.J." Office, 23, Bedford-street, Strand, W.C.

**D**IRECT from F. W. Sladen's original extra golden bee stocks.—British golden virgin queens, 2s. 6d. each, three for 6s. 9d.; apiary free from "I.O.W."—CHESTON CREWES' Apiary, Warringham, Surrey. v 20



### BEES ON THE BIOSCOPE.

During last week Mr. J. C. Bee-Mason was showing at the London Opera House two new films, "The Natural Enemies of Bees" and "The Bee Master." The former is very good, showing the enemies, including the toad, hedgehog, tits and chaffinch busily engaged devouring bees. The toad at times was literally covered with bees, and one expected to see him roll over in agony. He, however, appeared not to take any notice of the angry defenders of the hive, beyond calmly snapping them up one after another with the satisfied, good-humoured expression of an epicure at a feast. When taken away and examined seventeen stings only were found in his skin, and though removed to a distance he was at the hive again next day. The hedgehog was allowed to rest on the alighting board and munch bees with very little molestation. Mr. Mason said he had been trying for three years before he secured a film of the Blue Tits eating bees. Their alert, jerky movements were life-like, and one could be seen to hold a bee under its claw while it extracted the sting. A spider was shown winding a bee in a gossamer shroud. The last part of the film showed the damage caused by mice. The final picture being "Three Blind Mice"—three tiny baby mice in a nest formed inside a hive, within a few inches of the cluster of bees. The first part of the "Bee Master" film consisting of driving bees was good, but we cannot recommend Mr. Mason's method of weighing and hiving a swarm.

of the country I have toured I have always received a hearty welcome, and much help in the work from members and local secretaries of the various Associations. Some of the latter do yeoman service for their Associations in the districts they serve—service which is done purely for the love of the craft, without any fee or reward, and quite out of the limelight, no one probably being aware of the amount of work they do, except, perhaps, the visiting expert. On one occasion a local secretary was piloting me round his district: one member, however, would have nothing to do with us. When asked if he would like his stocks examined he replied, "Naw, naw; you knows no more about 'em than I does. You only pulls 'em about and tells me nowt." If the outside appearance of his hives was any guide as to what would have been found in the interior I should say they were managed on the severely "let alone" principle. When touring in Devon some years ago, the secretary described the work the experts (I think there were six) had to do as "missionary work." The Association received a grant from the County Council, part of which was to be expended on expert work, the experts to visit every bee-keeper as far as possible, whether a member of the Association or not. The county was mapped out into districts, six or eight being worked each year. Two or three years were taken to cover the whole county. So far as I can recollect during a three weeks' tour in one district I only visited three members. On the moors and other outlying districts the bee-keepers were years behind the times, nearly all being skeppists. One bee-keeper had his bees in all kinds of receptacles, boxes, buckets, and one lot were in a small hamper, covered over with a sack. Each swarm was hived wherever it happened to cluster, and there left. It was quite a business hunting around the garden among the berry bushes to find and count the hives. The owner did not know how many stocks he had until we had counted, and was not quite certain then. My notes say his bees had foul brood and were a nuisance to his neighbours. One hive had been used by mice as a storehouse for a quantity of broad beans; the bees of course, were dead. Another gentleman had one of the most delightful situations for a residence I have ever seen. On the south it was open to the sea, the back and sides being closed in by high ground, which kept out the north and east winds. The trees and vegetation were in a most flourishing condition. I found him at work in one of his fields with his man, "John," and on presenting my credentials and asking if I could be of any service to him he said he would be very pleased if I would look at his two stocks, but, he re-

### EXTRACTS FROM AN EXPERT'S DIARY.

*By J. Herrod.*

Some time ago I promised to give your readers a few of my experiences when "on tour" as a "bee expert" for various County Bee-keepers' Associations, work which I have done every year for about fifteen years. As may be imagined, an expert in the course of his work must meet with a variety of experiences, curious, amusing, and sometimes unpleasant. I have been fortunate in not having many of the latter. I am not going to attempt any classification, and, for obvious reasons, shall not always give times or places. In the first place, let me say that in the various parts

marked, "I'll warn you; they are perfect little demons." I am never alarmed by that kind of statement as I usually find the methods of the owner are more to blame for any ill-temper on the part of the bees than are the bees themselves. I got my smoker and proceeded to charge it, when he inquired what that thing was for. I explained its use, and inquired if he used a carbolic cloth. The reply was, "No, what is it?" I was somewhat surprised, and asked what he did use to subdue his bees. He said, "Nothing." There, of course, was the explanation of the bad temper of the bees. The first hive-roof I lifted off disclosed the bees without any covering other than a queen-excluder. They had been in that condition all winter. Nevertheless, the combs were crowded with bees from end to end. The

other lot were not quite so strong, but had been covered with one thickness of calico only. A few questions, and the reason for the scanty covering was explained. "John" had taken off the section rack the previous autumn without either subjugator or veil. The roof was removed, he then wrenched the section rack off and ran with it, his master remarked, "My word, he *did* get stung." They dare not go near the hives again until night, when "John" sneaked up very quietly and slipped the roof on, and from that time the hives had not been touched till my visit. I overhauled both stocks and fixed things up generally, much to their surprise, without receiving a single sting.

(To be continued.)



#### THE HIVING AND TREATMENT OF NATURAL SWARMS AND CASTS.

(Continued from page 265.)

The best time to hive a swarm is about six or seven o'clock in the evening. If attempted too early, especially when the sun is shining fiercely, heat and excitement will sometimes cause the bees to rise and abscond. If attempted too late, they do not run freely, but hang about, and if they alight upon the operator they creep in amongst the clothes in search of warmth, instead of flying off as they will do earlier. The consequent application of pressure by the clothes is not conducive to the comfort of the bee-keeper, especially if it happens quite unexpectedly some hours later, which is more often the case than not. If the swarm has been hived in the ordinary way it can be placed at once on a floor board (Fig. 35), in the position it is to occupy permanently. At the time stated it is moved on one side, the frame hive having its full complement of frames fitted with full sheets of wired foundation and quilts on the top is put in its place. If it is a double walled hive the outer case should be left off, or the bees will get between it and the brood chamber instead of going straight into the latter. The entrance to the hive should be propped up about an inch by means of the entrance slides placed in a V shape, with the apex inside to form a guide for the bees, and a board sloping from the alighting board to the ground, over which a cloth is thrown to make a plain even surface for the bees to travel up (Fig. 36). If it is a single walled hive the same procedure is followed, but, of course, the whole of the brood chamber is raised and the roof turned corner-wise to give ventilation. Take the skep and invert it, dislodge the bees by rapping sharply on the sides (Fig. 37) or for travelled bees remove the covering from the skep or the lid from the box; do not break the latter in your excitement, but search for the screws and take them out instead of prizing off the bottom with a screw-driver, which I have seen done repeatedly. The screws are sometimes at the side instead of the top. Rap the skep or bump the box, mouth upwards, on the ground to make all the bees lose their hold, then shoot them down on the cloth (Fig. 38). They will almost at once exercise their natural propensity for creeping uphill and march into the hive. If they show a disinclination

to move take a few bees in the hand and put them close to the entrance (Fig. 39); a spoon or post card can be used for the same purpose. The bees, finding a home, set up a contented hum, expose the scent organ, and commence to run in; the note and scent emitted attracts the other bees, and they will all commence to follow the lead



37

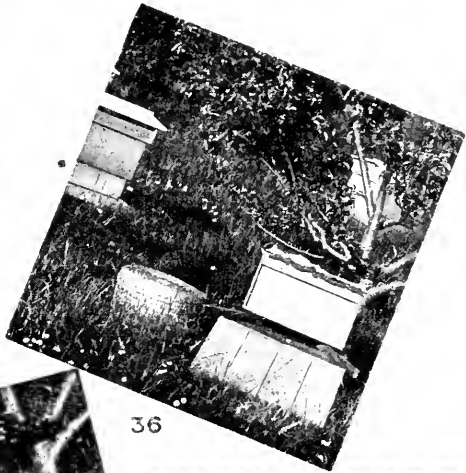

36



39



35



40



38

(Fig. 40). Watch for the queen and see her safely indoors. At night lower the front of the hive to its normal position, and put the outer case and roof on properly. Food should be given for at least a week, unless the weather is exceptionally fine and forage abundant, in which case one bottle of food will suffice. If it is possible to

obtain a comb of brood to place in the hive it will reduce the possibility of the swarm absconding to a minimum, as bees rarely forsake brood.

#### TREATMENT OF SWARMS.

The novice generally commences bee-keeping with a swarm which he purchases.

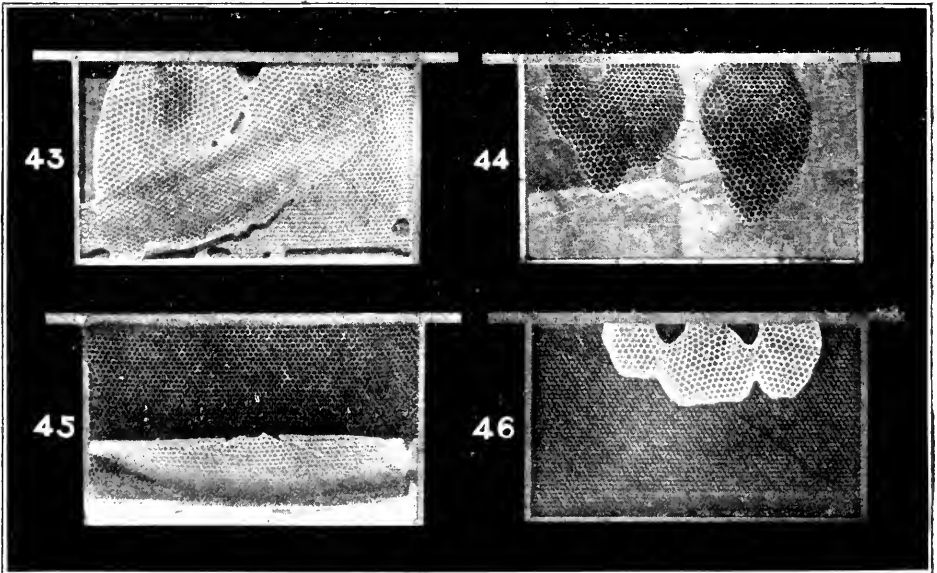

FIG. 41.



FIG. 42.

but very often we find that through accidentally obtaining a stray swarm people who had no idea of keeping bees have been initiated into the craft. A prominent case is that of A. I. Root, of America; from a vagrant swarm which he found, has grown one of the largest apiaries and manufacturing plants in that country.



Just as the first few years of life are to the human being the most vital for the health and strength in after years, so it is with bees. Treatment of the swarm for the first few weeks will either mar or make the stock. Instinct teaches wild creatures their work right from the moment they are born, but in the case of man

he has to rely upon his intelligence and the knowledge obtained by those who have lived before him in dealing with dumb creatures. The above is the orthodox method of hiving a swarm, and this should always be followed when possible. There are occasions when this cannot be done; for instance, if, after travelling a long distance, the swarm arrives on a damp or cold day, it would be foolish to try to run the bees in at the front; they would hang together in clusters, and refuse to move. Under such circumstances, take them into a warm room and feed as described previously. They can then be shaken in from the top; this should not be attempted with all the frames in position, as (Fig. 41), or the bees will run over the sides. To do it in this manner is like trying to keep the lid on a pot of water boiling over. When ready for hiving, remove five of the frames and space the remaining ones as far apart as possible; have ready a sheet larger than the top of the hive, "dump" the bees straight in (Fig. 42), cover quickly with the cloth and put on the roof. The next day the remaining frames can be put in and the feeder given. It is a mistake to hive a swarm on to the full number of frames, and pay no further attention to them for several weeks. Although every precaution in the way of wiring, etc., is taken, if a large swarm is hived upon full sheets of foundation some of them may fall on account of the hot weather, making the crowded interior of the hive above the normal temperature, thus softening the wax. This, together with the extra weight of the bees, causes it to fall as seen at (Figs. 43 and 44). In the former it has fallen from the top, and overwrapped at the bottom, the empty space has been filled with drone comb, while in the latter it has fallen right out and the bees have built drone-comb.

Even when interspaced with built-out combs the foundation is liable to fall, as illustrated at (Fig. 45). If the swarm is not capable of occupying all the frames and cold weather follows, it is possible they may build comb on to the side of the frame at the outside edge of the cluster (Fig. 46), instead of working out the foundation properly. This is caused by the cluster not expanding for work as it would do in warm weather. Therefore to put right these or any other faults, an examination should be made the second or third day after hiving; the bees should be confined to the number of frames they can cover thickly; when the combs are fully built out in these, add the other frames one at a time. In this way, perfectly straight combs will be obtained. If spare combs are on hand it is well to utilise these, and interspace them with full sheets of foundation, so providing the queen with cells to lay in straight away. If a swarm is hived on to all drawn-out combs, then a super should be put on at the same time; this will give them comb-building work to do, which they are well prepared for, as in a natural state they make their home in a combless and foodless hollow. Frequently, when drawn-out comb is given surplus is obtained.

*(To be Continued.)*



*The Editors do not hold themselves responsible for the opinions expressed by correspondents. No notice will be taken of anonymous communications, and correspondents are requested to write on one side of the paper only and give their real names and addresses, not necessarily for publication, but as a guarantee of good faith. Illustrations should be drawn on separate pieces of paper. We do not undertake to return rejected communications.*

#### AN OBLIGING QUEEN.

[9051] On Friday evening, June 26th, I was called for to deal with a large swarm

which had settled on the stump of a laburnum tree on the station embankment near here. It was eight o'clock, and someone else had already been trying to hive them, but without success. When I arrived, I found that the proposition was really very simple. If the skep were placed over the stump it was only a matter of time for the swarm to ascend into it. In such a public place it was not long before I had a crowd of spectators. One lady with her little boy scaled the embankment to have a better view, and for her safety I lent her a veil. The conversation ran something like this:—

"Is there a queen in the swarm? I should like to see one."

"Yes," I replied, "and if I see her I will show her to you."

A few minutes later the lady exclaimed, "Oh! there's a bee on my veil." I asked her to keep quiet and I would remove it. It was now nearly dusk, and with scarcely another glance, I took hold of this bee and tossed it into the air. Just as it left my fingers I recognised that it was the queen I had so served. I called to a friend who was by to keep an eye on the bee, and we saw it alight on the little boy's head. From there it was removed (carefully this time) and returned to the swarm, half of which was now in the skep.

This incident, Mr. Editor, would be discounted as impossible if it were included in an article of fiction, but it is the bare truth. I told the lady she must think herself highly honoured, that after expressing a desire to see the queen she should have been visited by the very bee she wished to see.

It was dark before the bees were quite in the skep, so I had to leave them, but fetched them next morning at four o'clock. They weighed 5½lbs. and are now in my apiary and working well. I found afterwards that they probably belonged to a local doctor, and came to terms with him, which were mutually satisfactory.—D. WILSON.

#### CURING "ISLE OF WIGHT" DISEASE.

[9052] I must first apologise for reading your paper so many years without ever attempting to write and thank you for its valuable information, or giving you any of my varied experiences, but I will try to do something in the future. Like so many others, I lost all my bees through foul brood in 1907, but restarted in 1909, only to lose all from "Isle of Wight" disease in 1912. This was a great blow to me, for bee-keeping is one of my chief hobbies. I at once bought some driven bees and started experiments to check this dread disease called "Isle of Wight," and I am glad to say, without burning a single frame I managed to succeed; that must sound strange, but it is, nevertheless, true, and I think this disease could be stamped out of any county in one week without destroying a bee or comb if all bee-keepers would pull together. But I do not wish to talk about this, but will say if any of your readers care to leave a stock with me for a week, no matter how bad it is infected, if there is any brood in comb and bees to cover it they can have the whole back in seven days perfectly healthy.

Now, one hive in which bees had died of "Isle of Wight" disease was taken possession of by a small cast on August 19th, 1913. They were a stray lot of hybrids with a good queen, about one dozen drones, and three pints of bees only. As they had voluntarily taken possession of hive and combs treated with my solution, I

gave them a chance by feeding up till they were a happy family with walls of plenty for coming winter. This I am glad to report, for in May this year I had one swarm and two casts from this one hive, which were hived on combs on which bees had died from "Isle of Wight" disease. Now, what has happened is this: The first swarm has twenty-one sections, second swarm ten sections, third swarm fifteen sections, all completed. I might say these also could be seen by any of your readers if they so desired, especially as this is a neighbourhood where we should be pleased to report an average of 30lbs. surplus. I will give some account of thirty to forty years' experiences when I write again if you care to receive it.—SATISFIED AT LAST.

[At present there is no known cure for "Isle of Wight" disease. Any person who can find one will be a benefactor, not only to bee-keepers but to the general public. If any of our readers have bees suffering from the disease perhaps they may be pleased to take advantage of the above offer, and report results. Needless to say, we cannot accept a cure as permanent until some time has elapsed without a recurrence of the disease.—Eds.]

#### WEATHER REPORT.

WESTBOURNE, SUSSEX,  
June, 1914.

Rainfall, 1.88in.	Minimum on grass, 32 on 4th and 8th.
Below average, .28in.	Frosty nights, 0.
Heaviest fall, 1.31in. on 14th.	Mean maximum, 67.2.
Rain fell on 6 days.	Mean minimum, 50.0.
Sunshine 275.7 hrs.	Mean temperature, 58.6.
Above aver., 41.7 hrs.	Above average 1.4.
Brightest day, 15th, 14.2 hrs.	Maximum barometer, 30.398 on 28th.
Sunless days, 0.	Minimum barometer, 29.575 on 9th.
Maximum temperature, 78 on 30th.	
Minimum temperature 39 on 4th.	

I. B. BIRKETT.

#### HONEY IMPORTS.

The value of honey imported into the United Kingdom during the month of June, 1914, was £4,902.—From a return furnished to the BRITISH BEE JOURNAL by the Statistical Office, H.M. Customs.



[8959] *Crooked Combs*.—I have six hives of bees, each hive has six or seven old and



crooked combs of brood and stores. Most of them are made up from pieces of old brood comb. Shall I do right in putting *under* each old brood chamber another brood-box with four or six new frames fitted with foundation?

REPLY.—Renew them next spring, taking out the old combs as early as possible. First bruise the capping of any honey there may be in, and allow time for the bees to clear it out. Take out all the combs not occupied by the bees, and as they need more room, insert new frames fitted with full sheets of foundation.

[8960] *Dividing Stock*.—One of my stocks gave off a swarm on May 14th last, which weighed about 7lbs. These were hived and about a fortnight later were given a rack of shallow frames with full sheets of foundation. On the 28th ult., this swarm gave off another one, which I did not weigh, but the bees half filled a skep. I returned the swarm after cutting out queen-cells, and gave another rack of shallow frames. Whilst I am writing I will take the opportunity of asking you if you would be so kind as to tell me up to what date one could divide one stock into two?—J. F. ROBERTS.

REPLY.—As soon as the honey harvest is over, but you should have a mated queen ready for the queenless half. If you have not reared a queen, purchase one.

[8961] *Dutch Bees*.—Will you kindly give me some information concerning the Dutch bee? I am in total ignorance, along with many other bee-keepers, of its merits or failings. The qualities I want to know are:—(1) Its honey-gathering propensities. (2) Its swarming propensities. (3) Its wintering propensities. (4) Its disease-resisting propensities, especially regarding "Isle of Wight" disease. (5) Its appearance. (6) Its disposition. (7) Its rate of increase, compared with Blacks and Italians. (8) Will you also tell me the difference between Leather-coloured Italians and Long-tongued Golden Italians? (9) Which is the better strain for resisting "Isle of Wight" disease and for honey gathering? The above questions are prompted by the appearance of the "Isle of Wight" disease in my apiary, and I am re-queening some of my stocks with Italians and some with Dutch queens. Am I taking the right steps to root it out?—CHAS. E. HARDWICK, Sutton Coldfield.

REPLY.—(1) Fair. (2) Very great. (3) Good. (4) Good. (5) Very like our own hybrid Italians. (6) Quiet. (7) Much better. (8) There is nothing to choose between them. (9) The Italians will not help you, but the Dutch may.

[8962] *Disabled Queen*.—I was with a friend the other day looking at his bees,

when our attention was attracted to a few bees a yard or two in front of one of the hives. On going to the spot we found a queen bee, apparently unable to fly. The bees referred to seemed to be agitating her to take wing. There were six or seven of them flying wildly here and there, and when they discovered her purposely knocked her over. She was vainly trying to fly the whole time. The bees appeared as if molested, they would instantly have stung one. We allowed the queen bee to run on to our hand and then threw her in the air, but she could not fly. My friend knew the hive she came from, as he expected a queen out for mating, and we put her back, and soon after the other bees disappeared. I am not a bee expert, but understand the main lines of bee-keeping, and as the incident is so unusual I am writing you on the subject. Had she been out for mating (the act disabling her from flying for a certain period), and were the bees anxious over her absence and agitating her to get back home? Will you please state if the queen bee does actually sting, if not unduly pressed, when being handled? If she does sting, is the sting left behind, and also is the sting worse than the sting of a worker?

There is one more point. I made an air-tight case, and my friend gave me a nice comb of brood, which I placed in this case, and took home a distance of one-and-a-half miles and put in my weakened stock to strengthen it. The sun was very hot, but a rather keen easterly wind was blowing at the time.—A. FRV.

REPLY.—The queen had evidently been turned out of the hive owing to some injury or malformation. The act of mating would not injure her. It is most unusual for the queen to sting, and after trying hundreds of times during the past twenty-five years to get a queen to sting, the writer was stung by one for the first time on June 15th, 1914. It is not so painful as a sting from the worker, and as the barbs on the laucets are rudimentary, the sting is easily withdrawn, so the act of stinging does not cause the queen to die. You do not finish the last part of your letter, so we cannot answer it; but perhaps you wish to intimate that you were successful in carrying the comb without chilling the brood.

[8963] *Bees in Wall*.—In an old wall of a disused cowshed, which is some 20 inches thick and about 22 feet high, we have had a swarm of bees for some years. The bees seem to have found some hollow places in the wall at the height of 14 feet from the ground. There are two main entrance holes about 4 feet apart, which seem as though there are two separate swarms, as there are such a large number of bees to

each hole. Inside the building there is no exit for the bees. Would it be possible to hive them? If so, could you let me know the best method.—G. B. B.

REPLY.—Impossible to say without seeing them. Get an expert to see what can be done.

[8964] *Various Queries*.—Would you oblige me with your advice through the JOURNAL on the following:—A swarm came off (a maiden swarm) but returned to box without clustering. As the honey-flow is on, I don't want increase, so I looked over bars and found two queen-cells. I destroyed one, and put two bars of brood, one with cell sealed over, one bar of honey and adhering bees, and a sheet of foundation into another box, replacing two frames fitted with foundation for the two combs taken away. This nuclei seems to be doing well, and also the box, but on Saturday (a very hot day), the swarm came off again, and settled near by. I again examined the bars carefully, and found neither queen nor even a cell, and in the evening returned the swarm, putting on another super, and raising box off floor-board  $\frac{3}{4}$  in. (1) What caused this box to swarm? (2) What breed of bees are they? (3) Can anyone try for an expert certificate by communication? I wish to convey to you my appreciation of the "B.B.J.," which I devour every week; in fact, everything we have had to do has been done per "Guide Book" or from hints in "B.B.J."—BUCKHOLM HILL.

REPLY.—(1) You overlooked a queen-cell somewhere. (2) Hybrid Italian. (3) Not the preliminary, as part of this consists of practical work. Apply to the Secretary, B.B.K.A. for a syllabus.

---

## Bee Shows to Come.

---

*A nominal charge of 2s. 6d. is made for notices (not exceeding 7 lines) in this column, 10 lines charged 3s. 6d., up to 15 lines 5s., which covers cost of insertion from order till date of show. Cash should accompany orders for insertion.*

---

**July 14th to 17th, at Hawick.**—Scottish Bee-keepers' Association. Exhibition of honey, wax, and appliances, in connection with the Highland and Agricultural Society's Show. Open to all British bee-keepers. Liberal prize-money. Write for schedules to A. Aikman Blair and John L. Gibson, joint secretaries, 176, Bruntsfield-place, Edinburgh.—**Entries closed.**

**July 16th and 17th, at Boston.**—Lincolnshire Bee-keepers' Association. Exhibition of Honey, Hives and Appliances. Open and county classes. Over £30 in prizes. Schedules and entry forms from Capt. J. H. Hadfield, Alford, Lincs. **Entries closed.**

**July 22nd to July 24th, at Bradford.**—Great Yorkshire Show. Classes for hives, honey, &c. Good prizes. For schedules and forms of entry (stating department), apply, The Secretary, Great Yorkshire Show, Blake-street, York. Telegrams, "Yas, York." **Entries closed.**

**July 22nd and 23rd, at Cardiff.**—The Glamorgan B.K.A., in connection with the Cardiff and County Horticultural Society's Show, in the Sophia Gardens, Cardiff. Open classes include:—Collection, Gift, Sections, Beeswax, &c. Schedules from W. J. Wiltshire, Mandy School, Cardiff. **Entries close July 18th.**

**July 23rd, at Southwell.**—The Notts. Annual County Show, in connection with the Southwell Horticultural Society. Open class for single jar extracted honey. Schedules now ready from G. Hayes, Mona-street, Beeston, Notts.

**July 23rd, at Bath.**—The Annual Show of the Somerset Bee-keepers' Association, in connection with the Larkhall Horticultural Society. Seven Open Classes. Schedules from J. W. Brewer, Glen Lynn, St. Saviour's Road, Bath. **Entries close July 18th.**

**August 4th, 1914, at Bridgnorth.**—Annual Show of the Bridgnorth and District Bee-keepers' Association. Held in connection with Hampton Load Horticultural Society. Open gift class single 1lb. jar extracted honey. Prizes, 7s. 6d., 5s., 2s. Schedules from J. S. Lawton, Oldbury Wells, Bridgnorth. **Entries close July 25th.**

**August 5th and 6th, at Abington Park, Northampton.**—Northants B.K.A. Annual Honey Show. In connection with the Municipal Show. Special prizes for open classes, including one for single 1lb. jar. Entry free. Schedules from R. Hefford, Kingsthorpe, Northants. **Entries close July 25th.**

**August 6th, at Madresfield, Malvern.**—In conjunction with the Agricultural and Horticultural Show. The Annual Show of the Worcestershire B.K.A. 5 open classes. Entry, 6d. each. Increased prizes. Schedules from George Richings, 2, Shubbery-terrace, Worcester. **Entries close August 1st.**

**Aug. 6th, at Bromham Park, Bedford.**—Honey show in connection with Biddenham and Bromham Flower Show, to be held in Bromham Park, near Bedford. Open classes for honey. Schedules from A. Henman, Bedford-road, Biddenham. **Entries close July 30th.**

**August 12th, at Wye, near Ashford, Kent.**—Kent Honey Show, 13th Annual Exhibition. Classes to suit all bee-keepers. Splendid prizes. One 6 guinea and two 5 guinea Challenge Cups; also two champion silver cups. A class for honey put up in short bottles, and a new class this year for best six photographs of bee life (taken by exhibitor); 2 silver medals for best exhibits of bee appliances. 26 different classes. Prize schedule and entry form free on application to Mr. Alfred Lepper, secretary, Kent Honey Show, Scottown-street, Wye, Kent. Prize schedule and entry form will be sent to all exhibitors of last year without application.

**August 17th and 18th, at Cannock (Staffs.).**—Honey Show, in connection with Cannock Horticultural Show. Eight open classes. Good prizes. Schedules from hon. sec., John Bird, Glenmay, Cannock.

**August 18th and 19th, at Brighton.**—The Fourth Annual Show of the Sussex Bee-keepers' Association, in connection with the summer show of the Brighton, Hove, and Sussex Horticultural Society. Seven Open Classes. Liberal Prizes. Schedules from C. A. Overton, Beecroft, Crawley. **Entries close August 10th.**

**August 19th, at Radstock.**—Honey show, in connection with the Radstock and District Horticultural and Fanciers' Association. Schedules from B. M. Clark, Fox Hills, Radstock.

**August 19th and 20th, at Derby.**—Derbyshire Bee-keepers' Association Annual Show, at Derby. Four open classes for honey. Reduced entry fees. For schedules apply, R. H. Coltman, 49, Station-street, Burton-on-Trent. **Entries close Wednesday, August 12th.**

**August 25th, 26th, and 27th, at Newcastle.**—Northumberland Bee-keepers' Association. Exhibition of honey and wax, in connection with the Newcastle Flower Show. Nine open classes. Schedules and entry forms from R. H. Newton, 24, Grainger-street West, Newcastle, or Captain F. Sitwell Wooler. **Entries close August 20th.**

**August 26th, at Prestbury.**—Honey show, in connection with the Prestbury Flower Show. One class open to the Kingdom. Several for those within 12 miles radius. Exceptional prize list. Schedules from A. H. Bowen, Coronation-road, Cheltenham.

**August 26th, at Chester.**—Annual Show of the Cheshire Bee-keepers' Association, in connection with Cheshire Agricultural Society. Several open classes. Good prizes. Schedules from T. A. Beckett, St. Werburgh Chams., Chester.

**August 26th and 27th, at Rugby.**—Exhibition of the Warwickshire Bee-keepers' Association, in connection with the Warwickshire Agricultural Society's Show. Open and county classes. For schedules apply, J. R. Ingerthorp, Knowle, Warwickshire. **Entries close August 17th.**

**September 1st, at Deddington.**—Honey show in connection with Deddington Horticultural Society's Show, to be held in the Castle Grounds. Open classes for honey. Schedules from H. J. Harmsworth, Deddington. Oxon.

**September 2nd, at Lancaster.**—Agricultural Show. Premier Honey Show of the North. 15 classes; £20 in cash prizes, silver cups and medals value 13 guineas, and other specials. Send for schedule (Honey) to Robert Gardner, solicitor, 69, Church-street, Lancaster. **Entries close August 19th.**

**Sept. 5th, at the Club Room, North-road, Kew.**—Honey Show of the Richmond and District Bee-keepers' Association. Open classes for honey and wax. For schedules, apply Hon. Sec., Mr. J. G. Romer, 234, Kew-road, Kew-gardens. **Entries close August 28th.**

**September 9th, at Stoke Park, Guildford.**—Annual Exhibition of honey, wax, appliances, &c., will be held by the Surrey B.K.A. in connection with the Guildford and West Surrey Agricultural Association. Eighteen classes, five open to all. Many medals. Schedules from F. B. White, hon. secretary, Marden House, Redhill, Surrey. **Entries close 31st August.**

MR. BEE-MASON'S BEE PICTURES.

Owing to the great interest taken in Mr. Bee-Mason's bee pictures at the London Opera House, his engagement has been extended for a further two weeks. He will therefore be showing them until the end of next week, at 3 p.m. and 8 p.m.

Notices to Correspondents

F. LLOYD (Haverfordwest).—*Variety of Bees.*—(1) British. (2) From our advertisers.

HEATHER (Blackburn).—*Various Queries.*—(1) Hybrid Italian. (2) No, they will sometimes hang several days. (3) It depends on circumstances, about the

second week in August. If season is good they may gather enough for winter stores, but are not likely to give any surplus.

J. CRAIB (Aberdeenshire).—*Bees in Ceiling.*—We cannot tell the best way to kill bees without seeing the place, and we do not supply anything for the purpose. Probably the space is so large that any fumes would be dissipated without affecting the bees. You might try blowing sulphur fumes in by means of a smoker, or soak a small piece of sponge or cotton-wool with chloroform; place in smoker barrel and blow fumes in. Cyanide of potash 1oz. in 1 pint of water would kill them if you could get the solution near to them. It is a deadly poison, and needs great care in handling.

ALPHA.—*Transferring Bees.*—It would have been better to have driven all the bees into hive.

A. S. (Sussex).—*Liability for Diseased Bees.*—It is a matter for arrangement. We do not think you are liable. If your own bees are still healthy, it is probable the swarm were infected after leaving your apiary.

CARADON (Cornwall).—*Honey Sample.*—It appears to be from hawthorn and charlock. You should get from 60s. to 70s. per cwt.

H. SCHROFFEL (Ilford).—*Extracting Honey.*—Not without breaking the combs up.

R. K. (Lanarks).—*Noise from Hive.*—It is the bees ventilating the hive to drive out the moisture given off by the ripening honey.

*Suspected Disease.*

W. H. (Hants).—British. Symptoms of "Isle of Wight" disease.

J. A. (Gosberton).—Bees appear healthy.

BAD START (Leicester), H. C. (Essex), J. H. (Manchester), A. C. T. (Anglesey).—Bees show symptoms of "Isle of Wight" disease.

C. B. (Bingley).—Bees were too dry for diagnosis. The symptoms you describe point to "Isle of Wight" disease. We do not endorse our correspondent's view in matter you mention. In our opinion they are not so hardy, too much given to swarming, nor do they give the quantity of honey in proportion to their numbers that one would expect, and they are admittedly inferior to natives for comb honey. They would be a danger to others; better keep them at home.

W. B. (Leamington Spa), F. M. G. (Hope, Wrexham), "BESSIE" (Bathpool), W. J. (Cowbridge Road), and D. P. (Rhayader).—It is "Isle of Wight" disease.

Novo (Kent).—We cannot say.

F. C. (Sheringham).—We are unable to give you any reason. Have you overdosed with disinfectants?

"MEL" (Cards).—"Isle of Wight" disease. Native with a trace of Italian.

### Special Prepaid Advertisements.

Two Words One Penny, minimum Sixpence.

Orders for three or more consecutive insertions entitle advertisers to one insertion in "The Bee-keepers' Record" free of charge.

Trade advertisements of Bees, Honey, Queens, and Bee goods are not admissible at above rate, but will be inserted at 1d. per word as "Business" Announcements, immediately under the Private Advertisements. Advertisements of Hire-manufacturers can only be inserted at a minimum charge of 3s. per  $\frac{1}{2}$  in., or 5s. per inch.

### PRIVATE ADVERTISEMENTS.

**H** EALTHY stock British bees, price, including strong frame hive, 25s.—WELLER, Stafford-road, Brighton. v 42

**1914 QUEEN**, with 3-frame nuclei, 14s.; four frames, 17s.; two strong stocks, 30s. each.—G. T. JONES, Cwmeisian Apiary, near Dolgelley. v 37

**T** YPEWRITER, Ideal, visible writing, standard keyboard, brief carriage, clear work, strong, modern machine, excellent condition, 80s., great bargain.—WAKEFIELD, Newhall Hill, Birmingham. v 49

**G** OOD standing for bees, miles of the finest heather.—Apply, ERNEST HOLMES, East Moors, Helmsley, Yorks. v 44

**N** UCLEI, six frames of brood, with 1914 laying queen, bred from 'Simmius' 1913 White Star Italian queens, f.o.r., 20s.; hives, 2s. 6d., returnable; can be seen any time by appointment.—R. HEISCH, 41, Wellington-rd, Wanstead, Essex. v 47

**E** XCHANGE, eight Silver Campine cockerels, and cash, for good stock bees.—BECK, Airton, Leeds. v 50

**W** ANTED, driven bees, free from disease, in August; state quantity and price per lb.; also secondhand hives, must be good condition, W.B.C. or Conqueror, standard frames, price.—PURSALL, 144, Hill Top, West Bromwich. v 46

**T** WO W.B.C. hives, complete, good order, 8s each; also three others, complete, 4s. 6d. each; approval; must clear.—F. OLD, Pimperne, Blandford. v 42

**T** AYLOR'S hot-air incubator, new spring, with run, complete, excellent machine, cost 34s., offers wanted; surplus swarm boxes, never used, good make and finish, 2s. each, bargain.—JONES, Cwmeisian Apiary, near Dolgelley. v 39

**F** OR SALE, five lovely pedigree Pekingese puppies, eight weeks old, splendidly bred; prices and particulars.—T. BAILEY, Oak View, Two Mile Ash, Horsham. v 39

**F** OR SALE, pure Irish honey, well filled sections.—SAMUEL SCOTT, Ballyronan, Magherafelt, Co. Derry. v 41

**5000** ARABIS PLANTS, grand early bee forage (see "Guide Book"), 30, 6d.; 100, 1s. 3d., free.—JONES, Cwmeisian Apiary, near Dolgelley.

**F** OR SALE, 12 cwt. of pure new Cambridge-shire honey, light colour, 65s. per cwt. in purchaser's receptacles, or 68s. 6d. in non-returnable tins, f.o.r.—CARTER, The Apiaries, Burwell, Cambs. v 56

**T** HREE strong stocks, W.B.C. hives, extra hives, appliances, cheap.—FRY, 38, Sydenham Park, Sydenham.

**F** IFTEEN to twenty dozen good clover sections for sale, price 10s. per dozen, carriage forward.—ROLLETT, 35, Tamworth-road, Ashby-de-la-Zouch. v 55

**P** URE Cambridgeshire honey, 28lb. tins, at 15s. per tin, cash with order; sample, 2d.—A. E. WILLETT, Cheveley, Newmarket, Cambs.

**3** -FRAME June swarm, 12s., no disease; box, 2s. 6d., returnable.—WATTS, Maridon Hill, Paignton. v 53

**H** ONEY, 140lb. excellent clover,  $3\frac{1}{2}$  lb., in 28lb. lots, the lot, £4 15s.; sample, 2d. stamp.—DR. LLOYD, Cradley Heath, Staffs. v 52

**P** URE Cambridgeshire honey, 65s. per cwt.; sample, 3d.—J. YOUNGER, 29, Newmarket-road, Cambridge. v 51

**E** XCHANGE 1913 utility pullets for bees.—WM. BECK, Bell Busk, Airton, Leeds. v 49

**5** -FRAME nuclei, young queen, in good hive, 17s., healthy district.—J. HISLOP, 24, Clifton-terrace, Whitley Bay. v 48

**A** four or five frame nuclei, 15s., 17s. 6d., this year's tested Queen. May swarm on 8 frames, plenty of brood, 25s., cash with order, f.o.r. Box to be returned carriage paid. Inspection invited, by appointment.—J., 9, Sunnyside-rd, Ilford. v 21

**W** ANTED, swarm of pure Carniolian Bees.—Haxby Vicarage, York. v 59

**Y** OUNG MAN requires situation as bee-keeper's assistant with experience, age 20.—Apply, ALBERT SYMONDS, The Lodge, Lessness Park, Abbey Wood, London, S.E. v 33

**T** HREE good stocks, with 1914 queens, healthy, packed free, 24s. each; take honey in exchange.—J. BOWDEN, Broomhill, Withey, Surrey. v 26

**F** OR SALE, Rymer heather honey press and drawer, no stand, unused, 40s., or offers.—"BUMBLE," "B.B.J." Office, 23, Bedford-street, Strand, W.C.

**W** ANTED, a complete comb of both a bad and mild case of Foul Brood.—HERROD, "B.B.J." Office.

**A** FEW good section racks, complete, with dividers, follower, and wedge, 1s. 6d. each; lace paper, neat pattern, 6d. 100, post free; lace bands, 2 $\frac{1}{2}$  in. and 3 in., 100 1s. 2d., post free, finest quality.—W. WOODLEY, Beedon, Newbury.

**S** ELL, Thould and Hutchinson portable cesspool pump, with all fittings, used once only, cost £3 10s.; offers.—"PUMP," "B.B.J." Office, 23, Bedford-street Strand, London, W.C.

**W** ANTED, the following: Cloth editions "British Bee-keepers' Guide Book," 1st, 3rd, 4th, 5th, 7th.—HERROD, "B.B.J." Office, 23, Bedford-street, Strand, W.C.



From "The Australasian Beekeeper,"  
May 15th, 1914.

DEPUTATION TO THE MINISTER  
OF AGRICULTURE.  
LEGISLATION PROMISED.

On April 20th a deputation of beekeepers sought the sympathy and assistance of the Minister for Agriculture, Mr. W. G. Ashford, in bettering the conditions of the industry. Their reception, and the promises the Minister made, sent them away well satisfied. The deputation, which was organised by the Apiarists' Association, was a representative one, and consisted of Messrs. T. G. Adamson, G. G. Phillips, Tamworth; Rev. Hessel Hall, Emu Plains; E. Abram, Beecroft; T. J. Davis and J. Irvine, Sofala; W. S. Pender and G. L. Armstrong, W. Maitland; A. Vollmer, Woodville; W. G. Humphrey, Kincumber; J. Deans, Coonabarabran; — Flemming, Blandford.

Mr. T. G. Adamson (Tamworth), President of the N.S.W. Apiarists' Association, said they were there in the interests of a small-man's industry. The bigger producers had no trouble in selling their honey, but he had seen small men "pretty well slaughtered by middlemen." This was largely owing to ignorance. As showing the possibilities of the industry, he pointed to one of the deputation as a young Australian who had started six years ago with £500 capital, and had since, without any assistance in the way of labour, produced £1,700 worth of honey. Their chief request was that the Minister would help them with legislation in the way of an Apiaries Act, on the lines of the New Zealand Act. They were living in a state of dread of foul brood and other possible bee diseases, and they desired the aid of the law to compel apiarists to suppress disease, and also to handle and market their honey under efficient sanitary conditions. They also thought honey should be graded for export, and that the Government might make advances on honey exported. In regard to the preservation of honey-bearing native timbers, they thought that more liberal provision should be made for this in regard to leaseholds and reserves, and that such provisions as existed should be made more effective, as they had instances in which these conditions were being ignored by lessees. Another matter was railway freights on honey. They asked the

Minister to use his influence with the Railway Commissioners to have the minimum quantity carried at the special rate reduced from 2 tons to 10 cwt. As the Agricultural Department subsidised agricultural shows, they desired the Minister to take some steps to ensure the appointment of competent judges. The Association, Mr. Adamson said, proposed to offer a prize of 50 guineas for the best essay on honey as a food, with a view to increasing its consumption. Honey was of better food value and cheaper than butter, and they desired the Minister to endeavour to have honey included in the dietary of Government institutions. In conclusion, Mr. Adamson said that, considering the prevalence of foul brood it was a wonder that there was a bee left alive. Unlike others, the industry had had to battle along almost without State encouragement, but they were gratified for the good work done of late by the demonstrator in apiculture and the biologist of the Department of Agriculture.

Mr. W. S. Pender (Maitland) said he knew of one man in the north who had for the past ten years averaged £350 a year from his bees by his own labour. Foul brood was very prevalent, and many apiaries had been completely wiped out by the disease. Many people who had devoted their whole time to the industry had, therefore, to give it up owing to continual infection from the diseased hives of careless or ignorant neighbours. In regard to ring-barking, he thought the same regulations should apply all over the State in respect of trees suitable for honey production. It would be an advantage if more than six trees per acre, as at present, could be left. Some of the timbered country could be more profitably used for bees than for grazing, as in those districts there was more value per acre in honey and bee products than in sheep and wool.

Mr. Hessel Hall (Emu Plains) said that very little indeed had been done by the Department of Agriculture for the industry, and the time had arrived when it should do a great deal more. Foul brood had wiped out the industry in some districts. Expert bee-keepers could deal with it in their own apiaries, but they could not overcome the danger of careless neighbours. There had been objections in the past to legislation for the supervision of apiaries. This, he believed, was the result of ignorance, and the work of the demonstrator in apiculture had largely overcome that prejudice. As it was, many men were earning a good living from their bees, and there was no industry that could better help on small settlement.

Mr. J. W. Irvine (Sofala) opposed any restrictions on the number of hives a man

could keep. Where years ago he could keep 150 hives on one stand, the same country would not maintain 30 or 40 colonies now. There should be no limit to the number of licences for stands a bee-keeper could hold.

Mr. E. E. Abram (Beecroft) objected to the remarks that had been made as to the competency of show judges. He had shown in Sydney for years, and had received satisfaction. He strongly opposed the suggestion that the Department of Agriculture should breed queens for sale, and thus come into competition with those who made their living in this way.

The Minister, in reply, said he was quite aware that this State had lagged behind in the matter of legislation to protect the bee-keeper. They had the natural conditions to make the industry equal to the position it attained in any part of the world. He would promise them he would introduce a Bill that would cover all the points of legislation they asked for, and he would do it this session if the Cabinet would allow him. (Hear, hear.) They had equal rights with any other body of producers for legislation to protect their industry. In regard to the breeding of queens, he thought the view of Mr. Abram was very narrow. The Government did not want to do anything to come seriously into competition with private breeders. The object of the Government must be to provide superior stock to those of anybody else, and by thus encouraging the industry make a bigger market for those who sold queens. The Department was alive to the wants of bee-keepers, but he was prepared to accept the advice of experienced apiarists in the proposed legislation. He would make representations to the Railway Commissioners in regard to the request for carrying half ton lots at the special rate, as he considered it a fair one. He would also do what he could to have honey more freely used in the Government institutions. In regard to Government control of export, he suggested that they should get together and arrange for a shipment of ten tons or more, subject to official inspection as to standard of quality. If this were done it was possible the Department might see its way to advance half the c.i.f. value. In regard to the preservation of timber, he could say that the Forestry Department did its best in this respect, as they realised the importance and necessity of it. But their representations would have to be passed on to the Minister for Lands, and he was sure Mr. Trefle would be in full sympathy with them. As for lands already taken up under certain ring-barking conditions, no Government could interfere with that. He suggested that when Crown lands were

being made available in any district the bee-keepers should make representations that a certain amount of timber should be left on the lands, and they would possibly have to rely on their own vigilance to see that restrictions were made and carried out. In regard to the appointment of judges, he did not see that the Department could do much in that direction.

Mr. Adamson finally thanked the Minister for having "got straight to the point and promised full satisfaction."

[The above extract will be interesting reading for English bee-keepers, in view of their hitherto vain attempts to get our own Government to do something to protect those of the craft who are anxious to keep their bees healthy and clean, but are thwarted again and again by careless or ignorant neighbours. In most of our Colonies the Government and Ministers are alive to the advantages to be derived by the colonists from bee-keeping, and are anxious to help them by giving them legislation to compel apiarists to suppress disease, and also to handle and market their honey under efficient sanitary conditions. Again, the Minister of Agriculture promised to use his influence with the Railway Commissioners to secure a more favourable rate for carrying honey. Can any of our readers imagine a British Minister promising to "do what he could to have honey more freely used in the Government institutions" in order to help the industry? The majority of English bee-keepers would be thankful for a "Bee Diseases Act" only—an Act which is sorely needed, as shown by the numbers of letters we receive in favour of it.—Eds.].

---

### "BLURTS FROM A SCRATCHY PEN."

SIGNOR PIANA'S APIARY.

My last jottings of our wanderings brought us to the station of Castel St. Pietro, and to our further journeying by road to Signor Piana's Apiary. I regret that our snapshot of his house did not come off as we could have wished, only one corner, and just a portion of the queen-rearing territory are shown in photograph No. 1. I must therefore essay to word-paint some description. Well, then, picture to yourself a house square as to the building, walls of dazzling whiteness in the brilliancy of the Italian sun, and roof red tiled. The illustration above alluded to only shows the scrub, but if you will look at No. 2 you will perceive that there is a surrounding of walnut, olive, and fruit trees, in which the deep green of their leaves forms a vivid and artistic contrast with the colour of the walls which

are in their centre. Needless, I think, to narrate (because everyone must know that it occurred) is it that hospitality was the first order of the day, and on our arrival

Photograph No. 3. Possibly the two outsiders in this are sufficiently well known not to need description. They have been before the public (that is the bee-

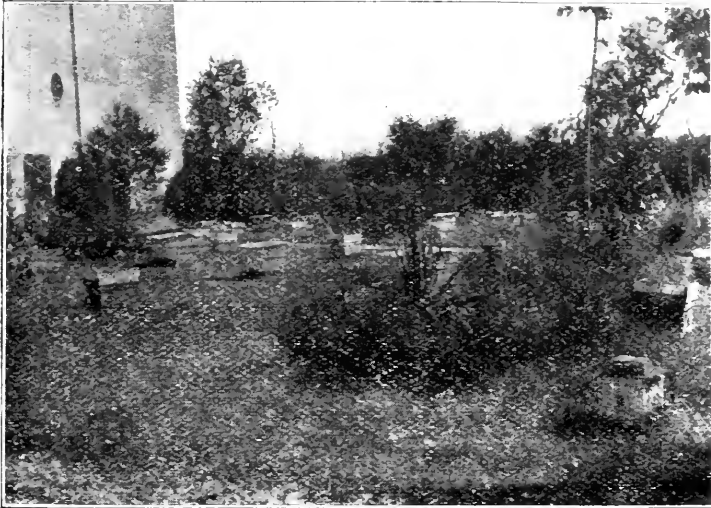

No. 1.

CORNER OF SIGNOR PIANA'S HOUSE AND PART OF QUEEN-MATING GROUND.

we found a very substantial breakfast awaiting us, and as we had been early travellers from Bologna (this is another thing which everyone will know) we were

keeping public) very often, but the gentleman standing between Mrs. and Mr. Herrod is Signor Piana, and the lady who occupies a similar position on the right,



No. 2.

WOODS SURROUNDING HOUSE.

particularly well disposed to attack it, and while minds were engaged I had an excellent opportunity of studying our host and hostess. But stay, here the camera shall again aid me.

intervening betwixt Mrs. Herrod and "Blurts," is the mother of Signor Piana. So far as this chronicler knoweth, the Signor has not entered the bondage of matrimony, and I would like to mention

that "La Signora's" courtesy and amiability added much to the pleasure of our day. But before passing from their personal descriptions let me introduce to

Two of our apiaries are on the mountains, the third, and that also for the raising of queens, we have on the hills near us. But during the summer we transport our

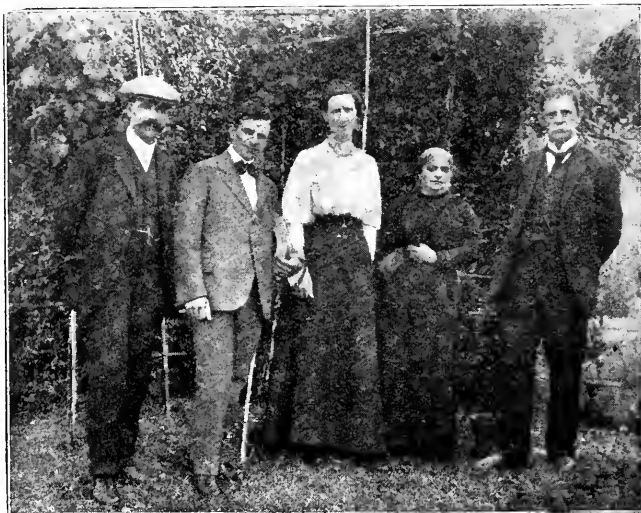

No. 3.

GROUP TAKEN IN SIGNOR PIANA'S GARDEN.

you Signor Piana "ipse solus"—all alone by himself in No. 4. A typical Italian, his features portray the commercial class who have always been the mainstay of Italy, and who, as our Lombard Street records, spread even to our own shores in times long past, and taught us how to trade. Signor Piana (as his portrait shows) is still young, but he is a keen and shrewd observant of Nature, and well studied. In taking up queen-rearing as a profession he has brought to it a most complete and scientific knowledge of all that is connected with bee life, and if possible some day he will record his experiences, we should learn much from him.

And now for a few words about the apiaries. In the Signor's own words, "We have at the present 200 hives only for the production of honey, but for the raising of queens we have over 300 nuclei.

colonies to the plain for the fertilization of the lucerne."

Look at photograph No. 5. Does it not fill one with envy to see such a long line of hives, dying out in the perspective? I know it did me when I saw them. But then, what is the use of being envious? If we could only manufacture our weather to our own liking, as I suggested in my last, we might do something like this. Our queens have only about four months to do their work in. They have not got the time. But Signor Piana tells me that January is the only month in which their queens do not lay. We are hopelessly handicapped.



No. 4.

SIGNOR PIANA.

And No. 6. The transporting of hives to the plains in the summer. Curious is the difference. We transfer our colonies to the mountains to catch the flow of the heather honey. On their side they bring them down from the mountains also to



catch a honey flow. But I have other things to tell you about these Italian bees in my next.—J. SMALLWOOD.

already been three cases of the disease, and that the victim in each case has been a top swarm.

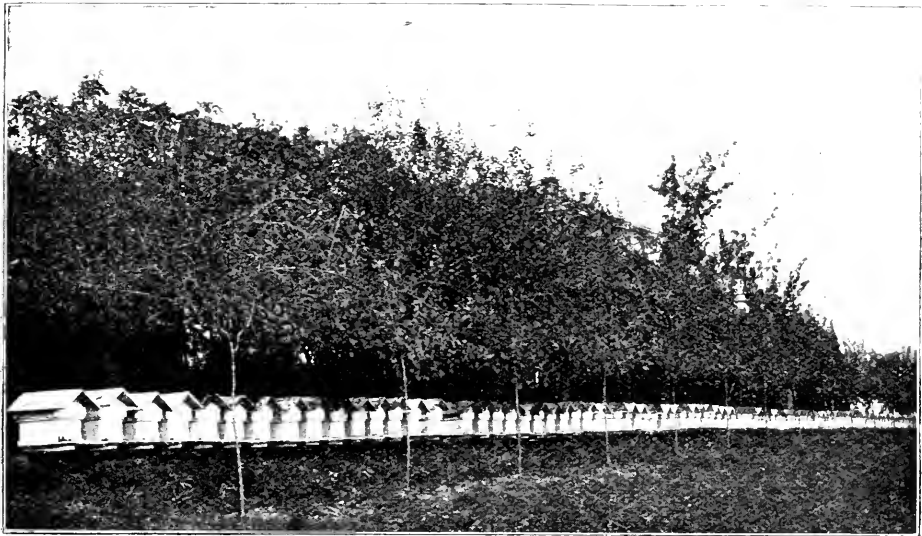

No. 5.  
A ROW OF COLONIES IN THE MOUNTAINS.

**CORRESPONDENCE**

A STUDY IN "ISLE OF WIGHT."  
[9053] A few bee-keepers at Stocksfield (a district which was recently cleared of

Swarm A was hived in a new hive and bees were dropping a week afterwards.

Swarm B was hived in a new hive, in which bees had died of "Isle of Wight" disease about a year ago. The hive had been burned out, but not treated with carbolic acid.

Swarm C absconded from my own

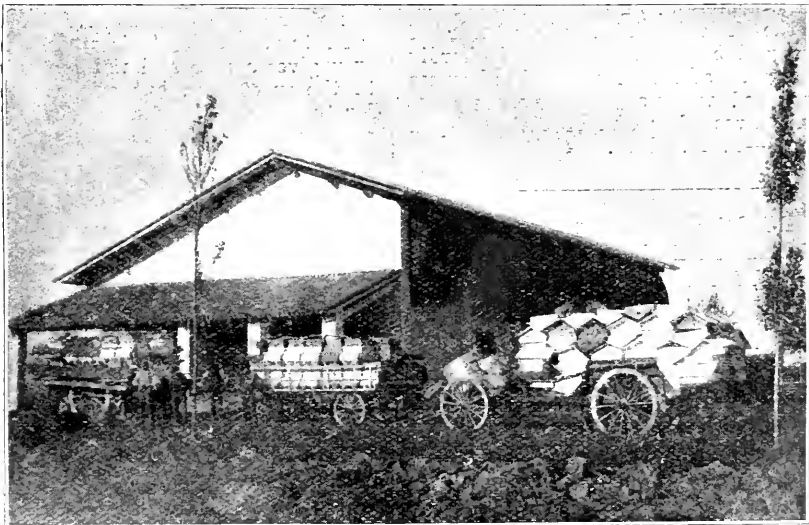

No. 6.  
TRANSPORTING COLONIES TO THE PLAINS.

bees by "Isle of Wight" disease) have this year restarted bee-keeping, and it seems worthy of note that there have

apiary and took possession of an empty hive a quarter of a mile away. The hive had been scorched with a painter's lamp

and the rack and excluder zinc had been boiled. No carbolic treatment had been applied. The bees in this hive commenced crawling on the ground a week after hiving themselves.

The official preventive instructions not having been completely carried out it may be assumed that the disease was met with in the hive itself in two of the cases. The other case cannot be explained in the same way, as the swarm was put into a new hive; but if the disease can be communicated by a contaminated hive after the swarm has entered, is it not probable that the scout bees which so industriously seek out all the empty hives (especially the derelict ones) may carry the disease by their visits to such hives? If so, swarm A might have also contracted the disease (through its scout bees) by contact with a contaminated hive.

Let me again refer to swarm C. This swarm was seen to alight at 2 p.m. It was covered with a sheet to await my return home. At 4 p.m. it took wing, and went into the empty hive referred to, which had been left open by a neighbouring bee-keeper. The intelligent and concerted action of the swarm indicated that scout bees had located the empty hive some time beforehand, and the question arises in the case of this and every other swarm in diseased areas: would the disease have been avoided if the swarm had been promptly hived in a new hive before it had time to abscond?

If there is sufficient evidence to indicate that scout bees do carry infection to the swarm (and probably to the stock also) the difficulty of keeping clear of disease will be apparent. It is hardly necessary to add that many bee-keepers do not, and will not, take proper steps to treat hives after disease has destroyed the bees.—J. N. KIDD.

#### EXCURSION OF THE CRAYFORD AND DISTRICT B.K.A. TO THE B.B.K.A. APIARY AT THE ZOOLOGICAL GARDENS.

[9054] An exceedingly profitable and interesting afternoon was spent by the members of the Crayford and District Bee-keepers' Association, on Saturday, the 11th inst., on the occasion of their excursion to the apiary at the Zoological Gardens, Regent's Park. As is now so well known, this apiary was founded by the British Bee-keepers' Association for the purpose of providing practical instruction in bee-keeping, under the grant given by the Development Commissioners for the encouragement of Apiculture in this country.

Fortunately the weather conditions were all that could be desired, and everything transpired to make the meeting a success. There was an attendance of about fifty, who had made the journey from various parts of Kent to witness what is being done by the Central Association for the training of bee-keepers at this convenient centre. Mr. W. Herrod, who is in charge of the apiary, lectured to the assembly, describing the work that had been done, and of that which was still going on for the benefit of the bee-keeping fraternity, at the same time relating the history of each of the various stocks.

The apiary, situated as it is in the heart of the metropolis, is excellently located for its purpose, inasmuch as it is within easy reach of most of the Associations within the home counties, and even for those in more distant parts it is probably in the best position to reach owing to the travelling facilities which are provided from all parts to the capital. It is certain, however, that the bee-keepers, and prospective bee-keepers, in and around London have not been slow to take advantage of the opportunity to profit by the instruction there provided, for we learned that the classes originally limited to twelve students had to be expanded, and now it is difficult to find room for all with classes of double that number.

The apiary is located in a very pretty part of the grounds, on the north bank of Regent's Canal, where all operations can be watched by visitors from the footpaths, both above and below; the hives being arranged on a series of terraces cut into the bank. This arrangement not only gives a safe and uninterrupted view to the spectators, but also a clear flight for the bees. As an additional safeguard against the spectators being stung, a high fence of  $\frac{1}{2}$  in. mesh wire netting has been erected round the apiary, and we were told that this protection had been successful in preventing anyone outside its limits from getting stung, notwithstanding the fact that there are always many people passing and looking on.

As will be seen from the photographs, various designs of hives are in use, even to the skep with the observation window, so that the particular advantages of each can be demonstrated. This is being done in the photograph, and Mr. Herrod, marked with a cross, is explaining the various types of hives. It will be seen that the portion of his audience shown are following his description with rapt attention. The apiary is well stocked with bees, including the native race, Italians, Bulgarians, and Banats, the latter being exceedingly quiet under manipulation. In all these

were eight stocks, in addition to four nuclei, and all were free from disease, and in a very flourishing condition. The

miles of Charing Cross. The propolis on the super, however, showed signs of its origin, and we were informed that the

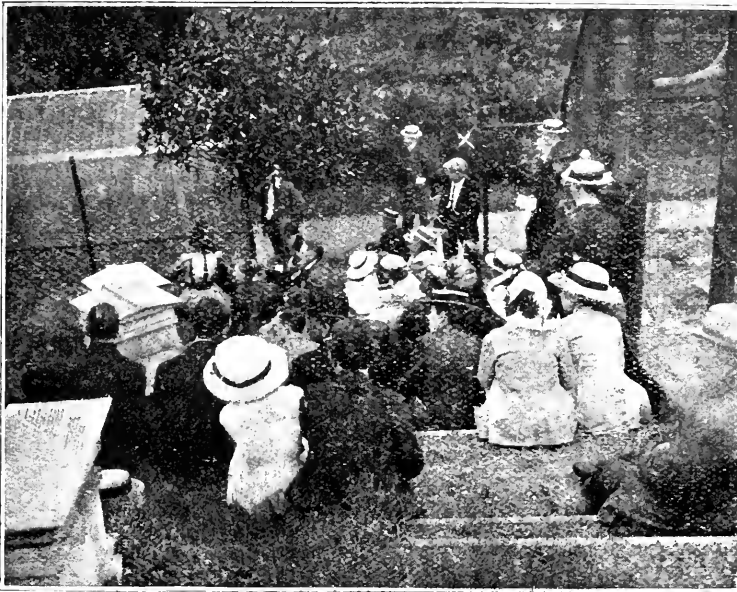

stocks were manipulated, and a super recently taken from one of them was inspected; the sections were found to be

sample was characteristic of the district. One feature which attracted a good deal of attention was the observatory hive,

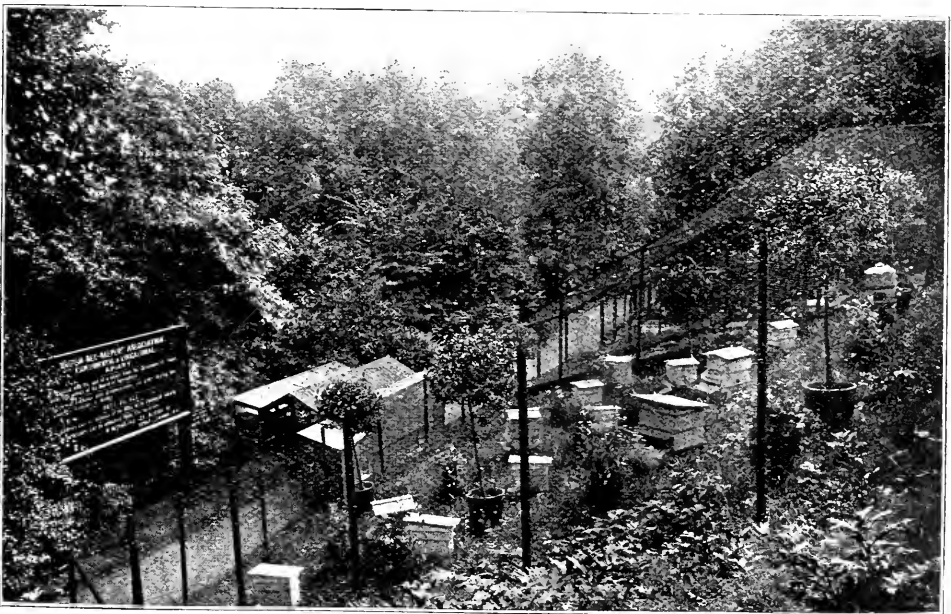

EXPERIMENTAL AND EDUCATIONAL APIARY.

British Bee-keepers' Association, Zoological Gardens, London, N.W.

excellent, and contained honey of very good quality, notwithstanding the fact that it was gathered within about three

with brood in all stages of development. This is arranged so that the entrance is within the enclosure, while the hive itself

is placed in a small shelter on the outside of the apiary, which permits the work of the hive being observed every day by visitors in safety.

After spending an exceedingly pleasant afternoon, a unanimous vote of thanks to Mr. Herrod was passed, and the audience adjourned for refreshments, and to participate in the other attractions these delightful Gardens offer.—GEO. W. JUDGE.



[8965] *Dealing with Fertile Worker.*—

On June 17th I hived a stray swarm in a "W.B.C." hive. On July 10th I examined them and found the brood to be that of a fertile worker. As this is the only colony I possess I cannot carry out the directions of the "Guide Book," by distributing the six frames. I shall be greatly obliged if you will advise me what to do.—MELROSE.

REPLY.—Remove the hive and bees as far as possible from the stand, at least 40 or 50 yards, spread a sheet or piece of sacking on the ground near the hive, and shake or brush every bee off the combs and out of the hive on to the sheet. Be as expeditious as possible, and then replace the hive and combs on the stand. The bees, of course, will return to it, but as, like the queen, the fertile worker does not fly from the hive she is unable to find her way home again, and you may possibly find her on the sheet. You may then introduce a laying queen, or, better still, purchase a small cast with queen and unite to them.

[8966] *Re-queening.*—Would you advise me on the following:—I lost thirteen stocks of English Black bees last year with "Isle of Wight" disease, and it is still in the district. I wish to re-queen my remaining stocks this year. (1) What breed of bee do you recommend? (2) Would you be good enough to give me the recipe for a honey cake you gave a year or so ago?—M. PARTRIGE.

REPLY.—(1) Better re-queen from your own stocks. (2) We cannot trace recipe. You will probably find it in "Producing, Preparing, Exhibiting, and Judging Bee Produce," by W. Herrod.

[8967] *Transferring Bees.*—On June 13th I hived a strong runaway swarm into a cheese box, no other or better

receptacle being then available, and placed it on a stand. I sent to a well-known maker of appliances for a certain hive to be sent at once by passenger train. Unfortunately delivery was not executed till three weeks had elapsed. On July 7th I placed the box with the bees on top of the brood chamber, in which the frames were filled with full sheets of foundation. They are, of course, now working down through the bar frame hive. What shall I proceed to do next? Is there time yet to make two stocks from this swarm?—ENQUIRER, Skipton.

REPLY.—If you wish to have all the bees in the frame hive remove the box and ascertain if the queen is on the new combs. If so, put on a queen excluder and replace the box, which may be finally removed twenty-two or twenty-three days afterwards. If you fail to find the queen in the frame hive you must "drive" the box until you can secure and place her there. If you wish to keep the box for further increase next year simply remove it with bees and queen to another stand a little distance away. Purchase a fertile queen, and introduce her to the bees in frame hive.

## Bee Shows to Come.

*A nominal charge of 2s. 6d. is made for notices (not exceeding 7 lines) in this column, 10 lines charged 3s. 6d., up to 15 lines 5s., which covers cost of insertion from order till date of show. Cash should accompany orders for insertion.*

**July 22nd to July 24th, at Bradford.**—Great Yorkshire Show. Classes for hives, honey, &c. Good prizes. For schedules and forms of entry (stating department), apply, The Secretary, Great Yorkshire Show, Blake-street, York. Telegrams, "Yas, York."

**July 22nd and 23rd, at Cardiff.**—The Glamorgan B.K.A., in connection with the Cardiff and County Horticultural Society's Show, in the Sophia Gardens, Cardiff. Open classes include:—Collection, Gift Sections, Beeswax, &c. Schedules from W. J. Wiltshire, Maindy School, Cardiff.

**July 23rd, at Southwell.**—The Notts. Annual County Show, in connection with the Southwell Horticultural Society. Open class for single jar extracted honey. Schedules now ready from G. Hayes, Mona-street, Beeston, Notts.

**July 23rd, at Bath.**—The Annual Show of the Somerset Bee-keepers' Association, in connection with the Larkhall Horticultural Society. Seven Open Classes. Schedules from J. W. Brewer, Glen Lynn, St. Saviour's Road, Bath.

**August 4th, 1914, at Bridgnorth.**—Annual Show of the Bridgnorth and District Bee-keepers' Association. Held in connection with Hampton Load Horticultural Society. Open gift class single 1lb. jar extracted honey. Prizes, 7s. 6d., 5s., 2s. Schedules from J. S. Lawton, Oldbury Walls, Bridgnorth. Entries close July 25th.

**August 5th and 6th, at Abington Park, Northampton.**—Northants B.K.A. Annual Honey Show. In connection with the Municipal Show. Special prizes for open classes, including one for single lb. jar. Entry free. Schedules from R. Heford, Kingsthorpe, Northants. **Entries close July 25th.**

**August 6th, at Madresfield, Malvern.**—In conjunction with the Agricultural and Horticultural Show. The Annual Show of the Worcestershire B.K.A. 5 open classes. Entry, 6d. each. Increased prizes. Schedules from George Richings, 2, Shubbery-terrace, Worcester. **Entries close August 1st.**

**Aug. 6th, at Bromham Park, Bedford.**—Honey show in connection with Biddenham and Bromham Flower Show, to be held in Bromham Park, near Bedford. Open classes for honey. Schedules from A. Henman, Bedford-road, Biddenham. **Entries close July 30th.**

**August 12th, at Wye, near Ashford, Kent.**—Kent Honey Show, 13th Annual Exhibition. Classes to suit all bee-keepers. Splendid prizes. One 6 guinea and two 5 guinea Challenge Cups; also two champion silver cups. A class for honey put up in short bottles, and a new class this year for best six photographs of bee life (taken by exhibitor); 2 silver medals for best exhibits of bee appliances. 26 different classes. Prize schedule and entry form free on application to Mr. Alfred Lepper, secretary, Kent Honey Show, Scotton-street, Wye, Kent. Prize schedule and entry form will be sent to all exhibitors of last year without application.

**August 17th and 18th, at Cannock (Staffs.).**—Honey Show, in connection with Cannock Horticultural Show. Eight open classes. Good prizes. Schedules from hon. sec., John Bird, Glenmay, Cannock.

**August 18th and 19th, at Brighton.**—The Fourth Annual Show of the Sussex Bee-keepers' Association, in connection with the summer show of the Brighton, Hove, and Sussex Horticultural Society. Seven Open Classes. Liberal Prizes. Schedules from C. A. Overton, Beecroft, Crawley. **Entries close August 10th.**

**August 19th, at Radstock.**—Honey show, in connection with the Radstock and District Horticultural and Fanciers' Association. Schedules from B. M. Clark, Fox Hills, Radstock.

**August 19th and 20th, at Derby.**—Derbyshire Bee-keepers' Association Annual Show, at Derby. Four open classes for honey. Reduced entry fees. For schedules apply, R. H. Coltman, 49, Station-street, Burton-on-Trent. **Entries close Wednesday, August 12th.**

**August 25th, 26th, and 27th, at Newcastle.**—Northumberland Bee-keepers' Association. Exhibition of honey and wax, in connection with the Newcastle Flower Show. Nine open classes. Schedules and entry forms from R. H. Newton, 24, Grainger-street West, Newcastle, or Captain F. Sitwell Wooler. **Entries close August 20th.**

**August 26th, at Prestbury.**—Honey show, in connection with the Prestbury Flower Show. One class open to the kingdom. Several for those within 12 miles radius. Exceptional prize list. Schedules from A. H. Bowen, Coronation-road, Cheltenham.

**August 26th, at Chester.**—Annual Show of the Cheshire Bee-keepers' Association, in connection with Cheshire Agricultural Society. Several open classes. Good prizes. Schedules from T. A. Beckett, St. Werburgh Chams., Chester.

**August 26th and 27th, at Rugby.**—Exhibition of the Warwickshire Bee-keepers' Association, in connection with the Warwickshire Agricultural Society's Show. Open and county classes. For schedules apply, J. R. Ingerthorp, Knowle, Warwickshire. **Entries close August 17th.**

**September 1st, at Deddington.**—Honey show in connection with Deddington Horticultural Society's Show, to be held in the Castle Grounds. Open classes for honey. Schedules from H. J. Harmsworth, Deddington, Oxon.

**September 2nd, at Lancaster.**—Agricultural Show. Premier Honey Show of the North. 15 classes; £20 in cash prizes, silver cups and medals value 13 guineas, and other specials. Send for schedule (Honey) to Robert Gardner, solicitor, 69, Church-street, Lancaster. **Entries close August 19th.**

**Sept. 5th, at the Club Room, North-road, Kew.**—Honey Show of the Richmond and District Bee-keepers' Association. Open classes for honey and wax. For schedules, apply Hon. Sec., Mr. J. G. Romer, 234, Kew-road, Kew-gardens. **Entries close August 28th.**

**September 9th, at Stoke Park, Guildford.**—Annual Exhibition of honey, wax, appliances, &c., will be held by the Surrey B.K.A. in connection with the Guildford and West Surrey Agricultural Association. Eighteen classes, five open to all. Many medals. Schedules from F. B. White, hon. secretary, Marden House, Redhill, Surrey. **Entries close 31st August.**

## Notices to Correspondents

A. PRICE (Rugby).—*Swarming Queries.*—(1) Old bees and queen. (2) During flight.

W. T. E. CHISLEHURST.—*Bees Hanging Out.*—Bees are overcrowded. Possibly some of the sections are ready for removing and replacing with new ones. If not, give another rack.

V. E. and A. S. K. (Rayleigh).—*Old Comb.*—(1) Probably four or five years. (2) Yes, a little. (3) It will be better to take all away; follow instructions in "Guide Book" for curing foul brood. (4) Yes, probably bees have not been strong enough to go into sections.

T. BRIGHT (Weybridge).—*Beginner's Queries.*—(1) Yes, to prevent swarming. (2) Place a section with partly drawn-out comb and a little honey in centre of rack. Take away the queen-excluder for a day or two. (3) Once a week will not do much harm. Do not pull the hive to pieces unless you have some definite object in view. Beginners usually do too much "examining." (4) Sixty grains sulphate quinine to every gallon of syrup.

JACK (Leeds).—*Melting Honey.*—No.

H. SCHROFFEL (Ilford).—(1) No, the organs are still attached; (2) Yes.

JNO. REID (Blantyre).—Queen was fertile.

H. CHEESEMAN (Worth).—(1) Hybrids; (2) English; (3) Dutch; (4) Carniolaus. There is very little difference between English and Dutch bees in appearance.

M. B. F. (Wolverhampton).—Thanks for cell. It is of no particular interest, as the queen is not likely to show any signs of disease.

*Suspected Disease.*

W. (Aberdovey).—Bees have "Isle of Wight" disease.

M. D. (Kent).—Odourless foul brood.

*Honey Samples.*

C. H. T. (Huntingdon).—(1) 1s. per bottle. (2) 10s. per doz. (3) 70s. per cwt.

A. PRINCE (Letchworth).—Both are mainly from clover. We prefer B for show purposes.

F. C. B. (Bouton).—(1) From mixed sources, mainly clover. (2) From 60s. to 70s. per cwt. (3) Yes, quite fit. Colour is just on the border line, try it in the class for light honey.

**Special Prepaid Advertisements.**  
**Two Words One Penny, minimum Sixpence.**

*Orders for three or more consecutive insertions entitle advertisers to one insertion in "The Bee-keepers' Record" free of charge.*

*Trade advertisements of Bees, Honey, Queens, and Bee goods are not admissible at above rate, but will be inserted at 1d. per word as "Business" Announcements, immediately under the Private Advertisements. Advertisements of Hive-manufacturers can only be inserted at a minimum charge of 3s. per  $\frac{1}{2}$ in., or 5s. per inch.*

**PRIVATE ADVERTISEMENTS.**

**WANTED**, honey, about  $\frac{1}{2}$  ton, or part.—Apply, with particulars and lowest price, to JOHN E. KNIGHT, Central Arcade, Wolverhampton. v 78

**FOR SALE**, first quality sections.—Apply to J. W. NELSON, Appleby, Westmorland. v 76

**REMOVING**. Healthy blacks, in strong hive; also unstocked hive, geared extractor, drawn out shallows, section rack, veil, smoker, feeders, gloves, all nearly new, perfect condition; removal sole cause of sale.—WILLIAMSON, Highfield House, Chapel Allerton, Leeds. v 76

**WANTED**, extractor, in good order.—DOM-BRAIN 57, Wickham-road, Beckenham. v 74

**WANTED**, drawn out shallow bars and sections warranted healthy.—EDWIN GLOSSOP, Ambergate. v 74

**DRIVEN BEES**, now ready, 1s. 6d. lb.; several good hives, some W.B.C., 4s. to 8s. 6d. each; also various sundries, cheap; exchange honey.—BOWDEN, Broomhill, Whitley, Surrey. v 73

**FOUR** 1913 Old English spangled bantams, laying, and cock; exchange healthy driven bees.—"B.B.J." Office, 23, Bedford-street, Strand, W.C. v 72

**GEARED** extractor, nearly new, Lee's, 26s. 6d., take 16s. 6d.—W. D., 33, Isla-road, Plumstead. v 71

**QUEENS!** Queens!! Queens!!! Home raised White Stars, Carnians, Dutch, 5s. each, return post. OLIVER KNIGHT, Epney, Stonehouse, Glos. v 70

**SEVERAL** 10-frame strong stocks, healthy, English bees, 30s. each.—P. JEFFERIES, Hilceast, Fitzjohn-avenue, Barnet, Herts. v 69

**FOR SALE**, four strong stocks of healthy hybrids, from Simmins' White Star Italians, 1914 queens, 25s., f.o.r.—Apply, W. BURGESS, Newport Pagnell, Bucks. v 68

**HONEY** sections for sale, 10s. 6d. per dozen, carriage forward.—GARFITT, Barnside, Coupar Angus, Perthshire. v 67

**FOR SALE**, strong stock bees, ten frames, 30s.—KIRKHAM, 51, Church-street, Altrincham. v 66

**STRONG**, healthy 8-frame stocks of bees, 25s. each; boxes to be returned, carriage paid.—MYTTON, Lyncroft, Stafford-road, Lichfield. v 65

**TEN DOZEN** first quality sections, 9s. per dozen.—F. COUSINS, Misterton, Gainsboro'. v 60

**HONEY**, first quality sections, 9s. 6d. dozen; three dozen, 27s., cash with order.—R. COUSINS, The Rosary, Misterton, Gainsboro'. v 63

**FINEST** English honey, 64s. per cwt.; sample, 2d.—DUTTON, Terling, Witham, Essex. v 61

**HEALTHY** stock British bees, price, including strong frame hive, 25s.—WELLER, Stafford-road, Brighton. v 42

**TYPEWRITER**, Ideal, visible writing, standard keyboard, brief carriage, clear work, strong, modern machine, excellent condition, 80s., great bargain.—WAKEFIELD, Newhall Hill, Birmingham. v 49

**GOOD** standing for bees, miles of the finest G heather.—Apply, ERNEST HOLMES, East Moors, Helmsley, Yorks. v 44

**FOR SALE**, pure Irish honey, well filled sections.—SAMUEL SCOTT, Ballyronan, Magherafelt, Co. Derry. v 41

**FOR SALE**, 12 cwt. of pure new Cambridge-shire honey, light colour, 65s. per cwt. in purchaser's receptacles, or 68s. 6d. in non-returnable tins, f.o.r.—CARTER, The Apiaries, Burwell, Cambs. v 56

**PURE** Cambridgeshire honey, 65s. per cwt.; sample, 3d.—J. YOUNGER, 29, Newmarket-road, Cambridge. v 51

**YOUNG MAN** requires situation as bee-keeper's assistant, with experience, age 20.—Apply, ALBERT SYMONDS, The Lodge, Lessness Park, Abbey Wood, London, S.E. v 33

**THREE** good stocks, with 1914 queens, healthy, packed free, 24s. each; take honey in exchange.—J. BOWDEN, Broomhill, Witley, Surrey. v 26

**FOR SALE**, Rymer heather honey press and drawer, no stand, unused, 40s., or offers.—"BUMBLE," "B.B.J." Office, 23, Bedford-street, Strand, W.C.

**WANTED**, a complete comb of both a bad and mild case of Foul Brood.—HERROD, "B.B.J." Office.

**A FEW** good section racks, complete, with dividers, follower, and wedge, 1s. 6d. each; lace paper, neat pattern, 6d. 100, post free; lace bands, 2 $\frac{1}{2}$ in. and 3in., 100 1s. 2d., post free, finest quality.—W. WOODLEY, Beeton, Newbury.

**SELL**, Thould and Hutchinson portable cesspool pump, with all fittings, used once only, cost £3 10s.; offers.—"PUMP," "B.B.J." Office, 23, Bedford-street, Strand, London, W.C.

**WANTED**, the following: Cloth editions "British Bee-Keepers' Guide Book," 1st, 3rd, 4th, 5th, 7th.—HERROD, "B.B.J." Office, 23, Bedford-street, Strand, W.C.



### BEES ON THE BIOSCOPE.

Mr. J. C. Bee-Mason will be showing the following "bee pictures" at Ipswich on July 30th and 31st, and August 1st:—"Life of the Bee," "Modern Bee Farming," "Dutch Pictures," "Bees and their Enemies," and "The Bee-Master," the whole taking about forty minutes. Mr. Bee-Mason will give a short introductory lecture before each subject.

### RANDOM JOTTINGS.

By Charles H. Heap, Reading.

I am greatly disappointed that my article entitled "The Immune Bee Chimera" has evoked no real discussion. So many people have their minds filled with the immune bee idea that I pictured myself having to defend my views against a battalion of keen immuners, but only Mr. Desmond and Mr. Illingworth, so far, have ventured to get their views into print.

I am quite aware that I did not enumerate all the known means by which immunity from disease may be conferred. To have attempted to do so would have laboured without helping my argument. The acquisition by a species of immunity from disease is, no doubt, a long process, extending over so many years that it may never be of any use to present-day bee-keepers. I fear my imagination is not sufficiently developed to enable me to join Mr. Desmond in supposing a worker bee to acquire by ingestion or miraculous gift an anti-microbe (whatever that may be) eager to feed on *Nosema apis*, and possessing various wonderful powers, including an anti-toxin which, administered to queen or drone larvæ, would render their progeny immune from microsporidiosis for ever and ever. Mr. Desmond brushes aside *à priori* argument, and invites us to consider actual facts. The actual facts consist of a not very conclusive experiment by Dr. Maassen and the absence of speedy death of a colony of robber bees. It happens that I have had experience of "Isle of Wight" disease in four counties, and have been familiar with some "Old Mortalities." In the winter of 1911-12 six out of seven stocks died in an apiary (not my own), and at the end of March I saw the seventh robbing the uninhabited hives of their stores. No. 7 became a strong stock, but in the autumn

it dwindled to such an extent that the owner destroyed it. Take another case. I diagnosed "Isle of Wight" disease in an apiary in August, 1912, and entered on my report, "Signs of 'Isle of Wight' disease." Presumably, because of this and the fact that I found "sigus" in the following spring, I was not admitted to the apiary in August, 1913; but in reply to an enquiry this spring the owner said "The bees died in the winter from 'Isle of Wight' disease." It is not uncommon for colonies infected one year to give a surplus the next, but so far as my experience goes they invariably perish.

We hear from time to time of "cured" stocks, but I should not pay the slightest regard to such a claim, unless the colony after an attack had survived and showed no symptoms of the disease for at least two years. I have seen blacks, Italians, and hybrids suffering from the disease, and it makes no difference whether the colony is in a frame hive or a skep, in a hole in a tree or in the roof of the house—all go the way of bee-flesh after the advent of *Nosema apis* in a neighbourhood. Some people have a notion that Dutch bees can resist the disease. I am not aware that any definite, unequivocal claim has ever been made that Dutch bees are immune to "Isle of Wight" disease. Suggestion has not been lacking, but I should like to point out that there is all the difference in the world between a claim and a suggestion, even if the suggestion happens to be made by an irresponsible halfpenny newspaper. So far as I am aware, Dutch bees have not been tested sufficiently long in an "Isle of Wight" district to enable anyone to speak authoritatively and definitely of their power to resist the present all-conquering pest.

I believe it is an open question whether there is such a thing as absolute immunity to disease. For instance, some animals under normal conditions are not attacked by certain deadly diseases, but alter the conditions under which they live, and the animals become susceptible.

While the evolution of a bee immune to "Isle of Wight" disease is exceedingly remote, the strain of *Nosema apis* with which bees in this island are afflicted may lose some of its virulence. This may be happening now, and possibly accounts for the remarkable reluctance of some colonies to become defunct in a reasonable and proper time. We must not, however, put too much trust in the possibility of a diminution of the virulence of our particularly destructive strain of *Nosema apis*, because while the virulence of an organism may, under some circumstances, be diminished, under others it may be recovered, or even increased.

I have no objection to bee-keepers

hoping for an immune bee, or for a decrease in the destructive power of *Nosema apis*, so long as it does not divert their minds from more practical lines of thought. It is not the immune bee or a lessening of the virulence of *Nosema apis* as we know it that we require so much as to be rid of the organism altogether. Is this possible? I believe it is. What do other readers of the *British Bee Journal* think?



The Editors do not hold themselves responsible for the opinions expressed by correspondents. No notice will be taken of anonymous communications, and correspondents are requested to write on one side of the paper only and give their real names and addresses, not necessarily for publication, but as a guarantee of good faith. Illustrations should be drawn on separate pieces of paper. We do not undertake to return rejected communications.

#### CURING "ISLE OF WIGHT" DISEASE.

[9055] *Re* 9052, your issue July 16th, I have many times been strongly tempted to reply to various correspondents in your valued journal, but have left it to more able men, but your correspondent "Satisfied at Last" is really too good to miss. I can fully take his statements as correct as to how his own bees may be thriving, but I think, like many more, he may find he is not all fair sailing. Most certainly he is in conflict with all the leading authorities or he is far in advance of the times with his discoveries in treating Zymotic disease or Microsporidiosis—call it whatever he likes. Your editorial remark fully confirms this, and now Mr. Editor, I would like to make one or two suggestions, the results of a little experience. "Isle of Wight" disease first made its appearance in this locality in 1913 by the indiscriminate purchase of swarms; the result was the owner lost the whole lot, eight hives altogether. Last year it developed in a neighbouring apiary, three hives were all cleared out, and finally my own twelve hives. We have all started again, obtaining all our bees locally, with a distinct understanding that on first appearance of disease, *burn at once*. This has already been the means of three hives going under, but now I am at a loss to know—are we going to gain our ambition when so many people will have a few bees as a hobby and not make themselves proficient in the most ordinary details of

their management, many not even in possession of the Guide Book, to say nothing of the "Journal" or "Record." While we have some dealers pressing their wares in such glowing terms, and selling swarms obtained from wherever they can get them, is it any wonder at disease spreading? I have in my mind now an advertiser in your journal who wanted 100 swarms, full price given. How is it possible for any man to obtain these under existing circumstances without running serious risk of spreading disease? Legislation similar to what is now applicable to most other diseases would, to my mind, be a long stride towards eradication. In conclusion it would be only fair to ask your correspondent to give us his name and address, as no doubt I shall be able ere long to find him something on which to test his wonderful discovery.

#### AN EASY AND EFFICIENT METHOD OF DESTROYING BEES.

Melt brimstone and run it out thinly on brown paper (old skeptists know this). Get well lighted in an old shallow salmon tin in the evening. Close entrance to hive, lift off the roof, roll up the quilt, place the tin of burning sulphur on the top of frames, replace roof, and the bees will soon all be dead.—JESSE FRY, Ilkley.

#### "ISLE OF WIGHT" DISEASE AND NOSEMA APIS.

[9056] On discussing this subject with a friend he stated that the bees in the Isle of Wight did not die of *Nosema apis*. He quotes the Board of Agriculture and Fisheries' Supplement No. 8, p. 39, "The relation of *Nosema apis* to the 'Isle of Wight' disease."

Yet in your issue of May 21st, p. 201, the lecturer is printed as saying ". . . the tiny organism that causes the badly named malady, popularly known as 'Isle of Wight' disease. . . ." The question naturally arises, then what is "Isle of Wight" disease? I know what *Nosema apis* is because my bees have had it.—INTERESTED.

[We have referred the above to the lecturer mentioned and have received the following reply.—EBS.]

The statement that bees in the Isle of Wight did not die of *Nosema apis* is inaccurate. On referring to the section quoted, namely the *Journal of the Board of Agriculture* for May, 1912, Supplement No. 8, p. 39, and the first paragraph therein, it is stated that bees from the "Isle of Wight" contained *Nosema apis*, which was pathogenic to them. Further, the whole section, pp. 39-56, clearly shows



that the parasite, *Nosema apis*, was responsible for the deaths of bees suffering from "Isle of Wight" disease from all parts of Great Britain. Reference to July, 1913, Supplement 10, p. 37, confirms the same.

"Isle of Wight" disease in bees is due to *Nosema apis*. Several other diseases of bees have been wrongly included under the same name. In fact, "Isle of Wight" disease has been used, at different times, as a cloak for any mortality among adult bees, without accurate microscopic diagnosis, which alone can determine the exact agent of the malady.

The disease, popularly named "Isle of Wight" disease, is badly so named, since it is distributed not only in the Isle of Wight, but throughout Great Britain and Ireland, in several European countries, in Australia, Brazil, and the United States of America. Hence the disease caused by *Nosema apis* is much better known as *Microsporidiosis*, which is what was stated by the lecturer.

#### A NOTE FROM AUSTRALIA.

[9057] I am enclosing a cutting from the current number of the *Week*, which I thought might prove of interest to your readers. The season here in Queensland is now at an end, and a bountiful one it has been, owing to splendid rains, which fell at the right time. Here on the Darling Downs we are getting a few frosts, but they disappear at sunrise, and I have noticed the bees at work almost every day even now. Wishing your readers a prosperous season and every success to your valuable little journal.—AN OLD READER.

[Sorry the picture is not suitable for reproduction.—Eds.]

#### "NEW ZEALAND 'HEATHER' HONEY."

[9058] I am afraid from the tone of Mr. D. M. Macdonald's communication (April 16th, page 153), he must have had a bad quarter-hour after reading the report of the last conference of our bee-keepers. From two innocent items in the report he appears to have conjured up some terrible rascality about to be perpetrated by New Zealand bee-keepers to the detriment of his own beloved heather honey trade. Let me hasten to assure him that his zeal for the latter has caused him to misinterpret the items, and that his fears are absolutely groundless. Neither will he have to, as he threatened, invoke the aid of the "British Board of Trade," "eminent analysts," "leading judges," and the "New Zealand Government" (what a formidable army) to pre-

vent, or put a stop to, what he has imagined is about to take place.

I have always looked upon my friend, D. M. M., as a level-headed bee-keeper and writer, and I was much surprised when I read his communication. Let us see what there is in the two items that could have upset my friend. One of twelve papers read at the conference dealt with exporting honey to England. In the discussion that followed, the President said:—"The export trade which they were developing was with the West Coast of England. The honey went to Liverpool and also to Glasgow, where they found that ti-tree honey would probably sell as well as New Zealand heather honey. It is of similar flavour to Scotch heather honey." The other item was a suggestion made by a member as follows:—"So far as dark honey is concerned, he thought that if some of their best dark honey were sent to Scotland and labelled New Zealand Heather Honey it would pay well. If some of the far-famed heather honey of Scotland were sent out here it would not realise 3½d. per lb."

Now, I maintain there is nothing in the above items to indicate fraud, or to give cause for my friend's perturbation. I suspect it is the last sentence that unnerved D.M.M. It must appear rank heresy, or even blasphemy, to find "Scotch heather honey" valued as low as our third-grade article; nevertheless, the statement is quite correct. We have genuine samples of Scotch heather honey in our Government exhibit, and Colonel H. J. O. Walker very kindly sent me two jars (about 4lbs.) of prize heather honey, so we know what it is, and our ti-tree and "heather honeys" are equally as good, although rated as third-grade by us, and are similar in flavour.

For independent testimony I may refer to our late Governor, Lord Islington, who declared it equal to the Scotch article, and had about 2cwt. of it shipped to his order when he left for England. We have a plant growing wild, known generally as "New Zealand heather," hence our heather honey.

I might also draw my friend's attention to some of the wild honey of South Africa, declared to be similar to Scotch heather honey in flavour. If he will look up the *South African Bee-keepers' Journal* for March, 1913, he will see the following: "The South African honey, with which it is proposed to test the English market, is known as 'Forest' honey, and comes from the neighbourhood of the great Knysna forest. . . . It has a flavour much the same as that known in this country (England) as heather honey."

We grade all our honey in comparison with white clover honey, which we dub

A.I. 100. D.M.M. need not be afraid of the English or Scotch markets receiving much of our ti-tree or heather honey, as we endeavour to get as far away from them as we can, owing to their being unextractable in the ordinary way. Scotch heather honey, like our ti-tree and "heather" honey, is preferred by those who only eat honey now and then, owing to their stronger flavour, but for everyday use the more delicate flavoured white clover honey is chosen every time.—J. HOPKINS, Auckland, New Zealand, June 5th, 1914.

#### SKEPS AND DISEASE.

[9059] Why should the skep be spoken of as an evil thing? In the "B.B.J." recently there has been rather an interesting line of argument between Mr. Crawshaw and Mr. Hopkins about the straw skep and immovable comb hives generally, and to-day I see there is a final letter from Mr. Hopkins, in which he evidently considers he has settled the matter. He may, of course, be quite right from his own point of view, but Mr. Crawshaw is also right. The point, I think, is this: In our country nearly every village or hamlet has—or had before—"Isle of Wight" disease wiped them out—one or more cottagers possessing a few skeps. Now, these men understand how to manage a skep quite well. They hive the swarms each year, and take up the old stocks, destroying the bees in the familiar way. Often this has gone on for many years, as the stock is kept going by casts and by the bees occasionally re-queening themselves. The yearly destruction of practically all old combs must be a very strong deterrent to foul brood making any headway. Nor is the take of honey always so bad; considering that the bee-keeper goes to no expense it is often a very good return. Now let us consider that an expert has been round to one of these peaceful villages, and has aroused the enthusiasm of a cottager who is the possessor of, say, half a dozen good skeps. The man buys a frame hive, he buys the fittings, he gets quilts, section racks,

smoker, &c., &c., which cost a good sum, often more than he can well afford. A good swarm is hived on to the ten frames, and all the rest of that season they take to fill up the brood chamber. If the swarm is early, and a good time follows, they may fill a rack of sections. Next year he may do better, especially if the expert introduces a young queen for him, as I have often done (not that I ever encouraged a man to get a frame hive unless he really wished to do so), but sooner or later I have found the bees get foul brood, and then it is all over unless someone is there to help. The weak stock will often stand ready for robbers, and infect the district. For men who thoroughly understand the craft, of course, the frame hive is immeasurably better and more profitable than the skep, but where a man does not understand much about bees—does not at once recognise disease, and understand how to take immediate steps for its suppression—the skep is the best. He will get a little honey with no risk, and his stocks will seldom be greatly diseased. Of course, we know well enough that a skep may be diseased as readily as a frame hive, but it is, I feel sure, not often so on account of the annual destruction of combs. The cottager with a diseased frame hive looks at the brood combs often, lifts them out and drops honey and bees about, and probably has no idea that they are diseased at all. I should like to hear other experiences, but for myself I can say that I have driven hundreds of stocks of bees in skeps and only once found disease, and that was in an old lady's garden where no hives had been taken up for years. I always removed at least one comb of brood after driving. Like others, I expect, I occasionally see signs of foul brood in my apiary, but I have been through the mill pretty thoroughly long ago and spot it immediately now, and proceed at once to put it right, which is not very difficult. I had one slight case this summer, but otherwise have not had it for years. I think Mr. Hopkins quite fails to consider the case from this point of view.—R. B. MANLEY.



THE HIVING AND TREATMENT OF NATURAL SWARMS AND CASTS.

(Continued from page 285.)

In all cases full sheets of foundation should be used. It is false economy to use starters, as it often happens that instead of continuing the worker cells, drone comb

is built as illustrated (Fig. 47). No. 1 is a starter, No. 2 a third of a sheet, and No. 3 two-thirds of a sheet of foundation. The result is the same in each case, *i.e.*, drone comb built on. So strong at times is the desire of bees to build drone comb that they will tear down worker base foundation to make room for it, or actually

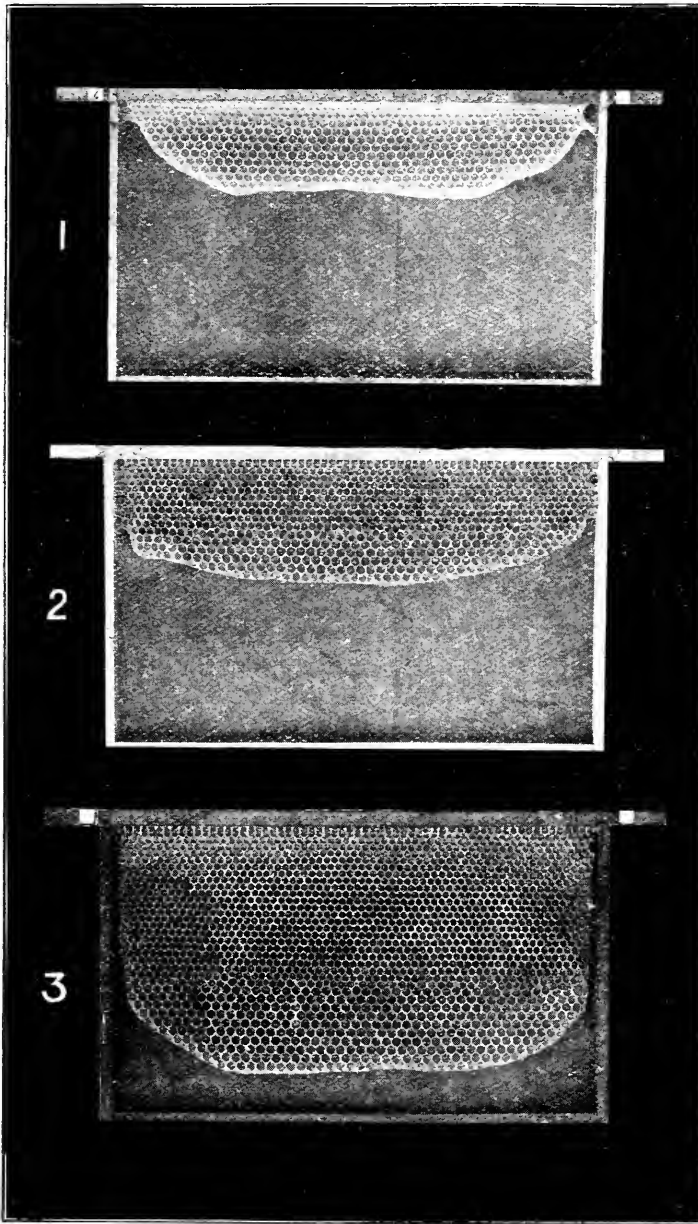
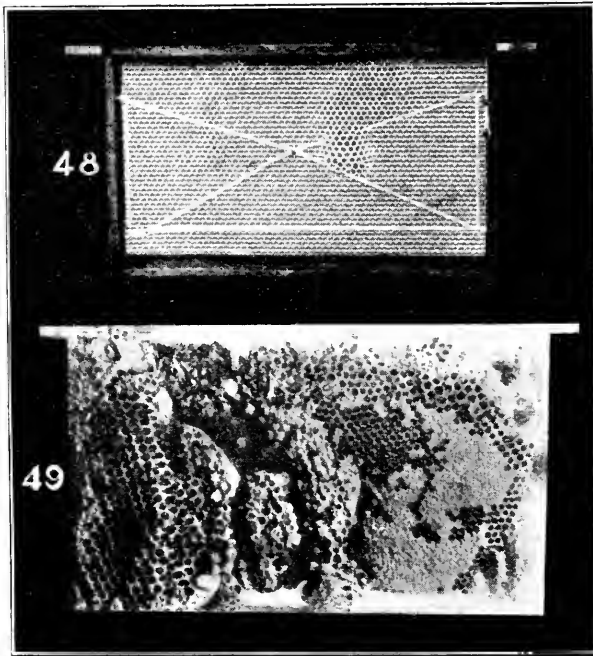

FIG. 47.

alter the base to that of drone cells (Fig. 48). Therefore, every endeavour should be made to limit the production of a preponderance of useless drones.

I have known cases where the swarm has been hived on to frames without foundation. The result is seen (Fig. 49). The removal for examination of combs braced together in this manner is impossible.

It may seem absurd and superfluous to mention that quilts must be put over the frames before hiving the swarm. Yet more than once I have been called in to put right bees that the owner found difficult to get to stay on the frames of foundation, as they had persisted in going up to the roof and building comb (Fig. 50), because,



in his ignorance, the elementary operation of putting on the quilt had not been carried out. Bees always go to the top of their home to build comb, therefore the top of the brood chamber must be made by a quilt to keep the bees confined to that part. The quilt next the frames should be of some smooth material. If a rough,



FIG. 50.

hairy one is used then many bees are made prisoners and die by getting their legs entangled, as seen (Fig. 51). Unbleached calico or ticking is best. If dressed calico is used the bees eat it away, as shown (Fig. 52). Over this is placed a couple or three pieces of warm material, such as under-felt for carpets or druggeting-

The quilts should be cut about an inch larger than the top of the brood chamber each way, so that they fit neatly, prevent the bees from escaping, yet do not overhang too much so that they are trapped when putting on the lifts.

Another detail of importance is to see that before the swarm is put into it the hive is fixed properly; the legs should stand upon bricks to prevent rotting. (Fig. 53) shows how to use the spirit-level on the floor-board in two positions. It should be quite level from side to side, *i.e.*, parallel with the entrance, and incline about half an inch to the front so that moisture will drain away from the inside of the hive. If this levelling is not carried out irregular combs will be built and the inside of the hive get damp and musty.



FIG. 51.

Swarms of the previous year very often are weakest in the spring. This can be accounted for by the fact that it is the old queen which accompanies the swarm. Therefore, if a record has been kept and the queen is an old one, she should be replaced by a young, vigorous one, about three weeks after hiving.

Where the bee-keeper does not pay attention to recording the age of queens, or carry out queen-rearing, and he suspects that the queen is an old one, she can easily be replaced by uniting a cast after first killing her.

#### PACKING SWARMS FOR TRANSIT.

This needs doing very carefully, with as much ventilation as possible. It is grievous to see time and again splendid swarms suffocated through inattention to this important detail. As a large buyer of swarms I have been astonished at the ignorance displayed in this matter. Many times bees have arrived all dead and in a sticky mess, through the covering material being of too close a texture to allow the

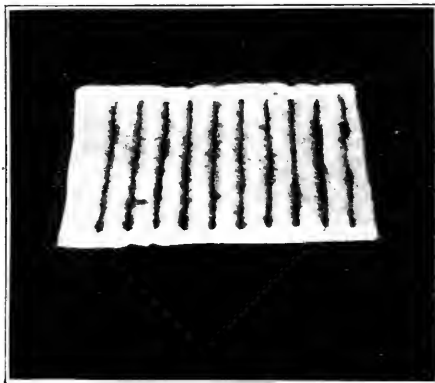

FIG. 52.



FIG. 53.

heat generated to escape and fresh air to enter. This illustrates very clearly how necessary it is for the bee-keeper to know something of the anatomy of the bee. Bees do not breathe through the mouth, but through little holes at each side of, and between the segments of the abdomen and thorax, called spiracles. These are protected by a number of hairs, the body is also covered with hair. When they issue as a swarm they fill their stomachs with food as mentioned above.

(To be continued.)

## Bee Shows to Come.

A nominal charge of 2s. 6d. is made for notices (not exceeding 7 lines) in this column, 10 lines charged 3s. 6d., up to 15 lines 5s., which covers cost of insertion from order till date of show. Cash should accompany orders for insertion.

**August 4th, 1914, at Bridgnorth.**—Annual Show of the Bridgnorth and District Bee-keepers' Association. Held in connection with Hampton Load Horticultural Society. Open gift class single lb. jar extracted honey. Prizes, 7s. 6d., 5s., 2s. Schedules from J. S. Lawton, Oldbury Wells, Bridgnorth. Entries closed.

**August 5th and 6th, at Abington Park, Northampton.**—Northants B.K.A. Annual Honey Show. In connection with the Municipal Show. Special prizes for open classes, including one for single lb. jar. Entry free. Schedules from R. Hefford, Kingsthorpe, Northants. Entries closed.

**August 6th, at Madresfield, Malvern.**—In conjunction with the Agricultural and Horticultural Show. The Annual Show of the Worcestershire B.K.A. 5 open classes. Entry, 6d. each. Increased prizes. Schedules from George Richings, 2, Shubbery-terrace, Worcester. Entries close August 1st.

**Aug. 6th, at Bromham Park, Bedford.**—Honey show in connection with Biddenham and Bromham Flower Show, to be held in Bromham Park, near Bedford. Open classes for honey. Schedules from A. Henman, Bedford-road, Biddenham. Entries close July 30th.

**August 12th, at Wye, near Ashford, Kent.**—Kent Honey Show, 13th Annual Exhibition. Classes to suit all bee-keepers. Splendid prizes. One 6 guinea and two 5 guinea Challenge Cups; also two champion silver cups. A class for honey put up in short bottles, and a new class this year for best six photographs of bee life (taken by exhibitor); 2 silver medals for best exhibits of bee appliances. 26 different classes. Prize schedule and entry form free on application to Mr. Alfred Lepper, secretary, Kent Honey Show, Scotton-street, Wye, Kent. Prize schedule and entry form will be sent to all exhibitors of last year without application.

**August 17th and 18th, at Cannock (Staffs.).**—Honey Show, in connection with Cannock Horticultural Show. Eight open classes. Good prizes. Schedules from hon. sec., John Bird, Glenmay, Cannock.

**August 18th and 19th, at Brighton.**—The Fourth Annual Show of the Sussex Bee-keepers' Association, in connection with the summer show of the Brighton, Hove, and Sussex Horticultural Society. Seven Open Classes. Liberal Prizes. Schedules from C. A. Overton, Beecroft, Crawley. Entries close August 10th.

**August 19th, at Radstock.**—Honey show, in connection with the Radstock and District Horticultural and Fanciers' Association. Schedules from B. M. Clark, Fox Hills, Radstock.

**August 19th and 20th, at Derby.**—Derbyshire Bee-keepers' Association Annual Show, at Derby. Four open classes for honey. Reduced entry fees. For schedules apply, R. H. Coltman, 49, Station-street, Burton-on-Trent. Entries close Wednesday, August 12th.

**August 25th, 26th, and 27th, at Newcastle.**—Northumberland Bee-keepers' Association. Exhibition of honey and wax, in connection with the Newcastle Flower Show. Nine open classes. Schedules and entry forms from R. H. Newton, 24, Grainger-street West, Newcastle, or Captain F. Sitwell Wooler. Entries close August 20th.

**August 26th, at Prestbury.**—Honey show, in connection with the Prestbury Flower Show. One class open to the kingdom. Several for those within 12 miles radius. Exceptional prize list. Schedules from A. H. Bowen, Coronation-road, Cheltenham

**August 26th, at Chester.**—Annual Show of the Cheshire Bee-keepers' Association, in connection with Cheshire Agricultural Society. Several open classes. Good prizes. Schedules from T. A. Beckett, St. Werburgh Chams., Chester.

**August 26th and 27th, at Rugby.**—Exhibition of the Warwickshire Bee-keepers' Association, in connection with the Warwickshire Agricultural Society's Show. Open and county classes. For schedules apply, J. R. Ingerthorp, Knowle, Warwickshire. Entries close August 17th.

**September 1st, at Deddington.**—Honey show in connection with Deddington Horticultural Society's Show, to be held in the Castle Grounds. Open classes for honey. Schedules from H. J. Harmsworth, Deddington, Oxon.

**September 2nd, at Lancaster.**—Agricultural Show. Premier Honey Show of the North. 15 classes; £20 in cash prizes, silver cups and medals value 13 guineas, and other specials. Send for schedule (Honey) to Robert Gardner, solicitor, 69, Church-street, Lancaster. Entries close August 19th.

**Sept. 5th, at the Club Room, North-road, Kew.**—Honey Show of the Richmond and District Bee-keepers' Association. Open classes for honey and wax. For schedules, apply Hon. Sec., Mr. J. G. Romer, 234, Kew-road, Kew-gardens. Entries close August 28th.

**September 9th, at Stoke Park, Guildford.**—Annual Exhibition of honey, wax, appliances, &c., will be held by the Surrey B.K.A. in connection with the Guildford and West Surrey Agricultural Association. Eighteen classes, five open to all. Many medals. Schedules from F. B. White, hon. secretary, Marden House, Redhill, Surrey. Entries close 31st August.

## Notices to Correspondents

M. C. (Shrewsbury).—*Moving Bees.*—It is usually considered advisable to move two miles. They will probably be all right if you place some obstruction at the entrance for a few days, a handful of coarse grass or hay, or rear up a piece of glass in front, so that the bees have a little difficulty in getting out of the hive. Do not close the entrance so they are unable to get out at all.

SHIRM (Grimsby).—*Signs of Queenlessness.*—(1 and 2) Possibly, or the young queen may not yet have mated and commenced to lay. Give a comb containing eggs and notice if they commence queen cells. (3) It would be a queen piping. (4) Use a slow feeder, or give about  $\frac{1}{2}$  pint syrup per week.

INTERESTED BEGINNER (Saxmundham).—*Transferring Bees.*—(1 and 2) Your best plan will be to treat both as per page 150 in Guide Book, early next spring; it is too late this year. (3) They will fight until one is killed. (4) The one you refer to will be in B.B.J. of Aug. 28, 1913. We can supply it for 1½d. stamps. (5) Yes.

W. F. JONES (Anglesea).—*Source of Propolis.*—Possibly you have been using Ayles' Cure in the hive. If not we cannot say what is the cause of the smell.

I. H. J. (Hammersmith).—*Various Queries.*—(1) You had better cut a hole in the top. (2) Thanks, but they will not be of any use. (3) No. (4) Sept. 5,

1912. (5) Powder some naphthaline and sprinkle where the ants congregate. Spraying slightly with a solution of 2lb. hyposulphite of soda in 1 gall. of water has been recommended, but we have no personal experience of this. (6) You will find the life history of the oil-beetle (*Meloe*) fully dealt with in "British Beetles," by E. C. Rye, and the "Transformation of Insects," by P. Martin Duncan, F.R.S. One of the best descriptions of special interest to beekeepers will be found in the French "Manuel d'Apiculture," by M. Girard, who devotes no less than twelve pages of this book to a history of the insect. For a German work we would refer to "Die Parasiten der Honigbiene," by Dr. Eduard Assmuss.
- E. M. SIMPSON (Painswick).—Yes, it is to be relied on. It is only a little out of date.
- M. A. B. (Hereford).—*Dealing with Wax Moth*.—Look the combs over occasionally and kill all larvæ you may find tunnelling under the cappings of brood, also kill all moths you can. Wrap boxes of combs securely in paper, placing some Apicure in with them.
- C. E. HARDWICK (Sutton Coldfield).—We have not had experience enough of them in this country to do so—unless you need swarms. The remarks you noticed referred to Italians.
- W. W. HAVARD (Brecon).—*Various Queries*.—(1) Yes, honey should be all sealed before removing from the hive. (2) The "Cowan," if you can afford it. "The Guinea" is a very good one at a moderate price. (3) Better to extract as soon as possible. (4) It is now generally used as a receptacle into which to strain honey. (5) South East. (6) There is no B.K.A. in Breconshire.
- H. I. HEWETT (Winchester).—*Queenless Colony*.—(1) The young queen may have been lost on her mating flight. (2) Probably because there is no queen. (3) Only by introducing a cast with queen. (4) Yes. You are handicapped by not being able to examine brood combs. If the bees live until next spring, transfer them to movable frames.
- "COTSWOLD" (Fairford).—*Raising Queen*.—It would be very risky. A better plan would be to make a nucleus for the purpose from the stock you wish to requeen. Stand the nucleus near the parent stock, and when the young queen is mated and laying, depose the old queen and unite the nucleus with young queen to the old stock again. The difficulty so late in the year is not rearing the queen but getting her mated.
- C. W. (Midhurst).—*Moving to Heather*.—They would probably reach it, but they would have a much better chance if nearer. It would be quite safe to move them that distance.
- "YOUNG RECRUIT" (Eastbourne).—*Various Queries*.—(1) We have always found driven bees do well. You need drawn-out combs on which to hive them. Yes, a queen is usually sent. You must stipulate for a young queen with each lot when ordering. Get them as early as possible, and feed up rapidly until they have 30lbs. of stores in the combs. Do not disturb them through the winter. (2) Unite them, first moving each hive a yard nearer the other at intervals of one or two days, when the weather permits the bees to fly freely until you have them not more than a couple of yards apart, then unite and place the hive with bees in centre of space, removing the other. (3) We cannot say what is wrong, without examination. If they are queenless, purchase a queen and introduce to them. (4) We are sorry this is not possible.
- H. B. (Cardenden).—There would be no difficulty so far as we are aware. Probably the shipping agents would be able to tell you; we hope you will be successful. Thanks for your appreciation of B.B.J.
- "IGNO" (Glos.).—*Extracting from Brood Combs*.—(1) No; under the circumstances stated it would probably contain syrup. (2) We should say your surmise is correct. Dutch bees are given to excessive swarming; this seems to be their chief characteristic. They are supposed to resist "Isle of Wight" disease better than natives. (3) No.
- "MEDICO" (Cheddleton).—*Swarming Queries*.—(1) Yes, it would be the queen. (2) Probably the young queens have been killed and bees are not likely to swarm.
- "NEOPHYTE" (Glasgow).—*Queries about Queens*.—(1) No, but she may occasionally. (2) Yes, it should not be attempted. (3) They usually locate the situation. In your case they were evidently confused. (4) Yes (5) and (6) We should prefer inserting the cell. (7) She would be destroyed. (8) If you have no queen excluder on, it would be safer.
- NEW BEGINNER (Navenby).—*Lost Queen*.—Let it stay now. Remove when honey flow is over, and take out the honey. It is too late to transfer bees to frame hive. Let them winter in the skep and transfer next year.
- W. SEAL (Basingstoke).—*Lost Queen*.—Under the circumstances your best plan will be to put queen in skep and transfer next year. The secretary of the Hants and Isle of Wight B.K.A. is Mr. F. D. Hills, Ivanhoe, Park Close Road, Alton.

*Honey Samples.*

H. F. G. (Millon).—Very good in all points. Not less than 1s. Why not try it on the show-bench?

T. E. (Romford).—Yes, it is English, and a very good sample. Mainly from clover; 70s. per cwt.

C. R. I.—A very nice honey, quite suitable for local shows, but needs more careful straining.

"ALTRAR" (Eastleach).—It is a shade too dark for light class. It might secure a prize. It is from mixed sources. Worth 60s. to 70s. per cwt.

*Suspected Disease.*

AT WATER (Gillingham).—"Isle of Wight" disease.

M. P. (Canterbury).—The symptoms you describe are those of "Isle of Wight" disease, but only one of the bees you sent seems to be affected. It would be best to destroy them.

L. M. (Winchester).—Bees are suffering from "Isle of Wight" disease. There is no fee, thanks.

R. T. C. (Chesterfield).—Bees show symptoms of "Isle of Wight" disease.

"PERPLEXED" (Wishaw).—Cannot detect symptoms of "Isle of Wight" disease. If you see bees crawling on the ground send us a few of them.

E. E. D. (Hants).—Bees appear to be affected with "May Pest." Will try to give you further information next week.

**Special Prepaid Advertisements**

**Two Words One Penny, minimum Sixpence.**

Orders for three or more consecutive insertions entitle advertisers to one insertion in "The Beekeepers' Record" free of charge.

Trade advertisements of Bees, Honey, Queens, and Bee goods are not admissible at above rate, but will be inserted at 1d. per word as "Business" Announcements, immediately under the Private Advertisements. Advertisements of Hive-manufacturers can only be inserted at a minimum charge of 3s. per  $\frac{1}{2}$  in., or 5s. per inch.

**PRIVATE ADVERTISEMENTS.**

**F**EW DOZEN good sections, 8s. per dozen; two 23lb. tins extracted, 30s.—C. KIDBY, Sizewell-road, Leiston, Suffolk. v 3

**O**N SALE, 40lb. of very fine Scotch heather honey, in six glass jars.—THOMAS ROBINSON, Sunnypoint, Crook, Kendal. v 90

**S**IX DOZEN sections, first quality, 10s. per dozen.—H. EVANS, Scampston Hall, York. v 39

**S**TRONG, healthy nuclei, seven and eight frames, 1914 queens, Simmins' White Star Italian strain 17s. 6d. and 19s. f.o.r.; hives, 2s., returnable.—COUSENS, 12, Grove-road, Wanstead, Essex. v 87

**M**EADOWS' geared extractor, almost new, cost 36s., sell 20s. EDWIN GLOSSOP, Amber-gate. v 86

**B**UFF ROCK cockerels, from Hy. Sutton's strain, second place in 1913 twelve months' laying competition Newport, March hatched, 5s. each.—NICHOLSON, Llangwathby. v 85

**H**ONEY, 2 cwt., from fruit, &c., slightly dark in colour, in 23lb. tins, at 56s. per cwt., f.o.r.; sample, 2d.—HENRY GOW, Crossford, near Dunfermline. v 84

**S**URPLUS 1914 queens, English, 4s.; special hybrids, 5s. 6d.; imported Italians, 4s. 6d.—WHEATLEY, expert, Spa Apiary, Hinckley. v 83

**E**XCHANGE, eight volumes "Modern Carpenter, Joiner, and Cabinet Maker," cost £3, perfect, not soiled, for two stocks of bees, or double barreled gun, or sell.—LEWIN, Winthorpe, Skegness. v 82

**A** FEW good 1914 tested queens, 6s. 6d. each; nuclei, three or four frames, 14s. 6d. and 16s. 6d., boxes free.—APIARY, 157, Camden-road, N.W. v 81

**T**EEING STOCKS healthy bees, 1914 queens, 25s.; inspection invited.—VINCENT, 132, Croydon-road, Anerley. v 80

**D**DOUBLE CONQUEROR, nearly new, healthy.—A. M. c/o "B.B.J.", 25, Bedford-street, Strand, W.C. v 79

**W**ANTED, drawn out shallow frames, healthy; also three good healthy lots driven bees.—JESSE HIRST, 68, Varley-road, Slaithwaite, near Huddersfield. v 92

**H**EALTHY STOCKS for sale, on frames and skeps; particulars.—JONES, Cwmeisian Apiary, near Dolgelly. v 1

**B**EELKEEPER, capable complete management large apiary; give fullest particulars in first communication.—N., 23, Bedford-street, Strand, W.C. v 100

**B**BETTER than driven bees; four swarms for sale, on six frames each, price 10s. 6d.—Apply, S. COCKS, Naption, Rugby. v 99

**P**URE Devonshire honey, 15s. per 28lb. tin.—BARFIELD, Gaddon, Craddock, Cullompton. v 98

**T**TWO 1914 healthy black queens, 3s. 6d. each.—HALL, 15, Boro', Hinckley, Leics. v 95

**F**FINE extracted honey, 60s. cwt., including tins, carriage paid; sample with pleasure.—AVERY, Deverill, Warminster. v 94

**F**OR SALE, a few very fine, healthy 1914 queens, 4s. each; also four and six frame nuclei, guaranteed healthy, and full of bee and brood, 12s. 6d. and 16s. 6d.—CROWE, c/o Mr. Shearsmith, Westgate, Tadcaster. v 93

**D**IVEN BEES, now ready, 1s. 6d. lb.; several good hives, some W.B.C., 4s. to 8s. 6d. each; also various sundries, cheap; exchange honey.—BOWDEN, Broomhill, Whitley, Surrey. v 73

**S**EVERAL 10-frame strong stocks, healthy, English bees, 30s. each.—P. JEFFERIES, Hillcrest, Fitzjohn-avenue, Barnet, Herts. v 69

**S**TRONG, healthy 8-frame stocks of bees, 25s. each; boxes to be returned, carriage paid.—MYTTON, Lyncroft, Stafford-road, Lichfield. v 65

**H**EALTHY stock British bees, price, including strong frame hive, 25s.—WELLER, Stafford-road, Brighton. v 42

**T**YPEWRITER, ideal, visible writing, standard keyboard, brief carriage, clear work, strong, modern machine, excellent condition, 80s., great bargain.—WAKEFIELD, Newhall Hill, Birmingham. v 49

**G**OOD standing for bees, miles of the finest Heather.—Apply, ERNEST HOLMES, East Moors, Helmsley, Yorks. v 44

**F**OR SALE, pure Irish honey, well filled sections.—SAMUEL SCOTT, Ballyronan, Magherafelt, Co. Derry. v 41

**F**OR SALE, 12 cwt. of pure new Cambridge-shire honey, light colour, 65s. per cwt. in purchaser's receptacles, or 68s. 6d. in non-returnable tins, f.o.r. CARTER, The Apiaries, Burwell, Cambs. v 56



# Editorial

## EXAMINATIONS.

The use or otherwise of examinations has been a debatable matter ever since they were inaugurated. There is no doubt that the consensus of opinion is that they are most useful, if only for two things. First, they enable the teacher to discover where he has failed to make his pupils understand their lessons; and second, to the students they reveal their ignorance and the necessity for close application to even the most simple subjects.

The teacher's failure is generally attributable to the mistake of taking it for granted that his students have a knowledge of, to him, simple matters, so he passes them by without explanation. The only safe way in teaching is to explain the subject to the pupils as if they were children about seven years old, and to ask questions from time to time to see if they have grasped and retained the knowledge imparted. After teaching for a quarter of a century we are convinced that examinations are useful for the above reasons, and also for stimulating the pupil's ambition, which results in closer application to work. Failure in even an unimportant examination has often been the salvation of a student.

The examinations of the British Bee-Keepers' Association are ridiculed at times, and one often hears the question asked, "Of what use or value are they?" The answer is that there are hundreds of people in the British Islands who are better bee-keepers to-day than they would have been had they not taken these examinations and so had some of the conceit taken out of them.

It is a mistake to imagine that they are easy and that no preparation is necessary, as so many have found to their cost when they have faced the ordeal.

Founded on the sound principle of combining practice with theory, they have played no unimportant part in raising bee-keeping to the high status it now enjoys in these islands. Our advice to those who imagine that it is quite easy to pass the tests is to "try and see."

## SCHOOLMASTERS AND BEE-KEEPING.

There is no doubt that schoolmasters can, and do, help considerably in extending a knowledge of and creating an interest in rural pursuits by instilling knowledge into the receptive minds of children. Mr. C. R. Forse, the Secretary of the Staffordshire Association, is no exception to the rule, and he has been responsible for the teaching of bee-keeping being adopted by the County Council of his county. In the photograph (page 312) he is shown with the bee exhibit staged by him under the County Councils' Association in the Education Department at the Royal Show this year at Shrewsbury. Space does not permit us to give particulars of the exhibit, but it was both instructive and interesting.

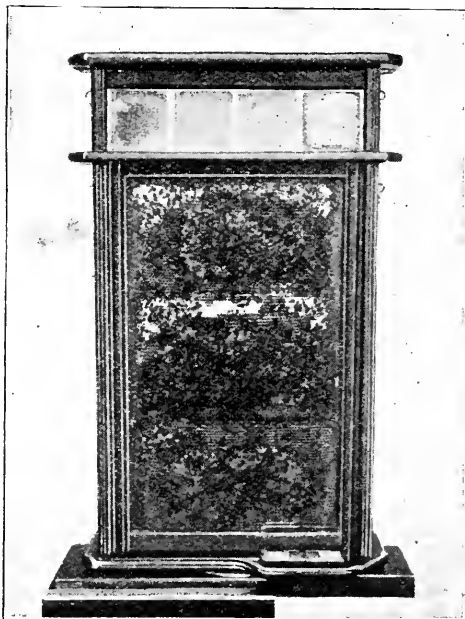

OBSERVATORY HIVE MADE BY MR. SIMCOX.

Another Staffordshire schoolmaster, Mr. A. W. Simcox, Fallings Park, Wolverhampton, was also in evidence, winning first prize with an observatory hive made by himself from the drawings and working instructions printed in the *BRITISH BEE JOURNAL*. We give an illustration of the hive taken at the show, but the camera fails to give an idea of the splendid workmanship, which was equal to that of a professional cabinet-maker.

## SENDING SPECIMENS FOR ADVICE.

May we draw our readers' attention to the "Editorial" in the "B.B.J." for January 15th, on "The Packing of Specimens sent for Advice," also to the conditions printed at the head of our Queries and Replies and Notices to Correspondents columns. A number of our readers who send queries and samples of bees and honey do not read the conditions mentioned, or they forget them. We have had samples of bees during the last few weeks with no mark to say whence they came, except the post mark, and that is often unreadable. It is surely not much trouble when bees or honey are sent in a separate package for the sender to write his or her name on it. When sending bees for diagnosis

number of entries was well above the average, and the quality of the Honey was exceptionally good. The success of the show was largely due to the untiring efforts of Mr. J. W. Brewer, the Honorary Show Secretary, and to Mr. W. A. Withycombe, who assisted him in the staging of the exhibits. During the afternoon Mr. J. W. Brewer gave an instructive lecture on the "Isle of Wight Disease," which was well attended.

The judges, Mr. T. W. Cowan, Colonel H. F. Jolly, Mr. S. Jordan, and Mr. L. E. Snelgrove made the following awards:—

*Finest Collection of Honey and Wax of any year.*—1st, H. J. Moore, Radstock; 2nd, R. J. C. Ferguson, Bishops Lydeard; 3rd, H. J. Prescott, Bath; 4th, H. Kingston, Whitechurch.



MR. C. R. FORSE WITH BEE EXHIBIT AT SHREWSBURY.

it is not enough to place from one to fifty bees in a box with the curt query, "Please report on enclosed bees." Always give particulars of any symptoms noticed and treatment given, and if an answer is required by post enclose a stamped addressed envelope, not a loose stamp. In any case, always send full name and address, which will not be published. We go to press on Tuesdays, therefore any queries requiring an answer in the next issue of the JOURNAL should reach this office not later than Monday. To quote from the article mentioned above: "We are at all times pleased to be of service to our readers, and therefore it is only right that we should receive consideration, especially as our services are given gratuitously."

## SOMERSET B.K.A.

The annual show of the Somerset Beekeepers' Association was held on July 23rd at Bath, in connection with the Larkhall Horticultural Society's Exhibition. The

*Best Twelve 1-lb. Bottles of Extracted Honey.*—1st, A. H. Bowen, Cheltenham; 2nd, H. J. Moore; 3rd, E. Bourne, Kilmersdon; 4th, H. Kingston.

*Best Twelve 1-lb. Sections of Comb Honey.*—1st, C. W. Dyer, Newbury, Berks; 2nd, R. Lane, Writhlington; 3rd, H. Kingston; 4th, A. H. Bowen.

*Best 1-lb. Bottle of Honey (not granulated).*—1st, F. Bird, Little Canfield, Dunmow, Essex; 2nd, F. D. Hills, Alton; 3rd, A. C. Jackson, Thetford, Norfolk; 4th, H. J. Moore; v.h.c., E. Bourne; h.c., R. Lane.

*Best 1-lb. Section of Comb Honey.*—1st, F. Bird; 2nd, C. W. Dyer; 3rd, R. Lane; 4th, A. H. Bowen; v.h.c., H. Evans, Bruton.

*Best Collection of Beehives and Appliances.*—1st, Ward and Co., Bath.

*Educational Exhibit.*—1st, J. W. Brewer.

## LOCAL CLASSES FOR BATH.

*Best Six Sections of Comb Honey.*—1st, F. G. Hales, Wellow, near Bath; 2nd,

H. E. Holder, Bath; 3rd, H. J. Prescott, Bath; h.c., S. Jones, Bath.

*Best Six Bottles of Extracted Honey.*—1st, F. G. Hales; 2nd, F. J. Exton, Bath; 3rd, H. J. Prescott; v.h.c., F. Jones.

CLASSES OPEN TO MEMBERS OF THE ASSOCIATION ONLY.

*Best Exhibit of Beeswax, not less than 1-lb.*—1st, R. Lane; 2nd, H. Kingston; 3rd, J. W. Brewer, Bath; v.h.c., E. Bourne.

*Observatory Hive with Bees.*—1st, H. J. Prescott; 2nd, A. Withycombe, Bridgewater.

*Best Three Shallow Frames of Comb Honey.*—1st, F. G. Hales; 2nd, E. Bourne; 3rd, R. Lane; v.h.c., H. Kingston; h.c., R. J. C. Ferguson.

*Best Three Bottles Granulated Honey.*—1st, R. Lane; 2nd, H. Kingston; 3rd, H. J. Prescott; h.c., W. Evans, Wincanton.

*Best Six Sections of Comb Honey.*—1st, H. Kingston; 2nd, R. Lane; 3rd, A. J. Hawkins, Halse, Taunton; v.h.c., W. Evans; h.c., H. J. Prescott.

*Best Six 1-lb. Bottles of Extracted Honey (Light or Medium).*—1st, R. Lane; 2nd, E. Bourne; 3rd, A. Gibbs, Norton Manor, Taunton; h.c., R. Litman, Castle Cary.

*Best Six Bottles of Dark Honey.*—1st, V. Davis, Sparkford, near Bath; 2nd, R. Lane; 3rd, H. J. Prescott.

NOVICE CLASSES.

*Best Three Sections.*—1st, E. Bourne; 2nd, W. Cuffe, Bridgewater; 3rd, H. Evans, Bruton.

*Best Three 1-lb. Bottles.*—1st, E. Bourne; 2nd, F. J. Exton; 3rd, H. J. Prescott; h.c., H. Evans.

The Challenge Honey Pot (presented by Colonel H. F. Jolly) was won by R. Lane.—L. BIGG-WITHER, Hon. Sec.

LINCOLNSHIRE B.K.A.

The annual exhibition of the Lincolnshire Bee-keepers' Association was held in connection with the Lincolnshire Agricultural Society's Show at Boston on July 16th and 17th.

A record entry had been obtained, and as most of the entries were staged, the exhibition was a great success. The quality of the honey, however, was not up to the standard of previous years. The judges were Dr. Percy Sharp (Swallowbeck), Mr. D. Seamer (Grimsby), and Mr. H. J. Banks (Wragby). Mr. R. N. Chapman (Boston) ably carried out the duties of steward.

Several demonstrations were given each day in the bee tent by Mr. H. J. Banks before large and appreciative audiences. The following were the awards:—

HONEY, HIVES, &c.

*Comb or Extracted Honey and Wax*

(*Open*).—1st, T. W. Swabey, Bracebridge Heath; 2nd, J. H. Hatfield, Alford; 3rd, F. Harris, High Ferry, Sibsey.

*Silver Medal.*—J. H. Hatfield.

*Bronze Medal.*—F. Harris.

*Twelve Sections of Comb Honey (Open).*—1st, Miss M. Wilson, Great Canfield, Dunmow; 2nd, T. W. Swabey; 3rd, W. Ion, Healing, Grimsby; 4th, Rev. W. Towers, South Thoresby, Alford.

*Extracted Honey, total weight to approximate 12-lb. (Open).*—1st, Mrs. A. Herring, Braucewell, Lincoln; 2nd, C. H. Marshall; 3rd, W. Patchett, Cabourne, Caistor; 4th, Mrs. G. Pilkington, Braucewell Grange, Lincoln.

*Twelve Sections of Comb Honey (County).*—1st and silver medal, Miss E. W. Davis, Market Rasen; 2nd and c., Mrs. G. Pilkington; 3rd, W. Ion; 4th, W. Patchett.

*Light Extracted Honey (County).*—1st and silver medal, W. B. Allister, Throckenholt, Wisbech; 2nd and bronze medal, C. H. Marshall; 3rd, W. Patchett; 4th, W. Wass, East Heckington, Boston; h.c., Mrs. A. Herring and A. H. Smith, Eastgate, Louth.

*Extracted Honey, other than Light (County).*—1st, C. Fairweather, Anton's Gowt, Boston; 2nd, W. Wass; 3rd, E. Robinson, Gosberton.

*Run Honey (Members).*—1st, W. Ion; 2nd, J. S. Baldry, Lincoln; 3rd, Rev. C. D. Baron, Alford.

*Granulated Honey (Open).*—1st, W. Patchett; 2nd, Mrs. G. Pilkington; 3rd, C. H. Marshall.

*Six 1-lb. Jars of Run Honey and Six Sections (Cottager).*—1st, F. Harris, Sibsey; 2nd, W. B. Allister, Wisbech.

*Beeswax (Open to County of Lincoln and to Members of the Lincolnshire Beekeepers' Association only), not under 3-lbs. nor over 5-lbs. in weight, produced by the exhibitor's own bees.*—1st, J. Balderstone, Authorpe; 2nd, Wm. Patchett, Cabourne; 3rd, Mrs. A. Herring, Braucewell, Lincoln.

*Observatory Hive, stocked with Bees and Queen (Open).*—1st, T. W. Swabey; 2nd, J. H. Hadfield, Alford.

APPLIANCES.

*Hives and Bee Furniture, applicable to the modern system of bee-keeping, to be staged on fifty superficial feet.*—1st, W. P. Meadows, Syston, Leicester; 2nd, J. Lee and Son, Ltd., Uxbridge; 3rd, E. H. Taylor, Welwyn, Herts.

*Hive for General Use.*—1st, J. Lee and Son; 2nd, E. H. Taylor; 3rd, W. P. Meadows.

*Hive for General Use.*—1st, E. H. Taylor; 2nd, J. Lee and Son; 3rd, W. P. Meadows.

*Any Appliance connected with Bee-keeping, recently introduced.*—1st, W. P. Meadows.

## NOTTS B.K.A.

The annual show of above was held in connection with the Southwell Horticultural and Gardening Society on "Lowes Wong," in the Cathedral city, on Thursday, July 23rd, the honey show being accommodated in a separate tent, which rather unfortunately proved too small for the effective display of the numerous exhibits. The weather was threatening all the day, but the rain kept off until towards the close. The honey tent was well patronised throughout the day, and appeared to be one of the most attractive spots on the show-ground, judging by the number of people always in it and from the many remarks overheard concerning it. The bee tent was also there, and demonstrations were given to very interested and enquiring audiences. There was also a "Training Class for Judging Honey" at this show, and a good number of bee-keepers availed themselves of it.

The judges were Dr. Percy Sharp, Swallowbeck, Lincoln, and Dr Thos. S. Elliot, of Southwell, and following is a list of their awards:—

*Winner of the "Herrod" Silver Challenge Vase.*—James North, Sutton-in-Ashfield.

*For Best Single Jar of Extracted Honey.*—1st, A. H. Bowen, Cheltenham; 2nd, J. North, Sutton; h.c., H. C. Jackson, Elveden; c., Miss Hale, N. Devon.

*Best and Most Attractive Display of Honey.*—1st, D. Marshall, Nottingham; 2nd, G. Marshall, Norwell.

*For Best Six Sections of Comb Honey to approximate 6-lbs., produced in 1914.*—1st, J. North, Sutton; 2nd, D. Marshall, Nottingham; 3rd, G. Marshall; h.c., W. Doleman, Keyworth.

*Twelve Jars of Best Light Colour Extracted Honey, to approximate 12-lbs., produced in 1914.*—1st, J. North; 2nd, J. T. Wilson, Shirebrook; 3rd, J. T. Duckmanton, Langwith; 4th, W. H. Mellors, Norton; h.c., J. C. Mellors; c., W. Lee.

*Twelve Jars of Best Dark Colour Extracted Honey to approximate 12-lbs., produced in 1914.*—1st, J. North; 2nd, G. Marshall; 3rd, A. G. Pugh, Beeston; 4th, H. Merryweather; h.c., W. Lee; c., Mrs. Waller.

*Six Jars of Best Granulated Honey, to approximate 6-lbs., produced in any year.*—1st, A. G. Pugh; 2nd, J. T. Wilson; 3rd, W. Mountney, Southwell; h.c., G. Marshall; c., J. T. Duckmanton.

*Best Shallow Frame of Honey suitable for Extracting, produced in 1914.*—1st, J. T. Wilson; 2nd, J. North; 3rd, G. Marshall; h.c., D. Marshall.

*Best Three Jars of Extracted Honey, produced in 1914 (for Members not having*

*previously taken a prize).*—1st, R. B. Hutchinson, Bilsthorp; 2nd, G. H. Worth, Long Eaton.

*Best Specimen of Bees of any race, with Queen, on best and most complete Single Comb in Observatory Hive.*—1st, H. Merryweather; 2nd, J. T. Duckmanton; 3rd, G. Marshall; 4th, J. North; h.c., W. Lucas; c., W. Mountney.

*Best Sample of Beeswax in six pieces to approximate 2-oz. each.*—1st, G. Marshall; 2nd, John Bee, Southwell; 3rd, J. North.—GEO. HAYES.



*Apodes and Apides* (p. 241).—I can hardly agree with Mr. Snelgrove that it is difficult to move hives on benches. I should have said it was both quicker and easier. My hives are arranged in this way, and it is the simplest thing to slide a hive to right or left. This makes certain manipulations possible, without involving conditions of level. As for removal, it is simply a question of a sufficiency of accommodation. Given sufficient gantrys, these apodal hives can be picked up and put down correctly in far less time than where no permanent stands exist. I had a striking illustration of this the other day. A stock began to swarm just as I was leaving home. As the queen came out I caught her with a match box. The swarm clustered during the time it took me to remove the hive, place an empty one on the old stand, and slip the box over the frames. When I returned at night, the swarm was satisfactorily settled in the new hive. The disadvantages mentioned by Mr. Snelgrove relate more to the regularity and similarity of hives than to their style of support, and this regularity may occur with ordinary hives. But the overwhelming reason for my gantrys is that, as a moor-going bee-keeper, I cannot tolerate legs, the case against which is well put by D. Wilson (p. 247).

*Hive Legs* (p. 242).—I am not sure whether Mr. Snelgrove's directions for fitting the legs can be followed by everyone, but they are undoubtedly accurate. I take it that it is unnecessary to run the bevel line right around the leg where the joist is to be let in. This prevents a possible error. To let the joist in, the tenon saw is sunk sufficiently along the line, and the wedge-shaped pieces removed with the chisel. I am not able to see the advantage of making the "W.B.C." stand and floorboard separate. It is cheaper,

and, I think, quite as good, to make the floor and stand in one. Nails are not much good as feet, and the ant-proof shoes do not protect if weeds are allowed to touch the leg. Why not make the legs of creosoted wood? I have one hive made thus, and it has remained sound and good for over ten years, although standing directly on the earth most of the time.

*Success at the Heather* (p. 246).—One or two points occur to me as questions upon D. Wilson's helpful article on moor-going, which article (9037) is, by the way, a fairly full and opportune "reply" to No. 9036. In my district the clover flow is often late, and sometimes runs right up to heather bloom. Others, perhaps, may have the same experience. How then can a young queen build up a stock in the "interval"? And where an interval of several weeks does actually occur, her bees will hardly be ready for harvest work, whilst brood-rearing will have made demands upon the stock. On the other hand, honey may be forced above, both by the presence of the brood, and the temper of the bees, which may be the point D. Wilson desires to make. But if a young queen is expanding the brood-nest, the reason for dispensing with excluder does not appear quite consistent. Not that an excluder is at all necessary. Indeed, I find that the woodwork of the section frames, and an inch or two of honey above the brood nest, are as effective as excluder zinc without its disadvantages. But sometimes pollen goes into the sections, and excluder will to a large extent prevent this trouble.

*Drone Brood for Chickens* (p. 252).—I must confess that I do not quite see what is wrong with the directions given by the gentleman who has assumed the mantle of C. N. White. Chickens really revel in this dish, and I never waste any such surplus pieces. They will pick out every grub once they learn the trick. Just shake a few out on the ground, and watch them do the rest. I really do not see why we should not eat them ourselves. I suppose it would be no use to bring them to the notice of Mr. Eustace Miles, but perhaps Colonel Newnham Davis might be induced to try them.

*Native v. Foreign Bees* (p. 253).—Here are two letters which very strongly advocate foreign bees as resistant to certain diseases and the question should undoubtedly be considered carefully even by those of us who are most prejudiced in favour of our own race. Facts are what we most desire, and no one can blame another who acts in accordance with his experience. For we are passing through troublous times, and although foreign bees may be inferior to our own in certain respects, it is better to have foreign bees than no bees at all. I believe, however, and I trust that the wish

is not father to the thought, that we are pulling through with the help of Nature, and that it will not be necessary to hire any foreign mercenaries to help us to fight the invader. Of course, gentlemen, you have yourselves to blame, and you will excuse my reminding you of it. You import these foreign disease carriers, and then suddenly hail them as immune to the diseases they have brought. Then you praise them for this, blind for the moment to their characteristic faults. May God save for us our good friend the English bee.

---



---

#### EXTRACTS FROM AN EXPERT'S DIARY.

By J. Herrod.

I have noticed a number of bee-keepers "haven't time" to look after their bees, except when the expert calls. One of these very busy men had not had time to take off his sections for two years, but he managed to spare a considerable amount of time when I called on him. The hive was one of those ancient abominations with the sides  $1\frac{1}{2}$  to 2 inches higher than the frames, forming a kind of well into which the racks are dropped. Of course, after that lapse of time the rack was tightly glued down, the bottom of the hive was also fast, and we had to use a crowbar before the rack could be moved. The bees were then found to be badly affected with foul brood. Another bee-keeper of this class lived at an hotel, and since the previous year had not had time to take off his surplus. I took off some very nice sections, when he remarked how pleased he would have been to have had them earlier, as some of his guests had asked for honey and he had none!

Occasionally, very bad-tempered bees are met with. When an expert does the work in one county or area for several years consecutively, he knows at which apiaries he may expect to have a warm time. Generally these vicious bees are hybrids. I have in mind one apiary that was started with Ligurians. In course of time the young queens mated with native drones and their progeny are not only "crossed," but cross, and give the owner and his man a lively time when they are manipulating. I fancy the master looks upon it as somewhat of a joke when the man gets stung; the latter on one occasion was doing something at the bees without a veil and got a severe stinging about the head and face, his master remarking that the number of stings in his face and chin caused him to look as though he needed a shave. The most vicious strain of bees I ever came across belonged to a clergyman. There were six stocks, but by the time we had looked into two we were glad to beat a retreat, and that, the owner

remarked, was the usual thing; some of them had been so bad he had destroyed them. Two other bee-keepers who had bad-tempered bees made good use of their propensity to sting. In each case the public were taking a short cut across their land, and it seemed impossible to stop them, until a hive or two of these bees were placed in the track, and they were as effective as a bull at large in the field would have been.

I had a most interesting talk on bee and other matters with two gentlemen whom I assisted at short intervals. The first was a "Uitlander" (this was at the time of the Boer War), who had been "commandeered" to fight for the Boers, but had "trekked" to fair Devon instead, and had therefore been condemned to be shot by the Boers—if they could catch him. When examining his bees, his wife and a lady who was visiting them, also from South Africa, were interested spectators. The lady was not accustomed to bees, but was not wearing a veil. She was told that if a bee should come near her, and she kept perfectly quiet, it was not likely to sting. After a short time she remarked quite coolly, "There is a bee on my face, what must I do now?" It was gently flicked off without any damage being done. The other gentleman was a doctor and a skilled bacteriologist, who had been down the crater of Mont Pelée only a short time before its destructive eruption.

In the course of my wanderings I have found that in diagnosing foul brood many bee-keepers attach too much importance to the smell. If they cannot smell anything wrong by placing the nose near the hive entrance, or on lifting the quilts, they jump to the conclusion that the brood is all right, when quite likely on examining the combs diseased brood may be found, either odourless foul brood or the early stages of the virulent variety. On three occasions only do I remember being able to detect the characteristic smell of foul brood when standing near the hive and before opening it. The worst of these cases was in South Devon, where, in an apiary of five stocks nearly every one was putrid with disease, which could be smelt two or three yards away from the hives. In my experience it is only when nearly the whole of the brood is absolutely rotten that the stench may be detected outside the hives.

The following incident relating to "telling the bees" when a death has occurred in their owner's family was told me at Honiton. The owner—a farmer—had died; just as the funeral cortège was starting, one of the labourers asked if "the hives had been turned," as if not the bees would all die. They had not been "turned," so he was told to do it. He succeeded in picking up one and

turning it round, but that was all. The next proceeding was to get him free from bees, take him in the house and send off post haste for the doctor. It is interesting to read of these old superstitions, and the various methods of telling the bees of a death, &c. An old bee-keeper died at a village some three miles from my native village. The hives (skeps) were draped with black crêpe, some cake and wine placed on the alighting-board, and someone rapped on each hive with the front door key and told the bees "Your master is dead."

(To be continued.)



*The Editors do not hold themselves responsible for the opinions expressed by correspondents. No notice will be taken of anonymous communications, and correspondents are requested to write on one side of the paper only and give their real names and addresses, not necessarily for publication, but as a guarantee of good faith. Illustrations should be drawn on separate pieces of paper. We do not undertake to return rejected communications.*

#### A DEVON BEE-KEEPER'S EXPERIENCES.

[9060] I was asked by a person unknown to me to examine some bees about three miles away. I went the following day, and found two strong stocks. One of them, a May swarm, had been hived on ten frames, in which the foundation was not wired, the consequence being that it fell, and the combs are built in all shapes, and will have to be cut out. Another smaller swarm had been hived on ten frames fitted with V shaped starters of drone foundation in centre of frames. This I was told had been advised by some person who was giving the owners instruction in bee-keeping! For two or three years they have had no honey. I have never seen bees with such scanty covering, neither stock being covered with more than one thin sheet of calico for fear of making the bees too hot. They were able to get through into the roof just as they pleased. No. 4 was a good stock in a skep. No. 5 was in a barrel laid on its side, the bung-hole being on the top with an empty skep placed over it to keep out the wet. I advised them to transfer the two latter into new frame hives.

One of my stocks affected with foul brood commenced building queen cells. They had no super on, so I thought I would let them swarm. Yesterday I examined them, thinking they might have swarmed without my knowledge, but as they are now much stronger than they

have been at any time this year, and also have two patches of healthy white larvæ, I conclude there is a new queen. There is also a fair quantity of sealed brood, some cappings of which look dark and sunken, but I hope Apicure will conquer the disease. On another stock I am trying a remedy which needs spraying on the combs, and am using a double ball throat spray for the purpose, but cannot tell yet what the result will be. I would rather use Apicure if I find it cures, but I think a stronger dose than is advised necessary.

I have spent over £1 in remedies and disinfectants this summer, as well as a lot of time, in fighting diseases.

The "Isle of Wight" disease puzzles me. One of the stocks first affected seems to be working up into health again, and in the evenings of hot days have sounded a good note at the entrance. The other, which was the worst, developed foul brood also. This is the one I am spraying, and of course it is not so strong.

I had a most curious experience with another stock. It was very strong, and had on three supers, but a large swarm issued in June. I moved the parent hive some distance away, and hived the swarm on the old stand in a hive treated with Ayles' cure. The stock immediately behind them was affected with "Isle of Wight" disease, numbers of bees being on the ground in front of it. The bees from the swarm seemed determined to get into the diseased hive; the reason being, I think, that it was the same colour as the one they swarmed from. It took me several hours to get them settled down. I next divided the combs in parent stock to raise two new queens. Judge what my feelings have been since, when day after day both these and the swarm have been sending out "crawlers" by hundreds, the swarm being the worst. The stock in the parent hive does not appear to be doing anything, but is surrounded by clusters of bees on the ground; the other half has appeared to be reviving and working well during the last fortnight.

Yesterday I examined all three again, and closed the swarm up on to six frames. The brood is healthy. The parent stock, which I thought not worth 2d., has worked out two new combs from foundation, and has seven combs full of honey and brood, and two patches of healthy larvæ from new queen; the other new stock has a new queen, and some healthy larvæ, and the crawling and clustering on the ground have nearly ceased from all three stocks.

I have never been so puzzled. I have kept bees for just over eighteen years, but this is more than I can understand. I keep the grass near the hives cut short, and have cut away the turf under them so that they stand on bare earth, and I try

to keep both inside and outside of hives as clean as possible. I should like to know if anyone else has had such an experience. I paid a visit to an apiary half a mile away, belonging to a man and his son, and found about twenty stocks of bees. Some were in old skeps, others in old boxes, buckets, &c., and not a hive among them that could be inspected. This apiary was on one side of the garden, and belonged to the father; on the other side the son is working up a row of a mixed kind in the same way. I have talked to them at different times, and tried to get them to change, but it all seems no good. Why should there not be a law to say that bees shall be kept in a proper way, just the same as for any other kind of stock? I am certain that one part of the bee-keepers who do their best have very often to suffer for the carelessness of others. Should there be a case of swine fever we find a motor car with an inspector from one place, another with a veterinary surgeon from another, and police and goodness knows who besides on the spot, and the thing is dealt with; but a careless bee-keeper may have one or more stocks die, and what does he do? In many cases he says, "Oh, never mind, I'll leave the butt (skep) there, and perhaps another lot will go into it this year or next." Meanwhile other bees rob out the stores, disease and all, and the Government of the country is asleep over the matter. Surely this ought not to be, it is unreasonable. I feel I would like to burn every skep or unmanageable bee hive in the country.—J. V., Axminster.

#### CURIOUS SWARMING.

[9061] I had a doubled hive. Finding some brood on all ten frames in the top half, and making sure the queen was down below, I removed this top half to a new situation on 11th May. Expecting a large number of bees to return to parent hive, I put on queen-excluder and three racks of sections. Although the bees went up, they gave off a large swarm—6lbs. or 7lbs. on 17th May. On examining this parent hive, I found nine combs of brood and honey (the latter I replaced with foundation), but to my surprise not one single queen cell, not even an "acorn." I returned the swarm and re-queened the removed portion with a 1914 queen on 17th May, but again to my astonishment they swarmed (a good 5lbs.) on 21st May, making well over 11lbs. from one queen in five days. The new queen had not laid a single egg up to that time.—A NOVICE.

#### HEATHER HONEY AS WINTER FOOD.

[9062] I have been much interested in the discussion, and it seems to me that the

sentence near the bottom of page 277, "Something may be due to weather or other conditions at the moors," has a great deal to do with differences of opinion on the subject.

As a beginner I took three stocks to the moors in 1912. The weather was bad, heavy rains, strong winds, and cold nights, even frost at the end of August. On returning, No. 1 had very little honey in brood chamber, No. 2 almost overdone with it, No. 3 nearly sufficient to carry them through the winter. In the spring 1913 (January) No. 2 started a rather bad attack of "Isle of Wight" disease, No. 3 had it later on not so bad, and No. 1 hardly at all. Thus the stock with most heather honey suffered most, and the one fed with syrup hardly suffered at all.

So possibly, heather stores gathered in a wet season may be bad as a winter food.

A friend informed me that pollen from heather, under certain circumstances, is rank poison for bees. Is this so?—**HEATHER.**

#### THE IMMUNITY CHIMERA.

[9063] The fact that Mr. Heap chooses to exaggerate and distort my argument shows pretty clearly that he feels his own to be weakened by it. It is surely as easy for a bee to pick up a beneficent microbe as a hostile one. Mr. Heap is able to imagine the latter because he knows that it has been done, but the former is impossible for him to imagine. It is not true to say that I "brush aside" the *a priori* argument. Mr. Heap brushes aside Zander and ends by relying on such a state of affairs as Zander proved. He now doubts whether there is any such thing anywhere as "absolute immunity." I doubt whether anyone ever suggested that there was; certainly I should not. What I am looking for and what I see coming is a state of affairs in which *Nosema apis* is (once more) not fatal to an ordinarily healthy bee community. The weaklings will spring dwindle, as they did in the past, others will die in the winter, and the loss be put down to the absence of two sticks under the quilts, malignant dysentery will not be unknown, and inconvenient Zanders will find *Nosema apis* in healthy colonies, but the "Isle of Wight" tornado of 1904-15 will be more or less forgotten. Mr. Heap and I will be found to be at one in this hope. He cites cases like mine of colonies showing "A remarkable reluctance to become defunct in a reasonable and proper time." He says it is not the bee developing immunity, but the disease developing weakness. I will agree. It doesn't matter whether the bee beats the disease or the disease beats itself on the bee. Action and reaction are equal and opposite. But

when Mr. Heap says, as he does in the next breath, that we must work for getting rid of *Nosema apis* altogether.—well, that's where my imagination breaks down.—**G. G. DESMOND, Sheepscombe, Gloucestershire.**

#### "ISLE OF WIGHT" DISEASE.

[9064] I am writing this thinking it may be of some use to other bee-keepers. The first case of "Isle of Wight" disease in this district that I heard of was in June, 1913. I was asked to look at the bees, and found them dying by hundreds, I tried different so-called cures, but they at last died out. In one orchard the bees died out from the end of July, 1913, to the middle of February of this year; fourteen stocks in all, one native stock surviving, the queen in this was a virgin when put in the orchard.

In another orchard I had seven stocks, three natives and four Italian hybrids, the three natives died early in the year; two of the hybrids got so weak (through robbing neighbouring hives that had been left open by careless bee-keepers) I did not know what to do with them—to destroy or try to cure—as they were down to two combs of bees.

On February 21st I procured some lime and slacked it, then threw some of it in at the entrance as far as possible, and also put some on top of the first quilt and down between the outer case and brood-box, and put two small pieces of camphor in the back of the hives. To-day the bees are on three sets of standard combs with a rack of shallow combs above. Since then I have only lost one stock of natives, which were too weak to recover.

A friend of mine had a stock affected with "Isle of Wight" disease in June, the bees had worked out and filled a rack of shallow combs and a rack of sections; they then began to die off, and left the supers, these he took off and tried the lime and camphor treatment; in twelve days' time they were back in the supers as soon as he put them on.

If other bee-keepers would like to try this remedy I hope they will have the same success. I could mention other cases that have been treated with lime and camphor, but am afraid of encroaching too much on your valuable space.—**H. K. HARTLEBURY.**



\*\*\* Owing to Monday last being Bank Holiday we are unable to reply to a number of queries in this week's



JOURNAL. The answers to these will appear in our next issue. Urgent queries will be replied to per post if a stamped addressed envelope is enclosed.

[8968] *Utilising Fermented Honey.*—Will you kindly tell me through the "B.B.J." if honey that is slightly fermented can be used for making vinegar, and, if so, whether it would have to be boiled first to destroy the original ferment? —JOHN D. TICKLE.

REPLY.—It is quite suitable for vinegar making; in fact, that is the best use to which you can put it. Do not boil, only add 1 gall. of warm water to every 2 lbs. or 3 lbs. of honey, and allow the fermentation to continue.

[8969] *Mead-making.*—Will you kindly state in the columns of the BRITISH BEE JOURNAL how mead is made from honey? Is mead made in the present day or is the art of making it lost? I see no such question as mine in your paper, but many may like to know how to make it as well as myself.—LILIAN REES.

REPLY.—You had better send to this office for "Mead and How to Make It," 2½d. post free. The art is not lost; we should say the quantity of mead made is increasing.

## Bee Shows to Come.

A nominal charge of 2s. 6d. is made for notices (not exceeding 7 lines) in this column, 10 lines charged 3s. 6d., up to 15 lines 5s., which covers cost of insertion from order till date of show. Cash should accompany orders for insertion.

**August 5th and 6th, at Abington Park, Northampton.**—Northants B.K.A. Annual Honey Show. In connection with the Municipal Show. Special prizes for open classes, including one for single lb. jar. Entry free. Schedules from R. Hefford, Kingsthorpe, Northants. Entries closed.

**Aug. 6th, at Bromham Park, Bedford.**—Honey show in connection with Biddenham and Bromham Flower Show, to be held in Bromham Park, near Bedford. Open classes for honey. Schedules from A. Henman, Bedford-road, Biddenham. Entries closed.

**August 12th, at Wye, near Ashford, Kent.**—Kent Honey Show, 13th Annual Exhibition. Classes to suit all bee-keepers. Splendid prizes. One 6 guinea and two 5 guinea Challenge Cups; also two champion silver cups. A class for honey put up in short bottles, and a new class this year for best six photographs of bee life (taken by exhibitor); 2 silver medals for best exhibits of bee appliances. 26 different classes. Prize schedule and entry form free on application to Mr. Alfred Lepper, secretary, Kent Honey Show, Scotton-street, Wye, Kent. Prize schedule and entry form will be sent to all exhibitors of last year without application.

**August 18th and 19th, at Brighton.**—The Fourth Annual Show of the Sussex Beekeepers' Association, in connection with the summer show of the Brighton, Hove, and Sussex Horticultural Society. Seven Open Classes. Liberal Prizes. Schedules from C. A. Overton, Bectcroft, Crawley. Entries close August 10th.

**August 19th, at Radstock.**—Honey show, in connection with the Radstock and District Horticultural and Fanciers' Association. Schedules from B. M. Clark, Fox Hills, Radstock.

**August 25th, 26th, and 27th, at Newcastle.**—Northumberland Bee-keepers' Association. Exhibition of honey and wax, in connection with the Newcastle Flower Show. Nine open classes. Schedules and entry forms from R. H. Newton, 24, Grainger-street West, Newcastle, or Captain F. Sitwell Wooler. Entries close August 20th.

**August 26th, at Prestbury.**—Honey show, in connection with the Prestbury Flower Show. One class open to the kingdom. Several for those within 12 miles radius. Exceptional prize list. Schedules from A. H. Bowen, Coronation-road, Cheltenham.

**August 26th, at Chester.**—Annual Show of the Cheshire Bee-keepers' Association, in connection with Cheshire Agricultural Society. Several open classes. Good prizes. Schedules from T. A. Beckett, St. Werburgh Chams., Chester.

**August 26th and 27th, at Rugby.**—Exhibition of the Warwickshire Bee-keepers' Association, in connection with the Warwickshire Agricultural Society's Show. Open and county classes. For schedules apply, J. R. Ingerthorp, Knowle, Warwickshire. Entries close August 17th.

**August 29th, at Nantwich.**—In connection with the Annual Flower Show. Bee demonstration by Mr. Franklin, the noted Cheshire bee expert. Classes for honey, both in comb and extracted. Schedules and entry forms from Hon. Sec., Mr. Lloyd, Hillfield Place, Nantwich.

**September 1st, at Deddington.**—Honey show in connection with Deddington Horticultural Society's Show, to be held in the Castle Grounds. Open classes for honey. Schedules from H. J. Harnsworth, Deddington, Oxon.

**September 2nd, at Lancaster.**—Agricultural Show. Premier Honey Show of the North. 15 classes; £20 in cash prizes, silver cups and medals value 13 guineas, and other specials. Send for schedule (Honey) to Robert Gardner, solicitor, 69, Church-street, Lancaster. Entries close August 19th.

**Sept. 5th, at the Club Room, North-road, Kew.**—Honey Show of the Richmond and District Bee-keepers' Association. Open classes for honey and wax. For schedules, apply Hon. Sec., Mr. J. G. Romer, 234, Kew-road, Kew-gardens. Entries close August 28th.

**September 9th, at Stoke Park, Guildford.**—Annual Exhibition of honey, wax, appliances, &c., will be held by the Surrey B.K.A. in connection with the Guildford and West Surrey Agricultural Association. Eighteen classes, five open to all. Many medals. Schedules from F. B. White, hon. secretary, Marden House, Redhill, Surrey. Entries close 31st August.

## Notices to Correspondents

\*\* Will the person who sent a postal order, value 2ls., to Mr. Cowan's private address on March 5th of this year kindly let us know what it is for, as there is nothing to indicate this, or yet who it is from. It is issued and posted at St. Giles, Oxford.

J. B. B. (Barrow).—*Bees Failing to Locate Hive.*—We can only suggest that you make a greater difference in appearance of your window. Could you not paint it a different colour, or put up a sun blind?

T. MILLAR (Lanark).—*Bees Killing Queen*.—Did you make sure bees had not started queen cells before placing the cage in position? You should have tried a coarser needle before pushing your finger through; the queen would be liberated too quickly.

H. T. (Worsley).—*Preventing Swarming*.—(1) As you found queen cells on the combs examined probably there are more on the other combs. Look them over if possible, and cut out any queen cells you may find, and bees will not be likely to swarm now. (2) They are probably young bees. You have done quite right in giving them ventilation and more work.

NOVICE (Burnham).—*Bees in Roof*.—Impossible to say without seeing them.  
*Suspected Disease*.

T. G. (Falkirk).—(1) Bees are suffering from "Isle of Wight" disease. (2) Natives. We shall be pleased to hear from you again.

H. S. (Bailaer).—It is "Isle of Wight" disease. You had better burn the few that are left, also combs, &c.  
"CYMRU," and J. W. S. (West Cumberland).—Bees have "Isle of Wight" disease.

F. WATERS (Banbury).—There are no symptoms of "Isle of Wight" disease.

#### *Honey Samples*.

A. FARNELL (Sussex).—(1) Very good quality. (2) From clover. (3) From Is. to Is. 3d. (4) Yes, quite. (5) Light.

W. COLTER (Suffolk).—The honey is all right in colour, but is thin and also fermenting.

INQUIRY (Ayr).—The piece of comb sent contains nothing worse than a little pollen.

E. E. D. (Hants).—There are a few *Nosema* spores in bees sent.

### Special Prepaid Advertisements

Two Words One Penny, minimum Sixpence.

Orders for three or more consecutive insertions entitle advertisers to one insertion in "The Beekeepers' Record" free of charge.

Trade advertisements of Bees, Honey, Queens, and Bee goods are not admissible at above rate, but will be inserted at 1d. per word as "Business" Announcements, immediately under the Private Advertisements. Advertisements of Hive-manufacturers can only be inserted at a minimum charge of 3s. per  $\frac{1}{2}$  in., or 5s. per inch.

### PRIVATE ADVERTISEMENTS.

PRIZE Cotswold honey, beautiful flavour, few 1lb. jars 9d. each; 8s. 6d. dozen; sections, in cases, 9s. dozen.—OWEN, Liberal Club, Cheltenham. v 22

FOR SALE, one strong stock of healthy hybrids, from Simmins' White Star Italians, 1914 queen, 25s., f.o.r.—Apply, W. E. BURGESS, Newport Pagnell, Bucks. v 19

HEALTHY June swarm, eight frames, 15s., f.o.r.; box, 2s.; overstocked.—PULLINGER, Milford, Surrey. v 17

SPLENDID first quality sections, 10s. dozen, carefully packed, safe delivery guaranteed; also few fit for keenest display; particulars, stamp for reply.—NORTH, Cressing, Braintree, Essex. v 15

SIX DOZEN first grade sections honey, well packed, 8s. 6d. per dozen, cash.—TREBBLE, Romansleigh, South Molton. v 12

PURE light Cambridgeshire honey, in 28lb. tins, 58s. 6d. per cwt.; sample, 3d.—v. JOCKMAN, Cherryhinton Post Office, Cambridge. Left till called for. v 13

ONE TON Cambridgeshire honey, direct from apiary, for sale; sample, 6d.—T. L., "B.B.J." Office, 25, Bedford-st, Strand, W.C. v 11

FOR SALE, healthy stock of English bees, 25s.—BENNETT, Harford, Wellington, Somerset. v 10

200 LB. extracted clover, at 8d. lb., 28lb. lots or more; sample, 2d.; sections, 9s. dozen.—DR. LLOYD, Cradley Heath, Staffs. v 8

PURE English honey, 56s. per cwt.; sample, 2d.—J. TOMLIN, Windmill-terrace, St. Neots, Hunts. v 9

PURE Essex honey, 28lb. tins, at 15s. per tin, chiefly from fruit blossom; tins free; sample, 3d.; cash with order, carriage forward.—J. PEARCE, Eariswood, Rectory-road, Little Thurrock, Grays, Essex. v 7

FOR SALE, splendidly bred, three Pekingeses puppies, nine weeks old, make lovely pets, 3gs. and 4gs. each, or nearest offer; pedigree and full particulars on application.—S. BAILEY, Oak Villa, Two Mile Ash, Horsham. v 6

FOR SALE,  $1\frac{1}{2}$  cwt. pure English honey, light colour, 60s. per cwt., carriage forward, cash with order; sample, 3d.—MARTIN, Wimbish, Walden, Essex. v 5

FOR SALE,  $3\frac{1}{2}$  acres land, with good bungalow and outbuildings, fruit trees, &c.—JOHNSON, Sheepdrove, Lambourn, Berks. v 4

SIX DOZEN sections, first quality, 10s. per dozen.—H. EVANS, Scampston Hall, York. v 89

HONEY, 2 cwt., from fruit, &c., slightly dark in colour, in 28lb. tins, at 56s. per cwt., f.o.r.; sample, 2d.—HENRY GOW, Crossford, near Dunfermline. v 84

SURPLUS 1914 queens, English, 4s.; special hybrids, 5s. 6d.; imported Italians, 4s. 6d.—WHEATLEY, expert, Spa Apiary, Hinckley. v 83

A FEW good 1914 tested queens, 6s. 6d. each; nuclei, three or four frames, 14s. 6d. and 16s. 6d., boxes free.—APIARY, 157, Camden-road, N.W. v 81

TEEMING STOCK healthy bees, 1914 queen, 25s.; inspection invited.—VINCENT, 132, Croydon-road, Anerley. v 80

HEALTHY STOCKS for sale, on frames and skeps; particulars.—JONES, Cwmeislan Apiary, near Dolgelly. v 1

PURE Devonshire honey, 15s. per 28lb. tin.—BARFIELD Gaddon, Cradock, Culmington. v 98

SEVERAL good hives, some W.B.C., 4s. to 8s. 6d. each; also various sundries, cheap; exchange honey.—BOWDEN, Broomhill, Whitley, Surrey. v 73

STRONG, healthy 8-frame stocks of bees, 25s. each; boxes to be returned, carriage paid.—MYTTON, Lyncroft, Stafford-road, Lichfield. v 65

WANTED, a complete comb of both a bad and mild case of Foul Brood.—HERROD, "B.B.J." Office.



### PRICE OF SUGAR.

We have received the following notice from our sugar merchants:—Owing to the present state of the country, and the high prices ruling, we are only accepting orders at open prices, and subject to goods being obtainable. You may rest assured we will do our best to meet your requirements, and will not charge you higher prices than the conditions warrant. All previous quotations and list prices are withdrawn. These conditions also apply to all orders in hand unexecuted, and await your instructions.

### REVIEW.

*A Modern Bee Farm*, by S. Simmins. Published by the Author, at Queenland, Heathfield, Sussex, and obtainable from BEE JOURNAL Office, 5s.—This is a new and revised edition, of which it is the fourth, and is both well written and illustrated. The author has had a long experience of bee-keeping, and has invented many appliances in connection therewith. Although not orthodox in many of his operations he has the courage of his convictions, and writes fearlessly of what he has done, without cant or plagiarism, and is at all times courteous to those who have opposite views to himself. He has written many interesting articles for the BRITISH BEE JOURNAL, and also for American bee papers. We are quite sure our readers will enjoy a perusal of this interesting book.

### LEICESTER AND RUTLAND B.K.A.

#### ABBEY PARK SHOW, LEICESTER.

The bees and honey department of the show was, as in former years, under the management of the Leicestershire and Rutland Bee-keepers' Association, Mr. John Waterfield, Kibworth, being responsible for the secretarial duties. Compared with past exhibitions, it was quite up to the average, the honey staged being of the best quality. The scarcity of sunshine during the past season has had a marked effect upon the quantity gathered, and exhibitors are to be congratulated on placing such a good display of produce upon the show-bench.

Live bees in the observatory hives were a continuous source of attraction, and

numerous were the questions asked by visitors, and information given on the habits and usefulness of the "Honey Bee," especially in connection with horticulture. The display of honey in any form and of any year proved a valuable addition to the show.

Lectures and demonstrations on bee-keeping were given at intervals in a special tent, by Mr. R. Brown, Somersham, expert to the British Bee-keepers' Association, and Mr. H. M. Riley, Leicester, who also officiated as judges, and made the following awards:—

*Observatory Hive of Bees (3 frames).—*—1st, S. Clark, Old Humberstone; 2nd, W. H. Fountain, Leicester.

*Observatory Hive of Bees (1 frame).—*1st, J. Hunt, Botcheston.

*Twelve Sections Comb Honey (open).—*1st and silver medal, W. J. Richards, East Langton; 2nd, C. Oxley, Desford; 3rd, Geo. Litchfield, Lubbesthorpe.

*Twelve Bottles Light-coloured Honey (North Leicestershire).—*1st, W. Woods, Billesdon; 2nd, J. H. Baum, Stoney Stanton; 3rd, S. Clark; 4th, W. W. Baum, Stoney Stanton.

*Twelve Bottles Light-coloured Honey (South Leicestershire).—*1st, S. Waterfield, Kibworth; 2nd, E. Wheatley, Hinckley; 3rd, Geo. Litchfield; 4th, C. Oxley; v.h.c., H. A. Wheatcroft, Ashby-de-la-Zouch.

*Twelve Bottles Dark-coloured Honey.—*1st, H. Burditt, Desborough; 2nd, B. Walker, Seagrave; 3rd, W. Ruddick, Desborough.

*Three Shallow Frames Comb Honey.—*1st, J. Hunt; 2nd, Geo. Litchfield; 3rd, W. H. Fountain, Leicester.

*Display of Honey in any form.—*J. Waterfield.

*Six Bottles Dark-coloured Honey (novices).—*1st, H. Elner, Castle Donington; 2nd, H. Weston, Barlestone.

*Six Sections Comb Honey (novices).—*1st, W. J. Richards; 2nd, F. Allen, Great Bowden.

*Six Bottles Light Honey (novices).—*1st, J. J. Abell, Newbold Verdon; 2nd, Geo. Litchfield; 3rd, H. Weston.

*Sample of Beeswax.—*1st, C. Bottrill, Kimcote; 2nd, B. Walker; 3rd, W. Stafford, Groby.

### ROYAL LANCASHIRE SHOW.

The Royal Lancashire Agricultural Society's great show at Liverpool, from the bee-keepers' point of view, was a great success this year. The exhibits of honey were more numerous than usual, being well over the three figures, and we are glad to see that bee-keepers are responding to the generous prizes which the

society offers. Judging was accomplished in good time on the first day by Mr. Eustace Parker, J.P., assisted by Dr. Anderton. It was a great pleasure to many Lancashire bee-keepers to meet Mr. Parker again, associated as he was many years ago with the late Mr. W. B. Carr, and other well-known and foremost bee-keepers of those days. The honey was of uniformly good character; the shallow frame class being particularly good.

The stewards would be glad if exhibitors would remember to always send wax in a box with glass lid; loose lumps of wax are a great nuisance in crowded shows; some of it will almost inevitably be stolen, though we do not know that it happened at this show. It seems a pity that the trophy prize should go begging; there was only one entry. On the other hand, there are obvious reasons why the observatory hive class was neglected, in this time of dread of disease. However, a local firm had one nice-looking three-frame hive of bees, which served to satisfy the demand of the public.

Mr. T. D. Richards lectured to large audiences twice each day. The Royal Agricultural Show of Lancashire always causes much interest in the town it visits year by year. Liverpool has had a few busy days, and a great many people have had the War scare brought home to them by the absence of the military bands and the dropping out, at the last hour, of the Military Tournaments, consequent upon the calling up of the forces of the country to their several stations in readiness for eventualities. The awards are as follows:

*Twelve Sections 1914 Honey.*—1st, Jas. Pearman; 2nd, W. H. Barlow; 3rd, F. Bird; r., C. W. Dyer; h.c., George Moir.

*Twelve Jars 1914 Honey.*—1st, J. C. Dutton; 2nd, A. S. Dell; 3rd, James Pearman.

*Twelve Sections 1914 Honey.*—1st, Joseph Draper; 2nd, A. S. Dell; 3rd, J. Jones.

*Twelve Jars 1914 Honey.*—1st, William Abram; 2nd, Joseph Draper; 3rd, J. Jones; r., James H. Fishwick; h.c., Hy. Fenney.

*Twelve Jars 1914 Medium Dark Honey (not Heather or Heather Blend).*—1st, W. H. Barlow; 2nd, J. Jones; 3rd, T. Alun Jones; r., Albert McCullah; h.c., James Pearman.

*Twelve Jars of Granulated Honey (of any year).*—1st, A. H. Bowen; 2nd, J. Jones; 3rd, James Pearman; r., A. W. Weatherhogg.

*Six Jars Heather or Heather Blend Honey (of any year).*—1st, A. S. Dell; 2nd, Jas. Pearman; 3rd, Chas. E. Smith; r., Albert McCullah; h.c., J. C. Dutton.

*Six Sections Heather Honey (of any year).*—1st, Wm. Dixon; 2nd, Joseph G. Nicholson; 3rd, Mrs. Henry Waddington.

*Trophy of Honey (collected within the County Palatine in any year, not less than 70-lbs. or more than 120-lbs. weight of honey in all).*—A. S. Dell.

*Best Exhibit of Wax.*—1st, F. W. Frusher; 2nd, J. C. Dutton; 3rd, William Dixon; r., W. H. Barlow.

*Pair of Shallow or Standard Size Frames of 1914 Honey.*—1st, Joseph Draper; 2nd, Albert McCullah; 3rd, T. Alun Jones; r., J. Hale; h.c., Hy. Fenney.

#### BRIDGNORTH AND DISTRICT B.K.A.

The largest exhibition of honey in Shropshire, held in connection with Hampton Loade Horticultural Society, on August 4th. The total number of entries for honey and wax was eighty-six. The exhibits were of exceptionally good quality, thus making the competition very keen in most classes. The Rev. G. E. H. Pratt, first class expert of B.B.K.A., officiated as judge, and made the following awards:—

*Honey in the Comb, three Sections (13 entries).*—1st, W. Shuker; 2nd, H. Hulme; 3rd, J. S. Lawton.

*Three 1-lb. Jars Light Extracted Honey (14 entries).*—1st, H. Hulme; 2nd, J. Williamson; 3rd, J. S. Lawton.

*Three 1-lb. Jars Medium Colour (9 entries).*—1st, A. Edge; 2nd, F. Short; 3rd, H. Hulme.

*Honey Trophy (not to exceed 40-lbs.).*—1st and extra 5s., H. Hulme; 2nd, J. S. Lawton.

*Three 1-lb. Jars Dark (3 entries).*—1st, silver medal, W. Shuker; 2nd, R. James; 3rd not awarded, one exhibit being disqualified for colour.

*Three 1-lb. Jars, Granulated (3 entries).*—1st, H. Hulme; 2nd, A. Edge; 3rd, W. Shuker.

*Members' Gift 1-lb. Jar (15 entries).*—1st, W. Shuker; 2nd, C. Rogers; 3rd, A. W. Westrop.

*Open Gift 1-lb. Jar (19 entries).*—1st, H. Hulme; 2nd, Miss M. Burrow; 3rd, S. J. Miller, Thetford, Norfolk.

*Beeswax, 4-oz. (8 entries).*—1st, W. Shuker; 2nd, H. Hulme.

The committee appreciate the services of the "B.B.J." for its wide circulation in advertising the show, as it brought them entries from Thetford, Northumberland, Cheltenham, Dorset, and one from "Yonkers," N.Y., and though this was not the specified weight it was allowed to take its place on the "stage."

The committee take this opportunity to thank all who contributed to the gift classes, thus helping to make the show a success. Owing to the congested state of affairs several exhibits were received too late for judging, which proves that it is necessary to send in good time.—J. S. LAWTON, Hon. Sec.

**HELPFUL HINTS FOR NOVICES.**  
*By W. Herrod.*

THE HIVING AND TREATMENT OF NATURAL SWARMS AND CASTS.

(Continued from page 307.)

Confinement without ventilation makes them excited and hot. This causes them to vomit the honey taken into the stomach, which sticks down the hairs over the spiracles (breathing holes) and suffocates them. This explains the reason why honey runs away from the receptacle in which a swarm has died in transit, and the bees being in such a sticky condition. In (Fig. 54) is seen a skep with the bees inside whose death was caused in this manner. Note the honey on the thick covering. If a swarm dies of starvation in transit the bees will be quite dry. When a number of swarms are to be sold it is necessary to have proper travelling boxes constructed. These should measure outside 2ft. long and 9in. deep and wide, and have as much perforated zinc top and bottom as possible. The ledges reaching the side, through pass for fastening. better than a plain the top, as in the after use for a and draw out lifted. (Fig. 55) A cheap box can empty 500 section shows how this is board from the opening thus perforated zinc as box, a couple of longer than the projecting ledge at either end to drop over for screwing, with a good open space between them covered with perforated zinc makes the lid as seen in left hand box. A piece of wood 1½ by 1in. nailed across for a handle on the left hand one completes the work, and a good box costing nothing beyond a little labour is the result. For small swarms a box similar to (Fig. 57) can be made. Instead of just a plain box it is made with rebates at either end, as in the brood chamber of a hive, so that it can also be used for sending out nuclei. It is 9in. deep and 7½in. wide. The length for top bar and body of the frame is the same as the interior measurements of a hive 17½ by 14½, and it will hold five frames. The lid is secured by means of a universal fastener at either end. These boxes are returnable, but as a rule it is difficult to get them back from purchasers unless a deposit of more than their value is insisted upon, to be refunded upon their return carriage paid. A non-returnable box, for which a small charge is made, is seen at (Fig. 58). It can be made in several sizes to suit large or small swarms. That shown is the smallest and measures outside 15in. long, 9½in. wide, and 7in. deep. The ends are ½in. thick and the rest ¼in. The bottom, ends and lid are solid, but the sides have a piece 1½in. left open the whole length. This is covered on the inside with wire cloth or perforated zinc. The ledges of the lid are on the inside and set back ½in. from the end and ¼in. at the side, so that when dropped into position it does not move. The lid is secured by means of nails. The small size can be sent through the post.

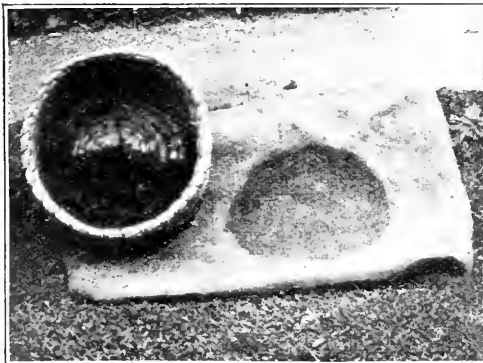

FIG. 54.

lid should have three inches down which the screws This is much lid screwed from latter the screws time become loose when the box is shows this box. be made out of cases. (Fig. 56) done. Remove a bottom, cover the made with per- seen in right hand boards a little box to allow a to be nailed

To get a swarm into any of these boxes one of two methods may be adopted. By the first, two operators are necessary. When it is dusk and the bees are clustering close together, place the box beside the skep. One person then takes off the

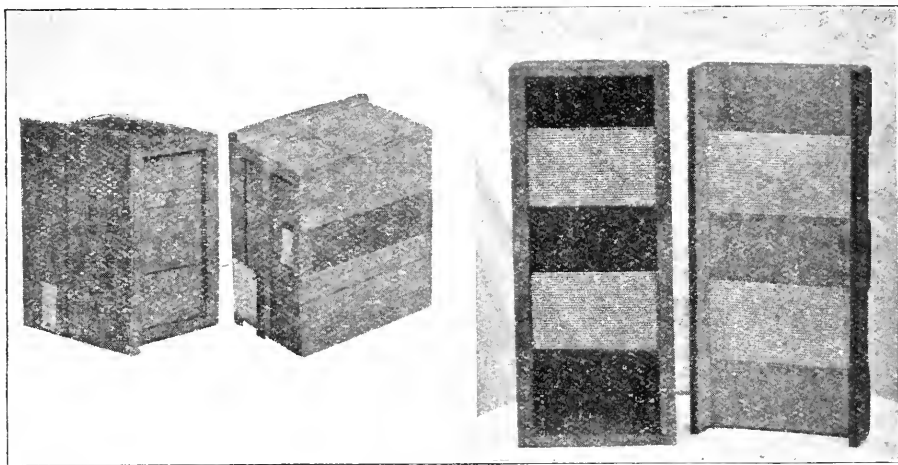

FIG. 56.

FIG. 55.

lid and holds it so that it can be put back in position very quickly. The other carefully inverts the skep and by one vigorous bang on the ground dislodges all the bees to one side, but at the bottom of the skep, from which, with a second quick move-

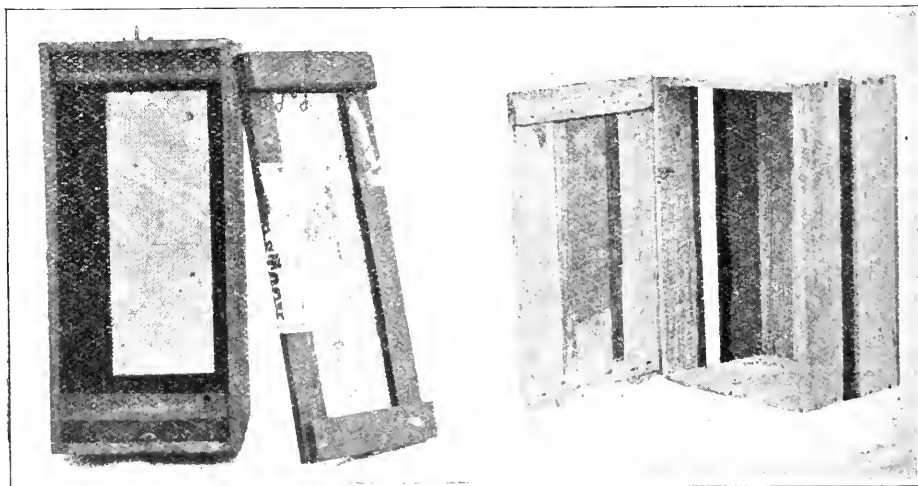

FIG. 57.

FIG. 58.

ment, they are shot into the box. A sharp rap with the hand on the top will dislodge the few remaining bees, the lid is dropped into position, and if the work is done expeditiously not a single bee will be lost. This method cannot be carried out in the daytime, as the bees fly too much, but at dusk, or even when dark, if care is exercised not one will take wing.

*(To be Continued.)*



### CURING "ISLE OF WIGHT" DISEASE.

[9065] My letter (9052) in your issue of July 16th has aroused some very interesting inquiries, from far and near. Your correspondent (9055) would have ere this received a private letter for his comfort had his name and address appeared in your valued paper. I quite agree with 9055, it is really too good to miss, and my own bees are still thriving, inasmuch as those mentioned in my previous letter (a small cast on August 18th, 1913) now, at date of writing, have increased to four strong stocks, two on nine combs and two on ten combs, with plenty of bees and stores. I have also taken off seventy-five sections, some weighing as much as 18½ ozs., so my *nom-de-plume* is something to be proud of. Now, may I say that I fully agree that I have a lot to put up with, for there are dozens of empty hives standing about, many less than half a mile away, where there are the germs of "Isle of Wight" disease and foul brood only waiting for my bees to go and inspect when a leisure hour comes. Let me say to your correspondent, "Isle of Wight" disease is as contagious among bees as diphtheria is among human beings, and just as deadly; but we have learnt at a great cost how to cure and check its spread amongst ourselves, and I say I have at last found what is as good for our bees, that is a cure which, as my former letter expressed, is free to any reader who will deposit a stock with me for a few days, and when it arrives it will be placed within 12 yards of my own hives.—SATISFIED AT LAST (E. Pressey, Carshalton Hill, Coulsdon, Surrey).



[8970] *Swarm Dividing*.—On Thursday, July 30th, a stock of Hybrid Italians swarmed for the second time this season. On following them I was surprised to find that they had formed two clusters three or four feet apart. Having only one stock of that particular breed I was certain that they both came from the same hive. As I considered it too late in the season to attempt to build up a separate stock I returned both swarms to the hive. On looking carefully through the frames I dis-

covered twelve queen cells, six sealed, five empty, and one apparently destroyed by the first queen out as it had a hole in the side. Is it not very unusual for a swarm to form two clusters, and is it due to several queens hatching at the same time? Thanking you for the many helpful suggestions I have received from your paper in the past, and wishing you every success.—HAWTHORN.

REPLY.—It is not unusual for a cast to form several clusters; this is due to there being several virgin queens in the hive. These issue with the cast, and a number of bees will form a cluster with each queen.

[8971] *Driving Bees*.—I am offered the bees from half a dozen skeps if I go to a place six miles from here and drive them and bring them home. I propose to drive the bees all into one or two empty skeps and tie stout muslin over the mouth and bring them home. (1) Can I, after driving skep No. 1, place the skep now containing bees above skep No. 2, and drive those up into the same lot, and so on as long as there is room, without raising a fight? (2) I don't expect that I will manage to secure the queens on their way up. Can I leave the queen business to be settled by the bees? (3) Is this likely to result in all the queens being destroyed? I wish to make one, or at most two very strong lots and feed up for winter, and as I am only a small bee-keeper I have not many empty skeps to drive the bees into, at least not sufficient to keep all six separate.—PHARMACIST, Aberdeen.

REPLY.—(1) Yes we have done it scores of times and never yet had the bees fight. (2) Yes. (3) No. (4) Tablets were sent on to a bee-keeper whose bees were suffering from the disease, and he reported they had no good effect at all.

## Bee Shows to Come.

THE FOLLOWING SHOWS ARE CANCELLED:—Aug. 25th, 26th, and 27th, at Newcastle; Aug. 26th and 27th, at Rugby; Sept. 2nd, at Lancaster.

August 18th and 19th, at Brighton.—The Fourth Annual Show of the Sussex Bee-keepers' Association, in connection with the summer show of the Brighton, Hove, and Sussex Horticultural Society. Seven Open Classes. Liberal Prizes. Schedules from C. A. Overton, Beecroft, Crawley. Entries closed.

August 19th, at Radstock.—Honey show, in connection with the Radstock and District Horticultural and Fanciers' Association. Schedules from B. M. Clark, Fox Hills, Radstock.

August 26th, at Chester.—Annual Show of the Cheshire Bee-keepers' Association, in connection with Cheshire Agricultural Society. Several open classes. Good prizes. Schedules from T. A. Beckett, St. Werburgh Chams., Chester.

**August 26th, at Prestbury.**—Honey show, in connection with the Prestbury Flower Show. One class open to the kingdom. Several for those within 12 miles radius. Exceptional prize list. Schedules from A. H. Bowen, Coronation-road, Cheltenham.

**August 29th, at Nantwich.**—In connection with the Annual Flower Show. Bee demonstration by Mr. Franklin, the noted Cheshire bee expert. Classes for honey, both in comb and extracted. Schedules and entry forms from Hon. Sec., Mr. Lloyd, Hillfield Place, Nantwich.

**September 1st, at Deddington.**—Honey show in connection with Deddington Horticultural Society's Show, to be held in the Castle Grounds. Open classes for honey. Schedules from H. J. Harmsworth, Deddington, Oxon.

**September 2nd, at Lancaster.**—Agricultural Show. Premier Honey Show of the North. 15 classes; £20 in cash prizes, silver cups and medals value 13 guineas, and other specials. Send for schedule (Honey) to Robert Gardner, solicitor, 69, Church-street, Lancaster. Entries close August 19th.

**Sept. 5th, at the Club Room, North-road, Kew.**—Honey Show of the Richmond and District Bee-keepers' Association. Open classes for honey and wax. For schedules, apply Hon. Sec., Mr. J. G. Romer, 234, Kew-road, Kew-gardens. Entries close August 28th.

**September 9th, at Stoke Park, Guildford.**—Annual Exhibition of honey, wax, appliances, &c., will be held by the Surrey B.K.A. in connection with the Guildford and West Surrey Agricultural Association. Eighteen classes, five open to all. Many medals. Schedules from F. B. White, hon. secretary, Marden House, Redhill, Surrey. Entries close 31st August.

## Notices to Correspondents

T. A. E. (Dawlish).—*Bees in Box.*—If the combs are straight, probably the best plan would be to cut them out carefully, brush the bees off, and tie them into frames. Place these in a frame-hive and put the bees back to them. The combs will be rough and irregular when the bees have patched them up, and should be taken out as early as possible next season and replaced with frames fitted with full sheets of foundation.

J. DRAPER (Swanwick).—You should be able to get them at a chemist's. Ask for Calvert's carbolic acid, No. 5.

K. C. A. P. (Herts).—*Vicious Bees.*—Queen from the other stock next spring, if possible. A little light tobacco mixed with the smoker fuel is at times efficacious. We have also known chloroform used by putting a few drops on a piece of sponge or cotton-wool placed in the smoker and blown in at the hive entrance, but unless carefully used there is danger of killing the bees.

"FIFE BEE-KEEPER" (Fife).—See answer to K. C. A. P. above.

A. H. Hanson (Ilkeston).—*Name of Insect.*—It is a fine specimen of the saw-fly.

"THORNTON MOOR"—*Moving Bees.*—(1) You might take them to the moor, as suggested, and now is the time to do it. (2) The seasons vary so much it is not possible to say.

H. S. G. (Crewkerne).—*Renewing Apiculture.*—In warm weather it will evaporate in from two to three weeks. In cold weather it may last from six to eight weeks.

### Honey Samples.

"G. B. 100." (Slough).—Honey is from mixed sources, including ragwort, and a little heather, worth 50s. to 56s. per cwt.

W. E. (Stockport).—Clover honey of fair quality, but very little flavour, will do to show locally.

S. N. (Dorset).—Honey very good quality.

### Suspected Disease.

T. M. B. (Clay Cross).—Bees have "Isle of Wight" disease. There is no fee.

B. W. K. (Strathpeffer), "ANXIOUS" (Crick), "ALSACE" (Harrogate).—Bees have "Isle of Wight" disease.

J. BENNAN (Northorpe).—Bees appear healthy.

C. F. H. (Tunbridge Wells).—Chilled larva. Native.

BES (Falkirk).—One bee shows symptoms of "Isle of Wight" disease.

LIST (Kilcan).—Comb contains foul brood. Letter should not have been placed on the comb but outside of box.

K. (Congleton).—K. 1 show symptoms of "Isle of Wight" disease. K. 2, no sign of disease; they have no doubt been killed when cleaning out the comb. There is always a risk of getting the apiary in an uproar when combs are placed outside for bees to clean out; they should be placed as far away from the hives as it is possible to get them.

## Special Prepaid Advertisements

Two Words One Penny, minimum Sixpence.

Orders for three or more consecutive insertions entitle advertisers to one insertion in "The Bee-keepers' Record" free of charge.

Trade advertisements of Bees, Honey, Queens, and Bee goods are not admissible at above rate, but will be inserted at 1d. per word as "Business" Announcements, immediately under the Private Advertisements. Advertisements of Hive-manufacturers can only be inserted at a minimum charge of 5s. per  $\frac{1}{2}$  in., or 5s. per inch.

## PRIVATE ADVERTISEMENTS.

**S**PLENDID light clover honey, 58s. per cwt., f.o.r.—SIMCOX, 17, Victoria-road, Fallings Park, Wolverhampton. v 33

**P**URE new (Lincolnshire) light coloured honey, from fruit, mustard, clover, price 64s. cwt., including tins, free on rail; sample, 2d.—CHARLES CUBLEY, Gedney, Holbeach. v 26





## PRICE OF SUGAR.

We have received the following notice from our sugar merchants:—Owing to the present state of the country, and the high prices ruling, we are only accepting orders at open prices, and subject to goods being obtainable. You may rest assured we will do our best to meet your requirements, and will not charge you higher prices than the conditions warrant. All previous quotations and list prices are withdrawn. These conditions also apply to all orders in hand unexecuted, and await your instructions.

## REVIEW.

*The Temperature of the Honey Bee Cluster in Winter*, by E. F. Phillips, Ph.D., and George S. Demuth (Bulletin No. 93, Bureau of Entomology, U.S. Dep. of Agriculture, Washington, D.C.).—It is well known that the care of bees, more especially in the Northern States of America, is one of the most perplexing problems confronting the bee-keeper. The authors say American bee-keepers lose thousands of dollars annually in winter from the actual death of colonies, and even still more from those colonies that do not die, but which are reduced in numbers and vitality. Various factors influence the welfare of the colony, the chief of which are external temperature, food, ventilation, humidity, the condition of the colony at the beginning of winter, and various forms of irritation. The present paper is specially devoted to heat production, and the authors object that all previous work in this direction is not reliable, a source of error which is found in all previous records being due to the use of the mercury thermometer, for when such an instrument is used, it is almost impossible to avoid disturbing the cluster. Because of what they consider the errors of other investigators in the work, caused by using mercury thermometers, they have employed electrical thermometers, by means of which readings could be made without approaching the hives, and the thermometers are permanently fastened in place. These thermometers are practically instantaneous in their action, and most sensitive, giving readings to an accuracy of 0.09deg. F. The method of carrying out the experiments are given in detail, but the authors finish by stating that too

hasty conclusions must not be drawn from the facts presented, and it is hoped that more work will throw some additional light on the subject.

EXTRACT FROM THE "LEADER ANNUAL AND GAZETTEER" OF BRITISH EAST AFRICA.

In British East Africa man does not capture the wild bees: they come to him. A hollow log is hung in a tree, and, in most cases, this is soon converted into a busy hive. An association has recently been formed in Nairobi, with the object of encouraging apiculture on sound, business lines.



## FIELD DAYS.

I am much taken with the descriptions I have lately read of these very interesting gatherings in America. We on this side might learn more than one useful lesson from these "Field-days," or "Field-meets," and I would repeat the query: Why should not we have more of these gatherings everywhere? Annual meetings with their small musters, dotting the "I's" of the secretary of the Association don't meet the need, conversaciones with their worn-out platitudes and smatter of small talk fail to accomplish more than a minimum of good, and even village and county shows teach only a limited lesson, and that only to a few. A field-meet gets to the root of the matter, the bee-keeping at the assemblages is a *live* thing. The reality is there, genuine actuality is patent in the sight of every man and woman present. Bees are seen and handled, produce is manifestly displayed in conception in the making, and as a finished article. Bee goods are in evidence, not pictures of the genuine articles, but the real articles themselves. Bee-keepers are untrammelled by convention, and all that is best and most interesting comes prominently to the front, the enthusiasm of the few calling up all that is good and true in others of each group of members.

"*Manufacturing*" a Queen.—It may have been known at an earlier date than the middle of the eighteenth century that bees could raise up a successor of their own accord, to replace a dying or failing mother bee; but it was only about 1760 that it was put on record beyond cavil that the workers of a hive had this mysterious power. Schirach then recorded it as his experience that while bees had

eggs or very young larvae in the hive they could create a queen-mother. Choosing any special cell, he observed that the workers nibbled away the walls of one or two others on each side, thus enlarging the cell of their choice and uprearing on this base the palatial residence in which they reared the young princess. This enlargement of the special cell, and the very copious feeding of the young larva, with the preparation known as "royal jelly," is all the treatment we can detect the bees bestow on the inmate, and yet the result is the production of a new creature, with separate parts and organs, capable of performing different functions. The egg, which otherwise would evolve into a common worker bee, produces a mother bee, which may become the parent of every other bee, male and female, in the community. This wonderful phenomenon is so common an occurrence in our times that we have ceased to marvel and quiescently accept it as a matter of course, but the results are indeed marvellous.

*Soft or Hard Candy?*—Invariably, when speaking of *candy*, we use the term *soft* candy; as invariably in America they speak of *hard* candy. I have often wondered why there should be this difference. I have of late been looking into the matter, and I am as much puzzled as ever. The recipe for the very finest candy we can turn out is given on page 195 of the "Guide Book," 20th ed., and the proportions are 10lbs. of sugar to *two quarts* of water—on page 197 we have it: 10lbs. of sugar to *five pints* of water. Note either of these mixtures produce our soft candy. The recipe for making *hard* candy for winter and spring feeding is "an equal amount of both sugar and water." I need not repeat either Mr. Cowan's or Brother Colomban's directions for making, as they will be found at the indicated pages, but I should like to reproduce the American recipe:—"Into a dish of hot water on the stove slowly pour out an equal amount of sugar, stirring constantly. Make sure the sugar is all dissolved before boiling commences. If this precaution is not observed, some of the undissolved sugar is likely to burn, injuring the flavour of the candy. If you have a candy thermometer, watch the temperature, and do not let it go above 275deg. to 280deg. Test frequently by dropping a very little of the syrup into cold water. When the boiling has continued long enough the drop of candy, when cooled in the water should be *hard and brittle* when taken out." Later, we are told, when the candy is first made "it is *hard and glassy*."

In *Gleanings*, January 1st issue, Mr. Mel Pritchard, Messrs. Root's chief operator, says: "*Hard* candy is the best

material to feed in an emergency during cold weather"; and, commenting on this, Dr. Miller says: "No doubt, that's right." "A.B.C.," &c., advises "cooking to a hard crack," so that there is no doubt about the hardness demanded by our cousins. Mr. Cowan's idea, and in general we will all agree with him, is to have our candy "soft and buttery." Bro. Colomban says "Candy thus made, if stored in a dry, cool room will keep *soft* for a very long time." Another author says when dropped on a cold plate "it must *set soft*," and yet another, "When cold it must be so soft as to be readily scraped by the finger-nail, and a piece placed in the mouth should dissolve almost instantly," all of which is quite a contrast to the "glassy" American concoction. Yet we find our "soft" candy thoroughly efficient as a food for bees; on the other side they pin their faith to "hard" candy. I must confess that the matter is rather a puzzle to me! Bees are much the same on both sides, climate alone cannot explain it—yet the *hard* and the *soft* hold the field.

---



---

#### "BLURTS FROM A SCRATCHY PEN."

SIGNOR PIANA'S APIARY.

Our breakfast over, of course, business, or rather, I would say, business and pleasure. We had travelled a thousand miles to see a great Italian queen rearing institution. Our business was to observe and learn as much as we possibly could; our pleasure was the very fact of visiting such an apiary to observe how these things are managed in other lands. In a business such as this everything had need to be at hand at the right moment and in the right place—well organised, in a word. And here it was. The proprietor had evidently well studied the various systems, Italian, English, and American, and adapted them to his own country, climate and needs. To tell you how he does his work would practically be a lesson on queen rearing which may better be reserved for another opportunity. The most approved appliances to raise from the artificial cells, the latest thing in nuclei and mating hives, the most perfect system of dispatching queens and nuclei to all parts of the world, were there. No. 7 will show you a very interesting *tête-à-tête*. Signor Piana is showing a row of cups to Mr. Herrod, and next on the right is the Signor's assistant and manager. How do you like their costume? The blouse is very convenient and suitable, keeps all splashes of honey away, and can be passed through the wash for disinfection. The hat would keep a veil well clear of the face. That would probably

be our English way of looking at it. But the Signor tells me that during the many years he has conducted this apiary they have had but one case of foul brood, "la loque," a long time past, which was promptly burnt out under the furnace; and "I.O.W." they have never seen. So much for the need of disinfection of the garments. And the hat! Well, bee veils are seldom worn here. The wonderful gentility of the Italian bees appeals to the visitor. You open a hive, almost any you may select, and with but very little smoke. The bees cling to their combs and seem scarcely disturbed. Another thing also astonishes us. You see the

i m m e n s e frames, each 42 by 27½ centimetres (about 10½ in. by 16½ in.) and ten in a hive, perfect slabs of brood, such as beekeepers love to see. The Italian smoker amuses me. They have no such thing. A roll of jute cloth, such as bales are packed in, say 12 in. long and 1½ in. in diameter, wrapped round loosely with twine, a wave or two of this over the tops of the bars when lighted. Behold! that is all. Here is a "wrinkle" for those who are at a loss occasionally for a smoker.

Signor Piana is a great patriot so far as his bees are concerned, for he believes that the Italian bees are the very best in the world. He is quite welcome to his belief if he is the more happy for it. I rather think I have heard the same thing said of the English strain. It is very easy to start him sounding their praises, and as he is our host it would be very rude to contradict him. Listen to his enumeration of their good qualities. "They are gentle and easily handled." Here we had had practical demonstration and so agreed. "They are very prolific and swarm but

little." First proposition we also concede, but of the second "we hae our doots." He continues. "They are great workers, and waste but little." Would that there were many more so. "And they are the best resisters of climatic conditions, diseases, and all enemies." To support his argument as to the latter he refers me to the Congress of American Inspectors (bee experts we call them here, the title is more modest), who say that to check foul brood the Italian queen, the leather-coloured bee, should be introduced into every hive. Here he arrives on debatable ground. However, as I have said before, politeness commands silence.



No. 7. A CONSULTATION.

From the general praise of Italian queens he comes to his own particular raisings. He claims that he always sends out queens of the present season, fertilised without inbreeding, because his several apiaries enable him to do this, and well selected because he is able to choose among his several hundred hives worked for honey the best gatherers, and they are raised under the most approved system. This is agreed *nem. con.* He further tells

me he expects to send out 2,000 queens in 1914; last year, 1913, he had sent away over 1,000.

After we had finished our bee chat a walk was proposed through the neighbouring district. It seemed strange to pass at will through any field, to gather as we went along the fruit from the vines, the orange, and the peach trees. The flowers in the meadows and the insects were curious to us. Hitherto our journeyings had been through towns and cities. Today we had a country ramble.

But we could not stay, much as we wished, our holidays were passing by even

too fast. Again, back to the house of our host. Before dinner the camera happened to catch unawares the Signor just as he was opening a nuclei, but some question was raised as to a matter of bee-keeping

loaded to breaking-down point with beet for the sugar manufacturers. The drivers were shoeless and nearly shirtless—it was cooler. Fortunately, perhaps, for us, we could not catch the meaning of the words.

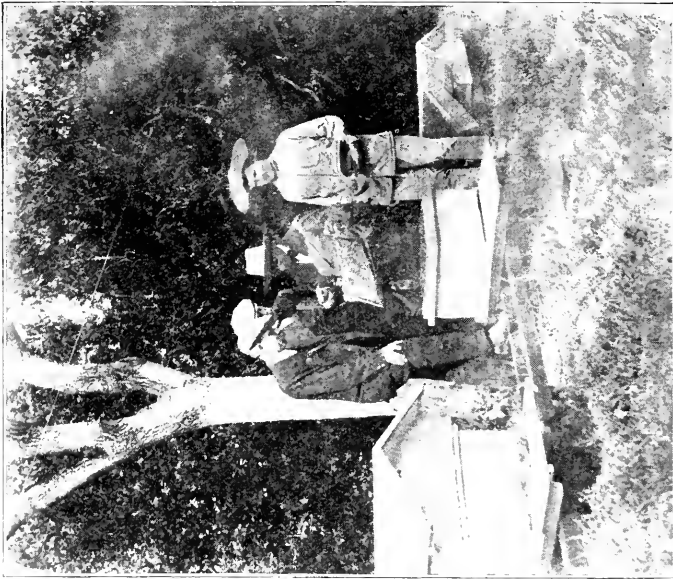

A DEBATED POINT.

which gave Mrs. Herrod an opportunity to capture the shadows as they appear in "a debated point."

In the cool of the evening, after such

which thickened the air, as the bullocks refused to do what was asked of them. For some "nickels" it was easy to get them to "pose."

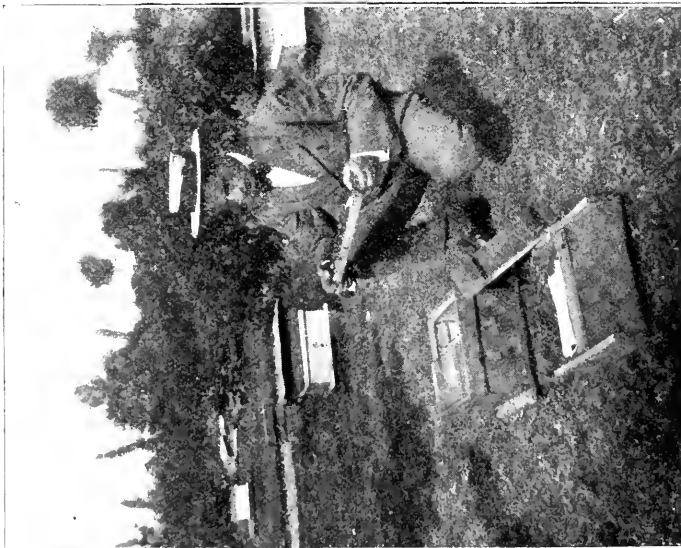

A "SNAPSHOT."

a day as one never forgets, we drove back to the station. Here were some ten or a dozen country wagons, immense things, drawn by six or eight bullocks each, and

Northward now, we journey to Milan and to Venice, where again we encountered other fearful adventures.

*(To be continued.)*



### THE IMMUNITY CHIMERA.

[9066] Mr. Heap seems rather hurt that no one has replied to his arguments against the immune "chimera," as he calls it. As the worthy "D. M. M." once said, "We have said our say, and he has said his; saying more would be like beating a dead donkey."

But Mr. Heap asks a very pointed question at the end of his jottings. My reply is a definite "No!" and I base it on experience in other fields. Of all the diseases which have been discovered, whether attacking man, beast, or plant, I know of none of which it can be said that we have got rid of it altogether. The nearest approach to that ideal which I can call to mind is "hydrophobia," which has been practically banished from England, and this very striking and exceptional result was only rendered possible by the discovery that it was only spread by infected animals biting others. As it also happened to be reasonably possible to entirely prevent this being done, the disease was exterminated. But of all the long lists of microscopic parasites to which flesh and blood, tree and herb are heir, I know of no other which can be entirely eliminated in this manner, simply because it is almost, if not quite, impossible to control the channels of distribution, even when we know what they are. In regard to the "Isle of Wight" disease, we are not sure that we have discovered all the channels, and many of those with which we are familiar we know it is almost impossible to control. Until we can discover a specific remedy, common sense alone tells us to cultivate resistant stocks. If one stock can resist better than another—as even Mr. Heap will admit it can—is it not logical to suppose that stocks may exist or be evolved which resist completely?

May I give an instance which will, I think, make intelligible the idea at the bottom of the immune theory? We all know the roses of our gardens are often attacked by a fungus called "mildew." I do not know a single variety which does not more or less suffer. But some varieties get it very badly, and we strive in vain to overcome it. Other varieties, although attacked, never seem to get it to any great extent, and by cultivating these we may easily succeed in having a garden of roses uninjured by mildew. Yet it is there all the time, and no amount of washes will entirely eliminate it. I do not deprecate attempts to find a remedy for "Isle of Wight" disease, nor do I say they are

foolish who try to get rid of it. But I do think we stand a better chance by cultivating resistant stocks, and I think Mr. Heap is strangely ill-advised in ridiculing what is, in the face of analogous cases, a common sense proceeding.—HERBERT MACE.

### SKEPS AND DISEASE.

[9067] I think that Mr. Manley's letter, on page 304, is very much to the point. Of course, the results obtained from frame-hives properly managed and skeps are not to be compared, but there is no doubt that the former do require a lot of attention often at just the time when the average cottager is away from home most, and there is, as Mr. Manley says, the question of expense, so that I think skeps will always have their place.

My experience, too, is that one rarely hears of an outbreak of disease amongst the skeppist's stocks. It is the people who can afford frame-hives, but who won't go to the trouble of looking after them properly, who are the danger, and it seems a great injustice to apiarists that there should not be a law to prevent them being the menace to bee-keeping that they undoubtedly are.

Two years ago I had, through ill-health, to get rid of most of my bees. Last year I bought all the stocks of a skeppist, who was giving up on account of old age. The number of swarms that he had had made it pretty certain that they were free from disease, and although the skeps were exceedingly old (some I believe belonged to his father), there is no doubt that this was due to the systematic destruction of the old combs.

One of the stocks I placed over frames fitted with foundation on April 28th. A few weeks later they were increased by some of the flying bees from two more skeps. On June 13th they swarmed, queen-cells evidently having been begun in the skep before the queen-excluder was put on. I gave away the skep with the bees that remained in it, returned the swarm, and from these I shall take well over 100lbs. of surplus, and I believe they have enough honey in the body-box to winter on.

It has been a very good season in this neighbourhood. From five stocks (three in skeps put over frames at the end of April) I shall take 4cwt. of surplus (extracted) and have had three swarms.—ALFRED STRATTON.



[8972] *Swallows Eating Bees.*—I have read your JOURNAL regularly for years,

and have also read many of the best English and American books, but I have *not* seen any complaint in the former, nor any remedy in the latter against swallows eating bees. I have twelve stocks, all of which were doing splendidly until the swallows began to nest in the neighbouring buildings; now I can see regularly thirty to forty of the thieves fetching the bees, and with such daring that they, if need be, follow their victims to within a few inches of the alighting-board, and at times they hardly get beyond the last hive before they double back in pursuit of another victim. The amount of bees I have lost—to say nothing of temper, &c., &c.—you may imagine when I say that though I had actually taken 175lbs. of honey before May was out, I have only taken 50lbs. since, and there is very little ready now in the hives. I attribute the loss of seven virgin queens to the wretches also. Can you suggest anything by which I can meet this difficulty? If so you will greatly oblige.—SWALLOWS, Midlands.

REPLY.—We have not had this experience with swallows, but sparrows have been a source of great loss by their adopting bees as food. We confess we know of no remedy. Sparrows can be shot, but swallows are too valuable.

## Bee Shows to Come.

**THE FOLLOWING SHOWS ARE CANCELLED:**—Aug. 25th, 26th, and 27th, at Newcastle; Aug. 26th, at Prestbury, Chester, and Rugby; Sept. 2nd, at Lancaster; Sept. 9th, at Guildford.

**August 29th, at Nantwich.**—In connection with the Annual Flower Show. Bee demonstration by Mr. Franklin, the noted Cheshire bee expert. Classes for honey, both in comb and extracted. Schedules and entry forms from Hon. Sec., Mr. Lloyd, Hillfield Place, Nantwich.

**September 1st, at Deddington.**—Honey show in connection with Deddington Horticultural Society's Show, to be held in the Castle Grounds. Open classes for honey. Schedules from H. J. Harmsworth, Deddington, Oxon.

**Sept. 5th, at the Club Room, North-road, Kew.**—Honey Show of the Richmond and District Bee-keepers' Association. Open classes for honey and wax. For schedules, apply Hon. Sec., Mr. J. G. Romer, 234, Kew-road, Kew-gardens. Entries close August 28th.

## Notices to Correspondents

J. W. (Belmont).—(1) It is true heather, and is the one from which honey is obtained. (2) Your bees will work the heather situated so near.

**NEW BEGINNER (Holme Pierrepont).**—

Take the comb out at midday, when all the old bees are out at work, put it into the observatory, then brush the bees from two more combs in as well. It is very late to stock an observatory hive.

S. T. R. (Chesterfield).—We know of no law that forbids the keeping of bees on an allotment; probably it is a special bye-law.

J. G. (Petworth).—The comb contains pollen only. Unless you squeeze it no harm will be done, but if you extract the honey by pressure then it will be muddy in appearance, owing to the pollen grains.

STANWELL.—Boil the syrup down until it assumes the right consistency.

### Honey Samples.

SISTER (Crowborough).—It is a very good sample of lime honey.

S. T. R. (Chesterfield).—1, 2, and 3 are mainly from clover. We should show No. 1, and consider it would stand a fair chance of winning. Our opinion of No. 4 is not much.

T. B. (Haverhill).—Both samples are very good. No. 2 should fetch 65s. per cwt. and No. 1 60s.

### Suspected Disease.

G. P. G. (Lutterworth).—We find no trace of disease.

POLAS, M. D. (Nunthorpe), J. H. (Hampstead), ANXIOUS (Newcastle), A. G. (Birkenhead).—Bees have "Isle of Wight" disease.

INQUIRER (Worsley).—It is "Isle of Wight" disease; the honey is fit for human food, but it is not worth while running risks.

## Special Prepaid Advertisements

**Two Words One Penny, minimum Sixpence.**

Orders for three or more consecutive insertions entitle advertisers to one insertion in "The Bee-keepers' Record" free of charge.

Trade advertisements of Bees, Honey, Queens, and Bee goods are not admissible at above rate, but will be inserted at 1d. per word as "Business" Announcements, immediately under the Private Advertisements. Advertisements of Hive-manufacturers can only be inserted at a minimum charge of 3s. per  $\frac{1}{2}$  in., or 5s. per inch.

## PRIVATE ADVERTISEMENTS.

**H**EALTHY driven bees, 5s.; 8-frame stocks, 24s.; light extracted honey, 16s. 28lb. tin; boxes returnable.—BOGGIS, Geldeston, Beccles. v 34

**F**OR SALE, sections, best quality, 10s. per dozen.—GARFITT, Coupar Angus, Perthshire. v 51

**N**INE dozen good sections for sale; also quantity driven bees, free from disease.—Apply, J. STONE, Manningford Abbas, near Pewsey. v 50

**E**XTRACTOR, Rymer's patent, wanted, second-hand.—Apply, stating price, to D. MORGAN, schoolmaster, Llandilo. v 48

**S**ECTIONS.—Splendid sections, 9s. dozen, cash with order.—W. P. LANGFORD, Baldock, Herts. v 47



### PRICE OF SUGAR.

We have received the following notice from our sugar merchants:—Owing to the present state of the country, and the high prices ruling, we are only accepting orders at open prices, and subject to goods being obtainable. You may rest assured we will do our best to meet your requirements, and will not charge you higher prices than the conditions warrant. All previous quotations and list prices are withdrawn. These conditions also apply to all orders in hand unexecuted, and await your instructions.

### THE WAR.

The effect of the war is being felt by all, and even our industry has not escaped. Bee-keepers should be careful to obtain the best price for their produce, as very shortly sugar will be unprocurable in this country, and honey will fill the gap at remunerative prices.

Bee-keepers are not backward at showing their loyalty to King and Empire. Our veteran Editor has not only done a tremendous amount of recruiting work, but has actually been sworn in as a special constable, and is taking his share of night work in guarding railway bridges and tunnels. For a man over seventy years of age, this is a splendid example. Miss Cowan is also a voluntary Red-Cross Nurse, and will, no doubt, go to the front, thus sacrificing the comforts and luxuries of home to help comfort and succour those who will suffer in putting down arrogance and despotism.

Captain Hadfield, the Hon. Secretary of the Lincs. Bee-keepers' Association, will also shortly leave for the seat of war. At the present moment he is stationed with his men close to our apiary at Luton, where they are getting fit for active service. Amongst his company are several Lincolnshire Bee-keepers, also spending a strenuous time in marching and drilling. We have had several long, interesting chats with the captain seated amongst our bees. Abroad the same feeling prevails amongst our Allies, as the following cutting from *The Times* will show:—

#### M. MAETERLINCK A VOLUNTEER.

M. Maeterlinck has written the following letter to another Belgian writer:—

"My Dear Friend,—I do not know if this short note will reach you. Gladly had

I come to Belgium to place myself at the disposal of the military authorities. Although I am fifty-two years old, I still could be an acceptable civil guard. The mobilisation order took me by surprise and I sit here stranded, not knowing when I shall be able to leave. At any rate, I shall attempt to join a Belgian corps of volunteers, because at all cost the fight must be taken up against the enemy of the human race, the terror of the world. In the meantime I help the peasants by the harvest. Here are only women and children. The heroic march of France to assistance is the finest thing one can see."

The place where this letter was written was not published in the Belgian and Dutch Press.—W. HERROD.

### HINTS FOR HOUSEWIVES.

Mr. George Knowles, Stockton House, Codford St. Mary, Wilts, informs us that the Roman fashion of sweetening food with honey has proved on trial excellent. Sugar is dear, and half a tablespoonful of honey will go as far as three tablespoonfuls of sugar.—*Daily Mail*.



*Native v. Foreign Bees* (p. 253).—By some mischance, I omitted to add to my note upon this subject an interesting fact which may have some bearing upon it. It is this: I have two cases of foul brood in my apiary. I have no direct knowledge of how this has come about, and can only conjecture that it has been contracted during predatory calls elsewhere. But the special point of interest is that these two stocks contain a few bees with reddish bands. That is to say, they show a slight trace of foreign blood, indicating that the queens have mated with hybrids some distance away. Now I do not assert that this slight taint is sufficient to make them more susceptible than any other stocks, but I think it very likely that they take more risks! And a few days' time will see them united upon fresh combs, and headed by a new queen of purer pedigree!

*Something Like a Swarm* (p. 255).—It is quite possible that this heavy swarm issued from one hive. But no details are given of the hive from which it issued, and unless this was a very large hive there is a reasonable doubt. Of course, if the bees were watched the whole time there is no doubt; but otherwise it would be quite possible for a passing swarm to join forces unnoticed, either before or

after the settling. When recording heavy swarms it is always more interesting to give such details as those furnished by W. Mountney (9044).

*A Little Arithmetic* (p. 261).—Mr. Smallwood must forgive me. I forgot that figures might be a sore point with him, but I little knew that he would claim poetic license for mathematics. I can readily believe that he has not attempted to work my foolish problem, or he would have discovered that no "decimal fraction" was involved. Perhaps when cooler weather comes he may try it. But may the hot weather last, for we brethren of the moor have our bees at the heather, and we look to the ling to improve an otherwise unsatisfactory year. "Hoping for a better season next year."

*Hiving Purchased Bees* (p. 265).—Another simple method is to stand the travelling skep upright on the hiving board. Before doing so make sure that the final untying can be quickly accomplished. When in place the cloth is spread out flat upon the hiving board and the skep lifted up. The bulk of the bees will be upon the cloth ready to run into the hive, and a few taps upon the skep will dislodge the rest.

"*New Zealand Box Hives*" (p. 276).—Really, I hardly know what to say to Mr. Hopkins. His standpoint appears so opposed to my own, so antipodean, that we probably could not agree. He seems to me to consider two irreconcilable things as one, which makes agreement hopeless. So that I am reduced to flat negatives, which is regrettable but necessary; for I am not "convinced against my will." I have the will to be convinced, but remain unconvinced that the

skep hive is an evil thing. His involved statement of comparative evil is amusing, but quite absurd, being based on the misconception referred to above, and the differing use in different countries of the same term, "box hive." As already stated, I am willing to concede his use of the term, although I consider it unfortunate and confusing. But I must take strong issue with him upon the subject of commercial bee-keeping. I am, of course, concerned with this, but not solely; and Mr. Hopkins is guilty of a glaring distortion of my words when he omits the qualifying word "solely" from his deductions. No one who has ever wasted time in reading this column would accuse me of being *solely* concerned with commercial methods. Neither am I a "teacher of bee-keeping," but merely an unfortunate scribbler who has the unhappy knack of rousing such gentlemen as Mr. Hopkins. No doubt he feels with me that we should sink our family differences at the moment in view of our common Imperial interest. I should like to take this opportunity of thanking him for the copy of his booklet on the "Humble Bees of New Zealand" very kindly sent to me.

*The Australasian Deputation* (p. 292).—What good reading is the report of this deputation! They seem to have some real live bee-keepers on the other side, and a well-informed Minister of Agriculture. It should not be long before suitable legislation is introduced, judging from the assurances given. I wonder why it is so easy to obtain a satisfactory hearing in the Colonies and so difficult at home. Is there some subtle difference in the atmosphere, or is it merely that the type of man who emigrates adopts more readily a wider horizon?



## THE HIVING AND TREATMENT OF NATURAL SWARMS AND CASTS.

(Continued from page 324.)

The other method is to run them in. Take out the screws on either side at one end and wedge the lid open about an inch; spread a sheet and put the box on to it upside down, so that the greater portion of the sheet is in front; throw the bees down as for hiving into a frame hive and they will run in. One precaution is necessary, that is to make the box dark by covering over the perforated zinc which admits a lot of light. I well remember the first time I tried to get a swarm into a travelling box. In three-quarters of an hour not more than a score of bees went in. The thought then struck me to make the box dark. This I did with my coat and in less than ten minutes all the bees were in, the reason being that bees prefer going into a dark place rather than one which is light. (Fig. 59) shows the box with the lid wedged



up, a sack over to make it dark, and the swarm nearly in. When it is dark the wedges are pulled out, the lid goes into position and is screwed fast so that the bees are secure.

If the swarm is to travel in a skep they should be fastened in with open material, such as mosquito netting or scrim cloth (cheese strainer). It should be cut large enough to allow the skep to be completely tied in. Put the covering on the ground, stand the skep in the centre, take two opposite corners and tie them tightly over the top, the other two are then treated in the same manner. Now invert the skep and tie round tightly with a piece of string about a couple of inches from the top edge, so that it is impossible for the bees to get out. The skep must travel mouth upwards or the bees will suffocate. To do this a rough skeleton framework may be made

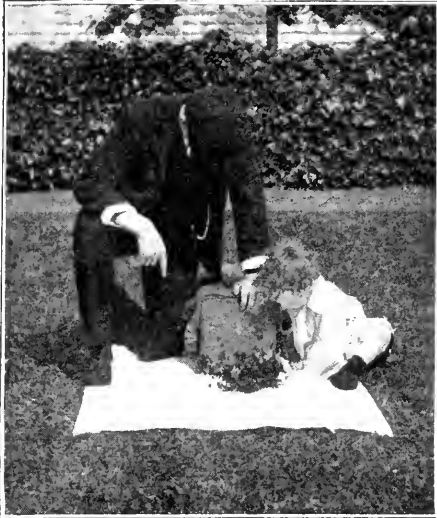

FIG. 59.

by nailing a couple of pieces of wood the length of the diameter of the skep in a  $\times$ . Two sets are made, one each for the top and bottom, four uprights are nailed or screwed on to these. The skep sits right down on to the bottom, but the top one should be six or eight inches above the top edge, so that when in the train if luggage is packed on it ventilation will be provided. The side pieces project about a couple of inches above the top cross, so that if the skep happens to be turned upside down they form legs to keep it clear of the ground so that air can enter. (Fig. 60) shows this method, while at (Fig. 61) a box is used. This must be six or eight inches deeper than the skep to give ventilation. The couple of pieces of wood nailed across the top prevents anything being put right down on to the skep.

Whatever form is adopted it is necessary to label the package in large red letters: *Live Bees*.—Please do not place either in the sun or under other luggage or they will suffocate. *Immediate Delivery*.

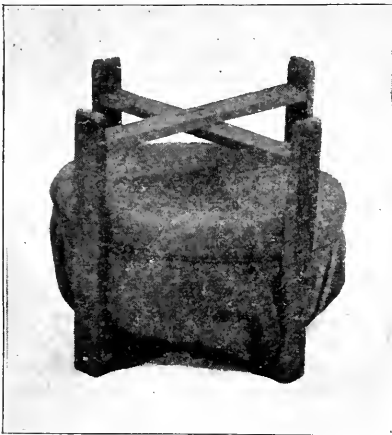

FIG. 60.

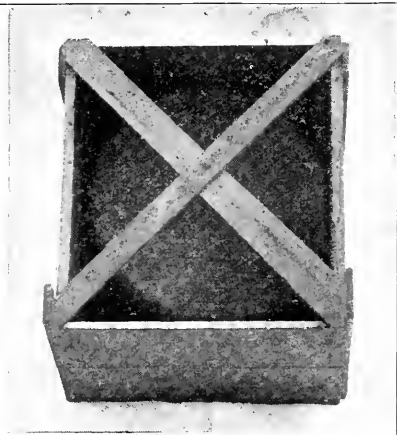

FIG. 61.

SWARM CATCHERS.

These are of two kinds, one for taking swarms that have clustered in high positions and the other for trapping and retaining swarms when they issue from the hive. The former are not used much in this country on account of the expense, the makeshift (Fig. 11) is as a rule all that is necessary. For those who wish to make

one (Fig. 62) is an illustration taken from "Cheshire's Practical Beekeeping," showing three kinds. The method of construction is so plain and simple that it is unnecessary for me to describe it.

Of the latter there are a number on the market. A very simple but efficacious one is that known as "The Brice." At (Fig. 63) it is shown in position. It is made to carry three brood frames which are fitted with foundation. When the bees show signs of preparing for swarming the porch is removed and the catcher fixed in position by means of a wire on either side fastened on to screw eyes on it and the outer case, or it can be screwed on to the outer case as shown in the illustration. From

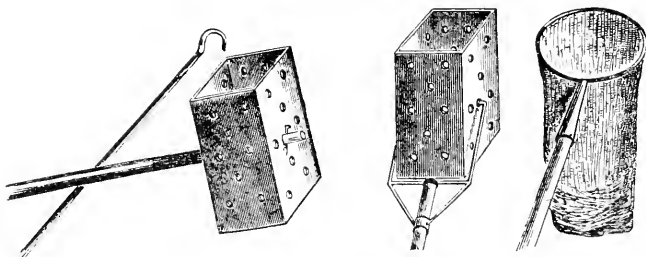

FIG. 62.

the bottom bars of the frames the catcher slopes away on the bevel to the floor board. The frames are not covered by the front board at the bottom by a couple of inches. Queen Excluder is nailed from the edge of the front board right down to the bottom of the bevel, which, when the catcher is placed in position, fits down on to the alighting board. The bees pass in and out through the excluder, but when the queen attempts to go out with a swarm she is unable to do so but runs up the sloping excluder to the frames, where the bees find her and cluster (Fig. 64), so that they hang clear of the entrance and allow the work of the hive to be carried on. The owner can then remove the swarm at his leisure (Fig. 65), hive it elsewhere, or return it after dealing with the stock as already described.

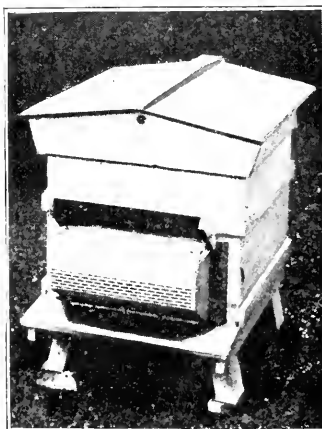

FIG. 63.

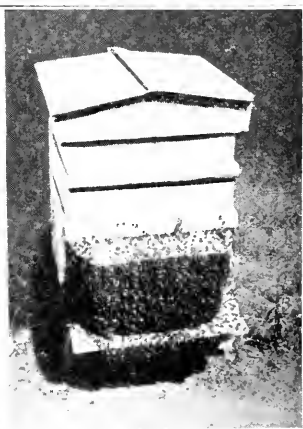

FIG. 64.

Swarm catchers should only be used under special conditions, as they hinder the work of the bees to a certain extent by having to pass through the perforations. Also the drones are trapped and block the entrance, so that it is necessary to liberate them from time to time as they hinder the workers if allowed to remain, or if they die they choke it up entirely. To those whose business takes them away from home in the daytime they are a boon. Catchers need not be kept on the hives for more than a fortnight or three weeks in the height of the swarming season. One advantage of this catcher in districts where too much pollen is gathered is that the pellets are scraped from the legs of the bees as they pass through, so that clogging of the combs with it is prevented.



FIG. 65.

## CORRESPONDENCE

*The Editors do not hold themselves responsible for the opinions expressed by correspondents. No notice will be taken of anonymous communications, and correspondents are requested to write on one side of the paper only and give their real names and addresses, not necessarily for publication, but as a guarantee of good faith. Illustrations should be drawn on separate pieces of paper. We do not undertake to return rejected communications.*

### SURREY B.K.A. PROPAGANDA WORK.

[9068] A series of lectures by the Association Lecturer, under the auspices of the Surrey Educational Committee, have just been concluded at Bramley. And they were very much enjoyed by the day school scholars. One lad is "after" bees, and the schoolmaster is "bitten," and intends to start keeping some bees next season; so if we are spared, and all is well, we hope to continue these lessons in a practical manner. The evening meetings arranged for adults were not very well attended, as, being a rural district, most of the menfolk were busy in the hayfields, and the district has also been scourged with the "Isle of Wight" disease, a good attendance was not to be expected. Why theoretical and preliminary knowledge of bee-keeping is not included in the school curriculum I cannot understand, especially when we consider the time given to gardening, botany, and various other nature studies; all relying to such a large extent on the bee for the perpetuation of the species. Most people will admit we have not touched the fringe as to the possibilities of bee-keeping as an

industry, which I suppose accounts for the apathy. I shall be getting close to what I hope will be "temporarily" a "tanned subject," but there appeared to be no views expressed in the recent discussion as to what we could put into our "Associations," but rather what we may get out of them. I believe if members were helped, and encouraged to meet locally, a better feeling of general usefulness would be engendered. Of course this is a big problem, but it might be made an ideal, and as such, should be brought forward and discussed "officially," as unless members have this "initiative guidance" and support, there is no possible means of making the rank and file understand the usefulness to which our Associations can be put, as there is not enough interest taken to ensure even a good annual meeting. I am thinking of my own Association in this particular, and when an annual meeting musters nine all told, something is wrong—where? By local meetings this could be rectified by delegate, whose report would be, we might imagine, looked forward to with much interest. Other co-operative problems, as buying appliances, selling produce, queen-rearing, and exchange would melt away, only to reappear as a useful, tangible combination, whose sole aim would be to further the interests and prosperity of its members and their industry. While, if we had been organised to this extent we might by a more united front have beaten down opposition to our Legislative Bill, and might even now have been enjoying the benefits of protection from disease centres. This "reform" must be worked for by those who really want it.—H. H. HAMSHAR.

## QUERIES AND REPLIES

[8973] *Transferring.*—Having put bees down into frame hives and placed queen excluder on, I find in the combs out of which the young are hatching, cells with material of all colours. (1) Is this pollen, and if so will the bees take it down into the combs? (2) After the young are all hatched must I take the honey-combs and scratch the cappings, and let the bees take the honey down, or shall I take out the combs and lay one at a time flat on top of frames?—WORKING MAN.

REPLY.—(1) It is pollen, and it is most unlikely that the bees will carry it down, in fact it is better that they should not do so. (2) It will be best to remove the boxes, take out the combs, and put them in a strainer to drain, smashing them up to facilitate this. If the bees require food

give the honey back by means of a rapid feeder.

[8974] *Ripening Honey and Melting Cappings*.—Will you kindly inform me through the "B.B.J." if uncapped honey can be ripened in what is termed a "honey-ripeners," and if so, by what process? Also the best method of melting and straining wax cappings?—H. FOUNTAIN.

REPLY.—Unripe honey can be brought to condition by allowing it to remain in the ripener in a warm room; leave off the lid, and cover with muslin to keep out dust and insects. The best method of melting cappings is in a solar wax extractor.

## Bee Shows to Come.

**THE FOLLOWING SHOWS ARE CANCELLED:**—Aug. 29th, Nantwich; Sept. 1st, Duddington; Sept. 2nd, Lancaster; Sept. 9th, Guildford.

Sept. 5th, at the Club Room, North-road, Kew.—Honey Show of the Richmond and District Bee-keepers' Association. Open classes for honey and wax. For schedules, apply Hon. Sec., Mr. J. G. Romer, 234, Kew-road, Kew-gardens. Entries close August 28th.

October 20th to 23rd, at Royal Agricultural Hall, Islington, London, N.—British Dairy Farmers' Association Annual Show. Classes for honey. Schedules and entry forms from the Sec., F. E. Hardcastle, 28, Russell-square, London, W.C. Entries close Sept. 11th.

## Notices to Correspondents

M. M. (Harborne).—We are indeed pleased to hear of your success, and the splendid return you have had. By all means send on an account of your treatment.

J. D. (Swanwick).—You do not say how far you have to move the bees. If over two miles you should let them fly at once. If less than that wedge grass into the entrance and let the bees liberate themselves. Boil the syrup until it is the consistency of honey.

A. W. B. (Buckhurst Hill).—You will find the sketch and particulars you desire for honey board in BEE JOURNAL, November 15th, 1900, which can be obtained from us post free for 2½d.

AMATEUR.—The bees show every sign of "Isle of Wight" disease. The queen sent had been killed in fighting the other. They are black bees and two

lots have been united to make up the weight you required. If you slow feed they will breed this autumn.

### Honey Samples.

CONSTANT READER (Baildon).—The honey is good in flavour, medium in colour and very thin.

ANXIOUS (Leiston).—It is a heather blend and worth 1s. per lb.

### Suspected Disease.

W. H. (Richmond, Yorks).—It is "Isle of Wight" disease, for which there is no cure.

WEST YORKS.—Bees too dry for us to give an opinion.

C. W. F. (Bolton Percy).—It is "Isle of Wight" disease; better destroy them.

W. R. C. (Donnoak).—The bees are affected with "Isle of Wight" disease. You did right in destroying them. If any of the others show the same symptoms destroy at once.

## Special Prepaid Advertisements

Two Words One Penny, minimum Sixpence.

Orders for three or more consecutive insertions entitle advertisers to one insertion in "The Bee-keepers' Record" free of charge.

Trade advertisements of Bees, Honey, Queens, and Bee goods are not admissible at above rate, but will be inserted at 1d. per word as "Business" Announcements, immediately under the Private Advertisements. Advertisements of Hive-manufacturers can only be inserted at a minimum charge of 3s. per 1/2 in., or 5s. per inch.

## PRIVATE ADVERTISEMENTS.

WANTED, secondhand "Conqueror" hives and accessories; send particulars.—BEVERIDGE, Maybank, Dundee. v 68

FOR SALE, twelve single and six double hives, quantity shallow frame and section crates, extractor, strainer, and ripener, three dozen 28lb. tins, &c., all in good order, no reasonable offer refused; further particulars on application.—EXORS. of E. STEVENS, Latimer, Chesham, Bucks. v 67

FINE clover honey, 60s. cwt.; tins free, f.o.r.—M. HACKER, Crockerton Villa, Warminster. v 66

OVERSTOCKED; a few ten-frame colonies for sale, teeming with bees and brood, 25s., f.o.r.; boxes free.—M. HACKER, Crockerton Villa, Warminster. v 66

FINEST English honey, 60s. cwt.; sample, 2d.—A. CUTFORTH, hairdresser, Oakham, Rutland. v 63

FIVE dozen 1lb. screw top jars English honey, 8s. dozen.—BUTLIN, Hartwell, near Northampton. v 61

REQUIRED immediately, 1 cwt. honey, in nominal 1lb. jars.—Quote price, carriage paid, to SOUTH DOWNS APIARIES, Cooksbridge. v 60

SUPERIOR Lincolnshire clover honey, 9d. lb., on rail.—SMITH, decorator, Caistor. v 56

WANTED, cloth bound copy "Bee-keepers' Record," Vol. 7, year 1889.—HERRÖD, "B.B.J." Office, 23, Bedford-street, Strand, W.C.

FOR SALE, zinc skep covers, better than new as they are well painted, half price. 1s. 3d. each, cash with order.—BOSS, "B.B.J." Office, 23, Bedford-street Strand, W.C.

WANTED, one ton of light honey; to be delivered 2 cwt. per week; lowest price, with sample.—APIARIAN, "B.B.J." Office, 23, Bedford-street, Strand London, W.C. v 53



## REVIEWS.

*Bee-keeping for Profit*, by W. S. Morley (London: Cassell and Co., price 1s. 6d.).—We do not know the author, but evidently he or she has attempted to write about a subject with very little knowledge of it, and we are surprised that a firm with the reputation of Messrs. Cassell should have undertaken the publication of a book with so many errors. We cull a few of the most glaring, and leave bee-keepers to form a judgment for themselves of the value of this work.

Frontispiece: "A lady holding a comb with about twenty bees on it, and two hives open at the same time, both with the quilts stripped off." Introduction: "A measure of success is open to anyone who brings *intelligence* into his work." We commend this passage to the author's attention respecting the writing on *practical* (?) bee-keeping. "As soon as the worker *grub* leaves the *cell*." "As she (the bee) becomes *less able to collect pollen* she *increases her honey-collecting powers*." The author evidently has a very poor knowledge of the natural history of the bee, as the next quotation will show. "Three eyes, one simple and two compound, form the complement for each bee." Some of the author's practical advice is equally erroneous, as, for instance: "Personally, I prefer a hive about eighteen inches square, outside measurements. This may be accounted rather large for winter requirements, but it is always a simple matter to reduce the interior space with a dummy." "One or two *odd-sized* hives are convenient to possess." "The escape is to provide the bees with an *additional exit* from the hive." "Of course, an observation hive is not intended to keep bees in for more than a *few days at a time*." A pair of *gloves* with gauntlets are *absolutely necessary*." Now we can understand the author's ignorance of practical bee-keeping; why not have added: If a bee attacks the person he should run away? "When bees are swarming they emit quite a distinct *scent*."

We have not got half-way through the book, but have quoted enough to show that it is not one that can be recommended to anyone wishing to keep bees for profit.—W. H.

*The Olfactory Sense of the Honey Bee*, by N. E. McIndoo, Bureau of Entomology, Washington, D.C.—This is a reprint of a paper which has been published in the *Journal of Experimental Zoology*, Vol.

16, No. 3, April 1914. It is generally admitted that bees have a very keen sense of smell, and many authors have suggested various parts of the insects as probably carrying such organs. So far back as 1838, Dugés was the first to advance the idea that the olfactory organs were situated in the antennæ, and in 1880 Hauser carried out a series of experiments which seemed to prove this to be so. Three years later Schiemenz published the results of his microscopical examinations of the antennæ and described them minutely (see "The Honey Bee," by T. W. Cowan, pages 89-91, for description and illustrations). On the antennæ he found cavities covered by a thin layer of chitine. The hollows are placed at an angle, and into the cavity below passes a nerve end cell. These Schiemenz considered smell hollows. Many other entomologists have had something to say about the seat of the organs of smell in insects, but most of the views have been purely speculative. Hicks discovered in 1857 some peculiar organs on the bases of the halteres and wings of insects, and suggested that these organs have an olfactory function. No further notice seems to have been taken of these since 1860, when Hicks presented his third and last paper on these organs. Subsequent investigations have been in the direction of locating the olfactory organs in the antennæ, a belief which has been generally accepted. The author, in taking an opposite view, objects that all the antennal organs are covered with a hard membrane through which odours must pass in order to stimulate these organs. By mutilating the antennæ, he has carried out a large number of experiments which apparently went to show that they have nothing to do with the sense of smell. Dr. McIndoo therefore looked elsewhere for the organs of smell. Having some years ago found on the appendages of spiders organs which he was able to prove were olfactory, on examining bees he observed similar organs. Drones had 2604 such organs, 606 of which lie on all six legs, and 1998 on all four wings. Workers have 2268, of which 100 lie on the sting, and the queens have an average of 1860 olfactory organs, 100 of which are also found on the sting. Under the microscope these organs appear as bright spots, and at first glance they resemble hair sockets, from which the hairs have been pulled, but on closer examination a great difference is seen. Judging from the anatomy of these organs and from the experiments carried out, Dr. McIndoo says it is only reasonable to regard these structures as the olfactory organs of the honey bee. He has also made a study of these organs in ants, wasps, and hornets, and the conclusion

obtained from this study confirms the above view. Moreover, similar organs are common to all insects, while the antennal organs differ much in structure, and no one kind of them is common to all insects. The author therefore thinks the view that the antennæ carry the olfactory organs must be abandoned. The paper, which extends to eighty pages and is profusely illustrated, will be of special interest to those studying the anatomy of the honey bee.

We have also received the same author's paper on *The Olfactory Sense of Hymenoptera*, reprinted from the *Proceedings of the Academy of Natural Sciences of Philadelphia*, April 1914. He refers to his study of these organs in the honey bee, and the present paper embodies the results of a comparative study on other *Hymenoptera* in much the same manner as pursued on the honey bee. His conclusions are the same, namely, that the antennæ play no part in receiving odour stimuli, but that the organs first discovered by Hicks in 1857 on the halteres and bases of the wings of all *diptera* examined are the true olfactory pores. They are found on the bases of all four wings of the four-winged tribes, on the trochanter and femur of all insects, and occasionally on the tibia.

---

#### HONEY AT THE BLETCHLEY HORTICULTURAL SOCIETY SHOW.

Held on August 3rd, 1914. The number of entries was well above the average, and the quality of honey was exceptionally good. The judge, Mr. Dant, of Newport Pagnell, made the following awards:—

*Best Six Sections of Comb Honey.*—1st, Miss Trench, Winston; 2nd, A. E. Warren, Simpson, Bletchley; 3rd, R. Eggleton, Bletchley.

*Best Four Bottles Light Honey.*—1st, G. Brewer, Bletchley; 2nd, Miss Trench; 3rd, L. Burell, Bletchley.

*Best Four Bottles Dark Honey.*—1st, G. Brewer; 2nd, Mrs. Barnboruck, Linslade; 3rd, A. E. Warren, Simpson.

Honey and Wax staged by Mr. A. E. Warren (not for competition) was very interesting.—A. E. W.

---

#### ROSS-SHIRE NOTES.

The clover honey-flow in the North has been fairly good, but not conducive to heavy yields of surplus. Nowhere have I heard of colonies storing in more than three racks, my own best giving only fifty completed sections. Fortunately, there is a prospect of heather making up for the deficiency in the previous crop. August was a failure for bees until the "Twelfth" dawned bright and sunny. On that day

the apiary boomed, the hum of laden bees and pleasant scent of heather filled the air, and to crown all, a big swarm came off. It settled on a fence post, obligingly waiting my evening home-coming, and the shades of night were falling fast as I shook the belated swarm into a spare empty hive. Mid-August swarming indicates a departure from the normal, and I wasn't surprised to find the parent colony minus unsealed brood, but displaying two recently vacated supersedure cells.

*Heather Honey.*—As a rule, the average colony is amply supplied with one super at the moors. Still, I have some extra strong stocks crowding two, and one (Banat) three racks of sections. The latter, however, is in a double-queen or modified "Wells" hive. Noticing that most of the incoming foragers were drifting towards one entrance, I accelerated matters by opening that one full width, closing the other to a bee-way, and massing all supers on the crowded portion. In this case scope for brood-nest storage is cut down 50 per cent., and, theoretically at least, the combined forces should store a larger surplus than if worked separately.

*Marketing.*—Personally, I have no difficulty in finding purchasers, and last year, after selling my own, managed to dispose of nearly two hundred heather sections for other bee-keepers. Yet many were quite unable to get buyers for last season's crop, and have much of it still on their hands. I think bee-keepers should try to find private customers who will buy in quantities of 20lbs. upwards. Such buyers should be given wholesale terms, their orders sent carriage paid, and, lastly, great care given to safe packing for distant journeys. Heather sections are especially fragile, and small parcels sent by rail usually arrive in lamentable condition. I always point this out, and urge my customers to buy in large quantities for disposal among their friends. When sent in lots of 30lbs. or 40lbs. I can guarantee safe delivery, even to the South of England, but take no risks with small parcels. Anyone who has seen such flung about in transit can account for the breakages.—J. M. ELLIS, Ussie Valley.

---

#### SOUTH STAFFORDSHIRE AND DISTRICT BEE-KEEPERS' ASSOCIATION.

On Aug. 1st R. Talbot Clayton, Esq., of Coseley Hall, Bilston, invited the members of the above association to inspect his apiary. This invitation was readily responded to, and a very good company met, some having travelled a considerable distance by train to take part in the gathering.

The enclosed photo, taken on the lawn, shows a number of enthusiastic

bee-keepers who mostly reside in towns. This picture, I believe, is unique, because, without an exception, all on it are regular readers of your BEE JOURNAL or RECORD.

Mr. Clayton is seen in the front row with the dog, Mr. Rollins, the Expert, being on his left, while the Hon. Sec. occupies the central position in the second row.

In the apiary Mr. Rollins examined the stock of bees, and the supers were greatly admired, the contents being of exceptionally good quality.

Prizes having been offered for the best 1lb. jar of honey and the best wired standard frame, the awards were as follow:—

trusted that this would not be the last time he should see them there.

During the conversation which followed it was evident that all had experienced an exceptionally good season, and the honey entered for competition was of very good quality. An amusing remark was overheard at the tea-table, namely, "How could this be called the Black Country when the fields and roadsides were covered with white clover?"

At the close of the meeting the Secretary was instructed to write to Mr. Joseph Cole (one of our keenest members), who unfortunately was detained in Wolverhampton Hospital, the result of an accident in the steel works, expressing sincerest sympathy with him in his mis-



A GROUP OF SOUTH STAFFS. BEE-KEEPERS.

*Best 1-lb. Jar (thirteen entries).*—1st, E. H. Hopkins, Tipton; 2nd, E. A. Such, Bearwood; 3rd, W. Hildreth, Bearwood; 4th, W. Eggington, Sedgley; 5th, E. Cheshire, Coseley.

*Standard Frame Wired (six entries).*—1st, E. A. Such; 2nd, A. Rollins, Stourbridge.

After partaking of an excellent tea Mr. Hopkins moved a hearty vote of thanks to Mr. Clayton for having so kindly entertained his brother bee-keepers. This was duly seconded and carried with acclamation.

Mr. Clayton, in replying, said he hoped everyone had enjoyed themselves, and

fortune and best wishes for his speedy recovery. Also it was left in the Secretary's hands to make arrangements with a local flower show for holding an exhibition of honey next year.

On Saturday, August 29th, we had another field day at the apiary of G. H. Hipkins, Esq., Dudley Castle Mill Farm, Dudley. The attendance was exceedingly good, but no doubt many more would have been present had they been aware that Mr. W. Herrod would be present. Being in the neighbourhood he attended the meeting and gave an address, which was listened to most attentively.

Mr. Hipkins placed his stocks at the disposal of the Association, and they were manipulated by Mr. Rollins. Mr. Hipkins gave an interesting account of the method of increase followed this season, which had been most successful, two colonies having been converted into eleven.

Tea was then partaken of, and a most profitable bee chat enjoyed afterwards. The Secretary reported that he had received many applications for membership, and that although a number of members had lost their bees through "Isle of Wight" disease they had not lost their interest, and some were present at that meeting. The number of members exceeded seventy, and no doubt that number would shortly be doubled, as the Association had been formed only a little over a year.—**JOSEPH PRICE**, Hon. Sec., Haden Hill, Old Hill, Staffs.

#### WORCESTERSHIRE B.K.A.

The annual show of the above was again held at Madresfield, Malvern, in conjunction with the Agricultural and Horticultural Show, on August 6th, and was in every way quite a success. The number of entries was 101 against forty-three and thirty-seven in 1913 and 1912 respectively, and the quality of the exhibits was never better. The trophy class was especially good, Mrs. John Walker well deserving the first prize with a splendid collection of some 2 doz. varieties of bee products.

The President of the Association (Rev. Canon Coventry) and Dr. W. E. Moore Ede officiated as judges, and had no easy task in making the awards. Demonstrations in the bee-tent were undertaken by Mr. G. Richings, and were attended by good numbers of interested persons. The Association has considerably over 200 members, and it is noticeable that very many fruit-growers are joining the ranks, being convinced of the importance of bee-keeping in conjunction with successful fruit-growing. The following is a list of the awards:—

#### OPEN CLASSES.

*Display of Bee Products.*—1st, Mrs. John Walker, Knightwick; 2nd, G. Richings, Worcester.

*Six 1-lb. Sections.*—1st, A. H. Bowen, Cheltenham; 2nd, W. Shuker, Bridgnorth; 3rd, G. Richings.

*Six 1-lb. Bottles.*—1st, J. Gladding, Corbridge-on-Tyne; 2nd, F. Bird, Little Caulfield; 3rd, W. Griffiths, Droitwich.

*Single 1-lb. Bottle.*—1st, J. Gladding; 2nd, F. Bird.

*Honey Cake.*—1st, P. V. Leeke, Leigh; 2nd, Mrs. Painter, Malvern; 3rd, G. Richings.

#### MEMBERS' CLASSES.

*Six 1-lb. Sections.*—1st (silver medal B.B.K.A.), W. J. Woolley; 2nd (bronze

medal B.B.K.A.), H. E. Scrope Viner; 3rd (certificate of merit), Miss Lloyd, Witley.

*Six 1-lb. Bottles Light.*—1st, J. Price, Old Hill; 2nd, H. W. Taylor, Earls Croome; 3rd, W. Griffiths.

*Six 1-lb. Bottles Medium or Dark.*—1st, P. V. Leeke; 2nd, G. Richings; 3rd, Mrs. John Walker.

*Six 1-lb. Bottles Granulated.*—1st, G. Richings; 2nd, A. Donkin, Naunton Beauchamp; 3rd, H. W. Taylor.

*Shallow Frame.*—1st, O. Taylor, Earls Croome; 2nd, H. E. Scrope Viner.

*Beeswax in Commercial Form.*—1st, J. Price; 2nd, Miss Nash, Upton-on-Severn; 3rd, T. Rouse.

#### NOVICES' CLASSES.

*Six 1-lb. Sections.*—1st, Miss Lloyd; 2nd, Mrs. Painter.

*Six 1-lb. Bottles.*—1st, G. Cook, Bastonford; 2nd, Mrs. John Walker.

*Beeswax.*—1st, O. Taylor; 2nd, W. Griffiths.—**GEORGE RICHINGS**, Hon. Show Sec.



*The Editors do not hold themselves responsible for the opinions expressed by correspondents. No notice will be taken of anonymous communications, and correspondents are requested to write on one side of the paper only and give their real names and addresses, not necessarily for publication, but as a guarantee of good faith. Illustrations should be drawn on separate pieces of paper. We do not undertake to return rejected communications.*

#### ENEMIES OF BEES.

[9069] I notice in this week's BEE JOURNAL a comment on swallows and sparrows eating bees. I can agree over sparrows and tits as enemies of an apiary, but should hardly fancy swallows do much that way unless flies and gnats are quite unobtainable. Does the hedgehog include bees among its dietary? One or two are busy round hives of mine, and no dead bees to be seen.—A. B.

[Hedgehogs do eat bees. In the BEE-KEEPERS' RECORD for June this year we give an illustration, and particulars of the habits of this creature.—Eds.]

#### A SWARM OF BEES IN AUGUST.

[9070] On Sunday, 16th August, at 5 p.m., I took a swarm of bees that were in an apple tree, and had issued from one of my hives. These bees came from the same hive that gave me a swarm in January of this year, and the strain of bees have been for at least twenty years with the same cottager. His rule has been to use a box, and destroy the bees when taking honey. Sometimes he took the



honey from the swarm, or he might take it another time from the original box according to which had done best, judging from weight of the box. Last August and this year I have had the bees. They stayed all last winter in the hive, and then swarmed in January, and the lot I had just lately, after staying about a week in the hive, swarmed as above stated.—**HEREFORDIAN.**

## QUERIES AND REPLIES.

[8975] *Keeping Races of Bees Pure.*—As a new Irish reader of "B.B.J.," might I ask you the following:—(1) If I have colonies of several different races of bees in my apiary, how can I control the mating of the queens so that I can keep at least one colony of each kind pure? (2) I have only native bees, but would like some other kinds also. Would you recommend Italians, Dutch, and Carniolans? Would these, if crossed with the native bee or between themselves be likely to develop a cross temper? (3) I have also seen Caucasian bees spoken well of. Where could I obtain either a queen or stock? (4) Can two queens be kept in one hive separated by an excluder division board? (5) At what price can you supply two stone cheapest sugar you advise for bees?—**JOHN W. COLLIER.**

REPLY.—(1) It is an impossibility. (2) Stick to your own for the present. Hybrids are, as a rule, cross in temper. (3) Caucasian bees have been tried and failed in this country. They come from Russia and, of course, at present are unobtainable from there. You might get them from America, where they are much used. (4) Better use a solid division board. (5) We are unable to quote price at present.

[8976] *Bees and Heather.*—(1) Will bees work heather situated between two and three miles away? (2) I have two "W.B.C." hives, and it seems to me they are quite unsuitable for transporting to heather. Can you recommend a good all-round hive, good for heather transporting? Is the "Snelgrove" such? (3) In packing up bees for the winter, I suppose it is policy to have the brood-chamber raised from the floor. Would an empty shallow frame rack, placed below, answer the purpose? (4) In a climate like Lancashire, with so many dull days, would the Italian bee do better than the English? Are the former easier for a

lady to handle than the latter? (5) Is it a common occurrence for deep combs to be braced to the shallow supers? When this occurs, is the depth of the shallow rack at fault? I am not clear as to between which racks the Rymer honey board is meant to be used. (6) Is it possible to insert super-clearer without subduing bees? (7) When the hive is touched, or, rather, jarred, in the evening there issues a hiss. Is that fright or anger? Does it cause consumption of stores? (8) The road past my home has been literally infested with heavy motor char-à-bancs since Whitsun. They simply shake the house. I am sure it disturbs the bees. I had the quilt partly raised one evening, and while watching one of the motors passed and down went the bees with a prolonged hiss. Would that cause consumption of stores? I have reasons for thinking so!—**MISS BEE.**

REPLY.—(1) The distance is too far for good work. Although bees work a radius of two miles, owing to changeable weather and short days during the heather harvest it is best to have stocks right on the moors. (2) We must refer you to our advertisers' catalogues, in which you will find hives suitable for the moors. (3) Leave the brood chamber as it is; in any case do not raise it more than the space of an eke, *i.e.*, 3in. (4) No to both questions. (5) In a good honey-flow this will happen in any hive, but, as a rule, it is the fault of the super. The Rymer board is used next the brood chamber, as are all excluders. (6) Possible, but very foolish to attempt. (7) Fright, &c., causes food to be consumed. (8) We do not think so, neither do we think the motors affect the bees. Many stocks are kept on railway embankments, and do remarkably well in spite of the jarring, which they evidently get accustomed to. You have not observed our rule of writing on one side of the paper only. Kindly bear this in mind in future, as it saves ourselves and the printers a great deal of trouble.

## Bee Shows to Come.

**THE FOLLOWING SHOW IS CANCELLED:—Sept. 9th, Guildford.**

**Sept. 5th, at the Club Room, North-road, Kew.**—Honey Show of the Richmond and District Bee-keepers' Association. Open classes for honey and wax. For schedules, apply Hon. Sec., Mr. J. G. Romer, 234, Kew-road, Kew-gardens. Entries open until first post on September 5th.

**October 20th to 23rd, at Royal Agricultural Hall, Islington, London, N.**—British Dairy Farmers' Association Annual Show. Classes for honey. Schedules and entry forms from the Sec., F. E. Hardcastle, 28, Russell-square, London, W.C. Entries close Sept. 11th.

## Notices to Correspondents

\*\* Mrs. Bee Mason asks us to announce that owing to Mr. Bee Mason's sudden departure to the front as war correspondent and cinematographer, he is unable to answer several correspondents, whose letters are awaiting a reply; also that there is no one at the farm.

B. C. (Wade).—Propolis can be removed from the hands with methylated spirit, from metal work with a solution of Fel's naphtha soap.

A. P. (Plymouth).—We are afraid, from your letter, that you have not sufficient experience to undertake the job. In any case, it is too late now to do as you suggest. Next spring cut out all the combs free from honey and brood, separate the centre ones by cutting right down with a long knife, and then insert a frame of foundation. When this is drawn out, draw apart and put in another, and so on, until the full complement is reached. As the old combs are brought to the sides of the hive the brood will hatch out, so that slices can be cut off from time to time to make room for the new frames.

F. M. J. (Wrexham).—The honey is fit for human consumption, but you must be very careful that other bees do not gain access to it.

E. L. C. (Fakenham).—"Mendelism," by R. C. Punnett, published by Macmillan and Co., Ltd., London, price 1s. 6d.; "Mendel's Principles of Heredity," by W. Bateson, M.A., F.R.S., published by Cambridge University Press, Fetter Lane, London, E.C., price 12s. We shall be pleased to secure the books for you.

E. M. E. (Painswick).—You can use unripe honey for feeding; it will be well to heat it. Naphthol Beta should be put in the same proportion as for sugar syrup.

READER (Eccles).—You can do this, but you will have to buy a fertile queen. The method is fully described on page 93 of "Guide Book."

A. C. R. (Hanwell).—There is no better method than scraping. We congratulate you on your splendid result, and reciprocate all your good wishes and kind words.

J. D. (Northwich).—(1) No, probably the bees will gather enough stores for wintering. (2) It is right to do so if combs are blocked with honey so that the queen has no room for ovipositing.

(3) It is better to replace super. It is not advisable for them to be overcrowded. (4) It is better to winter on eight frames at least, with not less than 25lbs. of stores. (5) Turpentine will be better. (6) No, use white. (7) Not necessary, but you may use two if combs are at right angles with entrance; do not use chaff or cloth as suggested. (8) No, see that entrances are not more than  $\frac{3}{8}$  in. high, and that mice, &c., cannot enter the roof.

A WIFE (Durham).—Sorry we cannot spare so much space. You will find the information in the "British Bee-keepers' Guide Book." It is quite possible for you to manage bees without help. The secretary of the Durham Bee-keepers' Association is Mr. G. E. Robson, Oakleigh, Butterknowle. He will be able to give you information as to the Association and its experts.

### Suspected Disease.

W. S. (Portsmouth).—Cut out a small piece of the brood, pack it in a tin box and send it to us, when we shall be able to tell you what is the matter.

J. F. (Lochfyne) and IVOR (Glamorgan).—It is "Isle of Wight" disease.

NOVICE (Yorks.).—The symptoms you describe are those of "Isle of Wight" disease, and both samples of bees are affected.

NESTOR (Leicester).—There is no disease; brood is chilled. Yes, add some driven bees and feed.

### Honey Samples.

R. D. (Tipton).—The honey is of very good quality, it is light in colour, very dense, bright, and of good flavour; obtained from clover.

F. P. (Solihull).—The honey is a good colour, medium density, flavour spoiled by using too much carbolic on the cloth.

## Special Prepaid Advertisements

Two Words One Penny, minimum Sixpence.

Orders for three or more consecutive insertions entitle advertisers to one insertion in "The Bee-keepers' Record" free of charge.

Trade advertisements of Bees, Honey, Queens, and Bee goods are not admissible at above rate, but will be inserted at 1d. per word as "Business" Announcements, immediately under the Private Advertisements. Advertisements of Hive-manufacturers can only be inserted at a minimum charge of 3s. per  $\frac{1}{2}$  in., or 5s. per inch.

## PRIVATE ADVERTISEMENTS.

3 CWT. English honey for sale, in 28lb. tins, 3 at 5s. per cwt., good quality.—W. H. WILLIAMS, St. Briavels, Glos. v 81

SURPLUS STOCKS, strong 10-frame, 22s. 6d., 3 box returnable; skeps, 12s. 6d., l.o.r., all 1914 queens.—ROYDS JONES, Fleet, Hants. v 76

6 FRAME stocks, Carniolan Hybrid, 1914 laying queens, plenty of brood, guaranteed healthy, 16s., boxes to be returned.—A. MAGSON, Kirkham, Lancashire. v 80

## Editorial

### BEE-KEEPING IN BULGARIA.

[From the nature of the Balkan peninsula, and more especially Bulgaria, it is a bee-keeping country. From immemorial times bee-keeping has been carried on in Bulgaria. Up to the year 1880, during the Turkish slavery, the modern hive with movable combs was quite unknown here. The first modern hive of the Dzierzon system was introduced in 1883. Notwithstanding the effort made to popularise this hive, it had little effect, and at the present

number of skeps fell to 241,918. In 1906 there were 19,128 frame hives, which shows an increase of 19,122, really doubling the number of those in 1906. In 1893 there were only 147 frame hives, so that the progress in the fifteen years has been very rapid.—Ebs.]

In Bulgaria it is principally school-masters who have contributed most to the development of bee-keeping. On their initiative, with the assistance of the educated people in general, there was founded in 1899 the Bulgarian Bee-keepers' Society, and on page 6 you will find a photograph of those taking part in its Congress. The first journal, *Pichela*, was founded in 1901, and is managed by an editorial committee. We have already had seven conferences of bee-keepers and two special exhibitions. These exhibitions have

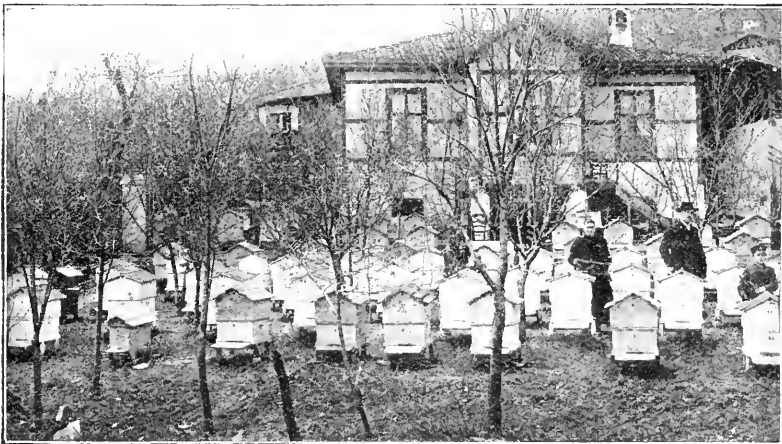

BULGARIAN APIARY.

time it has been entirely discarded, and has been replaced by the Dadant-Blatt hive. Recently an attempt has been made to introduce from America hives of the Dadant pattern, but the Dadant-Blatt is so universally used that it will not be possible to displace it. It is owing to the use of this hive that bee-keeping in this country has so rapidly developed. It is mainly since 1893 that the greatest progress has been made. The results obtained in fifteen years both as to quantity and quality of honey are considerable. In the pamphlet I send you on page 16 is a statistical table of the exportation up to the year 1907, and on page 18 a graphic representation of the increase in the number of hives. From this we find that in 1903 there were 262,108 common hives (skeps) and 9,720 frame hives, and in 1907 these had increased to 38,250, while the

been of use in demonstrating the extent to which Bulgaria and her people are adapted for bee-keeping.

Bulgarian literature consists of a bee journal, and a series of twelve books on bee-keeping, edited by me. Number II. of this library is the translation of your valued work on "The Honey Bee, its Natural History, Anatomy, and Physiology." Besides these books we have translations of Dadant's Langstroth and Huber, &c. Bulgarian apiculture has been represented in several international exhibitions, for instance, at St. Louis, 1904; Liège, 1905; Paris, 1900; and London, 1907. At this London exhibition several Bulgarian bee-keepers received first-class prizes. The principal bee pasturage in Bulgaria consists of wild flowers. The price of honey varies from 1.20fr. to 2fr. a kilo.—M. K. WATCHKOFF.

## RANDOM JOTTINGS.

By Charles H. Heap, Reading.

## A NATIONAL LOSS OF WEALTH.

The believers in the possibility of the evolution within the next few years of a bee immune to microsporidiosis are very shy of telling us on what substantial grounds their faith is based, and it is, therefore, not unreasonable to conclude that such grounds are entirely lacking. Mr. Desmond, it is true, shows an inclination to continue the discussion, but he seems more concerned with its personal than its scientific and practical aspect. Mr. Desmond accuses me of misrepresenting him, but I can assure him that if such is the case I did it unconsciously, just as I am sure he unintentionally misrepresented me in his last letter. I did not brush aside Zander; I brushed aside what seem to me to be the inconclusive experiments of Maassen. When I said "we must work to get rid of *Nosema apis* altogether," I was very careful to add the qualifying words "as we know it." If Mr. Desmond had not overlooked the qualifying words he might have been spared the breakdown of his imaginations. On the question of misrepresentation, which in this instance is of no importance, we are quits.

The main idea in Mr. Desmond's mind, and the only one of the least consequence, is that a bee may pick up a microbe which may, in some way that he does not attempt to explain, have an inhibitory or destructive effect on the organism which is playing such terrible havoc among the bees of the British Isles. The idea is pretty, but it is hopeless from the practical bee-keeper's point of view. It would be more encouraging if Mr. Desmond were to give us an instance in which a beneficial microbe has been picked up by a bee or other animal that has in consequence been cured of a disease. I scarcely think he will furnish an instance, so I will leave him with his chimera.

I thank Mr. Herbert Mace for the unintentional support he gave me in the last issue of the BEE JOURNAL. I remember the ridicule poured on the Board of Agriculture, and especially its President (Mr. Walter Long), in connection with its dog-muzzling order, but the Board proved that the extermination of rabies in this country was possible. I believe it would be possible to rid the country of the strain of *Nosema apis*, which is doing so much mischief among the bees of these Islands. Mr. Mace says: "Until we can discover a specific remedy, common sense tells us to cultivate resistant stocks." We should all like to cultivate resistant stocks; but who has any?

The object I had in view when I attacked his vague idea of immunity to

"Isle of Wight" disease was to divert the minds of practical bee-keepers (I use these words in the ordinary sense and without reference to any particular person or persons) from a wild-goose chase to the necessity of more concerted and vigorous action being taken to end the evil from which bees and bee-keepers are suffering. I know a County Bee-keepers' Association which has achieved a fair amount of success in the past. Its members last year collectively owned over 1,100 stocks. Since then half these have died, and the probability is that in 1915 not 200 will be left. Microsporidiosis is no respecter of persons, and bees die in the apiaries of non-members as well as those of members of county associations. It may, I think, be taken as a rule that not more than a tenth of the bee-keepers of the country are members of associations, and if we keep this in mind we may arrive at a fair estimate of the losses the disease is entailing upon the nation at large. The figures I am about to give are hypothetical, but if they are very much wrong we may rely upon Mr. Crawshaw, with his characteristic ingenuity, to put them right. There are forty English counties, twelve Welsh, thirty-three Scotch, and thirty-two Irish; but as the Welsh counties are small I calculate the number of stocks on a lower scale to Ireland, in which I once kept bees; I also allot stocks on the same scale as I do in respect of Wales. The totals I suggest are:—

England .....	440,000
Wales .....	96,000
Scotland .....	363,000
Ireland .....	256,000
Grand total .....	1,155,000

If microsporidiosis continues to progress at the same rate as it does at present, this grand total will be reduced to half or possibly a quarter a few years hence. In order to be on the right side let us take a modest half. This will mean a loss of 577,500 stocks of the total value, at 10s. each, of £288,750. As these 577,500 stocks should, with fair management, produce an average profit of 10s. each, we have an annual loss of considerably more than a quarter of a million sterling.

In what other industry than bee culture would the people engaged be so complaisant in face of such serious losses as are now being experienced by bee-keepers? This unfortunate complacency is due to two facts—first, that the loss is spread over a large number of people, and, secondly, that bee-keeping is in only a few cases solely depended upon as a means of securing a livelihood. Though the industry is conducted by persons in moderate circumstances on a small scale, as an adjunct to other callings, the loss

from a national point of view is just as bad as if it were occurring in a great industry. Not only is an enormous quantity of nectar—which is produced by natural means without entailing any special outlay of capital—wasted, but fruit and seed crops are curtailed for the want of bees to pollinate the flowers.

In the unhappy war now raging an immense amount of national wealth will be lost; and as soon as peace is restored we shall have to set about developing and accumulating fresh wealth from every available source. To bee-keeping, among other things, attention will be turned. The British Isles are rich in nectar-yielding plants, and if only our bees were healthy, half a million, perhaps a million, pounds worth of honey per annum might be secured. The question is: Shall this source of wealth, in which so many people may share, be neglected because of a few people's old-fashioned notions, ignorance, or contrariness?

---



---

#### “BLURTS FROM A SCRATCHY PEN.”

##### VENEZIA.

And now our raid into Italy is almost come to an end. We have left the sunny south in our rear. We have been spies! Yes, spies, right in the very face of our—no, not enemy. Ours has been a friendly espionage, we have been welcomed everywhere, and everyone has given us all the information we wanted, with even an excess of gladness. How beautiful is peace. How pleasant is this friendly intercourse with our brethren of the craft. Ours is a fraternity which no ambition of princes can ever interrupt. Wars may rage, battles may be fought, kingdoms may be swept away. When the calm has come again the cult of the bee will still remain as ever, and we are still the brotherhood.

We are travelling now on the eastern shores, we are making for Venice, “The Pearl of the Adriatic.” Shakespeare and Byron, and a host of poets whom no tongue can number, have sung its praises. Resting on the silt of the rivers flowing down from the fat Lombardian plains, it is a city like no other. Eighty isles are connected to each other by bridges. It has no roads, no streets, and consequently there are no carts, no motor-buses, and no taxis, for which latter providence we are thankful, for it makes safe the wandering about in the few narrow passages which occur between the quaint, old-time houses and their opposite neighbours. The sun had well set before we reached the lagoon, over which the railway approaches. Far, far away on the horizon we could notice the twinkling lights of a great city all at the water's edge. In

other towns these threads of light wander hither and thither up the hillsides. Until the reflection was lost in the slight haze, the lights of our train glared over the seas. It was just a little bit pleasantly novel and weird. On the right and left, obscurity, with an occasional flash from the lamps of a smack at anchor; in front, a galaxy floating on the sea.

We arrive at the station of Venice. During our travels we had always taken a card of introduction from one hotel to another. It saved in time, in temper (for we could at once silence the shouting hotel touts), and it put us on a good footing with our hosts. Therefore, when we got to the town we had arranged to stay at for the night, all we had to do was to look for the *voiture* of the hotel and hand it our baggage. Venice, as I have said, is a city as none other. The hotel porter seizes our luggage, and indicates to us our sally-port. We march out. There is a twinkling here and there, and everywhere lights of every colour rush past—now they are stationary, now they are at our feet. We find ourselves and our belongings carried forward to the water's edge, and in a moment we are on board a gondola.

And is this the picture one has always treasured? Is that man with a shiny hat, who is “slanging” in fluent language the railway porters, is he the gondolier? I had always seen him represented either in slashed doublets, *fez à la Turquie*, and in intervals when he had not got oar in hand he tuned a guitar; or alternatively he was clad in a shirt of brilliant colour, open at the neck, *à la Byron*, hat wide-brimmed, and undulating. And the gondola, it is certainly high in its prow as of yore, and the cushions are comfortable, but the smell—Faugh! it is of pitch, instead of the soft perfumes of the Orient. The waters of the Adriatic! Oh heavens! Floating on the surface are the flotsam and jetsam, all the accumulated débris of a large population, vegetable and animal refuse, corks, and the sweepings of the houses. Everything goes into the water. It saves dustbins, and the *service des égouts* of Continental towns.

But at last the word is given to start, and we glide over the waters. The motion is luxurious, no bumping, no knocking against kerbstones, but we could have wished the odour from the waves had been less pronounced. Our “gondolier,” in spite of his shiny hat, was disposed to be entertaining. He spoke passable French and a little English. He showed us the palaces of the various Doges, the “Bridge of Sighs,” and the “Rialto.” It was a journey of some twenty minutes to our hotel. The waterway from the station gradually led us into the Grand Canal, the main thoroughfare of the city. Here we

met, indeed, gondolas which more nearly realised our dreams. They were of white, of blue, of gold, of all colours, and in the night darkness their lamps placed for illumination in various positions had a pretty effect. Of course these were the property of wealthy and of aristocratic citizens, equivalent to the carriages and liveried servants or the well-upholstered motor-cars of other countries. As we floated then down the current the soft sound of music came over the waters. It was, indeed, a serenade. For the moment visions of Romeo and Juliet, of troubadours and lovers of that ilk, rose before us. But out oarsman soon dissipated the illusion, "Spectacle de Théâtre," he whispered. In plain English, "Got up for the occasion."

Yet it was interesting to live again in those old palaces, each with its history, now of help given to Crusaders (at a good price), another of combats against the pirates who coveted so rich a prize, and still others told of long and continued struggles against the Turks.

We neared our hotel—our interesting "gondolier" had volunteered the information that his due was five francs. His suavity had made me doubtful. I queried the "garçon" as to the right fare. "Three francs is ample," was the reply. There are still pirates in the Adriatic Sea.—J. SMALLWOOD.



*The Editors do not hold themselves responsible for the opinions expressed by correspondents. No notice will be taken of anonymous communications, and correspondents are requested to write on one side of the paper only and give their real names and addresses, not necessarily for publication, but as a guarantee of good faith. Illustrations should be drawn on separate pieces of paper. We do not undertake to return rejected communications.*

#### HONEY FOR SOLDIERS.

[9071] British Bee-keepers, in common with all Britons, must sympathise deeply with our brave comrades in arms in Belgium who have been driven from their homes by the "cultured" destroyers of Louvain. An opportunity now occurs to give practical effect to our sympathy, as the Belgian Minister has issued an appeal for all kinds of food-stuffs which are urgently needed by the refugees. I would suggest that each bee-keeper should send what he can spare from his abundant harvest to assist in alleviating the distress. Run honey in tins or jars is preferable to sections, and it should be addressed to

the Manager, Belgian Relief, care of Messrs. Harrod's, Ltd., Trevor Square, London, S.W.

If each donor were to place his name and address on his package it would show our Belgian friends how widespread is our sympathy with them.—WALTER F. REED, Vice-Chairman British Bee-keepers Association.

#### BARNET AND DISTRICT B.K.A.

[9072] Barnet and District Association have just concluded a series of demonstrations in bee-keeping which, it is believed, will have very far-reaching results. Mr. W. Herrod, F.E.S., in each case was the demonstrator, and of course no more need be said on that point. But to show the use of continued effort in this way it should be noted that each demonstration has had an increased audience, and where two years ago twenty or thirty would have been considered good, from 100 to 120 is now our usual attendance.

I know that all districts are not so fortunate as ours in being able to obtain such an exponent of the craft, but I do suggest that those associations in the Herts County should make as much use as possible of Mr. Herrod's services.

I would point out one noticeable thing in connection with our own district, and that is the number of young people who attend, and who, by their attention and by the questions with which they usually bombard the lecturer, show the interest they take in the subject.

From my own knowledge, several lads have taken up bee-keeping as a result of these lectures, and are conducting their apiaries on thoroughly up-to-date lines. I am strongly of opinion that this is the best way of increasing the number of bee-keepers in this country, and would call the attention of associations to the fact that by teaching the young they are raising future members who will be a credit to their trainers.—G. J. FLASHMAN, Hon. Sec.

#### WEATHER REPORT.

WESTBOURNE, SUSSEX.

August, 1914.

Rainfall, 1.76 in.	Minimum on grass,
Below average 1.03 in.	39 on 8th and 11th.
Heaviest fall, .43 on	Frosty nights, 0.
15th.	Mean maximum, 69.2.
Rain fell on 14 days.	Mean minimum, 53.0.
Sunshine, 228.4 hrs.	Mean temperature,
Above aver., 16.7 hrs.	61.1.
Brightest Day, 12th,	Above average, 1.0.
13.6 hrs.	Maximum barometer,
Sunless days, 2.	30.317 on 29th.
Maximum tempera-	Minimum barometer,
ture, 80 on 13th.	29.553 on 2nd.
Minimum tempera-	
ture, 46 on 8th.	

L. B. BIRKETT.

**HELPFUL HINTS FOR NOVICES.**  
*By W<sup>c</sup> Herrod.*

PROCURING SURPLUS.

*(Repeated by Special Request.)*

It is an indisputable fact that the most profitable system of working for surplus is shallow combs for extracting. At the same time it is necessary to take into account the district and also the demands of the particular market. There are some situations where it is impossible to produce good comb honey. In such it is futile to attempt the production of sections, but extracted honey should be obtained by means of shallow frame supers. If the district is suitable for comb-honey and the bees are kept near a town which is more residential than industrial, or near a seaside or inland holiday resort, then undoubtedly comb honey production will pay the best. Among the class of people usually residing or visiting in such localities comb honey is more in demand than extracted, for two reasons; first it is more delicate and appetising when put upon the table in the comb, and secondly they imagine it is impossible to

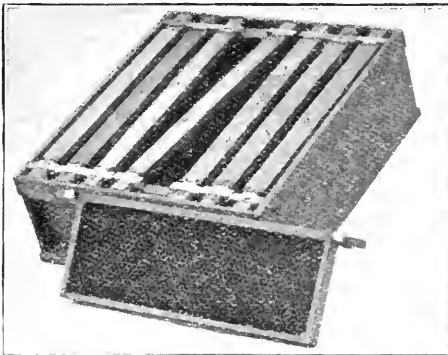

FIG. 1.

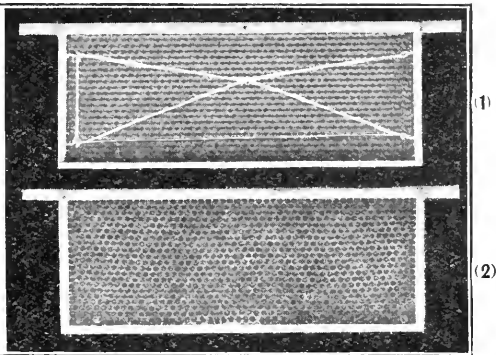

FIG. 2.

adulterate it. In a manufacturing centre, on the contrary, the people desire to get all they can for their money, and therefore prefer to buy honey in a jar, instead of in the comb, looking upon the latter in the same light as they do on the bone in their joint of meat, "something which is useless and has to be thrown away."

The points in favour of producing extracted honey are as follows: (1) There is less danger of swarming; (2) a greater quantity is obtained on account of saving wax secretion for comb building; (3) the supers can be tiered up and remain till the end of the season; (4) the honey can be stored for any length of time.

The first consideration is the super. This, as already remarked, should contain shallow and not deep frames (Fig. 1) except under special circumstances, such as where combs will be required for driven bees at the end of the season. In that case an eke is used under the shallow frame box, so that it is made 9in. deep (Fig. 23). The shallow frames must be wider than those in the brood chamber and should measure 1½in., so that they give more support to the comb than if the ordinary one measuring 7⁄8in. is used. Many bee-keepers use shallow frames, yet if asked why, they can give no reason beyond the fact that everyone else uses them. When extracting there is not so much danger of the comb breaking as there would be in a deep frame; they are also much more comfortable to handle so far as weight is concerned, either singly, or collectively in the super. Then again the shallow super can be given much earlier than a deep one, as it will not check brood-rearing by giving too much space at one time. Heat rises; therefore if a 9in. super is given, the bees

have to maintain the temperature in it as well as the brood-chamber, thereby wasting both energy and food. The object of the bee-keeper is to obtain combs as straight as possible; they should also project a little beyond the woodwork of the frame so that the capping can be cut off easily, and not have to be dug out. The cells should be drone, as they take less wax, and the honey presents a larger surface for ripening; it also leaves a larger cell more easily than a small one, and it provides the bees with the means for exercising their natural instinct for building drone comb in a place where it will be harmless. The excluder prevents the queen from getting up and ovipositing; therefore the rearing of a lot of useless drones is avoided. The foundation should be wired (No. 1, Fig. 2) to stand the strain of the centrifugal force when extracting, and the frames eight in number, as for the storage of food we can

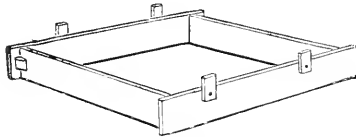

FIG. 23.

dispense with the  $\frac{7}{8}$ in. thick comb and go to 2in. In doing this two sheets of foundation are saved in each super, also the secretion of wax for sealing the faces of four sides of comb, which would be necessary if ten frames were used as in the brood chamber. Occasionally difficulty is experienced in getting the bees into the super when all the frames contain foundation and are widely spaced. This can be overcome by using the ordinary narrow end until the combs are built out perfectly, (No. 2 Fig. 2), when they can be replaced by the wide ones.

It is also an advantage to have a bait comb or two on hand, *i.e.*, according to the number of stocks, one or two supers of shallow combs should be kept from the previous year just as they leave the extractor without being cleaned. These can be distributed amongst the other supers when they are put on the following season.

(To be continued.)

## Notices to Correspondents

T. W. (O. Colwyn).—*Unsealed Stores in Super*.—You can do as you suggest.

PUZZLED.—*Combs Without Brood*.—The queen has been prevented from laying by the bees blocking up the cells she should have used with honey. Take out a couple of the combs, extract the honey, and replace them in the centre, when the queen will commence to lay.

F. M. D. B. (Babbacombe).—*Queens not Laying*.—It may be attributed to the dry weather. The queens are probably there all right, and no doubt feeding would cause them to lay again.

*Suspected Disease.*

M. Y. Z.—(1) No. (2) No.

A. W. (Craig Elvie).—Bees are suffering from "Isle of Wight" disease.

HEATHER (Worth).—Bees appear to be healthy.

F. C. H. N. (Mudford).—There is no doubt it is "Isle of Wight" disease.

E. W. (Wrexham).—Bees show symptoms of "Isle of Wight" disease. Better destroy them.

## Special Prepaid Advertisements

Two Words One Penny, minimum Sixpence.

Orders for three or more consecutive insertions entitle advertisers to one insertion in "The Beekeepers' Record" free of charge.

Trade advertisements of Bees, Honey, Queens, and Bee goods are not admissible at above rate, but will be inserted at 1d. per word as "Business" Announcements, immediately under the Private Advertisements. Advertisements of Hive-manufacturers can only be inserted at a minimum charge of 3s. per  $\frac{1}{2}$ in., or 5s. per inch.

## PRIVATE ADVERTISEMENTS.

WOODMAN'S hatchet, 8 $\frac{1}{2}$ lbs., ready handled; exchange bee appliance, offers.—LEWIS, Efailwen, Clynderwen. v 16

WANTED, pictures, photos, negatives, and slides; Bees and Bee-keeping, ancient and modern; also Wasps, Bumble Bees; list and prices.—TOMS, Roma, Barnet, Herts. v 22

SPLENDID white clover honey, £3 per cwt.; sample 3d.—ALBERT COE, Apiary Hall, Ridgewell, Halstead, Essex. v 2

FIRST QUALITY SUFFOLK honey; white candied, screwcaps, 9s.; light golden, 7 $\frac{1}{2}$ d. per lb.—WRIGHT, Sudbury, Suffolk. v 20

FOR SALE, 4 cwt. of pure Cambridgeshire honey, medium colour, fruit and clover, 28lb. tins, sample 2d.—HAZZARD, Haddenham, Ely. v 17

BARGAIN; Italian stock on ten frames, 1914 queen, Simmins' White Star strain, 17s. 6d., f.o.r.; travelling hive, 2s., returnable.—DODD, 37, Hermon-hill, Wanstead, Essex. v 9





### OURSELVES.

The British Empire is passing through one of the greatest episodes in history, and although we have not the slightest doubt as to the final result, who would dare to prophesy what trials we shall have to go through or what sacrifices we shall have to make for the sake of our beloved country?

We are not alarmists, but desire to face possibilities and be prepared rather than, ostrich-like, hide our head and imagine they are not there.

Up to the present we have been nobly supported by our readers, and all those with whom we have business connections. Our existence depends upon our readers, therefore we earnestly appeal to them to continue their support during the crisis, so that when the war is brought to a satisfactory conclusion we shall still be in existence to carry on as usual.

We make this appeal as we find there is a mistaken idea as to our position in connection with the British Bee-keepers' Association. Many, we believe, have an impression that our papers belong to this Association, therefore are not self-supporting. Both papers are privately owned and managed. Beyond being the official organ of the B.B.K.A. for the publication of reports of its meetings and other notices, and having our loyal support, the two have *no connection whatever*.

As a precautionary measure to conserve our stock of paper we have reduced the size of our journals, and in other ways are preparing for all contingencies. We are doing our best, and are quite certain *our readers* will do the same on our behalf.

### GLAMORGAN B.K.A.

#### CARDIFF SHOW.

The annual show was held at the Sophia Gardens, Cardiff, on July 22nd and 23rd, in connection with the Cardiff and County Horticultural Society. Although the entries were not numerous, the quality of the exhibits was very good. Mr. E. Church had a fine collection of honey and wax, which was staged in a very attractive manner. The extracted honey was carefully prepared, and one of the features

of the show was the excellence of the exhibits in the novice classes, showing that the Association is doing good work in spreading the knowledge of bee-keeping. Mr. S. Jordan was the judge, and Mr. W. O. Jones gave demonstrations with live bees. The weather, especially on Thursday, was most unsuitable for outdoor demonstrations, but the experts gave valuable advice and information to many enquirers. Messrs. F. Grivil, G. P. Workman, W. T. Gunter, Wm. Morgan, D. Hardcastle, C. J. Wiltshire, and others rendered valuable assistance, and the Rev. H. Morgan, as usual, gave his services for the two days. The following is the prize list:—

*Six 1-lb. Sections.*—1st — Kinghorn, Llanishen; 2nd, J. B. Kitt, Wenvoe; 3rd, D. George, Merthyr Mawr.

*Two Shallow Frames.*—1st and 2nd equally divided between E. Church, Cardiff, and W. T. Gunter, Cowbridge.

*Six 1-lb. Bottles of Extracted Honey (Light).*—1st, E. Lawrence, Ewenny; 2nd, E. Humphrey, Cowbridge; 3rd, D. Hardcastle, Llsrvane.

*Six 1-lb. Jars Extracted Honey (Medium).*—1st, W. Morgan, Llantrisant; 2nd, E. Lawrence; 3rd, H. Edmunds, Llsrvane.

*Six 1-lb. Jars Extracted Honey (Dark).*—1st, J. B. Kitt; 2nd, E. Lawrence; 3rd, Wm. Morgan.

*Beeswax.*—1st, Miss Penhorwood, Ewenny; 2nd, D. George.

*Articles of Food containing Honey.*—1st, W. T. Gunter; 2nd, Wm. Morgan.

*Honey Beverage.*—1st, Wm. Morgan; 2nd, W. T. Gunter.

*Observatory Hive with Live Bees and Queen.*—1st, D. Hardcastle.

*Six 1-lb. Sections.*—1st, H. Edmunds; 2nd, E. Thomas and Mr. Kinghorn (extra 2nd).

*Six 1-lb. Jars Extracted Honey (any colour).*—1st, H. Edmunds; 2nd, Miss Penhorwood.

*Collection of Honey and Wax.*—1st, E. Church.

*Best 1-lb. Bottle of Honey.*—1st, A. Bowen, Cheltenham; 2nd, Miss Penhorwood.

*Best 1-lb. Section of Comb Honey.*—1st, A. Bowen; 2nd, D. George.

*Six 1-lb. Sections.*—1st, D. George; 2nd, A. Bowen; 3rd, S. Lewis.

*Six 1-lb. Jars Extracted Honey (Light).*—1st, W. Gunter; 2nd, E. Lawrence; 3rd, J. Rees, Llanishen.

*Beeswax.*—1st, D. George; 2nd, E. Church.

*Six 1-lb. Jars Extracted Honey (Light).*—1st, S. Lewis; 2nd, W. T. Gunter; 3rd, J. Rees.

*Six 1-lb. Jars Extracted Honey (Dark)* 1st, D. George; 2nd, C. Jones.

## DERBYSHIRE NOTES.

Since sending the article 9037, on page 246, in which I indicated that a motor might be preferable to a dray for moving bees to the heather, I have heard from a friend. In his communication he deprecated any attempt at moving bees by motor, having had one experience recently when all the brood was shaken and killed, by moving his bees a distance of forty miles. This made me pause to consider the question more fully, but after due consideration I decided to make one trial. On August Bank Holiday Monday I moved eight stocks to the moors in a motor van. I never had such a quick removal before. From leaving home to getting back it only took four hours, inclusive of time taken in setting down stocks on their stands, making all secure, having breakfast and a look round the moor, the total distance being close on thirty-six miles by road, some of which was bad and steep. Nor did the bees or brood suffer in transit. On the following day I took more by means of the old-fashioned dray. I am afraid that the Editors would hardly allow my comments on that journey to appear in print, so will not inflict them on your readers. Since then I have been several times to visit my bees. It is only this week (August 17th onwards) that the honey-flow has come on. On Thursday the bees were doing splendidly, and honey was being rapidly stored. I notice that when on the heather the alighting-board is always crowded with bees apparently doing nothing, whilst others are flying freely. Is this experience a purely personal one, or have other bee-keepers noted the same occurrence? My hive entrances are open full width. Given a continuance of good weather for a few days there should be a bumping crop.

It will be extremely acceptable to me considering the price of sugar. Bee-keepers should look to this latter item at once. Leave as much natural store as possible and take every stock to the moors if within reach. It will pay.

Mr. Crawshaw takes me to task on page 315. I would like to answer that here, at any rate, I have generally found a lull of a few weeks between clover and heather, allowing me opportunity to reorganise my stocks. I look upon queen-excluder at the best as a very regrettable necessity, and when on the moors have done better without it. Even if a young queen gives a certain impetus to brood rearing in a stock, by the time the bees are ready to come back from the moors there is little danger that there will be brood in supers.

I would like to ask Mr. Crawshaw a question. This question does not apply directly to bee-keeping, but has a bearing on it: "What is the plural of gantury?"

(page 314). I am almost afraid to ask the above, as Mr. Crawshaw returns such heavy knocks; but then, as Mr. Macdonald, I believe it is, says, "Let us have precision in bee terms."—D. WILSON.

## NECTAR-PRODUCING PLANTS AND THEIR POLLEN.

By George Hayes, Beeston, Notts.

BEAN.

(*Vicia faba*.)

No. 30. NAT. ORD. LEGUMINOSÆ  
PAPILIONACEÆ.

(Continued from page 117.)

There are very few bee-keepers—or others for that matter—who are not acquainted with the subject under consideration. Many of us are glad of the opportunity to partake of the cottagers' repast of "beans and bacon," and for this and other reasons it is well known, and we might very well use the oft recurring phrase in a book that I have been reading, "too well known to need description." However, lest this should meet the eye of one who is not acquainted with or has mistaken it, we may venture on a short description.

It is an annual, the stem (or stems, for sometimes there are more than one) springs from the seed and grows erect. It will be found to be square and hollow with many joints, and when reaching a height of about 18in., will break out into branches, thus making the top part somewhat bushy.

Each leaf is composed of five leaflets. The leaves are set on to the stem singly, alternately on opposite sides, and are more frequent on the upper than on the lower part of the stem.

The flowers are borne in bunches at the axils of the leaves, and are of the papilionaceous kind, creamy white, with very distinct dark markings, so dark in fact that they are often said to be black.

The bean is mostly used to illustrate the growth of seeds, and of the Legumens or pod-bearing plants in particular, for, being one of the largest seeds, it is well adapted for the purpose of teaching.

It is not, however, to the garden bean that the beekeeper looks for any surplus, as the few rows there are of very little use; but rather does he look to a smaller and darker variety, known mostly as "horse beans," which are grown in the fields as provender for horses. There are many acres in places, and these beans yield both nectar and pollen in abundance.

The wild bees usually perforate the corolla or tube of the flower at the base to

enable them more readily to get to the nectary, and there is no doubt our hive bees use this very ready though illegitimate means to some extent, but not to the total rejection of the proper way. It must be remembered that when the beans are in bloom a very large amount of pollen is required by the bees, and is actually carried into the hive. In bean honey we find a good number of pollen

Its form is cylindrical having slightly flattened ends, and the grains are often found clinging together end to end as shown in No. 1. When a grain is viewed from a certain position it appears slightly dumb-bell shaped, as seen in the third one of Fig. 1. Its measurement when dry is  $\frac{2\frac{1}{2}}{1000}$  in. by  $\frac{1\frac{1}{2}}{1000}$  in.

When placed in honey it becomes more transparent, and three equi-distant

Dry.

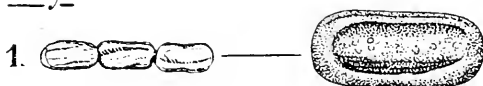

In Honey.



From Honey.

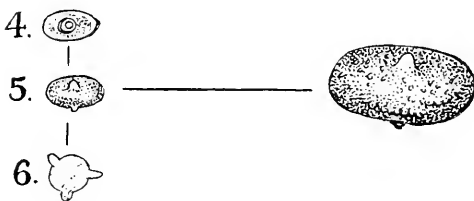

POLLEN OF BEAN.

grains, which prove that the hive bees do visit the blossoms largely in the legitimate way, and so are very instrumental in bringing about its fertilisation.

The pollen when dry is white, but by transmitted light is of a pale yellow. The fovilla or inner matter of a grain is mostly yellow in colour, although the extine or outer coat may be of some other colour, or even white, and when the light comes through the grain it shows up either white or blended with the colour of the extine.

processes are formed round the middle, as shown at Figs. 2 and 3. It also slightly increases in bulk.

When extracted from honey in which it has been for some time, it will measure  $\frac{2\frac{1}{2}}{1000}$  in. by  $\frac{1\frac{1}{2}}{1000}$  in. but the form does not alter from that assumed when first placed in it. The extine is also very wrinkled. Fig. 6 is a section through the centre.

(To be continued.)



The Editors do not hold themselves responsible for the opinions expressed by correspondents. No notice will be taken of anonymous communications, and correspondents are requested to write on one side of the paper only and give their real names and addresses, not necessarily for publication, but as a guarantee of good faith. Illustrations should be drawn on separate pieces of paper. We do not undertake to return rejected communications.

### HONEY YIELD IN WILTS.

[9073] It may interest your readers to hear what an old amateur has been able to do with five hives of bees worked on modern lines, during four years just closed. 1911, seven hives yielded 539 lbs., average 77 lbs.; 1912, six hives yielded 323 lbs., average 53 lbs.; 1913, five hives yielded 243 lbs., average 48 lbs.; 1914, five hives yielded 470 lbs., average 94 lbs. Up to 5th July each succession of flowers seemed to have perfect weather, hence there was a ceaseless honey flow. Had July been also fine, and had we been near heather moors, the above large yield would have been enormously increased. As my bees have always been devoted to the missionary cause, I hope this may benefit accordingly.

The largest yield this year from one hive was 134 lbs., a second yielded 127 lbs., and a third 121 lbs.; needless to say, neither of these swarmed. I pointed out the above results to a working man bee-keeper, remarking what a means of adding to the prosperity of the family was contained in bee-keeping. His answer was, "Poor little critturs, it do seem a shame to rob 'em, it do. I couldn't do ut, I couldn't."

My experience of over twenty-five years, dating back to my good old father, who, with Mr. Woodbury, was one of the early pioneers of bee-keeping in the West Country, is that bee-lecturers are not careful enough to warn the average bee-keeper never to touch bees without head-veil and gloves. The result has been that, "well stung," most men are afraid to touch them, and give them up in despair, sic, my friend. One question I have not solved, and that is how to use good combs which are blocked with pollen. Will the honey extractor save them when the pollen has got dry?

Foul brood and "Isle of Wight" disease have been about, but I have fortunately escaped, and I partly attribute it to keeping the bees at least two feet from the ground. I have noticed that apparently swarms in trees escape the latter pest. I should like to hear what

others have to say on this point.—REV. PHILIP W. G. FILLEUL, The Rectory, Devizes.

[Pollen clogged combs can be cleared either by putting them in a building where earwigs can gain access to them, when they will eat out the pollen, or they can be well soaked in water, and the pollen then washed out by playing on them with water from a hose-pipe or garden syringe.—Eds.]

### "ISLE OF WIGHT" DISEASE.

[9074] I am afraid Mr. Heap and I have got into an entanglement that makes us angry. That is not well with two bee-keepers. But in self-defence I must ask your readers to turn up the back numbers of June 4th and 11th, July 30th, August 6th, and September 10th, and form their own judgment. They will find that the beneficent microbe is by no means "the main idea" in my mind, that my reference to Zander was not unjustifiable, and that I have not indulged in personalities. Mr. Heap's more specific charge of misrepresentation can be met with three quotations.

July 30th, Mr. Heap wrote: "It is not the immune bee or the lessening of the virulence of *Nosema apis* as we know it that we require so much as to be rid of the organism altogether."

August 6th, I wrote: "When Mr. Heap says . . . that we must work for getting rid of *Nosema apis* altogether . . ."

September 10th, Mr. Heap writes: "When I said 'we must work to get rid of *Nosema apis* altogether,' I was very careful to add the qualifying words 'as we know it.'"

I think a large proportion of your readers would have said that the words "as we know it," referred to "virulence," a further large proportion would have said that they had no reference to the second part of the sentence, and the rest that, outside metaphysics, they were not qualifying words at all. What is the difference between "*Nosema apis*" and "*Nosema apis* as we know it"? Surely the organism of them both (as we know it), of which we are to get rid altogether, is one and the same.—G. G. DESMOND, Sheepscombe, Stroud, Glos.

### BEE-KEEPING AND SUNDRIES.

[9075] Just now harvest bugs and wasps are the order of the day. A teaspoonful of powdered sulphur put in each sock every morning will keep the former out, while a lump of cyanide of potassium poked into the entrance to the wasps' nests will kill every one.

I generally do this in the daytime, and the wasps fly in but do not come out again.

Unless one wears a veil the thing should be done quickly, because the "wasps" object to anyone meddling with their doorway.

A lady once said to me, "Of course you are never stung, because you are with your bees so much that they must know you"! I replied that seeing bees only live about six weeks in the summer the acquaintanceship would not be long.

Some people make a great fuss if they happen to be stung by a bee, but for my own part I think it does the system a certain amount of good in warding off rheumatism, gout, &c. And in connection with this matter I recently met a man who was very badly stung by bees last August. He said that up till then he always had a severe yearly attack of sciatica, which quite disabled him. Since this stinging he has had no return of the trouble, and he wondered whether to attribute this to the counter-irritant in the stings, or to the delightful bee weather we have so much enjoyed. As a bee man I assured him that this immunity is due to the bees. But if his sciatica returns I fear I shall have to take a back seat!

As the bee-driving season is now on a few experiences of my own might be interesting. Recently a skeppist wrote us that he could have his spare stocks to drive. These were located by the side of the road, and whilst my companion was laboriously drumming the bees from the last skep I heard a squeal, the dash of a bucket on the ground, and the scamper of hasty feet. A woman going to the village pump for water got a bee entangled in her hair, and fled forthwith, leaving her bucket in the road. She was much agitated, and said that "bee-taking didn't ought to be done in the daytime." I fetched her bucket of water, and picked the buzzing bee out of her hair. This was the result of having bees near the public road.

Another day I had practically driven all the bees from a very heavy skep sealing about 45lb., but to make sure none were left to annoy the cottager, I popped it over a sulphur match. About three minutes after I lifted the skep, which seemed very light, when, lo and behold, the whole contents lay in the pit, a horrible mixture of honey and earth. However, I got the mass quickly into a pan before robbers could find it out, and inwardly cursed the cottager for neglecting to place the two sticks across for safety in hot weather.

No one but actual bee-drivers know what difficulties there are to contend with in dealing with cottagers' hives, i.e., boxes, buckets, a trunk, an occasional card hat-box, and once a drainpipe!

"Drat that there bee-man; I won't let he drive my bees agen; I'll smother 'em first," said the cottager's wife. This outburst was caused by the bees from skeps carelessly driven crawling all over the larder floor and into the bread-pan.

Novices really ought not to attempt the operation on other people's bees. In one case a tyro had three skeps to drive in a quaint cottage garden on the hills. It was a hot day, and what with the excitement and the heat he was not fit for the task. However, things progressed fairly well for a time, and the skeppist's wife encouraged him much by explaining how her "owd mon" was nearly stung to death by trying to "drum a skip."

Presently robbers fell on the upturned hive, and the commotion quickly stopped the rightful bees from running above. So part was placed on the old stand, and the skep speedily carried in the cottage to get the "confounded thing out of the way." But the driven lot had no queen, and in a trice they were in the air in all directions, with fighting going on furiously in all the remaining six skeps. And our friend soon trampled the potato-bed down in running back and forth with carbolic acid and glass and water to try and set matters right. But not until evening did the bees quieten down, and the damage could be inspected.

One good stock robbed out, another lot only half driven, a dozen stings or so divided between the cottager and his wife, who came out to see what was wrong, and the potato crop sadly damaged. The moral therefore is, "Never drive the bees of others until you can drive your own." — A. H. BOWEN.

## QUERIES AND REPLIES.

[8977] *Various Queries.*—I have some very thin honey which, although I have kept it in a warm place in ripener (with lid on, as "Guide Book" does not say otherwise) for two weeks, has started to ferment. (1) Can I make vinegar out of it, and, if so, how much water should be added, and what else would be necessary to convert it into vinegar? (2) Can thin honey be thickened by simmering in a saucepan (not boiling)? (3) Is there any way of preventing bees from filling supers with pollen? (4) Is there any way of clearing the combs of pollen other than by syringing them? I find it is impossible to get all the pollen out in this way, even

though the combs have been soaked in water previously. I also find that, although I dried the combs in the sun for two days afterwards, they have begun to get covered with mildew, therefore (5) is there any way of removing the mildew from the combs?—C. J. M. P.

REPLY.—(1) Yes, use 1½ lbs. to 2 lbs. of honey to each gallon of water and a teaspoonful of cream of tartar. Get "The Production of Vinegar from Honey," 2½d., post free, from this office. You should have left the lid off the tin, otherwise how is the moisture to escape? (2) Honey will thicken if kept uncovered in a warm place, but it should not be "simmered" or the flavour will be entirely spoilt. (3) The use of a queen-excluder will prevent it to a great extent. You can do nothing else. (4) No, you had better renew the pollen-clogged combs. (5) You might try washing with a 10 per cent. solution of formalin.

#### HONEY IMPORTS.

The value of honey imported into the United Kingdom during the month of July, was £5,307, and during the month of August £1,923.—From a return furnished to the BRITISH BEE JOURNAL by the Statistical Office, H.M. Customs.

## Notices to Correspondents

G. S. (Croydon).—We had already noticed the coincidence that without exception those Associations adopting the pamphlet you mention have either become defunct or are moribund. Evidently it draws the evil eye. If, as you suggest, in your new venture you change your colour from green to pink or white, we are certain you will succeed. Just as the most beautiful bees are unprofitable to keep, so the pretty covers of a paper often enclose nothing but vituperation and drivel. We send you our good wishes.

"Hex" (Altrincham).—*Two Queens in Hive*.—This does occur at times. In the case mentioned the bees were probably superseding the old queen, and the young one had not yet mated.

D. W. H. (Breconshire)—*Extracting Sections*.—In the case of sections, yes. With shallow combs it is only necessary

to slice off the capping as thinly as possible; use the same method for both. If there are a large number of unsealed cells it is better to extract the unripe honey before uncapping the other, a few cells on edges of comb will not matter. Honey should be strained after extracting, and if ripe may be put in tins or bottled at once. The value depends on quality of honey.

K. P. (Mildenhall).—Write Mr. J. M. Ellis, Ussie Valley, Conon Bridge, N.B.

#### Honey Samples.

G. F. WILSON (Hunts).—Colour of honey is medium; both flavour and density good. It is worth about 58s. per cwt. We wish all our correspondents would observe our rules as carefully.

#### Suspected Disease.

W. SMITH (Portsmouth).—The brood in piece of comb sent is perfectly healthy.

C. E. (Sedgley).—Bees show symptoms of "Isle of Wight" disease.

### Special Prepaid Advertisements

Two Words One Penny, minimum Sixpence.

Orders for three or more consecutive insertions entitle advertisers to one insertion in "The Beekeepers' Record" free of charge.

Trade advertisements of Bees, Honey, Queens, and Bee goods are not admissible at above rate, but will be inserted at 1d. per word as "Business" Announcements, immediately under the Private Advertisements. Advertisements of Hive-manufacturers can only be inserted at a minimum charge of 3s. per ½ in., or 5s. per inch.

#### PRIVATE ADVERTISEMENTS.

HEALTHY driven bees, 1s. 6d. lb., 4lb. lots, box returnable.—MEPHAM, Orlestone, Ham Street, Kent. v 30

12 DOZ. best quality sections; offers wanted.—GARFITT, Burnside, Coupar Angus, Perthshire. v 41

THREE stocks of bees, in standard frame hives, healthy, plenty of stores, 25s. each; must sell, removing.—E. ERNEST PERRY, Trevilges, Wendron, Helston. v 39

WANTED, some secondhand W.B.C. hives, in good order.—Reply, giving particulars, to C. W. T., c/o BRITISH BEE JOURNAL, 23, Bedford-street, Strand. v 38

1 GROSS beautiful white sections, full weight, 10s. per doz.; also lwt. finest light extracted, 64s.—BETHAM, The Bungalow, Bishop Monkton, via Leeds. v 37

WANTED, six useless English queens, wings intact, alive, for collection.—JACKSON, 30, Windsor-road, Wanstead, London. v 36

FINE quality clover sections, 10s. doz., carriage paid, safe delivery; beeswax, 2s. lb., 28lb. tin honey, 16s.; exhibition sections; stamp reply.—NORTH, Cressins, Braintree, Essex. v 34

SECTIONS wanted, state price; three hives for sale, cheap.—HATFIELD, Parade, Grantham. v 35



### BRITISH BEE-KEEPERS' ASSOCIATION.

The Monthly Meeting of the Council was held at 23, Bedford Street, Strand, London, W.C., on Thursday, September 17th, 1914. Mr. W. F. Reid presided. There were also present Messrs. A. Richards, J. Smallwood, T. Bevan, C. L. M. Eales, R. H. Attenborough, E. Watson, C. R. Frankenstein, H. Jonas, and A. G. Pugh, association representatives; Rev. F. S. F. Jannings (Yorks), G. J. Flashman (Barnet), A. D. Woodley (Berks), G. W. Bryden, and J. W. Judge (Crayford), H. Watts (Mid Kent), G. S. Fauch (Essex), and F. W. Harper (St. Albans).

Letters regretting inability to attend were read from Messrs. T. W. Cowan, Dr. Seamer, E. Walker, G. R. Alder, J. B. Lamb, W. T. Sanderson, and Dr. W. Anderton.

The following new members were elected:—Mrs. A. Davies, Lieut. F. S. Cousins, Mr. E. F. Fell, Mr. J. W. Stephens, and Mr. S. Berry.

The report of the Finance Committee was presented by Mr. Smallwood, who stated that the payments into the bank for July were £30 3s. 11d., and for August £3 2s. 4d.; the bank balance at the end of August was £206 19s. 2d. Payments amounting to £60 1s. 1d. were recommended.

The report on the paper work for the final examination was presented, and out of fifteen candidates who sat the following qualified to take the lecture test. Miss N. M. Robinson, Miss E. M. Penrose, Miss H. Thrupp, Messrs. J. W. Moir, G. G. Desmond, F. W. Harper, J. Johnson, Dr. W. Anderton, and Dr. D. Wardleworth.

Reports on preliminary examinations, held at Gloucester, Swanley, Wymondham, Nottingham, Budleigh Salterton, Bristol, Bridgewater, Grimsby, Tashwell, Alford, Boston, Northampton, Cardiff, Presteign, Kington, Bromsgrove, Shrewsbury, and London, were presented, and it was resolved to grant certificates to the following:—Misses M. W. Johnstone, P. Wilkes, E. Strochneider, M. Tireman, M. Coates, M. A. Liversidge, D. Hosegood, M. Stark, H. Burr, E. Williams, L. Bradshaw, F. Bevington, E. Clutton, L. Hurst, C. Fleming, G. Bacchus, J. Johnson, N. Ross, S. Forssman, V. Taylor, K. Long, E. Richardson, and A. Tjaarda; Messrs. A. H. Powell, R. P. Gould, J. C. Allsop, G. Houghton, E. H. Hollingsworth, H. Mearing, H. Tope, J. W. Heard, R. J. C.

Ferguson, T. Evans, W. Ion, H. R. Nicholls, F. Brewis, H. Holland, A. C. Grant, F. Belgrave, J. E. James, E. Boobier, W. Woodhouse, J. A. Ralph, E. Ralph, J. W. Stephens, A. Burgoyne, P. W. Phillips, H. W. Kimmersley, W. H. Sisman, H. Hems, G. Bateman, S. Smith, S. Leedham, A. E. Taylor, W. Thorne, F. C. Beaumont, H. Berry, H. Henstock, W. H. Simms, G. S. Fletcher, and Dr. Leadbitter. Eight who presented themselves failed to satisfy the examiner.

The judge's report on the Royal Show was read and accepted, and a hearty vote of thanks passed for their gratuitous services.

Arrangements were made for the conversazione on October 22nd; to enable those from the provinces to be present right through, the time of opening to be altered from 5.30 p.m. to 4 p.m.; tea at 5 o'clock, the meeting to close at 8 p.m. Mr. A. Richards will give a paper on "Bees in Relation to Flowers and Fruit," illustrated by lantern slides.

The report of the Exhibitions Committee on the arrangements for the judging competition at the conversazione was read and adopted.

The intermediate examination was fixed for November 27th and 28th.

Several letters were read, and the Secretary was instructed to deal with them.

Next meeting of Council in the offices of the Zoological Society of London, Regent's Park, on October 22nd, at 3.30 p.m.

### BRITISH BEE-KEEPERS' ASSOCIATION NOTICE.

Will all those who wish to attend the winter courses of lectures at the Zoological Gardens please note that the first lecture takes place on Thursday, October 1st, 1914. Particulars can be had from the Secretary, B.B.K.A., 23, Bedford Street, Strand.

### BELGIAN RELIEF FUND. FOOD SHIPMENT SECTION.

We have been requested to publish the following letter to Walter F. Reid, Esq., Fieldside, Addlestone:—

DEAR SIR,—Many thanks for your action in appealing to the bee-keepers of Great Britain. Honey will be most acceptable to the refugees in Belgium. Would it be possible to strike a note of warning to the kind contributors with regard to packing? We have received a great many parcels of jam and honey in such a state that it is impossible to do anything with them at all. When one is dealing with such universal goodwill towards Belgians as is exhibited

by the enormous number of contributions received here, it seems a thousand pities that there should be any wastage.—Yours faithfully,

T. C. LEMMENS, Manager,  
Belgian Food Relief Fund.

[The above is another plain proof of the carelessness on the part of bee-keepers. For years we have been trying to impress upon those who have honey for sale to be careful in grading and packing. The complaints heard of difficulty in disposing of produce are due in ninety-nine cases out of one hundred to the purchaser being bit in the above manner by British bee-keepers; ever after he deals with a house that packs properly and sells mainly foreign produce.—Eds.]

### BEEHIVES IN BATTLE.

We read in a daily paper the other day that a handful of Belgians who had barricaded themselves on a bee farm were attacked by a whole regiment of German infantry. The defenders allowed the Germans to approach within a few yards of the barricades and then hurled the beehives at them. The maddened insects proved themselves valuable allies, for in less than a quarter-of-an-hour they had driven back the Germans, who fled panic-stricken.

That this is not the first time bees have been employed in war the following cutting from the *Cheltenham Chronicle* shows, while all who have read ancient history will be aware how important honey and wax were in those days, by the fact that a certain amount of these commodities were almost invariably exacted by the victors as tribute from the conquered provinces.

Now that our thoughts are occupied with the great European War it may be interesting to notice the part the bees played in the battles of bygone ages. The following historical reminiscences are of special interest to bee-keepers at the present time, and serve to show what effective "artillery" bees proved in those far-off times.

The idea seems to have originated in our island, when somewhere about 908 A.D. a host of Danes and Norwegians coming from Ireland laid siege to Chester. Under their leader the Danes set up hurdles beneath the city walls, and thus protected began to undermine the fortifications.

When the English hurled down rocks the invaders strengthened their hurdles with massive posts. The English retaliated by pouring down boiling mead (honey wine) and water, and when the attackers in reply covered their hurdles

with hides the English as a last resort gathered all the beehives in the city and flung them upon their foes. This plan was successful. The Danes were stung so frightfully on the legs, hands, and head that in despair they abandoned the siege.

The next use of beehives in mediæval warfare occurs some thirty years later, in the days when Otto the Great was laying the foundation of the German Empire. About 940 A.D. Ghiselbert, Duke of Lorraine, revolted against King Otto, who was powerless to crush him till assisted by one of the Duke's own followers—Immo the Crafty. When attacked Immo is reported to have collected a large number of hives and flung them "out against the Duke's horsemen. As the bees poured from the hives, stinging the horses into such madness that the riders could not control them, Immo ordered his men to protect themselves and make a sally." This stratagem was as successful in Germany as it proved in England, and it resulted in the complete route of the enemy.

A remarkable English MS. preserved at Oxford actually pictures the military engines used for slinging beehives. And when Acre was being besieged the Christians did but little good until the Bishop of Puy (in Germany) caused all the beehives—of his own Low German home at Namur and its neighbourhood—to be collected and sent to the "front," as well as the wasps and bees that at the brewing season were wont to swarm into the vessels in which the sweet-savoured beer of the Middle Ages was brewed. "All around us," urged the Bishop, "there is an abundance of beehives. Let us hurl them from our engines over the city walls. So shall we keep the Saracens off while we undermine their fortress." Twenty-five mangonels then commenced slinging their hives at the same moment. "The bees," we are told, "went swarming into the enemies' ears, stinging them on the eyes, and torturing them till they fled. The Christians broke through the walls, and in this manner was taken and conquered the noble city of Acre. Thus by bees was it taken and subdued."



#### EXTRACTS AND COMMENTS.

By D. M. Macdonald, Banff.

1. *Self-extinguishing Smoker.*—When finished with manipulations, quite a little time and trouble are often taken in



extinguishing the smoker fuel, and if thrown aside there is waste of material, with at times a little danger from the burning material. An American suggests the use of a slide which, on closing, will smother the flame, while the carbon dioxide gas generated will quickly put out the fire, even the most inflammable material being extinguished quickly. *Gleanings* editor suggests the use of a cork, or plug, attached to the smoker by a short piece of string as a simple way to accomplish the same results. I think the hint is a good one. The material would then always be present in an emergency ready to re-light. The corking could be quickly done, and hands could be kept cleaner.

*Red Clover Honey.*—From close observation, a Mr. Manley traced a fine flow of honey repeatedly to dwarfed growths of red clover. Owing to drought, and perhaps a light soil, the clover-heads were small, but the bloom was there, and on occasions literally covered with bees. One season a forty-acre field gave the bountiful yield of 200lbs. per colony, and the honey is described as "fine as any I have ever tasted."

*Encouraging Beginners.*—Bee-keepers are large-hearted and beneficent as a body. Not content with acquiring knowledge, they are eager to disseminate it and participate of their best with all and sundry. Australians have been discussing whether this is wise, and a few selfish individuals would like to keep all the plums in the hands of a few. There, and in America, bee farms, or bee ranches, are favoured. The first-prize taker launches a shower of fulminations against the small bee-keeper, and looks on him as a detriment to genuine progress. Perhaps he owes his successful position to the last part of his article, where he repents of his sledge-hammer blows, and admits that if they are *suitable people* the beginners should not only be encouraged to enter the ranks, but welcomed and aided. That is well. The small bee-keeper sheds his skin and grows and increases in his stocks and stores. Generally, from the small beginner grows the giant. Starting in the embryonic stage, he advances step by step to the full growth. And that is as it should be. Encourage beginners, say I, and leave it for economic laws to throw off all weak limbs. The percentage of failures may be considerable, because only a fair proportion of the starters are really naturally equipped with the elements of success. Yet, at the beginning, one scarcely knows who is who.

*Smoking Bees.*—Mr. Dadant, in his notes from abroad, relates that Dr. Brumrick does not smoke his bees. Instead he used a gentle spray of water, which appeared to be as efficient as smoke, and

the doctor held that it is preferable. Recently I had a similar experience. A prominent Scottish bee-keeper, on opening a hive, sprayed the bees with a gentle stream of *sweetened* water. The result was a confident and methodical examination of the hive interior without a single sting to operator or observer.

*Cleaning Combs.*—Mr. J. Wilder stacks up his extracted combs in a large pile in close proximity to his honey house. He places them out in the evening, and the humidity of the cool, damp night atmosphere makes the honey left after extracting in prime order for clearing out by the bees next morning. Practising this for many years he has never had a robbing boom. Personally, I would prefer all such combs being placed at some little distance from the apiary, with a clear course between the two points.

*Colony Odour.*—What bee-keepers believe about this subject; what they have confirmed by the observation of centuries, and what they have established on a solid basis, cannot be confuted by mere theorising, and the statement of a few guesses as facts. Making a few dashing statements is not reasoning, and fails to convince.

*Migratory Bee-keeping.*—It has ever been a dream amongst bee-keepers that apiculture could be made remunerative by transporting hives to different areas, generally north and south, following the seasons and the flower bloom. Ancient Egyptians practised this pursuit along the banks of the River Nile. Messrs. Root have been experimenting recently in carrying their hives from Medina to Florida, expecting there to find a rich harvest, and then to increase each 100 stocks to 300, or more. Following this, they transported them again to Medina. High hopes were entertained as to the rich success likely to follow, but these have not been realised, or only in a modified form. The average man is warned that making such an experiment he would be out of pocket. At present they are making trials of two other means for increasing their stocks. "We can make a colony by feeding sugar syrup for about a dollar—\$300 for 300 colonies. With an automobile we can move bees about for a like amount, and then move them back to the cellar, and thus eliminate the cost of sugar." They are sending a large consignment to some swampy land with a late flow, intending to double the number at least. I fear any such experiments would not be feasible in this country. The nearest we could come to it would be getting southern driven bees in early August and working them up to full stocks on the moors. This scheme fails too frequently to be thoroughly reliable.



## PROCURING SURPLUS.

*(Continued from Page 350.)*

In working for extracted honey it is imperative that a queen excluder be used. A great many bee-keepers are averse to this, but if it is desired to have nice clean combs free from brood and pollen, then the only way is to use one. That it does hinder the work of the bees to some slight extent there is no doubt, but if a "Wilkes' Free Way Wire" (Fig. 3) or the new metal one by Taylor, of Welwyn (Fig. 4), is used this is reduced to a minimum.

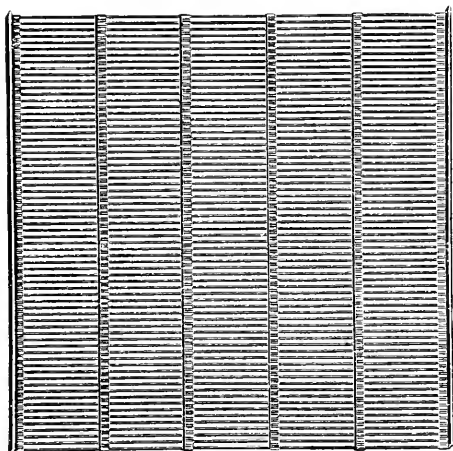

FIG. 3.

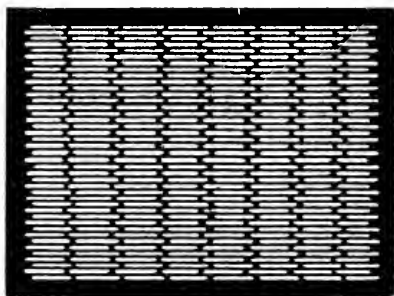

FIG. 4.

The right way to put on the excluder is with the slots at right angles to the frames (Fig. 5), so that the bees have more room to pass through than if placed parallel as seen (Fig. 6), when it will be noticed that only about one row of holes are available between each frame for the passage of the bees. There is also a right and a wrong side to the zinc queen excluder. The side on which are the roughened or

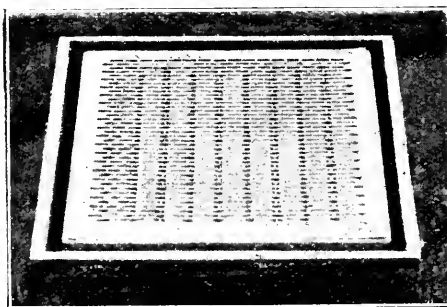

FIG. 5.

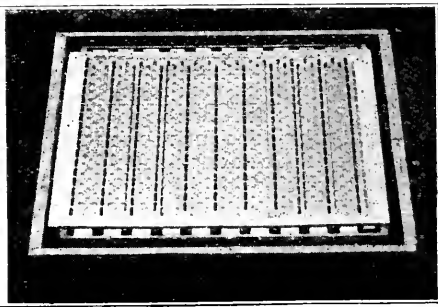

FIG. 6.

burled edges, caused by punching out the holes, should be placed uppermost, so that the laden bees will have no difficulty in getting through, which would be the case if they had to struggle against the rough edges. After the discharge of their load they pass back without trouble. It is an advantage to rub down this roughness when purchased, by means of emery cloth stretched on a piece of wood; if put on in a hurry no mistake can then be made.

Probably one of the difficulties a beginner has to contend with is to know just when to put on the super. Many imagine that the work can be done on a certain date, just as they pay their rent on quarter day. Owing to the vagaries of our seasons, and the difference in climatic conditions between north and south, it is impossible to give any set date. As an instance, I have seen full supers removed in the south, where cherry orchards abound, in the month of May, while in the north as a rule the first surplus is not obtained until the beginning of July. Then again, the strength of the stock must be taken into consideration. Until the brood-chamber

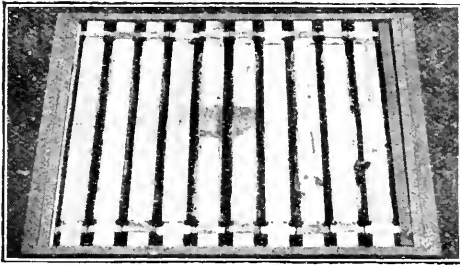

FIG. 7.

is full to overflowing, and there is an abundance of forage, it is useless to put on extra supers. Neither should the other extreme be reached by waiting until the bees are upon the point of swarming, for if once the stock gets the swarming fever it is very difficult to prevent the swarm issuing. The best gauge is to wait until the bees begin to elongate the first few rows of cells next the top bar; so that when looked at from the top (Fig. 7) the combs bulge and are very white. When this occurs, put on the super at once, and the bees will take possession of it immediately.

It is not unusual for them to crowd into supers put on under these conditions within an hour. The explanation of the extension of these cells is quite simple. Bees when crowded use up all available room. The usual space between the combs for capping is  $\frac{3}{8}$  in. for brood; this can never be smaller, as it is necessary for the bees to pass over the face of the combs back to back to feed the larva, but between honey cappings a bee space, *i.e.*,  $\frac{1}{4}$  in. will suffice; so when honey is coming in abundantly they utilise the extra  $\frac{1}{16}$  in. on each comb for the storage of honey. As the food is always stored above the brood-nest the cells are drawn out in the position indicated.

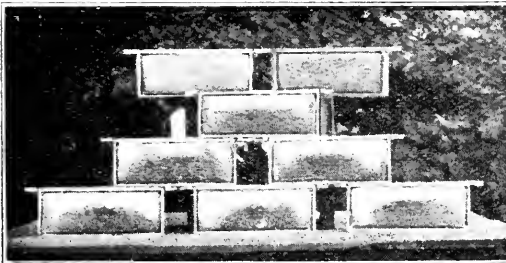

FIG. 8.

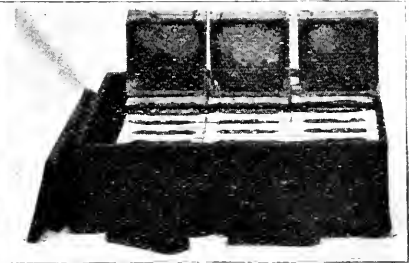

FIG. 9.

The first super can be put on very quickly and without the use of smoke or a carbolic cloth. To do this hold the super with the excluder underneath it in the right hand and with the left strip the quilt with a forward snatch, and instantaneously before a single bee has a chance to run on to the top bars drop the super into position.

The bee-keeper should ascertain at what period of the year in his district the flowers from which surplus is obtained come into bloom; he can then bring his stocks to full strength at that period by careful stimulation.

It is just as harmful to get bees to full strength too early as too late; in the former case only swarming will result, while in the latter no surplus will be obtained.

When once supering has commenced a watchful eye must be kept on the bees to keep them fully employed. Even with a super on they may become crowded to such an extent that they will swarm. Room just a little in advance of the bees' requirements and ample ventilation without a draught should be given. When the first super is about two-thirds full and sealing has commenced on the central combs (Fig. 8), shallow combs (Fig. 9), sections should be raised, and a second one placed underneath, and so with a third or more if the season and district are favourable.

*(To be continued.)*



The Editors do not hold themselves responsible for the opinions expressed by correspondents. No notice will be taken of anonymous communications, and correspondents are requested to write on one side of the paper only and give their real names and addresses, not necessarily for publication, but as a guarantee of good faith. Illustrations should be drawn on separate pieces of paper. We do not undertake to return rejected communications.

#### HONEY FOR REFUGEES.

[9076] I fear the editorial headline to my appeal in your issue of September 10th may deter many from giving effect to it. The "refugees" would not be the Belgian soldiers who are still actively engaged in fighting our common enemy, but their women and children, who are arriving in thousands on our shores, in many instances without means of subsistence. Englishmen will remember that when our soldiers arrived in Belgium they were heartily welcomed by the inhabitants, who shared their own none too abundant fare with them and did all they could to show their gratitude. Now, driven from their wrecked homes by a nation that calls itself civilised, these poor refugees are arriving among us, and I hope all British Beekeepers will, if they can, respond to the appeal of the Belgian Minister for foodstuffs, and send what honey they can spare to the Manager, Belgian Relief, c/o Messrs. Harrods, Ltd., Trevor Square, London, S.W.—WALTER F. REID.

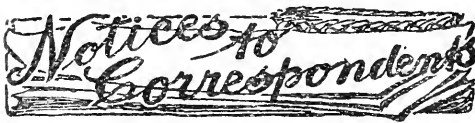

- A. PONTIN (Patcham).—*Various Queries*.—(1) See page 354, "B.B.J.," September 17th. (2) Take her by the wings or thorax. (3) Write to Secretary, British Beekeepers' Association, 23, Bedford Street, Strand, W.C.
- H. L. (Shap).—*Gears and Excluders*.—(1) We prefer the cog gear. (2) The Wilkes gives the bees freer passage, but it requires to be carefully handled when taking off and cleaning.  
*Honey Samples*.
- B. S. (Longridge).—(1) Yes. (2) Medium. (3) Heather and mixed sources—it is a heather blend.
- G. Brown (Fife).—Heather blend.  
*Suspected Disease*.
- D. A. (Bexley Heath).—Yes, bees show symptoms of "Isle of Wight" disease.

#### Special Prepaid Advertisements Two Words One Penny, minimum Sixpence.

Orders for three or more consecutive insertions entitle advertisers to one insertion in "The Beekeepers' Record" free of charge.

Trade advertisements of Bees, Honey, Queens, and Bee goods are not admissible at above rate, but will be inserted at 1d. per word as "Business" Announcements, immediately under the Private Advertisements. Advertisements of Hive-manufacturers can only be inserted at a minimum charge of 3s. per  $\frac{1}{2}$  in., or 5s. per inch.

#### PRIVATE ADVERTISEMENTS.

**H**ONEY, excellent quality, at 56s. the cwt., in 28lb. tins.—R. WATERS, Gestingthorpe, Essex. v 45

**F**OR SALE, 4 cwt. pure Cambridgeshire honey, fine quality, medium colour, 28lb. tins; sample, 2d.—HAZZARD, Haddenham, Ely. v 44

**600** LB. pure Welsh honey, in 11lb. and 3lb. screw cap bottles.—Prices, EVAN W. DAVIES, Rhydfelan, Pontypridd. v 45

**400** WELL sealed light sections, 10s. per dozen, cash with order, carriage forward; well packed cardboard cases.—JOHNSTON, Tullynessle, Alford, Aberdeen. v 60

**W**ANTED, geared extractor, in good order.—WATERS, Rydal, Foxfield-road, Meols, Cheshire. v 58

**4** YOUNG queens, from healthy, vigorous skeps, 7s. each.—C. PARISH, Addington, Surrey. v 55

**F**OR SALE, 14 cwt. pure English honey, light colour, 60s. per cwt.; sample, 5d.; also few dozen sections.—LAW, Buckoo, Ashwell, Herts. v 46

**C**LOVER SECTIONS, 8s. 6d. per dozen; extracted, 58s. per cwt.; sample, 2d.—SIMCOX, 17, Victoria-rd, Fallings Park, Wolverhampton. v 47

**S**ALE, double daffodil, all flowering bulbs, 2s. 6d. per 100.—CUTTS, Bee Gardens, Eagle, Lincoln. v 48

**S**UPERIOR Lincolnshire light honey, from fruit, clover, &c., price, 56lb. tin, 32s.; 28lb. tin, 15s.; tins included; sample, 2d.—CHARLIE CUBLEY, Gedney, Holbeach, Lincolnshire. v 49

**P**URE Essex honey, 28lb. tins, 14s.; 14lb. tin, 7s.; tins free, carriage forward; sample, 3d.—PEARCE, Earlswood, Rectory-rd, Little Thurrock, Grays. v 51

**2** CWT. honey, good heather blend, in 28lb. tins, 15s. tin; sample, 2d.—KIDBY, Sizewell-road, Leiston, Suffolk. v 52

**F**OR SALE, quantity of excellent flavoured medium coloured honey, fruit and clover, 14s. 28lb. tin; sample, 2d.—WADMAN, Stutton, Tadcaster. v 54

**F**OR SALE, ten dozen medium coloured sections 8s. dozen.—SEMMONS, Leiston, Suffolk. v 55

**3** CWT. extracted clover honey for sale, 55s. per cwt.; sample free.—ABBOTTS, Old Hall, Merrington, Bowers Heath, Shrewsbury. v 56

**H**EALTHY driven bees, 1s. lb., with young fertile queens.—B. BEAVER, 92, Westgate, Pickering. v 57

**F**INEST English honey, 60s. per cwt.; sample, 2d.—DUTTON, Terling, Witham, Essex. v 4

**12** DOZ. best quality sections; offers wanted.—GARFITT, Burnside, Coupar Angus, Perthshire. v 42

**A**PIARY of forty stocks, in W.B.C. hives, with all appliances, drawn combs, &c., to be sold, either in one lot or will divide to suit purchasers.—BOX 20, BRITISH BEE JOURNAL, 23, Bedford-street, Strand, W.C. v 31

# Editorial

## OBITUARY.

DR. ULRICH KRAMER.

It is with sincere regret that we have to announce the death of Dr. Ulrich Kramer, which took place in Zurich on August 19th.

gathered from the different stations, producing annually a profusely illustrated valuable report, which is a treasury of scientific and practical inquiry. From 1880 to 1887 Dr. Kramer conducted the annual courses of instruction of schoolmasters as bee-keepers, and in this way he had trained a large staff of peripatetic teachers in bee-keeping. In 1889, in conjunction with the Rev. J. Jeker and M. O. Theiler, Dr. Kramer published "Der Schweizerische Bienenvater," which has already gone through several editions. In 1896 he



DR. ULRICH KRAMER.

Dr. Kramer, who had attained the age of seventy years, was President of the Swiss Bee-keepers' Society, whose committee of management he joined in 1881. By profession he was a schoolmaster, and as a peripatetic instructor of bee-keeping he showed great activity. He was a fluent and animated speaker, and was the means of winning thousands over to rational methods of bee-keeping. He was a voluminous writer, and one of the ablest contributors to the *Schweizerische Bienenzeitung*. In 1884 he founded the "apicultural observation stations," and has since that time compiled the material

became President of the Swiss Bee-keepers' Society, which, through his indefatigable labours, now numbers over 9000 members. After numerous experiments with foreign bees, Dr. Kramer satisfied himself that the bee of the country, the product of the climatic conditions, was best suited for Switzerland. He therefore brought all his influence to bear on furthering the culture of the Swiss race. He established mating stations, remote places for the fertilisation of queens with pure-bred drones. In 1898 he commenced the annual courses of instruction for "race-breeders," at which over one

hundred Swiss bee-masters attended. The result has been most satisfactory, and a large number of colonies now consist of the pure Swiss race, headed by selected queens. The whole theory and practice of the race culture of Swiss bees is to be found in a book published by Dr. Kramer, entitled, "Die Rassenzucht der Schweitzer Imker," which is a valuable addition to the literature on the subject.

Bee-keeping certainly owed a debt of gratitude to Dr. Kramer, and the craft was honoured when the University of Bern conferred on him the well-merited reward of a doctor's degree *honoris causa*. Amongst other things that he has done to bring the Swiss Bee-keepers' Society to its present flourishing position was the foul brood insurance scheme of 5 centimes per colony, which, supported by legislation, is doing such good work in eradicating the disease in the country. In 1909 the B.B.K.A. elected Dr. Kramer an honorary member as a recognition of the services which he had rendered to bee-keeping. We made his acquaintance in 1883, and were then much struck by his erudition, and have been in communication with him ever since. His is a severe loss to bee-keeping, and one that will be felt more especially by the Swiss Bee-keepers' Society, as he was its moving spirit. His memory will be revered not only by those who knew him, but by thousands of bee-keepers who have profited by his work. We heartily sympathise with our Swiss friends and his family in the sad loss they have sustained.

## BEE-KEEPING AND SUNDRIES.

### AUTUMN ON THE COTSWOLD HILLS.

One pleasure in out-apiaries is that they enable one to keep in touch with and enjoy the beauties of Nature.

On returning home in the evening after a long day's work among the bees I sometimes hear the three sharp barks of the old dog fox, and then the answering "squawk" of the vixen in a distant plantation, which sounds so weird. And I like to hear the sweet plaintive whistle of the golden plover as it flashes past overhead; or the "chuck, chuck" of the moorhen, flying low from pond to pond.

An occasional cackle of wild geese may be heard, and sometimes the musical cry of the curlew, as well as the hootings and screamings of the different kinds of owls.

All these, and many more sounds, are well known to the bee-man who spends much time amongst the bees of the Cotswold Hills.

But of all the months of the year I think the hills are at their best in October, when the air is balmy and the sun shows

up those lights and shades which add so much of loveliness to a hilly district. The green of spring is turned to the russets and browns of autumn, and no fairer sight can be imagined than that of a Cotswold village at the close of the day, when the sun lights up the church tower and casts a halo of beauty over the score or so of tiled cottages on that sheltered bank.

The peacefulness of the scene seems to take away the sadnesses of life, and no one who has seen them could be anything but struck with the quiet beauty of the Cotswold hamlets. The sunny weather of late has been very favourable for bees, and I have noticed them working on the late charlock or the few ivy blossoms that are out, not getting their much, it is true, but supplying their daily needs.

And just at this time, when bee-men are settling their hives for the winter, it might be well to remark what an excellent winter cover and passageway the "Porter" escape board makes. When the "escape" has been removed it can be placed over the frames, and the bees appreciate this extra space so much that if it were lifted slightly later on whole seams would be found snugly packed along the frame tops. No one with escape-boards will let them lie idle all the winter when they can be turned to such good account as this.—A. H. BOWEN, Cheltenham.

## CANADA'S GIFT.

SACKS TO BE SOLD AT 5s. EACH.

Canada is making a splendid gift of flour to the Mother Country. It has been decided that the sacks, when empty, should be sold as souvenirs at 5s. each. Two-thirds of this sum will be devoted to the Prince of Wales' National Relief Fund, and one-third to the Belgian Refugees' Fund. The sacks are all marked "Canada's Gift."

Applications for the sacks as souvenirs, accompanied by a remittance of 5s., should be sent to the Hon. Secretaries, National Relief Fund, York House, St. James's Palace, London, S.W. Applications will be dealt with in strict rotation.

## "BLURTS FROM A SCRATCHY PEN."

A NIGHT OF HORRORS.

The moon, set in the deep blue of the Italian sky, shone softly over the Grand Canal. The lightest of grey mists was resting on the waters. All was calm and silent, save that the clocks in the many-towered city gave out each quarter as the night advanced, and that such miniature waves as were excited by the passing

gondola rippled at the foot of the wall beneath, for my chamber gave view over the waters, which came even unto the threshold. The weather was sultry. I gave all the access to the air that was possible, turning right back the jalousies. Letters had to be written for the morning homeward post, and notes had to be copied for the future edification of your readers; therefore, before I turned to take that sleep, which seldom fails to the weary traveller, it neared the midnight.

Indeed, ere long, the minor cadence of the smaller bells announced in quadruple attempts the passing of the hour, and then, far exceeding all in volume, the great bell of St. Mark's boomed across the seas the parting of this day and the advent of its successor. Again all was silence. The solemnity of it awed me. What was I, a wanderer from white-cliffed Albion, doing in this City of the Doges—at rest even in the palace of one of their merchant princes (for such was the history of our hotel)? This chamber is oaken, and bears the marks of time. Maybe in yon corner a bravo fierce, with stiletto armed, has murdered his victim and hurled him through the window into the waves. But what care I? It was no affair of mine. I am not particularly nervous, and should a ghost or two care to visit the scene of their exploits, if only they will let me sleep, they are, as far as I am concerned, quite at liberty to enjoy themselves.

And, thinking thus, I lay me down, as if to sleep. Stay! What is that faint trumpeting sound I hear arriving through the open window? Slowly it approaches, and increases in volume as it nears, as if there were a legion of Queen Mab's trumpeters heralding her coming. Round and round the room it circles. I never heard the like before. What may it mean? Closer and still more close it comes. Anon it nears my brow, reposing on the pillow, then, passing, pours its music into my ear. Oh, murder! Right 'twixt my eyebrows I feel a stab, as of a bee that stings. Impulsively I raise my hand in self-defence. In an instant the same weapon pierces my wrist. By heavens! the room is full of trumpeting demons. They crowd as if they were regiments of Germans through the open window; they are in every corner! What propitiation to the local gnomes have I omitted? What sins have I committed that I should thus in midnight hour be harried and cheived by elfin armies, who prick and pierce me? In desperation I turn on the light. With swift clutch of the right hand I grasp at one of my tormentors. I seize him. I immolate him on my upturned left. By the glare of electricity I discern an insect, small even as a gnat, but oh what a length of proboscis! I have never seen

the creature before, but verily I recognise it as a mosquito. My dream of fairy sprites. Is it dissipated thus?—thus have I travelled all these miles only to have my rest disturbed, and to scrape acquaintance with this low-bred offspring of Adriatic mud, that he may puncture me at his will and fatten on my blood?

But despicable as he is, the enemy is in possession. What can I do? At midnight, in pyjamas, standing by one's bedside is not the place nor opportunity to think heroic, and the study of the anatomy of the genus *Culex* may well be deferred to a more convenient time. I had satisfied myself as to the identity of my nocturnal visitor. Now would I seek some rest. Vain the thought. Through those long hours which intervened ere morning broke—one, two, three, four, five—I heard them all proclaimed—nor truce nor peace was permitted. Did I seek refuge 'neath the snowy sheets, one more hazardous than his mates would work his way betwixt the folds. If by sleep compelled I began to nod, then in serried masses the attack was forced, while scouting Uhlans made raids into my hair. It is said that they scorn the native blood, but that the new arrival is their favourite morsel. I have good reason to believe it. Until the morning sun rose in the eastern horizon they never seemed to cease their feast. But with his first rays they recognised their power was over, and, retreating to their diurnal hiding-places, left me sore and swollen to what sleep I might yet attain.

Brightly shone the morning o'er the azure sea. It was no flattering tale the faithful mirror told me. On cheek, on brow, on arm, on wrist the little crimson circles told where the attack had succeeded. Venice! I shall always carry with me the recollection of thy singular beauties, but equally shall I never forget that only night I stayed with thee.—J. SMALLWOOD.

---

#### NORTHANTS. B.K.A.

The annual show was held in Abington Park, Northampton, on August 5th and 6th, in connection with the Municipal Show of Flowers, &c. The honey exhibits were not quite so numerous as usual. Mr. W. Herrod, F.E.S., judged the exhibits and made the following awards:—

*Twelve Sections*.—1st, F. Ward, Twywell; 2nd, J. Adams, West Haddon.

*Extracted (Light)*.—1st, J. Adams; 2nd, N. Stops, Tiffeld; 3rd, J. W. Bocoek, Stony Stratford; 4th, F. Ward; 5th, W. H. Chambers.

*Extracted (Dark)*.—1st, F. Belgrove, Denton; 2nd, Miss E. Scott, Titchmarsh; 3rd, J. Adams.

*Granulated.*—1st, J. Adams; 2nd, Miss E. Scott; 3rd, W. Batchelor, Stoke Bruerne.

*Three Shallow Frames.*—1st, F. H. Ireson, Wellingborough; 2nd, J. Adams; 3rd, Miss E. Scott.

*Super in Glass and Wood.*—2nd, W. Batchelor.

*Bee wax.*—1st, Miss E. Scott.

#### NOVICE CLASS.

*Sections.*—Miss E. Scott.

*Etracted (Light).*—1st, J. W. Bocoek; 2nd, N. Stops.

*Etracted (Dark).*—1st, H. F. Swann, Northampton; 2nd, J. Shelton, Wollaston; 3rd, F. Belgrove.

#### SPECIAL PRIZES (OPEN).

*1-lb. Jar.*—1st, A. Hiscock, Barton Seagrave; 2nd, A. Gladding, Northumberland; 3rd, A. T. Church, Cardiff; 4th, A. H. Bowen, Cheltenham; 5th, F. Bird, Dunmow, Essex.

*Special Prize for 1-lb. Jar.*—1st, W. Patchett, Lincoln; 2nd, F. D. Wills, Alton, Hants.; 3rd, F. Bird; 4th, A. Hiscock; 5th, S. J. Miller, Thetford.

All entries in special prizes class will be given to the Weston Home and the Brixworth Workhouse.

*Cake, sweetened with Honey.*—1st, Mrs. Mason, Yardley Gobion; 2nd, Miss Florrie Munn, Wellingborough Road; 3rd, Mrs. James Adams, West Haddon; 4th, Mrs. R. Hefford, Kingsthorpe.



*A Study in "I.O.W."* (p. 295).—There is a further and not less interesting explanation of the phenomenon with which Mr. J. W. Kidd deals, namely, the manifestation of disease in prime swarms. This manifestation has been noted "off and on" ever since the disease became prevalent, and to suppose that all such cases owe their inception to hive infection puts a severe strain upon powers of credence. It is possible, however, that the disease exists in the stock; and that the extra exertions made by the swarm so lower its vitality as to render it a prompt victim. The question is worth an endeavour to clear, by ensuring a clean hive for the swarm, and making accurate note of subsequent development of disease not only in the swarm but in the parent stock. Mr. Kidd's explanation is not at all unreasonable, but I am afraid it also involves the probability of infection of the parent stock. There can of course be no

proof that a promptly hived swarm would have otherwise developed the disease, but immunity of the parent stock would seem to favour his theory.

*Skeps and Disease* (p. 304).—I am much obliged to Mr. Manley for his support. His experience, as no doubt he will have gathered, tallies amazingly with my own. It is this experience which has led me to take the stand which has been so criticised. Since doing so, I have compared notes with a number of travelling experts and others, and I may say that all the older and more experienced men agree with me. I must admit that some of the younger enthusiasts do not, but no doubt they will in time! An interesting point occurs to me in connection with the skeppist's method of taking "heavy" and "light" stocks. He has been condemned for this practice as tending to fix mediocre stock. But it is very doubtful whether there is anything in the charge. Many of the ultra-heavy stocks are really honey-bound, and are not certain either to survive or to succeed the following year. But the condemnation implies that the skeppist should reproduce from the heaviest. Even if this were possible, better results would be by no means certain. Experiments in this direction have been made, by expert apiarists, with disappointing results. The lightly-made charge overlooks the fact that the "middleweight" stocks hold the same potentialities as the heavy-weight champions.

*An Expert's Diary* (p. 316).—The disbelief in the method of detection of foul brood by means of the nose, reminds me of an invention of my old friend, Herr Alleswisser, now, alas! my friend no longer. This consists of a kind of modified anaesthetic apparatus, of which the tube is attached to the face mask at one end, and to a kind of hollow antenna at the other. This antenna is inserted at the hive entrance at night, and a deep-smell (*starkesschnuffeln*) taken by the operator. The inventor claims that he can discover single cells of disease by this method. Of course it is now impossible to import the apparatus, but under the present liberty to work German patents, there can be no objection to its construction in this country. I hope at some future date to furnish details of a number of remarkable ideas of this well-known bee-keeper.

*Soft or Hard Candy* (p. 328).—I am unable to see why "D. M. M." should be puzzled. Our own soft candy is of course well known to him, and the American hard candy has been fully described, and appears to be a kind of barley sugar. If so, it would still be available for use by the bees, by reason of its tendency to



soften in a moist atmosphere. But I think a fair trial of both kinds would convince Dr. Miller of the superiority of soft candy. If he would get some from Mr. Fuller, he would be able to make the experiment. I should like to point out to "D. M. M." that the proportions given in the "Guide Book" are not, of course, the finished proportions, but allow of considerable boiling down. This I believe to be quite unnecessary. Perfect candy can be made, with less risk of error and vagueness of direction, by using seven gills (spirit measure) of water to 10lbs. of sugar. By the way, the recipe which "D. M. M." quotes from "page 197" is not for candy at all but for thick syrup, which may account for the supposed discrepancy.



The Editors do not hold themselves responsible for the opinions expressed by correspondents. No notice will be taken of anonymous communications, and correspondents are requested to write on one side of the paper only and give their real names and addresses, not necessarily for publication, but as a guarantee of good faith. Illustrations should be drawn on separate pieces of paper. We do not undertake to return rejected communications.

#### STAMPING OUT "ISLE OF WIGHT" DISEASE.

[9077] "Random Jottings," p. 346. The argument that "Isle of Wight" disease may be stamped out as hydrophobia was, seems to me fallacious. There are no dogs living in a wild state in England. All dogs belong to somebody or other, and could be got at, so we could muzzle all dogs and get rid of the disease. But even if every diseased hive in the kingdom were discovered and burnt, there are plenty of bees in hollow trees, church and house roofs, and elsewhere, to keep the disease going.—H. S. WATTS.

#### ECONOMISING HONEY.

[9078] Is not the present awful crisis the grand opportunity for the British Bee-keepers' Association? With sugar 100 per cent. up and likely to remain so, every ounce of honey in the country should be saved. Can you get every available expert buzzing round his own district seeing that not an ounce of honey is lost?

My gardener is an expert. I have just sent him to see the local expert and secre-

tary of the local Association, and to offer his services to any possessor of honey within a cycle ride of here. He is to help cottagers free, and others can give a trifle, every penny of which will go to the War Fund.—S. R. WHITLEY.

[While commending the above to our readers, we would advise bee-keepers to see that they do not rob the bees too much. Ample stores should be left in the brood chamber, otherwise the bees will die of starvation. Sugar will, no doubt, be dear and difficult to obtain, therefore it will be well to practise a little self-denial in the way of sweets for ourselves rather than allow bees to become extinct.—Eds.]



[8978] *Moving Bees.*—May I trouble you to give me your advice about moving my bees? I purpose to leave here in December, first week, or February. I have now eight colonies. I want, if it is possible, to make the eight into four for wintering. 1st. Am I too late, if I selected a fine morning like it has been to-day? I have commenced feeding with syrup. Only one lot have taken any down. 2nd. How would you advise me to pack the bees? They are all in W.B.C. hives. Can they travel in motor van like my furniture goes in? I am moving to a better country for the bees, I think. I have about 250lbs. of honey. 3rd. Is that good? The shallow frames I have had well cleaned out by the bees. I have scraped all wax, &c., off, and I am putting them into a tin-lined case. 4th. Will this be sufficient to protect them in safety to use next summer?—A. W. GERRARD.

REPLY.—(1) It may still be done, but no time should be lost. (2) Make the body box fast to the floor-board, cover the entrance with perforated zinc, make a frame of wood to fit the top of the brood-box so that there is an opening in centre 10in. or 12in. square. Tack a piece of perforated zinc over the opening and screw the frame down on the top of the frames, zinc uppermost. The wood should be  $\frac{3}{4}$ in. thick, which will leave that space between the zinc and frames for ventilation. Do not cover over whilst travelling. (3) Yes, if care is taken that they are not suffocated. The amount of honey is moderate if from all eight hives. (4) Yes, put a couple of balls of naphthaline in box to keep out moth.

## Notices to Correspondents

S. J. FAGAN (Dulwich).—Sample of sugar is not suitable for bee food; use white sugar.

WAXMAN (Bristol).—There is nothing wrong in comb sent; it is quite healthy. The brown parts are where breeding has been carried on. You may space the combs a little wider, but be certain that bees cannot get out at the ends of top bars, and do not forget to close up again in the spring. If they have five frames full of stores they will be all right. Sprinkle some naphthaline under lugs of frames and put some among quilts. They do not do much damage. We do not know the district, but from your description of the flora it should be good for bee-keeping.

T. BRIGHT (Weybridge).—(1) Three or four inches. (2) Flour is only used in candy in the spring. (3) We prefer to leave it open. (4) Do not give syrup during the winter. If they should need any food then, give a cake of soft candy.

H. J. H. (Winchester).—(1) Ordinary methylated spirit will do. Any alcoholic spirit will dissolve it. (2) Honey will be all right so long as it is sealed over.

SCOTTY (Yatton).—(1) Yes. (2) Natives. (3) Odourless foul brood. (4) Not at all, most queens will have ceased laying now.

HONEY (Tisbury).—Pure honey will granulate sooner or later. Heating it in a water bath, taking care that the water does not boil, will check granulation. Keep it in a warm, dry place, preferably in the dark.

SUFFOLK (Leicester).—You may do so, but it is not advisable.

### Honey Samples.

R. S. (Castle Cary).—It is clover honey of excellent quality, and quite up to show standard, worth 60s. to 70s. per cwt.

R. W. (Carnarvon).—(1 and 2) It is a good sample of heather honey.

### Suspected Disease.

BEES (Kidderminster).—Bees have "Isle of Wight" disease. You did not observe our rule as to name and address.

G. E. M. (Countesthorpe), READER (Eccles), T. H. (Birmingham), G. A. P. (Parkstone), T. E. (Bath).—Bees are affected with "Isle of Wight" disease. M. G. (Greenock).—We cannot detect any disease in bees.

A. C. R. (Hanwell), W. T. (Umberleigh), J. T. (Baldon), C. J. P. (Rothley), and J. F. L. W. (Southampton).—Bees are suffering from "Isle of Wight" disease.

### Special Prepaid Advertisements

Two Words One Penny, minimum Sixpence.

Orders for three or more consecutive insertions entitle advertisers to one insertion in "The Beekeepers' Record" free of charge.

Trade advertisements of Bees, Honey, Queens, and Bee goods are not admissible at above rate, but will be inserted at 1d. per word as "Business" Announcements, immediately under the Private Advertisements. Advertisements of Hive-manufacturers can only be inserted at a minimum charge of 3s. per  $\frac{1}{2}$  in., or 5s. per inch.

### PRIVATE ADVERTISEMENTS.

**S**TRONG surplus stocks for sale, on 8 frames, all wired, full sheets, foundations, £1 5s. each, carriage paid; cash with order.—G. A. GILLETT, Morston, Glos. v 63

**2** GRAND stocks, 6 frames, plenty stores, 16s. each; new shallow combs, 4d. each.—OWEN, Liberal Club, Cheltenham. v 68

**H**ONEY, in 14lb. and 28lb. tins, also sections, for sale, on rail.—MRS. GREEN, Fingring-hoo Hall, Colchester, Essex. v 70

**4** SOUND stocks bees, in Lee's hives, for sale, very cheap.—VINCENT, 132, Croydon-road, Anerley. v 69

**W**ANTED, honey extractor, geared, good condition.—ATKINSON, Benton Hill, Horbury, Wakefield. v 73

**42** LB. choice Hampshire honey, 28s.; sample, 3d.—ARCHER, Anton-road, Andover, Hants. v 72

**F**INEST clover honey, 60s. cwt.—KETRIDGE & ACOCKS, Sudbury, Suffolk. v 71

**F**INEST quality heather honey, 12s. 6d. per doz. jars f.o.r.—WILSON, Apiary, Belper. v 66

**T**HREE strong stocks, in W.B.C. hives, extra hives and appliances, very cheap for cash.—FRY, 38, Sydenham Park, Sydenham. v 65

**F**OR SALE, few strong old-established colonies, in odd sized hives, some standard stocks and nuclei, W.B.C. and other hives, and sundries, cheap.—MASON, Poplars, Moored, Yardley Gobion, Northants. v 64

**F**OUR stocks of bees, fully stored; extractor (2 frames); several spare hives, for sale, cheap; giving up.—DUNHAM, Bridge-street, Work-sop, Notts. v 62

**F**OR SALE, two Spaniel puppies, 9 weeks, also good double barrel gun.—Apply, H. SEAMARK, Willingham, Cambs. v 61

**H**ONEY, excellent quality, at 56s. the cwt., in 28lb. tins.—R. WATERS, Gestingthorpe, Essex. v 45

**4** YOUNG queens, from healthy, vigorous skeps, 2s. each.—C. PARISH, Addington, Surrey. v 53

**C**LOVER SECTIONS, 8s. 6d. per dozen; extracted, 58s. per cwt.; sample, 2d.—SIMCOX, 17, Victoria-rd, Fallings Park, Wolverhampton. v 47



### HELP ONE ANOTHER.

How often are we told that there is a great amount of "freemasonry" among bee-keepers, and numbers of times we hear of instances that go to prove that this is so. As far as our experience goes bee-keepers are almost invariably ready to help one another. How quickly, too, do people who are complete strangers to each other fraternise and enjoy comparing notes when they discover that they are each and all bee-keepers. There probably has never been a more favourable opportunity than the last few weeks for bee-keepers to put their "freemasonry" to a practical test. We wonder how many of the thousands of our young men—aye, and numbers of those of mature years also—who have in one way or another responded to their country's call, either leaving their regular employment, or doing extra duty in addition to it, are our brethren in the craft of bee-keeping, and who may, owing to their ready response to the call of duty, not have been able to properly attend to the wants and necessities of their bees. We have had bee-keepers call on us for a few minutes chat, and had letters from others who have not had a chance to look to their bees for weeks. It would be an act of brotherly kindness for any bee-keeper who has to stay at home, if he has no special duty to perform, but just keep on at "business as usual," to give a helping hand to those who have gone away, if only by seeing that their bees are safely packed for winter. A lady who is well known in bee-keeping circles called at our office the other day to inquire if we knew of anyone near her home in need of such help, which she was willing to give free of charge. We heartily commend her example to others.

### THE NATIONAL RELIEF FUND.

We have received from one of the joint secretaries of the National Relief Fund a copy of a song entitled "The Homes they Leave Behind," which has just been published by Messrs. Enoch and Sons for the benefit of the National Relief Fund.

The song is one of direct appeal for support to the Fund, and should help it much, for Mr. Walter Rubens's music is of a tuneful and catchy nature, which will, it is believed, gain wide popularity, while Mr. Harold Begbie's words should arouse ready sympathy. We give the words of the chorus:

"Men are rolling up in thousands,  
And they've flung their jobs behind,  
They have kissed the girls and mothers,  
And they've told them not to mind.  
You have called them to the colours,  
Where the battle breaks and foams,  
Well! they're rolling up in thousands,  
It's for you to help their homes."

The price of the song, full music size, is 1s. net, and the entire profits are to be devoted to the National Relief Fund, and the Variety Artists' Benevolent Fund, the former taking seventy-five per cent. and the latter twenty-five per cent.

### BEE-KEEPING AND SUNDRIES.

#### THE SEASON ON THE COTSWOLDS.

The honey season would have been a record one had not the limes failed in July, owing to the dull and cool weather that prevailed just then. Many of the main roads of Cheltenham are lined with these fine trees, but this season there were few days on which the merry hum of the bees could be heard amongst the drooping blossoms. With hives strong and warm sunshine in the early part of the year, it was not long before the bees were up in supers, and they stored quite a lot of honey before the sainfoin blossomed. The average seems to be about 50lbs. per hive, while the number of swarms that issued was rather more than usual. Bees have been wonderfully good tempered, especially towards the latter end of the season.

Even the stock that "did used to terrify I, and sarve I out summat awful" made no demur when I took off the last two supers of "deeps" for the season. It has been a real pleasure to work amongst the bees all day, and not receive more than half-a-dozen stings!

Some bee-keepers are very happy-go-lucky. They read their bee-books and their journals, but it often seems like water on a duck's back, for they do the things which they ought not to do, and leave undone those things which they ought to have done, and so there is often no health—in their bees, at least!

It is about time now that hives which have their proper quantity of stores should be made comfortable for the winter. Two or three good newspapers over the quilts or escape-board, and pressed down tightly by the lift, excludes all draught; and if they are left a little higher in the centre, any rain which may leak through the roof runs away at the sides.

Most of our roofs are flat ones covered with galvanized iron, but some have wooden covers, and last winter when the rain in a few instances penetrated, it simply trickled away, and out between the lift and body. But for the paper it might have chilled the poor bees to death.

I have lately settled a hundred hives for winter, and the goldens especially are very strong, with the frames full of sainfoin or clover stores. Experience seems to show that the earlier bees are closed down in the autumn the sooner they commence work in the spring, because they are not worn out by excessive disturbance or breeding late in the season.

If the hive is built of good wood and the bee-man settles it comfortably and snugly for the winter by, say, October 15th, he need not trouble further about it for seven months, unless, perhaps, to satisfy himself occasionally that no malicious person has turned the hive upside down, or taken it away altogether. —A. H. BOWEN, Cheltenham.

### EXTRACTS FROM AN EXPERT'S DIARY.

*By J. Herrod.*

*(Continued from page 316.)*

There is a right and a wrong way—or perhaps it would be more correct to say one right and several wrong ways—to do most things, and this is especially true of commencing bee-keeping. I have noticed several of the wrong ways, not only when on tour, but have had them brought to my notice during “question time,” when giving demonstrations at shows, &c. Far too many people commence by first purchasing a hive and bees, afterwards reading the matter up, or worrying a neighbour to help them out. The following cutting from a North Country paper fairly illustrates this method: “Dear Sir.—Having commenced bee-keeping with a total outfit of three books, one stock and no experience, I should be grateful to any bee-keeper in the neighbourhood of Glasgow who would allow me to inspect his apiary at work. I am, etc., Novice.” I have been asked in all seriousness if it was not possible to commence by buying some comb and a queen, placing them in a hive, then catching some bees as they were at work on the flowers and putting them in the hive to the queen! One day I called at a farm in Devonshire, in the garden of which there were a couple of frame hives, both stocked with bees. I found the owner, a young farmer, very anxious to obtain information about them, as he knew nothing whatever about bee-keeping. Have I not read that “Some are born to greatness; others have it thrust upon them”? This farmer had certainly had bee-keeping “thrust upon him.” He had only been at the farm a few weeks, and the bees were included in the valuation for tenant right, and therefore he had to “take to” them, and was quite delighted to have someone look inside the hive, a thing he had not dared to do. Nor was it pos-

sible to even guess how long a time had elapsed since the combs had been last examined. The frames appeared to be glued fast, and defied all my efforts to move them. The thumb and two forefingers, as recommended some time ago by Col. Walker, were no good at all, nor was a screw-driver any more effective. The farmer therefore went for a strong “cold” chisel, but while he was away I noticed near by an old potato fork with a broken handle. One of the prongs used as a lever under the lug of a frame had the desired effect.

No wonder the frame was so fast, for a 1½ in. nail had been driven through each lug into the hive-side, and every frame was nailed in the same manner. The accumulation of propolis, &c., on the top of frames, prevented the heads of the nails being seen. There were very few bees in the hive, but I have not forgotten the pleased and surprised exclamations of their owner as they were lifted out. What he could not understand was why the bees did not “take wing.” When the queen was pointed out to him his delight was unbounded. I now, of course, knew what to expect at the next hive, but in this case not only were the frames nailed, but the queen excluder was also nailed down!

A contrast to these were the hives of a young joiner, all of them his own make and in very good order. Unfortunately, he was not at home when I called, so I had a chat with his mother, with whom he lived. The old lady was quite ready to talk and tell me all about bees, as she had kept them “years ago.” (This young man was evidently “born to bee-keeping.”) I found, however, that though the hives were up-to-date, the same could not be said of some of her ideas and notions of how bees should be managed. It was probably fortunate for them that she was too old and infirm to look after them. I was informed that a sparrow was a fine thing on which to feed bees occasionally. If it was plucked and placed on the alighting board the bees would eat it. This is the first and only time I have heard that bees are carnivorous, although I have, like most other bee-keepers, heard that it was proper to give them cake and wine on certain occasions. Naturally I expressed some doubt as to the bees utilising the sparrow as an article of diet, but the old lady was quite indignant at my want of belief, and declared somewhat warmly, “I have done it myself, so I know. I put a sparrow on the ‘light’ board one evening and the next day it was eaten.” After that, of course, there was no more to be said on the subject, so I diplomatically turned the conversation into another channel.

*(To be continued.)*



### PROCURING SURPLUS.

(Continued from Page 361.)

Do not put the empty super on top of a full one, or the bees may refuse to take possession of it, and swarm instead. The best time to put on the empty super is mid-day when the bees are hard at work. Many will be out in the fields foraging, so the hive will not be too crowded, and the operation can be carried out comfortably without loss of bee life by crushing. When the bees are working at full pressure, draw the entrance slides right out so that they may not be impeded in the least in coming out or going into the hive.

If the honey-flow comes on at a time when the stocks are not quite up to full strength, surplus can often be obtained by crowding them on to eight or nine combs. Stocks so treated will require careful attention afterwards to get them into proper condition for wintering.

In the case of shallow-comb supers, the honey should be allowed to remain on the hive as long as possible to ripen thoroughly. "What do you mean by ripening honey?" asks the beginner. Generally he is so anxious to take off his first surplus that he overlooks this important factor in the process of obtaining good saleable honey, that will keep for any length of time when properly stored. I have tasted honey over thirty years old which was as good in flavour and aroma as on the day it was taken off, simply because it was harvested and stored in a proper manner.

Honey, when first placed in the cells, contains an excessive amount of moisture, which, if allowed to remain, would eventually cause fermentation. This is evaporated by heat generated by the bees, it condenses on the inner walls of the hive trickles down to the floor board, and runs away at the entrance. To see this, go to a stock very early in the morning, when the honey-flow is at its height, and you will see the moisture coming away from the entrance. All the bees being home at night, evaporation takes place quicker than at any other time. To facilitate this the bees change the honey from one cell to another, so that the heat can penetrate the liquid better, just as good wine is racked off into other bottles from time to time to mature it and get rid of the sediment.

As mentioned before, the empty super should always be placed underneath the full one, to prevent over-crowding and swarming. Here we have illustrated another important reason why the partly-filled super should be at the top. Heat rises, therefore by lifting to the top it is placed in the warmest part of the hive, so that the honey ripens more quickly.

When thoroughly ripe, and not until, except in very rare instances, the bees seal over the honey hermetically with cappings made of pure bees-wax. If sealed over by the bees or removed by the bee-keeper before it is ripe, the same result occurs that would happen in the case of insufficiently boiled jam placed in jars and tied down; fermentation takes place, and the honey is spoilt.

Tiering up of supers must be carried out with care and foresight, to avoid having a number of combs at the end of the season with a quantity of unsealed honey in them. By the exercise of a little trouble this can be avoided; in fact, in small apiaries there is no excuse for such a condition.

We will suppose, as an illustration, that the second super has been on for some time, and that in it, as well as the upper one, there are combs complete and incomplete. Instead of putting on a third super, remove the top one, take out the incomplete combs and replace them with completed ones from the second super. Put all the unsealed and incomplete combs into the second super remaining on the hive; by the reduction of space the bees are crowded and complete the work, whereas if a third super is added they will commence working upon it, and if the honey-flow ceases before it is finished a number of combs containing unsealed and unripe

honey will be left. Although this would not be wasted, as it can be got into condition artificially, it entails a lot of extra work and trouble ; also the honey is never so good as when ripened by the bees in the natural way.



1



2



5



3



4

FIG. 10.

The beginner is, as a rule, anxious to do the best he can for his bees, and in his anxiety is apt to be over zealous. For instance, he reads that to prevent the bees from swarming a good plan is to cut out queen-cells, so he goes every other day to

the supered stock, removes the supers, and searches diligently for queen-cells. If the first super is put on and others added at the right time this is unnecessary. Let them alone as much as possible compatible with proper management, and they will thrive the better for it. If it is considered necessary to remove queen-cells (this can easily be ascertained by the bees crowding at the entrance, although everything possible has been done in the way of adding supers, giving ventilation, &c.), then examine the brood-nest and remove all queen-cells. The work should be done at mid-day, for the reason given previously. As each comb is taken out brush off the bees, or they may be cleared more quickly by shaking. The various methods of doing this are shown in (Fig. 10). At No. 1 the comb is raised and then lowered rapidly to near those in the hive and then stopped with a sudden jerk, No. 2, when all the bees will be dislodged into the hive. Another method is to hold the frame cornerwise by one lug in the left hand, so that the right can be raised to use as a hammer, No. 3, with which the back of the left hand is struck smartly, No. 4, when the bees will be dislodged. No. 5 shows how the bees are removed by raising the comb half way out and then bumping the hands on the side of the hive, every queen-cell and commencement of cells can then be seen at once and destroyed. I defy the most experienced bee-keeper to do this work thoroughly without removing the bees; if even the base of a queen-cell is missed the labour is in vain, for the bees will swarm, as they intended. It is advisable to place a board slanting from the entrance to the ground as for hiving a swarm, so that those bees which drop outside the hive during their removal from the combs may get back without trouble. Should all quieten down the operation need not be repeated, but if at the end of about nine or ten days the bees again crowd at the entrance then make another examination.

We will now suppose that the top super is complete, and the honey all sealed over. As customers are waiting for supplies it is imperative that some is obtained for them as quickly as possible to retain their custom and prevent them taking up the sale of foreign produce.

(To be continued.)



*The Editors do not hold themselves responsible for the opinions expressed by correspondents. No notice will be taken of anonymous communications, and correspondents are requested to write on one side of the paper only and give their real names and addresses, not necessarily for publication, but as a guarantee of good faith. Illustrations should be drawn on separate pieces of paper. We do not undertake to return rejected communications.*

#### SKEPS AND DISEASE.

[9079] *Re* "Skeps and Disease," page 366, I, too, would have welcomed Mr. Manby's support of Mr. Crawshaw's stand for the skep, but I failed to discover anything fresh to consider. Certainly the title we have now, bears no relation to the original discussion. I don't remember any

of the critics claiming for the skep "disease liability," but that, when once contracted, it was "practically impossible to remove." I will endeavour not to compare the two systems in so many words, or I shall be probably brought to book, but whether "ultra-heavy" or "mediocre" (which should possess the best queens?) or "light," the movable comb system lends itself to remedy easiest, both for the bees and their owner; in taking honey or decreasing stock, without loss of life, and referring to our title again, "health." But for my own part I would beg Mr. Crawshaw to get this further evidence put on paper in the interests of the younger enthusiasts, as life is short and we are progressing, and we want to leave nothing behind. In a few years' time I think and hope we shall have a lot to thank our "Isle of Wight" disease for. But the "home" must inevitably be the most easily "cleaned," and adaptable to "humane" requirements, that can be conceived. Thereby is the shortest cut to "light" and education.—A. H. HAMSLAR.

## WEATHER REPORT.

WESTBOURNE, SUSSEX.

September, 1914.

Rainfall, 1.67in.	Minimum on grass,
Below aver., .57in.	29 on 30th.
Heaviest fall, .45in.	Frosty nights, 0.
on 12th.	Mean maximum, 65.1.
Rain fell on 10 days.	Mean minimum, 48.5.
Sunshine, 230.3 hrs.	Mean temperature,
Above average, 53.8	56.8.
hours.	Above average, .8.
Brightest day, 1st	Maximum barometer,
and 2nd, 11.4 hrs.	30.407 on 30th.
Sunless days, 0.	Minimum barometer,
Maximum tempera-	29.633 on 17th.
ture, 76 on 4th.	
Minimum tempera-	
ture, 36 on 23rd.	

L. B. BIRKETT.



[8979] *Stock Dwindling.*—Last spring one of my colonies of bees killed their queen and requeened themselves. During the summer they have gathered scarcely any honey, not enough to take them through the winter. On examination I find there are a lot of young dead bees in cells, although the larvæ look healthy. Can you tell me what is wrong with them, as I have not seen any bees crawling?—H. T. L.

REPLY.—We cannot say without an examination.



G. H. I. (Llanberis).—Not so far as we can remember. The Canadian pattern.

W. MUDGE (Devon).—(1) Queen is a young one, and does not appear to have mated. (2) Probably not to a beginner. The wings are usually frayed, and the body shiny and almost black, owing to it being denuded of hair.

F. C. W. (Camb.).—We cannot say without examination. You do not say whether the "dark patches" were empty comb, or if the cells were sealed over.

C. M. C. (Painswick).—The simplest way is by means of a "Gerster" wax extractor. It may be extracted in an oven. The wax is placed in a sieve or wire gauze strainer over a basin containing water. The wax will melt and percolate through the strainer, dropping into the water below, on which it floats. When all the wax is melted it is allowed to cool gradually, when the cake of wax may be removed. The heat of the oven should not exceed 172deg. Fahr. Do not attempt to extract in a saucepan over the fire.

*Honey Samples.*

A. P. (Tattinstone).—Sample is mainly from clover; good quality worth about 60s. per cwt.

*Suspected Disease.*

G. H. J. (Llanberis), N. D. M. (Bishop's Stortford), and "ARTEFS" (Pembroke).—Bees are suffering from "Isle of Wight" disease.

**Special Prepaid Advertisements**

**Two Words One Penny, minimum Sixpence.**

Orders for three or more consecutive insertions entitle advertisers to one insertion in "The Beekeepers' Record" free of charge.

Trade advertisements of Bees, Honey, Queens, and Bee goods are not admissible at above rate, but will be inserted at 1d. per word as "Business" Announcements, immediately under the Private Advertisements. Advertisements of Hive-manufacturers can only be inserted at a minimum charge of 3s. per  $\frac{1}{2}$ in., or 5s. per inch.

**PRIVATE ADVERTISEMENTS.**

**F**INEST English honey, 60s. per cwt.; sample, 2d.—DUTTON, Terling, Witham, Essex. v 4

**F**INEST clover honey, 65s. per cwt., carriage forward; sample, 2d.—BUTTON, Manse Cottage, Haverhill, Suffolk. v 85

**H**ONEY, 1 cwt. clover, 73s., carriage paid; sample, 1d. stamp.—DR. LLOYD, Cradley Heath, Staffs. v 86

**O**FFER required for twenty-four shallow frames honey, mostly heather, all sealed.—LASH-BROOK, Lynton, Devon. v 87

**B**EE STOCKS, on eight full frames, strong, healthy, 21s.; also straw stocks, full, 12s. 6d., f.o.r.—HAINES, 22, Guildford-road, Tunbridge Wells. v 84

**F**OR SALE, seven young ferrets, 2s. 9d. each; exchange pullets.—P. COUSINS, Miston. v 83

**G**ENUINE heather honey, from moors near Buxton, 12s. dozen jars, f.o.r.—HUTCHINSON, bee-keeper, Leek. v 82

**T**WENTY stocks of bees, in W.B.C. hives; also quantity of appliances, going cheap to clear; particulars on application.—Box 20, "B.B.J.", 23, Bedford-street, Strand, W.C. v 81

**B**ARGAIN, a number of double walled hives, all interchangeable, W.B.C. principle, 6s. each, condition guaranteed.—STAPLEY, Potton, Beds. v 79





### NATIONAL RELIEF FUND.

LETTER FROM H.R.H. THE PRINCE OF WALES.  
Buckingham Palace.

October 5th, 1914.

On the 6th August I appealed to the nation to assist me in founding a National Fund to prevent and alleviate military and civil distress arising in consequence of the war. To-day, after the lapse of exactly two months, I am happy to say that the Fund has reached the splendid total of three million pounds. I wish to take this opportunity of thanking once more the many thousands of generous subscribers who have helped me to achieve this grand result.

I have delegated the responsibility of administering the Fund to the Executive Committee which I have appointed on the advice of the Prime Minister, and I count upon the Committee to see that assistance in emergency cases is adequate, and given with as little delay as circumstances permit. I trust that the portion of the Fund which is to be applied in relief of civil distress may, as far as possible, flow into productive channels, such as assisting schemes for male and female employment and perhaps industrial training; for it is as repugnant to me as it must be to the recipients, that assistance should be distributed only in the form of doles. What men most want is work, and what the young people need is training.

The sum which has already been raised is magnificent, and I am confident that the generous British public will continue to do their utmost to alleviate the distress which war inevitably brings in its train.

EDWARD.

### HONEY JUDGING COMPETITION.

The Dairy Show is always more or less of an "event" to bee-keepers. It is the last important show of the season, and during the show week a *Conversazione* is held by the British Bee-keepers' Association. This year more interest than usual attaches to the Dairy Show, as so many other shows, including the Grocers' Exhibition, have been "postponed till 1915." Another reason for increased interest is the new venture, a "Honey Judging Competition," which we hope will be a success. That there is need for some method of training judges will be conceded, we think, by all our readers, for the judging even at some of the more important shows is not always satisfactory, and is much less so at the smaller and local shows. No doubt a bee-keeper, by consistently exhibiting honey for competi-

tion year by year at numerous shows, becomes a very fair judge of the honey produced in his or her own district, and knows what qualities will be the most likely to meet with success on the show-bench. Still, his knowledge is local and is probably confined to one class of honey. Should he undertake the duties of judge at a show where there are classes for, say, "light," "medium," "dark," and heather honeys, he finds he is handicapped in one or more classes through having handled very little, if any, of those particular kinds of honey. If honey judging competitions could be arranged not only by the parent association, but also by the county associations a good work might be done in educating bee-keepers in judging. To do this successfully, however, there should be a good range of samples available, not only from different sources, but of different qualities.

The *CONVERSAZIONE* of members and friends will be held at THE LECTURE HALL, ZOOLOGICAL GARDENS, on Thursday, Oct. 22nd. Tea will be provided free for all at 5 p.m. At 4 p.m. a lecture will be given by Mr. D. Wilson, on "The Management of an Apiary for the Production of Heather and other Honeys where the Crops are Situated about Twenty Miles Apart." At 6 p.m. a lecture, illustrated by lantern slides, will be given by Mr. A. Richards, on "Bees in Relation to Flowers and Fruit." During the tea any novelties and articles of interest sent for exhibition will be shown. It is hoped members will bring as many friends as possible, ladies being especially invited. The time of opening of the *Conversazione* has been altered from 5.30 to 4 p.m., the meeting to close at 8 p.m. This will, it is hoped, enable those from the provinces to be present right through the meeting. The nearest station is Camden Town Tube, or a motor-bus (service No. 3) from Piccadilly Circus, takes visitors almost to the door of the hall.

### NECTAR-PRODUCING PLANTS AND THEIR POLLEN.

By George Hayes, Beeston, Notts.

RED CLOVER.

(*Trifolium pratense*.)

No. 31. NAT. ORD. LEGUMINOSÆ  
PAPILIONACEÆ.

(Continued from page 353.)

This plant is as familiar to all as is the White Clover (*T. repens*), and will be found in bloom from May to September. It thrives upon almost any kind of soil, but is most luxuriant upon clay and loam. It is often sown with corn in spring and allowed to grow on after the former is cut, and so forms a profitable crop alone the following year.

Many bee-keepers will wonder why I include this in the list of nectar-pro-

ducing plants, for they will probably think that although it may produce nectar, the hive bee gets very little of it, more especially as so much has been said and written about—and I believe our American cousins have tried to produce—a longer tongued bee for the purpose of working on this flower. They may also think that if the nectar were obtained, it would produce a dark coarse honey, and I must confess that I was of this same opinion until recently.

I knew that our hive bees worked upon the second crop in favourable seasons, and also in times of drought, for under both

times as worthy of a prize; but I was unable to find out its source until about a year ago. A sample of very light honey was sent to me for microscopical investigation as to its source, and I found it contained only *one* kind of pollen grain, which of course indicated that it had been gathered absolutely from *one* source. Now such a thing scarcely ever occurs in this country, for in all the samples of British honey I have examined—and I have examined many—I have always found more than one kind of pollen grain. Although it was a nice honey in taste, of good light colour, though somewhat lack-

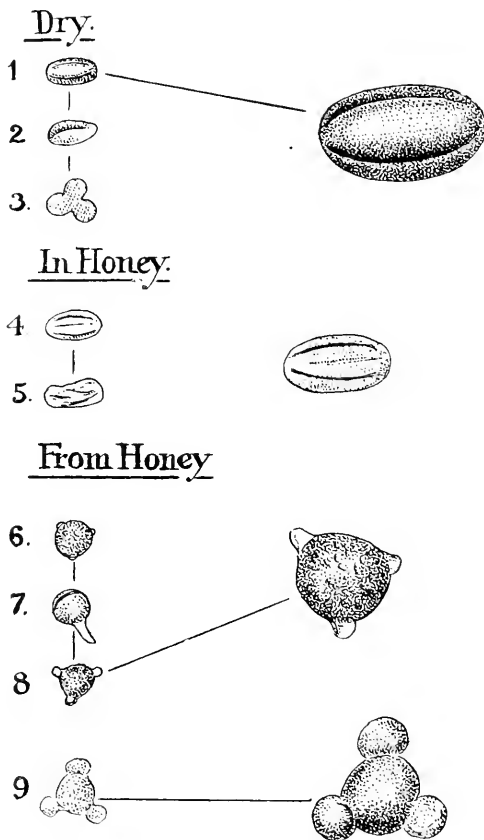

POLLEN FROM RED CLOVER.

these conditions the growth of the flower is dwarfed, consequently the corolla, or tube, is considerably shortened; but the honey obtained at these times was generally dark in colour. This I attributed to the Red Clover, but I have since found that the dark colour and heavy flavour was caused by nectar from other plants growing and yielding at the same time. I have also known of a very pleasant flavour in what was considered to be White Clover honey, and which has been picked out by several judges at different

ing in density, I was forced to the conclusion that it must be a foreign product; for in the vastness of crops abroad one may expect to find a sample gathered from one source.

I, however, afterwards received a letter from the owner of the honey in question who stated how his bees had been working on a good second crop of clover after he had put on the extracted combs to be cleaned out, and that when he came to remove them he found them again filled. He had noticed this Red Clover blooming with

scarcely any other flowers about, and he had no reason to doubt that it had been obtained from this source. Although I had not the least doubt on the veracity of this statement, I obtained from him a one pound sample and found it coincided with the previous one.

The reasons I failed to recognise the pollen grain as British was that from some yet unaccountable cause it had grown very much farther than any I had obtained from the same species, and larger than I have been able to force them to since; but I hope to be able to find out the cause of this by further investigation. The difference in the grains is shown at Nos. 8 and 9.

From the foregoing, it will be seen that under favourable circumstances, that is, favourable to the bee-keeper, though in one case unfavourable to the farmer—our bees do gather nectar from this plant, and I am inclined to think they do so to a larger degree than many have thought possible. This plant is often found in abundance growing on the roadsides, and some may think these dwarf specimens a different species from that growing in the meadows, but this is not so. The extra luxuriance of this meadow clover is the result of cultivation, such as the careful selection of seed, richer soils, etc.

We learn that the Red Clover was first introduced into notice as a food for cattle by Sir Richard Weston, our Ambassador to the Low Countries, in 1645, yet it was not until about the end of the seventeenth century that it was recognised as worthy of extensive cultivation.

Its specific name, "pratense," refers to its home, as being in the meadows and pasture lands. The common name "Trefoil" and generic title "Trifolium" each testify to the habit of growth, the combination of three leaflets in one leaf. By some it is called "Marl grass," for what definite reason I am unable to state, unless it refers to the marble shaped heads, or to the fact that it succeeds best on marl or clayey soils. Others define it as the "Meadow honeysuckle," not because it resembles the plant of that name, but certainly from the same reason that the name was applied to the true honeysuckle, as anyone may know who will pluck a flower from either of these plants, and suck the base of the corolla or tube. Country children often pick the flower heads for the purpose of extracting the sweet nectar (which they call honey) from them. I remember frequently doing so myself, and for this reason in some districts it is called "Honey suck."

The colour of the pollen grain when dry is yellow by reflected light and paler by transmitted light, and measures  $\frac{1}{1000}$  in. by  $\frac{2}{1000}$  in. In form it is an oval divided into

three very distinct lobes by three deeply cut grooves running from end to end, and is slightly rough on the surface. A section through the middle is seen at No. 3.

It is usually very slow in changing its form, and in honey does not at first alter as seen at Nos. 4 and 5, but swells slightly and becomes more transparent; but if left for a long time in the honey it may be found as shown at No. 6, having assumed a more spherical form and with very slight process.

When taken from honey, the grains, that up to this time had retained the form of No. 4, will have developed into those as shown at Nos. 6 and 7, whilst those of No. 6 will assume the more triangular form with clear processes, as seen at No. 8. In remote cases they appear to develop still further, becoming larger and with dense processes as shown at No. 9. The measurement of No. 8 is  $\frac{1\frac{1}{2}}{1000}$  in. and of No. 9  $\frac{2}{1000}$  in., taken from process to process.

(To be continued.)



*The Editors do not hold themselves responsible for the opinions expressed by correspondents. No notice will be taken of anonymous communications, and correspondents are requested to write on one side of the paper only and give their real names and addresses, not necessarily for publication, but as a guarantee of good faith. Illustrations should be drawn on separate pieces of paper. We do not undertake to return rejected communications.*

#### HONEY JUDGING COMPETITION. OCTOBER 22nd, 1914.

[9080] As I am very anxious this competition shall create much interest and draw many competitors I shall be glad if you will kindly allow me to supplement the notice which appears in THE BRITISH BEE JOURNAL by explaining how it is proposed to carry out the competition.

Each competitor will be provided with a card, upon which he (or she) will write the source from which each sample has, in their opinion, been gathered; they will also be asked to place the three samples which they consider best in order of merit, *i.e.*, as first, second, and third prizes. The completed papers will be placed in a ballot-box, and when examined five marks will be given for each sample correctly described, and further marks for placing

the winning exhibits in same order as they have been placed by competent judges before the competition takes place. At an early date full particulars will be given in *THE BRITISH BEE JOURNAL*, and competitors will thus be able to see how far they were correct in their adjudication and note their failures for future guidance, and thus receive a real useful lesson as the result of their attempts. No notice of entry is required.—ARTHUR G. PUGH.

#### HONEY JUDGING COMPETITION.

[9081] I am very pleased to see that something is to be done at last towards educating bee-keepers to enable them to become competent judges. We have too many of the other variety, especially at the smaller shows. Too often at these local shows the task of judging the honey is put on the shoulders of someone who is adjudicating in some other department of the show—flowers or fruit, &c. No doubt the expense entailed by appointing a judge for each section of a show is the reason this is not done at the small and local shows, but it is unfair both to the judge and the competitors. I recollect the first time my brother and I awarded prizes for honey it was done quite "unofficially." We had not been bee-keepers more than two years, and had just begun to take an interest in showing. We were in charge of a large marquee at a local show, where there were a couple of classes for honey. These, of course, attracted our attention, and as they were near the entrance, we amused ourselves by trying to conjecture which would win. After the judging was completed, we were surprised to find that the judge's opinion of the honey had exactly coincided with our own—until we discovered that an elderly gardener, who had stood near us when we were examining the honey (I ought to say we did not taste it) was the judge. He had gone to judge garden produce and been asked to judge honey also, though he knew nothing about it. Overhearing our conversation and thinking we knew something about honey, he just gave the prizes as he heard us allocate them. It is not, however, at the small shows alone that the judging is unsatisfactory, but at some of the larger ones. I have heard of a judge who had a partiality for honey tainted by carbolic acid, and gave it honours at several shows, and of others who give one sample of honey first prize in one class and under almost identical conditions will pass it over entirely in another class.—J. HERROD.

#### SOMETHING ABOUT ROBBING.

[9082] Of all the nuisances, there are

few like robbing, and it is far worse than a nuisance when it brings home foul brood or "Isle of Wight" disease. Even when a stock is not overpowered, all its work is apt to be suspended as the result of an attack by robbers, and if they do not get in to-day they will do so to-morrow, a week hence, or at some other time. The nucleus that is attacked would suffer less harm if we shut it completely up and let the bees fly only once a fortnight or so.

By dint of great effort and much grass and cold water we can stave off even a ferocious attack, but the least reminder or change of mood on the part of the robbers will bring them back days after they have completely cleared off. The bee books tell us to be careful not to spill syrup near these weak hives. But if any sweet is exposed anywhere near the robber hive, though it be a long way from the nucleus, it will start the robbers out on a general looting expedition, and bring trouble everywhere. There is no remedy like making all our increase in May, getting all stocks strong and rich by September, and thenceforward leaving everything quiet.

But here is one more chance for him who has weak little lots in October and a stock near with robbing propensities. It will be found that a small lot, unless very cosily hived, gets up rather late in the morning, and the robbers descend upon it before the guard is properly set. I should think it would be a good plan to close these nuclei over night and open their door about nine in the morning, when they are awake enough to deal with trespassers.—G. G. DESMOND, Sheepscombe, Stroud, Glos.



[9080] *Greek Hive*.—Although I have taken a casual interest in bees for some thirty years, it is only now I have taken up the subject in a practical form. The other day I came across a description of an early form of frame-hive—used on Mount Hymettus, in Greece, about 1800—"so arranged that a comb may be taken out easily without bruising." And the method of increasing in the spring is described, viz., "by taking out the sticks and comb with bees on either side, and transferring to another hive, which is placed in the position of the old one, doing

this about midday, so that returning bees strengthen the new hive." Further, the honey is "taken about August in the same manner, leaving only such a quantity as will keep the bees in the winter." This is so like the "modern" method that I wonder if this old procedure is referred to in any bee book. So far I have not seen any reference to it in a modern work, which seems to put Langstroth (1853) as the founder of this method.—E. C. M.

REPLY.—The description you allude to is taken from George Wheeler's "Journey in Greece," published first in 1682. It contains an illustration of the Greek beehive in Book VI., page 412, which we here

bars placed on the top, to which the bees attached the combs. A flat circular straw mat was placed over them, and a conical hackle covered the hive. There were no frames, so the bees fastened the combs to the sides, the tapering form of the skep enabling them to be easily lifted out when the attachments were severed. Similar hives are used to this day, and we have a picture showing thirteen of them in an apiary at Mount Hymettus. In the hives of the present day the bars do not project, but fit into a shoulder rebate at top, so that the cover fits close. The modern frame-hive has superseded the bar-hive, so that the latter is seldom alluded to in modern works.

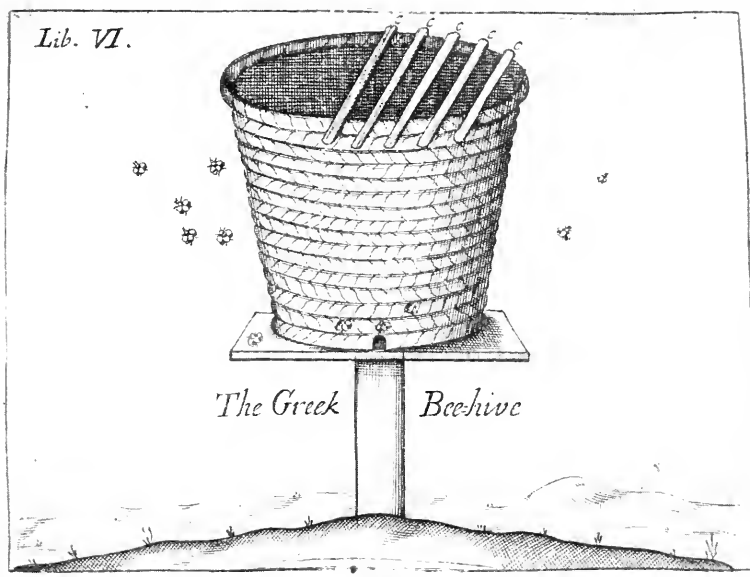

illustrate. It is not a frame-hive, and you will see that it differs from the Langstroth hive in that it has no frames but only bars, to which the combs are attached. The hive is described in many books besides the one quoted above, and several modifications have been in use both in this country and on the Continent of Europe. Allusion is made to it in Dr. Bevan's work on "The Honey Bee," and R. Golding in his "Shilling Bee Book" illustrates it with his improvement, which consists of inserting a piece of glass in the side of the skep for observation purposes. J. Mills, in his "Essay on the Management of Bees," illustrates the hive and fully describes the method of management, quoting freely from Mr. Wheeler's work. The Greek hive is a straw skep wider at the top than at the bottom, and contains

[8981] *Name of Insect*.—I enclose an insect. Can you tell me what it is? It is not a bee, wild sawfly, or horse fly. Please give the scientific name.—MEDICO (Cheddleton).

REPLY.—The insect is a drone fly (*Eristalis tenax*).

[8982] *Removal of Hives and Bees*.—I am changing my garden on 12th November but can be allowed to leave the bees longer if necessary. The new garden is about 100 yards away—the other side of some trees. (1) When will it be safe to make the move, and (2) what precautions ought I to take—doing up the entrances, time of day, &c.? I shall be grateful for early information.—J. DAVID PAUL.

REPLY.—(1) You may move them any

time when the bees have been confined to the hive for about a fortnight by cold weather. As a further precaution, you may place some obstacle in front of the entrance for a few days after removal should bees be flying, either a piece of clear glass reared up slantwise or a handful of dried grass laid loosely on the alighting board. (2) As the distance is so short you may just close the entrances by means of the slides, or some dried grass pushed in loosely. The best time of day is the evening.

[S983] *Bees Dwindling*.—I should feel very much obliged if you would tell me, through THE BRITISH BEE JOURNAL, the reason of the following case that has happened to one of my hives this year. A very strong stock of bees, in an eleven-frame hive, perfectly healthy, had filled two boxes of shallow combs and partly filled a section rack. These were all removed late in July, the hive then being crowded with bees. Being away from home the hive was not inspected till the middle of September, the hive then was all but empty of bees, there being not more than a pint of them left: they had a young queen with them and a small patch of brood, with any amount of food, and all perfectly healthy. I cannot understand what became of the huge stock. Would they swarm as late as August? or lose their queen? There were no dead bees in or round the hive. If you can give me any information I should be very much obliged.—E. G. H., Sherwood, Notts.

REPLY.—The bees probably swarmed more than once. As it was late in the season it might be two or three weeks before the young queen mated, so that quite likely there have been no young bees coming along for perhaps six or eight weeks to take the place of those gone away, or to make up for the loss of bees from natural causes in the meantime.

## Notices to Correspondents

DISGUSTED (Stafford).—We cannot improve upon the remark of a medical friend who brought the same paragraph for us to see to which you allude. He is a specialist in mental diseases, and said, "When a person *tries* to make puns of that description it is the first sure symptom of imbecility."

F. TWEMLOW (France).—(1) The district can be no good for bees, probably what few flowers there are secrete very little nectar. (2) The bees should be in one box only on one lot of combs; take away the combs with least food in them, or any that are too old or otherwise undesirable.

M. HARMAN (Beckenham).—(1) The precautions you have taken will be ample. It will be quite safe to use the hives again. (2) Some of the hive manufacturers may have a stand at the Dairy Show next week.

### Honey Samples.

A. E. W. (Wisbech).—It is honey dew. You might use it for bee food in the spring, but it is not suitable for winter food. Your best plan is to try and sell it to a chemist who makes up cattle medicines.

C. S. KUSEL (Allerton).—Both samples are good. There is very little difference between them, but we prefer No. 2. They should sell for at least 1s. per 1lb. bottle.

### Suspected Disease.

E. B. (Stafford).—One of the bees sent showed symptoms of "Isle of Wight" disease.

"NIL DESPERANDUM" (Chesterfield).—(1) Affected with "Isle of Wight" disease. (2 and 3) Appear to be healthy.

BEEs (Cheltenham).—The bees sent show symptoms of "Isle of Wight" disease.

BEGINNER (Aberystwyth).—It is "Isle of Wight" disease.

A. FURKINS (Glasgow).—The bees were much too dry for us to be able to do anything with them.

Y. E. J. (Dawlish).—Both samples of bees sent are suffering from "Isle of Wight" disease. The honey is quite good for human consumption.

## Special Prepaid Advertisements

Two Words One Penny, minimum Sixpence.

Orders for three or more consecutive insertions entitle advertisers to one insertion in "The Beekeepers' Record" free of charge.

Trade advertisements of Bees, Honey, Queens, and Bee goods are not admissible at above rate, but will be inserted at 1d. per word as "Business" Announcements, immediately under the Private Advertisements. Advertisements of Hive-manufacturers can only be inserted at a minimum charge of 3s. per  $\frac{1}{2}$  in., or 5s. per inch.

## PRIVATE ADVERTISEMENTS.

NINE stocks for disposal, just back from heather, in excellent condition for wintering, £1 and £1 5s., f.o.b., no disease in district.—J. FRASER, 3, Lombard-street, Inverness. v 88

ABOUT 2 cwt. genuine heather honey, gathered from an elevation of nearly 2000ft. on Radnorshire mountains, pressed, 10 $\frac{1}{2}$ d. in bulk, 12s. per dozen bottled; also about 1 cwt. heather flavoured clover honey, 7 $\frac{1}{2}$ d., or 10s. per dozen; all f.o.r.: sample, 2d.—STEPHENS, Westbourne, Kingston, Herefords. v 89



### SHOWS AND THEIR PURPOSE.

By the time these lines are in print the Dairy Show will have opened and the prizes have been awarded, this probably being the last show of any importance for the season. We wonder if the majority of our readers ever consider why these shows are held? A general idea will be that they are grand opportunities for a favoured few to reap a rich harvest in prize money, and they provide a meeting place where those who are in friendly rivalry for the prizes may meet each other and their friends to talk over their doings since the last show and what they hope to do ere the next one. The main idea is entirely overlooked. There are, we think, two important objects aimed at by the various shows: one to encourage new and better methods of management in the manufacture or production of various articles, and the consequent improvement in the articles themselves, not in a few instances but as a class. The other object is to bring the producers of machinery, foodstuffs, and other articles into communication with possible customers. The latter are enabled to see the latest and best specimens of any articles in which they are interested, and to enter into negotiations for their purchase. Competing at these shows is an education to anyone, and we think especially so to a bee-keeper. He may learn which is the best kind of honey, and the best and most attractive form in which to display it, not only for show purposes but for sale. It is not always necessary to win a prize to effect the latter; those who are looking out for a nice sample of honey may be attracted by the good quality, and the neatness in packing and the cleanliness of those samples that may not have secured a prize. Would-be competitors should bear in mind that to secure either prizes or customers not only must a good quality of honey be sent, but it must be absolutely clean, and put up in neat jars or cases, and to keep a customer he must be treated fairly, the honey always sent securely packed and in good condition.

---

### CONFERENCE OF SCOTTISH BEE-KEEPERS' ON NATIONAL FEDERATION.

On October 10th the second meeting of Conference was held in Perth.

Prominent bee-keepers and others were present from eight counties, and after a word of welcome from Mr. Jas. Fenwick, of the Perthshire B.K.A., Mr. D. M. Macdonald was unanimously called to the chair. With a few introductory remarks the Chairman urged all present to weigh well the matter in hand, and entered upon the business of the meeting. The rules, revised at the Newburgh meeting, were then debated and amended, and in their present form will be sent to the Bee-keeping Associations in Scotland. The next meeting of Conference will be held in Perth on January 9th, 1915.—CHARLES NICOL, Secretary of the Conference.

---

### OBSERVATIONS ON HIVES.

*By L. E. Snelgrove.*

*(Continued from page 242.)*

The alighting-board of a hive deserves thoughtful consideration. The skeppist is usually content with a projection of the floorboard towards the front, flat, and so small as to render safe settlement an act of precision on the part of a returning bee. Most bee-keepers have observed that returning bees often alight carelessly in the neighbourhood of the entrance of their hive, so carelessly indeed that on cold days many miss the hive altogether and fall to the ground to perish. A sufficiently large landing-stage entirely prevents this.

A very small alighting-board, by causing slight hesitation and deliberation on the part of each returning forager, may waste an appreciable amount of valuable time during a honey season.

Of more importance in this respect is the congestion resulting from the small area of the projecting piece of the floor of a skep and the tiny entrance. The latter is often no larger than would admit one's finger, and on busy days it is crowded within and without with bees impatiently awaiting their opportunity to pass.

"The poor mechanic porters crowding in  
Their heavy burdens at his narrow gate."

The first bar-frame hive I bought had a projecting floorboard. Water lodged on this after every storm and caused the death of many bees, which, happening to alight on their backs, became securely stuck down by the wings.

Few people would now make a level alighting-board. If, however, the slope is insufficient, and it is not well protected with a porch, water will adhere to it of sufficient depth to hold fast by the wings and so kill those luckless bees who happen to turn somersaults in landing. The earliest bees to fly on spring and autumn mornings are often entrapped by the heavy films of dew which cover the alighting-

board. At these times more than at any others the value of a porch is evident, for beneath it the dew does not so readily form.

The essential features of a good alighting-board are:—It is large, it has a convenient slope, and it is adequately protected from sun, rain, and dew by a suitable porch.

The majority of hives have ridiculously small alighting-boards. A width of 6in. or 7in. is usually considered sufficient, while 9in. is liberal.

The unreasonableness of this economy is shown by the recognised necessity of adding movable extensions which reach to the ground. These latter are considered useful for catching tired bees. They are recommended in bee-books and advertised in catalogues. As used they are often too steep for tired bees, and they encourage and admit such marauders as ants and mice. If, however, a good wide alighting-board of 11in. stuff is provided there is no need of an extension. Very few bees will miss such a landing-stage, and if those which do so cannot rise again in flight they are of no value.

A convenient slope for the alighting-board is 17deg. to 20deg. from the horizontal. This is sufficient to shoot off the rain, and is not unnecessarily steep for the bees. If the angle is much greater, not only is climbing made difficult, but bees often slip off the board especially if they are shaken on to it.

The extra width and comparatively slight slope of an alighting-board are especially appreciated when a swarm is being lived.

The nearer the porch is to the alighting-board the more efficient it will be in preventing the deposits of dew and the accumulation of heat on the latter.

For the sake of appearance, it is desirable that the porch and alighting-board should be parallel, and that the former should not be more than half the width of the latter. A very suitable distance between them is 3in. If the porch is provided with side supports these are sometimes effective in preventing bees from being blown from the alighting-board by rough winds. In sheltered places, however, they are unnecessary, and they complicate the construction of a hive without contributing to its utility or elegance.



### PROCURING SURPLUS.

(Continued from page 373.)

Compared with the methods adopted some few years ago for the removal of supers—such as drawing a quilt between the super to be removed and the chamber underneath,

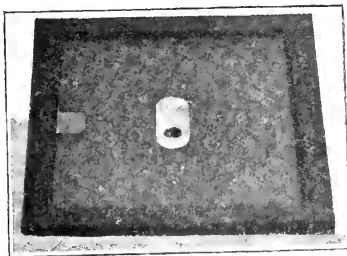

FIG. 11.

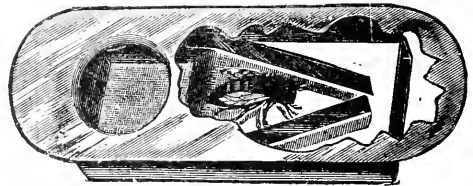

FIG. 12.

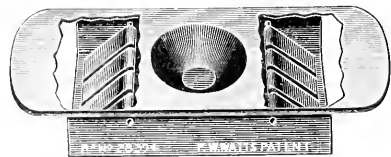

FIG. 13.

taking off the quilt and allowing the bees to escape through the cones in the roof, or taking it into an outbuilding having a window, so that the bees would fly to the light



and be liberated from time to time by opening the window, or taking the super some distance away, lifting out the combs or sections one by one and brushing or shaking off the bees, all of which were unsatisfactory, resulting oftentimes in the manipulator

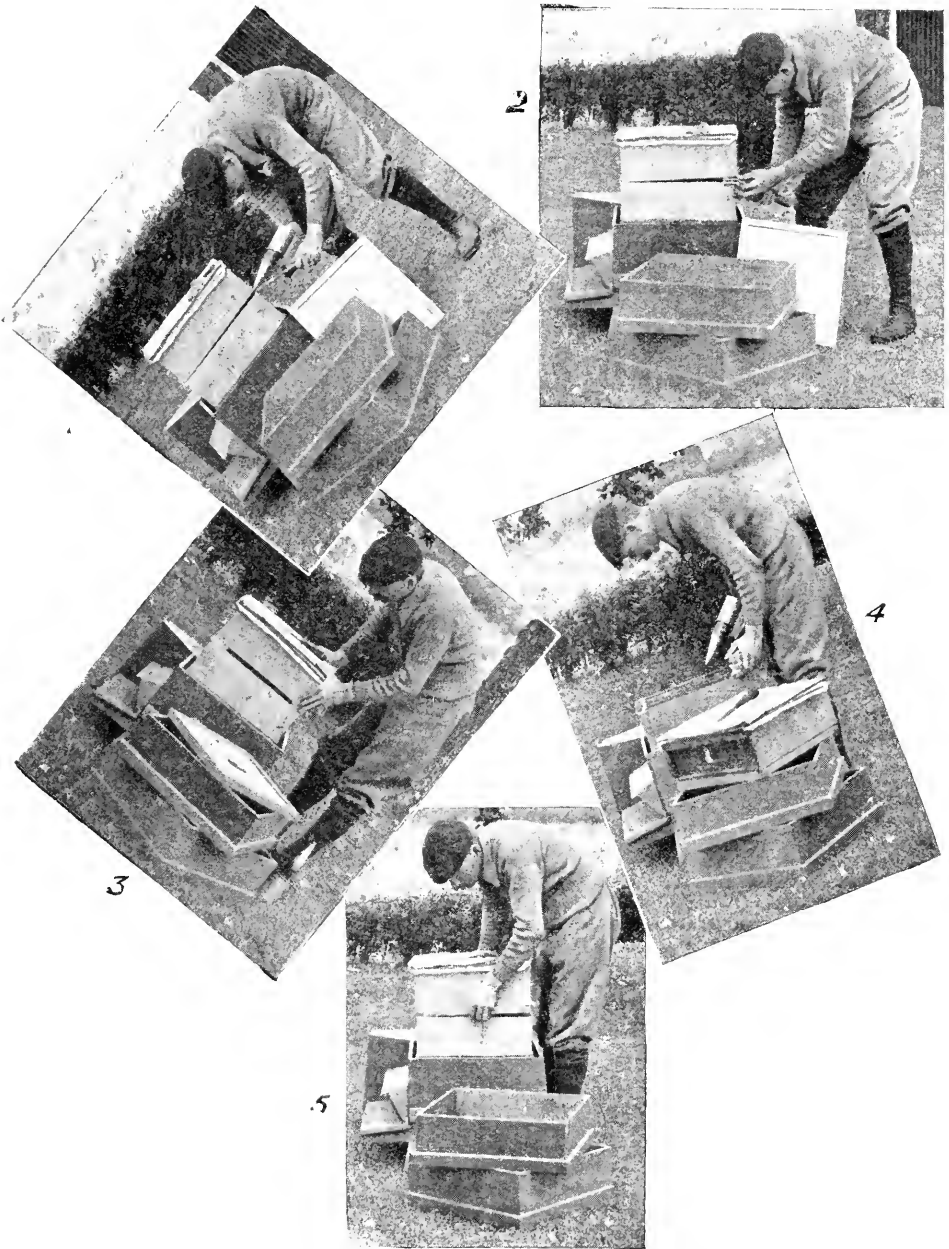

FIG. 14.

being badly stung or robbing by the bees started, also the sections were often spoilt by the bees perforating the cappings through the disturbance and prolonged operation—the present system is simple and easy and the above dangers are avoided.

A clearing board (Fig. 11), in the centre of which an escape is fixed, is used. The latter may be a "Porter Escape" (Fig. 12). This is an American invention and allows the bees to go out through V shaped springs which close after they have passed, and prevents them returning, or a better one invented by an Englishman, Mr. F. W. Watts, and called the Watts Escape (Fig. 13), which works with aluminium drop traps so that the clearing is done in much less time. (Figs. 14 and 15) show how the work is now accomplished.

Before commencing operations have everything ready, *i.e.*, four blocks of wood about  $\frac{1}{2}$  in. thick, 2 in. long, by 1 in. broad, a good strong screwdriver, and the clearing board. See that the escape fits properly into the hole in the board, and if a "Porter" that the springs are not blocked with dead bees or rendered unworkable by being propolized. Get the smoker working well and put on a veil. Mid-day is the best time to carry out the operation for reasons previously given. Before touching the hive send in two or three puffs of smoke at the entrance, wait for about a minute to give the bees time to gorge themselves with food. Next remove the roof and rear it by the side of the hive as seen at No. 1; don't put it on the ground just at the back of the hive or it will form an obstacle to fall over during the operation; if this is done the accident will happen at a most inconvenient time, just when on a balance with the full super in the hands. The lifts are now taken off and placed on the ground on the other side of the hive, stacking them cornerwise as also seen at No. 1. Lay the blocks of wood handy on the top of the quilts, then with the left hand use the screwdriver as a lever, puffing in a little smoke to drive the bees down, insert one of the blocks of wood at each back corner as seen in No. 2, then treat the two front corners in the same manner, so that the super is as in No. 3. One or two frames may stick to the bottom bars; these should be prised down with the screwdriver. Allow it to stand for a while for the bees to clean up the honey, a little of which will have leaked by the breaking of brace combs. To prevent robbing, the lifts and roof should be put back while this is going on.

When this has been done, put the clearing board on the top of the lifts as seen in No. 3; lift the super on to this, see No. 4. Drive down the bees in the next set of combs by means of the smoker, then lift super and clearing board intact into its original position on the hive, No. 5. In the course of a few hours every bee will have descended through the escape. Note particularly the manner of working with the lifts cornerwise on the ground, and the supers on top. The cross position gives stability, and by placing them in this way instead of on the ground all possible chance of grass, earth or stones adhering to the bottom bars of the frames is avoided.

*(To be continued.)*



*The Editors do not hold themselves responsible for the opinions expressed by correspondents. No notice will be taken of anonymous communications, and correspondents are requested to write on one side of the paper only and give their real names and addresses, not necessarily for publication, but as a guarantee of good faith. Illustrations should be drawn on separate pieces of paper. We do not undertake to return rejected communications.*

#### HONEY-JUDGING COMPETITION.

[9083] I have not taken up my pen to write you now for some long time. Truth is that during the summer months one's bees keep one fully employed, and added to that, the duties of expert leaves one little time for anything else.

There have been many letters to which I have often felt "disposed" to add a few words, but—I feel, however, I cannot let the fact that we are going to have a "judging competition" pass without just a few words. "Shure," as Pat would observe, "we are moving in the right direction." The idea is sure of success from the beginning, and is, to my mind, what a great many of us have felt was desirable for a long time. The number of shows and exhibitors are (except for 1914) growing every year, and yet the number of competent judges of honey and honey products seem to go to the other way and get less, and so many that act in the capacity of judge at numbers of our provincial shows do really put "the craft" down very much. An instance came to my knowledge just a few weeks ago. At a show that was held last August the judge never even uncapped one bottle to taste

the honey, but just inverted it, and, as a matter of fact, awarded the prize to a very inferior sample, and in the sections gave the prize to an entry of which only a bare 2in. of face was showing, and that not in any section a good sample. These things put bee-keeping, honey-producing, and exhibiting on a very low scale, and do not in any way enlist or encourage the would-be bee-keeper. I am, indeed, very sorry that I cannot present myself, as I feel that everyone who can should enter whether they aspire to continue judging or not; the experience will extend their knowledge, enlarge their views, and in every way help to widen the possibilities of the bee-keeper.

Every help and encouragement should therefore be given to the competition, and may I suggest that the proceeds (the honey given for competition) be given to the Belgian Relief Committee for the poor refugees?—R. LITMAN.

#### HONEY FOR WOUNDED SOLDIERS AND SAILORS.

[9084] I have collected several hundred pounds of honey within Suffolk amongst our generous-hearted members and others for the wounded soldiers and sailors. Most of this has been distributed to hospitals, some of them outside our borders, as our sympathy knows no bounds. Therefore I want to have opportunity to do much more, and would earnestly appeal to the generosity of your readers who have a few pounds of honey to spare to send it along addressed to me.

Many of the poor fellows are on a milk diet, and a little honey makes a delightful change.

My most enthusiastic friend there, who is making up the various parcels, won the Victoria Cross in the Afghan War, and it gives him great pleasure as well as myself to do something for those who are doing so much for us all.—OLIVER C. JONES, Hon. Sec., Suffolk B.K.A., Lattice Barn, Ipswich.

#### THE MINIMUM HIVE.

[9085] Now that the hive-making season is upon us again it may be useful to ask whether the pattern we are using is the very best, having due regard to all our circumstances. Probably the "W.B.C." and the "Cowan" hives are the acme of comfort and hygiene, but it may be that the man who is going to have a hundred stock apiary and also the cottager who has little capital can save a great deal of expense and labour, without impairing the efficiency of his bees, by adopting a much simpler pattern.

Let me jump into the midst of my subject by describing what I conceive to be the minimum hive, and yet one that falls very slightly if at all short of the complete "W.B.C." We could, I think, safely start from it, and without cost experiment towards greater complexity, to see whether any additions were necessary.

First, I would have the hive square on the outside, just for the joy of being able to put on a flat roof any way round that it came to hand. The size would be 18 $\frac{1}{4}$ in., the depth 8 $\frac{3}{4}$ in., which is the usual width of a 9in. board. Roof and floor-board being as before, the other parts are made entirely of  $\frac{3}{4}$ in. and  $\frac{1}{2}$ in. wood. The sides parallel to the frames are of the thicker wood, and are 17 $\frac{1}{4}$ in. long. The other sides consist of an outer  $\frac{1}{2}$ in. board, 18 $\frac{1}{4}$ in. long and an inner, 16 $\frac{3}{4}$ in. long (and 8 $\frac{3}{4}$ in. deep) held apart by horizontal strips of  $\frac{3}{4}$ in. wood at top and bottom. These strips could be dovetailed into the stouter sides, and the outer board nailed to them with clenched nails, but the usual nails at right-angles to one another would make a rigid and unwarpable piece of work of it. All the body boxes and shallow-frame boxes are of the same horizontal dimensions, and they stand one above the other without plinth. Neither is there a porch, the oversailing of the hive above the alighting-board being deemed sufficient. But there must be a telescoping rim projecting an inch above the top storey to accommodate blankets, and the roof fits over this rim, whose outer dimensions will be 19 $\frac{1}{4}$ in. both ways.

I should think that this hive as regards the double walls must be as warm as the "W.B.C.," except when the latter is very carefully packed. The other walls would be in effect double if a division board with oversailing top bar was kept next to them in winter. Those who had doubts of this could make their telescoping rim of 11in. wood, and it would thus overlap the bare joint of the storey next below it, or in winter come down to the floor-board.

To keep everything neat, excluders and escape-boards should also be 18 $\frac{1}{4}$ in. square, and, of course, section-racks the same. The filling out of these to such dimensions with thick double walls would make them deliciously warm, and cause them to be taken to at once.—G. G. DESMOND, Sheepscombe, Stroud, Glos.

#### HONEY IMPORTS.

The value of honey imported into the United Kingdom during the month of September was £533.—From a return furnished to the BRITISH BEE JOURNAL by the Statistical Office, H.M. Customs.

## QUERIES AND REPLIES.

[984] *Honey Leaking.*—I shall be much obliged if you will answer the following through "B.B.J." columns:—A customer of mine, a confectioner, tells me she is troubled by my honey "creeping," i.e., after bottling in screw-cap bottles the contents come out round the cap, and make the whole of the outside of the bottle sticky—so much so that the labels have to be renewed. This, she says, *always* happens in the case of honey supplied in candied form, which she liquefies (without, by her account, overheating it). *This year* my first supply of fresh honey, bottled as received, did the same thing! I have examined it in the bottles, it is not fermented or particularly thin. Neither of us can understand it, as I personally have never experienced the difficulty, but shall be very glad if you can throw light on it.—H. E. SCROPE VINER.

**REPLY.**—In the first place, the jars are evidently filled too full. Secondly, it is quite possible there is slight fermentation, although this may not be apparent to the naked eye. Thirdly, if the honey is put in a window where the sun shines on it part of the day this trouble will often occur. We are inclined to the first theory.

## Notices to Correspondents

D. W. H. (Brecon).—*Moving Bees.*—You can get the labels you require from Lee and Son. You may move the bees any time after they have been confined to the hive for two or three weeks by cold weather. You might transfer them the first warm day; it should have been done last month. The honey is good in quality, from mixed sources, mainly clover. The strainer you used was too coarse in texture; use two thicknesses of fine muslin.

W. H. (Somerford).—*Suspected Queenlessness.*—Probably the queens are all right, the season is too late for them to lay. You might on a warm, sunny day search for them. The only thing you can do if any are lost is to introduce another queen.

A. D. C. (Perth). *Observations on Hives.*—You will notice there is another article in this issue, and we hope to receive others from the same contributor.

### Honey Samples.

**ALPHA (Darwen).**—Nos. 1 and 2 are mainly from clover; light colour. The flavour of No. 1 is good; it is worth showing. No. 2 flavour is fair. Both samples worth from 1s. per lb. jar retail. No. 3 is mainly clover, with a little heather. It is a very nice honey. If shown it should be in the class for heather blend. It is worth 1s. 2d. per lb. jar.

**J. B. H. (Sheffield).**—Nos. 1 and 2 are clover honey of good quality. No. 2 is the best for showing, the grain of No. 1 being rather too coarse. If shown in the present condition they should be in the class for granulated honey; if liquefied, in the class for light honey. No. 3 is clover and heather, and should be shown in the heather blend class. Nos. 1 and 2 are worth 1s., No. 3 1s. 2d. to 1s. 3d. per lb jar.

### Suspected Disease.

**W. D. (Hersham).**—The cause of the trouble is "Isle of Wight" disease.

**E. S. (Worc.).**—It is "Isle of Wight" disease.

**B. D. (Quanton).**—The bees appear healthy. If they are so few in number it will be better to unite them.

## Special Prepaid Advertisements

**Two Words One Penny, minimum Sixpence.**

*Orders for three or more consecutive insertions entitle advertisers to one insertion in "The Beekeepers' Record" free of charge.*

*Trade advertisements of Bees, Honey, Queens, and Bee goods are not admissible at above rate, but will be inserted at 1d. per word as "Business" Announcements, immediately under the Private Advertisements. Advertisements of Hive-manufacturers can only be inserted at a minimum charge of 3s. per  $\frac{1}{2}$  in., or 5s. per inch.*

### PRIVATE ADVERTISEMENTS.

**F**OR SALE, 2 cwt. light honey, in tins, free on rail, 60s. per cwt., cash with order; sample, 2d.—EDGAR CAFF, Hilcoose, Grampond Road, Cornwall. v 1

**H**ONEY, excellent quality, screw top jars, 9s. doz.; 28lb. tins, 18s.—TICKELL, St. Marks, Cheltenham. v 2

**S**ECTIONS, splendid sections all over, 16oz., 10s. doz.—W. P. LANGFORD, Baldock, Herts. v 3

**P**URE Cambridgeshire honey, light, 65s. per cwt.; sample, 3d.; few dozen sections, light, first quality, 10s. per dozen.—J. YOUNGER, 29, Newmarket-road, Cambridge. v 4

**2** CWT. honey, good heather blend, in 28lb. tins, 15s. tin; sample, 2d.; also 6lb. new wax, 1s. 6d. per lb.—KIDBY, Sizewell-road, Leiston, Suffolk. v 5

**P**ERFECT sections, 10s. per dozen; run honey, white, in 28lb. tins, 15s.; in 14lb. tins, 8s.; all carriage forward.—Apply, MISS GORDON, Wethersfield-place, Braintree, Essex. v 6

**S**PLENDID Welsh clover honey for sale, also heather blend.—LEWIS, Dolafon, Llwyn-grwil, North Wales. v 7

**F**OR SALE, 3 cwt. pure honey, fruit and clover, medium colour, fine quality, 28lb. tins, granulated; sample, 2d.—HAZZARD, Haddenham, Ely. v 8



## BRITISH BEE-KEEPERS' ASSOCIATION.

The monthly meeting of the Council was held in the offices of the Zoological Society of London, Regent's Park, N.W., on Thursday, October 22nd, 1914. Mr. W. F. Reid presided. There were also present Miss M. D. Sillar, Messrs. C. L. M. Eales, J. B. Lamb, J. Smallwood, A. G. Pugh, and T. Bevan; Association representatives G. Hayes (Notts), G. S. Fauch (Essex), G. W. Judge, and G. Bryden (Crayford), W. E. Richardson, and Rev. F. S. F. Jannings (Yorks), J. Price (South Staffs.), and the Secretary, W. Herrod.

Letters regretting inability to attend were read from Mr. T. W. Cowan, Col. H. J. O. Walker, Col. H. F. Jolly, and Mr. E. W. Franklin.

The financial statement was made by Mr. Smallwood as follows:—Payments into bank, September, £16 4s. 6d.; the bank balance at the end of September was £163 2s. 7d. Payments amounting to £5 were recommended.

After the Council meeting the conversazione was opened at 4 o'clock, Mr. W. F. Reid occupying the chair. Over ninety members and friends were present at the opening, and at the tea at 5 o'clock. At 6 o'clock over 120 were present. These numbers were very satisfactory, and amply justified the holding of the conversazione. After the opening remarks by the Chairman, Mr. D. Wilson gave his lecture on "The Management of an Apiary for the Production of Heather and other Honeys, when the Crops are Situated about Twenty Miles Apart," and at the close he answered a number of questions. An interval of an hour was given for tea, and at 6 p.m. Mr. Richards gave his lecture on "Bees in Relation to Flowers and Fruit," illustrated by lantern slides. An interesting discussion followed. The honey-judging competition proved of great interest from 11 a.m. to 3 p.m. at our office, and from 4 p.m. to the close of the meeting at the Zoological Gardens, the majority of the competitors finding great difficulty in defining from what source the eight different samples of honey were obtained. We hope to give a full report of the conversazione in our issue for next week and the following numbers.

## THE DAIRY SHOW.

## LIST OF AWARDS.

The thirty-ninth Annual Show of the British Dairy Farmers' Association was held in the Agricultural Hall on October 29th to the 23rd inclusive. In normal years the rapid sequence of shows large and small during the autumn becomes almost wearisome, and there is something akin to a sigh of relief when the last one is over and the bee-keeper competitor has time to take a "breather" and consider his position as to the number of prizes won and sales effected through the medium of the various shows at which he has competed.

This year, however, there has been no glut, but an indefinable feeling that one has missed or forgotten something, and the Dairy Show has come as a welcome change from the usual "show postponed" notices, and though the total number of entries were a little below those for the last twelve years, in several sections they were better than in any one during that period. The attendance of the public has also been good. In the honey section the entries were 126, the highest number for the last twelve years, the previous best being 125 in 1903, 122 in 1904, and 124 in 1905. The lowest was 67 in 1907; from then the number has steadily increased to 87 in 1911, 95 in 1912, and 106 in 1913. The quality, as usual, was of the best. In the trophy class only two entries were made, and these were awarded equal first prize. In the class for an interesting exhibit the Rev. F. S. F. Jannings took premier honours with a very comprehensive display, many of the articles being his own handiwork. Mr. A. McCullah's exhibit, which received second prize, was an illustration of the variety of uses to which honey and wax may be put. Some excellent wax was shown, one or two exhibits it would be very difficult to beat, while on the other hand, were some samples that were not well strained and not at all fit to place on the show bench. Although the methods of dealing with beeswax and (as a result) the quality of the same have materially advanced during the last few years, there is still room for improvement in its preparation by a large number of bee-keepers. Mr. O. R. Frankenstein officiated as judge, and made the following awards:

*Twelve Jars of Light-coloured Extracted Honey (28 entries).—*1st, James Gladding, Bingfield, Corbridge-on-Tyne; 2nd, J. Mackenzie, Stretthall, near Saffron Walden; 3rd, John Berry, The Apiary, Llaurwst, North Wales; 4th, John T. Willson, York Villas, Shirebrook, near Mansfield.

*Twelve Jars of Medium-coloured Ex-*

*tracted Honey (other than Heather Honey) (19 entries).*—1st, John Berry; 2nd, E. C. R. White, Newton Toney, near Salisbury; 3rd, Albert MacCullah, Webberton, Dunchideock, Devon; 4th, James Lee and Son, Ltd., George Street, Uxbridge.

*Twelve Jars of Dark-coloured Extracted Honey, (including any variety of Heather Honey) (6 entries).*—1st, James Pearman, Penny Long Lane, Derby; 2nd, John T. Willson.

*Twelve Jars of Run (Ling, Caluna vulgaris) Heather Honey (11 entries).*—1st, James Pearman; 2nd, M. J. Lamboll, Chiddingfold, Surrey; 3rd, William Lloyd, 2, Bank Road, Skerton, Lancaster.

*Twelve Jars of Granulated Honey of 1913, or any previous Year (10 entries).*—1st, John Berry; 2nd, James Lee and Son; 3rd, James Pearman.

*Twelve Sections of Honey other than Heather (size  $4\frac{1}{4}$  by  $4\frac{1}{4}$ ) (13 entries).*—1st, Robert Robson, Cheviot Street, Wooler, Northumberland; 2nd, James Pearman; 3rd, James Lee and Son, Ltd.

*Six Sections of Heather Honey (8 entries).*—1st, John Robson, Old Bewick Moor, Alnwick; 2nd, Robert Robson.

*Display of Comb and Extracted Honey, of any Year (2 entries).*—Equal 1st, James Pearman and James Lee and Son, Ltd.

*Wax (not less than 2-lbs., in two cakes only). Extracted and cleaned by the Exhibitor or his assistants (14 entries).*—1st, T. Alun Jones, Halkyn, Flintshire; 2nd, H. W. Kinnersley, Waresley, Hastlebury, Kidderminster; 3rd, James Pearman.

*Wax (not less than 3-lbs.). To be shown in shape, quality and package suitable for the retail trade (8 entries).*—1st, Fred Harris, High Ferry, Sibsey, Boston; 2nd, Albert MacCullah; 3rd, James Pearman.

*Interesting and Instructive Exhibit of a Practical or Scientific Nature (3 entries).*—1st, F. S. F. Jannings, Warmsworth Rectory, Doncaster; 2nd, Albert MacCullah.



*A New Note (p. 337).*—The thanks of all Association workers are due to Mr. Hamshar for the note he strikes. How often is it suggested that to "put into" an

Association is as important as to "get out" of it? There is a wide spiritual chasm between the two but not an unbridgable gulf. There is, alas! a good deal more of the "get out" spirit than of the "put in." And who is to blame Human nature, no doubt, but Association officials are not entirely blameless. They, like most of the lecturers who advocate bee-keeping, preach self-interest to prospective recruits, and must not be surprised at their harvest. Very few thistles bear figs! And the entirely self-seeking member is no more of a success than the bee-keeper (*sic*) who treats his bees ungenerously. But if people will act like cheap politicians, and preach profit, even in the most altruistic spirit, they must expect disappointment. So Mr. Hamshar's comment is well-timed and very much to the point. "What has the State done for you, brother, and what will you do for the State?" is a question of the day.

*A National Loss (p. 346).*—With Mr. Heap's main line of argument I have no quarrel, though it would be well not to draw too hasty a conclusion as to the condition of things in the country generally, from experience in special counties, and some consideration might be given to the imports of honey. But as he particularly invites me to question his figures, I am only too willing to oblige him, knowing that he will not make reprisals. His estimate per county of the number of stocks is too crude, and might as well be *per* member of Parliament, for counties vary considerably both in size and possibility. The approximate square mileage of the several countries is as follows:—England 51,000 sq. miles; Wales, 7,000 sq. miles; Scotland, 30,000 sq. miles; Ireland, 32,500 sq. miles. Taking Mr. Heap's figures we get stocks per square mile:—England, 8; Wales, 14; Scotland, 12; Ireland, 8. This is hardly in keeping with Mr. Heap's hypothesis. But perhaps a sounder method would be to compare the acreage of permanent pasture, including land under clover. I have not the most recent figures, but they are easily obtainable, and will, I think, show a further discrepancy, supposing, of course, that the number of stocks kept is relative to possible pasturage. Moorland need not be considered, as few stocks are kept upon it alone permanently, although Scotch figures might be slightly modified. I venture to suggest, however, that nothing but an official census would give the true figures, and that we are not likely to get at present. So, Mr. Heap's figures may very well stand. I should like to point out to him, by the way, that his challenge to Mr. Desmond to produce the microbe carries no more weight than a challenge to pro-

duce an evolved animal, or the bee that went into the Ark. No one may remember the evolutionary days, but the presumptive evidence in favour of the theory of evolution is too strong to be dismissed by such a challenge.

*Storing Extracting Combs* (p. 350).—I feel sure that Mr. Herrod cannot have considered the varied conditions under which combs are stored over winter when he penned the advice to leave some combs uncleaned, or as they come from the extractor. Without qualification the advice is not, I think, sound. He may have a specially dry room in which such combs might be safe, but under no circumstances would I care to follow the practice. Fermentation or souring might easily occur, and I think, though I confess I am not absolutely sure, that the process would unfit the combs for further use. By an oversight I once allowed this to occur with a lot of combs, and I considered them spoiled. But the procedure for bait purposes seems as unnecessary as it is unwise. Fully drawn combs are themselves very attractive, and I doubt whether there would be anything in the comparative speed with which either would be adopted. Anyhow, the clean combs could easily be daubed with honey in the spring.

*A Spell of Precision* (p. 352).—*Touche* to D. Wilson, and many thanks for correcting an obvious error in orthography. "Gantrys" should certainly be "gantries." How the error arose I do not quite know, but it is clearly not the fault of the printing staff. I think it occurred in a spell of haste, or slipshod correction, the plural being created from an original singular, a singular plural, in fact. However, I trust the meaning was sufficiently clear, although as a believer in precision I cannot excuse the slip. I should be still more grateful to "D. W." if, as a moor brother, he would deal with the gantry question—either in support of gantries or otherwise. Legs are all very well in the south, or in tiny apiaries, but, where many hives are to be taken to the heather, they are an abomination. The hives are more difficult to load, and fewer can be carted at once. I cannot imagine any extensive bee-keeper removing and replacing legs for the trip, and gantries appear to be a sound solution. A spare set of bottom boards might be used, but here is extra labour and capital involved. I have experimented a good deal with bottom boards, and believe I have solved the problem.

*Do Bees Know their Owner* (p. 355)?—Why not? Are we to deny to them the intelligence of the ox or ass, which know their master's voice and crib? By this I do not mean that the mere possessor of bees has a charmed life. Far from it.

Indeed, I know instances which would seem to prove that the owner is a marked man! No doubt, deservedly. I have been told, "My bees are so vicious that I can do nothing with them," yet properly handled they prove to be lambs. But is it not possible that some old scarecrow of a bee-keeper is such a familiar object of the garden that the bees disregard him? I see no reason why not. Bees get used to hens scratching about the hives, whilst they will yet run a dog out of sight, and a white dog at that. Ask my dog, he knows! But there is a further wild thought which has occurred to me after a recent inspection of an apiary of the variety which rouses all my worst words. You know the kind I mean, dilapidated frame-hives stuffed with old garments. Now, is there any reason why, living in such intimate contact with the owner's cast-off clothing, the bees should not, so to speak, "acquire the odour," and recognise an old friend at scent?

---



---

#### EXTRACTS FROM AN EXPERT'S DIARY.

*By J. Herrod.*

*(Continued from page 370.)*

One of the pleasantest parts of a touring expert's work is the variety of scenery passed through in various parts of the country. One wishes for the facile pen of Mr. Smallwood to describe it. The scenery of sunny Italy, of the rugged snow-capped Alps and other Continental spots, may have its charms, but that of our own "tight little island" is not to be despised, even though it may not be compared to that of the Continent, any more than heather honey may be compared with that from clover, though both may be equally good. The variety, too, is almost infinite, the narrow winding lanes of "fair Devon," with their high banks on either side covered in the spring with primroses, violets, or ferns; the lonely moors, where one meets with wild-looking, shaggy highland cattle and sheep; the sea-scarred cliffs from which rocks are pointed out where many a good ship has come to grief, while above all rise the majestic "tors," whose heads are kissed by light, fleecy clouds; the broad, sweeping downs of Sussex; the hop-gardens and orchards of Kent; the fertile, highly-cultivated laud of Essex, with its flat, indented, and somewhat marshy sea coast; the Lincolnshire wolds; the well-wooded hills and valleys of my native county, "good old Notts"; the broad moors of Yorkshire; the densely-populated South Lancashire, and the rugged, rough-hewn pikes and deep dales of the north of the county,

where, I have been told by those who have climbed the Alps, some very good climbing may be had, the quality of the climbing being measured by the amount of risk to life and limb entailed by this pursuit—the greater the risk of a fall the better the climbing. For those in search of fame in this direction I believe there are still some pikes or peaks that have not yet been scaled. In all these counties I have travelled, not only on the beaten track of the tourist but in the lanes and byeways, where often the choicest gems of scenery are to be found. Then, again, there are the historical associations connected with the different counties, houses, castles, localities, and events. These are all among the pleasant experiences of an expert on tour; the only unpleasant ones are of wet cold days, when it is impossible to examine hives, occasional drenchings in an unexpected downpour of rain, and the prevalence of disease in some localities; the latter has sometimes been downright disheartening, especially when one reflects on the lack of power to deal with those whose apiaries are hotbeds of disease, and who will do nothing to help to check it. These cases I have always found among non-members of an Association. My own experience of members has been that they are willing and anxious to do their best to follow the advice given them. A note in my diary for May 3rd, 1901, reads: "I find all round this district an intelligent appreciation of the infectious nature of foul brood, and every means that the expert advises are taken to arrest the disease." Another note, on May 6th, says: "Foul brood very prevalent in this district. Members complain of old-fashioned bee-keepers, whose skeps, untidy and neglected, are a source of infection to the whole neighbourhood." These two notes pretty well sum up the conditions I have usually found. A note on May 8th gives a rather too frequent occurrence: "Had a twenty-mile ride to other three members for nothing, as they resigned." If a member of an Association does not intend to keep up his membership he should at once notify the secretary. It is extremely annoying to an expert after riding some miles to visit an apiary to be told on arrival, "Mr. --- is not at home, but does not intend to subscribe to the Association any longer." There is the waste of time that might have been employed in visiting someone who was perhaps staying at home, losing a day's work, anxiously looking out for the expert. Again, who is to bear the loss in £ s. d.? If the expert is paid at a fixed rate per week, it falls on the Association, but generally the payment is a certain amount per visit, and in that case who is to bear the loss? I would urge on all members of Associations

to bear this in mind, and send notice of their resignation to the secretary in good time; don't leave it until a postcard is received saying the expert may be expected on or about a certain date, as in all probability it will then be too late to stop him. It may seem a small matter to the member, but when this kind of thing is repeated a number of times during a tour it is serious enough for the Association and the expert.



*The Editors do not hold themselves responsible for the opinions expressed by correspondents. No notice will be taken of anonymous communications, and correspondents are requested to write on one side of the paper only and give their real names and addresses, not necessarily for publication, but as a guarantee of good faith. Illustrations should be drawn on separate pieces of paper. We do not undertake to return rejected communications.*

#### STAMPING OUT "ISLE OF WIGHT" DISEASE.

[9083] In the brief comment on an article of mine respecting the stamping out of "Isle of Wight" disease, Mr. H. S. Watts expresses an attitude of mind common, I fancy, to many people. They seem to think that because colonies of bees in various parts of the country have found homes in hollow trees and in buildings the extermination of disease is an impossibility. The holding of such a view includes of necessity the assumption, firstly, that such colonies cannot be found, or dealt with, and, secondly, that bees living under such conditions do not succumb to disease. It would not be beyond the wit of man, and certainly not of the country boy, provided a small reward were offered, to locate nearly every stray colony. Such "wild" bees are as liable to be attacked by disease as colonies in frame-hives or skeps, and any overlooked in a search would die if diseased. If not diseased their existence would not matter.—CHAS. H. HEMP.

#### PRESS CUTTING.

##### BEES AT FELTON.

Mr. James Summers, Felton, had a swarm of virgin bees on Monday.—*Newcastle Daily Journal*, 9th July, 1914.





[8985] *Making Honey Candy.*—This year I am intending to make candy for my bees with honey in it, and I should feel obliged if you would kindly give me the recipe of same.—W. WATSON.

REPLY.—What you need will probably be Brother Columban's recipe, which was given in our issue for September 14th, 1905. As it may be useful to other readers we reprint his letter:—

FOR MAKING SOFT BEE-CANDY.

In making this candy, I use an ordinary enamelled saucepan, or preserving pan, and into this is put 15lbs. of cane-sugar (white crystals) and three quarts of water (hot for preference). Place over a clear, strong fire and stir until the sugar is quite dissolved. When it begins to boil draw the pan aside for a moment, and while it continues to boil slowly remove the scum and other impurities from the surface of the sugar. This done, return the pan to the fire, and let it boil as fast as possible, without stirring, for about twenty minutes. Then, to ascertain if boiled enough, have a bowl of cold water ready at hand, and dip the forefinger of one hand first in the cold water, next in the boiling sugar, then again in cold water, and with the sugar adhering to the forefinger try to make a soft ball from it, like a piece of mastic ready for use. These last operations should only occupy two or three seconds. The forefinger must be kept curved whilst dipping it into the boiling sugar, and though a little skill and courage are required to do it for the first time, it is not difficult and does not burn the finger at all. A sugar-boiling thermometer would be a convenient substitute.

If unable to make a ball in the way mentioned, the sugar must be boiled a little longer, otherwise the boiling is finished. Next pour in 5lbs. of honey ready at hand (about 5oz. per lb. of sugar). The mixture must be then boiled again for one or two minutes, but great care must be taken not to let it overflow, as honey is apt to rise quickly like milk. I find that adding a small piece of butter of the size of a hazel-nut often causes it to settle down, but not always.

After the second boiling remove the pan from the fire and mediate with naphthol beta (two tablespoonfuls of the "Guide Book" solution for 20lbs.), mixing it well in. In cooling the mixture pour it into a square tin, 21 by 15 inches. In one of

this size, 20lbs. of candy will cool sufficiently in an hour, or in far less time if the vessel is placed in cold water. During the cooling process do not stir while hot. Note this well, for without this precaution the candy will be not smooth but rough in grain.

When the sugar has so cooled down that the finger may be kept in it for half a minute without scalding, then begin to stir, and continue to do so until the candy becomes white and stiff. It is now finished, but in order to transfer it into suitable moulds it must be warmed again; therefore, the whole is put into another pan or vessel which fits on to a boiler containing hot water. In a short time the candy becomes more or less liquid, like cream, and an occasional stir must be given to dissolve all lumps. When properly dissolved and brought to almost boiling point (say, 204 deg. Fahr.), pour it into the moulds or boxes and allow it to cool. Candy thus made, if stored in a dry, cool room, will keep soft for years.

If the sugar has been accidentally overboiled (in which case it is brittle and breaks when tested), add a little water and boil again to the proper point. As a preventive of overboiling, remove the pan from the fire while testing whether cooked enough. Also, to prevent mishap in another direction, the saucepan used for making the candy should not be more than half full. It must also be noted that the honey is to be boiled thoroughly, not merely mixed with the sugar.

I have toiled not a little in the endeavour to make a bee-candy which, while containing as nearly as possible all the advantages of the natural food, would have the advantage of being medicated without offering any inducement for the bees to start robbing, as so frequently happens when fed in autumn or early spring with honey or sugar-syrup. My own stocks have been fed entirely on this candy during the whole winter, and I have not lost a single colony during all the time I have been in charge of the Abbey Apiary here.

It is also very good for feeding queens and their attendant bees in mailing cages, as I have tested it scores of times for this purpose without a single complaint.

[8986] *Source of Chyle Food.*—It appears that Cowan in his "Honey Bee" holds that the larvæ of bees are fed on a mixture of chyle from the chyle stomach and a secretion from the glands of System L, and that in the case of the worker larvæ honey is added after the third day, and in the case of drone larvæ honey and undigested pollen is added after the fourth day. Cheshire, however, in "Bees and Bee-keeping" (Vol. I.)

seems to indicate that the chyle is solely a secretion from the glands of System I. (d) Have I read these authors correctly? (e) If so, which is in error?—A. TUCKER.

Reply.—(1) You have read the authors correctly, but you do not seem to have grasped the fact that Cowan's "Honey Bee" is a more recent publication, and gives the latest discoveries respecting brood food. Cheshire's Vol. I. appeared in 1886, and the description of the digestive system and the glands was taken from a paper published by Schiemenz in 1883, in which he propounded the theory suggested to him by Leuckart, that the glands of System I. produced the brood food. Cheshire adopted this theory, and even gave expression to his views in almost the same words as those used by Schiemenz. Subsequent investigations of Dr. A. de Planta, published in 1888 and 1889, clearly demonstrated that the theory of Schiemenz was not tenable, the view of Schönfeld being shown to be the correct one, and it is the one now generally accepted. (2) A careful study of Chapters XVII. and XVIII. in Cowan's "Honey Bee" will enable you to understand more clearly why Schiemenz's theory is not the correct one.

## Notices to Correspondents

H. T. (Eccles).—At present there is no reliable and permanent cure. Some remedies may check the disease for a time, but in very few instances do they effect a cure.

A. T. Young (Hants).—We had not overlooked the fact, and are quite aware that some queens may still be laying, but only in a few instances does the absence of eggs at this time of year mean there is no queen.

W. F. Cullum (Herts).—*Making Observatory Hives*.—The articles appeared in the numbers for May 12th and 26th, April 9th and 23rd. We can supply them from this office post free for 5d.

### Honey Samples.

"KARL."—(A) Mainly from clover. (B) It appears to be quite pure. (C) Fairly good; the aroma and flavour appear to have been somewhat spoiled by over-heating. (D) from 60s. to 65s. (E) Any of the firms advertising in the JOURNAL. Try Lee and Son or E. H. Taylor.

BLANCHE (Sale).—No, we should say it is foreign.

"NOVICE" (Lincs.).—The sample is clover honey of good flavour, and fairly good density. It will granulate in time, but will do so earlier if kept in a cold place and exposed to light. It is worth 70s. per cwt.

### Suspected Disease.

C. HARMAN and A.M.S. (Kettering).—Yes, NOVICE (Torquay) and "COLERNE DONKEY" (Wilts).—We cannot find any disease in the bees sent.

C. MURKIN (Hunts).—It is "Isle of Wight" disease. You had better burn them.

F. S. D. (Essex).—Both samples of bees are affected with "Isle of Wight" disease. Comb A has been robbed; in comb B the brood is chilled.

B. S. (Longridge).—It is "Isle of Wight" disease. The naphthaline sent is too crude for use in hives.

## Special Prepaid Advertisements

Two Words One Penny, minimum Sixpence.

Orders for three or more consecutive insertions entitle advertisers to one insertion in "The Bee-keepers' Record" free of charge.

Trade advertisements of Bees, Honey, Queens, and Bee goods are not admissible at above rate, but will be inserted at 1d. per word as "Business" Announcements, immediately under the Private Advertisements. Advertisements of Hive-manufacturers can only be inserted at a minimum charge of 3s. per  $\frac{1}{2}$ in., or 5s. per inch.

## PRIVATE ADVERTISEMENTS.

**F**INEST English honey, 60s. per cwt.; sample 2d. DUTTON, Terling, Witham, Essex. v 4

**S**IX DOZEN first grade sections, clover, number heather, 9s. dozen.—ANDERSON, 11, Church-place, Annan. v 30

**1** CWT. Lincolnshire extracted honey, in 28lb. tins, 60s. ROPER, Thorpe-on-the-Hill, Lincoln. v 29

**F**OR SALE, 3 cwt. honey, 28lb. tins, granulated, fine quality, 60s. cwt.—COLE, Roxholme, Sleaford. v 28

**F**IVE stocks bees, eight frames, standard hives, £1 each; used W.B.C. and other hives cheap; offers wanted for six old established stocks, on deeper frames and in hives; particulars.—MASOM, Poplars, Moorend, Yardley Gobion, Northants. v 27

**1** CWT. of honey; sample free, £3 cwt.—E. E. HARDY, Oak House, Great Yeldham, Castle Hedingham, Essex. v 26

**T**O LET, 8-roomed house, with five acres highly cultivated land, one acre being planted with choicest bush fruits, fifty minutes of Liverpool-street; good fishing, yachting, hunting, and golf; rent, £40, or would be sold.—7, Bulwer-road, Leytonstone. v 25

**1**3 CWT. light clover honey, in 28lb. tins, 60s. 4 cwt.; twenty-one dozen lb. screw cap jars ditto, 9s. dozen.—PRINCE, 161, Baldock-road, Letchworth, Herts. v 24

**W**ANTED to purchase, extractor to take large or shallow frames; also one or two stocks of guaranteed healthy English black bees.—Particulars and lowest price to W. H. TUMBY, 18, Well-street, Farsley, near Leeds. v 23

**F**OR SALE, two stocks bees, hybrid Carniolan, ample stores, guaranteed healthy, 25s. each.—CRUCKSHANK, station master, Grantown-on-Spey. v 22



### THE SIZE OF THE "JOURNAL."

Our readers will notice that this week we have reverted to the full number of pages in the JOURNAL.

We were sorry to have to reduce the size of our papers, and the necessity was forced on us, not alone by the enhanced price of paper—although that is no inconsiderable item—but by the possibility of the supply failing altogether. Much of the raw material for its manufacture comes from the Continent, and on the outbreak of war the supply was almost stopped. We have made arrangements to give the full number of pages on alternate weeks, and our readers may be assured that as soon as we can be certain that our supply of paper will hold out we will make every issue the full size. In the meantime, we are doing our best under somewhat difficult circumstances, and thank our readers for their continued support.

### THE CONVERSAZIONE.

MR. D. WILSON'S LECTURE ON "THE PRODUCTION OF HEATHER AND OTHER HONEYS WHERE THE CROPS ARE SITUATED ABOUT TWENTY MILES APART."

The subject on which I have to lecture this evening, "The Production of Heather and other Honeys," is one which covers the whole year's work in an apiary, because in a properly conducted apiary at no time can it be said that effort may be relaxed. Where work such as the management of an apiary runs in a circle from year to year, it is rather difficult to fix a definite point for the beginner to start at, especially if, as is often the case, he has made some appreciable start in bee-keeping before he decides to work with a dual object in view, that is the production of ordinary flower honey at home and the gathering of a crop of heather honey at some point more or less remote from his home apiary. All the year through he must have this dual object in mind. I have now been engaged for some years, with greater or less success, according to the season, and, I may add, according to growing experience and ability, in the production of two distinct crops of honey, the first consisting of a crop somewhat limited in quantity but possessing a fair

amount of certainty and long-drawn-out—gathered from fruit blossom, sycamore, clover, lime, and mixed sources. The other, the heather crop, is situated at a distance of about seventeen miles by road from my home apiary, and necessitates the transportation of bees. It is short and sharp, abundant while it lasts, but from the very shortness of its duration it is uncertain because of the vagaries of the weather. On a really fine day I doubt whether hundreds of stocks would exhaust the nectar-yielding capacities of the moor to which my bees have access, but during a bad season hives may come back lighter than they went.

I will endeavour to sketch out and make as clear as possible what departure from the normal routine of the apiary conducted for one crop only is necessary when an additional crop of heather honey is required. I shall presume for a start that all here are acquainted with this ordinary routine and understand the terms I shall use and references which I shall make to the ordinary work of the home apiary.

**FRAMES.**—It is now the general practice in every well-conducted apiary to nail together all frames and to wire all foundation into the frames before giving it to the bees to draw out. But although it is the *general practice*, I have reason to know from my own observation that in particular instances this simple precaution against breakdown of frames and combs is neglected. It should always be done to assure success in the ordinary manipulations as carried on at home. It is doubly necessary when it comes to the question of transporting bees over miles of rough roads in the heat of the summer season. Any bee-keeper who attempts to move a hive containing even one unwired comb or unnailed frame is asking for trouble, and will probably get it. He will be lucky if the breakdown of one comb is the end of his misfortunes. This, then, I put forward as being essential to success.

**HIVES.**—Next to the question of frames and combs I place the selection of a suitable hive—one which is equally serviceable at home and on the moors. There are scores of hives on the market which are more or less suitable for standing in the home apiary; some of them by a little adaptation may even be used for carrying bees to the moors and working them there; to take others is only to court disaster on the journey. A properly made heather hive is really indispensable if certainty of transportation and ease of working are to be considered. Such a hive ought also to be suitable for home work unless the bee-keeper desires to keep a duplicate set of hives by him. It is not the needs of the bees which have to be

studied so much as the requirements of the bee-keeper in the matter of transportation.

A suitable heather hive should take up as little floor-space as possible. It should pack easily along with others on a dray. It should have no legs to lift it from the dray floor, and render it top-heavy and liable to swing. It should be entirely self-contained, with no loose parts, and should be capable of being shut up securely for transportation in a minute or so.

**SKETCH.**—I have here a rough drawing of my own hives which I make myself. I find them to be equally serviceable either at home or on the moors, and they are exactly what is needed for transportation of bees. I do not claim that this hive is the best which could be chosen for home work only. Indeed, there are plenty better to be had for that purpose, but it must be borne in mind that it has to serve two purposes. This hive contains no loose body-boxes or lifts. The brood-box contains ten frames, which run at right angles to the entrance. For wintering, by the extraction of two or more side frames and the insertion of division-boards at the sides of the nest, the hive is easily turned into a double-walled one.

The lifts are similar in character, fitting over the body-box and each other when necessary by means of plintils. These lifts can be made of a depth suitable for carrying either shallow frames or "W.B.C." hanging frames for sections. Each hive may thus be worked either for the production of shallow frames or sections, or for producing both by the use of two or more lifts. The top of the roof is in one plane sloping backwards. Such roofs are more easy to pack separately from their hives than gabled or hipped roofs. There are no legs to this hive, but instead a couple of stout plintils about 4in. deep for floor joists. These are carried out to the front of the hive and above the alighting-board. A couple of notches are cut—one on either side—and into these drops a bit of wood. When in one position this piece of wood allows free access to the hive, but when reversed the piece of perforated zinc shown confines all bees. With such a hive bees can be shut up in a minute or so and confined either to the brood-chamber or to as many lifts as necessary by interposing a sheet of perforated zinc or piece of coarse sacking, and there is ample ventilation. Bees can be moved to the moors with all frames and sections in position, and may be brought back in the same way, the work of the removal of surplus being done in the apiary at home, where, generally speaking, there is more leisure, and where there are greater facilities for the work. I put forward this idea of a

hive rather as a basis for anyone to work upon than as being a fixed type and unalterable. The addition of a porch, entrances, slides, stands, &c., I leave to the task of the individual bee-keeper. Such a hive, being without legs, necessitates the use of permanent stands or gantries in the home apiary, and the formation of temporary ones on the moors.

The selection of a suitable hive I believe to be half the battle won, so far as moor going is concerned. There is a certain satisfaction, and quiet ease comes into the mind of the bee-keeper travelling his bees when he knows they cannot get out to sting the driver, the horse, and himself, and when he knows that there is ample ventilation to prevent the breakdown of combs and the suffocation of his bees.

**HONEY PRODUCTION.**—Having dealt with what I consider to be the chief essential to success in the dual operation I am considering, I will now pass on to the question of honey-production itself.

The bee-keeper has to make the best use he can of the honey-flow at home and of that on the moors. I will divide the work into two portions—the preparatory and the final stages. The preparatory stages include all the work done in the apiary previous to the removal of hives to the moors. By naming them as preparatory stages, I do not wish to minimise their importance or to suggest that in any way they are inferior to the moor-going stages, but for all that all work done in the early months should be done with one final aim and object in view—the heather erop.

**HOME WORK.**—If I were to attempt to draw up a calendar of operations in the apiary suitable for any bee-keeper to work to I should go wrong, because the time of these operations varies as we pass from one district to another, and there is a certain variation from year to year even in any selected district, due to the varying seasons. But, roughly, I suppose the main outline of a season's work may be sketched out. There is the spring stimulation of stocks to get them ready for the first honey flow, which in most districts, I suppose, comes from early fruit, such as plums, damsons, gooseberries, pears, and apples. There is no reason why a bee-keeper should not take full advantage of this early flow to secure surplus if he possibly can. In my own district of Derbyshire I generally find that this early flow is not sufficient to give me any surplus in the supers, but is generally quite enough to give a gentle stimulation to the brood raising, getting the stocks in fine condition for the later honey to be obtained from sycamore, hawthorn, clover, and limes.

It is this succession of honey-flows, lasting, roughly, from the beginning of May to the middle of July or later, but varying in various districts, that I refer to as the preparatory period. It is during this series of crops that the bee-keeper must decide whether he intends to go in chiefly for sections or extracted honey, and whichever be his aim, he must work accordingly. Perhaps his idea will be to obtain honey in both forms. There is no need to labour this point. All here are thoroughly well acquainted with the operations which must be carried out. But what I particularly wish to emphasise is this, that whilst striving to obtain as much honey as possible during this period, the chief object of the bee-keeper should be to obtain as much drawn out comb as he can. Of course, the two go together. Drawn-out comb means honey and *vice versa*. The moor-going bee-keeper is at this disadvantage compared with the stay-at-home exponent of the craft—that whilst his stay-at-home brother has a quantity of drawn-out shallow bars, saved from year to year, ready to put upon his hives at the minute they are wanted for surplus honey, the moor-goer has to produce new comb year by year. This, because of his method of extracting heather honey by means of a press, it being too thick to extract by centrifugal force. Thus his surplus combs are to a great extent used up every year according to the success of his heather crop, and this necessitates the production of fresh comb yearly. Moreover, since bees manifest a reluctance to draw out comb so late in the season as the heather honey flow, it is during the spring and summer months that comb must be produced for use on the moors later. This not only refers to the production of shallow bars, but to sections also. It is necessary to have as many drawn out sections as possible if section honey is to be produced on the moors. For this purpose extract all partly filled and unsaleable sections after the clover flow is over, utilising them again when the heather flow is on. It might be well for the bee-keeper to consider whether it would not be advisable to extract all his sections except the very best, using them again for heather honey. In this, of course, he would have to be guided by the relative values of the honey and sections to be obtained.

I wish to impress this one point most clearly: that is the necessity for the production of drawn-out comb. It often will make the difference of a handsome profit to have comb ready for the heather, because I have known bees glut up the brood-nest of a hive rather than draw out foundation in supers when on the moor. This necessity for comb preparation during the early summer months whilst

the honey-flow from flowers is on places the moor-going bee-keeper at a disadvantage compared with his neighbour, who can super his stocks with drawn-out comb. The one who has combs ready drawn out in spring will get the greater weight per hive from the clover and other flowers, and the heather-goer loses somewhat in spring owing to having to make new comb. If anyone can bring out a machine which will extract heather honey and leave the combs intact he will be doing bee-keeping a great service. I saw a notice of such a machine some years ago, but have never heard whether it was a success nor whether it has been put on the market.

The foregoing remarks being perfectly well understood by the aspirant to a double crop, the only thing remaining for him to do during the early summer is to work his bees in his own way for the production of as much honey as he can possibly obtain. I am not going to be dogmatic and state upon what definite lines this honey production shall go. Methods vary in different parts of the country, and may have to vary according to circumstances or according to the pet fancies of the individual bee-keeper. Some still go upon the old fashioned swarming system, others approve of non-swarming with re-queening. Whichever plan the bee-keeper has followed in previous years he may still follow. But looking upon the summer as a time of preparation, I would advise each bee-keeper to go in for the non-swarming system as being productive of the greatest quantity of honey and comb. Coupled with this, there is the necessity for re-queening. This should be prepared for whilst the summer honey-flow is on. The bee-keeper must either rear his own queens or have some means of obtaining new queens when he wants them. This is not a treatise on queen-rearing, but I simply wish to point out the necessity of having them ready or easily obtainable. The substitution of a non-swarming system for the older swarming system spells ruination for an apiary unless coupled with it there is a systematic re-queening.

So, having proper hives, frames properly nailed and wired, the bee-keeper will go on working in his own way for the production of as much clover and other honey as he can possibly obtain.

In my own case the main honey flow at home is chiefly from clover and limes, and extends, roughly, according to the season, from June 15th to July 15th, to be followed about a month later by heather honey flow on the moors.

This period of inactivity of about a month is most important to the up-to-date heather-going bee-keeper. It is then that

he removes his shallow frames and sections. Then he extracts his honey so as to have his combs ready for the next crop. His sections he selects for sale, extracting those he does not care to sell; in fact, extracting all possible so as to have as much comb ready as he can. I am aware that this interregnum does not always hold for such a length of time; sometimes the two crops work into each other or nearly so. When this happens, if the bee-keeper has not a supply of drawn-out comb by him, he is rather rushed to make his preparation for moor-going.

When supers are removed the brood-nest should be thoroughly overhauled. Where doubts exist as to the age or quality of any queen, she should be superseded by one of undoubted age and quality. These the bee-keeper, as I have said, should have by him. I would not advise total re-queening of all hives, but would suggest that the bee-keeper should use his own discretion. During the cessation of honey gathering I have mentioned the brood-nest should again be brought into the best form possible. Encourage egg-production by uncapping sealed stores, or even by stimulative feeding. Try to attain the desirable state of having every comb solid with brood by the time of removal of hives. If necessary extract from combs in the brood-nest if these are glutted, but leave sufficient food to tide your bees over a bad week or two which may come before there is any flow from the heather.

Remember that it is the quantity of brood taken to the moor along with the bees which is to determine the amount of success in terms of surplus heather honey.

Thus the bee-keeper comes to the time when he expects to make arrangements for the removal of his bees to the moors. In my case this generally happens by the first week in August, although I have not yet found the honey flow commence so early. Last year, 1913, it commenced about August 10th; this year it was a week later. So long as the bees are there in time it does not matter much about being there too early. A journey to the moors at about the time when the heather is expected to bloom will put the bee-keeper into possession of information as to the proper day to move his bees. I may add that if moved too early the bees, instead of giving a surplus of pure heather honey, may gather a certain amount of clover and other honey previous to the heather flow, and so present the bee-keeper with a blend instead of the pure stuff. This is because of the later flow from clover on the hills due to the higher elevation. It may not be any detriment—some people preferring a blend to the pure

heather honey—but it is as well to be aware of the fact.

The bee-keeper who decides for the first time to take his bees to the moors will require accommodation to stand the hives. This he may get in the garden of an adjacent cottager or the field of a neighbouring farmer for quite a small trifle. In my own case I pay one shilling per hive, and for this the farmer in whose field they are keeps his eye upon them.

When prospecting for a likely situation the bee-keeper should make enquiries to find out who will be willing to oblige him in the matter of suitable accommodation. Whilst there is no necessity that the stand shall be quite on the moor, it is as well to have it as near as possible in order to save time taken by the bees in travelling backwards and forwards.

My bees I place at the edge of an extensive moor. A friend of mine gets quite a good crop whilst putting his about one mile from the nearest heather, although I would not advocate this. But it is as well to take into consideration other details, such as shelter and aspect, as well as nearness to the crop.

**DISEASES.**—It is as well, when considering the question of removal of hives to the moors, to look at the work in conjunction with the prevalence of disease in the country.

In the first place, the bee-keeper may have disease in his own apiary. However well we try to guard against this, none of us is immune, and we may be attacked at any time. I refer, of course, to foul brood, and more especially to the dreaded "Isle of Wight" disease.

In the second place, although our own apiaries may be free from any trace of disease, the district into which we are to move may be somewhat affected, or there may even be the risk of infected bees from other districts being brought into close proximity to our own.

In such cases the bee-keeper's duty is clear.

If his own bees are affected he has no right to move them from the home apiary to be a source of infection to other bees and a cause of annoyance to other bee-keepers. It may be something of a sacrifice, but for the sake of stopping the spread of disease, which we all know should be aimed at, the bee-keeper had better keep his bees at home.

Also, if he has any reasonable doubt as to the health of the district into which he intends to move, he had far better keep his bees at home than run the risk of introducing disease into his own apiary, and of disseminating it into his home district on the return of his bees from the moors.

The time being opportune, the bee-keeper who has worked on the lines laid out should have hives with prolific queens, overflowing with bees and crammed with brood. He has, besides, a full supply of drawn-out shallow bars and sections. If he has not enough of these latter, he had better get them from others if he can be sure of them being free from contact with disease.

With the hive I have previously sketched out there will be no difficulty in removing bees. Place all supers in position, both shallow bars and frames of sections, and close the hives above the last super either by means of perforated zinc or cheese cloth. This is better than travelling bees in the brood-box only; it gives more room, at a time when hives are generally overcrowded. The front may be closed readily by means of the reversible bar I have shown. This should be done in the evening previous to removal, when the bees are all at home, and should not take much above a minute for each hive.

**Method.**—The question of method of transportation is an important one, and should occupy the mind for some time before the actual day comes. I believe that motor traction is preferable to all other methods of transporting bees. But failing that, take a good four-wheeled spring dray, a good horse, not necessarily so fleet as sure, and if you are not a good driver, take a driver also. Pay a good and fair price so as to command proper service.

The accommodation you can get for next to nothing is generally worth less and may land you in difficulties which will be far more costly in the long run than a few shillings extra for good service. Moorland roads are, of necessity, hilly and often bad and necessitate good wagoning. Start either in the evening, after the bees have been shut in, or very early in the morning so as to reach the moor before the heat of the day. To travel through the day is only to court disaster, unless the weather happens to be cold and wet, in which case as well travel by day as by night. Allow for the twenty miles of travel about four hours. The hive I have sketched will stand easily on a dray along with others and needs little roping, although it is advisable to make a turn or two of rope round all to make them doubly secure. But if the hives really need roping to hold them on the dray, better not start at all.

When on the moor, unpack and place in permanent locations your hives. As they are legless you will want stands. If you have not brought any a few stones from the moor answer the purpose well enough. Make all level and loose your bees. If the frames in the interiors of your hives

have been well packed, little more will be needed than to take away your perforated zinc or cloth and replace the quilts and warm packing.

When working bees on the moors there is no necessity (at least, I have found none) for queen-excluder. Although as a rule I use one at home on every hive, yet for heather honey I prefer to dispense with it. Even when young queens have been introduced there is a strong tendency on the part of the bees to keep on contracting the brood-nest, and I have never found the queen lay eggs to any appreciable extent in the supers. Besides, I believe that for all honey storing—heather especially—the less hindrances the bees have in their progress about a hive the better.

A word or two about the choice of location and standing for hives when on the moors. Choose the best you can under the circumstances, and if shelter can be got, such as a row of trees, then so much the better. But avoid, if possible, an open field, where one spot looks just about like another, and under such circumstances do not put the hives in rows but scatter them about, turn them various ways, and make the surroundings of one hive as much different from those of another as possible.

It is well known now that bees do far more visiting other hives than was at one time thought to be the case. This takes place, to a limited extent, in the home apiary, as can easily be found out if various races be kept, but at home each hive is generally better marked, as to its surroundings, than is the case on the moors. A bush here, a tree there, a row of peas elsewhere in the home garden, all serve to mark the positions of hives. But on the moor, where surroundings may be quite monotonous in character, if hives be put in rows there is a great tendency for the bees to gravitate towards the end hives.

Thus, these hives will strengthen up remarkably in bees, whilst those towards the middle of the row will gradually become weaker. The end hives will produce the surplus, the middle ones will do nothing. Thus when it comes to bringing home hives the bee-keeper has all his calculations upset by finding that perhaps what he thought were his best stocks have done nothing, and *vice versa*. Far better make such arrangements as will tend to assure that each hive shall work for itself, even if the surplus from any individual hive be not so great.

But a greater danger than this is incurred by setting hives in line, and that is the risk of queenlessness. A host of strange bees invades another hive, and is

received if bringing in food, but I have known cases where they have balled the queen of the hive they have invaded, causing serious damage and loss, if not the total extinction of the colony.

(To be continued.)

### PRESS CUTTINGS.

#### VALUE AND PRICES OF HONEY.

The bee-keeper with plenty of honey on his hands is lucky in that he can to a very great extent utilise it in the place of sugar, that has now gone up in price. Honey may be turned to account by the housewife in many ways besides just as a substitute for jam or butter, and is, in addition, one of the most wholesome foods that we possess.

The price of sugar will have, too, a bearing upon bee-keeping in another direction. Many stocks require to be sugar-fed to face the winter confidently, and it seems now pretty certain that but little of such feeding will be done. The consequence will be that many stocks will perish during the winter, and many more come out in the spring in so weak a condition as to be of little account for honey-gathering. English honey, therefore, promises to be a scarce commodity next season, and the assumption is that prices will be good, and the stocks in consequence all the more valuable.

At this season some bee-keepers procure driven bees, unite them into strong stocks, and feed up for wintering. Generally this is a safe and profitable proceeding, and it may be so in the present instance. Considering all things, however, it is best now to look upon such plan as having an element of speculation about it. The question arises whether the stored honey—the honey, that is, that was left in the hive for the bees to winter upon—should be taken toll of and replaced by fed syrup. The best plan is probably to let well alone, and, if necessary, use the sugar for household consumption. Where uniting is being done there will be vacant hives. When a hive is vacant it should be well cleaned out; scrape the woodwork if necessary, and then store the hive under cover until the long nights come, when any mending or painting required may be done. It is a mistake to repair a very decrepit hive, the wood of which is mainly unsound, for when hammered and pulled about it is rarely that such hive can be made thoroughly weatherproof, and the best way is to break it up and use for the fire.

Where queen-rearing has been done upon the unit system the surplus queens should ere this have been disposed of and the units made up into proper stocks ready for the facing of the winter.

*A Fresh Start.*—Where some bee-keepers have unfortunately had their stocks wiped out and desire to start again, the best advice that can be given is to wait until the spring before stocking, and in the meantime to disinfect all hives and wooden fittings with a blow-lamp, subsequently treating with a double-strength liquid disinfectant, and afterwards drying thoroughly before storing away. For reasons given above good stocks of bees will probably be dear to buy in the spring, and weak stocks are not then worth buying. But where disease worked havoc this season it is not advisable to stock heavily right away, a couple of good stocks being capable of developing into a number in the course of a couple of years if properly nursed, without taking the direct monetary risk that investing in a large number of stocks would mean.

As a suggestion merely, it seems an advisable proceeding to start the new apiary upon quite fresh ground wherever possible, and winter work may consist in the preparing of the new site for the hives to occupy in the spring.

*Mead.*—Now is the time of year that inquiries concerning how mead is made come to the fore. There are many ways of making mead, but the following recipe is one of the best:—Take 6galls. of water, add 24lbs. of honey, and boil briskly for half an hour, removing the scum as it appears. Now add 3oz. of hops, boil for a further fifteen minutes, and then pour into a large bowl or similar receptacle, to cool until lukewarm, when six tablespoonfuls of brewers' yeast should be added. Allow to work for twenty-four hours, after which place in a cask prepared by pouring in a bottle of brandy and two lemons in slices. Allow the whole to work as long as it will, and then bung tightly. Keep at least a year before bottling, and a couple of years is still better. Some add spices, but this is a matter of individual taste. There is no regular demand for mead, but it is a wine that is far better than many of the common commercial wines as regards both cost and virtue.—J. T. BRID, from *Farm and Home*.

#### OLD SUPERSTITIONS ABOUT HONEY.

Many quaint delusions prevailed in olden times relating to the bee and honey. The source and composition of honey were subjects for many ingenious speculations. Belief in the celestial origin of honey runs through all the old treatises on agriculture, from Virgil down. It was supposed to be a kind of manna from heaven, and its quality depended greatly on the favourable or unfavourable juxtaposition of the stars at the time of its descent. The existence in each hive of one bee much



larger than all the others was generally recognised, but it was believed to be merely a ruler or king over the rest. That this large bee was actually the queen of the whole colony never seemed to have occurred to anyone until recent times. The situation of the beehive was, in olden times, a matter of importance. It was placed always on the south side of a stream of water, and never in a place where there were echoes, as an echo was held to be injurious to bees.

Honey appears to have been held in extraordinary favour as a universal specific for human ills. It was largely recommended as a hair restorer. If dead bees were dried, pounded, and worked up into a thick paste, with the honey, its hair-producing capabilities were much enhanced. For weak eyes it was recommended to take a handful of the heads of bees, burn them, and mingle with the honey gathered in the dog days. The eyes were anointed liberally with the mixture. To the Dutch it is supposed to bring ill-luck to sell bees. If a neighbour wants to get hold of some of a friend's bees, he must go like a thief in the night and steal them, leaving the money for them in some handy place. Malays always revere the bee, and whenever a swarm visits their abode they make room for them. The coming of the bee is considered a good omen, and signifies that the inmates will be prosperous.—From *Bristol Times and Mirror*.

#### ANCIENT BEE-KEEPING IN RUSSIA.

A friend of mine, knowing my interest, has brought the following to my notice. As you will see, it is most interesting, and I thought perhaps you would like to have a copy of it for publication. These old books give us an insight into ancient conditions.—GEO. W. JUDGE.

Extract from a letter to Mr. Urban, of the *Gentleman's Magazine*, Dec., 1785:—

Kasanka.

May 2nd, 1785.

"About four years ago, I was at Bogorodskoe, on the banks of the River Usa, where I paid some attention to the manner in which the Russians of those parts, excited by the example of their neighbours the Baschkirians, who are famous in this way, apply themselves to the cultivation of bees, and were then applauding themselves exceedingly on the rich store of wax and honey they had got the preceding year. They excavate their hives in the trunks of different trees, giving the preference to such as are of the hardest wood, and consequently chose for this purpose the strongest and the loftiest trees of the forest. The hive is about five-and-twenty or thirty feet from the ground, frequently even higher, if the

length of the trunk allows it. They hollow them out lengthways, with small narrow hatches, and tools of a peculiar form, a sort of chisels or gouges, with which they complete their work. The longitudinal aperture of this hive is stopped by a cover of two or more pieces, which are exactly fitted to it, and pierced with small holes, to give ingress and egress to the bees.

"No means can be devised more ingenious or more convenient for climbing the highest and the smoothest trees than those practised by these people for the construction and visitation of their hives. For this purpose they need nothing but a very sharp axe, a leather strap or a common rope. The man places himself against the trunk of the tree and passes the cord round his body and round the tree, just leaving it sufficient play for casting higher and higher by jerks towards the elevation which he wants to attain, and there to place his body, bent as in a swing, his feet resting against the tree, and preserving the free use of his hands. This done, he takes his axe, and at about the height of his body makes the first notch or step in the tree. Then he takes his rope, two ends whereof he takes great care should be tied very fast, and throws it towards the top of the trunk. Placed thus in his rope by the middle of his body, and resting his feet against the tree, he ascends by two steps, and easily enables himself to put one of his feet in the notch: he now makes a new step, and continues to mount in this manner till he has reached the intended height. The Baschkirians perform all this with incredible speed and agility. Being mounted to the place where he is to make the hive, he cuts more convenient steps, and by the help of the rope, which his body keeps in distension, he performs his necessary work with the above-mentioned tools, which are stuck in his girdle.

"They carefully cut away all the boughs and protuberances beneath the hive, to render all access as difficult as possible to the bears, which still abound in vast numbers throughout the forests of the Ural, and, in spite of all imaginable precautions, do considerable damage to the hives. On this account they put in practice every kind of means, not only for defending themselves from these voracious animals, but for their destruction too. The method most in use consists of sticking in the trunk of the tree old blades of knives standing upwards, scythes, and pieces of pointed iron, disposed circularly round it, when the tree is straight, or at the place of bending when the trunk is crooked. The bear has common dexterity enough to avoid these points in climbing up the trees, but when he lets himself down, his posteriors foremost, he gets on

these sharp hooks, and gives himself such deep wounds in the belly that he usually dies. It frequently occurs that old bears take the precaution to bend down these blades with their fore-paws, as they mount, and thereby all this offensive armour is useless.

"Another destructive apparatus is used

with more success, which bears some similitude to the catapult of the ancients, and is fixed in such a manner that, at the very instant the bear prepares to climb the tree, he pulls a string that lets go the machine, whose elasticity strikes a dart into the animal's breast."



A GROUP OF MEMBERS OF THE SHEFFIELD AND DISTRICT B.K.A.

#### SHEFFIELD AND DISTRICT B.K.A.

The picture shows a group of the members of the Sheffield and District Beekeepers' Association, who visited the apiary of H. H. Ewing, Esq., on Saturday, September 12th. A heavy downpour of rain accounted for a smaller attendance than was expected. The Association was only formed last year, but it now has a membership of forty-eight. Although the weather was so bad, a very enjoyable time was spent by those who were present. After the members had partaken of tea, a paper by Mr. Livsey on "The Fertilisation of Fruit Bloom by Bees" was listened to with much interest. At the conclusion he answered a number of questions. A vote of thanks was expressed to Mr. Ewing for his kind invitation, and also to Mr. Livsey for his paper. In the group the secretary of the Association is in the

front row, marked x, and immediately behind him is Mr. Livsey, also marked x. Both are members of the parent Association, and have also gained the preliminary examination certificate.—*Communicated.*



*The Editors do not hold themselves responsible for the opinions expressed by correspondents. No notice will be taken of anonymous communications, and correspondents are requested to write on one side of the paper only and give their real names and addresses, not necessarily for publication, but as a guarantee of good faith. Illustrations should be drawn on separate pieces of paper. We do not undertake to return rejected communications.*

#### HIVE PORCHES.

[9087] I would like to ask Mr.

Snelgrove (page 381) if with a porch parallel with the alighting board, does not the wet drip off that porch on to the alighting board? To a really practical joiner it seems merely a sort of weather board. I prefer "a gable porch" projecting 3½ in. or 4 in., fitted with a piece of stout zinc at the back angle, with two slotted holes, so it will fit on two cone-headed screws. It is then detachable when desired.—A. HARRIS, Wavendon, Bucks.

#### STORING EXTRACTING COMBS.

[9088] Mr. Crawshaw rather scoffs at the idea of putting away for the winter combs wet from the extractor, without first having been cleaned up by the bees. It is a practice I have invariably followed for nearly twenty years without apparently any evil results. The correct method is without doubt to replace the supers with their combs on the hives, but this cannot be done till the honey flow has quite ceased, otherwise the bees will go on storing in them. Also when one has to deal with some forty supers, and therefore some three or four hundred combs, the labour involved is considerable. Let me give my experience of getting the combs cleaned up in the open, an experience which proves that the method is inexpedient and often highly dangerous. I am generally away during August and part of September, and like to get everything finished up before I go. One summer after the last extraction I placed all the supers with the wet combs in them on the lawn in the sun, about 80 yards away from my apiary. In about an hour's time it was not safe to go outside the house, and I had to make a dash for the yard to rescue my dog, who was howling pitifully, and put him in a place of safety. Many of the hens were stung to death, their heads being one mass of stings, and my cattle in the adjoining orchards were careering about madly. Since then I have once or twice tried the plan in a modified way with one or two supers, but I find it unduly excites the bees and tends to robbing. One learns wisdom by experience, and I now pile all the supers with their wet combs one on top of the other in a dry room, having first placed some balls of naphthaline underneath. The one and only drawback to the plan, as far as I can see, is that it renders the job of cleaning the propolis off the following spring a very dirty and messy one. On the other hand, there can be no doubt that bees take more readily to supers of wet combs than dry ones. This season has been a fairly good one here, but not so good as last, when I took nearly 12 cwt. of honey from twenty-two stocks.—E. H. OLDHAM, Stanford Rectory.

#### A MINIMUM HIVE.

[9089] Mr. G. G. Desmond's article, "The Minimum Hive," has greatly interested me.

It brings up the right subject at the right time.

As one who makes his own hives, I should like to discuss Mr. Desmond's article and add some of my own ideas. I agree that, to save expense and labour, many of us require "The Minimum Hive."

We cannot all appreciate Mr. Desmond's reason for having his hive square, as we do not all use flat roofs. My own idea is also to use ¾ in. material throughout, except for legs.

I would do away with the telescopic rim, having instead a 1½ in. or so of packing space above frames in brood box and supers.

The supers (shallow frame) have to be made with end walls deeper to fit into this space in brood box, in turn providing packing space.

I find this answers in practice, the super lifting off easier than many a section rack.

A word with regard to timber. Much difficulty is had in getting stuff to finish ¾ in. By procuring deals 2½ in. thick and having them cut into three ¾ in. full boards, I find five pieces of stuff make two minimum hives: 2 9ft. of 11 by 2½, 1 9ft. of 6 by 2½, 1 3ft. of 9 by 2½, 1 7ft. of 2½ by 2½ (legs) = 5.—A. W. BROCK.

#### DERBYSHIRE NOTES.

[9090] Until recently I thought that I had exhausted all available ways of selling my honey locally, and I should have been prepared to affirm that everybody in the small town, which, for pecuniary reasons, I honour by my residence, knew where to obtain good honey at a reasonable price. The following will show that I was wrong and will perhaps suggest to others further ways of selling honey.

Towards the end of July an agricultural and horticultural show was held in the town. There was no honey class, but I offered to give a little display if I could be allowed to sell. The result, from my point of view, was a complete success. I succeeded in selling a very fair quantity of jars and sections, but better still, the advertisement was well worth all the trouble. First one customer and then another expressed the pleasure it gave them to know where pure honey could be obtained; they bought some and have come again since. Consequently I am by now nearly sold out of summer honey, and that without troubling wholesale dealers at all.

The above may be a hint to others as to means of disposing of honey and getting

the full value without having to sacrifice part of the profit to a dealer.

With my heather honey I find that although some customers ask for and, in fact, prefer it, others have still to be educated to it, and it will take some time to gather round me a *clientèle* of heather customers. I find that with regard to honey the ordinary economic principle of demand creating supply can be reversed. A supply properly put upon the market will create a demand which will in time exceed the supply.

For some time I have been revolving in my mind a project having for its end the production of a complete "Book of the Bee." Perhaps this is not the time for its production, but still that does not alter the fact of its necessity. If a few lines here will set other minds to work upon the same idea, they may in less troublous times bear fruit.

We all know to how many books we have to turn to obtain anything approaching a complete knowledge of all pertaining to apiculture. The "Book of the Bee," when produced, would be a complete encyclopædia of bee-lore. In this book special articles would be written by experts in particular branches of bee-work, and the total result would be a work unsurpassed in its completeness of detail, and up-to-dateness of its authorities.

For example, the "History of Bee-keeping" would occupy one place, "Queen-rearing" another, "Diseases" another, and "Bee Flowers" another. Dozens of other subjects present themselves after only a few minutes' reflection.

The book could be produced if a number of subscribers could be guaranteed in advance, or it might even be brought out in fortnightly numbers at about sixpence per number, when, doubtless, more purchasers could be found than by offering it as a complete volume at once.

This, then, is my suggestion. What do the readers of the JOURNAL think? and what think our Editors and other contributors? Now, Mr. Crawshaw?—D. WILSON.



[8987] *Storing Sections.*—As a reader of your valuable little BEE JOURNAL, I would be much obliged if you would tell me through it where and how to store section honey. I have it stored in a press in a fairly close

room beside a hot cylinder. Would it keep better in a cold room, or is there any fear of it losing its flavour?—W. K. JOHNSTON.

REPLY.—You cannot keep it in a better place. It will not lose its flavour.

## Notices to Correspondents

### Honey Samples.

A. THOMAS (Haverhill).—The light honey is worth 65s., and the dark 60s. per cwt. The darker honey is mainly clover with a little ragwort.

V. DAVIS (Bath).—(1) Mainly clover. (2) Yes. (3) 65s. per cwt. (4) No, it generally makes a lower price; some people prefer dark honey, as the flavour is usually stronger.

C. C. TUNMER (Maldon).—The honey is from clover and ragwort.

### Suspected Disease.

J. D. (Newcastle), C. E. (Sedgley), "DALSTON" (Cumberland), CUMBRIAN (Maryport), and W. P. (Oswestry).—It is "Isle of Wight" disease.

M. HARMAN (Beckenham).—Yes, they are affected with "Isle of Wight" disease. No, you cannot do much now beyond liming and digging the ground and disinfecting the lives with Izal or Ayles' Cure. There is no charge for lectures.

## Special Prepaid Advertisements

### Two Words One Penny, minimum Sixpence.

Orders for three or more consecutive insertions entitle advertisers to one insertion in "The Beekeepers' Record" free of charge.

Trade advertisements of Bees, Honey, Queens, and Bee goods are not admissible at above rate, but will be inserted at 1d. per word as "Business" Announcements, immediately under the Private Advertisements. Advertisements of Hive-manufacturers can only be inserted at a minimum charge of 3s. per  $\frac{1}{2}$  in., or 5s. per inch.

## PRIVATE ADVERTISEMENTS.

YOUNG carpenter seeks work, used to be work, learn car if needed.—Box 2, "B.B.J.", 23, Bedford-street, Strand, W.C. v 35

$\frac{21}{2}$  CWT. finest quality honey, 60s. per cwt., in 28lb., 14lb. tins.—F. PENTNEY, Bromfield, Halesworth. v 35

FOR SALE, good quality heavy sections, 8s. 6d. per dozen; also extracted, in 28lb., 14lb., and 7lb. cans, 8d. lb., f.o.r. Winner of four firsts and silver medal at Essex County Show this season.—NASH, Dunmow, Essex. v 34

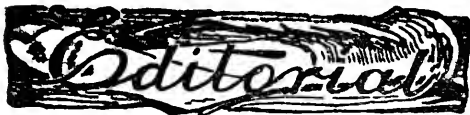

### OBITUARY.

DR. D. WARDLEWORTH.

It is with regret we have to chronicle the death of Dr. D. Wardleworth by drowning when bathing on October 24th, at Havre, while on active service. He was an enthusiastic bee-keeper and Hon. Secretary of the Norfolk Bee-keepers' Association, which he greatly improved during the time of his service. He was probably best known as the inaugurator of the scheme for repopulating Norfolk with Dutch bees.

In addition to that he did a great amount of gratuitous work in visiting bee-keepers and giving them help and advice. He will be greatly missed by the members of the Norfolk B.K.A., and especially by those in the neighbourhood of his home.

As a doctor his services were greatly in demand, and he cured many patients of rheumatism and kindred ailments by the application of bee stings.

During our stay with him last year we had many evidences of his popularity for miles around Sheringham. He was beloved by his patients on account of his sympathetic treatment. One instance alone will illustrate his unselfishness: A panel patient, suffering from chronic ulceration in the leg, was cured by grafting on to the wound several inches of skin from the doctor's own arm.

He leaves a widow and three children, the youngest being born on the day he met with his death. The sympathy of all bee-keepers will, we are sure, go out to the widow and children of a brave man who has lost his life while serving his country. He was a jovial companion, and we mourn another personal friend gone to the great unknown.

### MR. D. WILSON'S LECTURE.

(Continued from page 398.)

SECTIONS OR END HIVES.—Then also this arrangement leads to serious fighting and robbing at such times as when bees returning home with little or no store miss their own hives and wander on to others.

I want to impress this point carefully, as it is one of the few things that can be done by the bee-keeper *while on the moor* to ensure success. Most of the work

essential to success has to be done at home.

Having got his bees to the heather and settled them there as well as he can, the bee-keeper can do little to help them. He may visit periodically to see how they are going on. He may take more comb if needed, or even remove surplus, but, generally speaking, until the time of returning home comes he has little to do.

I have mentioned here very few tricks which the more advanced bee-keeper will carry out in order to increase his yield from individual stocks, while honey flow is on either at home or on the moor. I refer to doubling hives while on the moor, and to strengthening up for heather by utilising driven bees. These tricks will come later, but a man who is starting out for the double crop had better work at first on simple lines.

With such a hive as I have sketched the whole hive may be brought home on a dray without interfering with the surplus, which may be left *in situ* until the home apiary is reached, when it may be taken off at leisure.

Nothing then remains but to pack up carefully for winter.

When the last crop—the heather honey—is safely at home and taken from the hives the work for the year is not yet finished. There still remains the work of extracting and marketing the honey and of glazing or casing the sections.

The work of extraction of honey perhaps needs special mention.

As is well known, heather honey is too dense to extract by the ordinary method of using centrifugal force and must be pressed from the comb. For this purpose a press is absolutely necessary if ease in working is to be aimed at. The heather worker will be well advised to invest money on the purchase of such a press—say, a Rymer. This has a capacity of from four to six combs at a time according to their thickness, and work is quickly and expeditiously performed by its help.

It is much better to set up one of these at once or to make arrangements to hire one than to use home-made apparatus or trust to the very old, sticky and messy method of hand-squeezing.

Now a Rymer honey press is rather costly, and it would be a good move in co-operation if a number of bee-keepers could club together to purchase one for their own use. As even under the best circumstances the extraction or pressing of heather-honey is not a pleasant occupation and necessitates the destruction of plenty of comb, it would be well for anyone going in for heather-honey to consider whether it would not be best to work for sections as far as possible, and so get rid of the necessity of so much pressing.

By the method of working herein sketched out the bee-keeper will find himself at the end of the year with large quantities of wax on his hands ready for melting down, especially if he has worked chiefly for extracted honey.

It becomes a question what to do with this surplus wax, which is far greater, from the nature of the case, than if the apiary was run for one crop only.

Coupled with this there is the necessary expenditure yearly on new comb-foundation to take the place of that used up, over and above the normal use of foundation.

The two should be made to balance themselves as nearly as possible.

The bee-keeper should turn this wax to good account. He may work up a little connection so as to sell it for domestic use amongst his neighbours and honey customers, or, failing that, send it away to his dealer in bee appliances and have it returned to him in the shape of comb-foundation for the expenditure of a few pence per lb.

WINTER PACKING AND WINTERING.—As wintering bees comes into the question of management of an apiary I wish to touch upon it in connection with the question of heather-honey.

When the bees are brought back from the moors, after even only a moderately successful season, there is, generally, quite sufficient store in the brood-nest. After a successful season there is always ample store. It is a bad season indeed when bees have to be fed on their return.

(To be continued.)

---

#### “BLURTS FROM A SCRATCHY PEN.”

When you visit Venice, you *must* feed the pigeons on the Campo. It does not matter a hang if you are deeply interested in the wonderful architecture of the cathedral, or, that you have a little spare cash that you want to invest in beads or meerscham pipes, the local manufactures in which they glory. Those are but asides. If you fail in your duty to the pigeons, then you outrage every principle held sacred by the globe-trotter. You have failed in the object of your travels, and are simply a nobody. Just imagine that couple there, whose nasal accent would prevent them claiming any nationality but one. Just imagine them going back to Connecticut and saying they had not fed the pigeons at St. Mark's, Venice. How could their children ever forgive or forget the family stain? I often wonder, by the bye, what peculiar anatomical development it is which causes that very unmistakable evidence of the origin of their species.

And the varieties of language one hears. Babel is hopelessly outclassed. Here the

swarthy Moor, or the Arab from the desert in snow-white bernous, jostles up against the blonde Scandinavian, or the Russian merchant. French in every existent *patois*, high and low Dutch, guttural German, sonorous Spanish, English of Cockaine, and brogue of Dublin—every sub-solar language has its representative here. They are gathered together from all parts of the world, one common object only in view; this, indeed, is what all have travelled for—just to feed the pigeons of St. Mark's. Cannot we get up a furore like this for London? I venture, humbly, to suggest that the pigeons, say of the Guildhall, the British Museum, the Houses of Parliament, or many other places I could mention, are quite as numerous, not to be distinguished by their toes or the colours—blue, white, grey, or khaki—from their relations in Italy, and that, in their groups are to be found equally as respectable members of the great families of pouters, tumblers, homers, magpies, and others, which only the tongue of a pigeon-fancier (I am not of that ilk) can enumerate.

It might not be. We would have liked to stay a further day. I was prepared myself even for the martyrdom of another mosquito night, but Time, the inexorable, shook his hour-glass, pointed to the chart of our travels, and said, “Go.” The afternoon, therefore, of the day found us again *en route*, our destination for the day being Milan.

Of Milan, the Sheffield-Birmingham of Italy, famous during ever so many centuries for its skilful artificers in metal, and for its magnificent cathedral, we saw in our hurried visit but little. Our endeavour was to give as much as was possible of our, alas! too rapidly vanishing holidays to Switzerland.

And now we are passing a mighty chain of mountains. The engine grunts and grumbles as it climbs the ever-steepening gradient. Serpent-like, the railway, winds in circles, so restricted, that the van in the rear is seen from the carriages in front. Tunnel after tunnel do we pierce, until their number reaches forty-five. How tame and insipid now does the recollection of the lowlands, through which we have been travelling the last two days, seem to us. Even in our own beloved England we have nothing to equal this. Higher, and higher, as we journey the mountain peaks still grow until, in the clouds, with which they mate, their heads are lost. It is the month of August. In the plains below the peasant, as he toils, is forced to wipe his brow. Here we are, still in the midst of last winter's snow. Trickling from the glacier, and the eternal, fields of white, which never disappear, the glistening cascade rushes down the rocky

channel it has worn for itself during passing ages. Ever augmenting, ever growing, it leaps from shelf to shelf as if in wild joy at its liberation. Through the peepholes 'twixt the ever-recurring tunnels we watch its final tumble into the valley. And those lovely valleys! Often in earlier days we have seen pictures of these valleys which we looked upon then as living only in the artistic imagination, but here, actually underneath us, are the realities. Meadows, intensely green, in which pasture the herds with the tinkling bells, rivers, every laughing wavelet scintillating in the brilliant sun. Roads, ever so white; chalets and farm buildings with the wide overhanging roofs, protection against the winter storms, roofed with tiles of vivid red, which contrast with the sombre hues of the pine forests. And all these glorious gems set in a surrounding of hills, the rosy coloured cliffs of which seem as mighty columns supporting a strip of blue—the most intense blue that painter ever dreamed of. Oh! but it was grand, so grand that once seen the recollection can never fade. One wonders not at the patriotism of the Swiss; a country like this is indeed worth fighting for.

Even amidst such surroundings we had not forgotten our vocation. We still looked for the dwellings of bees, and, indeed, we had not far to seek. Even as we passed in the train we noticed their apiaries clustering under the thatched shed, or the ever present overhanging eaves of a farm building. There they were in rows one above the other in assemblies of fifty to a hundred colonies. To us this seemed as if it should not be. Disease, if once it happened, would decimate, and how to prevent the attacks of robbers? Some, indeed, we saw in bar-framed hives, but most in skeps, but in all the apiaries there was overcrowding. Yet probably they have wise reasons. It is not for us to judge by a passing glance.—  
J. SMALLWOOD.

#### STORING EXTRACTED COMBS.

With reference to this matter, I never give definite advice on practical work which I have not proved for myself. Theory and practice are often antagonistic when put to the test. Theoretically, Mr. Crawshaw is right, practically he is wrong. I have combs which were extracted three seasons ago and put away wet, which are as moist and sweet to-day as when they were stored. Of course they have been put in a dry, dark place. Another advantage is that wax moth will not attack wet combs. In the centre of the pile of supers containing wet combs a brood-chamber full of dry combs was stored; these were entirely

eaten up by wax moths, which did not touch the ones immediately above or below.

Although it is not advisable, combs can be cleaned in the open without inducing robbing by placing the supers in an empty hive. The mistake made by the Rev. E. H. Oldham was in placing the supers out too early. If open-air clearing is to be done successfully the supers should be placed out about 4 o'clock p.m., so that the bees have just time to clear them before it is dark, they are then taken indoors, when all will be quiet next day. The drawback of cleaning propolis from wet supers can be obviated by cleansing the frames before extracting the honey.—W. HERROD.

#### WEATHER REPORT.

##### WESTBOURNE.

October, 1914.

Rainfall, 2.26in.	Minimum on grass,
Below aver., 1.82in.	24 on 28th.
Heaviest fall, .48in.	Frosty nights, 1.
on 28th.	Mean maximum, 57.5.
Rain fell on 14 days	Mean minimum, 44.3
Sunshine, 92.1 hours.	Mean temperature,
Below average, 26.6	50.9.
hours.	Above average, 1.6.
Brightest day, 1st,	Maximum barometer,
9.2 hours.	30.395 on 5th.
Sunless days, 4.	Minimum barometer,
Maximum tempera-	29.306 on 31st.
ture, 63 on 1st.	
Minimum tempera-	
ture, 30 on 28th.	L. B. BIRKETT.



*The Editors do not hold themselves responsible for the opinions expressed by correspondents. No notice will be taken of anonymous communications, and correspondents are requested to write on one side of the paper only and give their real names and addresses, not necessarily for publication, but as a guarantee of good faith. Illustrations should be drawn on separate pieces of paper. We do not undertake to return rejected communications.*

#### HELP FOR BELGIAN REFUGEES.

[9091] Having several beds of the splendid bee flower, *Limnanthes Douglassi*, the thought struck me the other day that I may, with your kind help, raise a small sum towards helping the poor Belgian refugees. Therefore I ask if you will kindly make it known through the "B.B.J." that I have several hundred

good strong plants for sale at 3s. per hundred, 1s. 6d. per fifty, post free.

I shall give the proceeds of sale, less the postage, to the above fund, and shall be pleased if you will take charge of the sum realised and publish the amount in due course.

No bee-keeper should be without this flower; it is a splendid border plant, and when grown in large quantities it simply scents the garden.—EDWIN BALLARD, Beeholme, Aldington, Evesham.

[We shall be pleased to do as our correspondent suggests.—EDS.]

#### BEE NOTES FROM ACTON.

[9092] My bees were in a very bad condition when last I wrote you in February (8960) and it was not long before I was fully aware of it and destroyed them. After cleaning up the hives, &c., I got two fine stocks and ordered a swarm, which have done so well, supplying up to date 140 sections, that I am sending extracts from my diary of the doings in my apiary, which may be interesting to your readers; the harvest being mostly from lime blossom.

1914.

April 17th.—Hived two stocks, which had arrived the previous evening, giving them eleven combs each.

April 19th.—Removed one comb from stock No. 1, and gave them a rack of sections.

May 4th.—Drones were flying from this stock.

May 11th.—Removed 1 comb from No. 2 and gave them a rack of sections; drones were flying from this stock next day.

May 19th.—Received a swarm weighing 3½lbs. and hived them, giving a rack of sections at same time. This is stock No. 3.

June 4th.—No. 1 swarmed to the top of a sycamore tree, and while being removed all returned to the hive. Cut out all queen-cells and gave another rack of sections—the third.

June 17th. No. 1 again swarmed, at 9.30 a.m., and a cast issued at 2 p.m. After returning all to the hive, killing five queens and destroying many cells, I gave them a fourth rack of sections.

June 18th.—No. 2 swarmed; cut out queen-cells and returned swarm.

June 25th.—No. 2 again swarmed, and were returned without examination.

June 30th.—No. 3 swarmed, weight of swarm 4½lbs.; it was returned after examining combs, no queen or queen-cells could be found.

July 2nd.—Stock 2 swarmed, weight, 8½lbs. Removed two combs with queen-cells from stock, and placed with three

others in another hive as stock 4. Returned most of the swarm to parent stock and replaced the two combs with frames and foundation and united about 2lbs. of bees to stock No. 4, which were now on five frames.

July 24th.—Placed two combs and bees from stock 4 in an observatory hive with one frame of foundation. Lowered all hives to normal ventilation.

The three stocks gave me as follows:—No. 1, 63 sections; No. 2, 58; No. 3, 19 = 140 sections; in addition to an increase of one stock, and the bees placed in the observatory hive.—S. S. LEVIS.

#### CURING "ISLE OF WIGHT" DISEASE.

[9093] When I was just recommencing bee-keeping in this district I wrote to ask you if there was any prevention or cure for "Isle of Wight" disease, and your reply was in the negative.

As I very much hope my experience since then may be of some use to my fellow bee-keepers, I am sending you full particulars.

I started keeping bees here in a good deal of apprehension, as I heard they had nearly all died in the neighbourhood; besides, having had no experience of the disease, I was unable to recognise the earlier symptoms.

It attacked two of my hives. The first to suffer was an artificial swarm from the strongest and most forward hive in the apiary. I had left them alone for some time, thinking all was well. The queen was not a young one, having led off a swarm the preceding year (which I had bought).

I first noticed something was wrong from the number of crawling bees about that corner of the apiary—and then discovered that the strong swarm had dwindled to a mere handful of bees, the alighting-board being covered with crawling bees with twisted wings. I found the queen crawling on the floor of the hive, very repulsive looking, and dropping her eggs anywhere. She laid one in my hand, and seemed in a good deal of pain.

Knowing that no one else kept bees near enough for there to be any danger of infection, and being very anxious to experiment upon the sick bees, I did not destroy them, but sent particulars, and my own theory as to the cause of the disease to an acquaintance, who has not studied bee-keeping but is very scientific. He sent me a medicine. It was very simple to use, being put in an atomiser with very thin syrup, to be sprayed over the combs once a day.

For the first two or three days I sprayed with this morning and evening, with the result that after the third day I found



the queen again on the comb, laying normally. Within a fortnight, the remaining bees had become glossy and healthy looking, including the queen, and there was very soon not a crawling bee to be found.

I have kept this stock carefully watched, and they have developed into a nice colony for wintering, and I hope will do good work next year.

Soon after the disease had commenced in the hive, the same symptoms began to develop in another—this was a swarmed stock with a young queen. Though the attack rather weakened them, it very quickly gave way to the spraying, which was not done more than once during the first week, and then on alternate days. The chief difference between this treatment and all I have read of in bee journals lies in the fact that this entirely cures diseased bees, curing the queen herself, without there being any necessity for requeening.

I think that this medicine might be used more simply still by giving it in an ordinary feeding-bottle over the tops of frames, but have not yet had an opportunity of testing. I have tried to obtain other diseased bees to practise upon, but find people deny having the disease until the bees are all dead.

At first I sprayed the outsides and alighting-boards of all healthy hives with a disinfectant sent me by the same acquaintance, but did not continue this more than a few days. I have had no further outbreaks.

With regard to infection, I do not think that destroying infected bees will clear the country of this disease, as I think it probable that the disease originates with an infectious disease amongst plants upon which the bees forage, and until this can be found and stopped at its source, bee-keepers will not benefit by having their bees destroyed—the only help to bee-keepers lies in a remedy which will cure and render bees immune from further attacks.

The medicine used was supplied to me by Mr. Gelston, Chemist, 5, Church Street, Basingstoke, Hants.—M. T. BATTEN.

#### A PROFITABLE STOCK.

[9094] I thought you might like to know that Mr. T. Holt, of Westfield, Winchester, has already taken 150lbs. of honey from *one* hive of bees, and that there still remains at least 20lbs., which he intends to leave till spring, as they are still working hard. The remaining 20lbs. does *not* include honey left in brood combs. The bees were only received near end of May.—R. H.

#### LEICESTERSHIRE AND RUTLAND B.K.A.

Some sixty members and friends of the Leicestershire and Rutland Bee-keepers' Association attended an autumn conference at the Higheross Restaurant, Leicester, on Saturday afternoon. The Chairman of the Association, Mr. W. K. Bedingfield, distributed the medals and prizes gained at the Abbey Park Show. A discussion on "Queen-Rearing" was opened by the Rev. J. F. Anderson, and proved of a profitable character to bee-keepers.

After tea, Mr. Geo. Hayes, secretary to the Notts Bee-keepers' Association, delivered an instructive lecture on "The preparation of honey for market and show." A discussion followed.

Prizes were given for the best single lb. bottle of honey of any year, and afterwards a judging competition was arranged. The exhibits were given to the Association, who decided to distribute them between the Hospital for Wounded Soldiers and Sailors, Home for Waifs and Strays, and the Infant Orphan Asylum in Leicester.

#### PRESS CUTTING.

##### ALL ABOUT BEES.

Another of the series of lectures which are being conducted under the auspices of the Doncaster Scientific Society, was given in the Science Room, Guild Hall, on Wednesday evening. The subject was "Apiculture," and it was thoroughly dealt with by the Rev. F. S. F. Jannings, F.E.S. A beehive and bee appliances of all sorts and conditions served to lend an added interest to the proceedings. Dr. Corbett presided over a small attendance.—From the *Doncaster Chronicle*.



[8987] *Using a Sugar-boiler's Thermometer.*—In making soft bee-candy as per "B.B.J." October 29th, and using a sugar-boiler's thermometer, at what temperature would you keep it for twenty minutes?—J. W. G.

REPLY.—When using a sugar-boiler's thermometer in making soft bee-candy, you must remove the pan from the fire immediately the right temperature is reached. This is 235degs. Fahr. It must not exceed 238degs. or the candy will be too hard, and will need more water adding and reboiling to the correct temperature.

## Notices to Correspondents

J. H. (Oxford).—*Troublesome Wasps*.—Close the entrances to one bee space. You may make a slide of perforated zinc for the purpose.

W. E. Moss (Hinckley).—*Bee Candy*.—The sample you sent is very good in every way. It is quite a success.

R. M.—No, it is not a misprint, as you will see by referring to the "B.B.J." of November 23rd, 1905. You have not observed our rule as to name and address.

J. Y. (Cambridge).—It does not exist there, so far as we know.

CARNARVON (Llandudno).—(a) Yes, the bees will repair them. (b) Keep in a warm, dry place, or put them back on the hives and allow the bees to clean them. See letter on page 405. (c) There is something wrong if they are in that condition. Do you take the combs containing brood away from the bees and store them during the winter, or do you mean combs that are left in the hive? If the former is the cause, leave combs containing brood in the hive. They should not be taken out and stored. In the latter case, can you send us a piece of comb containing brood?—and do not use the combs again.

A. W. B. (Lyonsall).—We are afraid you do not read your JOURNAL carefully. If you refer to the list of awards at last year's Grocers' Exhibition, you will find that in the class mentioned six H.C. cards were awarded, and at the Dairy Show this year two V.H.C. and seven H.C. cards were awarded, so the number you suggest was exceeded. Our space is limited, therefore these were cut out of our report this year. To give the description you name would require pages and would be of interest to but few of our readers. We can assure you there was not a single exhibit which could be described as rubbish. All were very good, a few were better than the others, and these won the prizes.

### *Suspected Disease.*

A. B. C. (Lichfield).—Both are suffering from "Isle of Wight" disease.

"BRUM" (Solihull).—*Bees Carrying Pollen*.—(1) For future use, there may, however, still be a little brood needing some now. (2) Yes, if they can obtain it. (3) Unless they are collecting enough to keep them going they will use some of their stores.

E. HERD (Egham).—The bees sent appear healthy.

T. D. M. G. S. (Marlboro').—The bees are suffering from "Isle of Wight" disease. Was you aware you had sent the dead queen?

H. G. A. (Littlewick).—They are affected with "Isle of Wight" disease.

### Special Prepaid Advertisements

**Two Words One Penny, minimum Sixpence.**  
Orders for three or more consecutive insertions entitle advertisers to one insertion in "The Beekeepers' Record" free of charge.

Trade advertisements of Bees, Honey, Queens, and Bee goods are not admissible at above rate, but will be inserted at 1d. per word as "Business" Announcements, immediately under the Private Advertisements. Advertisements of Hive-manufacturers can only be inserted at a minimum charge of 3s. per 3in., or 5s. per inch.

### PRIVATE ADVERTISEMENTS.

THREE stocks bees, in Standard hives, healthy, 25s. each, f.o.r.—CASE, Wootton Bassett, Wilts. v 47

HONEY, fine quality, light colour, in 1lb. screw top bottles, 8s. dozen; sample bottle, post free 1s.; also sections, 9s. dozen.—COWELL, Station-road, Sheringham, Norfolk. v 42

PURE Leicestershire honey, light, excellent quality, 28lb. tins, 16s., carriage forward.—EVERETT, 40 Linden-street, North Evington, Leicester. v 45

BEST heather sections, 10s. 6d. dozen; clover, 9s.; flower, 8s. 6d., carriage paid.—GLAISTER, Lazonby, Cumberland. v 38

GOOD heather sections, seven dozen, 12s. per dozen; cash with order.—J. REAVELEY, Starbeck, Harrogate. v 46

HONEY trophy of English plate, complete with tall bottles, to be disposed of immediately; what offer?—Hyvale, Amersham. v 51

SOMERSET clover honey, colour and flavour perfect, five 28lb. tins, £1 each, delivered.—WYATT, Bishopswood, Chard. v 50

HONEY, finest quality, 60s. per cwt.; sample, 3d.—W. COXON, Ambaston, Derby. v 49

APIARY, complete, for sale, about forty stocks; full particulars.—W., "B.B.J." Office, 23, Bedford-st, Strand, W.C. v 48

WANTED, half cwt. (bulk) good light honey.—PURCELL, Woodstock-road, Waltham-stow. v 44

EXTRACTED HONEY, good light, 1½ cwt., in four tins, 6d. lb.; tins returnable.—A. SIMPSON, Chalfont St. Giles, Bucks. v 40

PURE Cornish honey, in 28lb. tins, 65s. cwt.; sample, 3d.—CHAPMAN, Berrycombe-road, Bodmin. v 39

2½ CWT. finest quality honey, 60s. per cwt., in 28lb., 14lb. tins.—F. PENTNEY, Bromfield, Halesworth. v 35

FOR SALE, good quality heavy sections, 8s. 6d. per dozen; also extracted, in 28lb., 14lb., and 7lb. cans, 8d. lb., f.o.r. Winner of four firsts and silver medal at Essex County Show this season.—NASH, Dunmow, Essex. v 34



## MR. D. WILSON'S LECTURE.

(Continued from page 404.)

I wish to point out that there is a diversity of opinion as to the wintering quality of heather honey.

Some heather-going bee-keepers condemn heather honey totally as a winter food for bees, and make it a rule to take out as much store as possible, supplying syrup store in its place.

I myself am an advocate for wintering bees on heather stores, never having found it detrimental to them.

Indeed, observation has taught me that in my case, year in and year out, bees do better on heather than on fed stores. I have no desire here to restart a controversy which is very old, but merely point out this apparent discrepancy for the benefit of those who may be contemplating heather-going. The subject requires more investigation.

Certainly, when competent investigators in different districts have arrived at different conclusions when examining the effects of heather honey as a winter food, we cannot say that one set is right and the other wrong. Rather it may be said that both are right in their own location. Causes may be purely local. The moor-going bee-keeper must settle the question for himself in his own district, and, having settled it, must work accordingly, removing all stores if necessary and putting his bees on to combs filled with syrup or summer honey, or, on the other hand, allowing them to winter on their own sealed stores.

In conclusion, I wish to say that when a bee-keeper has arrived at a certain stage of competence in the management of bees in his home apiary, for what I have called, for lack of better definition, "one crop only," he cannot do better than turn his thoughts to heather-going.

When he has done so, and has completed one season's working only, he will be compelled to admit that he is only on the threshold of bee-keeping as a paying hobby, or even as a business.

He will find that many of his notions and much of his apparatus need overhauling and revising in view of what he has learnt on his first journey, and he will admit that his work, hitherto, at home has only been of an elementary type. There are so many other factors which enter into

the question that it is the beginning of a new course in bee education.

Much can be said to lighten the burden of the bee-keeper who intends to take the journey for the first time, and he can be warned against many pitfalls; but, after all, there is no school like experience, and a journey to the moor will make more impression on the bee practice of a beginner than months of teaching.

A personal experience of my own will go to illustrate what I mean. A young bee-keeper with up-to-date appliances was desirous of going to the moors for the first time. His hives were of the W.B.C. pattern. He came to me in 1913 and told me by what methods he was going to make the journey. I tried to lead him to see that these would hardly pay, but he was obstinate and inclined to think that he knew better, so I let it go at that. I understand that he travelled his bees in these W.B.C. hives with quilts in position, but giving them a little ventilation at the entrance by means of perforated zinc. Before he was far on his journey he had to borrow a saw to cut away the legs from the hives. Not much farther on he found the interior bodies were moving, and these he had to wedge with any material which came to hand. Before he got to the moors he had swung a hive from the dray, and had to take the mare out hurriedly and get her to a place of safety. More by good luck than good management he secured a crop, but this year I notice that his ideas have been revised, and that his hives are now suitable for transportation.

This closed the lecture, and the Chairman (Mr. Reid) asked the audience to put any questions on the subject of the lecture to Mr. Wilson. Among others the following questions were put:—

Mr. Frankenstein asked whether the heather on the moor mentioned by Mr. Wilson was Ling or Bell Heather. Mr. Wilson said it was Ling.

Mr. Eales asked how many years Mr. Wilson had been working for heather honey. Mr. Wilson: "I have had eight years' experience."

Mr. Crawshaw: "I should like to ask whether the lecturer does not consider that the shallow-frame brood-chamber might be of considerable service in moor going?"

Mr. Wilson: "I have had no experience in using shallow frames in brood-boxes. I should consider it would be a very desirable object to work for—to make the hive so that instead of a standard frame a shallow frame could be used, and for this reason, the more confined for room we keep our bees when at the moors, the more likely are we to obtain finished comb. The only point is, when it comes to wintering will they winter as well upon the

shallow combs as upon those in standard frames?"

Tea was then served and objects of interest brought to the meeting were examined. There were several sections brought by Mr. G. J. Flashman, of Barnet, in which the bees had eaten away the base of a large number of cells, leaving holes or passages right through the comb. Various opinions were expressed as to why the bees had done this, but no satisfactory explanation was given.



By Nemo.

*The Scent-Producing Organ of the Honey Bee*, by N. E. McIndoo, Ph.D.—This is a paper published in the *Proceedings of the Academy of Natural Sciences of Philadelphia* for August, 1914. The organ studied by the author is the one first noted and described by M. Nassanoff, which he found on the sixth abdominal ring. This was in the form of a canal, at the bottom of which a large number of small glands open, each one having an oval cell and a well-defined globule. To these glands Nassanoff ascribed an excretory function (see Cowan's "The Honey Bee," page 94, for fuller particulars). Later, in 1901, F. W. L. Sladen, who made a further study of this organ, considered it a scent organ, and by numerous experiments showed that at certain times, especially when bees are swarming, the organ is exposed and emits a pungent odour, which is attractive to their comrades ("B.B.J.," 1901, page 142). Dr. McIndoo has carried the work a step further, and by dissecting those parts carrying the organ has been able to give a detailed account of their structure. The paper deals entirely with the morphology of what he agrees with Mr. Sladen is a scent-producing organ. Besides the worker bees the author found that queens were provided with a similar organ, but the gland cells are at least one-third larger than are those in adult workers. In the pupæ of both queens and workers the structure of the gland-cells is similar. No analogous structure was found in drones, but the author does not think that this means that they have no scent-producing organ, because other parts of the body were not examined for glandular structures. In discussing the five types of scent-producing

organs in insects he points out that that of the honey bee is probably the most highly developed organ of the type. The paper is well illustrated and is a valuable addition to our knowledge of the subject.

*Destruction of Germs of Infectious Bee Diseases by Heating*, by G. F. White, M.D. (Bulletin, No. 92, Bureau of Entomology, U.S. Dept. of Agriculture).—The author has been carrying out a series of experiments to determine the temperature necessary to destroy the germs that produce diseases among bees. The subject is of importance to beekeepers, as heat is employed by them in one form or another to reduce losses due to such diseases. Hives that have contained infected colonies are scorched, honey is heated before being given back as food, and heat is used in the rendering of wax. It is therefore natural that beekeepers should inquire what amount of heat is necessary to destroy the germs of infection. The results of these experiments show that if maintained for ten minutes the maximum temperature for so-called European foul brood (the strong smelling of this country) is between 140degs. Fahr. and 149degs. Fahr. That for so-called American foul brood (our odourless) is between 194degs. Fahr. and 212degs. Fahr. The minimum temperature for Nosema disease lies between 131degs. Fahr. and 140degs. Fahr. The melting-point of beeswax is between 143.6degs. Fahr. and 147.2degs. Fahr. inclusive. As Mr. Root points out in *Gleanings* that beeswax used for comb foundation is usually kept at a temperature of 180degs. to 190degs. for not less than an hour, there is no chance of foundation carrying the germs. As regards American foul brood, he says that "while the temperature is probably never up to 212degs., yet the separate heatings and prolonged periods of heat are sufficient to kill all the germs." Dr. White found that at a temperature of 212degs. Fahr. the germs were destroyed in five minutes.



EXTRACTS AND COMMENTS.

By D. M. Macdonald,

"Wear White!"—Why, Mr. Lovell, in *Gleanings*, has again and again reiteratedly exclaimed, "Wear white when working among bees"; while he and

several others have given (unconvincing) so-called proofs that bees hate black and love white. All my own observations over a period of thirty years go to prove that to the bees it is six of the one and half a dozen of the other. Even Mr. Lovell admits in a recent issue as follows:—"A black garment suspended from a pole in the apiary receives no attention from the bees, and they will gather honey from a black paper as readily as from a white. Black alone will not excite their anger." For this, thanks! Bees, he admits, do not feel any hostility towards black for its own sake. That is my own experience entirely. Every other writer, I think, has taken up a different position. They hate black just because it is black. Now, Mr. Lovell theorises that simple black must be accompanied by something else. "It must be worn by some animal or human being near the bee yard, and the bees must be angry." It is only then apparently that bees go for black. A white, or semi-white, object is to them *transparent*; a dark object is *opaque*. Hence they make for the more distinctly visible form and neglect the *semi-transparent*. The reasoning appears to me to be very far-fetched.

*Destruction of Germs.*—I think the following facts, supplied by Dr. G. F. White, expert engaged in the investigation of bee diseases, Washington, U.S., are worth recording:—

(1) The minimum temperature for destroying foul-brood germs (what we look on as the mild type) lies between 140degs. and 149degs.

(2) For the virulent type the higher temperature of from 194degs. and 212degs. is required.

(3) For *Nosema apis* disease it is strangely lower than either of above cases, ranging from a minimum of 131degs. to 140degs. In all the three cases the time required is ten minutes boiling; and although he admits that future experiments may cause slight changes, nothing but comparatively slight changes can be expected. A scare is now and again started suggesting that wax may be a fertile source of spreading disease. To allay any sense of insecurity on this head it may be interesting to supply the following from Mr. Root: "Beeswax used in foundation goes through not less than three separate heatings. After the wax has been refined and clarified it has to be melted again on hot steam pipes before it can be sheeted, and the three heatings cover a total period of thirty hours. This would kill anything." I think anyone who has had the privilege of seeing the "tried" process as carried out by Messrs. Lee can rest assured that wax

foundation does not act as a "germ-carrier."

*Smoke Introduction.*—It would be well to "make haste slowly" in adopting this system in preference to the familiar and well tried plans of queen introduction which have stood the test of years. Many of the rank and file on the other side report that smoke has proved a failure, and with such a good all-round man as Mr. Byers, in Canada, more queens were lost than with the caging plan. Dr. Miller's verdict is: "We have tried introducing queens by the Arthur C. Miller smoke method, only to find it a failure in every instance." Several other prominent writers are about as emphatic. Even with a sincere desire to give the new method his blessing, the following is the best Editor Root can say: "While we have had *fairly good* success in introducing queens by the use of smoke, not a few of our subscribers apparently have not made a success of it, and are going back to the cage method. We thought we could recommend this method in place of the cage plan of introducing with all queens sent out; but apparently we would better stick to the old plan for a while yet." This is wise advice. While the man who handles bees and queens may be able to introduce safely with any system, or, indeed, with no system at times, I venture to say that the smoke method will never be generally popular in this country, where the fraternity consists mainly of "small" bee-keepers, each with his dozen or half-dozen hives—because bee-keeping with us is not a business.

*Drone Comb.*—The best place for drone comb is in the melting tank as quickly as possible. The only plan I ever care for drone comb is to mass a few combs on colonies from which drones for mating are desirable."

*Winter Stores.*—Mr. Holterman has a great preference for sugar syrup over even natural stores as a winter food for bees. He says: "I feel sure that the very best winter stores obtainable is sugar syrup. Clover honey may be its equal, but nothing its superior. What makes natural stores unsafe, where the bees are confined to the hive for months at a time, is the uncertainty of their composition. What makes artificial winter stores better is the certainty and uniformity of these stores if the best of granulated sugar is used."

*Honey Crop Report.*—"Taking it all in all this Report is exceedingly valuable, and we note with pleasure that the general Government is taking hold of this work and doing it so well." This is an important advance on the part of the U.S. Statistical Department, and one worthy of imitation by others. The yield per

colony in 1913 varied from 75 in Wyoming and Nevada down to 20 in West Virginia, and 21 in Delaware. In 1914 California and Wyoming stood highest with 75, and Missouri and Kentucky with 5 and 8. The Report shows also the proportion of comb extracted and chunk honey. The latter is about 16 per cent., and both the others stand about 42 per cent.—being all but equal.



*A Self-extinguishing Smoker* (p. 359).—"Right here," I want to fall foul of the Editor of *Gleanings*, and of "D. M. M.," for encouraging him. They suggest that a cork or plug should be attached by a string to the smoker for the ultimate purpose of extinguishing it. Imagine working with a smoker having such a pendant! Do they realise what would be the condition of the plug after a little use? I know very well, because I always use one. But I leave it on the shelf where the smoker lives, and there it is always ready to hand when the smoker is done with. There is no reason why it should not be tied to the shelf, but the worst place for it is dangling from the smoker. A temporary plug is readily made from a screw of paper or a wisp of grass.

*A Long Lived Lot* (p. 359).—Archaeological bee-keepers who have confirmed their beliefs by "the observation of centuries" would be able to compare notes with the proprietor of Mr. Heap's evolved microbe. Honey is no doubt the elixir upon which such patriarchs live, and the fact ought to be widely advertised. By the way, I wonder which of Noah's stalwart sons looked after the bees. Possibly the father of Canaan, whose descendants developed a land flowing with honey. But, as the "archives" are long destroyed, this is, as "D. M. M." would say, only a guess.

*Moving Bees* (p. 367).—From internal evidence it is clear to the hypercritic that the question really relates to the removal of bees. But if not, I would suggest that Mr. Bee Mason has had about as much experience as anyone of "moving bees" on a large scale during the winter months. Needless to say, he makes generous use of a "screen" for these non-hibernating bees.

*An Expert's Diary* (p. 370).—This story of the sparrow and the alighting-board is kin to that of the old lady who sent a pair of boots to her son by telegraph wire, and was satisfied to "find them gone" in the morning. Possibly the sparrow was but moribund, and had a rude awakening in the morning, so that he took to himself wings and flew away, or the cat may have been able to satisfactorily account for him. The origin of the belief in a meat diet is no doubt related to that of the Vergilian ox-tale. Conclusive evidence was obtained by, with, or from the offered ox himself in the oblation case.

*Evaporation in the Hive* (p. 371).—Heat is no doubt a prime factor in the evaporation, but I think that this is not a full explanation of the process. There is probably little difference in the temperature of the honey by day or night, and no certainty that the night temperature exceeds that of the day. Indeed, I should expect to find the average excess upon the other hand. The true explanation is that of the water-carrying power of the atmosphere. Thus a cool, dry night would be better for the purpose than a hot, moist day, and *vice versa*. The cool air, *i.e.*, cool by comparison with the hive temperature, is drawn in and warmed up, when its hygroscopic power is increased. It is then expelled laden with moisture, and on a cold night this moisture is suddenly deposited at the hive entrance. Usually the intake and exit are clearly defined by this means. The fanners are hard at work during the day as well as the night, and tests would probably show that evaporation was proceeding constantly. There is sound reason for the placing of the honey clear of the brood, as, if interspersed, the bees could hardly dry one without the other, and the currents of air are cleverly deflected to avoid this calamity. In the breeding season, cells containing thin honey or water may be found within the protecting wall of the cluster proper. It would be labour lost if heat alone caused these stores to disappear nightly.

*Skeps and Disease* (p. 373).—I agree with Mr. Hamshar that the discussion has wandered a little, but it doesn't seem to matter much. I am unable to agree about the "impossibility of removal" of disease. The idea in my critic's mind is, no doubt, the salvation of the stock. But that is just what is unnecessary, and which does not occur with regular "taking" of the hives under skeppist management. As to which hives *should have* the best queens I am unable to say, for many things have to be considered. But it is certain that the heaviest stocks would not necessarily possess them, and

that regular breeding from the heaviest stock would not necessarily improve the yield. My point was that the "middle-weight" queen might be closely related to the heaviest, own daughter, perhaps, and possess similar potentialities.



### PROCURING SURPLUS.

(Continued from Page 384.)

There are several other ways of removing supers which with practice and experience the bee-keeper will soon learn how to carry out. For instance, if the supers are left on until the end of the season the bees will gradually leave them to concentrate in the brood chamber. At that time of the year, if one rises about 4 a.m., the majority of them can be removed without a single bee being inside. Another method is to tilt the super with one hand, and slide the clearing board underneath it with the other. No. 6. (Fig. 15). The super is now lowered on to the clearing board, No. 7, then drawn back so that it covers the board. Both the super and clearing board are then pushed forward, No. 8, into position, No. 9. The next morning it will be free from bees and can be taken off, No. 10. If this is done carefully and the board kept tight down on to the top bars of the frames not a bee will be killed; as the board in its progress forward presses against them, they naturally run out of the way. When supers are being lifted otherwise than with the screwdriver they should always be twisted cornerwise first to break away brace combs or attachment by propolis which may occur. Sometimes they are stuck down so tightly that it is almost impossible to move them by either lifting or twisting with the hands. In such cases a sharp knock cornerwise will generally liberate them. This can be done with a brick, or failing anything more handy a sharp knock with the heel of the boot will do the trick. When this is done care must be taken to subdue the bees properly first, or many stings may be received.

It is best to avoid propolization by the use of vaseline. Spread the thinnest possible coat on all those parts of the super which will come into contact with the woodwork below it.

For removing supers the most effective subjugator is smoke; used judiciously this will not taint the honey. If a carbolic cloth is used, being damp, as it should be, there is danger of the honey being tainted. Many good samples of honey are spoilt in this way. In removing sections, as little subjugation compatible with the work in hand (which should only take a few minutes) should be carried out. If it is overdone, or the work prolonged, the bees will puncture the cappings with numerous small holes to get at the food (Fig. 16), and the value of the sections, if not spoilt altogether, is considerably reduced.

To obtain the best results, swarming must be prevented. This can usually be accomplished by giving attention to details. Position of the hive is one factor, and is dealt with elsewhere. Ventilation in very hot weather is absolutely necessary. This can be given by turning the roof cornerwise, but it is necessary for one to be close at hand to replace it to keep out the wet should a rainstorm come on. Also it means attention each morning and evening. The best method of giving ventilation is by propping up the brood chamber all round, as illustrated in the chapter on natural swarming. In the natural home of the bee, in a hollow tree or other position, ventilation is always obtained at the bottom. On no account must ventilation be given by means of a draught right through the brood chamber or the brood

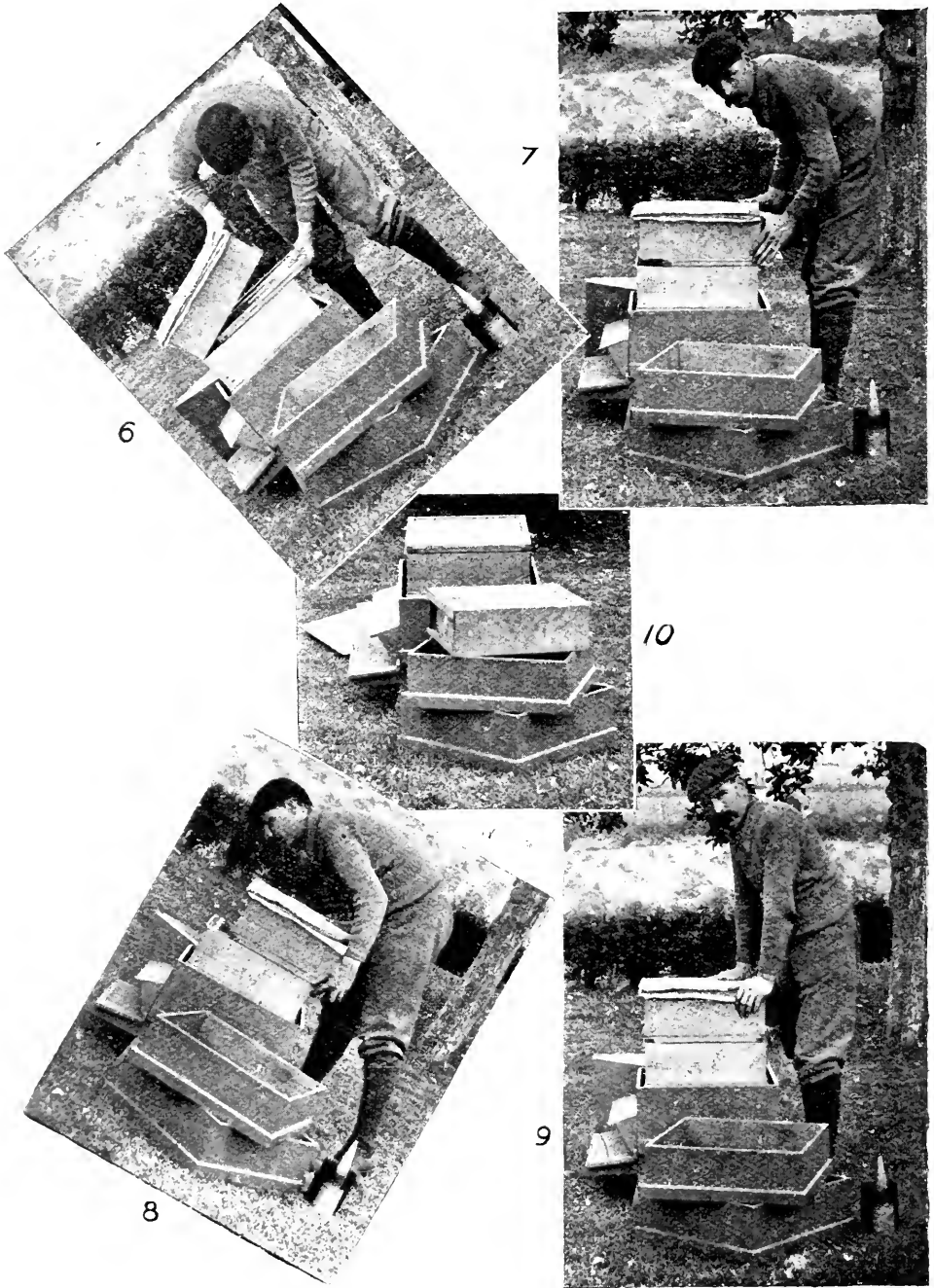

FIG. 15.



will be chilled. The method recommended avoids this. As soon as there is a scarcity of bee flowers, the brood chamber must be lowered or robbing will take place.

Having considered in detail the methods adopted for procuring extracted honey, we now turn to those comb-honey. In the there is very little bee-keeper beyond pre-the supers at the right rest. With sections the great deal depends upon requires considerable ex-saleable ones can be sideration is the sections. patterns, most of which 17), Nos. 1, 2 and 3 No. 1, plain; No. 2, and grooved for the 6 are four bee-way. above. Nos. 7, 8, 9 second descriptions as "Which is the better to use, two or four bee-way?" is a question repeatedly asked by the bee-keeper. Personally, I have found the two bee-way give the best results. The comb is built up to the woodwork of the section better in these than in the four bee-way, the reason no doubt being that there is a dead stop for the bees to work up to, whereas in the four bee-way the bees pass through the sides as well as top and bottom. As a rule they leave off about

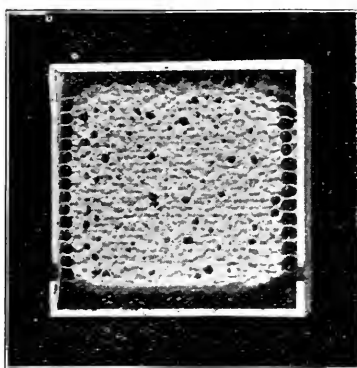

FIG. 16.

necessary for obtaining case of the former, trouble entailed by the paring and putting on time. The bees do the case is different, as a human agency, and it pierce before good, obtained. The first con- These are of varying are illustrated at (Fig. being two bee-way, split top; No. 3, split foundation. Nos. 4, 5, second description as are no bee-way sections, for the top three.

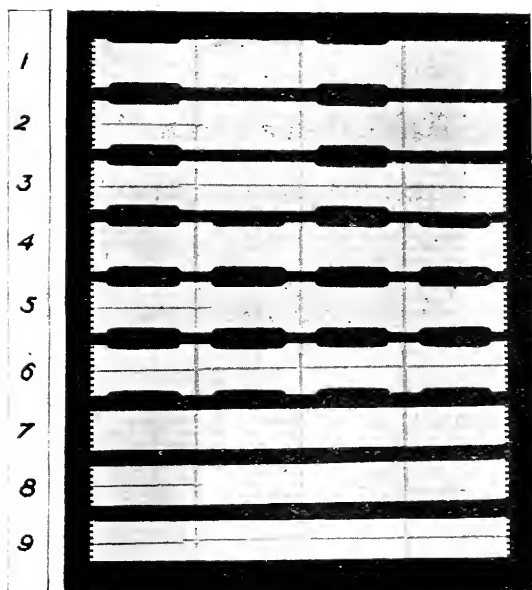

FIG. 17.

two-fifths of an inch from the wood, *i.e.*, two rows of cells, to enable them to pass through more readily. The free passage from all sides is claimed as a great advantage in the work, but I have not found this confirmed in practice. The no-bee-way sections have not found much favour and are used to-day by very few. Probably the necessity of having a special divider (Fig. 18), No. 1 plain, No. 2

slotted or gate, prevented a great many from taking them up. I have seen very good work produced by means of the no bee-way section, and would certainly prefer them to the four bee-way. The section used should be the  $4\frac{1}{4}$  in. by  $4\frac{1}{4}$  in. by  $1\frac{1}{2}$  in. as this produces the best work and does not need a special rack. At one time a section measuring 5 in. by 4 in. by  $1\frac{3}{8}$  in. was strongly advocated. The advantages claimed were that they sold better, as they presented a larger comb surface when exposed for sale. A buyer looks all ways at an article he is going to purchase, and quickly sees the difference in thickness. We had good evidence of this when a few years ago at the Grocers' Exhibition, at the Royal Agricultural Hall, London, the Canadians brought over with their exhibit of produce from that colony a large quantity of narrow sections which they tried to sell at a much lower figure than the pound sections produced in this country. Very frequently I saw them nonplussed by the taking the section in it critically and report more than three-in weight. No rather pay a little English pound second to dispose of the great loss, since which been sent to Great how this is working seeper in America, I *Gleanings*, of August *re* the new net weight says:—"It may be older readers of the years past I have the use of light-weight use them at all myself. to me too much like our customers to sell ounce section when thinking that they of honey for the lieved then, and do tice is an offence in the believed that He would to punish those who tice." Another that the honey ripens this is a debatable we take it for

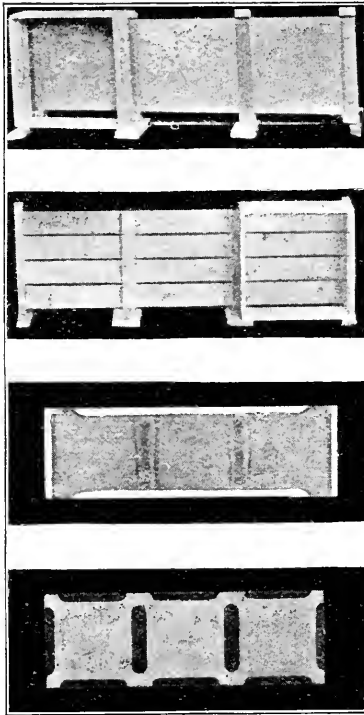

FIG. 18.

is the case, and balance it against the extra amount of wax needed to seal the larger surface, we find the  $4\frac{1}{4}$  in. section has the advantage. The claim that it can be worked in frames interspaced with shallow combs is also advanced in its favour. With regard to this, it is not true that a multiplicity of appliances and methods in one super gives indifferent results and is a nuisance in manipulation? One thing at a time, &c., applies here. Briefly the disadvantages are (1) that to use the tall sections it is necessary to have special appliances in the form of section racks, frames and dividers; (2) special glass or cases are necessary for glazing; (3) they are top-heavy, and do not stand firmly, being easily knocked over by a slight touch or jar. I have seen them fall off the staging at a show simply through the vibration caused by a person walking by; (4) their thinness makes the buyer look with suspicion upon them.

prospective purchaser his hand, balancing marking, "But this is quarters of a pound thanks; I would 1 more for a genuine tion"; and so they consignment at a time no more have Britain. To show out against the bee- 2 take the following from 15th, 1914. Writing law, T. K. Massie remembered by the bee-journals that for seriously objected to sections, refusing to 3 It has always looked taking advantage of them a 12, 13, or 14 the customers were were getting a pound price charged. I be- now, that such prac- sight of God. I use the works of man followed that prac- advantage claimed is quicker in a thincomb: point, but suppose granted that such

(To be continued.)



## CORRESPONDENCE.

*The Editors do not hold themselves responsible for the opinions expressed by correspondents. No notice will be taken of anonymous communications, and correspondents are requested to write on one side of the paper only and give their real names and addresses, not necessarily for publication, but as a guarantee of good faith. Illustrations should be drawn on separate pieces of paper. We do not undertake to return rejected communications.*

### HOLIDAY NOTES.

[9095] Having just returned from holiday in the Isle of Man, I thought it might interest your readers to know what a Mecca for bee-keepers the little island is. Nearly every village has one, and sometimes two or three, bee-keepers, and in all my rambles—and I have traversed most of the roads and lanes and a number of the paths—I did not see a single skep, but all modern frame-hives. At the little village of Glen Maye, near Peel, I had a most interesting chat with the wife of the Postmaster, who has a flourishing apiary of some thirty hives. He holds the record for the Island for the crop from one hive, and, I should think, for the whole of the British Isles too, having taken 345lbs. from one single stock! This was some years ago. He works entirely for extracted honey, and has many ingenious devices of his own invention—one in particular for catching swarms he finds most useful, as his grounds are surrounded by very tall trees, high up which the bees invariably tend to cluster. He therefore invented the ingenious device by which he catches them. Some of the hives are on the roof of an abutment of the house, and he has a cradle worked by a cord on a pulley track, by which he lowers or raises colonies as required.

The crop this year is late, he had only just commenced extracting in the middle of July. At Kirk Michael, where there are two flourishing apiaries, none had been taken right up to near the end of the month.

At the Point of Ayre, one of the light-house keepers has several hives, and from these he obtains nothing but heather honey, since no other forage grows anywhere within two miles. His harvest, of course, is late, but he does well, and finds that there is a bigger market for heather honey in Ramsey than can be met by the supplies from all around. His bees winter well on the heather honey they collect.

"Isle of Wight" disease is practically unknown, but one man has it now; he disregarded the advice of his fellow bee-

keepers and imported stocks from the mainland, and in these the disease appeared. They are all hoping that it will not spread, but are naturally nervous, and there is no Act by which he can be compelled to destroy the colonies. This seems a pity, but even with this doubtful spot the Island remains a very happy hunting ground for bee-keepers.—A. B. H., Leytonstone.

### CURIOUS SWARMING.

[9096] I had a doubled hive; finding some brood on all ten frames in top half, and making sure the queen was down below, I removed this top half to a new situation on May 11th. Expecting a large number of bees to return to parent hive, I put on wire excluder and three racks of sections; although the bees went up they gave off a large swarm—6lbs. to 7lbs.—on May 17th. On examining this parent hive, I found nine combs of brood and one of honey, which latter I replaced with foundation, but, to my astonishment, not one single queen-cell, not even an "acorn." I returned this swarm and requeened the removed portion with a 1914 queen on May 17th but again, to my astonishment, they swarmed (a good 5lbs.) on May 21st, making well over 11lbs. from one queen in five days. This new queen had not laid a single egg up to that time.—A NOVICE.



## QUERIES AND REPLIES.

[8988] *Candy Sample.*—I enclose sample of candy and shall esteem it a very great favour if you will kindly give opinion in the next issue of your valued JOURNAL. If not right I shall be laid under a deep obligation if you will please say where I am wrong. I boiled by the thermometer and took it off exactly at 235degs. Fahr. I thank you very much for all past favours and in anticipation. I have found the JOURNAL of inestimable help again and again, and I personally appreciate very much all your devoted and untiring efforts on behalf of the craft.—"SUFFOLK." Leicester.

REPLY.—It is rather too hard, and also tastes smoky. The candy should be soft enough to be easily scraped up by the thumb-nail into a buttery consistency. Try boiling to a lower temperature by your thermometer, say 233degs. or 234degs. Thanks for your appreciation. The number of letters of the same tone that we receive is very encouraging.

## THE PRINCE OF WALES'

AND

## BELGIAN REFUGEES' FUNDS.

In response to Mr. Smallwood's appeal in the RECORD for November we have received the following:—

For the Prince of Wales' Fund: Miss I. H. Jackson, £1 1s.; Miss R. F. Garratt, 5s.

For the Belgian-Refugees' Fund: Miss E. M. Woods, Vols. 27, 29, and 30 of THE BEE-KEEPERS' RECORD, bound and one copy of "The Irish Bee Guide"; Miss L. C. Jones, 2½ lbs. beeswax; Mr. R. A. French, 5s.

## Notices to Correspondents

H. J. A. (Barlow).—*Various Queries*.—

(1) The comb appears all right; you may use them next season. (2) We cannot say, so much depends on circumstances. Either plan will work, but you are more likely to get surplus by making two colonies into three. (3) You may if you go through them about twice a week, but that is neither practicable nor desirable. (4) It is sometimes the only way to prevent natural swarming. Give the bees plenty of room, rather in advance of their requirements—that is, do not allow them to become overcrowded, so that they hang or cluster at the entrance to the hives. In hot weather raise the brood-chamber about 1 in. by means of small blocks of wood at each corner. See "Helpful Hints" in this issue. (5) If you can procure wood dividers ½ in. thick they will be all right, but do not use those made of very thin wood, rather use some made of stouter tin.

T. OVERTON (Shorncliffe). *Buying Diseased Bees*.—In equity he should refund the money in full. We cannot say if you would succeed in law, it would all depend on the view a County Court judge might take of the matter.

ENQUIRER (Clonty).—*Moving and Wintering Bees*.—If you are moving the bees now, give some ventilation at the top, but it is not necessary to give so much as in warm weather, especially as the distance is so short. Yes, remove the dividers. Another rack of shallow combs with no queen-excluder between would have been better.

PERTSHIRE BEE-KEEPER.—*Prevention of "Isle of Wight" Disease*.—We are

afraid you can do very little. Disinfect the hive with Izal and medicate the food (syrup or candy) with one of the remedies advertised in the JOURNAL. Sprinkle lime on the ground round the hives and see that the bees have access to perfectly clean water when it is needed.

"CARMARVON" (Llandudno).—Yes, the combs may be used again.

### Suspected Disease.

A. B. C. (Plumstead).—The bees are suffering from "Isle of Wight" disease. There was no need to send comb containing honey. It should also have been put in a tin box. The cardboard box had allowed the honey to leak, so that the *outside* of the parcel was sticky. You may imagine the state of the bees and letter. Also please note our address is 23, Bedford Street.

I. C. (Bath).—The bees are suffering from "Isle of Wight" disease. The small insects are the Bee Louse (*Braula cæca*).

## Special Prepaid Advertisements

Two Words One Penny, minimum Sixpence.

Orders for three or more consecutive insertions entitle advertisers to one insertion in "The Bee-keepers' Record" free of charge.

Trade advertisements of Bees, Honey, Queens, and Bee goods are not admissible at above rate, but will be inserted at 1d. per word as "Business" Announcements, immediately under the Private Advertisements. Advertisements of Hive-manufacturers can only be inserted at a minimum charge of 3s. per ¼ in., or 5s. per inch.

## PRIVATE ADVERTISEMENTS.

FINEST Leicestershire honey, 15s. 28½ lb.; sample, three stamps.—WHEATCROFT, Ashby-de-la-Zouch. v 14

FOR SALE, ½ cwt. light honey, granulated, good quality, 27s. 5d.; ½ cwt. dark, for 25s.; sample sent, 6d.—J. WHITE, Fairstead Hall, near Witham, Essex. v 55

FOR SALE, a set of forty lantern slides on Bee-keeping, very cheap, owner not having further use for them, almost new.—CROWE, Bartlett House, Stawell, Bridgwater. v 52

THREE stocks bees, in Standard hives, healthy, 25s. each, f.o.r.—CASE, Wootton Bassett, Wilts. v 47

HONEY, fine quality, light colour, in 11b. screw top bottles, 8s. dozen; sample bottle, post free 1s.; also sections, 9s. dozen.—COWELL, Station-road, Sheringham, Norfolk. v 42

BEST heather sections, 10s. 6d. dozen; clover, 9s.; flower, 8s. 6d., carriage paid.—GLAISTER, Lazouby, Cumberland. v 38

GOOD heather sections, seven dozen, 12s. per dozen; cash with order.—J. REAVELEY, Starbeck, Harrogate. v 46

2½ CWT. finest quality honey, 60s. per cwt., in 28½ lb., 14½ lb. tins.—F. PENTNEY, Bromfield, Halesworth. v 35

FOR SALE, good quality heavy sections, 8s. 6d. per dozen; also extracted, in 28½ lb., 14½ lb., and 7½ lb. cans, 8d. lb., f.o.r. Winner of four firsts and silver medal at Essex County Show this season.—NASH, Dunmow, Essex. v 34



## ERRATA.

We regret that owing to an error "Reviews" were last week placed under the heading of "Reviews of Foreign Bee Journals," instead of in the "Editorial" column.

In "Helpful Hints," ninth line from bottom of page 416, read "is it not" for "it is not."

## REVIEWS.

*Honey Bees as Pollinizers: A Valuable Adjunct to the Horticulturist*, by Susan M. Howard (Bull. No. 8, Apiary Inspection, Massachusetts State Board of Agriculture, Boston).—The author of this bulletin treats the subject as a fruit-grower as well as a bee-keeper, so that she is able to appreciate the inestimable value of the honey bee as a pollinizer of certain grains, small fruits, vegetables and fruit trees. To-day the honey bee is more and more considered as an invaluable ally of the farmer. The orchardist and small fruit-grower consider their colonies as a part of their equipment. Thus, while the ultimate aims of the horticulturist and bee-keeper may be different, yet they are interdependent. The author shows the advantage to be gained by having sufficient colonies at hand among the trees of an orchard, and points out a factor of importance in this connection, that the distance at which bees gather pollen is limited, seldom exceeding one-half mile, which emphasises the desirability of bees at close range. She points out that hand pollination is a tedious and expensive process, and for this reason thousands of colonies of bees are used in Massachusetts, by growers of cucumbers. Unfortunately, many or most of these bees are sacrificed as the growers make little or no effort to save the colonies which have served for this purpose in the green-houses. Mrs. Howard shows the advantages of cross-fertilisation, and discusses the interrelation of spraying and bee-keeping. The testimony of the farmers in the vicinity of the author's apiary is convincing even to the most sceptical as to the value of bees.

*Soft Candy for Bees*, by Dr. Burton N. Gates (Bull. No. 7a, Apiary Inspection, Massachusetts State Board of Agriculture, Boston).—In this pamphlet the author dis-

cusses the advantage of candy as food for bees, and gives instructions for preparing it. The illustrations show the various receptacles for it and the way they are used. He recommends a soft candy as having numerous advantages, as it can be used as a most satisfactory stimulative food, or as winter stores. A modification of English candy is made from the following recipe, which is practically a confectioner's recipe for fondant:—12lbs. granulated sugar, 1½lbs. liquid glucose, 1¼qts. water (equal 40ozs.), ¼ teaspoonful (about) cream of tartar, added when the temperature reaches about 230degs. Fahr. Boil to 238degs. Fahr.

The measurements should be accurate. As soon as the sugar has begun to dissolve, *prior to boiling*, the spoon or paddle used in stirring should be removed from the kettle. *The candy should not be stirred while cooking*; to do it will cause a coarse grain. Remove from the stove and cool to 125degs. to 130degs. Fahr., when the specified boiling point has been reached. While cooling, in order to equalise the temperature, the mass may be stirred; or preferably, when cooled to the specified degree, it should be stirred until it commences to grain. Mr. Fuller's directions are to stir vigorously until the mass appears in colour and consistency like boiled starch or paste. At once pour into moulds or feeders and cool.

## THE CONVERSAZIONE LECTURE.

By Mr. A. Richards.

## BEES IN RELATION TO FLOWERS AND FRUIT.

It must not be expected that I am going to give you anything really new this evening, all I hope to do is to present an old subject in a fresh dress and illustrate it with slides which will convey its importance more readily to your minds, and probably give an insight to some of the younger members into a subject which was so masterfully dealt with by our President, Mr. Cowan, five years ago, when I myself obtained my first comprehensive glimpse of this most wonderful study.

I shall hope to show you how interdependent the different sides of nature are, and how flowers, fruit and insects depend the one on the other for the continuance of the race.

Reproduction in the botanical world is dependent upon the rudimentary seed in the seed pod of the flower becoming fertilised by the life-giving germ called pollen, which develops on the *Anther* of the *Stamen*, or male organ of the flower. This pollen must be transferred to the *Stigma* of the flower, and from thence it strikes roots through the channels in

the *Pistil*, which is that portion of the flower below the *Stigma*, and communicating with the ovaries or seed-pods, where the rudimentary seeds develop.

The following slide will fully explain the process, and it may be taken as the basis of all flower fertilisation. The transfer may be effected in three or more ways: (1) By means of the wind; (2) artificially or hand; (3) by insects. Or, as is the case with the *Begonia*, the pollinizer may be a separate flower set above the flower containing the seed-pod and upon the *Stigma* of which the pollen may drop when ripe by means of gravitation.

Artificial transference of pollen is of course unnatural, and is only effected by gardeners in the peach-houses of the wealthy or for experimental purposes. Wind pollinated plants have certain characteristics, such as no nectaries to attract the insects, for the same reason they are generally inconspicuous and devoid of the bright colours we associate with the word flowers. They also produce pollen in wasteful profusion to the exhaustion of the plant.

It has been estimated that one head of maize produces fifty million grains of pollen, and the American *Pinus* produces it so plentifully that its fall from the tree is known as sulphur showers. This brings us to our third method, viz., the transference of the pollen by insects, and so directly to the subject of bees which are by far the most important of all insect pollen-carriers, and in this instance let me quote a short paragraph from a paper given by Mr. Cecil Hooper at the Linnean Society of London, in December, 1912:—

“Out of nearly 3,000 insects observed this spring visiting the blossoms of the various fruit bushes and trees, 83 per cent. were hive-bees, 5½ per cent. bumble and other wild bees, and 6½ per cent. flies, ants, beetles, wasps, and other insects; but the latter group have not fluffy bodies for carrying and transferring pollen, and chiefly amuse themselves eating the pollen, and are not therefore proportionately as useful as the hive and wild bees.”

Bees have not always been referred to in these terms by fruit-growers, and prejudice still exists against them in some quarters of this enlightened island.

Our friend Mr. E. R. Root had an experience some years ago where he considered it best to advise the bee-keepers in one particular part of his country to remove their bees entirely for a season, as the prejudice against them was so strong by reason of the fact that Professor Waite, of the U.S. Department of Agriculture, had stated that the spread of pear blight in the neighbourhood was probably due to their agency.

The blight continued despite the absence of bees, and spread to trees which never blossomed, and so were unvisited by bees. The true cause was discovered later and bee-keepers and fruit-growers are now living amicably together.

(To be continued.)

---



---

#### BRITISH BEE-KEEPERS' ASSOCIATION.

The monthly meeting of the Council was held at 23, Bedford Street, Strand, London, W.C., on Thursday, November 19th, 1914. Mr. C. L. M. Eales presided. There were also present, Miss M. D. Sillar, Messrs. O. R. Frankenstein, E. Watson, J. Smallwood; Association representatives—G. Bryden (Crayford), F. Harper (St. Albans), G. J. Flashman (Barnet), G. S. Fauch (Essex), and the Secretary, W. Herrod.

Letters regretting inability to attend were read from Messrs. T. W. Cowan, F. W. Reid, A. G. Pugh, A. Richards, G. R. Alder, D. Seamer, and H. P. Perkins, Sir Ernest Spencer, Dr. W. Auderton, and Rev. F. S. F. Jannings.

Mr. J. A. Roberts was elected a member of the Association.

The report of the Finance Committee was presented by Mr. Smallwood, who stated that payments into the bank for October were £14 11s. 0d. The bank balance at the end of October was £172 13s. 7d. Payments amounting to £12 15s. 5d. were recommended.

The report on the judging competition, held at the October *Conversazione*, was sent by Mr. A. G. Pugh, and adopted as follows:—

Sample No. 1: White clover predominating, red clover secondary, with a trace of ordinary field flowers. Various competitors described this sample as being gathered from acacia, cherry, sainfoin, lime, and fruit blossom; no traces of pollen grains of any of these kinds were found upon microscopical examination.

Sample No. 2: A dark-coloured honey containing clover, lime, bean, hawthorn, fruit blossom, and dandelion, with a very perceptible lime flavour. Several competitors, no doubt led astray by the dark colour, described this as heather honey; as a matter of fact, no heather grows within ten miles of where it was gathered. Some others described it as honey-dew, of which there was no trace.

Sample No. 3: White clover and a little lime. This was allocated by various competitors to sainfoin, ragwort, and apple bloom, whilst another, evidently not knowing the peculiar “minty” flavour of lime honey, described it as from “mint.”

Sample No. 4: Clover and heather blend, probably about half clover and half bell heather, and slight trace of ordinary field flowers. Only three competitors missed the heather in this sample, two of whom classed it from beans and the other as fruit blossom honey. One went so far as to describe it as ling honey, whereas the consistency should have told him better. Several classed it as heather instead of heather blend.

Sample No. 5: White and red clover, with small quantity of wild flower honey, extracted from combs that had contained bell heather honey previous season. Few competitors got full marks here, as it was variously described as sainfoin, hawthorn, fruit blossom, lime, and barberry, none of these sources being available when and where this sample was gathered. Another competitor described it as ling heather, although the sample was sufficiently light coloured to be entered in a "light-coloured" honey class.

Sample No. 6: A very mixed sample, containing white and red clover, lime, fruit blossom, dandelion, hawthorn, raspberry, &c. Here again two competitors claimed it as heather honey, although no trace of heather was contained in it. Three others described it as honey-dew although none was present.

Sample No. 7: Practically all white clover. Competitors here went less astray than in any other sample, although two described it as sainfoin, and two others as lime honey.

Sample No. 8: About two-thirds clover and one-third sainfoin, the latter giving the predominant flavour. Several competitors classed this sample as from charlock, whilst one thought he detected syrup in it and another went a long way astray by describing it as fruit blossom honey.

For award of order of merit, sample No. 7 had been selected as first prize, and only three competitors failed to place it as first or second in their list. Sample No. 1, the second prize award, was considered first by two competitors, whilst thirty per cent. missed it altogether. Sample No. 8, the third prize award, secured first with three competitors, but was missed altogether by half of them. Every sample gained some recognition by the competitors, including the heather sample, which was expressly ruled out of the competition, whilst half the samples got premier honours at hands of some one or other of the competitors.

Mr. Joseph Price, Haden Hill, Old Hill, Staffordshire, is awarded first prize; Mr. S. H. Smith, 4 Halewood Villas, Kew Gardens, takes second prize, and is closely followed by Mr. T. Riley, of Beeston,

Notts., who is only one point behind prize winners.

The Committee are greatly indebted to Mr. Geo. Hayes for his microscopical analysis of the samples.

The Council may congratulate themselves upon the results of this first important effort in "judge training" as the competitors will gain much valuable information by comparing their duplicate forms with particulars given above, and it is to be hoped that competitions of this character will now be a prominent and interesting feature at all important shows or gatherings of bee-keepers, and that large numbers will participate in a friendly spirit of rivalry something on the lines of the old bee-driving competitions, which were at one time so popular at our honey shows.

A hearty vote of thanks was unanimously passed to Mr. A. G. Pugh for the great trouble and care with which he had prepared the report.

The Secretary was instructed to arrange for the insurance scheme on the same conditions as last year.

A letter was read from the Royal Agricultural Society of England stating that owing to lack of the usual support on account of the war no grant could be made for prize money and other expenses for the hives and honey department at the Royal Show to be held at Nottingham in 1915. Several other departments have been eliminated altogether, but they offered to provide the building, &c., if the Association could manage the rest. Mr. Watson proposed, Mr. Bryden seconded, and it was carried that the Editor of the BRITISH BEE JOURNAL be asked to insert an appeal and open a list for the receipt of donations to raise the necessary sum. A prompt response was immediately made by some of those present.

Miss N. M. Robinson, Miss H. Thrupp, Mr. G. F. Harper, and Mr. G. G. Desmond had earlier in the day attended before the Board of Examiners to lecture for the Final Examination, and upon their report, presented by Mr. C. L. M. Eales, it was resolved to grant all four the Expert's Certificate.

Next meeting of Council, December 17th, 1914, at 23, Bedford Street, Strand.

---



---

#### BRITISH BEE-KEEPERS' ASSOCIATION AND THE ROYAL SHOW FOR 1915.

As will be seen from the report of the Council meeting above, the Royal Agricultural Society of England, like a great many other institutions, is suffering finan-

cially on account of the war. The R.A.S.E. have met the Council very generously by offering to provide the building free of cost, but is unable to make a grant for next year's show. It is felt that it would be a great pity to break even for once a connection extending over thirty years. The Council have therefore decided to carry on the department and provide the funds themselves.

That each one may help, even by means of very small sums, and no one feel slighted, they have decided to open a fund for the reception of donations, which may be sent to the Secretary, 23, Bedford Street, Strand, London, W.C., a list of which will appear in our pages. We are sure exhibitors and bee-keepers generally will respond quickly, so that the Association may retain its position in the largest agricultural show in the world.

Donations already promised:—

	£	s.	d.
T. W. Cowan .....	2	2	0
C. L. M. Eales .....	1	1	0
O. R. Frankenstein.....	1	1	0
W. Herrod .....	1	1	0
G. Bryden .....	0	10	6

#### SHEFFIELD AND DISTRICT B.K.A.

The second annual show of the Sheffield and District Bee-keepers' Association was held in the Corn Exchange in conjunction with the Annual Chrysanthemum Show on November 12th to 14th inclusive. A great improvement had been made in the staging of the exhibits, and an attractive addition was the two effective trophies staged by Messrs. W. Garwell and P. Ridge, the former taking premier honours and winning the B.B.K. Association's bronze medallion. Some excellent clover and heather honey was staged, and some fine samples of wax were a pleasing feature of the show. The energetic secretary, Mr. W. Garwell, exhibited an observation hive made entirely from the measurements and details furnished by the B.B.K. Association's Secretary in the JOURNAL. Mr. W. E. Richardson, hon. secretary Yorkshire Bee-keepers' Association, acted as judge and made the following awards:—

*Six Jars Light-coloured Honey.*—1st, W. E. Tomlinson; 2nd, W. Garwell; 3rd, J. H. Berry.

*Six Jars Granulated.*—1st, W. Garwell; 2nd, P. Ridge.

*Six Jars Heather Honey.*—1st, W. E. Tomlinson; 2nd, S. Livsey; 3rd, H. E. Garwell.

*Six Jars Granulated Heather.*—1st, J. H. Berry; 2nd, W. Garwell; 3rd, W. E. Tomlinson.

*Six Clover Sections.*—1st, W. Garwell; 2nd, T. Beaver.

*Two Shallow Frames Light Honey.*—1st, E. S. Garwell.

*Two Shallow Frames Heather Honey.*—1st, W. E. Tomlinson; 2nd, E. S. Garwell. *Wax.*—1st, E. S. Garwell; 2nd, J. H. Berry; 3rd, W. Garwell.

*Honey Cake.*—1st, Mrs. Tomlinson; 2nd, Mrs. Watson; 3rd, Mrs. Livsey.

*Display of Honey and Wax, &c.*—1st and bronze medal, W. Garwell; 2nd, P. Ridge.

#### "BLURTS FROM A SCRATCHY PEN."

BEGGARY.

I am a beggar! You never know your fortune. For many years I have done my best to be respectable, but here at last I have come to begging. But "To dig I am not able, to beg I am ashamed," was never meant for me. I am an impudent beggar. I have no shame, or, rather, I glory in my shame. Why? Because I am not begging for myself, but for others, and those others heroes, who when the history of our day is written—now it is in making—will stand out worthy as any whose deeds have been recorded in any chapter in any record of any country's glories. I am begging for those who have stood to defend our country, those who made of Liège a Thermopylæ, who blocked the way, until their fellow heroes of France and Britain were able to come to their help. 'Fore Heaven! When one knows the authenticated atrocities, perpetrated by those who on their canting lips have always the name of Heaven's God, it is enough to make the veriest coward of us all, snatch up the rifle to avenge. And we know that were it not for these, who have not reckoned as worthy of counting their own lives and wounds, our own towns, our own villages would have been harried, burnt, and looted, our own people driven like animals into the woods and fields (for they have no friendly country of refuge). When we think of all these things, what sacrifice is too great, what self-denial is too much? You can never compensate the refugee for the bright, sunny home in Belgium he has had to give up or for his kin massacred. You can never give back to that widowed soldier's wife her husband, nor to that crippled soldier the limb or the eye he has given in *your* service. But you can share some of the comforts you have, because of their valour, with them; the greater your mortification, the greater your reward. You can try to make their exile less hard. You can smooth the years of the widowed mother who has given her



boy. All can help. It is the accumulation of grains of wheat which make up the bushel. We cannot all go out and fight, but we can pay. They say my years forbid me to shoulder the rifle, that I must stand aside and watch. Nay! That I cannot do. I must do something. Well, then, I'll beg.

And now to bee-keepers. There is not an association, there is not a society, I doubt if even there is any village club which has not contributed some of its funds to the great National Help and Relief Funds. There are few periodicals which have not opened their columns to appeals. The BEE JOURNAL is never going to be behind in this. Its Editors will gladly receive and administer any contributions. The Prince of Wales' Fund, the Refugees Fund, the Fund for Wounded Soldiers, all are imploring for assistance. "Buck-up, bee-keepers," cannot you do anything to make a decent "show"? Some can send money—not all. It is recognised that there are, and have been, so many demands. Of course money will be gladly received, but you can also send some things that can be turned into money. Send honey, send wax, send spare appliances, books—anything. There is a money value to everything. In the November *Record* an appeal was issued, and in reply was received books, wax, golf clubs, typewriter, money, and various other "baggage," all of which are fundable. These are mentioned as an illustration. Readers of the BEE JOURNAL are notoriously generous. There has never been an appeal made in its columns which has not been well responded to, and I think it would be a very safe "gamble" to say that this will be the same. And one thing more: Don't delay. It seems most probable, as far as man can judge, that in the next few months the necessities will be the greatest; the winter is severe, the fighting is severe, and the poverty is great. Give then, give freely, and give quickly.—JNO. SMALLWOOD.

#### INSTRUCTIONS IN BEE-KEEPING.

The following, taken from *The American Bee Journal*, will give an illustration that it is not necessary to repeat the saying, "Wake up, Great Britain," for everything. The writer saw his first demonstration at a show over thirty years ago:—

"Dr. Gates spoke of the plan of the Massachusetts Agricultural College whereby it will be possible to demonstrate the fundamental principles of bee-keeping at the large fairs in Massachusetts this fall. Arrangements have been completed to attend the Fitchburg Fair, the New England Fair at Worcester, the Brockton Fair, and the fair at Northampton in October.

"At each of these will be an extensive equipment, consisting of a demonstration tent, supplied with a work bench and display tables, and a cage in which demonstrations of handling bees will be made, together with a small model apiary. The display will also include the most recently approved methods used in bee-keeping. Demonstrations will be given daily by various authorities. This is probably the first attempt to promote apiculture through the medium of agricultural fairs."

#### BELGIAN RELIEF FUND.

We have received the following letter from Mr. Ballard:—

Beeholme, Aldington, Evesham.

DEAR SIRS,—I beg to inform you that as a result of the note which you so kindly inserted in "B.B.J." for November 12th, *re Limnanthes Douglassi* plants, I have received up to date orders to the value of 19s. 3d., which, after deducting 3s. 9d. postage, leaves a total of 15s. 6d., which I herewith enclose, asking your kindness in handing it over to the Belgian Relief Fund.

I should feel very gratified if you would allow me, through the "B.B.J.," to thank those who have assisted me in raising this sum for such a deserving object, and to add that I have still enough plants to raise as much more if only your readers will send in their orders. I am willing and anxious to do my share, and to give the proceeds as before to the above fund.

I thank you most sincerely for your kind help. Yours faithfully,

E. BALLARD.



*The Editors do not hold themselves responsible for the opinions expressed by correspondents. No notice will be taken of anonymous communications, and correspondents are requested to write on one side of the paper only and give their real names and addresses, not necessarily for publication, but as a guarantee of good faith. Illustrations should be drawn on separate pieces of paper. We do not undertake to return rejected communications.*

#### PROCURING SURPLUS (Page 384).

[9097] Is not the plan you advise of putting on super-clearer rather complicated and tedious?

I use a bricklayer's pointing trowel—the smallest size I can get—and as my hives stand on a sort of skeleton platform (that is, merely rails resting on bricks, which have, so far, lasted without attention fourteen years) I place the outer case on this and on that the flat top of the hive. This is then about level with the top of brood frames. Now slip the trowel under one corner of the super and work it along on top of the frames to the other

corner; now wriggle the super till you find it has broken all attachments to the tops of frames. Slightly prize up one corner and send in a few puffs of smoke; now lift off the super and place it on the live top, as before mentioned. There will be very few bees on the frame tops and a few gentle puffs of smoke will send them down, while you put on the super-clearer. This gives the chance to fix the clearer where desired to a hair's breadth. You can now put the super on top of clearer. This plan is far easier and more expeditious than putting the super on the clearer, before putting it on the top of the hive. At any rate, I manage it so, without killing or even irritating a single bee—but it may be a case of "Experiences vary and opinions differ."

*Do Bees Know their Owner?* (page 355).—I have been told that my bees "know me." My answer is: "No; I know them," for it seems to me that you can manage bees by gentleness and quietness—the same as we manage horses and dogs, or, in fact, all animals, and even children. I often tell people never to buffet bees, for when that is done the bees take it as a challenge to fight, and if they could talk would say, "All right, mind your nose and eyes"; but if they hold their hands before their face, with their fingers spread out and walk slowly away the bees will fly away without attempting to sting.—A. HARRIS, Wavendon, Bucks.

## Notices to Correspondents

**WORKMAN** (Ayrshire).—*Queen - Rearing, &c.*—(1) Yes, they will do so. A better plan would be to make a nucleus with one comb of brood and two of honey as directed in "Guide Book," page 132. Choose a brood comb containing a good number of eggs, and leave the queen in the old stock. These bees, being queenless, will commence queen-cells at once. You should also read instructions on page 124 of "Guide Book." (2) You are mistaken; look at it again, or, better still, take a sheet of foundation and examine it carefully. (3) About the middle of March.

### *Suspected Disease.*

**GARDNER** (Hertford).—The bees are suffering from "Isle of Wight" disease. In the majority of cases there is no soiling of the combs. This takes place when the bees are suffering from dysentery.

**ELWIN** (Ayrshire), E. G. H. (Sherwin), "DOUBTFUL" (Lancs.), "HAMISH" (Dinedin), A. D. (Handsworth).—The bees sent are affected with "Isle of Wight" disease.

## Special Prepaid Advertisements

**Two Words One Penny, minimum Sixpence.**  
Orders for three or more consecutive insertions entitle advertisers to one insertion in "The Bee-keepers' Record" free of charge.

Trade advertisements of Bees, Honey, Queens, and Bee goods are not admissible at above rate, but will be inserted at 1d. per word as "Business" Announcements, immediately under the Private Advertisements. Advertisements of Hive-manufacturers can only be inserted at a minimum charge of 3s. per  $\frac{1}{2}$  in., or 5s. per inch.

### PRIVATE ADVERTISEMENTS.

**F**AMOUS willow herb, seven roots, 6d.; Limnanthes, fifty plants, 6d.—BOWEN, apiarist, Cheltenham.

**1000** FIRST CLASS SECTIONS for sale, 7s. 9d. per dozen, packed, free on rail; cases returnable.—HOWE, Darling-street, Enniskillen. v 63

**A**BOUT one gross beautifully clean extracted shallow frames, price 5s. per dozen; thirty-two racks, taking nine frames, 1s. each; Lee's guinea extractor, scarcely soiled, 12s. 6d.—X. Y. Z., "B.B.J." Office, 23, Bedford-street, Strand, W.C.

**L**IGHT granulated honey, in 56lb. tins, £2 16s. per cwt.—COMLEY, Fairford, Glos. v 64

**W**ANTED, honey in bulk, carriage paid.—Prices and samples to THOS. WILCOX, Rosedale, Talywain, near Pontypool. v 61

**G**ENUINE heather honey, from moors near Buxton, 10s. dozen, screwcaps.—HUTCHINSON, bee-keeper, Leek. v 62

**B**EE BOOKS WANTED; give date or edition, condition and price.—MOIR, 30, Shandon-crescent, Edinburgh. v 60

**1** CWT. finest English honey, 60s. per cwt.—**2** SPRATT, Meadow Farm, Wetheringsett, Stowmarket, Suffolk. v 59

**2** CWT. extracted honey, 28lb. tins; tins free, carriage forward, 56s. per cwt.; sample, 3d.; cash with order.—A. LEE, Eastleigh, Bideford, Devon. v 58

**3** CWT. good light honey, 28lb. tins, 64s. cwt.; sample, 3d.; seven dozen grade sections, 7s. dozen, 47s. the lot, f.o.r.; taken over twenty prizes this season, including first and second at Royal; wanted, wax extractor.—BIRD, Little Canfield, Dunmow, Essex. v 57

**F**OR SALE,  $\frac{1}{2}$  cwt. light honey, granulated, good quality, 27s. 6d.;  $\frac{1}{2}$  cwt. dark, for 25s.; sample sent, 6d.—J. WHITE, Fairstead Hall, near Witham, Essex. v 55

**T**HREE stocks bees, in Standard hives, healthy, 25s. each, f.o.r.—CASE, Wootton Bassett, Wilts. v 47

**H**ONEY, fine quality, light colour, in 1lb. screw top bottles, 8s. dozen; sample bottle, post free 1s.; also sections, 9s. dozen.—COWELL, Station-road, Sheringham, Norfolk. v 42

**B**EST heather sections, 10s. 6d. dozen; clover, 9s.; flower, 8s. 6d., carriage paid.—GLAISTER, Lazonby, Cumberland. v 38

**F**OR SALE, or exchange, ice safe, 21in. long, 20in. deep, and 16in. wide, wants slight repairs, 10s.; too cheap for approval.—BUMBLE, "B.B.J." Office, 23, Bedford-street, Strand, W.C.

**F**OR SALE, zinc skep covers, 1s. 3d. each; also shaped skep floor boards, and stands for same, 1s. 6d. the set. The above are better than new as they are painted, and are being sold at half price, cash with order.—BOSS, "B.B.J." Office, 23, Bedford-street, Strand, W.C.

**S**ELL or exchange, good dress suit, 36in. chest, 20s.—DRESS, "B.B.J." Office, 23, Bedford-street, Strand, W.C.



## OBITUARY.

MR. THOMAS WALKER.

We are sorry to have to record the death of Mr. Thomas Walker, of Esthwaite, near Hawkshead, Lancs. Mr. Walker was well known in North Lancashire as an enthusiastic bee-keeper, and was also a constant exhibitor at the London and other shows, his name often appearing among the winners in the classes for



THE LATE MR. T. WALKER.

heather honey. Being a gamekeeper, he had his numerous hives scattered about the moors, where he could keep an eye on them during his rounds. Many of our northern bee-keepers will miss his genial face and vigorous hand-shake at the shows. We know from personal acquaintance that he was always willing and ready to help a novice and to forward the work of the County Bee-keepers' Association.

## FOREIGN APPRECIATION OF OUR SENIOR EDITOR.

Taking advantage of our chief's engrossment in working for our country's welfare, which prevents the inevitable use of blue pencil and scissors where personal matters are concerned, and believing that a man's worth should be publicly acknowledged while living instead of waiting to say nice things after he is dead, I am sure our readers will enjoy reading the following, taken from Mr. C. P. Dadant's account of his travels in Europe last year, published in *The American Bee Journal*, of which he is the Editor:—

“On the 29th we left Interlaken early. We had breakfast at Berne, lunch at Lausanne, and dined at the Bertrand home at Nyon. Our old friend had informed us by letter that he had extended an invitation to half-a-dozen leading bee-keepers to take tea with us at his home the next day, which was Sunday. But he had not told us that he also expected the arrival of Mr. Thos. W. Cowan, the senior Editor of the *BRITISH BEE JOURNAL*, for the same day. Mr. Cowan, who often spends the summer in Switzerland, had accepted the invitation to meet with us, and arrived from London punctually at 9 a.m. the next day. The trip from London requires a little less than twenty-four hours. The reader may imagine how glad we were to meet him, and how proud we felt that he had selected this date for his visit, since it looked as if our presence might have had some influence on his determination.

“It was a great day for us. The chalet is in one of the prettiest spots along Lake Geneva, and in full view of Mont Blanc. Our hosts had just come home from the mountain village mentioned in the May number, Gryon, where they spend the hot months (if anything can be called ‘hot’ in Switzerland). The flower-beds were all aglow, the pond lilies in full bloom, and the walks freshly raked. Of course we talked bees. Mr. Cowan, like Mr. and Mrs. Bertrand, speaks French or English at your pleasure, and you cannot show him a flower of which he is unable to tell the scientific name. Most of our readers have heard of his three leading works on bees: ‘The British Bee-keeper’s Guide-Book,’ a practical work; ‘The Honey Bee,’ an exhaustive treatise on the anatomy and natural history of the bee; and ‘Wax Craft,’ a thorough work on beeswax, its uses and its adulterations. Some of his books have had the honour of eight translations.

“Mr. Cowan gave me some valuable information concerning the Caucasian bee, and the reason why some bees of this race appear as if they were mixed with Italians.

He had made enquiries, and received the following information from Mr. Gorbottcheff, an official of the sericultural station of Caucasus at Tiflis: 'The bees of Erivan (Transcaucasia south of Tiflis) are distinguished by their bright yellow-orange colour, but the typical bee of the Caucasus Mountains is of a dull grey colour. The bees of North Caucasus are a mixture of the grey with the bees of Persia, which are also of bright colour. The bee of Persia is a typical bee of the South, and in Caucasus is known under the name of "Bee of Lencoran." Some bee-keepers of Russia and Europe make the mistake of calling these bees "Caucasians." They are lazy, wicked, and great robbers. The production of queens of this species is not large.

"On the contrary, the pure bees of the mountains of Caucasus are gentle, splendid workers, and their queens are great layers.'

"So when we rear Caucasian bees, if we want them pure, we must insist on the 'dull grey colour.' Had our time been unlimited, and the way to the Caucasus unhampered by the Balkan war then raging, I should have liked to make an excursion to that country, for everybody who has tried the Caucasians praises them. But in our four months of vacation we could only follow a narrow little path through France, Switzerland, and Italy. We still had the entire Italian trip before us, and had to refuse some very kind invitations from half-a-dozen bee-keepers of Great Britain, including a hearty one from Mr. Cowan, who readily excused us. He understood that if we went through Great Britain we must be prepared to spend a month or so there, and it was out of the question. It will be for some future date.

"Mr. Forestier, a noted entomologist present, told me that he had often dissected bees that had died of the May disease, and found no nosema in them. Mr. White had reported the same from sample bees sent to him by me. Yet, was it not in the May disease that the German scientists first found the nosema? This parasite was also reported as found in the 'Isle of Wight' disease. We have much to learn still. Mr. Cowan thought that the nosema was difficult to detect in dead bees. He was inclined to believe that it caused both the 'Isle of Wight' disease and the May disease, or paralysis, as it is called in America.

"The information already received by me that the Italian mixed with the Swiss bees, or the Swiss-bred Italians, are the best for that climate, was confirmed by nearly every man present, and they are all leading bee-keepers. Messrs. Bertrand, Odier, Warnery, Gautier, Bignens, Pain-

tard, and Forestier were unanimous on this point. In our own country how do northern-bred Italians compare with the southern-bred? Have any of our bee-keepers made any comparative experiments?

"On the following day we had the surprise of a visit from our Lyon friend, Mr. Vibert, who was spending his vacation on the south shore of the lake. He knew we were to be there about that time and came, relying on the kind hospitality of Mr. Bertrand, to spend a few hours with us again. An hour after his arrival a stranger came, and was announced as Mr. Ivan Louis Melikov, a bacteriologist at the Pasteur Institute of Paris. The Bee Association of Haute Savoie had asked for help in the study of the bacillus of foulbrood. This gentleman had come to them and had at once been directed to Mr. Bertrand for information. Our readers know of the long experience our friend has had with foulbrood. He had it in his own apiary, fought it with drugs and finally vanquished it. He translated F. C. Harrison's study of foulbrood, and wrote another study on it himself. Mr. Cowan, who was there, is also an authority on diseases.

"Mr. Vibert called our attention to the number of nationalities gathered together in this little party. Mr. Melikov is of Russian nationality, so we had Russia, England, Switzerland, France, and America represented. We enjoyed the day, and Mr. Melikov invited me to call on him at the Pasteur Institute on my return to Paris. He was in hopes of being able to prepare some studies of foulbrood in the meantime. Mr. Cowan said that, in his opinion, there are climatic differences between samples of the bacilli of Europe and America, and suggested that *Bacillus brandenbourgensis*, *Bacillus burri*, and *Bacillus larvæ* of White were perhaps identical.

"The following morning I went down into the little park early and found Mr. Bertrand there in a mournful mood. We were to leave them that morning for the Italian trip. He said: 'This is a melancholy morning for me, for I don't know whether I will ever see you again. Your father was one of my best friends, and I re-read some of his letters often. Yet I have never met him. Our friendship grew through correspondence.'

"It was a sad parting on both sides. We were glad that Mr. Cowan expected to remain a few days, as it made it less lonely for our old friends. We took the train at 10 o'clock for Bellinzona and Milan. This was the last episode of our month in Switzerland. It had been a happy month."

THE CONVERSAZIONE LECTURE.

By Mr. A. Richards.

BEEES IN RELATION TO FLOWERS AND FRUIT.

(Continued from page 420.)

Flower-growers sometimes complain with better cause that their flowers are fertilised too soon and wither too early, and that their selected varieties are crossed by the promiscuous transportations of the bees. The bee fertilises the flowers accidentally; it, of course, has no such object in view when visiting them, it is only there to gather nectar or pollen, or both, to take away to its hive: but in this process of gathering its own supplies the pollen grains on the flowers are caught by the numerous hairs with which the bee is covered, and some are left on the next flower visited, and generally they are distributed about by these constant visitations.

Some conception of the amount of work to be done may be gathered when it is remembered that each separate plant of the common clover requires a separate and distinct fertilisation, and the following quotation will give you some idea of the value of fertilisation as affecting the weight of the clover crop:—

“An experiment carried out by a friend of mine, Mr. G. Hayes, of Beeston, Notts, upon white clover, is as follows: ‘One vigorous root in garden grown previous year. When it began to flower, I selected three of the most vigorous heads, just before the first flowers were about to open. I supported the heads on small stakes, and put a framework of specially constructed wirework, balloon shape, over each head to give it plenty of room to develop, and over this spread some fine thin gauze, to exclude insects from above and to admit light and air. I also prevented small insects, such as beetles, from ascending the stalks by means of cotton-wool. Each flower-head had about three cubic inches of space in which to expand.

“On this single plant were twenty-nine flower-heads, and this shows it was very vigorous. The three heads protected flowered, and were the first to ripen; but there was a marked difference in the peduncles from those that were unprotected.

“When the majority of the seeds were ripe, I cut off the three heads which had been protected, and also three of those left unprotected; and after cutting the peduncles all to one length, they weighed as follows:—

3 Unprotected heads ...	18 Grains.
3 Protected heads ...	4 „

“Here was, I considered, strong evidence straight away; but I allowed them to thoroughly dry indoors for a fortnight, after which they weighed as follows:—

3 Unprotected heads ...	11 Grains.
3 Protected heads ...	2½ „

“I next separated seeds in unprotected heads, and found as follows:—

In No. 1	... 112	Seeds.
” 2	... 99	”
” 3	... 93	”

“Total, 304; average, 101; weight of seeds, 8½ grains.

“Going to the protected heads, after long and careful search I could not find a single seed. Conclusion, that white clover is entomophilous.”

Coming now to the direct question of garden and orchard fruit, we find subdivision again necessary—that is, into the self-fertile and the self-sterile varieties of fruit.

What are known as the small fruits, such as strawberries, red and black currant, gooseberries, raspberries, logans, &c., are self-fertile, and self-fertile with the same flower, but the visitation of the bees is necessary to the production of full crops of well-formed fruit.

The next slides show you the different effects of covering up red currant, gooseberry, and apple bushes during the flowering period, and you will notice the very small amount of fruit to be found on all those which were protected from insect visitation.

Mr. Cowan, in the paper he gave us in 1909, referred to a notable instance in his own personal experience, and I am sure you would like me to read you this extract of his:

“Unfruitfulness may be due to a scarcity of bees. I could mention several instances where orchards had proved unprofitable until bees were introduced. As a case in point, I can mention that when visiting a friend at Penryn, in California, some years ago, who had forty acres of ‘Alexander’ peach trees, which are generally supposed to be shy bearers, he complained that he could hardly get any fruit from them, and was about to cut them down and plant some other variety. It was spring, and the trees were a magnificent sight, being in full bloom. As we were going round I noticed that there were no bees of any sort on the blossoms, and therefore asked my friend how far was the nearest apiary. He told me it was at Newcastle, five miles from where we were. I said those bees were no use to him at all, and advised him to give the trees another season’s trial, and to get some bees at once, and if then the trees did not bear fruit he could replant in the autumn. He was an intelligent man, took my advice, and obtained two colonies of bees, which he placed in the centre of his orchard. Of course, by that time more than half the blossom was over, but for all that he got a fair amount of fruit, the trees nearest the hives having the most on them. This was the first fruit my friend had obtained from his trees, and he was so well pleased that instead of destroying the trees he got more bees. On visiting him the next year he took me out to see his orchard, which was a perfect sight, and showed the bees’ work, for the trees were so laden with fruit that, although they had been thinned, the branches had to be sup-

ported by strong wooden props. Needless to say, there were no further complaints about these "Alexander" peaches being shy bearers, for here was ample proof that only bees were required to make them fruitful."

Mr. Cowan gives six reasons for unfruitfulness of fruit trees:—

- (1) Vigorous wood growth.
- (2) Unhealthy conditions and lack of vigour.
- (3) Fungus on blossoms.
- (4) Frosts.
- (5) Bad weather (rain).
- (6) Lack of bees.

The amount of pollen transportation which has to be done in a large orchard in the early spring is simply enormous, and when we recollect that weather conditions are often very fitful at that season of the year, and the time when bees can work often very short, the importance of keeping a large number of stocks close to the orchard will be readily realised, for if the work is badly done, and in the process of fertilising those seeds which I showed on one of the early slides only a portion of the seeds are fertilised, the consequent fruit is ill-shapen and almost useless.

In the case of the apple, those seeds are the pips you find inside when opened, and if you open a misshapen, ill-formed apple you will discover on the side of the core facing the undeveloped side of the apple that the pips are flat and empty, and not plump and well formed as are those facing the properly developed side of the apple; this is all due to the imperfect fertilisation when the blossom was ripe.

*(To be continued.)*

#### SUFFOLK B.K.A.

As a result of the appeal issued through the Suffolk Bee-keepers' Association, 600lbs. of honey has been received for the wounded in Suffolk by the honorary secretary, Mr. Oliver C. Jones. Mr. Jones has expressed the hope that 1,000lbs. will be raised.

#### BEE-KEEPING LECTURE AT GRANTHAM.

The first of a course of four lectures was given by Mr. Geo. Hayes (silver medallist) on Tuesday evening, in the Guildhall. Alderman J. Handley Parker, the chairman, in introducing the lecturer, expressed the pleasure of the authorities in having obtained the services of Mr. Hayes again, and announced that the lectures would not be a repetition of those

given last year, but would deal with fresh matter of interest to bee-keepers. Mr. Hayes then lectured on the "Constituents of the Hive and their Offices," his remarks being illustrated by a number of excellent slides. At the lecture on Tuesday next he will deal with the "Chief Sources of Honey and the Relation of Bees to Fruit and Fodder Crops."

#### NECTAR-PRODUCING PLANTS AND THEIR POLLEN.

*By George Hayes, Beeston, Notts.*

THE CROCUS.

*(Urocus aureus, &c.)*

No. 33. NAT. ORDER IRIDEÆ.

*(Continued from page 377.)*

The plant under consideration is, I should imagine, known by all, and although it cannot be classed amongst the higher nectar-yielding plants, all will admit that it is good for the bees, hence our desire to include it.

The derivation of the name of this genus of plants is probably from the Greek word signifying Saffron. Its specific titles are rather numerous, viz., biflorus or Scotch, aureus or golden, vernus or purple, nudiflorus or naked flower, sativus or cultivated, luteus or yellow.

In East and West countries alike the crocus has been held in high esteem, both in its fresh and dried states, being used for many different purposes, chiefly that of supplying what is known as the true saffron. To obtain this, the stigmas are extracted and dried, and sometimes pressed into cakes. It was often used as a dye, but more especially as a scent or aromatic medicine. Some of the herbalists endued it with the power of mitigating the evil effects of the humid climate on the Irish people, and of having the power to quicken their spirits and provoke laughter.

Its flower is sometimes called "Hymen's torch," a name certainly appropriate to the flaming glow of the golden crocus, who, according to Roman mythology, was once a youth pining to death for his love when he was metamorphosed into a crocus.

It is stated that the crocus was introduced into England by a native of Walden, in Essex, from the district of Cashmir, and was done at the risk of his life, for, by the law of that country, if he had been found transporting a bulb the penalty would have been immediate execution.

He is said to have carved out a hollow in his staff and placed in it the precious bulb, and in this way it was brought without observation and it got safely landed

at Walden, where he cultivated it. It was, I believe, from this circumstance that the name Saffron-Walden originated.

The quantity of Saffron now grown in England is very small; indeed, I have no knowledge of any place where this is done, but there is evidence in various parts that such has been the case. It is stated that the crocus was at one time largely cultivated in what are known as the "Meadows" at Nottingham, and no doubt it would be for the saffron. I remember forty years ago a large number

### Dry.

1



### In Water & from Honey.

2

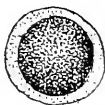

POLLEN OF CROCUS.

of these meadows being covered in the spring of every year with their blossoms, and seeing hundreds of people, young and old, picking the flowers for home decoration; but owing to the extent of building and filling up after mining operations, &c., we have now only one field left where they continue to bloom year by year, and it is a pleasant sight which I never miss on sunny days in spring.

To the bee-keeper it is an acknowledged help in that it yields pollen for his bees and they revel in its golden, white, or blue cups on warm sunny days. It also forms a very convenient vehicle for giving artificial pollen to the bees, the partly opened cups holding this admirably. I invariably use them each spring for this purpose and also to entice the bees into a box with the artificial pollen (equal quantities of pea and wheaten flour) sprinkled on fine wood shavings, which is readily found by the bees if placed beside the crocuses used for this purpose, for as soon as the latter get empty they are

foraging round the spot for more, and soon alight on the fresh supply, and if this is kept up the bees will continue to visit it until they have a good natural supply.

In mass, the pollen is a deep gold colour, but assumes a more orange tint when packed in the *corbicula*. Under the microscope the single grains are a vivid gold by reflected light and a rich deep gold by transmitted light, the fovilla being rather dense in colour, having a thin white outer pellicle. When dry, in form it is spherical, having numerous corrugations as seen at No. 1. and measures  $\frac{3}{1000}$  in diameter, one of the largest grains in our list.

In water it loses its corrugations and becomes a true sphere, but the seams of the corrugations are visible; the fovilla becomes more granular and opaque, but no processes are formed. Measurement,  $\frac{5}{10000}$  diameter. See No. 2. The extine swells rather largely, and is seen in a saturn-like ring round the fovilla when viewed by transmitted light. These will, of course, not often be found in honey, as at the time of the blooming all nectar gathered will be used up in brood-rearing.

(To be continued.)



### THREE SYSTEMS OF FEEDING.

In this country overhead feeding of bees is all but universal. The style of feeder may differ, the nature of the food may vary and the time and circumstances may depend upon the individual; but, perhaps in 99 cases out of 100, bees will have to ascend to the top of the frames to secure the syrup or candy supplied by their owner. The bees may sip the nectar through a regulated number of holes, they may suck it through one or more thicknesses of cloth over the mouth of the feeder, or they may ascend and drain the liquid dry, resting meanwhile on floats or slats running parallel all the length of the feeding chamber. In all these cases, however, what our American cousins call the "feed" is placed above the brood body. Many, if not, indeed, most, bee-keepers look on that as the ideal feeding ground. Yet it has its drawbacks, one of them being that not only has the hive to be opened every time we feed, but the tops of the frames have to be at least partially exposed every time the food is administered, and the

brood is liable to be chilled, especially in early spring or late autumn. Some feeders lessen the evil compared with others, but it is there every time. With many feeders it is a real evil, and every time a cake of candy is supplied, even with the best of care, the hive temperature is affected.

Sage men in bee-craft on the other side of the "herring pond" set their mighty wits to investigate and discover means to obviate this defect and hit upon the plan of feeding from below. Hence we have various floor-board feeders. Some are dealt with from the front, others from the rear, and yet others from the side—which side is immaterial. They "invented" these devices and took much credit to themselves for their ingenuity. Why, the very first feeder I ever saw—and 'tis fifty years or more since then—was on this very principle. Even then it was not a modern discovery. Five hundred years ago—a thousand, nay, well-nigh two thousand years ago—bees were fed from the floor-board, or whatever designation that part of the hive was then known by. Our forefathers and their forefathers before them used hollow twigs of various trees to carry out this operation. Mr. Boardman and his confrères may claim *improvements*, but the systems are the same in the main. Any of our apiarists keen on feeding may adopt the following plan and feeder.

The bottom board is pushed forward, and a trough feeder attached in the rear in such a way that the bees have easy access to the syrup. Any number of colonies can be quickly and easily fed without disturbing the interior, or even raising the roof or coverings. No robbing can take place, and the supply can be adjusted to a nicety to the actual requirements of each colony as previously ascertained. An even better plan has lately been devised. A deep bottom space is required, and also a deep entrance narrowed down by blocks to what is deemed best for actual need. The real feeder slides out and in, if necessary, or it may have the food replenished by means of a small hose. The bottom is a simple shallow chamber about 3in. deep and measuring about the length and breadth of the hive interior.

This system of feeding is largely practised in America, and is highly recommended by such writers as the late Mr. Alexander. He believed in stimulation at almost any time of the year, and praised the first of the two aforementioned feeders as the acme of perfection. The speed with which a large number could be fed was one of its chief recommendations in his eyes, and he also regarded the fact that no hives had to be opened as its strongest feature. Some hold that bees

will more readily ascend to secure artificial food, but if bees require stimulation they will easily scent syrup wherever it is placed in the hive. Fed below, the ascending odour of warm food will attract the bees at least as readily as if placed overhead. Many bee-keepers advocate that neither above nor below the brood frames is the place to feed, but at the *side* of the cluster. The Simmins and Doolittle feeders are really side frames with panels on both sides, and into the space between the food is either poured or placed. Whether the food is dry or liquid the bees find access at the side of the top bar, which the panel does not quite touch, a bee space being left for the purpose affording easy ingress and egress for the feeding bees. Mr. Root speaks well of this form of feeder, and, indeed, says that for some purposes it is the best and most favoured by his hands. It is easily replenished without removing top coverings to any extent, and it does not require brood frames to be tampered with in any way. Simmins' feed lump sugar in these spaces without turning it into syrup. They may also be used for candy feeding or even for supplying artificial pollen in spring. Much may be said in favour of each and all of these systems whereby bees can be aided whenever the regular store cupboard needs to be supplemented.

---

#### SHOW AT WORCESTER FOR THE BENEFIT OF THE WAR RELIEF FUND.

An exhibition of honey, in conjunction with flowers, fruit, &c., was held in the Guildhall, Worcester, on November 11th and 12th, for the benefit of the War Relief Fund. The honey section realised nearly £9, out of a total of £37 10s., about 200 sections and bottles of various sizes being sent, some from as far as Northumberland (from a prize-winner at our last annual show). We had intended holding a two days show in conjunction with the newly-formed Chrysanthemum Society, but it was abandoned owing to the national crisis.—GEO. RICHINGS.

---

#### ROYAL SHOW FUND.

	£	s.	d.
Donations already received .....	5	15	6
H. Jonas .....	5	0	0
A. H. E. Wood .....	5	0	0
Dr. Anderton .....	1	1	0
J. Pearman .....	0	10	0

---

#### WAR RELIEF FUNDS.

We have received the following further donations:—Anon, typewriter and golf clubs; Anon, 5s.; O. Knight, 4½lbs. beeswax.





PROCURING SURPLUS.

*(Continued from page 416.)*

Various forms of section racks are in use, some of them not at all convenient to work; in fact, in a great many instances they are only tolerated on account of the expense that would be entailed in replacing them. The day of the three-piece or divisional rack is past, though these had the advantage of enabling

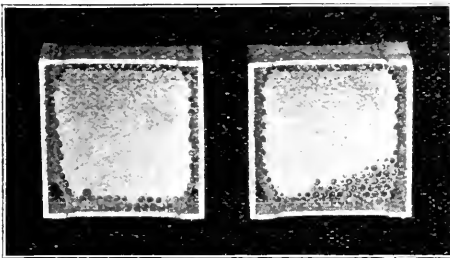

FIG. 19.

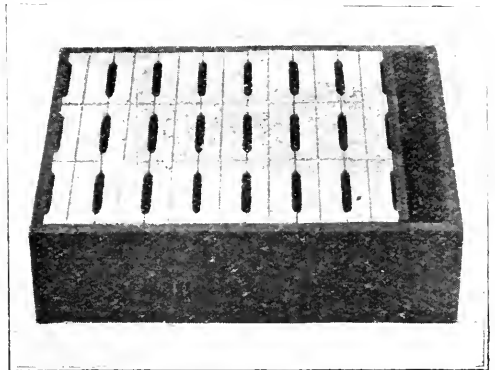

FIG. 20.

the bee-keeper to give extra room more gradually by placing seven sections only in position at one time. The disadvantages, however, were so numerous that they have fallen out of use altogether, and it is exceptional to find them in the catalogues

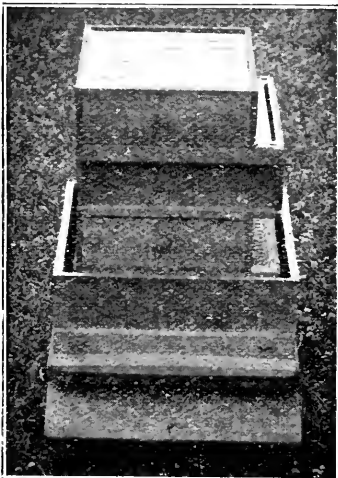

FIG. 21.

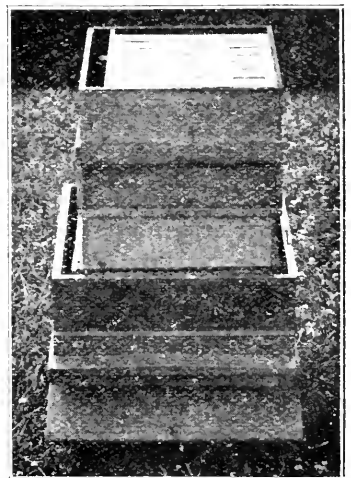

FIG. 22.

of manufacturers. Racks having one end cut out half-way with a wedge-shaped piece of wood to be used for tightening up the sections are uncomfortable to work. In these it is usual to tack a piece of coloured stair-carpet to the whole end and also

to the top of the wedge piece, the idea being to prevent the loss of the latter. In the first place, it is difficult to fasten the sections securely by means of the wedge; secondly, if not made to fit very accurately the bees escape through the joints at the

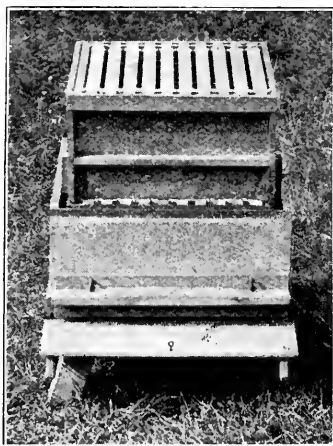

FIG. 23.

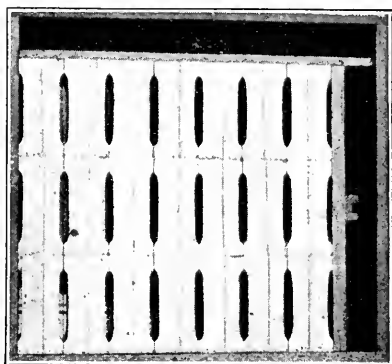

FIG. 24.

ends of the wedge into the roof portion of the hive, where hundreds of them perish, and it is no unusual thing to find the top of the rack covered to a depth of a couple

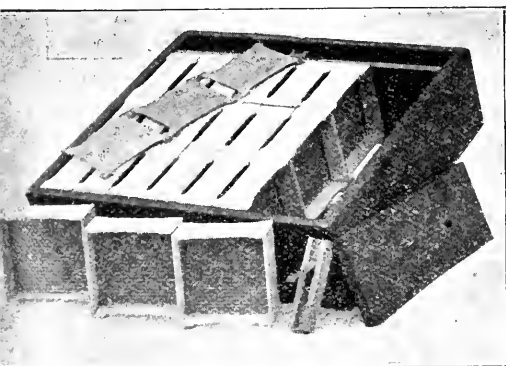

FIG. 25.

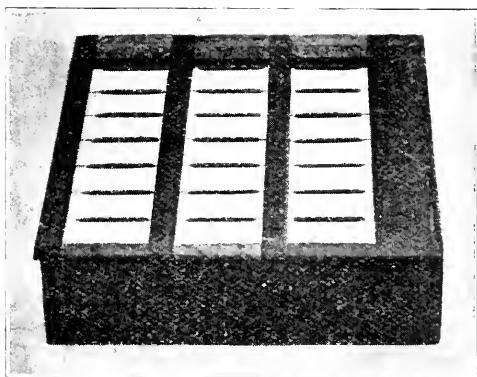

FIG. 26.

of inches with dead bees; it is curious that when bees escape through such small openings they seem incapable of finding their way back. Further, the use of the coloured material is a mistake, for the bees often chew this up and mix the fluff with

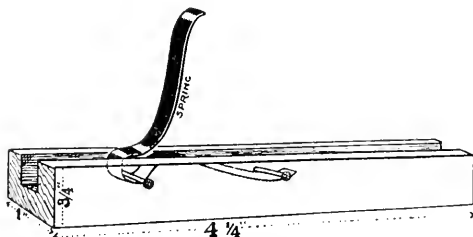

FIG. 27.

the cappings of the comb, giving the sections the appearance of Joseph's "coat of many colours" (Fig. 10), and spoiling them for selling. Good, clean, unbleached

calico should be placed next the frames or sections. Quilts should be renewed once each year, and the time to do this is when putting on the first super. Personally, I do not like a rack that is made just 12 $\frac{3}{4}$  in. wide (Fig. 20), as being narrow it cannot be worked in conjunction with a shallow frame super. The illustration (Fig. 21) shows this difficulty. If the shallow frame super is put on first, then when the section rack is put under it a space is left under the frames for the bees to escape. (Fig. 22) shows how this is obviated by using a properly made rack. While (Fig. 23) shows an eke being used under a shallow frame super so that it will take brood frames to obtain combs for driven bees as mentioned previously. The section-rack par excellence is that shown in illustrations (Figs. 24 and 25), brought out by Messrs. James Lee & Son some years ago. This fulfils all the requirements of a good rack; it is made the same width and length as a ten-frame brood-chamber, and when placed in position on the hive fits right over the frames and prevents the escape of bees without the trouble of putting narrow strips of calico at one or both sides. It also prevents all possible chance of draughts, which, if allowed, will prevent the bees taking to the super. The extra width in the rack referred to above is blocked at the bottom with a thin board (Fig. 26), and the sections are kept in position by means of a following board, seen in (Figs. 24 and 25), and a spring-block (Fig. 27), made by grooving a piece of wood and fitting a lock-spring into it, both at the side and end. With such a rack, trouble is reduced to a minimum, as it can be worked either above or below a shallow frame super without the slightest trouble.

*(To be continued.)*

#### AN INTERESTING BEE-HIVE.

The enclosed photographs show part of the apiary belonging to Mr. James Taylor, who is a member of the Aberdeen and

twelve miles from a railway station. Mr. Taylor has between sixty and seventy stocks; he is very fond of his bees and spends all his spare time among them. He has several varieties of hives; the one



AN INTERESTING BEE-HIVE.

District Bee-keepers' Association. It is situated in a beautiful district among the heather-clad hills of Deeside, and is about | in the foreground is decidedly "fancy," but meets with the same success as the others.—N. M. ROBINSON.

## BEGGARY.

Thanks, very many thanks to those who have so kindly responded to my appeal. Money, honey, and wax have been received, and the BEE JOURNAL will make acknowledgment. As for me, I have found begging so profitable that I am going to keep on at it, and (I am going to tell news which I know will not be censored) I am firmly determined to persist as long as it pays, and as long as there are the necessities for which I am appealing to you.

Discount rates as quoted in to-day's money markets are very firm—"getting harder" is the expression—so that I cannot hope for much cash, but by all means send any you can spare. I assure you it is extremely acceptable. But you must, as I said last week, have many things which can be turned into money. Even the Prince of Wales's Fund is begging for waste-paper. One of the most effective means for raising funds for parochial work is a "jumble sale" (I charge six-and-eightpence for this advice to my reverend friends, which I hope they will remit). Why not get up a bee-appliance jumble sale for our good cause? The JOURNAL will take charge. Send anything you can spare, the JOURNAL can find customers.—JNO. SMALLWOOD.

## HONEY IMPORTS.

The value of honey imported into the United Kingdom during the month of October was £3,990.—From a return furnished to the BRITISH BEE JOURNAL by the Statistical Office, H.M. Customs.

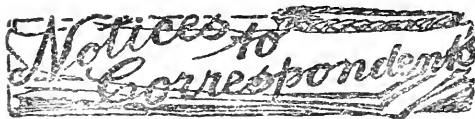

## Suspected Disease.

J. C. GRIFFIN (Dorset), G. R. TILLER (Barnes), E. M. EMERSON (Ross-on-Wye), and J. W. D. (Morpeith).—All the samples of bees sent are suffering from "Isle of Wight" disease.

W. WARD (Dunham).—The comb and bees were completely flattened in the post, but there are marked symptoms of "Isle of Wight" disease. Bees should always be enclosed in a TIN BOX.

E. G. H. (Sherwood).—The disease is more advanced than in the last sample you sent.

G. T. S. W. (Hertford). It is "Isle of Wight" disease. Did you know the dead queen was among the bees sent?  
J. G. DALZIEL (Dulwich). The bees are

affected with "Isle of Wight" disease. The hive described is the "Gravenhorst."

"CARDI" (Aberavon).—It is a bad case of "foul brood." As your other stocks are healthy it will be better to destroy *all* the combs. The hive may be scorched with a painter's lamp. We are sending you a tin of "Apicure." Use it for the other stocks as directed on the tin.

## Special Prepaid Advertisements

Two Words One Penny, minimum Sixpence.

Orders for three or more consecutive insertions entitle advertisers to one insertion in "The Beekeepers' Record" free of charge.

Trade advertisements of Bees, Honey, Queens, and Bee goods are not admissible at above rate, but will be inserted at 1d. per word as "Business" Announcements, immediately under the Private Advertisements. Advertisements of Hive-manufacturers can only be inserted at a minimum charge of 3s. per  $\frac{1}{2}$ in., or 5s. per inch.

## PRIVATE ADVERTISEMENTS.

**P**URE Leicestershire honey, light, excellent quality, 28lb. tins, 16s. each; sample three stamps.—EVERETT, expert, Rosebank Apiary, 40, Linden-street, North Evington, Leicester. v 77

**S**IX DOZEN first grade sections honey, in splendid condition, 50s., safely packed.—TREBBLE, Romansleigh, South Molton. v 76

**Y**ORKSHIRE heather honey sections, 9s. 6d. dozen.—EDWARD McLOUGHLIN, Grewelthorpe, Ripon. v 75

**F**INEST English honey, 60s. per cwt.; sample 2d.—DUTTON, Terling, Witham, Essex. v 4

**F**OR SALE, pure English honey, light colour, sample, 3d.—LAW, Cuckoo, Ashwell, Baldock, Herts. v 74

**3** CWT. honey, 28lb. tins, 56s. per cwt.; sample 2d.—GEORGE THOMPSON, Helpringham, Sleaford. v 73

**F**INEST clover honey, in 1lb. screw-capped glass jars, price 8s. 6d. per doz.—Address, L. J. MEASURES, Tilburn Grange, Kimbolton, Hunts. v 72

**S**EVENTY sections of first grade pure heather honey; these sections are extra well filled and beautifully clear.—JOHN RIGG, East Bank House, Kendal. v 71

**F**OR SALE, extracted clover honey, 9-28lb. tins, 16s. each; two dozen sections, and five dozen screw top bottles, 8s. 6d. per dozen; sample 3d.—W. PHILLIMORE, Three Horse Shoes, Buxford, near Pewsey, Wilts. v 68

**P**URE honey for sale, heather, heather blend, clover, 10s. per dozen jars; sample jar 1s. 3d., post free.—ISAAC HAWKEN, Stocksbridge, Sheffield. v 69

**S**ELL or exchange in the bee line, four true Belgian hares, 3 months old, 3s. 6d. each.—T. TONG, Ruskington, Sleaford. v 67

**T**WENTY bee hives, with crates, in good condition, 5s. each, together or separately.—47, Boston-rd, Brentford. v 65

**1000** FIRST CLASS SECTIONS for sale, 7s. 9d. per dozen, packed, free on rail; cases returnable.—HOWE, Darling-street, Enniskillen. v 63

**R**EMINGTON No. 7 typewriter, new condition, original cost upwards £20, sacrifice £6 10s., or nearest offer, cash wanted; free approval; trial willingly.—WALTER WHITE, "Muldo," Northampton. v 78



## NOTICE.

Owing to the dislike of one of my ancestors to a long signature he dropped a portion of his name. For several generations this caused no inconvenience, as they did very little business. Owing to the continued increase in my business interests, the dual situation of one signature for ordinary use and another for legal matters has become impossible; therefore, on and after January 1st, 1915, I shall assume my full name of W. Herrod-Hempsall. I shall be grateful if all correspondents will kindly note this and address me, also make out all cheques or documents, and insert in any list my name as above.

W. HERROD-HEMPSALL,

hitherto commonly known as W. Herrod.

## LEGISLATION FOR BEE DISEASES.

A cap that fits a few selfish people in these islands, and also shows that legislation and inspectors are not the bugbears some people would have us believe, is provided in an editorial from the *American Bee Journal*, November, 1914, as follows:—

## "FOULBROOD LAWS.

"Are our foulbrood laws adequate? Do we need to change them? Or would we be better off without them?"

"Considerable opposition has been offered to the enacting of foulbrood laws in our different States, and we meet a bee-keeper now and then who thinks the appointment of inspectors is an infringement on liberty and a useless expense. Even in the Old World, where regulations are much more common and more strict than in the United States, some bee-keepers have strenuously objected.

"However, in practice it has been found that often the persons who object to inspection are among the few who are too careless or too neglectful to look after their bees. They naturally resent intrusion. In the great majority of cases, not only is the inspector well received, but he is usually sent for, and his visit is desired by the owner who is in doubt as to the existence of disease in his apiary or in his vicinity. The work of inspection has in most cases resolved itself into a pleasant visit and the giving of advice

which is thankfully received. There are a few cases where careless owners have refused to act to treat the disease. But they feel themselves so positively in the wrong that it is not difficult to compel them to take radical measures when they are fully informed that the law is against them.

"The most dangerous transgressor is the willing but careless apiarist who, after asking for advice and promising to treat his diseased colonies, either does the work in a slovenly manner or neglects a part of it. I was once told, by a rather prominent apiarist, that he who has had the disease in his apiary once can never get rid of it entirely. This was said in reference to American foulbrood. Yet there is no difficulty in curing bees of that disease completely if the proper thorough treatment is followed. This man was either unable or unwilling to do thorough work, and there was little wonder that he did not succeed.

"But our foulbrood laws may be very much improved, especially by making them uniform. What is legal in one State is illegal in another. This should not be. The variation exists not only in laws upon diseases; it extends to almost all human affairs. Marriage and divorce vary, and a young couple that want to evade the law often do so by moving for a few days to another State. It may take centuries to correct infractions of common sense due to the irregularity of our laws.

"But that we are progressing in the regulations concerning the cure of bee diseases does not permit of a doubt. Every State in the Union should have a law on this subject."

## FROM A READER AT "THE FRONT."

The following letter, which we have received from "the front," will, we are sure, be read with interest, and our readers will join with us in wishing the writer a safe and speedy return to his home and the bees. His action in fixing up the hives is another instance of the freemasonry existing among bee-keepers, not only in our own country, but the world over. Reading between the lines we have no doubt Mr. Atwell ran considerable personal risk while performing his kindly action. As the letter is stamped "Passed by the Censor," we print it in full.

With the British Expeditionary Force,  
December 1st, 1914.

DEAR SIRS,—I thought I should like to write you a few lines to let you know how much I have appreciated the articles in your little JOURNAL, which I have had sent me regularly from home ever since I have

been on active service. I left England in August and have been through all the big engagements with my regiment. I have often read the JOURNAL under a perfect hell of heavy German artillery fire, often not knowing if the next second would be the last one. However, I have been one of the lucky ones and have steered clear so far, and if I am spared to see England again I hope to give the readers of the JOURNAL some very interesting stories of how their fellow bee-keepers (who are unfortunate enough to have their apiaries within the area of war) have suffered. I have seen apiaries destroyed by shell fire, I have seen them after they have been looted by the Germans, and I have picked up empty skeps on the roadside with a few bees still hovering around their home. Only a few days ago I came across a bee house at a farm which had been evacuated sometime. It was within three-quarters of a mile of the German firing line. Upon examination I found that two of the skeps had been knocked over on to the ground mouth upwards. They were both crowded with bees and had not been much disturbed. I expect the appearance of so many bees had somewhat frightened the intruder. I managed to get them back on their stand all right with six others which were undisturbed. The skeps were large, crammed full of comb and honey and heavy in bees. I only hope the owner will find them all right when he returns and will reap a double harvest next year to make up for the one he has left behind this. I may mention that when I found the bees the ground was thick with snow and a cold sleet was falling. German bullets were whistling around and as the apiary was somewhat exposed I had to undergo some risk when getting the skeps in place again. Space and time will not permit me to tell very much now of the sights I have seen here, but I hope with the Editor's permission to write them up at a later date if I am spared to do so. I should like before I close to give the readers of the JOURNAL a short account of my own bees, as I think I have been extremely lucky with them. I started bee-keeping last year, but of course did not get much surplus, as I did not know anything about them then and really started too late. However, I bought two stocks in a double hive, one swarm in May, which I divided later, and several skeps of driven bees which I had to drive myself without any personal instruction. I made two good stocks of these. I wintered them well, giving them plenty of food during the winter and spring. Things, however, did not turn out so rosy as I had anticipated, for when I examined them in the spring I found that I had foul brood in four lots (the double hive and two single), only two stocks were apparently healthy. But my troubles were not yet over. Later on bees were dropping around the hives.

I sent several packets of dead bees to the "B.B.J." Office. This was the verdict: Bees are suffering from "Isle of Wight" Disease. I was in despair. I thought of making a bonfire of the whole lot and forgetting that there was such a thing on the earth as a bee. I pondered over matters. Every hive in the district had been cleared out with "Isle of Wight" Disease previous to my bringing my six stocks there in the autumn of 1913. I couldn't be a menace to anyone else, and so I decided to give the bees a chance. One stock, a Carnolian lot, was so bad with foul brood that I thought it best to destroy that one at least, and a second one I shook from the frames, which I burnt, making an artificial swarm of the bees. I transferred the remaining colonies to clean hives well scrubbed with carbolic acid, putting the bees from the double hive into separate hives. I now had five stocks of hybrid bees, one of course being backward owing to my having to re-hive them. I used Apicure for the foul brood, but nothing beyond the disinfecting for the "Isle of Wight" Disease. This happened about the beginning of April. From this time onwards there was a decided change for the better, and this is the marvellous result: Increased from five to fourteen vigorous stocks and took 500lbs. of extracted and 205 sections of surplus honey. This would make a total of over 710lbs. of honey, as most of the sections weighed over a pound. I have not been at home to winter the bees, so they have been packed down on ten frames, and there must still be a considerable amount of honey left with them. I might say that the increase was made before I left for the war in August, and the purchase of a quantity of drawn-out comb added greatly to the harvest. It is also a splendid heather district and most of the hives were well prepared for this when I left, being strong and headed by young queens which I reared myself. My success is also greatly due to my wife, who, with the assistance of a neighbour, so ably managed the heather flow with practically no previous experience. I am only hoping for one thing now as regards my bees, and that is that I shall be home early enough in the spring to try and go even one better than I have done this season. With fraternal greetings to my fellow bee-keepers at home, I beg to remain, dear Sirs, yours very sincerely,

LANCE-CORPORAL A. G. ATWELL.

P.S.—Will you kindly excuse the scribble and composition in this letter? It is difficult writing at the front.

---

#### JOURNALISM UP TO DATE.

We cull the following from a hyper-critical contemporary:—

"I send you a shake of the *hand* from the bottom of my *heart*."

This, from the city of manualade, appearing in an Irish paper, looks like Scotland robbing Ireland of its male cattle.

The Editor of the same paper has evidently discovered a new disinfectant, for on the next page we find him recommending an inquirer to use "Naphthalin."

Again, in the same issue, a contributor with a German cognomen, has this:—"Mr. Morley's book must *certainly* be amusing. It *certainly* proves the truth of the old adage, "A little knowledge," &c., and it may *certainly* prove dangerous to a beginner purchasing the same."

As there are several other "certainlys" in the same paragraph, certainly we certainly think the writer has most certainly made certain that a beginner is certainly warned against this certain danger—in short, a "dead cert."

We would certainly recommend the Editor (?) to pin the following motto on his desk. "People who live in glass houses should undress in the dark."



*Observations on Hives* (p. 381).—Whilst agreeing with Mr. Snelgrove as to the need for a good-sized alighting-board, I cannot help thinking his 11in. excessive. But I speak principally from my own point of view. I require a hive to have as little projection as possible, so that it may be easily carted to the moor. And I would prefer both alighting-board and porch to be removable, in one fixture if you like. An 11in. alighting-board and deep porch would seriously inconvenience me, and in practice I have done away with porches altogether. Without porches, bees often use the front of the hive for alighting, and run easily down to the entrance. An extension or hiving-board is a great boon. Such can be quickly fitted to a hive needing a broad doorstep, and weeds no longer trouble the bees. Very few hives are rendered more readily accessible to ants and mice by the use of such extension. Mice should be excluded at the door, and if carbolised rags be wrapped round the legs of the extension ants will not pass that way.

*Stamping out "I.O.W."* (p. 390).—Unless Mr. Heap takes for granted that disease cannot be communicated by hive,

combs, or dead bees, it is not easy to see how he concludes that wild colonies may be ignored. Should such a diseased colony die, its habitat may be as readily re-occupied by a stray swarm as if it were a skep in a cottage garden.

*Storing Extracting Combs* (p. 401).—I hardly think that I "scoffed" at the idea of leaving combs wet with honey over the winter, but I tried to sound a strong note of warning. If Mr. Oldham will again read my very mild note (p. 350) I think he will agree, as also that it was partly directed against the unqualified nature of the advice. It may be at times all right for the experienced to do that which would prove disastrous to the beginner. So in this case, combs themselves may be safe in a very dry place, but, as I pointed out, we do not all possess such perfect storerooms. That being the case, how much better it would be to store the combs dry and clean, and how much more profitable. The hand extractor leaves something like 10 per cent. of the honey in the comb, and this would be much better employed as winter stores for the bees than as a perpetual legacy to succeeding crops. Cleaning of the combs can be safely and easily done by piling the supers above needy stocks. I may say that I often pile them near the bees in the afternoon to find them "as dry as a bone" in an hour's time. It is advisable to put them under shelter, and to leave them for a day or two until the bees are quite satisfied that no more is to be had from them.

*Book of the Bee* (p. 402).—Mr. Wilson's suggestion of an encyclopedia of bee-keeping is interesting, but has it not been forestalled by the "A.B.C. and X.Y.Z." published by the A.I. Root Co., of Medina, Ohio? In this regularly revised volume he will find such subjects as he indicates fully treated, even the history of bee-keeping being touched upon. The aim of the work is, however, mainly practical, and a "History of Bee-keeping," if it were to detail various national methods, might well be a volume in itself. The same might almost be said of "Bee Flowers," to judge by the amazing list of British plants already tabulated by Mr. Hayes. Whether such a book would be in sufficiently wide demand to repay the necessary research I cannot say, but it would be of undoubted service to the technical writer, who is in constant need of reference to some authority. It might, indeed, serve some purpose in preventing useless repetition of experiment, and at the same time stimulate ideas.

*Storing Extracting Combs* (p. 405).—I am no subscriber to the usual superficial dictum that theory and practice can be separated, or compared to disadvantage. Certainly these are not in conflict in the

present case. Rather is it a question of difference of practice, since I may equally claim to prove advice by practice. Now practice showed me once for all that it was not certainly safe to leave extracting combs wet, except possibly under ideal conditions, such as few bee-keepers can provide. The honey left in the combs, to which I referred, soured during, or due to, a damp winter, and I do not suppose that I am the only bee-keeper who has had such an experience. At any rate, I prefer my combs dry, rather than such a risk should be taken for the sake of a trifle of labour, even if there were no gain in putting the honey back into the hives. Then I am sure that the combs are free from what "D. M. M." styles the "seeds" of granulation, or of fermentation. As for wax-moth, there are other effective ways of preserving the combs, without making dust-traps of them. And all cleaning of frames can be done in the slack time of winter rather than in the hurry of extracting.



*The Editors do not hold themselves responsible for the opinions expressed by correspondents. No notice will be taken of anonymous communications, and correspondents are requested to write on one side of the paper only and give their real names and addresses, not necessarily for publication, but as a guarantee of good faith. Illustrations should be drawn on separate pieces of paper. We do not undertake to return rejected communications.*

#### PREVENTION OF "ISLE OF WIGHT" DISEASE.

[9098] It would be of interest to know whether any of your readers have found the following methods of value for the prevention of "Isle of Wight" disease:—

(a) The continuous use of Herrod's Apicure in the hive during the storing of winter supplies by the bees (say, from the middle of July) and the insertion of the apicure tablets when packing down for winter and early in the New Year.

(b) The autumn rapid feeding of the bees with syrup medicated with quinine or B-well.

(c) The prohibition of all candy-feeding before the New Year.

I have not personally had a wide experience of cases of "Isle of Wight" disease, but I have always, since 1911, by using some of the above precautions, managed to preserve at least one stock, although the disease has practically

cleared this neighbourhood of bees and destroyed many of my colonies.

My impression is that the combined fume and medicine treatment before mentioned is really of value for the saving of the bees. Perhaps some of your readers would criticise or support my suggestion. I ought to add that I owe much gratitude to Mr. Simmins and Mr. Wigley for valuable suggestions, and that all my bees are from the Queensland strains.—G. D. COOPER, Lower Beeding.

#### THE ROYAL SHOW FUND.

Coronation Road,  
Cheltenham.

[9099] DEAR SIR,—I notice you are asking for subscriptions for the Royal Show Fund. Well, now, I have a good bed of *Limnanthes Douglasii*, and it has occurred to me that I, too, might assist by selling them and giving the proceeds, less postage, to this or the other fund you are interested in. If it would help perhaps you would kindly make it known to your readers through the columns of the "B.B.J." They could have the plants for 2s. per 100, or 1s. 3d. for 50, post free. Wishing you every success, I am, yours very truly,

A. H. BOWEN.

#### SKEPS AND DISEASE (page 412).

[9100] Mr. Crawshaw, with his usual adroitness, has completely altered the moderate tone of my apostrophised sentence to one of a positive nature. I will retain mine, and surely he will admit there is a vast difference if he compares them again.

However, we will examine this "unnecessary" procedure of "taking," which it is claimed will eliminate disease, deplete surplus stock without impairing "economy." In the first place, our skeppist bee-master, or swarm-taker (which is the general height of ambition), will select by "lifting"—I believe this is the term; thereby will be disclosed the state of health; profit is quite an outside consideration—we keep bees for pleasure. The heaviest, and fairly so, will be selected for slaughter. This procedure, to my way of thinking, acts automatically in quite the reverse manner to a disease remover, as the strongest stocks would naturally have accomplished most; so we might reasonably expect them to be the healthiest. Again, with the moderately heavy we might expect the "age of the queen" to be right for the following season, which was the point I was thinking of. Of course, in some cases the finest queens would be in the light hives, considering age, but the



whole business is nothing but a haphazard mismanagement, and is not considered on any satisfactory basis, and unless queens are systematically introduced in the apiary no amount of "lifting," "breeding," or "slaughtering" will prevent inbreeding, with its consequent reduced stamina and disease-resistive powers, "as the bees are not allowed to follow their natural bent and find fresh fields and pastures new."

And I would contend that it is extremely necessary in these times of dearth—I am referring to bees alone—to save every stock we can, and I think the person who destroys one is jeopardising his country's welfare in more ways than one. Surely one can hardly take a delight in wilfully killing a stock, and the sooner everyone keeps bees for profit the better for all concerned, as after the newness has worn off, swarms galore without control are a nuisance, and if one does not like, and has no use for the spoils, we generally have not far to look for a deserving recipient.—A. H. HAMSHAR.

#### BEES DISTINGUISHING COLOURS.

[9101] With reference to the remarks in the "B.B.J." of November 19th, on "Bees Distinguishing Between Black and White," may I relate an episode which occurred in my apiary in August? An experienced bee-keeper told me in June that bees would sting black fowls, but would not interfere with white ones, but, having often been told many curious legends about bees, I took no notice, and still continued to let my chickens run about among the hives. One hot thundery afternoon in August the bees were distinctly irritable: they had stung a little boy who was on the other side of the hedge. Later on, we heard much "peeping" among the chickens, and, looking over the hedge, I saw a little brood in trouble. There were five chicks, three black and two white, and on the head of each black one there were two or three bees, evidently stinging them. I thought they were going to attack the hen too, so I released her from the coop and then tried to catch the chicks. But the hen flew at me and so did the bees, and I beat a hasty retreat, just having time to see the white chickens, with great presence of mind, quickly pecking the bees off the heads of the others. When I had got rid of the bees out of my hair, &c., I returned to the chickens and found the three black ones in a state of collapse, unable to walk or stand and looking very bad. I took them to the house and administered milk and brandy at intervals and kept them warm by the kitchen fire. Next morning they were better, still dis-

inclined to move, but they gradually recovered during the day and the bees have taken no notice of them since.

This little episode seems to be a confirmation of Mr. Lovell's statement that "if bees are angry" they will "go" for any black animal that is near them.—E. K. H.

---



---

#### WEATHER REPORT.

WESTBOURNE, SUSSEX.

November 1914.

Rainfall, 4.14in.	Minimum on grass,
Above aver., .91in.	19 on 21st.
Heaviest fall, .88 on	Frosty nights, 9.
15th.	Mean maximum, 50.3
Rain fell on 20 days.	Mean minimum, 39.8.
Sunshine, 69.6 hrs.	Mean temperature,
Above aver., 1.3 hrs.	45.0.
Brightest day, 18th,	Above average, 2.7.
5.8 hrs.	Maximum barometer,
Sunless days, 9.	30.548 on 18th.
Maximum tempera-	Minimum barometer,
ture, 59 on 6th.	29.206 on 15th.
Minimum tempera-	
ture, 28 on 15th,	
19th, and 21st.	L. B. BIRKETT.

---



---

#### ROYAL SHOW FUND.

	£	s.	d.
Donations already received ....	17	6	6
Rev. F. S. F. Jannings .....	2	2	0
A. G. Pugh .....	1	1	0

---



---

#### WAR RELIEF FUNDS.

E. Ballard, from sale of *Limnanthes Douglasii*, 6s. 2d.

---



---

#### IMPORTANT NOTICE.

We shall be greatly obliged if those of our readers who have their JOURNAL by post from this office, and who wish to continue their subscription, will kindly let us have their order immediately on the expiration of their previous subscription—of which due notice will be given. Failing an order, we shall assume the paper is not required, and therefore discontinue sending it.

We are obliged to take this course as, owing to the increased work of our staff in other directions, we are unable to undertake the extra work and expense involved in sending out bills for small accounts, or to bear the losses entailed by sending out the JOURNAL after subscriptions have run out, the recipients failing to notify us that the paper is not required and refusing to pay for those received after the subscription had

expired. We therefore respectfully notify our subscribers that the JOURNAL will not be sent unless the subscription is prepaid.

## Notices to Correspondents

"NOVICE" (Wood Green).—(1 and 2) Washing with a 10 per cent. solution of formalin would probably remove it, but it is not dangerous to the bees; use a sheet of calico next the frames and several thicknesses of carpet or felt over that. (3) You might do it on a mild day, but it is not advisable so late in the season. (4 and 5) No, you will do better without it altogether. (6) It is doubtful if they would, even if the queen was very prolific—but 1916 is rather too far ahead for us to prophesy. You had much better work the single colony, but if you do divide it use a perforated wooden division-board. (7) We cannot say. As a rule allotments do not provide much forage for bees. (8) You cannot do much in a garden or allotment in the way of plants for nectar-producing for surplus. A few early flowers are useful for stimulating the bees in the spring. The best of these for nectar is White Arabis (the single variety) and Crocus for pollen. Other useful flowers are Winter Aconite, Wallflowers, Snowdrops, *Limnanthes Douglasii*, &c. For climbers you might use Nasturtium, Canary Creeper, Scarlet Runner Beans, Convolvulus, or Morning Glory, &c. (8) If he could *prove* that your bees stung him and were a nuisance he might get an order to compel you to remove them. (9) If they come through the winter and the queen is a good one they should work up into a strong stock next year. Do not give syrup before the end of March or early in April, according to the weather. You might give them a 2lb. box of soft candy in February if you think they are short of food. (10) Probably they would;  $\frac{1}{4}$  in. is not enough, you should allow at least  $\frac{1}{2}$  in.

A. W. D. (Finchley).—We think it is abating a little. There is a certain amount of risk in commencing again at present. If you do so your best plan is to procure the bees locally if possible.

### Honey Samples.

G. OAKLEY (Yorks).—It is clover honey. Good in colour, aroma, and flavour; quite up to show standard.

C. (N. Wales).—Sorry we can give no reason, unless it has been stored in a damp place.

### Suspected Disease.

C. D. (Chippenham).—Both samples of bees are suffering from "Isle of Wight" disease. You can do very little in the way of trying remedies this time of year. Your best plan is to burn the contents of the hives and re-stock in the spring.

J. L. B. (Worcester).—It is "Isle of Wight" disease.

### Special Prepaid Advertisements

Two Words One Penny, minimum Sixpence. Orders for three or more consecutive insertions entitle advertisers to one insertion in "The Beekeepers' Record" free of charge.

Trade advertisements of Bees, Honey, Queens, and Bee goods are not admissible at above rate, but will be inserted at 1d. per word as "Business" Announcements, immediately under the Private Advertisements. Advertisements of Hive-manufacturers can only be inserted at a minimum charge of 3s. per  $\frac{1}{2}$  in., or 5s. per inch.

### PRIVATE ADVERTISEMENTS.

**F**INEST Wiltshire honey, 15s. 28lb.; sample, three stamps.—W. HANNAM, Stourton, Wilts. v 87

**F**OR SALE, one honey extractor, reversible cages, and cog gearing; two 1 cwt. honey ripeners, with strainers, complete; one steam wax extractor; one knife warmer, £3.—A. E. WILLETT, Cheveley, Newmarket, Cambs. v 88

**W**ANTED, Rymer honey press, good condition.—Offers to GIBSON, Leeming-Bar, Bedale. v 86

**F**OR SALE, three gross splendid sections and about thirty dozen 1lb. bottles first quality honey.—Box 10, "B.B.J." Office, 23, Bedford-street, Strand, W.C. v 85

**A**BOUT one gross beautifully clean extracted shallow frames, 5s. per dozen; thirty-two racks, taking nine frames, 1s. each.—X. Y. Z., "B.B.J." Office, 23, Bedford-street, Strand, W.C. v 84

**W**ANTED, direct photographs of Apiculture, comprising all sections; state subjects and price.—PHOTOGRAPHER, "B.B.J." Office, 23, Bedford-street, Strand, W.C. v 83

**H**ONEY, good light, 28lb. tin, 14s.; 56lb., 28s.; tins free; sample, 3d.; dozen screw capped, 8s.; all f.o.r.—SIMPSON, Chalfont St. Giles, Bucks. v 82

**S**EVEN 28lb. tins good heather blend honey, 15s. tin; sample, 2d.; also 6lb. new wax, 1s. 6d. lb.—C. KIDBY, Sizewell-road, Leiston, Suffolk. v 81

**L**IGHT Lincolnshire honey, in 28lb. tins, 7d. lb.; sample, 3d.—WAIN, Thorpe Bank, Wainfleet. v 80

**F**OR SALE, one 28lb. tin pressed Scotch heather F honey, at 20s.; also three tins finest clover granulated, at 16s.; tins free, and f.o.r.; sample, 3d.—HENRY GOW, Waggon-road, Crossford, near Dunfermline. v 79

**P**URE Leicestershire honey, light, excellent quality, 28lb. tins, 16s. each; sample three stamps.—EVRETT, expert, Rosebank Apiary, 40, Linden-street, North Evington, Leicester. v 77

**3** CWT. honey, 28lb. tins, 56s. per cwt.; sample 2d.—GEORGE THOMPSON, Helpringham, Sleaford. v 73

**S**EVENTY sections of first grade pure heather honey; these sections are extra well filled and beautifully clear.—JOHN RIGG, East Bank House, Kendal. v 71

**F**OR SALE, extracted clover honey, 9-28lb. tins, 16s. each; two dozen sections and five dozen screw top bottles, 8s. 6d. per dozen; sample 3d.—W. PHILLIMORE, Three Horse Shoes, Enford, near Pewsey, Wilts. v 68



## NOTICE.

Owing to the dislike of one of my ancestors to a long signature he dropped a portion of his name. For several generations this caused no inconvenience, as they did very little business. Owing to the continued increase in my business interests, the dual situation of one signature for ordinary use and another for legal matters has become impossible; therefore, on and after January 1st, 1915, I shall assume my full name of W. Herrod-Hempsall. I shall be grateful if all correspondents will kindly note this and address me, also make out all cheques or documents, and insert in any list my name as above.

W. HERROD-HEMPSALL,  
hitherto commonly known as W. Herrod.

## IMPORTANT NOTICE.

We shall be greatly obliged if those of our readers who have their JOURNAL by post from this office, and who wish to continue their subscription, will kindly let us have their order immediately on the expiration of their previous subscription—of which due notice will be given. Failing an order, we shall assume the paper is not required, and therefore discontinue sending it.

We are obliged to take this course as, owing to the increased work of our staff in other directions, we are unable to undertake the extra work and expense involved in sending out bills for small accounts, or to bear the losses entailed by sending out the JOURNAL after subscriptions have run out, the recipients failing to notify us that the paper is not required and refusing to pay for those received after the subscription had expired. We therefore respectfully notify our subscribers that the JOURNAL will not be sent unless the subscription is prepaid.

## NORTHUMBERLAND B.K.A.

Will the members of the above kindly note that the secretary *pro tem.* is Mr. R. Robson, Cheviot St., Wooler.

Capt. Sitwell, though not yet at the front, is on active service—judging from his letter, *very* active service—training men of our new army, and therefore finds it impossible to attend to Association business.

## THE CONVERSAZIONE LECTURE.

By Mr. A. Richards.

BEEES IN RELATION TO FLOWERS AND FRUIT.

(Continued from page 428.)

This brings me to probably the most interesting question—that of *cross-fertilisation* of varieties.

It is, of course, now well known among fruit-growers that many pears, apples, and plums are self-sterile—that is to say, that the pollen on a particular tree is impotent to fertilise the blossom on that tree, and for the production of fruit it is necessary to plant more than one tree of such a self-sterile variety within the radius of a few yards, but the question is rendered still more complicated and interesting from the fact that in nearly every case the largest and best-flavoured fruit is produced by the union of two distinct varieties of the same fruit by the transfer of the pollen from the one tree on to the *stigma* on the blossom of the other tree, and certain varieties show a distinct prepotency together, and one of the most interesting fields for investigation and discovery is open in this direction.

I must here again emphasise the very clear exposition of this matter which Mr. Cowan gave us in 1909, and I may say I have since mentioned some of the facts which Mr. Cowan then gave us to a very large and successful fruit-grower and considerably surprised him.

“As the seed, so the fruit shall be,” is a quotation we have often used, but it has a very *direct* meaning in this question; for the secret of successful fruit-growing is to produce large and well-formed *pips*, and we can then leave the question of the fruit to solve itself.

It is the old adage to “take care of the pence and the pounds will take care of themselves.”

The two following slides show you a William Pear, first the pips self-pollinated, and second the William Pear self-pollinated, and crossed with *Easter*.

Those who would like to follow this up should get a copy of Mr. Cowan's paper, which has been reprinted.

In conclusion, let me remind you that our orchard fruit is a grafted and consequently artificial production of our civilisation. It shows us how, if we aid nature, nature is ready to aid us, but we must complete the work and recognise that when one branch of her handiwork is thus stimulated, improved, and enlarged it necessitates the extension and perfection of its other and kindred branches.

A discussion on the subject of the lecture then followed.

Mr. Judge: I would like to know what the lecturer's experience has been this year where the “Isle of Wight” disease

has developed? I might say, in my district the fruit crops have, generally speaking, been excellent considering the shortage of bees. I should like to know if this is general.

Mr. Heap: I should just like to say that in our district (Berkshire) "Isle of Wight" disease has decimated the bees. The fruit crop this year has been better than at any other time. Last year we had just a moderate crop—this year the trees have been overcrowded.

Mr. W. Herrod: I do not think anyone can say that their district is without bees. Probably, if you look round you will see a number of hives. A friend of mine visited the Isle of Wight, a district where the bees were supposed to have been wiped out by "Isle of Wight" disease. He came to a lady who lived and had an apiary almost in the middle of the devastated district, and she had never heard that there was such a thing as "Isle of Wight" disease. Her bees were carrying out the work of fertilising the fruit blooms there. There is another thing which we have to remember, and that is, in a season like we have had in 1914 the bees have been able to work very freely. Now, take my own district, we have about 200 trees, and we have had an enormous crop, in fact, we have had to prop the trees up because they were so laden with fruit, and yet I found that round about the district there was very little fruit; but I think I can prove more conclusively the value of the hive bee for this work. I remember quite well during a bad summer visiting a garden in which there was a row of fruit trees; ten yards away were a number of bee-hives, and further afield a couple of pear trees and a couple of apple trees. The trees near the hives were laden with fruit, as the bees visited them during short spells of sunshine, on the others there was none, as they were too far off for the bees to visit. I think, if we study the subject, we shall find that in nature the work of the bee is the fertilisation of fruit and other blooms.

Mr. Harper: In our district we have very few bees, as "Isle of Wight" disease has killed most of them. I am practically the only one in my district who has bees, and I have noticed plenty of fruit. The Humble bee has worked splendidly. I have observed these bees working as late as a quarter to nine at night during the summer, when other bees have remained in the hive. As the hive bees fail the wild bees come along; because we have "Isle of Wight" disease it does not follow that we are not going to get any fruit at all, there is always a way out of a difficulty.

Mr. Flashman: We thought our district was cleared out of bees; it might have been so, but we get plenty of stray swarms.

Mr. W. Herrod: With regard to the bees in different districts it is very difficult for one to say whether there are bees or not. One day when a swarm was found near the apiary here, we were telephoned for to go and hive it. Mr. Smallwood went and he happened to look over the wall, and there saw a row of bee-hives. The swarm did not belong to us at all, although we supposed there were no other bees in the neighbourhood. If any of you have doubts as to the importance of bees for fertilising fruit blossoms read some of the American bee literature, and you will find that there is a great deal in keeping bees for the fertilisation of fruit bloom, and the Government there are taking steps to increase the number of bees kept. Even in our own country time and again fruit-growers ask me to get bee-keepers to take their bees and place them in the fruit orchards to fertilise the blossom.

Rev. F. S. F. Jannings: I should just like to refer to what Mr. Herrod has said with regard to the necessity of bees for fertilising fruit. I had a most interesting conversation with an intelligent young man—a fruit farmer—from British Columbia. He said it was absolutely necessary to understand the keeping of bees to have a successful fruit orchard. A great many fruit-growers in British Columbia are trying to purchase bees to fertilise their fruit bloom.

Mr. Crawshaw produced a considerable sample of heather pollen, which excited interest, and amid some amusement proceeded to read a letter from Mr. Laycock, of the West Yorks B.K.A., explaining how the sample was obtained. It appeared that several local bee-keepers carried a vacuum cleaner up to the moor and proceeded to clean the heather, afterwards extracting the pollen from a mixture of twigs and blossoms, but through a muslin bag, by the same means. The writer conjectured that some of the willing workers would have objected to a similar task had it been a question of carpets in the home. (Laughter.)

The Chairman (Mr. Reid): I think we cannot say that there is an absence or presence of bees in any particular place. Someone has mentioned wind pollination. The wind certainly does carry pollen. With regard to insects they do play a part in fertilisation. Probably the pollen of those plants which rely upon wind fertilisation has a different character to that of those relying upon fertilisation by means of insects. I think Mr. Herrod has struck the right note—that if we have a small number of hives in a very suitable position they may do more than fifty hives not so well situated. You cannot calculate the exact amount of work that each single bee may do and the number of

visits bees pay. I now call upon Mr. Richards to reply.

Mr. Richards: There is very little for me to say, as so many have answered each other's questions. Those who doubt the amount of work obtained from the honey bee had better put covers over their trees, as illustrated, and notice the result. I want to impress upon you the disadvantages of reducing the number of bees. You will find it very difficult to grow fruit to perfection without them. I hope I have been successful in my object this evening, to have interested you, and given you the desire to be more observant and investigate these matters for yourselves in your own gardens. (Hear, hear.)

A most successful and interesting meeting was brought to a close by hearty votes of thanks to the Chairman and lecturers.



EXTRACTS AND COMMENTS.

By D. M. Macdonald, Banff.

*Gentle Bees Cross.*—Every bee-keeper must have observed that the temper of bees is not uniformly sweet. It varies. Bees normally gentle, and not inclined to sting, become cross and revengeful. Several contributions to *Gleanings* deal with the enigma, and seek to explain it by attributing the change to altered surroundings. "Bees are crosser during the chiller hours of the morning or night than they are during the middle of the day when it is warm." "What makes bees crosser than anything I know is the sudden cessation of a honey-flow, or the abrupt stoppage of feeding." "When from climatic or other reasons there is an unexpected check in the inflow from basswood, buckwheat, heather, or honey-dew bees often turn savage—even gentle bees." "They would rush out to attack literally by the hundreds when we opened the hives. Smoke was worse than useless, and we had to beat an inglorious retreat." "The reason of the crossness was that the flow from buckwheat stopped in the early forenoon, and about midday the bees were idle." Manipulating in unseasonable weather causes the bees to wax hot-tempered. A rough, chilling wind blowing across the exposed frame tops rouses their ire. Bumping the frames, jarring the hives, or working with hands bearing disagreeable odours all tend to make gentle bees cross.

"*Millerisms.*"—Much poor bee-keeping is due to fear of stings. Many stings come from poor bee-keeping.

Do you want a nice weedless, mudless, dustless strip before, behind, beside, and beneath your hives? A fine asphalt walk about your hives sounds expensive, but it isn't—and the luxury of it!

I am glad to see that the tide is turning and that others are advocating doing "stimulative feeding" in the fall. A full larder and a young queen spell good wintering, good springing, and good cropping.

How very few bee-keepers study bee behaviour experimentally. Most of them are too busy with something or other, or are absorbed too much with planning manipulations. But such study will pay and do away with many manipulations.

Did you ever notice the nice things suggested for "floats" for feeding from pans, &c.? Cork chips, when you have no cork; planer chips, when you have no mill; grass, when you have no grass. The best non-soakable material is bits of comb and pieces of foundation, always at hand.

The foregoing from "A.C.M." are good. I wonder if the following may be swallowed in its entirety? Commenting on "scorching out a hive" he says: "Just remember that paint or common thin machine oil is an equally good steriliser. Scrape off the lumps of wax or propolis, as you would do before using the torch, and then apply your paint or oil."

"*Virgins.*"—"In every case where I have tried it, no matter what the conditions of the colony, a virgin less than a day old has always been accepted." Yes, such virgins will be welcomed by a queenless colony without any smoking or introducing, provided they do not carry the odours of the apiarist's finger, and even then they will generally be accepted. Introduce without touching, allowing them to run down quietly between the combs or in at the entrance.

*Bees out of Sections.*—"To get bees out of sections, the easy way is to smoke down most of the bees before taking off, then pile up the supers and put a Miller escape on top," says Dr. Miller. I do not think so. Smoke amongst sections is a mistake. Then driving bees down with smoke upsets the orderly arrangements of the brood-nest, and may make bees cross. A minimum of smoke should be used, the bees on frames should not be disturbed, and there should be no more disturbance than a simple severance of the two bodies of bees—with an easy exit from the super direct to the frames of brood.

*Admiration.*—"Thou shalt not envy thy neighbour's—apiary." The beautiful illustrations in recent issues of *Gleanings* of the new experimental apiary and apiarian laboratory at Washington make me almost break this new Commandment. Dr. Phillips and his staff are to be heartily

congratulated on being housed in such beautiful buildings and artistic surroundings.

*Propolis.*—The uses to which this substance are put in the hive are numerous and varied. They stop with it holes and crevices less than a bee space. In a skep they make the top and sides water-tight and air-tight. They employ it to varnish old cells. Some claim that a coating converts a "foul" cell into a clean one. Out of the hive here are three uses to which it may be put: (1) Melted and mixed with an equal measure of linseed oil it produces one of the best healing salves. It is an unexcelled dressing for chapped hands, or any abrasion of the skin. (2) Mixed with lampblack, it

makes an excellent shoe polish. It restores the flexibility of the leather and makes the shoe waterproof. (3) Propolis mixed with 25 or 30 per cent. of vaseline applied to the surface of a clean wound has a soothing effect and healing takes place under the most favourable conditions.

*Olfactory Organs.*—Dr. Brunnich, in *American Bee Journal* declares: (1) The sensitive organs described by McIndoo represent a protective organ, a kind of rough olfactory formation against injurious gases. (2) The sense for fine odours, for discovering honey sources, perceiving foreign individuals, sexual odours, &c., is situated in the antennæ.



#### PROCURING SURPLUS.

(Continued from page 433.)

The girders which carry the sections should be of wood about  $\frac{3}{4}$  in. wide, and not the metal T-shaped ones so often used. In the first place wood is warmer than metal; secondly the tail of the T standing up  $\perp$  between the rows of sections

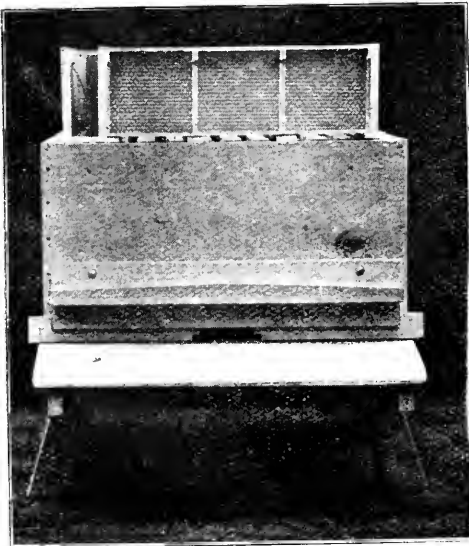

FIG. 28.

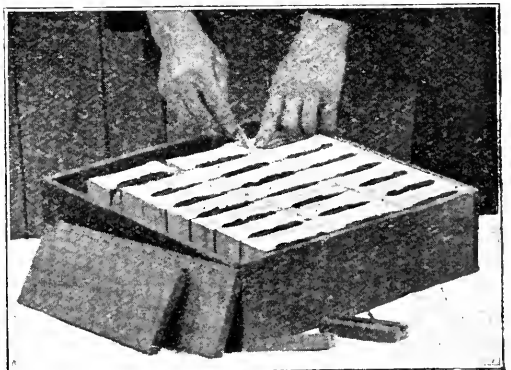

FIG. 29.

prevents them fitting closely together, providing a space which the bees fill with propolis; a waste of time on their part, and causing much trouble and waste of time to the bee-keeper in cleaning. Also by being separated slightly, *i.e.*, about

½ in., the sections often get out of the square and further trouble ensues when they are glazed. In the narrow rack with metal girders it is difficult to remove the sections, and if it is turned upside down, and an attempt made to force them out with the fingers, it often happens that several good ones are smashed in the process. With the wooden slats and wide rack all this is avoided. There is no ridge to hold

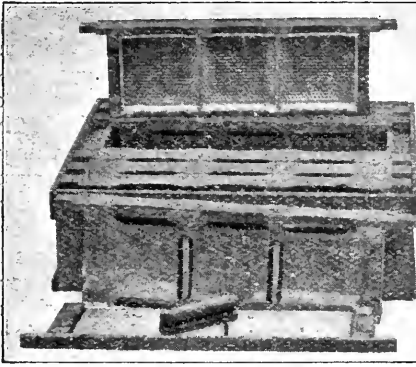

FIG. 30.

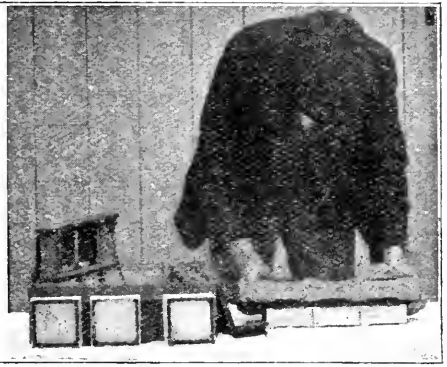

FIG. 31.

the sections apart, and the side following board forces them square (Fig. 28). Their removal is easily accomplished by taking away the side and end board; a strong knife pushed in between easily separates them with both a side and end movement (Fig. 29.)

Another form is the W.B.C. hanging section-rack, which is favoured by many bee-keepers. As will be seen in the illustration (Fig. 30), this rack has the same advantages as the one described above for working in conjunction with shallow-frame supers, being made the same size. In this case the sections are fitted into hanging frames, to which is attached the divider. They are all fastened tightly together in the frame by means of a wedge at one end, and the seven frames are

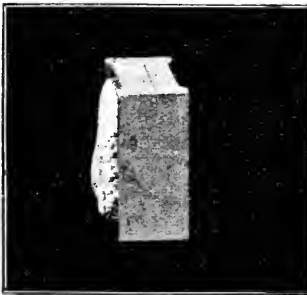

FIG. 32.



FIG. 33.

wedged firmly in place by means of a following board with a spring block at the back. To prevent the bees getting into the space at the back of this board from underneath, pieces of wood ¼ in. thick and 7/8 in. wide should be nailed on the underside of the end at which it works. The advantages claimed for this rack are that it keeps the sections quite clean, as they are covered, with the exception of the edges. Also, if it is necessary to move the sections while on the hive, it can be done without the sacrifice of bee life. For instance, if the bees have drawn out the combs just in the centre, and it is desirable to spread the cluster so as to make them work uniformly throughout the rack, it is a simple matter to place a frame of drawn-out sections alternately between those not worked upon. This cannot be done very comfortably with the ordinary rack, as it takes a long time, exposes the bees unnecessarily, and unless done carefully a number of bees are killed by crushing. The removal of the finished sections is not difficult if the frames are

made properly. They should be so constructed that when the wedge is removed and the frame turned face down on to a table, the sections slip out freely (Fig. 31) when the frame is lifted up. The one drawback is the extra cost involved.

The next point to consider is the divider. These must be used to keep the comb within the woodwork of the section. Although it is possible to get good sections without their use, many will be spoiled by bulging as seen (Fig. 32.) The best material for these is wood, No. 3 (Fig. 18), as it is warmer than metal, but there are several disadvantages which prevent its use. The divider should be as thin as possible; this prevents propolisation, and also gives better results by the conservation of heat effected. If of wood, they have to be made of very thick material to prevent buckling when in the rack. This prevents the best work being obtained; also they are difficult to clean, as they split very easily. All things considered, zinc is the most suitable material as it does not rust, and therefore can be washed with a disinfectant without injury. Tin is now used on account of its cheapness, but care is necessary to prevent rust. The ordinary slotted divider, No. 4 (Fig. 18), is the one generally used, but with this the top slots are often cut too large, the result being that a row or two of cells just at the top are drawn out too far, sometimes even to such an extent that they protrude beyond the woodwork (Fig. 33), making the handling, cleaning and glazing of the sections without damage an impossibility. In practice I have found a divider without slots give excellent results. The fence wood-divider, No. 2 (Fig. 18), is used by some, but unless it is carefully made its use will disfigure the combs, as the bees make ribs across them just opposite the openings in the divider; this spoils the appearance of the section.

*(To be continued.)*

## HOMES OF THE HONEY BEE.

### APIARIES OF OUR READERS.

#### A COTSWOLD OUT-APIARY.

I have pleasure in submitting a photograph of one of my apiaries on the Cotswold Hills, devoted mainly to the breed-

a high embankment of the Great Western Railway. To reach this spot means an uphill climb of twelve miles, but one has the advantage of being fairly isolated and amongst some of the finest bee-forage.

The chief sources of honey are sainfoin, white and alsike clover, in fields

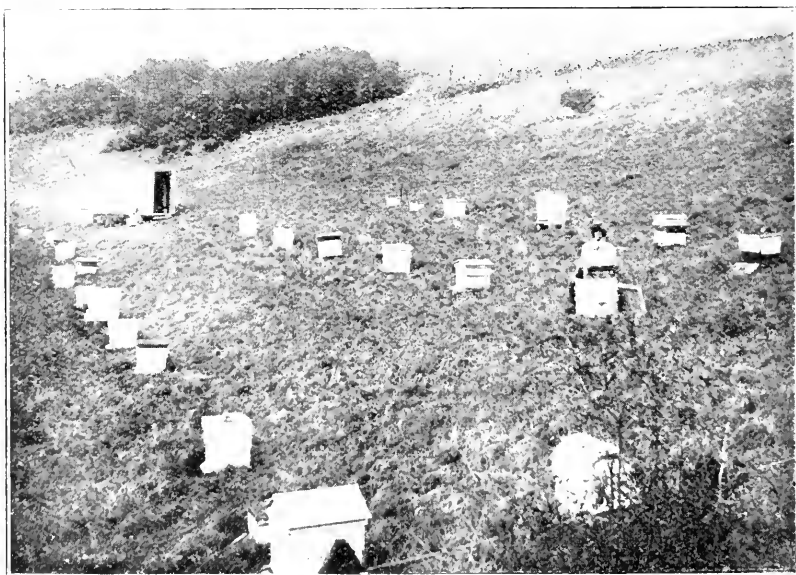

A COTSWOLD APIARY.

ing of golden bees and queens. As will be seen, it is prettily situated on a steep bank facing south, and at right angles to specially laid down for the feeding of sheep, with charlock that grows so luxuriously amongst the early corn, and



later on together with turnips and swedes. Occasionally we have fields of trefolium and beans, besides sycamore trees in May, and various other blossoms from then onwards till the bramble flows with richness during August. Early summer brings us honey that is particularly light and dense at first.

As the season wears on it decreases both in colour and consistency, until at the close of the flow it assumes a greenish tint; though the flavour is most delicious, being evidently imparted by the last white clover of the year. This apiary is well situated for the mating of queens. The surrounding country is open, and much swept by winds, while perfectly calm days are few, except during long spells of hot weather. But the apiary, being in a hollow, is well sheltered, and from the number of correct matings that have taken place it would appear that most of the queens met with golden drones quite close at home.

In order to get fairly good results I have found it necessary to raise drones in large numbers, by supering strong colonies with drone combs. Stocks that are in good heart will tolerate their drones right up till September if the bees are given occasional feeds of syrup. I have proved that a better bee pays for the trouble it takes to get it, and when breeding by selection is carried out year after year a very good strain may be separated; and the added vigour is a great factor in disease resistance. And now a word about the hives.

All those having flat tops are of a special design for out-apiary management. Several different types have been acquired at various times with the purchase of bees, but this hive embodies the good features of them all, without their disadvantages. Everything is square, whilst the supers tier one above another, and can be lifted on and off in a moment. As regards mating-boxes, two, holding five frames, or three, taking three combs each, fit on the regular floorboard side by side and are covered with the usual lift and roof.

This is a distinct advantage, since the boxes can be filled separately at any hive, and when placed together are compact and warm for wintering nuclei. All things considered the combination is ideal for utility purposes, with the man who does not care to fuss with bees or handle unnecessary fittings.

I fear I have now exceeded my space, but with the Editors' permission may later on be able to give yet another glimpse of some of the out-apiaries on the Cotswold Hills.—A. H. BOWEN, Coronation Road, Cheltenham.

## RANDOM JOTTINGS.

THE TOURING EXPERT: A QUESTION OF PROFESSIONAL CONDUCT.

By Charles H. Heap, Reading.

Should the touring expert regard as confidential what he sees and hears when he visits the apiary of a member of the County Bee-keepers' Association which employs him?

This is a question which does not seem to have been discussed, and yet badly needs discussing. There is a general understanding in all walks of life that it is improper for the servant to betray the confidence reposed in him by his employer. This is a good, wholesome rule which has many times been upheld in British courts of law; but from what I have heard, I fear it is often broken by gentlemen holding certificates of the British Bee-keepers' Association. Now, let it be clearly understood that I am making no accusation against any individual in particular, but am simply attacking a practice which I believe is harmful to County Bee-keepers' Associations, bee-keeping generally, and touring experts themselves. In most instances, when I have gone into fresh districts, I have been struck with the frequency of enquiries concerning the condition of other people's bees in the same village or neighbourhood, and the surprise generally expressed when I am compelled to ask to be excused answering such questions. Some people do not like the refusal, but when I turn the case the other way about, and say, "Suppose, Mr. A., I had to-day found your bees suffering badly from foul brood, how would you like me to tell Mr. B. when I go across to him?" The point of the situation is at once grasped, and with a word of apology the person addressed usually says, "I had not looked at it in that way." I am sure that if I were the average bee-keeper, I should not like the unsatisfactory state of my apiary talked about by the person whom I had paid to give me the benefit of his advice. Where is the touring expert who has not been told, or has not felt, that his discovery of disease in the apiary has not been appreciated, and has occasionally been followed by the bee-keeper's withdrawal from membership of the Association? In such an instance it is not the mere revelation of the existence of disease, so much as fear of the fact being noised abroad, that is the disturbing element in the bee-keeper's mind. By withdrawing from the County Bee-keepers' Association he gets rid of the visit of a talkative expert, and by applying antiseptics several times and announcing that he is once more clear of disease he rehabilitates himself in the eyes of his brother bee-keepers. On the other

hand, there are people who do not mind how much their apiarian affairs are talked of; indeed, they take the earliest opportunities to promulgate the findings of the expert.

In certain conceivable circumstances a member of an Association may be in a disadvantageous position compared with an unassociated bee-keeper. A striking instance within my own experience comes to mind. I visited one year a large apiary belonging to a lady; but as she had to remove a few miles she decided to sell a number of her stocks. She got into communication with a dealer, who asked a local appliance dealer to look at the bees. Presumably upon his report, a bargain was struck, but it did not turn out trumps. The buyer then wrote to me asking in what condition the bees were when I visited the apiary in the spring. I had not seen them for over a year, but I declined, not once, but three times, to give any information whatever; and then the buyer wrote to the Hon. Secretary of the Association, with what results I do not know, but I hope with a negative result, as, anticipating this move, I addressed him a note acquainting him with my attitude in the matter, and setting forth the grounds upon which I refused the information sought. This highly improper attempt to secure information which an inspection by a competent person would have rendered unnecessary was made, I imagine, to avoid the risk that might be entailed in an action at law. If the dealer thought I could give evidence which would assist him, it was within his power to subpoena me to attend the court, and even then I should not have given evidence without a protest.

Every touring expert needs to bear in mind that he is in exactly the same position as other professional men, and that it is his duty to respect the confidence of his clients. Unless he does so he will not achieve the highest degree of success in his calling, neither will he promote the best interests of bee-keeping, which is the reason of his professional existence. What would be thought of the medical man who talked about the diseases of his patients, the veterinary surgeon who let everybody know of the shortcomings of the cattle of the farmer who employed him, or of the lawyer who talked of the business and private affairs of his clients? Very little, and each would soon be without patients and clients to talk about. The touring bee expert, though his income falls far short of that of the lawyer, doctor, or veterinary surgeon, is no less a professional man, and he should not be content with a lower standard of professional honour.



*The Editors do not hold themselves responsible for the opinions expressed by correspondents. No notice will be taken of anonymous communications, and correspondents are requested to write on one side of the paper only and give their real names and addresses, not necessarily for publication, but as a guarantee of good faith. Illustrations should be drawn on separate pieces of paper. We do not undertake to return rejected communications.*

### "ISLE OF WIGHT" EXPERIENCES AND "GUESSES."

[9102] I should like, if I may, to relate two experiences with this dread disease this year. I have myself leaned to the idea that the disease is a digestive one, and affecting the bees by constipation. Whether the microbe is a preliminary, or resultant one, I am sorry I have not the experience or facilities for finding out.

I started the season with a colony each of Blacks and Golden Italians. The Blacks were badly affected by the end of February, and I couldn't find the heart to destroy them for a month, although I'm afraid I only prolonged their miserable existence, the result was rather startling. I made a quart of syrup and added the juice of two lemons, and bees in the final stages of collapse, fully distended, &c., were coaxed (?) to try a little medicine. This seemed to act as a violent aperient, relieving bees of excreta almost instantly, when they were able to indulge in a short flight, and their condition improved very rapidly, while bees which were not so ill enjoyed the freedom and a day or two of sunshine in a very marked manner; hence my report of hoping to save them. But they had fallen so weak in numbers, and the medicine proved so irresistible to the "Goldens" (I must give a warning against using syrup indiscriminately), I decided to place them with the majority.

The next slight attack was a small one-frame reserve nucleus from my "immunes," as it pleases me to call them. I have had them three years, but owing to foul brood I have not been able to increase them until this year. I have now four strong colonies, and have sold two. One of my own had an Italian queen introduced, and have managed to give about 90lbs. of honey, leaving ample stores. This slight attack happened after the third day during a cold spell, as the result of feeding with "Dem. sugar." Whether there is something in the refining or whether

it was "Demerara" at all I have no means of finding out; at any rate, I changed the syrup to pure white sugar, when, after killing what affected bees I could, the disease disappeared, and I was able to take out a frame and queen the second week in July for the second artificial swarm. Appearances seem to show the disease could hardly have been caught, as everything had been properly cleared three months before, and this stock at that time contained the youngest bees, being the last of five divisions made to rear a queen, and I don't know of any other bees in my flight area. Also, it appears to me, we must blame successive mild winters, which causes bees to consume more food, and of a nature that they cannot properly digest, nor can they get out for a cleansing flight. This empties the abdominal air sacs by internal pressure, thereby disabling them from flying, which accounts for the bees being unable to respond with returning spring, and unfortunately it is generally inadvisable to tamper with or endeavour to treat them at this time.

I have also heard of a stock surviving through last winter which had taken possession of combs on which bees had died for three consecutive years, and has thrown, to my knowledge, five swarms, although the possessor does not even own the hives.

Is the disease a contagious one, or is it "atmospheric circumstances"? I suppose I ought not to ask on the face of information.

"Immunity chimera," or not, this seems the only logical procedure to counteract the disease until we can find the remedy; it is also the most natural, therefore the most lasting. I read this week of a correspondent noticing an unnatural appearance in the queen. Well, I have not noticed this, and have thought how perfectly healthy they have looked when they could be found.

A. H. HAMSHAR.

ROYAL SHOW FUND.

	£ s. d.
Donations already received .....	20 9 6

WAR RELIEF FUNDS.

We have received a further donation of 7s. from Mr. E. Ballard, "Beeholme," Aldington, from the sale of *Limnanthes Douglasii* plants. Mr. Ballard writes, "I have yet plenty of plants, and hope to have more orders."

	£ s. d.
Donations in cash already received .....	2 17 8
Mr. E. Ballard .....	0 7 0



[8989] *Definition of Paraglossæ.*—Would you kindly give me your definition of the paraglossæ. I think I know something of their function, but I am unable to get "clear" by the way I read Mr. Cowan and Mr. Cheshire.—A. H. H.

REPLY.—We do not know how we can amplify the description given in the books named, except by saying that *paraglossa* is derived from the Greek *para*, beside, and *glossa*, tongue, which describes it as appendage to the ligula or labium. Paraglossæ are in shape of curtains which surround the ligula, and are capable of meeting at the upper end, the lower end being rounded off as shown in illustrations. If these, together with the description, are followed, they should convey a clear understanding of their function.



G. COLVILLE (Chatton).—We need not say more than that the heather honey was excellent. It was very little damaged in transit. We thank you for your kind wishes, and have enjoyed eating the section of our favourite honey.

K. (Leicester).—*Zinc for Feeders.*—It is not advisable to use zinc for the purpose.

W. WEST (Bridgwater).—Get the "British Bee-keepers' Guide Book."

G. GIBSON (Bedale).—You will have to use the cheese cloth in any case. Heather honey is too dense to strain in the ordinary way.

*Suspected Disease.*

A. HIBSON (Handsworth) and A. LOWN (Salop).—The bees are suffering from "Isle of Wight" disease.

J. G. (Petworth).—We do not find any signs of disease in either bees or comb. The cocoons are those of the wax-moth. We can only suggest that the colony became queenless. The combs will be all right for the other stock.

### HONEY IMPORTS.

The value of honey imported into the United Kingdom during the month of November, 1914, was £1,873.—From a return furnished to the BRITISH BEE JOURNAL by the Statistical Office, H.M. Customs.

### Special Prepaid Advertisements

Two Words One Penny, minimum Sixpence.

Orders for three or more consecutive insertions entitle advertisers to one insertion in "The Bee-keepers' Record" free of charge.

Trade advertisements of Bees, Honey, Queens, and Bee goods are not admissible at above rate, but will be inserted at 1d. per word as "Business" Announcements, immediately under the Private Advertisements. Advertisements of Hive-manufacturers can only be inserted at a minimum charge of 3s. per ½ in., or 5s. per inch.

### PRIVATE ADVERTISEMENTS.

**FINEST BEE PRODUCE.** Extracted fruit blossom and clover honey, 28lb. tin, 20s.; clover, 21s.; pressed clover and heather, 22s.; pure heather, 23s.; clover, 1lb. bottles, 12s.; heather, 13s. dozen; sections, prices as for bottles; any lot carriage paid.—WOOD, Ash Grove, Bishopton, Ripon. v 91

**FINEST clover honey,** in 1lb. screw capped glass jars, price 8s. 6d. per dozen; sample, 2d.—DUCKMANTON, Langwith, Mansfield. v 89

**FOR SALE,** or exchange, ice safe, 21in. long, 20in. deep, and 16in. wide, wants slight repairs, 10s.; too cheap for approval.—BUMBLE, "B.B.J." Office, 23, Bedford-street, Strand, W.C.

**FOR SALE,** zinc skep covers, 1s. 3d. each; also shaped skep floor boards, and stands for same, 1s. 6d. the set. The above are better than new as they are painted, and are being sold at half price, cash with order.—BOSS, "B.B.J." Office, 23, Bedford-street, Strand, W.C.

**SELL** or exchange, good dress suit, 36in. chest, 20s.—DRESS, "B.B.J." Office, 23, Bedford-street, Strand, W.C.

**FOR SALE,** ½ plate Kailos camera, with Goerz Dopp anastigmat f/125 lens, can be used either for hand or stand work, twelve single dark slides and film pack carrier. The whole packs in stout black leather sling case, 9in. long, 6in. deep, and 2½in. wide; also light brass telescopic tripod, in leather sling case, all in excellent condition, and used by me to take the illustrations in "Helpful Hints" and "Continental Wanderings." The outfit for sale in one lot for £6; reason for selling have bought a Reflex. A splendid opportunity for anyone wanting a good reliable camera. Will send on approval; Deposit.—HERROD, "B.B.J." Office, 23, Bedford-street, Strand, W.C.

**WANTED,** cloth bound copy "Bee-Keepers' Record," Vol. 7, year 1889.—HERROD, "B.B.J." Office, 23, Bedford-street, Strand, W.C.

**WANTED,** a complete comb of both a bad and mild case of Foul Brood.—HERROD, "B.B.J." Office.

**SELL,** Thould and Hutchinson portable cesspool pump, with all fittings, used once only, cost £3 10s.; offers.—"PUMP," "B.B.J." Office, 23, Bedford-street Strand, London, W.C.

**WANTED,** the following: Cloth editions "British Bee-Keepers' Guide Book," 3rd, 4th, 5th.—HERROD, "B.B.J." Office, 23, Bedford-street, Strand, W.C.

**FOR SALE,** extracted clover honey, 9-28lb. tins, 16s. each; two dozen sections and five dozen screw top bottles, 8s. 6d. per dozen; sample 3d.—W. PHILLIMORE, Three Horse Shoes, Enford, near Pewsey, Wilts v 68

**3 CWT.** honey, 28lb. tins, 56s. per cwt.; sample 2d.—GEORGE THOMPSON, Helpringham, Steaford. v 73

**WANTED,** Rymer honey press, good condition.—Offers to GIBSON, Leeming-Bar, Bedale. v 86

**FOR SALE,** three gross splendid sections and about thirty dozen 1lb. bottles first quality honey.—Box 10, "B.B.J." Office, 23, Bedford-street, Strand, W.C. v 85

**SIX DOZEN** finest amber brown pure heather honey sections, securely packed, and safe arrival guaranteed, 12s. per dozen, 13s. carriage paid.—LEWIS YOUNIE, Knockando, Strathspey, Morayshire. v 92

### BUSINESS ADVERTISEMENTS.

**HOW TO PREVENT SWARMING.**—A certain method, fully explained, with illustrations from life, of bees and their work, price 1s., postage 1d., from all dealers, and the author, A. H. WILKES, Lichfield-road, Four Oaks, Birmingham.

**SECTIONS WANTED,** any quantity, cash; also extracted.—F. W. WEITZEL, 21, Lonsdale-road, Kilburn, N.W.

**COMFORTABLE APARTMENTS** for Brother Bee-keepers visiting Douglas. Terms: Tea, bed, and breakfast, 3s. 6d.; or full board, 5s. per day.—HORSLEY'S, Merridale House, top of Castle Drive, Douglas, Isle of Man.

## IN WAR-TIME

The Nation's Food is of prime importance. The products of the Apiary, of Poultry and Farm Stock, of the Fruit and Vegetable Garden can be augmented. Buy your stock, sell the produce, through THE BAZAAR, EXCHANGE & MART Newspaper.

Get a Copy—Thursday, 2d.; Saturday, 1d. The "Bazaar" publishes also practical handbooks by experts. Send for full catalogue, ————post free from———

BAZAAR BUILDINGS, DRURY LANE, LONDON, W.C.

## THE British Bee-Keepers' Association.

DATES of LECTURES and DEMONSTRATIONS at the EXPERIMENTAL and EDUCATIONAL APIARY of the BRITISH BEE-KEEPERS' ASSOCIATION, in the Zoological Gardens, Regent's Park, London, N.W.

SESSION, 1914-15.

### WINTER COURSES.

No limit upon the number of Students.  
2nd Course. Thursdays, Jan. 7th, 14th, 28th,  
Feb. 4th, 11th, 25th.

Commencing at six o'clock.

W. HERROD, 23, Bedford-street, Strand, London.

**GEORGE ROSE, SEEDS & BEES, Ltd.,**  
22, Bolton Street, Liverpool.

Everything for the up-to-date Bee-keeper.

**OUR NOTED CANDY,**

Thousands of testimonials,

7s. 6d. dozen lb.

HONEY JARS at lowest possible prices for cash.

## Food for the Future.

Start planning to make the best of next year's honey flow by studying bee books (the records of other people's experience) this winter. Get your books from Edward J. Burt, Manufacturer, Gloucester. The Burt Bee Goods catalogue (post free on request) contains just a selection of some by the best known authors. If you want any book not listed don't hesitate to write for it.



---

### NOTICE.

Owing to the dislike of one of my ancestors to a long signature he dropped a portion of his name. For several generations this caused no inconvenience, as they did very little business. Owing to the continued increase in my business interests, the dual situation of one signature for ordinary use and another for legal matters has become impossible; therefore, on and after January 1st, 1915, I shall assume my full name of W. Herrod-Hempsall. I shall be grateful if all correspondents will kindly note this and address me, also make out all cheques or documents and insert in any list my name, as above.

W. HERROD-HEMPSALL,  
hitherto commonly known as W. Herrod.

---

### IMPORTANT NOTICE.

We shall be greatly obliged if those of our readers who have their JOURNAL by post from this office, and who wish to continue their subscription, will kindly let us have their order immediately on the expiration of their previous subscription—of which due notice will be given. Failing an order, we shall assume the paper is not required, and therefore discontinue sending it.

We are obliged to take this course as, owing to the increased work of our staff in other directions, we are unable to undertake the extra work and expense involved in sending out bills for small accounts, or to bear the losses entailed by sending out the JOURNAL after subscriptions have run out, the recipients failing to notify us that the paper is not required and refusing to pay for those received after the subscription had expired. We therefore respectfully notify our subscribers that the JOURNAL will not be sent unless the subscription is prepaid.

---

### BRITISH BEE-KEEPERS' ASSOCIATION.

The monthly meeting of the Council was held at 23, Bedford Street, Strand, London, W.C., on Thursday, December 17th, 1914. Sir Ernest Spencer presided.

There were also present: Miss M. D. Sillar, Messrs. E. Watson, O. R. Frankenstein, A. G. Pugh, J. Smallwood, T. Bevan; Association representatives, G. Hayes (Notts), G. W. Judge, and G. Bryden (Crayford), F. W. Harper (St. Albans), G. J. Flashman (Barnet), and the Secretary, W. Herrod.

Letters regretting inability to attend were read from Messrs. T. W. Cowan, W. F. Reid, H. Jonas, W. T. Sanderson, H. P. Perkins, E. Walker, C. L. M. Eales, D. Seamer, G. S. Faunch, and Rev. F. S. F. Jannings.

Mrs. F. S. F. Jannings was elected a member of the Association.

The financial statement was made by Mr. J. Smallwood, who stated that payments into the bank for November were £86 8s. 10d. The bank balance at the end of November was £246 17s. Payments amounting to £52 6s. were recommended.

Mr. G. Hayes and Mr. Jesse Johnson had earlier in the day attended before the Board of Examiners to lecture for the final examination, and upon their report, presented by Sir Ernest Spencer, it was resolved to grant experts' certificates to both.

The examiners' report on the intermediate examination was presented, and out of seventeen candidates it was resolved to grant passes to the following:—Misses G. B. Redmayne, P. Wilks, D. Burder, N. Ross, and H. Bisset; Messrs. W. D. Ridley, G. F. Stubbs, M. F. Judge, J. W. Heard, E. G. Burt, W. Carr, and Rev. F. S. F. Jannings.

The report of the Exhibition Committee was presented by Mr. A. G. Pugh as follows:—The Exhibition Sub-Committee having taken into consideration the fact that the Royal Agricultural Society will, in consequence of the war, be unable to make their usual grant towards the prize list of the 1915 show, although they offer to provide the usual building and other facilities; have decided to suggest to the Council that the show be held as usual and have considered the prize schedule and recommend that the cash prizes usually given in the appliance classes be withheld and that 5s. be deducted from each of the other prizes. A sufficient saving will then be made to enable the donations given to the special appeal to carry out a solvent scheme. The report was adopted.

The appointment of an auditor was considered and Messrs. Bevan and Frankenstein promised to see what they could do to secure the services of a chartered accountant.

Next meeting of Council, January 21st, 1915, at 23, Bedford Street, Strand, London, W.C.

## A REPORT FROM BRITISH COLUMBIA.

We have received the following report from Mr. W. J. Sheppard, late of Chingford, Essex. Mr. Sheppard did good work when secretary of the Essex B.K.A., and we hope his present venture will prove successful. It will be through no fault of his if it does not.—Eds.

I am afraid you will think me very neglectful in not sending the enclosed before, but the fact is I have been away from home on bee inspection work so much that I am afraid I have almost lost trace of a good many things that should have received my attention.

I finished up for the season on the 31st of last month, and shall now have a breathing space until next April.

We have had a good season for the bees here this year, and the number of stocks put up for winter is just double what it was at this time last year in the territory under my charge. I am obliged to call it territory, because my extreme northern boundary is about 200 miles away, and the distance from east to west is about the same. The honey crop has been four times the amount of last season, every bit of it being first class and equal in quality to any that I have ever seen. The largest apiary I have visited contained forty-eight stocks, spring count, from which 3,000lbs. of honey were taken. This is not in one of the best locations, however. In one district that I consider a good one, where the white clover makes the ground look like a white carpet during July, 400lbs. were taken from two stocks, which have now increased to four. In another instance, of an apiary of four stocks situated in the bush about three miles from any other habitation, and where there was practically no clover, 420lbs. of first-class light-coloured honey was the crop. This honey was evidently gathered mainly from what is called here Milk-weed (*Apocynum hypericifolium*) and Willow-herb, which is known here as Fire-weed. After clover, the two latter are our best honey plants. From my own seven stocks (spring count) I have taken 650lbs. and increased to fifteen, this in spite of being away from home so much.

We are just organising an Association for this district to be called the Kootenay Bee-keepers' Association, the objects of which read as follows:—

"The objects of this Association shall be to promote and encourage the keeping of bees and the most suitable methods for their profitable management.

"To assist members of the Association in disposing of their produce to the best advantage by the adoption of uniformity in its 'get up' for market, and the provision of a special distinctive honey label,

for the use of members only, which should ultimately be looked upon by the purchaser as a guarantee of excellence and purity.

"To obtain the most advantageous terms for members in the purchase of bee supplies.

"To effect the standardising of such bee appliances as may be found most suitable for the district.

"To promote and regulate local exhibitions of honey and other bee products and arrange for the competent judging thereof.

"To advocate the more general growing and cultivation of nectar-yielding trees and plants such as Linden or Basswood (*Tilia Americana*), Alsike Clover (*Trifolium hybridum*), &c.

"To aid in the dissemination of reliable and practical information with regard to the bee-keeping industry, and further its progress in every way possible in the interests of the members."

One of the great difficulties experienced here has been to get proper jars and tins for putting up the honey in a saleable manner, and also to get other bee supplies, the cost of freight, especially for small consignments, being so high, and it is only by a system of co-operation that this could have been got over, so I hope the Association will be able to accomplish much useful work. This Association is the first Bee-keepers' Association that has been formed in British Columbia.—W. J. SHEPPARD.

---



---

## DEALING WITH DISEASE.

A FEW WORDS WITH MR. CRAWSHAW.

I can assure Mr. Crawshaw that I do not take it for granted that disease cannot be communicated by hive, combs, or dead bees, and I do not think that colonies that have found homes for themselves should be ignored in any attempt that may hereafter be made to stamp out "Isle of Wight" disease. Colonies that might escape detection would not, as I tried to make clear some time ago, be so serious a menace to the success of a plan for exterminating the disease as many people, including Mr. Crawshaw, imagine. As I then said, if a colony were affected with the disease it would die, and if a colony were healthy it is obvious that its existence would not matter.

If the work of stamping out microsporidiosis were being undertaken the man in charge of its operations would do his utmost to track down every colony of bees in the area allotted to him. I anticipate that in his task he would be

greatly helped by the orders, having the force of law, which the Board of Agriculture would issue. These would, no doubt, make it obligatory upon owners or occupiers of property, or both, to notify the known existence of colonies of bees living under natural conditions on such property. The unknown "wild" colonies would be so extremely few that as sources of infection they would be practically negligible. I base this view upon two grounds: (1) That as diseased colonies die oftener than not out of the swarming season the combs would, in a bee-keeping district, in the southern half of Great Britain, at any rate, be attacked by the wax moth, which would rob the "hive" of its attractiveness to a swarm: (2) that in a district in which the stamping out process was going on there would be precious few swarms to take charge of a "hive" in a tree or building.

I think the difficulty of dealing with such cases is nothing like so formidable as it appears to be to imaginative persons. The chances of keeping the disease in existence by this means would be less than one in five hundred. The great trouble of this disease is that *Nosema apis* is a spore-forming organism, and that at present, so far as I am aware, the length of time the spores are capable of retaining their vitality is unknown. They are capable of retaining their vitality in honey for at least two years, and it is quite possible that in or on the soil they may retain it much longer. No one must suppose that a widespread disease of this character can be got rid of in one or two years. Of this the correspondence columns of the BEE JOURNAL furnishes, I think, some evidence. I had intended to let Mr. Crawshaw off for an unpardonable error on the part of a universal critic, but as he has led me to cross swords with him again I will not resist the temptation to give him an extra thrust. In the BEE JOURNAL of November 19th he says: "Archæological bee-keepers who have confirmed their beliefs by 'the observation of centuries' would be able to compare notes with the proprietor of Mr. Heap's evolved microbe." What this is all about I do not know; but I am interested in the microbe. I might, if I tried, perhaps, be able to cultivate a few microbes, but I am sorry I am not clever enough to "evolve" one. I have never claimed the accomplishment of so great a feat, but as Mr. Crawshaw infers that I have he will hasten, no doubt, to quote words of mine, if he can, to warrant his inference. If he fails to produce the quotations he ought to apologise handsomely to his readers for having wittingly or unwittingly misled them.—CHARLES H. HEAP, Reading.

## REPORT FROM SOUTH WESTMORLAND.

We have had a glorious summer, and even the most pessimistic of bee-keepers are satisfied. Honey has been an average crop, and the highest average I have heard of so far is 40lbs. per hive. This may seem small in comparison with some districts, but when the very limited bee flora here is taken into consideration an average of 40lbs. is considered good. Personally, considering the district, I think a stock which shows a clear profit of £1 (and which also provides a nucleus, which later is added to the parent hive, thereby requeening same) has not done badly.

Queen-rearing is a dead letter in this district, and out of about forty bee-keepers I am in touch with I only know a couple who go in for it. Perhaps if more did so we should have a bigger average return.

Bee-keepers who have complained to me about excessive swarming have always had their trouble traced to two and three-year-old queens. In my own apiary I have had but one swarm, which was from a stock headed by a third-year queen.

Taken on the whole, however, 1914 will go down to posterity as a non-swarming year. Many bee-keepers have complained about slow sealing of surplus. Of course, this can be put down at once to cells not being properly filled, and showing the importance of arranging frames and sections so that no more cells are available for storage than what could be filled and sealed. It is useless putting an extra rack on when there is not the least chance of getting the first one sealed. Many apiarists add an extra super to prevent swarming, while at the same time they probably overlook the fact that the brood-nest is blocked with honey. If this is the case, the bees will swarm, however many extra supers are added, as it is room for the queen to lay that is required. It is a simple matter to scan over the brood-nest when fixing supers any time, as it is, as a rule, only the outside combs which need be examined, the centre combs being packed with brood.

I have been much amused, upon asking several bee-keepers how they had fared this year, to be told that they had got no surplus, and that the bees must take their chance this winter, they were not going to pay 4d. per lb. for sugar for them. What a heap of rubbish, when it was clearly a case of mismanagement, or probably no management at all. I remonstrated with one man about taking such a cruel view of things, and eventually he asked me if I would help him to manipulate and ascertain their winter's need. Of course I promised, but was

somewhat chagrined to receive a few hours later a polite note saying that he might probably go for a walk on the appointed day if it was very fine, and if he did not turn up at the time would I mind manipulating them myself and write him how much stores each hive required! Comment is needless; my compliance with his wishes was due to my sympathy for his bees more than anything else.

In my last report I was enthusiastic about our freedom from disease. Since then we have had "Isle of Wight" disease in our midst. It has been overcome, however, by drastic but necessary measures being taken by the afflicted apiarist. He was one of our most intelligent men, and I have been much struck by his enthusiasm for his bees. He practically spent all his leisure with them and was never so happy as when showing his nucleus, hives, &c., to anyone. Being anxious to increase his apiary, he answered an advertisement and bought some second-hand goods. Upon receipt of them his trouble commenced. It was diagnosed as "Isle of Wight" disease, and he immediately destroyed everything in the apiary. All our thanks go out to him for his sacrifice, and our "anathema" upon the man who was the source of the trouble. Did he consider it playing the game? I am afraid many cases of "Isle of Wight" can be traced to purchase of infected goods. I know it is a big temptation to turn the same into money, but it is not the thing. May I appeal to bee-keepers to buy no second-hand goods, especially those ridiculously cheap? If they must do so, at least insist on having a guarantee from some responsible person that the goods are all right and free from infection. It is a great hardship on a working man, after he has spent much time and money in establishing an apiary, to have all his aspirations crushed by the unscrupulousness of some individual absolutely devoid of a sense of fair play. May we soon have legislation to remedy things is the wish of FRED NEWSHAM.

### PRESS CUTTING.

#### HIVE OF BEES IN A HAT.

Bee-keepers had some exciting experiences during the spell of hot weather, on account of excessive swarming. A crofter in the Buchan district had "skep cast," and the bees mysteriously disappeared. No trace of the swarm could be found in the neighbourhood, but one day about a fortnight thereafter, the crofter's wife was surprised to see a great many bees flying out and in at a broken pane in

the window of a small room off the kitchen. In the upper recess of an old wardrobe reposed the worthy "guid-man's" venerable tile hat, and there in the crown of it the missing bees had taken up their abode, converting it into a veritable hive, with a surprising amount of honey and honey combs already stored within the hat. Their strange quarters had given them no apparent inconvenience, and doubtless they found the atmosphere cooler in their retreat.—*The Aberdeen Journal*.



*The Editors do not hold themselves responsible for the opinions expressed by correspondents. No notice will be taken of anonymous communications, and correspondents are requested to write on one side of the paper only and give their real names and addresses, not necessarily for publication, but as a guarantee of good faith. Illustrations should be drawn on separate pieces of paper. We do not undertake to return rejected communications.*

### RESISTING "ISLE OF WIGHT" DISEASE.

[9103] Readers of this paper may remember that a few months ago I wrote a short article explaining how by careful selection and breeding I had at last got a strain of bees capable of resisting this dreadful disease. Now, since the war, I have been away serving with my regiment, so these bees have had to look after themselves, and the apiary has been left quite alone. Under these circumstances one would not have been very much surprised had the disease appeared, but upon my return home for a few days (4th Dec.) I find them in the best of condition and well prepared for winter. I may say that some of the stocks have two or three racks of shallow frames or section-racks still on, which will of course now have to remain all winter. I was especially struck with the enormous amount of bees and stores in most of the hives, and no doubt the bees have stored a considerable quantity of honey since I have been away. Another point of interest to readers may be the fact that when I went away I had two frame-hives and three skeps of native bees. These, without exception, have been completely robbed out by the Italian stocks,



and this will to some extent account for the quantity of stores in the Italian hives. I was rather pleased that the Italians had taken this step, for I have found that native bees are very liable to disease and never store the large quantities of honey the Italian bees do. I should like to make it clear that these are not the flimsy kind of Italian bees, such as we get from the Continent. For the benefit of bee-keepers I will shortly describe my method of procedure. In the first place, the queens should be obtained from reliable dealers, and they must be thoroughly selected and tested, and should not cost less than 10s. each. Secondly, and perhaps the most important point of all, each stock should be requeened every autumn. By doing this you will have a fine strain of bees ready to resist foul brood and "Isle of Wight" disease, and in a good season you may often get as much as 200lbs. of honey. One of my stocks had given me a yield of 280lbs., and one huge swarm by the beginning of August. The best and cheapest procedure is to buy two selected and tested queens from two good dealers. Breed the queens from one and the drones from the other, as by doing so you will get an extra strong strain of bees. You should try and get your selected drones on the wing before the native drones are flying, then if you have plenty of young queens ready which have been bred from your other selected queen you will stand a fair chance of getting a large number properly mated. I should advise all those who can to try this plan, and I have no doubt they will find it as successful as I have done. Before closing I should like to point out to my many bee-keeping friends that owing to the fact that I have been called up to serve my country I have been compelled to close my bee business, and any bee-keepers who have not received answers to their letters must excuse the delay, as I am so situated that it may be a month or more before I can attend to their requests. All orders for bees will be attended to as quickly as possible, but as I cannot say for certain any special day when orders can be sent I can assure all my customers that their wants will be attended to at the earliest possible date.

I should like to add that one of the greatest discomforts I have to put up with is that I am unable to have my BEE JOURNAL, and *Record*, though I can assure our Editors that I still take both papers, and they are always ready for me when I get the opportunity of going home.

As an expert of the Norfolk Bee-keepers' Association I feel I cannot close without mentioning the great loss that we as an Association have sustained through the sad death of our Secretary, Dr. D. Wardleworth, who was such a kind friend and helper to all of us. Our Association

at the time of his appointment as secretary was in very low water, but to-day it ranks as one of the most important in the country. His *Daily Mail* scheme for reviving the bee industry among cottagers was greatly appreciated in the county, but few may realise the enormous amount of time he devoted to it. We shall greatly miss him, and it will be very difficult for us to get such an able secretary.

With the best of wishes to our Editors and readers of this JOURNAL.—PRIVATE JULIAN E. LOCKWOOD, 2366, "H" Company, 5th Battalion Norfolk Regiment, Mile End, Colchester.

P.S.—I should very much like to hear from any bee-keeper who resides in Colchester, as I always like to come across fresh bee-keepers. If any care to drop me a line to my regimental address I should be very pleased to give them a call when I am off duty.

---



---

#### ROYAL SHOW FUND.

	£	s.	d.
Donations already received .....	20	9	6
R. Brown .....	1	1	0
Miss Sillar .....	0	10	0
R. Robson .....	0	5	0
A. H. Bowen, by sale of <i>Limnanthes Douglasii</i> .....	0	1	0

---



---

#### WAR RELIEF FUNDS.

	£	s.	d.
Donations in cash already received .....	3	4	8

---



---

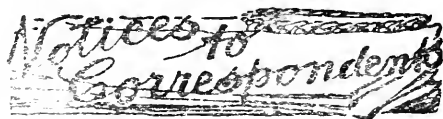

#### Suspected Disease.

CONSTANT READER (Worcester) and P. R. G. (Teesdale).—It is "Isle of Wight" disease.

T. P. G. (Dorsetshire).—The cause of death is "Isle of Wight" disease. Please read our rule as to name and address.

AMATEUR (Lincs.).—No. 1, odourless foul brood in an advanced stage; No. 2, seriously affected with odourless foul brood; No. 3 slightly affected odourless foul brood; No. 4, same as No. 2.

**Special Prepaid Advertisements****Two Words One Penny, minimum Sixpence.***Orders for three or more consecutive insertions entitle advertisers to one insertion in "The Bee-keepers' Record" free of charge.**Trade advertisements of Bees, Honey, Queens, and Bee goods are not admissible at above rate, but will be inserted at 1d. per word as "Business" Announcements, immediately under the Private Advertisements. Advertisements of Hive-manufacturers can only be inserted at a minimum charge of 3s. per 2in., or 5s. per inch.***PRIVATE ADVERTISEMENTS.****F**OUR American Langstroth hives, with super cases and new brood frames, 4s. each; four British standard hives, with super cases, 3s. 6d. each; four hives, British standard, with outer cases and lifts, 5s. 6d. each.—HEATON, Meth-wold, Norfolk. v 94**S**EVEN dozen screw cap bottles heather honey for sale, 9s. per dozen.—LASHBROOK, Lynton, North Devon. v 93**S**ELL or exchange, thirty-two microscopic slides, with box, to be sold in one lot, for 20s.; returnable list sent for 1d. stamp.—MICRO, "B.B.J." Office, 23, Bedford-street, Strand, W.C.**W**E have for sale a number of Bee Books, some very old; returnable list and prices will be sent for 1d. stamp.—MANAGER, "B.B.J." Office, 23, Bedford-street, Strand, W.C.**F**INEST BEE PRODUCE. Extracted fruit blossom and clover honey, 28lb. tin, 20s.; clover, 21s.; pressed clover and heather, 22s.; pure heather, 23s.; clover, 1lb. bottles, 12s.; heather, 13s. dozen; sections, prices as for bottles; any lot carriage paid.—WOOD, Ash Grove, Bishopton, Ripon. v 91**F**INEST clover honey, in 1lb. screw capped glass jars, price 8s. 6d. per dozen; sample, 2d.—DUCKMANTON, Langwith, Mansfield. v 89**F**OR SALE, or exchange, ice safe, 21in. long, 20in. deep, and 16in. wide, wants slight repairs, 10s.; too cheap for approval.—BUMBLE, "B.B.J." Office, 23, Bedford-street, Strand, W.C.**F**OR SALE, zinc skep covers, 1s. 3d. each; also shaped skep floor boards, and stands for same, 1s. 6d. the set. The above are better than new as they are painted, and are being sold at half price, cash with order.—BOSS, "B.B.J." Office, 23, Bedford-street, Strand, W.C.**S**ELL or exchange, good dress suit, 36in. chest, 20s.—DRESS, "B.B.J." Office, 23, Bedford-street, Strand, W.C.**F**OR SALE, ¼ plate Koilos camera, with Goerz Dopp anastigmat f/125 lens, can be used either for hand or stand work, twelve single dark slides and film pack carrier. The whole packs in stout black leather sling case, 9in. long, 6in. deep, and 2½in. wide; also light brass telescopic tripod, in leather sling case, all in excellent condition, and used by me to take the illustrations in "Helpful Hints" and "Continental Wanderings." The outfit for sale in one lot for £6; reason for selling have bought a Reflex. A splendid opportunity for anyone wanting a good reliable camera. Will send on approval; Deposit.—HERROD, "B.B.J." Office, 23, Bedford-street, Strand, W.C.**W**ANTED, a complete comb of both a bad and mild case of Foul Brood.—HERROD, "B.B.J." Office.**S**ELL, Thould and Hutchinson portable cesspool pump, with all fittings, used once only, cost £3 10s.; offers.—"PUMP," "B.B.J." Office, 23, Bedford-street, Strand, London, W.C.**W**ANTED, cloth bound copy "Bee-keepers' Record," Vol. 7, year 1889.—HERROD, "B.B.J." Office, 23, Bedford-street, Strand, W.C.**W**ANTED, the following: Cloth editions "British Bee-keepers' Guide Book," 3rd, 4th, 5th.—HERROD, "B.B.J." Office, 23, Bedford-street, Strand, W.C.**W**ANTED, Rymer honey press, good condition.—Offers to GIBSON, Leeming-Bar, Bedale. v 86**BUSINESS ADVERTISEMENTS.****H**OW TO PREVENT SWARMING.—A certain method, fully explained, with illustrations from life, of bees and their work, price 1s., postage 1d., from all dealers, and the author, A. H. WILKES, Lichfield-road, Four Oaks, Birmingham.**C**OMFORTABLE APARTMENTS for Brother Bee-keepers visiting Douglas. Terms: Tea, bed, and breakfast, 3s. 6d.; or full board, 5s. per day.—HORSLEY'S, Merridale House, top of Castle Drive, Douglas, Isle of Man.**BEE-KEEPING.****A Special Ten Lecture Course on Bee-keeping will be given in the Agricultural College, 6, Blythwood Square, Glasgow, on WEDNESDAY EVENINGS from 7-8 o'clock, commencing 6th JANUARY, 1915.***Lecturer, Mr. Joseph Tinsley, B.B.K.A. (1st Class).**Fee for the Course 5/-**Prospectus free on application to the Secretary.***IN WAR-TIME**

The Nation's Food is of prime importance. The products of the Apiary, of Poultry, and Farm Stock, of the Fruit and Vegetable Garden can be augmented. Buy your stock, sell the produce, through THE BAZAAR, EXCHANGE & MART

Newspaper.

Get a Copy—Thursday, 2d.; Saturday, 1d. The "Bazaar" publishes also practical handbooks by experts. Send for full catalogue, —post free from—

**BAZAAR BUILDINGS, DRURY LANE, LONDON, W.C.****THE****British Bee-keepers' Association.**

**DATES OF LECTURES and DEMONSTRATIONS** at the **EXPERIMENTAL and EDUCATIONAL APIARY** of the **BRITISH BEE-KEEPERS' ASSOCIATION**, in the **Zoological Gardens, Regent's Park, London, N.W.**

**SESSION, 1914-15.****WINTER COURSES.**

No limit upon the number of Students.  
2nd Course. Thursdays, Jan. 7th, 14th, 28th,  
Feb. 4th, 11th, 25th.

Commencing at six o'clock.

W. HERROD, 23, Bedford-street, Strand, London.

**GEORGE ROSE, SEEDS & BEES, Ltd.,**  
22, Bolton Street, Liverpool.

Everything for the up-to-date Bee-keeper.

**OUR NOTED CANDY,**

Thousands of testimonials,

7s. 6d. dozen lb.

HONEY JARS at lowest possible prices for cash.

**Food for the Future.**

Start planning to make the best of next year's honey flow by studying bee books (the records of other people's experience) this winter. Get your books from Edward J. Burt, Manufacturer, Gloucester. The Burt Bee Goods catalogue (post free on request) contains just a selection of some by the best known listed authors. If you want any book not

**P**HOTOGRAPH of Comb in clock-case from which 7 lbs. of Honey was extracted. Seventy pounds were abstracted from the hive also. These Bees were badly affected by "Isle of Wight" Disease and treated by M. C. Pay of Croydon, and cured by IZAL washing, spraying and Izalized food. He had the hive given to him to be destroyed, May 24th, 1912, on which day he began his treatment.

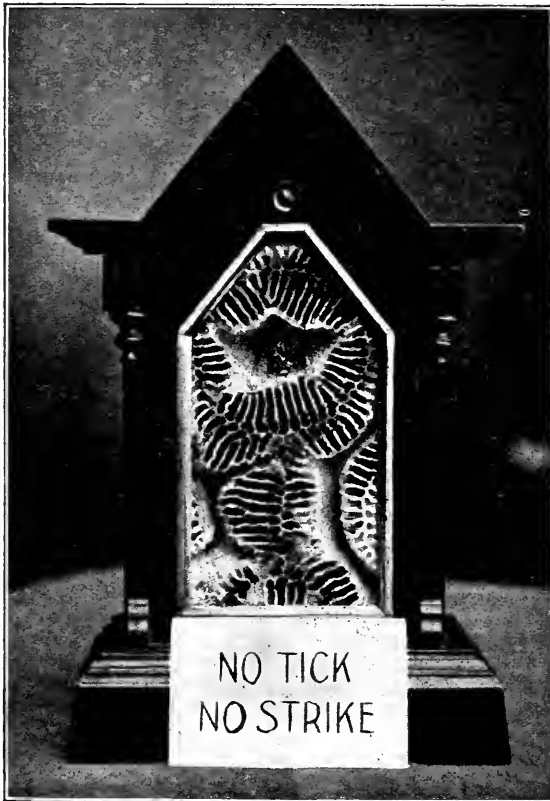

2 Teaspoonfuls Izal Fluid to 1 gallon of water for washing and spraying. New Queen Bee inserted on June 12th.

In September 77 lbs. Honey taken from them. At present, January, 1913, they appear to be quite healthy.

## IZAL

is a **Reliable Remedy** against **Foul Brood.**

Sold Everywhere in Bottles, 6d. & 1/- each.

*Ask for full details of IZAL treatment sent post free by*  
**Newton, Chambers & Co., Ltd., Thorncliffe, nr. Sheffield.**



## NOTICE.

Owing to the dislike of one of my ancestors to a long signature he dropped a portion of his name. For several generations this caused no inconvenience, as they did very little business. Owing to the continued increase in my business interests, the dual situation of one signature for ordinary use and another for legal matters has become impossible; therefore, on and after January 1st, 1915, I shall assume my full name of W. Herrod-Hempsall. I shall be grateful if all correspondents will kindly note this and address me, also make out all cheques or documents and insert in any list my name, as above.

W. HERROD-HEMPSALL,  
hitherto commonly known as W. Herrod.

## IMPORTANT NOTICE.

We shall be greatly obliged if those of our readers who have their JOURNAL by post from this office, and who wish to continue their subscription, will kindly let us have their order immediately on the expiration of their previous subscription—of which due notice will be given. Failing an order, we shall assume the paper is not required, and therefore discontinue sending it.

We are obliged to take this course as, owing to the increased work of our staff in other directions, we are unable to undertake the extra work and expense involved in sending out bills for small accounts, or to bear the losses entailed by sending out the JOURNAL after subscriptions have run out, the recipients failing to notify us that the paper is not required and refusing to pay for those received after the subscription had expired. We therefore respectfully notify our subscribers that the JOURNAL will not be sent unless the subscription is prepaid.

## BRITISH BEE-KEEPERS' ASSOCIATION.

A special meeting of the Council of the British Bee-keepers' Association was held at 23, Bedford Street, Strand, on Tuesday, December 22nd, 1914, when there

were present Mr. J. B. Lamb (in the chair), Miss D. Sillar, Messrs. J. Smallwood, G. Bryden, J. Roberts, R. Alder, G. Fauch, H. P. Perkins, J. G. Flashman, F. W. Harper, G. W. Judge, and O. R. Frankenstein.

Expressions of regret for absence were submitted from Messrs. C. L. M. Eales, Ernest Walker, T. Bevan, A. Richards, F. Jolly, E. Watson, T. W. Cowan, and Sir Ernest Spencer.

It was resolved that Mr. T. W. Cowan and Mr. Wm. Herrod should be appointed judges for the bee-keeping section of the Royal Show in 1915; that Mr. Walter F. Reid and Mr. Ernest Walker be nominated reserve judges; and that Miss Sillar and Mr. John Smallwood be elected joint secretaries.

## THE DYING YEAR.

## SOME MEMORIES IT RECALLS.

Another year is fast drawing to a close. The trees are once more bare, and the branches stand out darkly and indistinctly against a winter's sky.

Under the hedges the russet leaves of autumn are thickly strewn, blown thither by some chilly blast; and the most of wild life that we see is a startled rabbit, stoat, or weasel looking uncommonly scared now the natural shelter is so scanty.

It is with much pleasure that one can look back upon the doing of the past season; to the early days of spring, when everything was fresh and green; the richness of summer and all that it means; and to the quiet beauties of autumn, when the mellow sunlight gives an added charm to the countryside, on those warm, still, sleepy afternoons, with the rich flat meadows round and the bare downs in the distance; when the cattle chewed noisily round one, and the reeds ruffled faintly in the bed of the stream hard by. One's mind wanders back to the days of preparation for the bee season that was yet to come.

When the bees were given their first feeds of syrup on those balmy April mornings, and—

“With merry hum the willow copse they'd scale,

The fir's dark pyramid or poplar pale,  
Scoop from the alder's leaf its oozy flood,  
Or strip the chestnut's resin-coated bud.”

And as the days grew longer so the work would increase, and interest deepen. There were stocks and late driven lots to be transferred, hives spring-cleaned, frames and fixtures to get ready. An apiary to move, and trips into the country inspecting and buying bees from those who had to sell.

Dandelion, sycamores, hawthorn, and trefolium bloomed at intervals with many flowers between till the combs and hives were full and ready for the surplus chambers. Then it would be early morning rides to the apiaries, with a swaying load of supers on the carrier, while the engine purred merrily along the dusty uphill roads, when every movement seemed precious if the season's harvest was to be gathered to its full.

Ah! my masters, those were the days for real enjoyment when the sun shone hot, and the purple fields of sainfoin stretched away from the roadside walls; when the wild charlock glistened, and the "Puesdown Coaching Inn" looked blurred in the blue haze of the morning.

Then at midday you would leave the bees, and, seated on an old hive body, enjoy your lunch in the shade of trees. And so the hours went by, and the dazzling sunlight would soften into the warm glow of evening, lighting up the barns and ricks in the distance, and you would wander back to road through a peaceful stillness in which the buzzing of insects and the movements of the cattle seemed almost painfully loud.

At times it might be a day's extracting with a friend when the dripping combs would be returned just as the moon was rising to its full, and the apiary looked ghostly and unnatural in the silvery light. Occasionally nightfall would find one returning from some hamlet with a swarm or driven bees, and then it would be hiving them by the dim light of a candle, whilst the clouds rolled up darkly, and the uneasy mutter of approaching thunder came from the distance.

But, as the late autumn and the shortening days drew on, the time of outdoor work would once more pass, the hum of the bees grow fainter and fainter, and in those lives the inmates once so gay and active would be motionless and quiet, till called anew to the work and adventures of another season.

I should like to take this opportunity of thanking the British bee-keepers for the support they accorded me during 1914, and to express the hope that both they and our Editors will enjoy increased prosperity under happier circumstances in the New Year.—A. H. BOWEN, Coronation Road, Cheltenham.

The eastern half seems to have had an advantage over the western. On account of the outbreak of war, all the shows arranged to be held after the August Bank Holiday were cancelled, including our annual show at Chester. Under these circumstances it is impossible to say where the best honey was collected. It was pleasing to see Mr. W. Emery exhibiting again at the Sandiway Show on August 3rd, he is one of our best bee-keepers, and must have been exhibiting twenty years ago. As evidence that he has lost none of his skill he secured first prize in a big class for run honey and prizes in several other classes. We hope he will continue to show beginners how honey should be exhibited. We have been able to do very little in the way of educational work. Lectures and demonstrations were given at Bebington, Gresford, Sandiway, Hawarden, and to the Mid-Cheshire Farmers' Club. All the others were cancelled. The Association has again been well served by its two experts, Mr. Job Astbury, of Kelsall, and Mr. H. C. Barlow, of Newcastle. They toured the whole of the county and the neighbouring districts in the spring, calling upon every member. Nothing but praise is heard of the way in which they did their work. The autumn tour was abandoned this year on account of the war. Many members have not yet paid their subscriptions, and it is hoped they will do so without further delay, so as to enable the Association to face the coming year in a satisfactory financial condition.

One of our delegates, G. H. Garratt, has received the command of a company in one of the new regiments of Lord Kitchener's Army. Best wishes to Capt. Garratt for a safe return.

May the New Year bring a speedy termination to the war and a prosperous season to all bee-keepers, I am sure, is our unanimous wish. It would be interesting to know how many of the older bee-keepers are serving in the irregular volunteer corps—too old to take their places in the regular army. The other night there were six members of this Association out on a route march in this neighbourhood, all determined to sell their lives dearly should the Germans succeed in landing on our shores.—E. W. FRANKLIN, Hon. Sec., Mouldsworth, near Chester.

#### CHESHIRE B.K.A.

The close of the year enables me to report on the work carried out by this Association during the last twelve months. The honey harvest appears to have been fairly good all over the county without any exceptionally large takes being re-

#### WAR RELIEF FUNDS.

	£	s.	d.
Donations in cash already received .....	3	4	8
Mr. E. Ballard, a further sum from sale of <i>Limnanthes Douglasii</i> .....	0	1	4
Mrs. Whittaker 2lbs. beeswax.			



The Editors do not hold themselves responsible for the opinions expressed by correspondents. No notice will be taken of anonymous communications, and correspondents are requested to write on one side of the paper only and give their real names and addresses, not necessarily for publication, but as a guarantee of good faith. Illustrations should be drawn on separate pieces of paper. We do not undertake to return rejected communications.

#### A STUDY IN "ISLE OF WIGHT."

[9104] With regard to Mr. Crawshaw's reference (p. 366) to my letter (p. 295), I did not suggest that all cases of swarms manifesting "Isle of Wight" were due to visits of scout bees to empty diseased hives. I suggested that of three swarms which showed "Isle of Wight" last summer, two of them got the disease through being hived in contaminated hives; but the other having been hived in a brand new hive, I hit upon the activity of scout bees as a likely explanation.

Anyone who has observed bees engaged in "scout" work will, I think, admit that if, after a scourge of "Isle of Wight," the empty hives harbour spores of *Nosema apis*, at least a few of the scout bees, by their frequent visits to hives, must come into dangerous contact with the disease.

Assuming that a stock on the point of swarming is perfectly healthy and that a dozen of its scout bees have, by their visits to an empty hive, become infested by the parasite, the whole of the infested scout bees would not be likely to join the swarm, as some of them would probably be visiting the empty hive at the time the swarm issued, and would not be able to join it. Thus some of the scout bees would remain with the stock, and both stock and swarm would have the disease in their midst. As most of the scout bees would join the swarm, it would show signs of the disease sooner than the stock. Therefore the stock could not be expected to show immunity, unless all of the infested scout bees joined the swarm, which is very improbable.

This enquiry is not without some value to bee-keepers restarting in districts cleared by "Isle of Wight." The plan we are following here is to destroy a stock or swarm as soon as its bees begin to drop and are unable to rise. This appears to be quite successful so far in saving the other colonies in the case of disease arising from contaminated hives. An outbreak caused by robbing is much more serious, but prompt destruction wherever the disease shows itself in that and every case I think the proper course to pursue in the absence of any real faith in remedial measures.—J. N. KIDD, Stocksfield-on-Tyne.

#### ROYAL SHOW FUND.

	£	s.	d.
Donations already received ...	22	6	6



#### Suspected Disease.

C. WINHAM (Launceston).—Both samples of bees are affected with "Isle of Wight" disease. Do not use the combs again.

A. E. E. (Sunningdale).—The cause of death is "Isle of Wight" disease.

#### Honey Sample.

A. W. B. (Lyonshall).—The honey is good but rather lacking in flavour. It would probably be among the winners at a good local show. At the Dairy Show there were twenty-eight competitors in that class from all parts of the country. Sorry to hear of your loss. It must have been from the cause you suspect, as it was sent away from the show intact. We heartily reciprocate your good wishes.

\*\*\* Owing to this issue containing the Index, a number of articles and notices to correspondents are unavoidably held over till next week.

## 570lbs. from one Spring Stock in 'Conqueror' Hive

Daughters of this original 570lb. queen from 3s. 6d. Place orders early for May delivery. The man who stemmed the tide of desolation has proofs accumulating day by day, showing that—No Apiary—No Single Colony—need be lost by the "I.O.W." disease where his celebrated "White Star" Italians are used, in combination with his general recommendations, and the careful study of the New Edition of "A Modern Bee Farm." 5/4 post free.

Special New List and 16-page specimen sheet of New Book, free from S. Simmins, Queensland, Heathfield, Sussex.

# INDEX.

## EDITORIALS :—

- A Golden Wedding, 211
- Bee-Keeping in Bulgaria, 345
- Bee-Keeping in Other Countries, 151, 141, 157
- Bees on the Bioscope, 281, 301
- British Bee-Keepers' Association, 101; Annual Meeting, 121; Conversazione, 131; Special Meeting of Council, 458; Library, Notice to Members, 41
- Deputation to the Australian Minister of Agriculture, 251
- Errata, 231, 419
- Examinations, 311
- Help One Another, 359
- Honey Judging Competition, 375
- Lecture on "Isle of Wight" Disease, 201, 212
- Legislation for Bee Diseases, 435
- Meeting of Bee-Keepers at Bramhall, Cheshire, 221
- M. Maeterlinck a Volunteer, 335
- Notices, 435, 441, 451, 458
- Obituary Notices, Dr. D. Wardleworth, 403; Mr. T. Walker, 425; Dr. Ulrich Kramer, 335
- Ourselves, 351
- Packing of Specimens sent for Advice, 21
- Price of Sugar, 321, 327, 353
- Schoolmasters and Bee-Keeping, 311
- Sending Specimens for Advice, 312
- Shows and their Purpose, 381
- The National Relief Fund, 369, 375
- The Royal Show, 201, 251
- The Size of the "Journal," 303
- The War, 333
- To Our Readers, 171
- Volume Forty-Two, 1

## REVIEWS (Editorial) :—

- A Modern Bee Farm, 321
- Bee-Keeping for Profit, 359
- Bees as Rent-payers, 261
- Destruction of Germs of Infectious Bee Diseases by Heating, 410
- Die Biene und der Breitwabenstock, 51
- Honey Bees as Pollinizers, a Valuable Adjunct to the Horticulturist, 419
- How to Prevent Swarming, 91
- Insect Life: Its Why and Wherefore, 11
- Jahrbuch über die Faulbrutversicherung des Vereins schweitzer Bienenfreunde pro 1915, 181
- L'Ape e la sua Coltivazione, 171
- Soft Candy for Bees, 419
- Some Minute Animal Parasites, or the Unseen Foes in the Animal World, 151
- The Olfactory Sense of the Honey Bee, 359
- The Scent-Producing Organ of the Honey Bee, 410
- The Temperature of the Honey Bee Cluster in Winter, 327
- Vraagti Ptschel, 51

## AMERICAN AND COLONIAL PAPERS.

- Extracts and Comments by D. M. Macdonald, Esq. :—
- Apiculture Looking Up, 274
- Admiration, 443
- Bees in Buildings, 89
- Bees' Olfactory Organs, 274
- Bees Out of Sections, 443
- Bees and Poultry, 89
- Cleaning Combs, 359
- Colony Odour, 359
- College Bee-Keeping, 205
- Compound Words, 159
- Convention Groups, 159
- Destruction of Germs, 411
- Drone Comb, 411
- Encouraging Beginners, 359
- Gentle Bees Cross, 445
- Gleanings, 49
- Honey Crop Report, 411
- Larvæ for Queen Cells, 205
- Levelling Hives, 89
- Longevity, 204
- Migratory Bee-Keeping, 359
- "Millerisms," 443
- Motor Boat Transit, 205
- Moving Bees, 275
- Natural v. Artificial 205
- Olfactory Organs, 444
- One for Blacks, 159
- Points in Queen Rearing, 204
- Propolis, 444
- Rearing Queens, 275
- Red Clover Honey, 359
- Re-Queening, 159
- Self-Extinguishing Smoker, 358
- Smoke Introduction, 411
- Spraying Bloom, 158
- Standardisation, 159
- Sugar v. Honey, 204
- Swiss Bee-Keepers, 274
- Thick Syrup, 90
- "Virgins," 445
- Wear White, 410
- Wild Bees, 274
- Winter Stores, 411

## AMONG THE BEES. By D. M. Macdonald :—

- Acid in Wax Extracting, 221
- Bee Diseases, 222
- Bees and Luck, 2
- Checks to Swarming, 112
- Early Brood Rearing, 71
- Examinations, 25
- Field Days, 327
- Heather, 221
- How to Diagnose Queenlessness, 112
- Interesting and Useful Facts, 181
- Manufacturing a Queen, 327
- Moving Short Distances, 113
- New Zealand Heather Honey, 153
- Precision in Bee Terms, 72
- Propolized Frames, 112
- Queries and Replies, 24
- Sections for the Show Bench, 91
- Selecting a Queen, 24
- Soft or Hard Candy, 328
- Some Uncommon Honey Sources, 53
- Spring Feeding, 71
- Three Systems of Feeding, 429

## BEE AND HONEY SHOWS :—

- Bletchley Horticultural Society, 340; Bridgnorth and District, 322; Glamorgan, 351; Leicester and Rutland, 321; Lincolnshire, 315; Northants, 365; Notts, 314; Royal Counties Agricultural Show, 252; Royal Lancashire 321; Sheffield and District, 422; Somerset, 312; St. Albans and District, 251; Surrey, 241; The Royal Show at Shrewsbury, 271; The Dairy, 387; Worcestershire, 342; Worcester, 430

## BEE-KEEPERS' ASSOCIATIONS' ANNUAL MEETINGS :—

- Glamorgan, 71; Hants and Isle of Wight, 191; Leicestershire, 171; Lincolnshire, 171; Norfolk, 191; Northants, 101; Northumberland, 71; Notts, 111; Somerset, 111; Surrey, 191; Warwickshire, 187; Wear Valley and District, 61; Whitby and District, 91

## BLURTS FROM A SCRATCHY PEN :—

- A Night of Horrors, 364
- Beggary, 422
- Continental Wanderings, 7, 25, 42, 73, 105, 129, 157, 175, 186
- Italian Wanderings, 255
- Royal Show, 1914, 274
- Signor Piana's Apiary, 292, 328
- Sunday at the Zoo with the Pious Banats, 224
- Venezia, 347, 404

## CAPPINGS OF COMB. By L. S. Crawshaw, Norton, Malton, Yorks :—

- Accounts, Those Cooked, 9
- Arithmetic, A Little, 255, 534
- An Expert's Diary, 366
- Apiary Accounts, 78
- Apodes and Apides, 314
- Banatical Banter, 167
- Bee Associations, 78
- Bee-Keeping in Nyassaland, 58
- Bees, Poultry, and Fruit, 159
- Book of the Bee, 437
- Box Hives, 38, 207
- Brace or Burr Combs, 39
- Building up Stocks, 255
- Capturing a High Swarm, 278
- Controlling Brood Rearing, 278
- Confining Diseased Bees, 19
- Correct Bee Space, 255
- Cure of Colony or Individual, 169
- Do Bees Hear? 167
- Do Bees Know Their Owner? 389
- Doomed to Extinction, 255
- Drone Brood for Chickens, 315
- Evaporation in the Hive, 412
- Go to the Anti, Consider his Ways, 139
- Hawthorn Honey, 277
- Heather Honey for Winter, 277
- Hive Legs, 314
- Hive Roofs and Mouldy Combs, 187
- Hiving Purchased Bees, 334
- Hope On, Hope Ever, 205
- Huber's Hive, 78

CAPPINGS OF COMB (*cont.*)

- Increase, 256  
 Infectious or Contagious, 118  
 In Friendship's Name, 118  
 "Isle of Wight" Disease, 78, 169  
 Long Lived Bees, 98  
 Long Lived Lot, A, 412  
 Making Soft Candy, 138  
 Moving Bees, 39, 412  
 Native *v.* Foreign Bees, 315, 353  
 Nature's Plan, 187  
 New Zealand Box Hives, 354  
 Observations on Hives, 437  
 Pollen Mites and Disease, 187  
 Precision in Bee Terms, 118, 168  
 Pro Bono Publico, 256  
 Pure Heather Honey, 277  
 Putting on the Roof, 59  
 Re De-Queening, 98  
 Sanded Alighting Boards, 207  
 Sections for Show Bench, 168  
 Seeds of Granulation, 58  
 Selection of Breeding Queens, 9  
 Self-Extinguishing Smoker, A, 412  
 Shortage of Swarms, 278  
 Simple Slow Feeder, A, 187  
 Skeps, 207  
 Skeps and Disease, 366, 412  
 Skeps or Frame Hives, 9  
 Soft or Hard Candy, 366  
 Something Like a Swarm, 353  
 Spell of Precision, A, 389  
 Stamping Out "Isle of Wight" Disease, 457  
 Stop Thief, 255  
 Storing Extracting Combs, 389, 437  
 Study in "Isle of Wight" Disease, A, 366  
 Subduing Bees, 39  
 Success at the Heather, 315  
 Successful Stimulation, 186  
 Sundry Heresies, 139, 187  
 Swarm in January, A, 98  
 The Australasian Deputation, 354  
 The Fool Proof Skep, 39  
 Thick Syrup, 38, 159  
 Thickness of New Comb, 256  
 Up a Gum Tree, 98  
 Weight of Comb, 277  
 Wintering Bees, 118  
 Wiring Frames, 99, 169  
 Word for the Italian Bee, A, 79  
 Worker Comb from Starters, All, 9

## CORRESPONDENCE:—

- An Old-Fashioned Cotswold Apiary, 6  
 Another Advocate of Skeps, 156  
 Another Monster Swarm, 261  
 Apiary Accounts, 37, 46  
 Banat Bees, 185  
 Banats—The Fruitgrowers' Bee, 155, 178, 184, 185  
 Barnett and District B.K.A., 348  
 Bee Associations and Their Work, 35, 45, 54, 65, 66, 76, 93, 94, 109, 148  
 Bee Diseases Bill, The, 176  
 Bee-Keeper's Troubles, A, 16  
 Bee-Keeping Accounts, 17, 109  
 Bee-Keeping and Sundries, 354  
 Bee Notes from Acton, 406  
 Bee Notes from Derbyshire, 77, 225, 352, 401  
 Bees Distinguishing Colours, 439  
 Bees and Fruit Setting, 217  
 Bees Do Pay, 77  
 Bees in the Soudan and in Madeira, 195  
 Box Hives, 166  
 Brief Report from Durham, A, 68  
 Careless Methods and Disease, 262  
 Cinnamon, Essence of, for "Isle of Wight" Disease, 148, 185  
 Controlling Prolific Queens, 232  
 Cotswold Bee Note, A, 225  
 Crawshaw, Mr., and New Zealand Box Hives, 276  
 Crayford and District Bee-Keepers' Association at the B.B.K.A. Apiary at the Zoological Gardens, 256  
 Curing "Isle of Wight" Disease, 285, 302, 325, 406

CORRESPONDENCE (*cont.*).

- Curious Swarming, 317, 417  
 Destroying Bees, 302  
 Devon Bee-Keeper's Experiences, A, 315  
 Do Bees Hear? 148  
 Do Bees Know Their Owner? 423  
 Do Bees Pay? 48  
 Does it Pay Gardeners to Keep Bees? 77  
 Early Foragers, 77  
 Early Pollen Plants, 94  
 Early Surplus, 204  
 Early Swarms, 179  
 Economising Honey, 357  
 Enemies of Bees, 342  
 Experience with "Isle of Wight" Disease, 97  
 Fighting Bee Disease, 114  
 Fighting "Isle of Wight" Disease, 255  
 First Humble Bee, The, 128  
 Flowers of April, The, 137  
 Flowers of February, The, 57  
 Flowers of March, The, 96  
 Flowers of January, The, 5  
 Fungus Diseases of Brood, 251  
 Hants B.K.A., 68  
 Heather District, 49  
 Heather Honey, 255  
 Heather Honey as Winter Food, 317  
 Help for Belgian Refugees, 405  
 Hive Porches, 400  
 Holiday Notes, 417  
 Honey Judging Competition, 377, 378, 384  
 Honey for Refugees, 362  
 Honey for Soldiers, 348  
 Honey for Wounded Soldiers and Sailors, 385  
 Honey Yield in Wilts, 354  
 Hope on, Hope Ever, 155  
 "Ilowitis," 97  
 Immunity Chimera, The, 251, 318, 351  
 Immunity to "Isle of Wight" Disease, 157, 167, 231  
 Is "Isle of Wight" Disease a New Complaint? 108  
 Is "Isle of Wight" a New Disease? 196  
 "Isle of Wight" Cures, 113, 125, 136, 148, 185  
 "Isle of Wight" Disease, 5, 37, 48, 56, 57, 67, 75, 85, 86, 98, 115, 126, 137, 184, 254, 318, 354  
 "Isle of Wight" Disease, a Correction, 89  
 "Isle of Wight Disease," a Study in, 295, 460  
 "Isle of Wight" Disease and Nosema Apis, 302  
 "Isle of Wight" Disease, Resisting, 454  
 "Isle of Wight" Disease and Strong Queens, 165  
 "Isle of Wight" Disease, The Quinine Treatment for, 156  
 "Isle of Wight" Experiences and Guesses, 443  
 Keeping Apiary Accounts, 26  
 Legislation for Bee Diseases, 217  
 Lined and "Isle of Wight" Disease, 247  
 Little Arithmetic, A, 26  
 Long Lived Bees, 47  
 Marketing and Labelling Honey, 25  
 Miller, Dr., Intervenes, 114  
 Minimum Hive, The, 365, 401  
 Moving Bees, 185  
 Native *v.* Foreign Bees, 255  
 Neglected Frame Hives, 68  
 New Zealand Heather Honey, 303  
 Note from Australia, A, 303  
 Notes from Allan Vale, 55  
 Obliging Queen, An, 285  
 Observatory Hive, 276  
 Peasant Hives in Italy, 275  
 Planting for Bees, 94, 108  
 Planting Hedge and Providing Water for Bees, 204

CORRESPONDENCE (*cont.*).

- Pollen Mite and "Isle of Wight" Disease, 126  
 Precision in Bee Terms, 95  
 Prevention of "Isle of Wight" Disease, 458  
 Procuring Surplus, 423  
 Profitable Stock, A, 407  
 Progress of "Isle of Wight" Disease, 115, 123  
 Prolific Colony, A, 276  
 Prolific Stocks, 95  
 Queen as Architect, The, 195  
 Queen Rearing Experiences, 232  
 Raising Queens above Excluder, 25  
 Report from Scotland, A, 233  
 Report from South Westmorland, 114  
 Ross-shire Notes, 216  
 Royal Show Fund, The, 458  
 Simple Slow Feeder, A, 149  
 Skeps and Disease, 304, 351, 373, 458  
 Skeps and "Isle of Wight" Disease, 179  
 Something like a Swarm, 255  
 Spring Dwindling, 25, 68  
 Spring Flowers—and Winds, 156  
 Stamping Out "Isle of Wight" Disease, 367, 399  
 Starting in a Small Way, 139  
 Storing Extracting Combs, 401  
 Success at the Heather, 246  
 Sundry Heresies about Bees, 86, 155  
 Surrey B.K.A. Propaganda Work, 337  
 Swarm of Bees in August, A, 342  
 Testing Sugar, 138  
 The Duties of an Expert on Tour, 4  
 The Labelling of Honey, 5, 16  
 The Skep Question, 4  
 The South African Bee Journal, 88  
 The W.B.C. Memorial Fund, 6  
 Warning against Starvation, 88  
 What is Pure Heather Honey? 204  
 Wintering Bees, 155  
 Wiring Frames, 109  
 Word for the Anti-Skeppist, A, 87  
 Word for the Italian Bee, A, 47
- HELPFUL HINTS FOR NOVICES. (Illustrated). By W. Herrod:—  
 Growth of the Brood Nest, The, and Building up Stocks, 164, 172  
 Manipulating a Frame Hive, 12, 32  
 Natural Swarms and Casts, The Hiving and Treatment of, 214, 234, 242, 262, 282, 304, 323, 354  
 Observatory Hive, How to Make and Stock an, 102, 124, 145, 163  
 Procuring Surplus, 349, 360, 371, 382, 415, 451, 444  
 Solar Wax Extractor, How to Make and Use a, 192  
 Wintering Bees, 62, 82
- HOMES OF THE HONEY BEE.  
 APARIERS OF OUR READERS:—  
 Cotswold Out-Apiary, A, 445  
 Hanbury, The Hon. Rosamund, 93
- NECTAR-PRODUCING PLANTS AND THEIR POLLEN. (Illustrated.) By G. Hayes:—  
 Bean, 352; Broom, 51; Butter Burr, 28; Crocus, 428; Ragwort, 115; Red Clover, 375; Sainfoin, 225
- NOTICES TO CORRESPONDENTS:—  
 Adulteration of Honey, 70  
 Attempted Swarming, 100  
 Badly Packed Sample, 180  
 Banat Bees, 230  
 Bee Records, 20  
 Bees in Box, 325  
 Bees Casting out Queen, 160  
 Bees in Ceiling, 289  
 Bees Eating Holes in Foundation, 249  
 Bees Failing to Locate Hives, 319  
 Bees Hanging Out, 299  
 Bees Killing Queen, 320  
 Bees and Laureis, 200



NOTICES TO CORRESPONDENTS (*cont.*).

Bees near Houses, 140  
 Bees and Neighbours, 219  
 Bees Refused Admittance to Hives, 30  
 Bees Re-Queening Themselves, 209  
 Bees Robbing in January, 60  
 Bees Soiling Clothing, 70  
 Bee-Keeping in Belgium, 110  
 Bee-Keeping in Canada, 100  
 Beet Sugar for Bees, 229  
 Beginner's Queries, A, 299  
 Beginner's Question, A, 170  
 Brice Swarm Catcher, 150  
 Buying Honey for Bee Food, 150  
 Buying Swarms, 80  
 Candy Made of Demerara Sugar, 40  
 Candy Making, 60, 70  
 Cleaning Extracted Combs, 170  
 Cleaning Metal Appliances, 180  
 Clover Seed, 190  
 Coal Oil, 279  
 Colleges for Scientific Bee-Keeping, 140  
 Colour of Bees, 60  
 Colour of Excreta of Diseased Bees, 70  
 Combs from Diseased Stocks, 150  
 Converting Nectar into Honey, 140  
 Curing Foul Brood, 70  
 Danger of Introducing Disease, 150  
 Dead Drone, 210, 249, 259  
 Dead Larvæ Thrown Out, 249  
 Dead Queens, 30, 259  
 Dead Queen on Alighting Board, 220  
 Dead Young Bees in Cells, 210  
 Dealing with Infected Apiary, 59  
 Dealing with Wax Moth, 309  
 Definition of Paraglossæ, 429  
 Destroying Diseased Stock, 60  
 Discoloured Combs, 120  
 Disinfecting Hives, 120, 150, 229  
 Drone Breeding Queen, 180  
 Drone Brood in Shallow Frames, 239  
 Drones in Skeps, 259  
 Duplicate Eggs in One Cell, 159  
 Dutch Bees, 200  
 Dutch Bee-Keepers, 69  
 Early Examination, 149, 170  
 Elongated Cells, 159  
 Extracting from Brood Combs, 309  
 Extracting Sections, 356  
 Failing Queen, 210  
 Feeding in Spring, 160  
 Feeding Swarm, 249  
 Fermented Honey, 249  
 Gears and Excluders, 362  
 Getting Honey from Combs With out Extracting, 70  
 Good District for Bees, 140  
 Granulated Honey in Combs, 140  
 Hants B.K.A., 40, 150  
 Hive for Beginner, 100  
 Honey Candy for Bees, 40  
 Honey and Diabetes, 80  
 Honey from Diseased Stock, 140  
 Honey from Infected Hive, 60  
 Honey and "Isle of Wight" Disease, 110, 150  
 Honey Leaking, 385  
 Honey Prices, 238  
 Honey Sweets, 30  
 Honey Vinegar, 60  
 Immature Bees Cast Out, 220  
 Introducing Queen to Nucleus, 159  
 "Isle of Wight" Disease in Wells Hive, 110  
 Keeping Bees in Towns, 40  
 Kent as a Bee County, 20  
 Leaving on Swarm Catcher, 190  
 Lectures on Bee-Keeping, 30  
 Liability for Diseased Bees, 289  
 Making Artificial Swarm, 190  
 Making an Observatory Hive, 170  
 Making Soft Candy, 140  
 Mead, 10  
 Mead Making, 40  
 Mead Sample, 150  
 Moving Bees, 60, 308, 326, 385  
 Moving Suspected Stock, 40  
 Moving and Wintering Bees, 418

NOTICES TO CORRESPONDENTS (*cont.*).

New South Wales for Bees, 20  
 Noise from Hive, 289  
 Observatory Hive, 249, 259  
 Packing Bees for Travelling, 70  
 Painting Floor Board, 140  
 Peculiar Coloured Honey, 210  
 Preserving Combs in Spirit, 120  
 Preventing Disease, 150  
 Preventing "Isle of Wight" Disease, 418  
 Preventing Swarming, 80, 320  
 Queen Cast Out, 230  
 Queen Ceasing to Lay, 220  
 Queen Rearing, 149, 224  
 Raising Queen, 309  
 Re-Arranging the Apiary, 100, 120  
 Removing Combs, 189, 259  
 Renewing Apicure, 326  
 Renewing Brood Combs, 100  
 Re-Starting Bee-Keeping, 69, 150  
 Re-Starting with Bees, 120  
 Re-Stocking Hives, 120  
 Signs of Queenlessness, 308  
 Smell from Hive, 259  
 Spreading the Brood, 110  
 Starting Bee-Keeping, 100  
 Stock Casting out Live Bees, 40  
 Stock Dead in Well Stocked Hive, 20  
 Stock Found Dead, 30, 60, 140  
 Strange Behaviour of Bees, 180  
 Sugar Boiler's Thermometer, 239  
 Superfluous Drone Brood, 200  
 Surplus from Swarms, 149  
 Suspected Queenlessness, 210, 386  
 Suspicious Mortality among Bees, 209  
 Swarm Catchers, 69  
 Swarming Queries, 189  
 Swarm Suffocated, 279  
 Symptoms of Disease, 80, 279  
 Too Early Manipulations, 119  
 Transferring Bees, 279, 308  
 Transferring from Skeps to Frame Hives, 100, 209  
 Trouble with Wasps, 279  
 Troublesome Wasps, 408  
 Two Queens in a Hive, 356  
 Uniting Weak Stocks, 170  
 Unsatisfactory Queen, 189  
 Using Naphthaline, 69  
 Using Swarm Catcher, 219  
 Various Queries, 200  
 Varieties of Bees, 10, 100, 279  
 Ventilating Hive, 280  
 Vicious Bees, 200, 326  
 Wax Rendering, 219  
 Wrongly Built Cells, 200  
 Zinc for Feeders, 449

NOVELTIES FOR 1914:—  
 New Queen Excluder (Taylor's) 188  
 New Super Clearer (The Watts) 150  
 New Time-Saving Bar Frame 9

OBITUARY NOTICES:—  
 Dr. U. Wardleworth, 403; Dr. Ulrich Kramer, 353; Jacob-Hood Mr. J. W., 101; Schröder, Mr. A., 107; Walker, Mr. T., 425

PRESS CUTTINGS:—  
 All about Bees, 407  
 Bee Hives in Batt'e, 358  
 Bees at Felton, 390  
 Colour Blindness in Bees, 29  
 Extracts from the *Leader Annual and Gazetteer of British East Africa*, 327  
 Hints for Housewives, 333  
 Hive of Bees in a Hat, 454  
 Mixed Hive, 268  
 Old Superstitions about Honey, 398  
 Value and Price of Honey, 398

QUERIES AND REPLIES:—  
 Artificial Increase, 205  
 Artificial Swarming Trouble, 257  
 A Swarm in January, 59  
 Bees Dwindling, 380

QUERIES AND REPLIES (*cont.*).

Bees Not Entering Supers, 227  
 Bees and Heather, 345  
 Bees in Towns, 20  
 Bees in a Tree, 20  
 Bees in Wall, 287  
 Bees Working in Hive Roof, 257  
 Beginners' Queries, 188, 227, 256, 248, 267  
 Candy Sample, 417  
 Clarifying Wax, 218  
 Combs Built Together, 267  
 Controlling Queen Mating, 28  
 Covering Hive Roofs, 218  
 Crooked Combs, 286  
 Dealing with Fertile Worker, 293  
 Decoy Hives, 157  
 Disabled Queen, 287  
 Disinfecting Dividers and Combs, 119  
 Dividing Stock, 287  
 Driving Bees, 325  
 Dutch Bees, 218, 287  
 Feeding in Spring, 79  
 Finding Queen, 256  
 Fumigating Combs Containing Stores, 99  
 Greek Hive, 378  
 Hard Candy, 9  
 Honey Tea, 157  
 Infection with "Isle of Wight" Disease, 268  
 Keeping Races of Bees Pure, 343  
 Law Relating to Swarms, 218  
 Making Honey Candy, 391  
 Mead Making, 319  
 Moisture in Hive, 227  
 Moving Bees, 167, 179, 357  
 Moving Bees in Winter, 9  
 Novice's Queries, A, 79, 206, 258  
 Nucleus Swarming, 28  
 Oil Beetles and Bees, 257  
 Ownership of Swarms, 8  
 Preventing Brace Comb, 8  
 Preventing Disease, 119  
 Preventing Drone Comb Building, 180  
 Queen Rearing, 257  
 Rearing Italian Queens, 219  
 Removal of Hives and Bees, 378  
 Removing Bees, 39  
 Removing Brood Combs, 257  
 Removing Swarm Catchers, 188  
 Renewing Disinfectants, 268  
 Re-Queening, 28, 298  
 Ripening Honey and Melting Cappings, 338  
 Smooth Foundation, 238  
 Source of Chyle Food, 351  
 Source of Pollen, 79  
 Spring Dwindling, 22  
 Sterilising Beeswax, 8  
 Stock Dwindling, 374  
 Stocking Observatory Hive, 227  
 Storing Sections, 402  
 Superseding Queens, 256  
 Suspected Laying Worker, 206  
 Swallows Taking Bees, 331  
 Swarm Dividing, 325  
 Swarming Queries, 257  
 Transferring Bees from Skeps to Frame Hives, 69, 248, 337  
 Trouble with Neighbours, 257  
 Using a Sugar Boiler's Thermometer, 467  
 Using Swarm Catchers, 218  
 Utilising Fermented Honey, 319  
 Various Queries, 99, 206, 217, 268, 288, 355  
 Ventilating Hives, 119, 189  
 Weight of Sections, 20  
 Working for both Increase and Surplus, 59  
 Working for Sections, 99

RANDOM JOTTINGS. By C. H. Heap.  
 Reading:—  
 A National Loss of Wealth, 345  
 Disease Germs in Honey, 123  
 Extension Alighting Boards, 17  
 "Isle of Wight" Disease and Fruit Crops, 64  
 The Immune Bee Chimera, 222, 301

RANDOM JOTTINGS (*cont.*).

The Touring Expert, A Question of Professional Conduct, 47  
The Vitality of Nosema Spores, 123  
Things to Avoid in Spring Feeding, 122

## REVIEWS OF FOREIGN BEE JOURNALS.

By Nemo:—  
Apiculture in Egypt, 61  
A Good Mastic for Mahogany, 23  
Bee-Keeping in Greece, 23  
Cure for Bee Stings, A, 183  
Customs Officials and Bee-Keepers, 23  
How Often Should Combs be Renewed, 213  
How to Disencumber Bees of Parasites (*Braula Cœca*), 183  
Instruction in Advanced Bee-Keeping, 213  
The Late Alexander Schröder, 183  
The Position of the Cluster of Bees in Winter, 61  
The Use of Propolis, 183  
Wax More than a Thousand Years Old, 61

## TRADE CATALOGUES RECEIVED:—

Abbott Bros., 150  
Burt, E. J., 169, 238  
Gamage, A. W., 238  
Jas. Lee and Son, Ltd., 118  
Meadows, W. P., 258  
Steele and Brodie, 118  
Taylor, E. H., 130  
Wilkes, A. H., 118

Accounts, Bee-Keeping, 17, 109  
Accounts, Keeping Apiary, 26  
Accounts, Those Cooked, 9  
Admittance to Hives, Bees Refused, 30  
Alighting Boards, Sanded, 207  
Allan Vale, Notes from, 96  
Ancient Bee-Keeping in Russia, 399  
Anti-Skeppist, A Word for the, 87  
Apiary Accounts, 37, 46, 78  
Apiculture, Renewing, 326  
Apodes and Apides, 314  
Appreciation, 157  
April, Flowers of, 137  
Arithmetic, A Little, 255, 261, 334  
Australian Deputation, The, 334

Banat Bees, 185  
Banatual Banter, 187  
Banats, The Fruit Growers' Bee, 155, 178, 184, 185  
Barnet and District B.K.A., 348  
Bee Associations and Their Work, 35, 45, 54, 65, 66, 76, 78, 93, 94, 109, 148  
Bee Disease, 222  
Bee Diseases Bill, The, 176  
Bee Disease, Fighting, 114  
Bee Hives in Battle, 358  
Bee-Keepers' Troubles, A, 16  
Bee-Keeping Accounts, 17, 109  
Bee-Keeping in Bulgaria, 345  
Bee-Keeping in Canada, 241  
Bee-Keeping in Other Countries, 131, 141  
Bee-Keeping Lecture at Grantham, 428  
Bee-Keeping in New Zealand, 197  
Bee-Keeping in Nyasaland, 58  
Bee-Keeping and Sundries, 354, 364, 369  
Bee Literature for Schools, 107  
Bee Notes from Acton, 406  
Bee Notes from Derbyshire, 77  
Bee Pictures at Exeter, 91  
Bee Pictures at Hyde, 75  
Bee Pictures in London, 273  
Bee Pictures at Sunderland, 150  
Bees on the Bioscope, 112  
Bees and Birds on the Bioscope, 69  
Bees in Ceiling, 289  
Bees Distinguishing Colours, 439  
Bees Dwindling, 360  
Bees Failing to Locate Hive, 319

Bees and Fruit Setting, 217  
Bees Hear? Do, 148  
Bees, Long Lived, 47  
Bees and Luck, 2  
Bees, Moving, 39, 60, 167, 169, 185, 367, 386, 412  
Bees Do Pay, 77  
Bees, Planting for, 94, 108  
Bees, Poultry, and Fruit, 139  
Bees Robbing in January, 60  
Bees Soiling Clothes, 70  
Bees in the Soudan and in Madeira, 195  
Bees in a Tree, 20  
Bees in a Wall, 287  
Beeswax, Sterilising, 8  
Bees Working in Hive Roof, 267  
Bee Terms, Precision in, 72, 118, 168  
Beggary, 422, 434  
Beginners' Queries, A, 188  
Belgian Refugees, Help for, 403  
Belgian Relief Fund, 357, 423  
Box Hives, 38, 166, 207  
Brace or Burr Combs, 39  
Brace Combs, Preventing, 8  
Breeding Queens, Selection of, 19  
British Bee-Keepers' Association, 101  
British Bee-Keepers' Association Annual Meeting, 121  
British Bee-Keepers' Association Monthly Council Meetings, 51, 81, 162, 211, 252, 271, 357, 387, 420  
British Bee-Keepers' Association Notice, 357  
British Bee-Keepers' Association and Royal Show for 1915, 420  
Brood Combs, Removing, 267  
Brood Rearing, Controlling, 278  
Brood Rearing, Early, 71  
Building up Stocks, 255  
Canada, Bee-Keeping in, 241  
Canada's Gift, 364  
Candy, Hard, 9  
Candy Made of Demerara Sugar, 40  
Candy Making, 60, 70  
Candy, Making Soft, 138  
Candy Sample, 417  
Candy, Soft or Hard, 366  
Casting out Live Bees, Stock, 40  
Cheshire B.K.A., 459  
Chyle Food, Source of, 391  
Colony, A Prolific, 276  
Colour-Blindness in Bees, 29  
Colour of Bees, 69  
Colour of Excreta of Diseased Bees, 70  
Combs Built Together, 267  
Combs, Crooked, 286  
Comb Weighing, 277  
Conference of Scottish Bee-Keepers on National Federation, 381  
Conversazione, Lecture on "The Production of Heather and Other Honeys where the Crops are Situated about Twenty Miles Apart," 393, 403, 409; Lecture on "Bees in Relation to Flowers," 419, 427, 441  
Correct Bee Space, 255  
Cotswold Bee Note, A, 223  
Crawshaw, Mr., and New Zealand Box Hives, 276  
Crayford and District Excursion to the B.B.K.A. Apiary at the Zoological Gardens, 256  
Croydon and District B.K.A., 273  
Cure of Colony or Individual, 169  
Curing Foul Brood, 70  
Dealing with Disease, 452  
Death of a Good Bee-keeper, 101  
Death of Mr. A. Schröder, 107  
Definition of Paraglossæ, 449  
Derbyshire, Notes from, 223, 352, 401  
Destroying Bees, 302  
Devon Bee-Keepers' Experiences, A, 316  
Disease, Careless Methods and, 262  
Disease, Preventing, 119  
Disease, Symptoms of, 80  
Diseased Bees, Confining, 19  
Diseased Bees, Liability for, 289  
Diseased Stock, Destroying, 60  
Diseases of Bees Bill, Special Notice, 31

Diseases of Brood, Fungus, 261  
Disinfectants, Renewing, 268  
Disinfecting Dividers and Comb, 119  
Dividing Stock, 287  
Do Bees Hear? 187  
Do Bees Know Their Owner? 389, 424  
Do Bees Pay? 48  
Does it Pay Gardeners to Keep Bees? 77  
Doomed to Extinction, 256  
Driving Bees, 325  
Drone Brood for Chickens, 315  
Drone Comb, Preventing Building, 180  
Durham, A Brief Report from, 68  
Dutch Bees, 218, 287  
Duties of an Expert on Tour, The, 4  
Dwindling, Spring, 20, 25  
Dying Year, The, 458  
Early Examination, 149  
Early Foragers, 78  
Early Pollen Plants, 94  
Early Surplus, 204  
Echoes from the Hives, 167, 200  
Enemies of Bees, 342  
Errata, 135, 251, 419  
Evaporation in the Hive, 412  
Examinations, 25, 311  
Experience with "Isle of Wight," 97  
Expert's Diary, An, 366  
Extension, Alighting Boards, 18  
Extracting from Brood Combs, 309  
Extracting Combs, Storing, 389, 401, 405, 437  
Extracts from an Expert's Diary, 281, 315, 370, 359  
Feeding in Spring, 79  
Fermented Honey, Utilising, 319  
Fertile Worker, Dealing with, 258  
Field Days, 327  
Fighting "Isle of Wight" Disease, 253  
Finding Queen, 255  
Flowers of April, The, 137  
Flowers of February, The, 57  
Flowers of January, The, 5  
Flowers of March, The, 96  
Foundation, Smooth, 238  
Frame Hives, Neglected, 68  
Frames, Propolized, 112  
Frames, Wiring, 99, 109  
From a Reader at "The Front," 455  
Femigating Combs Containing Stores, 99  
Getting Honey from Combs Without Extracting, 70  
Go to the Anti, Consider His Ways, 139  
Granulation, Seeds of, 58  
Greek Hive, 378  
Hants B.K.A., 40  
Hawthorn Honey, 277  
Heather, 221  
Heather, Bees and, 343  
Heather Honey, 233  
Heather Honey, Pure, 277  
Heather Honey? What is Pure, 204  
Heather Honey for Winter Food, 277  
Heather Honey as Winter Food, 517  
Heather, Success at the, 315  
Help One Another, 369  
Heresies about Bees, Sundry, 85  
High Swarm, Capturing a, 278  
Hive of Bees in a Hat, 454  
Hive Legs, 314  
Hive Porches, 400  
Hive, The Minimum, 385  
Hive Roofs, Covering, 218  
Hive Roofs and Mouldy Combs, 187  
Hives, Decoy, 167  
Hives in Italy, Peasant, 275  
Hives, Moisture in, 227  
Holiday Notes, 417  
Honey-Candy for Bees, 40  
Honey-Candy, Making, 391  
Honey and Diabetics, 80  
Honey, Economising, 567  
Honey Imports, 23, 31, 71, 101, 151, 241, 253, 266, 356, 385, 434, 459

- Honey from Infected Hive 60  
Honey Judging Competition, 377, 378, 384  
Honey Leaking, 386  
Honey for Soldiers, 348  
Honey Sweets, 30  
Honey Tea, 167  
Honey? What is Pure Heather, 204  
Honey for Wounded Soldiers and Sailors, 385  
Honey Yield in Wits, 354  
Hope on, Hope Ever, 206  
Huber's Hive, 78  
Humble Bee, The First, 128  
Ignorance, 251  
" Howitis? " 97  
Immune Bee Chimera, The, 222  
Immunity and " Isle of Wight " Disease, 167, 231  
Immunity Chimera, The, 231, 318, 331  
Important Notice, 439, 441  
Increase, 236  
Increase, Artificial, 206  
Infectious or Contagious, 118  
In Friendship's Name, 118  
Instructions in Bee-Keeping, 423  
Interesting Bee Hive, An, 433  
Is " Isle of Wight " Disease a New Complaint? 108  
Is " Isle of Wight " a New Disease? 196  
" Isle of Wight " Disease, 6, 37, 48, 56, 57, 75, 78, 85, 88, 98, 115, 126, 137, 169, 254, 318, 354  
" Isle of Wight " Disease, A Study in, 295, 366, 460  
" Isle of Wight " Disease Cures, 113, 126, 126, 143, 185  
" Isle of Wight " Disease, Curing, 265, 302, 323, 406  
" Isle of Wight " Disease, Essence of Cinnamon for, 148, 185  
" Isle of Wight " Disease, Experience with, 97  
" Isle of Wight " Disease, Experiences and Guesses, 448  
" Isle of Wight " Disease, Infection with, 268  
" Isle of Wight " Disease, Linseed and, 247  
" Isle of Wight " Disease " and Nosema Apis, 302  
" Isle of Wight " Disease, Pollen Mite and, 126  
" Isle of Wight " Disease, Prevention of, 418, 438  
" Isle of Wight " Disease, Progress of, 115, 128  
" Isle of Wight " Disease, Resisting, 454  
" Isle of Wight " Disease, Stamping out, 367, 399, 437  
" Isle of Wight " Disease and Strong Queens, 166  
" Isle of Wight " Disease, The Quinine Treatment, 166  
Italian Bee, A Word for the, 47, 79  
Italian Queens, Rearing, 219  
Journalism Up to Date, 436  
Keeping Races of Bees Pure, 343  
Labelling of Honey, The, 5, 16  
Lancashire Agricultural Show, 273  
Laying Worker, Suspected, 205  
Lectures on Bee-Keeping, 30, 130  
Legislation for Bee Diseases, 217, 435  
Leicester and Rutland B.K.A., 407  
Literature for Schools, Bee, 107  
Long Lived Bees, 98  
Long Lived Lot, A, 412  
Manipulating, Too Early, 119  
March, The Flowers of, 96  
Mead Making, 40, 319  
Miller, Dr., Intervenes, 114  
Minimum Hive, The, 385, 401  
Moving Bees, 39, 60, 167, 169, 185, 367, 386, 412  
Moving Bees in Winter, 9  
Moving Short Distances, 113  
Moving Suspected Stock, 40  
Moving and Wintering Bees, 418  
National Loss, A, 388  
National Relief Fund, The, 369  
Native v. Foreign Bees, 253, 315, 333  
Nature's Plan, 187  
New Comb, Thickness of, 256  
New Feeder, A, 18  
New Note, A, 388  
New Zealand Box Hives, 334  
New Zealand Heather Honey, 155, 303  
Noise from Hive, 289  
Northumberland B.K.A., 441  
Note from Australia, A, 303  
Notes from Allan Vale, 96  
Notice, 435, 441  
Notice, Important, 439, 441  
Novices' Queries, A, 79, 206  
Nyassa Bee, The (continued from Vol. 41, page 345), 228  
Observation Bird Nesting Box, 207  
Observations on Hives (by L. E. Snelgrove), 41, 72, 144, 241, 381  
Observations on Hives, 437  
Observatory Hive, 276  
Observatory Hive, How to Make and Stock, 102, 124  
Observatory Hive, Stocking, 227  
Oil Beetles and Bees, 257  
Old Fashioned Cotswold Apiary, An, 6  
Our Juvenile Manipulator, 55  
Ourselves, 351  
Our Senior Editor, Foreign Appreciation of, 425  
Packing Bees for Travelling, 70  
Planting for Bees, 94, 108  
Planting Hedge and Providing Water for Bees, 204  
Pollen Mite and " Isle of Wight " Disease, 126, 187  
Pollen Plants, Early, 94  
Pollen, Source of, 79  
Precision in Bee Terms, 95, 168  
Preventing Swarming, 80  
Pro Bono Publico, 256  
Profitable Stock, A, 407  
Prolific Stocks, 95  
Propolized Frames, 112  
Queen, An Obliging, 285  
Queen as Architect, The, 195  
Queen, Bees Killing, 320  
Queen, Controlling Prolific, 232  
Queen, Finding, 255  
Queen, " Manufacturing," A, 327  
Queen Mating, Controlling, 28  
Queen Raising, 309  
Queen, Raising above Excluder, 25  
Queen Rearing, 149, 257  
Queen Rearing Experiences, 232  
Queen, Selecting, 24  
Queens, Superseding, 255  
Queenlessness, How to Diagnose, 112  
Queenlessness, Signs of, 336  
Queenlessness, Suspected, 386  
Queries and Replies, 24  
Rearing Italian Queens, 219  
Re De-Queening, 98  
Refugees, Honey for, 362  
Refugee and War Relief Funds, 418, 423, 429, 449, 455, 459  
Removal of Hives and Bees, 379  
Removing Bees, 39  
Report from Scotland, A, 233  
Re-Queening, 298  
Richmond and District B.K.A., 261  
Ripening Honey and Melting Cappings, 338  
Robbing, Something about, 378  
Roof, Putting on the, 59  
Ross-shire Notes, 216, 340  
Royal Show Fund, 450, 438, 439, 449, 455, 460  
Schoolmasters and Bee-Keeping, 311  
Sections, Storing, 402  
Sections for the Show Bench, 91, 168  
Sections, Weight of, 20  
Sections, Working for, 99  
Sheffield and District B.K.A., 91, 135, 400  
Shows and their Purpose, 381  
Skeps, 207  
Skeps and Disease, 304, 331, 366, 412, 439  
Skeps or Frame Hives, 19  
Skeps and " Isle of Wight " Disease, 179  
Slow Feeder, A Simple, 149, 187  
Skep Question, The, 4  
Skep, The Fool Proof, 39  
Smoker, A Self-Extinguishing, 412  
Soft or Hard Candy? 328, 356  
Solar Wax Extractor, How to Make and Use (Illustrated), 194  
Something Like a Swarm, 255, 333  
Something about Robbing, 378  
*South African Bee Journal*, The, 88  
South Staffs. and District B.K.A., 340  
South Westmorland, Report from, 114, 453  
Special Lectures, 3, 9, 10, 11, 22, 31, 41, 51, 81  
Specimens Sent for Advice, The Packing of, 21  
Spell of Precision, A, 389  
Spring Dwindling, 68  
Spring Feeding, 71  
Starting in a Small Way, 138  
Starvation, A Warning against, 88  
Stimulation, Successful, 185  
Stock Casting out Live Bees, 40  
Stock Found Dead, 60  
Stocks, Prolific, 95  
Stork Thief, 255  
Storing Extracted Combs, 369, 401, 405, 437  
Sudding Bees, 39  
Success at the Heather, 246  
Suffolk B.K.A., 428  
Sugar-boilers Thermometer, Using 407  
Sugar Testing, 138  
Suggestions for Observations on the Order of Blossoming of Different Varieties of Fruits, and Experiments in their Pollination, 159  
Sundry Heresies about Bees, 135, 139, 187  
Supers, Bees not Entering, 227  
Superseding Queen, 256  
Surplus, Procuring, 423  
Surplus, Procuring (Illustrated), 349, 360, 382, 413  
Surrey B.K.A. Propaganda Work, 357  
Swallows Eating Bees, 331  
Swarm, Another Monster, 261  
Swarm of Bees in August, A, 342  
Swarm Catchers, Removing, 188  
Swarm Catchers, Using, 218  
Swarm Dividing, 325  
Swarm in January, A, 59, 98  
Swarming, Checks to, 112  
Swarming, Curious, 317, 417  
Swarming, Nucleus, 28  
Swarming, Preventing, 320  
Swarming Queries, 257  
Swarming Troubles, Artificial, 257  
Swarms, Buying, 89  
Swarms and Casts, Treatment of (Natural (Illustrated)), 214, 234, 242, 252, 282, 304, 323, 334  
Swarms, Early, 179  
Swarms, Law Relating to, 218  
Swarms, Shortage of, 273  
Swarms, Surplus from, 149  
Swarms, Ownership of, 8  
Syrup, Thick, 58, 139  
Test for Cane or Beet Sugar, 44  
*The Bazaar, Exchange and Mart*, 110  
Thick Syrup, 58, 139  
Transferring Bees from Skeps to Frame Hives, 69, 298, 337  
Trouble with Neighbours, 257  
Unfortunate Bee-keeper, An, 140  
Up a Gum Tree, 98  
Vagrant, A, 227  
Various Queries, 99, 206, 217, 355  
Ventilating Hives, 119, 189  
Vinegar, Honey, 60  
Wax, Clarifying, 218  
Wax Extracting, Acid in, 221  
Wax Moth, Dealing with, 309  
W.B.C. Memorial Fund, 3, 11, 23, 41, 81  
Weather Reports, 30, 69, 110, 150, 199, 233, 286, 348, 374, 405  
Wintering Bees, 118, 136  
Wiring Frames, 99, 159  
Worker Comb from Starters, All, 19  
Working for both Increase and Surplus, 59  
Working for Sections, 99

## LIST OF CONTRIBUTORS.

- Anderson, John, 86  
Atwell, A. G., 435
- Ballard, E., 406, 423  
Balch, H. E., 148  
Batten, M. T., 406  
Berry, J., 179  
Betts, Annie, D., 56, 261  
Birkett, L. B., 30, 69, 110, 159, 199, 233, 286, 348, 374, 405, 439  
Bowden J., 158  
Bowen, A. H., 5, 17, 94, 108, 223, 354, 364, 369, 438, 446, 452  
Brook, A. W., 401  
Brook, H. H., 115, 128  
Brown, R., 168  
Browning, O., 115  
Buttel-Reepen, Prof. V., 148
- Campbell, H., 37, 57, 85, 156  
Campbell, R., 6, 66, 204  
Carver, W. A., 48  
Clark, F. A., 197  
Cooper, G. D., 438  
Copleston, L. G., 156  
Cowan, T. W., 131, 141, 151, 151  
Crawshaw, L. S., 18, 39, 58, 78, 118, 168, 186, 206, 255, 277, 314, 335, 355, 388, 412, 437  
Cruikshank, 253
- Desmond, G. G., 47, 113, 128, 165, 195, 231, 318, 354, 378, 385  
Deuss, L. W. J., 228
- Edge, E., 126  
Ehls, J. M., 216, 340
- Filtenl, Rev. P. W. G., 334  
Flashman, G. J., 348  
Fowler, F. H., 77  
Franklin, E. W., 459  
Fry, Jesse, 302
- Gambriil, A. G., 255, 261  
Garwell, W., 135  
Gerrard, A. W., 367  
Grabham, M., 196  
Grant, G. W., 128
- Hamshar, A. H., 25, 137, 337, 373, 438, 448  
Hancox, D., 179  
Harmer, H., 68  
Harris, A. H., 68, 109, 400, 423  
Hayes, G., 28, 51, 116, 225, 352, 375  
Heap, C. H., 17, 64, 122, 222, 301, 346, 399, 452  
Herrod, J., 281, 315, 370, 378, 389  
Herrod, W., 12, 32, 62, 82, 102, 124, 145, 163, 172, 192, 211, 214, 234, 242, 262, 282, 304, 335, 334, 349, 350, 371, 382, 405, 413, 444  
Hills, F. D., 191
- Illingworth, L., 6, 43, 67, 137, 231
- Jackson, Ida H., 204  
Johnson, J., 178  
Jones, Oliver, C., 385  
Judge, G. W., 296, 399
- Kidd, J. N., 295, 400  
Knight, O., 185
- Lambert, J., 77  
Lee, Jas., 136  
Lewis, G. G., 88  
Lewis, S. S., 406  
Litman, R., 94, 384  
Lockwood, J. E., 253, 454  
Low, A., 135  
Low, J., 68
- Macdonald, D. M., 2, 49, 53, 71, 89, 91, 112, 153, 158, 181, 204, 221, 273, 327, 358, 410, 443  
Mace, H., 5, 75, 331  
Mattinson, Rev. W., 37, 45, 76, 148  
Meech, T., 46  
Mihard, Magdalen, 275  
Miller, Dr. C. C., 114  
Moughton, J. J., 97  
Mounting, W., 261
- "Nemo," 23, 61, 183, 213  
Newsham, F., 114, 138, 453  
Nicholson, J. G., 94  
Nicol, C., 381
- "Northumbrian Bee," 54, 65, 109  
"Novice," 23, 26
- Oldham, E. H., 401
- Porter, Dr. A., 201, 212  
Pressey, E., 325  
Price, Joseph, 342  
Pugh, A. G., 377
- Quinton, H., 47
- Richards, A., 419, 427, 441  
Richings, G., 342  
Reid, W. F., 348, 352
- Salmon, A. W., 179  
Scrope-Viner, H. E., 85, 155, 165, 232, 385  
Seamark, H., 167  
Shepherd, W. J., 452  
Sillar, M. Dagmar, 88  
Sladen, F. W. L., 241  
Smallwood, J., 7, 26, 37, 43, 73, 105, 129, 157, 175, 186, 224, 251, 265, 274, 292, 323, 328, 347, 364, 404, 422  
Smith, E. E., 167  
Snelgrove, L. E., 41, 72, 144, 241, 381  
Straiton, A., 331  
Steele, J., 135, 178
- Taylor, T. T., 248
- Walker, Lieut.-Col. H. J. O., 121  
Watchkoff, M. K., 345  
Waterfield, J., 171  
Watson, E., 95  
Watts, H., 184, 367  
Wheatley, F., 149  
Whitley, S. R., 357  
Whittington, S., 185  
Wigley, H., 166  
Wilson, D., 15, 77, 108, 225, 245, 285, 352, 393, 401, 403, 409  
Withycombe W. A., 108  
Woolley, W., 163
- Yeo, H. R., 254

## ILLUSTRATIONS.

- Apiary in the Government of Tiflis, Caucasus, 144  
Apiary of I. Abakoumof, Russia, 141  
Apiary in Leucoran, Government of Baku, Caucasus, 143  
Apiary at Monastery, St. Panteley-mon, Servia, 133  
Apiary of M. J. Papovitch, Petchenovatz, Servia, 134  
Apiary of M. Kandratief, Ploussa, Russia, 142  
Apiary of The Hon. Rosamund Hanbury, 95
- Bees Dead from Hunger, 63  
Bees on a House Top, 177  
British Bee-Keepers' Association  
Apiary at the Zoological Gardens, London, 297
- Combs Worked out on Smooth Foundation, 228  
Combs of Various Ages, Sections of, 165  
Consultation, A, 329  
Corner of Sig. Piana's House, and Part of Queen-Mating Ground, 293  
Cotswood Out-Apiary, A, 445
- Debated Point, A, 330  
Dr. Ulrich Kramer, 350
- Experimental Apiary, Paris, 105
- Finding the Queen, 33
- Greek Hive, 379  
Group of Crayford and District Bee-Keepers, 297
- Group of Members of the Sheffield and District B.K.A., 400  
Group of South Staffs. Bee-Keepers, 341  
Group taken in Sig. Piana's Garden, 294  
Growth of the Brood Nest, The, 172, 173, 174, 175
- Home-made Observatory Hive, 224  
How to Make an Observatory Hive, 102, 103, 125, 127, 146, 147, 163, 164  
How to Make and Use a Solar Wax Extractor, 193, 194  
Huber's Hive, 43
- Lecture Pavilion, The (Paris), 105, 105
- Mr. A. Martin's Apiary, Prestbury, 7  
Manipulating a Frame Hive, 12, 13, 14  
Mating Station, Bruggen, Switzerland, and, 131  
Mr. C. P. Dadant, 161  
Mr. C. R. Forse with Exhibit at Shrewsbury, 312  
Mr. F. Baines' Apiary, 198  
M. Sevalle's Cider and Wax Press, 107
- Natural Swarms and Casts, The Hiving and Treatment of, 214, 215, 216, 234, 235, 255, 237, 243, 244, 245, 246, 263, 283, 284, 305, 305, 307, 323, 324, 335, 356, 337
- New Queen Excluder (Taylor's), 188  
New Zealand Bee-Keepers, 205
- Observation Bird Nesting Box, 208, 209  
Observatory Hive Made by Mr. Simcox, 311  
Observatory Hive in a Window, 102  
Our Little Guide, 186
- Packing of Specimens Sent for Advice, 21, 22  
Pollen of Bean, 353  
Pollen of Broom, 52  
Pollen of Butter Burr, 29  
Pollen of Ragwort, 117  
Pollen of Red Clover, 376  
Pollen of Sainfoin, 226  
Procuring Surplus, 349, 350, 360, 361, 372, 382, 383, 414, 415, 416, 444, 443  
Putting on the Roof, 34
- Row of Colonies in the Mountains, A, 295
- Signor Piana, 294  
Snapshot, A, 330  
Solar Wax Extractor, 195  
Surplus Gathered by Two Stocks of Bees, 95
- The Proprietor, 175  
Time Saving Frame, 9  
Transporting Colonies to the Plains, 295
- Village Laundry, A, 256
- Watts' Super Clearer, 150  
"William" Pears, 106  
Wintering Bees, 82, 83, 84, 85, 89  
Woods Surrounding Sig. Piana's House, 293













